

**THE No.1 MAGAZINE FOR ELECTRONICS TECHNOLOGY & COMPUTER PROJECTS**

**EVERYDAY**

**MARCH 2003**

**PRACTICAL**

# **ELECTRONICS**

**£2.95**

## **DRIVER ALERT**

**Tests thinking & reaction time**

## **200kHz FUNCTION GENERATOR**

**Sine, square & triangle waves**



## **WIND-UP TORCH II** **A battery-free design**

**PLUS**

## **BACK TO BASICS 2 -** **Metal Detector & Timer**



**NOW AVAILABLE TO BUY ON THE WEB**  
**EP**  
www.epemag.co.uk



<http://www.epemag.wimborne.co.uk>

World Radio History



Colour CCTV camera. 8mm lens, 12V d.c. 200mA 582x628 Resolution 380 lines Automatic aperture lens Mirror function PAL Back Light Compensation MLR, 100x40x40mm. Ref EE2 £69



Built-in Audio .15lux CCD camera 12V d.c. 200mA 480 lines s/n ratio >48db 1v P-P output 110x60x50mm. Ref EE1 £99



Metal CCTV camera housings for internal or external use. Made from aluminium and plastic they are suitable for mounting body cameras in. Available in two sizes 1 - 100x10x170mm and 2 - 100x70x280mm. Ref EE6 £22 EE7 £26 multi-position brackets. Ref EE8 £8



Excellent quality multi-purpose TV/TFT screen, works as just a LCD colour monitor with any of our CCTV cameras or as a conventional TV. Ideal for use in boats and caravans 49.7MHz-91.75MHz VHF channels 1-5, 168.25MHz-222.75MHz VHF channels 6-12, 471.25MHz-869.75MHz, Cable channels 112.325MHz-166.75MHz Z1-Z7, Cable channels 224.25MHz-446.75MHz Z8-Z35 5" colour screen. Audio output 150mW. Connections, external aerial, earphone jack, audio/video input, 12V d.c. or mains, Accessories supplied Power supply. Remote control. Cigar lead power supply. Headphone Stand/bracket. 5" model £139 Ref EE9. 6" model £149. Ref EE10



Fully cased IR light source suitable for CCTV applications. The unit measures 10x10x150mm, is mains operated and contains 54 infra-red LEDs. Designed to mount on a standard CCTV camera bracket. The unit also contains a daylight sensor that will only activate the infra red lamp when the light level drops below a preset level. The infrared lamp is suitable for indoor or exterior use, typical usage would be to provide additional IR illumination for CCTV cameras. £49. Ref EE11



This device is mains operated and designed to be used with a standard CCTV camera causing it to scan. The black clips can be moved to adjust the scan angle, the motor reversing when it detects a clip. With the clips removed the scanner will rotate constantly at approx 2.3rpm. 75x75x80mm £23. Ref EE12



Colour CCTV Camera measures 60x45mm and has a built in light level detector and 12 IR LEDs. 2 lux 12 IR LEDs 12V d.c. Bracket Easy connect leads £69. Ref EE15



A high quality external colour CCTV camera with built in Infra-red LEDs measuring 60x60x60mm Easy connect leads colour Waterproof PAL 1/4" CCD 542x588 pixels 420 lines .05 lux 3.6mm F2 78 deg lens 12V d.c. 400mA Built in light level sensor. £99. Ref EE13



A small compact colour CCTV camera measuring just 35x28x30mm (camera body) Camera is supplied complete with mounting bracket, built in IR, microphone and easy connect leads. Built in audio Built in IR LEDs Colour 380 line resolution PAL 0.2 us +18db sensitivity. Effective pixels 628x582 Power source 6-12V d.c. Power consumption 200mW £36. Ref EE16



Complete wireless CCTV system with video. Kit comprises pinhole colour camera with simple battery connection and a receiver with video output. 380 lines colour 2.4GHz 3 lux 6-12V d.c. manual tuning Available in two versions, pinhole and standard. £79 (pinhole) Ref EE17. £79 (standard). Ref EE18



Small transmitter designed to transmit audio and video signals on 2.4GHz. Unit measures 45x35x10mm. Ideal for assembly into covert CCTV systems Easy connect leads Audio and video input 12V d.c. Complete with aerial Selectable channel switch £30. Ref EE19



2.4GHz wireless receiver Fully cased audio and video 2.4GHz wireless receiver 190x140x30mm. metal case, 4 channel. 12V d.c. Adjustable time delay, 4s, 8s, 12s, 16s. £45. Ref EE20



Colour pinhole CCTV camera module with audio Compact colour pinhole camera measuring just 20x20x20mm, built-in audio and easy connect leads PAL CMOS sensor 6-9V d.c. Effective Pixels 628x582 Illumination 2 lux Definition >240 Signal/noise ratio >40db Power consumption 200mW £35. Ref £35



Self-cocking pistol plcr002 crossbow with metal body. Self-cocking for precise string alignment Aluminium alloy construction High tec fibre glass limbs Automatic safety catch Supplied with three bolts Track style for greater accuracy. Adjustable rearsight 50lb drawweight 150ft sec velocity Break action 17" ranging 30m range £21.65 Ref PLCR002 INFRA-RED FILM 6" square piece of flexible infra-red film that will only allow IR light through. Perfect for converting ordinary torches, lights, headlights etc to infra-red output only using standard light bulbs Easily cut to shape 6" square £15. Ref IRF2 or a 12" sq for £29 IRF2A NEW 12V 42" SQUARE SOLAR PANEL Kevlar backed. 3watt output. Copper strips for easy solder connections £14.99. Ref 15P42 PACK QF 4 JUST £39.95. Ref 15P42ZP



Dummy CCTV cameras These motorised cameras will work either on 2 AA batteries or with a standard DC adapter (not supplied) They have a built in movement detector that will activate the camera if movement is detected causing the camera to 'pan' Good deterrent. Camera measures 20cm high, supplied with rawl plugs and fixing screws. Camera also has a flashing red LED built in. £9.95. Ref CAMERAB

## BULL ELECTRICAL

UNIT D, HENFIELD BUSINESS PARK,  
HENFIELD, SUSSEX BN5 9SL  
TERMS: CASH, PO OR CHEQUE WITH ORDER  
PLUS £5.50 P&P (UK) PLUS VAT.  
24 HOUR SERVICE £7.50 (UK) PLUS VAT.  
OVERSEAS ORDERS AT COST PLUS £3.50  
(ACCESS/VISA/SWITCH ACCEPTED)

'phone: 01273 491490 Fax 491813

Sales@bullnet.co.uk

## POWERSAFE DEEP CYCLE BATTERIES



6V 100AH NOW ONLY £19 EACH



12V 51AH NOW ONLY £29.95 EACH



We also have some used 2.3AH 12V (same as above) these are tested and in good condition and available at an extremely good price for bulk buyers, box of 30 just £49.99. Ref SLB23C



Aiptek Pocket DV Up to 2000 still pics before requiring download! The all new Pocket DV, it's amazing... such advanced technology, such a tiny size - you will be the envy of your friends! This camera will take up to 3.5 minutes of Video and Audio, up to 2000 digital still pictures or 30 minutes of voice recording! Then just connect it to your PC via the USB cable (Supplied) and after transferring the data you can start all over again! £69. Ref POCKETDV



The smallest PMR446 radios currently available (54x87x37mm). These tiny handheld PMR radios not only look great, but they are user friendly & packed with features including VOX, Scan & Dual Watch. Priced at £59.99 PER PAIR they are excellent value for money. Our new favourite PMR radios! Standby: - 35 hours Includes: - 2 x Radios, 2 x Belt Clips & 2 x Carry Strap £59.95 Ref ALAN1 Or supplied with 2 sets of rechargeable batteries and two mains chargers £84.99. Ref Alan2



Beltronics BEL550 Euroradarand GATSO detector Claimed Detection Range. GATSO up 400m. Radar & Laser guns up to 3 miles. Detects GATSO speed cameras at least 200 metres away, plenty of time to adjust your speed £319. Ref BEL550

At Last Drug Free Pain Relief



Fully Portable - Use anywhere Six automatic programmer for full body pain relief, shoulder pain, back/neck pain, aching joints, rheumatic pain, sports injuries EFFECTIVE DRUG FREE PAIN RELIEF TENS (Transcutaneous Electrical Nerve Stimulation) units are widely used in hospitals, clinics throughout the United Kingdom for effective drug free pain relief. This compact unit is now approved for home use. TENS works by stimulating nerves close to the skin releasing endorphins (nature's anaesthetics) and helping to block the pain signals sent to the brain. Relief can begin within minutes, and a 30 minute treatment can give up to 12 hours relief or more. The TENS mini Microprocessors offer six types of automatic programme for shoulder pain, back/neck pain, aching joints, Rheumatic pain, migraines headaches, sports injuries, period pain, in fact all over body treatment. Will not interfere with existing medication. Not suitable for anyone with a heart pacemaker. Batteries supplied. £19.95 Ref TEN327 Spare pack of electrodes £5.99. Ref TEN327X

SHOP ONLINE

AT

WWW.BULLNET.CO.UK



ISSN 0262 3617  
 PROJECTS ... THEORY ... NEWS ...  
 COMMENTS ... POPULAR FEATURES ...

VOL. 32. No. 3 MARCH 2003

Cover illustration by jgr22

EVERYDAY

# PRACTICAL ELECTRONICS

INCORPORATING ELECTRONICS TODAY INTERNATIONAL

[www.epemag.wimborne.co.uk](http://www.epemag.wimborne.co.uk)  
 EPE Online: [www.epemag.com](http://www.epemag.com)

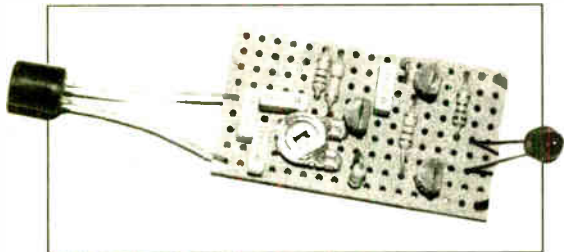
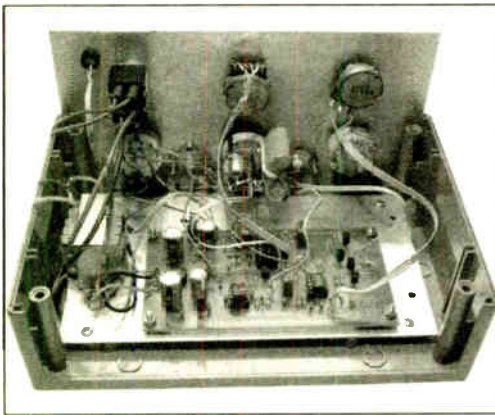

© Wimborne Publishing Ltd 2003. Copyright in all drawings, photographs and articles published in EVERYDAY PRACTICAL ELECTRONICS is fully protected, and reproduction or imitations in whole or in part are expressly forbidden.

Our April 2003 issue will be published on Thursday, 13 March 2003. See page 163 for details

## Projects and Circuits

- WIND-UP TORCH MK II** by Thomas Scarborough **172**  
 A new twist for providing light without a battery!
- DRIVER ALERT** by Josh Arkell, Adam Wolley and Max Horsey **184**  
 A thinking time reaction tester – award winning design in the *Young Electronic Designer Awards 2002*
- 200kHz FUNCTION GENERATOR** by Andy Flind **197**  
 Versatile test gear that generates sine, square and triangle-wave outputs, with controllable amplitude
- INGENUITY UNLIMITED** hosted by Alan Winstanley **217**  
 Random Doorbell; Headphone Amplifier; Low Battery Indicator; Pico Prize Winners
- BACK TO BASICS – Part 2. Metal Detector; Simple Timer** **220**  
 by Bart Trepak. Illustrating how transistors can create useful designs

## Series and Features

- TECHNO TALK** by Andy Emmerson **176**  
 Bendy Batteries for Flexible Power
- CIRCUIT SURGERY** by Alan Winstanley and Ian Bell **182**  
 Surface Mount Reworking; Bleeder Resistors; More on Motors
- NET WORK – THE INTERNET PAGE** surfed by Alan Winstanley **205**  
 Buy Now on eBay
- LCR PASSIVE COMPONENT ANALYSER** by Andy Flind **206**  
 An appreciative examination of Peak's new handheld analyser for measuring resistors, capacitors and inductors
- PRACTICALLY SPEAKING** by Robert Penfold **210**  
 Constructor's guide to mounting loudspeakers, resonators and meters in the front panels of enclosures
- NEW TECHNOLOGY UPDATE** by Ian Poole **215**  
 Printed plastic transistors and organic I.e.d.s could provide truly flexible display screens

## Regulars and Services

- EDITORIAL** **171**
- NEWS** – Barry Fox highlights technology's leading edge **178**  
 Plus everyday news from the world of electronics
- READOUT** John Becker addresses general points arising **191**
- BACK ISSUES** Did you miss these? Many now on CD-ROM! **194**
- SHOPTALK** with David Barrington **219**  
 The *essential* guide to component buying for *EPE* projects
- CD-ROMS FOR ELECTRONICS** **212**  
 A wide range of CD-ROMs for hobbyists, students and engineers
- DIRECT BOOK SERVICE** **224**  
 A wide range of technical books available by mail order, plus more CD-ROMs
- PRINTED CIRCUIT BOARD AND SOFTWARE SERVICE** **227**  
 PCBs for *EPE* projects. Plus *EPE* project software
- ELECTRONICS MANUALS** **228**  
 Essential reference works for hobbyists, students and service engineers
- ADVERTISERS INDEX** **232**

Readers Services • Editorial and Advertisement Departments 171



Visit our website  
www.distel.co.uk

# THE ORIGINAL SURPLUS WONDERLAND!

THIS MONTH'S SELECTION FROM OUR VAST EVER CHANGING STOCKS

Surplus always  
wanted for cash!

## GIANT 10" 7-SEGMENT DISPLAYS

A bulk purchase enables us to bring to you these GIANT 7-segment digital displays at a now affordable price! The 10" character size gives exceptional readability at long distances and enables a host of applications including score boards, digital clocks, counters, event timers etc. As the units are a simple electro-mechanical device and operate from 12V DC, simple switching via switches, relays, PIC or PC may be used to control single or multiple digits. Units feature integral 'Zero Power' memory which greatly simplifies design. For an excellent DIY practical article, see the May issue of 'Everyday Practical Electronics' magazine, Ideal School / College construction project. Supplied in good RFE condition, complete with data sheet.



Less than 30% Only £29.95(B) or 4 / £99.00(D)  
of makers price Order RW44 Order PH26

## THE AMAZING TELEBOX



Converts your colour monitor into a QUALITY COLOUR TV!!

The TELEBOX is an attractive fully cased mains powered unit, containing all electronics ready to plug into a host of video monitors or AV equipment which are fitted with a composite video or SCART input. The composite video output will also plug directly into most video recorders, allowing reception of TV channels not normally receivable on most television receivers\* (TELEBOX MB). Push button controls on the front panel allow reception of 8 fully tuneable off air UHF colour television channels. TELEBOX MB covers virtually all television frequencies VHF and UHF including the HYPERBAND as used by most cable TV operators. Ideal for desktop computer video systems & PIP (picture in picture) setups. For complete compatibility - even for monitors without sound - an integral 4 watt audio amplifier and low level Hi Fi audio output are provided as standard. Brand new - fully guaranteed.

TELEBOX ST for composite video input type monitors £36.95  
TELEBOX STL as ST but fitted with integral speaker £39.50  
TELEBOX MB Multiband VHF/UHF/Cable/Hyperband tuner £69.95  
For overseas PAL versions state 5.5 or 6 MHz sound specification.  
\*For cable / hyperband signal reception Telebox MB should be connected to a cable type service. Shipping on all Teleboxes, code (B)

**NEW** State of the art PAL (UK spec) UHF TV tuner module with composite TV pp video & NICAM hi fi stereo sound outputs. Micro electronics all on one small PCB only 73 x 160 x 52 mm enable full tuning control via a simple 3 wire link to an IBM pc type computer. Supplied complete with simple working program and documentation. Requires +12V & +5V DC to operate. **BRAND NEW - Order as MY00. Only £39.95 code (B)**  
See [www.distel.co.uk/data/my00.htm](http://www.distel.co.uk/data/my00.htm) for picture & full details

## HARD DISK DRIVES 2 1/2" - 14"

2 1/2" TOSHIBA MK1002MAV 1.1Gb laptop (12.5 mm H) New £59.95  
2 1/2" TOSHIBA MK4313MAT 4.3Gb laptop (8.2 mm H) New £105.00  
2 1/2" TOSHIBA MK6409MAV 6.1Gb laptop (12.7 mm H) New £98.00  
2 1/2" TOSHIBA MK1614GAV 1.8Gb laptop (12 mm H) New £149.95  
2 1/2" to 3 1/2" conversion kit for Pc's, complete with connectors £15.95  
3 1/2" COMPAQ 313706-B21 (IBM) 9 gb ULT/SCSI3 New £199.00  
3 1/2" FUJI FK-309-26 20mb MFM I/F RFE £59.95  
3 1/2" CONNER CP3024 20 mb IDE I/F (or equiv.) RFE £59.95  
3 1/2" CONNER CP3044 40 mb IDE I/F (or equiv.) RFE £69.00  
3 1/2" QUINTUM 40S Prodriv 4e 42mb SCSI I/F, New RFE £49.00  
5 1/4" MINISCRIBE 3425 20mb MFM I/F (or equiv.) RFE £49.95  
5 1/4" SEAGATE ST-238R 30 mb RLL I/F Refurb £69.95  
5 1/4" CDC 94205-51 40mb RLL I/F RFE tested £69.95  
5 1/4" HP 9754B 850 Mb SCSI RFE tested £99.00  
5 1/4" HP C3010 2 Gbyte SCSI differential RFE tested £195.00  
8" NEC D2246 85 Mb SMD interface New £99.00  
8" FUJITSU M2322K 160Mb SMD I/F RFE tested £195.00  
8" FUJITSU M2392K 2 Gb SMD I/F RFE tested £345.00  
Many other floppy & H drives, IDE, SCSI, ESDI etc from stock, see website for full stock list. Shipping on all drives is code

## IC's - TRANSISTORS - DIODES

OBSOLETE - SHORT SUPPLY - BULK  
10,000,000 items EX STOCK  
For MAJOR SAVINGS  
CALL or see web site [www.distel.co.uk](http://www.distel.co.uk)

## COMPUTER MONITOR SPECIALS

Legacy products  
High spec genuine multisync.  
CGA, EGA, VGA, SVGA

Mitsubishi FA3415ETKL 14" SVGA Multisync colour monitor with fine 0.28 dot pitch tube and resolution of 1024 x 768. A variety of inputs allows connection to a host of computers including IBM PC's in CGA, EGA, VGA & SVGA modes. BBC, COMMODORE (including Amiga 1200), ARCHIMEDES and APPLE. Many features: Etched faceplate, text switching and LOW RADIATION MIPR specification. Fully guaranteed, in EXCELLENT little used condition. Tilt & Swivel Base £4.75

VGA cable for IBM PC included. Only £129 (E) Order as CG73

External cables for other types of computers available - CALL

Generic LOW COST SVGA Monitors  
We choose the make, which includes Compaq, Mitsubishi, IBM, etc. Supplied ready to run with all cables, Standard RTB 90 day guarantee.

14" £59.00	15" £69.00	17" £79.00
---------------	---------------	---------------

Supplied in good used condition. Shipping code (D)

## VIDEO MONITORS

PHILIPS HCS35 (same style as CM8833) attractively styled 14" colour monitor with both RGB and standard composite 15.625 KHz video inputs via SCART socket and separate phono jacks. Integral audio power amp and speaker for all audio visual uses. Will connect direct to Amiga and Atari BBC computers. Ideal for all video monitoring / security applications with direct connection to most colour cameras. High quality with many features such as front concealed flap controls, VCR correction button etc. Good used condition - fully tested - guaranteed  
Dimensions: W14" x H12 3/4" x 15 1/2" D.  
Only £99.00 (E)

PHILIPS HCS31 Ultra compact 9" colour video monitor with standard composite 15.625 KHz video input via SCART socket. Ideal for all monitoring / security applications. High quality, ex-emptive fully tested & guaranteed (possible minor screen bums). In attractive square black plastic case measuring W10" x H10" x 13 3/4" D. 240 V AC mains powered.  
Only £79.00 (D)

## INDUSTRIAL COMPUTERS

Tiny shoebox sized industrial 40 Mhz 386 PC system measuring only (mm) 266 w x 88 h x 272 d. Ideal for dedicated control applications running DOS, Linux or even Windows! Steel case contains 85 to 266 V AC 50 / 60 Hz 70 Watt PSU, a 3 slot ISA passive backplane and a Rocky 318 (PC104) standard, single board computer with 8 MByte NON VOLATILE solid state 'Disk On Chip' RAMDISK. System comprises: Rocky 318 (PC104) SBC ISA card with 40MHz ALI 386SX CPU, 72 pin SIMM slot with 16 Mbyte SIMM, AMI BIOS, battery backed up real time clock, 2 x 9 pin D 16550 serial ports, EPP/ECP printer port, mini DIN keyboard connector, floppy port, IDE port for hard drives up to 528 MByte capacity, watchdog timer and PC/104 bus socket. The 8 MByte solid state 'disk on chip' has its own BIOS, and can be formatted, booting & booted. Supplied BRAND NEW fully tested and guaranteed. For full data see featured item on website. Order as Q336  
100's of applications inc: firewall, routers, robotics etc  
Only £99.00 (D)

## 19" RACK CABINETS

Europe's Largest Stocks of  
quality rack cabinets,  
enclosures and accessories.  
Over 1000 Racks from stock

This month's special  
33 / 42 / 47 U - High Quality  
All steel Rack Cabinets

Made by Eurocraft Enclosures Ltd to the highest possible spec, rack features all steel construction with removable side, front and back doors. Front and back doors are hinged for easy access and all lockable with five secure 5 lever barrel locks. The front door is constructed of double walled steel with a 'designer style' smoked acrylic front panel to enable status indicators to be seen through the panel, yet remain unobtrusive. Internally the rack features fully slotted reinforced vertical fixing members to take the heaviest of 19" rack equipment. The two movable vertical fixing struts (extras available) are pre punched for standard 'cage nuts'. A mains distribution panel internally mounted to the bottom rear, provides 8 x IEC 3 pin Euro sockets and 1 x 13 amp 3 pin switched utility socket. Overall ventilation is provided by fully louvered back door and double skinned top section with top and side louvres. The top panel may be removed for fitting of integral fans to the sub plate etc. Other features include: fitted castors and floor levers, pre-punched utility panel at lower rear for cable / connector access etc. Supplied in excellent, slightly used condition with keys. Colour Royal blue, some grey available - CALL - Can be supplied in many other configurations.



33U Order as BC44 External dimensions mm=1625H x 635D x 603 W. (64" H x 25" D x 23 3/4" W) Only £245	42U Order as DT20 External dimensions mm=2019H x 635D x 603 W. (79.5" H x 25" D x 23 3/4" W) Only £345	47U Order as RV36 External dimensions mm=2019H x 635D x 603 W. (88" H x 25" D x 23 3/4" W) Only £410
---	---	---

Call for shipping quotation

## COLOUR CCD CAMERAS

Undoubtedly a miracle of modern technology & our special buying power! A quality product featuring a fully cased COLOUR CCD camera at a give away price! Unit features full auto light sensing for use in low light & high light applications.  
A 10 mm fixed focus wide angle lens gives excellent focus and resolution from close up to long range. The composite video output will connect to any composite monitor or TV (via SCART socket) and most video recorders. Unit runs from 12V DC so ideal for security & portable applications where mains power not available. Overall dimensions 66 mm wide x 117 deep x 43 high. Supplied BRAND NEW & fully guaranteed with user data, 100's of applications including Security, Home Video, Web TV, Web Cams etc.



Order as LK33 ONLY £79.00 or 2 for £149.00 (B)

## SOFTWARE SPECIALS

NT4 WorkStation, complete with service pack 3 and licence - OEM packaged. ONLY £89.00 (B)  
ENCARTA 95 - CDROM. Not the latest - but at this price! £7.95  
DOS 5.0 on 3 1/2" disks with concise books c/w QBASIC £14.95  
Windows for Workgroups 3.11+ Dos 6.22 on 3.5" disks £55.00  
Windows 95 CDROM Only - No Licence £19.95  
Wordperfect 6 for DOS supplied on 3 1/2" disks with manual £24.95

## SOLID STATE LASERS

Visible red, 670nm laser diode assembly. Unit runs from 5 V DC at approx 50 mA. Originally made for continuous use in industrial barcode scanners, the laser is mounted in a removable solid aluminium block, which functions as a heatsink and rigid optical mount. Dims of block are 50 w x 50 d x 15 h mm. Integral features include over temperature shutdown, current control, laser OK output, and gated TTL ON / OFF. Many uses for experimental optics, comms & lightshows etc. Supplied complete with data sheet.  
Order as TD91 ONLY £24.95 (A)

## DC POWER SUPPLIES

Virtually every type of power supply you can imagine. Over 10,000 Power Supplies  
Ex Stock - Call or see our web site.

## RELAYS - 200,000 FROM STOCK

Save £££'s by choosing your next relay from our Massive Stocks covering types such as Military, Octal, Cradle, Hermetically Sealed, Continental, Contactors, Time Delay, Reed, Mercury Wetted, Solid State, Printed Circuit Mounting etc., CALL or see our web site [www.distel.co.uk](http://www.distel.co.uk) for more information. Many obsolete types from stock. Save £££'s

## TEST EQUIPMENT & SPECIAL INTEREST ITEMS

MITSUBISHI FA3445ETKL 14" Ind. spec SVGA monitors £245  
FARNELL 0-60V DC @ 50 Amps, bench Power Supplies £995  
FARNELL AP3080 0-30V DC @ 80 Amps, bench Suppy £1850  
KINGSHILL CZ403/1 0-50V @ DC 200 Amps - NEW £3950  
1KW to 400 KW - 400 Hz 3 phase power sources - ex stock £POA  
IBM 8230 Type 1, Token ring base unit driver £760  
Wayne Kerr RA200 Audio frequency response analyser £2500  
INFODEC 1U, 24 port, RJ45 network patchpanels. #TH93 £49  
3COM 16670 12 Port Ethernet hub - RJ45 connectors #LD97 £69  
3COM 16671 24 Port Ethernet hub - RJ45 connectors £89  
3COM 16700 8 Port Ethernet hub - RJ45 connectors NEW £39  
IBM 53F5501 Token Ring ICS 20 port lobe modules £POA  
IBM MAU Token ring distribution panel 8228-23-5050N £45  
ALL 501 Low distortion Oscillator 9Hz to 330KHz, IEEE I/O £550  
AIMGON 8360.11805-1880 MHz hybrid power combiners £250  
Trend DSA 274 Data Analyser with G703(2M) 64 i/o £POA  
Marconi 6310 Programmable 2 to 22 GHz sweep generator £4500  
Marconi 2022C 10KHz-1GHz RF signal generator £1550  
HP1650B Logic Analyser £3750  
HP3781A Pattern generator & HP3782A Error Detector £POA  
HP6214 Dual Programmable GPIB PSU 0-7 V 160 watts £1800  
HP6264 Rack mount variable 0-20V @ 20A metered PSU £475  
HP541214 DC to 22 GHz four channel test set £POA  
HP8130A opt 020 300 MHz pulse generator, GPIB etc £7900  
HP A1, A0 pen HGCL high speed drum plotters - from £550  
HP DRAFTMASTER 118 pen high speed plotter £750  
EG-G Brooktek 95035C Precision lock in amp £1800  
Keithley 590 CV capacitor / voltage analyser £POA  
Racal ICR40 dual 40 channel voice recorder system £3750  
Flskers 45KVA 3 ph On Line UPS - New batteries £4500  
Emerson AP130 2.5KVA industrial spec UPS £1499  
Mann Tally MT645 High speed line printer £2200  
Intel SBC 486/133SE Multibus 486 system. 8Mb Ram £945

## Unless marked NEW, items in this section are pre owned.

HP6030A 0-200V DC @ 17 Amps bench power supply £1950  
Intel SBC 486/125C08 Enhanced Multibus (MSA) New £1150  
Nikon HFX-11 (Ephiphot) exposure control unit £1450  
PHILIPS VM5518 pro. TV signal generator £1250  
Motorola VME Bus Boards & Components List. SAE / CALL £POA  
Trio 0-18 vdc linear, metered 30 amp bench PSU. New £550  
Fujitsu M3041R 600 LPM high speed band printer £1950  
Fujitsu M3041D 600 LPM printer with network interface £1250  
Siemens K4400 64Kb to 140Mb dex analyser £2950  
Perkin Elmer 299B Infrared spectrophotometer £500  
Perkin Elmer 597 Infrared spectrophotometer £3500  
Vig Electronics 1035 TELETEXT Decoding Margin Meter £3250  
LightBand 60 output high spec 2u rack mount video VDA's £495  
Sekonic SD 150H 18 channel digital Hybrid chart recorder £1995  
B&K 2633 Microphone pre amp £300  
Taylor Hobson Tallysurf amplifier / recorder £750  
ADC SS200 Carbon dioxide gas detector / monitor £1450  
BBC AM20/3 PPM Meter (Ernest Turner) + drive electronics £75  
ANRITSU 9654A Optical DC-2.5Gb/w waveform monitor £5650  
ANRITSU ML93A optical power meter £390  
ANRITSU Fibre optic characteristic test set £POA  
R&S FT02 Dual sound unit £650  
R&S SBUP-E1 Vision modulator £775  
WILTRON 6630B 12.4 / 20GHz RF sweep generator £5750  
TEK 2445 150 MHz 4 trace oscilloscope £1250  
TEK 2465 300 MHz 300 MHz oscilloscope rack mount £1955  
TEK TDS524A 500MHz digital realtime + disk drive, FFT etc £2900  
HP5955A Opt 907 20Hz to 40 Mhz spectrum analyser £5100  
PHILIPS PW1730/0 60KV XRAY generator & accessories £3950  
VARIACS - Large range from stock - call or see our website £POA  
CLAUDE LYONS 12A 240V single phase auto. volt. regs £325

# DISPLAY ELECTRONICS

ALL MAIL TO  
Dept PE, 29 / 35 Osborne Rd  
Thornton Heath  
Surrey CR7 8PD  
Open Mon - Fri 9.00 - 5.30

18 Million Items On Line Now!  
Secure ordering, Pictures, Information  
[www.distel.co.uk](http://www.distel.co.uk)  
email = [admin@distel.co.uk](mailto:admin@distel.co.uk)

ALL ENQUIRIES  
0208 653 3333  
FAX 0208 653 8888

All prices for UK Mainland, UK customers add 17.5% VAT to TOTAL order amount. Minimum order £10. Bona Fide account orders accepted from Government, Schools, Universities and Local Authorities - minimum account order £50. Cheques over £100 are subject to 7 working days clearance. Carriage charges (A)=£3.50, (B)=£6.50, (C)=£10, (D)=£15.00, (E)=£18.00, (F)=CALL. Allow approx 3 days for shipping - faster CALL. All goods supplied to our Standard Conditions of Sale which can be viewed at our website and unless stated guaranteed for 90 days. All guarantees on a return to base basis. All rights reserved to change prices / specifications without prior notice. Orders subject to stock. Discounts for volume. Top CASH prices paid for surplus goods. All trademarks, tradenames etc acknowledged. © Display Electronics 2002. E & O. E.



# NEXT MONTH

## EPE PIC TUTORIAL V2

Quite simply the best low-cost way to learn about using PIC microcontrollers! Three Special EPE Supplements to be published in the April, May and June issues contain the revised edition of the highly-acclaimed series published in 1998 and which has enabled many thousands of readers to understand and use PICs in their own electronic designs.

Using the EPE Toolkit TK3 hardware and software (Oct/Nov '01) as the demonstration platform, the series assumes that you have no prior knowledge of PICs and leads you "by the hand", showing how each of the PIC's commands can be used, and encouraging you to experiment with them. At the simplest level you are shown how to just turn on an l.e.d., but we progress to show how switches can be monitored, sound generated, matrixed 7-segment l.e.d. displays used, liquid crystal alphanumeric displays controlled, and a real-time clock control program written.

The demonstrations are based around the PIC16F84, the simplest device in the PIC family through which to learn. In Part Three we also examine some of the simpler differences between this PIC16F8x family device and the more sophisticated PIC16F62x and PIC16F87x families. We also illustrate some of the more advanced PIC programming techniques available, such as binary coded decimal conversion, multiplication, division, analogue-to-digital conversion, and data EEPROM reading and writing for all three families.

By the end of the series you should be well equipped to conceive of a design and to program a PIC so that it will do what you've always wanted to achieve!

FREE  
SPECIAL  
SUPPLEMENT

## EARTH RESISTIVITY LOGGER

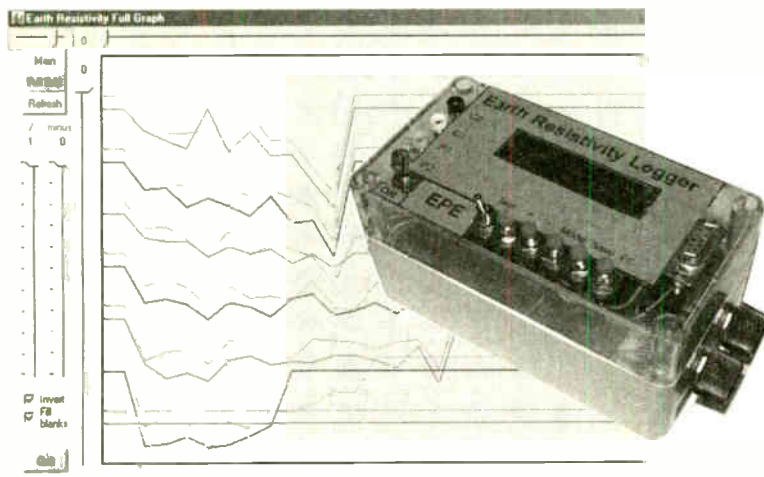

Help your local archaeological society to "see beneath the soil" and discover the hidden mysteries of our ancestors. This data logging design is based on the well-established principle of transmitting an electrical frequency into the soil via simple metal probes, retrieving it at a distance via two other probes, and storing it for further analysis.

The data is stored into an on-board non-volatile serial memory (EEPROM) capable of holding 16384 data samples, representing a survey grid typically comprised of 128 columns and 128 rows – a vast amount of survey data!

Stored data can be transferred to a PC-compatible computer and saved to disk as often as required without affecting its on-board retention.

FREE Windows-based software allows the survey data to be analysed in full or in selected blocks, as intensity-graded colour or monochrome grid squares, or as graphical signal amplitude waveforms, with zoom option. The data files are compatible with Windows Excel graphing and analysis software.

## ATMOSPHERICS MONITOR

Tune in and listen to the sounds of the heavens in turmoil – Whistles, Pings, Chirps, Chinks, Clinks, Tweaks, Risers and even the exotic Dawn Chorus, all created by the electrical activity of lightning when a storm is in progress. even when it's on the other side of the globe!

PLUS

**BACK TO BASICS – two more simple, easy to build projects**

# NO ONE DOES IT BETTER

EVERYDAY  
**PRACTICAL**  
**ELECTRONICS**

**DON'T MISS AN  
ISSUE – PLACE YOUR  
ORDER NOW!**

Demand is bound to be high

**APRIL 2003 ISSUE ON SALE THURSDAY, MARCH 13**



# QUASAR ELECTRONICS LIMITED

PO Box 6935, BISHOPS STORTFORD, Herts. CM23 4WP

TEL: 0871 717 7168 FAX: 0871 277 2728

ADD £2.00 P&P to all orders (or 1st Class Recorded £4, Next day (Insured £2.00) £7 Eur. £5.00, Rest of World £10.00). We accept all major credit cards. Make cheques/PO's payable to Quasar Electronics. Prices include 17.5% VAT. MAIL ORDER ONLY  
**FREE CATALOGUE** with order or send 2 x 1st class stamps (refundable) for details of over 150 kits & publications.



## PROJECT KITS

Our electronic kits are supplied complete with all components, high quality PCBs (NOT cheap Tripad strip board!) and detailed assembly/operating instructions

- **2 x 25W CAR BOOSTER AMPLIFIER** Connects to the output of an existing car stereo cassette player, CD player or radio. Heatsinks provided. PCB 76x75mm. 1046KT £24.95
- **3-CHANNEL WIRELESS LIGHT MODULATOR** No electrical connection with amplifier. Light modulation achieved via a sensitive electret microphone. Separate sensitivity control per channel. Power handling 400W/channel. PCB 54x112mm. Mains powered. Box provided. 6014KT £24.95
- **12 RUNNING LIGHT EFFECT** Exciting 12 LED light effect ideal for parties, discos, shop-windows & eye-catching signs. PCB design allows replacement of LEDs with 220V bulbs by inserting 3 TRIACS. Adjustable rotation speed & direction. PCB 54x112mm. 1026KT £19.95; BOX (for mains operation) 2026BX £39.00
- **DISCO STROBE LIGHT** Probably the most exciting of all light effects. Very bright strobe tube. Adjustable strobe frequency 1-60Hz. Mains powered. PCB 60x68mm. Box provided. 6037KT £28.95

- **ANIMAL SOUNDS** Cat, dog, chicken & cow. Ideal for kids farmyard toys & schools. SG10M £5.95
- **3 1/2 DIGIT LED PANEL METER** Use for basic voltage/current displays or customise to measure temperature, light, weight, movement, sound levels, etc. with appropriate sensors (not supplied). Various input circuit designs provided. 3061KT £13.95
- **IR REMOTE TOGGLE SWITCH** Use any TV/VCR remote control unit to switch onboard 12V/1A relay on/off. 3058KT £10.95
- **SPEED CONTROLLER** for any common DC motor up to 100V/5A. Pulse width modulation gives maximum torque at all speeds. 5-15VDC. Box provided. 3067KT £12.95
- **3 x 8 CHANNEL IR RELAY BOARD** Control eight 12V/1A relays by Infra Red (IR) remote control over a 20m range in sunlight. 6 relays turn on only, the other 2 toggle on/off 3 operation ranges determined by jumpers. Transmitter case & all components provided. Receiver PCB 76x69mm. 3072KT £52.95

## PRODUCT FEATURE

### COMPUTER TEMPERATURE DATA LOGGER

PC serial port controlled 4-channel temperature meter (either deg C or F). Requires no external power. Allows continuous temperature data logging of up to four temperature sensors located 200m+ from motherboard/PC. Ideal use for old 386/486 computers. Users can tailor input data stream to suit their purpose (dump it to a spreadsheet or write your own BASIC programs using the INPUT command to grab the readings). PCB just 38mm x 38mm. Sensors connect via four 3-pin headers. 4 header cables supplied but only one DS18S20 sensor.  
 Kit software available free from our website.  
**ORDERING:** 3145KT £23.95 (kit form); AS3145 £29.95 (assembled); Additional DS18S20 sensors £4.95 each

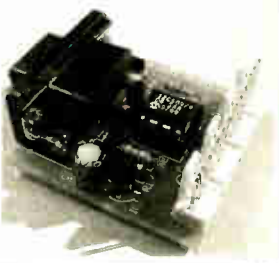

- **SOUND EFFECTS GENERATOR** Easy to build. Create an almost infinite variety of interesting/unusual sound effects from birds chirping to sirens. 9VDC. PCB 54x85mm. 1045KT £8.95
- **ROBOT VOICE EFFECT** Make your voice sound similar to a robot or Darlek. Great fun for discos, school plays, theatre productions, radio stations & playing jokes on your friends when answering the phone! PCB 42x71mm. 1131KT £8.95
- **AUDIO TO LIGHT MODULATOR** Controls intensity of one or more lights in response to an audio input. Safe, modern opto-coupler design. Mains voltage experience required. 3012KT £8.95
- **MUSIC BOX** Activated by light. Plays 8 Christmas songs and 5 other tunes. 3104KT £7.95
- **20 SECOND VOICE RECORDER** Uses non-volatile memory - no battery backup needed. Record/replay messages over & over. Playback as required to greet customers, etc. Volume control & built-in mic. 6VDC. PCB 50x73mm. 3131KT £12.95
- **TRAIN SOUNDS** 4 selectable sounds: whistle blowing, level crossing bell, 'clackety-clack' & 4 in sequence. SG01M £6.95

- **PC CONTROLLED RELAY BOARD** Convert any 286 upward PC into a dedicated automatic controller to independently turn on/off up to eight lights, motors & other devices around the home, office, laboratory or factory. Each relay output is capable of switching 250VAC/4A. A suite of DOS and Windows control programs are provided together with all components (except box and PC cable) 12VDC. PCB 70x200mm. 3074KT £31.95
- **2 CHANNEL UHF RELAY SWITCH** Contains the same transmitter/receiver pair as 30A15 below plus the components and PCB to control two 240VAC/10A relays (also supplied). Ultra bright LEDs used to indicate relay status. 3082KT £27.95
- **TRANSMITTER RECEIVER PAIR 2-button** keyboard style 300-375MHz Tx with 30m range. Receiver encoder module with matched decoder IC. Components must be built into a circuit like kit 3082 above. 30A15 £14.95
- **PIC 16C71 FOUR SERVO MOTOR DRIVER** Simultaneously control up to 4 servo motors. Software & all components (except servos/control pots) supplied. 5VDC. PCB 50x70mm. 3102KT £15.95
- **UNIPOLAR STEPPER MOTOR DRIVER** for any 5/6/8 lead motor. Fast/slow & single step rates. Direction control & on/off switch. Wave, 2-phase & half-wave step modes. 4 LED indicators. PCB 50x65mm. 3109KT £14.95
- **PC CONTROLLED STEPPER MOTOR DRIVER** Control two unipolar stepper motors (3A max. each) via PC printer port. Wave, 2-phase & half-wave step modes. Software accepts 4 digital inputs from external switches & will single step motors. PCB fits in D-shell case provided. 3113KT £17.95
- **12-BIT PC DATA ACQUISITION/CONTROL UNIT** Similar to kit 3093 above but uses a 12 bit Analogue-to-Digital Converter (ADC) with internal analogue multiplexer. Reads 8 single ended channels or 4 differential inputs or a mixture of both. Analogue inputs read 0-4V. Four TTL/CMOS compatible digital input/outputs. ADC conversion time <10µs. Software (C, QB & Wfn), extended D shell case & all components (except sensors & cable) provided. 3118KT £52.95
- **LIQUID LEVEL SENSOR/RAIN ALARM** Will indicate fluid levels or simply the presence of fluid. Relay output to control a pump to add/remove water when it reaches a certain level. 1080KT £5.95
- **AM RADIO KIT 1** Tuned Radio Frequency front-end, single chip AM radio IC & 2 stages of audio amplification. All components inc. speaker provided. PCB 32x102mm. 3063KT £10.95
- **DRILL SPEED CONTROLLER** Adjust the speed of your electric drill according to the job at hand. Suitable for 240V AC mains powered drills up to

## X FACTOR PUBLICATIONS

THE EXPERTS IN RARE & UNUSUAL INFORMATION!

Full details of all X-FACTOR PUBLICATIONS can be found in our catalogue. NB Minimum order charge for reports and plans is £5.00 PLUS normal P&P

- **SECRET-EAR LISTENING DEVICE** Complete plans to build your own parabolic dish microphone. Listen to distant voices and sounds through open windows and even walls! Made from readily available parts. R002 £3.50
- **LOCKS** - How they work and how to pick them. This fact filled report will teach you more about locks and the art of lock picking than many books we have seen at 4 times the price. Packed with information and illustrations. R008 £3.50
- **RADIO & TV JOKER PLANS** We show you how to build three different circuits for disrupting TV picture and sound plus FM radio! May upset your neighbours & the authorities! DISCRETION REQUIRED. R017 £3.50
- **INFINITY TRANSMITTER PLANS** Complete plans for building the famous Infinity Transmitter. Once installed on the target phone, device acts like a room bug. Just call the target phone & activate the unit to hear all room sounds. Great for home/office security! R019 £3.50
- **THE ETHER BOX CALL INTERCEPTOR PLANS** Grabs telephone calls out of the air! No need to wire-in a phone bug. Simply place this device near the phone lines to hear the conversations taking place! R025 £3.00
- **CASH CREATOR BUSINESS REPORTS** Need ideas for making some cash? Well this could be just what you need! You get 40 reports (approx. 800 pages) on floppy disk that give you information on setting up different businesses. You also get valuable reproduction and duplication rights so that you can sell the manuals as you like. R030 £7.50

# SURVEILLANCE

High performance surveillance bugs. Room transmitters supplied with sensitive electret microphone & battery holder/clip. All transmitters can be received on an ordinary VHF-FM radio between 88-108MHz. Available in Kit Form (KT) or Assembled & Tested (AS)

## ROOM SURVEILLANCE

● **MTX - MINIATURE 3V TRANSMITTER** Easy to build & guaranteed to transmit 300m @ 3V. Long battery life. 3-5V operation. Only 45x18mm. 8 3007KT £6.95 AS3007 £11.95

● **MRTX - MINIATURE 9V TRANSMITTER** Our best selling bug. Super sensitive, high power - 500m range @ 9V (over 1km with 18V supply and better aerial). 45x19mm. 3018KT £7.95 AS3018 £12.95

● **HPTX - HIGH POWER TRANSMITTER** High performance 2 stage transmitter gives greater stability & higher quality reception. 1000m range. 6-12V DC operation. Size 70x15mm. 3032KT £9.95 AS3032 £18.95

● **MMTX - MICRO-MINIATURE 9V TRANSMITTER** The ultimate bug for its size, performance and price. Just 15x25mm. 500m range @ 9V. Good stability. 6-18V operation. 3051KT £8.95 AS3051 £14.95

● **VTX - VOICE ACTIVATED TRANSMITTER** Operates only when sounds detected. Low standby current. Variable trigger sensitivity. 500m range. Peaking circuit supplied for maximum RF output. On/off switch. 6V operation. Only 63x38mm. 3028KT £12.95 AS3028 £24.95

● **HARD-WIRED BUG/TWO STATION INTERCOM** Each station has its own amplifier, speaker and mic. Can be set up as either a hard-wired bug or two-station intercom. 10m x 2-core cable supplied. 3021KT £15.95 (kit form only)

● **TRVX - TAPE RECORDER VOX SWITCH** Used to automatically operate a tape recorder (not supplied) via its REMOTE socket when sounds are detected. All conversations recorded. Adjustable sensitivity & turn-off delay. 115x19mm. 3013KT £9.95 AS3013 £21.95

## TELEPHONE SURVEILLANCE

● **MTXX - MINIATURE TELEPHONE TRANSMITTER** Attaches anywhere to phone line. Transmits only when phone is used! Tune-in your radio and hear both parties. 300m range. Uses line as aerial & power source. 20x45mm. 3016KT £8.95 AS3016 £18.95

● **TRV - TELEPHONE RECORDING INTERFACE** Automatically record all conversations. Connects between phone line & tape recorder (not supplied). Operates recorders with 1.5-12V battery systems. Powered from line. 50x33mm. 3033KT £9.95 AS3033 £18.95

● **TPA - TELEPHONE PICK-UP AMPLIFIER/WIRELESS PHONE BUG** Place pick-up coil on the phone line or near phone earpiece and hear both sides of the conversation. 3055KT £11.95 AS3055 £20.95

## HIGH POWER TRANSMITTERS

● **1 WATT FM TRANSMITTER** Easy to construct. Delivers a crisp, clear signal. Two-stage circuit. Kit includes microphone and requires a simple open dipole aerial. 8-30VDC. PCB 42x45mm. 1009KT £12.95

● **4 WATT FM TRANSMITTER** Comprises three RF stages and an audio preamplifier stage. Piezoelectric microphone supplied or you can use a separate preamplifier circuit. Antenna can be an open dipole or Ground Plane. Ideal project for those who wish to get started in the fascinating world of FM broadcasting and want a good basic circuit to experiment with. 12-18VDC. PCB 44x146mm. 1028KT £22.95 AS1028 £34.95

● **15 WATT FM TRANSMITTER (PRE-ASSEMBLED & TESTED)** Four transistor based stages with Philips BLY 88 in final stage. 15 Watts RF power on the air. 88-108MHz. Accepts open dipole, Ground Plane, 5/8, J or YAGI antennas. 12-18VDC. PCB 70x220mm. SWS meter needed for alignment. 1021KT £99.95

● **SIMILAR TO ABOVE BUT 25W OUTPUT** 1031KT £109.95

700W power. PCB: 48mm x 65mm. Box provided. 6074KT £17.95

● **3 INPUT MONO MIXER** Independent level control for each input and separate bass/treble controls. Input sensitivity: 240mV. 18V DC. PCB: 60mm x 185mm. 1052KT £16.95

● **NEGATIVE/POSITIVE ION GENERATOR** Standard Cockcroft-Walton multiplier circuit. Mains voltage experience required. 3057KT £10.95

● **LED DICE** Classic intro to electronics & circuit analysis. 7 LEDs simulate dice roll, slow down & land on a number at random. 555 IC circuit. 3003KT £9.95

● **STAIRWAY TO HEAVEN** Tests hand-eye co-ordination. Press switch when green segment of LED lights to climb the stairway - miss & start again! Good intro to several basic circuits. 3005KT £9.95

● **ROULETTE LED 'Ball'** spins round the wheel, slows down & drops into a slot. 10 LEDs. Good intro to CMOS decade counters & Op-Amps. 3006KT £10.95

● **12V XENON TUBE FLASHER TRANSFORMER** steps up 12V supply to flash a 25mm Xenon tube. Adjustable flash rate. 3163KT £13.95

● **LED FLASHER 1** 5 ultra bright red LEDs flash in 7 selectable patterns. 3037MKT £9.95

● **LED FLASHER 2** Similar to above but flash in sequence or randomly. Ideal for model railways. 3052MKT £9.95

● **INTRODUCTION TO PIC PROGRAMMING.** Learn programming from scratch. Programming hardware, a P16F84 chip and a two-part, practical, hands-on tutorial series are provided. 3081KT £21.95

● **SERIAL PIC PROGRAMMER** for all 818/28/40 pin DIP serial programmed PICs. Shareware software supplied limited to programming 256 bytes (registration costs £14.95). 3096KT £10.95

● **ATEMEL 89C051 PROGRAMMER** Simple-to-use yet powerful programmer for the Atmel 89C1051, 89C2051 & 89C4051 uC's. Programmer does NOT require special software other than a terminal emulator program (built into Windows). Can be used with ANY computer/operating system. 3121KT £24.95

● **3V1-5V TO 9V BATTERY CONVERTER** Replace expensive 9V batteries with economic 1.5V batteries. IC based circuit steps up 1 or 2 AA batteries to give 9V/18mA. 3035KT £5.95

● **STABILISED POWER SUPPLY 3-30V/2.5A** Ideal for hobbyist & professional laboratory. Very reliable & versatile design at an extremely reasonable price. Short circuit protection. Variable DC voltages (3-30V). Rated output 2.5 Amps. Large heatsink supplied. You just supply a 24VAC/3A transformer. PCB 55x112mm. Mains operation. 1007KT £16.95.

● **STABILISED POWER SUPPLY 2-30V/5A** As kit 1007 above but rated at 5Amp. Requires a 24VAC/5A transformer. 1096KT £27.95

● **MOTORBIKE ALARM** Uses a reliable vibration sensor (adjustable sensitivity) to detect movement of the bike to trigger the alarm & switch the output relay to which a siren, bikes horn, indicators or other warning device can be attached. Auto-reset. 6-12VDC. PCB 57x64mm. 1011KT £11.95 Box 2011BX £7.00

● **CAR ALARM SYSTEM** Protect your car from theft. Features vibration sensor, courtesy/boot light voltage drop sensor and bonnet/boot earth switch sensor. Entry/exit delays, auto-reset and adjustable alarm duration. 6-12V DC. PCB 47mm x 55mm. 1019KT £11.95 Box 2019BX £8.00

● **PIEZO SCREAMER** 110dB of ear piercing noise. Fits in box with 2 x 35mm piezo elements built into their own resonant cavity. Use as an alarm siren or just for fun! 6-9VDC. 3015KT £10.95

● **COMBINATION LOCK** Versatile electronic lock comprising main circuit & separate keypad for remote opening of lock. Relay supplied. 3029KT £10.95

● **ULTRASONIC MOVEMENT DETECTOR** Crystal locked detector frequency for stability & reliability. PCB 75x40mm houses all components. 4-7m range. Adjustable sensitivity. Output will drive external relay/circuits 9VDC. 3049KT £13.95

● **PIR DETECTOR MODULE** 3-lead assembled unit just 25x35mm as used in commercial burglar alarm systems. 3076KT £8.95

● **INFRARED SECURITY BEAM** When the invisible IR beam is broken a relay is tripped that can be used to sound a bell or alarm. 25 metre range. Mains rated relays provided. 12VDC operation. 3130KT £12.95

● **SQUARE WAVE OSCILLATOR** Generates square waves at 6 preset frequencies in factors of 10 from 1Hz-100KHz. Visual output indicator. 5-18VDC. Box provided. 3111KT £8.95

● **PC DRIVEN POCKET SAMPLER/DATA LOGGER** Analogue voltage sampler records voltages up to 2V or 20V over periods from milli-seconds to months. Can also be used as a simple digital scope to examine audio & other signals up to about 5KHz. Software & D-shell case provided. 3121KT £18.95

● **20 MHz FUNCTION GENERATOR** Square, triangular and sine waveform up to 20MHz over 3 ranges using 'coarse' and 'fine' frequency adjustment controls. Adjustable output from 0-2V p-p. A TTL output is also provided for connection to a frequency meter. Uses MAX038 IC. Plastic case with printed front/rear panels & all components provided. 7-12VAC. 3101KT £69.95

## BARGAIN BUY!

## 30-IN-ONE Electronic Projects Lab

Great introduction to electronics. Ideal for the budding electronics expert! Build a radio, burglar alarm, water detector, Morse code practice circuit, simple computer circuits, and much more! NO soldering, tools or previous electronics knowledge required. Circuits can be built and unassembled repeatedly. Comprehensive 68-page manual with explanations, schematics and assembly diagrams. Suitable for age 10+. Excellent for schools. Requires 2 x AA batteries. Order Code EPL030 ONLY £14.95 (phone for bulk discounts). 130, 300 and 500-in-ONE also available.



WEB: <http://www.QuasarElectronics.com>  
 email: [epesales@QuasarElectronics.com](mailto:epesales@QuasarElectronics.com)

Secure Online Ordering Facilities  
 Full Kit Listing, Descriptions & Photos  
 Kit Documentation & Software Downloads

www.QuasarElectronics.com

Credit Card Sales: 0871 717 7168



## Enhanced 'PICALL' ISP PIC Programmer

Kit will program virtually ALL 8 to 40 pin\* serial and parallel programmed PIC micro-controllers. Connects to PC parallel port. Supplied with fully functional pre-registered PICALL DOS and WINDOWS AVR software packages, all components and high quality DSPTH board. Also programs certain ATMEL AVR, SCENIX SX and EEPROM 24C devices. New devices can be added to the software as they are released. Blank chip auto detect feature for super-fast bulk programming. Hardware now supports ISP programming. \*A 40 pin wide ZIF socket is required to program 0.3in. devices (Order Code AZIF40 @ £15.00).



3144KT	Enhanced 'PICALL' ISP PIC Programmer	£59.95
AS3144	Assembled Enhanced 'PICALL' ISP PIC Programmer	£64.95
AS3144ZIF	Assembled Enhanced 'PICALL' ISP PIC Programmer c/w ZIF socket	£79.95

## ATMEL AVR Programmer

Powerful programmer for Atmel AT90Sxxxx (AVR) micro controller family. All fuse and lock bits are programmable. Connects to serial port. Can be used with ANY computer and operating system. Two LEDs to indicate programming status. Supports 20-pin DIP AT90S1200 & AT90S2313 and 40-pin DIP AT90S4414 & AT90S8515 devices. NO special software required - uses any terminal emulator program (built into Windows). The programmer is supported by BASCOM-AVR Basic Compiler software (see website for details).



3122KT	ATMEL AVR Programmer	£24.95
AS3122	Assembled 3122	£34.95

Atmel 89Cx051 and 89xxx programmers also available.

## PC Data Acquisition & Control Unit

With this kit you can use a PC parallel port as a real world interface. Unit can be connected to a mixture of analogue and digital inputs from pressure, temperature, movement, sound, light intensity, weight sensors, etc. (not supplied) to sensing switch and relay states. It can then process the input data and use the information to control up to 11 physical devices such as motors, sirens, other relays, servo motors & two-stepper motors.



### FEATURES:

- 8 Digital Outputs: Open collector, 500mA, 33V max.
- 16 Digital Inputs: 20V max. Protection 1K in series, 5-1V Zener to ground.
- 11 Analogue Inputs: 0-5V, 10 bit (5mV/step.)
- 1 Analogue Output: 0-2.5V or 0-10V. 8 bit (20mV/step.)

All components provided including a plastic case (140mm x 110mm x 35mm) with pre-punched and silk screened front/rear panels to give a professional and attractive finish (see photo) with screen printed front & rear panels supplied. Software utilities & programming examples supplied.

3093KT	PC Data Acquisition & Control Unit	£99.95
AS3093	Assembled 3093	£124.95

See opposite page for ordering information on these kits

## ABC Mini 'Hotchip' Board



Currently learning about microcontrollers? Need to do something more than flash a LED or sound a buzzer? The ABC Mini 'Hotchip' Board is based on Atmel's AVR 8535 RISC technology and will interest both the beginner and expert alike. Beginners will find that they can write and test a simple program, using the BASIC programming language, within an hour or two of connecting it up.

Experts will like the power and flexibility of the ATMEL microcontroller, as well as the ease with which the little Hot Chip board can be "designed-in" to a project. The ABC Mini Board 'Starter Pack' includes just about everything you need to get up and experimenting right away. On the hardware side, there's a pre-assembled micro controller PC board with both parallel and serial cables for connection to your PC. Windows software included on CD-ROM features an Assembler, BASIC compiler and in-system programmer. The pre-assembled boards only are also available separately.

ABCMINISP	ABC MINI Starter Pack	£64.95
ABCMINIB	ABC MINI Board Only	£39.95

## Advanced 32-bit Schematic Capture and Simulation Visual Design Studio

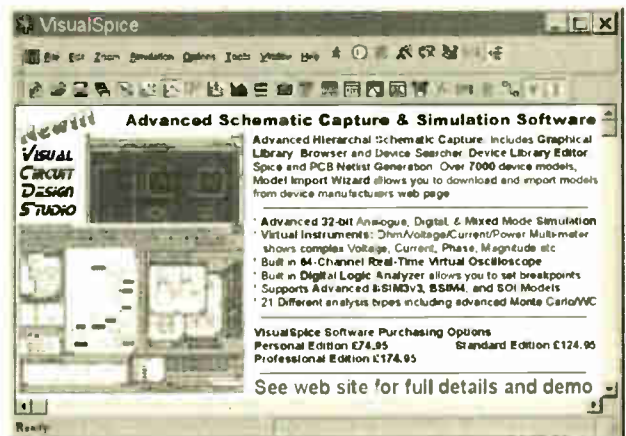

## Serial Port Isolated I/O Controller

Kit provides eight relay outputs capable of switching 4 amps at mains voltages and four optically isolated digital inputs. Can be used in a variety of control and sensing applications including load switching, external switch input sensing, contact closure and external voltage sensing.



Programmed via a computer serial port, it is compatible with ANY computer & operating system. After programming, PC can be disconnected. Serial cable can be up to 35m long, allowing 'remote' control. User can easily write batch file programs to control the kit using simple text commands. NO special software required - uses any terminal emulator program (built into Windows). All components provided including a plastic case with pre-punched and silk screened front/rear panels to give a professional and attractive finish (see photo).

3108KT	Serial Port Isolated I/O Controller Kit	£54.95
AS3108	Assembled Serial Port Isolated I/O Controller	£64.95

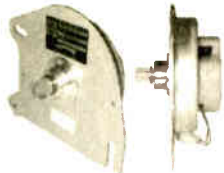

**80-173** 12V DC motor, flat style, 3000 RPM, 18 NCM torque, draws 5 Amps, reversible, 24 toothed gear. Ideal for robot wars, etc. Dimensions 152mm diameter x 80mm including spindle and gear. Very good quality mounted on a fixing bracket. Some sort of speed counting circuitry on rear. **Bargain at just £19.95**



**80-176** 12V, 50Ah, gel type lead acid battery. Made by Dynasty High Rate Series, 200 WPC. Model No. UPS12-200. 230 x 140 x 225mm. Brand new. *Please note that there is no extra carriage charge when purchasing this item.* **Only £25.00**



**80-135** Flat pack fan, 12V DC. Made by Papst. Air flows around the blades and out the side to produce a strong air flow. Excellent for cooling down in crowded enclosures. 121 x 121 x 37mm. Ex-equipment but in full working order and excellent condition. These are normally over £25.00 new. **Our price just £5.50**



**80-046** Electronic digital caliper for both imperial (0-6 inches) and metric (0-150mm). Accuracy +/- 0.001". Simple touch button facility to change from metric to imperial (and vice versa). On/off and zero button, inside and outside measuring plus locking screw to hold measurement. Uses a standard watch battery (included). Metal construction. Supplied in a neat plastic storage case. **Special price of £34.95**



**80-175** In-line RCD protected powerbreaker. Maximum load 10A @ 250V AC. Reset and test buttons. IEC plug for mains input with an IEC socket on a 1m long lead. These usually sell for around £36.00. **Our price £5.00**



**80-132** Switch mode PSU. Nice little unit. Model No. BM43024. Input 120V AC or 240V AC. Output +5V @ 2.5A and +12V @ 2A, 36.5W. Semi-cased with mains IEC filter and switch. **£3.95**



**42-337** Plastic construction metric dial vernier. Reads 0-100mm. Outside, inside, depth and step measurements. Has a jocking device and comes supplied in a neat case. **£7.95**

**80-083** CR2025 lithium, 3V coin cell, 20mm diameter x 2.5mm thick. Branded Sony. **Pack of 25 for £7.50; Pack of 100 for £25.00.** *Our normal price individually is £1.00 each!!!*



**80-428** USB lead, 2m long, 'A' plug to 'A' plug. **£2.95**

**80-429** USB lead, 2m long, 'A' plug to 'B' plug. **£2.95**

**80-430** USB lead, 2m long, 'B' plug to 'B' plug. **£2.95**

**48-140** PVC electrical tape, 19mm wide x 0.15mm thick x 33 metres long. Flame retardant, BS3924. **75p**



**48-259** Ferrite rod with 1 x tuning coil. 140mm long x 10mm diameter. **£1.75**



**WCN Supplies**  
Dept EE - The Old Grain Store  
Rear Of 62 Rumbridge Street  
Totton - Southampton - SO40 9DS  
Telephone or Fax On  
Southampton 023 8066 0700  
Email: info@wcn-supplies.fsnet.co.uk

**SEND FOR OUR FREE CATALOGUE CONTAINING EVEN MORE BARGAIN ITEMS!**

**ALL PRICES INCLUDE VAT ADD £2.25 FOR P & P**

**SPECIAL OFFERS**

**TEKTRONIX 2445A** 4-ch 150MHz delay, cursors etc. Supplied with 2 Tektronix probes. **ONLY £425**

**TEKTRONIX 2232** Digital Storage Scope. Dual Trace, 100MHz, 100MS with probes... £525  
**H.P. 54501A** Dig. Oscilloscope, 100MHz 4-Ch... £425  
**AM/FM Sweep/Tru/Gate/Burst** etc. £300  
**FARNELL Dual PSU XA35-2T**, 0-35V, 0-2A. £180  
**Twice QMD** i.c.d. Display. £160  
**CIRRIUS CRL254** Sound Level Meter with Calibrator 80-120dB, LEO. £150  
**FARNELL AMM255** Automatic Mo Meter, 1-5MHz-2GHz, unused. £300  
**FARNELL DSG1** Low Frequency Syn Sig. Gen., 0.01Hz-99.99Hz, low distortion, TTL/Square/Pulse Outputs etc. £95  
**FLUKE 8060A** Handheld True RMS, DMM, 4 1/2 digit. As new £150, used £95  
**BECKMAN HD110** Handheld 3 1/2 digit DMM, 28 ranges, with battery, leads and carrying case. £40

**H.P. 3310A** Function Gen., 0-005Hz-5MHz, Sine/Sq/Tri/Ramp/Pulse... £125  
**FARNELL LFM4** Sine/Sq Oscillator, 10Hz-1MHz, low distortion, TTL output, Amplitude Meter. £125  
**H.P. 545A** Logic Probe with 546A Logic Pulser and 547A Current Tracer. £90  
**FLUKE 77** Multimeter, 3 1/2 digit, handheld. £60  
**FLUKE 77 Series 11**. £70  
**HEME 1000** L.C.D. Clamp Meter, 00-1000A, in carrying case. £60

**BLACK STAR ORION PAL/TV** Colour Pattern Generator. from £75-£125  
**THURBY/THANDER TG210** Function Generator. 0.002Hz-2MHz, TTL, etc. £80-£95  
**THURBY/THANDER P.S.U. PL320CQM**, 0V-32V, 0A-2A Twice (late colours). £200

**Datron 1061** High Quality 5-5 Digit Bench Multimeter. True RMS/4 wire/Current Converter/IEEE. **£150**

**Datron 1061A** High Quality 6 1/2 digit Bench Multimeter. True RMS/4 wire/Current Converter. **£225**

**Racal Receiver RA1772** 50kHz-30MHz. L.E.D. Display, Basically working. **£250**

**MARCONI 2019A**

**AM/FM SYNTHESISED SIGNAL GENERATOR** 80 kHz - 1040MHz. **£400** NOW ONLY

**MARCONI 893C** AF Power Meter, Sinad Measurement. Unused £100, Used £60. £30  
**MARCONI 893B**, No Sinad. £195  
**MARCONI 2610** True RMS Voltmeter, Autoranging, 5Hz-25MHz. £195  
**GOULD J3B** Sine/Sq Osc., 10Hz-100kHz, low distortion. **£75-£125**  
AVO 8 Mk. 6 in Every Ready case, with leads etc. £80  
Other AVOs from **£50**  
**GOODWILL GVT427** Dual Ch AC Millivoltmeter, 10mV-300V in 12 ranges, Freq. 10Hz-1MHz. £100-£125  
**SOLARTRON 7150** DMM 6 1/2 digit. £95-£150  
**SOLARTRON 7150 Plus**. £200

**HIGH QUALITY RACAL COUNTERS**  
9904 Universal Timer Counter, 50MHz. £50  
9916 Counter, 10Hz-520MHz. £75  
9918 Counter, 10Hz-560MHz, 9-digit. £50  
**WAYNE KERR B424** Component Bridge. £125  
**RACAL/AIN 9343M** LCR Databridge. Digital Automeasurement of R, C, L, Q, D. £200  
**HUNTRON TRACKER Model 1000**. £125  
**FLUKE 8050A** 4-5 Digit, 2A, True RMS. £175  
**FLUKE 8010A** 3-5 Digit, 10A. £50  
**FLUKE 8012A** 3-5 Digit, 2A. £40

**Racal 9008** ONLY **£95**  
Automatic Modulation Meter, AM/FM 1-5MHz-2GHz.

**Portable Appliance Tester** Megger Pat 2. **£180** ONLY

**H.P. 8012B** DC PSU 0-60V, 0-50A, 1000W. £1000  
**FARNELL AP60/50** 1KW Autoranging. £1000  
**FARNELL H60/50** 0-60V 0-50A. £750  
**FARNELL H60/25** 0-60V 0-25A. £400  
**Power Supply HPS3010**, 0-30V, 0-10A. £140  
**FARNELL L30-2** 0-30V, 0-2A. £80  
**FARNELL L30-1** 0-30V, 0-1A. £60  
Many other Power Supplies available

**FARNELL DTV12-14 OSCILLOSCOPE.**

Dual trace, 12MHz TV, coupling. ONLY **£75**  
**FARNELL LF1 SINE/SQ OSCILLATOR.** 10Hz-1MHz. ONLY **£75**

**OSCILLOSCOPES**  
TEKTRONIX TDS350 dual trace, 200MHz, 1G/S. Unused £1500  
TEKTRONIX TDS320 dual trace, 100MHz, 500MS. £1200  
TEKTRONIX TDS310 dual trace, 50MHz, 200MS. £950  
LECROY 9400A dual trace, 175MHz, 5G/S. £750  
HITACHI VC6523, 0 trace, 20MHz, 20MS, delay etc. Unused £500  
PHILIPS PM3092 2+2-ch., 200MHz, delay etc. £800 as new £350  
PHILIPS PM3082 2+2-ch., 100MHz, delay etc. £700 as new £200  
TEKTRONIX TDS310 100MHz, delay etc. £750  
TEKTRONIX TDS310 100MHz, delay etc. £750  
TEKTRONIX TDS310 100MHz, delay etc. £750  
TEKTRONIX 2465 4-ch., 300MHz, delay cursors etc. £900  
TEKTRONIX 468 Dig. Storage, dual trace, 100MHz, delay. £450  
TEKTRONIX 466 Analogue Storage, dual trace, 100MHz. £250  
TEKTRONIX 485 dual trace, 350MHz, delay sweep. £550  
TEKTRONIX 475 dual trace, 200MHz, delay sweep. £350  
TEKTRONIX 465B dual trace, 100MHz, delay sweep. £325  
TEKTRONIX 2215 dual trace, 60MHz, delay sweep. £250  
PHILIPS PM3217 dual trace, 50MHz, delay. £200-£250  
GOULD O51100 dual trace, 30MHz, delay. £125  
HAMEG HM303.6 dual trace, 35MHz component tester. £200  
HAMEG HM303 dual trace, 30MHz component tester. £200  
Many other Oscilloscopes available

**MARCONI 2022E** Synth AM/FM Sig Gen 10kHz-1.01GHz L.c.d. display etc. £525-£750  
**H.P. 8657A** Synth sig gen, 100kHz-1040MHz. £2000  
**H.P. 8656B** Synth sig gen, 100kHz-990MHz. £1350  
**H.P. 8656A** Synth sig gen, 100kHz-990MHz. £995  
**RIS APN62** Synth, 1Hz-260kHz sig. gen., balanced/unbalanced output, i.c.d. display. £425  
**PHILIPS PM5328** sig gen, 100kHz-180MHz with 20MHz, freq. counter, IEEE. £550  
**RACAL 9081** Synth AM/FM sig gen, 5kHz-1024MHz. £500  
**H.P. 3325A** Synth function gen, 21MHz. £500  
**MARCONI 6500** Amplitude Analyser. £1500  
**H.P. 4192A** Impedance Analyser. £5000  
**H.P. 4275A** LCR Meter, 10kHz-10MHz. £2750  
**H.P. 8903A** Distortion Analyser. £1000  
**WAYNE KERR 3245** Inductance Analyser. £2000  
**H.P. 8112A** Pulse Generator, 50MHz. £1250  
**MARCONI 2440** Frequency Counter, 20GHz. £1000  
**H.P. 5350B** Frequency Counter, 20GHz. £2000  
**H.P. 5342A** 10Hz-18GHz Frequency Counter. £800  
**H.P. 1650B** Logic Analyser, 80-channel. £1000  
**MARCONI 2035** Mod Meter, 500kHz-2GHz. £750

**RADIO COMMUNICATIONS TEST SETS**  
**MARCONI 2955/2955A** From £1500  
**RHODE & SCHWARZ CMT 0-1-1000MHz**. £2000  
**SCHLUMBERGER 4040**. £900

**JUST IN**

**H.P. 6063B** DC Electronic Load, 3-240V0-10A, 250W. POA £800  
**H.P. 66312A** PSU, 0-20V0-2A. £400  
**H.P. 66311B** PSU, 0-15V0-3A. £400  
**H.P. 66300D** PSU Dual, 0-15, 0-3A/0-12, 0-1.5A. £750  
**H.P. 6632B** PSU, 0-20V0-5A. £500  
**H.P. 6623A** PSU, triple output ranging from 0-7V 0-5A to 0-20V 0-4A. £650  
**H.P./AGILENT 34041A** DMM 6 1/2 digit. £400/£450  
**H.P. 3478A** DMM 5 1/2 digit. £275  
**FLUKE 45** DMM dual display. £400  
**KETHLEY 610** DMM 7 1/2 digit. £950  
**KETHLEY 617** Programmable Electrometer. £1250  
**H.P. 43388** Microammeter. £1500  
**RACAL** Counter type 1989 2GHz. £350  
**H.P. Counter type 53131A** 3GHz. £850  
**H.P./AGILENT 33120A** Func. Gen/ARB, 100kHz-15MHz frequency counter. £900/£1000  
**SONY/TEKTRONIX AFG320** Arbitrary Func. Gen. £1250  
**H.P. 8904A** Syn. Func. Gen. DC-600kHz. £1000/£1250  
**BLACK STAR JUPITER 2010** Func. Gen. 0-2Hz-2MHz with frequency counter. £140  
**H.P. 8116A** Pulse Generator, 1mH-50MHz. £1950  
**H.P. 8657B** Syn Sig. Gen. 0-1-2080MHz. £2500  
**CO-AXIAL SWITCH**, 1-5GHz. £40  
**IEEE CABLES**. £10

**SPECTRUM ANALYSERS**

**H.P. 8561B** 50Hz-6.5GHz. £5000  
**H.P. 8560A** 50Hz-2.9GHz synthesised. £5000  
**H.P. 8594E** 9kHz-2.9GHz. £4500  
**H.P. 8591E** 1MHz-1.8GHz, 75 Ohm. £2750  
**H.P. 853A** with 8559A 100kHz-21GHz. £1750  
**H.P. 8558B** with Main Frame, 100kHz-1500MHz. £750  
**H.P. 3585A** 20Hz-40MHz. £2500  
**H.P. 3580A** 5Hz-50kHz. £360  
**ADVANTEST RA131B** 10kHz-3.5GHz. £2750  
**EATON/WALTECH 757** 0.001-22GHz. £750  
**MARCONI 2382** 100kHz-400MHz, high resolution. £2000  
**MARCONI 2370** 30Hz-110MHz. from £500  
**H.P. 182** with 8557 10kHz-350MHz. £500  
**H.P. 141T SYSTEMS**  
8553 1Hz-110MHz. £500  
8554 500kHz-1250MHz. £750  
8555 10MHz-18GHz. £1000  
**H.P. 8443** Tracking Gen/Counter, 110MHz. £250  
**H.P. 8444** OPT 059. £1000  
**B&K 2033R** Signal Analyser. £650  
**H.P. 8754A** Network Analyser, 4MHz-1300MHz. £1250  
**H.P. 3557A** Network Analyser, 5Hz-200MHz. £3000  
**H.P. 5310A** Mod Domain Analyser Opt 001/000. £5000  
**ONO SOKKI CF300** Portable FFT Analyser. £1500  
**H.P. 8720C** Microwave Network Analyser, 50MHz-20GHz. £12,500

**STEWART of READING**  
110 WYKHAM ROAD, READING, BERKS. RG6 1PL  
Telephone: (0118) 9268041. Fax: (0118) 9351696  
www.stewart-of-reading.co.uk  
Callers welcome 9am-5.30pm Monday to Friday (other times by arrangement)

**Used Equipment - GUARANTEED. Manuals supplied**  
This is a VERY SMALL SAMPLE OF STOCK. SAE or Telephone for lists.  
Please check availability before ordering.  
CARRIAGE all units £16. VAT to be added to Total of Goods and Carriage



## Learn to Program in C with FED !

Free book provides complete introduction to C programming for the PIC

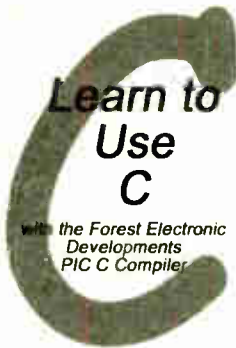

Our free book will take you through the process of learning C from variables through constants to pointers and then structures and unions. Most of the examples are standalone and are as small as possible to enable the purpose and effect to be easily understood. Nearly all can be run on our PIC C Compiler simulator so you can experiment quickly - but code can also be run on practically any C Compiler.

- Start to use C for the PIC – standard portable code with a standard syntax designed to be “close” to the processor for efficiency in size and speed
- Suitable for beginners or BASIC programmers
- Covers Comments and Statements, Variables and Constants, Expressions, Functions, Program Control, Pointers, Structures & Unions, and the Pre-processor.
- The final example is a comprehensive real time programming application showing the simultaneous use of LCD, keypads, timers, clocks and ports
- Examples will run on our development board
- Soft copy of examples provided - ready to run on the PIC C Compiler
- Examples will run on other C Compilers

Download Free of Charge – [www.fored.co.uk/ccomp.htm](http://www.fored.co.uk/ccomp.htm) (follow the link “Learn C with FED”)

## FED – PIC C Compiler products

### WIZ – C Visual Development for the FED PIC C Compiler

- An application designer for the FED PIC C Compiler FULLY including the PIC C Compiler
- Drag a software component on to your design & set up the parameters using check boxes, drop down boxes and edit boxes (see shot below)
- Connect the component to the PIC pins using the mouse
- Select your own C functions to be triggered when events occur (e.g. Byte received, timer overflow etc.)
- Simulate, Trace at up to 10x the speed of MPLAB
- Generate the base application automatically and then add your own functional code in C or assembler
- Supports over 80 PICS - 16F87x, 16F627/8, 16C55x, 16C6x, 16F8x, 16C7xx 18Cxx, 18Fxxx, 12F629/675 etc.
- Demonstration download available :

[www.fored.co.uk/CDemo.htm](http://www.fored.co.uk/CDemo.htm)

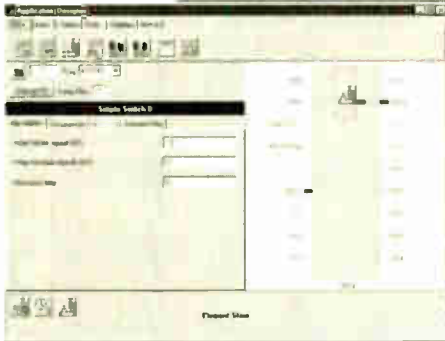

Screen shot (left) shows push button element connected to the PIC, Parameters may be set to control debounce and repeat. C function may be specified to call when the button is pressed

### FED PIC C Compiler

- C Compiler designed to ANSI standards
- Supplied with library routines for C standard functions and many interface applications including I2C, LCD, LED's, timers, EEPROM, IRDA, Dallas 1 Wire, Hex Keypad, Maths, asynchronous serial interfacing, clocked data etc.
- With complete development/simulation environment including LCD/Keypad/LED/RS232 terminal
- View your simulation on a logic analyser application showing waveforms, timing or analogue results
- Profiler shows execution count, execution time and average time for functions and code blocks
- Smart linker – efficiently tiles routines throughout memory to minimise long jumps and page setting bits
- Supports the FED In Circuit Debugger for 16F87x and 18Fxx devices

### WIZ-C and C Compiler Pricing :

PIC C Compiler	£60.00
PIC C Compiler Professional	£90.00
WIZ-C	£70.00
WIZ-C Professional	£100.00

WIZ-C products are provided with introductory tutorial, full extensive manuals provided on CD.

All prices may be reduced by £20.00 if the product is purchased at the same times as WIZ-ASM, or serial programmer, or our Development board.

### In Circuit Debugger Supports 16F87x and 18Fxxx

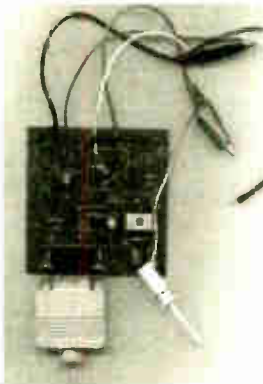

- Allows real hardware to be examined & programs to be debugged and to be run in real time on your application
- The FED ICD requires only one data I/O pin on the PIC which can be chosen from any of ports B, C or D.
- Can program and re-program applications in circuit
- Up to 13 breakpoints (18F version)
- Run. Animate single step and step over, run to cursor line, set PC to any value in the program
- Trace execution in the original C or Assembler source files
- View and change values of PIC special function registers. W and the ports
- Standard serial interface to PC

### Programmers and Development Board (See web pages)

**PIC Programmer** – Handles serially programmed PIC devices in a 40 pin multi-width ZIF socket. 16C55X, 16C6X, 16C7X, 16C8x, 16F62x, 16F8X, 12C508, 12C509, 16C72XPIC 14C00, 16F87X, 18Cxxx, 18Fxxx, 12F6xx etc.

Also In-Circuit programming. Operates on PC serial port

Price : £45/kit, £50/built & tested

**Development Board** – For ALL 40 pin PICS from 16cxxx, 16Fxxx and 18C/Fxxx. Includes In-Circuit Programmer – NO separate programmer required. LCD interface, hex keypad, LED's and Driver, 32 I/O pins on header, I2C EEPROM, 2 Serial Interfaces, Will run FED PIC BASIC (supplied free on CD ROM), 1A 5V regulator etc.

The CD-ROM is supplied with FED PIC BASIC and Compiler  
Price : £45/kit, £50/built & tested, CD - £5.00. Manual on CD-ROM or download free from our web site

Forest Electronic Developments  
12 Buldowne Walk, Sway,  
LYMINGTON, Hampshire, SO41 6DU  
Email – [info@fored.co.uk](mailto:info@fored.co.uk)  
Web Site – <http://www.fored.co.uk>  
01590-681511 (Voice/Fax)



Prices Please add £3.00 for P&P and handling to each order, and then EU residents add VAT at 17.5%. Cheques/POs payable to Forest Electronic Developments, phone with credit card details, or order from our secure web site



## MAIL ORDER ONLY • CALLERS BY APPOINTMENT

### EPE PROJECT PICS

Programmed PICs for \*EPE Projects

12C508/9 - £3.90; 16F627/8 - £4.90

16C84/16F84/16C71 - £5.90

16F876/877 - £10.00

All inc. VAT and Postage

(\*Some projects are copyright)

### EPE MICROCONTROLLER P.I. TREASURE HUNTER

The latest MAGENTA DESIGN - highly stable & sensitive - with I.C. control of all timing functions and advanced pulse separation techniques.

- High stability drift cancelling
- Easy to build & use
- No ground effect, works in seawater



- Detects gold, silver, ferrous & non-ferrous metals

- Efficient quartz controlled microcontroller pulse generation.
- Full kit with headphones & all hardware

**KIT 847 ..... £63.95**

### PIC PIPE DESCALER

- SIMPLE TO BUILD
- HIGH POWER OUTPUT
- AUDIO & VISUAL MONITORING
- SWEPT FREQUENCY

An affordable circuit which sweeps the incoming water supply with variable frequency electromagnetic signals. May reduce scale formation, dissolve existing scale and improve lathering ability by altering the way salts in the water behave.

Kit includes case, P.C.B., coupling coil and all components. High coil current ensures maximum effect. L.E.D. monitor.

**KIT 868 ..... £22.95**

**POWER UNIT.....£3.99**



### MICRO PEST SCARER

Our latest design - The ultimate scarer for the garden. Uses special microchip to give random delay and pulse time. Easy to build reliable circuit. Keeps pets/pests away from newly sown areas, play areas, etc. uses power source from 9 to 24 volts.

- RANDOM PULSES
- HIGH POWER
- DUAL OPTION

**KIT 867.....£19.99**

**KIT + SLAVE UNIT.....£32.50**



Plug-in power supply £4.99

### WINDICATOR

A novel wind speed indicator with LED readout. Kit comes complete with sensor cups, and weatherproof sensing head. Mains power unit £5.99 extra.

**KIT 856.....£28.00**

## ★ TENS UNIT ★

### DUAL OUTPUT TENS UNIT

As featured in March '97 issue.

Magenta have prepared a FULL KIT for this excellent new project. All components, PCB, hardware and electrodes are included. Designed for simple assembly and testing and providing high level dual output drive.

**KIT 866. . Full kit including four electrodes £32.90**

Set of 4 spare electrodes  
**£6.50**

### 1000V & 500V INSULATION TESTER



Superb new design. Regulated output, efficient circuit. Dual-scale meter, compact case. Reads up to 200 Megohms.

Kit includes wound coil, cut-out case, meter scale, PCB & ALL components.

**KIT 848.....£32.95**

## EPE TEACH-IN 2000

Full set of top quality NEW components for this educational series. All parts as specified by EPE. Kit includes breadboard, wire, croc clips, pins and all components for experiments, as listed in introduction to Part 1.

\*Batteries and tools not included.

**TEACH-IN 2000 -**

**KIT 879 £44.95**

**MULTIMETER £14.45**

### SPACEWRITER

An innovative and exciting project. Wave the wand through the air and your message appears. Programmable to hold any message up to 16 digits long. Comes pre-loaded with "MERRY XMAS". Kit includes PCB, all components & tube plus instructions for message loading.

**KIT 849 .....£16.99**



### 12V EPROM ERASER

A safe low cost eraser for up to 4 EPROMS at a time in less than 20 minutes. Operates from a 12V supply (400mA). Used extensively for mobile work - updating equipment in the field etc. Also in educational situations where mains supplies are not allowed. Safety interlock prevents contact with UV.

**KIT 790 .....£29.90**

### SUPER BAT DETECTOR

1 WATT O/P, BUILT IN SPEAKER, COMPACT CASE 20kHz-140kHz NEW DESIGN WITH 40kHz MIC.

A new circuit using a 'full-bridge' audio amplifier i.c., internal speaker, and headphone/tape socket. The latest sensitive transducer, and 'double balanced mixer' give a stable, high performance superheterodyne design.

**KIT 861 .....£24.99**

ALSO AVAILABLE Built & Tested... £39.99



### 68000 DEVELOPMENT TRAINING KIT

- NEW PCB DESIGN
- 8MHz 68000 16-BIT BUS
- MANUAL AND SOFTWARE
- 2 SERIAL PORTS
- PIT AND I/O PORT OPTIONS
- 12C PORT OPTIONS

**KIT 621**

**£99.95**

- ON BOARD 5V REGULATOR
- PSU £6.99

• SERIAL LEAD £3.99

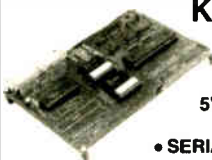

### Stepping Motors

MD100...Std 100 step...£9.99

MD200...200 step...£12.99

MD24...Large 200 step...£22.95



### MOSFET MKII VARIABLE BENCH POWER SUPPLY 0-25V 2.5A

Based on our Mk1 design and preserving all the features, but now with switching pre-regulator for much higher efficiency. Panel meters indicate Volts and Amps. Fully variable down to zero. Toroidal mains transformer. Kit includes punched and printed case and all parts. As featured in April 1994 EPE. An essential piece of equipment.



Kit No. 845 .....£64.95

### ULTRASONIC PEST SCARER

Keep pets/pests away from newly sown areas, fruit, vegetable and flower beds, children's play areas, patios etc. This project produces intense pulses of ultrasound which deter visiting animals.

- KIT INCLUDES ALL COMPONENTS, PCB & CASE
- EFFICIENT 100V TRANSDUCER OUTPUT
- COMPLETELY INAUDIBLE TO HUMANS
- UP TO 4 METRES RANGE
- LOW CURRENT DRAIN

**KIT 812.....£15.00**



### SIMPLE PIC PROGRAMMER

**KIT 857... £12.99**

Includes PIC16F84 chip disk, lead, plug, p.c.b., all components and instructions

Extra 16F84 chips £3.84 Power Supply £3.99



## MAGENTA BRAINBOT I & II

- Full kit with ALL hardware and electronics
- As featured in *EPE* Feb '03 - KIT 910
- Seeks light, beeps, avoids obstacles
- Spins and reverses when 'cornered'
- Uses 8-pin PIC
- ALSO KIT 911 - As 910 PLUS programmable from PC serial port - leads and software CD provided

**NEW**



**KIT 910 £16.99    KIT 911 £24.99**

## PIC 16F84 MAINS POWER 4-CHANNEL CONTROLLER & LIGHT CHASER

- ZERO VOLT SWITCHING
- OPTO ISOLATED 5 Amp
- 12 KEYPAD CONTROL
- HARD-FIRED TRIACS
- WITH SOURCE CODE
- SPEED & DIMMING POT.
- EASILY PROGRAMMED

**Kit 855 £39.95**

## PIC 16F84 LCD DISPLAY DRIVER

INCLUDES 1-PIC16F84 WITH DEMO PROGRAM SOFTWARE DISK, PCB, INSTRUCTIONS AND 16-CHARACTER 2-LINE LCD DISPLAY

**Kit 860 £19.99**

Power Supply £3.99

FULL PROGRAM SOURCE CODE SUPPLIED - DEVELOP YOUR OWN APPLICATION!

Another super PIC project from Magenta. Supplied with PCB, industry standard 2-LINE x 16-character display, data, all components, and software to include in your own programs. Ideal development base for meters, terminals, calculators, counters, timers - Just waiting for your application!

## 8-CHANNEL DATA LOGGER

As featured in Aug./Sept. '99 *EPE*. Full kit with Magenta redesigned PCB - LCD fits directly on board. Use as Data Logger or as a test bed for many other 16F877 projects. Kit includes programmed chip, 8 EEPROMs, PCB, case and all components.

**KIT 877 £49.95 inc. 8 x 256K EEPROMS**

## ICEBREAKER

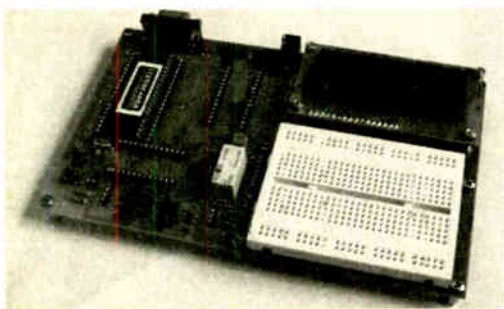

## PIC Real Time In-Circuit Emulator

- Icebreaker uses PIC16F877 in circuit debugger
- Links to Standard PC Serial Port (lead supplied)
- Windows™ (95+) Software included
- Works with MPASM and MPLAB Microchip software
- 16 x 2 L.C.D., Breadboard, Relay, I/O devices and patch leads supplied

As featured in March '00 *EPE*. Ideal for beginners AND advanced users. Programs can be written, assembled, downloaded into the microcontroller and run at full speed (up to 20MHz), or one step at a time.

Full emulation means that all I/O ports respond exactly and immediately, reading and driving external hardware. Features include: Reset; Halt on external pulse; Set Breakpoint; Examine and Change registers, EEPROM and program memory; Load program, Single Step with display of Status, W register, Program counter, and user selected 'Watch Window' registers.

**KIT 900 . . . £34.99**

POWER SUPPLY £3.99    STEPPING MOTOR 100 STEP £9.99

## EPE PIC TOOLKIT 3

**NEW**

- THE LATEST TOOLKIT BOARD - 8, 18, 28 AND 40-PIN CHIPS
- MAGENTA DESIGNED P.C.B. WITH COMPONENT LAYOUT AND EXTRAS
- L.C.D., BREADBOARD AND PIC CHIP INCLUDED
- ALL TOP QUALITY COMPONENTS AND SOFTWARE SUPPLIED

**KIT 880 . . . £34.99 with 16F84 . . . £39.99 with 16F877**

## PIC TOOLKIT V2

- SUPER UPGRADE FROM V1 • 18, 28 AND 40-PIN CHIPS
- READ, WRITE, ASSEMBLE & DISASSEMBLE PICS
- SIMPLE POWER SUPPLY OPTIONS 5V-20V
- ALL SWITCHING UNDER SOFTWARE CONTROL
- MAGENTA DESIGNED PCB HAS TERMINAL PINS AND OSCILLATOR CONNECTIONS FOR ALL CHIPS
- INCLUDES SOFTWARE AND PIC CHIP

**KIT 878 . . . £22.99 with 16F84 . . . £29.99 with 16F877**

## EPE PIC Tutorial

At last! A Real, Practical, Hands-On Series

- Learn Programming from scratch using PIC16F84
- Start by lighting I.e.d.s and do 30 tutorials to Sound Generation, Data Display, and a Security System.
- PIC TUTOR Board with Switches, I.e.d.s, and on board programmer

## PIC TUTOR BOARD KIT

Includes: PIC16F84 Chip, TOP Quality PCB printed with Component Layout and all components\* (\*not ZIF Socket or Displays). Included with the Magenta Kit is a disk with Test and Demonstration routines.

**KIT 870 .... £27.95, Built & Tested .... £42.95**

Optional: Power Supply - £3.99, ZIF Socket - £9.99

LCD Display ..... £7.99    LED Display ..... £6.99

Reprints Mar/Apr/May 98 - £3.00 set 3

## SUPER PIC PROGRAMMER

- READS, PROGRAMS, AND VERIFIES
- WINDOWS® SOFTWARE
- PIC16C AND 16F - 6X, 7X, AND 8X
- USES ANY PC PARALLEL PORT
- USES STANDARD MICROCHIP • HEX FILES
- OPTIONAL DISASSEMBLER SOFTWARE (EXTRA)
- PCB, LEAD, ALL COMPONENTS, TURNED-PIN SOCKETS FOR 18, 28, AND 40 PIN ICs

- SEND FOR DETAILED INFORMATION - A SUPERB PRODUCT AT AN UNBEATABLE LOW PRICE.

**Kit 862    £29.99**

Power Supply £3.99

**DISASSEMBLER SOFTWARE    £11.75**

## PIC STEPPING MOTOR DRIVER

INCLUDES PCB, PIC16F84 WITH DEMO PROGRAM, SOFTWARE DISC, INSTRUCTIONS AND MOTOR.

**Kit 863 £18.99**

FULL SOURCE CODE SUPPLIED ALSO USE FOR DRIVING OTHER POWER DEVICES e.g. SOLENOIDS

Another Magenta PIC project. Drives any 4-phase unipolar motor - up to 24V and 1A. Kit includes all components and 48 step motor. Chip is pre-programmed with demo software, then write your own, and re-program the same chip! Circuit accepts inputs from switches etc and drives motor in response. Also runs standard demo sequence from memory.

# MAGENTA

All prices include VAT. Add £3.00 p&p. Next day £6.99

Tel: 01283 565435    Fax: 01283 546932    E-mail: sales@magenta2000.co.uk



032003



**Station Road, Cullercoats, Tyne & Wear, NE30 4PQ**

Prices Exclude Vat @17.5%  
UK Carriage £1.50 (less than 1kg)  
£3.50 greater than 1kg  
Cheques / Postal orders payable to  
ESR Electronic Components.  
PLEASE ADD CARRIAGE & VAT TO ALL ORDERS



See Next / Last Months Ad. for  
**ELECTRONIC COMPONENTS**

**DIL Sockets**

<b>Stamped Pin</b>	
3 Pin DIL 0.3"	£0.07
8 Pin DIL 0.3"	£0.06
14 Pin DIL 0.3"	£0.11
16 Pin DIL 0.3"	£0.11
18 Pin DIL 0.3"	£0.12
20 Pin DIL 0.3"	£0.12
24 Pin DIL 0.6"	£0.12
28 Pin DIL 0.6"	£0.13
40 Pin DIL 0.6"	£0.19
<b>Turned Pin</b>	
8 Pin DIL 0.3"	£0.11
14 Pin DIL 0.3"	£0.20
16 Pin DIL 0.3"	£0.23
18 Pin DIL 0.3"	£0.25
20 Pin DIL 0.3"	£0.28
24 Pin DIL 0.6"	£0.35
28 Pin DIL 0.6"	£0.39
40 Pin DIL 0.6"	£0.64
<b>ZIF Sockets</b>	
Universal ZIF DIL Sockets	
24 Way 0.3-0.6"	£5.85
28 Way 0.3-0.6"	£6.60
32 Way 0.3-0.6"	£7.50
40 Way 0.3-0.6"	£8.93
<b>Transistor Sockets</b>	
T018-4 Base Socket	£0.24
T05 Base Socket	£0.24
<b>IDC Cable Sockets</b>	
10 Way Socket	£0.23
14 Way Socket	£0.35
16 Way Socket	£0.37
20 Way Socket	£0.37
26 Way Socket	£0.38
34 Way Socket	£0.39
40 Way Socket	£0.55
50 Way Socket	£0.80
<b>IDC Cable Plugs</b>	
10 Way Plug	£0.52
14 Way Plug	£0.58
16 Way Plug	£0.62
20 Way Plug	£0.66
26 Way Plug	£0.70
34 Way Plug	£0.82
40 Way Plug	£0.92
50 Way Plug	£1.12
<b>PCB Box Headers</b>	
10 Way Straight	£0.22
14 Way Straight	£0.33
16 Way Straight	£0.32
20 Way Straight	£0.41
26 Way Straight	£0.55
34 Way Straight	£0.68
40 Way Straight	£0.68
50 Way Straight	£1.03
10 Way 90	£0.32
14 Way 90	£0.39
16 Way 90	£0.42
20 Way 90	£0.62
26 Way 90	£0.63
34 Way 90	£0.81
40 Way 90	£1.17
50 Way 90	£1.14
<b>PCB Latch Headers</b>	
10 Way Straight	£0.39
14 Way Straight	£0.45
16 Way Straight	£0.51
20 Way Straight	£0.55
26 Way Straight	£0.73
34 Way Straight	£0.88
40 Way Straight	£0.92
50 Way Straight	£1.27
10 Way 90	£0.46
14 Way 90	£0.48
16 Way 90	£0.54
20 Way 90	£0.59
26 Way 90	£0.81
34 Way 90	£1.03
40 Way 90	£1.23
50 Way 90	£1.41
<b>DIL Headers</b>	
14 Way DIL	£0.51
16 Way DIL	£0.53
24 Way DIL	£0.90
40 Way DIL	£1.37

**Transition Headers**

10 Way Transition	£0.42
14 Way Transition	£0.42
16 Way Transition	£0.48
20 Way Transition	£0.48
26 Way Transition	£0.52
34 Way Transition	£0.56
40 Way Transition	£0.63
50 Way Transition	£0.84
<b>Large Range of Connectors in stock - Few Connectors Catalogue now available see our web site for details.</b>	

**D Type Connectors**

9 Way Male Plug	£0.20
9 Way Female Socket	£0.20
15 Way Male Plug	£0.27
15 Way Female Socket	£0.29
15 Way H.D. Plug	£0.42
15 Way H.D. Socket	£0.45
23 Way Male Plug	£0.60
23 Way Female Socket	£0.66
25 Way Male Plug	£0.30
25 Way Female Socket	£0.35
<b>IDC Ribbon Mounting</b>	
9 Way Male Plug	£1.08
9 Way Female Socket	£0.93
15 Way Male Plug	£1.30
15 Way Female Socket	£1.32
25 Way Male Plug	£1.10
25 Way Female Socket	£1.13
IDC Crimp Tool	£11.80
<b>Right Angled PCB</b>	
9 Way Male Plug	£0.33
9 Way Female Socket	£0.33
15 Way Male Plug	£0.39
15 Way Female Socket	£0.39
15 Way H.D. Socket	£0.58
25 Way Male Plug	£0.58
25 Way Female Socket	£0.50
<b>Plastic D Covers</b>	
9 Way Cover - Grey	£0.27
9 Way Cover - Black	£0.30
15 Way Cover - Grey	£0.30
15 Way Cover - Black	£0.40
25 Way Cover - Grey	£0.38
25 Way Cover - Black	£0.34
25 Way Cover - 8 Pole	£0.37
9 to 9 Cover / Case	£0.80
25 to 25 Cover / Case	£0.84
9 to 25 Cover / Case	£0.80

**Solder Basket**

9 Way Male Plug	£0.20
9 Way Female Socket	£0.20
15 Way Male Plug	£0.27
15 Way Female Socket	£0.29
15 Way H.D. Plug	£0.42
15 Way H.D. Socket	£0.45
23 Way Male Plug	£0.60
23 Way Female Socket	£0.66
25 Way Male Plug	£0.30
25 Way Female Socket	£0.35

**IEC Mains 6A 250Vac**

3 Pin IEC Line Socket	£1.08
3 Pin IEC Line Plug	£0.85
3 Pin Chassis Socket	£0.56
3 Pin Chassis Plug	£0.56
<b>8 Way Bulgin</b>	
8 Pin Line Plug P551	£3.58
8 Pin Chassis Skt P552	£1.28

**Toggle Switches**

3A 125V 1A 250V	
5mm Ø Mounting Hole	
SPST 5 x 10mm	£0.47
SPDT 5 x 10mm	£0.53
SPDT c/o 5 x 10mm	£1.01
DPDT 9.2 x 10mm	£0.63
<b>Miniature</b>	
6A 125V 3A 250V	
6.2mm Ø Mounting Hole	
SPST 8 x 13mm	£0.58
SPDT 8 x 13mm	£0.55
SPDT c/o 8 x 13mm	£0.65
SPDT c/o Biased 2 way 11.8	£1.15
DPDT 12 x 13mm	£0.65
DPDT c/o 12 x 13mm	£0.88
DPDT c/o Biased 2W	£1.20
DPDT c/o Biased 1W	£1.28

**Standard**

10A 250V Push on terminals	
12mm Ø Mounting Hole	
SPST 18 x 30mm	£1.05
SPDT 18 x 30mm	£1.18
SPDT c/o 18 x 30mm	£1.18
DPDT 21 x 30mm	£1.78
DPDT c/o 21 x 30mm	£1.78

**Slide Switches**

Red Line Plug	£0.20
Black Line Plug	£0.20
Yellow Line Plug	£0.20
White Line Plug	£0.20
Red Line Socket	£0.20
Black Line Socket	£0.20
Yellow Line Socket	£0.20
White Line Socket	£0.20
Red Chassis Socket	£0.20
Black Chassis Socket	£0.20
Gold Plated Plug Red	£0.68
Gold Plated Plug Black	£0.68
<b>XLR Series - metal</b>	
3 Pin Line Plug	£0.94
3 Pin Line Socket	£0.94
3 Pin Chassis Plug	£1.23
3 Pin Chassis Socket	£1.22
Neutrik Line Plug	£1.80
Neutrik Line Socket	£2.10
Neutrik Chassis Plug	£2.24
Neutrik Chassis Socket	£2.40

**Audio Connectors**

2.5mm Jack Plug	£0.25
2.5mm Line Socket	£0.24
2.5mm Chassis Socket	£0.12
3.5mm Mono Plug	£0.24
3.5mm Mono Line Skt	£0.24
3.5mm Mono Chassis	£0.14
3.5mm Stereo Plug	£0.35
3.5mm Stereo Line Skt	£0.36
3.5mm Stereo Chassis	£0.22
4 Mono Plug	£0.30
4 Mono Line Socket	£0.36
4 Mono Chassis Skt	£0.46
4 Stereo Plug	£0.36
4 Stereo Line Socket	£0.36
4 Stereo Chassis Skt	£0.38
Neutrik Speakon Plug	£2.85

**Phono Series**

10 Way Straight	£0.39
14 Way Straight	£0.45
16 Way Straight	£0.51
20 Way Straight	£0.55
26 Way Straight	£0.73
34 Way Straight	£0.88
40 Way Straight	£0.92
50 Way Straight	£1.27
10 Way 90	£0.46
14 Way 90	£0.48
16 Way 90	£0.54
20 Way 90	£0.59
26 Way 90	£0.81
34 Way 90	£1.03
40 Way 90	£1.23
50 Way 90	£1.41

**Rotary Switches**

150mA 250V Moke before	
Break 22mm Ø	
9.8mm Ø Mounting Hole	
1 Pole 12 Way	£0.84
2 Pole 6 Way	£0.84
3 Pole 4 Way	£0.84
4 Pole 3 Way	£0.84

**RF Connectors**

8NC Plug 50Ω Solder	£0.99
8NC Plug 50Ω Crimp	£0.68
8NC Plug 75Ω Solder	£1.08
8NC Plug 75Ω Crimp	£0.69
8NC Chassis Socket	£0.76
F Plug - Twist	£0.20
F Plug - Crimp	£0.20
TNC Plug 50Ω Solder	£1.08
TNC Plug 50Ω Crimp	£1.04
TNC Plug 75Ω Solder	£1.17
TNC Plug 75Ω Crimp	£0.96
UHF Plug 5mm Cable	£0.63
UHF Plug 11mm Cable	£0.72
UHF Chassis Skt - Sqr	£0.54
UHF Chassis Skt - Rnd	£0.75
Extensive range of RF connectors in stock, inc. FME, SMA, Mini UHF & N Type.	

**Terminals**

Colours Red, Black, Green, Blue, White or Yellow	
2mm Solder Plugs	£0.23
2mm Chassis Sockets	£0.28
4mm Plug - Solder	£0.34
4mm Plug - Screw	£0.38
4mm Stackable Plug	£0.40
4mm Shrouded Plugs	£0.74
4mm Chassis Sockets	£0.21
4mm Binding Posts	£0.48
33mm Crocodile Clips	£0.10

**Power Connectors**

DC Plug 0.71D 2.35OD	£0.47
DC Plug 1.31D 3.40OD	£0.17
DC Plug 1.71D 4.00OD	£0.44
DC Plug 1.71D 4.75OD	£0.50
DC Plug 2.11D 5.00OD	£0.24
DC Plug 2.51D 5.00OD	£0.24
DC Plug 3.11D 6.30OD	£0.53
DC Line Socket 2.5mm	£0.68
DC Line Socket 2.1mm	£0.44
DC Chassis Skt 2.1mm	£0.44
DC Chassis Skt 2.5mm	£0.44

**Computer Accessories**

9M Gender Changer	£1.73
9F Gender Changer	£1.73
25M Gender Changer	£2.20
25F Gender Changer	£2.43
9 Male - 25 Female	£1.73
9 Female - 25 Male	£1.73
9M - 6 Mini Din Male	£2.48
9F - 6 Mini Din Female	£2.23
5M Din - 6F Mini Din	£1.73
5F Din - 6M Mini Din	£1.73
<b>Testers / Patch Boxes</b>	
Mini Tester 7 LEDs	£4.72
Check Tester 18 LEDs	£6.32
Enhanced+ Switches	£15.18
25D Patch Box M-F	£2.64
Anti-Static Wrist Strap	£4.76
RS232 Surge Protector	£5.43
5A Surge Protector	£5.20
13A Surge Protector	£10.00
4 Gang Surge Block	£10.50
<b>Leads &amp; Cables</b>	
1.5m Printer Lead	£2.55
2m 8D Printer Lead	£2.98
5m 8D Printer Lead	£4.98
10m 8D Printer Lead	£9.88
2m IEEE1284 Printer L	£4.38
5m IEEE1284 Printer L	£8.90
10m IEEE1284 Printer L	£16.13
Serial Printer 25M-9F	£4.88
Serial Printer 25M-25F	£4.38
<b>Null Modem Leads</b>	
9 Female - 9 Female	£4.38
25 Female - 25 Female	£6.48
9 Female - 25 Female	£4.38
9825F to 9825F	£4.88
<b>Modem Leads</b>	
25Male to 9Female	£4.08
25Male to 25Female	£3.78
<b>PC Link Leads</b>	
Interlink 25M to 25M	£3.88
<b>Patch Leads</b>	
25Male to 25Male	£3.60
36Male to 36Male	£2.60
<b>Internal Leads</b>	
Floppy Cable A/8	£2.28
Hard Disk 2xIDE	£1.65
Hard Disk 2xATA66	£3.38
Power 3-2 x 3	£1.88
Power 5-2 x 5	£1.50
Power 5-2 x 3	£1.88
Power 5-2 x 3	£1.88
<b>Networking</b>	
BNC T Piece MF	£1.71
BNC Connector F	£0.81
BNC Rotchet Crimper	£15.68
50Ω BNC Terminator	£0.98
Thinned Cable per m	£0.38

**Push Switches**

<b>Miniature Round</b>	
250mA 125V 28 x 10mm	
7mm Ø Mounting Hole	
Non Latching Push to Make	
Black, Red, Yellow, Green	
Blue or White	£0.23
Non Latching Push to Break	
Black PTB	£0.24
<b>Standard Square</b>	
1A 250V	
39 x 15MM	
17mm Ø Mounting Hole	
Non Latching Push to Make	
Black, Red, Blue	
or White	£0.60
Latching - push on push off	
Black, Red, Blue	
or White	£0.65

**Rocker Switches**

<b>Miniature</b>	
13 x 19mm Mounting Hole	
SPST 4A 250V	£0.57
SPST 6A Red Neon	£1.65
SPST 3A Red LED	£1.92
SPDT 6A 250V	£0.75
DPST 4A 250V	£0.81
DPST 4A Red Neon	£1.10
DPST 3A Amber Neon	£1.40
DPST 3A Green Neon	£1.32
<b>Standard</b> </	



EVERYDAY

# PRACTICAL ELECTRONICS

THE No.1 MAGAZINE FOR ELECTRONICS TECHNOLOGY &amp; COMPUTER PROJECTS

VOL. 32 No. 3 MARCH 2003

**Editorial Offices:**

EVERYDAY PRACTICAL ELECTRONICS EDITORIAL  
WIMBORNE PUBLISHING LTD., 408 WIMBORNE ROAD EAST,  
FERNDOWN, DORSET BH22 9ND  
Phone: (01202) 873872. Fax: (01202) 874562.

Email: enquiries@epemag.wimborne.co.uk

Web Site: www.epemag.wimborne.co.uk

EPE Online (downloadable version of EPE): www.epemag.com

EPE Online Shop: www.epemag.wimborne.co.uk/shopdoor.htm

See notes on **Readers' Technical Enquiries** below – we regret lengthy technical enquiries cannot be answered over the telephone.

**Advertisement Offices:**

EVERYDAY PRACTICAL ELECTRONICS ADVERTISEMENTS  
MILL LODGE, MILL LANE,  
THORPE-LE-SOKEN, ESSEX CO16 0ED

Phone/Fax: (01255) 861161 Email: epeads@aol.com

**OOPS!**

Another electronics magazine bites the dust. I have to say that I can't really understand why *Poptronics*, the American hobby electronics magazine formed from the merger of *Popular Electronics* and *Electronics Now* a couple of years ago, has now ceased publication. In a country the size of America and with a subscription list of over 30,000 readers it seems that something was not being managed too well. It is, of course, a great pity to lose yet another hobbyist magazine, even if its title was rather odd! We believe there is now just one hobbyist title in the USA, one in Australia and nothing in other English-speaking countries around the world, except, of course, imported magazines like *EPE*.

Even the famous *Wireless World* – now, of course, *Electronics World* – seems to have lost its way in the UK and is a poor shadow of its former self, selling much less than half the number of copies of *EPE* on the newsstands. At one time there were also a number of new web-based electronics magazines springing up, but they too seem to have fallen by the wayside (even though our own *EPE Online* edition remains very popular around the world). Having tried to link to some of them recently I was dismayed to find a number of unavailable sites or sites that had not been updated in the last year or so. Like a lot of web-based businesses, there does not seem to be the financial input to keep these sites going. Having said that, there are some excellent sites being run by hobbyists or engineers for their own enjoyment and for the furtherance of knowledge, so it is worth doing a bit of hunting around. Alan Winstanley's *Net Work Links* page (click on this at the top of the Home page on the *EPE UK* website) gives hundreds of links – everything from Aaron's Home page to Zetex and Zoom.

I'm pleased to say that our readers seem to be as keen on *EPE* as ever – just look at our letters page or our Chat Zone to see what I mean.

**OOPS!**

We can all make mistakes, of course, and I must apologise if I misled you last month. Our *Next Month* item (page 83 Feb '03 issue) incorrectly showed the *Function Generator* project as being 200MHz instead of 200kHz, although the accompanying text made the true figure clear. We apologise for the misleading heading, it just shows that once a basic mistake like that has been made how difficult it is to spot afterwards. Until, that is, the magazine comes back from the printers when everyone notices it straight away.

I can, however, recommend the design to you. Andy Flind always produces excellent projects and this 200kHz *Function Generator* is no exception – see page 197 for full details.

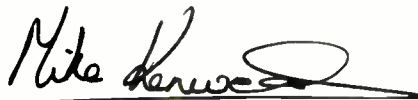
**AVAILABILITY**

Copies of *EPE* are available on subscription anywhere in the world (see opposite), from all UK newsagents (distributed by COMAG) and from the following electronic component retailers: Omni Electronics and Yebo Electronics (S. Africa). *EPE* can also be purchased from retail magazine outlets around the world. An Internet on-line version can be purchased and downloaded for just \$10.99US (approx £7) per year available from [www.epemag.com](http://www.epemag.com)

**SUBSCRIPTIONS**

Subscriptions for delivery direct to any address in the UK: 6 months £15.50, 12 months £29.50, two years £54; Overseas: 6 months £18.50 standard air service or £27.50 express airmail, 12 months £35.50 standard air service or £53 express airmail, 24 months £66 standard air service or £101 express airmail.

Online subscriptions, for downloading the magazine via the Internet, \$10.99US (approx £7) for one year available from [www.epemag.com](http://www.epemag.com).

Cheques or bank drafts (in £ sterling only) payable to *Everyday Practical Electronics* and sent to EPE Subs. Dept., Wimborne Publishing Ltd, 408 Wimborne Road East, Ferndown, Dorset BH22 9ND. Tel: 01202 873872. Fax: 01202 874562. Email: subs@epemag.wimborne.co.uk. Also via the Web at: <http://www.epemag.com>.

Subscriptions start with the next available issue. We accept MasterCard, Amex, Diners Club, Switch or Visa. (For past issues see the *Back Issues* page.)

**BINDERS**

Binders to hold one volume (12 issues) are available from the above address. These are finished in blue p.v.c., printed with the magazine logo in gold on the spine. Price £6.95 plus £3.50 p&p (for overseas readers the postage is £6.00 to everywhere except Australia and Papua New Guinea which cost £10.50). *Normally sent within seven days but please allow 28 days for delivery – more for overseas.*

*Payment in £ sterling only please. Visa, Amex, Diners Club, Switch and MasterCard accepted. Send, fax or phone your card number, card expiry date and card security code (the last 3 digits on or just under the signature strip), with your name, address etc. Or order on our secure server via our UK web site. Overseas customers – your credit card will be charged by the card provider in your local currency at the existing exchange rate.*

Editor: MIKE KENWARD

Deputy Editor: DAVID BARRINGTON

Technical Editor: JOHN BECKER

Business Manager: DAVID J. LEAVER

Subscriptions: MARILYN GOLDBERG

Administration: FAY KENWARD

Editorial/Admin: (01202) 873872

Advertisement Manager:

PETER J. MEW, Frinton (01255) 861161

Advertisement Copy Controller:

PETER SHERIDAN, (01202) 873872

On-Line Editor: ALAN WINSTANLEY

EPE Online (Internet version) Editors:

CLIVE (MAX) MAXFIELD and ALVIN BROWN

**READERS' TECHNICAL ENQUIRIES**

E-mail: techdept@epemag.wimborne.co.uk

We are unable to offer any advice on the use, purchase, repair or modification of commercial equipment or the incorporation or modification of designs published in the magazine. We regret that we cannot provide data or answer queries on articles or projects that are more than five years old. Letters requiring a personal reply *must* be accompanied by a **stamped self-addressed envelope** or a **self-addressed envelope and international reply coupons**.

**PROJECTS AND CIRCUITS**

All reasonable precautions are taken to ensure that the advice and data given to readers is reliable. We cannot, however, guarantee it and we cannot accept legal responsibility for it.

A number of projects and circuits published in *EPE* employ voltages that can be lethal. **You should not build, test, modify or renovate any item of mains powered equipment unless you fully understand the safety aspects involved and you use an RCD adaptor.**

**COMPONENT SUPPLIES**

We do not supply electronic components or kits for building the projects featured, these can be supplied by advertisers (see *Shoptalk*). **We advise readers to check that all parts are still available before commencing any project in a back-dated issue.**

**ADVERTISEMENTS**

Although the proprietors and staff of EVERYDAY PRACTICAL ELECTRONICS take reasonable precautions to protect the interests of readers by ensuring as far as practicable that advertisements are *bona fide*, the magazine and its Publishers cannot give any undertakings in respect of statements or claims made by advertisers, whether these advertisements are printed as part of the magazine, or in inserts.

The Publishers regret that under no circumstances will the magazine accept liability for non-receipt of goods ordered, or for late delivery, or for faults in manufacture.

**TRANSMITTERS/BUGS/TELEPHONE EQUIPMENT**

We advise readers that certain items of radio transmitting and telephone equipment which may be advertised in our pages cannot be legally used in the UK. Readers should check the law before buying any transmitting or telephone equipment as a fine, confiscation of equipment and/or imprisonment can result from illegal use or ownership. The laws vary from country to country; readers should check local laws.





## Constructional Project

# WIND-UP TORCH MK II

THOMAS SCARBOROUGH

*A new twist for providing light without a battery*

SEVERAL years ago, the author's worst torch nightmare came true. He was walking on a dirt track on a remote tropical island as darkness was falling, when a violent storm overtook him. He pulled out a small krypton torch, which quickly faded and died – and found himself lost in complete darkness in a frightening storm. Thus the idea for a Wind-up Torch was born!

### NEW DESIGN

The Wind-up Torch MkII described here is a successor to the original *Wind-up Torch* (EPE, October 2000). Virtually every aspect of the original circuit was re-assessed, and most aspects redesigned.

The new version also has one completely new feature, namely a visual indication of full charge, which spares the user from any unnecessary winding. The new version sports the following improvements:

*30% smaller size; 120% brighter light; 500% faster winding.*

Its periods of service, however, are shorter than the original torch. The

advantages of this are the vastly improved winding times and brighter light. On “high beam”, it offers well over a minute of service off one period of winding, while as a reading light it offers about ten minutes. These times may be substantially increased (see following).

With rapid spinning of the generator's spindle in one's fingers, less than 15% of the total period of service is spent winding the torch on “high beam”, while as a reading light, this reduces to about 3% (see Fig.1). This is assuming that a charge already exists in the power “reservoir” (two memory backup “super-capacitors”), and that these are not being charged from empty.

### HIGH BRIGHTNESS

In the author's subjective assessment, “high beam” offers a brightness of about 35 lux at two metres – that is, almost as much light as a 40W incandescent light-bulb in a 10m<sup>2</sup> room. While this may not seem very bright, it is perfectly adequate for walking on a footpath at night, lighting up the way seven to ten metres in front. Moreover, at one metre's distance this may be multiplied by four, so that the torch is strikingly bright at close quarters.

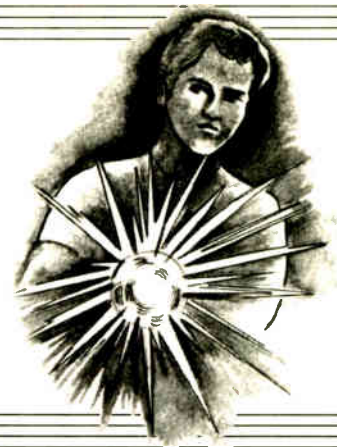

The Wind-up Torch uses no batteries – not even rechargeables – and while its generator is not cheap if bought new, it promises to pay for itself within a mere 48 hours continuous use through savings on batteries (about 15 hours if a surplus motor is used). In addition to this, the white l.e.d. should last hundreds of times longer than any filament bulb.

### DESIGN CONSIDERATIONS

Great store was put into producing an enduring design – that is, one that could be repeated in five or ten years' time. This meant a deliberate choice to steer clear of some cutting-edge technology and more unique components. While the final circuit is very simple on the face of it, it is a carefully balanced whole, and the result of many different options having been evaluated.

In early experiments, the author achieved just three seconds of light with capacitors as the power reservoir. A number of tricks were used to increase this performance many times over.

First, a suitable power generator was needed. After testing various motor “families”, a 12V four-phase unipolar stepper motor was chosen, which offered good voltage at low revs. Coming in a close second was a 100V 12.5r.p.m. (about 3.5W) synchronous motor – a rare bird indeed! Unipolar stepper motors, on the other hand, are commonly available, and with a little searching may be obtained for a very small outlay.

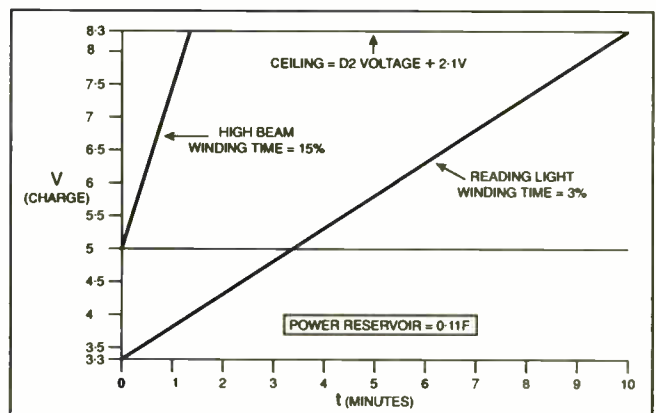

Fig.1. Charge versus time graph.

The power reservoir of the original design, which comprised two 1F (Farad) memory backup "super-capacitors" in parallel, was replaced with two smaller 0.22F super-capacitors in series, together with a "piggy-back" 4,700µF capacitor (to be explained later), making up about 0.1F in all. The most important consequence of wiring the two super-capacitors in series is that their voltage rating is thereby doubled, so that their charge may be taken much higher than in the original design (the reason for this is explained below). Not least, two 0.22F capacitors in series may be charged far more quickly than two 1F capacitors in parallel.

## BRIGHT REGULATION

With regard to voltage regulation, a suitable regulator needed to deal with widely fluctuating input voltages, to provide (ideally) a selection of output voltages, and continue to function with just a fraction of 1mA output current.

tricks were used, both to increase light output, and to do so with minimum current drain.

Two 10x magnifying lenses were used to focus the beam, and this produced a brighter beam than a white i.e.d. would ever seem to offer. The light was also pulsed, thereby significantly conserving power. Also, a very low power circuit was used to pulse it.

## GENERATING POWER

The generator is a standard 12V four-phase unipolar stepper motor. These are commonly found in old 5¼in. disk drives, as well as fax machines and printers. The power consumption rating of the selected motor should be 5W or more, and this may be estimated by choosing a motor of about 40mm diameter, and 30mm deep.

The motor selected can make a significant difference to the torch's winding times. The author selected an old (1982)

common leads. Ignore any measurements which show an open circuit (infinite resistance).

## CIRCUIT DETAILS

The complete circuit diagram for the Wind-Up Torch MkII is shown in Fig.2. Current from each of the motor's four phases is full-wave rectified (REC1 to REC4), to charge capacitors C1 to C3. A 6.2V 1W Zener diode, D2, is used to limit the voltage across the capacitors, and an ultrabright red i.e.d. (not a green i.e.d.), D1, in series with Zener diode D2 serves to show when charging is complete.

This permits a maximum charge of about 8.3V across charge capacitors C1 to C3. While this could be raised as high as 11V, the internal resistance of the super-capacitors and the modest voltage produced by the stepper motor would make this awkward in practice.

The power supply, Zener diode D2, together with red i.e.d. D1, limits the

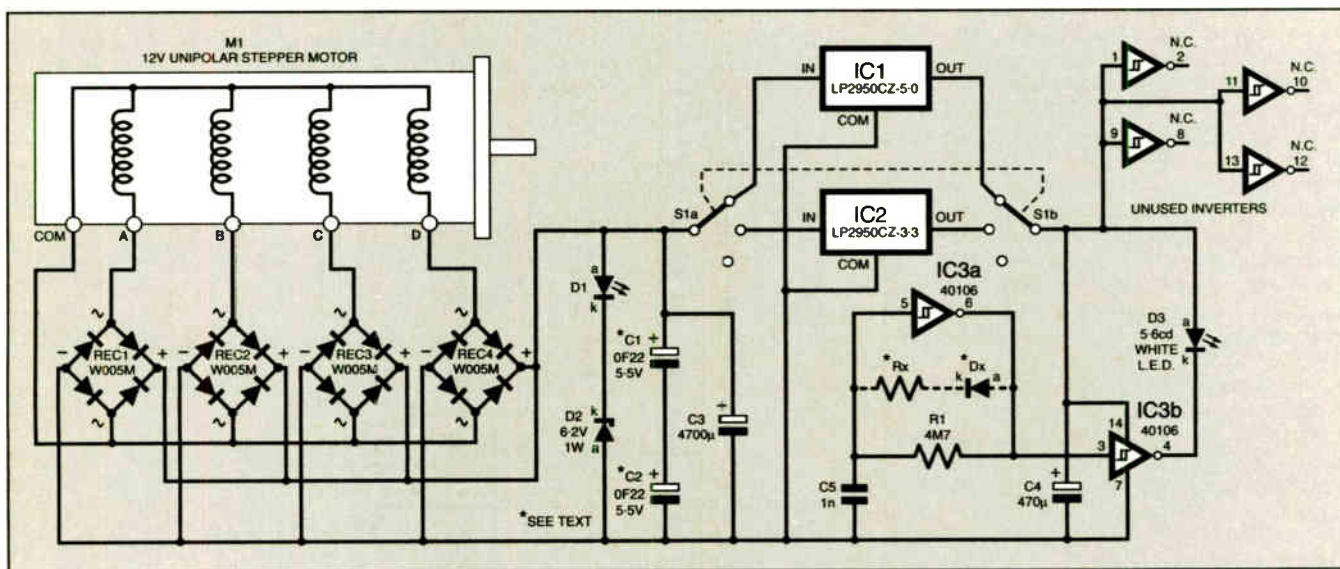

Fig.2. Complete circuit diagram for the Wind-Up Torch Mk II.

A suitable three-pin adjustable linear regulator was not to be found – at least not one that could cope well with the very small output current in particular – and the author wished to steer clear of proprietary packages with many pins. After trying several options, two fixed micropower linear voltage regulators were chosen, namely the LP2950CZ-5.0, and the LP2950CZ-3.3. These devices should be commonly available, and a number of suitable substitutes exist.

The obvious alternative would have been a switching regulator, and these were given serious consideration. However, while they potentially offer better performance, they were finally ruled out. Several factors were considered – among them cost, component count, and present and future availability. In the final analysis, the real difference to the design would have been five or ten seconds' light on "high beam".

The i.e.d. which was used in the original design – rated 0.4 candelas – was replaced with a more recent 5.6 candela white i.e.d. with a narrower viewing angle. However, while recent white i.e.d.s are extraordinarily bright, they are not normally bright enough to be practicable as a torch except at short distances. Therefore a number of

stepper motor, which turned out four times as much power as some modern equivalents of the same size! A rough and ready indication of a higher power output may be a stiffer feel when turning the spindle (that is, higher detent torque – say 5mNm or more).

## LEAD ON

Most four-phase unipolar stepper motors have either five or six leads. Four of these are connected to each of the four phases (or windings) inside the motor – the other one or two are "common" leads.

It is not difficult to discover which are the common leads. In the case of five leads, this is frequently a wire on one or the other side of a ribbon cable. If you systematically measure the resistances across the various wires with a multimeter, you will find that one wire is consistently involved where the lowest resistance is measured. This is the common lead.

In the case of six wires, the common leads are usually at the centre of two rows of three. In the same way, systematically measure the resistances across the various wires. In this case, two wires will be consistently involved where the lowest resistances are measured – these are the

charge on the capacitors. As, in practice, D1 is not likely to carry more than 5mA, it was not felt necessary to include a ballast resistor in series with the i.e.d. Capacitor C4 serves to stabilise the output of the regulators IC1 and IC2.

The regulators IC1 and IC2 are switched in and out of circuit by means of a double-pole, three-position slide switch. The reason why their IN terminals as well as their OUT terminals are switched out of circuit is that this saves up to 1mW power. While this may not seem much, it becomes important especially for retaining a charge on capacitors C1 to C3 when the torch is switched off.

This arrangement enables one to switch on and re-charge the torch without needing to charge again from "flat". On the other hand, the power lost through the Zener diode and bridge rectifiers is close to nil once the charge on C1 to C3 has dropped to 5V or less.

While in some circuits one would need to be careful that capacitor C4 should not "reverse dump" its charge through regulators IC1 and IC2, in the present circuit C4 always discharges more quickly than C1 to C3, so that no such danger exists.



## LONG LIFE

Turning again to the power reservoir, if the constructor should wish to build a Wind-up Torch with very long life, the value of the super-capacitors will need to be raised. It is recommended values not larger than 0.47F each for C1 and C2. If a larger power reservoir should be preferred, the author wishes the constructor many happy hours of winding!

Initial charging may be helped along by wiring a PP3 9V battery across the capacitors, with a "turbo" pushbutton (push-to-make) to charge. Even if the battery should go completely flat, the torch would still be on standby for use at any time.

A charge versus time graph, using two 0.22F capacitors in series, is shown in Fig.1. By extrapolation, one may obtain a rough idea as to the periods of service when C1 to C2 capacitance is increased or decreased. About 8.3V was found to be ideal for the graph's "ceiling". However, this may be altered by changing the value of Zener diode D2. It must not, under any circumstances, have a higher voltage rating than 8.2V.

Capacitor C3 has a vital function, in that it serves to reduce charge times by about two-thirds. Super-capacitors typically have an internal resistance of 30 to 70 ohms, which is very high. Therefore, they are far more reluctant to charge than ordinary capacitors, and need every encouragement to charge. Capacitor C3, on the other hand, has an internal resistance some 1,000 times less than C1/C2, therefore it charges much more rapidly, and to a higher voltage than C1/C2.

Thus, whenever the stepper motor slows or comes to a stop as it is turned back and forth, the higher charge on C3 is dumped into C1 and C2. Also, C3 bridges the ripples from the motor far more quickly than C1 and C2 are able to do.

## POWER POINT

In order to conserve power, i.e.d. D3 is pulsed with a 50% duty cycle, while the supply voltage is raised to 5V on "high beam" – which is 1.4V above the i.e.d.'s rated voltage. A white i.e.d. will endure a higher voltage if it is pulsed – the author's endured sustained testing at 10V (see *Circuit Surgery*, EPE Nov '02, for details), but if in doubt use a ballast resistor in series with it.

It might be asked, at this point, why the circuit could not be run at the i.e.d.'s rated voltage, namely 3.6V – without pulsing the i.e.d. On the face of it, this would seem to make for a simpler circuit and a brighter light. However, in practice this does not work – while the 50% duty cycle leads to far more than the expected doubling of the torch's periods of service. This is due mainly to two factors:

First, due to persistence of vision, the eye "sees" pulsed light for much longer than its actual duration. This may be witnessed by looking briefly into a light-bulb, then looking away at a blank wall. The image of the light-bulb persists.

Second, if current drain is reduced, the capacitors retain their charge longer, even if the voltage is raised by thirty or forty percent, as it is in the present design. These factors combined lead to much longer life than the 50% duty cycle would suggest.

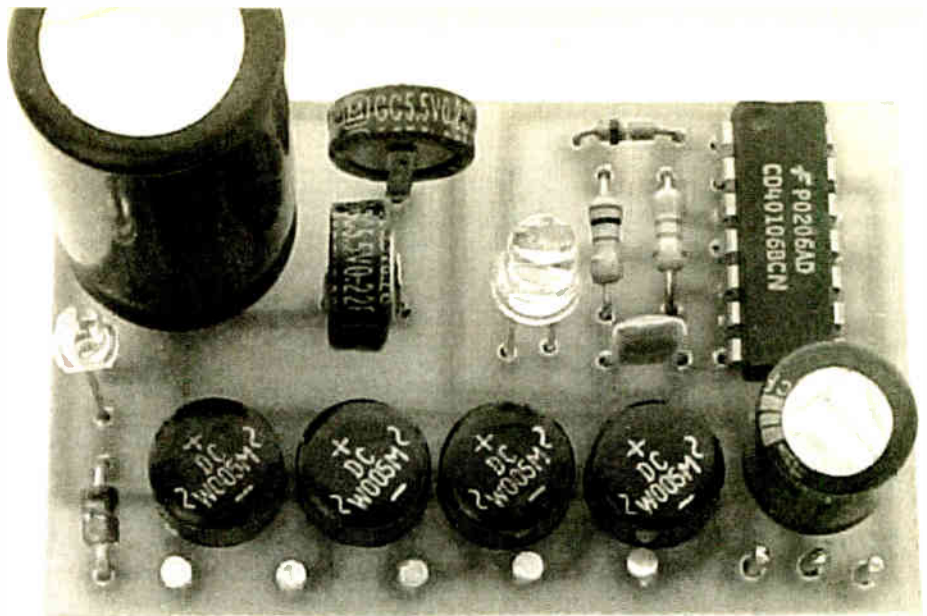

Completed prototype circuit board. In the final version, the red charge indicator i.e.d. is mounted off-board on the case.

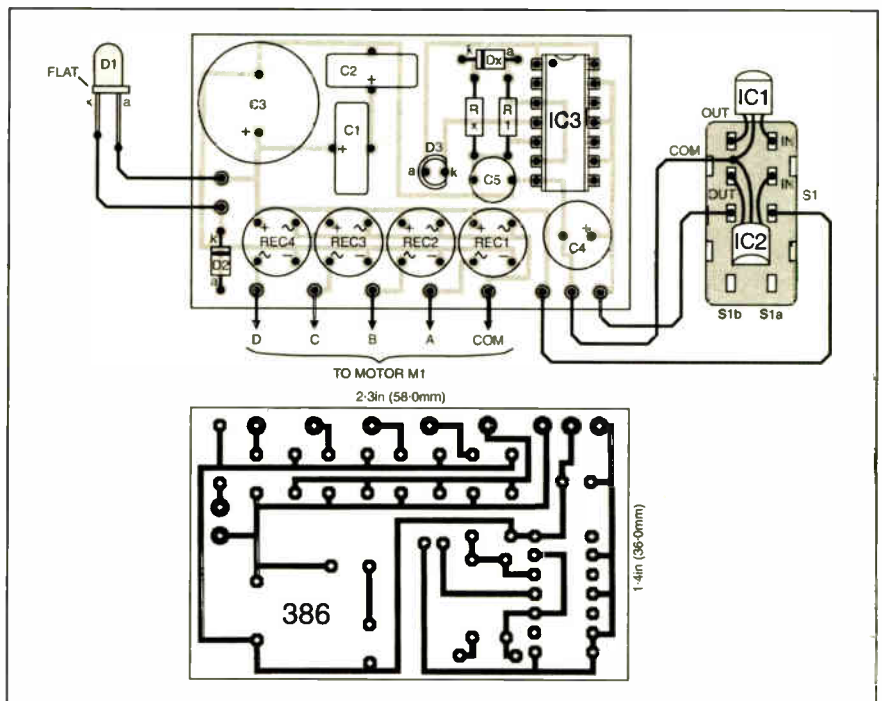

Fig.3. Printed circuit board component layout, wiring details and full-size copper foil master pattern for the Wind-Up Torch Mk II.

Finally, the values of resistor R1 and capacitor C5 – being the timing elements of a very low power "clock generator" to pulse i.e.d. D3 – are chosen so as to give the maximum perceived light output with minimum power consumption, while also seeking to avoid too great a sensitivity to damp, which would be the case if the value of R1 were too high. Also, the value of C is small, and that of R high, so as to conserve power.

The duty cycle of the i.e.d. may be changed so as to produce more light, by the addition of Rx (try 10M to begin) and series diode Dx (a 1N4148 would suit). If the diode is reversed, less light is produced, and power saving is increased.

## CONSTRUCTION

The Wind-Up Torch MkII is built on a small printed circuit board, measuring just 58mm x 36mm. The topside component layout and full-size underside copper foil are shown in Fig.3. This board is

available from the EPE PCB Service, code 386.

Two components require special handling, namely IC3 and the white i.e.d. D3, which are both static sensitive. Discharge your body to earth before handling. All components should be of a high grade, since loss of power through low-grade components will lead to a less efficient torch – in some cases quite markedly.

Begin construction by soldering in position the solder pins and the dual-in-line (d.i.l.) socket. Some of the pins are inserted from the front of the p.c.b. – that is, they protrude from the rear or copper side, so that switch S1, i.e.d. D1, and the stepper motor leads may be more easily wired up from the back. Pins for i.e.d. D1 may be omitted if it is to be soldered directly to the p.c.b.

Next, solder the resistor(s) and bridge rectifiers, then the diodes and capacitors in position. Keep long legs for white i.e.d. D3, to allow for later adjustment when the lenses are fitted.



The regulators IC1 and IC2 are soldered to the double-pole three-position slide switch S1 as shown in Fig.3. This reduces the number of wires in the enclosure, and makes for a simpler and smaller p.c.b.

Carefully ascertain the polarity of l.e.d. D1 before soldering, since this is not always immediately obvious with ultra-bright l.e.d.s. (the "flat" on the plastic encapsulation is the cathode (k)). Finally, wire up the stepper motor, switch S1, and l.e.d. D1, and insert IC3 in the d.i.l. socket.

## ASSEMBLY

Motor M1 and switch S1 are mounted at one end of the case and on one side panel, while a suitable hole is prepared for the lenses at the other end. Take note of the position of white l.e.d. D3 in relation to the lenses, since it is situated off-centre on the p.c.b.

The p.c.b. is slotted into the case in front of the motor as shown in the photographs (its edges may need filing for an easy fit). Make its position a temporary arrangement until you have carried out tests to see how

The micropowered regulators (IC1 and IC2) wired directly across the slide switch contacts.

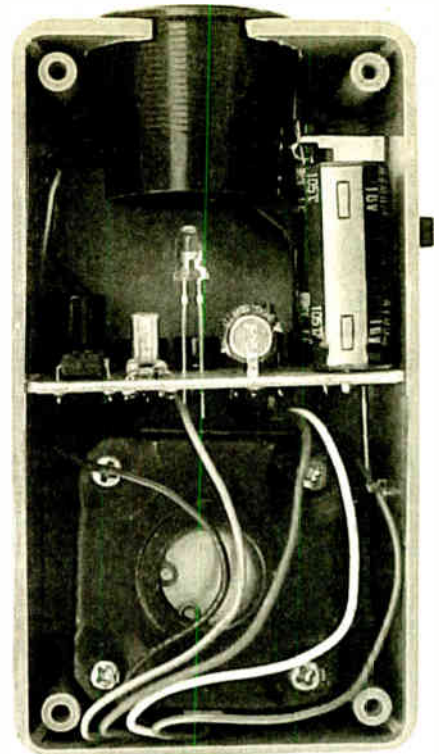
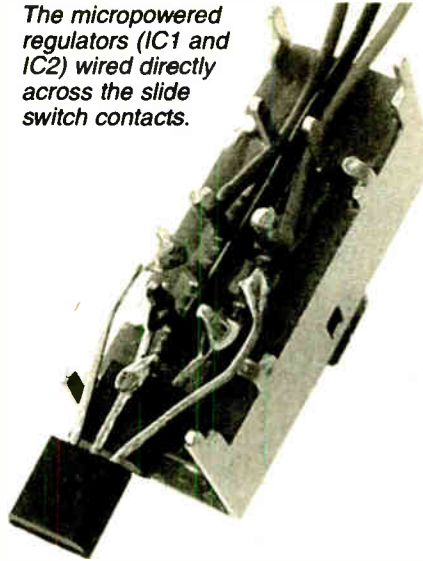

Internal component layout inside the torch. Note that the lens barrel is positioned off-centre at one end of the case, over the board-mounted white l.e.d.

## COMPONENTS

### Resistors

R1 4M7  
Rx 3M3 to 10M  
(see text)

All 0-25W 10% carbon film

See  
**SHOP  
TALK**  
page

### Capacitors

C1, C2 0F22 min. p.c.b. mounting memory back-up elect. 5-5V, vertical (2 off)  
C3 4700µ radial elect. 16V  
C4 470µ radial elect. 10V  
C5 1n tubular foil polystyrene

### Semiconductors

REC1 to REC4 W005M 1A bridge rectifier (4 off)  
D1 3mm ultra-bright red l.e.d.  
D2 6-2V 1W Zener diode  
D3 5-6cd 20° viewing angle white l.e.d.  
IC1 LP2950CZ-5-0 linear micropower regulator  
IC2 LP2950CZ-3-3 linear micropower regulator  
IC3 40106 Hex Schmitt inverter  
Dx 1N4148 signal diode

### Miscellaneous

M1 12V four-phase unipolar stepper motor (recommended min. ratings 5W power consumption, 5mNm detent torque)  
S1 2-pole 3-position slide switch

Printed circuit board available from the *EPE PCB Service*, code 386; ABS plastic enclosure (internal dimensions 107mm x 57mm x 32mm, 2mm walls), 14-pin dual-in-line (d.i.l.) socket; 10x magnifying lenses (2 off); link wire; solder pins; solder, etc.

Approx. Cost  
Guidance Only

**£20**  
excl. motor

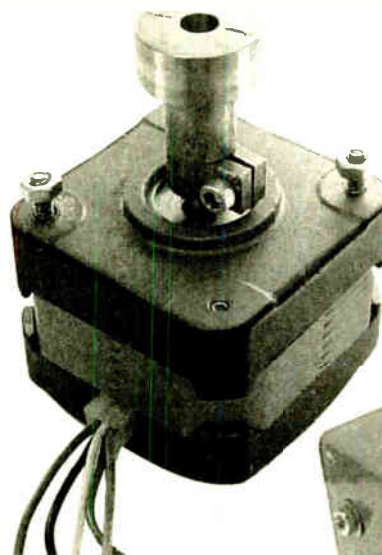

Prototype 12V four-phase unipolar stepper motor from an old 5 1/4 in. disk drive (circa 1982).

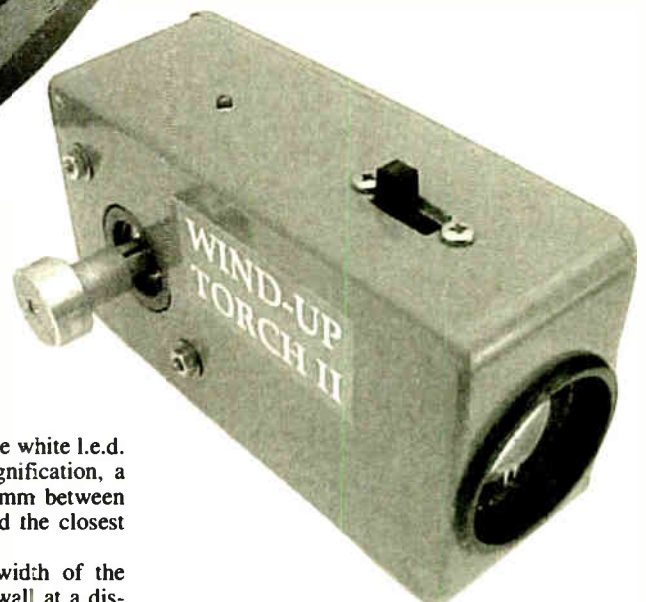

General appearance of the completed torch.

far the lens should be from the white l.e.d. With two lenses of 10x magnification, a distance of just 10mm or 20mm between the tip of the white l.e.d. and the closest lens should be required.

The author adjusted the width of the beam to about 300mm on a wall at a distance of one metre. This seemed to represent a good compromise between beam width and brightness.

## IN USE

Switch S1 to High Beam, then briskly wind the torch until red l.e.d. D1 illuminates, indicating a full charge (the motor's spindle may be turned in two directions). Once l.e.d. D1 shines brightly, do not wind any further.

Because capacitors C1 to C3 have no residual charge to begin with, a vigorous wind of up to a minute may at first be required. After this, charge times will be considerably shorter (in a best case about five seconds, depending on the motor used). The torch may also be given small

in-between winds, which will keep it going almost effortlessly – and it may be wound when switched off.

If the torch is likely to be exposed to severe weather, the constructor might wish to omit the d.i.l. socket and solder IC3 directly to the p.c.b., and coat the p.c.b. with epoxy resin. The torch could be virtually completely sealed by using magnetic reed switches in place of S1 inside the case, with a sliding magnet outside as the "on/off" toggle. Such measures would be advisable especially where there might be a risk of damp or condensation inside the torch, since very small currents flow on the p.c.b. □



## Bendy Batteries For Flexible Power

Ultra-thin batteries are making smart cards smarter and could add major new functionality to travel tickets, ID tags and greetings cards.

IMAGINE what you could do with low-cost, paper-thin batteries. As a manufacturer you could embed them in credit and identity cards, in baggage labels, in price and product tags, in contactless car park and travel tickets, in novelty greetings cards and in all manner of toys and games. As a hobbyist you could squeeze a power source into radio-controlled models and many other projects where standard batteries are out of the question.

Applications both novel and conventional stand to benefit from cheaper, lighter batteries. The same technology would reduce the size and weight of all manner of portable and mobile devices, such as notebook computers and personal digital assistants, as well as space satellites.

Computerised clothing, wearable computers and disposable cell phones are further applications touted for this ultra-thin battery technology but the first use is a smart electronic credit card with a built-in battery and microprocessor from a firm that won market consultancy Frost & Sullivan's Market Engineering Award for Smart Card and Payment Solutions in 2002.

### STACKING THE CARDS

The company is PrivaSys and according to Joan Ziegler, CEO and co-founder of the card manufacturer, trials have taken place with their SecurSys battery-powered cards some time in the fourth quarter of 2002 with several US credit and debit card issuers.

The PIN-activated card protects cardholders' credit information through the use of secure card numbers that are created dynamically for each purchase. When consumers need to pay, they tap their personal identification number into the keypad. A microprocessor chip on the card generates a random number that is visible on the l.c.d. display and is also transmitted to the card's magnetic stripe.

The one-time code is converted into the consumer's actual card number at the card issuer's mainframe computer after it has been swiped through the point-of-sale terminal and sent up line. This, says PrivaSys, entirely eliminates unauthorised cloning or "skimming", one of the key methods of counterfeiting credit and debit cards. The number display allows cardholders to use the cards to make purchases by telephone or over the Internet.

Key enabler for these cards is the dry polymer battery, which itself is nearly the thickness of a credit card and fits between the laminated outside layers of a card. The supplier is Leading Edge Technologies,

Lakeland, Florida and the company is quoted as aiming for a price of 10 cents or less per unit once production volumes enter the millions. Battery life is stated to be three to five years, depending on use, and contacts on the card allow it to be recharged.

### POWER PAPER

Outside the world of credit cards the big name in tiny batteries is the Power Paper company of Israel, whose product of the same name works exactly like a traditional battery but is nearly as thin as a piece of paper. Power Paper cells make an ideal replacement for watch or calculator batteries but unlike these button cells are just half a millimetre thick.

The cell is made up of five ink-like layers of material – a collector and cathode layer on one side, a collector and anode layer on the other and an electrolyte core. This not only provides the cells with their flexibility, but also produces a dry battery that eliminates the need for a hermetically sealed metal case. It's "green" too; all ingredients are non-toxic and safe, permitting disposal without endangering the environment.

A one-square inch printed cell will provide 1.5V output voltage with a capacity of 15mAh and a shelf-life of more than two years. They can be used in multiple combinations for greater power and voltage requirements in any shape or size.

A rechargeable version is planned although the first production of Power Paper batteries will be targeted at disposable products, such as travel cards, car park season tickets, greeting cards, toys and industrial tags. Standard silkscreen printing presses are used to print the batteries onto paper and other substrates, giving amazing versatility.

They can also be integrated with printed circuits, RFID patch antennas and microchips, enabling them to perform functions such as controlling prescription drug injections, monitoring smart tags and labels or transmitting radio frequency identification label information over long distances.

Another promising niche market is in medical applications, such as bracelets that monitor temperature and provide health readings, prescription labels that read directions aloud to patients and remind them to take their medication, powered transdermal patches that deliver medication and combined micro-sensors and readouts on disposable strips for performing complex diagnosis at home.

### CHEMICALLY SAFE

Unlike other batteries, Power Paper's energy cell is open and requires no casing to hold chemicals. It can be printed, pasted, or laminated onto paper, plastic, and other media. The actual power source is a zinc and manganese dioxide based cathode and anode, both fabricated from proprietary inks. As these are dry, the metal casing needed in conventional batteries to contain active chemicals is unnecessary. No special production equipment is required, nor does Power Paper require to be made under clean-room conditions, lowering manufacturing costs.

Power Paper expects to form a broad range of joint ventures and licensing agreements with companies wishing to integrate the technology into their manufacturing process and deals have already been announced. Graphic Solutions, Inc., of Burr Ridge, Illinois, USA will use the technology to enhance its existing business making printed circuitry, electroluminescent products, antennas for r.f. tags, labels, nameplates and panels.

Consumer applications are possible too. The thin, flexible batteries might soon come plastered on cardboard or plastic surfaces, producing novelty packaging items like cereal boxes that twinkle with light.

### HEAVIER DUTY

New battery materials do not stop here either. Another thin and flexible (but intrinsically more expensive) battery technology uses lithium polymer and offers more power. One model, developed by a research team of the Korea Institute of Science and Technology, uses polyacrylonitrile as an electrolyte and is aimed at use in portable computers.

In the USA researchers at The John Hopkins University have developed a polymer-based all-plastic battery that is rechargeable and environmentally friendly. This has military and space applications but can also be cost-effective in small consumer devices, such as hearing aids and wristwatches.

In the longer term batteries may be commercialised using "cages" of the pure carbon variant known as buckminsterfullerene ("buckyball") to contain lithium and fluorine or methanol. Japan's NEC Corporation has developed a fuel cell battery of this kind that can power a notebook computer for days rather than hours.

Devices such as these employ nanotubes, stringy supermolecules that make hair-thin tubes, but these no longer have to be made of carbon, as scientists at Purdue University, USA, have demonstrated with nanotubes formed from synthetic organic molecules. For these, however, we will have to wait rather longer.



BS2-IC



BS2-SX



BS2E-IC

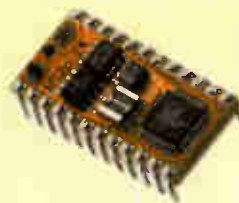

BS2P/24

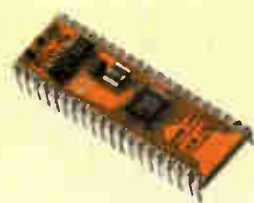

BS2P/40

**Parallax BASIC Stamps - still the easy way to get your project up and running!**

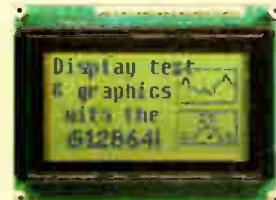
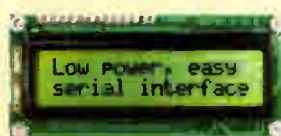

**Serial Alphanumeric and Graphic Displays, Mini-Terminals and Bezel kits**

[www.milinst.com](http://www.milinst.com)



Animated Head



3-Axis Machine



Six-Legged Walkers



Robotic Arms



Bipeds

**Robotic models for both the beginner and the advanced hobbyist**



Servo Drivers

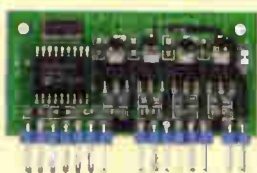

Motor Drivers



On-Screen Displays



DMX Protocol



U/Sound Ranging

**Animatronics and Specialist Interface-Control Modules**



Quadvox MP3 & Speech Systems



SensoryInc Voice Recognition



Parallax Ubicom Tool Kits



Tech-Tools PIC & Rom Emulators



BASICMicro PIC BASIC Compilers

**Development Tools**

Milford Instruments Limited Tel 01977 683665, Fax 01977 681465, sales@milinst.com



## TETRA SAFETY IN QUESTION

Could the new Tetra system of 2-way radios disrupt hospital life-saving equipment? Barry Fox highlights the question.

If you are going into hospital, keep your fingers crossed that no-one from the emergency services comes close to any medical equipment on which your life depends. The new Tetra system two-way radios that they are just starting to use are even more likely to upset pacemakers, confuse defibrillators, blank out electronic thermometers and stop ventilators, than the cellphones which are rigorously banned from most hospitals.

The warning comes from the Medical Devices Agency which has been studying the effects of all kinds of radio transmitters in hospitals. The MDA fears its findings have so far passed largely unnoticed. "Most of the resistance to Tetra has come from concerns over the possible health effects" says Andy Smith, author of the MDA's reports. "We are only looking at interference".

Wireless network devices of the 802.11 type used in the new Microsoft Tablet PC caused few problems because they work with between 30mW and 100mW. But radio handsets interfered with medical equipment, when around three metres away.

The MDA tested medical devices with the new Tetra communications system now being adopted by the emergency services in Europe, Africa, Asia, Asia Pacific and Latin America, and found that Tetra interfered with more of them and more seriously than cellphones.

The Terrestrial Trunked Radio System is an ETSI (European Telecommunications Standards Institute) standard. It works like a cellphone system but pulses digital data at 17.6Hz, which is much slower than a cellphone (217Hz). This makes the signal more robust. Also because Tetra operates on its own frequencies (400MHz instead of 900MHz and 1800MHz for cellphones) there is no risk of busy lines. Police, fire, ambulance and paramedic services in nearly 50 countries are now signed up to use Tetra and have started field trials.

### Alarming Pulse

Tetra's low data pulse rate is more likely to cause interference than a cellphone because it is harder to filter. The MDA found it made infusion pumps sound alarms, while cardiac monitors went haywire and ventilators had to be shut down and re-booted to clear corrupt software. A patient alarm was unaffected by a cellphone but it sounded when a Tetra handset came close. A printer started up of its own accord.

Motorola says that because of interference risks it offers an option called Transmit Inhibit. The Tetra radio can only receive calls, not transmit. The MDA is not

convinced this is a good solution because, like a cellphone, the Tetra handset needs to handshake with the nearest base station to transmit emergency messages and let the network know where it is to receive messages reliably.

### Through the Roof

Says Andy Smith of the MDA "Our next project will be to test the effect of Tetra base stations on hospital roofs. The antennae will have to focus the radio beam tightly so that it does not hit the ground for 60m. This means it may have direct line of sight through a window and into a ward. Hospitals are getting worried about this".

Sean Brennan is a consultant to the health industry, and recalls what happened before hospitals fully understood the

effects of interference. "I was working in a hospital when the emergency services were using old fashioned walkie-talkies on the roof above the operating theatre. They interfered with the morphine drip and we were scraping patients off the ceiling".

### Taking a Tablet

The MDA says it will also have to study plans to fit Tablet PCs with cell-phone radio modules as well as wireless network transceivers, to provide seamless communication as staff leave and re-enter the building. Doctors carrying Tablets will have to remember to disable the cellphone module every time they come in from outside.

Also the Outside Broadcast trucks used by TV news crews now rely on speech links which cause serious interference. Until further research is done, the MDA can only advise that the OB vehicles are "parked as far away as possible".

Despite repeated requests for comment, the DoH could not say how the MDA's findings would affect its Tetra procurement plans and safety policies.

## MICROCHIP'S LATEST MPLAB



MICROCHIP'S new 32-bit MPLAB Integrated Development Environment (IDE) provides the ability to edit, compile, debug and emulate embedded PIC microcontroller designs. Available at no cost, the software provides increased code writing efficiency, intuitive graphical user interface, easier interfacing of third party tools, USB to MPLAB In-Circuit Debugger 2 interface, faster operating speed and full memory emulation.

MPLAB IDE currently supports Microchip's PIC16 and PIC18 microcontroller families. The software is downloadable from Microchip's website at [www.microchip.com/1010/pline/tools/picmicro/devenv/mplabi/index.htm](http://www.microchip.com/1010/pline/tools/picmicro/devenv/mplabi/index.htm).

The software is also available on CD-ROM. Contact Microchip Ltd, Microchip House, Dept EPE, 505 Eskdale Road, Winnersh Triangle, Wokingham, Berks RG41 5TU. Tel: 0118 921 5858. Fax: 0118 921 5835. Web: [www.microchip.com](http://www.microchip.com).

## WEBBED ROBOTS AND GPS

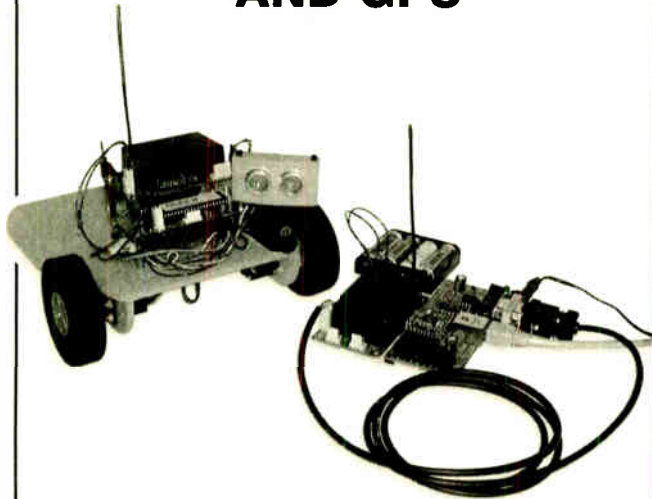

TOTAL Robots Ltd have sent us brief details of an amazing way in which a robot buggy can be controlled – wirelessly from an html web page! They've called the application an R/C Net Rover and it uses their TR2 Rover Kit, two wireless control modules (WCMS), an OOPic microcontroller and a SitePlayer module. The latter is an embedded web server coprocessor encapsulated in a tiny module that enables you to easily communicate with connected devices via Ethernet over a LAN or WAN (Local and Wide Area Networks).

In the example application (that can be found at [www.totalrobots.com/examples/example17.htm](http://www.totalrobots.com/examples/example17.htm)), a simple web page running on SitePlayer is used to take control of an autonomous mobile robot. Once the operator has finished controlling the robot it can be returned to autonomous control by a click of the mouse.

John Taylor of Total Robots comments that you could "add a wireless web cam to this arrangement and you could control your home security robot whilst you're away on holiday in another country!"

In a separate communication, Total Robots tell us that their associate company TR Control Solutions has announced a new GPS (global positioning system) designed specifically for use with PIC microcontrollers, or any micro capable of RS232 or I<sup>2</sup>C communication.

Raw GPS data selected from 24 satellites orbiting the Earth is received by the GPM and stored within its internal registers. This data can very easily be accessed by an attached PIC. The registers are updated once per second and hold data for latitude, longitude, altitude, heading, speed, and the satellites detected.

In addition, the GPM features an on-board fully configurable 4-line TTL I/O port and a 4-line analogue input port with automatic measurement, which can be controlled by the connected micro. An auxiliary connection is also provided that delivers an accurate one pulse-per-second signal and raw NMEA 0183 data.

For more information on Total Robots Ltd browse [www.totalrobots.com](http://www.totalrobots.com) or tel: 020 8823 9220. For TR Control Solutions browse [www.trcontrolsolutions.com](http://www.trcontrolsolutions.com), or tel: 020 8823 9230. Please mention *EPE* if you are phoning!

## HOW MANY TERRESTRIAL TV CHANNELS?

**That's the 16 and 64 QAM question raised by Barry Fox.**

**T**HE Independent Television Commission has confirmed that the BBC and commercial TV stations can continue to transmit Digital Terrestrial TV in different standards. This maintains the UK's dubious distinction of being the first and only country in the world to broadcast digital terrestrial TV in two different standards.

The UK launched a standard definition DTTV service in late 1998 – with a mix of pay services from a new company called On Digital, and free services from the BBC (which carries no advertising) and commercial stations ITV, Channel 4 and Channel 5 (which are funded by adverts). On Digital gave away over a million set-top boxes but viewers with old antennae or in fringe reception areas got poor pictures.

The encryption system was hacked and many viewers bought pirate smart cards to watch pay programmes for free. After confusingly changing its name to ITV Digital, the company ran out of cash and shut down in April 2002.

According to the BBC's post-mortem: "Only 40% of the potential audience was able to receive without a new aerial and half of those had reception problems".

In August 2002 the UK government regulator, the Independent Television Commission, tried to salvage something from the mess by giving ITV Digital's terrestrial frequencies to Freeview, a newly-formed consortium of the BBC, Rupert Murdoch's BskyB and transmitter operator Crown Castle. Freeview started broadcasting around two dozen free programmes on October 30th.

To try and improve reception, Freeview changed the transmission system from 64 QAM to 16 QAM, and reduced the number of programmes.

The 64 QAM (quadrature amplitude modulation) system switches the transmitter signal through 64 steps, to turn the 8MHz TV channels used in Europe into 24Mbps data pipes, each carrying six or seven standard definition TV programmes. The penalty is that the signal is easily spoiled by interference. The 16 QAM signal switches through 16 steps and is much more robust. But it reduces the data rate to 18Mbps, so there is room for only four TV programmes per channel.

The UK's commercial stations, ITV, C4 and C5, are however sticking with 64 QAM because it gives them room for more programmes and they hope eventually to launch new pay channels. The ITC has allowed the split standard because receivers can decode either 16 or 64 QAM.

Some viewers are now getting clear pictures from 16 QAM programmes and erratic reception from 64 QAM stations. Channel-hopping can be slower as the receiver self-adjusts. The BBC and Freeview fear that these problems – coming hot on the heels of the problems with ITV Digital – will turn UK viewers off the whole idea of digital terrestrial.

Says Peter Davies, Director of Strategy at the BBC: "I tried a bedroom portable with a set-stop aerial. It got 16 QAM BBC channels but not the 64 QAM commercials. We think the ITC will see the effect and make everyone change to 16 QAM. It is clearly in the consumer's interests. No other country is using mixed mode transmission".

Counters ITC spokesman Philip Candice: "The differences are certainly not entirely due to the use of different transmission modes."

## MINI JIGSAW

MINICRAFT'S new Mini Jigsaw kit may well provide you with a tool that enables you to be adventurous in your attempt to both construct something great and to keep domestic harmony. The MB5481 Mini Jigsaw is said to be "the ideal solution for cutting intricate shapes and finer detail".

The kit comes complete with a wide range of accessories and includes a lightweight and compact precision jigsaw and variable speed transformer. It features a powerful 100W motor for greater cutting efficiency, and an adjustable shoe for cutting 45° and 90° angles. It comes in a handy carrying and storage case, and includes six blades, three of which can be used for cutting wood, and three for cutting metal and plastic.

For more information contact Roto Zip UK Ltd., Dept EPE, 1 & 2 Enterprise City, Meadowfield Avenue, Spennymoor, Co Durham DL16 6JF. Tel: 01388 420535. Fax: 01388 817182. Web: [www.minicraft.co.uk](http://www.minicraft.co.uk).





## PROTEUS 6 UPGRADE

LABCENTER Electronics tell us that they have released version 6 of Proteus, their integrated schematic capture, simulation and p.c.b. design environment. They comment that Proteus remains the only EDA system on the market that can co-simulate microcontroller software within a SPICE mixed mode circuit simulation.

Proteus 6 has been under development for over two years and offers increased functionality and ease of use in all areas of the package. Some of the major features include:

- Completely new look and feel with docking toolbars.
- Integration of p.c.b. package library viewing into schematic capture.
- Completely new p.c.b. packaging tool.
- Enhanced track editing facilities.
- New connectivity and design rule check listings.
- Thousands of new library parts.
- Full multiple undo/redo functionality.

Proteus VSM is compatible with compilers from leading vendors such as IAR, Keil, Crownhill Associates, Bytcraft and CCS.

Further information and downloads are available from [www.labcenter.co.uk](http://www.labcenter.co.uk). Also see Labcenter's advert in this issue. Labcenter Electronics, Dept EPE, 53-55 Main Street, Grassington, North Yorks BD23 5AA. Tel: 01756 753440. Fax: 01756 752857.

## DONATED PIC SOFTWARE ARTICLES

EPE reader John Waller is a dedicated PIC programmer, having initially learned how to use PIC microcontrollers through our *PIC Tutorial* of Mar-May '98. He is currently engrossed in designing a PIC controlled system for use with a digitally controlled model railway. As part of that system he is using a PIC16F877 and its inter-integrated-circuit (I<sup>2</sup>C) facilities, together with RS232 serial communication protocol.

John has kindly presented us with two articles, one on each of these subjects, which we have now put up on our ftp site in the PIC Tricks folder.

The I<sup>2</sup>C protocol uses two wires (clock and data) to pass messages between i.c.s. Several PIC types are furnished with hardware to handle synchronous serial protocol. In the PIC16F877, the hardware is called master-slave serial port (MSSP) protocol, whereby two port pins are dedicated to the clock and data lines, and various flags and buffers are provided to interface between hardware and software.

In his I<sup>2</sup>C article, which is accompanied by software example files (ASM), John describes the use of MSSP in both master and slave roles, both with and without interrupts. Several example PIC programs are given for one-way transfer, both master to slave ("send") and slave to master ("read"). The complex operations, comprising two sets of software and two sets of hardware operating together, are explained in detail with diagrams and text. The programs may be run with a minimum of hardware at both master and slave end.

In his second article, John briefly introduces the concept of asynchronous serial communications and the history of how it evolved into the RS232 format in use today. The RS232 format is then described in its most common form, showing how data is transmitted and received. A sample program is given using the PIC16F877 to transmit and receive RS232 data to and from a model train command station.

The articles can be accessed via our home page at [www.epemag.wimborne.co.uk](http://www.epemag.wimborne.co.uk). Take the click-link at the top of the Home page that says FTP Site (Downloads) and then take the path PUB/PICS/PIC Tricks. In the PIC Tricks folder are two sub-folders holding John's material, I<sup>2</sup>C Bus Text Article and RS232 Text Article.

We express our appreciative thanks to John for providing these detailed software discussions and examples.

## FML KITS

THE latest "flyer" from FML Electronics has arrived in which they highlight the fact that they have kits of components for many EPE projects, listing those published in the November, December '02 and January '03 issues.

FML also have a catalogue and Bargain Lists for other items, and say that official orders from schools, trade and government etc. are welcome, as are cheques, postal orders and credit/debit cards. Trading is by mail order only.

For more information contact FML Electronics, Dept EPE, Freeport NEA 3627, Bedale, North Yorks DL8 2BR. Tel: 01677 425840.

# YOU WON'T GET YOUR FINGERS BURNT

It may surprise you but buying an Antex soldering iron costs less than you think in the long run. British made to exacting standards, they last significantly longer than imported brands. And with a wide range of thermally balanced soldering irons, you can pick up a "fixed temperature" or "in-handle" temperature model that will suit your needs perfectly.

None of which will burn a hole in your pocket.

If your hobby demands the best iron for the job but you don't want to get your fingers burnt by the cost, visit our website or your electronics retailer for the coolest models around.

Pick up an

**ANTEX**

Not just any old iron.



[www.antex.co.uk](http://www.antex.co.uk)

2 Westbridge Industrial Estate Tavistock  
Devon PL19 8DE Tel 01822 613565



# PROTEUS

**The Complete Electronics Design System**

**Schematic Capture**

**PCB Layout**

**SPICE Simulation**

**Auto Placement**

**CPU Models**

**Auto Routing**

**VSM**

*Virtual System Modelling*

## **Schematic & PCB Layout**

- Powerful & flexible schematic capture.
- Auto-component placement and rip-up/retry PCB routing.
- Polygonal gridless ground planes.
- Libraries of over 8000 schematic and 1000 PCB parts.
- Bill of materials, DRC reports and much more.

## **Mixed Mode SPICE Circuit Simulation**

- Berkeley SPICE3F5 simulator with custom extensions for true mixed mode and interactive simulation.
- 6 virtual instruments and 14 graph based analysis types.
- 6000 models including TTL, CMOS and PLD digital parts.
- Fully compatible with manufacturers' SPICE models.

## **Proteus VSM - Co-simulation and debugging for popular Micro-controllers**

- Supports PIC, AVR, 8051, HC11 and ARM micro-controllers.
- Co-simulate target firmware with your hardware design.
- Includes interactive peripheral models for LED and LCD displays, switches, keypads, virtual terminal and much, much more.
- Provides source level debugging for popular compilers and assemblers from Crownhill, IAR, Keil, and others.

## **New Features in Version 6**

- Drag and drop toolbars.
- Visual PCB packaging tool.
- Improved route editing.
- Point and click DRC report.
- Multiple design rules (per net).
- Multiple undo/redo.

**Call Now for Upgrade Pricing**

**labcenter**

**Electronics**  
53-55 Main Street, Grassington. BD23 5AA

Tel: 01756 753440  
Fax: 01756 752857

Contact us for  
**Free Demo CD**

**Works with  
PIC Basic Plus  
from Crownhill  
Associates**

**www.labcenter.co.uk**  
**info@labcenter.co.uk**



# CIRCUIT SURGERY

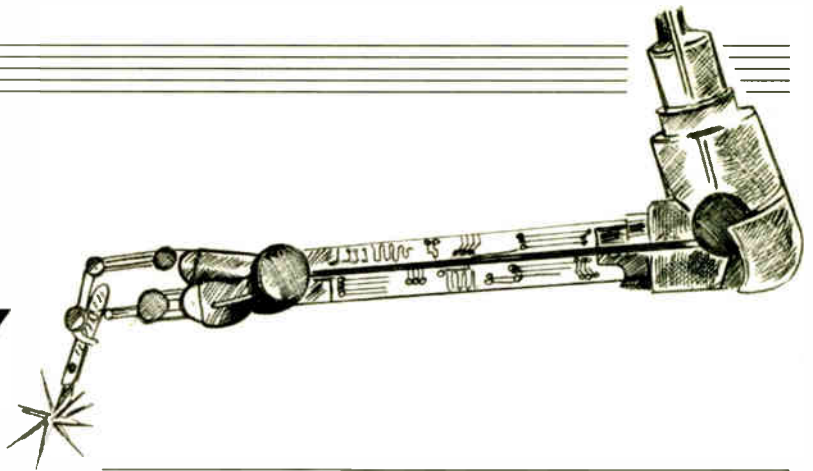

**ALAN WINSTANLEY  
and IAN BELL**

*We look at surface mount reworking and round off our earlier item discussing electric motors.*

## On the Surface

*"Can you give me some advice on soldering l.e.d.s within cellular phones? I wish to change them for another colour but I have no soldering experience.*

*I purchased a couple of broken ones to practise with. I wondered if there was a certain temperature or tip size needed? Any information will be appreciated." B.R. by email.*

The cellphone (mobile phone) is a miracle of miniaturisation, made possible due to the use of large-scale integrated surface mount technology (SMT), low power chips and multilayer printed circuit boards. Nearly 20 years ago in the February 1984 issue of *Everyday Electronics*, the then Editor Fred Bennett described in his leader the advent of "SMA" – surface mount assembly – adding the comforting note for fearful constructors that "lead bending and cropping will remain essential operations for the home constructor, for far enough into the future as makes no difference." Time has proved Fred right, because in our hobby we are still deeply involved with the use of ordinary discrete components, which is just as well, given the dexterity and equipment needed to use surface mount devices (SMDs) effectively.

## Hands Off!

There are lots of reasons why you shouldn't try to change the l.e.d.s in your handset. Your cellphone will use surface mount l.e.d.s on a transparent carrier to illuminate the keyboard and l.c.d. The tiny chips (SMD parts are often called "chips", even if they are discrete parts such as resistors or capacitors) are extremely difficult to handle without the necessary specialist equipment. It may be hard or impossible to remove them without damaging the board irreparably.

Furthermore, unless you know what to look for, you may have problems deciphering the SM l.e.d. polarity, though you could try a test with a suitable diode checker. Therefore I can't recommend experimenting on your mobile phone in case you wreck it or invalidate the warranty, but in the USA where disposable

mobiles are available, maybe you could have a go. It's up to you.

## Reworking

If the specialist gear isn't available, the next best thing is to try using the very finest soldering iron tip (bit) available, applied for a fraction of a second to both pads and use a solder sucker to remove the entire l.e.d. chip and solder. Replace it, perhaps using silver solder, even more quickly – and the right way round of course!

A number of so-called surface mount "rework" tools are available. Most high-end systems use blasts of hot air or gas instead of applying heat conducted through a tip: the hot air provides a clean source of distributed heat, because contamination of the solder pads and components is a major concern. Also, the use of a dirty, flux-laden tip can prove unsatisfactory in this line of work. In fact, SM components themselves may have a surprisingly short shelf life, because oxidation of the connections over time may prevent them from being soldered properly.

The high-end rework units made by Weller, for example, for industrial use cost thousands of pounds but a competitively-priced range of soldering and desoldering equipment is available from Antex ([www.antex.co.uk](http://www.antex.co.uk)) whose web site shows an SMT Rework system for just £235 + VAT (see photo). The Antex unit is especially worth looking at if you only need to handle the occasional surface mount repair.

You'll have to dig deep to find Weller on the web – see [www.coopertools.com](http://www.coopertools.com). Search the web including the major component dealers too, at <http://rswww.com> and [www.farnell.com](http://www.farnell.com). ARW.

## Bleeder Resistors

*"Can you explain the meaning of the term 'bleeder resistor'?"* Thanks from Mahmoud Darweesh in the EPE Chat Zone message board ([www.epemag.wimborne.co.uk](http://www.epemag.wimborne.co.uk)).

It is simply the term used to describe a resistor that is placed across a circuit, usually to discharge a voltage. An example is shown in Fig.1, which shows a classic way of connecting a mains-rated X-class suppressor capacitor across a mains supply. The capacitor helps prevent mains-borne voltage spikes from damaging the circuit.

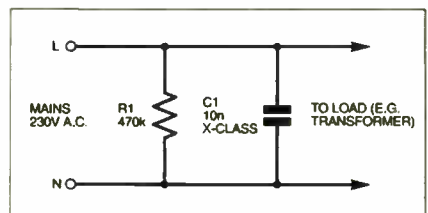

*Fig.1. A bleeder resistor R1 will discharge the high voltage across the suppressor capacitor C1.*

In a typical mains appliance, imagine what would happen if the mains supply



*A surface-mount rework station by Antex, with special tips, temperature controller and digital display.*

were disconnected and the mains plug removed from its socket: since the capacitor charges up to the *peak* voltage, there could be up to 340V peak a.c. ( $240V \times \sqrt{2}$ ) present across the capacitor, so anyone handling the plug could receive a very nasty jolt. The bleeder resistor R1 has a nominal 470k value (say 220 kilohms upwards) and will quickly discharge the capacitor to prevent shock. The resistor must also be suitably mains-rated, meaning that several resistors in series should be used if necessary, to accommodate the voltage.

In Fig. 2 a typical voltage regulator is drawn which has an electrolytic capacitor C1 on the input, to act as a filter and smoothing capacitor. A bleeder resistor R1 will discharge C1 when the power is turned off.

One problem worth remembering is that when a capacitive load is placed on the output, then a voltage can still remain across the output of the regulator, even after the input voltage is removed! So if the output terminal then has a higher potential than its input, the regulator will be reverse-biased, and possibly damaged.

In the circuit diagram of Fig.3, a rectifier diode D1 is included to protect the regulator against this event. It bypasses the regulator and shorts the capacitor C1 to a lower voltage. ARW.

## More on Motors

The subject of electric motors is a query that often pops up in the *Circuit Surgery* mailbox. It is always useful for hobbyists to know the basic differences between types of electric motor, especially if they are considering adapting one to function in a particular project.

In December 2002's issue, we outlined the operation of *induction motors*, and explained how a "capacitor start" motor operates. This month, a little later than planned, and again without delving too much into the associated electrical engineering, we explain the basic operation of d.c. electric motors. Everyone has used d.c. motors in models, toys, robotics and more – and a modern motor vehicle contains dozens of them.

If we need to use a motor on a d.c. supply then an a.c.-only induction motor presents us with a problem. Its inner rotor behaves like a series of spinning "bar magnets" (poles) because currents are *induced* into them by the stator's circulating fields. Thus the rotor is magnetically attracted and moved around, which provides the rotation effect. As the applied fields are alternating in nature, the rotor must inherently spin. In the case of a d.c. motor, though, without an alternating field being present in the stator to force the rotation, we are stuck – literally!

## D.C. Motors – Inner Spin

There are other ways of creating the motor effect by using d.c. voltages. For instance, we could do away with the stator and replace it with a *fixed* magnetic field, e.g. derived from *permanent magnets*. This means that the magnetic field surrounding the rotor is stationary.

If the rotor now carries copper windings that are electrically powered, they can form "electromagnets" which are the "poles" of the motor. But how to make the *rotor* of a d.c. motor spin round, if there are no

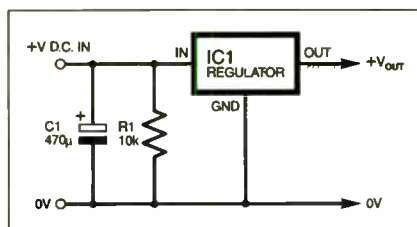

Fig.2. In this circuit, R1 is used to discharge the filter/smoothing capacitor C1.

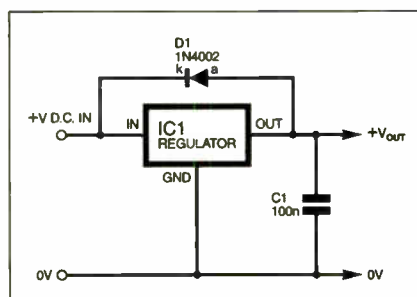

Fig.3. In this circuit, protection against reverse polarity across IC1 is provided by rectifier diode D1.

moving magnetic fields circulating in the *stator* surrounding it? The answer is to switch the *rotor's* magnetic fields around instead.

A d.c. supply can be connected to the coils (which form the *armature*) that are carried by the rotor, by using a set of *brushes*. These connect to the armature's windings via a series of copper segments called the *commutator* which are fitted around the rotor. Thus an external d.c. voltage can be applied to the motor that will power the armature windings through the commutator and brushes.

In the simplest form, the commutator reverses the direction of current flowing through the armature during rotation, causing the armature windings to be "pushed" and then "pulled", and it is this alternating action that causes the d.c. motor to spin. The way that the armature windings are wired to the commutator means that just as one winding is being disconnected, the next winding is being powered, thereby maintaining the momentum of the motor which will run at a constant speed.

## Cruise Control

Most readers will have, at some time, taken a small d.c. model motor apart, marvelling at the feats of Chinese miniature engineering that went into its production and wondering why it didn't always work again when re-assembled!

When examining the innards, you will doubtless have noticed two small ferrite magnets held together with steel keepers. These create a stationary North-South magnetic field that surrounds the armature. Doubtless too you will have seen the brushes (often just a set of simple sprung copper contacts) that connect the armature to the outside world.

It is relatively simple to control the d.c. motor's speed just by varying the d.c. voltage, which is a big advantage over induction motors that need complex controllers (for example, see the a.c. inverter/ frequency controller of the *EPE Wind Tunnel* in

the February 2003 issue). Remote-control model vehicles use simple resistors, switched in series via a servo, to control the vehicle's speed, but the power wasted in the resistor makes this a very inefficient technique. It is fairly simple to build a PWM (pulse width modulation) circuit using, say a 555 and power transistor, that will supply variable power levels to d.c. motors, or you could use a variable voltage regulator instead.

However, a simple "unintelligent" controller will eventually result in the motor stalling under load at low speeds. More advanced methods are available that take account of the back-e.m.f. generated by the motor, to ensure good levels of torque at lower speeds. Some motors provide a feedback output that can be utilised by external controllers to maintain power.

## Taking The Field

By replacing the permanent magnets on the outside of the motor with a set of electrical coils or windings, a *magnetic field* is produced – hence the term *field windings*. You may find these on intermediate to larger size d.c. motors.

Now, by wiring the field in series with the d.c. supply to the motor's armature, a *series-wound* motor is created. These produce a very high start-up torque that is capable of driving a heavy mechanical load. A 12V car starter motor is an example, and these will draw 200 to 300 amps during start-up.

A *shunt-wound* motor has its field winding in parallel with (shunted by) the main d.c. supply to the armature, and they are useful in applications needing just a steady constant torque (e.g. an electric pump). A *compound-wound* motor has the best features of series and shunt wound types in one unit, i.e. steady running with a high start-up torque available.

As we know, a small permanent magnet motor can spin either way depending which way the supply is connected (to the armature). When a separate field winding exists, then if *either* the field *or* the armature currents are reversed, the direction of rotation can be switched, but if you change *both* the field *and* the armature supplies together, the motor will continue in the same direction as before – so in theory a d.c. motor can be successfully run from an alternating supply.

What is called a *universal motor* is usually a single-phase series-wound motor that is capable of running on either alternating or direct currents. Many power drills (both a.c. mains and rechargeable d.c. types), kitchen food mixers and countless other power tools use brush-type d.c. or universal motors in their construction. Motors fitted with brushes have to overcome the friction they exhibit, and as we all know, the screech of a brush-type motor can be very noisy given their fairly small size.

The other main drawback, of course, is the high levels of radio-frequency interference (RFI) that can be created, and those sparking brushes don't help! A ceramic capacitor is usually hard-wired across the armature somewhere to help reduce electrical noise. ARW

● We will be continuing our item on the use of MOSFETs in the coming months.



# DRIVER ALERT



\*JOSH ARKELL, \*ADAM WOLLEY and MAX HORSEY

## A thinking time reaction tester

**R**EACTION times are affected by many factors, such as alcohol, drugs, general medical conditions and tiredness. It seemed a good idea, therefore, to devise a circuit to test reaction times.

Unfortunately, during extensive tests using volunteers who consumed large quantities of beer, it was found that sheer reaction time is not greatly affected – particularly if the person is poised waiting for something to happen.

This is quite unlike driving a car, where anything can happen at any time, and so concentration and thinking times are critical. Using a dual 7-segment display, the project described here tests the “driver’s” ability to concentrate, think and react. The beer tests now provided more dramatic results. How thinking/reaction time increased progressively with the number of cans of lager consumed is shown in Fig.1.

A mobile phone test was also devised, and, surprisingly it was found that speaking on a mobile phone, including a hands-free unit gave similar results to drinking four cans of lager. The results for several people are also illustrated by the graphs in Fig1.

### HOW IT WORKS

The Driver Alert allows drivers to test their own thinking/reaction time. It consists of three buttons labelled 1, 2 and 3, three lights and a dual 7-segment display.

Any button is pressed to activate the machine.

A number 1 appears, meaning “Test 1”. After a random delay a single l.e.d. lights up in any position, or two lights in any position, or all three lights appear.

You have to press the appropriate button according to the number of lights that appear. Since the lights may be in any position, a little thought is needed to press the correct button, and it is mainly this thinking time which is affected by alcohol etc.

The machine offers the user five attempts, and displays the reaction time after each try. After the five attempts, the average time is calculated and displayed. If you attempt to press a button before a light appears or try to press two buttons, the system flashes and then resets, indicating “cheat”.

### CIRCUIT DETAILS

The basic block diagram is shown in Fig.2. At the heart of the system is a PIC microcontroller i.c., this controls the l.e.d.s and displays, and provides a “fairly random” sequence to ensure that the user

cannot predict which l.e.d.s are going to light. An inexpensive 7-segment decoder i.c. is also employed in order to reduce the number of outputs required of the PIC, and to simplify programming.

The full circuit diagram for the Driver Alert is shown in Fig.3. The PIC, IC1, used is a type PIC16F627. This is one of the more recent PICs and has a built in oscillator, is flash reprogrammable, and available for a remarkably low price.

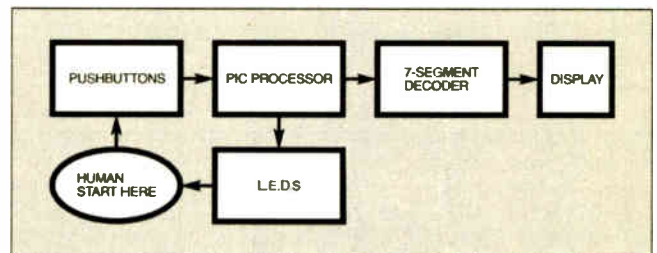

Fig.2. Basic system block diagram.

The Reset pin (4) of IC1 is made positive by resistor R1 in order for the PIC to function normally. If a reset is required then switch S1 can be pressed, pulling pin 4 to 0V for a moment.

This reset function is rarely required and so the switch was mounted on the copper side of the printed circuit board (p.c.b.) in

\*Developed by Josh and Adam, the design won them the Under 15 Award in last year’s Young Electronic Designer Awards (YEDA) competition. The text is by Max.

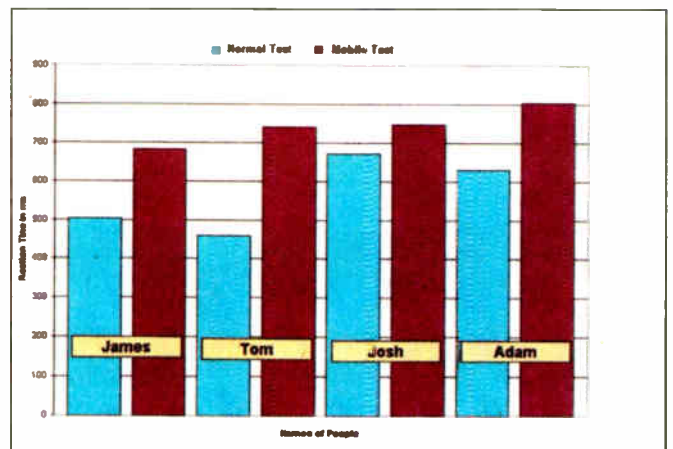
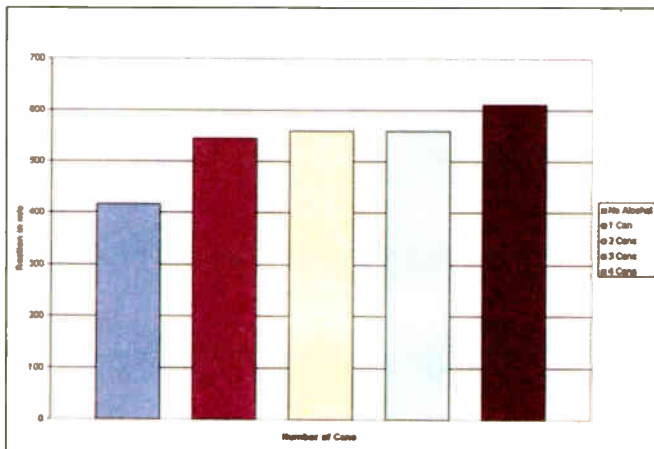

Fig.1. Two thinking/reaction graphs showing a student’s time against cans of beer drunk, and results for four 14-year-olds with and without being on a mobile ‘phone.

line with a small hole in the bottom of the case. A pointed object can be pushed through the hole in the rare event of a reset being required.

Since the system is also reset when the batteries are removed, switch S1 could be omitted if preferred. However, resistor R1 must still be fitted.

## INPUTS AND OUTPUTS

The "trigger reaction" signals from push-switches S2 to S4 are fed to the PIC's pins RA0, RA1 and RA2. The three 22 kilohm resistors (R2 to R4) pull these inputs to 0V, unless one of the pushswitches S2 to S4 is pressed, in which case the appropriate input is made positive (logic 1).

The three l.e.d.s D1 to D3 are driven from the PIC's pins RB7, RB6 and RB5 respectively via current limiting resistors R6, R7 and R8. Pins RB0, RB1, RB2 and RB3 provide a binary coded decimal (BCD) output equivalent to the number you wish to display. This is converted to a seven-segment output by the BCD to 7-segment decoder IC2, and the outputs to the dual display X1 are delivered from pins QA to QG via ballast resistors R11 to R17.

IC2 pins 3, 4 and 5 are for controlling special display functions, namely Lamp Test, Blanking and Strobe respectively. Since these functions are not required in this project, pins 3 and 4 are tied to positive, and pin 5 to 0V, to disable their functions.

## STROBING

There is insufficient power available from the PIC to drive two displays, and in any case, it is customary to use "strobing" (multiplexing) to drive two displays from one set of segment outputs. Virtually all displays are driven in this way – which explains why calculators etc. often appear to flicker when filmed with a video camera.

Strobing is achieved by careful programming, and the use of PIC pin RB4 to control which display is lit at any one time. The action is as follows:

RB4 at logic 1 = tens digit appears

RB4 at logic 0 = units digit appears

Hence the program causes outputs 0 to 3 to work in sync with RB4, so that the display shows the units, then the tens, then the units etc. in very quick succession, so fast that the two numbers appear to be continuously lit.

## READOUT

When RB4 is at logic 1, current flows through current limiting resistor R5 into the base (b) of transistor TR1. Hence TR1 switches on, and its collector (c) is effectively pulled to 0V, via its emitter (e). The

collector of TR1 is also connected to the common cathode connection k2 (of display X1), and so the Tens display is able to light up according to the code output by IC2.

Since the left-hand side of resistor R10 is also pulled down to 0V via TR1, TR2 is turned off, and so no current can flow from cathode connection k1. The Units digit cannot therefore function.

However, when RB4 is at logic 0 (0V), TR1 is turned off, and so its collector is made positive due to resistor R9. Current flows through resistor R10, turning on transistor TR2. Current can therefore flow from cathode k1, making the Units display work. At

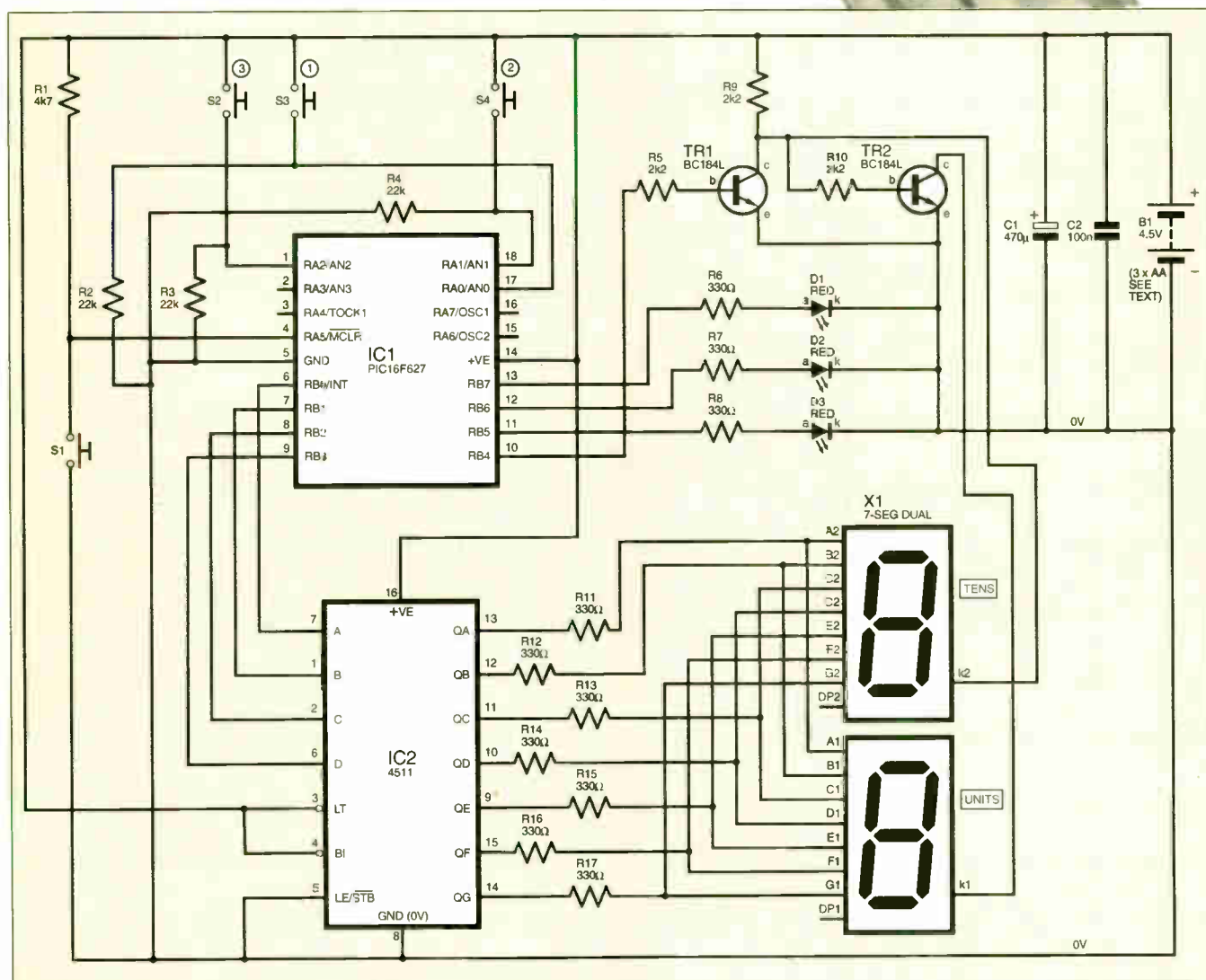

Fig.3. Full circuit diagram for the Driver Alert. Note that X1 is a dual 7-segment device in a single package.



the same time, current cannot flow from k2 (remember that TR1 is turned off) and so the Tens display will not function.

Decoupling of the supply is provided by capacitors C1 and C2, and an AA battery pack provides the necessary 4-5V supply.

## CONSTRUCTION

Most of the Driver Alert components are mounted on a small single-sided printed circuit board and the topside component layout together with a full-size underside copper foil master are shown in Fig.4. This board is available from the *EPE PCB Service*, code 387.

The circuit board has been designed so that the 7-segment dual display can be housed directly on the p.c.b., as can the l.e.d.s, although in the prototype the l.e.d.s are front panel mounted and lead-off wires taken to the board. The reaction pushswitches (S2 to S4) are also front panel mounted. The optional Reset "click" switch S1 is soldered on the p.c.b. copper side.

Begin construction by fitting the d.i.l. sockets required for IC1 and IC2 as shown in Fig.4, noting that IC1 is "upside-down". Fit s.i.l. sockets for the 7-segment dual display, followed by the required wire links, the two longest of which should be insulated. Note that these two links are soldered underneath the display X1.

Next fit the resistors followed by the two transistors, ensuring that their flat edges are as shown. Also ensure that TR1 and TR2 are

BC184L (not BC184 – without the L); other 184s have different pinouts.

Capacitors C1 and C2 should be soldered in, noting that C1 is electrolytic and so must be fitted the correct way round. Its positive (+) side is nearer the positive battery supply connection. If the circuit is to be housed in the case as listed, then C1 must be fitted so that it can be bent over against the p.c.b. to reduce its height.

The l.e.d.s (D1 to D3) may be housed directly on the p.c.b. or via connecting wires. If using wires, note that the three cathode (k) sides are connected together and so a single wire may be used as in the prototype. Also fit connecting wires for the pushswitches S2 to S4.

Reset switch S1 may be omitted as described earlier, but if a Reset option is required, then a p.c.b. pushbutton switch may be directly housed on the copper side of the board so that it can be operated via a small hole drilled in the underside of the case.

Finally, connect colour-coded wires for the battery pack and fit the dual

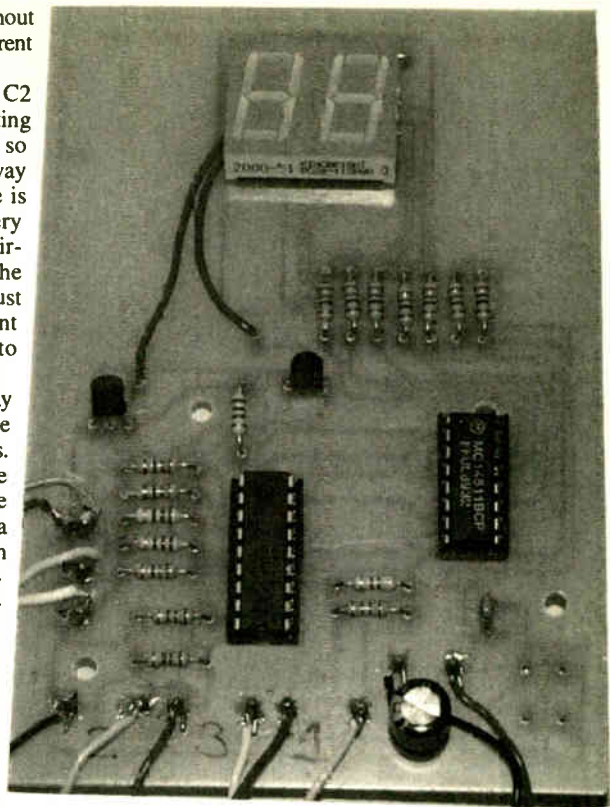

Topside printed circuit board component layout.

common cathode 7-segment display; the decimal point of the display indicates the bottom side.

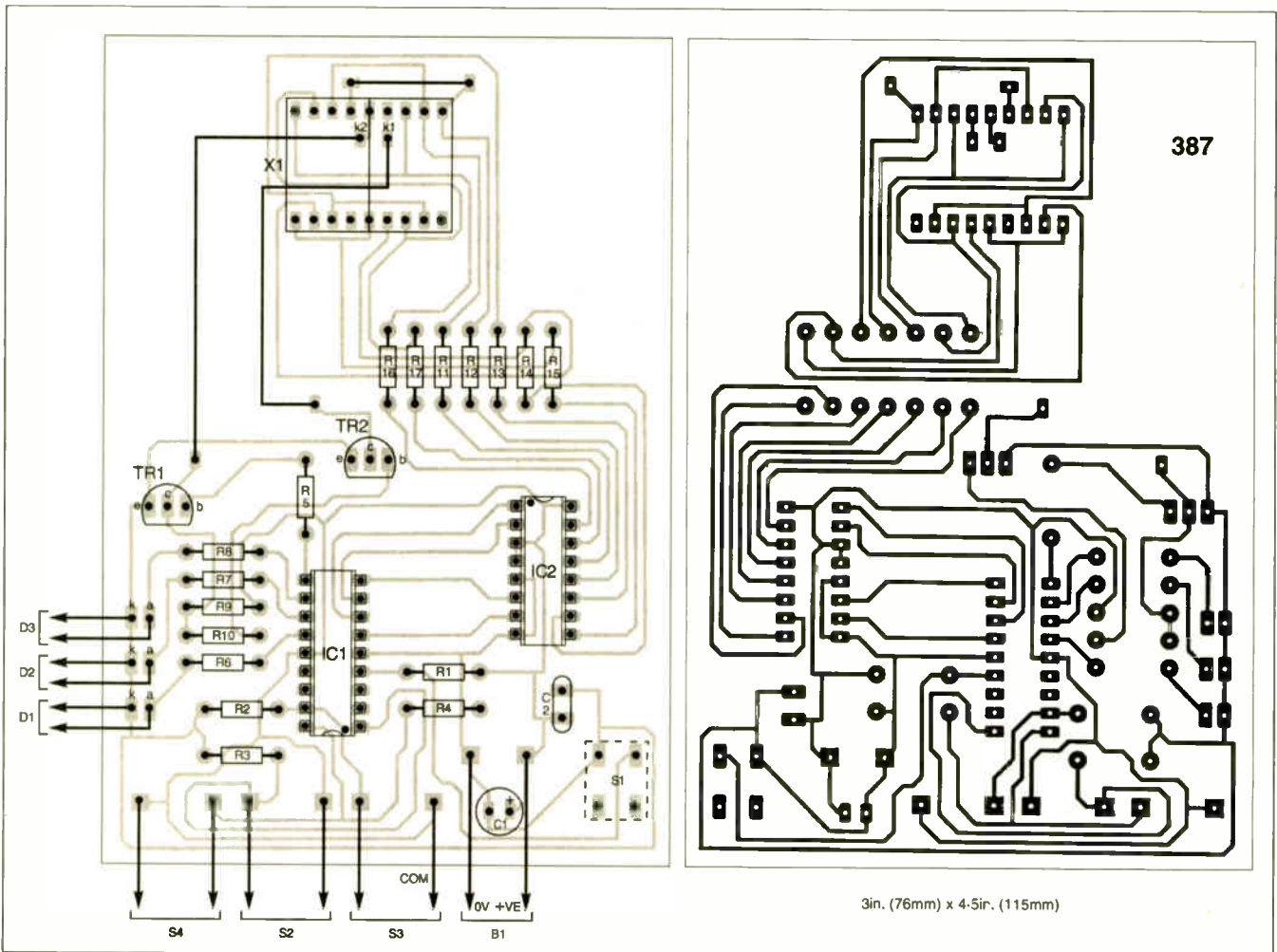

Fig.4. Driver Alert printed circuit board component layout and full-size underside copper foil master pattern. The Reset switch S1 is soldered on the track side and a small access hole drilled in the underside of the case.

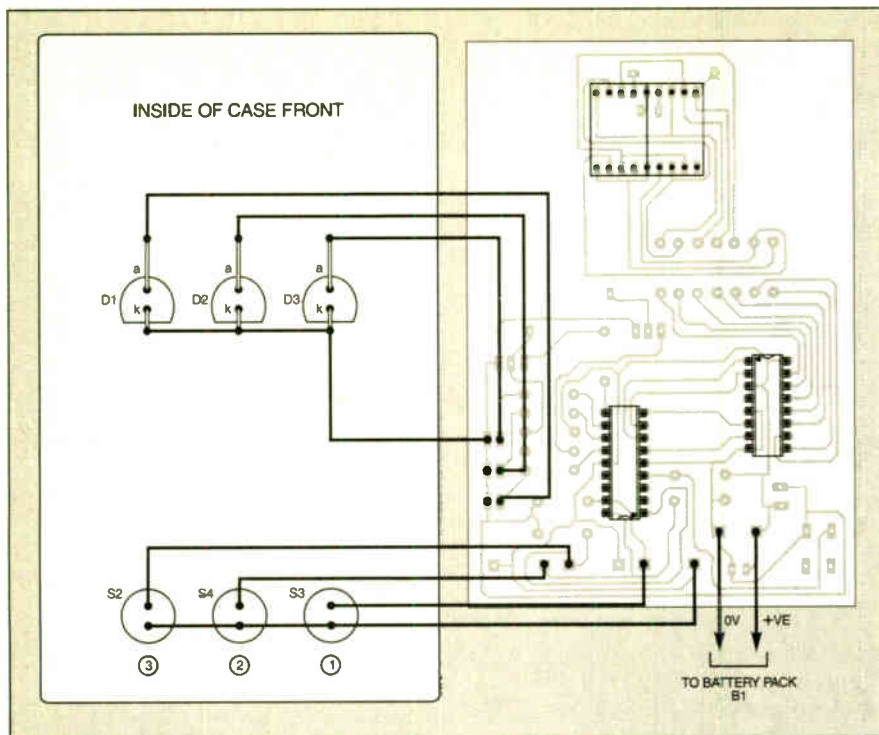

Fig.5. Interwiring details from the printed circuit board to front panel switches, i.e.d.s and to the battery pack.

### BOXING-UP

A range of cases with display cutouts is available, and some are supplied with red filters that provide much greater contrast for the display. Begin by checking how the p.c.b. will fit so that the display is visible, noting that the p.c.b. will be fitted with the components facing towards the front surface of the case. Self-adhesive p.c.b. mounts can be employed to support the circuit board, but do not fasten until all drilling is complete.

Drill the necessary holes for the i.e.d.s and pushswitches as shown in Fig.5. A cardboard cutout was made to partly mask the cutout for the dual 7-segment display.

A small hole also needs to be drilled in the base of the case, so that it lines up with Reset switch S1's actuating button.

The wiring from the p.c.b. to the i.e.d.s and switches is also shown in Fig.5. The i.e.d.s all share a common cathode connection and so a single wire can be used to connect their shorter leads to the circuit board. Likewise, the pushbutton switches share a single connection. Connect the wires with care, noting that the switches are out of sequence.

### BATTERY PACK

The circuit operates on a supply of 2V to 5.5V, and so a set of three AA cells (4.5V) is suggested. In the prototype, the battery compartment was designed for four AA cells, but has provision for three, by soldering the connecting lead to the appropriate spring clip.

It is *not* acceptable to power the circuit from four standard AA cells since the total

voltage supplied will be above the 5.5V maximum acceptable by the PIC. If *rechargeable* cells are employed, then the voltage supplied by four in series will be about 4.8V, and so would be acceptable.

### PROGRAMMING

The program for this design was written in BASIC using the software required when programming PICAXE devices, such as those in the *PICAXE Projects* series in the Nov, Dec '02 and Jan '03 issues. However, the program was too long to fit into a PICAXE, and so a standard



Cardboard mask behind display window.

## COMPONENTS

#### Resistors

R1	4k7
R2 to R4	22k (3 off)
R5, R9	
R10	2k2 (3 off)
R6 to R8,	
R11 to R17	330Ω (10 off)

All 0.25W 5% carbon film

#### See

**SHOP  
TALK  
page**

#### Capacitors

C1	470μ radial elect. 35V
C2	100n ceramic disc

#### Semiconductors

D1 to D3	5mm red i.e.d. (3 off)
TR1, TR2	BC184L <i>n</i> pn transistor (2 off)
IC1	PIC16F627 microcontroller, pre-programmed (see text)
IC2	4511B BCD to 7-segment decoder/driver
X1	7-segment dual display, common cathode

#### Miscellaneous

S1	p.c.b. mounting, click-effect, switch (push-to-make) – see text
S2 to S4	pushbutton switch, push-to-make (3 off)
B1	4.5V battery pack (3 x AA – see text)

Printed circuit board available from the *EPE PCB Service*, code 387; plastic handheld case, with display window and battery compartment, case size 180mm x 100mm x 44mm approx.; 16-pin d.i.l. socket; 18-pin d.i.l. socket; s.i.l. socket strip for display; panel mounting i.e.d. clip (3 off); self-adhesive p.c.b. mounting pillars; multi-coloured connecting wire; solder etc.

Approx. Cost  
Guidance Only

**£21**  
excl. batts & case

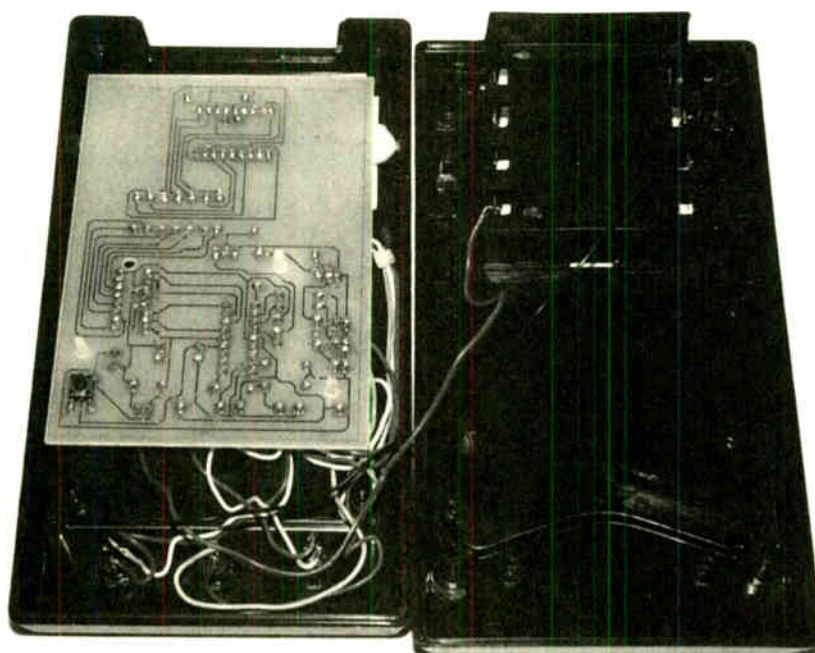

Completed unit showing the optional Reset switch on the board copper side.





Adam and Josh receiving their awards (£500 and a trophy) from HRH Prince Andrew for winning the Best Under 15 project at last year's YEDA prizegiving ceremony.

given on the *EPE PCB Service* page, and in this month's *Shoptalk*, which also gives details about obtaining preprogrammed PICs.

### TESTING

It is now time to insert the i.c.s, noting that they are static sensitive and so you should touch an earthed metal object before handling each i.c. Note also that they face opposite ways – ensure that each notch or dot is as shown in Fig.4. The PIC16F627 must, of course, first be programmed either by

downloading the hex file, or by buying a ready-programmed chip (see *Shop Talk*).

Commence testing by switching on and pressing any switch button. The number 1 should appear, indicating your first go. If you do nothing, the number 99 appears, showing that you took longer than the time allowed. The machine then moves on to go-number 2.

If you respond correctly to the number of l.e.d.s displayed, then your time is shown on the displays. Note that when you multiply the reading by ten, your time is in milliseconds. Hence a display of 56 indicates 560 milliseconds. After go-number 5, the display flashes the average score before switching off.

After five practice goes, you should be able to achieve a time of under 600 milliseconds. In trials, some people achieved times of under 200 milliseconds. Alcohol etc. will, of course, affect your score, and using a mobile phone will also have a significant effect – even a hands-free type, see graphs in Fig.1

Note that "switching off" is not a physical switch off of the power supply. Rather,

### Instructions

Press any button to start the sequence.

Add the number of lights that come up together and press the relevant button.

e.g. 2 lights press button 2

when taking the test remember to ignore the display until the end

Instruction panel for glueing to rear of unit.



the PIC is told to SLEEP. In this mode it places itself into a low power condition, in which it typically consumes only about 15µA. □

# Radio Bygones



WHETHER your interest is in domestic radio and TV or in amateur radio, in military, aeronautical or marine communications, in radar and radio navigation, in instruments, in broadcasting, in audio and recording, or in professional radio systems fixed or mobile, RADIO BYGONES is the magazine for you.

ARTICLES on restoration and repair, history, circuit techniques, personalities, reminiscences and just plain nostalgia – you'll find them all. Plus features on museums and private collections and a full-colour photo-feature in every issue.

ITS MOSTLY about valves, of course, but 'solid-state' – whether of the coherer and spark-gap variety or early transistors – also has a place.

FROM THE DAYS of Maxwell, Hertz, Lodge and Marconi to what was the state-of-the-art just a few short years ago . . .

THERE IS ALSO a selection of free readers' For Sale and Wanted advertisements in every issue.

## Radio Bygones covers it all!

THE MAGAZINE is published six times a year, and is only available by postal subscription. It is not available at newsagents.

TO TAKE OUT a subscription, or to order a sample copy, please contact:

RADIO BYGONES, Wimborne Publishing, 408 Wimborne Road East, Ferndown, Dorset BH22 9ND.

Tel: 01202 873872. Fax 01202 874562. Web sites: [www.radiobygones.co.uk](http://www.radiobygones.co.uk) [www.radiobygones.com](http://www.radiobygones.com)

# Technobots Ltd



**THE ONE STOP SHOP FOR THE ROBOT  
BUILDER, RADIO CONTROL AND  
ENGINEERING ENTHUSIAST**



www.m2robot.com

Below is just a small selection of the thousands of products we supply, details of these and many more are available on-line at [www.technobots.co.uk](http://www.technobots.co.uk) or contact us for a free catalogue

Secure on-line ordering at [www.technobots.co.uk](http://www.technobots.co.uk)

YUASA SLA BATTERIES NP SERIES		MOTORS		ALSO ON OUR WEB SITE	
Ah - Voltage	Price	Voltage, A / W	Price		
NP1-6	£12.31	1.5 - 3V, 1.2A	£0.80	 <b>150W 24Vdc Motor Just £24.95</b>	
NP1.2-6	£6.89	3-6V, 0.76A	£1.20		
NP2.8-6	£8.58	12-24V, 1A	£3.00		
NP4-6	£8.22	6-12V, 4.6A	£4.40		
NP7-6	£20.68	24V, 150W	£24.95		
NP10-6	£12.34	12V, 400W	£113.74		
NP12-6	£12.45	12V, 630W	£98.23		
NP0.8-12	£16.25	24V, 750W	£88.23		
NP1.2-12	£9.03	12V, 500W*	£74.97		
NP2-12	£18.99	12V, 800W*	£74.97		
NP2.1-12	£10.26	24V, 500W*	£74.97		
NP2.3-12	£12.34	24V, 800W*	£74.97		
NP2.8-12	£11.49	24V, 1200W*	£90.48		
NP3.2-12	£13.53	* Motor not continuously rated			
NP4-12	£14.68	<b>ELECTRONIZE MOTOR SPEED CONTROLLERS</b>			
NP7-12	£12.63	These controllers plug direct into a standard RC radio receiver 2-24V (7-24V for controllers with BEC)			
NP12-12	£27.43	Rating	Price	 <b>From £18.67</b>	
NP17-12	£37.15	10A - Kit	£18.67		
NP24-12	£47.25	10A + BEC - Kit	£20.85		
NP38-12	£72.05	15A - Kit	£20.66		
NP65-12	£111.81	15A + BEC - Kit	£23.04		
YUASA SLA BATTERIES NPC SERIES		10A	£26.08		
Ah - Voltage	Price	10A + BEC	£28.26		
NPC17-12	£38.78	15A	£28.07		
NPC24-12	£49.90	15A + BEC	£30.35		
NPC30-12	£59.10	15A - CPU Based	£33.20		
NPC38-12	£78.44	15A + BEC - CPU	£35.48		
NPC65-12	£114.04	30A - CPU Based	£37.95		
Also available, the Hawker Odyssey range of batteries		<b>4QD MOTOR SPEED CONTROLLERS</b>			
<b>NI-CADS</b>		These controllers use a potentiometer or voltage input to set speed. For RC input, interfaces available			
Sanyo N-3000CR Fast charge / discharge		Voltage / Current	Price	 <b>Just £107.99</b>	
1.2V 3000mAh	£3.35	12V / 35A	£57.00		
Also available, Ni-Cad Ni-MH packs from 4.8V to 14.4V from 600 to 3000mAh		24V / 35A	£57.00		
<b>BATTERY CHARGERS</b>		36V / 35A	£59.38		
We have a range of chargers for SLA / Ni-CAD / Ni-MH batteries from 600mA to 20A		12V / 70A	£83.13		
<b>LED VOLTMETERS</b>		24V / 70A	£83.13		
Type	Price	36V / 70A	£85.50		
12V 3LED	£4.50	12V / 120A	£123.50		
24V 5 LED	£6.00	24V / 120A	£123.50		
36V 5 LED	£6.00	36V / 120A	£128.25		
36V 7LED	£8.50	24/36V / 150A	£180.50		
4.8V Micro	£8.49	24.36V / 200A	£190.00		
6.0V Micro	£8.49	24/36V / 300A	£232.75		
<b>RADIO CONTROL</b>		Futaba radio control gear available at discount prices		Model	Price
Sanyo N-3000CR Fast charge / discharge		These controllers use a potentiometer or voltage input to set speed. For RC input, interfaces available		Skysports 4	£107.99
1.2V 3000mAh	£3.35	Voltage / Current		Skysports 4	£107.99
Also available, Ni-Cad Ni-MH packs from 4.8V to 14.4V from 600 to 3000mAh		12V / 35A	£57.00	Skysports 6	£120.79
<b>BATTERY CHARGERS</b>		24V / 35A	£57.00	Fieldforce 6	£215.94
We have a range of chargers for SLA / Ni-CAD / Ni-MH batteries from 600mA to 20A		36V / 35A	£59.38	These prices also include Ni-Cad batteries, charger, receiver, servo's and crystals. Upgrade options available.	
<b>LED VOLTMETERS</b>		12V / 70A	£83.13		
Type	Price	24V / 70A	£83.13		
12V 3LED	£4.50	36V / 70A	£85.50		
24V 5 LED	£6.00	12V / 120A	£123.50		
36V 5 LED	£6.00	24V / 120A	£123.50		
36V 7LED	£8.50	36V / 120A	£128.25		
4.8V Micro	£8.49	24/36V / 150A	£180.50		
6.0V Micro	£8.49	24.36V / 200A	£190.00		
<b>RADIO CONTROL</b>		24/36V / 300A	£232.75		
Sanyo N-3000CR Fast charge / discharge		Futaba radio control gear available at discount prices			
1.2V 3000mAh	£3.35	These controllers use a potentiometer or voltage input to set speed. For RC input, interfaces available			
Also available, Ni-Cad Ni-MH packs from 4.8V to 14.4V from 600 to 3000mAh		12V / 35A	£57.00		
<b>BATTERY CHARGERS</b>		24V / 35A	£57.00		
We have a range of chargers for SLA / Ni-CAD / Ni-MH batteries from 600mA to 20A		36V / 35A	£59.38		
<b>LED VOLTMETERS</b>		12V / 70A	£83.13		
Type	Price	24V / 70A	£83.13		
12V 3LED	£4.50	36V / 70A	£85.50		
24V 5 LED	£6.00	12V / 120A	£123.50		
36V 5 LED	£6.00	24V / 120A	£123.50		
36V 7LED	£8.50	36V / 120A	£128.25		
4.8V Micro	£8.49	24/36V / 150A	£180.50		
6.0V Micro	£8.49	24.36V / 200A	£190.00		
<b>RADIO CONTROL</b>		24/36V / 300A	£232.75		
Sanyo N-3000CR Fast charge / discharge		Futaba radio control gear available at discount prices			
1.2V 3000mAh	£3.35	These controllers use a potentiometer or voltage input to set speed. For RC input, interfaces available			
Also available, Ni-Cad Ni-MH packs from 4.8V to 14.4V from 600 to 3000mAh		12V / 35A	£57.00		
<b>BATTERY CHARGERS</b>		24V / 35A	£57.00		
We have a range of chargers for SLA / Ni-CAD / Ni-MH batteries from 600mA to 20A		36V / 35A	£59.38		
<b>LED VOLTMETERS</b>		12V / 70A	£83.13		
Type	Price	24V / 70A	£83.13		
12V 3LED	£4.50	36V / 70A	£85.50		
24V 5 LED	£6.00	12V / 120A	£123.50		
36V 5 LED	£6.00	24V / 120A	£123.50		
36V 7LED	£8.50	36V / 120A	£128.25		
4.8V Micro	£8.49	24/36V / 150A	£180.50		
6.0V Micro	£8.49	24.36V / 200A	£190.00		
<b>RADIO CONTROL</b>		24/36V / 300A	£232.75		
Sanyo N-3000CR Fast charge / discharge		Futaba radio control gear available at discount prices			
1.2V 3000mAh	£3.35	These controllers use a potentiometer or voltage input to set speed. For RC input, interfaces available			
Also available, Ni-Cad Ni-MH packs from 4.8V to 14.4V from 600 to 3000mAh		12V / 35A	£57.00		
<b>BATTERY CHARGERS</b>		24V / 35A	£57.00		
We have a range of chargers for SLA / Ni-CAD / Ni-MH batteries from 600mA to 20A		36V / 35A	£59.38		
<b>LED VOLTMETERS</b>		12V / 70A	£83.13		
Type	Price	24V / 70A	£83.13		
12V 3LED	£4.50	36V / 70A	£85.50		
24V 5 LED	£6.00	12V / 120A	£123.50		
36V 5 LED	£6.00	24V / 120A	£123.50		
36V 7LED	£8.50	36V / 120A	£128.25		
4.8V Micro	£8.49	24/36V / 150A	£180.50		
6.0V Micro	£8.49	24.36V / 200A	£190.00		
<b>RADIO CONTROL</b>		24/36V / 300A	£232.75		
Sanyo N-3000CR Fast charge / discharge		Futaba radio control gear available at discount prices			
1.2V 3000mAh	£3.35	These controllers use a potentiometer or voltage input to set speed. For RC input, interfaces available			
Also available, Ni-Cad Ni-MH packs from 4.8V to 14.4V from 600 to 3000mAh		12V / 35A	£57.00		
<b>BATTERY CHARGERS</b>		24V / 35A	£57.00		
We have a range of chargers for SLA / Ni-CAD / Ni-MH batteries from 600mA to 20A		36V / 35A	£59.38		
<b>LED VOLTMETERS</b>		12V / 70A	£83.13		
Type	Price	24V / 70A	£83.13		
12V 3LED	£4.50	36V / 70A	£85.50		
24V 5 LED	£6.00	12V / 120A	£123.50		
36V 5 LED	£6.00	24V / 120A	£123.50		
36V 7LED	£8.50	36V / 120A	£128.25		
4.8V Micro	£8.49	24/36V / 150A	£180.50		
6.0V Micro	£8.49	24.36V / 200A	£190.00		
<b>RADIO CONTROL</b>		24/36V / 300A	£232.75		
Sanyo N-3000CR Fast charge / discharge		Futaba radio control gear available at discount prices			
1.2V 3000mAh	£3.35	These controllers use a potentiometer or voltage input to set speed. For RC input, interfaces available			
Also available, Ni-Cad Ni-MH packs from 4.8V to 14.4V from 600 to 3000mAh		12V / 35A	£57.00		
<b>BATTERY CHARGERS</b>		24V / 35A	£57.00		
We have a range of chargers for SLA / Ni-CAD / Ni-MH batteries from 600mA to 20A		36V / 35A	£59.38		
<b>LED VOLTMETERS</b>		12V / 70A	£83.13		
Type	Price	24V / 70A	£83.13		
12V 3LED	£4.50	36V / 70A	£85.50		
24V 5 LED	£6.00	12V / 120A	£123.50		
36V 5 LED	£6.00	24V / 120A	£123.50		
36V 7LED	£8.50	36V / 120A	£128.25		
4.8V Micro	£8.49	24/36V / 150A	£180.50		
6.0V Micro	£8.49	24.36V / 200A	£190.00		
<b>RADIO CONTROL</b>		24/36V / 300A	£232.75		
Sanyo N-3000CR Fast charge / discharge		Futaba radio control gear available at discount prices			
1.2V 3000mAh	£3.35	These controllers use a potentiometer or voltage input to set speed. For RC input, interfaces available			
Also available, Ni-Cad Ni-MH packs from 4.8V to 14.4V from 600 to 3000mAh		12V / 35A	£57.00		
<b>BATTERY CHARGERS</b>		24V / 35A	£57.00		
We have a range of chargers for SLA / Ni-CAD / Ni-MH batteries from 600mA to 20A		36V / 35A	£59.38		
<b>LED VOLTMETERS</b>		12V / 70A	£83.13		
Type	Price	24V / 70A	£83.13		
12V 3LED	£4.50	36V / 70A	£85.50		
24V 5 LED	£6.00	12V / 120A	£123.50		
36V 5 LED	£6.00	24V / 120A	£123.50		
36V 7LED	£8.50	36V / 120A	£128.25		
4.8V Micro	£8.49	24/36V / 150A	£180.50		
6.0V Micro	£8.49	24.36V / 200A	£190.00		
<b>RADIO CONTROL</b>		24/36V / 300A	£232.75		
Sanyo N-3000CR Fast charge / discharge		Futaba radio control gear available at discount prices			
1.2V 3000mAh	£3.35	These controllers use a potentiometer or voltage input to set speed. For RC input, interfaces available			
Also available, Ni-Cad Ni-MH packs from 4.8V to 14.4V from 600 to 3000mAh		12V / 35A	£57.00		
<b>BATTERY CHARGERS</b>		24V / 35A	£57.00		
We have a range of chargers for SLA / Ni-CAD / Ni-MH batteries from 600mA to 20A		36V / 35A	£59.38		
<b>LED VOLTMETERS</b>		12V / 70A	£83.13		
Type	Price	24V / 70A	£83.13		
12V 3LED	£4.50	36V / 70A	£85.50		
24V 5 LED	£6.00	12V / 120A	£123.50		
36V 5 LED	£6.00	24V / 120A	£123.50		
36V 7LED	£8.50	36V / 120A	£128.25		
4.8V Micro	£8.49	24/36V / 150A	£180.50		
6.0V Micro	£8.49	24.36V / 200A	£190.00		
<b>RADIO CONTROL</b>		24/36V / 300A	£232.75		
Sanyo N-3000CR Fast charge / discharge		Futaba radio control gear available at discount prices			
1.2V 3000mAh	£3.35	These controllers use a potentiometer or voltage input to set speed. For RC input, interfaces available			
Also available, Ni-Cad Ni-MH packs from 4.8V to 14.4V from 600 to 3000mAh		12V / 35A	£57.00		
<b>BATTERY CHARGERS</b>		24V / 35A	£57.00		
We have a range of chargers for SLA / Ni-CAD / Ni-MH batteries from 600mA to 20A		36V / 35A	£59.38		
<b>LED VOLTMETERS</b>		12V / 70A	£83.13		
Type	Price	24V / 70A	£83.13		
12V 3LED	£4.50	36V / 70A	£85.50		
24V 5 LED	£6.00	12V / 120A	£123.50		
36V 5 LED	£6.00	24V / 120A	£123.50		
36V 7LED	£8.50	36V / 120A	£128.25		
4.8V Micro	£8.49	24/36V / 150A	£180.50		
6.0V Micro	£8.49	24.36V / 200A	£190.00		
<b>RADIO CONTROL</b>		24/36V / 300A	£232.75		
Sanyo N-3000CR Fast charge / discharge		Futaba radio control gear available at discount prices			
1.2V 3000mAh	£3.35	These controllers use a potentiometer or voltage input to set speed. For RC input, interfaces available			
Also available, Ni-Cad Ni-MH packs from 4.8V to 14.4V from 600 to 3000mAh		12V / 35A	£57.00		
<b>BATTERY CHARGERS</b>		24V / 35A	£57.00		
We have a range of chargers for SLA / Ni-CAD / Ni-MH batteries from 600mA to 20A		36V / 35A	£59.38		
<b>LED VOLTMETERS</b>		12V / 70A	£83.13		
Type	Price	24V / 70A	£83.13		
12V 3LED	£4.50	36V / 70A	£85.50		
24V 5 LED	£6.00	12V / 120A	£123.50		
36V 5 LED	£6.00	24V / 120A	£123.50		
36V 7LED	£8.50	36V / 120A	£128.25		
4.8V Micro	£8.49	24/36V / 150A	£180.50		
6.0V Micro	£8.49	24.36V / 200A	£190.00		
<b>RADIO CONTROL</b>		24/36V / 300A	£232.75		
Sanyo N-3000CR Fast charge / discharge		Futaba radio control gear available at discount prices			
1.2V 3000mAh	£3.35				



# Learn About Microcontrollers

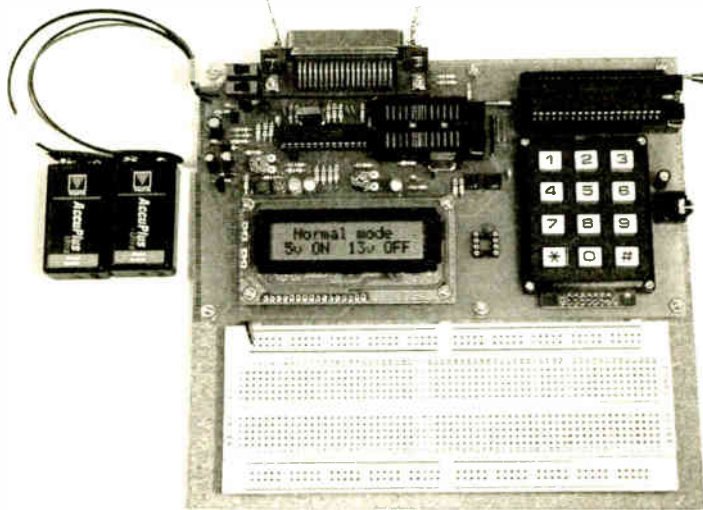

## PIC Training & Development System

The best place to start learning about microcontrollers is the PIC16F84. This is easy to understand and very popular with construction projects. Then continue on using the more sophisticated PIC16F877 family.

The heart of our system is a real book which lies open on your desk while you use your computer to type in the programme and control the hardware. Start with four very simple programmes. Run the simulator to see how they work. Test them with real hardware. Follow on with a little theory.....

Our complete PIC training and development system consists of our universal mid range PIC programmer, a 306 page book covering the PIC16F84, a 262 page book introducing the PIC16F877 family, and a suite of programmes to run on a PC. The module is an advanced design using a 28 pin PIC16F872 to handle the timing, programming and voltage switching requirements. The module has two ZIF sockets and an 8 pin socket which between them allow most mid range 8, 18, 28 and 40 pin PICs to be programmed. The plugboard is wired with a 5 volt supply. The software is an integrated system comprising a text editor, assembler disassembler, simulator and programming software. The programming is performed at normal 5 volts and then verified with plus and minus 10% applied to ensure that the device is programmed with a good margin and not poised on the edge of failure. Requires two PP3 batteries which are not supplied.

- Universal mid range PIC programmer module
- + Book Experimenting with PIC Microcontrollers
- + Book Experimenting with the PIC16F877 (2nd edition)
- + Universal mid range PIC software suite
- .....+ PIC16F84 and PIC16F872 test PICs. . . . . £157.41
- UK Postage and insurance. . . . . £ 7.50
- (Europe postage & Insurance. . £13.00. Rest of world. . £24.00)

## Experimenting with PIC Microcontrollers

This book introduces the PIC16F84 and PIC16C711, and is the easy way to get started for anyone who is new to PIC programming. We begin with four simple experiments, the first of which is explained over ten and a half pages assuming no starting knowledge except the ability to operate a PC. Then having gained some practical experience we study the basic principles of PIC programming, learn about the 8 bit timer, how to drive the liquid crystal display, create a real time clock, experiment with the watchdog timer, sleep mode, beeps and music, including a rendition of Beethoven's *Für Elise*. Finally there are two projects to work through, using the PIC16F84 to create a sine wave generator and investigating the power taken by domestic appliances. In the space of 24 experiments, two projects and 56 exercises the book works through from absolute beginner to experienced engineer level.

### Ordering Information

Telephone with Visa, Mastercard or Switch, or send cheque/PO for immediate despatch. All prices include VAT if applicable. Postage must be added to all orders. UK postage £2.50 per book. £1.00 per kit, maximum £7.50. Europe postage £3.50 per book, £1.50 per kit. Rest of World £6.50 per book, 2.50 per kit.

Web site:- [www.brunningssoftware.co.uk](http://www.brunningssoftware.co.uk)

## NEW 32 bit PC Assembler

*Experimenting with PC Computers* with its kit is the easiest way ever to learn assembly language programming. If you have enough intelligence to understand the English language and you can operate a PC computer then you have all the necessary background knowledge. Flashing LEDs, digital to analogue converters, simple oscilloscope, charging curves, temperature graphs and audio digitising. Kit now supplied with our 32 bit assembler with 84 page supplement detailing the new features and including 7 experiments PC to PIC communication. Flashing LEDs, writing to LCD and two way data using 3 wires from PC's parallel port to PIC16F84.

- Book *Experimenting with PCs* ..... £21.50
- Kit 1a 'made up' with software ..... £52.00
- Kit 1u 'unmade' with software ..... £45.00

## C & C++ for the PC

*Experimenting with C & C++ Programmes* teaches us to programme by using C to drive the simple hardware circuits built using the materials supplied in the kit. The circuits build up to a storage oscilloscope using relatively simple C techniques to construct a programme that is by no means simple. When approached in this way C is only marginally more difficult than BASIC and infinitely more powerful. C programmers are always in demand. Ideal for absolute beginners and experienced programmers.

- Book *Experimenting with C & C++* ..... £24.99
- Kit CP2a 'made up' with software ..... £32.51
- Kit CP2u 'unmade' with software ..... £26.51
- Kit CP2t 'top up' with software ..... £12.99

## The Kits

The assembler and C & C++ kits contain the prototyping board, lead assemblies, components and programming software to do all the experiments. The 'made up' kits are supplied ready to start. The 'top up' kit is for readers who have already purchased kit 1a or 1u. The kits do not include the book.

## Hardware required

All systems in this advertisement assume you have a PC (386 or better) and a printer lead. The experiments require no soldering.

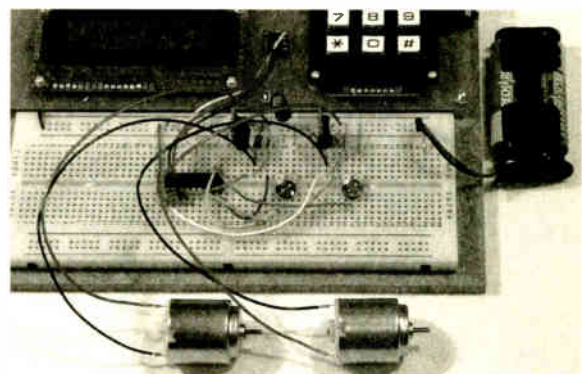

## Experimenting with the PIC16F877

The second PIC book starts with the simplest of experiments to give us a basic understanding of the PIC16F877 family. Then we look at the 16 bit timer, efficient storage and display of text messages, simple frequency counter, use a keypad for numbers, letters and security codes, and examine the 10 bit A/D converter.

The 2nd edition has two new chapters. The PIC16F627 is introduced as a low cost PIC16F84. We use the PIC16F627 as a step up switching regulator, and to control the speed of a DC motor with maximum torque still available. Then we study how to use a PIC to switch mains power using an optoisolated triac driving a high current triac.

Mail order address:

**Brunning Software** 138 The Street, Little Clacton, Clacton-on-sea, Essex, CO16 9LS. Tel 01255 862308

# READOUT

Email: john.becker@epemag.wimborne.co.uk

**John Becker addresses some of the general points readers have raised. Have you anything interesting to say? Drop us a line!**

All letters quoted here have previously been replied to directly.

## WIN A DIGITAL MULTIMETER

A 3½ digit pocket-sized l.c.d. multimeter which measures a.c. and d.c. voltage, d.c. current and resistance. It can also test diodes and bipolar transistors.

Every month we will give a Digital Multimeter to the author of the best Readout letter.



## ★ LETTER OF THE MONTH ★

### UNIFIED PIC RESOURCES

Dear EPE,

First may I say how much I enjoy your magazine. I remember getting a glimpse of the first issue, via my cousin, when I was in my teens. The thing that inspired me was all the projects that allowed me to build things I simply could not get in the shops. Today things are very different – there is not much you can't buy cheaper than you can build it now.

I have to confess to a long period of not subscribing to your mag. As for many others, as I progressed up to management, I found less time to spend on my hobby. Happily, I was made redundant four years ago and decided to "return to my roots". I became a contractor and soon found that despite umpteen years of not keeping in touch with developments, things had hardly changed in many areas. People were still using the 2N3055! I've now moved into analogue ASIC design and I'm loving every minute of it.

At the time of being made redundant I started subscribing to *EPE* and other electronics magazines. First impressions were – where did all this digital stuff come from?! In particular PICs. I'm an analogue person, so digits doesn't come that easy. There was a quantum leap required and I soon invested in a PIC development system. It sat on the shelf for quite a while. That quantum leap looked too high a hurdle.

Eventually, I decided to give it a try. I started surfing the web and found a very simple flashing l.c.d. project. What's more, it worked! There then followed a series of simple projects – stepper motor control, via RS232 (ahhh, RS232, another old friend!) – a multi-channel voltmeter with output to my PC via RS232. Suddenly, I'm a PIC junky!

I'm at that time of life where money isn't really a problem. What is a problem is an attention span of 30 minutes and a still sizeable hole in my knowledge. It's not the hardware – it's this cursed software. I've got plenty of ideas I want to build, but how to interface them to my PC? What I'd like to see from a magazine like *EPE* is some guidance. You have some excellent articles by John Becker and other regular contributors, the problem is that some of the important ones got missed. Have you thought of producing tutorial CDs? For example, a starter CD for PICs. Some simple projects utilizing special features of the PIC. Also, how to get

started in Visual Basic. Basic control panels and interfacing via the COMs and parallel ports, ditto for C++.

I draw a parallel with my other hobby – photography. Here the wonders of using Photoshop was a major hurdle. The magazine I subscribe to has regular Video tutorials showing exactly what to do. They also sell CDs that cover a variety of topics.

I guess you could argue that if I took out a regular subscription, I wouldn't miss stuff. However, trawling through back issues to find that article I think I saw is not as efficient as having it all in one place – the CD.

Finally, here is an idea I have for a new project. A friend recently had his boat broken into. What would have been really neat would have been an intruder detector (not difficult) that sent a message to his mobile telling him that it had happened (ergh! Mobile knowledge required!).

It would not stop an intruder – boats are often left in remote places anyway, but at least the owner would know about it quickly and know that he had to go and sort things out. (The high power ultrasonic sounder would have disintegrated the intruder and would need to be cleared up before a smell started to develop!) I'm currently surfing for more information on interfacing to mobiles. Any ideas?

Hope this has helped you understand what some of us oldies are looking for.

Graham Johnston, via email

*Thanks Graham for your kind comments about us – I'm pleased you've found a renewed interest in electronics. In my many years enjoying electronics I too have seen many changes.*

*In fact we are probably producing a CD with the type of info you suggest, to accompany my revision of the EPE PIC Tutorial of Mar-May '98. All sorts of PIC related projects and articles will be on it. Also, are you aware that we do mini CDs, each of which holds six past issues? They are advertised in our pages each month.*

*Your boat alarm idea is interesting but not something I would wish to take on. Quoting your letter here, though, might inspire a reader to design one. No, I don't know about interfacing to mobiles (and I hate the darn things – don't people ever talk face-to-face these days?).*

For many years I have used the Stanley laminate cutting blade No. 5194 which fits the Stanley knives mentioned above and is much safer as the knife is held conventionally. The blade is intended for cutting SRBP type laminates such as Formica, Paxolin and Veroboard, but it works well on acrylic sheet. I also have a Wickes acrylic sheet knife which works even better, but I don't know if this is still available.

Barry Taylor, via email

*Thank you Barry, your concern is noted and re-broadcast. I wish I had known this information when cutting the acrylic sides for my Wind Tunnel of Feb '03.*

### PIC INTERRUPTS AND PCLATH

Dear EPE,

I'm grateful to John Waller for drawing my attention (in private correspondence) to a point that isn't fully covered in my *Programming PIC Interrupts* articles in *EPE* Mar/Apr '02, and which may cause confusion.

In any program that's longer than 2K bytes it's likely that PCLATH is having to be manipulated in order that CALL and GOTO instructions end up in the right places. If the program also uses interrupts, then the program's ISR will need to preserve and restore PCLATH as part of the program's context. Having saved PCLATH, the ISR should then reset it for its own use, as explained in the article. Until the ISR has done this, it is not safe to use any CALL or GOTO instructions in the ISR itself, because at the time the interrupt is taken PCLATH may be wrongly set to address the ISR's code. This restriction includes the GOTO ISR instruction which is often assembled into Page 0 location 4, the interrupt vector.

To re-emphasise, if PCLATH bits 4 and 3 may be non-zero when an interrupt occurs, then a GOTO ISR instruction in page 0 location 4 cannot be used as the first instruction of the ISR. Code must be assembled in contiguous locations starting at location 4 to preserve the context, including PCLATH, and then reset PCLATH, before any CALL or GOTO instructions can be used. It's somewhat analogous to the Bank switching discussion following Experiment 2 in my article, except that here the problem is to do with the Page select bits, not the Bank select bits.

This issue doesn't arise on 16x8x processors, which have a maximum of 2K program memory and which ignore the setting of bits 4 and 3 of PCLATH.

For readers who would like more details, a new test program, *intproga.asm*, can be downloaded from the /pub/PICS/Interrupts directory of the *EPE* ftp site, together with instructions on how to run it in the file *intproga.txt*. This test program illustrates the effect of getting an interrupt when PCLATH is non-zero, and how to fix it.

Malcolm Wiles, via email

*Thanks Malc, the code is now on our ftp site.*

### TELE FEEDING

Dear EPE,

I am trying to design a small animal feeder for a project. I wish to use this in conjunction with the telephone lines so that I can call up the feeder and tell it to turn a set amount of degrees to expose the food. I need to design a p.c.b. that will connect to the telephone line to tell a small stepper motor to move. Help in this area would be much appreciated.

Norman Blair, via email

*So sorry Norman but we cannot help on this as it is illegal to connect anything to a telephone line that has not been fully approved for such use – permission that would never be granted to a DIY project. Ask via our Chat Zone if anyone knows of a way round it – counting the number of phone bell rings for instance (though the animals might occasionally get second helpings on some days, of course!). When necessary I use a feeder that's motor driven and opens food flaps at set intervals (not PIC controlled though!).*

### CUTTING ACRYLIC SHEET

Dear EPE,

Referring to Raymond Haigh's *Tesla Transformer* of Feb '03, I was intrigued by his tip for using the back of a Stanley knife blade (I assume this is a standard No. 1992 blade) for scoring acrylic sheet, so I've just tried it out. I found it very difficult to hold either a Stanley 99 retractable blade knife or a Stanley 199A fixed blade knife at the correct angle to score the sheet. But more importantly, if one's hand slipped then a severe injury would occur to either one's index finger or little finger, depending on how the knife was being held.



## PIC TRAINING COURSES

Dear EPE,

In reply to Dave Williams' letter in *Readout* Dec '02 regarding PIC training courses, could you pass on the following to your readers? We currently teach PIC microcontroller technology as part of a National Diploma in Electrical/Electronic Engineering courses in Bracknell and Wokingham College. In the course, which is two hours per week over two years, we cover the following:

1. The basics of binary and hexadecimal arithmetic and appropriate conversions.
2. Programming the PIC using a BASIC cross compiler that I have developed.
3. Development of programs to illustrate I/O capability of the PIC.
4. Development of programs using PIC assembler (using MPLAB), covering logic and arithmetic instructions, indirect addressing, loops and timing loops, all in assembler.
5. Developing programming techniques such as moving data, moving averages, also in assembler.
6. Development of programs to handle the PIC timers.
7. Development of programs to handle code translation necessary for 7-segment displays.

In addition, students are taught how to drive, for example, discrete A to D and D to A converters when the facilities are not within the PIC being employed.

The course is very practical with approximately half the lessons devoted to practical programming. The hardware we use was developed in the College but is fairly standard and in general we use either the faithful PIC16F84 or PIC16F876. All the teaching material is produced using PowerPoint and with handouts covering almost all aspects of the course. The course could easily be adapted to the needs of any specific customer and I would be pleased to discuss training needs with anyone who would like to contact me.

Dr Alan R Fuller,  
Head of Engineering and CAD,  
Bracknell and Wokingham College

Thanks Alan. Searching the Web via Google, I find that your web and telephone details are [www.bracknell.ac.uk](http://www.bracknell.ac.uk), and 01344 460200.

## MORE PIC COURSES

Dear EPE,

In *Readout* of Dec '02, Dave Williams asks about PIC training courses. Although I do not formally run such courses, having used PICs in 99% of my designs, I have at times assisted companies to develop/use/program PICs in their own products. Such projects can be seen at [www.StephenAlsop.co.uk](http://www.StephenAlsop.co.uk) under S&S Products.

EPE is a really good professional magazine with an excellent balance of projects and expertise. It is a pleasure to receive it each month.

Stephen Alsop,  
via email

Thank you for the link Stephen, and your kind comment!

## PORTABLE PIC PROGRAMMER

Dear EPE,

I've had an idea for a possible project. I made a controller for an oven that we use for work, using a PIC16F877. It works very well but I wanted to add some features (mainly implemented in software). All of your recent projects feature the in-circuit programming connector. I overlooked this feature on my circuit but the next revision will have this in place. However, it would not be of much use to me as I do not have a computer at work.

Since the circuit is now "plumbed in", it would require a bit of tinkering to swap the PIC. I thought it would be real nice to have a portable PIC program transferer. Trouble is, I wouldn't have the faintest idea how to implement this idea. I think it would need the big guns such as yourself to work out a solution. I suppose it

would have to emulate a PIC being programmed when being loaded from the programmer, and to emulate a programmer when transferring the program to the destination PIC.

This is just an idea, to stimulate the grey matter, but it would make a nice gadget I think.

Gerard Galvin, via email

Thanks Gerard, it's certainly scope for thought, but my immediate reaction is that not enough people would find it of interest as most have PCs where their PIC programming is done.

At its simplest, what would be needed is a portable board running from a battery and having a PIC that would accept code from the PC and store it in onboard memory (serial EEPROM). This board would then be taken to the location at which your main PIC is being used in circuit, and that PIC would then be programmed from the portable board.

That would be fine if the destination had been set up to allow +5V programming in its configuration, but most will not have (none of mine have). Otherwise additional chips would be needed to generate the +14V programming voltage (the front end of TK3 for instance).

I could certainly do one if enough readers are interested - tell me if you are!

## STACKING UP

Dear EPE,

I have recently run into a PIC programming problem that arises from PICs having a Stack of only eight levels. As the Stack can neither be written to nor read from, this is a severe limitation. Does anyone know how this can be overcome?

As an aside, having a character (alphanumeric) I.c.d. connected to the circuit being developed is an invaluable aid when debugging, in being able to view the values of variables at critical locations.

John Waller, via email

*JW and I have frequent private chats via email about PIC programming (and other things!) and we have discussed this particular matter and cannot conceive a solution. The problem is that complex programs might ideally have many nested calls to tables and sub-routines and each call places return address data on the Stack. If more than eight calls are nested, the Stack simply overwrites earlier calls, resulting in program "crashes" because the return address data is wrong. So, to echo JW, does anyone know of a solution if many nested calls are otherwise the ideal requirement?*

*Like John, I too depend on an I.c.d. when writing code. It was an horrendous task when I recently programmed a giant I.e.d. clock that will be published soon (PICronos). Extreme multiplexing techniques control nearly 200 I.e.d.s and there were no spare PIC pins left to monitor the multiplexing on an I.c.d.*

## FLANGING AND CHATTING

Dear EPE,

I am a Year 11 GCSE pupil at The Hayling School in Hampshire. As part of my GCSE Electronics coursework I have chosen to design and make a guitar Flanger pedal. The finished design should be able to create a professional sounding Flange effect; have Depth, Speed and Resonance controls; be strong enough to withstand being kicked and stamped on, as happens on stage.

I would be very grateful for any information you may have about Flanger pedals as electronic designs.

Michael Sinden,  
via email

*Apart from including the facility in my PIC Polywhatsit of Dec '01, Michael, it's not something that we have done for many years. One of the problems is that the so-called "bucket brigade" chips (CCDs - charge coupled devices), that used to be widely available and made such designs really practical, are now hard*

*to find. I briefly explain the flanging principle in the Polywhatsit text, and copies are available at the usual Back Issue prices. I suggest you also ask readers via our Chat Zone if they can offer advice.*

*On the subject of the Chat Zone, I have recently been surprised to be told by a couple of readers that they regularly use the web and our ftp download site, but were unaware of our Chat Zone until I mentioned it. This is a type of "bulletin board" where you can chat with other readers about anything related to electronics and allied computing subjects.*

*It's all very informal and you don't need passwords to get into it. Simply to go to our home page at [www.epemag.wimborne.co.uk](http://www.epemag.wimborne.co.uk). At the top of the page are several click-links. Click on the one that says Chat Zone (Message Board) and then scroll down and read the entries made by other readers, just by clicking on the subject titles. You can readily join in the discussions too if you wish, and even start your own subject that other readers can join in with.*

*There is a lot benefit that people can gain from this facility, both from a general interest point of view and the possibility of being offered solutions to problems - it can't be guaranteed you'll get the information you want, but it's well worth asking questions if you have any. Note though, that if you have technical queries relating to our published projects, you should send those to me at the Editorial office, via [john.becker@wimborne.co.uk](mailto:john.becker@wimborne.co.uk).*

## REAL-TIME CLOCKS

Dear EPE,

In response to Andrew Jarvis' *Letter of the Month*, Jan '03, a good method of keeping track of date and time when the power is off is by using a dedicated real-time clock chip such as the Dallas Semiconductor DS1302. This uses a standard 32kHz watch crystal and will run for years on a lithium coin cell. It comes in an 8-pin package and has a simple 3-wire interface to access its registers. Data sheet and application notes are downloadable from [www.maxim-ic.com](http://www.maxim-ic.com). It is available from most of the usual sources and is quite inexpensive (about £2.20).

David Sharp,  
via email

Thanks David.

## METRIC MUDDLE

Dear EPE,

You were kind enough to publish a letter of mine some months ago, regarding "failures in our educational system".

I was recently dismayed by what I have also come across in the basic skills testing being offered to anyone encouraged to test themselves.

I was most concerned to see some questions in which metric rules appear and one is asked to indicate the lengths for some lines, which ought to be, for example, either 75mm or 7.5cm, but such an answer is not permitted. The choices are, for example, 7½ (7 and one half centimetres).

In the sixties I was Metrication officer for my then employer, and we were taught never to mix fractions in a metric environment. There is no place for such an answer as required in the basic skills testing I refer to. What is even more worrying is that when I pointed the error out to the tutors, no one could see any problem. Regrettably, my tutors were in the private sector. When I asked within a regular college teaching profession, all the engineering lecturers instantly saw the error.

We are still not thinking metric after forty years of teaching. Surely only the Brits could foul up a perfectly good decimal system. The problem highlighted was only one of many in the exam.

Name withheld on request

*Thanks for the comments - it is a disturbing situation. I note from the information you sent that the college intends to correct the test appropriately.*





## 20% discount for EPE readers

### Temperature controlled soldering stations



**Vann Draper Electronics Ltd**

The test & measurement specialists

[www.vanndraper.co.uk](http://www.vanndraper.co.uk)

Grundig, Kenwood, Hitachi, Fluke, Avo and more.

#### Use this coupon for your order

Please supply me:

- ..... SL20 soldering station(s) at £55 inc. vat & del
- ..... SL30 soldering station(s) at £65 inc. vat & del
- ..... Extra 0.8mm bit(s) at £1.88 inc vat & del
- ..... 1.6mm bit(s) at £1.88 inc vat & del
- ..... 3.2mm bit(s) at £1.88 inc vat & del

Name:

Address:

Tel No:

Total £

Cheques payable to Vann Draper Electronics Ltd or debit my visa, mastercard or switch card.

Card type:

Card No:

Expiry date:

Switch Issue No:

Signature:

Overseas readers can still obtain this discount but carriage charges vary according to country. Please telephone, fax, email or write to Vann Draper.

**Vann Draper** is offering over 20% discount for a limited period to readers of *Everyday Practical Electronics* on their temperature controlled soldering stations.

The SL20 bar graph display soldering station normally sells at £69.33 and is available to readers of *EPE* at only **£55** fully inclusive of vat & delivery.

The SL30 digital display version is normally priced at £81.08 but for readers of *EPE* the price is just **£65** fully inclusive.

Both soldering stations feature 24V 48W elements for rapid heating and have full electronic temperature control between 150°C and 420°C (SL20), 160°C and 480°C (SL30).

The SL20 and SL30 are supplied ready to use complete with a 48W iron, 0.8mm long life bit, mains lead, operating instructions and a 12 month guarantee.

To order, simply post the coupon to: **Vann Draper Electronics Ltd**, at **Stenson House, Stenson, Derby DE73 1HL**. Alternatively –

Tel 01283 704706 Fax 01283 704707 Email [sales@vanndraper.co.uk](mailto:sales@vanndraper.co.uk)



## A COMPLETE RANGE OF INVERTERS

150W TO 2500W - 12V & 24V

A Complete range of regulated inverters to power 220V and 240V AC equipment via a car, lorry or boat battery. Due to their high performance (>90%) the inverters generate very little heat. The high stability of the output frequency (+/-1%) makes them equally suitable to power sensitive devices.

These inverters generate a modified sine wave, which are considerably superior to the square waves which are produced by most other inverters. Due to this superior feature they are capable of powering electrical equipment such as TV's, videos, desktop & notepad computers, microwave ovens, electrical lamps, pumps, battery chargers, etc.

### Low Battery Alarm

The inverters give an audible warning signal when the battery voltage is lower than 10.5V (21V for the 24V version). The inverter automatically shuts off when the battery voltage drops below 10V (20V for the 24V version). Fuse protected input circuitry.

Order Code	Power	Voltage	Price
651.581	150W Continuous	12V	£36.39
651.578	150W Continuous	24V	£36.39
651.582	300W Continuous	12V	£50.64
651.585	300W Continuous	24V	£50.64
651.583	600W Continuous	12V	£101.59
651.593	600W Continuous	24V	£101.59
651.587	1000W Continuous	12V	£177.18
651.597	1000W Continuous	24V	£177.18
651.602	1500W Continuous	12V	£314.52
651.605	1500W Continuous	24V	£314.52
651.589	2500W Continuous	12V	£490.54
651.599	2500W Continuous	24V	£490.54



ILLUSTRATION SHOWN IS 651.583 600W VERSION.

All prices are inclusive of V.A.T. Carriage £6.00 Per Order

Many uses include:- \* Fetes \* Fairgrounds \* Airshows \* Picnics \* Camping \* Caravans \* Boats \* Carnivals \* Field Research and \* Amateur Radio field days \* Powering Desktop & Notepad Computers.



**B.K. ELECTRONICS**



UNIT 1, COMET WAY, SOUTHEND-ON-SEA, ESSEX. SS2 6TR  
TEL.: +44(0)1702-527572 FAX.: +44(0)1702-420243

DELIVERY CHARGES ARE £6.00 PER ORDER. OFFICIAL ORDERS FROM SCHOOLS, COLLEGES, GOVT. BODIES, PLC'S ETC. PRICES ARE INCLUSIVE OF V.A.T. SALES COUNTER. VISA AND ACCESS ACCEPTED BY POST, PHONE OR FAX, OR EMAIL US AT [SALES@BKELEC.COM](mailto:SALES@BKELEC.COM) ALTERNATIVELY SEND CHEQUE OR POSTAL ORDERS MADE PAYABLE TO BK ELECTRONICS.

For Full Specifications View our web site at:-

**[WWW.BKELEC.COM/INVERTERS.HTM](http://WWW.BKELEC.COM/INVERTERS.HTM)**



We can supply back issues of *EPE* by post, most issues from the past three years are available. An *EPE* index for the last five years is also available at [www.epemag.wimborne.co.uk](http://www.epemag.wimborne.co.uk) or see order form below. Alternatively, indexes are published in the December issue for that year. Where we are unable to provide a back issue a photocopy of any *one article* (or *one part* of a series) can be purchased for the same price. Issues from Nov. 98 are available on CD-ROM – see next page – and issues from the last six months are also available to download from [www.epemag.com](http://www.epemag.com).

## DID YOU MISS THESE?

### NOV '01

**PROJECTS** • Capacitance Meter • Pitch Switch • Lights Needed Alert • Teach-In 2002 Power Supply.  
**FEATURES** • Teach-In 2002 – Part 1 • Practically Speaking • Circuit Surgery • New Technology Update • Ingenuity Unlimited • Net Work – The Internet Page • Free 16-page Supplement – PIC Toolkit TK3 For Windows.

### DEC '01

**PROJECTS** • Ghost Buster • PIC Polywhatsit • Twinkling Lights • Mains Failure Alarm.  
**FEATURES** • Teach-In 2002 – Part 2 • Marconi – The Father of Radio • Interface • Ingenuity Unlimited • Circuit Surgery • New Technology Update • Net Work – The Internet Page • 2001 Annual Index.

### JAN '02

**PROJECTS** • PIC Magick Musick • Time Delay Touch Switch • Versatile Bench Power Supply • Forever Flasher.  
**FEATURES** • Teach-In 2002 – Part 3 • Practically Speaking • Ingenuity Unlimited • New Technology Update • Circuit Surgery • Net Work – The Internet Page.

### FEB '02

**PROJECTS** • PIC Spectrum Analyser • Guitar Practice Amp • HT Power Supply • Versatile Current Monitor.  
**FEATURES** • Teach-In 2002 – Part 4 • Ingenuity Unlimited • Russian Space Shuttle Revisited • Circuit Surgery • Interface • New Technology Update • Net Work – The Internet Page.



### MAR '02

**PROJECTS** • MK484 Shortwave Radio • PIC Virus Zapper • RH Meter • PIC Mini-Enigma.  
**FEATURES** • Teach-In 2002 – Part 5 • Ingenuity Unlimited • Programming PIC Interrupts-1 • Circuit Surgery • Practically Speaking • New Technology Update • Net Work – The Internet Page.

### APR '02

**PROJECTS** • Electric Guitar Tuner • PIC Controlled Intruder Alarm • Solar Charge and Go • Manual Stepper Motor Controller.  
**FEATURES** • Teach-In 2002 – Part 6 • Interface • Programming PIC Interrupts-2 • Circuit Surgery • Ingenuity Unlimited • New Technology Update • Net Work – The Internet Page • FREE Giant Op.Amp Data Chart.

### MAY '02

**PROJECTS** • PIC Big-Digit Display • Simple Audio Circuits – 1 • Freezer Alarm • Washing Ready Indicator.  
**FEATURES** • Teach-In 2002 – Part 7 • Ingenuity Unlimited • Practically Speaking • New Technology Update • Circuit Surgery • Net Work – The Internet Page.

### JUNE '02

**PROJECTS** • Biopic Heartbeat Monitor • Frequency Standard Generator • Simple Audio Circuits – 2 • World Lamp.  
**FEATURES** • Teach-In 2002 – Part 8 • Interface • New Technology Update • Circuit Surgery • Ingenuity Unlimited • Net Work – The Internet Page.

### JULY '02

**PROJECTS** • EPE StyloPIC • Infra-Red Autoswitch • Simple Audio Circuits – 3 • Rotary Combination Lock.  
**FEATURES** • Teach-In 2002 – Part 9 • Practically Speaking • Using The PIC's PCLATH Command • Ingenuity Unlimited • Circuit Surgery • New Technology Update • Net Work – The Internet Page.



### AUG '02

**PROJECTS** • PIC World Clock • Pickpocket Alarm • Big-Ears Buggy • Simple Audio Circuits – 4.  
**FEATURES** • Teach-In 2002 – Part 10 • Using Square Roots with PICs • Ingenuity Unlimited • Evolutionary Electronics • Interface • Circuit Surgery • Net Work – The Internet Page.

### SEPT '02

**PROJECTS** • Freebird Glider Control • Portable Telephone Tester • EPE Morse Code Reader • Vinyl to CD Preamplifier.  
**FEATURES** • Circuit Surgery • New Technology Update • Practically Speaking • Net Work • Flowcode for PICmicro • Logic Gate Inverter Oscillators • Net Work – The Internet Page.

### OCT '02 Photocopies only

**PROJECTS** • EPE Bounty Treasure Hunter • IC Tester • Headset Communicator • PIC-Pocket Battleships.  
**FEATURES** • Circuit Surgery • New Technology Update • Logic Gate Inverter Oscillators – 2 • Interface • Network – The Internet Page • Using TK3 With Windows XP and 2000.

### NOV '02

### Photocopies only

**PROJECTS** • EPE Hybrid Computer – 1 • Tuning Fork and Metronome • Transient Tracker • PICAXE Projects-1 (Egg Timer – Dice Machine – Quiz Game Monitor).  
**FEATURES** • Practically Speaking • Ingenuity Unlimited • Circuit Surgery • New Technology Update • Net Work – The Internet Page.

### DEC '02

**PROJECTS** • Versatile PIC Flasher • EPE Hybrid Computer – 2 • Door Defender • PICAXE Projects – 2 (Temperature Sensor – Voltage Sensor – VU Indicator).  
**FEATURES** • Electronic Paper • Alternative Uses for Transistors • Interface • Circuit Surgery • New Technology Update • Ingenuity Unlimited • Net Work – The Internet Page • 2002 Annual Index.



### JAN '03

**PROJECTS** • EPE Minder • F.M. Frequency Surfer • Wind Speed Meter • PICAXE Projects-3 (Chaser Lights).  
**FEATURES** • Who Really Invented The Transistor • TechnoTalk • Circuit Surgery • Practically Speaking • New Technology Update • Computer GOTOs • Ingenuity Unlimited • Net Work – The Internet Page.

### FEB '03

**PROJECTS** • Wind Tunnel • Brainbot Buggy • Back To Basics-1 (Hearing Aid, Audio Power Amplifier) • Tesla High Voltage Transformer.  
**FEATURES** • In The Bag • Techno Talk • Circuit Surgery • New Technology Update • Interface • Ingenuity Unlimited • Net Work – The Internet Page.

**BACK ISSUES ONLY £3.50** each inc. UK p&p.  
Overseas prices £4 each surface mail, £5.50 each airmail.

We can also supply issues from earlier years: 1998 (except Jan. to May, July, Sept., Nov., Dec.), 1999 (except Aug., Dec.), 2000 (except Feb.), 2001 (except May, Sept., Oct.), 2002 (except Oct., Nov.) Where we do not have an issue a photocopy of any *one article* or *one part* of a series can be provided at the same price.

### ORDER FORM – BACK ISSUES – PHOTOCOPIES– INDEXES

Send back issues dated .....

Send photocopies of (article title and issue date) .....

Send copies of last five years indexes (£3.50 for five inc. p&p – Overseas £4 surface, £5.50 airmail)

Name .....

Address .....

.....Tel: .....

I enclose cheque/P.O./bank draft to the value of £ .....

Please charge my Visa/Mastercard/Amex/Diners Club/Switch £ ..... Switch Issue No. ....

Card No. ....

Card Expiry Date ..... Card Security Code ..... (The last 3 digits on or just under the signature strip)

SEND TO: **Everyday Practical Electronics, Wimborne Publishing Ltd., 408 Wimborne Road East, Ferndown, Dorset BH22 9ND.**  
Tel: 01202 873872. Fax: 01202 874562.

E-mail: [orders@epemag.wimborne.co.uk](mailto:orders@epemag.wimborne.co.uk) On-line Shop: [www.epemag.wimborne.co.uk/shopdoor.htm](http://www.epemag.wimborne.co.uk/shopdoor.htm)

Payments must be in £ sterling – cheque or bank draft drawn on a UK bank. Normally supplied within seven days of receipt of order.

Send a copy of this form, or order by letter if you do not wish to cut your issue.

M03/03



# STORE YOUR BACK ISSUES ON MINI CD-ROMS



**VOL 7  
NOW AVAILABLE**

**ONLY  
£14.45** each  
including VAT  
and p&p

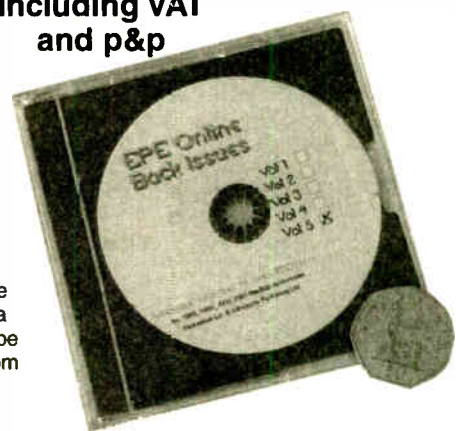

A great way to buy *EPE* Back Issues – our mini CD-ROMs contain back issues from our *EPE Online* website plus bonus articles, all the relevant PIC software and web links. Note: no free gifts are included. All this for just £14.45 each including postage and packing.

## VOL 1 CONTENTS

**BACK ISSUES** – November 1998 to June 1999 (all the projects, features, news, IUs etc. from all eight issues). Note: No advertisements are included. **PIC PROJECT CODES** – All the available codes for the PIC based projects published in these issues.

## VOL 2 CONTENTS

**BACK ISSUES** – July 1999 to December 1999 (all the projects, features, news, IUs, etc. from all six issues). Note: No advertisements are included. **PIC PROJECT CODES** – All the available codes for the PIC-based projects published in these issues.

## VOL 3 CONTENTS

**BACK ISSUES** – January 2000 to June 2000 (all the projects, features, news, IUs, etc. from all six issues). **PIC PROJECT CODES** – All the available codes for the PIC-based projects published in these issues.

## VOL 4 CONTENTS

**BACK ISSUES** – July 2000 to Dec. 2000 (all the projects, features, news, IUs etc. from all six issues). **PROJECT CODES** – All the available codes for the programmable projects in these issues.

## VOL 5 CONTENTS

**BACK ISSUES** – January 2001 to June 2001 (all the projects, features, news, IUs etc. from all six issues). **PROJECT CODES** – All the available codes for the programmable projects in these issues, including those for *Interface*.

## VOL 6 CONTENTS

**BACK ISSUES** – July 2001 to December 2001 (all the projects, features, news, IUs etc. from all six issues). **PROJECT CODES** – All the available codes for the programmable projects in these issues, including those for *Interface*.

## VOL 7 CONTENTS

**BACK ISSUES** – Jan 2002 to June 2002 (all the projects, features, news, IUs etc. from all six issues). **PROJECT CODES** – All the available codes for the programmable projects in these issues, including those for *Interface*.

## EXTRA ARTICLES – ON ALL VOLUMES

**BASIC SOLDERING GUIDE** – Alan Winstanley's internationally acclaimed fully illustrated guide. **UNDERSTANDING PASSIVE COMPONENTS** – Introduction to the basic principles of passive components. **HOW TO USE INTELLIGENT L.C.D.s**, By Julian Ilett – An utterly practical guide to interfacing and programming intelligent liquid crystal display modules. **PHYZZYB COMPUTERS BONUS ARTICLE 1** – Signed and Unsigned Binary Numbers. By Clive "Max" Maxfield and Alvin Brown. **PHYZZYB COMPUTERS BONUS ARTICLE 2** – Creating an Event Counter. By Clive "Max" Maxfield and Alvin Brown. **INTERGRAPH COMPUTER SYSTEMS 3D GRAPHICS** – A chapter from Intergraph's book that explains computer graphics technology in an interesting and understandable way with full colour graphics.

**EXTRA ARTICLE ON VOL 1 & 2. THE LIFE & WORKS OF KONRAD ZUSE** – a brilliant pioneer in the evolution of computers. A bonus article on his life and work written by his eldest son, including many previously unpublished photographs.

NOTE: These mini CD-ROMs are suitable for use on any PC with a CD-ROM drive. They require Adobe Acrobat Reader (available free from the Internet –

[www.adobe.com/acrobat](http://www.adobe.com/acrobat))

## Order on-line from

[www.epemag.wimborne.co.uk/shopdoor.htm](http://www.epemag.wimborne.co.uk/shopdoor.htm)  
or [www.epemag.com](http://www.epemag.com) (USA \$ prices)  
or by phone, Fax, E-mail or Post

## BACK ISSUES MINI CD-ROM ORDER FORM

Please send me ..... (quantity) BACK ISSUES CD-ROM VOL 1  
Please send me ..... (quantity) BACK ISSUES CD-ROM VOL 2  
Please send me ..... (quantity) BACK ISSUES CD-ROM VOL 3  
Please send me ..... (quantity) BACK ISSUES CD-ROM VOL 4  
Please send me ..... (quantity) BACK ISSUES CD-ROM VOL 5  
Please send me ..... (quantity) BACK ISSUES CD-ROM VOL 6  
Please send me ..... (quantity) BACK ISSUES CD-ROM VOL 7  
Price £14.45 each – includes postage to anywhere in the world.

Name .....

Address .....

.....

..... Post Code .....

I enclose cheque/P.O./bank draft to the value of £ .....

Please charge my Visa/Mastercard/Amex/Diners Club/Switch

£ .....

Card No. ....

Card Security Code ..... (The last 3 digits on or just under the signature strip)

Expiry Date ..... Switch Issue No. ....

SEND TO: Everyday Practical Electronics,  
Wimborne Publishing Ltd.,

408 Wimborne Road East, Ferndown, Dorset BH22 9ND.

Tel: 01202 873872. Fax: 01202 874562.

E-mail: [orders@epemag.wimborne.co.uk](mailto:orders@epemag.wimborne.co.uk)

Payments must be by card or in £ Sterling – cheque or bank draft drawn on a UK bank.

Normally supplied within seven days of receipt of order.

Send a copy of this form, or order by letter if you do not wish to cut your issue.



# Autotrax™

## Electronic Design Automation

Schematic Capture  
SPICE Simulation  
PCB Layout  
Auto-Layout/Router  
3D PCB Visualization  
Database Support

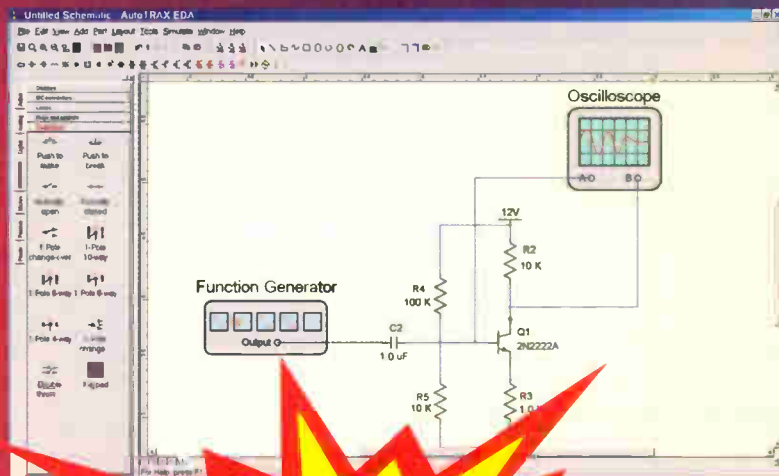

**Totally  
FREE!  
No limits**

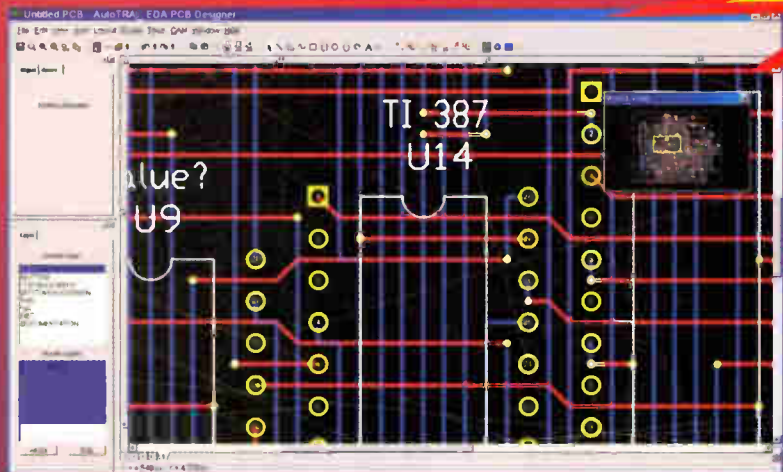

- Drag and drop parts onto your schematic.
- Connect them together.
- Add virtual instruments such as scopes and function generators.
- Use the PCB design wizard to create your PCB.
- Autolayout and autoroute the board.
- View the board in 3D.
- Output to Gerber and AutoCAD/Solidworks.

To find out more go to [www.autotraxEDA.com](http://www.autotraxEDA.com)

*First, I want to congratulate you on an excellent EDA concept. Great graphics, nice storage concept, nice integration. And you have got the tool use JUST RIGHT. It might seem minor, but sensible ways of doing things like building parts, adding pins to parts, using wires, etc make a massive difference to the basic useability of an EDA tool. I've been using EDA tools for 20 years now ... and the system you have here is as good as anything I've ever used ... Phillip Dimond*

**Why wait? Download the unlimited FREE software NOW!**

# [www.autotraxEDA.com](http://www.autotraxEDA.com)



See us on booth #824 at the PCB West conference/exhibition  
in San Jose, California, March 12-13 2003

# 200kHz FUNCTION GENERATOR

ANDY FLIND

*Versatile test unit that generates sine, square and triangle-wave outputs.*

ONE of the most useful facilities in the electronic experimenter's workshop is an ability to generate a.c. test signals of various waveforms, frequencies and amplitudes. This is where this Function Generator project comes in, the "function" in the name referring to the waveform of its output signal.

The Generator can be used for testing or driving many circuits, from below audio up to a couple of hundred kilohertz, and may even be used as a variable speed clock for logic circuit testing. It has sine, square and triangle-wave outputs plus a separate 0V to +5V squarewave output for logic driving. This may also be used with a "sync" input when, for example, inspecting low-level signals on an oscilloscope.

## DEDICATED APPROACH

Where a sinewave output is required two function generator i.c.s are generally available, these being the industry standard 8038 and the more recent Maxim MAX038. The latter can operate at frequencies above 20MHz but is still fairly expensive. Also, its sheer speed can make it difficult to work with, especially for the less experienced constructor.

For audio and general purpose work at lower frequencies the older 8038 has much to recommend it. Various claims have been made for its maximum operating frequency, up to 1MHz in fact, but 300kHz is more common and the author has tended to regard 100kHz as "top whack" to date.

However, this design operates up to 200kHz and the results at this frequency are quite acceptable for most purposes. Its maximum output can be seen in the accompanying oscilloscope screen shots. Even the squarewave remains quite good, with rise and fall times of around 0.5µs. At the other end of the scale it offers ultra-low frequencies which may be found useful, right down to one cycle in twenty seconds.

As with many commercially available generators of this type the frequency

ranges are of the 2 to 20, 20 to 200 type, giving a good range to either side of nominal decade steps. Four switched amplitude ranges cover 0V to 10mV up to 0 to 10V, these figures being the peak-to-peak voltage of the output waveforms. Function generators usually have outputs calibrated as pk-pk values because the r.m.s. value of a signal depends on its waveform as well as amplitude.

## CIRCUIT DETAILS

The full circuit diagram is shown in Fig. 1. Starting with the power supply, this is of the dual rail type. The very low output frequencies require d.c. coupling in the output circuit, which in turn makes a circuit using separate positive and negative supplies about a central 0V or ground much simpler to design.

Transformer T1 has a 15V-0V-15V 100mA centre-tapped output, which after rectification by REC1 produces raw positive and negative supplies of about 22V each across capacitors C1 and C3. The voltage regulators IC1 and IC2 reduce these to plus and minus 12V.

Since the supply voltages must be symmetrical to avoid a d.c. offset voltage at the output an adjustable regulator is used for IC2, which can be trimmed with preset VR1 to achieve this. These regulators are 1A and 1.5A types which can dissipate the small amount of internally generated heat without additional heatsinks. Their outputs have the usual decoupling capacitors, C5 to C8, and the l.e.d. D1 indicates when the unit is powered.

## WAVEFORM GENERATION

Most of the waveform generation is carried out by IC3, an 8038 dedicated waveform generator chip. The output frequency is determined by the voltage applied to the Frequency Sweep input at pin 8 and the value of the capacitor connected between the negative supply rail and pin 10.

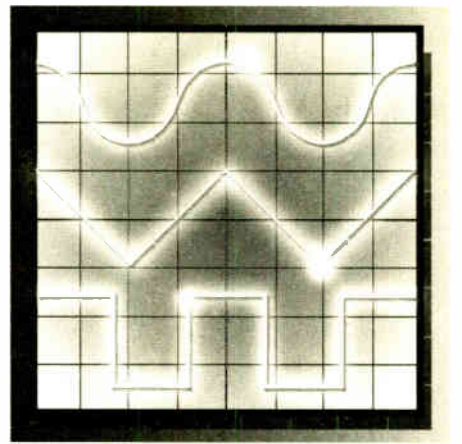

The required range of control voltage is applied by the panel mounted Frequency control VR3 with minimum and maximum values adjustable with presets VR2 and VR4 for the desired frequency range. Note that the frequency rises as the control voltage is lowered and vice-versa, which explains why preset VR4, Set High Freq., is at the bottom.

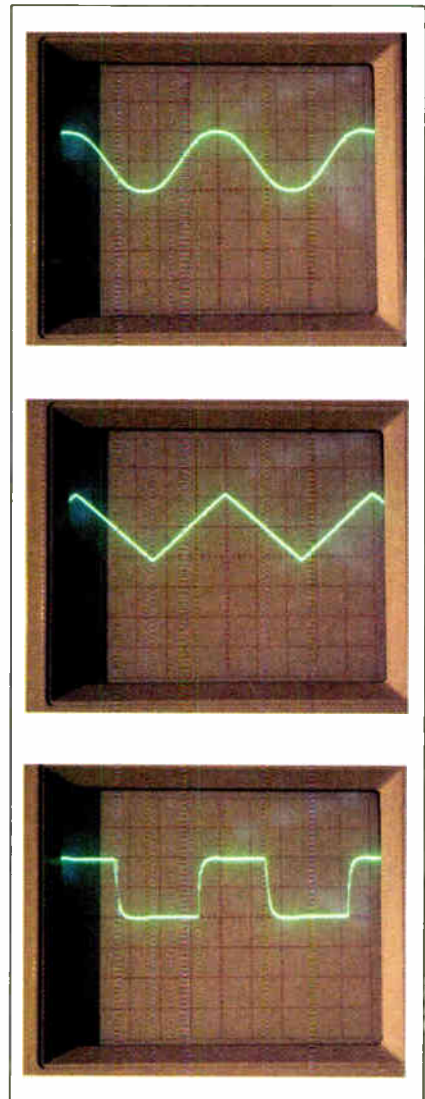

Screen shots showing sine, triangle and square waveforms at 200kHz.



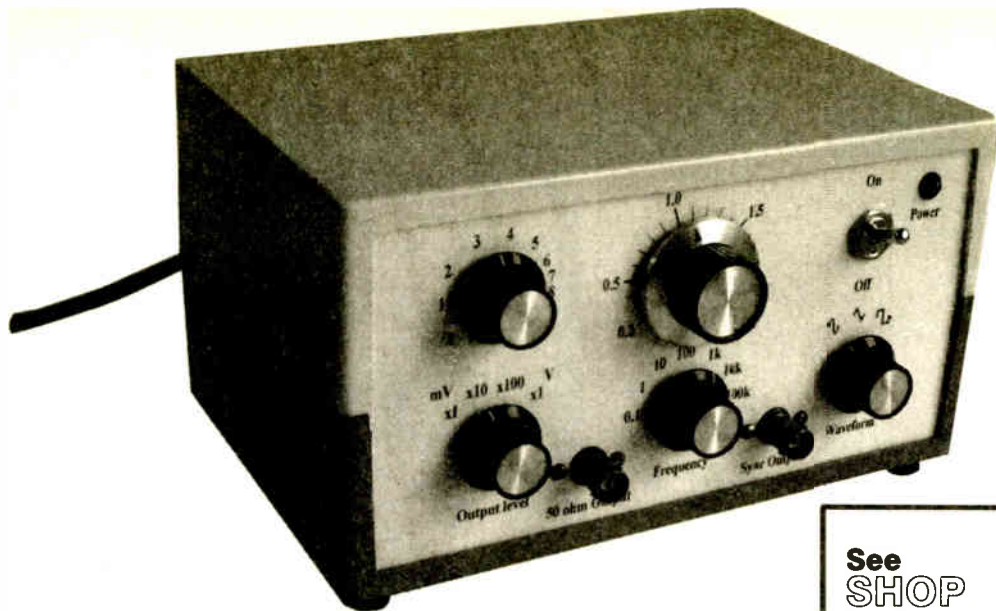

## COMPONENTS

### Resistors

R1	1k5
R2, R4	220Ω (2 off)
R3, R23, R27	1k (3 off)
R5, R8 to R11,	
R19, R20, R22	10k (8 off)
R6, R7, R16	6k8 (3 off)
R12, R15, R18	4k7 (3 off)
R13	5k6
R14	3k3
R17	39k
R21	12k
R24	100Ω
R25	12Ω
R26	150Ω
R28, R31	3k9 (2 off)
R29, R30,	
R32, R33	47Ω (4 off)

All 0.5W 1% metal film

See  
**SHOP**  
**TALK**  
page

### Potentiometers

VR1, VR2, VR5	1k 22-turn cermet preset (top adjust) (3 off)
VR3	10k rotary carbon, linear
VR4	50k 22-turn cermet preset (top adjust)
VR6, VR7	100k 22-turn cermet preset (top adjust) (2 off)
VR8	10k rotary carbon, linear

### Capacitors

C1, C3	470μ radial elect. 63V (2 off)
C2, C4 to C6,	
C9, C10, C11,	
C19 to C22	100n resin-dipped ceramic (11 off)
C7, C8	470μF radial elect. (2 off)
C12	180p polystyrene (150p + 33p, see text)
C13	2n2 polystyrene 5% or better
C14	22n polystyrene 5% or better
C15	220n polyester layer
C16	2μ2 radial elect. 35V
C17	22μ radial elect. 35V
C18	220μ radial elect. 35V

### Semiconductors

D1	5mm red l.e.d.
D2	IN4148 signal diode
REC1	W02 bridge rectifier, 200V 1.5A
TR1, TR3, TR4	BC184L npn silicon transistor (3 off)
TR2, TR5	BC214L pnp silicon transistor (2 off)
IC1	LM7912 1A 12V negative voltage regulator
IC2	LM317T 1.5A variable positive regulator
IC3	ICL8038 waveform generator
IC4	LM393N dual comparator
IC5	EL2045CN op.amp, Elantec

### Miscellaneous

T1	230V a.c. mains transformer, with 15V-0V-15V 100mA secondary
S1	d.p.d.t. toggle switch, rated at 250V a.c.
S2	1-pole 12-way rotary switch
S3	2-pole 3-way rotary switch
S4	1-pole 4-way rotary switch
SK1, SK2	50 ohm BNC chassis socket (2 off)

Printed circuit board available from the *EPE PCB Service*, code 385; two-piece plastic instrument case with aluminium front and back panels, case size 205mm x 140mm x 110mm; aluminium base plate, size 175mm x 100mm; 8-pin d.i.l. socket (2 off); 14-pin d.i.l. socket; panel mounting l.e.d. clip; control knob (5 off – one with aluminium skirt); nuts, washers and bolts; rubber sleeving; connecting wire; solder pins; solder etc.

Seven frequency ranges are provided, in decade steps, by rotary switch S2 with associated capacitors C12 to C18. Some of these capacitors can be obtained in 1% tolerance, others may have to be 5% or 10%, and for the bottom two ranges electrolytics are used. These are notoriously inaccurate, so where these ranges are to be provided it helps if a capacitance meter is available to pick ones reasonably close to the correct value.

The top range is set with capacitor C11, which is slightly lower than the expected value to compensate for stray capacitance in the circuit. The value shown proved to be about right in the prototype.

Although the 8038 is capable of quite good waveform linearity without adjustment, some worthwhile improvement can be achieved by external trimming. Presets VR5, VR6 and VR7 are provided for minimising sinewave distortion. The sinewave output is taken from pin 2 and the triangle output from pin 3.

## SQUAREWAVE

The squarewave output is usually taken from pin 9. This is an "open-collector" output which requires a pull-up resistor to the positive supply so the speed of the rising edge depends to some extent on the value of this resistor. A sufficiently low value was found to result in some distortion of the sinewave output during development of this project so it was decided not to use it. Instead, the triangle output at IC3 pin 3 is fed to the inputs of the LM393 dual comparator IC4 at pin 3 and pin 5, via resistors R10 and R11.

One of the comparator outputs, from pin 1, is taken to the Waveform selector switch S3. The other, pin 7, drives the base of transistor TR1 which gives a 0V to +5V squarewave output from SK1 for driving logic circuits. This output may also be used for synchronising external equipment such as oscilloscopes when working with low level signals.

A couple of minor precautions are included in this part of the circuit to minimise breakthrough of the squarewave into the other waveforms. Resistors R10 and R11 eliminate a problem of feedback which appeared to be from the inputs of IC4 back into the triangle waveform, and use of a two-pole switch for the waveform selector S3 allows the squarewave signal from resistor R17 to be "grounded" through S3b when not selected.

## RANGE SELECTION

The three signals, Square, Triangle and Sinewave, all have different peak-to-peak amplitudes at this point. Op.amp IC5 has a gain set by resistors R20 and R21 so that the sinewave leaves it at 10V pk-pk, then the two resistors R16 and R17 are used to attenuate the other two signals in conjunction with resistor R19 to obtain the same pk-pk level.

Op.amp IC5 is an Elantec EL2045 which is a high-speed type. A TL071 can be used here, but the faster component offers less distortion of the triangle and squarewave signals at high frequencies. Potentiometer VR8 provides variable control of the output amplitude with decade ranges added by the attenuator network built around Amplitude Range switch S4 and resistors R22 to R26.

Finally, a buffer stage using transistors TR2 to TR5 and resistors R27 to R33 gives the circuit a 50-ohm output. The complementary design of this stage minimises quiescent current and keeps distortion to a minimum, even at high frequencies.

Approx. Cost  
Guidance Only

**£47**  
excluding case

Fig. 1. Complete circuit diagram for the 200kHz Function Generator.

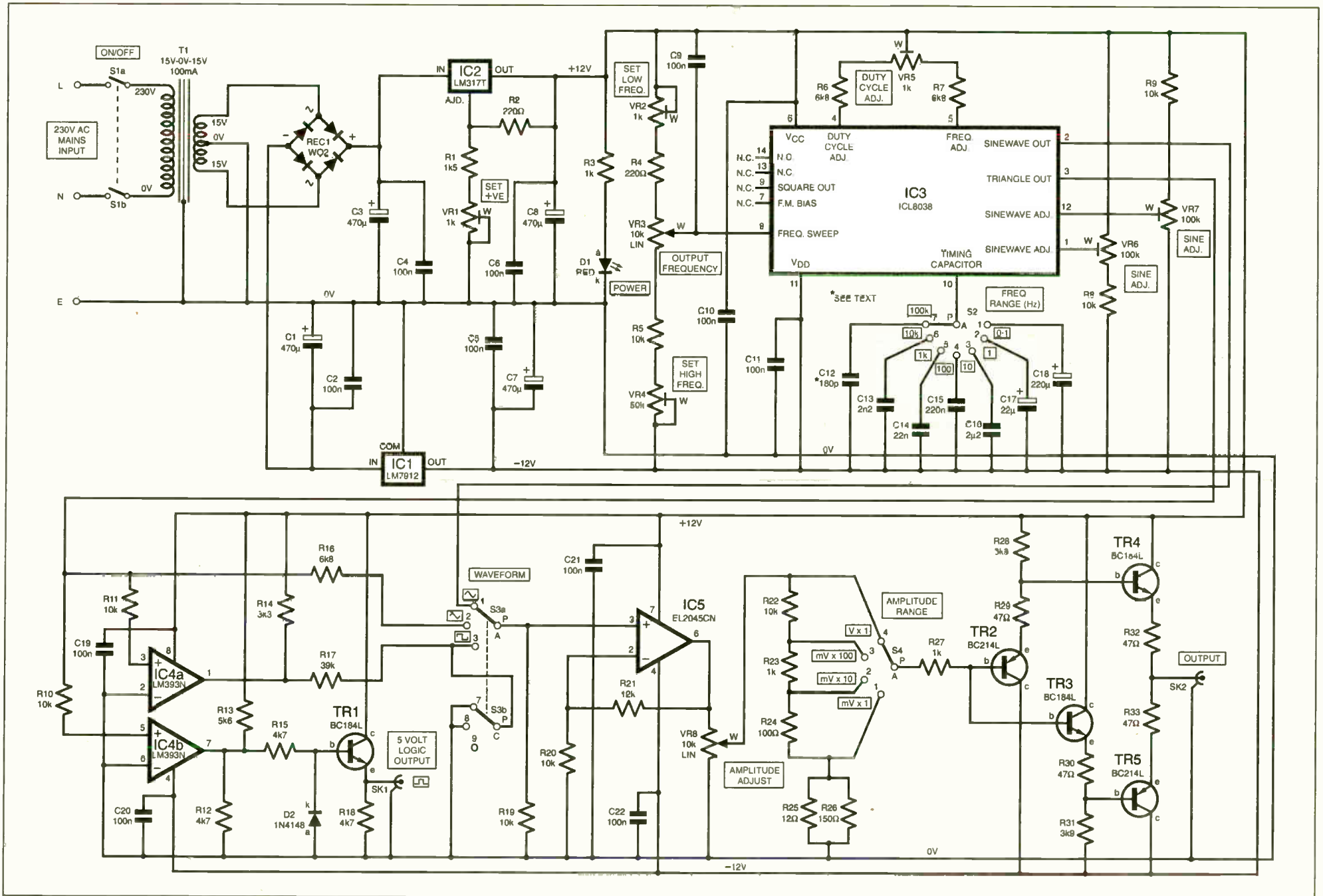



## CONSTRUCTION

Only construct this project if you are competently experienced at constructing mains powered circuits, or are supervised by someone who is suitably qualified. Readers are reminded that the voltages involved can KILL.

Most of the components for the 200kHz Function Generator are mounted on a single-sided printed circuit board. The top-side component layout and full-size underside copper foil master is shown in Fig.2. This board is available from the *EPE PCB Service*, code 385.

The author prefers to use solder pins for external connections to the board as these are then more robust and may be made from the component side of the board. Where these pins are used it is generally advisable to fit them first as some insertion force is usually necessary. There are 22 of them in total.

Following this the two wire links should be fitted, then the resistors and diode D2, the eleven 100n capacitors, the i.c. sockets and bridge rectifier REC1 which should have its positive output situated at top right. After this, the six presets should be fitted followed by the four electrolytic capacitors all of which have their positive sides towards the top of the board. None of the i.c.s should be fitted yet as these will be added during testing.

## FIRST TESTS

**Always remember to disconnect the unit from the mains before making any adjustments. Do not come into contact with the 230V a.c. input to the transformer.**

Normally the author recommends initial testing with a current-limited bench power supply but this is a bit difficult with a dual supply rail design so this project was just connected to its transformer (T1) and powered up, testing each part of the circuit in turn. It is assumed that a DVM and an oscilloscope will be available as a function generator is usually used in conjunction with a 'scope anyway.

The first check is to connect the transformer and power it up. Around 22V d.c. should be present with respect to ground or 0V, positive at the top of capacitor C4 and negative at the bottom of C2.

If these voltages appear correct IC1 can be fitted and on powering the board again the regulated *negative* 12V should appear at the bottom of C5. It should also appear at pin 4 of the sockets for IC4 and IC5, and pin 11 of the socket for IC3.

Next IC2 should be fitted. This time the regulated *positive* voltage should be present at the top of capacitor C6 and on pin 8 of IC4's socket, pin 7 for IC5, and pin 16 for IC3. It can now be adjusted to approximately this value with preset VR1.

## WAVEFORM CHECK

Frequency control VR3 should now be temporarily connected along with a 22nF 1% capacitor across the two connection points for switch S2. All of these points can be readily identified from the connections diagram shown in

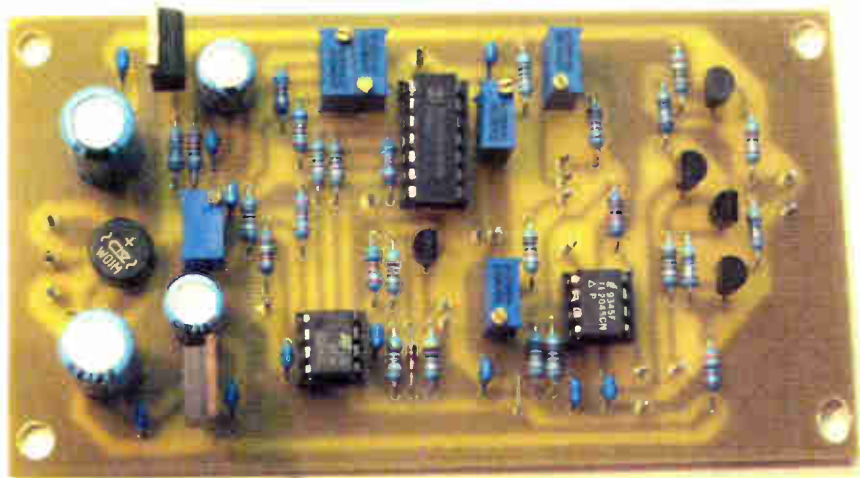

Layout of components on the completed circuit board.

Fig.3. IC3 should now be inserted into its socket.

When the circuit is now powered up, the sine wave (around 5V pk-pk) and triangle wave (8V pk-pk) should be present at their connection points for switch S3. The 22nF capacitor is the value for 200Hz to 2kHz, so Frequency control VR3 should give a range somewhere around this, though it may not be accurate until the presets VR2 and VR4 have been adjusted.

Next IC4 can be fitted. Both outputs of this, pins 1 and 7, should produce squarewaves with an amplitude of about 20V pk-pk. If transistor TR1 is now fitted, the 5V pk-pk squarewave output should appear from the connections for socket SK1. Note that this swings between ground (0V) and +5V, not symmetrically about 0V as the other waveforms will.

If IC5 is now fitted and an oscilloscope used to view its output (pin 6, but helpfully

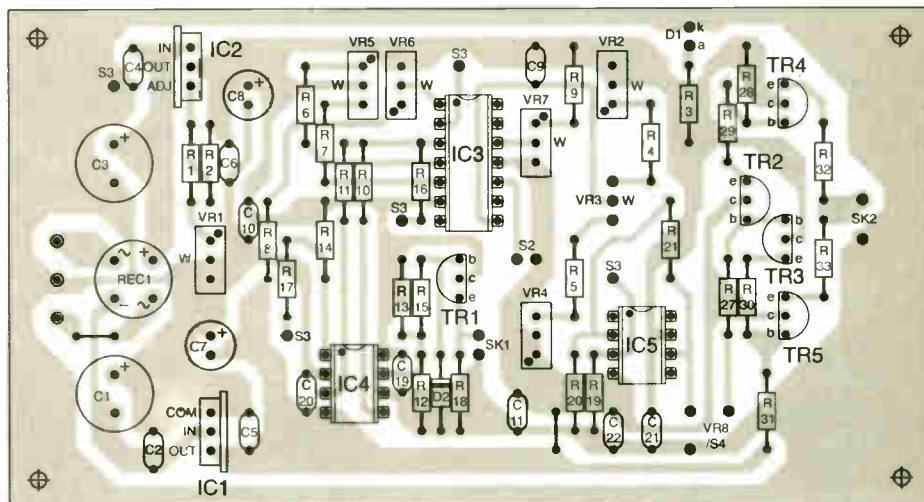

122mm (4.8in.) x 65mm (2.6in.)

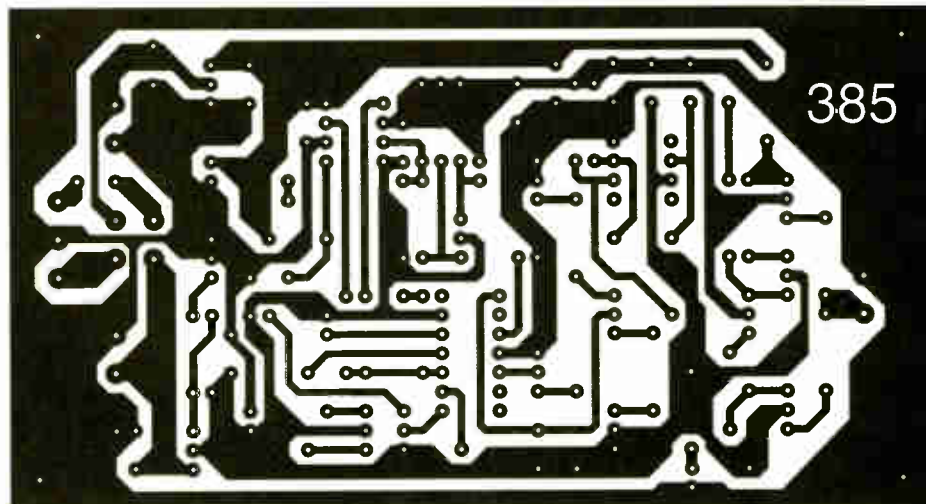

Fig.2. Printed circuit board topside components layout and full-size underside copper foil master for the 200kHz Function Generator.

it also appears at the connection point for the top of amplitude control VR8), connecting the input (the connection point immediately above it) to any of the three waveform outputs for S3 should produce the appropriate output waveform at about 10V pk-pk. The last stage of testing is to fit the remaining four transistors, taking care with type and orientation as there are two *pn*p and two *np*n types, and to connect the output from IC5 directly to the input to this stage (the connection point for the pole of S4). When the input to IC5 is connected to each waveform as before, it should appear at the final output, connection point for SK2, with a 10V pk-pk amplitude.

This completes the board testing. It may be found that IC1 to IC3 run very slightly warm, this is normal.

### OUTPUT ATTENUATOR

The resistors (R22 to R26) for the output attenuator are soldered directly to switch S4 as shown in the wiring diagram Fig.3. This also shows the connections of the frequency range capacitors C12 to C18 to frequency range switch S2, though these are shown positioned



Frequency range capacitors mounted directly on the switch tags.



Amplitude range resistors mounted directly across the switch tags.

radially for clarity. In fact there is not room for this, so they are assembled pointing backwards from the switch, using a piece of fairly thick tinned copper wire soldered to an unused switch connection (position 11) for their common or negative connection point. This should be clear from the photographs.

Frequency switch S2 is a single-pole 12-way switch with its limiting device set to give seven ways. Although C12 is shown as a single component in the circuit diagram it actually consists of a 150pF and a 33pF capacitor connected in parallel, this combined value being selected for the correct range by trial and error after the rest of the circuit was complete and fully adjusted.

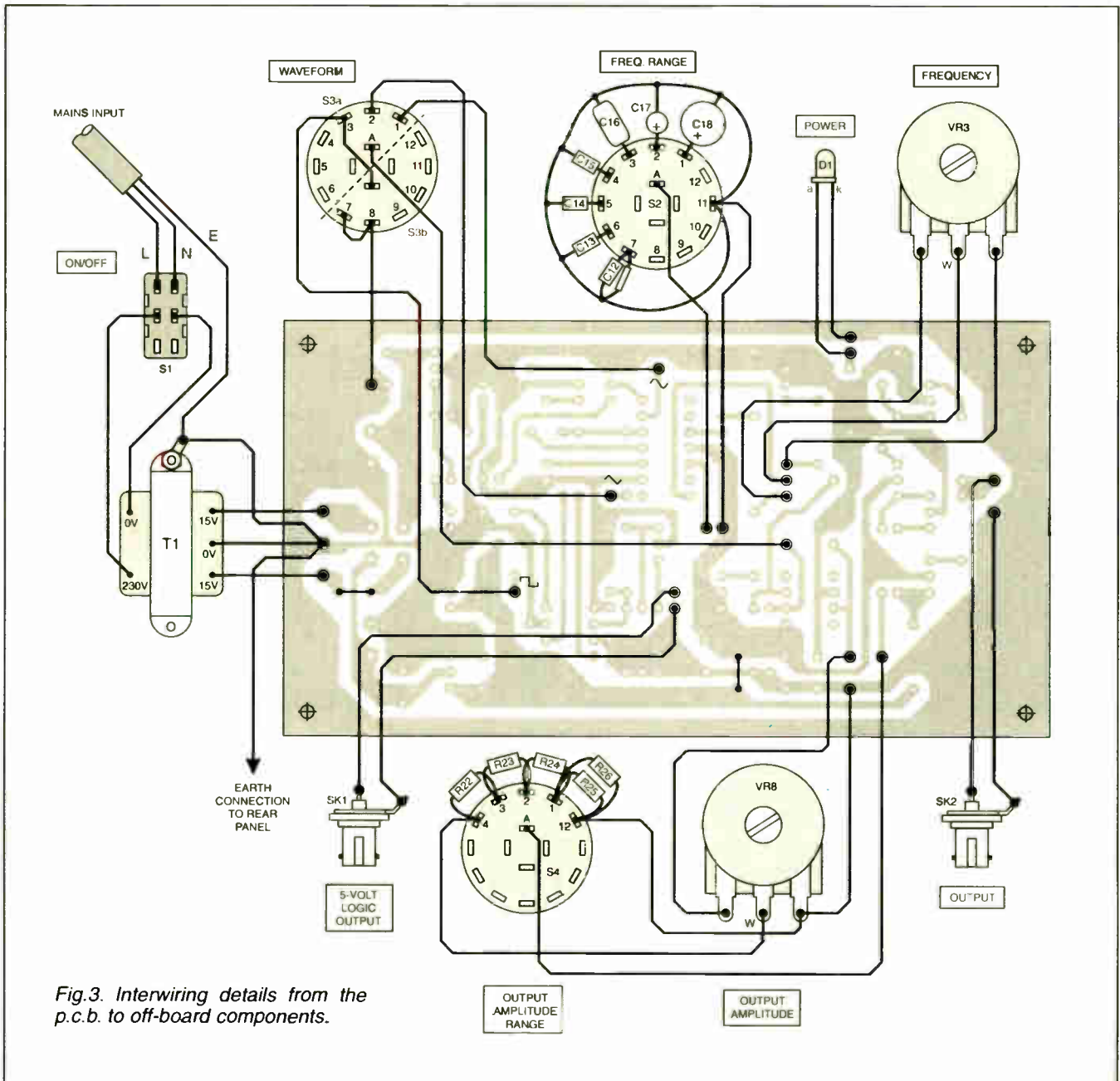

Fig.3. Interwiring details from the p.c.b. to off-board components.



## CASE DETAILS

All the switches and potentiometers were assembled on the case front panel and interconnections between them completed before connection to the board. The two output sockets are BNC types as these are generally more reliable especially with heavy usage. The author has experienced problems with the cheaper phono sockets in this type of application in the past.

In the prototype the board and transformer are mounted on a small aluminium plate which was first drilled to fit onto the mounting points provided in the case. Four nuts were used as spacers to provide clearance between the board and this plate, with some insulation tape beneath it as further precaution against accidental contact.

The mains Earth is connected to a solder terminal under one of the transformer mounting screws from which another connection is made to the circuit "ground" on the p.c.b. A wire from here carries the earthing to the rear metal plate of the case. The front metal panel is earthed via the two socket earth connections. This panel also earths the metal cases of VR3 and VR8. If an all-plastic case is used it would be advisable to connect these to 0V.

Although not used in the prototype, it is recommended that a fuse should be used in the Live mains lead prior to switch S1a, having a suggested value of 100mA, slow blow. Mount the fuseholder in the rear panel, near to the mains cable input (which should be via a locking cable grommet).

The incoming mains connections *must* be insulated with sleeving, so that it is impossible to come into contact with mains voltage whilst working on the unit. Remaining connections are made as shown in Fig.3, some using short lengths of ribbon cable for a neater appearance.

## FINAL ADJUSTMENTS

The project is now ready for final adjustment, where the preset resistors are trimmed to obtain the optimum performance. Before commencing the 1kHz frequency range (using C14, 22n 1%) should be selected with switch S2, and Frequency control VR3 should be set to around mid-travel so that the unit is operating at about 1kHz.

Preset VR1 should have previously been set to give a positive supply of about 12V, and the remaining presets VR2, VR4, VR5,

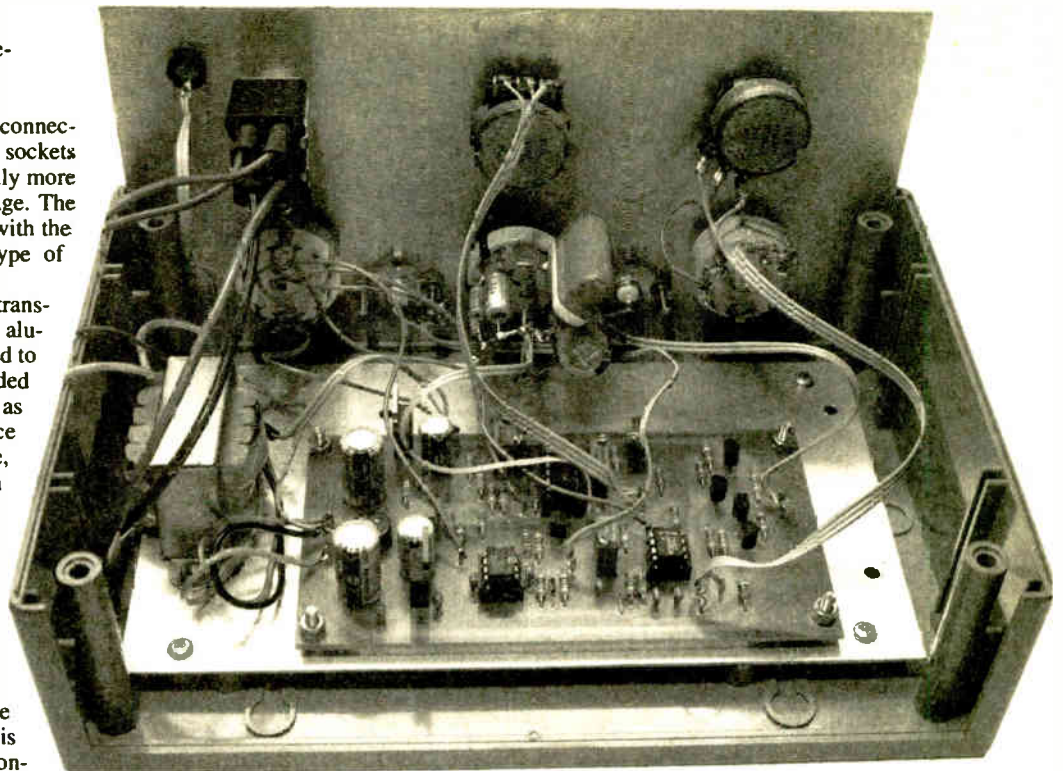

Internal layout of the 200kHz Function Generator showing the mains transformer and p.c.b. mounted on the aluminium base plate.

VR6 and VR7 should all be set to about half travel. Multi-turn types seem to be supplied already set to this, but if doubt exists they can be turned in one direction until a "click" is heard and then turned back again for half their total number of turns.

The triangle output waveform should be selected with S3 and the project allowed a few minutes to settle to its normal operating temperature following power-up. The first adjustment consists of connecting a meter between ground (0V) and the output of IC5 (pin 6), and carefully adjusting preset VR1 to obtain an average d.c. voltage of zero at this point, i.e. no d.c. offset in the output waveform.

Sinewave adjustment is carried out using presets VR5, VR6 and VR7. Presets VR6 and VR7 adjust the shapes of the positive and negative output half cycles respectively, clockwise rotation giving them a more "pointed" shape, and anti-clockwise a more "rounded" one. Preset VR5 has less effect but actually adjusts both duty cycle and frequency to a small extent.

Connect an oscilloscope to the output at

SK1 and adjust VR6 and VR7 for the best sinewave shape. Presets VR6 and VR7 interact to some extent so repeated adjustment will be required.

## TWIN-T NOTCH FILTER

Better results can be obtained by filtering out the fundamental sinewave and adjusting presets VR6, VR7 and VR5 for a

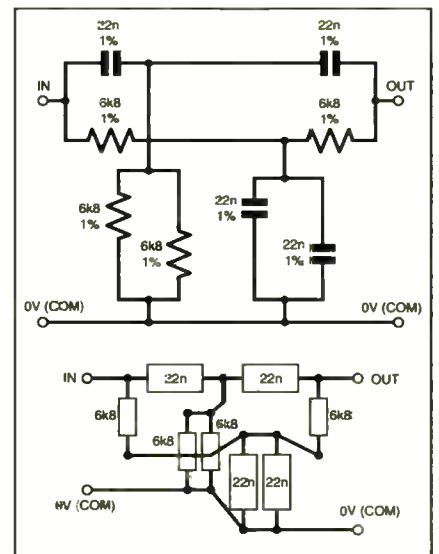

Fig.4. Twin-T Notch Filter circuit diagram and construction

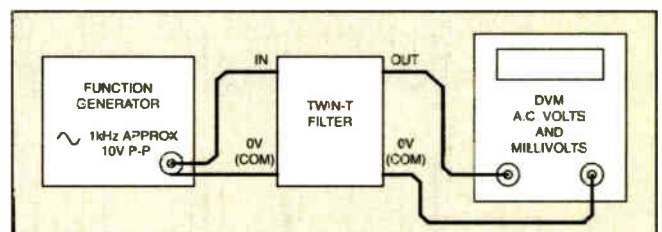
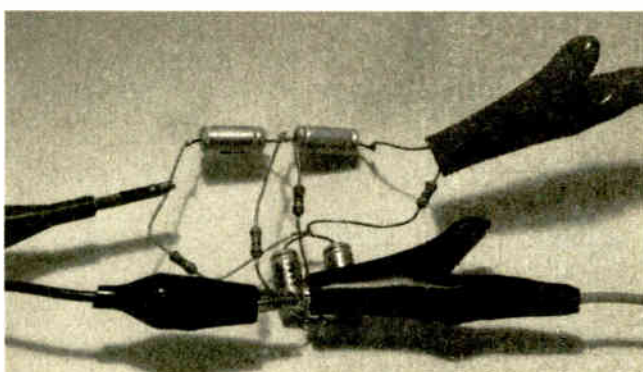

Fig.5. Connection details for setting up and using the notch filter. The filter "lash-up" in use is shown on the left.

minimum of harmonic and distortion products in the remaining signal. The circuit shown in Fig.4 is a "twin-T" notch filter with a center frequency close to 1kHz that can be temporarily constructed and used as shown in Fig.5.

It is difficult to set the optimum points by viewing the filter output with an oscilloscope due to the complexity of the waveforms from it but measuring the r.m.s. output with a millivoltmeter makes the job straightforward. The ideal would be an analogue millivoltmeter since adjustments of this kind are always easier with analogue indication, but it can be done successfully using a DVM set to an a.c. millivolt range.

The procedure is as follows. The Function Generator should be connected as shown in Fig.5, with the sinewave output selected by switch S3 and maximum output voltage (10V pk-pk) set with S4 and VR8.

Frequency control VR3 should be adjusted for minimum output or "null" from the filter, i.e. to the filter's working frequency. Next preset VR6 should be adjusted for minimum output, then VR7, and these adjustments should be repeated successively until no further improvement can be obtained. Following this VR3 and VR5 should be adjusted similarly for minimum output. These two sets of adjustments should be repeated until no further improvement is possible, at which point the project should have optimum sinewave purity.

On the prototype it proved possible to reduce the harmonics and distortion products from the 10V pk-pk output to around 10mV r.m.s. on the DVM and just over 50mV pk-pk on the 'scope, or around 0.5%. The action of VR3 is a little coarse for the final stages of this procedure so, if the constructor prefers, a fine-tuning adjustment can be temporarily added as shown in Fig.6.

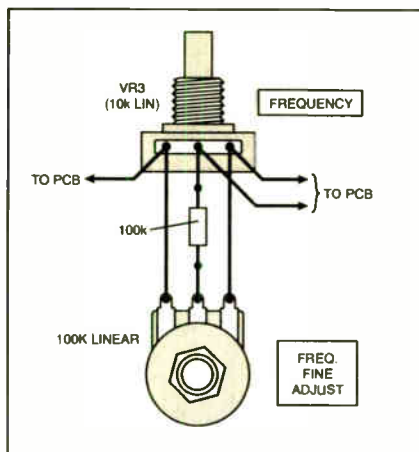

Fig.6. Temporary addition of a Fine Frequency control.

This leaves just presets VR2 and VR4 to be set up for minimum and maximum frequencies respectively. Frequency control VR3 should be set close to minimum, say ten percent above it, and VR2 adjusted to give 200Hz. The procedure is then repeated for the other end of VR3's travel where VR4 is adjusted to give 2kHz. There is some interaction between these two adjustments so it would be wise to repeat them a few times.

Calibration points for the controls can be marked on the front panel in the usual way. Note that the action of amplitude control VR8 is not linear due to the loading effect of the attenu-

ator network that follows it. After this the project is complete and ready to go.

## IN USE

Function generators have many uses in the electronic workshop of which just a few can be mentioned here to give an idea. Squarewaves are useful for testing rise and fall times of circuits, and to some extent frequency response. They can also be used for driving logic.

Sinewaves are useful for testing frequency response, especially of filters. Triangle waves are also sometimes useful for testing frequency response, and for testing audio amplifiers as pure sinewaves actually sound quite quiet to the ear.

The author finds triangle waveforms more useful than sinewaves when checking for "crossover distortion" in class B amplifier outputs, as used internally by most op.amps. In general, the wide range of output level, frequency and waveform shapes should prove invaluable to experimenters, and the ultra-low frequency ranges obtainable from this project may also prove useful to those working with biological and environmental monitoring circuits. □

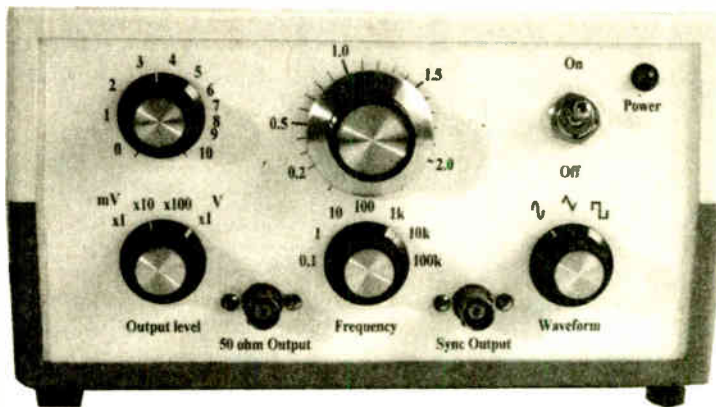

**NEXT MONTH WE MOVE TWIXT HEAVEN AND EARTH TO BRING YOU AN IRRESISTIBLE ISSUE – SO ORDER YOUR COPY NOW!**

★ **EARTH RESISTIVITY LOGGER – 1** ★

**PLUS: ATMOSPHERICS MONITOR**

**GARDEN LIGHTS CONTROLLER**

**Annual subscription rates:**

6 Months: UK £15.50, Overseas £18.50 (standard air service),  
£27.50 (express airmail)

1 Year: UK £29.50, Overseas £35.50 (standard air service)  
£53 (express airmail)

2 Years: UK £54.00, Overseas £66.00 (standard air service)  
£101 (express airmail)

To: Everyday Practical Electronics,  
Wimborne Publishing Ltd., 408 Wimborne Road East, Ferndown, Dorset BH22 9ND

Tel: 01202 873872 Fax: 01202 874562

E-mail: [subs@epemag.wimborne.co.uk](mailto:subs@epemag.wimborne.co.uk)

Order from our online shop at:

[www.epemag.wimborne.co.uk/shopdoor.htm](http://www.epemag.wimborne.co.uk/shopdoor.htm)

Name .....

Address .....

Post code ..... Tel. ....

If you do not wish to cut your issue, send a letter or copy of this form.

**EVERYDAY PRACTICAL ELECTRONICS**



**TAKE ADVANTAGE NOW!**

**SUBSCRIPTION ORDER FORM**



I enclose payment of £ .....  
(cheque/PO in £ sterling only),  
payable to Everyday Practical Electronics



My card number is: .....

Please print clearly, and check that you have the number correct

Signature .....

Card Security Code ..... (The last 3 digits on or just under the signature strip)

Card Ex. Date ..... Switch Issue No. ....

Subscriptions can only start with the next available issue.  
For back numbers see the *Back Issues* page.



# FLOWLOG

datalogging • control • electrical measurement

## A NEW, LOW COST OSCILLOSCOPE, DATALOGGER AND CONTROL UNIT

**£99**  
+VAT

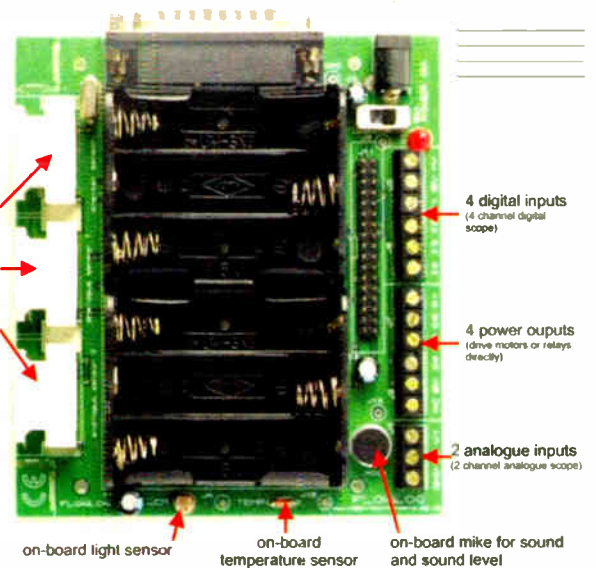

**FREE SOFTWARE APPLICATIONS INCLUDE:**

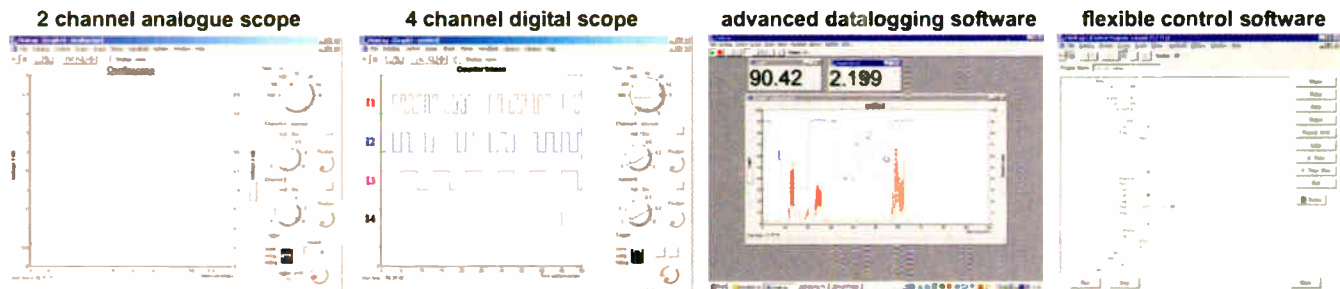

Flowlog is a new computer interface that provides datalogging, control and electrical measurement functions for use in science and electronics. Flowlog provides unrivalled value for money and performance. Please log onto our web site for full specification and description.

[www.matrixmultimedia.co.uk](http://www.matrixmultimedia.co.uk)  
[sales@matrixmultimedia.co.uk](mailto:sales@matrixmultimedia.co.uk)  
 t. 0870 700 1831 f. 0870 700 1832

# TRcontrol Solutions

*Innovative Products Imaginative Solutions*



I<sup>2</sup>C and Serial LCD Modules

Embedded Internet Solutions



Rapid Development Micro-Controllers



Visit our site [www.trcontrolsolutions.com](http://www.trcontrolsolutions.com)  
 or Phone us on 020 8823 9230

# TOTALROBOTS

Robotics, Control & Electronics Technology

BEAM Robots

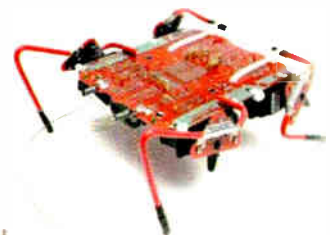

Programmable Mobile Robots



Robot Arms



Visit our site [www.totalrobots.com](http://www.totalrobots.com)  
 or Phone us on 020 8823 9220

# SURFING THE INTERNET

# NET WORK

# ALAN WINSTANLEY

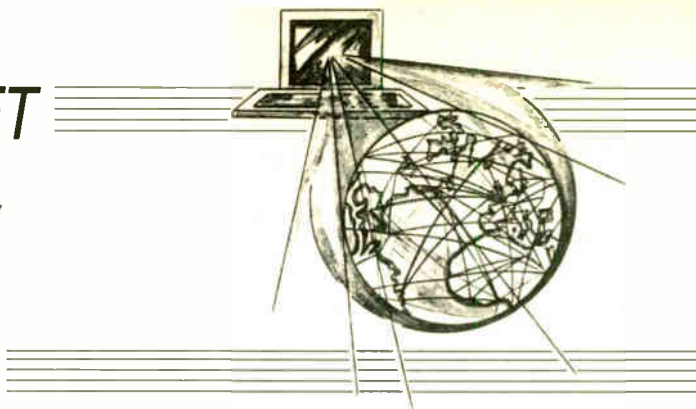

## Buy Now on eBay

**M**ANY years ago, a friend of the writer advertised an item for sale in the small ads. of his local newspaper. His philosophy was that he only needed one person to say yes, and it was sold. If you have something for sale – almost anything, in fact – then there is a good chance of finding at least one person who will say “yes” when you offer it for sale online.

Head over to [www.ebay.co.uk](http://www.ebay.co.uk) (or [www.ebay.com](http://www.ebay.com) then find your regional site), and discover eBay, which ranks as the world's largest online auction house. It offers an enormous variety of objects offered for sale from individuals as well as enterprises: the writer's local photographic shop sells off all its secondhand digital cameras via eBay.

This month's *Net Work* guides you through the stages of becoming “an excellent eBay A+++++” – whatever that means (read on!). eBay describes itself as “one of the safer places to trade online” which implies that it won't be 100% secure at all times, but there are many security measures in place to help avoid fraud. However, you do need to exercise your judgment to decide how authentic the offers for sale actually are, and one important way is to judge from the feedback that is posted online after a sale is completed (see later).

Anyone over 18 can register for free to buy at eBay, which can be a rather tortuous process of creating usernames, passwords and reminder phrases. It can take many attempts to find a suitable username, but after registering and responding to eBay's automated emails, you can bid for goods on sale. There's something to cater for almost every interest or hobby.

From the buyer's point of view, eBay offers sellers several ways to sell items on the web site. The easiest method is the fixed “Buy It Now” price – simply click it and the price you see is the price you'll pay. This is convenient but it is often not the cheapest way to purchase an item.

## Buy Proxy

Usually, sellers will enter their items into an online auction for up to ten days. eBay operates a system it calls “proxy bidding”. In a traditional English auction, bidders just offer a price – for instance, if they bid £1 million for an autographed copy of *Net Work* (yes please) then they would pay that if they won the auction, even if the next bidder below only offered 20p (more likely).

However, eBay's proxy bidding works differently and protects buyers from overspending (or typing in too many zeros!). Bids are raised in fixed increments (say 50p or £1 or £2, depending on the product value).

You simply enter a *single bid* showing the *maximum* you are prepared to pay. eBay then maintains the bidding for you in the stated increments, until your maximum bid is reached.

For example, if you bid a *maximum* of £160 for an

oscilloscope that is currently listed at £140, eBay will enter your bid at £142 and raise each bid by £2 (the stated increment) until £160 is reached, after which you'll lose if you are outbid by someone who bids more than that. However, if the rest of the bidding stops at say £154, you win the auction but you only pay £156, *not* £160.

Easy really. If you are the winning bidder at that time, eBay emails you to tell you, and if you are subsequently outbid, then, like the finest of auctioneers, eBay implores you to bid again.

## Going Dutch

The so-called “Dutch Auction” is an option eBay offers for selling multiple units of the same product (e.g. 50 hard drives to be sold off separately). This system harks back to the selling of tulip bulbs in Holland, where the auction price was progressively *lowered*, not increased, as the auction proceeded.

The idea was that those who definitely needed to buy bulbs would bid a high price early on, which guaranteed their consignment of bulbs or flowers. The rest would be sold at a gradually *lowered* price to a level that the more reluctant bidder found attractive. Thus, the rest of the crowd got their cheaper tulips at a knockdown price, but without the guaranteed supply that the early higher bidders enjoyed.

Anyone over 18 with a credit card and bank account can *sell* on eBay who will charge sellers a small commission, which in the UK is deducted by direct debit a few weeks later. Sellers can also decide a reserve price if desired, and those sellers with HTML skills can create their own mini web page to advertise goods, including hyperlinks to images. Some sellers have built an entire cottage industry based on selling their wares through eBay then nipping to the Post Office with their products.

## Feedback

Bear in mind that buyers enter into legal contracts in the UK when they win an auction, and sellers have obligations to describe the goods fully and accurately. eBay has a feedback system in which buyers can rate sellers and vice versa – typical buyers' comments include “Excellent eBay! Will buy again A+++”.

So, if goods turn out to be dodgy, badly packaged or misrepresented (which is unlikely, but not 100% impossible), buyers can give the seller a black mark as a warning to others. Similarly if a buyer bounces a cheque, the seller can register this in the feedback system. By checking the feedback for previous auctions, you can gain confidence of how genuine the bids or auctions actually are.

In the writer's experience, eBay has proved to be a valuable way of recycling useful items that are too good to throw away. And you only need one person to say “yes” after all.

If you have a particular topic that you think should be “aired” on *Net Work*, email your suggestion to [alan@epemag.demon.co.uk](mailto:alan@epemag.demon.co.uk).



Screenshot from the eBay auction web site.



# LCR PASSIVE COMPONENT ANALYSER

ANDY FLIND



Anyone requiring a quick and simple means of measuring resistors, capacitors and inductors of all types will find that Peak's Atlas LCR Analyser represents superb value.

THE Atlas LCR Passive Component Analyser is the latest item of test equipment to be produced by Peak Electronic Design, and is claimed to test and measure all types of passive components including resistors, capacitors and inductors. It complements their Atlas Component Analyser which tests most types of discrete semiconductors, such as diodes, transistors and various f.e.t. devices. The author reviewed this some time ago and found it so useful that it has been in regular use in the workshop ever since, so the opportunity to review this new product from Peak was welcomed with much enthusiasm.

## On The Inside

A quick inspection of the interior revealed a surprisingly high component count, nearly all of the surface-mount type, laid out on a single neat printed circuit board – see photograph. There is a "PSU corner" with two i.c.s, some electrolytics and an inductor, set a short distance apart from most of the rest of the components.

The heart of the unit is, not surprisingly, one of the PIC family, in this case a PIC16F873 accompanied by an 8MHz crystal. Jeremy Siddons of Peak

Electronic Design says that one of the most important aspects of the design is the purity of the sinewave signals used for testing reactive components, and that these signals are generated by the PIC and then shaped by 5th-order Chebyshev filters constructed with op.amps. Two LPV324 quad op.amps can be seen accompanied by plenty of passive components so they are probably these filters. Several other i.c.s bring the total count to nine.

The two control buttons and the display are mounted directly to the opposite side of the board and even the battery, a miniature 12V alkaline type, fits between two contacts at each end of a rectangular hole cut into the p.c.b. The assembled unit is very light and robust and would probably survive the odd fall from the workbench although such testing is not recommended!

## TASK FORCE . . .

**Inductance Range:** 1 $\mu$ H to 10H  
**Capacitance Range:** 1pF to 10,000 $\mu$ F  
**Resistance range:** 1 $\Omega$  to 2M $\Omega$   
**Basic Accuracy:** 1%  
**Test Signals:** 1V, 3mA max

The Atlas LCR arrived in a stout cardboard box accompanied by a small manual and a folded sheet of paper describing the procedure for "probe compensation". First impressions were of the similarity to the earlier unit since it even uses the same plastic case, but this time it is moulded in bright yellow plastic, pleasing to the eye and, more important for such a small device, easy to locate on an untidy workbench!

The display is again a 2-line by 16-character l.c.d., but is smaller than that used on the earlier unit. It's actually easier to read however since it is of the greenish variety which have better contrast and a wider viewing angle than the silver types. The probes are small clip-on types in red and black, attached to a short screened lead from the case with tiny plugs and sockets.



The Atlas LCR Passive Component Analyser from Peak Electronic Design.

## Simplicity Itself

The Atlas LCR is so simple to use that there is a risk that purchasers may simply not bother to read the manual! However two points should be noted before commencing use.

The first concerns probe compensation which should be done if measurements are to be accurate. This is probably why Peak includes the separate sheet describing the procedure, since it is repeated in the manual.

The probes and their leads have some resistance, capacitance and inductance of their own and this procedure enables the unit to read the values of these and store them in non-volatile RAM in the PIC for subtraction from subsequent readings. The procedure is fully automatic and takes just seconds to complete, indeed the proverbial child of three could do it!

It does not need to be carried out every time the unit is used, and a quick check as to whether it is required can be made at any time by taking readings for open-circuit and short-circuited probes.

## Take Charge

The other essential observation is that damage could be caused by connecting the probes to an external potential. This obviously includes charged capacitors, so it is most important to ensure that these, especially electrolytic types, are fully discharged before testing.

In most cases momentarily bridging the connections with a metal object is sufficient, though a large, well-charged electrolytic or high-voltage type is perhaps better discharged through a resistor to avoid pyrotechnic displays and possible damage to the capacitor!

## Taking Book

The manual is small, concise and very easy to follow and provides plenty of interesting information regarding the measurement techniques employed and the criteria used in deciding what type of component the unit is connected to. It is well worth taking the small amount of time required to read it in order to understand how some of these decisions are taken.

For instance, some 230V solenoid coils from the author's collection were interpreted as resistors. The reason for this became obvious when it was understood that anything with a resistance greater than 1k will not be recognised as an inductor!

Small capacitors and inductors are tested with a.c. signals of 1kHz, 15kHz or 200kHz, the appropriate frequency being selected automatically. Resistors and larger capacitors are tested using a d.c. technique. The type of measurement used can usually be found by scrolling through the displays.

## On Display

Using the Atlas LCR is simplicity itself. A press of the left-hand button produces a brief message about due date for the next full calibration (more on this later) followed by a five-second countdown during which the probes can be placed against the connections of the component to be tested. If the probes are already connected another press of the button cancels this countdown and analysis commences immediately.

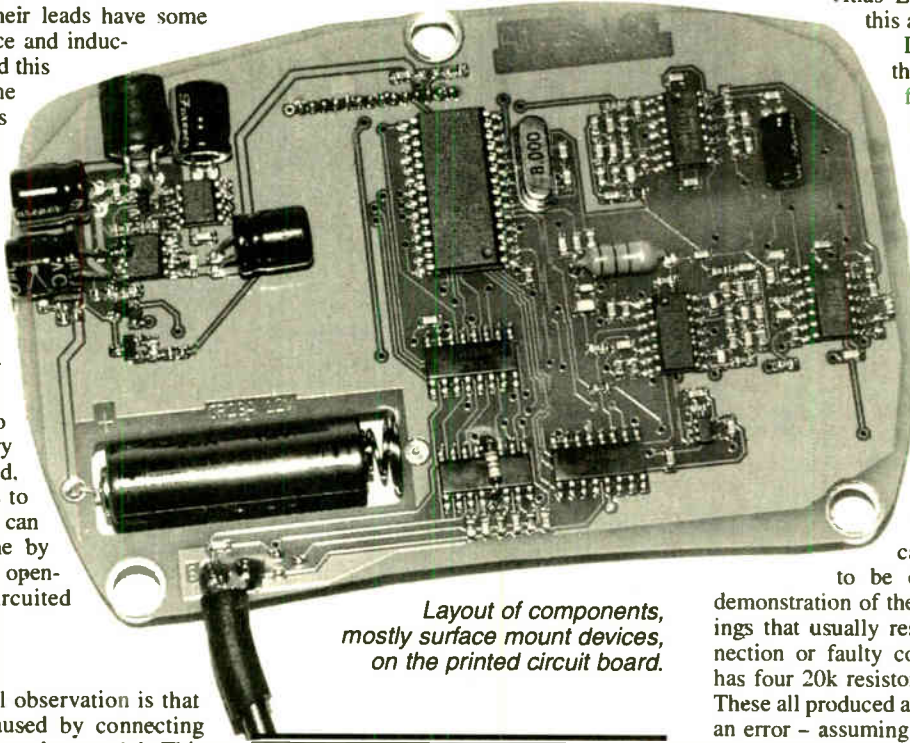

Layout of components, mostly surface mount devices, on the printed circuit board.

**"Astonishingly, this little unit seems to pack most of the punch of a large and very expensive automated LCD bridge into its tiny plastic case."**

After a few more seconds, the type of component and its value are displayed and presses of the right-hand button will scroll through the test frequency used, and in the case of inductance, the d.c. resistance of the component. The measurement procedure can be repeated at any time by another press of the left-hand button. The unit powers down automatically after a few seconds, but can be switched off manually if required by holding down the right-hand button.

## Testing Time

The author spent a most interesting couple of hours putting this little unit through its paces on a large number of components ranging from modern types to, frankly, old junk! Most people involved with electronics will have a digital

**"It is definitely the most useful addition made to the author's workshop equipment in a very long time, and can be thoroughly recommended..."**

voltmeter at the very least and most of these can measure resistance, but they tend not to be so accurate for low values so the Atlas LCR will have uses in this area.

In addition it displays the resistor's inductance for values below 10 ohms, which may be significant in the case of the wirewound types which these sometimes are. In fact, Peak warn that such types may fool the Atlas into indicating that the component is an inductor, but nothing in the author's collection managed to cause this!

One resistor that consistently read as a few picofarads of capacitance was found to be open-circuit, the first demonstration of the obviously false readings that usually result from a poor connection or faulty component. The author has four 20k resistors of 0.01% tolerance. These all produced an indication of 20.06k, an error – assuming they are still accurate – of less than 0.3%, well within the claimed 1% accuracy of the Atlas.

## Peak Practice

Some DVMs these days can also measure capacitance but their ranges tend to be limited and probe inconsistencies would make low-value readings unreliable. The Atlas LCR, by contrast, automatically covers a huge capacitance range, from half a picofarad to 10,000 $\mu$ F.

It really does measure low values accurately, a 2.7pF ceramic capacitor was checked with no problems at all. Air-spaced tuning capacitors were also easy to test and could even be set to precise values quite readily, which might have its uses.



Resistance measurement readout.





Checking-out the value of a suspect electrolytic capacitor.

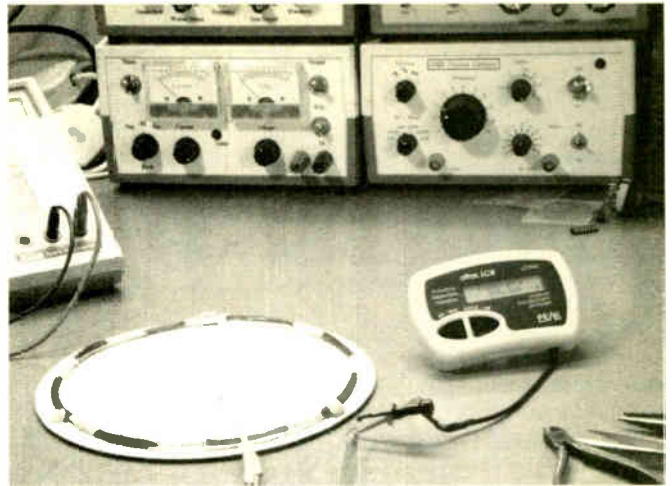

Checking the inductance of a metal detector pulse induction search coil.

More to the point it can measure both maximum and minimum values of those little preset trimming capacitors which never seem to be clearly marked.

The inter-track capacitance of stripboard can be measured, which is useful as it is often sufficient to cause problems in some circuits, and even a home-made capacitor of a few picofarads made by twisting two pieces of wire together was readily measurable.

A bunch of 1% tolerance capacitors all produced the expected results, but this raises a new possibility. Capacitors of this tolerance are occasionally required in designs but they seem to be increasingly hard to find and expensive. With this instrument to hand a bunch of cheaper types could be checked to find an accurate one.

At the other end of the scale Peak state that since testing of electrolytics is done with no more than 1V of test voltage it is unnecessary to observe polarity. The author tested some twice, reversing the polarity of the probe connections, and received consistent readings both ways. A couple of really big electrolytics were tested, one of 22,000 $\mu$ F, twice the official maximum range. The "analysis" took a little longer than usual, but up came a clear reading, "21.22mF" (millifarads).

### Inductors

Finally, the unit was tested with a wide selection of inductors. This is where it really comes into its own.

Inductors rarely seem to bear any useful markings, and are the most difficult of the passive components to measure. The traditional method is an "inductance bridge", but these are less common than DVMs and

much more difficult to operate. Automated LCR measuring instruments are available but are generally very expensive and often require the user to decide what the component actually is.

Items tested with the Atlas by the author included r.f. coils, from three turns of thick wire on a small former, probably from a VHF radio, which measured at 0.8 $\mu$ H, to coils of many turns on ferrite rods. The primaries of transformers measuring several henries were tried, along with lots of small chokes and inductors intended for use in things like filters and small switch-mode power supplies.

As a long-time enthusiast of metal detector design, the author has a collection of experimental air-cored coils of large cross-section used in the design of search heads. All of these were unflinchingly recognised as inductors and their values and d.c. resistances were clearly indicated.

A couple of the smaller inductors with values of a few millihenries were also checked on an old Marconi TF2000 Universal Bridge, an instrument renowned in its day for accuracy, and the results corresponded accurately with those from the Atlas. It should be said that operating the bridge was far more tricky and time-consuming than using the Atlas, since a "null" had to be found using a combination of four controls and a range switch, with the value being read from two of them.

A far cry from just connecting and pressing a button! It is probably safe to say that, with the introduction of the Atlas LCR, Peak have put an end to the difficulties of inductance measurement.

### Extras

In addition to the standard probes supplied with the Atlas LCR, Peak plan to offer a range of extras in the near future. Tweezers for simple testing of leadless surface mount components are already available and details of more accessories will, we understand, be released just as this issue of *EPE* appears on the bookstalls.

A carrying case is available, which may be useful to those in the service industries. A re-calibration service is also available for anyone needing guaranteed accuracy, and certification of this to recognised standards can be supplied where required.

### Summing Up

Astonishingly, this little unit seems to pack most of the punch of a large and very expensive automated LCR bridge into its tiny plastic case. For anyone requiring a quick and simple means of measuring resistors, capacitors and inductors of all types to a basic accuracy of 1%, it represents superb value with its ease of use, low cost, and ready availability.

It is definitely the most useful addition made to the author's workshop equipment in a very long time, and can be thoroughly recommended to any fellow enthusiasts wishing to make such measurements.

Available directly from Peak, the *Atlas LCR Passive Component Analyser* costs £79, including VAT and p&p. For further details contact: *Peak Electronic Design Ltd., Dept EPE, Atlas House, Kiln Lane, Harpur Hill Industrial Estate, Buxton, Derbyshire, SK17 9JL.* Phone 01298 70012. Fax 01298 70046.

Web: [www.peakelec.co.uk](http://www.peakelec.co.uk)

Email: [sales@peakelec.co.uk](mailto:sales@peakelec.co.uk)

EVERYDAY  
**PRACTICAL**  
**ELECTRONICS**  
 THE No.1 MAGAZINE FOR ELECTRONICS TECHNOLOGY & COMPUTER PROJECTS

## NEWSAGENTS ORDER FORM

Please reserve/deliver a copy of *Everyday Practical Electronics* for me each month

Signed .....

Name and Address .....

Post Code .....

*Everyday Practical Electronics* is published on the second Thursday of each month and distributed S.O.R. by COMAG. Make sure of your copy of *EPE* each month – cut out or photostat this form, fill it in and hand it to your newsagent.

# New Product

Atlas LCR Passive Component Analyser (Model LCR40)

**"No other LCR is as easy as this!"**

Just clip on the test leads and press test. The Atlas LCR will automatically identify the type of component, apply the appropriate test level and frequency, display the component's value and more!

Probes are detachable too, so you can use the optional SMT tweezers for your tiny unmarked passives - **fantastic**.

Inductance range: 1 $\mu$ H to 10H  
 Capacitance range: 1pF to 10,000 $\mu$ F  
 Resistance range: 1 $\Omega$  to 2M $\Omega$   
 Basic accuracy: 1%  
 Test signals: 1V, 3mA max



# £79

fully inclusive UK price



Lots of accessories available soon!

- Automatic component identification (Inductor, Capacitor or Resistor).
- Component value measurement.
- Automatic test frequency selection (DC, 1kHz, 15kHz or 200kHz).
- Inductor DC resistance measurement.
- Non-volatile probe compensation memory.
- Detachable probes allowing use of optional test prods, SMT tweezers, etc...
- Hands free mode with value hold.

# atlas

semiconductor analyser

Check and identify your semi's

# £60

fully inclusive UK price

- Automatic component identification
- Pinout identification
- Transistor gain measurement
- MOSFET gate threshold measurement
- PN junction characteristics measurement
- Shorted Junction identification
- Transistor leakage measurement
- Just connect the part anyway round and press the button!
- Auto power on/off

### Supports:

- Bipolar transistors,
- Darlington transistors,
- Diode protected transistors,
- Resistor shunted transistors,
- Enhancement mode MOSFETs,
- Depletion mode MOSFETs,
- Junction FETs,
- Low power triacs and thyristors,
- Diodes and diode networks,
- LEDs (+bicolours)

NPN bipolar Darlington  
 Diode protection between C-E  
 Resistor shunt between B-E  
 Current gain Hfe=126  
 Enhancement mode N-Ch MOSFET  
 Gate Threshold Vgs=3.4  
 BLUE Col. Emit  
 Volt 1.9.77  
 Peak  
 C=8



**NOW MEASURES TRANSISTOR LEAKAGE**

enclosure colours may vary

Visit [www.peakelec.co.uk](http://www.peakelec.co.uk) to download the data sheets, user guides and copies of independent reviews. You can pay using a cheque, postal order, credit or debit card and even pay securely online. Please contact us for your volume requirements.

Also available from: (prices vary)



**PEAK**  
 electronic design ltd

Atlas House, Kiln Lane  
 Harpur Ind. Est., Buxton  
 Derbyshire, SK17 9JL, UK

[www.peakelec.co.uk](http://www.peakelec.co.uk)  
[sales@peakelec.co.uk](mailto:sales@peakelec.co.uk)

Tel. 01298 70012 Fax. 01298 70046





# PRACTICALLY SPEAKING

Robert Penfold looks at the Techniques of Actually Doing It!

THE majority of electronic components are easily fitted into a project. It is just a matter of soldering them onto a circuit board, or drilling a hole in the case, securing the component in place using the mounting nut, and hard wiring it to the rest of the unit.

A few components are a bit more awkward, and miniature loudspeakers certainly fall into this category. These are used not used in projects as frequently as in the past, but they are still needed for any project that will produce anything more than simple "beeping" alarm sounds.

## Sound Advice

On picking up one of these miniature loudspeakers for the first time it soon becomes apparent that something is missing. There is no built-in mounting bracket of any kind, and no obvious way of fixing the component to the front panel – see Fig.1.

The main use for miniature loudspeakers in the world of commercial electronics is in small portable radios. The standard technique for mounting them on the front panel is outlined in Fig.2. In effect, the printed circuit board is used as a mounting bracket that traps the loudspeaker in position. The spacers are often moulded into plastic cases, and the board is then held in place using self-tapping screws.

It would be possible to use the same technique in a home constructed gadget, but in practice it can be a bit awkward to implement. It is not too difficult to improvise a mounting bracket made from about 18s.w.g. to 20s.w.g. steel, and something along the lines of Fig.3 usually does the job quite well.

the correct tools are available, so it is best to use a fairly thin strip of thin gauge material.

The most popular method of fitting loudspeakers is to simply glue them in place, but this has to be done very carefully. The adhesive must be applied to the raised outer rim on the front of

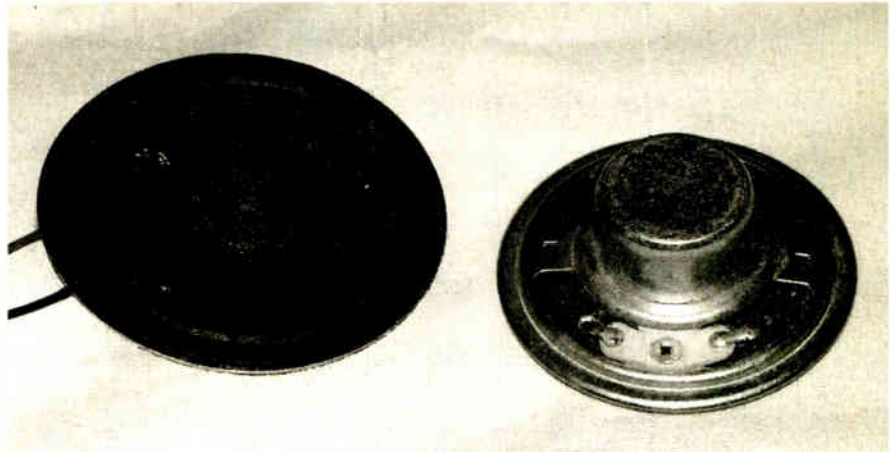

Fig.1. Miniature loudspeakers, such as those shown here, normally lack a built-in mounting bracket.

Aluminium is not well suited to this task as it lacks the springiness needed to keep the loudspeaker firmly trapped in place. Steel is not easily bent unless

the component, taking care not to smear or trail any onto the diaphragm. While adhesive on the diaphragm is unlikely to prevent the loudspeaker from working, it could seriously degrade the audio quality.

Traditionally the diaphragm is made from a paper based material, but plastic and even metal foil are also used for modern loudspeakers. All these materials are easily damaged, so handle loudspeakers carefully and avoid touching the diaphragm. A quick setting epoxy adhesive, Superglue, or any general-purpose adhesive should do the job well.

## Undercover

Another slightly awkward aspect of loudspeakers is that a grille is needed so that the sound waves can pass through the case but the diaphragm is protected. Simply mounting the loudspeaker behind a cutout in the front panel is not a good idea as it leaves the loudspeaker exposed. Sooner or later it is almost certain to be damaged. One option is to glue some loudspeaker fret or cloth behind the cutout and then glue the loudspeaker onto this.

Special fret and cloth materials are not widely available these days, but one of the larger electronic component catalogues should have something suitable. Loudspeaker cloth should be available from retailers that specialise in loudspeaker and hi-fi components. However, it might be necessary to buy quite a large piece, making this option economically unviable.

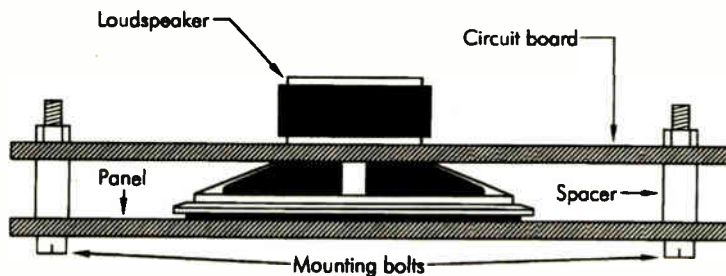

Fig.2. Normal commercial method of mounting a loudspeaker. The spacers are often moulded into the case, and the circuit board is then secured in position using self-tapping screws.

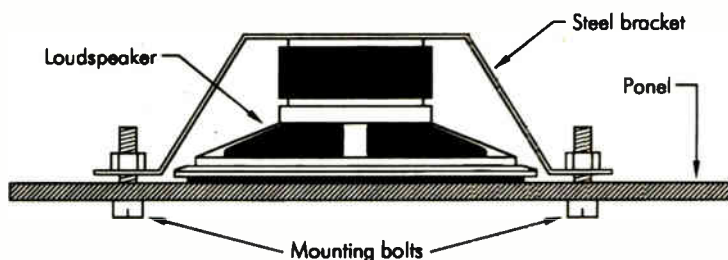

Fig.3. A loudspeaker can be held in place using a steel bracket.

Some types of expanded aluminium make a good alternative to loudspeaker fret. This material is used in a variety of applications such as car bodywork repairs and flower arranging. It is available from some do-it-yourself stores and craft shops.

Whatever material is used, it is generally best to choose one that has a fairly fine pattern. Only small pieces are needed in this application, and one having a coarse pattern can produce some odd looking results.

### Grilling

A simple alternative is to drill a neat grille of holes in the front panel. Getting really neat results is more difficult than you might expect, so it is essential to work as accurately as possible. Making the grille is quicker using just a few large holes, but this still leaves the loudspeaker vulnerable to damage.

At the other extreme, a large number of small holes can produce a very neat looking grille, but it can be very time consuming to drill all the holes. Also, with some plastic cases the grille would be physically weak.

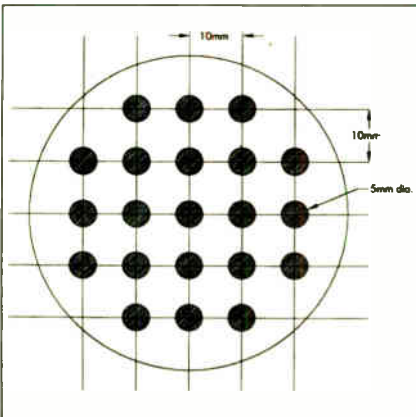

Fig.4. Drilling a matrix of small holes produces a simple but effective grille design.

It is best to use around 20 holes of no more than about 5mm in diameter. The design of Fig.4 works well with loudspeakers of around 50mm to 75mm in diameter. The holes can be anything from about 4mm to 5.5mm in diameter.

Mark the positions of the holes and centre-punch them as carefully and accurately as possible. Drill small holes initially, again working as accurately as possible. Holes of about 1mm or 2mm diameter will do for the guide holes. Then drill them out to the required final diameter. Deburr the holes to produce the neatest possible results, and then the loudspeaker can be fitted.

### Loading

These days most miniature loudspeakers have an impedance of 8 ohms. At one time they were available with various impedances from 8 ohms to about 80 ohms, and the higher impedance types were much used in projects. If you build an old design that requires a high impedance loudspeaker it is not a good idea to substitute an 8 ohm unit unless you know exactly what you are doing.

In some cases a low impedance loudspeaker will work after a fashion, but with rather low efficiency. Also, there is a risk that the lower load impedance will cause an excessive output current to flow. A miniature 64 ohm loudspeaker is still available, and this is a better choice. It should work well enough in place of 25 ohm to 80 ohm units.

On the face of it, there is no problem in substituting a smaller loudspeaker than the one specified in the parts list. In most cases this is perfectly all right, but it is necessary to be slightly wary about power ratings.

Most of the really small loudspeakers have quite low power ratings. In some cases the rating is a mere 100 milliwatts, and many small output stages can supply substantially higher powers. It is unlikely that an excessive drive power would burn out the coil, but the audio quality would be very poor. There is also a slight risk of the loudspeaker literally tearing itself apart.

### Resonators

Ceramic resonators have largely replaced loudspeakers in simple audio alarm and alert applications. These are mostly cased (like the resonator on the right in Fig.5) and have provision for a couple of small mounting bolts. This makes them relatively easy to deal with, since no grille is required. A single small hole in the front of the case acts as the grille!

The correct way of mounting a cased resonator is to fit it on the rear surface of the front panel. This requires a large mounting hole to accommodate the body of the component, plus two small holes for the mounting bolts.

This method tends to be a bit awkward, because all sorts of odd diameters are needed for the main mounting hole. This hole has to be cut very accurately if the finished unit is to look reasonably neat.

A simpler method is to mount the resonator on the front surface of the panel. Three small mounting holes are then required. There are two holes for the mounting bolts and one to permit the connecting leads to pass through to the interior of the case. The resonator itself can be used as a sort of template when marking the positions of the three holes.

Most ceramic resonators have red and black insulation on the connecting leads, suggesting that the component is polarised and must be connected the right way round. The colours of the leads are presumably used as a means of indicating the phasing of the component, but this is not relevant in normal applications. The two leads can be connected either way round.

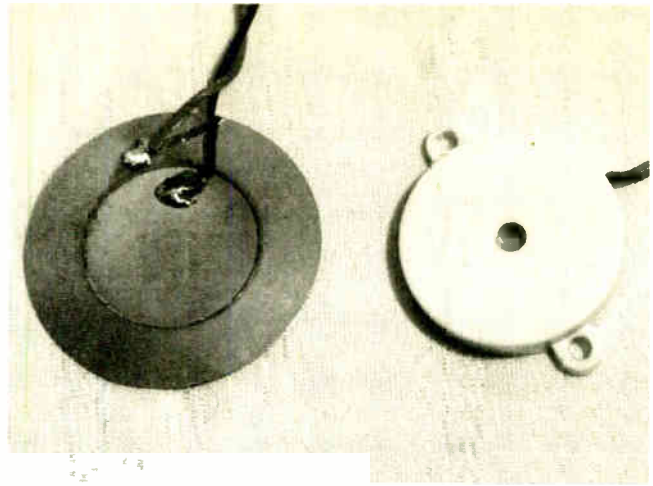

Fig.5. A ceramic resonator (left) and a cased resonator (right).

The mounting holes in the smaller resonators are often very small, making it difficult to obtain suitably small mounting bolts. A simple way around the problem is to carefully drill out the mounting holes to a slightly larger diameter. Take due care though, or the plastic casing might split.

Some projects use uncased resonators (as on the left in Fig.5), and these are mainly used where only low volume levels are sufficient. They are mostly just glued to the inside of the case, with the latter effectively acting as an extension to the resonator.

Most are now supplied with flying leads, but some require the constructor to connect a couple of leads. One connects to the inner disc and the other connects to the outer ring. Tin the two connection points with solder prior to making the connections and also tin the ends of the leads. Give the component time to cool between each application of the soldering iron, and try to complete the two connections as quickly as possible. This should ensure that the resonator does not become overheated.

### Meters

Most panel meters require a large cut-out to accommodate the rear section of the unit, and four small holes for the built-in mounting bolts. The retailer's catalogue usually provides drilling and cutting details. At about 38mm in diameter, the main cutout can be awkward unless a suitable hole cutting tool is available. If not, cut just inside the perimeter of the required hole using something like a coping saw or a miniature round file. Then enlarge the cutout to precisely the required size using a large round or half-round file.

Panel meters of the "cheap and cheerful" variety often require odd shaped main cutouts. These can be cut roughly to size using a coping saw, etc., and then carefully enlarged to the correct size and shape using a file.

Alternatively, drill a hole that just fits within the cutout, and then file this out to the correct size and shape. Some of these low-cost meters lack the built-in mounting bolts or any obvious means of fixing them to the panel. It's then time to reach for the glue again.



# EPE IS PLEASED TO BE ABLE TO OFFER YOU THESE ELECTRONICS CD-ROMS

## ELECTRONICS PROJECTS

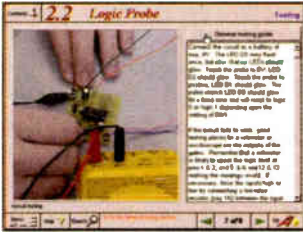

Logic Probe testing

*Electronic Projects* is split into two main sections: **Building Electronic Projects** contains comprehensive information about the components, tools and techniques used in developing projects from initial concept through to final circuit board production. Extensive use is made of video presentations showing soldering and construction techniques. The second section contains a set of ten projects for students to build, ranging from simple sensor circuits through to power amplifiers. A shareware version of Matrix's CADPACK schematic capture, circuit simulation and p.c.b. design software is included.

The projects on the CD-ROM are: Logic Probe; Light, Heat and Moisture Sensor; NE555 Timer; Egg Timer; Dice Machine; Bike Alarm; Stereo Mixer; Power Amplifier; Sound Activated Switch; Reaction Tester. Full parts lists, schematics and p.c.b. layouts are included on the CD-ROM.

## ELECTRONICS CAD PACK

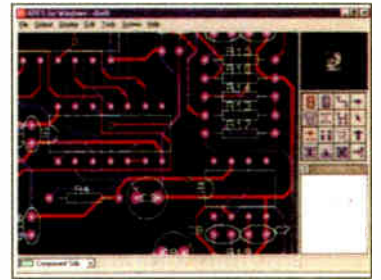

PCB Layout

Electronics CADPACK allows users to design complex circuit schematics, to view circuit animations using a unique SPICE-based simulation tool, and to design printed circuit boards. CADPACK is made up of three separate software modules. (These are restricted versions of the full Labcenter software.) **ISIS Lite** which provides full schematic drawing features including full control of drawing appearance, automatic wire routing, and over 6,000 parts. **PROSPICE Lite** (integrated into ISIS Lite) which uses unique animation to show the operation of any circuit with mouse-operated switches, pots, etc. The animation is compiled using a full mixed mode SPICE simulator. **ARES Lite** PCB layout software allows professional quality PCBs to be designed and includes advanced features such as 16-layer boards, SMT components, and an autorouter operating on user generated Net Lists.

## ELECTRONIC CIRCUITS & COMPONENTS V2.0

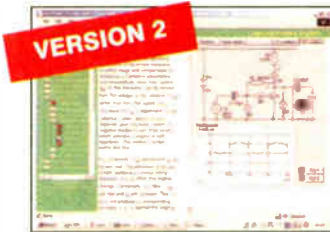

Circuit simulation screen

Provides an introduction to the principles and application of the most common types of electronic components and shows how they are used to form complete circuits. The virtual laboratories, worked examples and pre-designed circuits allow students to learn, experiment and check their understanding. Version 2 has been considerably expanded in almost every area following a review of major syllabuses (GCSE, GNVQ, A level and HNC). It also contains both European and American circuit symbols. Sections include: **Fundamentals:** units & multiples, electricity, electric circuits, alternating circuits. **Passive Components:** resistors, capacitors, inductors, transformers. **Semiconductors:** diodes, transistors, op.amps, logic gates. **Passive Circuits.** **Active Circuits.** **The Parts Gallery** will help students to recognise common electronic components and their corresponding symbols in circuit diagrams. Included in the Institutional Versions are multiple choice questions, exam style questions, fault finding virtual laboratories and investigations/worksheets.

## ANALOGUE ELECTRONICS

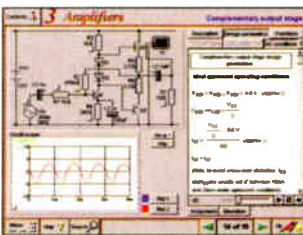

Complimentary output stage

*Analogue Electronics* is a complete learning resource for this most difficult branch of electronics. The CD-ROM includes a host of virtual laboratories, animations, diagrams, photographs and text as well as a SPICE electronic circuit simulator with over 50 pre-designed circuits.

Sections on the CD-ROM include: **Fundamentals** – Analogue Signals (5 sections), Transistors (4 sections), Waveshaping Circuits (6 sections). **Op.Amps** – 17 sections covering everything from Symbols and Signal Connections to Differentiators. **Amplifiers** – Single Stage Amplifiers (8 sections), Multi-stage Amplifiers (3 sections). **Filters** – Passive Filters (10 sections), Phase Shifting Networks (4 sections), Active Filters (6 sections). **Oscillators** – 6 sections from Positive Feedback to Crystal Oscillators. **Systems** – 12 sections from Audio Pre-Amplifiers to 8-Bit ADC plus a gallery showing representative p.c.b. photos.

## ROBOTICS & MECHATRONICS

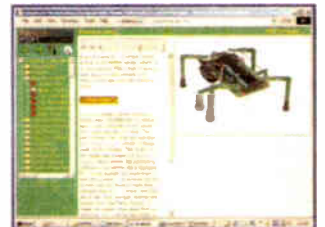

Case study of the Milford Instruments Spider

Robotics and Mechatronics is designed to enable hobbyists/students with little previous experience of electronics to design and build electromechanical systems. The CD-ROM deals with all aspects of robotics from the control systems used, the transducers available, motors/actuators and the circuits to drive them. Case study material (including the NASA Mars Rover, the Milford Spider and the Furby) is used to show how practical robotic systems are designed. The result is a highly stimulating resource that will make learning, and building robotics and mechatronic systems easier. The Institutional versions have additional worksheets and multiple choice questions.

- Interactive Virtual Laboratories
- Little previous knowledge required
- Mathematics is kept to a minimum and all calculations are explained
- Clear circuit simulations

## DIGITAL ELECTRONICS V2.0

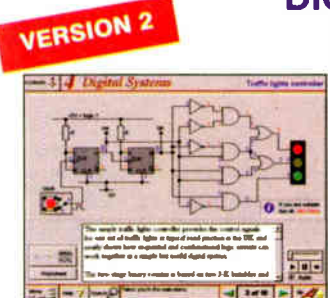

Virtual laboratory – Traffic Lights

*Digital Electronics* builds on the knowledge of logic gates covered in *Electronic Circuits & Components* (opposite), and takes users through the subject of digital electronics up to the operation and architecture of microprocessors. The virtual laboratories allow users to operate many circuits on screen.

Covers binary and hexadecimal numbering systems, ASCII, basic logic gates, monostable action and circuits, and bistables – including JK and D-type flip-flops. Multiple gate circuits, equivalent logic functions and specialised logic functions. Introduces sequential logic including clocks and clock circuitry, counters, binary coded decimal and shift registers. A/D and D/A converters, traffic light controllers, memories and microprocessors – architecture, bus systems and their arithmetic logic units. Sections on Boolean Logic and Venn diagrams, displays and chip types have been expanded in Version 2 and new sections include shift registers, digital fault finding, programmable logic controllers, and microcontrollers and microprocessors. The Institutional versions now also include several types of assessment for supervisors, including worksheets, multiple choice tests, fault finding exercises and examination questions.

## FILTERS

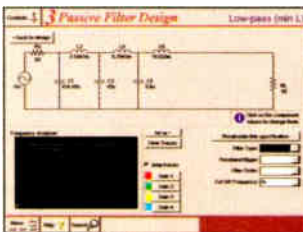

Filter synthesis

*Filters* is a complete course in designing active and passive filters that makes use of highly interactive virtual laboratories and simulations to explain how filters are designed. It is split into five chapters: **Revision** which provides underpinning knowledge required for those who need to design filters. **Filter Basics** which is a course in terminology and filter characterization, important classes of filter, filter order, filter impedance and impedance matching, and effects of different filter types. **Advanced Theory** which covers the use of filter tables, mathematics behind filter design, and an explanation of the design of active filters. **Passive Filter Design** which includes an expert system and filter synthesis tool for the design of low-pass, high-pass, band-pass, and band-stop Bessel, Butterworth and Chebyshev ladder filters. **Active Filter Design** which includes an expert system and filter synthesis tool for the design of low-pass, high-pass, band-pass, and band-stop Bessel, Butterworth and Chebyshev op.amp filters.

## PRICES

Prices for each of the CD-ROMs above are:

(Order form on third page)

Hobbyist/Student .....£45 inc VAT  
 Institutional (Schools/HE/FE/Industry).....£99 plus VAT  
 Institutional 10 user (Network Licence) .....£199 plus VAT  
 Site Licence.....£499 plus VAT

(UK and EU customers add VAT at 17.5% to "plus VAT" prices)



# PICmicro TUTORIALS AND PROGRAMMING

## HARDWARE

### VERSION 2 PICmicro MCU DEVELOPMENT BOARD

*Suitable for use with the three software packages listed below.*

This flexible development board allows students to learn both how to program PICmicro microcontrollers as well as program a range of 8, 18, 28 and 40-pin devices. For experienced programmers all programming software is included in the PPP utility that comes with the development board. For those who want to learn, choose one or all of the packages below to use with the Development Board.

- Makes it easier to develop PICmicro projects
- Supports low cost Flash-programmable PICmicro devices
- Fully featured integrated displays – 13 individual I.e.d.s, quad 7-segment display and alphanumeric I.c.d. display
- Supports PICmicro microcontrollers with A/D converters
- Fully protected expansion bus for project work
- All inputs and outputs available on screw terminal connectors for easy connection



**£145 including VAT and postage**

**12V 500mA plug-top PSU (UK plug) £7**

**25-way 'D' type connecting cable £5**

## SOFTWARE

*Suitable for use with the Development Board shown above.*

### ASSEMBLY FOR PICmicro V2 (Formerly PICtutor)

Assembly for PICmicro microcontrollers V2.0 (previously known as PICtutor) by John Becker contains a complete course in programming the PIC16F84 PICmicro microcontroller from Arizona Microchip. It starts with fundamental concepts and extends up to complex programs including watchdog timers, interrupts and sleep modes. The CD makes use of the latest simulation techniques which provide a superb tool for learning: the Virtual PICmicro microcontroller. This is a simulation tool that allows users to write and execute MPASM assembler code for the PIC16F84 microcontroller on-screen. Using this you can actually see what happens inside the PICmicro MCU as each instruction is executed which enhances understanding.

- Comprehensive instruction through 39 tutorial sections
- Includes Vlab, a Virtual PICmicro microcontroller: a fully functioning simulator
- Tests, exercises and projects covering a wide range of PICmicro MCU applications
- Includes MPLAB assembler
- Visual representation of a PICmicro showing architecture and functions
- Expert system for code entry helps first time users
- Shows data flow and fetch execute cycle and has challenges (washing machine, lift, crossroads etc.)
- Imports MPASM files.



Virtual PICmicro

### 'C' FOR PICmicro VERSION 2

The C for PICmicro microcontrollers CD-ROM is designed for students and professionals who need to learn how to program embedded microcontrollers in C. The CD contains a course as well as all the software tools needed to create Hex code for a wide range of PICmicro devices – including a full C compiler for a wide range of PICmicro devices.

Although the course focuses on the use of the PICmicro microcontrollers, this CD-ROM will provide a good grounding in C programming for any microcontroller.

- Complete course in C as well as C programming for PICmicro microcontrollers
- Highly interactive course
- Virtual C PICmicro improves understanding
- Includes a C compiler for a wide range of PICmicro devices
- Includes full Integrated Development Environment
- Includes MPLAB software
- Compatible with most PICmicro programmers
- Includes a compiler for all the PICmicro devices.

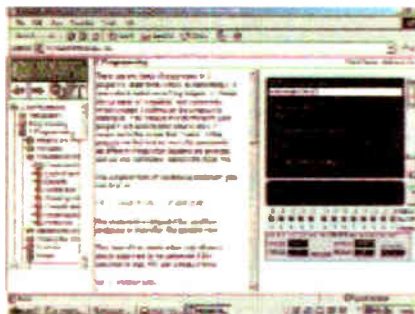

Minimum system requirements for these items: Pentium PC running Windows 98, NT, 2000, ME, XP; CD-ROM drive; 64MB RAM; 10MB hard disk space.

### FLOWCODE FOR PICmicro

Flowcode is a very high level language programming system for PICmicro microcontrollers based on flowcharts. Flowcode allows you to design and simulate complex robotics and control systems in a matter of minutes.

Flowcode is a powerful language that uses macros to facilitate the control of complex devices like 7-segment displays, motor controllers and I.c.d. displays. The use of macros allows you to control these electronic devices without getting bogged down in understanding the programming involved.

Flowcode produces MPASM code which is compatible with virtually all PICmicro programmers. When used in conjunction with the Version 2 development board this provides a seamless solution that allows you to program chips in minutes.

- Requires no programming experience
- Allows complex PICmicro applications to be designed quickly
- Uses international standard flow chart symbols (ISO5807)
- Full on-screen simulation allows debugging and speeds up the development process
- Facilitates learning via a full suite of demonstration tutorials
- Produces ASM code for a range of 8, 18, 28 and 40-pin devices
- Institutional versions include virtual systems (burglar alarms, car parks etc.).



Burglar Alarm Simulation

## PRICES

Prices for each of the CD-ROMs above are:

*(Order form on next page)*

*(UK and EU customers add VAT at 17.5% to "plus VAT" prices)*

Hobbyist/Student  
Institutional (Schools/HE/FE/Industry)  
Flowcode Institutional  
Institutional 10 user (Network Licence)  
Site Licence

£45 inc VAT  
£99 plus VAT  
£70 plus VAT  
£249 plus VAT  
£599 plus VAT



# TEACH-IN 2000 – LEARN ELECTRONICS WITH EPE

EPE's own *Teach-In* CD-ROM, contains the full 12-part *Teach-In* series by John Becker in PDF form plus the *Teach-In* interactive software covering all aspects of the series. We have also added Alan Winstanley's highly acclaimed *Basic Soldering Guide* which is fully illustrated and which also includes *Desoldering*. The *Teach-In* series covers: Colour Codes and Resistors, Capacitors, Potentiometers, Sensor Resistors, Ohm's Law, Diodes and L.E.D.s, Waveforms, Frequency and Time, Logic Gates, Binary and Hex Logic, Op.amps, Comparators, Mixers, Audio and Sensor Amplifiers, Transistors, Transformers and Rectifiers, Voltage Regulation, Integration, Differentiation, 7-segment Displays, L.C.D.s, Digital-to-Analogue.

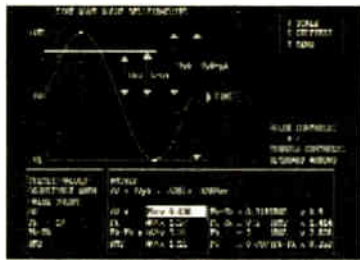

Sine wave relationship values

**FREE BOOK WITH TEACH-IN 2000 CD-ROM**

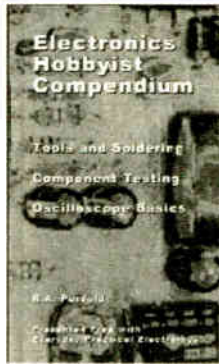

Each part has an associated practical section and the series includes a simple PC interface so you can use your PC as a basic oscilloscope with the various circuits. **A hands-on approach to electronics with numerous breadboard circuits to try out.**

**£12.45 including VAT and postage.** Requires Adobe Acrobat (available free from the Internet – [www.adobe.com/acrobat](http://www.adobe.com/acrobat)).

**FREE WITH EACH TEACH-IN CD-ROM – Electronics Hobbyist Compendium** 80-page book by Robert Penfold. Covers Tools For The Job; Component Testing; Oscilloscope Basics.

# DIGITAL WORKS 3.0

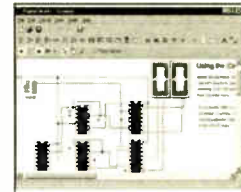

Counter project

*Digital Works Version 3.0* is a graphical design tool that enables you to construct digital logic circuits and analyze their behaviour. It is so simple to use that it will take you less than 10 minutes to make your first digital design. It is so powerful that you will never outgrow its capability • Software for simulating digital logic circuits • Create your own macros – highly scalable • Create your own circuits, components, and i.c.s • Easy-to-use digital interface • Animation brings circuits to life • Vast library of logic macros and 74 series i.c.s with data sheets • Powerful tool for designing and learning. **Hobbyist/Student £45 inc. VAT. Institutional £99 plus VAT. Institutional 10 user £199 plus VAT. Site Licence £499 plus VAT.**

## ELECTRONICS IN CONTROL

Two colourful animated courses for students on one CD-ROM. These cover Key Stage 3 and GCSE syllabuses. **Key Stage 3:** A pictorial look at the Electronics section featuring animations and video clips. Provides an ideal introduction or revision guide, including multi-choice questions with feedback. **GCSE:** Aimed at the Electronics in many Design & Technology courses, it covers many sections of GCSE Electronics. Provides an ideal revision guide with Homework Questions on each chapter. Worked answers with an access code are provided on a special website.

**Single User £29 inc. VAT. Multiple User £39 plus VAT**  
**Student copies (available only with a multiple user copy) £6 plus VAT**  
 (UK and EU customers add VAT at 17.5% to "plus VAT" prices)

## MODULAR CIRCUIT DESIGN

**VERSION 3**

Contains a range of tried and tested analogue and digital circuit modules, together with the knowledge to use and interface them. Thus allowing anyone with a basic understanding of circuit symbols to design and build their own projects. Version 3 includes data and circuit modules for a range of popular PICs; includes PICAXE circuits, the system which enables a PIC to be programmed without a programmer, and without removing it from the circuit. Shows where to obtain free software downloads to enable BASIC programming. Essential information for anyone undertaking GCSE or "A" level electronics or technology and for hobbyists who want to get to grips with project design. Over seventy different Input, Processor and Output modules are illustrated and fully described, together with detailed information on construction, fault finding and components, including circuit symbols, pinouts, power supplies, decoupling etc.

**Single User £19.95 inc. VAT. Multiple User £34 plus VAT**  
 (UK and EU customers add VAT at 17.5% to "plus VAT" prices)

## ELECTRONIC COMPONENTS PHOTOS

A high quality selection of over 200 JPG images of electronic components. This selection of high resolution photos can be used to enhance projects and presentations or to help with training and educational material. They are royalty free for use in commercial or personal printed projects, and can also be used royalty free in books, catalogues, magazine articles as well as worldwide web pages (subject to restrictions – see licence for full details).



Also contains a **FREE** 30-day evaluation of Paint Shop Pro 6 – Paint Shop Pro image editing tips and on-line help included!

**Price £19.95 inc. VAT**

Minimum system requirements for these CD-ROMs: Pentium PC, CD-ROM drive, 32MB RAM, 10MB hard disk space. Windows 95/98/NT/2000/ME/XP, mouse, sound card, web browser.

Please send me:

## CD-ROM ORDER FORM

- Electronic Projects
- Electronic Circuits & Components V2.0
- Analogue Electronics
- Digital Electronics V2.0
- Filters
- Electronics CAD Pack
- Robotics & Mechatronics
- Assembler for PICmicro
- 'C' for PICmicro
- Flowcode for PICmicro
- Digital Works 3.0

- Version required:
- Hobbyist/Student
  - Institutional
  - Institutional 10 user
  - Site licence



- PICmicro Development Board (hardware)
- Development Board UK plugtop power supply
- Development Board 25-way connecting lead

- Teach-In 2000 + FREE BOOK
- Electronic Components Photos
- Electronics In Control – Single User
- Electronics In Control – Multiple User
- Modular Circuit Design – Single User
- Modular Circuit Design – Multiple User

Note: The software on each version is the same, only the licence for use varies.

Full name: .....

Address: .....

Post code: ..... Tel. No: .....

Signature: .....

I enclose cheque/PO in £ sterling payable to WIMBORNE PUBLISHING LTD for £ .....

Please charge my Visa/Mastercard/Amex/Diners Club/Switch £ ..... Card expiry date: .....

Card No: ..... Switch Issue No. ....

Card Security Code ..... (The last 3 digits on or just under the signature strip)

## ORDERING

**ALL PRICES INCLUDE UK POSTAGE**

Student/Single User/Standard Version price includes postage to most countries in the world  
 EU residents outside the UK add £5 for airmail postage per order

**Institutional, Multiple User and Deluxe Versions** – overseas readers add £5 to the basic price of each order for airmail postage (do not add VAT unless you live in an EU (European Union) country, then add 17½% VAT or provide your official VAT registration number).

Send your order to:  
**Direct Book Service**

**Wimborne Publishing Ltd**  
 408 Wimborne Road East  
 Ferndown, Dorset BH22 9ND

To order by phone ring

**01202 873872. Fax: 01202 874562**

Goods are normally sent within seven days

E-mail: [orders@wimborne.co.uk](mailto:orders@wimborne.co.uk)

Online shop:

[www.epemag.wimborne.co.uk/shopdoor.htm](http://www.epemag.wimborne.co.uk/shopdoor.htm)

# New Technology Update

*Printed plastic transistors and organic I.e.d.s could provide true flexibility for display screens. Ian Poole reports.*

ONLY a relatively few years ago cathode ray tubes were the only viable option for large displays. Now there is a whole variety of different types of display that can be used. This can be seen by the fact that the new types of display are being used in high volumes. Laptop computers are an example of this, and flat screens are now being used for television screens, even though they are still expensive.

Although there have recently been many developments in display technology, new and interesting ideas for the future are appearing. When these ideas come to fruition they will enable displays that are far more flexible (literally) in their use and enable them to meet requirements that might not have been conceived only a year or two ago.

## Xerox Research

In one development, researchers at the Xerox Research Centre in Canada have developed a new stable inkjet printable conductive organic polymer suitable for printing circuits onto plastic substrates. This is the plastic equivalent of etching circuits on silicon wafers.

This provides the possibility of creating plastic transistors as an alternative to the silicon, germanium, and gallium arsenide ones that reign supreme today, providing the possibility of ushering in a whole new generation of products. These may include portable, poster-like television screens and monitors made of a single sheet of flexible plastic.

The new research was presented by Beng Ong, a research fellow from Xerox, at the Autumn meeting of the Materials Research Society that took place in Boston Massachusetts, USA at the beginning of December 2002. In the research, Ong said that the development process involved identifying the structural features that were responsible for the limitations in existing materials and then formulating new design rules to overcome the limitations. Finally the new materials were synthesised.

The new material that has been developed has some key properties. Like other materials that have been developed before this polymer can be used in what can be termed as the printing process to generate plastic circuits.

However, the key attribute that the new material possesses is that it is stable in air and does not oxidise. Most of the previously known semiconductor polymers tended to become unstable in the presence of oxygen, as a result the research team has concentrated on designing novel semiconductor polymers that are oxidation resistant. This is an essential

requirement if low cost manufacture is to be able to proceed.

In his presentation, Ong described both the design and the properties of his new material. It is one of the polythiophene family of organic polymers which offer significantly improved performance over the currently established ones. Additionally, the experimental organic semiconductor material developed by the group is a second generation smectic liquid crystal.

As a measure of the electron speed per unit electric field, the field effect transistor mobility was measured and figures were found to be up to 0.12 square centimetres per volt second. This is around an order of magnitude greater than any other polymer materials that have been measured using the same device architecture.

A further measure of the effectiveness of the semiconductor material is the value of the on-off ratio. This has been found to be within the range 106 to 107 to 1, an enormous value. Also the devices containing the material exhibit little bias stress, hysteresis of instability in air. In fact the combination of the two areas of development has enabled this remarkable result to be achieved.

## Transistors

Although plastic transistors do not have the performance or the sub-micron sizes of their silicon counterparts, they are still more than adequate for use in many applications such as large area displays for use in television screens, electronic paper and many more. The transistors still require further development before they can enter production, but it is anticipated that this should occur in the next three to five years.

At this point it is likely that many new applications will be seen, and ideas that are currently being thought of include radio frequency identification tags for product security and stock control, and they could also be used in electronic smart cards.

Eventually Xerox see that some new and revolutionary applications might include roll-up television screens or electronic paper that could be used to display data, but be handled in exactly the same way as today's conventional paper.

## Manufacture

One of the major factors determining the success or failure is the manufacturing cost associated with it. High manufacturing costs will result in the development only being applicable to a small specialist market. However if costs are low, and particularly if they are lower than existing equivalent processes then

the new development is likely to have a very good chance of succeeding.

Conventional silicon semiconductor fabrication technology is both sophisticated and capital intensive. Other forms of conventional semiconductor fabrication are even more costly. They all use high temperature vacuum systems and complex and exacting photolithographic processes combined with ultra-clean environments.

In contrast the new process is very much lower cost. It uses simple low cost patterning techniques instead of the photolithography. The process also uses solvent processable organic or polymer materials and this enables common printing processes to be used under ambient conditions.

In fact, fabrication of plastic transistor circuits using an ink jet type printer enables them to be produced using a low waste process with a direct write capability and this leads to high manufacturing productivity. As a result of these advantages plastic transistors will be much cheaper to produce than conventional transistors. Currently silicon semiconductor technology costs around \$10,000 a square metre to produce. The new plastic transistors will be only a small fraction of this.

Whilst they will not be able to offer the high transistor densities of silicon semiconductors, they will nevertheless find many new applications in view of their cost, low weight, and their true flexibility – it will actually be possible to bend them.

## Other Interest and Possibilities

Whilst the printed organic transistors are able to provide considerable improvements in display electronics, they themselves are not able to emit light. However one of the developments that Xerox are talking about for the future is printed organic light emitting diodes. These would enable complete printed displays to be made. These displays would undoubtedly be very cheap to produce.

This is likely to be very successful because liquid crystal displays used today are very expensive. Even though these displays do not require the high performance of many of the fastest semiconductor i.c.s they still require the expensive production techniques. This makes them very costly – a factor that can be seen very easily when looking at the cost of large liquid crystal displays.

Beyond this there are several other possible applications. These include their use in Xerox's colour toners, and they might also be applicable in some areas of biotechnology and for personal care applications



# Measure pH, Voltage, Humidity, Sound & Light, on your PC!

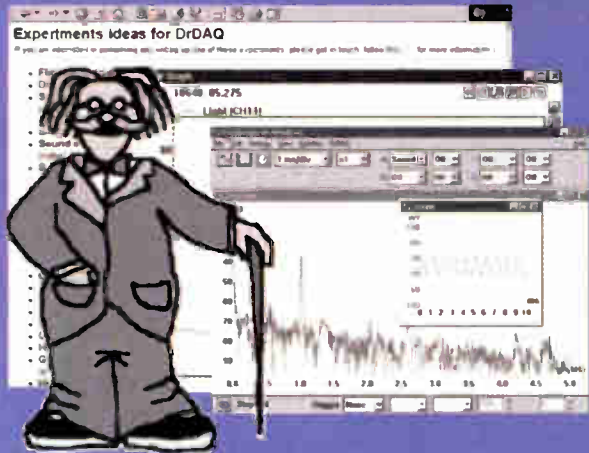

- ✓ Very low cost
- ✓ Built in sensors for light, sound (level and waveforms) and temperature
- ✓ Use DrDAQ to capture fast signals (eg sound waveforms)
- ✓ Outputs for control experiments
- ✓ Supplied with both PicoScope (oscilloscope) and PicoLog (data logging) software

**Only £59!**  
+ VAT

The DrDAQ is a low cost data logger from Pico Technology. It is supplied ready to use with all cables, software and example science experiments.

**DrDAQ represents a breakthrough in data logging.** Simply plug DrDAQ into any Windows PC, run the supplied software and you are ready to collect and display data. DrDAQ draws its power from the parallel port, so no batteries or power supplies are required.

As well as the built in sensors, DrDAQ has two sockets for external sensors. When a sensor is plugged in, the software detects it and automatically scales readings. For example, if a temperature sensor is plugged in, readings are displayed in °C. Details are provided to allow users to develop their own sensors.



To order the DrDAQ please choose one of the following options:

- i) Visit our web site and place an order over the Internet,
- ii) Place an order over the phone by ringing the number below, or,
- iii) Fill out the order form and either fax it, or post it back to Pico Technology.

DrDAQ Order Form:			
Quantity	Package	Price inc VAT	Total
	DrDAQ + Software	£69.32	
	DrDAQ + 2 Temp Sensors	£92.85	
	DrDAQ + 2 Temp, pH Electrode, Humidity + Reed Switch Sensors	£175.08	
	Delivery	£4.11	£4.11
	Grand Total	£	

Name			
Address			
Post code			
Phone			
Credit Card	Visa / Mastercard / Switch / Amex		
Card Number			
Expiry Date	/	Start Date & or Issue No.	
Cheque with order	<input type="checkbox"/>		

Pico Technology Ltd, The Mill House, Cambridge Street, St Neots, Cambridgeshire. PE19 1QB  
Tel: 01480 396395, Fax: 01480 396296, E-mail: post@picotech.com, Web: www.drdaq.com

# INGENUITY UNLIMITED



Our regular round-up of readers' own circuits. We pay between £10 and £50 for all material published, depending on length and technical merit. We're looking for novel applications and circuit designs, not simply mechanical, electrical or software ideas. Ideas *must be the reader's own work and must not have been submitted for publication elsewhere*. The circuits shown have NOT been proven by us. *Ingenuity Unlimited* is open to ALL abilities, but items for consideration in this column should be typed or word-processed, with a brief circuit description (between 100 and 500 words maximum) and full circuit diagram showing all relevant component values. **Please draw all circuit schematics as clearly as possible.** Send your circuit ideas to: *Ingenuity Unlimited*, Wimborne Publishing Ltd., 408 Wimborne Road East, Ferndown Dorset BH22 9ND. (We do not accept submissions for *IU* via E-mail.) Your ideas could earn you some cash and a prize!



## WIN A PICO PC BASED OSCILLOSCOPE WORTH £586

- 100MS/s Dual Channel Storage Oscilloscope
- 50MHz Spectrum Analyser
- Multimeter • Frequency Meter
- Signal Generator

If you have a novel circuit idea which would be of use to other readers then a Pico Technology PC based oscilloscope could be yours. Every 12 months, Pico Technology will be awarding an ADC200-100 digital storage oscilloscope for the best IU submission. In addition, a DrDAQ Data Logger/Scope worth £69 will be presented to the runner up.

## Random Doorbell – Pieces of Eight

**T**HE Random Doorbell circuit diagram shown in Fig.1 plays about 17 million tunes, thus employing about one component for every one million tunes played! Low frequency oscillators IC1a to IC1c provide eight possible combinations of notes, while timer IC1d plays a sequence of about eight notes every time pushbutton switch S1 is pressed – resulting in 8<sup>8</sup> tunes. (There are bound to be some world hits in there!)

The circuit is based on a HEX Schmitt inverter IC1. Four inverters are wired as RC oscillators, with three of these (IC1a to IC1c) modulating the fourth (IC1e). Gate IC1d provides a timer, which plays a sequence of about eight notes, while the remaining inverter (IC1f) isolates the piezo transducer WD1 from the carefully balanced circuit.

### On Balance

The circuit strikes a balance between playing too many notes at too fast a tempo (which would approach “white noise”) and playing too few notes at too slow a tempo (which would tend towards monotony). This balance is fixed by resistors R2 to R4. Presets VR1 to VR3, with correct adjustment, ensure that all of the notes are played in tune. These may be used to select major or minor scales, arpeggios, or any other such combination of notes.

Switch S1 may be replaced with a tilt switch or a lever-operated microswitch for various applications. Inset diagram Fig.2 shows how the sound may be amplified to a level that should be hard to ignore. Note that since the circuit is carefully balanced, only the HEF40106BP (Philips) should be used for IC1, and the supply voltage and component values should not at first be altered.

### On Call

The author built a unit for friends, who claimed that they often didn't hear a multi-tune doorbell they had, since they had grown accustomed to the sound. Since the installation of the Random Doorbell, they said, they had not missed it once. As the circuit plays continuously in the background (that is, without being heard) so that when the pushbutton is pressed, a small slice of its continual

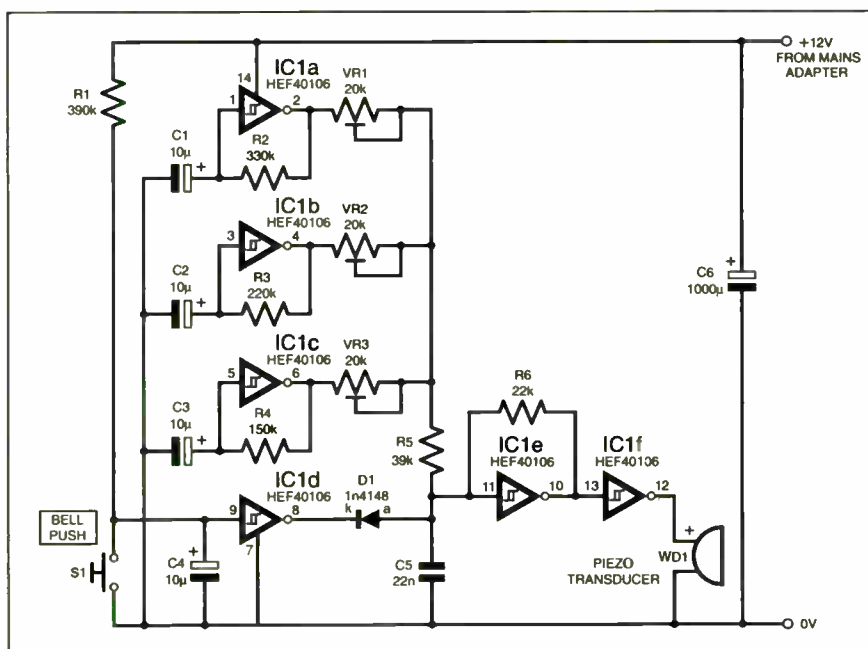

Fig.1. Circuit diagram for the Random Doorbell.

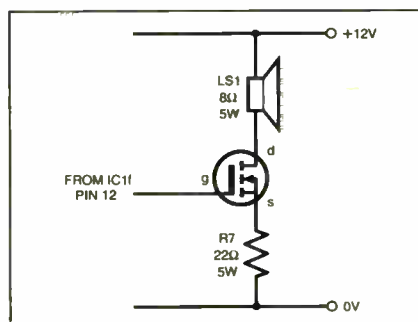

Fig.2. Adding a simple MOSFET amplifier stage.

activity is played out loud, for this reason the use of a mains adapter is advisable.

Rev. Thomas Scarborough, South Africa.

**WHY NOT SEND US YOUR CIRCUIT IDEA? Earn some extra cash and possibly a prize!**





# Headphone Amplifier – Pushbutton Control

**A** DESIRE to listen to music late at night, and a hi-fi amplifier with no headphone output, prompted the design of the Headphone Amplifier circuit shown in Fig.2. It is intended to deliver 100mW into 32 ohms when driven by line-level signals (1V peak); this allows musical peaks, and dips in the headphone impedance, to be handled without clipping, but most headphones will produce adequate volume levels with a few milliwatts. The circuit diagram shows a single audio channel, components marked with an asterisk (\*) are duplicated for the second channel.

The power amplifier is of a conventional design, with voltage gain given by  $(1 + R6/R7)$ . IC3 is a dual NE5532 op.amp with excellent noise and distortion performance, but it cannot drive headphones directly, so a discrete output stage built around transistors

TR2 and TR3 is added. Current source TR1, resistors R8 to R10, and diodes D6, D7 provide stable biasing for the output transistors. These do not require heatsinks, and the presence of diodes D6 and D7 minimises the effect of ambient temperature on the quiescent current.

A pushbutton volume control system is implemented using IC2, which is a DS1666-10 digital potentiometer (available from RS Components) that simulates a single-gang, low law 10k pot. The DS1666 was chosen because it has a simple control interface, and also because it has a  $V_{BIAS}$  pin (12) that can be held at a negative voltage so that analogue signals of either polarity can be controlled.

The chip's "wiper" (VW) can be "moved" between the VH and VL terminals (pins 10 and 9). The CS input pin 4 must be held low in order to vary the setting. Then, a pulse at the INC input (pin 3) moves VW by one step: towards VH if the U/D input pin 2 is high, and towards VL if U/D is low. An oscillator

based on Schmitt trigger IC1b provides the clock pulses.

When one of the non-latching switches S1 or S2 are closed, the CS input is pulled low after a debouncing delay determined by R4 and C2, the U/D input is held at the appropriate logical level by D3 and/or R3, and clock pulses are gated to the INC pin via IC1a, to increase or decrease the volume.

To avoid the bulk and stray fields of a transformer in the enclosure, the amplifier was powered by a separate plug-in 12V mains adapter. Designing with op.amps is simpler with symmetrical supplies, so after pre-regulation by TR4, a negative rail was generated by two ICL7660SCPA d.c.-d.c. converters IC4 and IC5 connected in parallel to reduce output impedance, with final regulation provided by a couple of three-terminal regulators, IC6 and IC7. Light-emitting diode D10 provides a power-on indication.

*Mike Toohy,  
Manchester.*

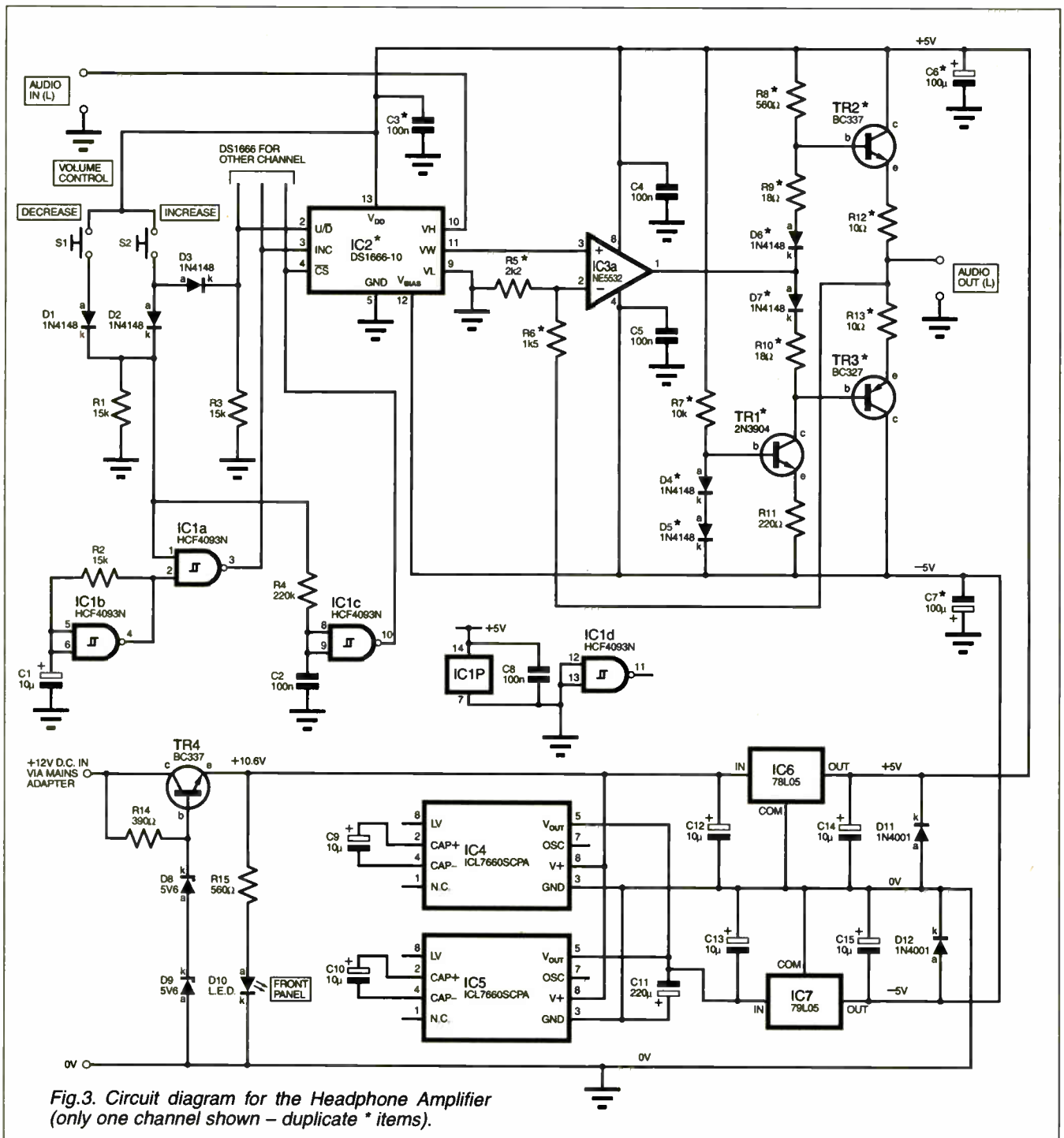

Fig.3. Circuit diagram for the Headphone Amplifier (only one channel shown – duplicate \* items).

## Low Battery Indicator – Low-glow

A SIMPLE add-on circuit that can be connected to most occasionally used 9V battery-powered equipment to give a low battery warning is shown in Fig.4. It is simply connected to the circuit so that it is powered up when the main circuit is turned on.

With a new battery, the l.e.d. D1 should light briefly. This period will get progressively longer until the l.e.d. fails to extinguish, which shows that the battery needs replacement.

The circuit therefore doubles as a power-on indication to show that there is a battery fitted. It also has advantages over many other similar designs as it only lights the l.e.d. briefly when the battery is good but gives a permanent warning of a bad battery, and it does not place a large current burden on the battery either.

Resistors R1 and R2 make up a voltage divider, which needs to be set so that the output is just under 0.6V when the battery needs replacement (i.e. it is greater than 0.6V for a good battery). This is used to charge the capacitor C1 and is fed into the base of transistor TR1. When the base goes above 0.6V, TR1 conducts and takes the base of TR2, which is normally held high by resistor R3, low. This therefore turns off the l.e.d. that is connected to TR2.

The circuit may be modified for other battery voltages. Adjust the value of R2 to change the final battery voltage and change C1 to change the time delay. The transistors are not critical and may be substituted for alternatives, but an  $h_{FE}$  of 150 or greater is essential.

The l.e.d. current of about 10mA gives a good indication of the battery status. A high efficiency l.e.d. could be used.

Lyn Jones,  
Abergavenny,  
Gwent.

Fig.4. Circuit diagram for a simple add-on Low Battery Indicator.

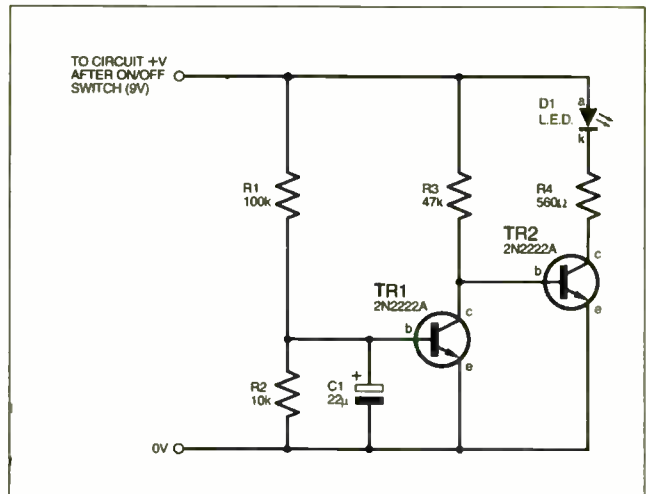

## PICO PRIZE WINNERS

It's time to decide the lucky winners of superb PC-based Oscilloscopes, generously donated to *Everyday Practical Electronics* by Pico Technology, to whom we extend our appreciation for sponsoring the column once again. There is more information about Pico's range of PC-based test equipment by visiting their web site at <http://www.picotech.com>, or see their advertisement elsewhere in this issue.

EPE Editor Mike Kenward and host Alan Winstanley considered all *Ingenuity Unlimited* entries published over the last twelve months, and the lucky prizewinners were finalised as follows:

**Winner** – receives a superb Pico ADC200-10 Digital Storage Oscilloscope worth £586. *Fluid Finder* by Rev. Thomas Scarborough, Fresnaye, South Africa (EPE December 2002).

**Runner-Up** – a Pico DrDAQ Data Logger/Scope worth £69. *Single-Cylinder Ignition* by Damien Maguire, Greystones, Ireland (EPE February 2003).

## SHOP TALK

with David Barrington

### Wind-Up Torch Mk II

After testing various motors for the *Wind-up Torch Mk II* project, the author settled for a 12V four-phase unipolar stepper motor. This was salvaged from an old 5¼in. disk drive – they can also be found in fax machines and printers.

Brand new motors can prove expensive, so constructors might like to look for an "almost-new" cast-off motor from one of our component advertisers. You are on your own on this one! One word of warning, not all "steppers" will live up to the recommended 5W minimum power consumption laid down by the designer.

A small problem came up when we researched a source for IC1, the LP2950CZ linear, low-dropout, voltage regulator, as there seems to be some confusion as to whether it is being discontinued by the supplier, RS Components. However, we appear to have a choice of three: the LP2950CZ-5.0, code 648-567 (used in model); LP2950ACZ-5, code 411-826 and LM2931AZ-5.0, code 177-3759. The LP2950CZ-3.3 for IC2 is coded 177-3771. With both IC1 and IC2, equivalents should work, on condition that they are micro-power regulators and ideally in a TO92 package.

The HEX inverter, with Schmitt trigger, type CD4016BCN, also came from the above mentioned company, code 345-5324. Although the author recommends the CD version for IC3, other 4016 i.c.s should work in this circuit.

You can order RS components through any *bona-fide* stockists, including some of our advertisers. Alternatively, you can order direct (credit card only) from RS on ☎ 01536 444079 or on the web at [rswww.com](http://rswww.com). A post and packing charge will be made.

The 0.22F miniature, vertical p.c.b. mounting, memory back-up capacitor is from the RS SD gold series and carries the stock code 377-372. We understand virtually any high intensity white l.e.d. should work in this circuit. After much searching, we have discovered that Knightlight (email: [dpotter@knightlight.co.uk](mailto:dpotter@knightlight.co.uk), web: [www.knightlight.co.uk](http://www.knightlight.co.uk) or fax 023 9243 9103) are able to supply a 6800mcd ultrabright white l.e.d. for the sum of £1.50 each, plus 50p (UK only) p&p. Quote code YZ-WB5S20Y. Cheques payable to Knightlight. Also try Solar Energy Alliance (☎ 01502 51532 or [www.solarenergyalliance.com](http://www.solarenergyalliance.com)) for their Superbright 6800mcd (code SBW01 £1.99) and Hyperbright 7000mcd (code HBW01 £2.29) white l.e.d.s. Add 50p (UK only) p&p.

The small printed circuit board is obtainable from the EPE PCB Service, code 386 (see page 227). Finally, before wiring up the 2-pole 3-way slider type switch, check the contact arrangement as it may differ from the author's.

### 200kHz Function Generator

We have found only a single listing for the Elantec high speed, low power, op.amp type EL2045CN used in the *200kHz Function Generator* project. This

was from RS Components, code 112-383. Any *bona-fide* RS stockist will be able to order it for you. You can, if you wish, order direct (mail order) from them on ☎ 01536 444079 or on the web at [rswww.com](http://rswww.com). A post and handling charge will be made. The TL071 op.amp has been used in the unit, but with a reduced performance. You could possibly use the EL2044 device, but this has not been tried in the prototype.

Polystyrene capacitors seem to be disappearing from component shelves, particularly in the higher values (22nF) one per cent types, and they also tend to be fairly expensive, so you will need to shop around for "best price". It may even be easier to go for polyester types as they are widely stocked and tend to be a bit cheaper.

The 8038 waveform/function generator chip is very common now and most of our components advertisers should be able to supply. As the mains transformer is mounted off-board, almost any miniature chassis-mounting type with a 15V-0V-15V 100mA rated secondary winding should be able to handle this circuit's requirements. The printed circuit board is available from the EPE PCB Service, code 385 (see page 227).

### Driver Alert

Most of the parts for the *Driver Alert* project came from Rapid Electronics (☎ 01206 751166 or [www.rapidelectronics.co.uk](http://www.rapidelectronics.co.uk)). If you wish to use the same handheld case, with battery compartment and display window cutout, this is coded 30-2474. The separate AA cell clips are coded 30-2464 and a tilting foot is 30-2480.

The 7-segment, common cathode dual display is a Kingbright DC56-11SRWA "super red" device, Rapid code 57-0139. Pinout connections run along the top and bottom of the display package. If you want to use identical low-profile pushbutton switches, these are coded 78-1520.

A programmed PIC16F627 microcontroller can be purchased (mail order only) from M. P. Horsey, Electronics Dept, Radley College, Abingdon, Oxon, OX14 2HR, for the inclusive sum of £5.90 each (overseas add £1 p&p). Make cheques payable to Radley College.

The software is available on a 3.5in. PC-compatible disk (EPE Disc 6) from the EPE Editorial Office for the sum of £3 each (UK), to cover admin costs (for overseas charges see page 227). It is also available for free download from the EPE ftp site.

The printed circuit board is available from the EPE PCB Service, code 387.

### Back To Basics 2 – Metal Detector/Simple Timer

Some constructors may experience a small problem in finding the miniature 100µH radial inductor used in the Metal Detector, one of this month's *Back To Basics Pt 2* projects. The rest of the components for both the *Metal Detector* and the *Simple Timer* look as though they are all "off-the-shelf" items.

The author's inductor came from his "spares box" and we are not sure of its origin, it appears to be a Toko device. We have found two possible inductors that you can use, one from Maplin (☎ 0870 264 6000 or [www.maplin.co.uk](http://www.maplin.co.uk)) code AH32K, and the other from RS, code 250-264. For details of ordering the latter device, see earlier comments.



# BACK TO BASICS



## BART TREPAK

## Part Two

*Illustrating how useful circuits can be designed simply using transistors.*

# METAL DETECTOR

**M**ETAL detectors were first employed by the military for use in mine clearance, but are now used in less warlike applications, such as DIY to find buried pipes and nails, or finding buried treasure. The device to be described here is intended for the first of these (DIY, not mine clearance!) and can detect a small nail at a distance of about one centimetre, and larger objects such as pipes about 3cm from the sensor.

There are many ways to detect the presence of metals and virtually all of them depend on the metal object changing some parameter of an inductor, which the circuit then detects and produces an audible output. The inductor normally forms part of a tuned circuit oscillator and the resulting change alters the frequency or amplitude of the oscillation. To understand the circuit, we must therefore understand tuned circuits and how oscillators work.

## TUNED CIRCUITS

A tuned circuit basically consists of a capacitor and an inductor connected in parallel, as shown in Fig.12. A capacitor stores energy in the form of an electric charge which manifests itself as a voltage differential across the capacitor. An inductor, on the other hand, stores energy in the form of a magnetic field due to the current flowing in the coil.

When a charged capacitor is connected to an inductor as in Fig.12, the capacitor will discharge into the inductor, causing the energy to be transferred to it. In other

words, the voltage on the capacitor will be changed into a current in the inductor. As this current decays, a voltage will be generated which will recharge the capacitor with the opposite polarity. When it is so charged, it will discharge again into the inductor causing an oscillation in the voltage and current in the circuit as shown.

Of course, this cannot and does not go on indefinitely. There is a loss of energy with each charge and discharge cycle and so the process eventually ends. This is illustrated by the waveform in Fig.12.

## PUSHING SWINGS

The process can be likened to a child's swing, where supplying an initial push will cause the swing to oscillate between its two extremes. At the top of the swing, the energy will be *potential* energy and this will be converted to *kinetic* energy as the swing falls back again, reaching a maximum at the bottom of its excursion before climbing to the other peak, converting back to potential energy again.

For as long as there is energy available this will continue, but because of losses in the system (air resistance, friction, gravity etc.) the size of each successive excursion will be reduced until the swing eventually comes to rest. The same is true with the electrical equivalent where resistance in the circuit and losses in the dielectric and the inductor core will cause the oscillations to decay.

Just as the frequency of the swing is determined solely by its length and mass, and not the initial push, so the frequency

of the oscillation in the electrical circuit depends only on the value of the inductance and capacitance.

The circuit has its own natural frequency to which it is said to be tuned and this can be altered by changing the value of either the capacitor or the inductor. The rate at which the oscillation decays depends on the losses in the circuit, which occur mainly in the inductor.

To keep the swing going, it is necessary to give it a little push every now and again to replace the losses. This is also true in the electrical circuit where the current will be smaller in each successive oscillation cycle.

The trick, as every parent and child knows, is to apply a push of sufficient force at precisely the correct time when the swing is moving in the right direction. Otherwise, instead of the swing amplitude being increased, it will be reduced further.

In an electronic circuit, a transistor can be used to replace the losses but since a transistor can only conduct in one direction, it is essential that it switches on when the current in the tuned circuit is flowing in the same direction as the transistor can conduct. For the rest of the time it must remain off so that it will not add to the losses of the tuned circuit and stop it oscillating.

## OSCILLATORS

There are a number of ways of doing this, but they are mostly variations on two themes and use either a tap on the inductive or on the capacitive arm of the tuned

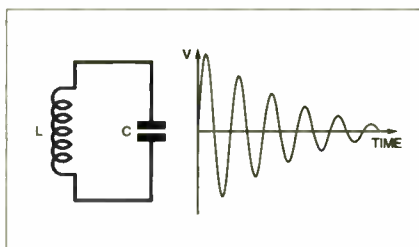

Fig.12. "Ringing" in a tuned circuit as the charge decays.

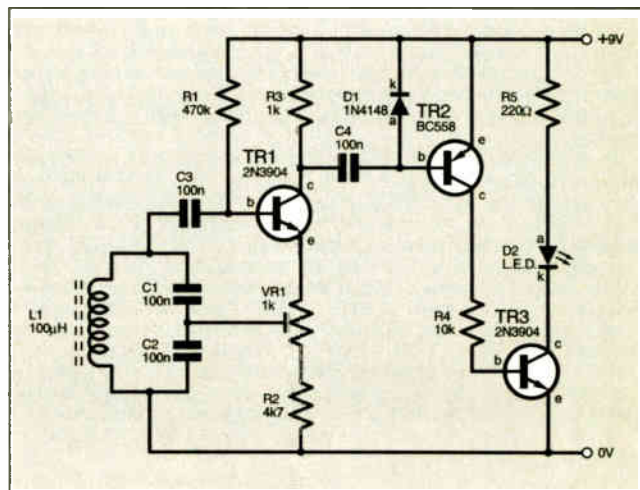

Fig.13. Metal Detector circuit diagram.

# COMPONENTS

## Resistors

R1	470k
R2	4k7
R3	1k
R4	10k
R5	220Ω

All 0.25W 5% carbon film

## Potentiometer

VR1	1k skeleton preset
-----	--------------------

## Capacitors

C1 to C4	100n ceramic disc, 5mm pitch (4 off)
----------	--------------------------------------

## Semiconductors

D1	1N4148 signal diode
D2	red i.e.d.
TR1, TR3	2N3904 npn transistor (2 off)
TR2	BC558 pnp transistor

## Miscellaneous

L1 100μH Inductor, radial leads  
Stripboard, 17 holes x 9 strips; PP3 battery and clip; case to suit; connecting wire; solder, etc.

Approx. Cost  
Guidance Only

**£5**

excl. case and battery

See  
**SHOP  
TALK**  
page

circuit to provide a small signal to cue the transistor to switch on at the correct time.

Winding inductors with a tap is more difficult than winding one without and since ready-wound inductors without a tap are widely available, the second version has been chosen. This is simply formed by replacing the single tuning capacitor by two series-connected capacitors where their junction forms the required tap.

This type of oscillator is known as a Colpitts oscillator and is shown built around transistor TR1 in Fig.13. (Incidentally, the version with a tapped inductor is known as a Hartley oscillator.) The tuned circuit consists of inductor L1 and the two series connected capacitors C1 and C2. It is coupled to the transistor's base circuit by capacitor C3 to avoid upsetting the transistor's d.c. bias, which is provided via resistor R1.

Positive feedback from the emitter is applied to the capacitive tap via VR1, which allows control of the amount of feedback. Note that positive feedback (i.e. in phase with the signal) is required to make the circuit oscillate. This contrasts with the negative feedback (discussed and used in Part 1) where the feedback signal is out of phase with the incoming signal).

This circuit produces a sinewave signal with a frequency determined by the values

of inductor L1 and capacitors C1 and C2. When a metal object is introduced into the vicinity of L1, its inductance changes and so do the losses in its core. Effectively, the latter now consists of the inductor's ferrite core material, which is designed to have a low loss, and the metal object, which will not be so good.

This results in a change in the frequency and also a change in the amplitude of the oscillation. Either of these can be detected and used to indicate the presence of a metal object. The changes in frequency are normally very small and special techniques have to be used to detect them, but the amplitude is much easier to work on and can be made to give an unambiguous signal on a light emitting diode (l.e.d.).

## DETECTION

To make the amplitude of the oscillation easier to determine, the signal output at the collector of TR1 is first a.c. coupled by capacitor C4 and then half-wave rectified by the diode D1. A sufficiently high oscillation amplitude causes transistor TR2 to turn on, providing sufficient current via resistor R4 to TR3 so that it then conducts, causing l.e.d. D2 to be turned on.

By adjusting the positive feedback via preset VR1, sensitivity of the circuit can be set so that it will cease oscillating when in close proximity to a piece of metal, so causing the l.e.d. to be turned off.

Ideally, VR1 should be set at the very minimum position where the circuit just oscillates and the oscillation amplitude therefore progressively reduces as the coil approaches the metal. This would cause the l.e.d. brightness to reduce as the circuit approaches the metal.

In practice, the circuit response should not be made too sensitive since temperature changes could adversely affect the oscillator, resulting in the circuit failing to restart when moved away from the metal object.

In use, when the inductor is passed over a wall or piece of wood, the l.e.d. will normally be on. However, if the coil comes into close proximity to a nail or

screw head, the l.e.d. will turn off, giving an indication of the presence of metal in the material.

The small size of the coil specified enables the position to be closely pinpointed. Larger objects such as pipes in walls will give an indication when they are further away or buried deeper in the wall.

## CONSTRUCTION

The circuit is constructed on a small piece of stripboard having 9 strips by 17 holes. The component layout and track cutting details are shown in Fig.14. Pay particular attention to the orientation of the transistors and diodes. Note that resistor R2 and diode D1 are mounted vertically on the board.

When the circuit has been assembled and checked, a 9V battery should be connected and VR1 adjusted so that the l.e.d. just lights when there are no metal objects in close proximity to L1. Bringing L1 close to a nail or other metal object should cause the l.e.d. to be turned off and no further adjustment of VR1 should be necessary.

The completed unit including the battery can be mounted in a small plastic case with the position of L1 marked externally to aid in determining the position of the hidden nails. Alternatively, the coil could be mounted outside and the leads passed into the box through two small holes drilled at the correct pitch.

The battery, which is normally metal cased, should be kept away from the coil. An on/off switch should also be connected in series with the positive battery lead if a case is used.

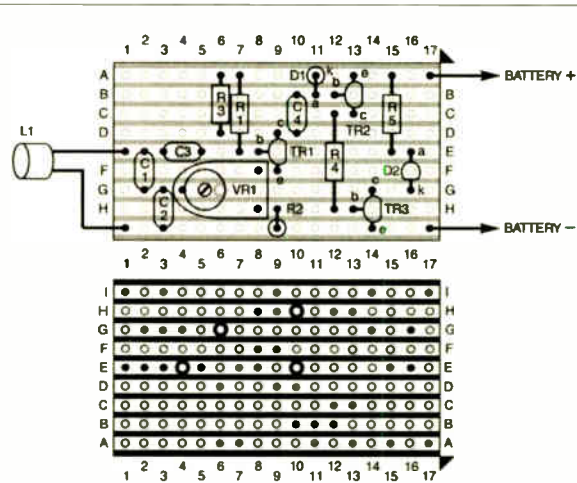
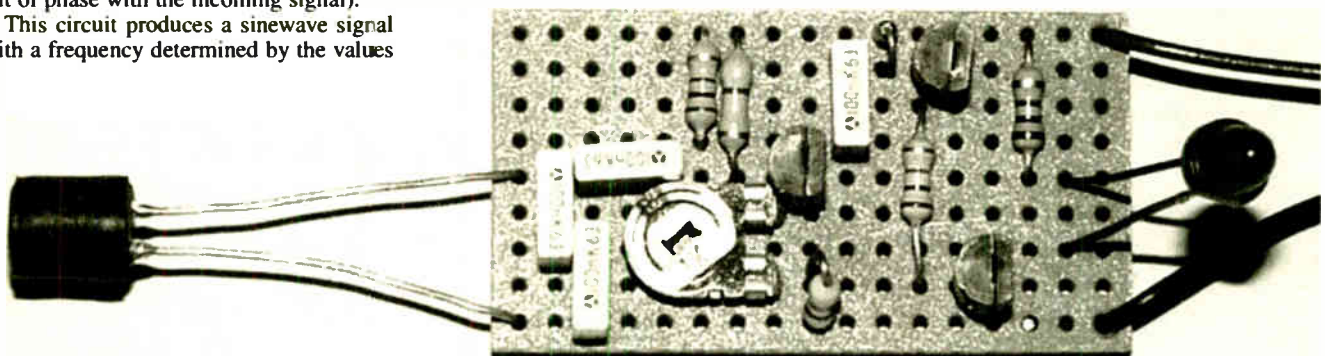

Fig.14. Metal Detector stripboard component layout and details of copper track breaks.





# SIMPLE TIMER

**N**OWADAYS, timers normally consist of digital circuits driving liquid crystal displays (l.c.d.s) that not only show how the time is passing, but also enable the user to set the time required accurately using the display.

A stable high frequency crystal oscillator is used as a timebase and pulses from this are counted to determine when the selected number of seconds, minutes or even hours have passed. Indeed using these techniques and a large enough counter, time delays of days, months or even years can be accurately achieved.

There are, however, many applications, such as timing how long your breakfast eggs need to boil, or your tea to brew to achieve perfection, which do not require such long delays or indeed such accuracy and these can be achieved in a much simpler manner. A capacitor can be charged by connecting it to a battery and by limiting the charging current by means of a resistor, the time taken to charge it up can be increased to obtain the delay required.

## DELAY

When a capacitor is charged through a resistor, the initial charging current is determined by the supply voltage and the value of the resistor. As the capacitor charges, the voltage across it will rise while the voltage across the resistor will fall. The charging current will therefore fall as the capacitor charges, resulting in the characteristic exponential curve of capacitor voltage against time, shown in Fig.15.

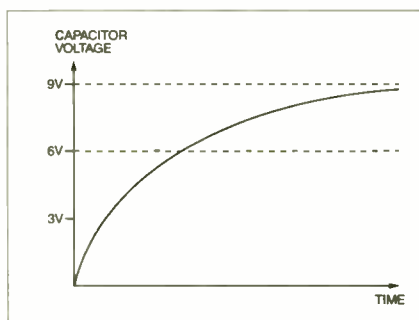

Fig.15. Capacitor charging through a resistor.

The voltage across the capacitor rises quickly at first but then the rate of rise slows. As the capacitor voltage approaches the supply, it changes more slowly. It is therefore difficult to determine when the capacitor has become fully charged.

For this reason, when using this configuration in a timer, it is best to decide on some other arbitrary voltage level and say that when the voltage across the capacitor reaches that level, the timing period has elapsed.

Clearly, it is best to choose a voltage level where the voltage is changing relatively quickly because any errors in

measuring it will only result in smaller changes in the time period and therefore smaller timing errors.

Any noise superimposed on the input of the sensing circuit, for example, causing it to trigger at a slightly higher or lower voltage, will have a smaller effect on the timed period. This would indicate utilising the earlier portion of the curve of Fig.15, by choosing a lower end voltage. From the point of view of achieving a relatively long delay while using reasonably low values of capacitor and resistor however, a higher end voltage would be preferable and so a compromise solution is required.

With the capacitor charging to 9V an end voltage of around 6V would represent a good compromise as around this voltage, the capacitor voltage is still rising fairly quickly while still having taken a relatively long time to reach this level.

Because the time taken to reach 6V will also depend to a large extent on the supply voltage, which could vary as the battery ages, it is better to set the end voltage as a fraction of the supply rather than an absolute value such as 6V. The final circuit, therefore, measures the voltage across the capacitor and when this equals about two-thirds of the supply voltage, the timing period is ended.

## INDICATOR

Once the voltage across the capacitor has reached the required level, some form of indication is required and this should operate until the user switches it off. A bistable device is therefore required and the indicator can be an l.e.d. or an audible device. An l.e.d. is cheaper but an audio indicator is much better as it will attract attention even when the user is not watching the timer. A piezo buzzer was therefore chosen. This type of device differs from a simple piezo sounder in that it contains an internal oscillator and requires only a d.c. voltage to produce sound.

The circuit diagram of the Simple Timer is shown in Fig.16 and uses transistor TR1 to detect the voltage across capacitor C1. At the moment that the circuit is switched on by switch S1, a positive-going pulse through C1 will immediately take the emitter (e) of TR1 to +9V, so holding TR1 turned off.

The capacitor now has equal voltage on both sides, and so is effectively in a discharged state. The voltage differential across C1, though, will increase as current flows from the emitter/C1 junction through

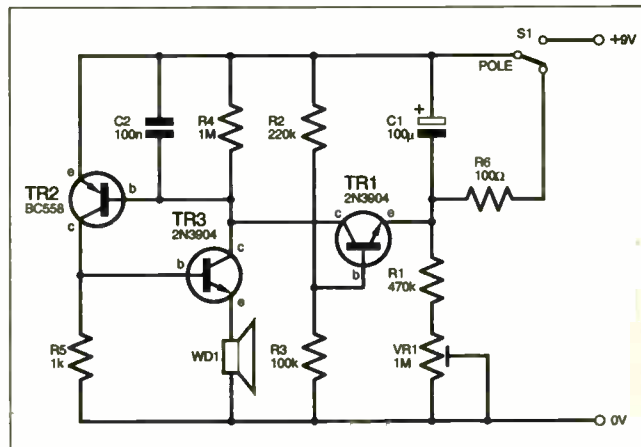

Fig.16. Circuit diagram for the Simple Timer.

## COMPONENTS

### Resistors

R1	470k
R2	220k
R3	100k
R4	1M
R5	1k
R6	100Ω

All 0.25W 5% carbon film.

### Potentiometer

1M	min. open skeleton preset (see text)
----	--------------------------------------

### Capacitors

C1	100μF radial elect. 16V
C2	100nF ceramic disc, 2.5mm pitch

### Semiconductors

TR1, TR3	2N3904 npn transistor (2 off)
TR2	BC558 npn transistor

### Miscellaneous

S1	s.p.d.t. min slide switch
WD1	12V piezo buzzer

Stripboard, 13 holes x 7 strips; PP3 battery and connector; box to suit; connecting wire; solder, etc.

Approx. Cost  
Guidance Only

£5

excl. case and battery

preset VR1 and resistor R1 to the 0V line, and so the voltage at TR1's emitter falls.

The base (b) voltage of TR1 is set at roughly one third of the supply voltage by the potential divider formed by resistors R2 and R3. When the emitter voltage of TR1 falls to 0.6V below the base voltage, TR1 will switch on.

Its collector current will supply base current to TR2 causing TR3 to conduct, so supplying a larger base current to TR2. This causes both these transistors to conduct heavily, switching on buzzer WD1 and indicating that the set time has elapsed. The buzzer will continue sounding until TR2 and TR3 are switched off by switching off the supply.

The time delay depends on the values of C1, VR1, R1. With the values shown, a period of 86 to 270 seconds was obtained with the test model, although this will vary with other units due to component value tolerances.

If changing the values, note that electrolytic capacitors leak current. This effect can be considered as a high value resistor connected in parallel with the capacitor through which it continuously discharges while being charged. If the charging resistance is too high, the capacitor may not be able to charge due to the leakage current. Good quality capacitors typically have lower leakage currents.

Another timing error could occur if the capacitor is not in a discharged state before timing commences as any residual charge from a previous run would mean that the voltage reached the required value earlier than required. Consequently, switch S1 is wired so that resistor R6 is connected across C1 to discharge it when the power is switched off.

Note that the timing value will be affected by temperature changes, the base-emitter voltage of TR1 falling by about 2mV for each degree Celsius rise.

## CONSTRUCTION

The circuit, with the exception of the on/off switch, buzzer and resistor R6, are assembled on a small piece of stripboard measuring 7 strips by 13 holes, as shown in Fig.17.

Before assembling and soldering the components to the board, two of the strips should be cut in places indicated by means of a 2.5mm drill or the tool available for this purpose. Note that three of the resistors (R1, R2 and R4) are mounted vertically and one link is required between the tracks. Resistor R6 is wired between the board and switch S1 as shown.

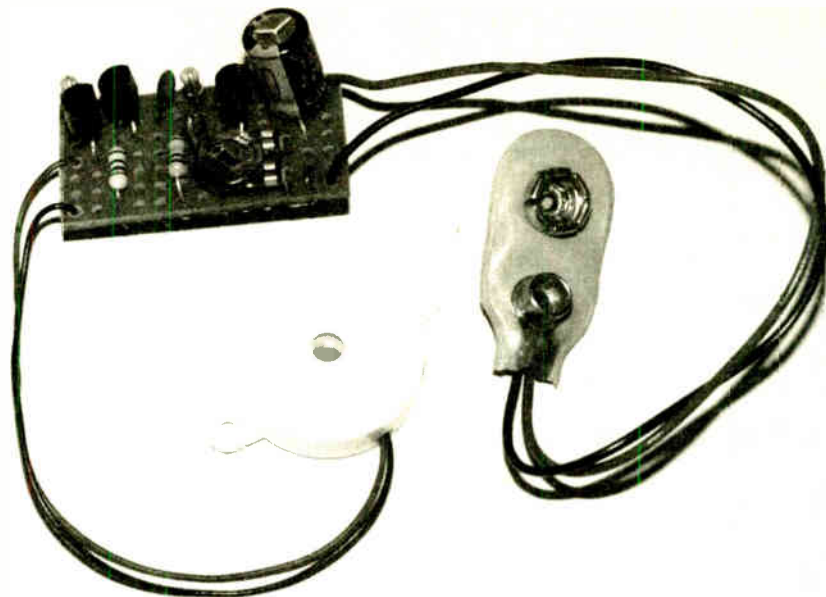
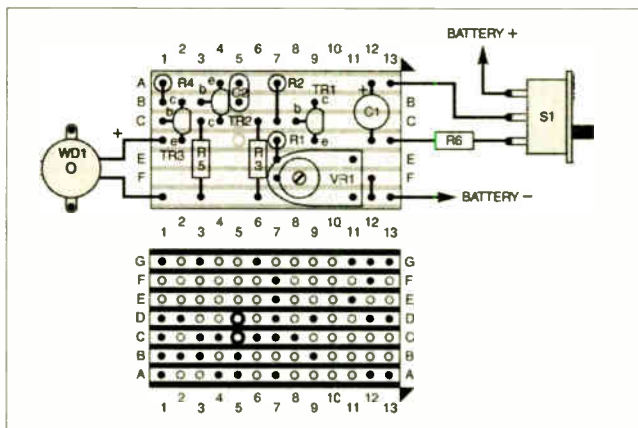

Fig.17. Simple Timer stripboard component layout and details of track breaks.



Take care to ensure that the transistors, capacitor C1 and the buzzer are inserted the correct way around. Pinouts for the transistors may differ if other transistor types are used.

Potentiometer VR1 could be replaced by a panel mounted linear type and calibrated by marking a scale on the front panel if the

unit is mounted in a case. No suggestions for case types are offered for any of the projects in this series.

## NEXT MONTH

In the next issue a Touch Light and a Plant Watering Reminder are described, again using just three transistors.

# EPE BINDERS

**KEEP YOUR MAGAZINES SAFE – RING US NOW!**

This ring binder uses a special system to allow the issues to be easily removed and re-inserted without any damage. A nylon strip slips over each issue and this passes over the four rings in the binder, thus holding the magazine in place.

The binders are finished in hard-wearing royal blue p.v.c. with the magazine logo in gold on the spine. They will keep your issues neat and tidy but allow you to remove them for use easily.

The price is £6.95 plus £3.50 post and packing. If you order more than one binder add £1 postage for each binder after the initial £3.50 postage charge (overseas readers the postage is £6.00 each to everywhere except Australia and Papua New Guinea which costs £10.50 each).

Send your payment in £'s sterling cheque or PO (Overseas readers send £ sterling bank draft, or cheque drawn on a UK bank or pay by card), to **Everyday Practical Electronics, Wimborne Publishing Ltd, 408 Wimborne Road East, Ferndown, Dorset BH22 9ND.** Tel: 01202 873872. Fax: 01202 874562.

E-mail: [editorial@epemag.wimborne.co.uk](mailto:editorial@epemag.wimborne.co.uk). Web site: <http://www.epemag.wimborne.co.uk>  
Order on-line from [www.epemag.wimborne.co.uk/shopdoor.htm](http://www.epemag.wimborne.co.uk/shopdoor.htm)

We also accept card payments. Mastercard, Visa, Amex, Diners Club or Switch. Send your card number, card expiry date and Card Security Code (the last three digits on or just below the signature strip) plus Switch Issue No. with your order.

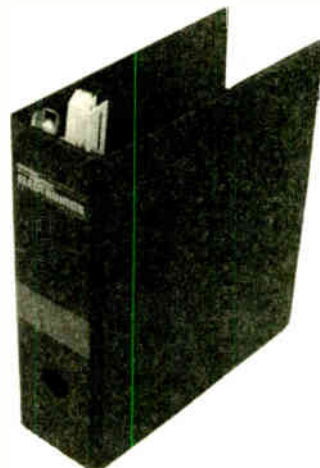



# DIRECT BOOK SERVICE

NOTE: ALL PRICES INCLUDE UK POSTAGE

FREE *Electronics Hobbyist Compendium* book with Teach-In 2000 CD-ROM



## EPE TEACH-IN 2000 CD-ROM

The whole of the 12-part *Teach-In 2000* series by John Becker (published in *EPE* Nov '99 to Oct 2000) is now available on CD-ROM. Plus the *Teach-In 2000* interactive software covering all aspects of the series and Alan Winstanley's *Basic Soldering Guide* (including illustrations and Desoldering).

*Teach-In 2000* covers all the basic principles of electronics from Ohm's Law to Displays, including Op.Amps, Logic Gates etc. Each part has its own section on the interactive software where you can also change component values in the various on-screen demonstration circuits.

The series gives a hands-on approach to electronics with numerous breadboard circuits to try out, plus a simple computer interface which allows a PC to be used as a basic oscilloscope.

ONLY **£12.45** including VAT and p&p

Order code Teach-In CD-ROM

## Circuits and Design

### Practical Remote Control Projects Owen Bishop

Provides a wealth of circuits and circuit modules for use in remote control systems of all kinds; ultrasonic, infra-red, optical fibre, cable and radio. There are instructions for building fourteen novel and practical remote control projects. But this is not all, as each of these projects provides a model for building dozens of other related circuits by simply modifying parts of the design slightly to suit your own requirements. This book tells you how.

Also included are techniques for connecting a PC to a remote control system, the use of a microcontroller in remote control, as exemplified by the BASIC Stamp, and the application of ready-made type-approved 418MHz radio transmitter and receiver modules to remote control systems.

160 pages Order code BP413 £6.49

### Discovering Electronic Clocks W. D. Phillips

This is a whole book about designing and making electronic clocks. You start by connecting HIGH and LOW logic signals to logic gates. You find out about and then build and test bistables, crystal-controlled astables, counters, decoders and displays. All of these subsystems are carefully explained, with practical work supported by easy to follow prototype board layouts.

Full constructional details, including circuit diagrams and a printed circuit board pattern, are given for a digital electronic clock. The circuit for the First Clock is modified and developed to produce additional designs which include a Big Digit Clock, Binary Clock, Linear Clock, Andrew's Clock (with a semi-analogue display), and a Circles Clock. All of these designs are unusual and distinctive.

This is an ideal resource for project work in GCSE *Design and Technology: Electronics Product*, and for

project work in AS-Level and A-Level *Electronics and Technology*.

194 pages, A4 spiral bound Order code DEP1 £17.50

### Domestic Security Systems

A. L. Brown

This book shows you how, with common sense and basic do-it-yourself skills, you can protect your home. It also gives tips and ideas which will help you to maintain and improve your home security, even if you already have an alarm. Every circuit in this book is clearly described and illustrated, and contains components that are easy to source. Advice and guidance are based on the real experience of the author who is an alarm installer, and the designs themselves have been rigorously put to use on some of the most crime-ridden streets in the world.

The designs include all elements, including sensors, -detectors, alarms, controls, lights, video and door entry systems. Chapters cover installation, testing, maintenance and upgrading.

192 pages Order code NE25 £17.95

### Microcontroller Cookbook

Mike James

The practical solutions to real problems shown in this cookbook provide the basis to make PIC and 8051 devices really work. Capabilities of the variants are examined, and ways to enhance these are shown. A survey of common interface devices, and a description of programming models, lead on to a section on development techniques. The cookbook offers an introduction that will allow any user, novice or experienced, to make the most of microcontrollers.

240 pages Order code NE26 £21.99

### A Beginner's Guide to TTL Digital ICs

R. A. Penfold

This book first covers the basics of simple logic circuits in general, and then progresses to specific TTL logic integrated circuits. The devices covered include gates, oscillators, timers, flip-flops, dividers, and decoder circuits. Some practical circuits are used to illustrate the use of TTL devices in the 'real world'.

142 pages Order code BP332 £5.45

### Practical Electronics Calculations and Formulae

F. A. Wilson, C.G.I.A., C.Eng., F.I.E.E., F.I.E.R.E., F.B.I.M.

Bridges the gap between complicated technical theory, and "cut-and-try" methods which may bring success in design but leave the experimenter unfulfilled. A strong practical bias - tedious and higher mathematics have been avoided where possible and many tables have been included.

The book is divided into six basic sections: Units and Constants, Direct-Current Circuits, Passive Components, Alternating-Current Circuits, Networks and Theorems, Measurements.

256 pages Order code BP53 £5.49

## Computing & Robotics

### Windows XP Explained

N. Kantaris and P. R. M. Oliver

If you want to know what to do next when confronted with Microsoft's Windows XP screen, then this book is for you. It applies to both the Professional and Home editions.

The book was written with the non-expert, busy person in mind. It explains what hardware requirements you need in order to run Windows XP successfully, and gives an overview of the Windows XP environment.

The book explains: How to manipulate Windows, and how to use the Control Panel to add or change your printer, and control your display; How to control information using WordPad, Notepad and Paint, and how to use the Clipboard facility to transfer information between Windows applications; How to be in control of your filing system using Windows Explorer and My Computer; How to control printers, fonts, characters, multimedia and images, and how to add hardware and software to your system; How to configure your system to communicate with the outside world, and use Outlook Express for all your email requirements; How to use the Windows Media Player 8 to play your CDs, burn CDs with your favourite tracks, use the Radio Tuner, transfer your videos to your PC, and how to use the Sound Recorder and Movie Maker; How to use the System Tools to restore your system to a previously working state, using Microsoft's Website to update your Windows set-up, how to clean up, defragment and scan your hard disk, and how to backup and restore your data; How to successfully transfer text from those old but cherished MS-DOS programs.

268 pages Order code BP514 £7.99

### Introducing Robotics with LEGO Mindstorms

Robert Penfold

Shows the reader how to build a variety of increasingly sophisticated computer controlled robots using the brilliant Lego Mindstorms Robotic Invention System (RIS). Initially covers fundamental building techniques and mechanics needed to construct strong and efficient robots using the various "click-together" components supplied in the basic RIS kit. Explains in simple terms how the "brain" of the robot may be programmed on screen using a PC and "zapped" to the robot over an infra-red link. Also, shows how a more sophisticated Windows programming language such as Visual BASIC may be used to control the robots.

Detailed building and programming instructions provided, including numerous step-by-step photographs.

288 pages - large format Order code BP901 £14.99

### More Advanced Robotics with LEGO Mindstorms - Robert Penfold

Covers the Vision Command System

Shows the reader how to extend the capabilities of the brilliant Lego Mindstorms Robotic Invention System (RIS) by using Lego's own accessories and some simple home constructed units. You will be able to build robots that can provide you with 'waiter service' when you clap your hands, perform tricks, 'see' and avoid objects by using 'bats radar', or accurately follow a line marked on

the floor. Learn to use additional types of sensors including rotation, light, temperature, sound and ultrasonic and also explore the possibilities provided by using an additional (third) motor. For the less experienced, RCX code programs accompany most of the featured robots. However, the more adventurous reader is also shown how to write programs using Microsoft's VisualBASIC running with the ActiveX control (Spirit.OCX) that is provided with the RIS kit.

Detailed building instructions are provided for the featured robots, including numerous step-by-step photographs. The designs include rover vehicles, a virtual pet, a robot arm, an 'intelligent' sweet dispenser and a colour conscious robot that will try to grab objects of a specific colour.

298 pages Order code BP902 £14.99

### PIC Your Personal Introductory Course

Second Edition John Morton

Discover the potential of the PIC microcontroller through graded projects - this book could revolutionise your electronics construction work!

A uniquely concise and practical guide to getting up and running with the PIC Microcontroller. The PIC is one of the most popular of the microcontrollers that are transforming electronic project work and product design.

Assuming no prior knowledge of microcontrollers and introducing the PICs capabilities through simple projects, this book is ideal for use in schools and colleges. It is the ideal introduction for students, teachers, technicians and electronics enthusiasts. The step-by-step explanations make it ideal for self-study too: this is not a reference book - you start work with the PIC straight away.

The revised second edition covers the popular reprogrammable EEPROM PICs: P16C84/16F84 as well as the P54 and P71 families.

270 pages Order code NE36 £13.99

### Introduction to Microprocessors

John Crisp

If you are, or soon will be, involved in the use of microprocessors, this practical introduction is essential reading. This book provides a thoroughly readable introduction to microprocessors, assuming no previous knowledge of the subject, nor a technical or mathematical background. It is suitable for students, technicians, engineers and hobbyists, and covers the full range of modern microprocessors.

After a thorough introduction to the subject, ideas are developed progressively in a well-structured format. All technical terms are carefully introduced and subjects which have proved difficult, for example 2's complement, are clearly explained. John Crisp covers the complete range of microprocessors from the popular 4-bit and 8-bit designs to today's super-fast 32-bit and 64-bit versions that power PCs and engine management systems etc.

222 pages Order code NE31 £18.99

The books listed have been selected by *Everyday Practical Electronics* editorial staff as being of special interest to everyone involved in electronics and computing. They are supplied by mail order direct to your door. Full ordering details are given on the last book page.

FOR A FURTHER SELECTION OF BOOKS SEE THE NEXT TWO ISSUES OF *EPE*

All prices include UK postage



# Testing, Theory and Reference

## Bebop To The Boolean Boogie

By Clive (call me Max) Maxfield

Specially imported by EPE –

Excellent value

An Unconventional Guide to Electronics Fundamentals, Components and Processes

This book gives the "big picture" of digital electronics. This indepth, highly readable, up-to-the-minute guide shows you how electronic devices work and how they're made. You'll discover how transistors operate, how printed circuit boards are fabricated, and what the innards of memory ICs look like. You'll also gain a working knowledge of Boolean Algebra and Karnaugh Maps, and understand what Reed-Muller logic is and how it's used. And there's much, MUCH more (including a recipe for a truly great seafood gumbo!).

Hundreds of carefully drawn illustrations clearly show the important points of each topic. The author's tongue-in-cheek British humor makes it a delight to read, but this is a REAL technical book, extremely detailed and accurate. A great reference for your own shelf, and also an ideal gift for a friend or family member who wants to understand what it is you do all day. . . .

470 pages – large format

Order code BEB1

£26.95

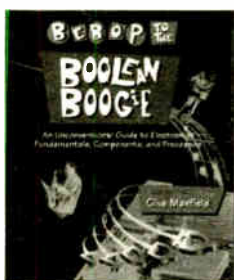

## BEBOP BYTES BACK (and the Beboputer Computer Simulator) CD-ROM

Clive (Max) Maxfield and Alvin Brown

This follow-on to *Bebop to the Boolean Boogie* is a multimedia extravaganza of information about how computers work. It picks up where "Bebop I" left off, guiding you through the fascinating world of computer design . . . and you'll have a few chuckles, if not belly laughs, along the way. In addition to over 200 megabytes of mega-cool multimedia, the CD-ROM contains a virtual micro-computer, simulating the motherboard and standard computer peripherals in an extremely realistic manner. In addition to a wealth of technical information, myriad nuggets of trivia, and hundreds of carefully drawn illustrations, the CD-ROM contains a set of lab experiments for the virtual micro-computer that let you recreate the experiences of early computer pioneers. If you're the slightest bit interested in the inner workings of computers, then don't dare to miss this!

Over 800 pages in Adobe Acrobat format

Order code BEB2 CD-ROM

£21.95

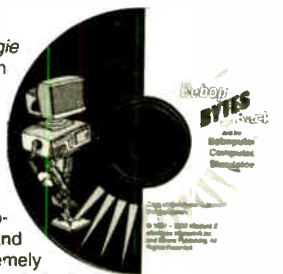

## DIGITAL ELECTRONICS – A PRACTICAL APPROACH

With FREE Software: Number One Systems – EASY-PC

Professional XM and Pulsar (Limited Functionality)

Richard Monk

Covers binary arithmetic, Boolean algebra and logic gates, combination logic, sequential logic including the design and construction of asynchronous and synchronous circuits and register circuits. Together with a considerable practical content plus the additional attraction of its close association with computer-aided design including the FREE software.

There is a "blow-by-blow" guide to the use of EASY-PC Professional XM (a schematic drawing and printed circuit board design computer package). The guide also conducts the reader through logic circuit simulation using Pulsar software. Chapters on p.c.b. physics and p.c.b. production techniques make the book unique, and with its host of project ideas make it an ideal companion for the integrative assignment and common skills components required by BTEC and the key skills demanded by GNVQ. The principal aim of the book is to provide a straightforward approach to the understanding of digital electronics.

Those who prefer the "Teach-In" approach or would rather experiment with some simple circuits should find the book's final chapters on printed circuit board production and project ideas especially useful.

250 pages

Order code NE28

£19.95

## OSCILLOSCOPES – FIFTH EDITION

Ian Hickman

Oscilloscopes are essential tools for checking circuit operation and diagnosing faults, and an enormous range of models are available.

This handy guide to oscilloscopes is essential reading for anyone who has to use a 'scope for their work or hobby; electronics designers, technicians, anyone in industry involved in test and measurement, electronics enthusiasts . . . Ian Hickman's review of all the latest types of 'scope currently available will prove especially useful for anyone planning to buy – or even build – an oscilloscope.

The contents include a description of the basic oscilloscope; Advanced real-time oscilloscope; Accessories; Using oscilloscopes; Sampling oscilloscopes; Digital storage oscilloscopes; Oscilloscopes for special purposes; How oscilloscopes work (1): the CRT; How oscilloscopes work (2): circuitry; How oscilloscopes work (3): storage CRTs; plus a listing of Oscilloscope manufacturers and suppliers.

288 pages

Order code NE37

£20.99

## EDA – WHERE ELECTRONICS BEGINS

By Clive "Max" Maxfield and Kuhoo Goyal Edson

ON SALE 50% OFF

"Did you ever wonder how the circuit boards and silicon chips inside your personal computer or cell phone were designed? This book walks you through the process of designing a city on an alien planet and compares it to designing an electronic system. The result is a fun, light-hearted and entertaining way to learn about one of the most important – and least understood – industries on this planet."

EDA, which stands for electronic design automation, refers to the software tools (computer programs) used to design electronic products. EDA actually encompasses a tremendous variety of tools and concepts. The aim of this book is to take a 30,000-foot view of the EDA world. To paint a "big picture" that introduces some of the most important EDA tools and describes how they are used to create integrated circuits, circuit boards and electronic systems. To show you how everything fits together without making you want to bang your head against the nearest wall.

SPECIALLY IMPORTED BY EPE – EXCELLENT VALUE

£29.95

98 pages – Large format

Order code EDA1

£14.95 while stocks last

## DIGITAL GATES AND FLIP-FLOPS

Ian R. Sinclair

This book, intended for enthusiasts, students and technicians, seeks to establish a firm foundation in digital electronics by treating the topics of gates and flip-flops thoroughly and from the beginning.

Topics such as Boolean algebra and Karnaugh mapping are explained, demonstrated and used extensively, and more attention is paid to the subject of synchronous counters than to the simple but less important ripple counters.

No background other than a basic knowledge of electronics is assumed, and the more theoretical topics are explained from the beginning, as also are many working practices. The book concludes with an explanation of micro-processor techniques as applied to digital logic.

200 pages

Order code PC106

£9.95

## UNDERSTANDING ELECTRONIC CONTROL SYSTEMS

Owen Bishop

Owen Bishop has produced a concise, readable text to introduce a wide range of students, technicians and professionals to an important area of electronics. Control is a highly mathematical subject, but here maths is kept to a minimum, with flow charts to illustrate principles and techniques instead of equations.

Cutting edge topics such as microcontrollers, neural networks and fuzzy control are all here, making this an ideal refresher course for those working in Industry. Basic principles, control algorithms and hardwired control systems are also fully covered so the resulting book is a comprehensive text and well suited to college courses or background reading for university students.

The text is supported by questions under the headings Keeping Up and Test Your Knowledge so that the reader can develop a sound understanding and the ability to apply the techniques they are learning.

228 pages

Order code NE35

£17.99

## HOW ELECTRONIC THINGS WORK – AND WHAT TO DO WHEN THEY DON'T

Robert Goodman

You never again have to be flummoxed, flustered or taken for a ride by a piece of electronics equipment. With this fully illustrated, simple-to-use guide, you will get a grasp on the workings of the electronic world that surrounds you – and even learn to make your own repairs.

You don't need any technical experience. This book gives you: Clear explanations of how things work, written in everyday language. Easy-to-follow, illustrated instructions on using test equipment to diagnose problems. Guidelines to help you decide for or against professional repair. Tips on protecting your expensive equipment from lightning and other electrical damage. Lubrication and maintenance suggestions.

Covers: colour TVs, VCRs, radios, PCs, CD players, printers, telephones, monitors, camcorders, satellite dishes, and much more!

394 pages

Order code MGH3

£21.99

## VINTAGE RADIOS – COLLECTING ● SERVICING ● RESTORING

Tony Thompson

The essential guide to collecting, repairing and restoring vintage valve radios. These receivers are becoming ever more popular as collectibles, this is a good thing because it means that a very large piece of technological history is being reclaimed when at one time many thought it lost forever. If you look around, you will find plenty of valve radio sets just waiting for a loving restoration. They may not yet be the most highly prized, and they are unlikely to be in top condition, but they can be yours and, if you develop the skills outlined in this book, you will possess radio receivers to be proud of.

The book covers radio history, styling, faultfinding, chassis and cabinet restoration, types of set.

124 pages spiral bound

Order code TT1

£13.95

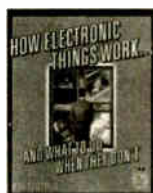

All prices include UK P&P





# Circuits and Design

## PRACTICAL ELECTRONIC FILTERS

Owen Bishop

This book deals with the subject in a non-mathematical way. It reviews the main types of filter, explaining in simple terms how each type works and how it is used.

The book also presents a dozen filter-based projects with applications in and around the home or in the constructor's workshop. These include a number of audio projects such as a rhythm sequencer and a multi-voiced electronic organ.

Concluding the book is a practical step-by-step guide to designing simple filters for a wide range of purposes, with circuit diagrams and worked examples.

188 pages **Order code BP299** £5.49

## PREAMPLIFIER AND FILTER CIRCUITS

R. A. Penfold

This book provides circuits and background information for a range of preamplifiers, plus tone controls, filters, mixers, etc. The use of modern low noise operational amplifiers and a specialist high performance audio preamplifier i.c. results in circuits that have excellent performance, but which are still quite simple. All the circuits featured can be built at quite low cost (just a few pounds in most cases). The preamplifier circuits featured include: Microphone preamplifiers (low impedance, high impedance, and crystal). Magnetic cartridge pick-up preamplifiers with R.I.A.A. equalisation. Crystal/ceramic pick-up preamplifier. Guitar pick-up preamplifier. Tape head preamplifier (for use with compact cassette systems).

Other circuits include: Audio limiter to prevent overloading of power amplifiers. Passive tone controls. Active tone controls. PA filters (highpass and lowpass). Scratch and rumble filters. Loudness filter. Mixers. Volume and balance controls.

92 pages **Order code BP309** £4.49

## HOW TO USE OPAMPS

E. A. Parr

This book has been written as a designer's guide covering many operational amplifiers, serving both as a source book of circuits and a reference book for design calculations. The approach has been made as non-mathematical as possible.

160 pages **Temporarily out of print**

## PIC YOUR PERSONAL INTRODUCTORY COURSE

SECOND EDITION John Morton

Discover the potential of the PIC microcontroller through graded projects - this book could revolutionise your electronics construction work!

A uniquely concise and practical guide to getting up and running with the PIC Microcontroller. The PIC is one of the most popular of the microcontrollers that are transforming electronic project work and product design.

Assuming no prior knowledge of microcontrollers and introducing the PIC's capabilities through simple projects, this book is ideal for use in schools and colleges. It is the ideal introduction for students, teachers, technicians and electronics enthusiasts. The step-by-step explanations make it ideal for self-study too: this is not a reference book - you start work with the PIC straight away.

The revised second edition covers the popular reprogrammable EEPROM PICs: P16C84/16F84 as well as the P54 and P71 families.

270 pages **Order code NE36** £13.99

## RADIO BYGONES

We also carry a selection of books aimed at readers of *EPE's* sister magazine on vintage radio *Radio Bygones*. These books include the *Comprehensive Radio Valve Guides* (five books with a Free copy of the Master Index) for just £15. Also Jonathan Hill's excellent *Radio Radio*, a comprehensive book with hundreds of photos depicting the development of the British wireless set up to the late 1960s.

The three volumes of our own *Wireless For the Warrior* by Louis Meulstee are also available. These are a technical history of radio communication equipment in the British Army from pre-war through to the 1960s.

For details see the shop on our UK web site at [www.epemag.wimborne.co.uk](http://www.epemag.wimborne.co.uk) or contact us for a list of *Radio Bygones* books.

# Project Building

## ELECTRONIC PROJECTS FOR EXPERIMENTERS

R. A. Penfold

Many electronic hobbyists who have been pursuing their hobby for a number of years seem to suffer from the dreaded "seen it all before" syndrome. This book is fairly and squarely aimed at sufferers of this complaint, plus any other electronics enthusiasts who yearn to try something a bit different. No doubt many of the projects featured here have practical applications, but they are all worth a try for their interest value alone.

The subjects covered include:- Magnetic field detector, Basic Hall effect compass, Hall effect audio isolator, Voice scrambler/descrambler, Bat detector, Bat style echo location, Noise cancelling, LED stroboscope, Infra-red "torch", Electronic breeze detector, Class D power amplifier, Strain gauge amplifier, Super hearing aid.

138 pages **Order code BP371** £5.45

## ELECTRONIC PROJECT BUILDING FOR BEGINNERS

R. A. Penfold

This book is for complete beginners to electronic project building. It provides a complete introduction to the practical side of this fascinating hobby, including the following topics:

Component identification, and buying the right parts; resistor colour codes, capacitor value markings, etc; advice on buying the right tools for the job; soldering; making easy work of the hard wiring; construction methods, including stripboard, custom printed circuit boards, plain matrix boards, surface mount boards and wire-wrapping; finishing off, and adding panel labels; getting "problem" projects to work, including simple methods of fault-finding.

In fact everything you need to know in order to get started in this absorbing and creative hobby.

135 pages **Temporarily out of print**

## PRACTICAL FIBRE-OPTIC PROJECTS

R. A. Penfold

While fibre-optic cables may have potential advantages over ordinary electric cables, for the electronics

enthusiast it is probably their novelty value that makes them worthy of exploration. Fibre-optic cables provide an innovative interesting alternative to electric cables, but in most cases they also represent a practical approach to the problem. This book provides a number of tried and tested circuits for projects that utilize fibre-optic cables.

The projects include:- Simple audio links, F.M. audio link, P.W.M. audio links, Simple d.c. links, P.W.M. d.c. link, P.W.M. motor speed control, RS232C data links, MIDI link, Loop alarms, R.P.M. meter.

All the components used in these designs are readily available, none of them require the constructor to take out a second mortgage.

132 pages **Order code BP374** £5.45

## ELECTRONIC MUSIC AND MIDI PROJECTS

R. A. Penfold

Whether you wish to save money, boldly go where no musician has gone before, rekindle the pioneering spirit, or simply have fun building some electronic music gadgets, the designs featured in this book should suit your needs. The projects are all easy to build, and some are so simple that even complete beginners at electronic project construction can tackle them with ease. Stripboard layouts are provided for every project, together with a wiring diagram. The mechanical side of construction has largely been left to the individual constructors to sort out, simply because the vast majority of project builders prefer to do their own thing.

None of the designs requires the use of any test equipment in order to get them set up properly. Where any setting up is required, the procedures are very straightforward, and they are described in detail.

Projects covered: Simple MIDI tester, Message grabber, Byte grabber, THRU box, MIDI auto switcher, Auto/manual switcher, Manual switcher, MIDI patchbay, MIDI controlled switcher, MIDI lead tester, Program change pedal, Improved program change pedal, Basic mixer, Stereo mixer, Electronic swell pedal, Metronome, Analogue echo unit.

138 pages **Order code PC116** £10.95

## BOOK ORDERING DETAILS

All prices include UK postage. For postage to Europe (air) and the rest of the world (surface) please add £2 per book. For the rest of the world airmail add £3 per book. CD-ROM prices include VAT and/or postage to anywhere in the world. Send a PO, cheque, international money order (£ sterling only) made payable to Direct Book Service or card details, Visa, Mastercard, Amex, Diners Club or Switch to:

**DIRECT BOOK SERVICE, WIMBORNE PUBLISHING LTD.,  
408 WIMBORNE ROAD EAST, FERNDOWN, DORSET BH22 9ND.**

Books are normally sent within seven days of receipt of order, but please allow 28 days for delivery - more for overseas orders. Please check price and availability (see latest issue of *Everyday Practical Electronics*) before ordering from old lists.

For a further selection of books see the next two issues of *EPE*.

Tel 01202 873872 Fax 01202 874562. Email: [dbs@epemag.wimborne.co.uk](mailto:dbs@epemag.wimborne.co.uk)

Order from our online shop at: [www.epemag.wimborne.co.uk/shopdoor.htm](http://www.epemag.wimborne.co.uk/shopdoor.htm)

## BOOK ORDER FORM

Full name: .....

Address: .....

.....

.....

..... Post code: ..... Telephone No: .....

Signature: .....

I enclose cheque/PO payable to DIRECT BOOK SERVICE for £ .....

Please charge my card £ ..... Card expiry date.....

Card Number ..... Switch Issue No.....

Card Security Code ..... (the last three digits on or just under the signature strip)

Please send book order codes: .....

.....

Please continue on separate sheet of paper if necessary  
If you do not wish to cut your magazine, send a letter or copy of this form

# PCB SERVICE

Printed circuit boards for most recent *EPE* constructional projects are available from the PCB Service, see list. These are fabricated in glass fibre, and are fully drilled and roller tinned. All prices include VAT and postage and packing. Add £1 per board for airmail outside of Europe. Remittances should be sent to The PCB Service, *Everyday Practical Electronics*, Wimborne Publishing Ltd., 408 Wimborne Road East, Ferndown, Dorset BH22 9ND. Tel: 01202 873872; Fax 01202 874562; Email: [orders@epemag.wimborne.co.uk](mailto:orders@epemag.wimborne.co.uk). On-line Shop: [www.epemag.wimborne.co.uk/shopdoor.htm](http://www.epemag.wimborne.co.uk/shopdoor.htm). Cheques should be crossed and made payable to *Everyday Practical Electronics* (Payment in £ sterling only).

**NOTE: While 95% of our boards are held in stock and are dispatched within seven days of receipt of order, please allow a maximum of 28 days for delivery – overseas readers allow extra if ordered by surface mail.**

Back numbers or photostats of articles are available if required – see the *Back Issues* page for details. We do not supply kits or components for our projects.

**Please check price and availability in the latest issue.**

**A number of older boards are listed on our website.**

Boards can only be supplied on a payment with order basis.

PROJECT TITLE	Order Code	Cost
Doorbell Extender: Transmitter	MAR '01 292	£4.20
Receiver	293	£4.60
Trans/Remote	294	£4.28
Rec./Relay	295	£4.92
EPE Snug-bug Heat Control for Pets	APR '01 296	£6.50
Camcorder Mixer	MAY '01 299	£6.34
★PIC Graphics L.C.D. Scope	300	£5.07
Hosepipe Controller	JUNE '01 301	£5.14
Magfield Monitor (Sensor Board)	302	£4.91
Dummy PIR Detector	303	£4.36
★PIC16F87x Extended Memory Software only	-	-
Stereo/Surround Sound Amplifier	JULY '01 304	£4.75
Perpetual Projects Uniboard-1	305	£3.00
Solar-Powered Power Supply & Voltage Reg.		
MSF Signal Repeater and Indicator		
Repeater Board	306	£4.75
Meter Board	307	£4.44
★PIC to Printer Interface	308	£5.39
Lead/Acid Battery Charger	AUG '01 309	£4.99
Shortwave Loop Aerial	310	£5.07
★Digitimer – Main Board	311	£6.50
– R.F. Board	312	£4.36
Perpetual Projects Uniboard-2		
L.E.D. Flasher – Double Door-Buzzer	305	£3.00
Perpetual Projects Uniboard-3	SEPT '01 305	£3.00
Loop Burglar Alarm, Touch-Switch Door-Light and Solar-Powered Rain Alarm		
L.E.D. Super Torches – Red Main	313	} Set £6.10
– Display Red	314	
– White L.E.D.	315	
★Sync Clock Driver	316	
★Water Monitor	317	£4.91
Camcorder Power Supply	OCT '01 318	£5.94
PIC Toolkit Mk3	319	£8.24
Perpetual Projects Uniboard-4. Gate Sentinel, Solar-powered Bird Scarer and Solar-Powered Register	305	£3.00
Teach-In 2002 Power Supply	NOV '01 320	£4.28
Lights Needed Alert	321	£5.39
Pitch Switch	322	£5.87
Capacitance Meter – Main Board (double-sided)	323	} Set £12.00
– Display Board (double-sided)	324	
★ ★PIC Toolkit TK3 – Software only	-	-
4-Channel Twinkling Lights	DEC '01 325	£6.82
Ghost Buster – Mic	326	} Set £5.78
– Main	327	
★PIC Polywhatsit – Digital	328	} Set £7.61
– Analogue	329	
Forever Flasher	JAN '02 330	£4.44
Time Delay Touch Switch	331	£4.60
★PIC Magick Musick	332	£5.87
Versatile Bench Power Supply	333	£5.71
★PIC Spectrum Analyser	FEB '02 334	£7.13
Versatile Current Monitor	335	£4.75
Guitar Practice Amp	336	£5.39
★PIC Virus Zapper	MAR '02 337	£4.75
RH Meter	338	£4.28
★PIC Mini-Enigma – Software only	-	-
★Programming PIC Interrupts – Software only	-	-
★PIC Controlled Intruder Alarm	APR '02 339	£6.50
★PIC Big Digit Display	MAY '02 341	£6.02
Washing Ready Indicator	342	£4.75
Audio Circuits-1 – LM386N-1	343	£4.28
– TDA7052	344	£4.12
– TBA820M	345	£4.44
– LM380N	346	£4.44
– TDA20C3	347	£4.60
– Twin TDA2003	348	£4.75
World Lamp	JUNE '02 340	£5.71
Simple Audio Circuits-2 – Low, Med and High Input Impedance Preamplifiers (Single Trans.)	349	£4.60
Low-Noise Preamplifier (Dual Trans.)	350	£4.75
Tone Control	351	£4.60
Bandpass Filter	352	£4.75
Frequency Standard Generator – Receiver	353	£4.12
– Digital	354	£6.82
★Biopic Heartbeat Monitor	355	£5.71

PROJECT TITLE	Order Code	Cost
Simple Audio Circuits – 3	JULY '02	
– Dual Output Power Supply	356	£4.60
– Crossover/Audio Filter	357	£4.44
Infra-Red Autoswitch	358	£4.91
★EPE StyloPIC	359	£6.50
Rotary Combination Lock – Main Board	360	£5.39
– Interface Board	361	£4.91
★Using the PIC's PCLATH Command – Software only	-	-
Big-Ears Buggy	AUG '02 362	£5.71
★PIC World Clock	363	£5.39
Simple Audio Circuits-4		
Low Freq. Oscillator	364	£4.44
Resonance Detector	365	£4.28
Vinyl-To-CD Preamplifier	SEPT '02 366	£5.71
★Freebird Glider Control	367	£4.91
★Morse Code Reader	368	£5.23
Headset Communicator	OCT '02 369	£4.75
EPE Bounty Treasure Hunter	370	£4.77
★ ★ Digital I.C. Tester	371	£7.14
★PIC-Pocket Battleships – Software only	-	-
Transient Tracker	NOV '02 372	£4.75
★PICAXE Projects-1: Egg Timer; Dice Machine; Quiz Game Monitor (Multiboard)	373	£3.00
★Tuning Fork & Metronome	374	£5.39
★ ★ EPE Hybrid Computer – Main Board	375	£18.87
– Atom Board	376	£11.57
★PICAXE Projects-2: Temperature Sensor; Voltage Sensor; VU Indicator (Multiboard)	373	£3.00
★Versatile PIC Flasher	377	£5.07
★PICAXE Projects-3: Chaser Lights	JAN '03 373	£3.00
6-Channel Mains Interface	381	£5.08
EPE Minder – Transmitter	378	£4.75
– Receiver	379	£5.39
★Wind Speed Monitor	380	£5.08
Tesla Transformer	FEB '03 382	£5.07
★Brainbot Buggy	383	£3.00
★Wind Tunnel	384	£6.02
200kHz Function Generator	MAR '03 385	£6.34
Wind-Up Torch Mk II	386	£4.75
★Driver Alert	387	£6.35

## EPE SOFTWARE

Software programs for *EPE* projects marked with a single asterisk ★ are available on 3.5 inch PC-compatible disks or free from our Internet site. The following disks are available: **PIC Tutorial** (Mar-May '98); **PIC Toolkit Mk2 V2.4d** (May-Jun '99); **EPE Disk 1** (Apr '95-Dec '98); **EPE Disk 2** (1999); **EPE Disk 3** (2000); **EPE Disk 4** (2001); **EPE Disk 5** (2002); **EPE Disk 6** (Jan 2003 issue to current cover date); **EPE Teach-In 2000**; **EPE Spectrum**; **EPE Interface Disk 1** (October '00 issue to current cover date).

★ ★ The software for these projects is on CD-ROM. The 3.5 inch disks are £3.00 each (UK), the CD-ROMs are £6.95 (UK). Add 50p each for overseas surface mail, and £1 each for airmail. All are available from the *EPE PCB Service*. All files can be downloaded free from our Internet FTP site: <ftp://ftp.epemag.wimborne.co.uk>.

## EPE PRINTED CIRCUIT BOARD SERVICE

<b>Order Code</b>	<b>Project</b>	<b>Quantity</b>	<b>Price</b>
.....	.....	.....	.....

Name .....

Address .....

Tel. No. ....

I enclose payment of £..... (cheque/PO in £ sterling only) to:





### Everyday Practical Electronics

**MasterCard, Amex, Diners Club, Visa or Switch**

Card No. ....

Card Exp. Date ..... Switch Issue No .....

Card Security Code .....

(The last 3 digits on or just under the signature strip)

Signature .....

**NOTE: You can also order p.c.b.s by phone, Fax, Email or via our Internet site on a secure server:**

<http://www.epemag.wimborne.co.uk/shopdoor.htm>



**WHETHER ELECTRONICS IS YOUR HOBBY  
OR YOUR LIVELIHOOD . . .**

**YOU NEED THE MODERN ELECTRONICS MANUAL  
and the ELECTRONICS SERVICE MANUAL**

## **THE MODERN ELECTRONICS MANUAL (CD-ROM VERSION ONLY)**

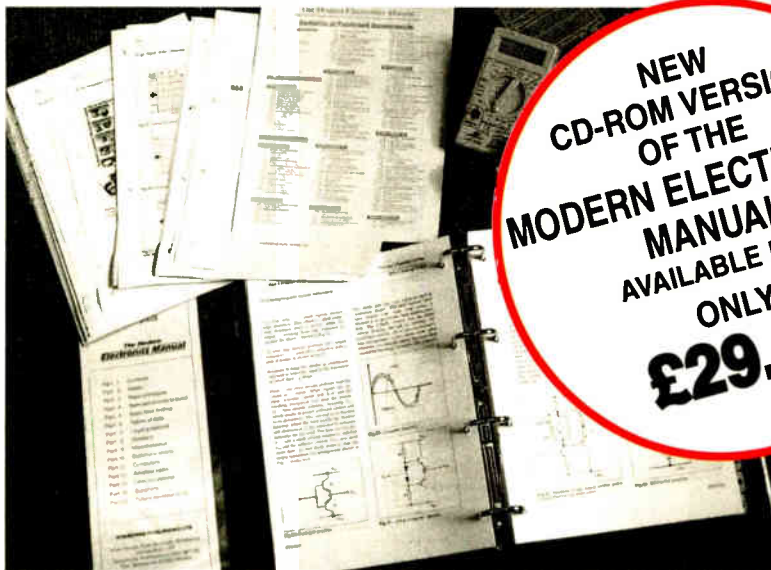

**NEW  
CD-ROM VERSION  
OF THE  
MODERN ELECTRONICS  
MANUAL  
AVAILABLE NOW  
ONLY  
£29.95**

**The essential reference  
work for everyone  
studying electronics**

- Over 800 pages
- In-depth theory
- Projects to build
- Detailed assembly instructions
- Full components checklists
- Extensive data tables
- Manufacturers' web links
- Easy-to-use Adobe Acrobat format
- Clear and simple layout
- Comprehensive subject range
- Professionally written
- Regular Supplements

## **EVERYTHING YOU NEED TO GET STARTED AND GO FURTHER IN ELECTRONICS!**

The revised CD-ROM edition of the Modern Electronics Base Manual (MEM) contains practical, easy-to-follow information on the following subjects:

**BASIC PRINCIPLES:** Electronic Components and their Characteristics (16 sections from Resistors and Potentiometers to Crystals, Crystal Modules and Resonators); Circuits Using Passive Components (10 sections); Power Supplies; The Amateur Electronics Workshop; The Uses of Semiconductors; Digital Electronics (6 sections); Operational Amplifiers; Introduction to Physics, including practical experiments; Semiconductors (5 sections) and Digital Instruments (3 sections).

**CIRCUITS TO BUILD:** There's nothing to beat the satisfaction of creating your own projects. From basic principles, like soldering and making printed circuit boards, to the tools needed for circuit-building, the Modern Electronics Manual and its Supplements describe clearly, with appropriate diagrams, how to assemble a radio, loudspeaker circuits, amplifiers, car projects,

a computer interface, measuring instruments, workshop equipment, security systems, medical and musical circuits, etc. The Base Manual describes 12 projects including a Theremin and a Simple TENS Unit.

**ESSENTIAL DATA:** Extensive tables on diodes, transistors, thyristors and triacs, digital and linear i.c.s.

**EXTENSIVE GLOSSARY:** Should you come across a technical word, phrase or abbreviation you're not familiar with, simply look up the glossary included in the Manual and you'll find a comprehensive definition in plain English.

The Manual also covers **Safety** and provides web links to component and equipment **Manufacturers and Suppliers**. The most comprehensive reference work ever produced at a price you can afford, the CD-ROM edition of **THE MODERN ELECTRONICS MANUAL** provides you with all the **essential** information you need.

## **THE MODERN ELECTRONICS MANUAL (MEM - CD-ROM version only)**

**Revised CD-ROM Edition of Basic Work:** Contains over 800 pages of information in Adobe Acrobat format. Edited by John Becker.

**Regular Supplements:** Additional CD-ROMs each containing approximately 500 pages of additional information on specific areas of electronics are available for £19.95 each. Information on the availability and content of each Supplement CD-ROM will be sent to you.

**Presentation:** CD-ROM suitable for any modern PC. Requires Adobe Acrobat Reader which is included on the MEM CD-ROM.

**Price of the Basic Work: £29.95 POST FREE.**

## **ORDER BOTH MANUALS TOGETHER AND SAVE £20**

**A mass of well-organised and clearly explained information is brought to you by expert editorial teams whose combined experience ensures the widest coverage**  
**Regular Supplements to these unique publications, keep you abreast of the latest technology and techniques if required**

# ELECTRONICS SERVICE MANUAL

(PRINTED VERSION ONLY)

## EVERYTHING YOU NEED TO KNOW TO GET STARTED IN REPAIRING AND SERVICING ELECTRONIC EQUIPMENT

**SAFETY:** Be knowledgeable about Safety Regulations, Electrical Safety and First Aid.

**UNDERPINNING KNOWLEDGE:** Specific sections enable you to Understand Electrical and Electronic Principles, Active and Passive Components, Circuit Diagrams, Circuit Measurements, Radio, Computers, Valves and Manufacturers' Data, etc.

**PRACTICAL SKILLS:** Learn how to identify Electronic Components, Avoid Static Hazards, Carry Out Soldering and Wiring, Remove and Replace Components.

**TEST EQUIPMENT:** How to Choose and Use Test Equipment, Assemble a Toolkit, Set Up a Workshop, and Get the Most from Your Multimeter and Oscilloscope, etc.

**SERVICING TECHNIQUES:** The regular Supplements include vital guidelines on how to Service Audio Amplifiers, Radio Receivers, TV Receivers, Cassette Recorders, Video Recorders, Personal Computers, etc.

**TECHNICAL NOTES:** Commencing with the IBM PC, this section and the regular Supplements deal with a very wide range of specific types of equipment – radios, TVs, cassette recorders, amplifiers, video recorders etc..

**REFERENCE DATA:** Detailing vital parameters for Diodes, Small-Signal Transistors, Power Transistors, Thyristors, Triacs and Field Effect Transistors. Supplements include Operational Amplifiers, Logic Circuits, Optoelectronic Devices, etc.

## The essential work for servicing and repairing electronic equipment

- Around 900 pages
- Fundamental principles
- Troubleshooting techniques
- Servicing techniques
- Choosing and using test equipment
- Reference data
- Easy-to-use format
- Clear and simple layout
- Vital safety precautions
- Professionally written
- Regular Supplements
- Sturdy gold blocked ring-binder

## ELECTRONICS SERVICE MANUAL (ESM – Printed version only)

**Basic Work:** Contains around 900 pages of information. Edited by Mike Tooley BA  
**Regular Supplements:** Unlike a book or encyclopedia, this Manual is a living work – continuously extended with new material. If requested, Supplements are sent to you on approval approximately every three months. Each Supplement contains around 160 pages – all for only £23.50+£2.50 p&p. You can, of course, return any Supplement (within ten days) which you feel is superfluous to your needs. You can also purchase a range of past Supplements to extend your Base Manual on subjects of particular interest to you.

**Presentation:** Durable looseleaf system in large A4 format

**Price of the Basic Work: £29.95**  
 (to include a recent Supplement FREE).



### Guarantee

Our 30 day money back guarantee gives you complete peace of mind. If you are not entirely happy with the *Electronics Service Manual*, for whatever reason, simply return it to us in good condition within 30 days and we will make a full refund of your payment – no small print and no questions asked. All we ask is that you pay the return postage. (Overseas buyers also have to pay our overseas postage charge). Sorry, but we can only make exchanges on the *Modern Electronics Manual* (CD-ROM version) if the CD-ROM is faulty, we cannot offer a money back guarantee on this product as the content can be printed out.

Wimborne Publishing Ltd., Dept Y3, 408 Wimborne Road East, Ferndown, Dorset BH22 9ND. Tel: 01202 873872. Fax: 01202 874562.  
 Online shop: [www.epemag.wimborne.co.uk/shopdoor.htm](http://www.epemag.wimborne.co.uk/shopdoor.htm)

**PLEASE** send me



- THE MODERN ELECTRONICS MANUAL (CD-ROM version only)
- ELECTRONICS SERVICE MANUAL plus a FREE SUPPLEMENT (Printed version only)
- I enclose payment of £29.95 (for one Manual) or £39.90 for both Manuals (saving £20 by ordering both together) plus postage if applicable.
- I also require the appropriate ESM Supplements four times a year. These are billed separately and can be discontinued at any time. (Please delete if not required.)

FULL NAME .....  
 (PLEASE PRINT)

ADDRESS .....

.....POSTCODE .....

SIGNATURE .....

I enclose cheque/PO in UK pounds payable to Wimborne Publishing Ltd.

Please charge my Visa/Mastercard/Amex/Diners Club/Switch Switch Issue No .....

Card No .....

Card Exp. Date ..... Card Security Code .....  
 (The last 3 digits on or just under the signature strip)

### ORDER FORM

Simply complete and return the order form with your payment to the following address:  
**Wimborne Publishing Ltd, Dept. Y3, 408 Wimborne Road East, Ferndown, Dorset BH22 9ND**  
 We offer a 30 day MONEY BACK GUARANTEE ON ESM – see the panel above for details.

### POSTAGE CHARGES FOR ESM

**MEM CD-ROM POST FREE TO ALL COUNTRIES**  
 (Note we use the VAT portion of the MEM CD-ROM payment to pay for overseas postage)

Postal Region	Price PER ESM PRINTED MANUAL	
	Surface	Air
Mainland UK	FREE	–
Scottish Highlands, UK Islands & Eire	£7 each	–
Europe (EU)	–	£23 each
Europe (Non-EU)	£23 each	£30 each
USA & Canada	£28 each	£39 each
Far East & Australasia	£35 each	£43 each
Rest of World	£28 each	£52 each

Please allow four working days for UK delivery.  
 NOTE: Surface mail can take over 10 weeks to some parts of the world. Each ESM weighs about 4kg when packed.



# PRACTICAL ELECTRONICS

Everyday Practical Electronics reaches twice as many UK readers as any other UK monthly hobby electronics magazine, our sales figures prove it. We have been the leading monthly magazine in this market for the last eighteen years.

If you want your advertisements to be seen by the largest readership at the most economical price our classified and semi-display pages offer the best value. The prepaid rate for semi-display space is £8 (+VAT) per single column centimetre (minimum 2.5cm). The prepaid rate for classified adverts is 30p (+VAT) per word (minimum 12 words).

All cheques, postal orders, etc., to be made payable to Everyday Practical Electronics. VAT must be added. Advertisements, together with remittance, should be sent to Everyday Practical Electronics Advertisements, Mill Lodge, Mill Lane, Thorpe-le-Soken, Essex CO16 0ED. Phone/Fax (01255) 861161.

For rates and information on display and classified advertising please contact our Advertisement Manager, Peter Mew as above.

## TOTALROBOTS

### ROBOTICS, CONTROL & ELECTRONICS TECHNOLOGY

High quality robot kits and components  
UK distributor of the OOPic microcontroller

Secure on-line ordering  
Rapid delivery  
Highly competitive prices

Visit [www.totalrobots.com](http://www.totalrobots.com)

**Tel: 0208 823 9220**

## X-10® Home Automation We put you in control™

### Why tolerate when you can automate?

An extensive range of 230V X-10 products and starter kits available. Uses proven Power Line Carrier technology, no wires required.

Products Catalogue available Online.

Worldwide delivery.

### Laser Business Systems Ltd.

E-Mail: [info@laser.com](mailto:info@laser.com)

<http://www.laser.com>

Tel: (020) 8441 9788

Fax: (020) 8449 0430



## www.kidstuff.co.uk

**Build your own Robot** at the Windmill Workshops! **2 days** of Robot fun for all ages. Learn soldering, electronics, Micro Controllers and much more!  
**£78**  
Tel: 01225 760629 or Book online NOW!

Also: Program in **BASIC**, using the AVR Powerful 'TINY 26' Micro Controller.

Inc: BASIC language(2K), 128 BYTE EEPROM, Programming Lead, Chip, 10 BIT ADs.16 MHZ, 16 I/O Pins & more!  
No crystal Req. Simple and cost effective, far superior to other chips. This is what we have waited for! Further chips £4.50

**£35**

## VVT TRANSFORMERS

Transformers and Chokes for all types of circuits including specialist valve units

Custom design or standard range  
High and low voltage

### Variable Voltage Technology Ltd

Unit 3, Sheat Manor Farm, Chillerton,  
Newport, Isle of Wight, PO30 3HP

Tel: 0870 243 0414 Fax: 01983 280593

email: [sales@vvt-cowes.freemove.co.uk](mailto:sales@vvt-cowes.freemove.co.uk)

[www.vvttransformers.co.uk](http://www.vvttransformers.co.uk)

## BTEC ELECTRONICS TECHNICIAN TRAINING

VCE ADVANCED ENGINEERING

ELECTRONICS AND ICT

HNC AND HND ELECTRONICS

NVQ ENGINEERING AND IT

**PLEASE APPLY TO COLLEGE FOR  
NEXT COURSE DATE**

**FULL PROSPECTUS FROM**

**LONDON ELECTRONICS COLLEGE  
(Dept EPE) 20 PENYWERN ROAD  
EARLS COURT, LONDON SW5 9SU  
TEL: (020) 7373 8721**

## Z88 NOW AVAILABLE WITH 128K AND 512K - OZ4

### ALSO SPECTRUM AND QL PARTS

**W. N. RICHARDSON & CO.**

PHONE/FAX 01494 871319

E-mail: [wnr@compuserve.com](mailto:wnr@compuserve.com)

RAVENSMED, CHALFONT ST PETER, BUCKS, SL9 0NB

## JJJ Electronic Kits

Electronic kits for students and hobbyists.  
Quality PC Board, reasonable prices. All kits are fully assembled. Check our products on <http://www.geocities.com/jjjelectronickit>

## Cooke International

[www.cooke-int.com](http://www.cooke-int.com)

Electronic Test &  
Measuring Equipment

Tel: (+44) 0 1243 55 55 90

Operating & Service Manuals

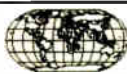

## BOWOOD ELECTRONICS LTD

Contact Will Outram for your  
Electronic Components

Email: [sales@bowood-electronics.co.uk](mailto:sales@bowood-electronics.co.uk)

Web: [www.bowood-electronics.co.uk](http://www.bowood-electronics.co.uk)

7 Bakewell Road, Baslow, Derbyshire DE45 1RE

Tel/Fax: 01246 583777

Send 41p stamp for catalogue

## FOR SALE

Hameg Spectrum Analyser HM5014 (boxed, unused), £1,000; Hameg HZ530 Nearfield Probe Kit (boxed, unused), £250; Hameg 20MHz HM203-6 Oscilloscope (calibrated), £150; Thurlby-Thander 1750 DMM (boxed, unused), £150; Thurlby-Thander Single Output Bench Power Supply, £50.

**Tel: 01922 631465.**

## CIRCUIT & PCB DESIGN

Circuit & PCB Design offers a quality design service, we produce professional schematic diagrams, prototypes and design multi-layer p.c.b.s complete with parts lists and full working drawings. We can either provide p.c.b. artworks or professionally made p.c.b.s. No job too small or large.

**Email Nick on [nwhitehouse@cix.co.uk](mailto:nwhitehouse@cix.co.uk).**

## Ervan International Co.

Discount Prices

Ultra-bright I.e.d.s. I.e.d. cluster kits,  
flashlights, laser pointers.

[www.ervan-int.com](http://www.ervan-int.com)

Tel/Fax: +44 117 3301711

## PC Oscilloscope & Signal Generator



Affordable Digital PC Oscilloscope and Signal Generator. Plugs into printer port. Samples at up to 20MHz or 30MHz. Generates sine, triangular, saw, square and sweep wave. Custom wave downloaded and output at 20MHz or 30MHz step rates.

Prices from £139.00

Visit [www.cisystem.co.uk](http://www.cisystem.co.uk) or call 07986 860815

## Miscellaneous

**FREE PROTOTYPE PRINTED CIRCUIT BOARDS!** Free prototype p.c.b. with quantity orders. Call Patrick on 028 9073 8897 for details. Agar Circuits, Unit 5, East Belfast Enterprise Park, 308 Albertbridge Road, Belfast BT5 4GX.

**PRINTED CIRCUIT BOARDS - QUICK SERVICE.** Prototype and production artwork raised from magazines or draft designs at low cost. PCBs designed from schematics. Production assembly, wiring and software programming. For details contact Patrick at Agar Circuits, Unit 5, East Belfast Enterprise Park, 308 Albertbridge Road, Belfast, BT5 4GX. Phone 028 9073 8897, Fax 028 9073 1802. Email [agar@argonet.co.uk](mailto:agar@argonet.co.uk).

**G.C.S.E. ELECTRONICS KITS, TOOLS,** pocket money prices. S.A.E. for free catalogue. SIR-KIT Electronics, 52 Severn Road, Clacton, CO15 3RB. [www.geocities.com/sirkituk](http://www.geocities.com/sirkituk). **VALVES AND ALLIED COMPONENTS IN STOCK** - please ring for free list. Valve equipment repaired. Geoff Davies (Radio). Phone 01788 574774.

**KITS OF COMPONENTS** for *Everyday Practical Electronics* projects now being produced by metaStable Electronics. Visit [www.metastable.electronics.btinternet.co.uk](http://www.metastable.electronics.btinternet.co.uk), or send large s.a.e. for details to metaStable Electronics, PO Box 3103, Sheffield S11 7WW.

## YOUR FUTURE LOOKS BRIGHT WITH ICS

Make a real success of yourself by gaining the vital skills and qualifications you need with an ICS home study course. You learn in your own time, at your own pace and from the comfort of your home. And with over 13 million successful students, you'll be joining the most experienced home study school in the world. You can do it with ICS! So why not improve your job prospects today by calling us now or returning the coupon below.

Electrical Contracting & Installation  
Electrical Engineering  
C&G Basic Electronic Engineering  
C&G Basic Mechanical Engineering  
TV & Video Servicing  
Radio & Hi-Fi Servicing  
Refrigeration, Heating & Air Conditioning  
Motorcycle & ATV Repair

**FREEPHONE 0500 581 557 www.icslearn.co.uk**

Or write to International Correspondence Schools, FREEPOST 882, 8 Elliot Place, Clydeside Skypark, Glasgow, G3 8BR. Tel: 0500 581 557 or from Eire call 1800 620 490

Please send me my Free information on your Technical Courses.

Mr/Ms/Miss  
(BLOCK CAPITALS PLEASE)

Date of Birth / /

Address

Postcode

Email

Tel No

From time to time we permit other carefully screened organisations to write to you about products and services. If you prefer not to hear from such organisations please tick box

Dept ZEEVC1B3

Autonomous Programmable Robot Kits  
Accessories - Sensors - Controller Boards

**competition-robotics.com**

Secure on-line ordering. Fast, friendly service.

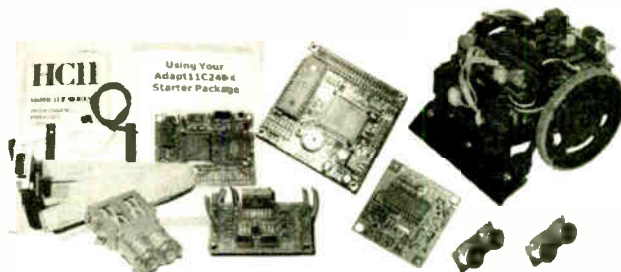

Web: www.competition-robotics.com

Tel: 01793 636119 Fax: 01793 705772  
e-Mail: sales@competition-robotics.com

## N. R. BARDWELL LTD (Est. 1948)

100	Signal Diodes 1N4148	£1.00	80	Ass'd. capacitors 1nF to 1µF	£1.00
75	Rectifier Diodes 1N4001	£1.00	200	Ass'd. disc ceramic capacitors	£1.00
50	Rectifier Diodes 1N4007	£1.00	50	Ass'd. Seal Presets (sm, stand, cement)	£1.00
10	W01 Bridge Rectifiers	£1.00	50	Ass'd. RF chokes (inductors)	£1.00
10	555 Timer I.C.s	£1.00	50	Ass'd. grommets	£1.00
4	741 Op Amps	£1.00	80	Ass'd. solder tags, p/conn, terminals	£1.00
50	Assorted Zener Diodes 400mW	£1.00	10	Ass'd. crystals - plug in	£1.00
12	Assorted 7-segment Displays	£1.00	8	Ass'd. di switches	£1.00
25	5mm I.e.d.s. red, green or yellow	£1.00	20	Miniature slide switches sp/co	£1.00
25	3mm I.e.d.s. red, green or yellow	£1.00	8	Ass'd. push-button switches, multi-bank, multi-pole	£1.00
75	5mm I.e.d.s. green, 6.5mm legs	£1.00	30	Ass'd. di sockets up to 40 way	£1.00
50	Axial I.e.d.s. 2mcd red Diode Package	£1.00	10	TV coax plugs, plastic	£1.00
25	Ass'd. High Brightness I.e.d.s. var coats	£1.00	40	metres very thin connecting wire, red	£1.00
20	BC182L Transistors	£1.00	20	1m glass reed switches	£1.00
25	BC212L Transistors	£1.00	10	Ass'd. IFTs (no data)	£1.00
30	BC237 Transistors	£1.00	100	Any one value ¼W 5% of resistors range 1R to 10M	£0.45
20	BC327 Transistors	£1.00	10	7812 Voltage Regulators	£1.00
30	BC328 Transistors	£1.00	300	Ass'd. resistors, ¼W/½W, mostly on tapes	£1.00
30	BC547 Transistors	£1.00			
20	BC547B Transistor	£1.00			
30	BC548 Transistors	£1.00			
30	BC549 Transistors	£1.00			
25	BC557 Transistors	£1.00			
30	BC558 Transistors	£1.00			
30	BC559 Transistors	£1.00			
20	2N3904 Transistors	£1.00			
100	1nF 50V wkg Axial Capacitors	£1.00			
100	4N7 50V wkg Axial Capacitors	£1.00			
80	Ass'd. capacitors electrolytic	£1.00			
40	Ass'd. Radial Electrolytics, 4.7-2200µF	£1.00			

288 Abbeydale Road, Sheffield S7 1FL

Phone: 0114 255 2886 ★ Fax: 0114 255 5039

e-mail: sales@bardwells.co.uk ★ Web: www.bardwells.co.uk

Prices include VAT. Postage £1.65

44p stamp for lists or disk

POs, Cheques and Credit Cards accepted

## DIGITAL TEST METER

Built-in transistor test socket and diode test position.  
DC volts 200mV to 1000V.  
AC volts 200V to 750V.  
DC current 200mA to 10A.  
Resistance 200 ohms to 2000K ohms.

**£5.99** incl. VAT

SEE OUR WEB PAGES FOR MORE COMPONENTS AND SPECIAL OFFERS  
[www.bardwells.co.uk](http://www.bardwells.co.uk)



# SQUIRES

## MODEL & CRAFT TOOLS

A COMPREHENSIVE RANGE OF MINIATURE HAND AND POWER TOOLS AND AN EXTENSIVE RANGE OF

### ELECTRONIC COMPONENTS

FEATURED IN A FULLY ILLUSTRATED

**624 PAGE MAIL ORDER CATALOGUE**

## 2003 ISSUE

**SAME DAY DESPATCH**

**FREE POST AND PACKAGING**

Catalogues: FREE OF CHARGE to addresses in the UK.  
Overseas: CATALOGUE FREE, postage at cost charged to credit card

## SHOP EXTENSION NOW OPEN

Squires, 100 London Road,  
Bognor Regis, West Sussex, PO21 1DD

TEL: 01243 842424

FAX: 01243 842525



## FRUSTRATED!

### Looking for ICs TRANSISTORS?

A phone call to us could get a result. We offer an extensive range and with a world-wide database at our fingertips, we are able to source even more. We specialise in devices with the following prefix (to name but a few).



2N 2SA 2SB 2SC 2SD 2P 2SJ 2SK 3N 3SK 4N 6N 17 40 AD  
ADC AN AM AY BA BC BD BDT BDV BDW BDX BF  
BFR BFS BFT BFX BFY BLY BLX BS BR BRX BRY BS  
BSS BSV BSW BSX BT BTA BTB BRW BU BUK BUT BUY  
BUW BUX BUY BUZ CA CD CX CXA DAC DG DM DS  
DTA DTC GL GM HA HCF HD HEF ICL ICM IRF J KA  
KIA L LA LB LC LD LF LM M M5M MA MAB MAX MB  
MC MDAJ MJE MJF MM MN MPS MPMA MPMS MPSP  
MRF NJM NE OM OP PA PAL PIC PN RC S SAA SAB  
SAD SAJ SAS SDA SG SI SL SN SO STA STK STR STRD  
STRM STRS SVI T TA TAA TAG TBA TC TCA TDA TDB  
TEA TIC TIP TIPL TEA TL TLC TMP TMS TPU U UA  
UAA UC UDN ULN UM UPA UPC UPD VN X XR Z ZN  
ZTX + many others

We can also offer equivalents (at customers' risk)

We also stock a full range of other electronic components  
Mail, phone, Fax Credit Card orders and callers welcome



Connect

## Cricklewood Electronics Ltd

40-42 Cricklewood Broadway London NW2 3ET  
Tel: 020 8452 0161 Fax: 020 8208 1441



# ELECTRONICS 2002



**FREE 304-page colour catalogue**

Great value for Speakers, Microphones, Headphones, Aerials, Transmitters, TV Ams, Plugs, Sockets, Leads, CD Storage Cases, CCTV Security, Connectors, Adaptors, Switch Boxes, Gadgets, Disco Lighting & Effects, Mixers, Amplifiers, Turntables, Musicians' Leads, Car Audio, Test Equipment, Hobby Kits, Computer Leads & Accessories, Power Supplies, Inverters, Transformers, Battery Chargers, Tools, Soldering, Switches, Fuses, Indicators, Cable & Wire, Crossovers, Speaker Hardware, PA Amps, and a great deal more... all for the price of a stamp.

**Sky Electronics**  
 40-42 Cricklewood Broadway,  
 London, NW2 3ET  
 Tel: 020 8450 0995  
 Fax: 020 8208 1441  
 Email: sales@cricklewoodelectronics.com  
 www.skyelectronics.co.uk

The Catalogue is FREE to shop callers or send £2 to cover postage.

## Watch Slides on TV.

Make videos of your slides. Digitise your slides (using a video capture card) "Liesgang diat" automatic slide viewer with built in high quality colour TV camera. It has a composite video output to a phono plug (SCART & BNC adaptors are available). They are in very good condition with few signs of use. More details see [www.diatv.co.uk](http://www.diatv.co.uk).  
 £91.91 + VAT = £108.00



Board cameras all with 512 x 582 pixels 8.5mm 1/3 inch sensor and composite video out. All need to be housed in your own enclosure and have fragile exposed surface mount parts. They all require a power supply of between 10V and 12V DC 150mA.

47MR size 60 x 36 x 27mm with 6 infra red LEDs (gives the same illumination as a small torch but is not visible to the human eye) £37.00 + VAT = £43.48  
 30MP size 32 x 32 x 14mm spy camera with a fixed focus pin hole lens for hiding behind a very small hole £35.00 + VAT = £41.13  
 40MC size 39 x 38 x 27mm camera for 'C' mount lens these give a much sharper image than with the smaller lenses £32.00 + VAT = £37.60  
 Economy C mount lenses all fixed focus & fixed iris  
 VSL1220F 12mm F1.6 12 x 15 degrees viewing angle £15.97 + VAT £18.76  
 VSL4022F 4mm F1-22 63 x 47 degrees viewing angle £17.65 + VAT £20.74  
 VSL6022F 6mm F1-22 42 x 32 degrees viewing angle £19.05 + VAT £22.38  
 VSL8020F 8mm F1-22 32 x 24 degrees viewing angle £19.90 + VAT £23.38

## Better quality C Mount lenses

VSL1614F 16mm F1-6 30 x 24 degrees viewing angle £26.43 + VAT £31.06  
 VWL813M 8mm F1.3 with iris 56 x 42 degrees viewing angle £77.45 + VAT = £91.00  
 1206 surface mount resistors E12 values 10 ohm to 1M ohm  
 100 of 1 value £1.00 + VAT 1000 of 1 value £5.00 + VAT

866 battery pack originally intended to be used with an orbital mobile telephone it contains 10 1-6Ah sub C batteries (42 x 22 dia. the size usually used in cordless screwdrivers etc.) the pack is new and unused and can be broken open quite easily  
 £7.46 + VAT = £8.77

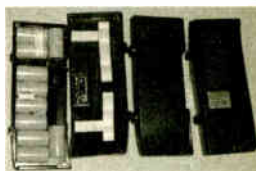

Please add £1.66 + vat = £1.95 postage & packing per order

## JPG Electronics

Shaws Row, Old Road, Chesterfield, S40 2RB.  
 Tel 01246 211202 Fax 01246 550959  
 Mastercard/Visa/Switch  
 Callers welcome 9.30 a.m. to 5.30 p.m. Monday to Saturday

## SHERWOOD ELECTRONICS

### FREE COMPONENTS

Buy 10 x £1 Special Packs and choose another one FREE

SP1 15 x 5mm Red LEDs SP2 12 x 5mm Green LEDs SP3 12 x 5mm Yellow LEDs SP6 15 x 3mm Red LEDs SP7 12 x 3mm Green LEDs SP8 10 x 3mm Yellow LEDs SP10 100 x 1N4148 diodes SP11 30 x 1N4001 diodes SP12 30 x 1N4002 diodes SP18 20 x BC182 transistors SP20 20 x BC184 transistors SP21 20 x BC212 transistors SP23 20 x BC549 transistors SP24 4 x CMOS 4001 SP25 4 x 555 timers SP26 4 x 741 Op.Amps SP28 4 x CMOS 4011 SP29 3 x CMOS 4013 SP34 20 x 1N914 diodes SP36 25 x 10/25V radial elect. caps. SP37 12 x 100/35V radial elect. caps. SP39 10 x 470/16V radial elect. caps. SP40 15 x BC237 transistors SP41 20 x Mixed transistors SP42 200 x Mixed 0.25W C.F. resistors SP47 5 x Min. PB switches SP49 4 x 5 metres stranded core wire SP102 20 x 8-pin DIL sockets SP103 15 x 14-pin DIL sockets SP104 15 x 16-pin DIL sockets SP105 4 x 74LS00 SP109 15 x BC557 transistors SP112 4 x CMOS 4093 SP115 3 x 10mm Red LEDs SP116 3 x 10mm Green LEDs SP124 20 x Assorted ceramic disc caps SP126 6 x Battery clips - 3 ea. PP3 + PP3 SP130 100 x Mixed 0.5W C.F. resistors SP131 2 x TL071 Op.Amps SP133 20 x 1N4004 diodes	SP134 15 x 1N4007 diodes SP135 6 x Miniature slide switches SP136 3 x BFY50 transistors SP137 4 x W005 1-5A bridge rectifiers SP138 20 x 2-2/63V radial elect. caps. SP140 3 x W04 1-5A bridge rectifiers SP142 2 x CMOS 4017 SP143 5 Pairs min. crocodile clips (Red & Black) SP145 6 x ZTX300 transistors SP146 10 x 2N3704 transistors SP147 5 x Stripboard 9 strips x 25 holes SP151 4 x 8mm Red LEDs SP152 4 x 8mm Green LEDs SP153 4 x 8mm Yellow LEDs SP154 15 x BC548 transistors SP156 3 x Stripboard, 14 strips x 27 holes SP160 10 x 2N3904 transistors SP161 10 x 2N3906 transistors SP165 2 x LF351 Op.Amps SP166 20 x 1N4003 diodes SP167 5 x BC107 transistors SP168 5 x BC108 transistors SP172 4 x Standard slide switches SP174 20 x 22/25V radial elect. caps. SP175 20 x 1/63V radial elect. caps. SP177 10 x 1A 20mm quick blow fuses SP182 20 x 4-7/63V radial elect. caps. SP183 20 x BC547 transistors SP187 15 x BC239 transistors SP189 4 x 5 metres solid core wire SF192 3 x CMOS 4066 SP195 3 x 10mm Yellow LEDs SP197 6 x 20 pin DIL sockets SP198 5 x 24 pin DIL sockets SF199 5 x 2.5mm mono jack plugs SP200 5 x 2.5mm mono jack sockets
--	--

**2003 Catalogue now available £1 inc. P&P or FREE with first order. P&P £1.50 per order. NO VAT**

Orders to:  
**Sherwood Electronics,**  
**7 Williamson St., Mansfield,**  
**Notts. NG19 6TD.**

<b>RESISTOR PACKS - C.Film</b>		
RP3	5 each value - total 365 0.25W	£3.10
RP7	10 each value - total 730 0.25W	£4.35
RP10	1000 popular values 0.25W	£6.15
RP4	5 each value-total 345 0.5W	£4.00
RP8	10 each value-total 690 0.5W	£6.65
RP11	1000 popular values 0.5W	£8.50

## ADVERTISERS INDEX

ANTEX .....	180
AUTOTRAX .....	196
N. R. BARDWELL .....	231
B.K. ELECTRONICS .....	Cover (iv)/193
BRUNNING SOFTWARE .....	190
BULL ELECTRICAL .....	Cover (ii)
CRICKLEWOOD ELECTRONICS .....	231
CROWNHILL ASSOCIATES .....	Cover (iii)
DISPLAY ELECTRONICS .....	162
ENERGISE TECHNOLOGY .....	231
ESR ELECTRONIC COMPONENTS .....	170
FOREST ELECTRONIC DEVELOPMENTS .....	167
ICS .....	231
JPG ELECTRONICS .....	232
LABCENTER .....	181
MAGENTA ELECTRONICS .....	168/169
MATRIX MULTIMEDIA .....	204
MILFORD INSTRUMENTS .....	177
PEAK ELECTRONIC DESIGN .....	209
PICO TECHNOLOGY .....	216
QUASAR ELECTRONICS .....	164/165
SHERWOOD ELECTRONICS .....	232
SKY ELECTRONICS .....	232
SQUIRES .....	231
STEWART OF READING .....	166
TECHNOBOTS .....	189
TOTAL ROBOTS .....	204
VANN DRAPER ELECTRONICS .....	193
WCN SUPPLIES .....	166

**ADVERTISEMENT MANAGER: PETER J. MEW**  
**ADVERTISEMENT OFFICES:**  
 EVERYDAY PRACTICAL ELECTRONICS, ADVERTISEMENTS,  
 MILL LODGE, MILL LANE, THORPE-LE-SOKEN,  
 ESSEX CO16 0ED.  
 Phone/Fax: (01255) 861161

*For Editorial address and phone numbers see page 171*



# PIC BASIC

Crownhill Associates

smart electronic solutions

The most cost effective solution to PIC programming and development - Ever!!

## Proton <sup>New Improved</sup> LET PIC BASIC

- ReWritten from the ground up
- Best Value For Money
- Most powerful entry level compiler
- 100% MPASM™ compatibility
- Windows™ 98,ME,2000,NT & XP compliant
- Real-Time Syntax checking
- Integrated PIC Programmer driver
- Program with one keystroke
- View BASIC and the resulting Assembly
- Supplied with book "LET PIC BASIC Unleashed" by Les Johnson

Free Evaluation copy from:  
[www.picbasic.org](http://www.picbasic.org)

LET PIC BASIC £65.00

## Proton <sup>ACCESS THE WORLD OF</sup> SMART SMART CARDS

### PIC BASIC Smart Card Development system

Another First from Crownhill, access the world of SMART CARDS using PIC BASIC. This versatile development system provides a platform for the development of applications using SMART memory cards and SECURE memory cards. Detailed documentation describes all aspects of development using the sample cards supplied, source code and circuit diagrams are included.

- Includes card Reader Writer hardware and circuit
- Integrated Boot Loader - No programmer required
- Sample cards. Documentation
- Fully commented LICENSE FREE Source code

Proton Smart from £59.95

8 smart cards in stock over 28 types and 40,000 smart cards in stock over 28 types

## Proton <sup>LCD</sup> LCD

2 x16 serial LCD display, supplied as a kit or ready assembled. PCB, PICmicro, LCD display, Circuit, LICENSE FREE commented source code

Proton LCD £16.95

## Proton <sup>PIC BASIC Plus</sup> v2

- Windows™ Integrated Development Environment
- Integrated serial bootloader software  
"program without a programmer!"
- Support for 12/14/18bit series devices
- Handles 32bit signed and unsigned variables  
(numbers up to ± 2147483647)
- Specific commands for on-chip peripherals
- Comprehensive command set
  - Tighter code generation than MBASIC
  - More functionality than MELABS PICBASIC Pro
  - More flexible than all BASIC Stamps
- Integrates directly into Proteus VSM - allows you to build a virtual circuit and see your BASIC code run in real-time - see [www.labcenter.co.uk](http://www.labcenter.co.uk)
- Easy macro Integration  
(includes Floating pointmath example)
- Aimed at graduates, and professionals, all code produced is LICENCE FREE

Free Evaluation copy from:  
[www.picbasic.org](http://www.picbasic.org)

Crownhill PIC BASICv2 £125.00

## Proton <sup>NET</sup> PIC BASIC / InterNet Development System

The worlds First PIC BASIC InterNet development system allowing PIC BASIC projects to communicate across the WORLD via the InterNet. Development board includes RS232, Ethernet Interface and dedicated controller, LCD, Prototype area, Power supply and full documentation.

Proton Net £169.95

Visit [www.picbasic.org](http://www.picbasic.org) for comprehensive details of these and other PIC BASIC products, including:



Full range of DEVELOPMENT boards, incl Graphics LCD's and Audio



[www.labcenter.co.uk](http://www.labcenter.co.uk)  
Proteus VSM Fully supported by PICBASIC Plus



Infra RED TX and Rx development system, with experiments and source code

www.picbasic.org

32 Broad Street, Ely, Cambs, CB7 4AH United Kingdom Tel: +44 (0) 1353 666709 Fax: +44 (0) 1353 666709

All prices subject to Postage Packing and VAT

All major credit cards accepted, telephone, web or mail order.





# POWER AMPLIFIER MODULES-LOUDSPEAKERS-MIXERS 19 INCH STEREO AMPLIFIERS-ACTIVE CROSS/OVERS.

\* PRICES INCLUDE V.A.T.  
\* PROMPT DELIVERY

## OMP MOS-FET POWER AMPLIFIERS HIGH POWER, TWO CHANNEL 19 INCH RACK

10,000'S  
SOLD  
TO PRO  
USERS



### THE RENOWNED MXF SERIES OF POWER AMPLIFIERS

FOUR MODELS:- MXF200 (100W + 100W) MXF400 (200W + 200W)  
MXF600 (300W + 300W) MXF900 (450W + 450W)

ALL POWER RATINGS ARE R.M.S. INTO 4 OHMS, WITH BOTH CHANNELS DRIVEN  
FEATURES:- \* Independent power supplies with two toroidal transformers  
\* Twin L.E.D. Vu Meters \* Level controls \* Illuminated on/off switch \* Jack / XLR inputs  
\* Speakon Outputs \* Standard 775mv inputs \* Open and Short circuit proof \* Latest Mos-Fets  
for stress free delivery into virtually any load \* High slew rate \* Very low distortion \* Aluminium  
cases \* MXF600 & MXF900 fan cooled with D.C. Loudspeaker and thermal protection.

USED THE WORLD OVER IN CLUBS, PUBS, CINEMAS, DISCOS ETC

SIZES:-  
MXF200 W19" D11" H3 1/2" (2U)  
MXF400 W19" D12" H5 1/2" (3U)  
MXF600 W19" D13" H5 1/2" (3U)  
MXF900 W19" D14" H5 1/2" (3U)

PRICES:- MXF200 £175.00 MXF400 £233.85  
MXF600 £329.00 MXF900 £449.15  
SPECIALIST CARRIER DEL £12.50 Each



## FLIGHT CASED LOUDSPEAKERS

A new range of quality loudspeakers, designed to take advantage of latest loudspeaker technology and enclosure designs. All models utilise high quality studio cast aluminium loudspeakers with factory fitted grilles, wide dispersion constant directivity horns, extruded aluminium corner protection and steel ball corners, complimented with heavy duty black covering. The enclosures are fitted as standard with top hats for optional loudspeaker stands. The FC15-300 incorporates a large 16 X 6 inch horn. All cabinets are fitted with the latest Speakon connectors for your convenience and safety. Five models to choose from.



PLEASE NOTE:- POWER RATINGS  
QUOTED ARE IN WATTS R.M.S. FOR  
EACH INDIVIDUAL CABINET ALL  
ENCLOSURES ARE 8 OHMS

15=15 Inch speaker  
12=12 Inch speaker

- ibl FC15 300 WATTS Freq Range 35Hz-20kHz, Sens 101dB, Size H695 W502 D415mm  
Price:- £299.00 per pair
- ibl FC12-300 WATTS Freq Range 45Hz-20kHz, Sens 96dB, Size H600 W405 D300mm  
Price:- £249.00 per pair
- ibl FC12-200 WATTS Freq Range 40Hz-20kHz, Sens 97dB, Size H600 W405 D300mm  
Price:- £199.00 per pair
- ibl FC12-100 WATTS Freq Range 45Hz-20kHz, Sens 100dB, Size H546 W380 D300mm  
Price:- £179.00 per pair
- ibl WM12-200 WATTS Freq Range 40Hz-20kHz, Sens 97dB, Size H418 W600 D385mm  
Price:- £125.00 Each

SPECIALIST CARRIER DEL:- £12.50 per pair, wedge monitor £7.00 each  
Optional Metal Stands PRICE:- £49.00 per pair Delivery:- £6.00

## CATALOGUE 2001-2002

Robots  
Test & Testis  
Electronic Kits  
The Sky's  
The Limit  
Catalogue  
Communication  
u's The Limit From & Security  
E lectronics  
Unit 1, Comet Way, Southend-on-Sea,  
Essex, SS2 6TR  
Tel: 01702 527572 Fax: 01702-420243  
Email: sales@bkelec.com  
Web Site: http://www.bkelec.com

## OMP X03-S STEREO 3 WAY ACTIVE CROSSOVER SWITCHABLE 2-WAY



FEATURES:-  
Advanced 3-Way Stereo Active Cross-Over (Switchable two way), housed in a 19" x 1U case. Each channel has three level controls: Bass, Mid & Top. The removable front fascia allows access to the programmable DIL switches to adjust the cross-over frequency. There are two versions available:- X03-S Bass-Mid 125/250/500Hz, Mid-Top 1.8/3/5kHz, all at 24 dB per octave. X03 Bass-Mid 250/500/800Hz, Mid-Top 1.8/3/5kHz, all at 24 dB per Octave. Please make sure you ask for the correct model when ordering. The 2/3 way selector switches are also accessed by removing the front fascia. Each stereo channel can be configured separately. Bass Invert Switches are incorporated on each channel. Nominal 775mV input/output. Fully compatible with the OMP Rack Amplifier and Modules.

BOTH MODELS PRICED AT :- £117.44 + £5.00 P&P

## OMP MOS-FET POWER AMPLIFIER MODULES SUPPLIED READY BUILT AND TESTED

These modules now enjoy a world-wide reputation for quality, reliability and performance at a realistic price. Four models are available to suit the needs of the professional and hobby market i.e. Industry, Leisure, Instrumental and Hi-Fi etc. When comparing prices NOTE that all models include toroidal power supply, integral heatsink, glass fibre P.C.B. and drive circuits to power a compatible Vu meter. All models are open and short circuit proof.

### THOUSANDS OF MODULES PURCHASED BY PROFESSIONAL USERS

- OMP/MF 100 Mos-Fet Output Power 110 watts R.M.S. into 4 ohms, frequency response 1Hz - 100kHz -3dB, Damping Factor >300, Slew Rate 45V/uS, T.H.D. typical 0.002%, Input Sensitivity 500mV, S.N.R. 110dB, Size 300 x 123 x 60mm  
Price:- £42.85 + £4.00 P&P
- OMP/MF 200 Mos-Fet Output Power 200 watts R.M.S. into 4 ohms, frequency response 1Hz - 100kHz -3dB, Damping Factor >300, Slew Rate 50V/uS, T.H.D. typical 0.001%, Input Sensitivity 500mV, S.N.R. 110dB, Size 300 x 155 x 100mm.  
Price:- £66.35 + £4.00 P&P
- OMP/MF 300 Mos-Fet Output Power 300 watts R.M.S. into 4 ohms, frequency response 1Hz - 100kHz -3dB, Damping Factor >300, Slew Rate 60V/uS, T.H.D. typical 0.001%, Input Sensitivity 500mV, S.N.R. 110dB, Size 330 x 175 x 100mm.  
Price:- £83.75 + £5.00 P&P
- OMP/MF 450 Mos-Fet Output Power 450 watts R.M.S. into 4 ohms, frequency response 1Hz - 100kHz -3dB, Damping Factor >300, Slew Rate 75V/uS, T.H.D. typical 0.001%, Input Sensitivity 500mV, S.N.R. 110dB, Fan Cooled, D.C. Loudspeaker Protection, 2 Second Anti Thump Delay, Size 385 x 210 x 105mm.  
Price:- £135.85 + £6.00 P&P
- OMP/MF 1000 Mos-Fet Output Power 1000 watts R.M.S. into 2 ohms, frequency response 1Hz - 100kHz -3dB, Damping Factor >300, Slew Rate 75V/uS, T.H.D. typical 0.001%, Input Sensitivity 500mV, S.N.R. 110dB, Fan Cooled, D.C. Loudspeaker Protection, 2 Second Anti Thump Delay, Size 422 x 300 x 125mm.  
Price:- £261.00 + £12.00 P&P

NOTE: MOS-FET MODULES ARE AVAILABLE IN TWO VERSIONS: STANDARD - INPUT SENS 500mV/BANDWIDTH 100kHz OR PEC (PROFESSIONAL EQUIPMENT COMPATIBLE) - INPUT SENS 775mV, BANDWIDTH 50kHz ORDER STANDARD OR PEC

## 100 WATT ACTIVE SUB BASS AMPLIFIER PANEL



AN ACTIVE SUB BASS AMPLIFIER WITH A TRUE 100W RMS OUTPUT, SUPERB CONSTRUCTION WITH THE FACILITIES TO INTEGRATE SEAMLESSLY INTO MOST HI-FI OR HOME CINEMA SETUPS. USE THIS PANEL PLUS ONE OF OUR LOUDSPEAKERS TO MAKE YOUR OWN SUB WOOFER THAT WILL MATCH OR BEAT MOST COMMERCIALLY AVAILABLE SUB WOOFERS.

FEATURES:- \* 100W RMS INTO 8 OHMS \* HIGH AND LOW LEVEL INPUTS \* TOROIDAL TRANSFORMER \* SHORT CIRCUIT PROTECTION \* D.C. SPEAKER PROTECTION \* FREQUENCY ROLL OFF, LOWER 10Hz, UPPER 60Hz TO 240Hz (FULLY ADJUSTABLE) \* AC3 COMPATIBLE FILTER CAN BE BYPASSED FOR 5-1 FORMATS. \* AIRTIGHT CONSTRUCTION \* TENS OF THOUSANDS OF OUR PANELS ALREADY IN USE. \* COMPLETE WITH LEADS

SPECIFICATIONS:- \* POWER 100W RMS @ 8 OHMS \* FREQ RANGE 10Hz 15KHz -3dB \* DAMPING FACTOR >200 \* DISTORTION 0.05% \* S/N A WEIGHTED >100dB \* SUPPLY 230V A.C. \* WEIGHT 2.7Kg \* SIZE H254 X W254 X D94mm

THERE ARE 2 VERSIONS OF THE ABOVE PANEL AVAILABLE :- **BSB100/8 8 OHM VERSION** BSB100/4 4 OHM VERSION BOTH PANELS ARE PRICED AT £117.44 + £5.00 P&P INCL. V.A.T. CHECK WEBSITE FOR PANELS UP TO 500W

DELIVERY CHARGES:- PLEASE INCLUDE AS ABOVE, TO A MAXIMUM AMOUNT £30.00. OFFICIAL ORDERS FROM SCHOOL, COLLEGES, GOVT., PLCs ETC. PRICES INCLUSIVE OF V.A.T. SALES COUNTER. CREDIT CARD ORDERS ACCEPTED BY POST PHONE OR FAX.

# B.K. ELECTRONICS REF D5

UNIT 1 COMET WAY, SOUTHEND-ON-SEA, ESSEX. SS2 6TR.  
TEL.: 01702-527572 FAX.: 01702-420243  
Web:- <http://www.bkelec.com> E-Mail [sales@bkelec.com](mailto:sales@bkelec.com)