

THE No.1 MAGAZINE FOR ELECTRONICS TECHNOLOGY & COMPUTER PROJECTS

EVERYDAY

JUNE 2002

PRACTICAL

ELECTRONICS

£2.85

BIOPIC Electrocardiograph



NOW AVAILABLE TO BUY ON THE WEB
EPe
www.epemag.com



WORLD LAMP
Cheap, simple
& efficient

**FREQUENCY
STANDARD**

High precision 1Hz
to 100kHz source

**SIMPLE AUDIO
CIRCUITS - 2**

Preamplifiers,
tone controls & filters

PLUS

**Ingenuity Unlimited
Circuit Surgery • Net Work**

<http://www.epemag.wimborne.co.uk>



GAS MASKS RUSSIAN, new and boxed, NATO filter, £39.
LOW COST NIGHT VISION system, Russian handheld complete with infra-red illuminator, 100m range. Runs on 2 AA batteries, just £109.95
COBRA NIGHT VISION equipment also stocked, more info on our web site at www.cobra-optics.co.uk.
ELECTRIC SCOOTERS 18kph, 24V motor, 6 hour charge time, 22kg weight, max load 90kg, running time up to 1 hour, range 15km, 8.5A motor, 24V, direct drive. Our Price £229.95. Ref ESCOOT.
VOICE CHANGERS Hold one of these units over your phone mouthpiece and you can adjust your voice using the controls on the unit. Battery operated, £15. Ref CC3.
EMMINENCE LOUDSPEAKERS 12in. dia., 50W nom, 100W peak, 16 ohm impedance, Pack of 4 just £39.95. Ref SPEAK39.
PIR SECURITY SWITCHES These brand new swivel mounting PIR units will switch up to 2 kilowatts, Adjustable sensitivity, light level and time delay (9 seconds to 10 minutes), 15m detection range, mains operated, waterproof, £5.99 Ref PIR1PACK or a pack of 5 for £22.95 Ref PIR5PACK or 10 for £39.95 Ref PIR10PACK.
12V 12AH SEALED LEAD ACID BATTERIES, 100mm x 150mm x 95mm, 4kg, £15 each. Ref SSLB.
SEALED LEAD-ACID CHARGER AND FLOAT CHARGER. Complete unit will charge 12V lead acids and maintain them with an automatic trickle charger. Charger on its own is £15 Ref LAC or charger and a 12V 12Ah battery (all fully cased) is £25 Ref ACB.
AERIAL PHOTOGRAPHY KIT. This rocket comes with a built-in camera! It flies up to 500 feet (150m), turns over and takes an aerial photograph of the ground below. The rocket then returns with its film via its parachute. Takes 110 film. Supplied with everything including a launch pad and 3 motors (no film), £29.98 Ref Astro.
BUILD YOUR OWN WINDFARM FROM SCRAP. New publication gives step-by-step guide to building wind generators and propellers. Armed with this publication and a good local scrapyard could make you self-sufficient in electricity! £12. Ref LOT81.
MAGNETIC CREDIT CARD READERS AND ENCODING INFO, £9.95. Cased with filelays, designed to read standard credit cards! Complete with control electronics p.c.b. and manual covering everything you could want to know about what's hidden in that magnetic strip on your card! Just £9.95 Ref BAR31.
77 KILO LIFT MAGNET. These Samarium magnets measure 57mm x 20mm and have a threaded hole (5/16th UNF) in the centre and a magnetic strength of 2.2 gauss. We have tested these on a steel beam running through the offices and found that they will take more than 170lb. (77kg) in weight before being pulled off. Supplied with keeper, £19.95 ea. Ref MAG77.
HYDROGEN FUEL CELL PLANS. Loads of information on hydrogen storage and production. Practical plans to build hydrogen fuel cell (good workshop facilities required). £8 set. Ref FCP1.
STIRLING ENGINE PLANS. Interesting information pack covering all aspects of Stirling engines, pictures of home made engines made from an aerosol can running on a candle! £12 STIR2.
12V OPERATED SMOKE BOMBS. Type 3 is a 12V trigger and 3 smoke canisters, each canister will fill a room in a very short space of time! £14.99. Ref SB3. Type 2 is 20 smaller canisters (suitable for mock equipment fires etc.) and 1 trigger module for £29. Ref SB2. Type 1 is a 12V trigger and 20 large canisters, £49. Ref SB1.
BRAND NEW NATO ISSUE RADIATION DETECTORS, SALE PRICE JUST £69.95. Current NATO issue standard emergency services unit. Used by most of the world's military personnel. New and boxed, Normal retail price £400. Bull's bargain price just £69.95. Ref PDRM.
BASIC GUIDE TO BIO DIESEL. How to make diesel fuel from used kitchen oil, £6. Ref BIOF.
SAVE ££££s. RCB UNITS. Inline IEC lead with fitted RC breaker. Installed in seconds. Fit to any computer, monitor, office equipment and make it safe! Pack of 10 just £9.98. Ref LOT5B.
INFRA-RED REMOTE CONTROL WATCHES, £16.99.
VIBRATING WATCHES, vibrate when your phone rings, £16.99.
PULSE WATCHES, display your pulse, £16.99.
www.quemex.co.uk
STEPPER MOTORS. Brand new stepper motors, 4mm fixing holes with 47-14mm fixing centres, 20mm shaft, 6.35mm diameter, 5V/phase, 0.7A/phase, 1-8 deg. step (200 step). Body 56mm x 36mm, £14.99 each. Ref STEP6, pack of 4 for £49.95.
BASIC GUIDE TO LOCKPICKING. New publication gives you an insight! £6. Ref LPK.
NEW HIGH POWER MINI BUG. With a range of up to 800 metres and 3 days use from a PP3 this is our top selling bug! Less than 1in. square and a 10m voice pick-up range. £28. Ref LOT102.
IR LAMP KIT. Suitable for CCTV cameras, enables the camera to be used in total darkness! £6. Ref FFI38.
INFRA-RED POWERBEAM. Handheld battery powered lamp, 4in. reflector, gives out powerful pure infra-red light! Perfect for CCTV use, night sights, etc. £29. Ref PB1.
YOUR HOME COULD BE SELF-SUFFICIENT IN ELECTRICITY. Comprehensive plans with loads of info on designing systems, panels, control electronics etc. £7. Ref PV1.
200 WATT INVERTERS, plugs straight into your car cigarette lighter socket and is fitted with a 13A socket so you can run your mains operated devices from your car battery, £49.95. Ref SS66.
THE TRUTH MACHINE. Tells if someone is lying by micro tremors in their voice, battery operated, works in general conversation and on the phone and TV as well! £42.49. Ref TD3.
INFRA-RED FILM. 6in. square piece of flexible infra-red film that will only allow IR light through. Perfect for converting ordinary torches, lights, headlights etc. to infra-red output using only standard light bulbs. Easily cut to shape, 6in. square, £15. Ref IIRF2 or a 12in. square for £29.95. Ref IIRF2A.
SMOKE ALARMS. Mains powered, made by the famous Gent company, easy fit next to light fittings, power point. Pack of 5 £15. Ref SS23, pack of 12 £24. Ref SS24.
CCTV CAMERAS FROM £25. Check out our web site at www.ccvistuff.co.uk and www.home-ctv.co.uk.
14 WATT SOLAR PANELS. Amorphous silicon panel fitted in an anodised aluminium frame. Panel measures 3ft. by 1ft. with 3m leads for easy connection. 3ft. x 1ft. solar panel £79. Ref MAG45. Unframed 4 pack, 8-9W (3ft. x 1ft), £99. Ref SOLX. 35 watts of solar power for just £99. 4 panels, each one 3ft. x 1ft. and producing 8W min., 13V. Pack of four £99. Ref SOLX.

POWERSAFE DEEP CYCLE BATTERIES



6V 100AH £39 EACH

NEW 12V 12in. SQUARE SOLAR PANEL. Kevlar backed, 3 watt output, copper strips for easy solder connectors. £14.99 Ref 15PA2. Pack of four just £39.95. Ref 15PA2SP.
NEW UNIVERSAL SOLAR CHARGER. Charges AAAs, AAs, Cs and D-type NiCads. £9.99. Ref UNISOL.
12V SOLAR POWER WATER PUMP. Perfect for many 12V d.c. uses, from solar fountains to hydroponics! Small and compact yet powerful, works direct from our 10W solar panel in bright sun. Max HD: 17ft, max flow = 8 Lpm, 1.5A. Ref AC88, £18.99.
SOLAR MOTORS. Tiny motors which run quite happily on voltages from 3V-12V d.c. Works on our 6V amorphous 6in. panels and you can run them from the sun! 32mm dia., 20mm thick, £1.50 each.
MAMOD STEAM ENGINES and a full range of spare parts. Check out www.mamodspares.co.uk.
SUPER WIDEBAND RADAR DETECTOR. Whistler 1630. Detects both radar and laser, X, K and KA bands, speed cameras and all known speed detection systems, 360 degree coverage, front and rear waveguides, 1.1in. x 2.7in. x 4.6in., fits on visor or dash, new low price £99. Ref WH1630. Other models available at www.radargun.co.uk.
BUG DETECTORS. A new detector at a sensible price! Detects bugs hidden in rooms, computers etc., between 1-200MHz, adjustable sensitivity, 9V PP3 battery required £29.95. Ref BDET2.
GIANT WEATHER BALLOONS made by Torex, we blew one up to 7ft. diameter then it popped due to stones on the ground! £13.99. Ref TOTEX.
PHILIPS VP406 LASER DISC PLAYERS, sale price just £9.95. Scarf output, just put your video disk in and press play, standard audio and video outputs. £9.95. Ref VP406.
12V DC SIRENS. Very loud, suitable for indoors or outdoors, two-tone, 160mm x 135mm, finished in white with bracket. £4.99. Ref SIRA.
FREEZER/MAINS FAIL ALARMS. Designed to fit around the mains cable on a freezer this alarm will sound if the device is unplugged from the mains supply, battery operated, cased, built-in sounder, ideal for TVs, Hi-Fi equipment etc. £7.01. Ref FREZ.
BARNET CROSSBOWS. We stock the entire range of crossbows, check out our web site at www.xbows.co.uk.
HOT AIR BALLOON KITS. Everything you need to build a 1-7m high, 4-5m in circum. hot air balloon, launch over a small burner or heater, £12.49. Ref HA1.
CROOKES RADIOMETER. Fascinating glass bulb contains blades driven around by the sun, £9.99. Ref SC120B.
GIANT TV OR PC VIEWING SCREEN. Turn your TV into a super-size screen, converts small screens into a super size 26in. £26.99. Ref SVGA2.
RADIOSONDES. Made by Valsala, unused, they measure pressure, temperature and humidity. Model RS80, good stripper at £15. Ref SONDE.
AIR WIND POWER MODULE. Produces nearly 400 watts of power from the wind, 1-14m blade, 12V d.c. output, 3 year warranty, built-in battery regulator, £549. Ref AIR1.
WORMERIES. The ideal solution for your kitchen waste! Supplied complete with worms. Turn your rubbish into liquid feed! Two sizes available, small (ideal for 1-2 people), £25.45. Ref WM2, and a large one (ideal for 4 or more), £42.44. Ref WM1.
COMPLETE WIRELESS CCTV SYSTEM. Includes monitor, camera, up to 100m range, audio and video, UK legal, complete with infra-red lights, £169. Ref WMS333.
PELTIER MODULES. 56W, 40mm x 40mm, 16V, sealed edges, new and boxed. Supplied with 18-page Pellier design manual featuring circuit designs, design information etc. 1 module and manual is £29.99. Ref PELT1, pack of 4 modules and manual is £99.99. Ref PELT2. The manual on its own is £4. Ref PELT3.
DC MOTOR. 12V d.c., general purpose model motor, 70mm x 50mm, 12V d.c., permanent magnet, 4mm x 25mm shaft, £6. Ref GPM1, pack of 10 is just £40. Ref GPM2.
180R.P.M. MAINS MOTOR. Induction type, 90mm x 70mm, 50mm x 5mm shaft, 12A continuous rating, thermal protected. £22. Ref MGM1.
SOLID STATE RELAYS. P.C.B. mounting, these relays require 3-32V d.c. to operate but will switch up to 3A a.c. mains. Pack of 4 £5. Ref SPEC1B.
12V RELAYS, 2 x 2 c/o 16A contacts p.c.b. mount (will fit Vero), tray of 25 relays for just £9.95. Ref SPEC1.
VENNER TIME CONTROLS. Designed to be wired in permanently they will switch up to 16A 240V a.c. motorised with dial and pins. New and boxed, £15. Ref VTS.
GYROSCOPES. We still sell original 1917 design, hours of fun for all the family, complete with stand, string, box and info. £6. Ref EP70.
INNOVATIONS. We also sell a wide range of innovative products for the home, these are at www.seemans.com.
INVERTERS. Convert 12V d.c. into 240V mains (modified sine wave), 300 watt (150 watt continuous), £59.95. Ref VER3. 600 watt model (330 watt continuous), £79.97. Ref VER4.
10 WATT SILICON SOLAR PANEL, 10 year life, waterproof, 365mm x 365mm x 26mm, 14V, 1.0kg, framed £84.99 Ref PAN.

STICKY LABELS. Small address labels etc. are very useful and can be ordered online at www.stickon.co.uk.
MICROSOFT TRACKBALL AND MOUSE. Called the Microsoft Ballpoint this has 4 buttons, a trackball and PS2 connector. Will work with most PCs. £5.99. Ref EP50.
MAXON WALKIE TALKIES, up to 2 mile range, UK legal, 300 channel, 2 x walkie talkies, £74.95. Ref. Maxon1. Chargers £14. Ref. Maxonc, battery packs £12. Ref. Maxonb (otherwise uses AAA batteries).
2-WAY MIRROR KIT. Contains enough material to make up to a 500mm x 2200mm mirror (excl. glass), full instructions, £19.95. Ref WF001.
.22 AIR RIFLE. Under lever type, powerful Chinese training rifle, £38.26. Ref A1047, 500 pellets, £2.68. Ref A1091.
.22 AIR RIFLE STANDARD TYPE. Chinese training rifle, on legal limit for air rifles, £29.75. Ref A1040. Pellets £2.68. Ref A1091.
SHUT THE BOX. Check out www.bullybeef.co.uk for a range of pub games and magic tricks.
WANT TO MAKE SOME MONEY? STUCK FOR AN IDEA? We have collated 140 business manuals that give you information on setting up different businesses, you peruse these at your leisure using the text editor on your PC. Also included is the certificate enabling you to reproduce (and sell) the manuals as much as you like! £14. Ref EP74.
ANICS CO2 GAS POWERED PISTOL. Russian handheld pistol powered by Sparklets CO2 cylinders (give approx. 70 shots), fires steel BB. Pistol £58.22. Ref AGA101, tub of 1,500 BB shot £10. Ref A1015, pack of 5 CO2 cartridges £3.50. Ref GA55.
33 KILO LIFT MAGNET. Neodymium, 32mm diameter with a fixing bolt on the back for easy mounting. Each magnet will lift 33 kilos, 4 magnets bolted to a plate will lift an incredible 132 kilos! £15. Ref MAG33. Pack of 4 just £39. Ref MAG33AA.
BSA METEOR AIR RIFLE. UK made, .22 rifle, top quality professional air rifle, £84.15. Ref BSAMET 500 Lazapell pellets £5. Ref LAZAPPELL.
MAMOD 1313 TE1A TRACTION ENGINE. Attractive working model of traditional steam engine, £85. Ref 1313.
MAMOD STEAM ROADSTER (white), magnificent working steam model car, £112. Ref 1319.
MAMOD STEAM WAGON. Working model steam wagon finished in blue, £112. Ref 1318. Broken version (with barrels), £122. Ref 1450.
POCKET SPY MONOCULAR. Clever folding monocular with 8 x 21 magnification, made by Helios, with case, £14.99. Ref MONOC.
KEVLAR BRITISH ARMY HATS. Broken or missing straps, hence just £8 each. Ref KEV99.
CCTV SYSTEMS, £24.99. Complete with camera, 20 metres of cable, p.s.u. and info simple connection to scart, £24.99. Ref CCTVCAM2.
FM BROADCAST BAND HIGH POWER TRANSMITTERS can be viewed and bought online at www.veronica-kits.co.uk.
TONER CARTRIDGES FOR COPIERS AND PRINTERS can be bought online at www.nationaltoners.co.uk.
VELOSOLEX. Traditional French style two-stroke moped (engine over front wheels), black only, £695. Ref VELO. Delivered direct in a box, you need to fit the pedals etc. then register it with your local DVLC.
HYDROPONIC GROWING SYSTEMS. Complete, everything you need apart from plants and light, contains grow tank, nutrients, pump, tester etc. GT205 710mm x 390mm, NFT system, £31.45. Ref GT205. GT424 1070mm x 500mm, NFT system, £58.65. Ref GT424.
ELECTRIC BIKES, £679. Viking, built-in indicators, radio, lights, 13mph, 5 hour charge, Shimano gears, up to 50 mile range, horn, 26in. wheels, suspension, no licence needed, key operated, £679. Ref VIKING.
PIR PCBs. These contain a standard PIR detector circuit with all components, easy to wire up and use. Pack of 4 £6. Ref PIRB.
NEBULISER, WATER ATOMISER. Ultrasonic module that you place in water, atomises the water into a very fine mist, many applications from special effects to scientific. £69. Ref NEB6.
PORTABLE X-RAY MACHINE PLANS. Easy to construct plans on a simple and cheap way to build a home X-ray machine! Effective device, X-ray based assemblies, can be used for experimental purposes. Not a toy or for minors! £6/set. Ref FXP1.
TELEKINETIC ENHANCER PLANS. Mystify and amaze your friends by creating motion with no known apparent means or cause. Uses no electrical or mechanical connections, no special gimmicks yet produces positive motion and effect. Excellent for science projects, magic shows, part demonstrations or serious research and development of this strange and amazing psychic phenomenon. £4/set. Ref FTK1.
ELECTRONIC HYPNOSIS PLANS & DATA. This data shows several ways to put subjects under your control. Included is a full volume reference text and several construction plans that when assembled can produce highly effective stimuli. This material must be used cautiously. It is for use as entertainment at parties etc only, by those experienced in its use. £15/set. Ref F/EH2.
GRAVITY GENERATOR PLANS. This unique plan demonstrates a simple electrical phenomena that produces an anti-gravity effect. You can actually build a small mock spaceship out of simple materials and without any visible means cause it to levitate. £10/set. Ref F/GRA1.
TESLA COIL/LIGHTNING DISPLAY GLOBE PLANS. Produces up to 750,000 volts of discharge, experiment with extraordinary HV effects, 'Plasma in a jar', 'St Elmo's fire, corona, excellent science project or conversation piece. £5/set. Ref F/BTC/ILG5.
COPPER VAPOUR LASER PLANS. Produces 100mW of visible green light. High coherency and spectral quality similar to argon laser but easier and less costly to build, yet far more efficient. This particular design was developed at the Atomic Energy Commission of NEGEV in Israel, £10/set. Ref F/CVL1.
VOICE SCRAMBLER PLANS. Miniature solid-state system turns speech sound into indecipherable noise that cannot be understood without a second matching unit. Use on telephone to prevent third party listening and bugging. £6/set. Ref F/V59.
PULSED TV JOKER PLANS. Little handheld device utilises pulse techniques that will completely disrupt TV picture and sound! Works on FM too! *Discretion advised*, £8/set. Ref F/TJ5.
BODYHEAT TELESCOPE PLANS. Highly directional long range device uses recent technology to detect the presence of living bodies, warm and hot spots, heat leaks etc. Intended for security, law enforcement, research and development etc. Excellent security device or very interesting science project. £8/set. Ref BHTT1.
BURNING/CUTTING CO2 LASER PLANS. Projects an invisible beam of heat capable of burning and melting materials over a considerable distance. This laser is one of the most efficient, converting 10% input power into useful output. Not only is this device a workhorse in welding, cutting and heat processing materials, but it is also a likely candidate as an effective directed energy beam weapon against missiles, aircraft, ground-to-ground etc. Burning and etching wood, cutting, plastics, textiles etc. £12/set. Ref F/LC7.

AIR RIFLES FROM LESS THAN £40, CROSSBOWS, WIDE RANGE OF BB GUNS, AMMO, TARGETS, PISTOLS, REPLICAS GUNS, UZI MACHINE GUN REPLICAS (BB), REPEATERS, LASER SIGHTS, ELECTRIC BB, GAS BB

www.airpistol.co.uk

INKJET CARTRIDGES FROM JUST £3 AT
www.officebits.co.uk

BULL ELECTRICAL

UNIT D, HENFIELD BUSINESS PARK,
 HENFIELD, SUSSEX BN5 9SL
TERMS: CASH, PO OR CHEQUE WITH ORDER PLUS £5.00 P&P (UK) PLUS VAT
24 HOUR SERVICE £7.50 (UK) PLUS VAT
OVERSEAS ORDERS AT COST PLUS £3.50
 (ACCESS/VISA/SWITCH ACCEPTED)
 'phone: 01273 491490 Fax 491813
 Sales@bull-electrical.co.uk

www.bullnet.co.uk

ISSN 0262 3617

PROJECTS ... THEORY ... NEWS ...
COMMENTS ... POPULAR FEATURES ...

VOL. 31. No. 6 JUNE 2002

Cover illustration by Jonathan Robertson

EVERYDAY
PRACTICAL
ELECTRONICS

INCORPORATING **ELECTRONICS TODAY INTERNATIONAL**

www.epemag.wimborne.co.uk

EPE Online: www.epemag.com

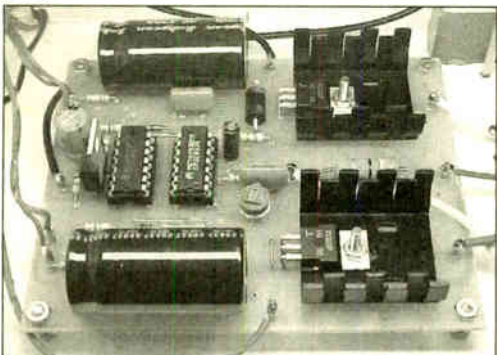
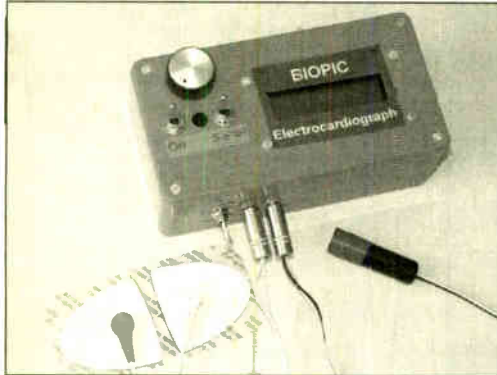

© Wimborne Publishing Ltd 2002. Copyright in all drawings, photographs and articles published in **EVERYDAY PRACTICAL ELECTRONICS** is fully protected, and reproduction or imitations in whole or in part are expressly forbidden.

Our July 2002 issue will be published on Thursday, 13 June 2002. See page 387 for details

Projects and Circuits

- BIOPIC HEARTBEAT MONITOR** by John Becker 396
Take a peek at the rhythmic waveforms that keep you ticking!
- INGENUITY UNLIMITED** hosted by Alan Winstanley 406
L.E.D. Sequencer; Quiz Master
- WORLD LAMP** by Thomas Scarborough and Surya Rao Maturu 408
Low cost lighting when there's no mains supply available
- SIMPLE AUDIO CIRCUITS – 2. Preamplifiers, Tone Controls and Filters** by Raymond Haigh 418
A compendium of useful audio amplifier circuits for the experimenting constructor
- FREQUENCY STANDARD GENERATOR** by Andy Flind 432
High precision 1Hz to 100kHz frequency source, derived "off-air"

Series and Features

- NEW TECHNOLOGY UPDATE** by Ian Poole 402
Glass and silver high speed non-volatile memories
- CIRCUIT SURGERY** by Alan Winstanley and Ian Bell 439
Darlington Transistors; Scope Grounding; Fleming's Rules; X/Y Capacitors
- INTERFACE** by Robert Penfold 442
Accessing Serial Ports via MSCOMM Control
- NET WORK – THE INTERNET PAGE** surfed by Alan Winstanley 447
Broadband services
- TEACH-IN 2002 – 8. Filters, Actuators, Smoke and Gas Detection, with experiments** by Ian Bell and Dave Chesmore 448

Regulars and Services

- ELECTRONICS MANUALS** 390
Essential reference works for hobbyists, students and service engineers
- EDITORIAL** 395
- NEWS** – Barry Fox highlights technology's leading edge 403
Plus everyday news from the world of electronics
- READOUT** John Becker addresses general points arising 415
- BACK ISSUES** Did you miss these? Many now on CD-ROM! 429
- SHOPTALK** with David Barrington, 431
The *essential* guide to component buying for *EPE* projects
- PLEASE TAKE NOTE** 431
Washing Ready Indicator
- CD-ROMS FOR ELECTRONICS** 444
A wide range of CD-ROMs for hobbyists, students and engineers
- DIRECT BOOK SERVICE** 458
A wide range of technical books available by mail order
- PRINTED CIRCUIT BOARD AND SOFTWARE SERVICE** 461
PCBs for *EPE* projects. Plus *EPE* software
- ADVERTISERS INDEX** 464

Readers Services • Editorial and Advertisement Departments 395

Visit our website
www.distel.co.uk

THE ORIGINAL SURPLUS WONDERLAND!

THIS MONTH'S SELECTION FROM OUR VAST EVER CHANGING STOCKS

Surplus always
wanted for cash!

GIANT 10" 7-SEGMENT DISPLAYS

A bulk purchase enables us to bring you these GIANT 7-segment digital displays at a now affordable price! The 10" character size gives exceptional readability at long distances and enables a host of applications including, score boards, digital clocks, counters, event timers etc. As the units are a simple electromechanical device and operate from 12V DC, simple switching via switches, relays, PIC or PC may be used to control single or multiple digits. Units feature integral 'Zero Power' memory which greatly simplifies design. For an excellent DIY practical article, see the May issue of 'Everyday Practical Electronics' magazine. Ideal School / College construction project. Supplied in good RFE condition, complete with data sheet.



Less than 30% of makers price! Only £29.95 (B) or 4 / £99.00 (D) of makers price!
Order RW44 Order PH26

THE AMAZING TELEBOX



TV SOUND & VIDEO TUNER
CABLE COMPATIBLE*

Converts your colour monitor into a QUALITY COLOUR TV!!

The TELEBOX is an attractive fully cased mains powered unit, containing all electronics ready to plug into a host of video monitors or AV equipment which are fitted with a composite video or SCART input. The composite video output will also plug directly into most video recorders, allowing reception of TV channels not normally receivable on most television receivers* (TELEBOX MB). Push button controls on the front panel allow reception of 8 fully tuneable 'off air' UHF colour television channels. TELEBOX MB covers virtually all television frequencies VHF and UHF including the HYPERBAND as used by most cable TV operators. Ideal for desktop computer video systems & PIP (picture in picture) setups. For complete compatibility - even for monitors without sound - an integral 4 watt audio amplifier and low level Hi Fi audio output are provided as standard. Brand new - fully guaranteed.

TELEBOX ST for composite video input type monitors £36.95
TELEBOX STL as ST but fitted with integral speaker £39.50
TELEBOX MB Multiband VHF/UHF/Cable/Hyperband tuner £69.95
For overseas PAL versions state 5.5 or 6 mhz sound specification.
*For cable / hyperband signal reception Telebox MB should be connected to a cable type service. Shipping on all Teleboxes, code (B)

NEW State of the art PAL (UK spec) UHF TV tuner module with composite 1v pp video & NICAM hi fi stereo sound outputs. Micro electronics all on one small PCB only 73 x 160 x 52 mm enable full tuning control via a simple 3 wire link to an IBM pc type computer. Supplied complete with simple working program and documentation. Requires +12V & +5V DC to operate. BRAND NEW - Order as MY00. Only £39.95 code (B)
See www.distel.co.uk/data_my00.htm for picture & full details

HARD DISK DRIVES 2 1/2" - 14"

2 1/2" TOSHIBA MK102MAV 1.1Gb laptop (12.5 mm H) New £59.95
2 1/2" TOSHIBA MK4313MAT 4.3Gb laptop (8.2 mm H) New £105.00
2 1/2" TOSHIBA MK6409MAV 6.1Gb laptop (12.7 mm H) New £98.00
2 1/2" TOSHIBA MK1614GAV 18 Gb laptop (12 mm H) New £149.95
2 1/2" to 3 1/2" conversion kit for PCs, complete with connectors £15.95
3 1/2" COMPAQ 313706-B21 (IBM) 9 gb ULT/SCSI3 New £199.00
3 1/2" FUJI FK-309-26 20mb MFM I/F RFE £59.95
3 1/2" CONNER CP3024 20 mb IDE I/F (or equiv.) RFE £59.95
3 1/2" CONNER CP3044 40 mb IDE I/F (or equiv.) RFE £69.00
3 1/2" QUANTUM 40S Prodriv ve 42mb SCSI I/F, New RFE £49.00
5 1/4" MINISCRIBE 3425 20mb MFM I/F (or equiv.) RFE £49.95
5 1/4" SEAGATE ST-238R 30 mb RLL I/F Refurb £69.95
5 1/4" CDC 94205-51 40mb HSI MFM I/F RFE tested £69.95
5 1/4" HP 97548 85 Mb SCSI RFE tested £99.00
5 1/4" HP C3010 2 Gbyte SCSI differential RFE tested £195.00
8" NEC D2246 85 Mb SMD interface. New £99.00
8" FUJITSU M2322K 160Mb SMD I/F RFE tested £195.00
8" FUJITSU M2392K 2 Gb SMD I/F RFE tested £345.00
Many other floppy & H drives, IDE, SCSI, ESDI etc from stock, see website for full stock list. Shipping on all drives is code (C)

IC's - TRANSISTORS - DIODES

OBSELETE - SHORT SUPPLY - BULK
10,000,000 items EX STOCK

For MAJOR SAVINGS
CALL or see web site www.distel.co.uk

COMPUTER MONITOR SPECIALS

Legacy products
High spec genuine multisync.
CGA, EGA, VGA, SVGA

Mitsubishi FA3415ETKL 14" SVGA Multisync colour monitor with fine 0.28 dot pitch tube and resolution of 1024 x 768. A variety of inputs allows connection to a host of computers including IBM PC's in CGA, EGA, VGA & SVGA modes, BBC, COMMODORE (including Amiga 1200), ARCHIMEDES and APPLE. Many features: Etched faceplate, text switching and LOW RADIATION MPR specification. Fully guaranteed, in EXCELLENT little used condition. Tilt & Swivel Base £4.75

VGA cable for IBM PC included. Only £129 (E) Order as CG73

External cables for other types of computers available - CALL

Generic LOW COST SVGA Monitors

We choose the make, which includes Compaq, Mitsubishi, IBM, etc. Supplied ready to run with all cables, Standard RTB 90 day guarantee.

14"	15"	17"
£59.00	£69.00	£79.00

Supplied in good used condition. Shipping code (D)

VIDEO MONITORS

PHILIPS HCS35 (same style as CM8833) attractively styled 14" colour monitor with both RGB and standard composite 15.625 KHz video inputs via SCART socket and separate phono jacks. Integral audio power amp and speaker for all audio visual uses. Will connect direct to Amiga and Atari BBC computers. Ideal for all video monitoring / security applications with direct connection to most colour cameras. High quality with many features such as front concealed flap controls, VCR correction button etc. Good used condition - fully tested - guaranteed Dimensions: W14" x H12 3/4" x 15 1/2" D. Only £99.00 (E)

PHILIPS HCS31 Ultra compact 9" colour video monitor with standard composite 15.625 KHz video input via SCART socket. Ideal for all monitoring / security applications. High quality, ex-equipment fully tested & guaranteed (possible minor screen burns). In attractive square black plastic case measuring W10" x H10" x 1 3/4" D. 240 V AC mains powered. Only £79.00 (D)

INDUSTRIAL COMPUTERS

Tiny shoebox sized industrial 40 Mhz 386 PC system measuring only (mm) 266 x X 88 h X 272 d. Ideal for dedicated control applications running DOS, Linux or even Windows! Steel case contains 85 to 265 V AC 50 / 60 Hz 70 Watt PSU, a 3 slot ISA passive backplane and a Rocky 318 (PC104) standard, single board computer with 8 MByte NON VOLATILE solid state 'Disk On Chip' RAMDISK. System comprises: Rocky 318 (PC104) SBC ISA card with 40MHz ALI 386SX CPU, 72 pin SIMM slot with 16 Mbyte SIMM, AMI BIOS, battery backed up real time clock, 2 x 9 pin D 1560 serial ports EPP/ECP printer port, mini DIN keyboard connector, floppy port IDE port for hard drives up to 528 MByte capacity, watchdog timer and PC/104 bus socket. The 8 MByte solid state 'disk on a chip' has its own BIOS, and can be disked, formatted & booted. Supplied BRAND NEW fully tested and guaranteed. For full data see featured item on website. Order as QG36

100's of applications inc: firewalls, routers, robotics etc Only £99.00 (D)

19" RACK CABINETS

Save £££'s
Europe's Largest Stocks of quality rack cabinets, enclosures and accessories. Over 1000 Racks from stock

This month's special
33 / 42 / 47 U - High Quality
All steel Rack Cabinets



Made by Eurocraft Enclosures Ltd to the highest possible spec, rack features all steel construction with removable side, front and back doors. Front and back doors are hinged for easy access and all lockable with five secure 5 lever barrel locks. The front door is constructed of double walled steel with a 'designer style' smoked acrylic front panel to enable status indicators to be seen through the panel, yet remain unobtrusive. Internally the rack features fully slotted reinforced vertical fixing members to take the heaviest of 19" rack equipment. The two movable vertical fixing struts (extras available) are pre punched for standard 'cage nuts'. A mains distribution panel internally mounted to the bottom rear, provides 8 x IEC 3 pin Euro sockets and 1 x 13 amp 3 pin switched utility socket. Overall ventilation is provided by fully louvered back door and double skinned top section with top and side louvres. The top panel may be removed for fitting of integral fans to the sub plate etc. Other features include: fitted castors and floor levelers, prepunched utility panel at lower rear for cable / connector access etc. Supplied in excellent, slightly used condition with keys. Colour Royal blue, some grey available - CALL - Can be supplied in many other configurations.

33U Order as BC44 External dimensions mm=1625H x 635D x 603 W. (64" H x 25" D x 23 3/4" W) Only £245	42U Order as DT20 External dimensions mm=2019H x 635D x 603 W. (79.5" H x 25" D x 23 3/4" W) Only £345	47U Order as RV36 External dimensions mm=2019H x 635D x 603 W. (88" H x 25" D x 23 3/4" W) Only £410
--	--	--

Call for shipping quotation

COLOUR CCD CAMERAS

Undoubtedly a miracle of modern technology & our special buying power! A quality product featuring a fully cased COLOUR CCD camera at a give away price! Unit features full autolight sensing for use in low light & high light applications. A 10 mm fixed focus wide angle lens gives excellent focus and resolution from close up to long range. The composite video output will connect to any composite monitor or TV (via SCART socket) and most video recorders. Unit runs from 12V DC so ideal for security & portable applications where mains power not available.



Overall dimensions 66 mm wide x 117 deep x 43 high. Supplied BRAND NEW & fully guaranteed with user data, 100's of applications including Security, Home Video, Web TV, Web Cams etc, etc.

Order as LK33 ONLY £79.00 or 2 for £149.00 (B)

SOFTWARE SPECIALS

NT4 WorkStation, complete with service pack 3 and licence - OEM packaged. ONLY £89.00 (B)
ENCARTA 95 - CDROM, Not the latest - but at this price! £7.95
DOS 5.0 on 3 1/2" disks with concise books c/w QBasic. £14.95
Windows for Workgroups 3.11+ Dos 6.22 on 3.5" disks £55.00
Windows 95 CDROM Only - No Licence - £19.95
Wordperfect 6 for DOS supplied on 3 1/2" disks with manual £24.95
shipping charges for software is code B

LOCAL STATE LASERS

Visible red, 670nm laser diode assembly. Unit runs from 5 V DC at approx 50 mA. Originally made for continuous use in industrial barcode scanners, the laser is mounted in a removable solid aluminium block, which functions as a heatsink and rigid optical mount. Dims of block are 50 x 50 x 15 mm. Integral features include over temperature shutdown, current control, laser OK output, and gated TTL ON / OFF. Many uses for experimental optics, comms & lightshows etc. Supplied complete with data sheet.

Order as TD91 ONLY £24.95 (A)

DC POWER SUPPLIES

Virtually every type of power supply you can imagine. Over 10,000 Power Supplies Ex Stock - Call or see our web site.

RELAYS - 200,000 FROM STOCK

Save £££'s by choosing your next relay from our Massive Stocks covering types such as Military, Octal, Cradle, Hermetically Sealed, Continental, Contactors, Time Delay, Reed, Mercury Wetted, Solid State, Printed Circuit Mounting etc., CALL or see our web site www.distel.co.uk for more information. Many obsolete types from stock. Save £££'s

TEST EQUIPMENT & SPECIAL INTEREST ITEMS

MITSUBISHI FA3445ETKL 14" Ind. spec SVGA monitors £245	HP6030A 0-200V DC @ 17 Amps bench power supply £1950
FARNELL 0-60V DC @ 50 Amps, bench Power Supplies £995	Intel SBC 486/125C08 Enhanced Multibus (MSA) New £1150
FARNELL AP3080 0-30V DC @ 80 Amps, bench Supply £1850	Nikon HF-X11 (Ephiphot) exposure control unit £1450
KINGSBILL CZ403/1 0-50V @ DC 200 Amps - NEW £3950	PHILIPS PM5518 pro. TV signal generator £1250
1kW to 400 kW - 400 Hz 3 phase power sources - ex stock £POA	Motorola VME Bus Boards & Components List. SAE / CALL £POA
IBM 8230 Type 1, Token ring base unit driver £760	Trio 0-18 vdc linear, metered 30 amp bench PSU. New £550
Wayne Kerr RA200 Audio frequency response analyser £2500	Fujitsu M3041R 600 LPM high speed band printer £1950
INFODEC 1U, 24 port, RJ45 network patchpanels, #TH93 £49	Fujitsu M3041D 600 LPM printer with network interface £1250
3COM 16670 12 Port Ethernet hub - RJ45 connectors #LD97 £69	Siemens K4400 64Kb to 140Mb demux analyser £2950
3COM 16671 24 Port Ethernet hub - RJ45 connectors # £89	Perkin Elmer 299B Infrared spectrophotometer £500
3COM 16700 8 Port Ethernet hub - RJ45 connectors NEW £39	Perkin Elmer 597 Infrared spectrophotometer £500
IBM 53F5501 Token Ring ICS 20 port lobe modules £POA	VE Electronics 1035 TELETEXT Decoding Margin Meter £3250
IBM MAU Token ring distribution panel 8228-23-5050N £45	LightBand 60 output high spec 2u rack mount Video VDA's £495
AIM 501 Low distortion Oscillator 9Hz to 330KHz, IEEE I/O £550	Sekonic SD 150H 18 channel digital Hybrid card recorder £1995
ALLGON 8380.11805-1880 MHz hybrid power combiners £250	BEK 2633 Microphone pre amp £300
Trend DSA 274 Data Analyser with G703(2M) 64 I/O £POA	Taylor Hobson Talysurf amplifier / recorder £750
Marconi 6310 Programmable 2 to 22 GHz sweep generator £4500	ADC S200 Carbon dioxide gas detector / monitor £1450
Marconi 2022C 10KHz-1GHz RF signal generator £1550	BBC AM20/3 PPM Meter (Ernest Turner) + drive electronics £75
HP1850B Logic Analyser £3750	ANRITSU 9654A Optical DC-2.5Gb/w waveform monitor £5650
HP3781A Pattern generator & HP3782A Error Detector £POA	ANRITSU ML93A optical power meter £990
HP6621A Dual Programmable GPIB PSU 0-7 V 160 watts £1800	ANRITSU Fibre optic characteristic test set £775
HP6264 Rack mount variable 0-20V @ 20A metered PSU £475	R&S FTDZ Dual sound unit £650
HP54121A DC to 22 GHz 400 channel test set £POA	R&S SBUF-E1 Vision monitor £775
HP18130A opt 020 300 MHz pulse generator, GPIB etc £7900	WILTRON 6630B 12.4 / 20GHz RF sweep generator £1250
HP A1, A0 8 pen HPGL high speed drum plotters - from HP DRAFTMASTER 1 8 pen high speed plotter £550	TEK 2445 150 MHz 4 trace oscilloscope £5750
EG-G Brookdeal 95035C Precision lock in amp £750	TEK 2465 300 Mhz 300 Mhz oscilloscope rack mount £1955
Keithley 590 CV capacitor / voltage analyser £1800	TEK TDS380 400Mhz digital realtime + disk drive, FFT etc £2900
Recal ICR40 dual 40 channel voice recorder system £POA	TEK TDS524A 500Mhz digital realtime + colour display etc £3950
Flakers 45KVA 3 ph On Line UPS - New batteries £4500	PHILIPS Opt 907 20Hz to 40 Mhz spectrum analyser £5100
Emerson AP130 2.5KVA industrial spec. UPS £1499	PHILIPS PW1730/10 60KV XRAY generator & accessories £POA
Mann Tally MT645 High speed line printer £2200	VIARICS - Large range from stock - call or see our website £325
Intel SBC 486/133SE Multibus 486 system, 8Mb Ram £945	CLAUDE LYONS 12A 240V single phase auto. volt. regs £2900
	CLAUDE LYONS 100A 240/415V 3 phase auto. volt. regs £2900

display
-ELECTRONICS-

ALL MAIL TO
Dept PE, 29 / 35 Osborne Rd
Thornton Heath
Surrey CR7 8PD
Open Mon - Fri 9.00 - 5:30

18 Million Items On Line Now!
Secure ordering, Pictures, Information
www.distel.co.uk
email = admin@distel.co.uk

ALL ENQUIRIES
0208 653 3333
FAX 0208 653 8888

All prices for UK Mainland. UK customers add 17.5% VAT to TOTAL order amount. Minimum order £10. Bona Fide account orders accepted from Government, Schools, Universities and Local Authorities - minimum account order £50. Cheques over £100 are subject to 7 working days clearance. Carriage charges (A)=£3.50, (B)=£6.50, (C)=£10, (D)=£15.00, (E)=£18.00, (F)=CALL. Allow approx 3 days for shipping - faster CALL. All goods supplied to our Standard Conditions of Sale which can be viewed at our website and unless stated guaranteed for 90 days. All guarantees on a return to base basis. All rights reserved to change prices / specifications without prior notice. Orders subject to stock. Discounts for volume. Top CASH prices for surplus goods. All trademarks, tradenames etc acknowledged. © Display Electronics 2002. E & O.E.

NEXT MONTH

EPE STYLOPIC

Rolf Harris is well known these days for his concern for sick animals. Back in the 1970's though, he was popular as an entertainer who would delight his audience by (amongst many other activities) playing the didgeridoo and the Stylophone. The latter was a compact hand-held electronic musical instrument having a built-in keyboard which was activated by an electrically conductive stylus.

The EPE StyloPIC pays homage to this classic design, which is now relegated to the depths of history and enthusiast's web sites (although we know some readers still have the real thing!). Whereas the original had 20 keypad zones, the StyloPIC has been extended to cover two full octaves – 25 notes including sharps and flats. It too is, of course, activated by a stylus, which makes contact with the integral keyboard-style p.c.b. that also holds the electronic components. Its tuning accuracy is superb, the software making use of a technique hitherto unpublicised through EPE.

Apart from the PIC microcontroller, there are only three active integrated circuits – a waveform converter, an envelope shaper and a power op.amp. It is really simple in its concept, yet remarkably fun to play!

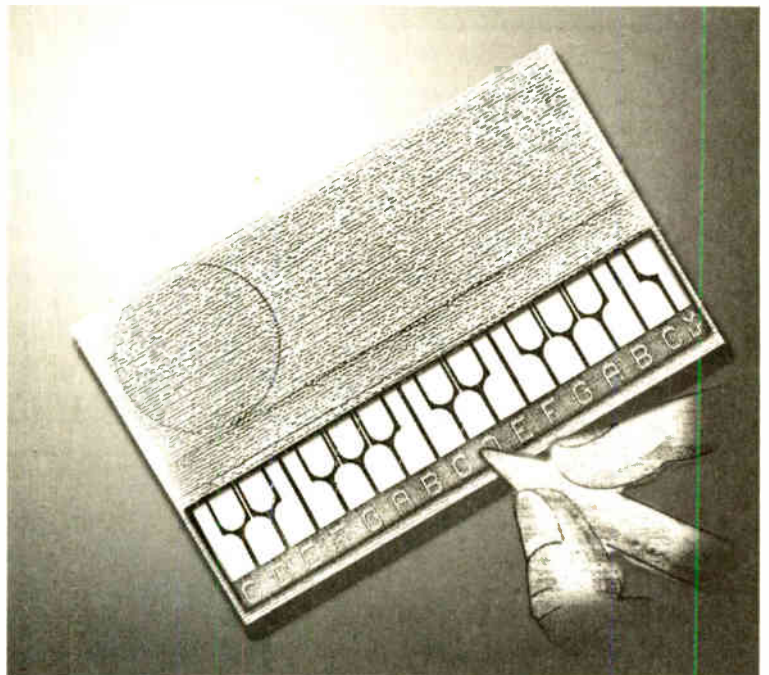

INFRA-RED AUTOSWITCH

The Infra-Red Autoswitch will find many applications, but it was designed initially to switch on the concealed lighting around a set of kitchen units. Simply waving your hand near the unit will cause the lights to switch on for a timed period. If you stay in the area the unit will remain triggered. The sensor employed is similar to the auto-switches used in up-market public wash hand basins and hand driers, where the water or air is switched on when your hand is in place. The system described here is triggered when your hand is about 30cm from the unit. The project was designed for maximum ease of assembly and fitting.

USING THE PIC'S PCLATH COMMAND

Readers are probably very familiar with the PIC16x84, which has 1K of program memory in a single page. With this device, many readers will believe that for successful table calling, any tables need to be placed within the first 256 bytes of program memory, a restriction imposed for a reason that may not immediately be apparent. In fact, tables may be put anywhere in program memory space, once the operation of the program counter and the PCLATH function are understood. The use of PCLATH is also essential with those PICs which have more than 2K of program memory, the PIC16F87x family for example, since these higher program addresses cannot be directly accessed without it being set appropriately. There are constraints, though, on setting the program counter through PCLATH, and which must be complied with for correct operation of the program, as this feature article explains.

NO ONE DOES IT BETTER

EVERYDAY
PRACTICAL
ELECTRONICS

INCORPORATING ELECTRONICS TODAY INTERNATIONAL

**DON'T MISS AN
ISSUE – PLACE YOUR
ORDER NOW!**
Demand is bound to be high

JULY 2002 ISSUE ON SALE THURSDAY, JUNE 13

QUASAR ELECTRONICS LIMITED

PO Box 6935, BISHOPS STORTFORD, Herts. CM23 4WP

TEL: 01279 467799 FAX: 07092 203496

ADD £2.00 P&P to all orders (or 1st Class Recorded £4, Next day (insured £250) £7, Europe £5.00, Rest of World £10.00). We accept all major credit cards. Make cheques/POs payable to Quasar Electronics. Prices include 17.5% VAT. MAIL ORDER ONLY. FREE CATALOGUE with order or send 2 x 1st class stamps (refundable) for details of over 150 kits & publications.



PROJECT KITS

Our electronic kits are supplied complete with all components, high quality PCBs (NOT cheap Tripad strip board!) and detailed assembly/operating instructions

- **2 x 25W CAR BOOSTER AMPLIFIER** Connects to the output of an existing car stereo cassette player, CD player or radio. Heatsinks provided. PCB 76x75mm. 1046KT £24.95
- **3-CHANNEL WIRELESS LIGHT MODULATOR** No electrical connection with amplifier. Light modulation achieved via a sensitive electret microphone. Separate sensitivity control per channel. Power handling 400W/channel. PCB 54x112mm. Mains powered. Box provided. 6014KT £24.95
- **12 RUNNING LIGHT EFFECT** Exciting 12 LED light effect ideal for parties, discos, shop-windows & eye-catching signs. PCB design allows replacement of LEDs with 220V bulbs by inserting 3 TRIACs. Adjustable rotation speed & direction. PCB 54x112mm. 1026KT £15.95; BOX (for mains operation) 2026BX £30.00
- **DISCO STROBE LIGHT** Probably the most exciting of all light effects. Very bright strobe tube. Adjustable stroke frequency 1-60Hz. Mains powered. PCB. 60x68mm. Box provided. 6037KT £28.95
- **ANIMAL SOUNDS** Cat, dog, chicken & cow. Ideal for kids farmyard toys & schools. 5G10M £5.95
- **3 1/2 DIGIT LED PANEL METER** Use for basic voltage/current displays or customise to measure temperature, light, weight, movement, sound levels, etc. with appropriate sensors (not supplied). Various input circuit designs provided. 3061KT £13.95
- **IR REMOTE TOGGLE SWITCH** Use any TV/VCR remote control unit to switch onboard 12V/1A relay on/off. 3058KT £10.95
- **SPEED CONTROLLER** for any common DC motor up to 100V/5A. Pulse width modulation gives maximum torque at all speeds 5-15VDC. Box provided. 3067KT £12.95
- **3 x 8 CHANNEL IR REMOTE BOARD** Control eight 12V/1A relays by Infra Red (IR) remote control over a 20m range in sunlight. 6 relays turn on only the other 2 toggle on/off 3 operation ranges determined by jumpers. Transmitter case & all components provided. Receiver PCB 76x89mm. 3072KT £52.95

PRODUCT FEATURE

COMPUTER TEMPERATURE DATA LOGGER

PC serial port controlled 4-channel temperature meter (either deg C or F). Requires no external power. Allows continuous temperature data logging of up to four temperature sensors located 200m+ from motherboard/PC. Ideal use for old 386/486 computers. Users can tailor input data stream to suit their purpose (dump it to a spreadsheet or write your own BASIC programs using the INPUT command to grab the readings). PCB just 38mm x 38mm. Sensors connect via four 3-pin headers. 4 header cables supplied but only one DS18S20 sensor. Kit software available free from our website. ORDERING: 3145KT £23.95 (kit form); AS3145 £29.95 (assembled); Additional DS18S20 sensors £4.95 each

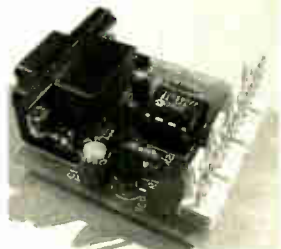

- **SOUND EFFECTS GENERATOR** Easy to build. Create an almost infinite variety of interesting/unusual sound effects from birds chirping to sirens. 9VDC. PCB 54x85mm. 1045KT £8.95
- **ROBOT VOICE EFFECT** Make your voice sound similar to a robot or Darlek. Great fun for discos, school plays, theatre productions, radio stations & playing jokes on your friends when answering the phone! PCB 42x71mm. 1131KT £8.95
- **AUDIO TO LIGHT MODULATOR** Controls intensity of one or more lights in response to an audio input. Sale, modern opto-coupler design. Mains voltage experience required. 3012KT £8.95
- **MUSIC BOX** Activated by light. Plays 8 Christmas songs and 5 other tunes. 3104KT £7.95
- **20 SECOND VOICE RECORDER** Uses non-volatile memory - no battery backup needed. Record/replay messages over & over. Playback as required to greet customers etc. Volume control & built-in mic. 6VDC. PCB 50x73mm. 3131KT £12.95
- **TRAIN SOUNDS** 4 selectable sounds: whistle blowing, level crossing bell, 'clackety-clack' & 4 in sequence. 5G01M £6.95

- **PC CONTROLLED RELAY BOARD** Convert any 286 upward PC into a dedicated automatic controller to independently turn on/off up to eight lights, motors & other devices around the home, office, laboratory or factory. Each relay output is capable of switching 250VAC/4A. A suite of DOS and Windows control programs are provided together with all components (except box and PC cable). 12VDC. PCB 70x200mm. 3074KT £31.95
- **2 CHANNEL UHF RELAY SWITCH** Contains the same transmitter/receiver pair as 30A15 plus the components and PCB to control two 240VAC/10A relays (also supplied). Ultra bright LEDs used to indicate relay status. 3082KT £27.95
- **TRANSMITTER RECEIVER PAIR** 2-button keyboard style 300-375MHz Tx with 30m range. Receiver encoder module with matched decoder IC. Components must be built into a circuit like kit 3082 above. 30A15 £14.95
- **PIC 16C71 FOUR SERVO MOTOR DRIVER** Simultaneously control up to 4 servo motors. Software & all components (except servos/control pots) supplied. 5VDC PCB 50x70mm. 3102KT £15.95
- **UNIPOLAR STEPPER MOTOR DRIVER** for any 5/6/8 lead motor. Fast/slow & single step rates. Direction control & on/off switch. Wave, 2-phase & half-wave step modes. 4 LED indicators. PCB 50x65mm. 3109KT £14.95
- **PC CONTROLLED STEPPER MOTOR DRIVER** Control two unipolar stepper motors (3A max. each) via PC printer port. Wave, 2-phase & half-wave step modes. Software accepts 4 digital inputs from external switches & will single step motors. PCB fits in D-shell case provided. 3113KT £17.95
- **12-BIT PC DATA ACQUISITION/CONTROL UNIT** Similar to kit 3093 above but uses a 12-bit Analogue-to-Digital Converter (ADC) with internal analogue multiplexer. Reads 8 single ended channels or 4 differential inputs or a mixture of both. Analogue inputs read 0-4V. Four TTL/CMOS compatible digital input/outputs. ADC conversion time <10µs. Software (C, QB & Win), extended D shell case & all components (except sensors & cable) provided. 3118KT £52.95
- **LIQUID LEVEL SENSOR/RAIN ALARM** Will indicate fluid levels or simply the presence of fluid. Relay output to control a pump to add/remove water when it reaches a certain level. 1080KT £5.95
- **AM RADIO KIT 1** Tuned Radio Frequency front-end, single chip AM radio IC & 2 stages of audio amplification. All components inc. speaker provided. PCB 32x102mm. 3063KT £10.95
- **DRILL SPEED CONTROLLER** Adjust the speed of your electric drill according to the job at hand. Suitable for 240V AC mains powered drills up to

X FACTOR PUBLICATIONS

THE EXPERTS IN RARE & UNUSUAL INFORMATION

Full details of all X-FACTOR PUBLICATIONS can be found in our catalogue. NB Minimum order charge for reports and plans is £5.00 PLUS normal P&P

- **SUPER-EAR LISTENING DEVICE** Complete plans to build your own parabolic dish microphone. Listen to distant voices and sounds through open windows and even walls! Made from readily available parts. R002 £3.50
- **LOCKS** - How they work and how to pick them. This fact filled report will teach you more about locks and the art of lock picking than many books we have seen at 4 times the price. Packed with information and illustrations. R008 £3.50
- **RADIO & TV JOKER PLANS** We show you how to build three different circuits for disrupting TV picture and sound plus FM radio! May upset your neighbours & the authorities! DISCRETION REQUIRED. R017 £3.50
- **INFINITY TRANSMITTER PLANS** Complete plans for building the famous infinity Transmitter. Once installed on the target phone, device acts like a room bug. Just call the target phone & activate the unit to hear all room sounds. Great for home-office security! R019 £3.50
- **THE ETHER BOX CALL INTERCEPT PLANS** Grabs telephone calls out of thin air! No need to wire-in a phone bug. Simply place this device near the phone lines to hear the conversations taking place! R025 £3.00
- **CASH CREATOR BUSINESS REPORTS** Need ideas for making some cash? Well this could be just what you need! You get 40 reports (approx. 800 pages) on floppy disk that give you information on setting up different businesses. You also get valuable reproduction and duplication rights so that you can sell the manuals as you like. R030 £7.50

SURVEILLANCE

High performance surveillance bugs. Room transmitters supplied with sensitive electret microphone & battery holder/cip. All transmitters can be received on an ordinary VHF/FM radio between 88-108MHz. Available in Kit Form (KT) or Assembled & Tested (AT).

ROOM SURVEILLANCE

- **MTX - MINIATURE 3V TRANSMITTER** Easy to build & guaranteed to transmit 300m @ 3V Long battery life 3-5V operation. Only 45x18mm. B 3007KT £8.95 AS3007 £11.95
- **MTX - MINIATURE 9V TRANSMITTER** Our best selling bug. Super sensitive, high power - 500m range @ 9V (over 1km with 18V supply and better aerial). 45x19mm. 3018KT £7.95 AS3018 £12.95
- **HPTX - HIGH POWER TRANSMITTER** High performance, 2 stage transmitter gives greater stability & higher quality reception. 1000m range @ 12V DC operation. Size 70x15mm. 3032KT £9.95 AS3032 £18.95
- **MMTX - MICRO-MINIATURE 9V TRANSMITTER** The ultimate bug for its size, performance and price. Just 15x25mm. 500m range @ 9V. Good stability. 618V operation. 3051KT £8.95 AS3051 £14.95
- **VTX - VOICE ACTIVATED TRANSMITTER** Operates only when sounds detected. Low standby current. Variable trigger sensitivity. 500m range. Peaking circuit supplied for maximum RF output. On/off switch. 6V operation. Only 63x38mm. 3026KT £12.95 AS3028 £21.95
- **HARD-WIRED BUG/ TWO STATION INTERCOM** Each station has its own amplifier, speaker and mic. Can be set up as either a hard-wired bug or two-station intercom. 10m x 2-core cable supplied. 9V operation. 3021KT (kit form only)
- **TRVS - TAPE RECORDER VOX SWITCH** Used to automatically operate a tape recorder (not supplied) via its REMOTE socket when sounds are detected. All conversions recorded. Adjustable sensitivity & turn-off delay. 115x19mm. 3013KT £9.95 AS3013 £21.95

TELEPHONE SURVEILLANCE

- **MTTX - MINIATURE TELEPHONE TRANSMITTER** Attaches anywhere to phone line. Transmits only when phone is used! Tune-in your radio and hear both parties. 300m range. Uses line as aerial & power source. 20x45mm. 3016KT £8.95 AS3016 £14.95
- **TRT - TELEPHONE RECORDING INTERFACE** Automatically record all conversations. Connects between phone line & tape recorder (not supplied). Operates recorders with 1.5-12V battery systems. Powered from line. 50x33mm. 3033KT £9.95 AS3033 £18.95
- **TPA - TELEPHONE PICK-UP AMPLIFIER/WIRELESS PHONE BUG** Place pick-up coil on the phone line or near phone earpiece and hear both sides of the conversation. 3055KT £11.95 AS3055 £20.95

HIGH POWER TRANSMITTERS

- **1 WATT FM TRANSMITTER** Easy to construct. Delivers a crisp, clear signal. Two-stage circuit. Kit includes microphone and requires a simple open dipole aerial. 8-30VDC. PCB 42x45mm. 1009KT £14.95
- **4 WATT FM TRANSMITTER** Comprises three RF stages and an audio preamplifier stage. Piezoelectric microphone supplied or you can use a separate preamplifier circuit. Antenna can be an open dipole or Ground Plane. Ideal project for those who wish to get started in the fascinating world of FM broadcasting and want a good basic circuit to experiment with. 12-18VDC. PCB 44x45mm. 1028KT £22.95 AS1028 £34.95
- **15 WATT FM TRANSMITTER (PRE-ASSEMBLED & TESTED)** Four transistor based stages with Philips BLR 88 in final stage. 15 Watts RF power on the air. 88-108MHz. Accepts open dipole, Ground Plane, 5/8, J, or YAGI antennas. 12-18VDC. PCB 70x220mm. SWS meter needed for alignment. 1021KT £99.95
- **SIMILAR TO ABOVE BUT 25W Output.** 1031KT £109.95

- 700W power. PCB: 48mm x 65mm. Box provided. 6074KT £17.95
- **3 INPUT MONO MIXER** Independent level control for each input and separate bass/treble controls. Input sensitivity: 240mV. 18V DC. PCB: 60mm x 185mm. 1052KT £16.95
- **NEGATIVE/POSITIVE ION GENERATOR** Standard Cockcroft-Walton multiplier circuit. Mains voltage experience required. 3057KT £10.95
- **LED DICE** Classic intro to electronics & circuit analysis. 7 LEDs simulate dice roll, slow down & land on a number at random. 555 IC circuit. 3003KT £9.95
- **STAIRWAY TO HEAVEN** Tests hand-eye co-ordination. Press switch when green segment of LED lights to climb the stairway - miss & start again! Good intro to several basic circuits. 3005KT £9.95
- **ROULETTE LED 'Ball'** spins round the wheel, slows down & drops into a slot. 10 LEDs. Good intro to CMOS decade counters & Op-Amps. 3006KT £10.95
- **12V XENON TUBE FLASHER TRANSFORMER** steps up a12V supply to flash a 25mm Xenon tube. Adjustable flash rate. 3163KT £13.95
- **LED FLASHER 1** 5 ultra bright red LEDs flash in 7 selectable patterns. 3037MKT £5.95
- **LED FLASHER 2** Similar to above but flash in sequence or randomly. Ideal for model railways. 3052MKT £5.95
- **INTRODUCTION TO PIC PROGRAMMING.** Learn programming from scratch. Programming hardware, a P16F84 chip and a two-part, practical, hands-on tutorial series are provided. 3081KT £21.95
- **SERIAL PIC PROGRAMMER** for all 8/18/28/40 pin OIP serial programmed PICs. Shareware software supplied limited to programming 256 bytes (registration costs £14.95). 3096KT £12.95
- **ATMEL 89C2051 PROGRAMMER** Simple-to-use yet powerful programmer for the Atmel 89C1051, 89C2051 & 89C4051 uC's. Programmer does NOT require special software other than a terminal emulator program (built into Windows) Can be used with ANY computer/operating system. 3121KT £24.95
- **3V/1-5V TO 9V BATTERY CONVERTER** Replace expensive 9V batteries with economic 1.5V batteries. IC based circuit steps up 1 or 2 'AA' batteries to give 9V/18mA. 3035KT £5.95
- **STABILISED POWER SUPPLY 3-30V/2.5A** Ideal for hobbyist & professional laboratory. Very reliable & versatile design at an extremely reasonable price. Short circuit protection. Variable DC voltages (3-30V). Rated output 2.5 Amps. Large heatsink supplied. You just supply a 24VAC/3A transformer. PCB 55x112mm. Mains operation. 1007KT £16.95.

- **STABILISED POWER SUPPLY 2-30V/5A** As kit 1007 above but rated at 5Amp. Requires a 24VAC/5A transformer. 1096KT £27.95
- **MOTORBIKE ALARM** Uses a reliable vibration sensor (adjustable sensitivity) to detect movement of the bike to trigger the alarm & switch the output relay to which a siren, bikes horn, indicators or other warning device can be attached. Auto-reset. 6-12VDC. PCB 57x64mm. 1011KT £11.95. Box 20118X £7.00
- **CAR ALARM SYSTEM** Protect your car from theft. Features vibration sensor, courtesy/boot light voltage drop sensor and bonnet/boot earth switch sensor. Entry/exit delays, auto-reset and adjustable alarm duration. 6-12V DC. PCB: 47mm x 55mm. 1019KT £11.95. Box 20198X £8.00
- **PIEZO SCREAMER** 110dB of ear piercing noise. Fits in box with 2 x 35mm piezo elements built into their own resonant cavity. Use as an alarm siren or just for fun! 6-9VDC. 3015KT £10.95
- **COMBINATION LOCK** Versatile electronic lock comprising main circuit & separate keypad for remote opening of lock. Relay supplied. 3029KT £10.95
- **ULTRASONIC MOVEMENT DETECTOR** Crystal locked detector frequency for stability & reliability. PCB 75x40mm houses all components. 4-7m range. Adjustable sensitivity. Output will drive external relay/circuits. 9VDC. 3049KT £13.95
- **PIR DETECTOR MODULE** 3-lead assembled unit just 25x35mm as used in commercial burglar alarm systems. 3076KT £8.95
- **INFRARED SECURITY BEAM** When the invisible IR beam is broken a relay is tripped that can be used to sound a bell or alarm. 25 metre range. Mains rated relay provided. 12VDC operation. 3130KT £12.95
- **SQUARE WAVE OSCILLATOR** Generates square waves at 6 preset frequencies in factors of 10 from 1Hz-100KHz. Visual output indicator. 5-18VDC. Box provided. 3111KT £8.95
- **PC DRIVEN POCKET SAMPLER/OA LOG-GER** Analogue voltage sampler records voltages up to 2V or 20V over periods from milli-seconds to months. Can also be used as a simple digital scope to examine audio & other signals up to about 5KHz. Software & D-shell case provided. 3112KT £18.95
- **20 MHz FUNCTION GENERATOR** Square, triangular and sine waveform up to 20MHz over 3 ranges using 'coarse' and 'fine' frequency adjustment controls. Adjustable output from 0-2V p-p. A TTL output is also provided for connection to a frequency meter. Uses MAX038 IC. Plastic case with printed front/rear panels & all components provided. 7-12VAC. 3101KT £69.95

BARGAIN BUY!!

Great introduction to electronics. Ideal for the budding electronics expert! Build a radio, burglar alarm, water detector, Morse code practice circuit, simple computer circuits, and much more! NO soldering, tools or previous electronics knowledge required. Circuits can be built and unassembled repeatedly. Comprehensive 68-page manual with explanations, schematics and assembly diagrams. Suitable for age 10+. Excellent for schools. Requires 2 x AA batteries. Order Code EPL030 ONLY £14.95. (phone for bulk discounts). 130, 300 and 500-in-ONE also available.

30-In-ONE Electronic Projects Lab



WEB: <http://www.QuasarElectronics.com>
email: epesales@QuasarElectronics.com

Secure Online Ordering Facilities
Full Kit Listing, Descriptions & Photos
Kit Documentation & Software Downloads

Credit Card Sales: 01279 467799

www.QuasarElectronics.com

Enhanced 'PICALL' ISP PIC Programmer

Kit will program virtually ALL 8 to 40 pin serial and parallel programmed PIC micro-controllers. Connects to PC parallel port. Supplied with fully functional pre-registered PICALL DOS and WINDOWS AVR software packages, all components and high quality DSPTH board. Also programs certain ATMEL AVR, SCENIX SX and EEPROM 24C devices. New devices can be added to the software as they are released. Blank chip auto detect feature for super-fast bulk programming. Hardware now supports ISP programming. *A 40 pin wide ZIF socket is required to program 0-3in. devices (Order Code AZIF40 @ £15.00).



3144KT	Enhanced 'PICALL' ISP PIC Programmer	£64.95
AS3144	Assembled Enhanced 'PICALL' ISP PIC Programmer	£74.95
AS3144ZIF	Assembled Enhanced 'PICALL' ISP PIC Programmer c/w ZIF socket	£89.95

ATMEL AVR Programmer



Powerful programmer for Atmel AT90Sxxxx (AVR) micro controller family. All fuse and lock bits are programmable. Connects to serial port. Can be used with ANY computer and operating system. Two LEDs to indicate programming status. Supports 20-pin DIP AT90S1200 & AT90S2313 and 40-pin DIP AT90S4414 & AT90S8515 devices. NO special software required - uses any terminal emulator program (built into Windows). The programmer is supported by BASCOM-AVR Basic Compiler software (see website for details).

3122KT	ATMEL AVR Programmer	£24.95
AS3122	Assembled 3122	£39.95

Atmel 89Cx051 and 89xxx programmers also available.

PC Data Acquisition & Control Unit

With this kit you can use a PC parallel port as a real world interface. Unit can be connected to a mixture of analogue and digital inputs from pressure, temperature, movement, sound, light intensity, weight sensors, etc. (not supplied) to sensing switch and relay states. It can then process the input data and use the information to control up to 11 physical devices such as motors, sirens, other relays, servo motors & two-stepper motors.



FEATURES:

- 8 Digital Outputs: Open collector, 500mA, 33V max.
- 16 Digital Inputs: 20V max. Protection 1K in series, 5-1V Zener to ground.
- 11 Analogue Inputs: 0-5V, 10 bit (5mV/step.)
- 1 Analogue Output: 0-2.5V or 0-10V. 8 bit (20mV/step.)

All components provided including a plastic case (140mm x 110mm x 35mm) with pre-punched and silk screened front/rear panels to give a professional and attractive finish (see photo) with screen printed front & rear panels supplied. Software utilities & programming examples supplied.

3093KT	PC Data Acquisition & Control Unit	£99.95
AS3093	Assembled 3093	£124.95

See opposite page for ordering information on these kits

ABC Mini 'Hotchip' Board



Currently learning about microcontrollers? Need to do something more than flash a LED or sound a buzzer? The ABC Mini 'Hotchip' Board is based on Atmel's AVR 8535 RISC technology and will interest both the beginner and expert alike. Beginners will find that they can write and test a simple program, using the BASIC programming language, within an hour or two of connecting it up.

Experts will like the power and flexibility of the ATMEL microcontroller, as well as the ease with which the little Hot Chip board can be "designed-in" to a project. The ABC Mini Board 'Starter Pack' includes just about everything you need to get up and experimenting right away. On the hardware side, there's a pre-assembled micro controller PC board with both parallel and serial cables for connection to your PC. Windows software included on CD-ROM features an Assembler, BASIC compiler and in-system programmer. The pre-assembled boards only are also available separately.

ABCMINISP	ABC MINI Starter Pack	£64.95
ABCMINIB	ABC MINI Board Only	£39.95

Advanced 32-bit Schematic Capture and Simulation Visual Design Studio



Serial Port Isolated I/O Controller

Kit provides eight relay outputs capable of switching 4 amps at mains voltages and four optically isolated inputs. Can be used in a variety of control and sensing applications including load switching, external switch input sensing, contact closure and external voltage sensing.



Programmed via a computer serial port, it is compatible with ANY computer & operating system. After programming, PC can be disconnected. Serial cable can be up to 35m long, allowing 'remote' control. User can easily write batch file programs to control the kit using simple text commands. NO special software required - uses any terminal emulator program (built into Windows). All components provided including a plastic case with pre-punched and silk screened front/rear panels to give a professional and attractive finish (see photo).

3108KT	Serial Port Isolated I/O Controller Kit	£54.95
AS3108	Assembled Serial Port Isolated I/O Controller	£69.95

**WHETHER ELECTRONICS IS YOUR HOBBY
OR YOUR LIVELIHOOD . . .
YOU NEED THE MODERN ELECTRONICS MANUAL
and the ELECTRONICS SERVICE MANUAL**

THE MODERN ELECTRONICS MANUAL (CD-ROM VERSION ONLY)



*The essential reference
work for everyone
studying electronics*

- Over 800 pages
- In-depth theory
- Projects to build
- Detailed assembly instructions
- Full components checklists
- Extensive data tables
- Manufacturers' web links
- Easy-to-use Adobe Acrobat format
- Clear and simple layout
- Comprehensive subject range
- Professionally written
- Regular Supplements

EVERYTHING YOU NEED TO GET STARTED AND GO FURTHER IN ELECTRONICS!

The revised CD-ROM edition of the Modern Electronics Base Manual (MEM) contains practical, easy-to-follow information on the following subjects:

BASIC PRINCIPLES: Electronic Components and their Characteristics (16 sections from Resistors and Potentiometers to Crystals, Crystal Modules and Resonators); Circuits Using Passive Components (10 sections); Power Supplies; The Amateur Electronics Workshop; The Uses of Semiconductors; Digital Electronics (6 sections); Operational Amplifiers; Introduction to Physics, including practical experiments; Semiconductors (5 sections) and Digital Instruments (3 sections).

CIRCUITS TO BUILD: There's nothing to beat the satisfaction of creating your own projects. From basic principles, like soldering and making printed circuit boards, to the tools needed for circuit-building, the Modern Electronics Manual and its Supplements describe clearly, with appropriate diagrams, how to assemble a radio, loudspeaker circuits, amplifiers, car projects,

a computer interface, measuring instruments, workshop equipment, security systems, medical and musical circuits, etc. The Base Manual describes 12 projects including a Therman and a Simple TENS Unit.

ESSENTIAL DATA: Extensive tables on diodes, transistors, thyristors and triacs, digital and linear i.c.s.

EXTENSIVE GLOSSARY: Should you come across a technical word, phrase or abbreviation you're not familiar with, simply look up the glossary included in the Manual and you'll find a comprehensive definition in plain English.

The Manual also covers **Safety** and provides web links to component and equipment **Manufacturers and Suppliers**. The most comprehensive reference work ever produced at a price you can afford, the CD-ROM edition of **THE MODERN ELECTRONICS MANUAL** provides you with all the *essential* information you need.

THE MODERN ELECTRONICS MANUAL (MEM – CD-ROM version only)

Revised CD-ROM Edition of Basic Work: Contains over 800 pages of information in Adobe Acrobat format. Edited by John Becker.

Regular Supplements: Additional CD-ROMs each containing approximately 500 pages of additional information on specific areas of electronics will be available for £19.95 each. Information on the availability and content of each Supplement CD-ROM will be sent to you as they become available.

Presentation: CD-ROM suitable for any modern PC. Requires Adobe Acrobat Reader which is included on the MEM CD-ROM.

Price of the Basic Work: ~~£29.95~~ OFFER PRICE £24.95 POST FREE. Offer ends May 31st 2002

ORDER BOTH MANUALS TOGETHER AND SAVE ANOTHER £10

*A mass of well-organised and clearly explained information is brought to you by expert editorial teams whose combined experience ensures the widest coverage
Regular Supplements to these unique publications, keep you abreast of the latest technology and techniques if required*

ELECTRONICS SERVICE MANUAL

(PRINTED VERSION ONLY)

EVERYTHING YOU NEED TO KNOW TO GET STARTED IN REPAIRING AND SERVICING ELECTRONIC EQUIPMENT

SAFETY: Be knowledgeable about Safety Regulations, Electrical Safety and First Aid.

UNDERPINNING KNOWLEDGE: Specific sections enable you to Understand Electrical and Electronic Principles, Active and Passive Components, Circuit Diagrams, Circuit Measurements, Radio, Computers, Valves and Manufacturers' Data, etc.

PRACTICAL SKILLS: Learn how to identify Electronic Components, Avoid Static Hazards, Carry Out Soldering and Wiring, Remove and Replace Components.

TEST EQUIPMENT: How to Choose and Use Test Equipment, Assemble a Toolkit, Set Up a Workshop, and Get the Most from Your Multimeter and Oscilloscope, etc.

SERVICING TECHNIQUES: The regular Supplements include vital guidelines on how to Service Audio Amplifiers, Radio Receivers, TV Receivers, Cassette Recorders, Video Recorders, Personal Computers, etc.

TECHNICAL NOTES: Commencing with the IBM PC, this section and the regular Supplements deal with a very wide range of specific types of equipment – radios, TVs, cassette recorders, amplifiers, video recorders etc..

REFERENCE DATA: Detailing vital parameters for Diodes, Small-Signal Transistors, Power Transistors, Thyristors, Triacs and Field Effect Transistors. Supplements include Operational Amplifiers, Logic Circuits, Optoelectronic Devices, etc.

ELECTRONICS SERVICE MANUAL

(ESM – Printed version only)

Basic Work: Contains around 900 pages of information. Edited by Mike Tooley BA

Regular Supplements: Unlike a book or encyclopedia, this Manual is a living work – continuously extended with new material. If requested, Supplements are sent to you on approval approximately every three months. Each Supplement contains around 160 pages – all for only £23.50+£2.50 p&p. You can, of course, return any Supplement (within ten days) which you feel is superfluous to your needs. You can also purchase a range of past Supplements to extend your Base Manual on subjects of particular interest to you.

Presentation: Durable looseleaf system in large A4 format

Price of the Basic Work: ~~£39.95~~ **SALE PRICE £24.95**

(to include a recent Supplement **FREE**). Offer ends May 31st 2002.

The essential work for servicing and repairing electronic equipment

- Around 900 pages
- Fundamental principles
- Troubleshooting techniques
- Servicing techniques
- Choosing and using test equipment
- Reference data
- Easy-to-use format
- Clear and simple layout
- Vital safety precautions
- Professionally written
- Regular Supplements
- Sturdy gold blocked ring-binder



Guarantee

Our 30 day money back guarantee gives you complete peace of mind. If you are not entirely happy with the *Electronics Service Manual*, for whatever reason, simply return it to us in good condition within 30 days and we will make a full refund of your payment – no small print and no questions asked. All we ask is that you pay the return postage. (Overseas buyers also have to pay our overseas postage charge). Sorry, but we can only make exchanges on the *Modern Electronics Manual* (CD-ROM version) if the CD-ROM is faulty, we cannot offer a money back guarantee on this product as the content can be printed out.

Wimborne Publishing Ltd., Dept Y6, 408 Wimborne Road East, Ferndown, Dorset BH22 9ND. Tel: 01202 873872. Fax: 01202 874562.
Online shop: www.epemag.wimborne.co.uk/shopdoor.htm

PLEASE send me



- THE MODERN ELECTRONICS MANUAL (CD-ROM version only)
- ELECTRONICS SERVICE MANUAL plus a FREE SUPPLEMENT (Printed version only)
- I enclose payment of £24.95 (for one Manual) or £39.90 for both Manuals (saving another £10 by ordering both together) plus postage if applicable. (Offers end May 31st 2002)
- I also require the appropriate Supplements four times a year. These are billed separately and can be discontinued at any time. (Please delete if not required.)

FULL NAME
(PLEASE PRINT)

ADDRESS

POSTCODE

SIGNATURE

I enclose cheque/PO in UK pounds payable to Wimborne Publishing Ltd.

Please charge my Visa/Mastercard/Amex/Diners Club/Switch Switch Issue No.....

Card No. Card Exp. Date

ORDER FORM

Simply complete and return the order form with your payment to the following address:
Wimborne Publishing Ltd, Dept. Y6, 408 Wimborne Road East, Ferndown, Dorset BH22 9ND
We offer a 30 day MONEY BACK GUARANTEE on ESM – see the panel above for details.

POSTAGE CHARGES FOR ESM

MEM CD-ROM POST FREE TO ALL COUNTRIES
(Note we use the VAT portion of the MEM CD-ROM payment to pay for overseas postage)

Postal Region	Price PER ESM PRINTED MANUAL	
	Surface	Air
Mainland UK	FREE	–
Scottish Highlands, UK Islands & Eire	£7 each	–
Europe (EU)	–	£23 each
Europe (Non-EU)	£23 each	£30 each
USA & Canada	£28 each	£39 each
Far East & Australasia	£35 each	£43 each
Rest of World	£28 each	£52 each

Please allow four working days for UK delivery.
NOTE: Surface mail can take over 10 weeks to some parts of the world. Each ESM weighs about 4kg when packed.

MAIL ORDER ONLY • CALLERS BY APPOINTMENT

EPE MICROCONTROLLER P.I. TREASURE HUNTER

The latest MAGENTA DESIGN - highly stable & sensitive - with I.C. control of all timing functions and advanced pulse separation techniques.

- High stability drift cancelling
- Easy to build & use
- No ground effect, works in seawater



- Detects gold, silver, ferrous & non-ferrous metals

- Efficient quartz controlled microcontroller pulse generation.
- Full kit with headphones & all hardware

KIT 847£63.95

PIC PIPE DESCALER

- SIMPLE TO BUILD
- HIGH POWER OUTPUT
- AUDIO & VISUAL MONITORING
- SWEPT FREQUENCY

An affordable circuit which sweeps the incoming water supply with variable frequency electromagnetic signals. May reduce scale formation, dissolve existing scale and improve lathering ability by altering the way salts in the water behave.

Kit includes case, P.C.B., coupling coil and all components. High coil current ensures maximum effect. L.E.D. monitor.



KIT 868 £22.95 POWER UNIT.....£3.99

MICRO PEST SCARER

Our latest design - The ultimate scarer for the garden. Uses special microchip to give random delay and pulse time. Easy to build reliable circuit. Keeps pets/pests away from newly sown areas, play areas, etc. uses power source from 9 to 24 volts.

- RANDOM PULSES
- HIGH POWER
- DUAL OPTION



Plug-in power supply £4.99

KIT 867.....£19.99

KIT + SLAVE UNIT.....£32.50

WINDICATOR

A novel wind speed indicator with LED readout. Kit comes complete with sensor cups, and weatherproof sensing head. Mains power unit £5.99 extra.

KIT 856.....£28.00

★ TENS UNIT ★

DUAL OUTPUT TENS UNIT

As featured in March '97 issue.

Magenta have prepared a FULL KIT for this excellent new project. All components, PCB, hardware and electrodes are included. Designed for simple assembly and testing and providing high level dual output drive.

KIT 866. Full kit including four electrodes £32.90

Set of 4 spare electrodes
£6.50

1000V & 500V INSULATION TESTER



Superb new design. Regulated output, efficient circuit. Dual-scale meter, compact case. Reads up to 200 Megohms.

Kit includes wound coil, cut-out case, meter scale, PCB & ALL components.

KIT 848.....£32.95

EPE TEACH-IN 2000

Full set of top quality NEW components for this educational series. All parts as specified by EPE. Kit includes breadboard, wire, croc clips, pins and all components for experiments, as listed in introduction to Part 1.

*Batteries and tools not included.

TEACH-IN 2000 -

KIT 879 £44.95

MULTIMETER £14.45

SPACEWRITER

An innovative and exciting project. Wave the wand through the air and your message appears. Programmable to hold any message up to 16 digits long. Comes pre-loaded with "MERRY XMAS". Kit includes PCB, all components & tube plus instructions for message loading.

KIT 849.....£16.99

12V EPROM ERASER

A safe low cost eraser for up to 4 EPROMS at a time in less than 20 minutes. Operates from a 12V supply (400mA). Used extensively for mobile work - updating equipment in the field etc. Also in educational situations where mains supplies are not allowed. Safety interlock prevents contact with UV.

KIT 790.....£29.90

SUPER BAT DETECTOR

1 WATT O/P, BUILT IN SPEAKER, COMPACT CASE 20kHz-140kHz NEW DESIGN WITH 40kHz MIC.

A new circuit using a 'full-bridge' audio amplifier i.c., internal speaker, and headphone/tape socket. The latest sensitive transducer, and 'double balanced mixer' give a stable, high performance superheterodyne design.

KIT 861.....£24.99

ALSO AVAILABLE Built & Tested...£39.99



PORTABLE ULTRASONIC PEST SCARER

A powerful 23kHz ultrasound generator in a compact hand-held case. MOSFET output drives a special sealed transducer with intense pulses via a special tuned transformer. Sweeping frequency output is designed to give maximum output without any special setting up.

KIT 842.....£22.56

68000 DEVELOPMENT TRAINING KIT

- NEW PCB DESIGN
- 8MHz 68000 16-BIT BUS
- MANUAL AND SOFTWARE
- 2 SERIAL PORTS
- PIT AND I/O PORT OPTIONS
- 12C PORT OPTIONS

KIT 621

£99.95

- ON BOARD 5V REGULATOR
- PSU £6.99
- SERIAL LEAD £3.99

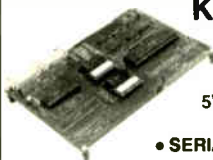

Stepping Motors

MD38...Mini 48 step...£8.65

MD35...Std 48 step...£9.99

MD200...200 step...£12.99

MD24...Large 200 step...£22.95



MOSFET MkII VARIABLE BENCH POWER SUPPLY 0-25V 2.5A

Based on our Mk1 design and preserving all the features, but now with switching pre-regulator for much higher efficiency. Panel meters indicate Volts and Amps. Fully variable down to zero. Toroidal mains transformer. Kit includes punched and printed case and all parts. As featured in April 1994 EPE. An essential piece of equipment.



Kit No. 845£64.95

EPE PROJECT PICS

Programmed PICs for all* EPE Projects
 16C84/18F84/16C71
 All **£5.90 each**

PIC16F877 now in stock £10 inc. VAT & postage
 (*some projects are copyright)

ULTRASONIC PEST SCARER

Keep pets/pests away from newly sown areas, fruit, vegetable and flower beds, children's play areas, patios etc. This project produces intense pulses of ultrasound which deter visiting animals.

- KIT INCLUDES ALL COMPONENTS, PCB & CASE
- EFFICIENT 100V TRANSDUCER OUTPUT
- COMPLETELY INAUDIBLE TO HUMANS



- UP TO 4 METRES RANGE
- LOW CURRENT DRAIN

KIT 812.....£15.00

SIMPLE PIC PROGRAMMER

INCREDIBLE LOW PRICE! Kit 857 **£12.99**

INCLUDES 1-PIC16F84 CHIP
SOFTWARE DISK, LEAD
CONNECTOR, PROFESSIONAL
PC BOARD & INSTRUCTIONS

Power Supply £3.99

EXTRA CHIPS:
PIC 16F84 £4.84

Based on February '96 EPE. Magenta designed PCB and kit. PCB with 'Reset' switch, Program switch, 5V regulator and test L.E.D.s, and connection points for access to all A and B port pins.

PIC 16C84 DISPLAY DRIVER

INCLUDES 1-PIC16F84 WITH DEMO
PROGRAM SOFTWARE DISK, PCB,
INSTRUCTIONS AND 16-CHARAC-
TER 2-LINE

Kit 860 **£19.99**

Power Supply £3.99

LCD DISPLAY

FULL PROGRAM SOURCE CODE
SUPPLIED - DEVELOP
YOUR OWN APPLICATION!

Another super PIC project from Magenta. Supplied with PCB, industry standard 2-LINE x 16-character display, data, all components, and software to include in your own programs. Ideal development base for meters, terminals, calculators, counters, timers - Just waiting for your application!

PIC 16F84 MAINS POWER 4-CHANNEL CONTROLLER & LIGHT CHASER

- WITH PROGRAMMED 16F84 AND DISK WITH SOURCE CODE IN MPASM
- ZERO VOLT SWITCHING
- MULTIPLE CHASE PATTERNS
- OPTO ISOLATED
- 5 AMP OUTPUTS
- 12 KEYPAD CONTROL
- SPEED/DIMMING POT.
- HARD-FIRED TRIACS

Now features full 4-channel chaser software on DISK and pre-programmed PIC16F84 chip. Easily re-programmed for your own applications. Software source code is fully 'commented' so that it can be followed easily.

Kit 855 **£39.95**

LOTS OF OTHER APPLICATIONS

8-CHANNEL DATA LOGGER

As featured in Aug./Sept. '99 EPE. Full kit with Magenta redesigned PCB - LCD fits directly on board. Use as Data Logger or as a test bed for many other 16F877 projects. Kit includes programmed chip, 8 EEPROMs, PCB, case and all components.

Kit 877 **£49.95** inc. 8 x 256K EEPROMS

ICEBREAKER

□□□□□□□□□□

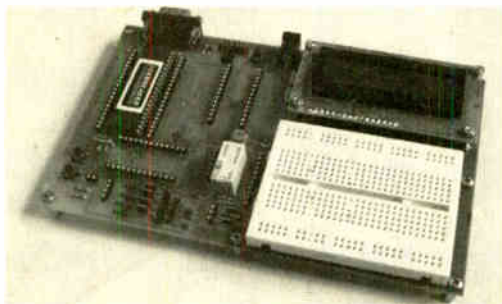

PIC Real Time In-Circuit Emulator

- Icebreaker uses PIC16F877 in circuit debugger
- Links to Standard PC Serial Port (lead supplied)
- Windows™ (95+) Software included
- Works with MPASM and MPLAB Microchip software
- 16 x 2 L.C.D., Breadboard, Relay, I/O devices and patch leads supplied

As featured in March '00 EPE. Ideal for beginners AND advanced users. Programs can be written, assembled, downloaded into the microcontroller and run at full speed (up to 20MHz), or one step at a time.

Full emulation means that all I/O ports respond exactly and immediately, reading and driving external hardware.

Features include: Reset; Halt on external pulse; Set Breakpoint; Examine and Change registers, EEPROM and program memory; Load program, Single Step with display of Status, W register, Program counter, and user selected 'Watch Window' registers.

Kit 900 . . . **£34.99**

POWER SUPPLY £3.99 STEPPING MOTOR £5.99

EPE PIC TOOLKIT 3

NEW

- THE LATEST TOOLKIT BOARD - 8, 18, 28 AND 40-PIN CHIPS
- MAGENTA DESIGNED P.C.B. WITH COMPONENT LAYOUT AND EXTRAS
- L.C.D., BREADBOARD AND PIC CHIP INCLUDED
- ALL TOP QUALITY COMPONENTS AND SOFTWARE SUPPLIED

Kit 880 . . . **£34.99** with 16F84 . . . **£39.99** with 16F877

PIC TOOLKIT V2

- SUPER UPGRADE FROM V1 • 18, 28 AND 40-PIN CHIPS
- READ, WRITE, ASSEMBLE & DISASSEMBLE PICS
- SIMPLE POWER SUPPLY OPTIONS 5V-20V
- ALL SWITCHING UNDER SOFTWARE CONTROL
- MAGENTA DESIGNED PCB HAS TERMINAL PINS AND OSCILLATOR CONNECTIONS FOR ALL CHIPS
- INCLUDES SOFTWARE AND PIC CHIP

Kit 878 . . . **£22.99** with 16F84 . . . **£29.99** with 16F877

EPE PIC Tutorial

At last! A Real, Practical, Hands-On Series

- Learn Programming from scratch using PIC16F84
- Start by lighting I.e.d.s and do 30 tutorials to Sound Generation, Data Display, and a Security System.
- PIC TUTOR Board with Switches, I.e.d.s, and on board programmer

PIC TUTOR BOARD KIT

Includes: PIC16F84 Chip, TOP Quality PCB printed with Component Layout and all components* (*not ZIF Socket or Displays). Included with the Magenta Kit is a disk with Test and Demonstration routines.

Kit 870 **£27.95**, Built & Tested **£42.95**

Optional: Power Supply - **£3.99**, ZIF Socket - **£9.99**

LCD Display **£7.99** LED Display **£6.99**

Reprints Mar/Apr/May 98 - **£3.00** set 3

SUPER PIC PROGRAMMER

- READS, PROGRAMS, AND VERIFIES
- WINDOWS® SOFTWARE
- PIC16C6X, 7X, AND 8X
- USES ANY PC PARALLEL PORT
- USES STANDARD MICROCHIP • HEX FILES
- OPTIONAL DISASSEMBLER SOFTWARE (EXTRA)
- PCB, LEAD, ALL COMPONENTS, TURNED-PIN SOCKETS FOR 18, 28, AND 40 PIN ICs

• SEND FOR DETAILED INFORMATION - A SUPERB PRODUCT AT AN UNBEATABLE LOW PRICE.

Kit 862 **£29.99**

Power Supply £3.99

DISASSEMBLER SOFTWARE **£11.75**

PIC STEPPING MOTOR DRIVER

INCLUDES PCB, PIC16F84 WITH DEMO PROGRAM, SOFTWARE DISC, INSTRUCTIONS AND MOTOR.

Kit 863 **£18.99**

FULL SOURCE CODE SUPPLIED ALSO USE FOR DRIVING OTHER POWER DEVICES e.g. SOLENOIDS

Another NEW Magenta PIC project. Drives any 4-phase unipolar motor - up to 24V and 1A. Kit includes all components and 48 step motor. Chip is pre-programmed with demo software, then write your own, and re-program the same chip! Circuit accepts inputs from switches etc and drives motor in response. Also runs standard demo sequence from memory.

MAGENTA

All prices include VAT. Add £3.00 p&p. Next day **£6.99**

Tel: 01283 565435 Fax: 01283 546932 E-mail: sales@magenta2000.co.uk

062002



Station Road, Cullercoats, Tyne & Wear, NE30 4PQ

Prices Exclude Vat @17.5%. UK Carriage £1.50 (less than 1kg) £3.50 greater than 1kg

Cheques / Postal orders payable to ESR Electronic Components. PLEASE ADD CARRIAGE & VAT TO ALL ORDERS



See Next / Last Months Ad for COMPONENT ACCESSORIES

4000 Series

Table listing various electronic components like capacitors and resistors with their part numbers and prices.

Table listing electronic components such as RAM, A/D Converters, and Voltage Regulators.

Table listing electronic components including Thyristors, Triacs, Diodes, and Transistors.

Table listing electronic components like Relays, Optocouplers, and Photo Transistors.

Table listing electronic components such as Relays, Optocouplers, and Photo Transistors.

Table listing electronic components like Relays, Optocouplers, and Photo Transistors.

Table listing electronic components such as Relays, Optocouplers, and Photo Transistors.

Table listing electronic components like Relays, Optocouplers, and Photo Transistors.

Quality Components. No surplus or redundant stock. All from leading manufacturers.

Quality Service. Sameday despatch an all stock items. Friendly helpful staff.

Fast Delivery. Nextday service for all small (<1kg) orders at a extra charge. 3 day service for orders >1kg

No Minimum Order. Order what you need, no pack quantities or min order value.

Quantity Discounts Available. We offer discounts for all items subject to quantity required, phone, fax or email for a quote.

New Electronic Component Catalogue. Free - when requested or via Web Site

We carry a large range of capacitors in stock, including: Ceramic Mini Disc, Dipped Ceramic Multilayer, Dipped & Baked Polyester, Mylar Film, Polystyrene, Plastic Film, MKT Polyester, Tantalum Bead, Sub-miniature Radial, 105 C Radial, Low Leakage Radial, Non Polarised Radial & Axial, PCB Can Electrolytics, Polypropylene & Ceramic Trimmers and Tuning capacitors. Full technical details available.

Resistors - Please State Value Required. per 100 of one value only. 1/8W Carbon Film 5% E12 Series 10k-1M0 £0.02 Each, £0.80 per 100

Presot Resistors - Please State Value Required. Enclosed, 10mm Square Horiz / Vert. 100k- 1M0 0.1W £0.12 Each

Potentiometers - Please State Value Required. Single Gang 1/4" Shaft, 25mm Dia. 470k-2M2 Linear £0.56 Each

Bridge Rectifiers. 1A 50V £0.35. PCB Mount, Splined Shaft, 16mm Dia. 470k-2M2 Linear £0.48 Each

EVERYDAY PRACTICAL ELECTRONICS

INCORPORATING ELECTRONICS TODAY INTERNATIONAL

THE No.1 MAGAZINE FOR ELECTRONICS TECHNOLOGY & COMPUTER PROJECTS

VOL. 31 No. 6 JUNE 2002

HELP PLEASE

It is very rare for us to request articles for *EPE*, in fact we actually receive or commission plenty of material to fill our pages. (Although we are always on the lookout for unusual or ingenious projects, so do let us know if you have such an item.) However, there is one project that has basically eluded us for many years and I would like to ask if anyone could assist us in our search for suitable information.

As a reader recently pointed out, many of our projects are repeated over a period of time but he had only once seen an ultrasonic cleaning bath project in the magazine, and that was more than 20 years ago. He is, of course, quite right, the problem being the lack of a suitable transducer at a reasonable price for hobbyist use.

So, if you work for a company that could supply such an item or if you know of a supplier please get in touch. What we are looking for is a fairly high powered piezoelectric ultrasonic transducer that can be fixed to a small stainless steel cleaning bath for cleaning small items like jewellery, watches, p.c.b.s etc.

ORIGINAL PROJECT

The original design, back in the January 1980 issue of *Practical Electronics* relied heavily on some specially made transformers and, of course, an ultrasonic transducer, unfortunately soon after publication the company supplying the specialist parts had a fire and their stock was destroyed, so even that design was relatively short-lived.

This is the type of project that will attract interest over a number of years so, if possible, we need to find a reliable supplier and not just a few "surplus" transducers.

Commercial ultrasonic cleaning baths do seem to be quite expensive and we believe it should be possible to make a small bath reasonably cheaply provided, of course, we can find that elusive transducer.

Any ideas, anyone?

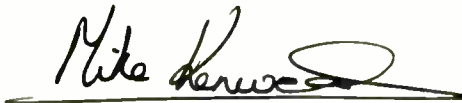

AVAILABILITY

Copies of *EPE* are available on subscription anywhere in the world (see below), from all UK newsagents (distributed by COMAG) and from the following electronic component retailers: Omni Electronics and Yebo Electronics (S. Africa). *EPE* can also be purchased from retail magazine outlets around the world. An Internet on-line version can be purchased and downloaded for just \$9.99(US – approx £7.70) per year available from www.epemag.com

SUBSCRIPTIONS

Subscriptions for delivery direct to any address in the UK: 6 months £15, 12 months £28.50, two years £52; Overseas: 6 months £18 standard air service or £27 express airmail, 12 months £34.50 standard air service or £52 express airmail, 24 months £64 standard air service or £99 express airmail. Online subscriptions, for downloading the magazine via the Internet, \$9.99(US – approx £7.70) for one year available from www.epemag.com.

Cheques or bank drafts (in £ sterling only) payable to *Everyday Practical Electronics* and sent to EPE Subs. Dept., Wimborne Publishing Ltd, 408 Wimborne Road East, Ferndown, Dorset BH22 9ND. Tel: 01202 873872. Fax: 01202 874562. Email: subs@epemag.wimborne.co.uk. Also via the Web at: <http://www.epemag.wimborne.co.uk>. Subscriptions start with the next available issue. We accept MasterCard, Amex, Diners Club, Switch or Visa. (For past issues see the *Back Issues* page.)

BINDERS

Binders to hold one volume (12 issues) are available from the above address. These are finished in blue p.v.c., printed with the magazine logo in gold on the spine. Price £5.95 plus £3.50 p&p (for overseas readers the postage is £6.00 to everywhere except Australia and Papua New Guinea which cost £10.50). Normally sent within seven days but please allow 28 days for delivery – more for overseas.

Payment in £ sterling only please. Visa, Amex, Diners Club, Switch and MasterCard accepted. Send, fax or phone your card number and card expiry date with your name, address etc. Or order on our secure server via our UK web site. Overseas customers – your credit card will be charged by the card provider in your local currency at the existing exchange rate.

Editorial Offices:

EVERYDAY PRACTICAL ELECTRONICS EDITORIAL
WIMBORNE PUBLISHING LTD, 408 WIMBORNE ROAD EAST,
FERNDOWN, DORSET BH22 9ND
Phone: (01202) 873872. Fax: (01202) 874562.

Email: enquiries@epemag.wimborne.co.uk

Web Site: <http://www.epemag.wimborne.co.uk>

EPE Online www.epemag.com

EPE Online Shop: www.epemag.wimborne.co.uk/shopdoor.htm

See notes on *Readers' Technical Enquiries* below – we regret lengthy technical enquiries cannot be answered over the telephone.

Advertisement Offices:

EVERYDAY PRACTICAL ELECTRONICS ADVERTISEMENTS

MILL LODGE, MILL LANE

THORPE-LE-SOKEN, ESSEX CO16 0ED

Phone/Fax: (01255) 861161

Editor: MIKE KENWARD

Deputy Editor: DAVID BARRINGTON

Technical Editor: JOHN BECKER

Business Manager: DAVID J. LEAVER

Subscriptions: MARILYN GOLDBERG

Administration: FAY KENWARD

Editorial/Admin: (01202) 873872

Advertisement Manager:

PETER J. MEW, Frinton (01255) 861161

Advertisement Copy Controller:

PETER SHERIDAN, (01202) 873872

On-Line Editor: ALAN WINSTANLEY

EPE Online (Internet version) Editors:

CLIVE (MAX) MAXFIELD and ALVIN BROWN

READERS' TECHNICAL ENQUIRIES

E-mail: techdept@epemag.wimborne.co.uk

We are unable to offer any advice on the use, purchase, repair or modification of commercial equipment or the incorporation or modification of designs published in the magazine. We regret that we cannot provide data or answer queries on articles or projects that are more than five years old. Letters requiring a personal reply *must* be accompanied by a stamped self-addressed envelope or a self-addressed envelope and international reply coupons. All reasonable precautions are taken to ensure that the advice and data given to readers is reliable. We cannot, however, guarantee it and we cannot accept legal responsibility for it.

COMPONENT SUPPLIES

We do not supply electronic components or kits for building the projects featured, these can be supplied by advertisers (see *Shoptalk*). We advise readers to check that all parts are still available before commencing any project in a back-dated issue.

ADVERTISEMENTS

Although the proprietors and staff of EVERYDAY PRACTICAL ELECTRONICS take reasonable precautions to protect the interests of readers by ensuring as far as practicable that advertisements are *bona fide*, the magazine and its Publishers cannot give any undertakings in respect of statements or claims made by advertisers, whether these advertisements are printed as part of the magazine, or in inserts.

The Publishers regret that under no circumstances will the magazine accept liability for non-receipt of goods ordered, or for late delivery, or for faults in manufacture.

TRANSMITTERS/BUGS/TELEPHONE EQUIPMENT

We advise readers that certain items of radio transmitting and telephone equipment which may be advertised in our pages cannot be legally used in the UK. Readers should check the law before buying any transmitting or telephone equipment as a fine, confiscation of equipment and/or imprisonment can result from illegal use or ownership. The laws vary from country to country; readers should check local laws.



BIOPIC HEARTBEAT MONITOR



JOHN BECKER

Take a peek at the rhythmic waveforms that keep you ticking!

BEFORE joining *EPE*, the author was on a short-term contract with a life-support equipment manufacturer. Of particular interest were the heartbeat waveforms displayed on the heart defibrillator screens, which had to match certain software criteria before electric shock treatment could be given to patients.

The various categories of waveform could be simulated electronically, but in active service the system would monitor a patient's heart via chest electrodes.

BEATING HISTORY

Inspired by the simplicity of the heart monitoring circuits, the author designed one for *EPE*. This was published in Feb/Mar '93 as the *Biomet* (which loosely translates as *Life Meter*).

PIC microcontrollers were unheard of to hobbyists at that time and the three-board design required 13 i.c.s. Heartbeats were monitored across the chest using simple electrodes. Pulse rates could be monitored separately by a handheld sensor that detected the opacity of the thumb, which changes as blood pulses through it.

A 3½ digit liquid crystal display (l.c.d.) showed the pulse rate. Data could also be output to a computer for waveform display.

MODERNISED MONITORING

Although heart monitoring techniques may not have changed fundamentally since that design, the methods for processing the data have moved on dramatically. The Biopic design presented here takes advantage of a PIC16F876 microcontroller's capabilities and uses an alphanumeric l.c.d. screen, plus an electrically-isolated serial data link to a PC-compatible computer. There are only five i.c.s.

The probes and contact pads used are those sold inexpensively by major chemists for use with proprietary TENS (pain relief) machines.

The design can be used as a handheld unit without using a PC. In this role it outputs heartbeat waveforms to the l.c.d., which is used in the same graphical fashion as with the author's *Micro-PICscope* (simple oscilloscope) of April '00. The display also shows the heartrate in beats per minute

(BPM) and a real-time pulse beat via a flashing asterisk and l.e.d.

When used with a PC, the design switches off the l.c.d. waveform and outputs data as a 9600 baud serial stream to a program written for QB (QBasic or QuickBASIC). The Biopic software is self-contained and does not require QB itself to be installed.

The QB program can be run in DOS mode or under Windows 3.1, 95, 98 and ME (other Windows versions have not been tested with it and no advice can be offered for them).



Example of a thumb-monitored waveform on the Biopic.

PC WAVEFORM DISPLAY

A composite photo of several typical heart waveforms displayed on a PC screen is shown on the next page. Whilst the subject is believed to be in good health, a medical opinion of the waveforms has not been sought.

Normally a real-time waveform starts at top left (zone 1), continues to the right, recommences in zone 2, continues right, etc. At the end of zone 10, zone 1 is cleared and the display continues from the top again, each zone then clearing in sequence as the waveform starts at its beginning.

The BPM rate is calculated across each zone, and the value displayed at the screen's top right. This value is updated each time a zone line is completed. The BPM and a real-time calendar/clock display are updated simultaneously.

At the bottom of the screen, details of the COM port in use are shown. The COM port address (shown here as COM 2) can be changed by pressing keyboard key <C> (more later). The baud rate and its format cannot be changed as this is set within the PIC software as well as in the QB program.

The span between screen data plotting points can be changed to vary the display detail, using the <+> and <-> keys. The

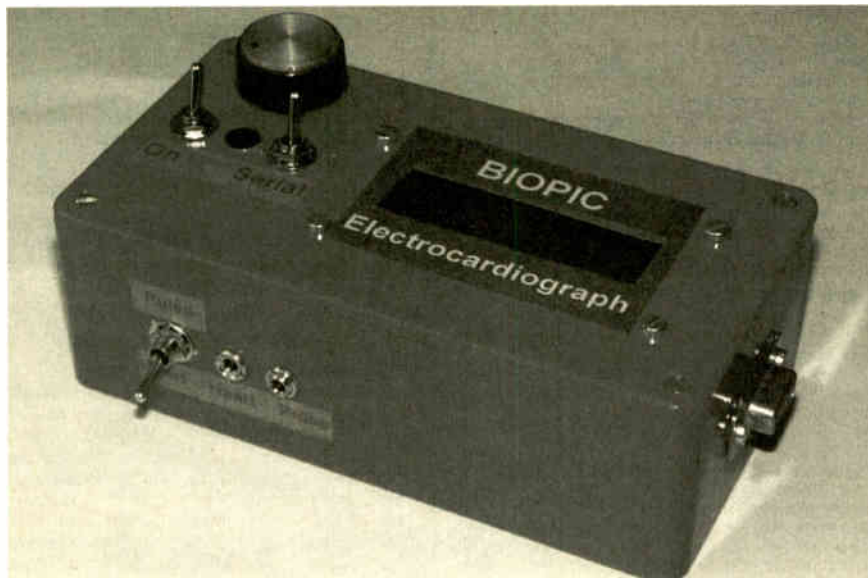

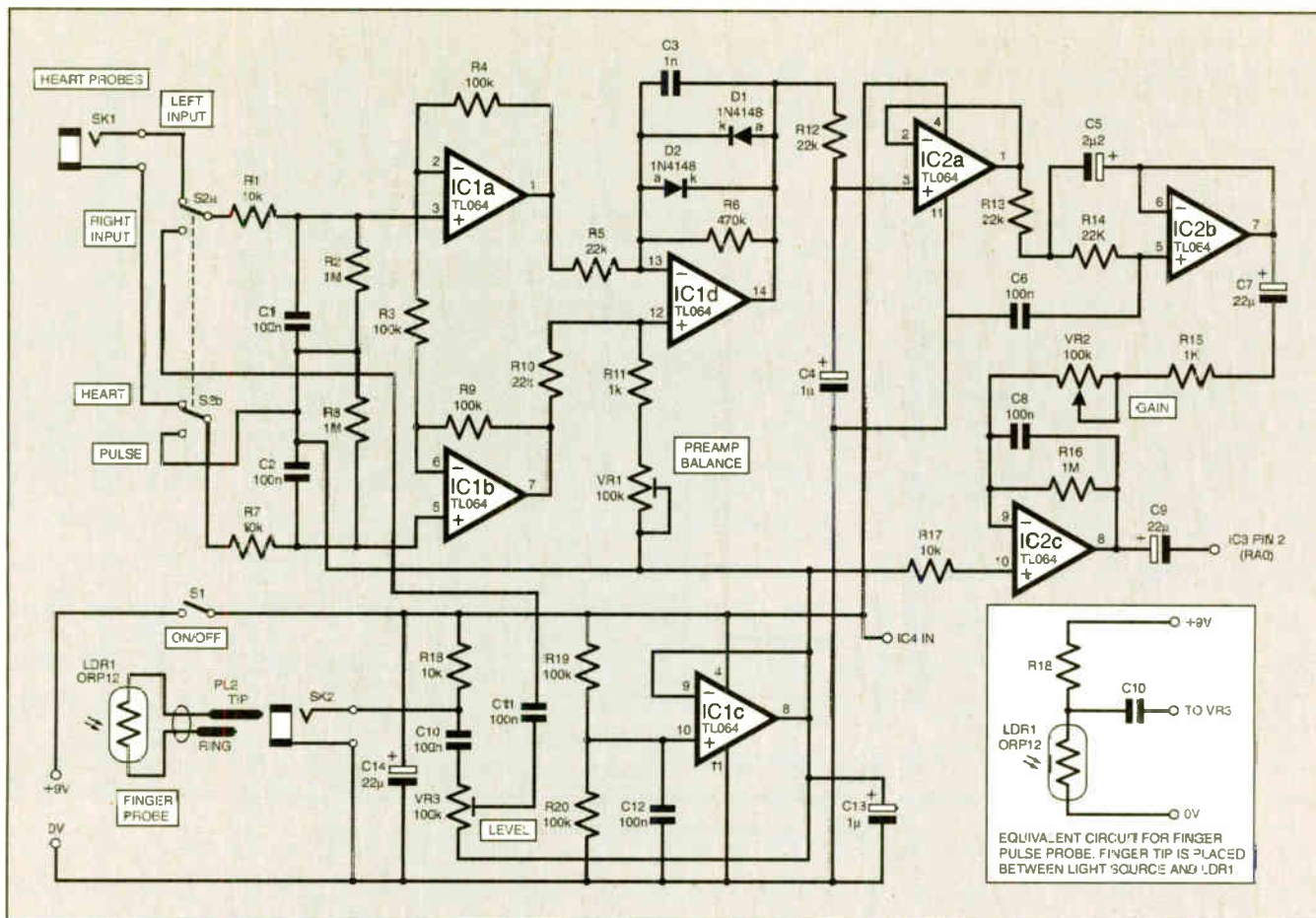

Fig.1. Circuit diagram for the analogue stages of the Biopic Heartbeat Monitor.

range is 1/1 to 1/50, the latter showing waveforms closer together. The sampling rate is not affected by these changes, the result is purely cosmetic on the PC's screen.

Pressing <H> turns on the "hold" function. The display then pauses when it reaches the far right of its current zone. Pressing any key then lets the display run again.

Pressing <Q> causes an exit from the program and a return to the screen from which it was first called.

Pressing <L> enlarges the display to cover just one nearly full-screen line. Pressing <L> again returns you to 10-line mode.

When run under Windows, waveforms can be "captured" for saving to disk and printing to paper (via Paint).

ANALOGUE CIRCUIT

The Biopic effectively has two circuits, the sensor input and signal pre-conditioning circuit, plus the PIC-controlled display and data output circuit.

The analogue circuit diagram is shown in Fig.1. Probes from the subject whose heart is to be monitored are connected into socket SK1. The circuit is not "earthed" for safety reasons and a differential amplification technique is used.

The probes are each connected separately to the non-inverting inputs of two op.amps, IC1a and IC1b, via resistors R1 and R7. Both inputs are biased at about 4.5V (half the nominal 9V supplied by a PP3 battery) via resistors R2 and R3, which have a high value to minimise the voltage drop across R1 and R7.

A pumping heart is accompanied by a small electrical field across the chest. This can be detected by using two electrical contact pads and probes. One pad is placed below the heart, near the bottom left of the subject's rib cage. The other is placed on the subject's right towards the top of the chest. It is worth experimenting to find the best position.

The self-adhesive pads have terminals to which the commercially purchased probe leads are clipped. As the heart beats, the electrical field is detected as a voltage difference between the probes, and thus by their amplifiers. The difference in potential between the probes is extremely small and needs a considerable amount of amplification.

Initially, the difference is d.c. amplified by a factor of two, as set by resistors R4, R3 and R9, although this is complicated by the intercoupling between IC1a and IC1b via R3 (see *Teach-In 2002* Part 5 (Mar '02) for an explanation).

Further amplification of about x21 is given when combining both paths via differential op.amp IC1d. The balance between the two signals can be set by

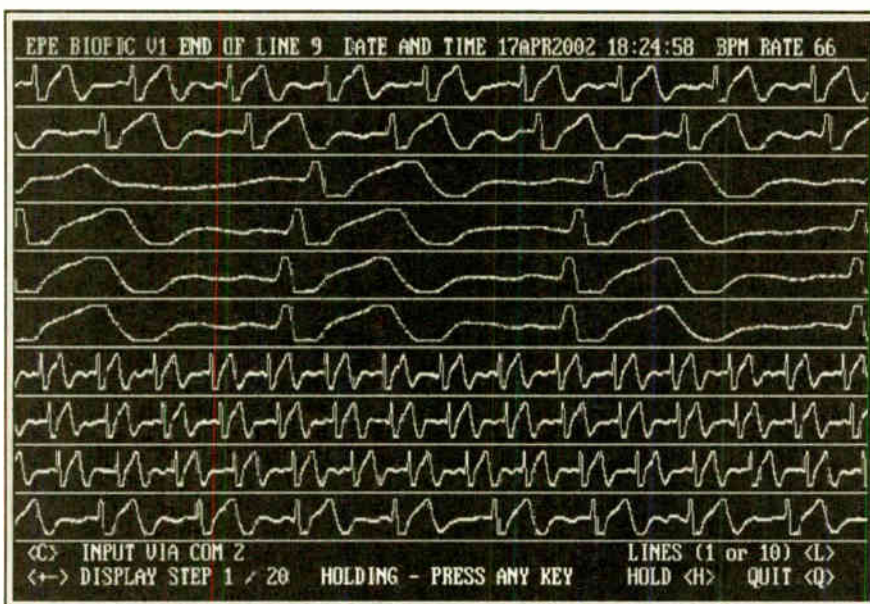

Composite of several heart waveform traces as shown on the PC screen. In normal running the waveforms run continuously.

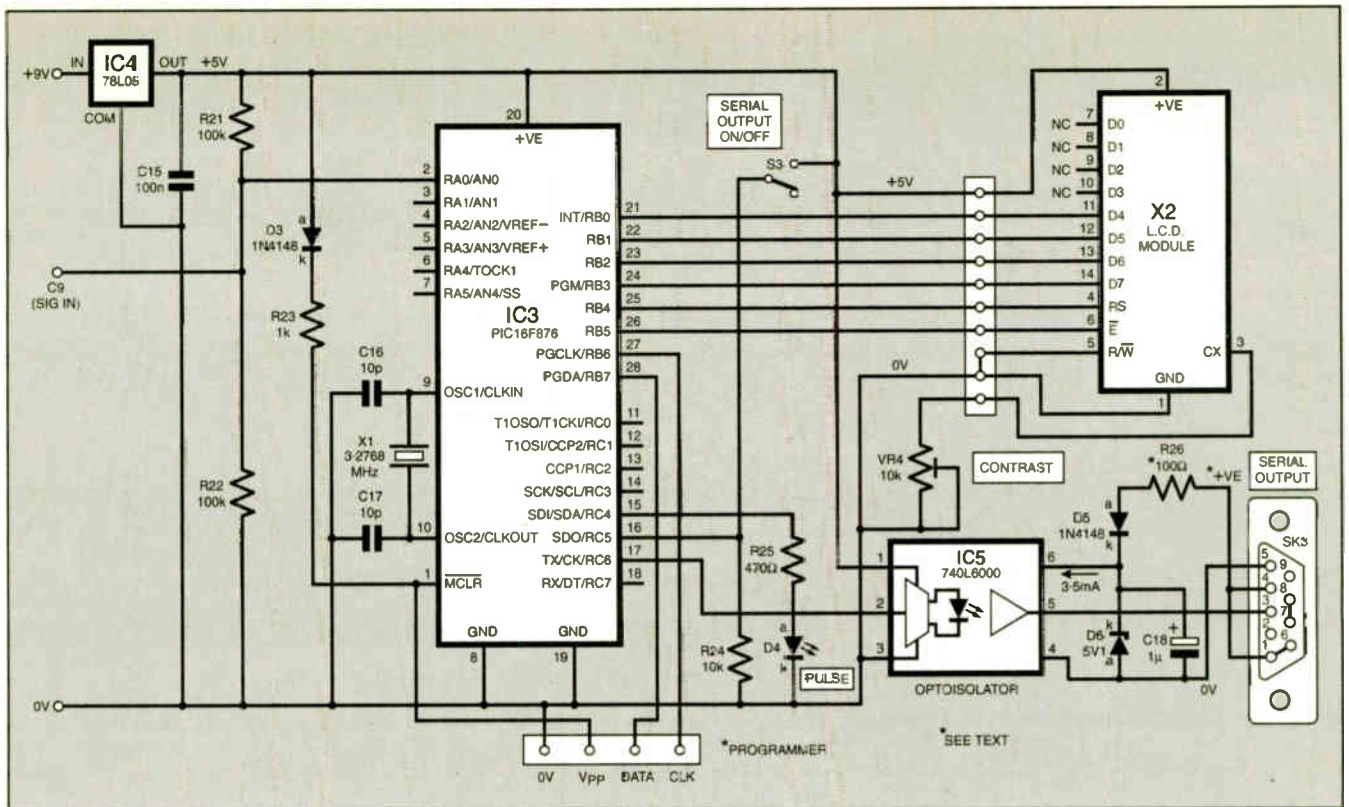

Fig.2. The Biopic's control circuit details.

preset VR1. High-frequency cut-off is provided by capacitor C3.

Still as a d.c. voltage, the signal is fed to the first stage of a low-pass filter via resistor R12, with capacitor C4 providing some preliminary upper-frequency cut. Heartbeats normally take place at around one per second, and seldom above two per second except under extreme conditions.

Whereas the previous *Biomet* used a switched-mode filter (MF10), *Biopic* uses a purely analogue filter. This is a variant of the Third Order Chebyshev low-pass filter from the *Filter Handbook* by Stefan Niewiadomski. It is formed around op.amps IC2a and IC2b and removes practically all frequencies above those that are to be expected from a heartbeat waveform.

Its output is a.c. coupled by capacitor C7 to the final gain stage, formed around IC2c. Here the gain can be varied between about $\times 10$ and $\times 1000$ by potentiometer VR2. Capacitor C9 gives stability to IC2c at high gain levels.

The final output is a.c. coupled by capacitor C9 to one of the ADC inputs (RA0/AN0) of the PIC microcontroller (Fig.2).

THUMB PULSE

Still referring to Fig.1. The circuit can be switched to monitor a pulse beat detected via a thumb probe, detecting blood flow as mentioned earlier.

The familiar ORP12 light dependent resistor (l.d.r.) is used. This is biased across the 9V/0V power rails via resistor R18. An equivalent circuit of the sensor configuration is shown in the inset of Fig.1.

As the blood pulses, the amount of light passing to the l.d.r. through the thumb varies. This causes the resistance across the l.d.r. to change minutely. The resulting fluctuating voltage at the l.d.r./R18 junction is a.c. coupled via C10 to

potentiometer VR3. This sets the amplitude that is fed via C11 to op.amp IC1a and switch S2a. Amplification takes place as before, but with IC1b not used.

CONTROL CIRCUIT

In the control circuit of Fig.2, the principal component is the PIC16F876 microcontroller, IC3. This is clocked at 3.2768MHz as set by crystal X1.

The amplified and a.c. coupled signal from IC2c is fed to the PIC's RA0/AN0 analogue-to-digital converter (ADC) input. The input is biased to about 2.5V (half the PIC's nominal 5V supply), by resistors R21 and R22.

When no signal is present, the ADC conversion value read by the PIC is about decimal 128, out of a possible 8-bit range of 0 to 255 (the PIC's full 10-bit range is not needed in this design).

From the incoming values, the PIC calculates the BPM rate according to an internal clock. It does not attempt to determine which pulses are truly heart-generated and which have been caused, for example, by movement of the thumb on the l.d.r. The twin heart-probe path is less prone to extraneous conditions.

The pulse beats are displayed by l.e.d. D4, which is buffered by resistor R25 and controlled by PIC output RC4. The calculated BPM rate is output to the l.c.d. via lines RB0 to RB5, the display being operated in conventional 4-bit mode. Preset VR4 adjusts the l.c.d. screen contrast.

The software also outputs graphics data to the l.c.d. for display on line 1 in cells 1 to 8 as a simple waveform (as shown earlier and on the final page). The technique was first used by the author in the l.c.d. display for his *Micro-PICscope*.

Readers familiar with alphanumeric l.c.d.s will be aware that the display has several internal character generator registers that can

be programmed by the user. Data is written from the PIC into these registers such that the pixels show a moving display of the heartbeat waveforms.

It has to be emphasised, though, that the l.c.d. shows less detail than can be displayed on the PC screen. Nonetheless, for simple handheld use of the unit, the l.c.d. can produce informative results.

SERIAL OUTPUT

When the PIC detects that its RC5 pin has been set high via switch S3, it switches from l.c.d. output mode to serial output mode via pin RC6, feeding to opto-isolator IC5. This has an integral l.e.d. that is controlled by RC5 and buffered internally. The l.e.d.'s behaviour controls an opto-sensor coupled to IC5's internal buffer. The resulting logic level changes are output from pin 5 to the serial connector SK3, and thence to the PC.

The buffer within IC5 draws its power directly from the PC. The positive supply is passed via ballast resistor R26 and diode D5 to IC5 pin 6. Zener diode D6 ensures that the voltage across the buffer cannot exceed 5.1V and capacitor C18 smooths this supply. As a result, the data logic levels output to the PC stays within its acceptable range of nominally 0V to 5V.

The PIC16F87x series all have serial communications routines built into them, and the protocol (e.g. Baud rate etc.) can be changed as detailed in this PIC family's data sheets. The rate has been set at 9600 baud, 8-bit, 0 parity, 1 stop bit. This configuration data is also set into the *Biopic's* QB software that controls the PC's serial reception mode.

Each PIC-generated ADC conversion is sent to the PIC's serial data output register and then to the PC, which receives each data byte and processes it as discussed later. The l.e.d., D4, is not active in this mode.

COMPONENTS

Resistors

R1, R7, R17,	
R18, R24	10k (5 off)
R2, R8, R16	1M (3 off)
R3, R4, R9,	
R19 to	
R22	100k (7 off)
R5, R10,	
R12 to	
R14	22k (5 off)
R6	470k
R11, R15,	
R23	1k (3 off)
R25	470Ω
R26	100Ω (see text)
LDR1	ORP12 light dependent resistor

See
**SHOP
TALK**
page

Potentiometers

VR1	100k min. preset, round
VR2, VR3	100k min. preset, round, or panel mounting, lin. (see text) (2 off)
VR4	10k min. preset, round

Capacitors

C1, C2, C6,	
C8, C10,	
C11 C12,	100n ceramic, 5mm pitch
C15	(8 off)
C3	1n ceramic, 5mm pitch
C4, C13,	
C18	1μ radial elect. 16V (3 off)
C5	3μ2 radial elect. 16V
C7, C9,	
C14	22μ radial elect. 16V (3 off)
C16, C17	10p ceramic, 5mm pitch (2 off)

Semiconductors

D1 to D3,	
D5	1N4148 signal diode (4 off)
D4	red l.e.d.
D6	5V1 400mW Zener diode
IC1, IC2	TL064 quad op. amp (2 off)
IC3	PIC16F876-4P microcontroller, pre-programmed (see text)
IC4	78L05 +5V 100mA voltage regulator
IC5	740L6000 logic-to-logic opto-isolator

Miscellaneous

S1, S3	min. s.p.d.t. toggle switch (2 off)
S2	min. d.p.d.t. toggle switch
SK1, SK2	3.5mm jack socket (2 off)
SK3	9-pin serial connector
PL1, PL2	3.5mm jack plug (2 off)
X1	3.2768MHz crystal
X2	2-line x 16-character (per line) l.c.d. module

Printed circuit board, available from the *EPE PCB Service*, code 355; TENS replacement electrode pads (2 off, minimum), plus twin connecting lead; 6-pin d.i.l. socket; 14-pin d.i.l. socket (2 off); 28-pin d.i.l. socket, narrow; 6.35mm plastic jack plug cap (see text); plastic case 150mm x 80mm x 50mm; PP3 9V battery plus clip; knobs (see text) (2 off); connecting wire; solder, etc.

Approx. Cost
Guidance Only

£40

excluding chest electrodes

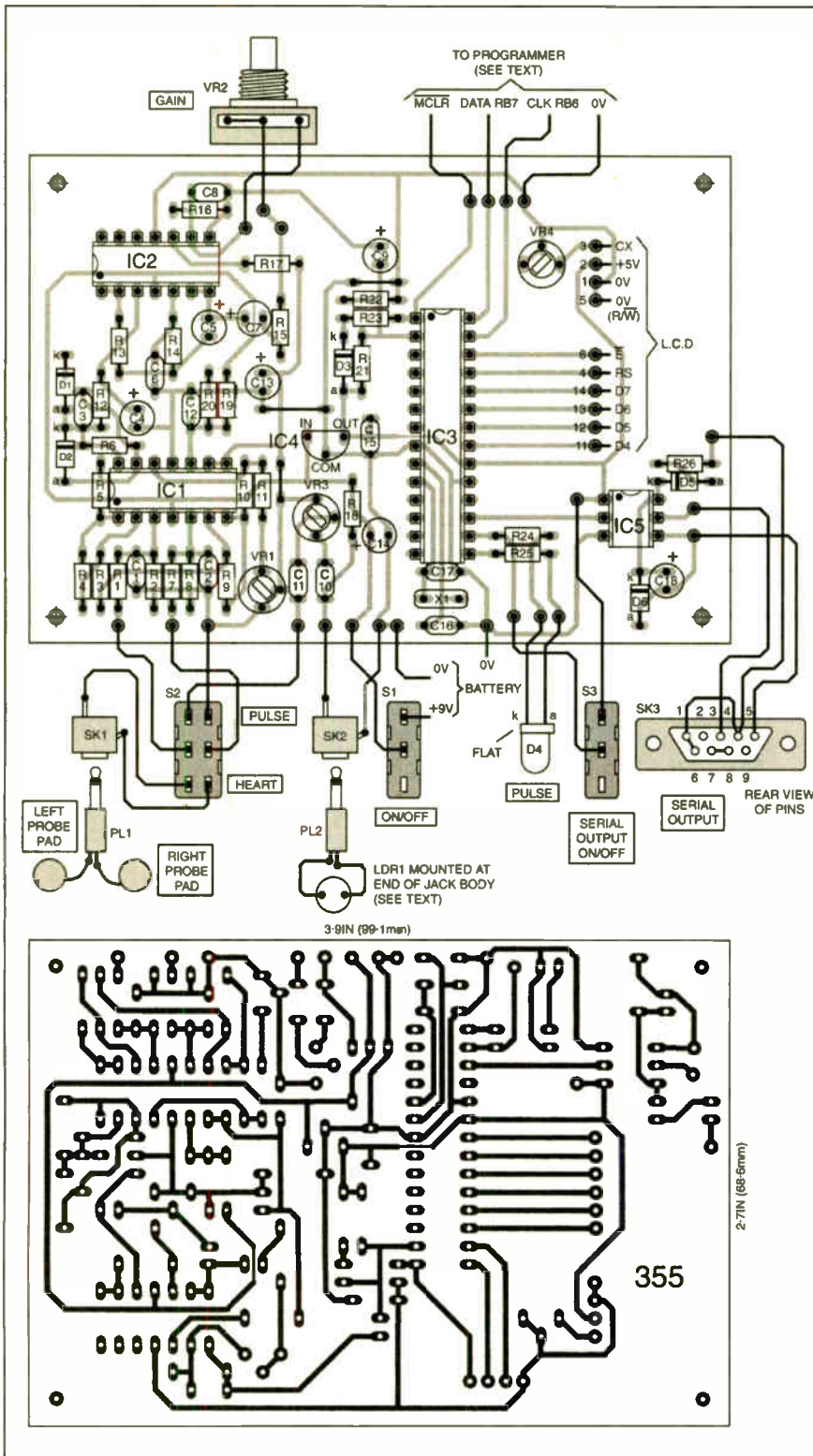

Fig.3. Printed circuit board component layout and full-size master track pattern, plus off-board connection details.

OPTO-ISOLATION

The importance of using an opto-isolator cannot be over-emphasised. The most dangerous route that an electrical current can take across the human body is via the chest. The voltages and currents that can be lethal can vary between subjects, but can be as low as 50V and 10mA.

It is therefore imperative that any unit which requires a pair of electrodes to be secured across the chest when that unit is also connected to a mains powered piece of equipment, such as a PC, must provide total electrical isolation between them.

Any designer must ensure that his units and their users cannot be harmed by mains power faults. The opto-isolator specified for the Biopic is stated by the manufacturer to provide isolation up to 2500V, well in excess of the 230V a.c. present on a normal UK a.c. mains supply.

The reason for using a serial connection between the PC and the Biopic was to simplify the isolation circuit. To have used the parallel port as the connection path (easier in some respects) would have required using an isolator for each data line.

Also for electrical safety reasons, the Biopic MUST NOT be powered from a

mains operated power supply of any type. Only battery power must be used. The safety of the person to whom the probes are connected must be the prime consideration. **DO NOT IGNORE THIS SAFETY ADVICE.**

CONSTRUCTION

The component and track layout details for the Biopic, plus the off-board wiring, are shown in Fig.3. This board is available from the *EPE PCB Service*, code 355.

Sockets must be used for all d.i.l. (dual-in-line) i.c.s, but do not insert the i.c.s until the correctness of the power supply regulator has been proved. Assemble the other components in any order you prefer, but it is recommended that they should be inserted and soldered in order of ascending size.

It is up to you whether you use preset potentiometers for VR2 and VR3, mounting them on the p.c.b. in the holes provided. The alternative is to use panel mounted rotary potentiometers with knobs. The former is neater, but the latter provides easy external control of signal amplitudes. On consideration, the author opted for VR2 as a rotary pot.

If you do not intend to use a PC with the Biopic, connect the lead that would otherwise go to the pole of switch S2 to the 0V connection.

A plastic case measuring 150mm x 80mm x 50mm was used for the prototype. A viewing slot for the l.c.d. was cut in its lid, and holes drilled for the controls and sockets.

PROBES

The ORP12 l.d.r. for thumb pulse monitoring conveniently has a diameter that allows it to be inserted in the plastic "cap" of a 6.35mm (1/4in) jack plug. Solder a suitable length (say half a metre) of twin low-voltage cable to the l.d.r.'s pins, pass the cable through the hole at the end of the cap and gently push the device into the cap until it is flush with the rim.

Secure the l.d.r. with a suitable glue or adhesive-backed tape, such as insulating tape (as was done with the prototype). Connect a 3.5mm plug to the other end of the cable. Polarity does not matter.

The heart monitoring pads are likely to be sold in multi-packs - two pairs in the pack bought by the author. They are intended as replacements for use with proprietary TENS machines and their

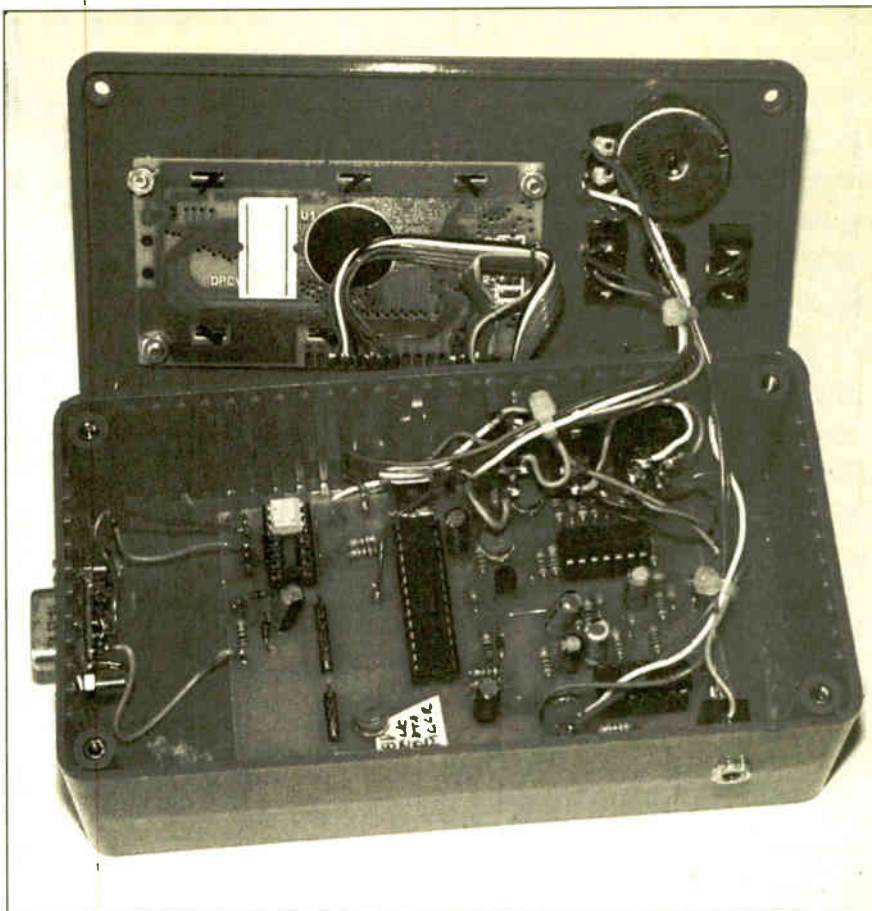

Interior details of the Biopic enclosure.

existing cables. Spare cables can be purchased, however. Two were in the pack supplied for the prototype, having prestuds that clip onto the pads at one end, and a 2-pin female plug at the other.

The author made no attempt to buy a suitable male connector for use with the Biopic. Instead, the plug was cut off and the twin wires soldered to a 3.5mm jack plug. Again polarity does not matter.

PRELIMINARY CHECKS

Having completed the board assembly, thoroughly check that all components are in the right place and that their polarity has been correctly observed as appropriate. Pay great attention to the soldering, especially for those components in the physical region of opto-isolator IC5.

It is imperative to ensure that no solder bridges or "hairs" occur in that area. The isolation value quoted earlier only holds true if the manufacturer's pin separation distance is maintained. The board area in that region (above and below) must be scrupulously clean to maintain its own electrical isolation qualities.

With d.i.l. i.c.s and the l.c.d. omitted, apply battery power to the board. Check that +5V exists at the output of regulator IC4 and at strategic points around the board. If the voltage is not correct, within about five per cent or so, switch off and investigate the reason.

When satisfied, and with the battery disconnected, insert the remaining i.c.s., ensuring their correct orientation in the sockets. Connect the l.c.d. Apply power

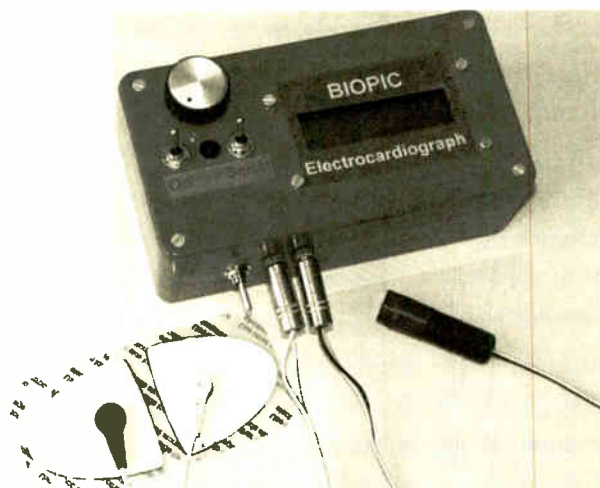

Completed Biopic, plus heart monitoring probe pads, and thumb pulse detector.

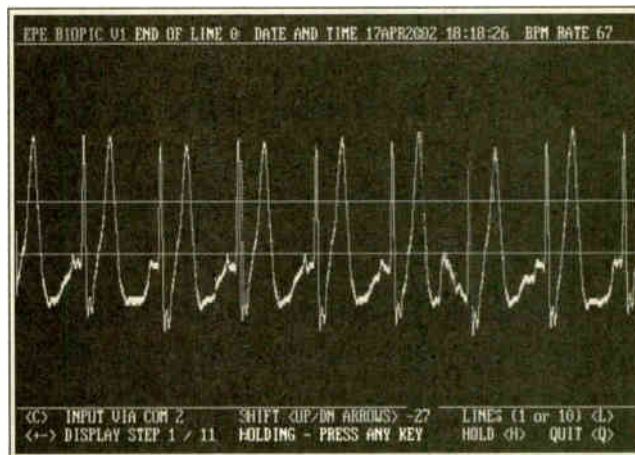

Typical example of a heart waveform shown on the PC when the program is in "enlarge" mode. The two horizontal lines indicate the "trigger" zone used for assessing beat rate.

again and recheck that the regulator still outputs +5V.

If you have *Toolkit Mk2* or *Mk3 (TK3)* you can now program your PIC while *in situ*, making the required connections via the connections provided. The PIC configuration is for crystal XS, POR on, WDT off.

For those who do not have programming facilities, pre-programmed PICs can be obtained as stated on this month's *Shoptalk* page, which also gives details of obtaining the software itself..

ACTIVE TESTS

Once the programmed PIC is running, adjust preset VR4 until a message is visible on the l.c.d. With mode switch S2 in the Pulse setting, line 1 should show the word **BIOPIC** on the right, to its left nothing recognisable is likely to be displayed. Line 2 should read **PULSE RATE** followed by a



Example of a heart waveform monitored across a subject's chest.



Another example of a pulse being monitored via the thumb probe (the lack of uniformity is due to the subject's slight agitation!).



The Biopic's screen while it outputs pulse waveform data to the PC.

numerical value and perhaps an asterisk.

It is best to check the unit while using the "thumb-pulse" detector, with the first message on display. Plug the l.d.r. assembly into socket SK2 and switch S2 to "Pulse" mode.

Set preset VR1 midway and potentiometers VR2 and VR3 for maximum signal gain. Move your hand back and forth across the l.d.r.'s face in a reasonably well-lit room, so putting the l.d.r. in and out of shadow. Observe l.e.d. D4 while you do so. It should flash on and off in response. If it does not, check that you have set VR2 and VR3 in the correct direction.

Looking at the l.c.d. screen, the asterisk at the right of line 2 should also go on and off in response to light changes. On line 1 a pulsed waveform should now be seen, corresponding to the high and low light levels as the shadow crosses the l.d.r.

Gently place your thumb across the l.d.r. face and point the top of your thumb towards the light. As your blood pulses, so the l.e.d. should flash, accompanied by meaningful detail on the l.c.d. screen.

You must keep your hold of the l.d.r. gentle and steady to avoid false triggering. It may either be necessary to come closer to the light or to reduce the setting of VR3 until an even l.c.d. waveform is shown,

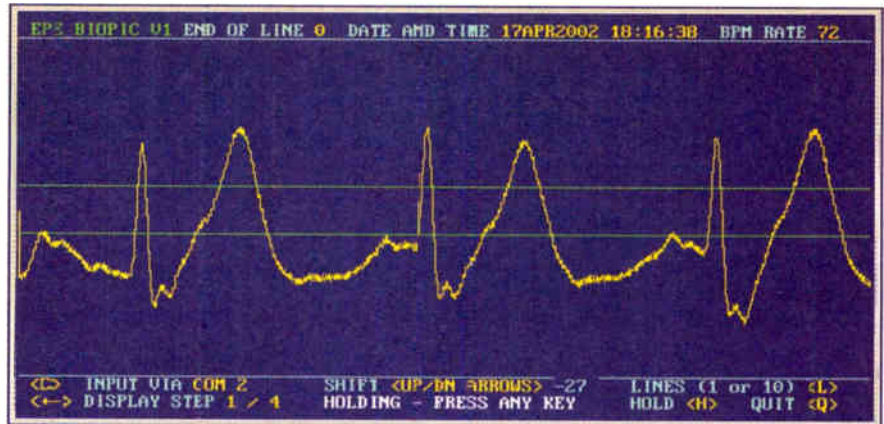

Another "enlarged" waveform, displayed horizontally on a wider scale.

together with a reasonable BPM value on line 2. A certain amount of practice is needed to get the technique right.

CHEST PROBES TESTING

To check the chest probes mode, switch S2 to Heart. Plug the heart sensor cable into its socket.

Attach the TENS monitoring pads to your chest, as described earlier, and clip the cable to them. Next, stop moving, relax and observe the l.c.d. screen. If you have positioned the pads on your chest correctly, you should see your heart waveform begin to appear on the l.c.d. It may take a few seconds to stabilise.

Adjust potentiometer VR2 until distinct pulses are seen. Your pulse rate should again be indicated numerically, together with a flashing asterisk, and the l.e.d. flashing in sympathy.

Again, it takes a bit of practice to remain in a sufficiently passive state for the display and BPM rate to remain stable.

Having set VR2 for what appears to be a reasonable gain setting, return to using the thumb monitor and if necessary readjust VR3 to compensate for the change in VR2's setting.

If you have an oscilloscope, preset VR1 can be adjusted to balance the gain between the two input signal paths. If not, leave VR1 set midway.

PC MONITORING

Instructions for loading the PC with its program for monitoring the Biopic are to be found in the text file **BIOPIC.TXT** that accompanies the software. This file may be read via a text editor such as Notepad or MS-DOS Edit. Follow the instructions,

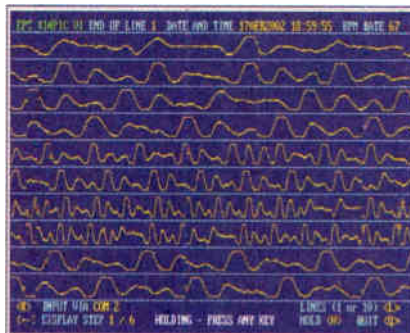

Composite of several typical pulse displays when the thumb pulse monitor is used. Slight involuntary movement of the patient causes unevenness.

connect a serial cable between the PC and Biopic, using the type required by standard modems.

Set the Biopic for thumb monitoring and switch S2 for serial output. Then run the program.

On first running, it may be that the software and PC have different ideas on which COM port to use. If the PC screen does not show a series of waveforms such as appear in the screen photos, press key <C> to change the COM address used by the Biopic's PC software.

Pressing <C> again reverts to the previous COM port address, of which there are two, COM1 and COM2. It is not known if PCs can have more than two COM ports – if yours has, consult its Help file for more information.

Do not change any of the settings within the Biopic's PC program unless you know what you are doing.

SCREEN "DUMPING"

When the program is run from within Windows, the display can at any time be "captured" and pasted into the Windows Paint program, from where it can be saved to disk or sent to a printer (i.e. a "screen dump" – such as shown in on this page). Screen dumps cannot be created from within DOS, nor can other forms of screen output to disk or printer (there are methods to do so, but discussing these is beyond the scope of this article).

To capture a screen, press the Print Screen function key. Now press the Windows-symbol key, and select the route Programs > Accessories > Paint > Edit > Paste > Save As. If you are not familiar with Paint, explore its range of options.

MEDICAL GUIDANCE

Biopic should not be used as a substitute for seeing your medical practitioner. It is not claimed that the waveforms it displays accurately mimic those that would be displayed by fully professional heart monitors. The displays are purely for interest. They should not be taken as an indication of anyone's true state of health.

If you have any reason to believe that anyone's heart is not behaving as it should, seek prompt medical advice. □

REFERENCE

Filter Handbook – a practical design guide. Stefan Niewiadomski. Heinemann Professional Publishing. ISBN 0 434 91378 2.

New Technology Update

Combining glass and silver allows a new type of non-volatile high speed and very low power semiconductor memory device to be created. Ian Poole reports

MEMORIES are a key element in today's digital electronics scene. With the developments that are being undertaken there is a considerable pressure on all i.c. technologies to keep up with the pack. However, it is quite possible that the standard DRAM which is widely used may be overtaken by some emerging technologies such as polymer ferro-electric memory, magnetic RAM (MRAM) and Ovonic Unified Memory (OUM).

Axon's PMCM

A new entry into this field by a company named Axon shows great promise. Called Programmable Metallisation Cell memory (PMCM) it uses a completely different approach to any memory technologies available now or to others that are also in development.

It uses solid state electrochemistry and it provides large non-volatile resistance changes in the substance. It has the ability to be scaled down to very small dimensions, allowing it to remain a viable technology for many years to come. It is thought that it will be possible to scale the technology down to below 10nm and this will bring with it the possibility of being able to have truly enormous levels of data density. Furthermore, it operates at a low voltage and this reduces the problems of heat dissipation that are encountered on some chip technologies.

Principles

It is found that when certain glasses are combined with silver they enable silver ions to move very quickly over short distances under the influence of a high electric field. In effect this generates what could be looked at as a high ion mobility solid electrolyte.

Electrodes across the electrolyte are formed by using an anode of oxidisable silver and an inert cathode. Together with the solid electrolyte these form a device that normally has a high resistance but can be quickly switched to have a low resistance.

When a bias is applied, the silver ions are reduced at the cathode and the silver anode becomes oxidised. This results in the fast formation of stable conducting regions in the electrolyte, providing a conducting path between the anode and cathode. The cell can be returned to its non-conducting state by applying a reverse bias. This process is non-volatile and enables the cell to be in either a non-conducting or a conducting state. These states have a large resistance difference between them enabling them to be easily identified electrically, and providing an excellent basis for a highly reliable memory cell.

Operation

Part of the key to the elegance of the new technology is its simplicity. The typical PMCM structure consists simply of a sandwich of a minimum geometry conductor, solid electrolyte, oxidisable electrode. Typically silver concentrations of more than 30% are used, and this provides high switching speeds and maximum stability in the "on" state. Despite the high silver concentration the off state resistivity is still very high and is typically around 100 ohm centimetres.

To switch the device a voltage in excess of 200mV is applied. For an "off" device this is applied so that the negative potential is applied to the inert contact and the positive to the oxidisable electrode. This is called forward bias and silver oxidation/reduction takes place as a result and a conducting pathway starts to form. The application of a voltage of as little as 200mV causes the local fields in the cell to be very high and electro-deposition will proceed very quickly, fed by the ion current in the device.

With this, the growing zone where the reduced silver forms and the conducting point close to the anode becomes the favoured area for electro-deposition because of the increased local field in this area. This has the effect of reducing the gap between the anode and the cathode which still further increases the electric field. This positive feedback mechanism speeds up the growth, and makes the switching very fast. Eventually a conducting bridge is formed between the two electrodes, putting the device into its low resistance or "on" state.

The characteristics of the device in the "on" state are simply those of the deposited link. The greater the amount of silver that has been deposited the lower the resistance of the link. Typically it might be of the order of 20 kilohms in view of the very small diameter of the link. Although this may seem high it is many orders of magnitude lower than that of the device in its "off" state.

To reverse the state of the device a reverse bias in excess of 200mV is applied. The electro-deposited silver is dispersed and the cathode becomes an oxidisable electrode again. The process is self limiting and terminates when all the excess silver in the electro-deposit has been oxidised.

In use

It is obvious that programming the device is effected by applying either a forward bias to "write", or reverse bias to "erase" the cell. As already mentioned

this occurs at less than a quarter of a volt. Reading the device must be achieved non-destructively if the data in the cell is to be preserved. One method is to apply a sub-switching threshold voltage. Alternatively an extremely fast forward pulse can be applied. This would charge the capacitance of the cell in the "off" state or see the low resistance of the "on" state. It is then relatively easy to differentiate between the very small capacitance of the "off" state and the low resistance of the "on" state.

Programming is very fast and currently matches the speeds of today's DRAMs. Typical switching speeds of around 10 nano seconds are achieved. However the density of the new PMCM devices can be made very much higher. In addition to this the very low programming voltage or around 200 millivolts, switching current of around 10 microamps and switching time of 10 nano seconds means that the energy required to switch the device is astonishingly low (around 20 femto Joules). This is a distinct advantage for high density devices where heat dissipation becomes a problem.

The reliability of the data is another issue. The data in the new memory does not require constant refresh and is therefore considered to be non-volatile. However the retention time depends upon how hard the data is written into the cell. Data written with the minimum amount of energy will not be retained indefinitely. If a higher energy level is used, closer to 1 pico Joule then data will be retained for many months.

Applications

Work on the new memory device is progressing and no products are available at the moment although it is anticipated that the first products will be seen around 2004. The technology has been licensed to Micron with whom Axon has been working since 2000. When the devices are launched it is hoped that they will be comparable to DRAMs in terms of cost. This results from the fact that they have relatively low material costs, the device structures are simple and they use many existing fabrication techniques.

A further exciting possibility is that PMCM could be used alongside existing CMOS technology as the processes are compatible and the outputs from the cells and the inputs to them could be supplied by CMOS circuitry. In this way many more possibilities are opened up, but for the moment the main focus is on launching the basic memory cell onto the market.

For more information browse www.axontc.com.

IT'S MORE THAN THE MONKEY AT STAKE

If digital TV does become common-place reality, important existing analogue radio links could be lost, to our detriment. Barry Fox reports.

HIGH profile publicity for the ITV Digital's financial problems has completely overshadowed an important side-issue. Switching Europe onto digital television will switch off the radio links which theatres, concerts, business conferences, television studios and sports broadcasts now rely on.

The warning comes from the Joint Frequency Management Group, the government-approved body which licences the link frequencies. If anyone is in charge of digital TV in the UK, it is Culture Minister Tessa Jowell. Despite ITV Digital's predicament she still talks hopefully about the UK "being on track for analogue switch-off between 2006 and 2010". Even the government's own Radiocommunications Agency is worried about what this will do to the existing microphone links which it licences.

"No-one is reading the value of radio links to UK PLC", Dave Toman of the RA told engineers recently. "We need to shout louder to the DTI and Department of Culture Media and Sport about the contribution to GDP and jobs".

Radio microphones, in-ear sound monitors, talkback links and video links for portable cameras use analogue FM frequencies at the top of the UHF TV band.

One TV channel, 8MHz wide, can support eight microphones. Granada uses 40 links to record *This is Your Life*. West End musical shows use 50. Film-maker Robert Altman straps a radio mic to every actor on the set.

The DTI and DCMS recently suggested that the 10 TV channels at the top of the UHF band could be sold off for mobile radio (www.digitaltelevision.gov.uk). The new Independent Review of Spectrum Management (www.spectrumreview.radio.gov.uk) recommends auctioning to the highest bidder, trading surplus spectrum and raising costs "to the full opportunity cost level".

Paul Gill of the JFMG thinks the Review board did not understand what the Group tried to tell them, "Surplus spectrum is exactly what we depend on".

Says John Hesketh, Technical Co-ordinator for Granada Television, "If switching to digital television means we lose our radio links, there won't be any programmes to put on digital television."

Ron Hope, Sound Supervisor for Carlton, thinks there is a very simple way to remind the government how much they rely on radio mics. "Let's just turn them all

off for a day. The government would then find it can't talk to anyone."

RA engineers have told JFMG its members should be developing digital links that work in microwave frequency bands. "First you tell me what work you have done to show it is healthy and safe to strap a microwave transmitter to your body for eight hours a day", challenges Aldo Hakligil Managing Director of microphone manufacturer Audio Engineering. "Unlike a cellphone these things are pumping out continuous power".

Triangular Heads

PATENTS show that Intel has been working with the Indian Institute of Technology in Kharagpur on novel ways to reduce the amount of information needed for video conferencing (W0 02/03709).

Existing video compression systems divide each image into a mosaic of rectangles, compare how they change as people talk and transmit only the difference information. Because all the conference images are of heads, they can be divided into triangles which fit naturally over the curved surface. Some of these patches are then sub-divided into smaller triangles to capture more detail for key areas such as the eyes and mouth. Larger triangles suffice for the cheeks and head top where there is less motion. So, overall, the system needs less digital code for realistic pictures.

Barry Fox

STRIPPING WITH SHESTO

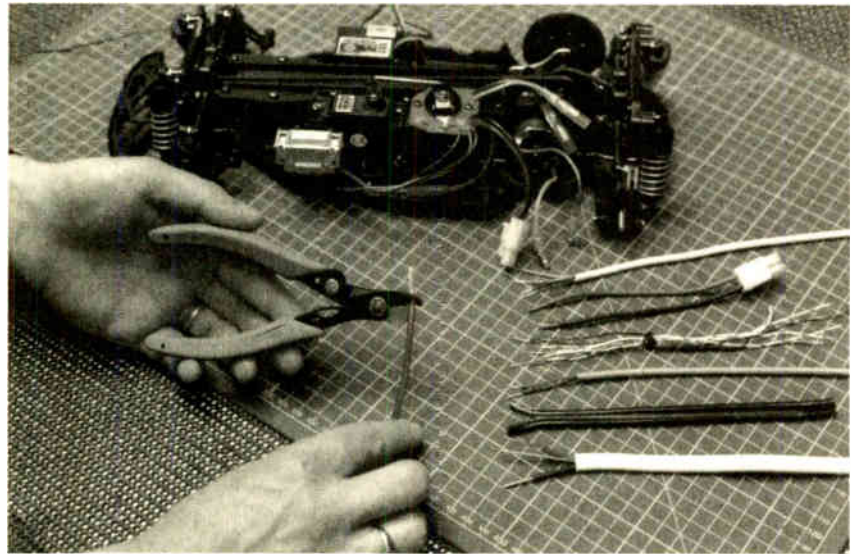

SHESTO, renowned for their tools, supplies and equipment for technicians and craftsmen, have introduced a new precision wire cutter and stripper. It is said to be invaluable for practical electronics, computer and hi-fi applications, and equally well-suited for railway modelling, building radio controlled models and for other similar crafts. In fact, say Shesto, it is useful wherever fine control and accurate repeatability are the essential objectives.

The new combination wire cutter and stripper features a simple thumb adjustable cam for easy setting when working on desired wire sizes from 0.4mm to 2.6mm. Manufactured in the USA by the famous Xuron Tool Corporation, this quality tool is made from alloyed steel for durability and is ergonomically designed with cushioned hand grip and a light touch return spring for ease of use. There is optimum leverage for high performance.

Shesto's part number for this tool is PL0501 and the UK price is £12.95 including VAT.

For more information contact Shesto Ltd., Dept. EPE, Unit 2 Sapcote Trading Centre, 374 High Road, Willesden, London NW10 2DH. Tel: 020 8451 6188. Fax: 020 8451 5450. Email: sales@shesto.co.uk. Web: www.shesto.com.

SCREEN ESPIONAGE

Optical techniques can hack PC screen data even through closed curtains. Barry Fox reports.

COMPANIES that have just spent a fortune on electrical screening to stop hackers eavesdropping on stray radiation from computers, now have something completely new to worry about – optical hacking of the plain text on screen. As we go to press, Markus Kuhn of the University of Cambridge Computer Laboratory was scheduled to tell delegates at the May 2002 IEEE Symposium on Security and Privacy, in Oakland, California, how it is done, and why optical eavesdropping can be as effective as radio-frequency snooping.

Even though the data stored by a PC can be securely encrypted, it must be de-encrypted before display on screen. In 1985 Wim van Eck proved that a sensitive radio receiver could pick up stray electromagnetic signals from the screen and display it on a modified TV set. So screens, casings and cables are now screened to stop leakage, and office windows are treated with transparent shielding.

Security experts also know that a simple amateur astronomy telescope can read even small font text from a screen at 60 metres. So security-conscious offices keep screens away from windows.

Now Markus Kuhn, working with a European Commission grant, has found that it is possible to reconstruct the image on screen from the light emitted and diffusely reflected off walls, out through a window and even through curtains.

Most PC displays work on the raster scan principle, like a TV set. An electron beam scans the screen in lines, with varying intensity to change the brightness of light emitted by phosphors on the surface. The intensity of light tracks the video signal voltage; the scanning parameters for screen display rasters are set by the Video Electronics Standards Association, and freely available.

Afterglow Sensing

Although screen phosphors have an afterglow of milliseconds, there is an immediate and detectable fall in glow intensity as the beam leaves a phosphor spot. These changes can be detected by off-the-shelf photodiode light sensors, developed for gigabit optical fibre communication links and laser rangefinders.

The Cambridge lab ran tests with a PC monitor screen using a standard 640 x 480 raster, with images displayed at normal 85Hz refresh rate, and the PC's screen brightness and contrast at the manufacturer's settings. Flickering light from the screen, bounced off walls and picked up by a detector, is electronically filtered to reduce random noise from ambient light. Light from mains lamps can be "tuned out" because it flickers at a fixed frequency, e.g. 100Hz.

When the detected signal was fed to another monitor screen, text was clearly legible. By using a telescope to home in on a patch of light reflected from the screen, eavesdroppers could work from 100m or more.

Exposing the risk, says Kuhn, helps people take counter-measures. Simple solutions are, not to work in a dark room, and choose fluorescent lights with similar phosphors to the monitor, so the screen light is swamped. L.C.D. panels refresh more slowly so they may be harder to track.

The paper which the IEEE will hear makes passing mention of an even more

intriguing security risk. Although screen phosphors show an initial and very rapid dimming, they retain some glow energy for minutes or even hours. It may thus be possible to read confidential information from a screen even after it has been switched off and the staff have gone home.

Do commercial companies and government departments recognise the significance of this?

I asked D. K. Matai who runs the high profile security consultancy called mi2g, which says it advises Lloyd's and the London insurance markets and "liaises with UK Government Departments on Digital Risk Management matters".

I was told I must put my question in writing, so I did.

Would you like to comment pithily on this? Are you shocked? Does nothing surprise you any more? Do you think companies are aware of the risks?

I am still puzzling over the statement I got back:

"The UK Government's Terrorism Act 2000 in which the disruption of key computer systems or interference with them was classified as terrorism has played a critical part in heightening awareness within the hacking community about cyber crime and its consequences."

Graham Cluley, senior technology consultant with security software company Sophos has a pragmatic view: "James Bond technology like this sounds cool, but it's usually a lot easier to rely on humans – like cleaners. Even if someone can't take home a floppy disk, no-one can wipe their memory of what they read on screen."

NANOTECHNOLOGY

READERS interested in nanotechnology will be interested to know of a new service provided by Derwent Information, said to be the world's leading patent information provider. The service provides comprehensive information about global patents specific to the nanotechnology field.

Each patent is summarised in a clearly-written abstract, highlighting the novelty, advantages and uses of the new invention. The volume of nanotechnology patents files worldwide has grown dramatically over the past few years and by browsing Derwent's site at www.derwent.com you should get a pretty good insight into how this amazing technology is progressing.

It is a technology that is used in industries such as aerospace, communications, semiconductors, and civil engineering and is based upon structures whose sizes are measured in nanometres – a billionth of a metre, that's 1/80,000th the diameter of an average human hair, or 10 times the diameter of a hydrogen atom.

MICROCHIP CHARGES-UP



MICROCHIP, the manufacturers of PIC microcontrollers, have entered the stand-alone battery charging market with three high-performance charger i.c.s.

The Li-Ion battery charger devices, in the MCP7382x family, each have unique feature sets dedicated to single-cell battery-powered portable applications. The features include the ability to monitor charge current and temperature, to indicate a constant-current to constant-voltage transition, to maximise battery life and minimise system cost, and they additionally feature low shutdown ($1\mu\text{A}$) and operating current ($25\mu\text{A}$). The devices are available in 4.1V and 4.2V options, to accommodate various Li-Ion battery types. Packaging is surface mount, in SOT-23 and MSOP styles.

For more information browse www.microchip.com.

PIC C COMPILER

R.F. SOLUTIONS has announced its ANSI C compiler designed for use with Microchip's PIC18xxx series of microcontrollers.

The compiler enables PIC designs to be developed and managed from within an ICEPIC environment or MPLAB. It is officially recommended by Microchip as a "preferred professional development tool", has an unlimited number of source files, a comprehensive library with source code and the ability to carryout mixed C and assembler programming.

For further information contact R.F. Solutions Ltd., Dept. EPE, Unit 21 Cliffe Industrial Estate, South Street, Lewes, E.Sussex BN8 6JL. Tel: 01273 488880. Fax: 01273 480661. Email: sales@rfsolutions.co.uk. Web: www.rfsolutions.co.uk.

PENNY & GILES

LONG RENOWNED for the very high quality of their potentiometers, Penny & Giles tell us that they have changed their name to PG Drives Technology Ltd. They go on to say that their parent company, Spirent plc, has recently sold some of the aerospace component companies that also traded under the Penny & Giles group name, which is a well-known brand in aerospace markets.

This means that the Drives Technology aspect of the company can no longer use the original name. They feel that the new name is close enough to the old so that any potential confusion is kept to a minimum.

For more information contact PG Drives Technology Ltd., Dept. EPE, 1 Airspeed Road, Christchurch BH23 4HD. Tel: 01425 271444. Fax: 01425 272655. Web: www.pgdt.com.

**SPECIAL
READER -
SEE WEBSITE
FOR DETAILS**

PROTEUS

VSM

Virtual System Modelling

Build It In Cyberspace

www.labcenter.co.uk

Develop and test complete micro-controller designs without building a physical prototype. PROTEUS VSM simulates the CPU and any additional electronics used in your designs. And it does so in real time. *

- CPU models for PIC and 8051 and series micro-controllers available now. 68HC11 coming soon. More CPU models under development. See website for latest info.
- Interactive device models include LCD displays, RS232 terminal, universal keypad plus a range of switches, buttons, pots, LEDs, 7 segment displays and much more.
- Extensive debugging facilities including register and memory contents, breakpoints and single step modes.
- Source level debugging supported for selected development tools.
- Integrated 'make' utility - compile and simulate with one keystroke.
- Over 4000 standard SPICE models included. Fully compatible with manufacturers' SPICE models.
- DLL interfaces provided for application specific models.
- Based on SPICE3F5 mixed mode circuit simulator.
- CPU and interactive device models are sold separately - build up your VSM system in affordable stages.
- ARES Lite PCB Layout also available.

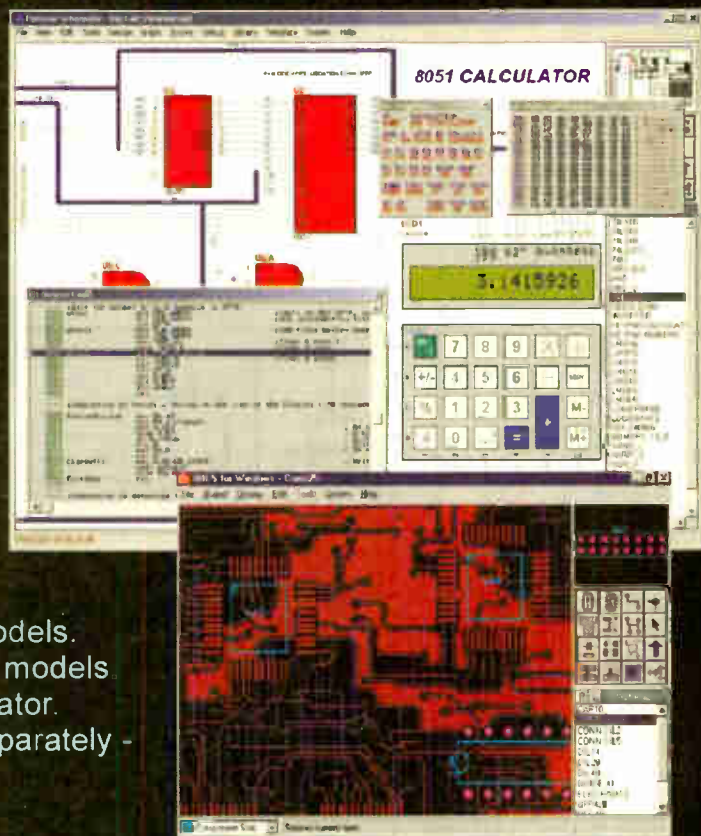

labcenter
Electronics

*E.g. PROTEUS VSM can simulate an 8051 clocked at 12MHz or a 300MHz Pentium II.

Write, phone or fax for your free demo CD - or email info@labcenter.co.uk.
Tel: 01756 753440. Fax: 01756 752857. 53-55 Main St, Grassington. BD23 5AA.

INGENUITY UNLIMITED

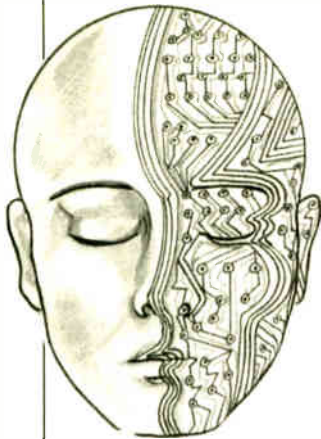

Our regular round-up of readers' own circuits. We pay between £10 and £50 for all material published, depending on length and technical merit. We're looking for novel applications and circuit designs, not simply mechanical, electrical or software ideas. Ideas *must be the reader's own work* and **must not have been submitted for publication elsewhere**. The circuits shown have NOT been proven by us. *Ingenuity Unlimited* is open to ALL abilities, but items for consideration in this column should be typed or word-processed, with a brief circuit description (between 100 and 500 words maximum) and full circuit diagram showing all relevant component values. **Please draw all circuit schematics as clearly as possible.** Send your circuit ideas to: Alan Winstanley, *Ingenuity Unlimited*, Wimborne Publishing Ltd., 408 Wimborne Road East, Ferndown Dorset BH22 9ND. (We do not accept submissions for *IU* via E-mail.) Your ideas could earn you some cash and a prize!

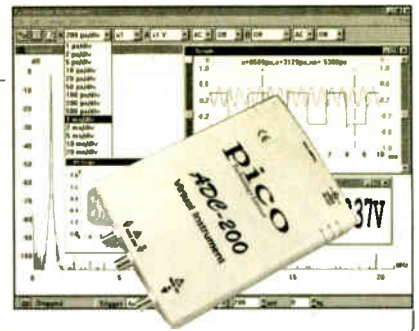

WIN A PICO PC BASED OSCILLOSCOPE WORTH £586

- 100MS/s Dual Channel Storage Oscilloscope
- 50MHz Spectrum Analyser
- Multimeter • Frequency Meter
- Signal Generator

If you have a novel circuit idea which would be of use to other readers then a Pico Technology PC based oscilloscope could be yours. Every 12 months, Pico Technology will be awarding an ADC200-100 digital storage oscilloscope for the best *IU* submission. In addition, a DrDAQ Data Logger/Scope worth £69 will be presented to the runner up.

L.E.D. Sequencer – Light Rider

WHEN asked by a friend whether it was possible to make a simple circuit to replicate the "bouncing light" effect used by the talking car "Kit" in the TV series *Knight Rider*, after some experimentation the result was the circuit diagram shown in Fig. 1.

A timer is formed by IC1, a standard NE555 timer running in astable mode, with resistors R1, R2 and capacitor C1 determining its frequency. The output of IC1, at pin 3, is used to control a pair of 4017 divide-by-ten counters, with pulses fed into the clock input (pin 14) of IC2 and the Enable input (pin 13) of IC3.

The Q9 output (pin 11) of IC2 is used to clock IC3. Because Q9 is low when the circuit is initially powered up, IC3 does nothing while IC2 begins to count as normal which illuminates the l.e.d.s D1 to D9 one at a time from left to right.

When Q9 goes high, it disables any further counting on IC2 and it enables

counting on IC3 instead. As the outputs of IC3 are connected to the l.e.d.s in the reverse order the light seems to move from right to left.

Once a further clock pulse is received after Q9 output goes high, IC3 resets and the Carry Out pin (12) goes high, this is fed via the differentiating circuit of capacitor C2 and resistor R4 to the Reset pin (15). This disables counting on IC3 and the whole cycle starts again.

Clocking On

This circuit could have many interesting uses other than in a "talking car", for example it could provide an electronic "pendulum" effect to a digital clock, or even as an eye-catching warning indicator. Consider using high-efficiency l.e.d.s for the display, if available.

Ian Hill, Plymouth, Devon

WHY NOT SEND US YOUR CIRCUIT IDEA? Earn some extra cash and possibly a prize!

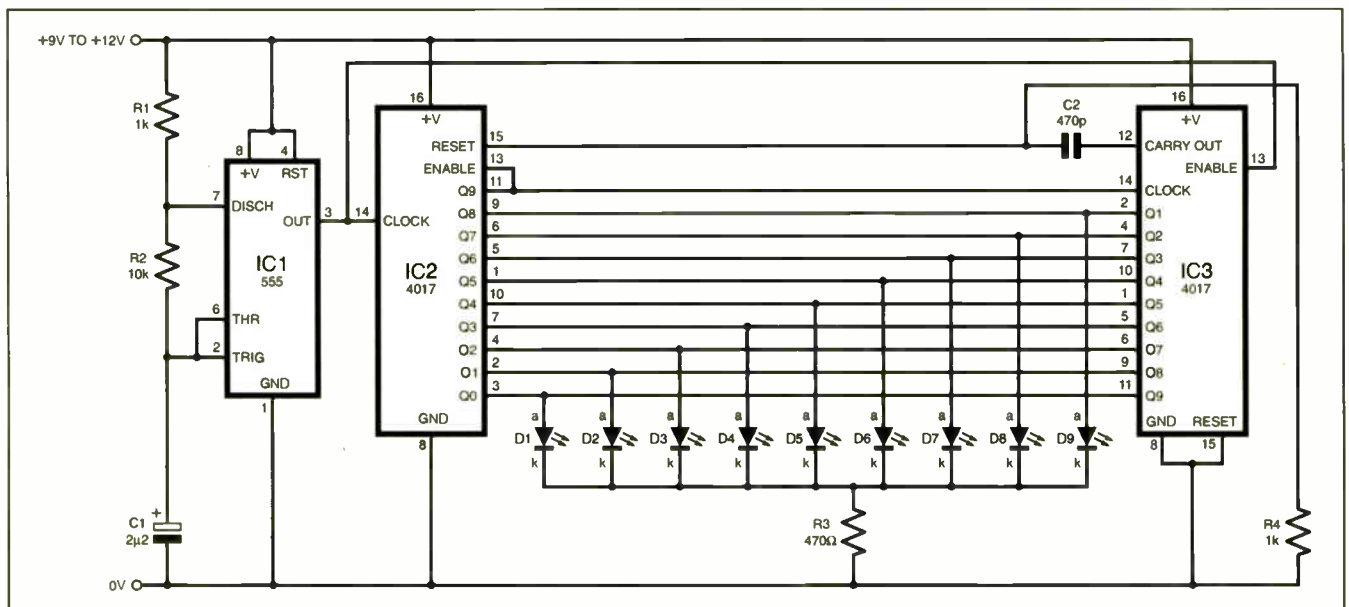

Fig.1. Circuit diagram for the L.E.D. Sequencer.

Quiz Master - A Team Effort

THE circuit diagram shown in Fig.2 resulted from a practice exercise which the pupils of my electronics set and I designed at the start of school term. The brief given to my pupils was to design the old favourite of a Quiz Master to give a "who pressed first" i.e.d. display. Although the circuit does not provide a buzzer, one could be added if desired.

We used a CD4013 dual D-type flip-flop as it was realised that we could utilise their Set and Reset inputs as follows. In the "Ready" state both latches IC2a and IC2b have an output of zero and they are reset, which means that the inputs to IC1c are both high; therefore the output (pin 10) of this gate (labelled EN for Enable) is also high. When a contestant presses a button, switch S1 or S2, the output of IC1a or IC1b as appropriate goes high, which will set the appropriate latch. The output of that latch will go high and illuminate the corresponding i.e.d. D1 or D2.

At the same time, one of the inputs to IC1c will be taken low, and so Enable will go low, this prevents the other contestant setting their latch as further pulses are blocked by the AND gates IC1a and IC1b. Capacitor C1 in parallel with the Reset switch S3 provides a power-on reset pulse to ready the circuit for action. The values of the pull-down resistors R1 to R3 are not critical and the i.e.d. series resistors (R4/R5) should reflect the supply voltage used.

On the Buzzer

If an audio signal is required, the "Enable" signal may be used to switch on a buzzer

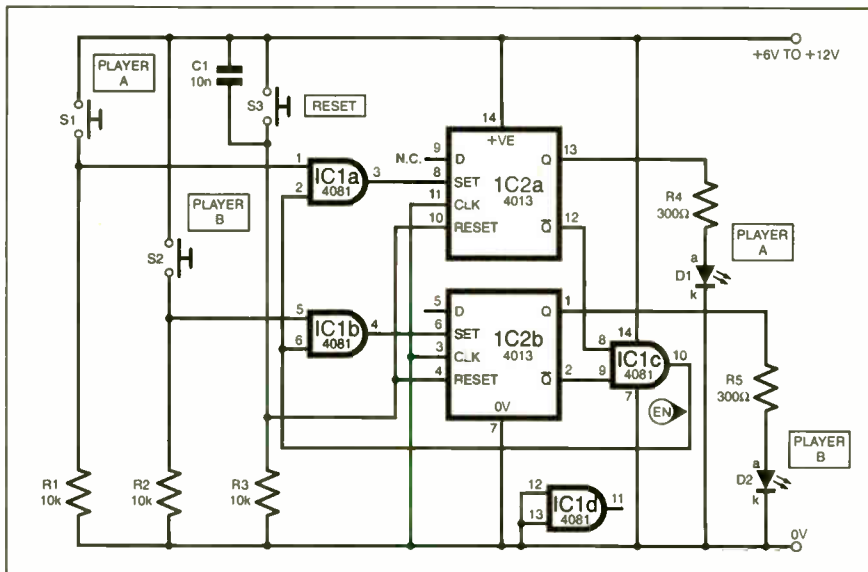

Fig.2. Circuit diagram for the Quiz Master.

(switch on when Enable is low), or for the more adventurous, each output, Q_A, Q_B could activate its own, unique, buzzer. Alternatively, a single buzzer whose frequency could be controlled could be used.

To extend the circuit for *n* players, repeat the circuit segment IC1a and IC2a, and replace IC1c with an *n* input AND gate to provide the Enable signal. Some pupils used the Enable signal to trigger a monostable

which would apply a reset pulse a few seconds after a button was pressed.

In addition to myself, the boys involved in the design were the members of form L3c, namely Oliver Russell, David Steynor, Patrick Overy, Patrick Almeida, Jon Dawes and Russell Garrett.

M. A. Burbridge,
The Royal Grammar School,
Guildford, Surrey.

<h3>SPECIAL OFFERS</h3> <p>TEKTRONIX 2445A 4-ch 150MHz delay, cursors etc. Supplied with 2 Tektronix probes. ONLY £425</p> <p>TEKTRONIX 2232 Digital Storage Scope. Dual Trace, 100MHz, 100M/S with probes ... £525 H.P. 54501A Dig. Oscilloscope, 100MHz 4-Ch ... £425 H.P. 3312A Function Gen., 0-1Hz-13MHz, AM/FM Sweep/TriGate/Burst etc. ... £300 FARNELL Dual PSU XA35-2T, 0-35V, 0-2A, Twice OMD, i.c.d. Display ... £180 CIRRUS CRL254 Sound Level Meter with Calibrator 80-120dB, LEQ ... £150 FARNELL AMM255 Automatic Mo Meter, 1.5MHz-2GHz, unused ... £300 FARNELL DSG1 Low Frequency Syn Sig. Gen., 0-001Hz-99.99kHz, low distortion, TTL/Square/Pulse Outputs etc. ... £95 FLUKE 8060A Handheld True RMS, DMM, 4 1/2 digit ... As new £150, used £95 BIECKMAN HD110 Handheld 3 1/2 digit DMM, 28 ranges, with battery, leads and varying case. £40</p> <p>H.P. 3310A Function Gen., 0-005Hz-5MHz, Sine/Sq/Tri/Trap/Pulse ... £125 FARNELL LFM4 Sine/Sq Oscillator, 10Hz-1MHz, low distortion, TTL output, Amplitude Meter. £125 H.P. 545A Logic Probe with 546A Logic Pulser and 547A Current Tracer ... £90 FLUKE 77 Multimeter, 3 1/2-digit, handheld ... £70 FLUKE 77 Series 11 ... £60 HEME 1000 L.C.D. Clamp Meter, 00-1000A, in carrying case ... £60</p> <p>BLACK STAR ORION PAL/TV Colour Pattern Generator ... from £75-£125 THURBY/HANDER TG210 Function Generator, 0-002Hz-2MHz, TTL etc. ... £90-£95 THURBY/HANDER P.S.U. PL320QMD, 0V-32V, 0A-2A Twice (late colours) ... £200</p> <p>Datron 1061 High Quality 5-5 Digit Bench Multimeter True RMS/4 wire Res/Current Converter/IEEE £150</p> <p>Datron 1061A High Quality 6 1/2 digit Bench Multimeter True RMS/4 wire/Current Converter £225</p> <p>Racal Receiver RA1772 50kHz-30MHz L.E.D. Display, Basically working. £250</p> <h3>STEWART OF READING</h3> <p>110 WYKEHAM ROAD, READING, BERKS. RG6 1PL Telephone: (0118) 9268041. Fax: (0118) 9351696 www.stewart-of-reading.co.uk Callers welcome 9am-5.30pm Monday to Friday (other times by arrangement)</p>	<h3>MARCONI 2019A</h3> <p>AM/FM SYNTHESISED SIGNAL GENERATOR 80 kHz - 1040MHz £400 NOW ONLY</p> <p>MARCONI 893C AF Power Meter, Sinad Measurement Unused £100, Used £80 MARCONI 2610 True RMS Voltmeter, Autoranging, 5Hz-25MHz ... £195 GOULD J3B Sine/Sq Osc., 10Hz-100kHz ... £75-£125 AVO 8 Mk. 6 in Every Ready case, with leads etc. ... £80 Other AVOs from ... £50 GOODWILL GVT427 Dual Ch AC Millivoltmeter, 10mV-300V in 12 ranges, Freq. 10Hz-1MHz ... £100-£125 SOLAARTRON 7150 DMM 6 1/2-digit Tri-RMS-IEEE ... £95-£150 SOLAARTRON 7150 Plus ... £200</p> <h3>HIGH QUALITY RACAL COUNTERS</h3> <p>9904 Universal Timer Counter, 50MHz ... £50 9918 Counter, 10Hz-520MHz ... £75 9918 Counter, 10Hz-560MHz, 9-digit ... £50 WAYNE KERR B424 Component Bridge RACAL/AIM 9343M LCR Databridge. Digital Automeasurement of R, C, L, Q, D ... £200 HUNTRON TRACKER Model 1000 ... £125 FLUKE #050A 4-5 Digit, 2A, True RMS ... £75 FLUKE #010A 3-5 Digit, 10A ... £50 FLUKE #012A 3-5 Digit, 2A ... £40</p> <p>Racal 9008 Automatic Modulation Meter, AM/FM 1-5MHz-2GHz ONLY £95</p> <p>Portable Appliance Tester Megger Pat 2 ONLY £180</p> <p>H.P. 8012B DC PSU 0-60V, 0-50A, 1000W ... £1000 FARNELL AP60/50 1KW Autoranging ... £1000 FARNELL H60/50 0-80V, 0-50A ... £750 FARNELL H60/25 0-80V, 0-25A ... £400 Power Supply HPS3010, 0-30V, 0-10A ... £140 FARNELL L30-2 0-30V, 0-2A ... £80 FARNELL L30-1 0-30V, 0-1A ... £60 Many other Power Supplies available</p>	<h3>GOULD OS300</h3> <p>Dual Trace, 20MHz Tested with Manual ONLY £95</p> <h3>OSCILLOSCOPES</h3> <p>TEKTRONIX TDS350 dual trace, 200MHz, 1GS Unused £1500 TEKTRONIX TDS320 dual trace, 100MHz, 500M/S ... £1200 TEKTRONIX TDS310 dual trace, 50MHz, 200M/S ... £950 LECROY 9400A dual trace, 175MHz, 5GS ... £1500 WITACH NC622, dual trace, 20MHz, 20M/S, delay etc. Unused £600 PHILIPS PM3092 2+2-ch, 200MHz, delay etc., £800 as new £350 PHILIPS PM3082 2+2-ch, 100MHz, delay etc., £700 as new £300 TEKTRONIX TAS465 dual trace, 100MHz, delay etc. ... £750 TEKTRONIX 2465B 4-ch, 400MHz, delay cursors etc. ... £1500 TEKTRONIX 2465 4-ch, 300MHz, delay cursors etc. ... £900 TEKTRONIX 2445A/B 4-ch 150MHz, delay cursor etc. £500-£300 TEKTRONIX 468 Dig. Storage, dual trace, 100MHz delay ... £450 TEKTRONIX 466 Analogue Storage, dual trace, 100MHz ... £250 TEKTRONIX 465 dual trace, 350MHz, delay sweep ... £550 TEKTRONIX 475 dual trace, 200MHz, delay sweep ... £400 TEKTRONIX 465B dual trace, 100MHz, delay sweep ... £325 PHILIPS PM3217 dual trace, 50MHz delay ... £200-£250 GOULD OS1100 dual trace, 30MHz delay ... £150 HAMEG H8030 dual trace, 30MHz component tester ... £275 HAMEG H82037 dual trace, 20MHz component tester ... £200 FARNELL DTV20 dual trace, 20MHz component tester ... £125 Many other Oscilloscopes available</p> <p>MARCONI 2022E Synth AM/FM Sig Gen 100Hz-1.01GHz i.c.d. display etc. £525-£750 H.P. 8657A Synth sig gen, 100kHz-1040MHz ... £2000 H.P. 8656B Synth sig gen, 100kHz-990MHz ... £1350 H.P. 8656A Synth sig gen, 100kHz-990MHz ... £995 R&S APM2E Synth, 1Hz-260kHz sig gen, balanced/unbalanced output, i.c.d. display ... £425 PHILIPS PM5328 sig gen, 100Hz-180MHz with 200kHz, freq. counter, IEEE ... £550 RACAL 9081 Synth AM/FM sig gen, 5kHz-1024MHz ... £250 H.P. 3325A Synth function gen, 21MHz ... £600 MARCONI 8500 Amplitude Analyser ... £1500 H.P. 4192A Impedance Analyser ... £5000 H.P. 4275A LCR Meter, 10Hz-10MHz ... £2750 H.P. 8503A Spectrum Analyser ... £1000 WAYNE KERR 3245 Inductance Analyser ... £2000 H.P. 8112A Pulse Generator, 50MHz ... £1250 MARCONI 2440 Frequency Counter, 20GHz ... £1000 H.P. 5350B Frequency Counter, 20GHz ... £3000 H.P. 5342A 10Hz-18GHz Frequency Counter ... £300 H.P. 1650B Logic Analyser, 80-channel ... £1000 MARCONI 2035 Mod Meter, 500Hz-2GHz ... £750</p> <h3>RADIO COMMUNICATIONS TEST SETS</h3> <p>MARCONI 2955/2956A ... From £1500 RONDAC SCHWARZBEIT 0-1-1000MHz ... £2000 SCHLUMBERGER 4040 ... £900</p>	<h3>JUST IN</h3> <p>H.P. 6063B DC Electronic Load, 3-240V/0-10A, 250W ... POA H.P. 86312A PSU, 0-20V/0-2A ... £400 H.P. 86311B PSU, 0-15V/0-3A ... £400 H.P. 8630BD PSU Dual, 0-15, 0-3A/0-12, 0-1-5A ... £750 H.P. 8632B PSU, 0-20V/0-5A ... £500 H.P. 6823A PSU, triple output ranging from 0-7V 0-5A to 0-20V 0-4A ... £850 H.P./JAGLENT 34401A DMM 6 1/2 digit ... £400/£450 H.P. 3478A DMM 5 1/2 digit ... £275 FLUKE 45 DMM dual display ... £140 KEITHLEY 2010 DMM 7 1/2 digit ... £950 KEITHLEY 617 Programmable Electrometer ... £1500 H.P. 4338B Milliohmmeter ... £1500 RACAL Counter type 1999 2.6GHz ... £500 H.P. Counter type 53131A 3GHz ... £850 H.P./JAGLENT 33120A Func. Gen./ARB, 100kHz-15MHz 0-20V 0-4A ... £1000/£1000 SONY/TEKTRONIX AFG320 Arbitrary Func. Gen. ... £1250 H.P. 8904A Syn. Function Gen. DC-600kHz ... £1000/£1250 BLACK STAR JUPTOR 2010 Func. Gen. 0.2Hz-2MHz with frequency counter ... £140 H.P. 8116A Pulse Generator, 1mH-50MHz ... £1850 H.P. 8657B Syn Sig. Gen. 0-1-200MHz ... £2500 CO-AXIAL SWITCH, 1-5GHz ... £40 IEEE CABLES ... £10</p> <h3>SPECTRUM ANALYSERS</h3> <p>H.P. 8661B 50Hz-6.5GHz ... £6500 H.P. 8560A 50Hz-2.9GHz synthesised ... £5000 H.P. 8596E 9kHz-2.9GHz ... £4500/£5000 H.P. 8591E 1MHz-1.9GHz, 75 Ohm ... £3500 H.P. 853A with 8559A 100kHz-21GHz ... £2250 H.P. 8558B with Main Freq. 100kHz-1500MHz ... £1250 H.P. 3585A 20Hz-40MHz ... £3000 H.P. 3580A 5kHz-50MHz ... £800 ADVANTEST RA131B 10kHz-3.5GHz ... £3500 EATON/AULTECH 757 0-001-22GHz ... £1500 MARCONI 2382 100Hz-400MHz, high resolution ... £2000 MARCONI 2370 30Hz-110MHz ... from £500 H.P. 182 with 8557 10kHz-350MHz ... £500 H.P. 1411 SYSTEMS 8553 1Hz-110MHz ... from £500 8554 500Hz-1250MHz ... from £750 8555 10kHz-18GHz ... from £1000 TEKTRONIX 491 10MHz-12-4GHz ... £500 H.P. 8443 Tracking Gen/Counter, 110MHz ... £250 H.P. 8442 Opt Gen ... £750 B&K 2033R Signal Analyser ... £750 H.P. 5372A Frequency & Time Interval Analyser ... £2250 H.P. 8754A Network Analyser, 4MHz-1300MHz ... £1250 H.P. 3557A Network Analyser, 5Hz-200MHz ... £3000 H.P. 5310A Mod Domain Analyser Opt 001/003 ... £5000 OWO SOXNK CF300 Portable FFT Analyser ... £1500</p>
---	---	--	---

WORLD LAMP

THOMAS SCARBOROUGH
and SURYA RAO MATURU

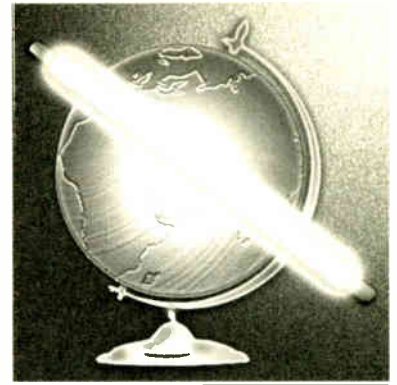

Low cost lighting when there's no mains supply available

THE quest for a battery-powered lamp for lighting in poorer areas has presented an interesting and important design challenge for many years. Such a lamp should ideally be cheap, simple, efficient, and flexible – all at the same time.

With this in mind, the authors have designed a lamp which is made from inexpensive stock parts throughout, runs off a nominal 12V d.c. supply, and will power any ordinary fluorescent lamp between 100mW and 15W. It will power the equivalent of a 60W incandescent lamp for about 80 hours off a standard 12V car battery.

CORE CONCEPT

Most d.c. powered fluorescent lamps use specialised components. While this may not pose a problem in major urban centres, it could pose serious supply problems in more remote areas of the world. The authors therefore searched for a means to unhook the World Lamp from the need for any uncommon or custom-made parts.

This is accomplished in the present design through a.c. pulse-width modulation (p.w.m.), which is the core concept of

the design. In short, the faster a pulse passes through an inductor, the more the inductor resists it (called reactance).

The simple equation which applies to a pure sine wave is defined by X_L (reactance) = $2\pi fL$, where f is frequency, and L is inductance. If, for instance, an inductor of 1H is used on a 50Hz mains supply, its reactance is 314Ω. At 100Hz, its reactance rises to 628Ω. This fact is obviously useful in controlling a.c. power.

However, instead of simply changing the frequency which passes through the inductor (see Fig.1a), the present design modulates the pulse-width (Fig.1b), thus making the circuit very versatile, and also minimising problems associated with power dissipation.

The practical implications of using a.c. p.w.m. are that a single circuit will power a very wide range of fluorescent lamps. Also, component tolerances may be fairly wide, since it is the pulse-width which is critical, not the components themselves. Supply voltage also becomes less critical, as p.w.m. compensates for voltage variations.

WORLD LAMP CIRCUIT

The complete circuit diagram for the World Lamp is shown in Fig.2.

The circuit around Schmitt NAND gate IC1a is configured as an oscillator whose frequency is determined by the value of capacitor C3 and the total resistance across resistor R1 and preset VR1. The latter is used to set the square wave output frequency to between 60Hz and 70Hz.

From IC1a, the signal is routed in two directions, to IC1d and IC1b, the latter inverts the signal and sends it to IC1c. The circuits around IC1c and IC1d are identical and their input signals are the two complementary (opposite phase) signals from IC1a and IC1b. The two sub-circuits are configured as oscillators whose outputs can have their mark-space ratios simultaneously and identically changed. The

oscillators can only run when their control inputs are held high by the preceding gates.

To take the circuit around IC1c as the example, assume that the control input at pin 8 held high by IC1b. Capacitor C5 charges slowly via resistor R4 when the output of IC1c is high, until the voltage on input pin 9 crosses the Schmitt threshold, which causes the output to go low. Now the capacitor discharges at a faster rate via not only R4 but also resistor R5, diode D1 and potentiometer VR2a, which is used as a variable resistor. As a result, the time that the output of IC1c is low, can be varied in relation to the time that it is high.

Schmitt NAND gates IC2a and IC2b invert and buffer the twin pulse waveforms from IC1c/IC1d and their outputs are used to control the switching of power MOSFETs TR1 and TR2 in push-pull fashion. In turn, the MOSFETs drive the 6V-0V-6V dual winding of transformer T1, whose centre tap is connected to the +12V supply line.

The transformer is used in step-up mode and the resulting voltage across its output

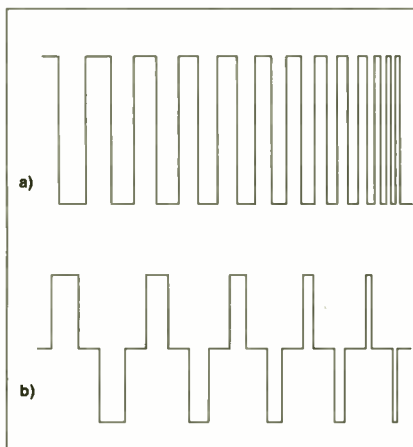

Fig.1. A.C. pulse width modulation.



ON STRIKE

Capacitor C8 in series with the output winding of T1 provides current limiting – but not too much, otherwise more “stubborn” fluorescent lamps may not strike. If more stubborn fluorescent lamps are used (i.e. which will not strike easily), the value of C8 may be increased – with caution. The value of C8 may also be reduced, to prevent accidental abuse of smaller tubes.

“Pre-striking” of lamps when power is switched on is prevented by the R2, R3, C4 arrangement on one input of IC1b. This holds pin 6 low for a brief moment during switch-on, for the duration it takes capacitor C4 to charge up via resistor R2 before the gate’s threshold logic level is passed. During this time gate IC1c is disabled, so that only pulsed d.c. reaches the fluorescent lamp, as triggered via the IC1d path.

This greatly assists “striking” of the tube, since a unidirectional bombardment of ions first takes place, thus initiating conduction in the tube. A bidirectional bombardment can inhibit conduction.

It was found unnecessary to add any protection circuitry to the lamp. Only diode D3, in the 0V line, is added to prevent reversed polarity.

Transistor TR3 is switched on for half a minute at start-up to warm one of the filaments in the tube. While it is not entirely orthodox to strike a tube while warming a filament, this is common practice, and simplifies the start-up procedure. The warming of one filament can reduce the necessary start-up power by half, and thus greatly extends the life of the tube.

Although TR3 is directly connected to the high voltage section of the circuit, it does not close it, and is therefore unaffected by the high voltages present.

BENEFICIAL BLIPS

In order for the pulse width modulation to work smoothly, IC1a must oscillate either at or below the frequencies of oscillators IC1c and IC1d, otherwise these begin to fall out of sync with IC1a. If the frequency of IC1a rises above that of gates IC1c and IC1d, “blips” appear in the waveform across transformer T1’s windings, and the fluorescent lamp begins to “cycle”, or blink.

This, however, has a very useful function. With the correct setting of VR1, as soon as the lamp is turned up too high, it begins to blink. This provides a cheap and effective means of preventing any serious wastage of power, which can easily occur with fluorescent lighting. Preset VR1 needs to be adjusted with the aid of an ammeter (see later), or is disabled by turning it back (anti-clockwise).

The operation of this “Overload Adjust” function may best be understood visually. The two oscilloscope traces in Fig.3 show the voltage across the fluorescent tube when the World Lamp is: a) powering a 10W linear “strip light” at full brightness, and b) is turned up too high, so that a “blip” appears in the pulse width modulation.

Note that in some cases the lamp may need to be turned up “too high” momentarily in order to “strike” the tube (that is, to ionize the gas inside). Once this has been accomplished, it is turned down to its optimal level, and ceases to blink. In many

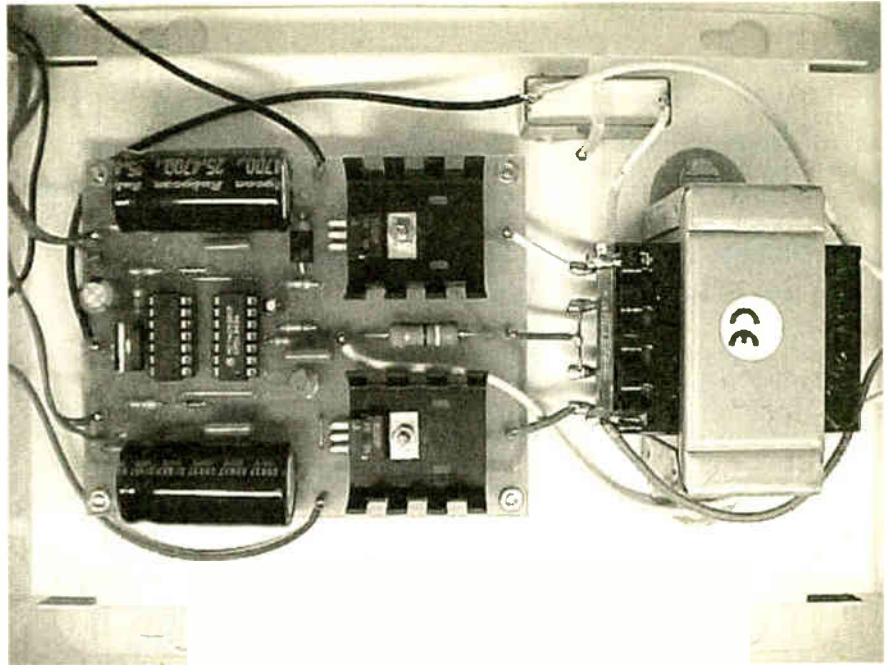

cases a correct setting of VR2a/VR2b will cause the tube to strike without the need for readjustment, as “run” current disables the higher “strike” voltage.

Note that since the output of the World Lamp is continuously variable, it is also possible on occasion to light up an otherwise “dead” fluorescent lamp. This could squeeze a few more evenings of light out of a lamp which would otherwise be a lost cause. Life may also be extended sometimes by reversing a tube.

Lastly, although transformer T1 may sometimes be pushed beyond its ratings, in practice this should not present a problem, so long as power dissipation, and thus heat, is kept within bounds. The authors pushed several standard transformers way beyond their voltage and power ratings, without any sign of failure. However, iron loss increases at higher power, which means reduced efficiency.

CONSTRUCTION

The World Lamp is built up on a single-sided printed circuit board (p.c.b.) measuring 100mm x 90mm. Details of the topside

component layout, together with the underside details, are shown in Fig.4. This board is available from the *EPE PCB Service*, code 340.

Begin construction by soldering the seven link-wires. Note that three of these are soldered underneath IC1 and IC2. Continue with the solder pins and 14-pin dual-in-line (d.i.l.) sockets. Then solder the resistors and diodes, continuing with the capacitors and transistor TR3.

Be careful to observe the correct polarity of the electrolytic capacitors, and the correct orientation of the transistors, diodes, and i.c.s. Note that C1 and C2 mirror each other on the board. The cathodes of the diodes are banded. Capacitor C8 may be strapped to the case with a cable-tie.

Bolt transistors TR1 and TR2 to their two heatsinks, using heatsink compound, then solder them in place, to achieve the correct stand-off from the p.c.b. Since the transistors are MOSFET devices, these should be treated with due care (ideally, short out the pins with a paper-clip while handling).

Attach switch S1, potentiometer VR2, and transformer T1 to the solder pins provided by means of suitable lengths of sheathed and stranded wire. If desired, use a panel mounting potentiometer in place of cermet preset VR1, and attach this to the p.c.b. as well. Insert IC1 and IC2 in their sockets, observing antistatic precautions (touching an earthed item before handling them).

BOXING UP

A metal enclosure is recommended, to help dissipate heat from the transformer in particular, and to minimise radio frequency interference (r.f.i.).

The p.c.b. and transformer are mounted securely inside with suitable nuts and bolts. If necessary, drill a few holes in the case to assist cooling. Fix S1 and VR2 (and VR1 if desired) to the front panel, adding a calibrated scale if preferred.

Ensure that all the circuitry surrounding the transformer’s 230V winding is enclosed. If available, connect this winding to proprietary fixtures to hold the tube, using suitably rated mains connecting

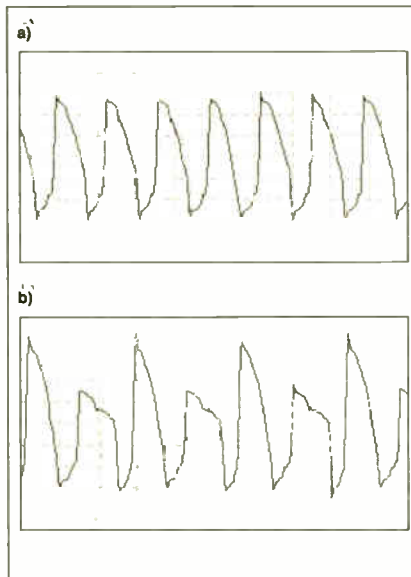

Fig.3. “Blips” across a 10W tube: (a) full brightness and (b) too high.

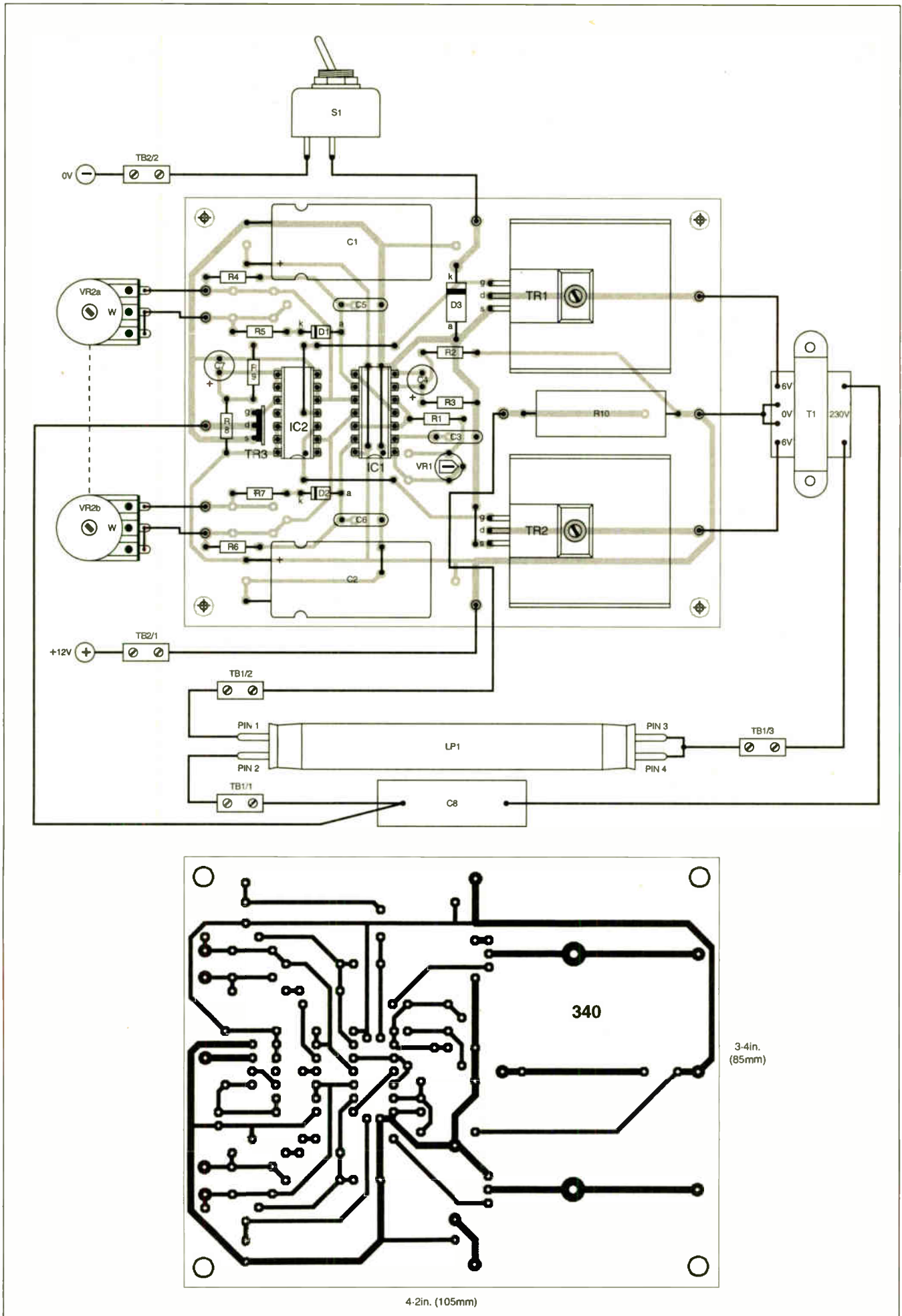
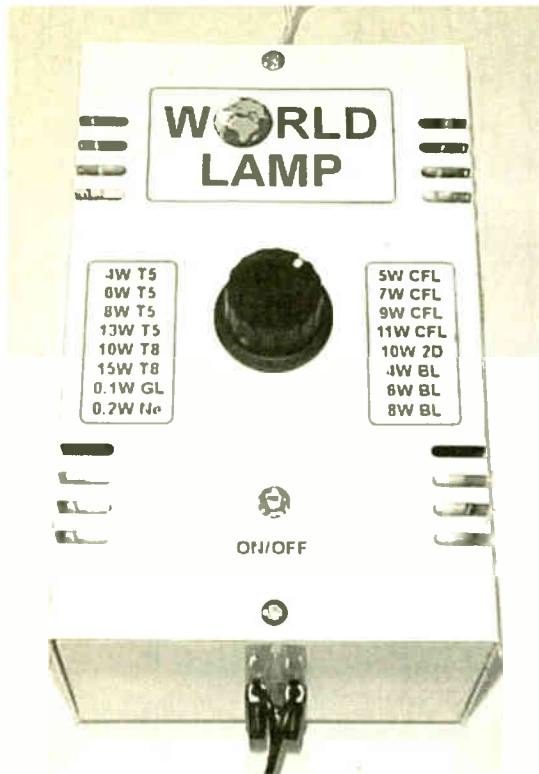

Fig.4. Printed circuit board component layout and off-board connection details, plus full size underside copper foil master track pattern.



Completed World Lamp in a robust well-ventilated metal case.

wire. Keep these wires relatively short, to minimise wiring capacitance. A 2-way and 3-way terminal block are used to connect wires to the battery and lamp, and in the prototype they were mounted on the outside of the case.

To prevent over-voltages in a tube through careless starting (thus causing sputtering from the filaments), optional presets may be wired in parallel with VR2a/VR2b to make up about 50kΩ in parallel – the equivalent of a rotation-limit stop. Provision is made for such presets on the p.c.b.

EQUIVALENTS

Generally speaking, any rough equivalent to the components specified may be

used. Where equivalent transistors are used, check the pinouts for correct placement on the p.c.b. Special note should be taken of the following:

- **Potentiometer VR2a/VR2b.** A dual potentiometer is ideal, but two single potentiometers may be used, with one or both of these being used to strike the tube. During normal running, both potentiometers are turned to the same position.
- **Capacitor C6.** A 600V a.c. rating is recommended, although slightly lower voltages may work without trouble.
- **Transistors TR1 and TR2.** Some care needs to be taken in the selection of these MOSFETs. They should be able to conduct at least 50W, and their "on" resistance should ideally be 0.02Ω. An "on" resistance of up to 0.05Ω may be used, but monitor heat dissipation carefully. Note that prices of equivalents may vary tremendously. Possible equivalents would include: IRFZ44N, IRL3202, IRFU3303, HUF75321P3 and (likely to run hotter) BUZ22, IRFZ34E, RFP25N06 and IRL2703.
- **Transistor TR3.** This may be the same as TR1 and TR2, or virtually any MOSFET which is rated about 0.5A or more.
- **Gate IC1.** The Motorola version of this Schmitt trigger NAND gate is recommended (MC14093BCP), although any make should suffice. Do not use the 4011 quad NAND gate as this is not a Schmitt trigger device.
- **Transformer T1.** The VA rating should be at least double that of the fluorescent lamp wattage to prevent overheating – e.g. an 11W c.f.l. tube should use at least a 22VA transformer (11VA or 1.8A per low voltage winding). Other close similar secondary voltage ratings may be used, particularly 5V-0V-5V. Secondaries having too high a voltage

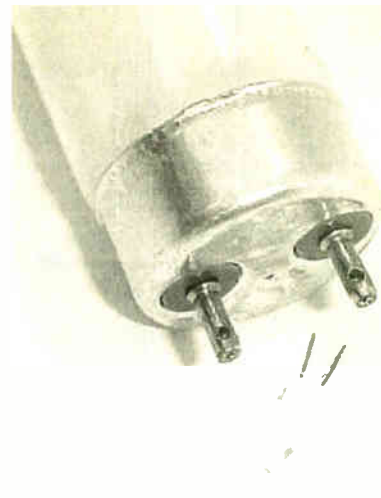

The World Lamp can drive fluorescent tubes from 100mW to 15W.

rating, though, may not strike the fluorescent tubes, especially the larger ones.

COMPONENTS

Resistors

R1	180k
R2, R8	100k (2 off)
R3, R9	470k (2 off)
R4, R6	330k (2 off)
R5, R7	4k7 (2 off)
R10	39Ω 3W

All carbon film 0.25W 20% except R10

Potentiometers

VR1	100k cermet preset (see text)
VR2	50k dual-ganged rotary carbon, lin

Capacitors

C1, C2	4700μ radial elect. 25V (2 off)
C3, C5, C6	100n polyester (3 off)
C4	10μ radial elect. 16V
C7	220μ radial elect. 16V
C8	470n 600V a.c. rated (see text)

Semiconductors

D1, D2	1N4148 signal diode (2 off)
D3	1N5400 rectifier diode
TR1 to TR3	HUF75329P3 n-channel power MOSFET (3 off) (see text)
IC1, IC2	4093 quad Schmitt trigger NAND gate

Miscellaneous

S1	s.p.s.t. toggle switch, 3A
T1	6V-0V-6V 20VA mains transformer, chassis mounting (see text)

Printed circuit board, available from the EPE PCB Service, code 340; heatsink, 20°C/W or less (2 off); terminal blocks PVC or ceramic, 500V a.c. 3-way and 2-way; fluorescent lamp and fittings (see text); metal case to suit; 14-pin d.i.l. socket (2 off); connecting wire; terminal pins; solder, etc.

Approx. Cost
Guidance Only

£20
excluding batts

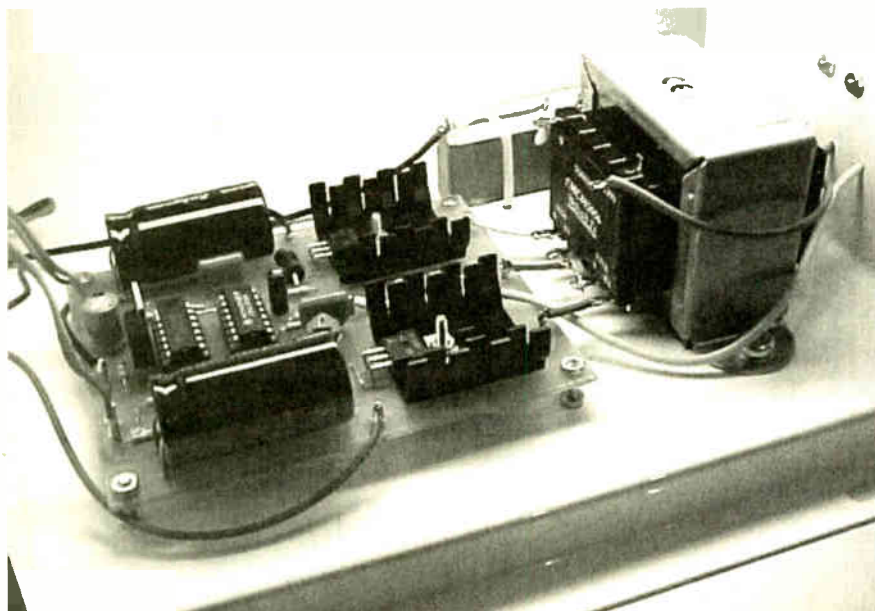

Interior view of the World Lamp, showing the relative positions of the printed circuit board and transformer.

- **Heatsinks.** Any 0.5mm or greater thickness metal may be cut and drilled. Note that the two heatsinks should never touch each other.

SAFETY PRECAUTIONS

The World Lamp produces high voltage, up to and exceeding 400V a.c. This is hazardous, even though the current is limited, and is capable of giving a nasty, potentially fatal, shock.

Contact with all circuitry surrounding transformer T1's 230V winding should be carefully avoided when the unit is on. If you need to work on the World Lamp when it is on, use insulated tools, and work with one hand behind your back.

High voltage circuitry should be fully enclosed and, as far as possible, proprietary fittings should be used to hold the fluorescent tube. Failing this, suitable lengths of plastic tubing may be tightly fitted over the ends of a tube to prevent fingers from touching the terminals.

Fluorescent tubes contain a small amount of metallic mercury, so contact with any broken glass would best be avoided.

IN USE

Begin by turning back (anti-clockwise) VR1 and VR2 completely. Attach a fluorescent lamp to the circuit, exactly as shown in Fig.4, observing full safety precautions. Colour-coded wires were used in the prototype.

To calculate the circuit's likely power consumption, note the wattage of the tube on test. Add 20 per cent to this (e.g. 10W + 20% = 12W). Then divide by 12. This represents the approximate power which the circuit should be drawing while running normally (this might differ from tube to tube, and even drop as tube filaments warm).

Power up the circuit, using an ammeter in series with a d.c. power supply to monitor current consumption. If you have a

choice, set this to a 2A or higher output setting. Use an adequate power supply, otherwise the lamp may flicker. It is suggested that a modestly rated tube be used to begin with, say 6W.

On start-up, the florescent tube should briefly flicker, then gently glow. Current consumption should initially be between 200mA and 300mA. If not, switch off and recheck the circuit.

Now gently turn up (clockwise) VR2. At a certain point, the tube should "strike" – that is, its brightness should suddenly and dramatically increase. Then it may be necessary to turn VR2 back to find the normal running current. Note that one filament is warmed for half a minute at start-up. If the tube does not "strike", you may have exceeded this period. In this case, switch off the lamp for five seconds, then start again. The filament draws around 200mA current.

Once the lamp is running satisfactorily, gently turn VR1 (Overload Adjust) clockwise until the tube begins to blink or flicker. Then turn back slightly so that it just stops flickering. If VR2 is now turned up too high, the lamp will blink again. VR1 may be disabled by turning it back (anti-clockwise) – but not too far, otherwise the lamp may again flicker slightly due to reduced frequency.

For the first hour, carefully monitor heat dissipation in the circuit, since heat can slowly build up. The transformer may become warm, as well as transistors TR1 and TR2, and diode D3. The transformer in particular ought to run below 50°C.

If you are sure that there is no chance of reversed polarity, D3 may be omitted for improved efficiency (its absence will release seven per cent more power, and may help to strike tubes up to about 20W).

The circuit may buzz gently. This is normal for a fluorescent lighting circuit.

While the approximate cost is shown in the components list as £20, this represents a conservative first-world estimate.

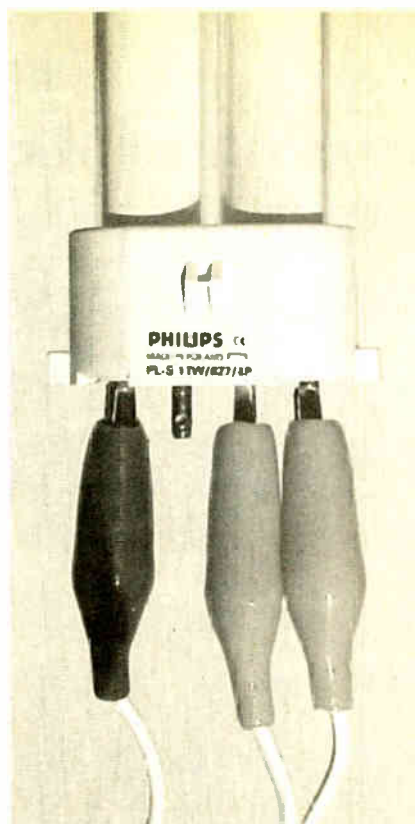

Test clips on an 11W c.f.l. assembly.

The one-off cost in poorer regions of the world is likely to fall substantially below this.

The following Internet resources were found to be particularly helpful, and may be referred to:

Lights and electronics – www.epanorama.net/links/lights.html (links)

Sam's F-Lamp FAQ – www.misty.com/people/don/f-lamp.html

Fluorescent lamp inverters – www.misty.com/people/don/flvdc.html

This World Lamp and its p.c.b. may be freely copied and manufactured without restriction. Copyright in the published article itself remains with *Everyday Practical Electronics*. □



NEWSAGENTS ORDER FORM

Please reserve/deliver a copy of *Everyday Practical Electronics* for me each month

Signed.....

Name and Address.....

.....

.....

Post Code.....

Everyday Practical Electronics is published on the second Thursday of each month and distributed S.O.R. by COMAG. Make sure of your copy of *EPE* each month – cut out or photostat this form, fill it in and hand it to your newsagent.

Learn About Microcontrollers

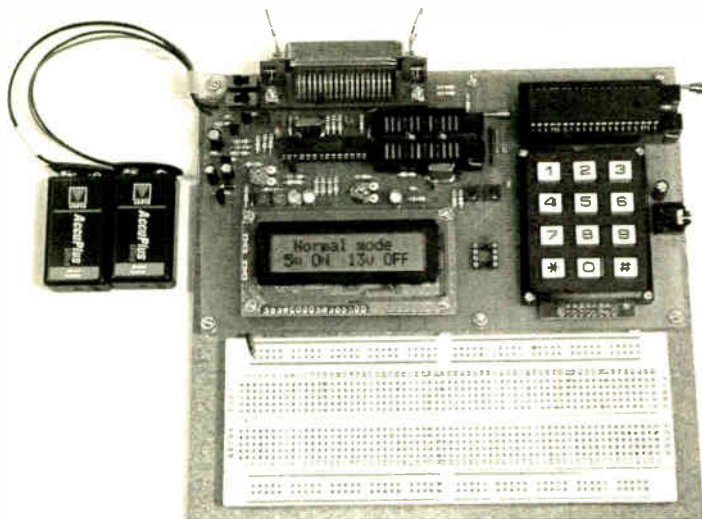

PIC Training & Development System

The best place to start learning about microcontrollers is the PIC16F84. This is easy to understand and very popular with construction projects. Then continue on using the more sophisticated PIC16F877 family.

The heart of our system is a real book which lies open on your desk while you use your computer to type in the programme and control the hardware. Start with four very simple programmes. Run the simulator to see how they work. Test them with real hardware. Follow on with a little theory....

Our complete PIC training and development system consists of our universal mid range PIC programmer, a 306 page book covering the PIC16F84, a 212 page book introducing the PIC16F877 family, and a suite of programmes to run on a PC. The module is an advanced design using a 28 pin PIC16F872 to handle the timing, programming and voltage switching requirements. The module has two ZIF sockets and an 8 pin socket which between them allow most mid range 8, 18, 28 and 40 pin PICs to be programmed. The plugboard is wired with a 5 volt supply. The software is an integrated system comprising a text editor, assembler disassembler, simulator and programming software. The programming is performed at normal 5 volts and then verified with plus and minus 10% applied to ensure that the device is programmed with a good margin and not poised on the edge of failure. Requires two PP3 batteries which are not supplied.

- Universal mid range PIC programmer module
- + Book *Experimenting with PIC Microcontrollers*
- + Book *Experimenting with the PIC16F877* (2nd edition)
- + Universal mid range PIC software suite
-+ PIC16F84 and PIC16F872 test PICs. £157.41
- UK Postage and insurance. £ 7.50
- (Europe postage & insurance. . £13.00. Rest of world. . £22.00)

Experimenting with PIC Microcontrollers

This book introduces the PIC16F84 and PIC16C711, and is the easy way to get started for anyone who is new to PIC programming. We begin with four simple experiments, the first of which is explained over ten and a half pages assuming no starting knowledge except the ability to operate a PC. Then having gained some practical experience we study the basic principles of PIC programming, learn about the 8 bit timer, how to drive the liquid crystal display, create a real time clock, experiment with the watchdog timer, sleep mode, beeps and music, including a rendition of Beethoven's *Für Elise*. Finally there are two projects to work through, using the PIC16F84 to create a sine wave generator and investigating the power taken by domestic appliances. In the space of 24 experiments, two projects and 56 exercises the book works through from absolute beginner to experienced engineer level.

Ordering Information

Telephone with Visa, Mastercard or Switch, or send cheque/PO for immediate despatch. All prices include VAT if applicable. Postage must be added to all orders. UK postage £2.50 per book, £1.00 per kit, maximum £7.50. Europe postage £3.50 per book, £1.50 per kit. Rest of World £6.50 per book, £2.50 per kit.
Web site:- www.brunningssoftware.co.uk

NEW 32 bit PC Assembler

Experimenting with PC Computers with its kit is the easiest way ever to learn assembly language programming. If you have enough intelligence to understand the English language and you can operate a PC computer then you have all the necessary background knowledge. Flashing LEDs, digital to analogue converters, simple oscilloscope, charging curves, temperature graphs and audio digitising. Kit now supplied with our 32 bit assembler with 84 page supplement detailing the new features and including 7 experiments PC to PIC communication. Flashing LEDs, writing to LCD and two way data using 3 wires from PC's parallel port to PIC16F84.

- Book *Experimenting with PCs* £21.50
- Kit 1a 'made up' with software £52.00
- Kit 1u 'unmade' with software £45.00

C & C++ for the PC

Experimenting with C & C++ Programmes teaches us to programme by using C to drive the simple hardware circuits built using the materials supplied in the kit. The circuits build up to a storage oscilloscope using relatively simple C techniques to construct a programme that is by no means simple. When approached in this way C is only marginally more difficult than BASIC and infinitely more powerful. C programmers are always in demand. Ideal for absolute beginners and experienced programmers.

- Book *Experimenting with C & C++* £24.99
- Kit CP2a 'made up' with software £32.51
- Kit CP2u 'unmade' with software £26.51
- Kit CP2t 'top up' with software £12.99

The Kits

The assembler and C & C++ kits contain the prototyping board, lead assemblies, components and programming software to do all the experiments. The 'made up' kits are supplied ready to start. The 'top up' kit is for readers who have already purchased kit 1a or 1u. The kits do not include the book.

Hardware required

All systems in this advertisement assume you have a PC (386 or better) and a printer lead. The experiments require no soldering.

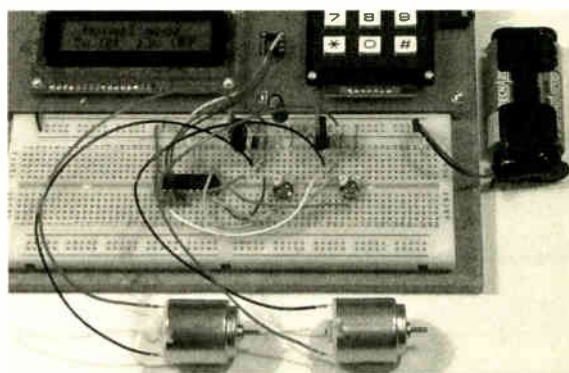

Experimenting with the PIC16F877

The second PIC book starts with the simplest of experiments to give us a basic understanding of the PIC16F877 family. Then we look at the 16 bit timer, efficient storage and display of text messages, simple frequency counter, use a keypad for numbers, letters and security codes, and examine the 10 bit A/D converter.

The 2nd edition has two new chapters. The PIC16F627 is introduced as a low cost PIC16F84. We use the PIC16F627 as a step up switching regulator, and to control the speed of a DC motor with maximum torque still available. Then we study how to use a PIC to switch mains power using an optoisolated triac driving a high current triac.

Mail order address:

Brunning Software 138 The Street, Little Clacton, Clacton-on-sea, Essex, CO16 9LS. Tel 01255 862308

READOUT

E-mail: editorial@epemag.wimborne.co.uk

John Becker addresses some of the general points readers have raised. Have you anything interesting to say? Drop us a line!

WIN A DIGITAL MULTIMETER

A 3½ digit pocket-sized I.c.d. multimeter which measures a.c. and d.c. voltage, d.c. current and resistance. It can also test diodes and bipolar transistors.

Every month we will give a Digital Multimeter to the author of the best Readout letter.



★ LETTER OF THE MONTH ★

ALARM CONSIDERATIONS

Dear EPE,

I notice that the inputs to the PIC Controlled Intruder Alarm (Apr '02) are directly interfaced with the microcontroller via resistors. This means that there is no hardware RFI or surge (transient voltage) protection on the inputs. I note that the author, John Becker, asks for any reader comments on this.

On many circuits I have seen, three-terminal capacitor filters have been used to counteract RFI problems in hardware. Software solutions don't always work in my experience. However, my major concerns would be over transient surges.

Transients from motors, relays and even lightning could pose a more serious threat to the PIC as the high voltages could cause premature failure of the device. This could be difficult to detect as transients could damage the PIC along with stored data and other hardware. Normal practice would be to use a metal oxide varistor or a decent Zener diode (or something similar) to clamp the high voltages.

The EMC standard for alarm systems (BS EN 50130-4) requires that commercial systems be tested with slow and fast transients of 1kV for signal inputs and outputs. This is higher than many other EMC standards due to the threat of false alarms on both intruder and fire alarm systems. This test has nothing to do with malicious use of electromagnetic pulses to

destroy the integrity of the system, as this would be covered under a functional standard.

I suppose that I should say that, having just taken the hobby to professional leap, I have noticed a number of things that are mandatory in commercial designs, but often left out in hobbyist designs, including EMC. However, I consider that people who are in (or considering) the hobby to professional transition would benefit from this information – I would have without a doubt. As the constraints are simply not there in hobby design, it would just be "best practice" rather than mandatory.

Many thanks for an invaluable and indispensable magazine. Keep the current balance between hardware and software: without hardware skills, we would not be able to use microcontrollers in the first place!

**Lyn Jones B.Eng. (Hons), AMIEE
via email**

Thanks for your various comments, Lyn. By our nature, we publish designs principally from hobbyists and do not expect them to conform to all commercial niceties, though we try to make sure they do not break any rules, and we do publish feature articles that look periodically into deeper design considerations.

The input side to this design is based on that used in the Intruder Alarm Control Panel of Apr/May '01, which was designed to meet British Standards specification BS4737.

Thanks Guy. Yes, fortunately throughout the ages many rebels have emerged who question the "orthodox" opinions of their day, resulting in discoveries that profoundly changed our understanding of "life, the universe and everything". Marconi is but one name on a very lengthy list of illustrious technology-changing investigators who emerged once Aristotle's influence receded.

EPROM ERASER

Dear EPE,

I have a PIC development kit for programming various PIC's (in particular the 16C57). To erase the program on this PIC, ultra-violet light needs to be used. However, they cost about 170 Euro. Do you know of any better value EPROM erasers. Would it be practical to just buy a UV light and place the light and the PIC together into a box?

Paul McGovern, via email

UV erasure is not something we've done for many years, Paul, and we can't help you on it. I would comment though that UV lights for p.c.b. prototypes and those for EPROM erasing are not the same, each using very different UV wavelengths. I once tried to erase an EPROM with my p.c.b. exposure unit, and failed to do it, even after 24 hours. Many years ago I bought a UV erasure kit from Magenta – ask them if they still do one.

Incidentally, always remember never to look directly at the UV light, which can be damaging to eyesight.

AUSTRALIAN SKILLS SHORTAGES

Dear EPE,

I am currently in Adelaide, South Australia. I have been following the recent discussions relating to both employment and skills shortages in the UK with interest. Coming originally from the UK some 37-odd years ago, I have never lost the feeling that the UK was "home" for me. Some people will probably say "why?" but I wish to return there with my new wife. The problem is – employment.

I have been involved in electronics ever since I was old enough to use a soldering iron, did my training with the New Zealand Post Office as a Telephone Exchange Tech, moved to Australia and held various jobs all in the electronics field as a tech. I've run my own business designing, prototyping and building electronic equipment for 15 years and a couple of years ago decided to have a break and work as an employee for a while. Big mistake!

Despite all my years of knowledge (I kept myself up-to-date in the business), at 44 nobody wanted to know me. There were jobs advertised out there and I thought maybe I was just too old. Eventually I got a casual job, at the equivalent of four pounds per hour as a senior testing technician and was working with people in the 18 to 26 age group. They too were having trouble getting permanent jobs. In conversations with them, they had no problems getting into courses and getting their qualifications, apparently the classes were and are still quite full. So I would like to know, who are actually getting the supposedly advertised jobs?

Do they genuinely exist? We out here seem to have plenty of qualified people, or is it the old "must be 16 to 18 yrs old with experience" roundabout? One day the employers will wake up, but by then it will be too late because, judging by your experiences in the UK, the young have worked out that better money can be made elsewhere along with better job security and satisfaction.

**Terry Mowles,
via email**

It's interesting to have an overseas viewpoint on this subject as well, Terry, thank you.

I.C. DATASHEETS

Dear EPE,

As a regular reader of EPE, I am writing to see if you can help me to track down a source of data sheets for some i.c.s. This information is for my 14-year-old godson who I introduced to electronics a few years ago, and who is now trying to design circuits with components he has procured.

**Jim Bradshaw, Preston,
via email**

I find that manufacturer's web sites are normally the best source for data sheets, which can be downloaded free. I think the ones you quoted in your email are Philips. I suggest you search via www.google.com on Philips for their i.c. site. When a manufacturer is not known it is worth searching generally via Google on the i.c. numbers, it's amazing how often such a search produces results.

MARCONI AND ANTENNAE

Dear EPE

Ian Poole's excellent article on Guglielmo Marconi (Dec '01) makes the important point that he was not a theoretical scientist. If he had been he would not have tried to transmit across the Atlantic Ocean. It was generally thought that Herzian waves travelled in more or less straight lines and it was known that they did not pass through water. The theoretical physicists pointed out that if the earth's curvature was taken into account there was a 50 mile high mountain of water between Poldhu and Cape Cod so that there was no chance of any radio waves crossing the ocean. However, Marconi was not one to be put off by experts and no one knew of the existence of the ionosphere but which allowed his tests to work.

Marconi never used an antenna. This was a word introduced into the technology by the Americans, many of whom deny many of Marconi's achievements. The classic book on the subject *Antennas* by Professor Kraus does not contain the name Marconi although Yagi, Booker and many other pioneers are mentioned. The same applies to the many works of Professor Terman.

Marconi's early patents refer to "an aerial conductor" which he and his colleagues abbreviated to *aerial*. This was the term in common use in the UK until the 1939/45 War brought an influx of US equipment. I doubt whether Marconi ever considered an antenna to be other than the sense organ of an insect.

**Guy Selby-Lowndes,
Billingshurst, Kent**

ENLIGHTENING JAVA

Dear EPE,

I hope that your readers will be interested in my suite of Javascript/HTML programs. Two of them, temperature conversion (actually intended for hygrometers) and frequencies of musical notes, were inspired by the November edition. The musical notes program, in particular, gives a display rather like page 808 Fig.7 of the *Pitch Switch*, but can be set for a wide range of octaves from the sub-audible up to ultrasonic and beyond to VHF! Also available are: reactance, resonance, trigonometry, quadratic equations and the coded character set used in HTML.

Readers wanting any (or all) of these should send a formatted 3.5in IBM floppy with return (pre-paid and pre-addressed) mailing facilities. There is no charge, but because the software is copyright, readers may only install it on one computer and must not copy or give it to anyone else. Feedback as to performance is welcomed.

All run in a web browser that can interpret Javascript. I tested the software using Microsoft Internet Explorer 5.

I would also suggest that the best use of the *Lights Needed Alert* (Nov '01) would be to always switch on side lights as part of the "afterstart" check. The "lights on" feed at TB2/3 would then be from a pair of diodes, cathodes together to the R8/C8 junction but each anode going to one filament of the headlights (dim and main beam respectively). The warning then sounds when it gets dark and the headlamps (not side lights) need switching on. Regrettably, it won't work this way on my car as it has the dim-dip system.

Dr G.L. Manning,

63 The Drive, Edgware, Middx, HA8 8PS

Thank you, Doctor, for the offer and suggestion.

ASTEROID MONITORING

Dear EPE,

Thank you for your excellent magazine. Wonderful ideas and ingenious adaptations. I have a potential project that I want to discuss with you. As you may remember, a very large asteroid recently passed close by. Astronomers didn't know it until it was about 5,000,000 miles away and there-in is my question and idea. First, how did they discover it? I assume it was from continual searching with passive receivers (telescopes) and not radar units. If so, then the mechanism used was the eyes, or maybe sensitive film exposed over a "period" of time allowing for comparisons to detect movement.

If human eyes can detect the asteroids, it must be because: (1) they reflect light; (2) block out light behind them (like a moving black hole); or (3) generate light/energy, or, maybe, some combination thereof. And that's my idea.

Just like a photoreceptor reacts to light – or the absence of it – couldn't a way be found to focus the sensitivity of a device, using large (3-metre) backyard C-Band TVRO antennas (available everywhere for free in the US), so that as an object blacks out the light behind it, a sensor would activate and record it. The sensor would, of course, pick up airplanes, falling trees, maybe even fog, but with the right sensors and computer power, maybe it could be adapted not to sound a siren but instead select a different electronic wavelength to monitor. Infrared? Visible? Near infrared? Background noise disrupted by a passing object . . . ?

I don't know what the "trigger event" would be, but if it's true that the majority of asteroids are located by backyard telescopes and amateur scientists – like those reading *EPE* – maybe electronics could be developed to substitute. What do you think?

Dave Mynatt,
Manchaca, Texas, via email

I thanked Dave for the suggestion and commented that radar is probably used in astronomy for asteroid monitoring, rather than optical techniques. Not the sort of thing that really seems feasible for us to design a project for. I suggested he should ask one of the astronomy

mag for more info on how it's done, or browse the web. He replied:

I searched the web and found that both are used, with visual a predominant methodology. Radar has too many limitations, in terms of range, band spread, filtering. So a bunch of folks get together and search the skies with telescopes, comparing one night's star positions to another, looking for streaks and smudges and new things.

I'm not sure anything can be done, so just wanted to get your take on it. What do you think if it is an optical design?

I really don't know Dave, it seems that optical techniques need very high magnification, maybe beyond the scope of amateurs, and that the sky area searched on any scan becomes smaller the greater the magnification, hence lots of people with similar equipment would be needed, as you say.

Some years ago I designed a CCTV camera that would respond to bright starlight and I was able to view a few stars through my PC, but it certainly would not have been up to asteroid searching. Cryogenically-cooled electronics is used professionally when faint star images need to be monitored.

It's possibly not really a subject for a hobbyist electronics mag, but an interesting one nonetheless. Let's see what readership reaction might be.

MSF REPEATER

Dear EPE,

I live in Capetown SA, and have built Andy Flind's *MSF Signal Repeater* (Jul '01). My problem is that the antenna is not readily available here. Can you inform me how to build the antenna myself. I will need specs on the ferrite core, the wire used and the tuning cap value. How many turns are needed on the core. I would really appreciate this help from you to help me complete this project.

Donovan Robertson,
South Africa, via email

Andy Flind replies to Donovan:

At such low frequencies as 60kHz all one needs is a bit of ferrite rod, some enamelled copper wire and a suitable capacitor, say a silvermica of around 470p. I'd try driving the circuit with a signal generator through a series resistor of about 10k whilst observing the amplitude across the tuned circuit with a scope. This would get broadly into range, though final trimming would be required, if only to compensate for the removal of the capacitance of the scope lead. There's a lot of trial and error in this sort of stuff, and needs a little patience.

Andy Flind

P.C.B. SIZES

Dear EPE,

I subscribe to *EPE* and download it electronically as a pdf. I've recently tried making a couple of p.c.b.s using printouts from the magazine, only to find that they are coming out at a reduced scale. My printer is set for 100% printing. Any ideas how I can overcome this problem.

Dave Stacey,
Northampton College, via email

The page size of the Online issue is reduced to American A4 so that pages can be printed on that size paper. Also various printers will distort the original size which is why we give the size of the p.c.b. alongside the image. If you are lucky enough to have some graphics software, i.e. Photoshop or Corel Draw, then you should be able to import the image and resize it before you print it. Alternatively, you could use an enlarging photocopier, printing onto OHP (overhead projection) film, which is translucent enough to use in a UV exposure unit. I use it all the time when making my own prototype p.c.b.s via PC printouts, it's excellent. Major computer retailers sell it, and possibly also office stationers.

GRAPHICALLY SPEAKING

Dear EPE,

I design and build loudspeaker enclosures and as you know most of the work is done in testing and measuring of the loudspeaker parameters. So when I saw your *PIC Graphics L.C.D. Scope* of May '01 I thought to build it to replace my old equipment. I see in previous articles you make light of the Lissajous mode, but in my case it allows one to easily and precisely find the speaker or crossover network's resonant frequency (zero phase angle).

Is it possible to enable this feature with this scope? If it requires two inputs one could use the spare opamp IC1b. All one needs is to see the Lissajous circle collapse to a straight line which indicates that zero phase or that the circuit is resonating.

Looking on the Web, one will notice that the majority of electronics involves audio and the building of amps and speakers, so test equipment will be of much interest to all concerned. I see you have just published a Spectrum Analyser (Feb '02) for the PC, but I would like to see a portable version similar to the *Graphics Scope* but displaying a bar type or VU display.

I was busy designing an 8-channel one that would use i.e.d.s for the display but think this is rather outdated when one sees your designs using l.c.d. graphics displays. The VU display would use the usual eight filters multiplexed by a 4051 under control of the PIC.

I am also building an 8-channel graphic equalizer that will be used in measuring room response and aid in the setting up of hi-fi systems.

I hope that this inspires you to consider designing the above ideas which I am sure will stimulate much interest from the audio fraternity.

Mike MacLeod,
via email

Thanks for the suggestions which I'll give thought to (but can't promise!). Lissajous I've dabbled with through PICs but it's not too successful because of the limitation of the sampling and plotting rates. A real dual-trace scope is far more suited to the task it would seem. Having said that, my Virtual Scope of Jan/Feb '98, which was PC controlled (rather than PIC), had far better sampling rates, but was complex to build.

Best wishes for your own designs.

TK3 AND PICTutor

I have downloaded the *PIC Toolkit TK3* software which appears to work as documented. However, when I try to run the *PICTutor* program from within *TK3* it requests a *PICTutor.exe*. This file was not in the ftp folder, is it available on the site?

Eb Sleep,
via email

You have misunderstood, Eb. The TK3 facility for accessing PICTutor is for those who already possess this commercial product. PICTutor can be bought from us on CD-ROM, see the advert in this issue.

TK3 AND XP

There seem to be loads of posts on the *EPE Chat Zone* over *TK3* and Windows XP with suggestions ranging from AllowIO to others more ludicrous.

If (in Win XP) you create a shortcut to an EXE on your desktop, then right click and select properties, then select compatibility. You can then tell it to run in Windows 95 mode. This bypasses all IO problems et cetera, my *TK3* prog running fine under Win XP once this has been configured.

Mark Jones,
via email

Following Mark's email, we had discussions with him, and we now have his more detailed article on XP/W2K and TK3 in the pipeline for publication. It's useful, watch out for it! Thank you Mark.

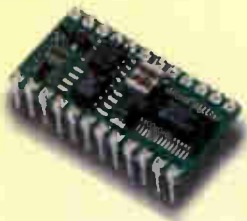

BS2-IC



BS2-SX

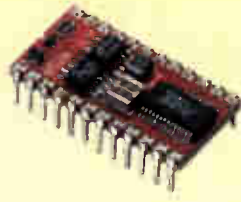

BS2E-IC

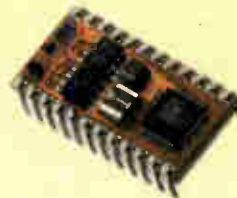

BS2P/24

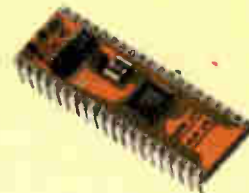

BS2P/40

Parallax BASIC Stamps - still the easy way to get your project up and running!



**Serial Alphanumeric and Graphic Displays,
Mini-Terminals and Bezel kits**

www.milinst.com



Animated Head



3-Axis Machine



Six-Legged Walkers



Robotic Arms



Bipeds

Robotic models for both the beginner and the advanced hobbyist



Servo Drivers

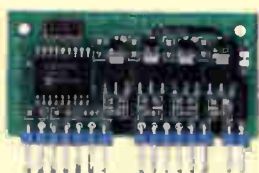

Motor Drivers



On-Screen Displays



DMX Protocol

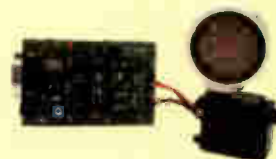

U/Sound Ranging

Animatronics and Specialist Interface-Control Modules

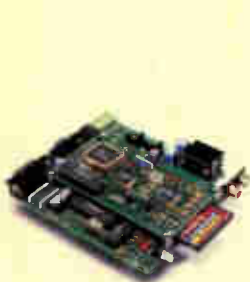

Quadravox
MP3 & Speech Systems



SensoryInc
Voice Recognition



Parallax
Ubicom Tool Kits



Tech-Tools
PIC & Rom Emulators



BASICMicro
PIC BASIC Compilers

Development Tools

Milford Instruments Limited Tel 01977 683665, Fax 01977 681465, sales@milinst.com

SIMPLE AUDIO CIRCUITS

Part 2 – Preamplifiers, Tone Controls and Filters



RAYMOND HAIGH

A selection of "pic-n-mix" low-cost audio circuits – from preamplifier to speaker!

ALTHOUGH the power amplifiers described last month have a respectable amount of gain, some signals may be too weak to produce an adequate loudspeaker output without additional amplification. They can also be further weakened by an excessive mismatch between signal source and amplifier. Tone controls are usually required when music is being reproduced, and restricting the bandwidth will clarify speech signals, especially under noisy conditions.

These three issues: preamplification, impedance matching and tailoring the frequency response, are covered in this article.

TRANSISTOR AMPLIFIERS

Impedances

The impedances presented by the input and output ports of transistor amplifier stages are extremely variable. Load and bias resistors exert a major influence, as do the gain of the transistor and its emitter current. Negative feedback can either raise or lower impedance and, to further confuse the issue, the load connected across one port influences the impedance presented by the other.

The impedance figures quoted are, therefore, intended as no more than a *guide* when selecting the best circuit for a particular application.

Biasing

Transistor amplifier stages are usually biased so that the output (collector or emitter; drain or source) rests at half the supply voltage under no-signal conditions. This enables the stage to deliver the greatest possible signal swing; i.e. the highest output, before the onset of clipping.

Transistor gain (h_{fe}), and supply voltage, affect the biasing. However, over a wide range of h_{fe} values (at least 200 to 600), and supply voltages from +9V to +12V, the circuits described here will deliver a low distortion output that is more than

sufficient to fully drive the power amplifiers described last month.

Experimenters who require the stages to have the highest possible signal-handling capability for a given supply voltage may have to adjust the bias resistors. Guidance on this is given later.

Cascading

The various preamplifiers, tone controls and filters can be combined to suit individual requirements. Blocking capacitors have been provided at the inputs and outputs, and the units can be used safely with any equipment.

Cascading makes one of these capacitors redundant. Similarly, when they are connected to the power amp described last month, the output blocking capacitor can be omitted (C1 on the power amplifier p.c.b. duplicates this component).

Decoupling

All of the preamplifier circuits are decoupled from the power supply by a resistor and capacitor. Failure to include these components will almost certainly result in motor boating (low frequency instability).

The main cause of this instability is the wide swing in power amplifier current drain: even with small units this can range from 10mA to 150mA. These signal-induced current swings cause variations in the voltage of dry batteries or badly regulated mains power supplies. When high gain preamplifiers share the same supply rail, the resulting feedback causes low-frequency oscillation.

If problems are encountered, increase the value of the decoupling resistor, or capacitor, or both, by a factor of ten. A capacitor of 2000 μ F or more, connected across a dry battery power supply, will also help to eliminate instability at high volume levels.

R.F. Interference

The single transistor preamplifiers described here have an extended high

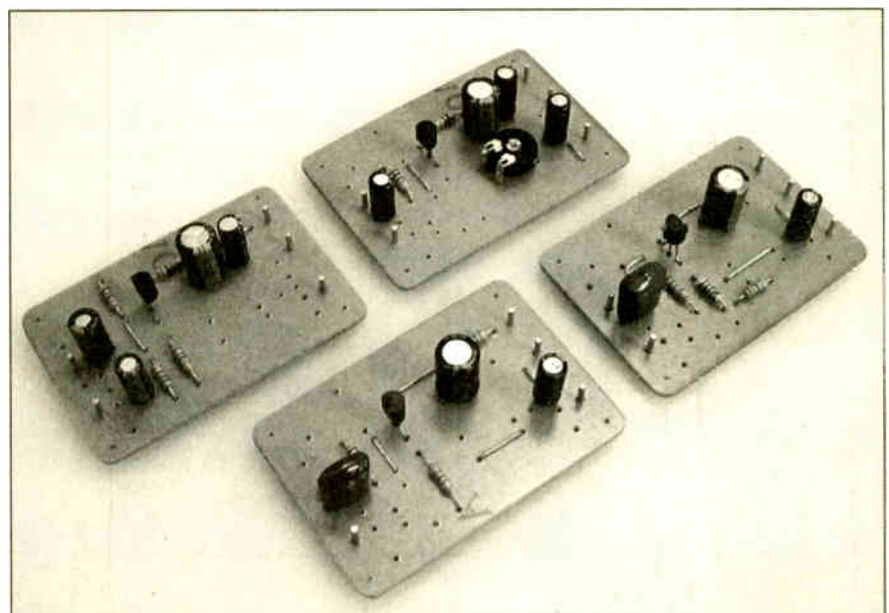

Four single-transistor preamplifiers (left-to-right). ● Low Impedance ● Medium Impedance ● High Impedance ● F.E.T. High Impedance.

frequency response, and problems with r.f. interference may be encountered. Connecting a low value ceramic capacitor between the input (emitter or base) and the 0V rail will cure the problem, and the accompanying printed circuit board (p.c.b.) makes provision for this.

SINGLE TRANSISTOR CIRCUITS

In many cases, all that is required is the additional gain and/or impedance matching afforded by a single transistor stage. Four circuits will now be considered.

Low Input Impedance Pre-amplifier

It is convenient, with simple intercom units, to make the speaker double up as a microphone. Voice coil impedance and output are very low: a few ohms and less than 1mV at a close speaking distance. Transformers are often used to increase the impedance and voltage of this signal

source, but a transistor can be made to do the job just as well.

The "grounded base" stage illustrated in Fig.1 has an input impedance of around 50 ohms, an output impedance roughly equal to the collector load resistance (R2) of 10 kilohms, and a voltage gain of around 100. Although more commonly encountered at the front-end of a radio receiver, this configuration is suitable for matching low source impedances to the power amplifier and, at the same time, providing a useful amount of voltage gain.

In the circuit diagram for the Low Input Impedance Pre-amplifier shown in Fig.1, C1 is a d.c. blocking capacitor, R1 and R2 are the input and output load resistors, and resistors R3 and R4 bias the transistor. The base (b) is grounded at audio frequencies by capacitor C3.

Supply line decoupling is effected by C4 and R5, and C2 is the output coupling and d.c. blocking capacitor.

CIRCUIT BOARD

The printed circuit board component layout, wiring details and full-size copper foil master pattern are shown in Fig.2. This board is available from the *EPE PCB Service*, code 349 (Single Trans.).

Before commencing assembly, check the component, construction and interconnection notes at the end of the article.

VARIATIONS

Readers wishing to operate the stage from lower supply voltages should check the voltage on the collector (c) of transistor TR1 under no-signal conditions. If it is much more than half the supply voltage, reduce the value of resistor R3 to increase the bias current. With 3V on the supply rail, R3 will need reducing to around 6-8 kilohms and, with a 6V supply, its value will be in the region of 12k.

Because of its very low input impedance, the circuit of Fig.1 is not prone to capacitive hum pick up, and the input lead can be

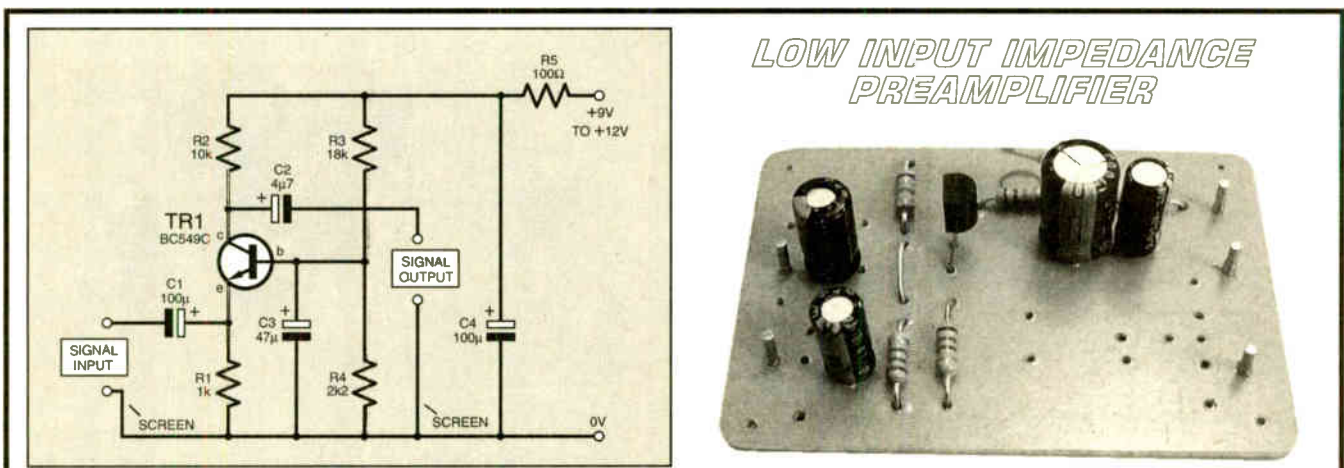

VOLTAGE GAIN 100 OVER AN h_{fe} SPREAD OF 110 TO 600. CURRENT DRAIN AT 9V SUPPLY 0.75mA.

Fig.1. Circuit diagram for the single-transistor Low Input Impedance Pre-amplifier.

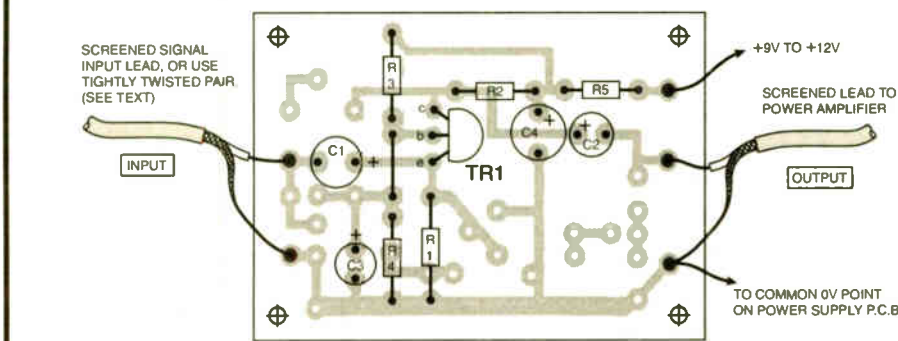

Fig.2. Printed circuit board component layout, wiring and full-size copper foil master pattern for the Low Input Impedance Pre-amplifier.

COMPONENTS

LOW INPUT IMPEDANCE

Resistors

R1	1k
R2	10k
R3	18k (see text)
R4	2k2
R5	100Ω

All 0.25W 5% carbon film

Capacitors

C1, C4	100μ radial elect. 25V (2 off)
C2	4μ7 radial elect. 25V
C3	47μ radial elect. 25V

Semiconductors

TR1	BC549C npn transistor (or similar - see text)
-----	---

Miscellaneous

Printed circuit board available from the *EPE PCB Service*, code 349 (Single Trans); audio screened cable; multi-strand connecting wire; input and output sockets, type to choice; solder pins; solder etc.

Approx. Cost
Guidance Only

£7

tightly twisted flex rather than screened cable. If r.f. interference problems are encountered, connect a 100nF capacitor between the emitter (e) of TR1 and the 0V rail: provision is made for this on the p.c.b.

Combining this low impedance circuit (Fig.1) with the LM386N-1 or the TBA820M power amplifiers (fully described in Part 1, last month) will produce a decent intercom unit, but more amplification is needed for surveillance purposes. Cascading the grounded base stage with the medium impedance preamplifier described next (Fig.3) is one possible answer.

Medium Input Impedance Preamplifier

The input impedance of the single transistor, common emitter preamplifier

illustrated in Fig.3 is approximately 1500 ohms (1.5k), and the output impedance roughly equal to the value of the load resistor, R2; i.e. 4700 ohms (4.7k).

Base bias resistor R1 is connected to transistor TR1 collector (c) rather than the supply rail. The resulting d.c. negative feedback makes the biasing more immune to transistor gain spreads and variations in supply voltage.

Preset potentiometer VR1 acts as the emitter bias resistor. Connecting capacitor C2 to the slider (moving contact) enables part of it to be left un-bypassed. This introduces varying levels of negative feedback and, with the specified transistor, the gain of the stage can be set between 10 and 160 times to suit different applications.

Comment has already been made about supply rail decouplers, R3 and C4, and blocking capacitors, C1 and C3.

CIRCUIT BOARD

The printed circuit board component layout, wiring details and full-size copper foil master pattern are shown in Fig.4. This board is available from the EPE PCB Service, code 349 (Single Trans.).

Before undertaking assembly work, see the component, construction and inter-connection details at the end of the article.

Provision is made for connecting an r.f. bypass capacitor across the input. A 1nF or 10nF ceramic component should be adequate if problems arise.

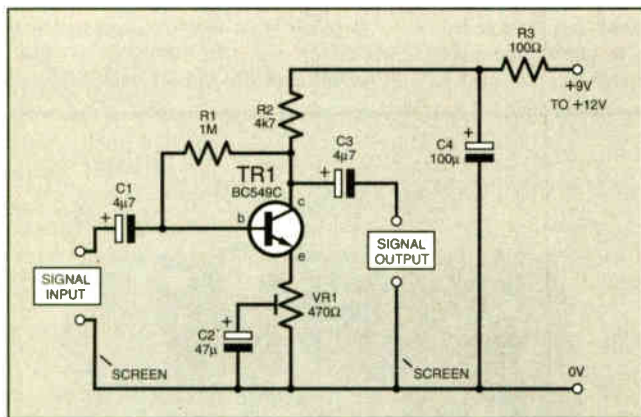

VOLTAGE GAIN WITH VR1 SLIDER AT 0V RAIL, 8 TO 10 OVER AN h_{fe} SPREAD OF 110 TO 600.
VOLTAGE GAIN WITH SLIDER AT TR1 EMITTER, 80 TO 600 OVER AN h_{fe} SPREAD OF 110 TO 600.
CURRENT DRAIN AT 9V SUPPLY: 1.25mA.

Fig.3. Circuit diagram for the Medium Input Impedance Preamplifier.

MEDIUM INPUT IMPEDANCE PREAMPLIFIER

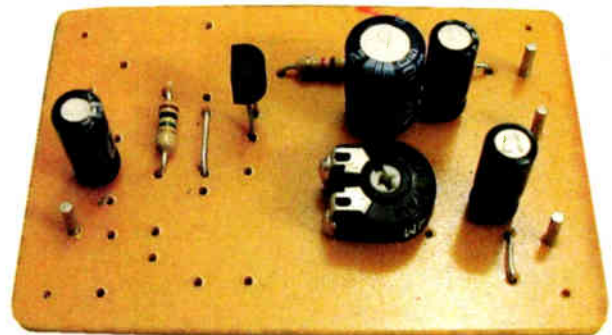

Medium Input Impedance preamplifier components mounted on the "single" p.c.b.

COMPONENTS

MEDIUM INPUT IMPEDANCE

- Resistors**
R1 1M
R2 4k7
R3 100Ω
All 0.25W 5% carbon film
- Potentiometers**
VR1 470Ω enclosed carbon preset
- Capacitors**
C1, C3 4μ7 radial elect. 25V (2 off)
C2 47μ radial elect. 25V
C4 100μ radial elect. 25V
- Semiconductors**
TR1 BC549C npn transistor (or similar - see text)

Miscellaneous

Printed circuit board available from the EPE PCB Service, code 349 (Single Trans.); audio screened cable; multi-strand connecting wire; input and output sockets, type and size to choice; solder pins; solder etc.

Approx. Cost Guidance Only

£7

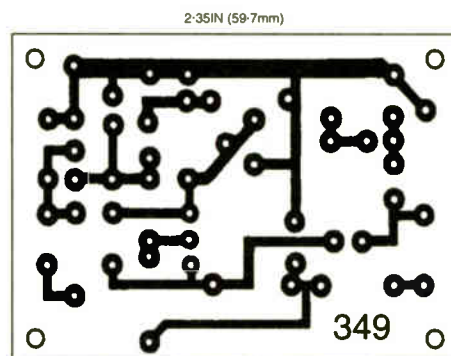
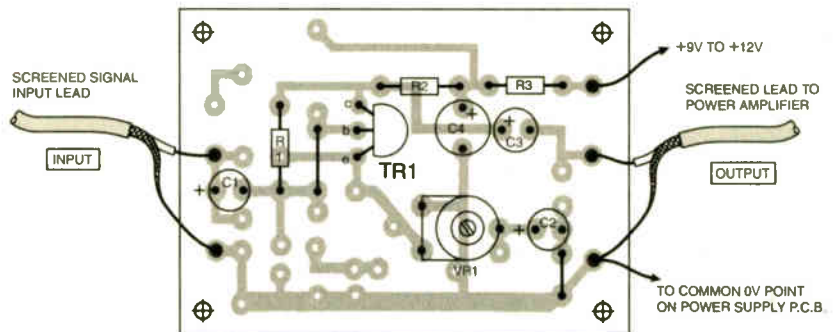

Fig.4. Medium Input Impedance Preamplifier printed circuit board component layout, wiring and full-size copper foil master.

High Input Impedance Preamplifier

Crystal microphones and ceramic gramophone pick-ups (there are still a few in use) require an amplifier with a high input impedance, and a stage of this kind is useful when the damping on a signal source has to be kept low.

Configuring a bipolar transistor in the emitter-follower (common collector) mode results in a high input and low output impedance, and a typical High Input Impedance Preamplifier circuit diagram is shown in Fig.5. The input impedance is roughly equal to the gain of the transistor (h_{fe}) multiplied by the value of the emitter load resistor R2.

This is, however, limited by the bias resistor R1, and the output load, which shunts the emitter resistor. Nevertheless, a high gain transistor will still produce an input impedance of about 100 kilohms.

Often the low output impedance is the sought after feature, either for matching purposes or for avoiding high-frequency losses and hum pick-up when long screened cables have to be used. Output impedance is

directly related to the impedance presented by the signal source, and is usually in the region of 1000 ohms. The voltage gain of the circuit is a little less than unity.

CIRCUIT BOARD

The printed circuit board component layout, wiring details and full-size copper foil master pattern for the High Input Impedance Preamplifier are shown in Fig.6. This board is the same one used for all the single transistor preamplifiers, and is available from the *EPE PCB Service*, code 349 (Single Trans.). See the component, construction and inter-connection notes at the end of the article.

High input impedance makes the stage very vulnerable to hum pick up. Careful attention must, therefore, be paid to screening the input leads and, possibly, the entire unit.

VARIATIONS

It is possible to obtain higher input impedances with a bipolar transistor by applying positive feedback from the emitter to the base bias network. This involves an extra pair of resistors and a capacitor, and an alternative solution, if very high

input impedances are required, is to use a field effect transistor (f.e.t.); a device which tends to introduce less noise at audio frequencies.

USING A F.E.T.

A circuit diagram for a F.E.T. High Input Impedance Preamplifier is given in Fig.7. The gate resistor R1 is tapped down to the source resistors R2/R3 in order to improve biasing and, hence, signal handling. By this means the f.e.t. develops its gate bias across R2, and R3 drops an additional 3V or so to fix the voltage on the source at around half the supply voltage.

Connecting the gate resistor R1 in this way applies a proportion of the in-phase output signal to its lower end, and the resulting positive feedback, or "bootstrapping", increases its effective resistance, and the input impedance of the circuit, to around 6 megohms (6M).

Output impedance is independent of signal source impedance. It is governed by the transconductance (gain) of the device, and is usually of the order of 500 ohms.

HIGH INPUT IMPEDANCE PREAMPLIFIER

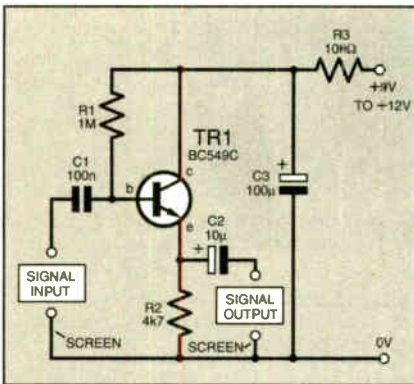

VOLTAGE GAIN: UNITY
CURRENT DRAIN AT 9V SUPPLY: 1.25mA.

Fig.5. High Input Impedance Preamplifier circuit diagram.

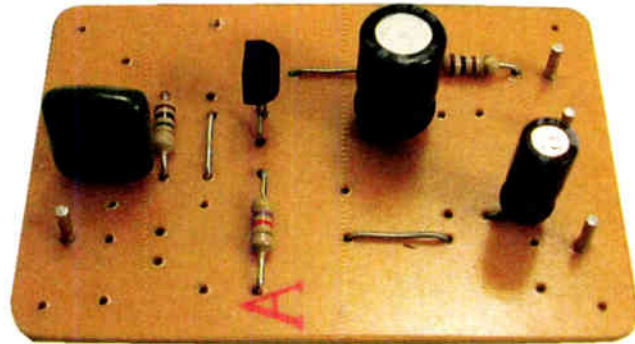

High Input Impedance Preamplifier circuit board.

COMPONENTS

HIGH INPUT IMPEDANCE

Resistors

R1	1M
R2	4k7
R3	100Ω

All 0.25W 5% carbon film

See
SHOP
TALK
page

Capacitors

C1	100n polyester
C2	10µ radial elect. 25V
C3	100µ radial elect. 25V

Semiconductors

TR1	BC549C npn transistor (or similar - see text)
-----	--

Miscellaneous

Printed circuit board available from the *EPE PCB Service*, code 349 (Single Trans.); audio screened cable; multi-strand connecting wire; input and output sockets, type to choice; solder pins; solder etc.

Approx. Cost
Guidance Only

£7

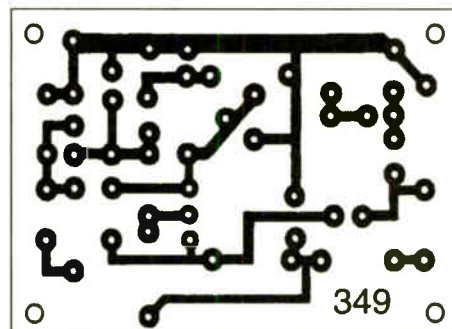
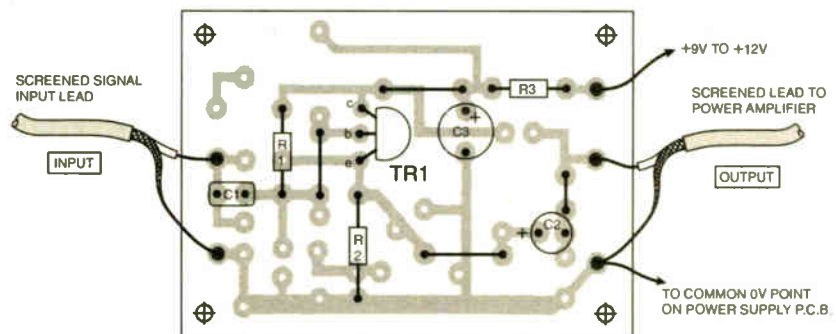

Fig.6. Printed circuit board component layout, wiring and full-size copper foil master for the High Input Impedance Preamplifier.

This is the circuit of choice when a high impedance source has to be connected to a long screened cable; e.g., a capacitor or crystal microphone. However, f.e.t. characteristics vary widely, and readers wishing to use the circuit of Fig.7 should be prepared to adjust the value of resistor R3, over the range of 1500 to 4700 ohms, especially when low supply voltages are used, in order to optimise signal handling capability.

CIRCUIT BOARD

Details of the printed circuit board component layout, wiring and copper foil master pattern are given in Fig.8. The board is the single transistor version and is available from the *EPE PCB Service*, code 349 (Single Trans).

Before assembly, check the component, construction and interconnection details at the end of the article.

LOW-NOISE PREAMPLIFIER

Amplifiers introduce unwanted noise and, as gain increases, more care has to be taken to prevent the noise becoming too intrusive. The noise generated by a bipolar transistor can be reduced by operating it at a low collector current, typically between 10 μ A and 50 μ A. This technique has been adopted for the first stage of the directly-coupled, two transistor, Low-Noise Preamplifier shown in Fig.9.

Overall gain is stabilised by negative feedback applied via preset VR2. With the value shown, gain is approximately 300. If a 47k potentiometer is used instead, gain will be reduced to around 150, and it can be taken down to 70 or so with a 22k component.

Rotating the slider (moving contact) of preset VR2 causes it to be progressively bypassed by capacitor C6, increasing the

negative feedback, and reducing gain, at high frequencies. This feature is useful for reducing noise and for correcting the recording characteristic of long playing records. It is usual to incorporate more complicated RC networks in the VR2 position for the latter purpose but, unless the listener has a very refined ear, there will be little or no discernible difference.

Operating conditions are stabilised by d.c. negative feedback applied via resistor R5. This, together with the high value collector load, R3, fixes the collector current of transistor TR1 at around 50 μ A with a 12V supply.

Input impedance is around 50k, but the optimum signal source resistance for lowest noise is between 5k and 10k. This has influenced the value of the input potentiometer, VR1.

The purpose of the remaining components will be evident from earlier circuit descriptions. However, because of the

F.E.T. HIGH INPUT IMPEDANCE PREAMPLIFIER

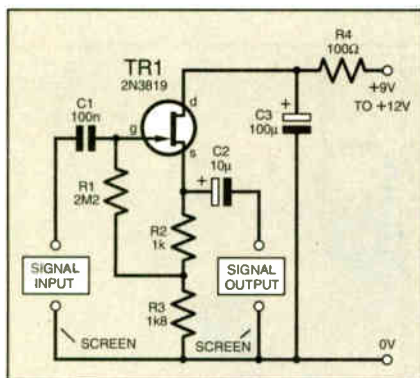

VOLTAGE GAIN: UNITY
CURRENT DRAIN AT 9V SUPPLY: 1.75mA.

Fig.7. Alternative circuit diagram for a High Input Impedance Preamplifier using a field effect transistor (f.e.t.).

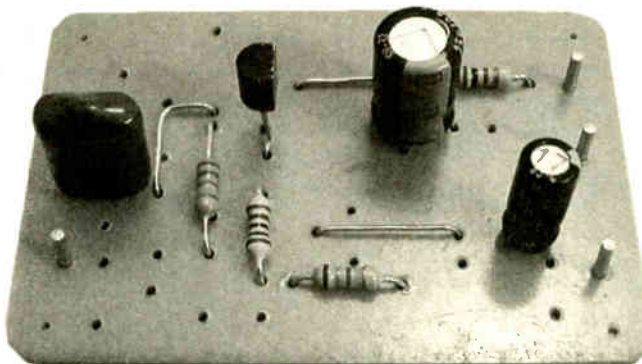

F.E.T. High Input Impedance Preamplifier p.c.b.

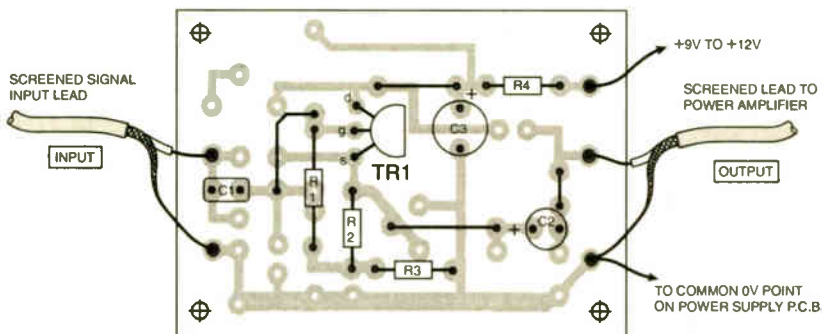

2.35IN (59.7mm)

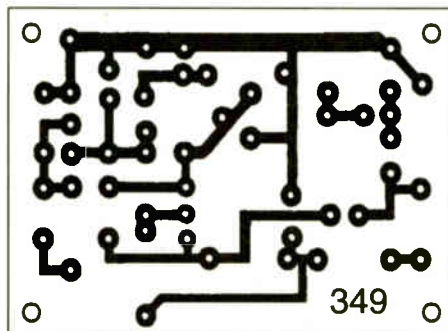

Fig.8. Printed circuit board component layout, wiring and full-size copper foil master for the F.E.T. High Input Impedance Preamplifier.

COMPONENTS

HIGH INPUT IMPEDANCE (F.E.T.)

Resistors

R1 2M2
R2 1k
R3 1k8 (see text)
R4 100Ω

See
SHOP
TALK
page

All 0.25W 5% carbon film

Capacitors

C1 100n polyester
C2 10 μ radial elect. 25V
C3 100 μ radial elect. 25V

Semiconductors

TR1 2N3819 n-channel field effect transistor (f.e.t.)

Miscellaneous

Printed circuit board available from the *EPE PCB Service*, code 349 (Single Trans); audio screened cable; multi-strand connecting wire; input and output sockets, type to choice; solder pins; solder etc.

Approx. Cost
Guidance Only

£7

higher gain, the supply line decoupling capacitor C7 has been increased in value to ensure stability.

CIRCUIT BOARD

The printed circuit board component layout, wiring details and full-size copper foil master pattern for the Low-Noise Preamplifier are shown in Fig.10. This board is available from the *EPE PCB Service*, code 350 (Dual Trans.).

See the general construction, component and interconnection guide-lines on the last page.

VARIATIONS

Some readers may wish to use this circuit with electret microphones which contain an internal line-powered f.e.t. amplifier. The load for this remote device is provided by resistor R1, and the supply voltage is reduced to around 4-5V, which is optimum for most microphones of this kind, by resistor R2. Decoupling is by means of capacitor C1.

These components (R1, R2 and C2) should only be fitted if an electret microphone is used, as the circuit maintains a

LOW-NOISE PREAMPLIFIER

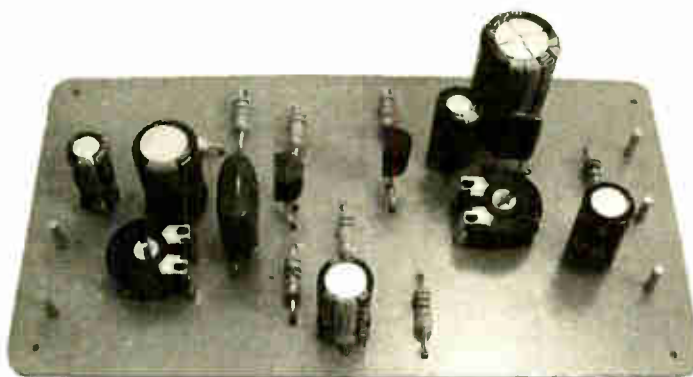

Completed p.c.b. for the Low-Noise Preamplifier.

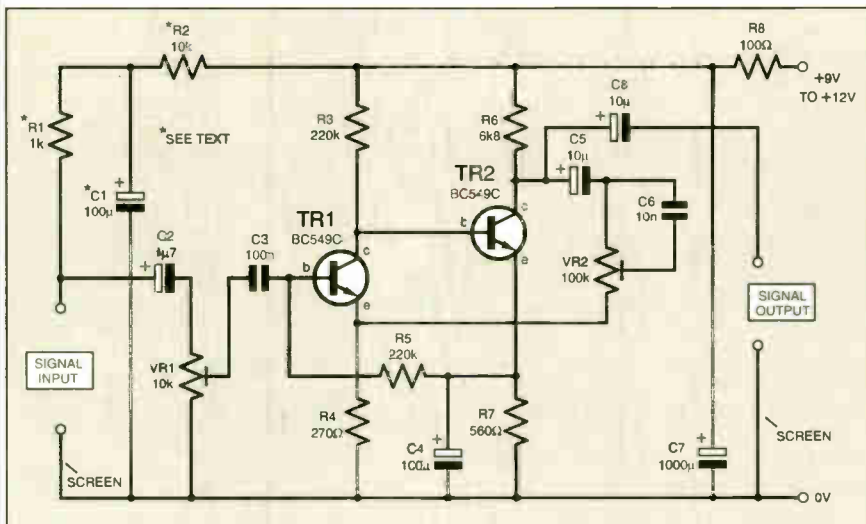

VOLTAGE GAIN 300 OVER h_{ie} SPREAD OF 450 TO 600. CURRENT DRAIN AT 9V SUPPLY: 1mA.

Fig.9. Circuit diagram for the Low-Noise Preamplifier. Components marked with an asterisk are only needed if an electret microphone is used. Increase the value of R2 to 18k with 12V supplies.

COMPONENTS

LOW NOISE PREAMPLIFIER

Resistors

R1*	1k	See SHOP TALK page
R2*	10k	
R3, R5	220k (low-noise metal film preferred) (2 off)	
R4	270Ω	
R6	6k8	
R7	560Ω	
R8	100Ω	

All 0.25W 5% carbon film, except R3 and R5.

*Only required if electret mic. used

Potentiometers

VR1	10k enclosed carbon preset
VR2	100k enclosed carbon preset

Capacitors

C1*, C4	100μ radial elect. 25V (2 off)
C2	4μ7 radial elect. 25V
C3	100n polyester
C5, C8	10μ radial elect. 25V (2 off)
C6	10n polyester
C7	1000μ radial elect. 25V

*Only required if electret mic. used

Semiconductors

TR1, TR2	BC549C npn transistor (or similar - see text) (2 off)
----------	---

Miscellaneous

Printed circuit board available from the *EPE PCB Service*, code 350 (Dual Trans.); audio screened cable; multistrand connecting wire; input and output sockets, type to choice; solder pins; solder etc.

Approx. Cost
Guidance Only

£8

excluding microphone

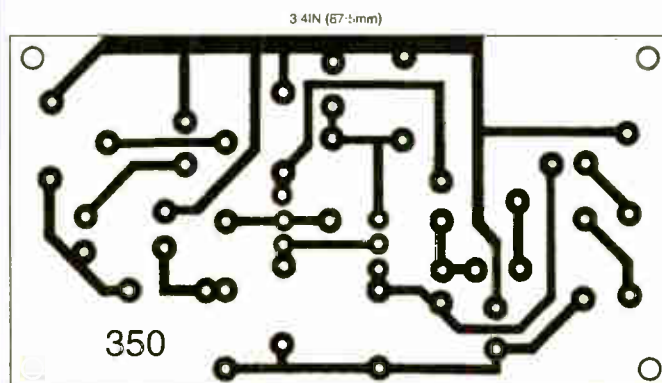
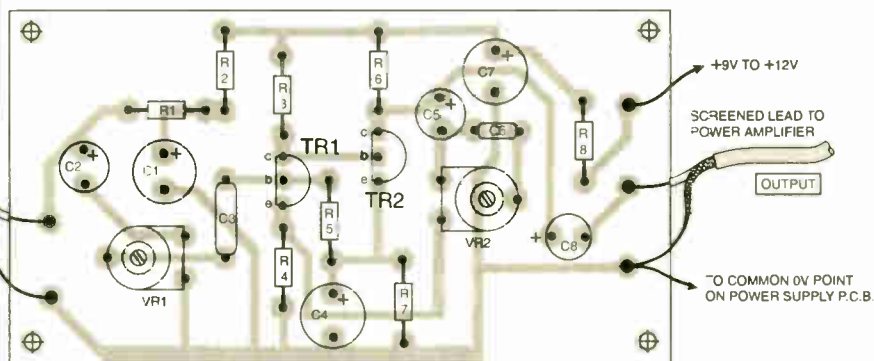

Fig.10. Printed circuit board component layout, wiring and full-size copper foil master for the Low-Noise Two-Transistor Preamplifier.

d.c. voltage on the input which could disturb the action of some signal sources.

This circuit, and variations of it, form the basis of the front-ends of most high quality preamplifiers. With the component values shown, 3-3mV r.m.s. input will produce a 1V output before the onset of clipping.

The noise introduced by the amplifier is about the same, or a little less, than that generated by the single transistor amplifier set for a gain of 150. The noise level could be further reduced by using low-noise, metal film resistors for R3 and R5.

FREQUENCY RESPONSE

Although inductors are sometimes used for "tailoring" the frequency response, the key components in networks which modify audio frequency response are normally capacitors.

The resistance presented by a capacitor to the flow of alternating current (a.c.) decreases as frequency rises. This frequency dependant resistance is known as *reactance*.

Capacitors combined with resistors form frequency dependant potential dividers which can be used to tailor the response.

These RC networks can, of course, only attenuate signals. So called "bass boost" is obtained by reducing the response of the system to the higher audio frequencies.

Table 1 lists the reactances of a range of standard capacitor values, at spot frequencies, across the audio spectrum. Referring to it, an 0.1µF (100nF) capacitor presents a resistance of 5300 ohms at a frequency of 300Hz. This rises to 32000 ohms at 50Hz and falls to 320 ohms at 5kHz.

Fitting a blocking capacitor of this value to an amplifier with an input impedance of 5000 ohms will result in signal levels at 300Hz being halved. (Capacitor and input impedance act as a potential divider). This attenuation will increase as the frequency is lowered, and reduce as frequency is raised, at a rate of 6dB per octave.

Fitting low value d.c. blocking capacitors to one or more stages will, therefore, roll-off the low frequency response. Capacitors connected from signal lines to ground; e.g. across the tracks of volume controls, will progressively attenuate high frequencies. Although simple, these measures can make a significant improvement in clarity and signal-to-noise ratio.

Refer to Table 1 when selecting a capacitor to give the desired roll-off with a particular input impedance, then refine its value by trial and error.

FEEDBACK NETWORKS

Capacitors are used to make gain-reducing negative feedback networks frequency dependant; for example, capacitor C6 in the two-transistor Low-Noise Preamplifier shown in Fig.9.

Reducing the emitter bypass capacitor C2, in the single transistor preamplifier shown in Fig.3, to 4.7µF, will progressively increase feedback, and reduce gain, as frequency lowers. This is another simple, but effective, way of securing low frequency roll-off.

TONE CONTROLS

Some means of continuously varying the frequency response is desirable when music is being reproduced, and a suitable Tone Control circuit diagram is given in

Table 1: Reactance, in Ohms, of standard value capacitors at stated audio frequencies

Cap. µF	50 Hz	100 Hz	200 Hz	300 Hz	400 Hz	500 Hz	1 kHz	2 kHz	3 kHz	4 kHz	5 kHz	10 kHz	20 kHz
1000	3Ω2	1Ω6	0Ω8	0Ω5	-	-	-	-	-	-	-	-	-
470	6Ω8	3Ω4	1Ω7	1Ω1	-	-	-	-	-	-	-	-	-
100	32	16	8	5	4	3Ω2	1Ω6	-	-	-	-	-	-
47	68	34	17	11	8Ω5	6Ω8	3Ω4	1Ω7	1Ω1	-	-	-	-
10	320	160	80	53	40	32	16	8	5Ω3	4	3Ω2	1Ω6	-
4.7	680	340	170	110	85	68	34	17	11	8Ω5	6Ω8	3Ω4	1Ω7
1	3k2	1k6	800	530	400	320	160	80	53	40	32	16	8
0.47	6k8	3k4	1k7	1k1	850	680	340	170	110	85	68	34	17
0.1	32k	16k	8k	5k3	4k	3k2	1k6	800	530	400	320	160	80
0.047	68k	34k	17k	11k	8k5	6k8	3k4	1k7	1k1	850	680	340	170
0.01	320k	160k	80k	53k	40k	32k	16k	8k	5k3	4k	3k2	1k6	800
0.0047	680k	340k	170k	110k	85k	68k	34k	17k	11k	8k5	6k8	3k4	1k7

Reactance values rounded off

Fig.11. This is the medium impedance transistor preamplifier illustrated in Fig.3 with negative feedback applied, via a frequency dependant network, from transistor TR1 collector to base. First published by P J Baxandall in 1952, the circuit has since been used, with minor variations, in most high quality preamplifiers.

Potentiometers VR1 (Bass), and VR2 (Treble), control the impact of capacitors C1, C2 and C3 on the feedback network. Resistors R2 and R3 minimise interaction between the controls, and the circuit affords 15dB of "boost" or cut at 100Hz and 10kHz.

CIRCUIT BOARD

The printed circuit board component layout, wiring details and full-size copper foil master pattern are shown in Fig.12. This board is available from the *EPE PCB Service*, code 351 (Tone).

Before undertaking any assembly work, see the general component, construction and interconnection notes at the end of the article.

IN-CIRCUIT

When circuits are cascaded, the Tone Control unit should always be the last in the chain; i.e. the one connected to the power amplifier. Most high quality preamplifiers consist of the two transistor circuit illustrated in Fig.9 followed by this Tone Control circuit.

BANDPASS FILTERS

Reducing bandwidth to around 300Hz to 3kHz greatly improves the clarity of speech signals, and the practice is adopted by tele-

phone companies around the world. Limiting the frequency response in this way significantly improves the signal-to-noise ratio. This is particularly desirable with sensitive radio equipment and surveillance systems, where the high level of amplification needed for the weakest signals brings with it a good deal of background and equipment generated noise.

For best results, roll-off beyond the pass band should be fairly steep: the 6dB per octave afforded by a single RC combination is not sufficient.

The Bandpass Filter circuit diagram shown in Fig.13 cascades three high-pass (low frequency cut) sections between transistors TR1 and TR2, and three low-pass (high frequency cut) sections between TR2 and TR3. By this means, a roll-off of 18dB per octave is achieved above and below the desired frequency range.

Filter networks of this kind need to be fed from a comparatively low impedance, and feed into a high impedance. The emitter follower stages, TR2 and TR3, are thus eminently suitable, and amplifiers of this kind have already been discussed. The input stage, transistor TR1, overcomes signal losses, or, with the slider of VR1 at TR1 emitter (e), ensures an overall circuit gain of around 25.

Emitter to base feedback around TR2 and TR3, via the RC networks, improves the action of the filters. Component values have been selected to start the roll-off just within the pass band, and the response falls steeply below 300Hz and above 3kHz.

Two capacitors have to be combined to produce a difficult-to-obtain value. To avoid confusion they are shown separately on the circuit diagram as C8 and C9.

CIRCUIT BOARD

Details of the printed circuit board component layout, wiring and copper foil master are given in Fig.14. The Bandpass Filter board is also available from the *EPE PCB Service*, code 352 (Filter).

See component, construction and interconnection notes before commencing building.

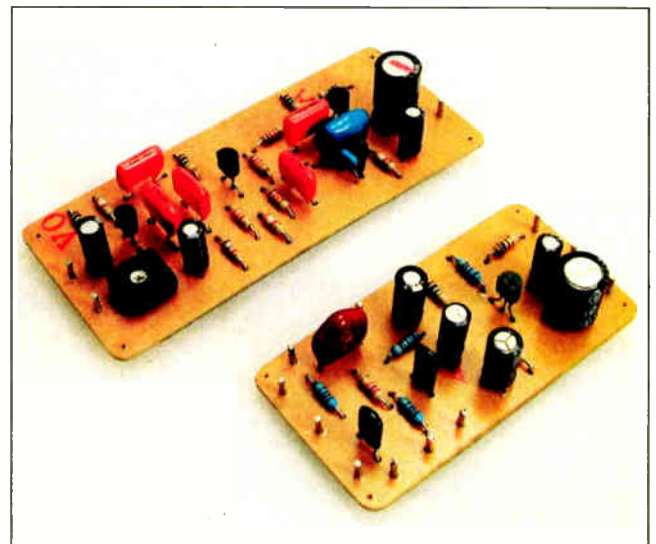

Bandpass Filter (top) and Tone Control p.c.b.s.

TONE CONTROL

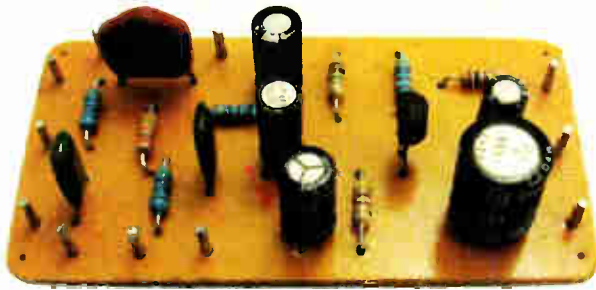

Tone Control printed circuit board.

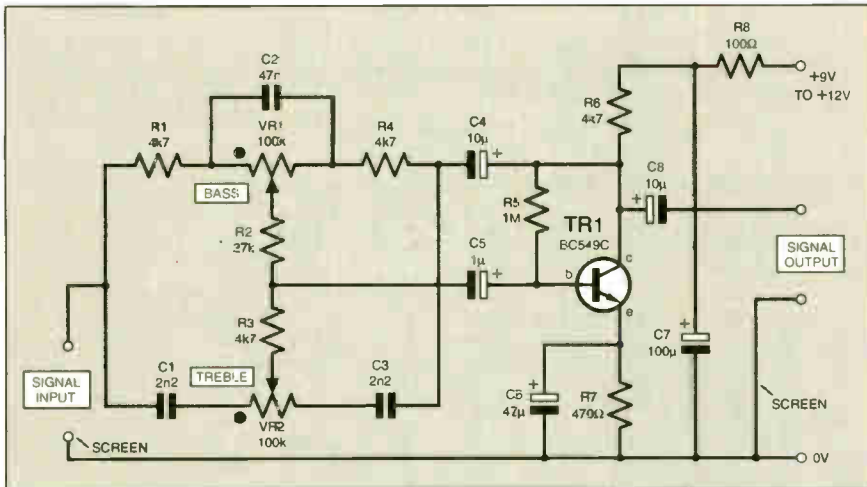

- = BOOST END OF POTENTIOMETERS (VR1, VR2) MOVING CONTACT (SLIDER). VOLTAGE GAIN UNITY WHEN VR1 AND VR2 SET AT MID TRAVEL. BOOST AND CUT $\pm 15\text{dB}$ AT 100Hz AND 10kHz. CURRENT DRAIN AT 9V SUPPLY: 1.25mA.

Fig. 11. Circuit diagram for the Tone Control (bass, treble boost and cut).

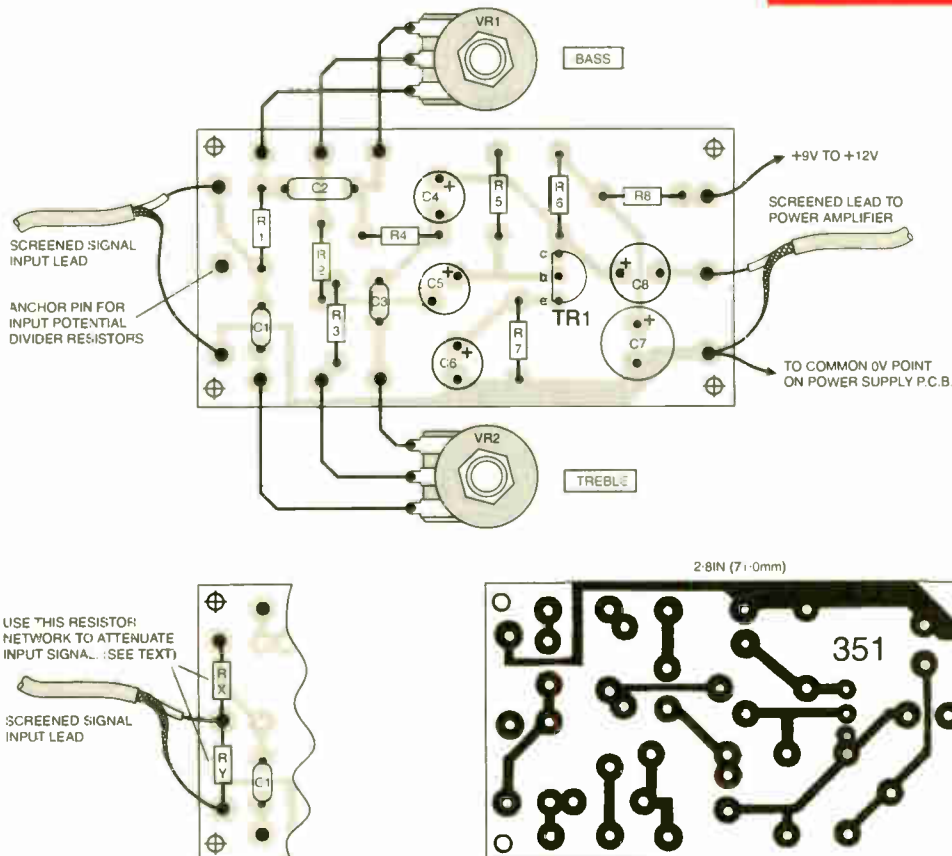

Fig. 12. Tone Control printed circuit board component layout, interwiring and full-size copper foil master. The tape and CD player signal input attenuation resistors (see text) are shown in the inset diagram (left).

COMPONENTS

TONE CONTROL

Resistors

- R1, R3, R4, R6 4k7 (4 off)
 - R2 27k
 - R5 1M
 - R7 470 Ω
 - R8 100 Ω
- All 0.25W 5% carbon film

See **SHOP**
TALK
page

Potentiometers

- VR1, VR2 100k min. rotary carbon, linear (2 off)

Capacitors

- C1, C3 2n2 polyester (2 off)
- C2 47n polyester
- C4, C8 10 μ radial elect. 25V (2 off)
- C5 1 μ radial elect. 25V
- C6 47 μ radial elect. 25V
- C7 100 μ radial elect. 25V

Semiconductors

- TR1 BC549C npn transistor (or similar – see text)

Miscellaneous

Printed circuit board available from the *EPE PCB Service*, code 351 (Tone); metal case (optional), size and type to choice – see text; audio screened cable; multistrand connecting wire; input and output sockets, type to choice; solder pins; solder etc.

Approx. Cost
Guidance Only

£9
excluding case

SPEECH FREQUENCIES (300Hz TO 3kHz) BANDPASS FILTER

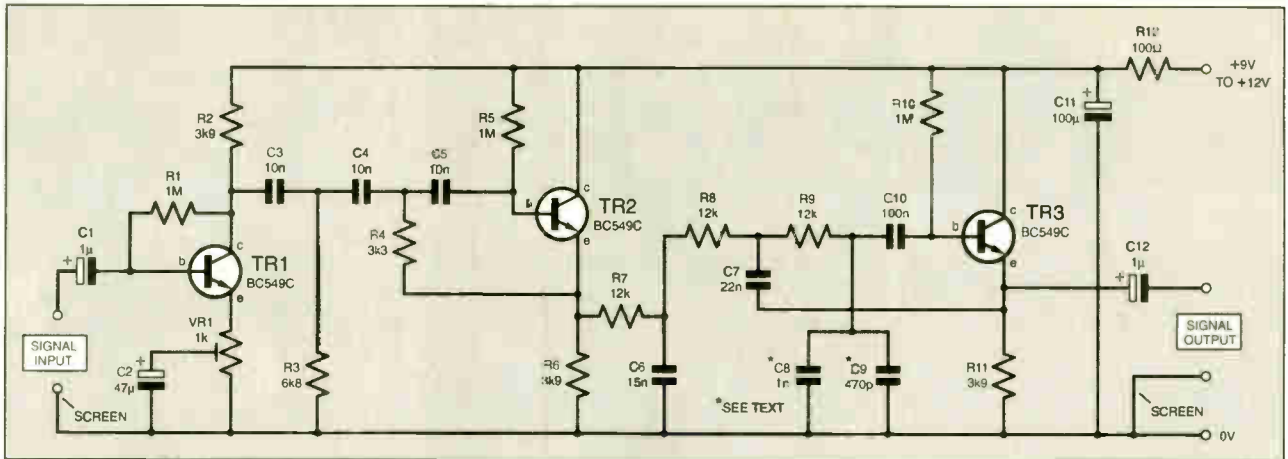

VOLTAGE GAIN WITH PASSBAND, UNITY WITH VR1 SLIDER AT 0V RAIL; 25 WITH SLIDER AT TR1 EMITTER END.
 ROLL-OFF 18dB PER OCTAVE BELOW 30Hz AND ABOVE 3kHz. CURRENT DRAIN AT 9V SUPPLY 4mA.

Fig. 13. Circuit diagram for the Bandpass Filter for speech frequencies (300Hz - 3kHz).

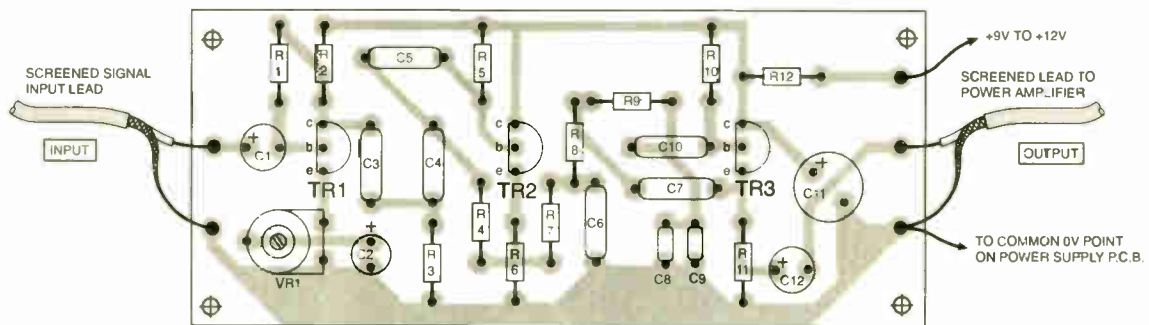

3 84IN (97.5mm)

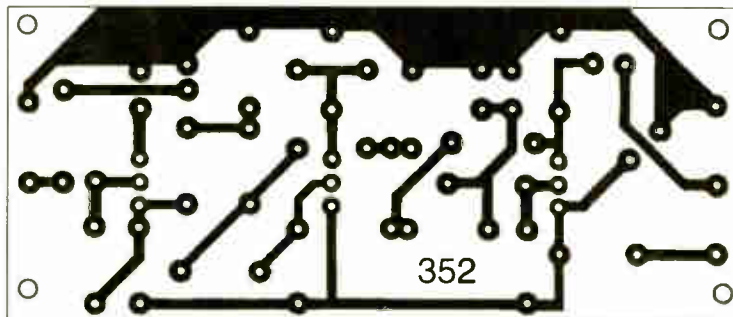

Fig. 14. Printed circuit board component layout, wiring and full-size copper foil master for the Bandpass Filter.

COMPONENTS

BANDPASS FILTER

Resistors

- R1, R5, R10 1M (3 off)
- R2, R6, R11 3k9 (3 off)
- R3 6k8
- R4 3k3
- R7 to R9 12k 1% metal film (3 off)
- R12 100Ω

All 0.25W 5% carbon film, except R7 to R9

Potentiometers

- VR1 1k carbon preset

Capacitors

- C1, C12 1µ radial elect. 25V (2 off)
- C2 47µ radial elect. 25V
- C3 to C5 10n polyester (5% or better) (3 off)

- C6 15n polyester
- C7 22n polyester
- C8* 1n polyester
- C9* 470p ceramic
- C10 100n polyester
- C11 100µ radial elect. 25V

*Combined (parallel) to give 1n5

Semiconductors

- TR1 to TR3 BC549C npn transistor (or similar - see text) (3 off)



Bandpass Filter printed circuit board.

See
SHOP
TALK
page

Miscellaneous

Printed circuit board available from the EPE PCB Service, code 352 (Filter); audio screened cable; multistrand connecting wire; input and output sockets, type to choice; solder pins; solder etc.

Approx. Cost
Guidance Only

£9

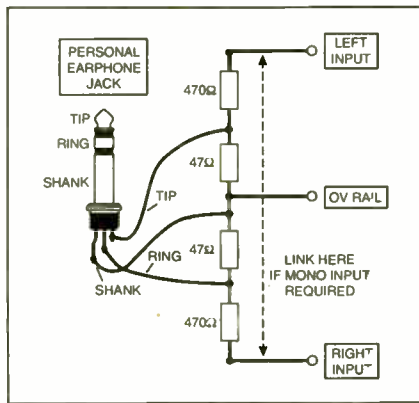

Fig. 15. Method of connecting a "Walkman" tape or CD player.

SUMMARY

Operational amplifiers (op.amps) are more commonly used in filters of this kind but, when the need is simply for a unity gain buffer with a high input and low output impedance, the ubiquitous bipolar transistor can be made to serve our purpose just as well.

SIGNAL SOURCES

Radio Receivers

The output from the detector or f.m. discriminator in a superhet radio receiver should fully load the power amplifiers described last month. After the usual filtering, the signal can be fed directly to the power amplifier, or via the Tone Control unit shown in Fig. 11 and Fig. 12.

Microphones

The single transistor preamplifiers shown in Fig. 1 to Fig. 8 will provide appropriate matching and sufficient gain for dynamic (moving coil), electret and crystal microphones when they are used for intercom purposes. (A circuit for line-powering electret microphones can be taken from Fig. 9). The common emitter circuit given in Fig. 3 should be used with moving coil units as these present an impedance of around 600 ohms.

When electret or dynamic microphones are deployed for surveillance or "sound capturing" purposes, the two transistor circuit of Fig. 9 will ensure a good degree of sensitivity. Electret microphones have an extended low frequency response. If this proves troublesome, reduce the value of the d.c. blocking capacitor C2. Try 47nF (0.047μF) as a starting point.

Gramophone Pick-ups

The low output of moving-coil pick-ups necessitates the use of the two transistor preamplifier detailed in Fig. 9. Omit preset VR1 and feed the signal to the base of transistor TR1 via capacitor C3. Low output ceramic pick-ups should be connected via a 1M (megohm) or 2M2 series resistor to preserve low frequency response.

The F.E.T. Preamplifier circuit illustrated in Fig. 7 is more suitable for high output ceramic and crystal pick-ups.

Personal Tape and CD Players

An arrangement for extracting the signal from personal cassette players and headphone radios is given in Fig. 15. The 47 ohm resistors substitute for the 32 ohm earpieces, and the 470 ohm resistors attenuate the signal.

Preamplification is not required, but readers may wish to use the Tone Control unit to process the signal. Provision is accordingly made, on the Tone Control p.c.b. illustrated in Fig. 12, for a signal attenuating network; resistors Rx and Ry.

STEREO

The chosen system must, of course, be duplicated if stereo operation is required. Tone and Volume controls are usually ganged, and an additional potentiometer is provided to balance the gain of the two channels.

With the simple circuit arrangement shown in Fig. 16, the Balance potentiometer is connected across the ganged Volume controls at the inputs to the two power amplifiers (VR1 on the power amplifier circuit diagrams).

COMPONENTS

All of the components, for this part of the series, are readily available from a variety of sources. Transistor types are not critical and almost any small-signal npn device will function in the circuits.

A low-noise, high gain transistor will, however, ensure the best performance, and the base connections for some alternative types are given in Fig. 17. With European transistors, the suffix "C" indicates the highest gain grouping.

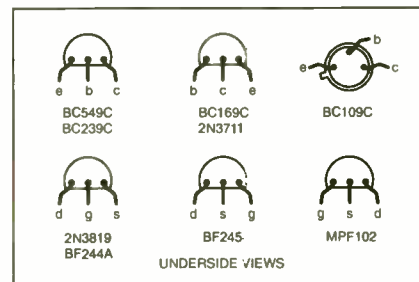

Fig. 17. Base connections for suitable transistors and f.e.t.s.

If possible, use transistors with an h_{fe} of at least 450 for the input stage of the Low-Noise Preamplifier and for the various emitter follower stages (where high input impedance depends on the use of a high gain device).

CONSTRUCTION

All the preamplifiers covered in this part are assembled on printed circuit boards and construction is reasonably straightforward. Solder pins, inserted at the lead-out points, will simplify any off-board wiring. Remember to earth the metal bodies of rotary potentiometers and to use screened audio (mic.) cable for the leads to tone and volume controls to minimise hum pick-up.

The single transistor preamplifiers all use the same p.c.b. and wire links are required. If units are cascaded, and coupling capacitors deleted, remember to install wire links to maintain the signal path.

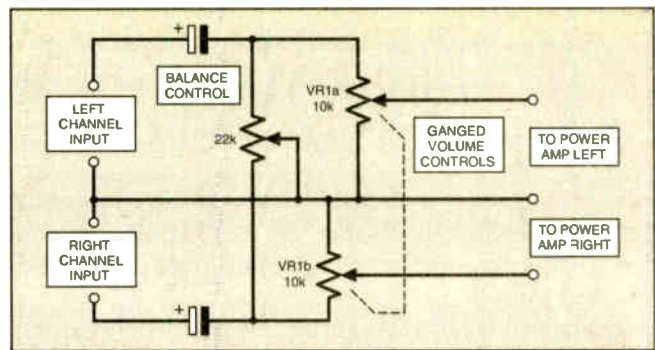

Fig. 16. Circuit arrangement for a stereo Balance control.

It may help to start construction by first placing and soldering in position the various wire links on the chosen preamplifier p.c.b. This should be followed by the lead-off solder pins, and then the smallest components (resistors) working up to the largest, electrolytic capacitors and presets. Finally, the lead-off wires (including the screened cables) should be attached to the p.c.b.

On completion, check the orientation of electrolytic capacitors and transistors, and examine the board for poor connections and bridged tracks, before connecting the power supply. The approximate current drains are included with the circuit diagrams.

INTERCONNECTIONS

Overall voltage gain can be in excess of 2000, and care must be taken to avoid hum pick-up and instability.

Hum pick-up is of two kinds, capacitive and inductive. High impedance circuits are prone to the former, and low impedance to the latter. Housing the pre- and power amplifiers in a metal case will do much to minimise these problems.

If hum increases when a finger is brought near to the preamplifier, the pick-up is capacitive. It can usually be cured by providing an earthed metal screen around the input wiring or even the entire preamplifier board.

All mains and a.c. power leads within the metal case of the unit must be tightly twisted to minimise external fields, and the mains transformer should be sited at least 150mm (6in) from the input circuitry. Tightly twist power amplifier output leads, and keep them as far away as possible from preamplifier inputs. Keep all leads as short as possible.

Run a separate negative power supply connection from each of the p.c.b.s to a common 0V point on the power supply board, or to the negative battery terminal. Do not connect one circuit board via another to supply negative, or rely upon screened cable braiding or a metal case to provide this connection. Make only one connection to any metal case, close to the negative terminal on the power supply p.c.b.

If all of the above measures have been adopted and hum problems still persist, try disconnecting, one by one, the screens of the audio cables, at one end only. Reorientating the mains transformer can also effect a cure.

Next Month: Mains power supplies, loudspeakers and signal filtering will be discussed.



A COMPLETE RANGE OF INVERTERS

150W TO 2500W - 12V & 24V

A Complete range of regulated inverters to power 220V and 240V AC equipment via a car, lorry or boat battery. Due to their high performance (>90%) the inverters generate very little heat. The high stability of the output frequency (+/-1%) makes them equally suitable to power sensitive devices.

These inverters generate a modified sine wave, which are considerably superior to the square waves which are produced by most other inverters. Due to this superior feature they are capable of powering electrical equipment such as TV,s, videos, desktop & notepad computers, microwave ovens, electrical lamps, pumps, battery chargers, etc.

Low Battery Alarm

The inverters give an audible warning signal when the battery voltage is lower than 10.5V (21V for the 24V version). The inverter automatically shuts off when the battery voltage drops below 10V (20V for the 24V version). Fuse protected input circuitry.

Order Code	Power	Voltage	Price
651.581	150W Continuous	12V	£36.39
651.578	150W Continuous	24V	£36.39
651.582	300W Continuous	12V	£50.64
651.585	300W Continuous	24V	£50.64
651.583	600W Continuous	12V	£101.59
651.593	600W Continuous	24V	£101.59
651.587	1000W Continuous	12V	£177.18
651.597	1000W Continuous	24V	£177.18
651.602	1500W Continuous	12V	£314.52
651.605	1500W Continuous	24V	£314.52
651.589	2500W Continuous	12V	£490.54
651.599	2500W Continuous	24V	£490.54



All prices are inclusive of V.A.T. Carriage £5.00 Per Order

Many uses include:- * Fetes * Fairgrounds * Airshows * Picnics * Camping * Caravans * Boats * Carnivals * Field Research and * Amateur Radio field days * Powering Desktop & Notepad Computers.

DELIVERY CHARGES ARE £6.00 PER ORDER. OFFICIAL ORDERS FROM SCHOOLS, COLLEGES, GOVT. BODIES, PLC,S ETC. PRICES ARE INCLUSIVE OF V.A.T. SALES COUNTER. VISA AND ACCESS ACCEPTED BY POST, PHONE OR FAX, OR EMAIL US AT SALES@BKELEC.COM ALTERNATIVELY SEND CHEQUE OR POSTAL ORDERS MADE PAYABLE TO BK ELECTRONICS.



B.K. ELECTRONICS



UNIT 1, COMET WAY, SOUTHEND-ON-SEA, ESSEX. SS2 6TR
TEL.: +44(0)1702-527572 FAX.: +44(0)1702-420243

For Full Specifications View our web site at:-
WWW.BKELEC.COM/INVERTERS.HTM

FRUSTRATED!

Looking for ICs TRANSISTORS?

A phone call to us could get a result. We offer an extensive range and with a world-wide database at our fingertips, we are able to source even more. We specialise in devices with the following prefix (to name but a few).



2N 2SA 2SB 2SC 2SD 2P 2SJ 2SK 3N 3SK 4N 6N 17 40 AD
ADC AN AM AY BA BC BD BDT BDV BDW BDX BF
BFR BFS BFT BFX BFY BLY BLX BS BR BRX BRY BS
BSS BSV BSW BSX BT BTA BTB BRW BU BUK BUT BUW
BUX BUY BUZ CA CD CX CXA DAC DG DM DS
DTA DTC GL GM HA HCF HD HEF ICL ICM IRF J KA
KIA L LA LB LC LD LF LM M M5M MA MAB MAX MB
MC MDAJ MJE MJF MM MN MPS MP5A MP5H MP5U
MRF NJM NE OM OP PA PAL PIC PN RC S SAA SAB
SAD SAJ SAS SDA SG SI SL SN SO STA STK STR STRD
STRM STRS SVI T TA TAA TAG TBA TC TCA TDA TDB
TEA TIC TIP TIPL TEA TL TLC TMP TMS TPU U UA
UAA UC UDN ULN UM UPA UPC UPD VN X XR Z ZN
ZTS + many others

We can also offer equivalents (at customers' risk)

We also stock a full range of other electronic components
Mail, phone, Fax Credit Card orders and callers welcome



Connect

Cricklewood Electronics Ltd

40-42 Cricklewood Broadway London NW2 3ET
Tel: 020 8452 0161 Fax: 020 8208 1441

The LabJack U12

USB Data Acquisition & Control



- ◆ 8-Analogue in, 2-out, 20 digital I/O, counter
- ◆ USB plug-and-play - no PSU needed
- ◆ FREE 'scope and logger software
- ◆ Write data to disk, a web page or email
- ◆ Temp/humidity probes, relay boards available
- ◆ Connect 80 LabJacks to one USB port

ONLY £95!

DAQLab Software

Data Acquisition, Control, HMI, analysis

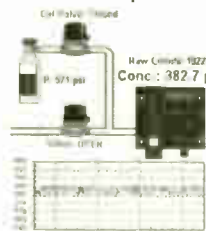

- ◆ Data acquisition and logging
- ◆ User screens with components in text form, on a graph or an animated image.
- ◆ An industrial symbol library with over 3800 images
- ◆ Data analysis features
- ◆ Sequences for automation and control

DAQLAB LITE £49! - DAQLAB FOR LABJACK £89!

All prices exclude VAT and delivery. Order on-line: major credit/debit cards accepted



AUDON Electronics

www.audon.co.uk +44 (0)115 925 8412 <- Fax (0)115 925 9757

STORE YOUR BACK ISSUES ON MINI CD-ROMS



A great way to buy *EPE* Back Issues – our mini CD-ROMs contain back issues from our *EPE Online* website plus bonus articles, all the relevant PIC software and web links. Note: no free gifts are included. All this for just £12.45 each including postage and packing.

VOL 1 CONTENTS

BACK ISSUES – November 1998 to June 1999 (all the projects, features, news, IUs etc. from all eight issues). Note: No advertisements are included. **PIC PROJECT CODES** – All the available codes for the PIC based projects published in these issues.

VOL 2 CONTENTS

BACK ISSUES – July 1999 to December 1999 (all the projects, features, news, IUs, etc. from all six issues). Note: No advertisements are included. **PIC PROJECT CODES** – All the available codes for the PIC-based projects published in these issues.

VOL 3 CONTENTS

BACK ISSUES – January 2000 to June 2000 (all the projects, features, news, IUs, etc. from all six issues). **PIC PROJECT CODES** – All the available codes for the PIC-based projects published in these issues.

VOL 4 CONTENTS

BACK ISSUES – July 2000 to Dec. 2000 (all the projects, features, news, IUs etc. from all six issues). **PROJECT CODES** – All the available codes for the programmable projects in these issues.

VOL 5 CONTENTS

BACK ISSUES – January 2001 to June 2001 (all the projects, features, news, IUs etc. from all six issues) **PROJECT CODES** – All the available codes for the programmable projects in these issues, including those for *Interface*.

EXTRA ARTICLES – ON ALL VOLUMES

BASIC SOLDERING GUIDE – Alan Winstanley's internationally acclaimed fully illustrated guide.

UNDERSTANDING PASSIVE COMPONENTS – Introduction to the basic principles of passive components.

HOW TO USE INTELLIGENT L.C.D.s, By Julyan Ilett – An utterly practical guide to interfacing and programming intelligent liquid crystal display modules.

PhyzyB COMPUTERS BONUS ARTICLE 1 – Signed and Unsigned Binary Numbers. By Clive "Max" Maxfield and Alvin Brown.

PhyzyB COMPUTERS BONUS ARTICLE 2 – Creating an Event Counter. By Clive "Max" Maxfield and Alvin Brown.

INTERGRAPH COMPUTER SYSTEMS 3D GRAPHICS – A chapter from Intergraph's book that explains computer graphics technology in an interesting and understandable way with full colour graphics.

EXTRA ARTICLE ON VOL 1 & 2

THE LIFE & WORKS OF KONRAD ZUSE – a brilliant pioneer in the evolution of computers. A bonus article on his life and work written by his eldest son, including many previously unpublished photographs.

NOTE: These mini CD-ROMs are suitable for use on any PC with a CD-ROM drive. They require Adobe Acrobat Reader (available free from the Internet – www.adobe.com/acrobat)



ONLY
£12.45 each
including VAT
and p&p



Order on-line from

www.epemag.wimborne.co.uk/shopdoor.htm
or www.epemag.com (USA \$ prices)
or by phone, Fax, E-mail or Post

BACK ISSUES MINI CD-ROM ORDER FORM

Please send me (quantity) BACK ISSUES CD-ROM VOL 1

Please send me (quantity) BACK ISSUES CD-ROM VOL 2

Please send me (quantity) BACK ISSUES CD-ROM VOL 3

Please send me (quantity) BACK ISSUES CD-ROM VOL 3

Please send me (quantity) BACK ISSUES CD-ROM VOL 5

Price £12.45 each – includes postage to anywhere in the world.

Name

Address

..... Post Code

I enclose cheque/P.O./bank draft to the value of £

Please charge my Visa/Mastercard/Amex/

Diners Club/Switch

£

Card No.

Expiry Date Switch Issue No.

SEND TO: **Everyday Practical Electronics,**
Wimborne Publishing Ltd.,

408 Wimborne Road East, Ferndown, Dorset BH22 9ND.

Tel: 01202 873872. Fax: 01202 874562.

E-mail: orders@epemag.wimborne.co.uk

Payments must be by card or in £ Sterling – cheque or bank draft drawn on a UK bank.

Normally supplied within seven days of receipt of order.
Send a copy of this form, or order by letter if you do not wish to cut your issue.

We can supply back issues of *EPE* by post, most issues from the past three years are available. An *EPE* index for the last five years is also available – see order form. Alternatively, indexes are published in the December issue for that year. Where we are unable to provide a back issue a photostat of any one article (or one part of a series) can be purchased for the same price. Issues from Jan. 2001 onwards are also available to download from www.epemag.com.

DID YOU MISS THESE?

FEB '01

PROJECTS • Ice Alert • Using LM3914-6 Bargraph Drivers • Simple Metronome • PC Audio Power Meter.
FEATURES • The Schmitt Trigger-Part 4 • Ingenuity Unlimited • Circuit Surgery • New Technology Update • Net Work – The Internet • Free 16-page supplement – How To Use Graphics L.C.D.s With PICs.

MAR '01

PROJECTS • Doorbell Extender • Body Detector • DIY Tesla Lightning • Circuit Tester
FEATURES • Understanding Inductors • The Schmitt Trigger-Part 5 • Circuit Surgery • Interface • New Technology Update • Net Work – The Internet Page.

APRIL '01

PROJECTS • Wave Sound Effect • Intruder Alarm Control Panel-Part 1 • Sound Trigger • EPE Snug-Bug Pet Heating Control Centre.
FEATURES • The Schmitt Trigger-Part 6 • Practically Speaking • Ingenuity Unlimited • Circuit Surgery • Net Work – The Internet Page • FREE supplement – An End To All Disease.



MAY '01

Photostats only

PROJECTS • Camcorder Mixer • PIC Graphics L.C.D. Scope • D.C. Motor Controller • Intruder Alarm Control Panel-Part 2.
FEATURES • The Schmitt Trigger-Part 7 • Interface • Circuit Surgery • Ingenuity Unlimited • New Technology Update • Net Work – The Internet Page.

JUNE '01

PROJECTS • Hosepipe Controller • In-Circuit Ohmmeter • Dummy PIR Detector • Magfield Monitor.
FEATURES • Controlling Jodrell Bank • PIC1687x Extended Memory Use • Practically Speaking • Ingenuity Unlimited • New Technology Update • Circuit Surgery • Net Work – The Internet Page.

JULY '01

PROJECTS • Stereo/Surround Sound Amplifier • PIC to Printer Interface • Perpetual Projects 1 – Solar-Powered Power Supply and Voltage Regulator • MSF Signal Repeater and Indicator.
FEATURES • The World of PLCs • Ingenuity Unlimited • Circuit Surgery • New Technology Update • Net Work – The Internet Page.

AUG '01

PROJECTS • Digitimer • Lead-Acid Battery Charger • Compact Shortwave Loop Aerial • Perpetual Projects 2 – L.E.D. Flasher – Double Door-Buzzer.
FEATURES • Controlling Power Generation • Ingenuity Unlimited • Interface • Circuit Surgery • New Technology Update • Net Work – The Internet Page.

SEPT '01

PROJECTS • Water Monitor • L.E.D. Super Torches • Synchronous Clock Driver • Perpetual Projects 3 – Loop Burglar Alarm – Touch-Switch Door-Light – Solar-Powered Rain Alarm.
FEATURES • Controlling Flight • Ingenuity Unlimited • Practically Speaking • Circuit Surgery • New Technology Update • Net Work – The Internet Page.



OCT '01

Photostats only

PROJECTS • PIC Toolkit Mk3 • Camcorder Power Supply • 2-Valve SW Receiver • Perpetual Projects 4 – Gate Sentinel – Bird Scarer – In-Out Register.
FEATURES • Traffic Control • Ingenuity Unlimited • New Technology Update • Circuit Surgery • Interface • Net Work – The Internet Page • Free 2 CD-ROMs – Microchip 2001 Tech Library.

NOV '01

PROJECTS • Capacitance Meter • Pitch Switch • Lights Needed Alert • Teach-In 2002 Power Supply.
FEATURES • Teach-In 2002 – Part 1 • Practically Speaking • Circuit Surgery • New Technology Update • Ingenuity Unlimited • Net Work – The Internet Page • Free 16-page Supplement – PIC Toolkit TK3 For Windows

DEC '01

PROJECTS • Ghost Buster • PIC Polywhatsit • Twinkling Lights • Mains Failure Alarm.
FEATURES • Teach-In 2002 – Part 2 • Marconi – The Father of Radio • Interface • Ingenuity Unlimited • Circuit Surgery • New Technology Update • Net Work – The Internet Page • 2001 Annual Index.

JAN '02

PROJECTS • PIC Magick Musick • Time Delay Touch Switch • Versatile Bench Power Supply • Forever Flasher.
FEATURES • Teach-In 2002 – Part 3 • Practically Speaking • Ingenuity Unlimited • New Technology Update • Circuit Surgery • Net Work – The Internet Page.

FEB '02

PROJECTS • PIC Spectrum Analyser • Guitar Practice Amp • HT Power Supply • Versatile Current Monitor.
FEATURES • Teach-In 2002 – Part 4 • Ingenuity Unlimited • Russian Space Shuttle Revisited • Circuit Surgery • Interface • New Technology Update • Net Work – The Internet Page.

MAR '02

PROJECTS • MK484 Shortwave Radio • PIC Virus Zapper • RH Meter • PIC Mini-Enigma.
FEATURES • Teach-In 2002 – Part 5 • Ingenuity Unlimited • Programming PIC Interrupts-1 • Circuit Surgery • Practically Speaking • New Technology Update • Net Work – The Internet Page.



APR '02

PROJECTS • Electric Guitar Tuner • PIC Controlled Intruder Alarm • Solar Charge and Go • Manual Stepper Motor Controller.
FEATURES • Teach-In 2002 – Part 6 • Interface • Programming PIC Interrupts-2 • Circuit Surgery • Ingenuity Unlimited • New Technology Update • Net Work – The Internet Page • FREE Giant Op.Amp Data Chart.

MAY '02

PROJECTS • PIC Big-Digit Display • Simple Audio Circuits – 1 • Freezer Alarm • Washing Ready Indicator.
FEATURES • Teach-In 2002 – Part 7 • Ingenuity Unlimited • Practically Speaking • New Technology Update • Circuit Surgery • Net Work – The Internet Page.

BACK ISSUES ONLY £3.30 each inc. UK p&p.

Overseas prices £3.80 each surface mail, £5.25 each airmail.

We can also supply issues from earlier years: 1998 (except Jan. to May, July, Nov., Dec.), 1999, 2000 (except Feb., July), 2001 (except May/Oct). Where we do not have an issue a photostat of any one article or one part of a series can be provided at the same price.

ORDER FORM – BACK ISSUES – PHOTOSTATS – INDEXES

- Send back issues dates
 Send photostats of (article title and issues date)
 Send copies of last five years indexes (£3.30 for five inc. p&p – Overseas £3.80 surface, £5.25 airmail)

Name

Address

Tel:

I enclose cheque/P.O./bank draft to the value of £

Please charge my Visa/Mastercard/Amex/Diners Club/Switch £ Switch Issue No.

Card No. Card Expiry Date

SEND TO: Everyday Practical Electronics, Wimborne Publishing Ltd., 408 Wimborne Road East, Ferndown, Dorset BH22 9ND.

Tel: 01202 873872. Fax: 01202 874562.

E-mail: orders@epemag.wimborne.co.uk On-line Shop: www.epemag.wimborne.co.uk/shopdoor.htm

Payments must be in £ sterling – cheque or bank draft drawn on a UK bank. Normally supplied within seven days of receipt of order.

Send a copy of this form, or order by letter if you do not wish to cut your issue.

M06/02

SHOP TALK

with David Barrington

Biopic Heartbeat Monitor

The 740L6000 logic-to-logic opto-isolator used in the *Biopic Heartbeat Monitor* came from RS and can be ordered from any bona-fide stockists, including some of our advertisers, code 650-829. You can order direct (credit card only) from RS on 01536 444079 or on the web at rswww.com. A post and handling charge will be made. The original prototype used a TLP215 opto-isolator, which has now become obsolete, but if you already have this device you can use it in this circuit.

For those readers unable to program their own PICs, a ready-programmed PIC16F876-4P microcontroller can be purchased from Magenta Electronics (☎ 01283 565435 or www.magenta2000.co.uk) for the inclusive price of £10 each (overseas add £1 p&p). They are also able to supply a suitable 2 line x 16 characters per line alphanumeric display module and a set of four TENS electrodes at a very reasonable price. The T.E.N.S. Replacement Electrode Pads used in the author's model were purchased from Boots together with a separate lead pack.

The software is available on a 3.5in. PC-compatible disk (EPE Disk 5) from the EPE Editorial Office for the sum of £3 each (UK), to cover admin costs (for overseas charges see page 461). It is also available *Free* from the EPE web site: [ftp://ftp.epemag.wimborne.co.uk/pub/PICS/Biopic](http://ftp.epemag.wimborne.co.uk/pub/PICS/Biopic).

The printed circuit board is available from the EPE PCB Service, code 355 (see page 461). Finally, you *MUST* take heed of the safety notes under the cross-head "Opto-Isolation".

World Lamp

Most parts needed to construct the *World Lamp* project should, it is claimed, be very easy to acquire as they are standard "off-the-shelf" stock items. Also, most of our components advertisers should be able to suggest suitable substitutes, including rough equivalents to those specified in the circuit.

The n-channel power MOSFET type HUF75329P3 appears to be only listed by RS (☎ 01536 444079 or rswww.com – see earlier notes above regarding ordering), code 294-9648. Suggested alternatives include: IRFZ44N; IRFU3303; BUZ22 (likely to run hot). The Motorola version (MC14093BCP – RS code 640-765) of the quad Schmitt trigger NAND gate is recommended, but any 4093 device should work here.

If you do not want to use a finned heatsink for the MOSFETs TR1 and TR2 then any 0.5mm or greater thickness piece of metal may be cut and drilled. Take great care to ensure that the two heatsinks are never allowed to touch each other.

Note that capacitor C8 *MUST* be rated at a minimum of 600V a.c. This will probably mean that you have to select a suppression type (Class X2) rated at 275V a.c. (See also this month's *Circuit Surgery* page 439.) The VA rating of the mains transformer should be at least double the fluorescent lamp wattage to prevent overheating.

The printed circuit board is available from the EPE PCB Service, code 340 (see page 461).

Frequency Standard Generator

All the semiconductor devices called up for the Receiver and Digital circuits that drive the *Frequency Standard Generator* project are standard devices and should be stocked by most of our components advertisers, such as ESR, Bardwell, Bowood, Cricklewood and Sherwood Electronics.

The ferrite rod for the homemade "aerial" coil used in the Receiver came from Rapid Electronics (☎ 01206 751166 or www.rapidelectronics.co.uk), code 88-3098. The mains transformer was purchased from Maplin (☎ 0870 264 6000 or www.maplin.co.uk), code YN17T. Almost any small 250mA output mains transformer with 15V-0V-15V, centre tapped secondaries should be suitable for this circuit.

The low-current 10mH choke used in the model is an RS device and was ordered from RS (credit card only) on 01536 444079 or rswww.com, code 228-343. A p&p charge will be incurred.

The printed circuit boards are available from the EPE PCB Service, codes 354 (Rec.) and 355 (Digital), see page 461.

Simple Audio Circuits – 2

We do not expect any buying problems when shopping for parts for this month's instalment of the *Simple Audio Circuits*.

Transistor types are not critical and almost any small-signal *npn* will function in the various circuits. However, a low-noise high gain transistor will ensure the best performance and some alternative types to those shown in the circuits would be: BC109C; BC239C; BC169C and 2N3711. For f.e.t.s you could use: BF244A; BF245 and MPF102. With European transistors the suffix C indicates the highest gain grouping.

All the printed circuit boards for this month's modules are available from the EPE PCB Service, see page 461. The single-transistor Low, Med, High Impedance and F.E.T. Preamplifiers are covered by p.c.b. code 349.

Teach-In 2002 – Lab 8

Just some of the semiconductor and sensor devices could give sourcing problems in this month's *Teach-In 2002 Lab Works*. The Intersil ICL8038CC waveform generator i.c. was purchased from RS (☎ 01536 444079 or rswww.com), order code 305-844. You could also use the Maxim MAX8038. The same above company also supplied the Linear Technology LTC1062CN8 5th order switched capacitor low-pass filter chip, code 633-880.

The QPE1113 matched pair of infra-red emitter and phototransistor detector came from Farnell (☎ 0113 263 6311 or www.farnell.com), code 280-367. The emitter is the opaque yellow device.

PLEASE TAKE NOTE

Washing Ready Indicator

It has been found that the ICL7642 quad op.amp is now discontinued. It is suggested that the LMC6044IN is a pin-for-pin alternative. It is listed by Farnell (code 954-767) and RS (code 853-472). See above for ordering details.

May '02

SQUIRES

MODEL & CRAFT TOOLS

A COMPREHENSIVE RANGE OF MINIATURE HAND AND POWER TOOLS AND AN EXTENSIVE RANGE OF ELECTRONIC COMPONENTS

FEATURED IN A FULLY ILLUSTRATED

528 PAGE MAIL ORDER CATALOGUE

2002 ISSUE

SAME DAY DESPATCH

FREE POST AND PACKAGING

Catalogues: FREE OF CHARGE to addresses in the UK.
Overseas: CATALOGUE FREE, postage at cost charged to credit card

SHOP EXTENSION NOW OPEN

Squires, 100 London Road,
Bognor Regis, West Sussex, PO21 1DD

TEL: 01243 842424

FAX: 01243 842525



DISTANCE LEARNING SHORT COURSES with BTEC CERTIFICATION

Analogue and Digital Electronics, Fibre Optics, Fault Diagnosis, Mechanics, Mathematics and Programmable Logic Controllers

- Suitable for beginners and those wishing to update their knowledge and practical skills
- Courses are very practical and delivered as self contained kits
- No travelling or college attendance
- Learning is at your own pace
- Each course can stand alone or be part of a modular study programme
- Tutor supported and BTEC certified

For information contact:

NCT Ltd., P.O. Box 11
Wendover, Bucks HP22 6XA
Telephone 01296 624270; Fax 01296 625299
Web: <http://www.nct.ltd.uk>

FREQUENCY STANDARD GENERATOR

ANDY FLIND

A high-precision selectable 1Hz to 100kHz frequency source derived from BBC Radio Four's transmission signal.



DURING the design stage of the *Synchronous Clock Driver*, featured in *EPE* Sept '01, doubts arose as to the accuracy of the frequency meter being used to check and adjust the output frequency of the project. Since this instrument was the author's primary means of measuring frequency, the difficulty arose as to how it could itself be checked and, if necessary, adjusted.

TRANSMISSION FREQUENCIES

One of the broadcast radio carrier signals appeared to be the best way of obtaining a suitable reference. Most British readers will know of the time signal transmitted at 60kHz from Rugby, but this isn't really suitable for frequency testing since it is pulsed on and off by the data signals it carries.

Another source which seemed better suited for the purpose was the 198kHz "longwave" carrier for *Radio 4*. Originally this was intended for use as a national frequency standard and its accuracy is still maintained to an incredible level, having a Rubidium frequency source as its reference with constant monitoring by the National Physical Laboratory.

In fact, the accuracy is claimed to be one part in 10^{11} , which translates to about a third of a millisecond per year of error. This should be more than adequate as a standard for most home workshops!

HOME SERVICE DESIGNING

Various circuits are available for receiving and using this signal "off air", so one was soon obtained through the good offices of one of our better radio magazines and hastily constructed. In fact, the "error" of the author's meter turned out to be of insignificant proportions, but by then the "design bug" had bitten.

Electronic "old-timers" sometimes fondly recall the days when Radio 4 (the Home Service for really old-timers!) was broadcast on the longwave frequency of 200kHz. Division by two gave a perfect 100kHz squarewave and subsequent decade dividers could reduce this to any required value.

FREQUENCY CHANGING

Nowadays, getting to 100kHz from 198kHz presents slightly more difficulty. It turns out that the largest factor common to both frequencies is just 2, so to obtain 100kHz one must divide by 99 and then multiply by 50, but not necessarily in that order. Division is easy enough using modern logic, even with an odd number like 99.

Multiplication requires a phase-locked loop (PLL), however, with a divider in the feedback circuit. How this method was used to obtain 100kHz from a 2kHz input is shown in Fig.1. The most important components of the phase-locked loop, a phase comparator and a voltage-controlled oscillator (VCO), are shown here.

In essence, the input is compared with a feedback signal from the voltage-controlled oscillator and if the two are not in phase the phase comparator adjusts a control voltage to bring the oscillator into line with the input. A couple of external components filter the control voltage to ensure stability.

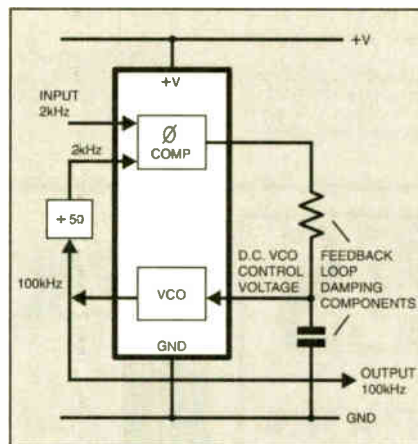
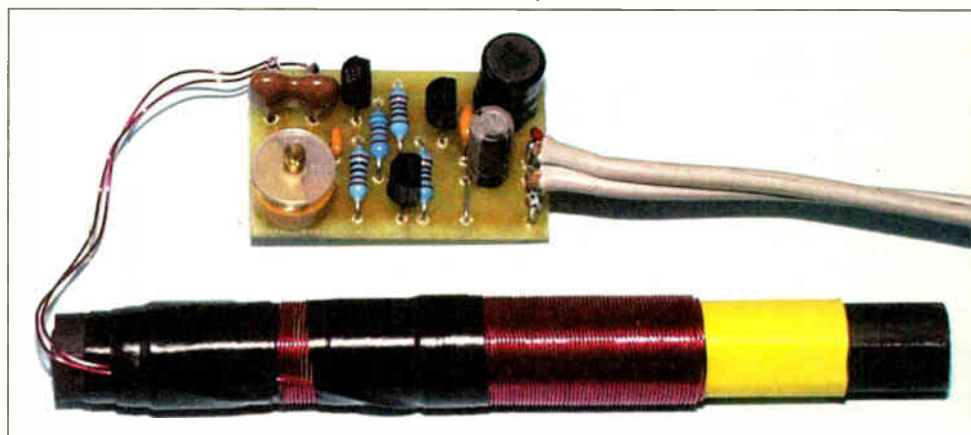

Fig.1. Phase-locked loop principle.

Could a better version be built offering more useful output frequencies such as 100kHz and the decades beneath it, 10kHz, 1kHz and so forth? Such a source would be very useful for calibrating all sorts of equipment, including oscilloscopes and frequency meters, and perhaps also in the testing and adjustment of clocks.



If the output is divided by a discrete factor n before going to the comparator the oscillator will automatically run at n times the input frequency, so frequency multiplication is achieved. Integrated phase-locked loop devices are available with most of the necessary building blocks contained internally.

PHASE-LOCKED LOOP

The CMOS 4046 phase-locked loop device has been around for some years and has many useful features, including a phase comparator that can operate happily with signals which do not have equal mark-space ratios, and a high impedance input for the VCO control voltage to simplify the loop filter design.

In the author's first attempt at this design, the 198kHz signal was divided by 99 to obtain 2kHz and then multiplied by 50 using a phase-locked loop. However, unlike dividing circuits these loops are inherently slightly unstable since the output frequency is controlled by a series of minute adjustments of the oscillator control voltage, made each time a phase comparison takes place.

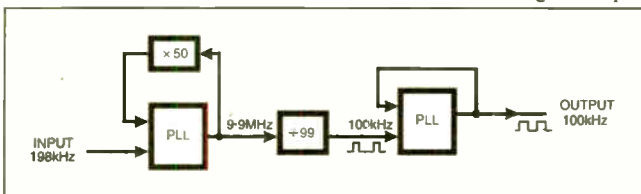

Fig.2. Block diagram showing conversion from 198kHz to 100kHz.

It follows that with an input of only 2kHz and an output of 100kHz the output frequency is only adjusted every 500 μ s, or fifty output cycles, allowing plenty of scope for output phase jitter and perhaps short-term frequency errors. It was decided therefore to try operating the circuit the other way round, with multiplication before division, as this would result in the adjustments taking place very nearly twice per cycle of output frequency.

The block diagram of this is shown in Fig.2, where the first PLL multiplies the 198kHz input to 9.9MHz, which is then divided by 99 to reach 100kHz. The divider circuit output has an uneven mark-space ratio so it is passed through a further PLL, this time without a divider, to produce the same frequency but as a perfect squarewave.

Whilst the intermediate frequency of 9.9MHz is well above the capability of ordinary CMOS, it is well within the range of high-speed CMOS devices (74HC series).

RECEIVER CIRCUIT

Moving on to the circuit shown in Fig.3, this is the Receiver used to obtain the signal "off-air". A lot of difficulty was initially encountered due to feedback from later parts of the circuit, but as soon as the receiver circuit was positioned a metre or so away from the rest of the unit on screened leads these problems vanished.

The Receiver was therefore designed as a separate unit with its own small printed circuit board (p.c.b.). Coil L1 is wound on a short ferrite rod and uses fixed capacitor C1 with variable capacitor VC1 to tune it to

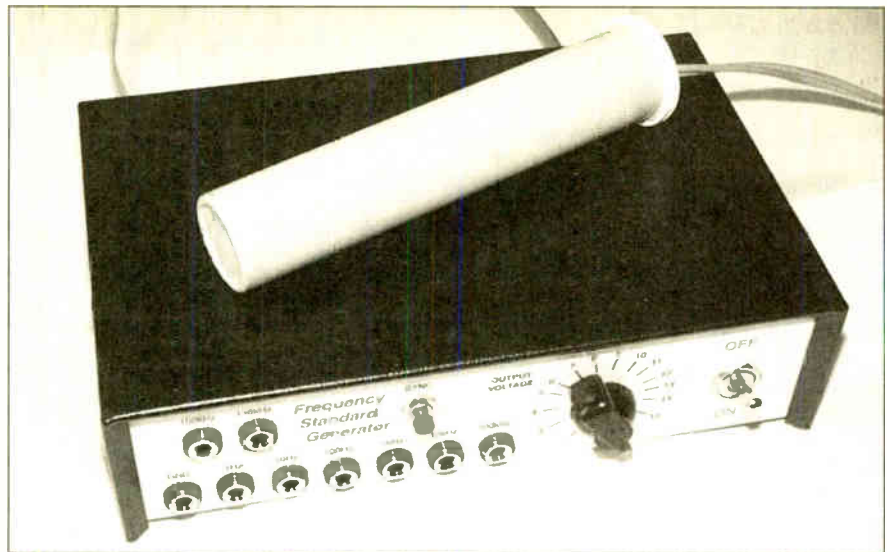

resonance at 198kHz. Field effect transistor (f.e.t.) TR1 buffers this resonant circuit to minimize loading whilst transistors TR2 and TR3 provide voltage gain and buffering of the output before the main circuit.

A regulated power supply of 5V is used as this can be taken from the supply for the following high-speed CMOS circuit. Connections are made with screened twin "figure-of-eight" audio lead, with the power arriving through one core, the output

signal leaving through the other and the two screens acting as ground or 0V.

Local supply decoupling is provided by capacitors C3 and C4 with choke L2 in place of the usual resistor, since with a supply of only 5V the voltage drop across a resistor would be unacceptable. The output from this circuit obviously depends on the signal available, but at the author's location, some 100 miles from the Droitwich transmitter, it is about 400mV peak-to-peak.

The circuit also continued to operate well during a period of drastically reduced transmitter power over a maintenance period, suggesting that a much greater operating range is achievable.

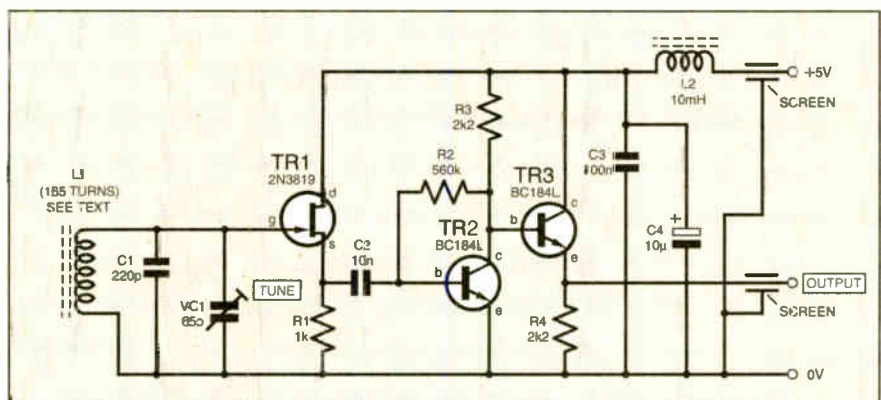

Fig.3. Full circuit diagram for the Receiver section of the Frequency Standard Generator.

COMPONENTS		Approx. Cost Guidance Only	£6
Receiver			
Resistors			
R1	1k		
R2	560k		
R3, R4	2k2 (2 off)		
All 0.6W 1% metal film			
Capacitors			
C1	220p silvered mica		
C2	10n resin-dipped ceramic		
C3	100n resin-dipped ceramic		
C4	10 μ radial elect. 50V		
VC1	5.5p to 65p trimmer		
Semiconductors			
TR1	2N3819 <i>n</i> -channel field effect transistor		
TR2, TR3	BC184L <i>npn</i> transistor (2 off)		
Miscellaneous			
L1	ferrite rod, 10mm dia x 100mm length (see text), 165 turns 0.4mm enamelled copper wire		
L2	10mH choke		
Printed circuit board (Receiver), available from the EPE PCB Service, code 353; plastic container, see text.			

MAIN CIRCUIT

In the main circuit of Fig.4 the signal is first amplified to logic levels. This amplifier was the main cause of feedback problems when the receiver was close to it, since it inevitably re-radiates a little of the amplified signal. After much trial and error, the simple amplifier based on IC1, a CMOS 4007 transistor pair plus inverter i.c., is used as a three-stage amplifier, was found to be by far the most effective.

Each of the first two stages has an a.c. input coupling capacitor (C1 and C2) and a resistor (R1 and R2) to bias it into analogue operation, whilst the third stage buffers the output.

Next IC2, a 74HCT7046 which is a high-speed version of the 4046 PLL, raises the frequency to 9.9MHz. To do this it has a divide-by-50 circuit in its logic feedback, provided by binary divider IC3 and one half of the dual quad-input AND gate IC4a, again high-speed types. The gate decodes three outputs from IC3 and when these reach the binary equivalent of 50 it pulses IC3's Reset pin.

Preset VR1 is used to set the VCO to the centre of its control voltage range at the normal operating frequency. The 9.9MHz output from IC2 pin 4 is divided by another high-speed binary divider IC5, used with IC4b to divide this time by 99, again by decoding the divider outputs and pulsing the Reset pin (2) of IC5.

Two outputs are available from this part of the circuit. The first is raw 198kHz from IC1, at socket SK1. The second is the 100kHz from IC5 at SK2, which may be useful for checking frequency counters although it does not have an even mark-space ratio. Both of these are 0V to 5V logic-level outputs.

LOGIC LEVEL SHIFTING

The high-speed versions of CMOS *must* have a supply of 5V so this is supplied by the 5V positive 100mA regulator IC6, which also supplies the receiver.

For reasons which will be explained, most of the rest of the circuit (IC8 and beyond) operates from a 12V supply. Consequently, IC8 acts as a comparator to convert the 5V logic output of IC5 into a 12V logic output. IC8 is a CA3130 CMOS op.amp, which is fairly fast and has a rail-to-rail output.

The signal from this drives IC9, this time a standard 4046 CMOS PLL. The purpose is to convert the input to a perfect 50:50 squarewave output. Preset VR2 is used to set the optimum operating point for the VCO, and the output is taken to the first of six output buffers provided by IC15.

The signal from IC8 also goes to the first of the string of five decade dividers IC10 to IC14, giving a series of frequencies down to 1Hz. It doesn't matter that the input to IC10 is not a squarewave since the output will be anyway. All the outputs are buffered by the remaining five buffers of IC15.

The reason for the 12V supply can now be explained. IC15 does more than simply buffer the outputs, it is also capable of "voltage translation", meaning that its output signal "high" or positive level is determined by its supply voltage. If a suitable variable supply is provided for this i.c. its output can be adjusted from about 3V to 15V.

However, for this to work the input signal "high" voltage must be greater than half the maximum supply voltage, so it is necessary to raise the supply voltage from 5V used by the first part of the circuit to the 12V used by the rest. The 12V supply is provided by regulator IC7 and the variable supply is generated by IC16, an LM317 adjustable positive regulator controlled by panel-mounted potentiometer VR3 used as a variable resistor.

Pushbutton switch S2 is fitted for resetting all the counters simultaneously so that they can be synchronized to an external event if necessary. As a manual switch this is really only useful for synchronizing the final output which counts seconds, but some form of electronic switching could be added here if this feature is required for a particular application.

It works by pulling all the reset inputs high very briefly at the instant the line from S2 goes positive. Resistor R11 and capacitor C20 ensure that only one reset pulse takes place for each operation of S2, eliminating the effects of switch bounce.

Power for all three regulators comes from the centre-tapped transformer T1 and rectifier diodes D1 and D2, together with main supply decoupling capacitor C14. T1 is a 15V-0V-15V type which produces about 20V of unregulated output in this circuit.

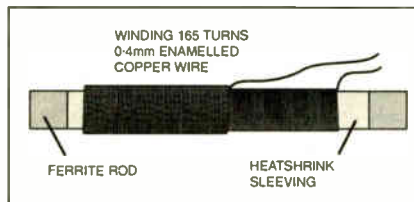

Fig.5. Ferrite rod aerial winding details. Using 0.4mm enamelled copper wire and starting from one end, 100 turns are close-wound on the "sleeving" and then a further 65 turns are wound over this, working back towards the start, to give a total of 165 turns.

ANTENNA WINDING

Despite the apparent complexity of the circuit diagram, this is a relatively simple circuit to construct and test. It is suggested that the Receiver should be built and tested first as this is required for testing the remainder of the project.

The antenna is wound as shown in Fig.5 on a 10cm x 10mm diameter ferrite rod. The one obtained for the prototype had rather sharp lengthwise moulding edges so these were smoothed off with a file and a length of heat-shrink sleeving was fitted over it. Warming the ferrite a little before attempting to shrink the sleeve proved helpful for this process. The coil was then wound onto it using 0.4mm enamelled copper wire, which is relatively thick and easy to handle.

Starting about 10mm from one end, 100 turns were close-wound into position, then a further 65 turns were wound over this going back towards the start, giving a total of 165 turns altogether. The winding was secured with insulating tape, taking care to prevent the wire from coming into contact with the ferrite to avoid the possibility of insulation damage.

The tuning range of trimmer capacitor VC1 is quite small so if another type of rod

COMPONENTS

Digital Circuit

Resistors

R1, R2	47k (2 off)
R3	15k
R4, R9	220k (2 off)
R5, R10	2k2 (2 off)
R6	39k
R7, R12	10k (2 off)
R8	100k
R11	470k
R13	470Ω
R14	560Ω

All 0.6W 1% metal film

See
SHOP
TALK
page

Potentiometers

VR1	10k min. preset, horiz.
VR2	100k min. preset, horiz.
VR3	4k7 (or 5k) rotary carbon, lin.

Capacitors

C1, C2	10n resin-dipped ceramic (2 off)
C3, C21	100p ceramic (2 off)
C4 to C8, C10, C12, C13, C15, C16, C19, C20, C22, C24	100n resin-dipped ceramic (14 off)
C9, C11, C23	10μ radial elect. 50V (3 off)
C14	470μ radial elect. 35V
C17	470p ceramic
C18	470n resin-dipped ceramic

Semiconductors

D1, D2	1N4001 rec. diode (2 off)
IC1	4007UBE dual CMOS transistor pair/inverter
IC2	74HCT7046AE phase-locked loop
IC3, IC5	74HC4024 7-stage binary counter (2 off)
IC4	74HC21 dual quad-input AND gate
IC6	78L05 +5V 100mA voltage regulator
IC7	78L12 +12V 100mA voltage regulator
IC8	CA3130E CMOS op.amp
IC9	4046 phase-locked loop
IC10 to IC14	4017B decade counter (5 off)
IC15	4050 hex buffer
IC16	LM317 adjustable positive voltage regulator

Miscellaneous

S1	d.p.s.t. mains switch
S2	push-to-make switch
T1	15V-0V-15V 250mA mains transformer

Printed circuit board (Digital), available from the EPE PCB Service, code 354; 8-pin d.i.l. socket; 14-pin d.i.l. socket (4 off); 16-pin d.i.l. sockets (8 off); 4mm chassis socket, red (8 off); 4mm chassis socket, black; metal case, see text; p.c.b. mounting supports, to suit; twin screened audio cable, see text; connecting wire; solder, etc.

Approx. Cost
Guidance Only

£25
excluding case

Fig. 4. Complete circuit diagram for the Digital section of the Frequency Standard Generator.

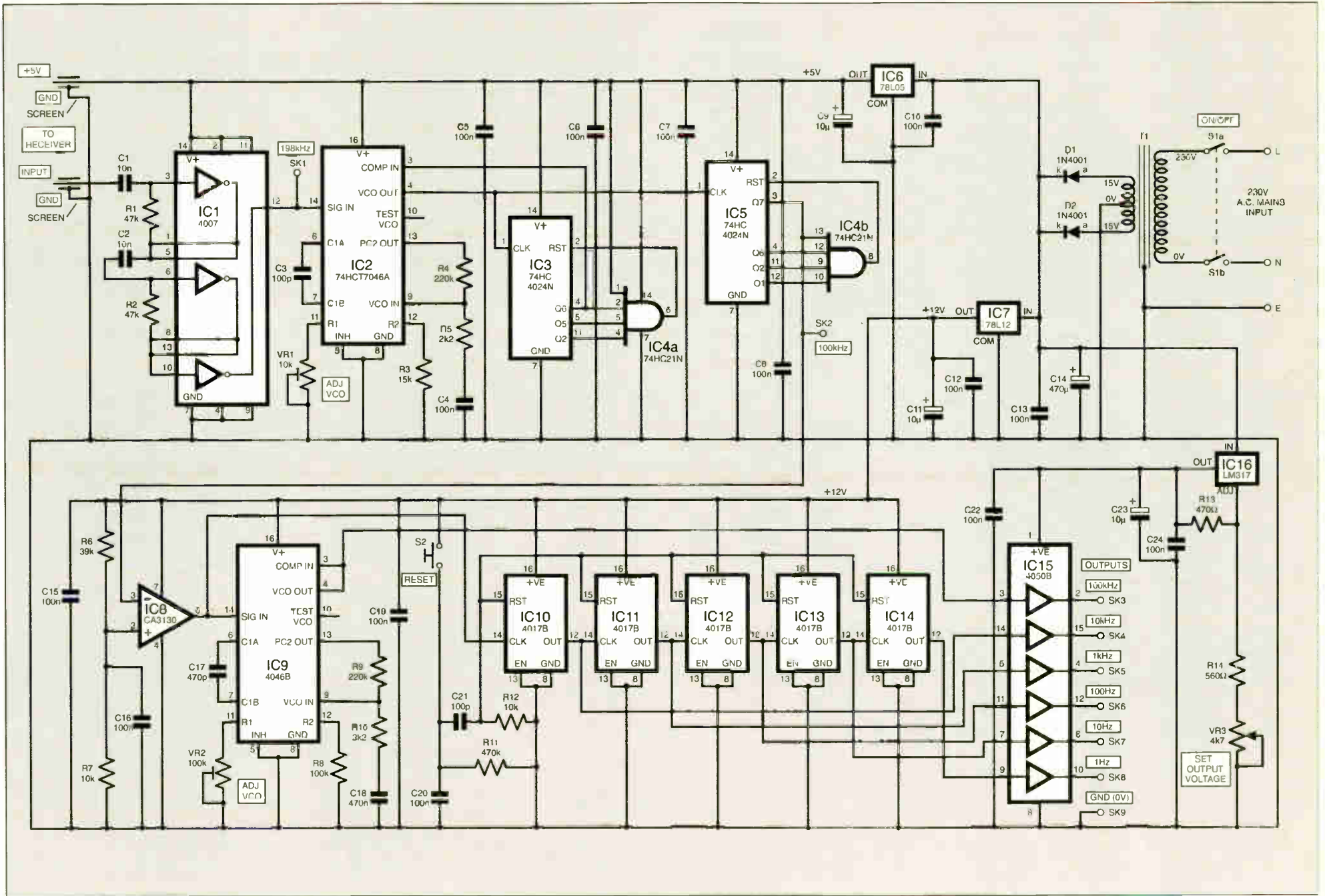

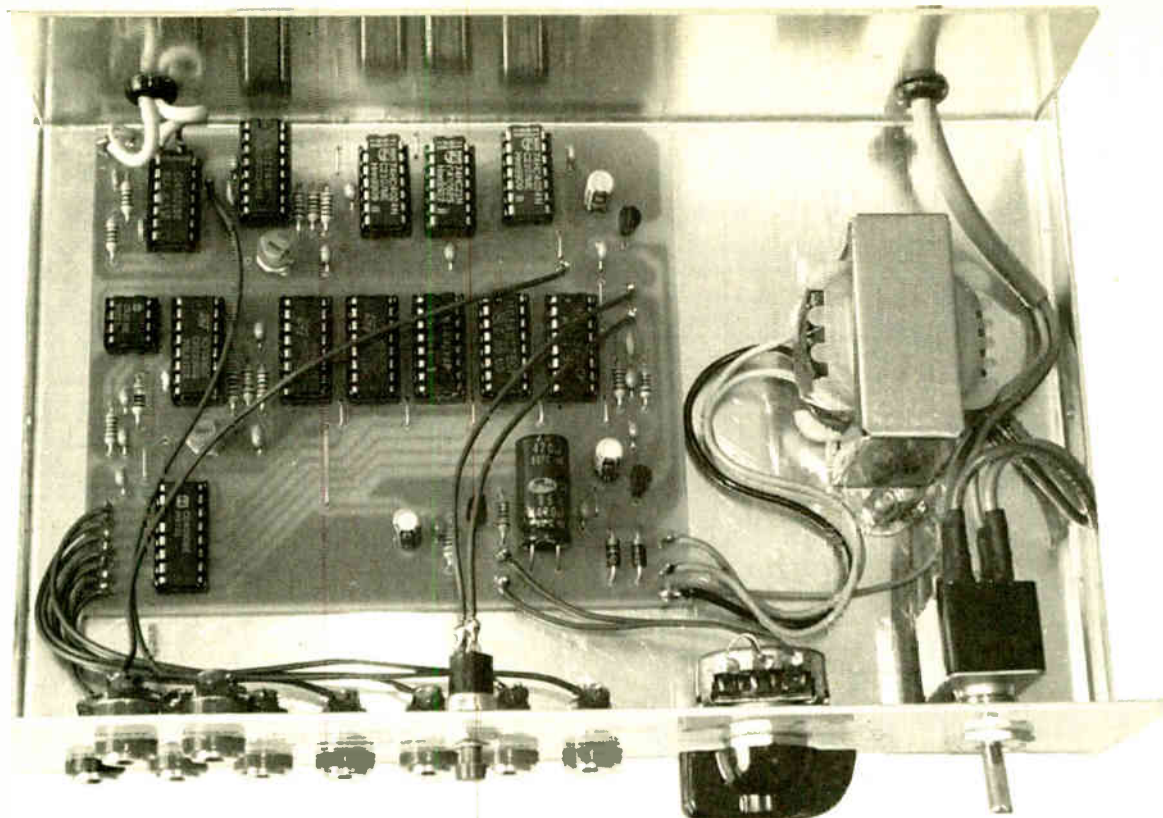

is employed or difficulty is experienced in tuning a check of the resonant frequency may be needed. A simple method often used by the author is shown in Fig.6. It requires a frequency generator and an oscilloscope and is an extremely easy way to find the resonant frequency since the peak produced is quite unmistakable, much greater than those due to harmonics.

Turns can be simply added or removed on the coil until the desired point is reached.

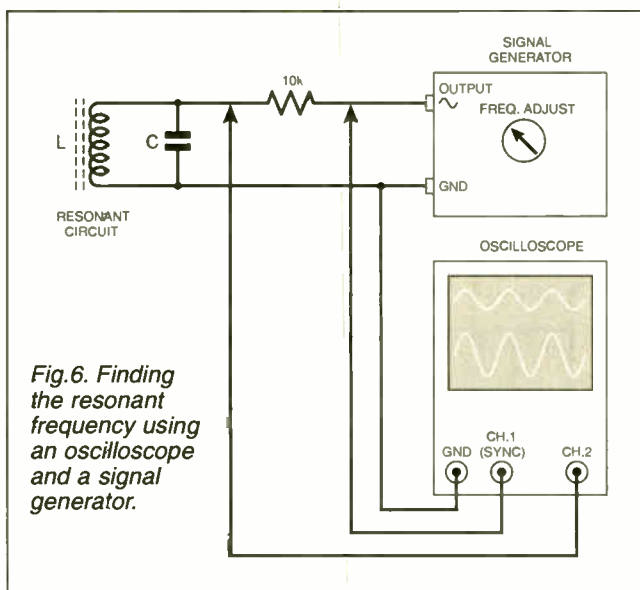

Fig.6. Finding the resonant frequency using an oscilloscope and a signal generator.

RECEIVER CONSTRUCTION

The component layout of the Receiver p.c.b. is shown in Fig.7 and construction should present no problems. Note that capacitor C1 is a silvered-mica type for maximum stability. When powered at 5V with the antenna attached, it forms part of the biasing circuit and a small d.c. voltage should appear at the source (s) of TR1. The actual value of this voltage will depend on the characteristics of the individual f.e.t. used for TR1 but a figure of 0.5V to 2V should be acceptable.

Likewise, about 1.5V should be present at the emitter (e) of transistor TR3 though this will be dependent to some extent on the gain of TR2. A scope can be used to set the tuning, but if one is not available the test circuit shown in Fig.8 works well.

The diode drops about 0.5V so the output will be about 1V plus the peak value of

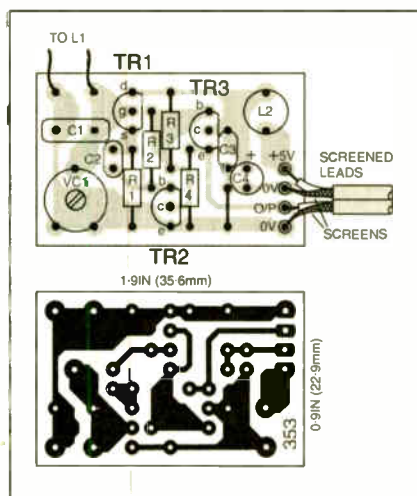

Fig.7. Printed circuit board component layout, wiring and full-size copper foil master pattern for the Receiver.

the signal, so tuning should be adjusted for the maximum obtainable value. An analogue meter may be found preferable to a digital one when making this adjustment.

It should be remembered that the signal is amplitude modulated – a bit of a nuisance this, really! – so the level will fluctuate a little. Ferrite aerials are also very directional, so if difficulty is experienced in finding the signal it may be helpful to use a longwave radio receiver to find the correct orientation for it.

The receiver and aerial must be housed in a non-metallic case so that the radio signals can penetrate to them. The prototype uses the plastic tube from a pack of effervescent vitamin C tablets, which is about the right size and can easily be made waterproof. Small pieces of foam plastic secure the board and ferrite rod in place inside the tube.

Interconnection between Receiver and Digital board is made through "figure-of-8" twin screened audio cable. A couple of metres is all that is required, though in some areas of weak signal it may be preferable to place the receiver in an elevated or external location for reliable results.

ASSEMBLY OPTIONS

If the full facilities of this project are not required it may not be necessary to construct all of it. For example, if a quick test of a frequency meter is all that is required, the Receiver on its own may be all that is

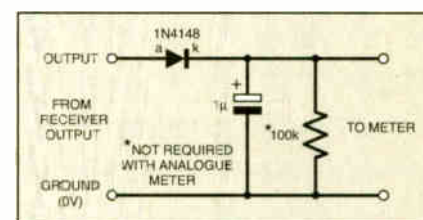

Fig.8. Simple test circuit for tuning the Receiver.

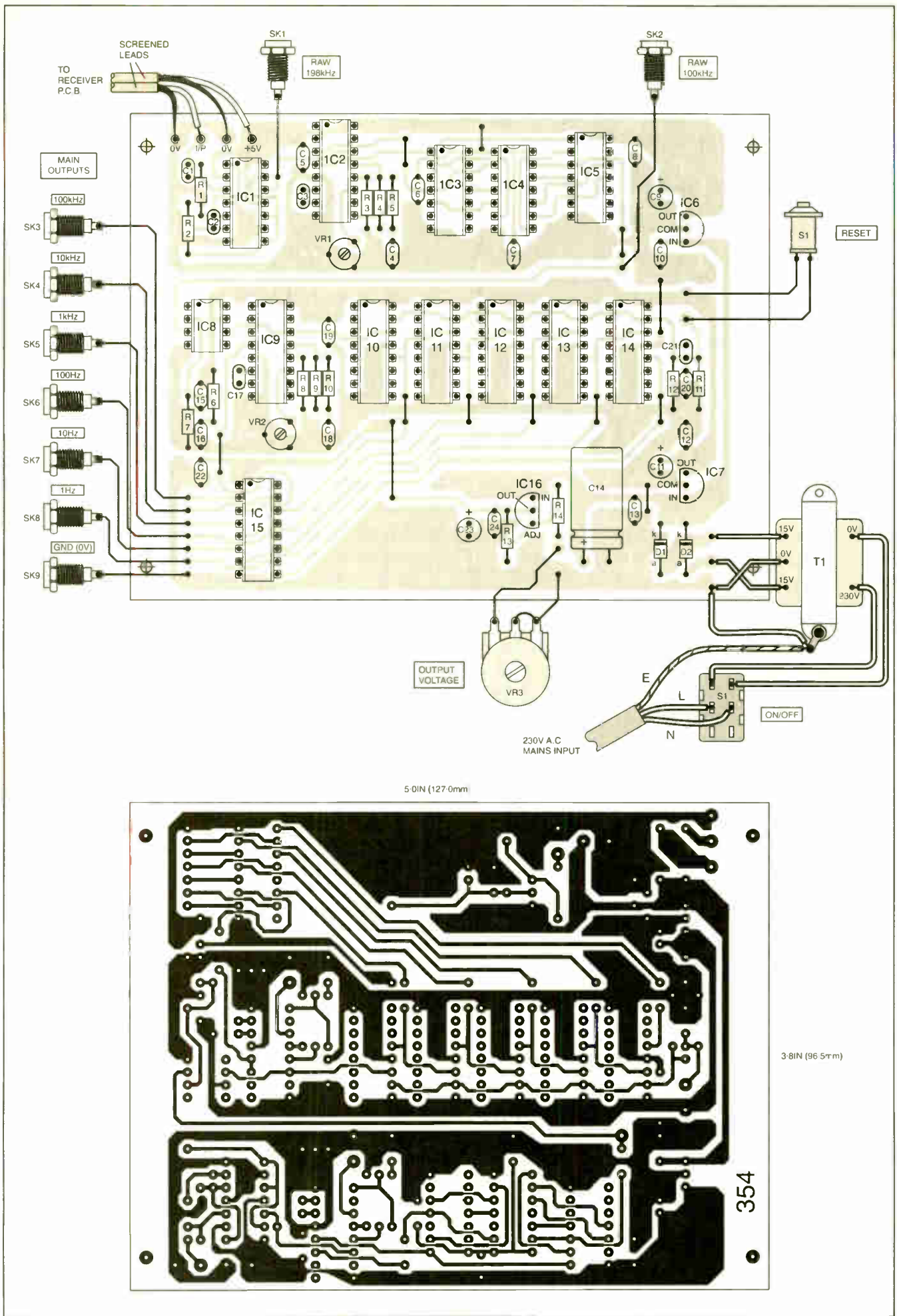
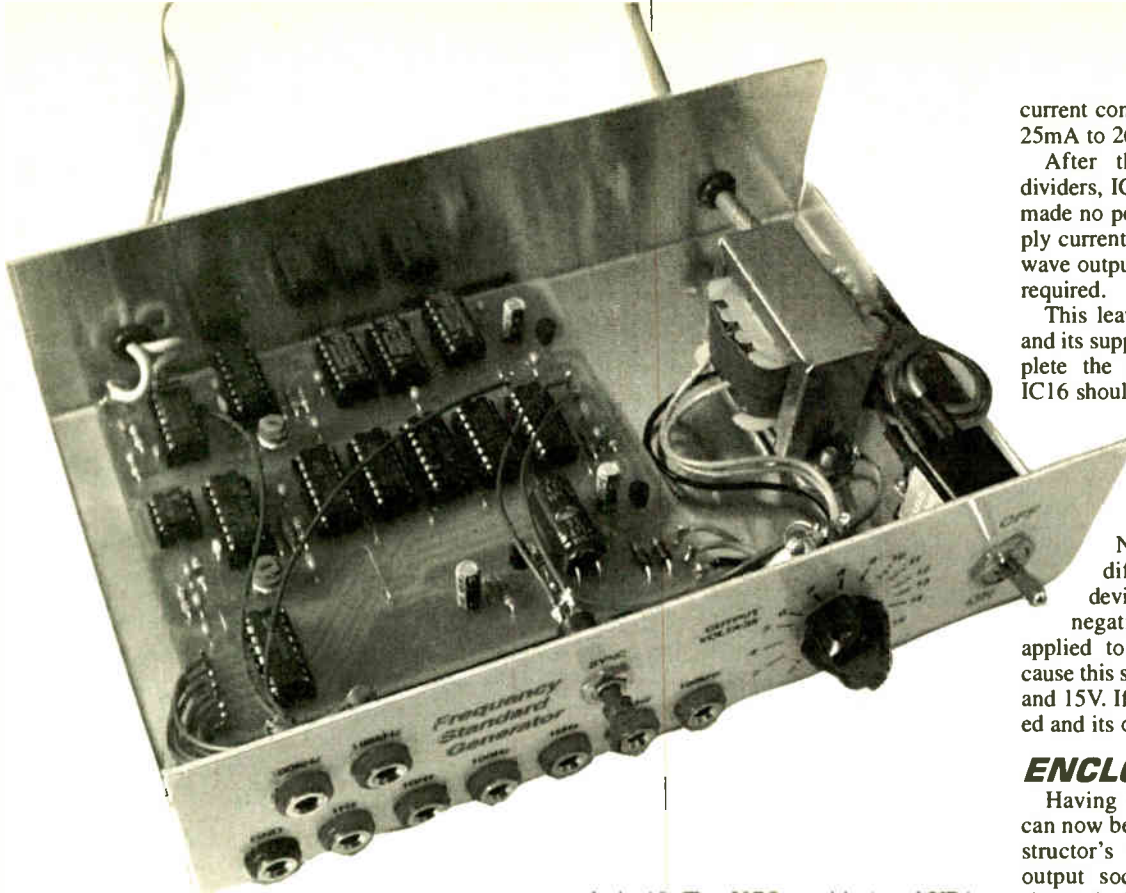

Fig.9. Printed circuit board component layout, wiring and full-size master for the Digital board.



needed. If the output level from this is insufficient, the amplifier section of IC1 of the main board and its associated components should be sufficient to do the job.

The p.c.b. component and track layout for the full digital circuit is shown in Fig.9. To simplify testing following construction, dual-in-line (d.i.l.) sockets are recommended for all the i.c.s, except, of course, for the three voltage regulators.

Where a current-limited bench power supply is available, use of this would be preferable to simply connecting the unit to its transformer and powering up. It can be connected across the leads of capacitor C14.

Construction should begin with the fitting of all the passive components, links, resistors, diodes and capacitors, then the d.i.l. sockets, then the 5V regulator IC6. The two presets VR1 and VR2 can also be fitted, holes are provided to accept a variety of types.

TESTING

If the circuit is powered, with around 18V d.c. from a bench supply, the presence of the 5V regulated supply can be checked at the top right-hand pin of any of the upper five d.i.l. sockets. It should draw only a couple of milliamps from the supply at this stage.

If the receiver is connected and IC1 inserted into its socket, this should rise to about 5mA in total. The d.c. voltage at pin 12 of IC1 should measure as about 2.5V, indicating (hopefully!) that the output is operating at 198kHz squarewave. If a 'scope or frequency meter is available, these can be used to check it, of course.

Next, IC2, IC3, IC4 and IC5 can be inserted. These all work together so there is really no way of testing them individually. The method of setting up the operating point of IC2 is quite simple, a DVM should be connected between ground (negative)

and pin 10 (Test VCO, positive) and VR1 carefully adjusted for a reading of about half the supply, or 2.5V.

The PLL should then be locked and working at the correct frequency and optimum VCO operating point. The output from IC5 pin 3 should now be exactly 100kHz, although it will not be a square-wave. A meter connected to it should read about 1.75V d.c., and a scope will show it as positive-going pulses. The overall supply drain should now be about 20mA.

Next the 12V regulator IC7 should be fitted and the presence of its output checked. This should appear at all of the positive supply pins for the logic i.c.s on the lower part of the board. The current drawn by IC7 should raise the supply current to about 23mA. If this checks out IC8 can be fitted, which will add another 1mA or so.

Following this the second PLL, IC9, can be fitted and adjusted in a similar manner to the first by monitoring the voltage at pin 10 whilst adjusting VR2. In this case, though, since the supply is 12V, the voltage set at this pin should be about 6V. The 100kHz squarewave output should now be available from pin 4 of IC9 and, of course, the average d.c. voltage measured here should be half the supply, or 6V. Total

current consumption should now be about 25mA to 26mA.

After this the five 4017B decade dividers, IC10 to IC14, can be fitted. This made no perceptible difference to the supply current of the prototype. Their square-wave outputs, at pin 12, can be checked if required.

This leaves just the output buffer IC15 and its supply regulator to be fitted to complete the board. The variable regulator IC16 should be fitted first. With VR3 temporarily connected, the board should be powered again and the output from IC16 checked, pin 1 of the socket for IC15 can be used for this.

Note that the pinout for IC15 is different from most CMOS devices in that, although pin 8 is negative, the positive supply is applied to pin 1. Rotating VR3 should cause this supply to vary between about 3V and 15V. If this works, IC15 can be inserted and its outputs checked.

ENCLOSURE

Having completed the main board, it can now be fitted into the case of the constructor's choice and connected to the output sockets and the transformer as shown in Fig.9. A metal case is recommended, connected to mains earth as shown through a solder tag under one of the mounting bolts of transformer T1. This connection is essential as the high frequencies around IC2 to IC5, plus the squarewave nature of the signals throughout the circuit, can radiate some interference. Use of an earthed metal case does much to reduce this.

The outputs from this circuit can be used for many purposes, including the testing of digital circuits where the ability to vary their input signal voltage and use several outputs simultaneously should come in very useful (but do not exceed the power line voltage of the i.c.s. under test).

However, the primary virtue of this design is its phenomenal accuracy and stability. There will not usually be many really accurate standards of any kind in the workshop of a home constructor since they are usually prohibitively expensive. This design provides an exception to this rule by bringing a national frequency standard right onto the amateur's bench.

It should prove useful for checking and adjusting the calibration of frequency meters, oscilloscopes, and any other equipment used for measuring or generating frequency of any kind. □



CIRCUIT SURGERY

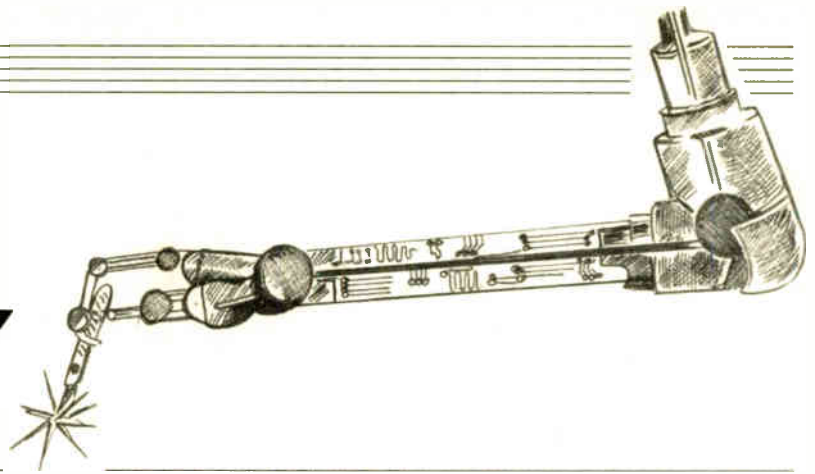

**ALAN WINSTANLEY
and IAN BELL**

Our monthly roundup of readers' queries looks at Darlington transistors, ambidextrous hands, a grounding problem and a close-up on X-Class and Y-Class capacitors

All the way to Darlington

Muhammed Abdallah Saif from Ngora, Uganda emailed to ask for an explanation of the operation and uses of Push-Pull transistors and "Darlington" pairs. Both of these are circuits comprising two transistors, and are commonly (but not exclusively) used in outputs stages of circuits including high power applications.

The basic ideal of a push-pull circuit is to use two complementary transistors (an *npn* and *pnp* matched pair) to drive current through the load in opposite directions (hence *push* and *pull*). A classic application is in analogue power amplification at both low and high power levels, the most basic form of which is shown in Fig.1.

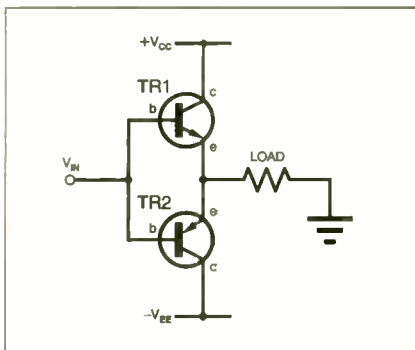

Fig.1. Basic push-pull amplifier circuit arrangement.

The basic push-pull output stage suffers from a problem called *crossover distortion*, which is important if the signal in the load must be an accurate copy of the input (e.g. in a high fidelity audio circuit). The effect of crossover distortion on a waveform is illustrated in Fig.2.

In Fig.1 only one transistor can be on at any time, that is: if $V_{in} > V_{BE}$ (the base-emitter voltage of the transistor) then TR1 is conducting, and if $V_{in} < -V_{BE}$ then TR2 is conducting instead. But this means that for small inputs neither transistor is on: if $-V_{BE} < V_{in} < V_{BE}$ then TR1 and TR2 are both off. By using appropriate bias circuits, which hold both transistors at the point of conduction, this problem can be overcome.

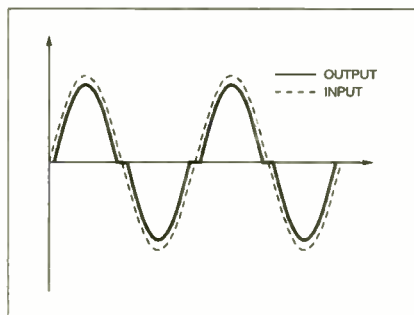

Fig.2. Waveform showing crossover distortion.

Elimination of crossover distortion is not always required, particularly if the push-pull circuit is driven with a digital signal (e.g. to drive a motor full speed forward or reverse). The H-bridge circuit used in the "Dog and Cat Scarer" discussed in May 2002 *Circuit Surgery* uses two push-pull circuits driven in opposite directions. Although this is an "audio" application hi-fi sound is not required; and the signal source is a square wave so crossover distortion is not an issue – the basic push-pull circuit can be used.

In the Darlington configuration, one transistor is used to drive another resulting in a very high gain (typically thousands) and high input impedance. A couple of variations on the theme are shown in Fig.3. The Darlington pair behaves like a single transistor with twice the value of V_{BE} (i.e.

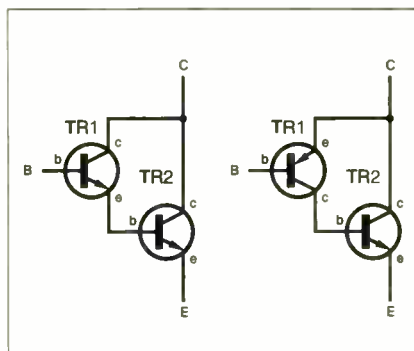

Fig.3. Darlington configurations using a driver transistor, TR1, to provide base current to TR2, which could be a power device.

it has a higher switch-on voltage) and gain equal to the product of the gain of the two transistors. The input resistance is increased by a factor comparable with the gain of (one of) the transistors. One disadvantage is that the configuration can be rather slow in switching.

In high power applications the first transistor (TR1) makes sure that the power transistor (TR2) receives sufficient base current to fully turn on. A high power transistor may require significant base current, which would not be readily available from the controlling circuit's output (e.g. logic gate) if it were connected directly.

Darlington configurations can be used in situations other than power outputs, for example a Darlington arrangement can be used to increase the gain of a phototransistor. Lastly, remember that you can buy "ready-made" Darlington transistors that make life easier. They have a very high gain, say 20-50,000 or so. *I.M.B.*

More Scope for Grounding

"With respect, your answer to Gerard Galvin in the first section of *Circuit Surgery* in the April '02 issue seems to make no sense! With reference to Fig.1 in April and just considering measurements: if the oscilloscope has its probe's screen and croc-clip joined to earth (ground) via the mains plug, and the power supply circuit under test has its 0V rail grounded via its mains plug as well, then the probe's ground connection can short out nothing when connected to 0V in the Power Supply. In fact the croc clip does not need to be connected at all!

"It seems to me that there is more "potential danger" of doing damage if the power supply has its output fully floating. In this case when connecting the probe's earth to the 0V line of the supply, that will be pulled to ground potential. But even here it is difficult to see what the damage might be." *Dan Woods* via email.

We were attempting to refer to the problem of measuring the voltage between two points in a circuit other than ground. If the p.s.u. 0V rail is grounded and so is the scope probe, then if you connect the probe croc clip anywhere in the circuit other than

0V you obviously connect that point to ground. How a component can be accidentally shorted to 0V in this way is illustrated in Fig.4.

As we said in the article, if the power supply is floating then there should be no d.c. path to earth so connecting a single scope ground should not cause a problem. It is often true that the croc clip might not need to be connected at all, but only if the reference point is ground in both cases. I.M.B.

Ambidexterity Rules OK

I have just received the April issue of EPE and on scanning the articles I am puzzled by the item in Teach-In 2002 Part 6 on page 252. Fig.6.16 shows Fleming's Right Hand Rule while the text speaks about:

"We sometimes need to know the force exerted by a magnetic field given the direction of movement of a charge and the magnetic field's direction."

I am a retired Electronic Engineer and I am sure Fleming's Rule was always taught as: Left Hand Rule for Motors (i.e. Magnetic Field and Current Known - Direction of Motion required); Right Hand Rule for Generators (i.e. Magnetic Field and Motion Known - Current Direction required.) The rule shown in Fig. 6.16 would appear to be the wrong one, or does my memory fail me! Good magazine, keep it up. John Avery via email.

Your memory is fine, Mr. Avery! To clarify, what we were actually referring to in the Teach-In text was the force exerted on the electrons, not a physical force placed on the conductor itself.

You are right to say that Fleming's Left Hand Rule relates to the "motor effect", and it describes the direction of force with respect to the direction of the magnetic field and electric current. With fingers and thumb of the left hand held perpendicular as in the Right Hand Rule, if the first finger points in the direction of the field and the second finger points in the direction of current, then the thumb points in the direction of motion. This gives us the principle of the electric motor. ARW.

X/Y Capacitors

Mr C. A. White writes by email: "Wanting a method of driving a 6V to 12V piezo buzzer from the mains without using a transformer/relay, I trawled back through my stack of Everyday Electronics (and its progeny to the early seventies!) and I found "Transformerless P.S.U.s" by Andy Flind (EPE February 1995).

"I was aware of "X" and "Y" rated capacitors but could only find one rather expensive one in an old Maplin catalogue. When I went into my local components store, I found that we also had X2 and Y2 and even, I believe, Y1(X1). Can you explain the difference between X1, X2, Y1, Y2 types?"

This question has cropped up several times recently in my mailbag. The full answer involves looking through some scary technical standards, which goes beyond the scope of *Circuit Surgery*, but the basic aspects are as follows.

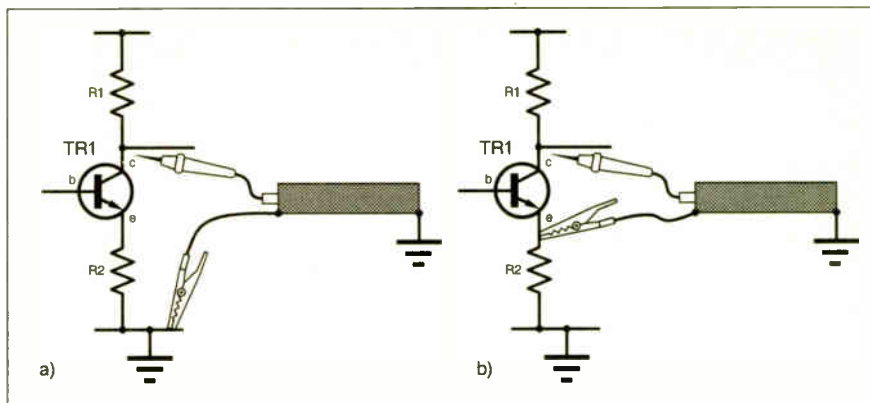

Fig.4. (a) "Safe" measurement - both referenced to ground and (b) "unsafe" measurement - resistor R2 is shorted to ground, via croc-clip and cable screen.

Constructors usually first come across the terms "X1" "Y1" etc. when dealing with mains-rated filter capacitors. These are designed to be fitted directly across the mains supply between live and neutral, but certain types are safe enough to be fitted between live-earth and neutral-earth. A Class X capacitor can go across Live and Neutral, but **only a Class Y should be connected to the Earth terminal** as they are designed to be able to bridge insulation in the equipment: there is much less chance of them causing a shock should they fail.

Next, voltage ratings: filter capacitors have to withstand spikes and surges on the mains caused by everything from e.g. nearby equipment operating (say 400V-800V spikes for up to 1 millisecond) all the way up to 6kV or more caused by lightning impulses. It is said that 80% of all transients last no more than 10 microseconds with amplitudes up to 1.2kV; in their working life a suppressor will have to withstand thousands of such spikes without catching fire, blowing out or failing catastrophically.

The Euronorm EN 132 400 contains the technical information relating to mains filter capacitor specifications. Amongst other things, the standards cover flammability, pulses and ageing and the circumstances in which they are to be connected to the mains. A Class X1 type of 1.0µF or less has been impulse tested at 4.0kV whilst Class X2 is the most common, and is tested up to 2.5kV. The latter will be found, where applicable, in electrical equipment that is plugged into the mains.

Being connected directly to ground, Y Class capacitors are designed so as not to

be a source of electric shock should they fail. There are several classes that design engineers have to consider, and which class to select also depends on the insulation characteristics of the equipment itself. As far as I know, only Class Y1 and Y2 are used, the latter being the most popular for use up to 250V and are impulse tested to 5kV (Class Y1: 8kV).

Delta Force

A convenient arrangement is the *delta capacitor* which has three wires and contains an X Class 0.1µF straight across the mains, plus two Y Class 5,000pF capacitors between live/earth and neutral/earth. Some stud-mounting types even have a built-in suppressor choke. For many suppression jobs a delta capacitor across the mains is effective enough, and remember that they can also help prevent "noisy" equipment from feeding RFI back into the mains as well.

If I may round off with a true story: The "boss" of the writer's household owns an awesome Swiss-built motorised double-bed knitting machine, a wonder to behold when it's in full flight. The author was in the process of photographing some components including an X Class RFI capacitor, when a "pop" was heard to come from the room next door. A dense plume of acrid smoke was pouring from the back of the machine's motor controller, which was hastily isolated from the mains. Would you believe that its X Class RFI filter capacitor had just failed? The replacement was fitted in less than two minutes - once I'd finished taking its photograph that is! ARW.

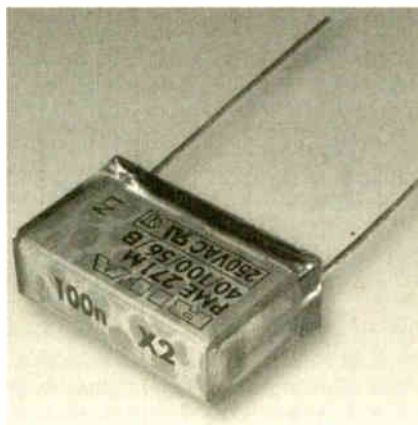

A Class X2 capacitor for direct connection across the mains supply.

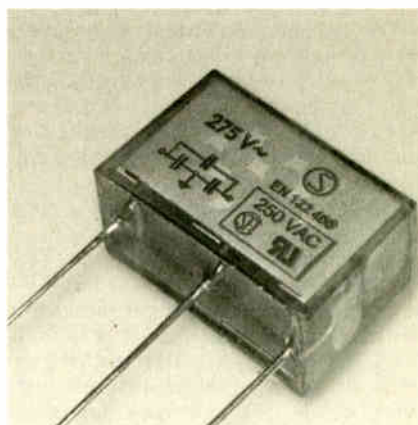

A three-wire delta capacitor contains an X class and two Y Class capacitors.

Video Surveillance



- C-MOS B/W Camera 15mm/15mm £29.00
- C-MOS Colour Camera 15mm/15mm £65.00
- PCB B/W Camera 32mm/32mm £24.00
- PCB Colour Camera w/Audio 32mm/32mm £65.00
- 23cm (1.3GHz) Video/Audio Transmitter £35.00
- 13cm (2.4GHz) Video/Audio Transmitter £35.00
- 1.2 Watt 2.4GHz Video/Audio Transmitter £120.00
- 4" TFT Boxed Colour Monitor w/Audio £110.00
- Video to VGA Converter £65.00
- VGA to Video Converter £90.00
- External USB Video Capture Box £55.00

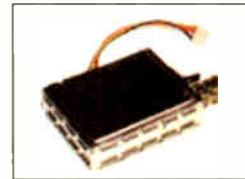

All prices exclude VAT.

Many more products on our website:

WWW.BITZTECHNOLOGY.COM

Tel: 01753 522 902 Fax: 01753 571 657

Wireless Remote Controls



RC-11
3 channels RC-11 Key fob
Control Transmitter with
Rolling Code technology.

UC-216
3 channels receiver with 2 relays
output working from 9V to 12Vdc
UC-216 with learning mode and
rolling code technology.

RC-11 Price: £14.99

UC-216 9-12Vdc £29.00
UC-222 240 Vac £29.00

Also

- Wireless pager alarm PG-4W £125.00
- Wireless PIR alarm JA-60S £49.00
- Wireless door magnet alarm £39.00
- Wireless smoke alarm £49.00
- Wireless glass break alarm £49.00
- Wireless alarm control panel £99.00
- Wireless alarm control panel with digital /voice dialler £149.00

Distributors Welcome.

All prices exclude VAT and carriage. All transmitters are licence exempt working on 433.92Mhz. All transmitters work with rolling code technology.

Bitz Technology Ltd
sales@bitztechnology.com
+44 (0) 1753 522 902

INTERFACE

Robert Penfold

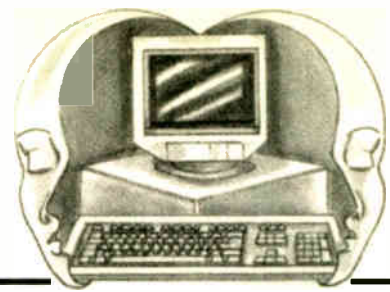

ACCESSING SERIAL PORTS VIA MSCOMM CONTROL

THERE has been some discussion in the *Readout* pages about a free version of Visual BASIC, and I have received a few enquiries on the same subject. Reasonably enough, Microsoft does not give away the full product, but it did produce a demonstration version of Visual BASIC 6.

Unfortunately, this does not seem to be available as a download on their web site, and it was only given away by one or two computer magazines on their cover-mounted discs. Your chances of tracking it down are now probably negligible.

In Control

The next best thing is Visual BASIC 5 CCE (control creation edition), which is available as a free download from the www.ms.com web site. Using something like "Visual BASIC CCE" in the main search engine should soon track down the program file and some useful documentation.

The download search engine does not seem to have heard of this program, so it is best to use the main one. This version is primarily intended for producing ActiveX controls, but the Standard EXE option is available from the opening screen.

Neither the demonstration version of Visual BASIC 6 nor CCE version 5 has the ability to compile standalone EXE files or program groups. However, both versions have the option to compile and run programs from within the programming language itself. This is much like using an interpreted language, but with the speed of a language that is largely compiled. The usual Save and Open functions are also available. Therefore, you can still write and develop your own applications, and at zero cost.

Many people have a form of Visual BASIC already installed on their PCs, but are unaware of its existence. Some of the more major applications programs, such as Microsoft's Office, are supplied with Visual BASIC for Applications, or VBA as it is better known. This is intended as a means of adding functions to applications programs, but it can be used to develop simple software for PC add-ons.

However, this is a rather clumsy way of doing things, and the range of applicable components available in VBA seems to be a bit limited. I would definitely recommend forgetting VBA for this type of thing and downloading Visual BASIC 5 CCE instead.

MSComm

Using serial ports for communications with add-ons via a UART was covered in the previous *Interface* article. The hardware for serial interfacing is reasonably

straightforward, but how does the software make contact with the add-on device?

One option is to directly control the serial port hardware using INP and OUT instructions, or an equivalent to these. This is not the only method available though, and most high level programming languages have instructions that provide access to the serial and parallel ports.

The approved method of accessing the serial ports using Visual BASIC is to use the MSComm control. Unfortunately, this option is only available to those using the Professional and Enterprise editions. It does not seem to be present in any of the free versions or in the low-cost versions such as the Standard edition. This control is not included in the Toolbox by default, and it must be loaded before it can be used.

this control is unimportant because it will not be displayed when the program is run. It is only shown on the form so that its parameters can be accessed via the Properties window. Simply position it out of the way in a corner of the form.

With the MSComm icon selected, the Properties window will show a number of parameters for it. The defaults might be suitable, but it is important to check down the list to ensure that the settings are all acceptable.

It is particularly important to check that the CommPort setting is correct. This defaults to a value of 1, which means that the control is used for communications via serial port 1 (Com1). This must be changed to a different value if a different port will be used for this test. Note that a different MSComm control is required for each serial port if a program will be used with more than one of these ports.

The Settings parameter controls the baud rate, the type of parity checking, the number data bits, and the number of stop bits. By default this will be 9600-baud, no parity, eight data bits, and one stop bit (9600,n,8,1). This word format is the best one to use when interfacing user add-ons to a PC, but a baud rate of 19200 might be preferable in some applications as it gives double the rate of data transfer. To double the baud rate to 19200 simply delete 9600 and replace it with 19200.

Windows supports some "turbo" baud rates, and one of these can be used if a higher rate of transfer is required. The highest rate that is likely to work is 115200 baud, which provides a maximum transfer rate of about 11 kilobytes per second. Note that the figure used for the baud rate parameter must correspond to one of the standard rates supported by Windows. Trying to set any baud rate that happens to take your fancy will simply produce an error message.

Various handshaking options are available, but handshaking is not needed with most user add-ons. The speed of the peripheral device and the PC, together with the limited flow of data, make it unnecessary. If handshaking is not required, make sure that the None option is selected. There might otherwise be problems with things grinding to a halt due to the PC expecting handshake signals that it does not receive.

Hitting the Buffers

Two further parameters that can be of importance are InBuffer and OutBuffer. It is not necessary for programs to read each byte of data as it is received. Instead, data can be stored in a section of memory called a buffer, and then read when the appropriate number has been received.

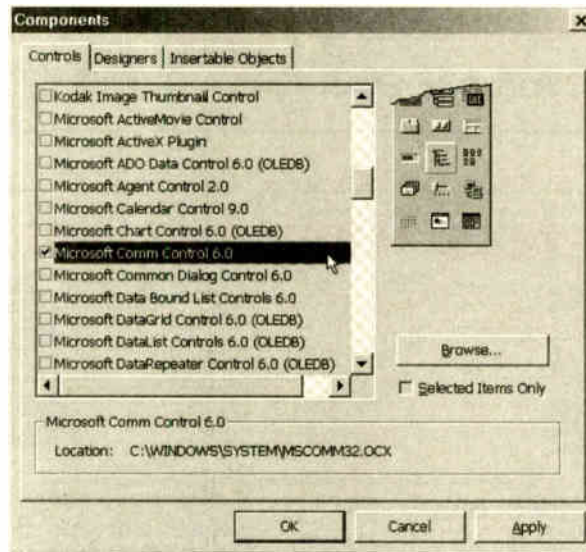

Fig.1. The MSComm control must be switched on via the Components window.

In order to do this, first select Components from the Project menu, which will produce a window showing all the available components (Fig.1). Scroll down the list for a control called "Microsoft Comm Control 6.0". You do not have a suitable version of Visual BASIC if this control is not listed. Assuming it is present and correct, place a tick in its checkbox and then operate the Apply button followed by the Close (OK) button. The icon for MSComm, which looks like a yellow telephone, should then appear in the Toolbox.

On Form

Probably the best starting point with MSComm is a simple program that will output values to a serial port. Enlarge the form slightly and then add an MSComm control to it. The position of the icon for

Similarly, a program does not have to wait for one byte to be transmitted before it sends the next one to the serial port. A block of data can be sent, and it will be stored in the buffer. The operating system then handles the transmission of this data.

In both cases it is obviously essential for the buffer to be large enough, or the buffer will overflow and data will be lost. This process is sometimes called "hitting the buffers", and it more or less guarantees a breakdown in communications between the PC and the peripheral device.

The InBuffer and OutBuffer parameters respectively set the sizes of the input (receiving) and output (transmitting) buffers in bytes. In most cases the default values will do, but higher values might be needed in applications that send or receive blocks of data. The buffer must be comfortably larger than a block of data.

Adding Components

Having made any necessary adjustments to the MSComm parameters it is time to add some components to the form so that values can be sent to the selected serial port. Add a large horizontal scrollbar, a command button, and a large label with an equally large font size. The scrollbar will be used to generate the values that will be sent to the port, so its Max parameter must be set at 255. Delete the default caption of the label, and change the button's caption to "Exit".

Next, the following three subroutines should be assigned to the button, the form, and the scrollbar respectively (no subroutine is needed for the label):

```
Private Sub Command1_Click()
MSComm1.PortOpen = False
End
End Sub
```

```
Private Sub Form_Load()
MSComm1.PortOpen = True
End Sub
```

```
Private Sub HScroll1_Change()
MSComm1.Output =
Chr$(HScroll1.Value)
Label1.Caption = HScroll1.Value
End Sub
```

Before a port can be used for sending or receiving data it must be opened. This

is done by setting the PortOpen parameter of MSComm1 to True when the form loads. It is standard practice for a port to be closed when the program using it is either closed or does not require the port any more. This leaves the port available for other programs to use. In this case the program is closed by operating the EXIT button, which first sets PortOpen as False so that the port is closed. It then uses an End instruction to close the program.

Data is sent to the serial port by the subroutine assigned to the horizontal scrollbar. Changing the setting of the scrollbar triggers its subroutine, which sets MSComm1.Output to the new value read from the scrollbar. This value is in the variable called "HScroll1.Value". The obvious method of simply making MSComm1.Output equal to HScroll1.Value does not work. A character or string seems to be needed rather than a number or a numeric variable.

There are ways around this problem, and in this case the Chr\$ function is used. This generates a character equal to the ASCII code number inserted in the brackets, and this value is provided by the scrollbar.

Presumably, MSComm1 then duly changes this character back to its equivalent code number, which then is sent to the serial port. This seems a bit mad to say the least, but it is the only way I could get it to work properly. The next line in the subroutine writes the new scrollbar value to the label so that the user can see what values are being sent.

XP Compatibility

Having completed the program you should have something like Fig.2. The prototype program in operation is shown in Fig.3. Since writing data direct to the serial port hardware is a very simple process, using MSComm might seem to be a pointless exercise.

However, it does have one or two advantages. It does not require any third party add-ons such as Inport32.dll, but note that the file

MSComm32.ocx must be present in the C:\Windows\System folder for the compiled program to work. This is the ActiveX control that provides communication with the serial port. It will be installed on your PC as part of the Visual BASIC installation.

The biggest advantage of using this method is that it accesses the port via the operating system. With Windows 95, 98, and ME it is acceptable to directly access ports, but this is not permitted with Windows NT4, 2000, or XP. Ports have to be accessed via the official channels so that the operating system can prevent two programs trying to access the same port simultaneously.

The practical consequence of this is that programs do not work with Windows NT4, etc. if they use Inport32.dll, assembly language routines, or any other method of directly accessing the ports. Ploys such as using the Windows XP compatibility modes do not seem to get around this problem.

On the other hand, using MSComm to access the serial ports results in the data going via the operating system, and should give compatibility with any 32-bit version of Windows. Fig.4 shows the test program running under Windows XP. It was found to be perfectly stable and changes in the scrollbar produced the correct data from the serial port. This contrasts with programs that directly access the ports, which at best appear to run correctly but do not communicate with the ports at all.

As Windows ME and its predecessors are due to be phased out and replaced by Windows XP, compatibility will become an increasingly important issue.

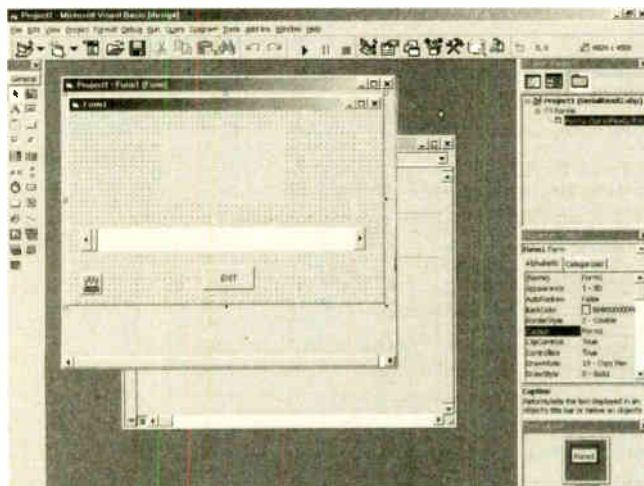

Fig.2. The completed program ready for testing.



Fig.3. The test program running under Windows ME.



Fig.4. The test program runs properly under Windows XP, and even "talks" to the serial port.

EPE IS PLEASED TO BE ABLE TO OFFER YOU THESE ELECTRONICS CD-ROMS

ELECTRONICS PROJECTS

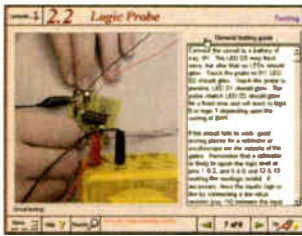

Logic Probe testing

Electronic Projects is split into two main sections: **Building Electronic Projects** contains comprehensive information about the components, tools and techniques used in developing projects from initial concept through to final circuit board production. Extensive use is made of video presentations showing soldering and construction techniques. The second section contains a set of ten projects for students to build, ranging from simple sensor circuits through to power amplifiers. A shareware version of Matrix's CADPACK **schematic capture, circuit simulation and p.c.b. design** software is included.

The projects on the CD-ROM are: Logic Probe; Light, Heat and Moisture Sensor; NE555 Timer; Egg Timer; Dice Machine; Bike Alarm; Stereo Mixer; Power Amplifier; Sound Activated Switch; Reaction Tester. Full parts lists, schematics and p.c.b. layouts are included on the CD-ROM.

ELECTRONICS CAD PACK

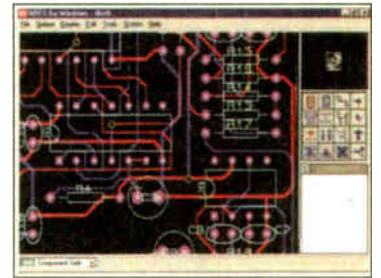

PCB Layout

Electronics CADPACK allows users to design complex circuit schematics, to view circuit animations using a unique SPICE-based simulation tool, and to design printed circuit boards. CADPACK is made up of three separate software modules. (These are restricted versions of the full Labcenter software.) **ISIS Lite** which provides full schematic drawing features including full control of drawing appearance, automatic wire routing, and over 6,000 parts. **PROSPICE Lite** (integrated into ISIS Lite) which uses unique animation to show the operation of any circuit with mouse-operated switches, pots, etc. The animation is compiled using a full mixed mode SPICE simulator **ARES Lite** PCB layout software allows professional quality PCBs to be designed and includes advanced features such as 16-layer boards, SMT components, and an autorouter operating on user generated Net Lists.

ELECTRONIC CIRCUITS & COMPONENTS V2.0

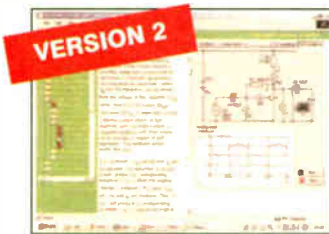

Circuit simulation screen

Provides an introduction to the principles and application of the most common types of electronic components and shows how they are used to form complete circuits. The virtual laboratories, worked examples and pre-designed circuits allow students to learn, experiment and check their understanding. Version 2 has been considerably expanded in almost every area following a review of major syllabuses (GCSE, GNVQ, A level and HNC). It also contains both European and American circuit symbols. Sections include: **Fundamentals**: units & multiples, electricity, electric circuits, alternating circuits. **Passive Components**: resistors, capacitors, inductors, transformers. **Semiconductors**: diodes, transistors, op.amps, logic gates. **Passive Circuits**. **Active Circuits**. **The Parts Gallery** will help students to recognise common electronic components and their corresponding symbols in circuit diagrams. Included in the Institutional Versions are multiple choice questions, exam style questions, fault finding virtual laboratories and investigations/worksheets.

ANALOGUE ELECTRONICS

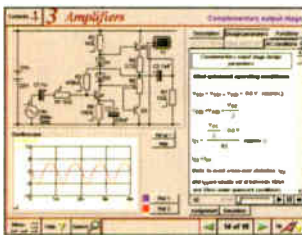

Complimentary output stage

Analogue Electronics is a complete learning resource for this most difficult branch of electronics. The CD-ROM includes a host of virtual laboratories, animations, diagrams, photographs and text as well as a SPICE electronic circuit simulator with over 50 pre-designed circuits.

Sections on the CD-ROM include: **Fundamentals** – Analogue Signals (5 sections), Transistors (4 sections), Waveshaping Circuits (6 sections). **Op.Amps** – 17 sections covering everything from Symbols and Signal Connections to Differentiators. **Amplifiers** – Single Stage Amplifiers (8 sections), Multi-stage Amplifiers (3 sections). **Filters** – Passive Filters (10 sections), Phase Shifting Networks (4 sections), Active Filters (6 sections). **Oscillators** – 6 sections from Positive Feedback to Crystal Oscillators. **Systems** – 12 sections from Audio Pre-Amplifiers to 8-Bit ADC plus a gallery showing representative p.c.b. photos.

DIGITAL WORKS 3.0

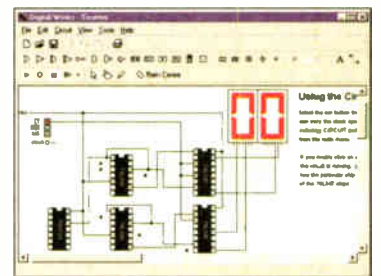

Counter project

Digital Works Version 3.0 is a graphical design tool that enables you to construct digital logic circuits and analyze their behaviour. It is so simple to use that it will take you less than 10 minutes to make your first digital design. It is so powerful that you will never outgrow its capability.

- Software for simulating digital logic circuits.
- Create your own macros – highly scalable.
- Create your own circuits, components, and i.c.s.
- Easy-to-use digital interface.
- Animation brings circuits to life.
- Vast library of logic macros and 74 series i.c.s with data sheets.
- Powerful tool for designing and learning.

DIGITAL ELECTRONICS V2.0

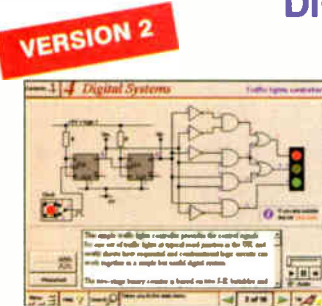

Virtual laboratory – Traffic Lights

Digital Electronics builds on the knowledge of logic gates covered in *Electronic Circuits & Components* (opposite), and takes users through the subject of digital electronics up to the operation and architecture of microprocessors. The virtual laboratories allow users to operate many circuits on screen. Covers binary and hexadecimal numbering systems, ASCII, basic logic gates, monostable action and circuits, and bistables – including JK and D-type flip-flops. Multiple gate circuits, equivalent logic functions and specialised logic functions. Introduces sequential logic including clocks and clock circuitry, counters, binary coded decimal and shift registers. A/D and D/A converters, traffic light controllers, memories and microprocessors – architecture, bus systems and their arithmetic logic units. Sections on Boolean Logic and Venn diagrams, displays and chip types have been expanded in Version 2 and new sections include shift registers, digital fault finding, programmable logic controllers, and microcontrollers and microprocessors. The Institutional versions now also include several types of assessment for supervisors, including worksheets, multiple choice tests, fault finding exercises and examination questions.

FILTERS

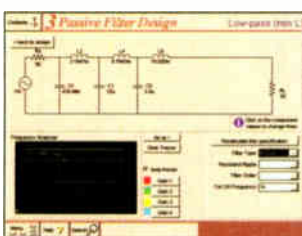

Filter synthesis

Filters is a complete course in designing active and passive filters that makes use of highly interactive virtual laboratories and simulations to explain how filters are designed. It is split into five chapters: **Revision** which provides underpinning knowledge required for those who need to design filters. **Filter Basics** which is a course in terminology and filter characterization, important classes of filter, filter order, filter impedance and impedance matching, and effects of different filter types. **Advanced Theory** which covers the use of filter tables, mathematics behind filter design, and an explanation of the design of active filters. **Passive Filter Design** which includes an expert system and filter synthesis tool for the design of low-pass, high-pass, band-pass, and band-stop Bessel, Butterworth and Chebyshev ladder filters. **Active Filter Design** which includes an expert system and filter synthesis tool for the design of low-pass, high-pass, band-pass, and band-stop Bessel, Butterworth and Chebyshev op.amp filters.

PRICES

Prices for each of the CD-ROMs above are:

(Order form on third page)

(UK and EU customers add VAT at 17.5% to "plus VAT" prices)

Hobbyist/Student£45 inc VAT
 Institutional (Schools/HE/FE/Industry).....£99 plus VAT
 Institutional 10 user (Network Licence)£199 plus VAT
 Site Licence.....£499 plus VAT

PICmicro TUTORIALS AND PROGRAMMING

HARDWARE

VERSION 2 PICmicro MCU DEVELOPMENT BOARD

Suitable for use with the three software packages listed below.

This flexible development board allows students to learn both how to program PICmicro microcontrollers as well as program a range of 8, 18, 28 and 40-pin devices. For experienced programmers all programming software is included in the PPP utility that comes with the development board. For those who want to learn, choose one or all of the packages below to use with the Development Board.

- Makes it easier to develop PICmicro projects
- Supports low cost Flash-programmable PICmicro devices
- Fully featured integrated displays – 13 individual I.e.d.s, quad 7-segment display and alphanumeric I.c.d. display
- Supports PICmicro microcontrollers with A/D converters
- Fully protected expansion bus for project work
- All inputs and outputs available on screw terminal connectors for easy connection

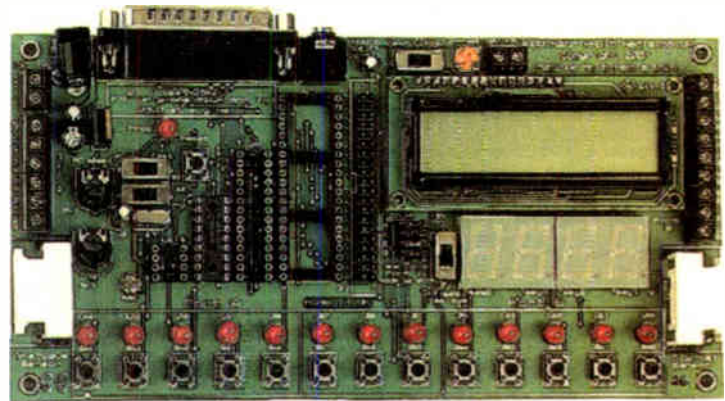

£145 including VAT and postage
12V 500mA plug-top PSU (UK plug) £7
25-way 'D' type connecting cable £5



SOFTWARE

Suitable for use with the Development Board shown above.

ASSEMBLY FOR PICmicro V2 (Formerly PICtutor)

Assembly for PICmicro microcontrollers V2.0 (previously known as PICtutor) by John Becker contains a complete course in programming the PIC16F84 PICmicro microcontroller from Arizona Microchip. It starts with fundamental concepts and extends up to complex programs including watchdog timers, interrupts and sleep modes. The CD makes use of the latest simulation techniques which provide a superb tool for learning: the Virtual PICmicro microcontroller. This is a simulation tool that allows users to write and execute MPASM assembler code for the PIC16F84 microcontroller on-screen. Using this you can actually see what happens inside the PICmicro MCU as each instruction is executed which enhances understanding.

- Comprehensive instruction through 39 tutorial sections
- Includes Vlab, a Virtual PICmicro microcontroller: a fully functioning simulator
- Tests, exercises and projects covering a wide range of PICmicro MCU applications
- Includes MPLAB assembler
- Visual representation of a PICmicro showing architecture and functions
- Expert system for code entry helps first time users
- Shows data flow and fetch execute cycle and has challenges (washing machine, lift, crossroads etc.)
- Imports MPASM files.

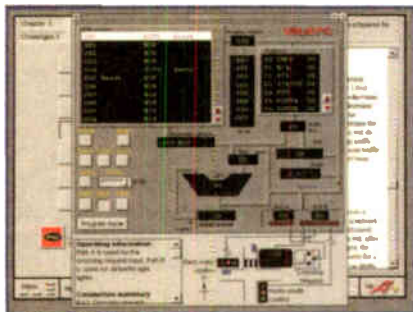

Virtual PICmicro

'C' FOR PICmicro

The C for PICmicro microcontrollers CD-ROM is designed for students and professionals who need to learn how to program embedded microcontrollers in C. The CD contains a course as well as all the software tools needed to create Hex code for a wide range of PICmicro devices – including a full C compiler for a wide range of PICmicro devices.

Although the course focuses on the use of the PICmicro microcontrollers, this CD-ROM will provide a good grounding in C programming for any microcontroller.

- Complete course in C as well as C programming for PICmicro microcontrollers
- Highly interactive course
- Virtual C PICmicro improves understanding
- Includes a C compiler for a wide range of PICmicro devices
- Includes full Integrated Development Environment
- Includes MPLAB software
- Compatible with most PICmicro programmers
- Includes a compiler for a wide range of PICmicro devices.

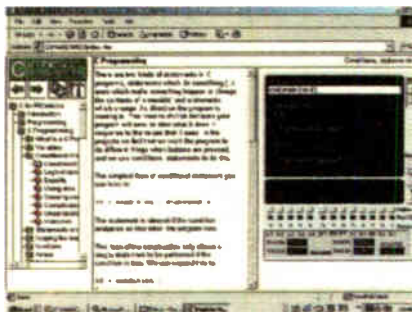

Minimum system requirements for these items: Pentium PC running Windows 95, 98, NT, 2000, ME, XP; CD-ROM drive; 64MB RAM; 10MB hard disk space.

FLOWCODE FOR PICmicro

Flowcode is a very high level language programming system for PICmicro microcontrollers based on flowcharts. Flowcode allows you to design and simulate complex robotics and control systems in a matter of minutes.

Flowcode is a powerful language that uses macros to facilitate the control of complex devices like 7-segment displays, motor controllers and I.c.d. displays. The use of macros allows you to control these electronic devices without getting bogged down in understanding the programming involved.

Flowcode produces MPASM code which is compatible with virtually all PICmicro programmers. When used in conjunction with the Version 2 development board this provides a seamless solution that allows you to program chips in minutes.

- Requires no programming experience
- Allows complex PICmicro applications to be designed quickly
- Uses international standard flow chart symbols (ISO5807)
- Full on-screen simulation allows debugging and speeds up the development process
- Facilitates learning via a full suite of demonstration tutorials and virtual systems (burglar alarms, car parks etc.)
- Produces ASM code for a range of 8, 18, 28 and 40-pin devices.

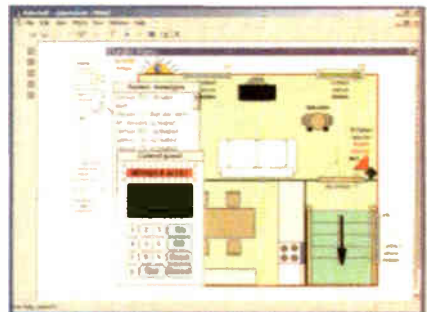

Burglar Alarm Simulation

PRICES

Prices for each of the CD-ROMs above are:

(Order form on next page)

(UK and EU customers add VAT at 17.5% to "plus VAT" prices)

Hobbyist/Student	£45 inc VAT
Institutional (Schools/HE/FE/Industry).....	£99 plus VAT
Institutional 10 user (Network Licence).....	£249 plus VAT
Site Licence.....	£599 plus VAT

TEACH-IN 2000 – LEARN ELECTRONICS WITH EPE



Resistor colour codes

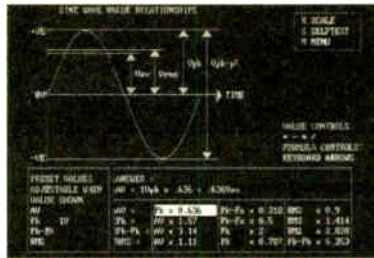

Sine wave relationship values



Op.amp demonstration

**FREE BOOK
WITH TEACH-IN
2000 CD-ROM**

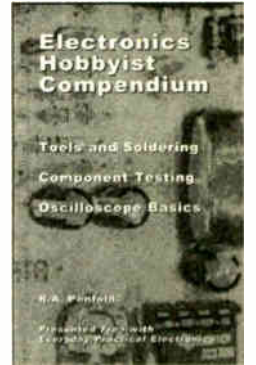

EPE's own *Teach-In* CD-ROM, contains the full 12-part *Teach-In* series by John Becker in PDF form plus the *Teach-In* interactive software covering all aspects of the series. We have also added Alan Winstanley's highly acclaimed *Basic Soldering Guide* which is fully illustrated and which also includes *Desoldering*. The *Teach-In* series covers: Colour Codes and Resistors, Capacitors, Potentiometers, Sensor Resistors, Ohm's Law, Diodes and L.E.D.s, Waveforms, Frequency and Time, Logic Gates, Binary and Hex Logic, Op.amps, Comparators, Mixers, Audio and Sensor Amplifiers, Transistors, Transformers and Rectifiers, Voltage Regulation, Integration, Differentiation, 7-segment Displays, L.C.D.s, Digital-to-Analogue. Each part has an associated practical section and the series includes a simple PC interface so you can use your PC as a basic oscilloscope with the various circuits.

A hands-on approach to electronics with numerous breadboard circuits to try out.

£12.45 including VAT and postage. Requires Adobe Acrobat (available free from the Internet – www.adobe.com/acrobat).

FREE WITH EACH TEACH-IN CD-ROM – *Electronics Hobbyist Compendium* 80-page book by Robert Penfold. Covers Tools For The Job; Component Testing; Oscilloscope Basics.

ELECTRONICS IN CONTROL

Two colourful animated courses for students on one CD-ROM. These cover Key Stage 3 and GCSE syllabuses. **Key Stage 3:** A pictorial look at the Electronics section featuring animations and video clips. Provides an ideal introduction or revision guide, including multi-choice questions with feedback. **GCSE:** Aimed at the Electronics in many Design & Technology courses, it covers many sections of GCSE Electronics. Provides an ideal revision guide with Homework Questions on each chapter. Worked answers with an access code are provided on a special website.

Single User £29 inc. VAT. Multiple User £39 plus VAT

Student copies (available only with a multiple user copy) £6 plus VAT
(UK and EU customers add VAT at 17.5% to "plus VAT" prices)

ELECTRONIC COMPONENTS PHOTOS

A high quality selection of over 200 JPG images of electronic components. This selection of high resolution photos can be used to enhance projects and presentations or to help with training and educational material. They are royalty free for use in commercial or personal printed projects, and can also be used royalty free in books, catalogues, magazine articles as well as worldwide web pages (subject to restrictions – see licence for full details). Also contains a FREE 30-day evaluation of Paint Shop Pro 6 – Paint Shop Pro image editing tips and on-line help included!



Price **£19.95** inc. VAT

MODULAR CIRCUIT DESIGN

VERSION 3

Contains a range of tried and tested analogue and digital circuit modules, together with the knowledge to use and interface them. Thus allowing anyone with a basic understanding of circuit symbols to design and build their own projects. Version 3 includes data and circuit modules for a range of popular PICs; includes PICAXE circuits, the system which enables a PIC to be programmed without a programmer, and without removing it from the circuit. Shows where to obtain free software downloads to enable BASIC programming. Essential information for anyone undertaking GCSE or "A" level electronics or technology and for hobbyists who want to get to grips with project design. Over seventy different Input, Processor and Output modules are illustrated and fully described, together with detailed information on construction, fault finding and components, including circuit symbols, pinouts, power supplies, decoupling etc.

Single User £19.95 inc. VAT. Multiple User £34 plus VAT
(UK and EU customers add VAT at 17.5% to "plus VAT" prices)

Minimum system requirements for these CD-ROMs: Pentium PC, CD-ROM drive, 32MB RAM, 10MB hard disk space. Windows 95/98/NT/2000/ME/XP, mouse, sound card, web browser.

Please send me:

CD-ROM ORDER FORM

- Electronic Projects
- Electronic Circuits & Components V2.0
- Analogue Electronics
- Digital Electronics V2.0
- Filters
- Digital Works 3.0
- Electronics CAD Pack
- Assembler for PICmicro
- 'C' for PICmicro
- Flowcode for PICmicro

Version required:

- Hobbyist/Student
- Institutional
- Institutional 10 user
- Site licence



- PICmicro Development Board (hardware)
- Development Board UK plugtop power supply
- Development Board 25-way connecting lead

- Teach-In 2000 + FREE BOOK
- Electronic Components Photos
- Electronics In Control – Single User
- Electronics In Control – Multiple User
- Modular Circuit Design – Single User
- Modular Circuit Design – Multiple User

Note: The software on each version is the same, only the licence for use varies.

Full name:

Address:

.....

..... Post code: Tel. No:

Signature:

I enclose cheque/PO in £ sterling payable to WIMBORNE PUBLISHING LTD for £

Please charge my Visa/Mastercard/Amex/Diners Club/Switch: £ Card expiry date:

Card No: Switch Issue No.

ORDERING

**ALL PRICES INCLUDE UK
POSTAGE**

Student/Single User/Standard Version
price includes postage to most
countries in the world
EU residents outside the UK add £5 for
airmail postage per order

**Institutional, Multiple User and Deluxe
Versions** – overseas readers add £5 to the
basic price of each order for airmail postage
(do not add VAT unless you live in an EU
(European Union) country, then add 17½%
VAT or provide your official VAT registration
number).

Send your order to:

**Direct Book Service
Wimborne Publishing Ltd
408 Wimborne Road East
Ferndown, Dorset BH22 9ND**

To order by phone ring

01202 873872. Fax: 01202 874562

Goods are normally sent within seven days

E-mail: orders@wimborne.co.uk

Online shop:

www.epemag.wimborne.co.uk/shopdoor.htm

SURFING THE INTERNET

NET WORK

ALAN WINSTANLEY

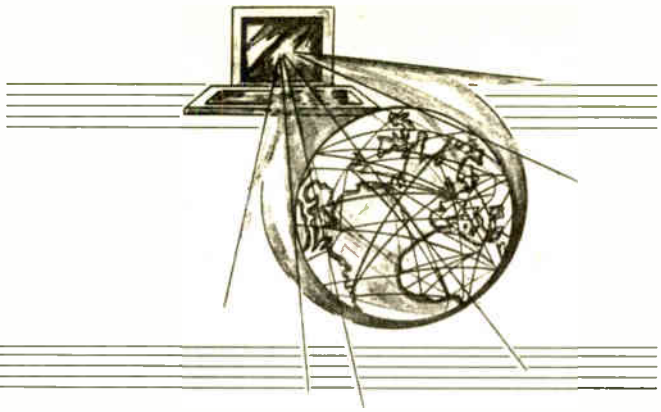

Welcome to Broadband Britain

MY thanks to Greg Newton of Sydney, Australia who wrote by email: "I've just read Net Work in the January issue and my heart goes out to you. It made me feel lucky. I sit here on the other side of the world, tucked away down under in Sydney, Australia getting your magazine and lots more via my way-cool (fast!) cable internet connection. It's connected 24x7 and is very reliable. Downloading a 2-CD Linux distribution takes about 10-15 minutes. The connection comes into a cheap router then a hub and is shared around the house via a wireless (802-11b) 11Mbps LAN... Alan, I hope things get better for you soon."

I welcome your sympathy, Greg, but at last there are signs of improvement in the UK. For many Internet users, dial-up 56k access is a serious bottleneck but it is the only feasible way of connecting to the Internet. From the end users' perspective, British Telecom (BT) has not exactly leaned over backwards to deliver broadband services to the masses, at least until now. They would rather you rented a second line for your modem, or install more expensive ISDN. This month's *Net Work* looks at the options starting to open up to Internet users in the UK as the connectivity "temperature" starts to rise quite dramatically.

Alternatives

What alternatives do you have if your 56k modem is too slow? ISDN is marginally faster and connects rapidly, but in practice it can prove more expensive, especially if a high number of shorter calls are made (remember BT's minimum 5p per call). To obtain 128k means placing two ISDN calls at the same time, which costs twice as much. I don't know anyone who relishes the cost or speed of ISDN.

Next up is cable access; if your region has been cabled up then you could buy a cable modem for your PC. Some cable TV users find that they have had a cable modem installed all the time; they just never knew what it actually was or how to connect it! Obviously, unless the cable network has been laid in your locality by e.g. Telewest or NTL, then this option is ruled out. As regular readers will know, in my case cable was laid approximately four years ago but it has yet to be switched on.

Satellite access is the next option, which offers roughly 400k download and 40k to 140k upload, but the cost of installing and running an unwieldy USB satellite modem (up to £1,000) will rule out this option for many. Both BT and Tiscali are testing satellite systems, and they will be perfect for those living in rural areas. A cheaper satellite option will involve using a satellite dish to download from the Internet while uploading is performed via a phone line.

Wireless access is another technology that is undergoing limited trials. In the future there will be BFWA – Broadband Fixed Wireless Access – operating in the 28GHz and 40GHz bands.

Last up is Asymmetric Digital Subscriber Line or ADSL which operates through your BT line. This offers up to 512kbps download or more if you can afford it. One of BT's problems has been to assess where to start the ADSL network upgrade to begin with. Some exchanges were upgraded by adding scores of ADSL ports but the uptake from the customer base was almost zero, so it has been very hard to plan the rollout. One major hurdle with ADSL is that its performance depends on how far away you are from the exchange in terms of "copper-wire miles". The rule is about three kilometres, but a new rate-adaptive system will extend this to say five kilometres of copper wire if your line passes the tests.

A future problem will be contention ratios – with typically 20 users sharing a 512kb ADSL connection for business tariffs, rising

to 50:1 on residential rates, you only need a few users setting up a live videoconferencing feed for example, and the rate of data throughput is likely to plunge. I expect I'll be writing about this problem in five or ten years' time.

The Need for Speed

In February 2002 some ISPs including ClaraNet and Pipex unexpectedly cut the cost of home ADSL services, and for heavier users ADSL suddenly started to appear a whole lot more feasible. Pipex were amongst the first to break loose and offer a service for home users priced at £24.99 (\$35) per month, and self-install products also came along.

It seems like the handbrake was released when wholesale broadband rates were cut by BT. This encouraged ISP's to price their ADSL services more realistically. There is hope yet, but there is still one fundamental problem, namely that BT owns the copper wires – the local loop – that connect into your home: a BT line is still necessary, so we all depend upon BT upgrading the exchanges for ADSL to begin with. Presently about 1,000 exchanges have been converted, having a catchment area of 63 per cent of homes.

In order to learn whether your postcode and phone number fall within an ADSL-enabled area, use the Fast Track Checker on BT's web site www.broadband1.bt.com/home/home.asp (note the digit "one" after broadband) after which you must still find an ISP who will offer you an ADSL tariff.

Estuary English

At a recent broadband seminar in Hull, BT was unable to show me what ADSL looked like or how fast it went because the telco. for the entire Hull area is Kingston Communications, not BT. The former city-owned company has managed to deliver broadband access into 110,000 homes around the city. For this reason the region has been dubbed the "silicon estuary" as the Humber estuary runs close by.

Kingston also claims to run the world's largest video server offering video on demand over its entire network, and some of the applications they are toying with are eye-watering, including security and CCTV delivered by broadband with the future potential for face recognition too. Other applications include online gaming and mobile delivery.

So broadband is finally creeping towards the centre stage. The paradox now is that actually, many users have been conditioned to 56k dialup and don't know that much better things are possible, so they can't see the need for faster speeds. The pressure is now on to develop attractive broadband content alongside the networks that carry it. In time you will be able to download music, monitor your remote security cameras, control your IP-enabled appliances – the central heating, the fridge and more – fetch massive software packages ten times more quickly, watch streaming videos, and record live TV to a hard disk and watch it from a remote system. And of course, broadband means that you are always connected to the Internet so you could finally run a webcam or videoconferencing, or use Voice Over IP to talk over a network to anyone anywhere in the world. Broadband will do this and a whole lot more.

Just under a decade ago my "information superhighway" consisted of me unwinding a telephone extension reel and plugging it into a phone socket next door, then trying to access the Internet on a treacherous phone line via a 14-4kbps modem inside a sprightly 486 PC. Now there is the prospect of TV, video, music, voice, security, real time gaming, powerful remote control and mobile Internet all delivered over a broadband network. The future contents of *EPE* may well include projects that utilise broadband communications at their heart. Interesting and exciting times are ahead! You can email me at alan@epemag.co.uk

TEACH-IN 2002

Part Eight – Filters, Actuators, Smoke and Gas Detection

IAN BELL AND DAVE CHESMORE

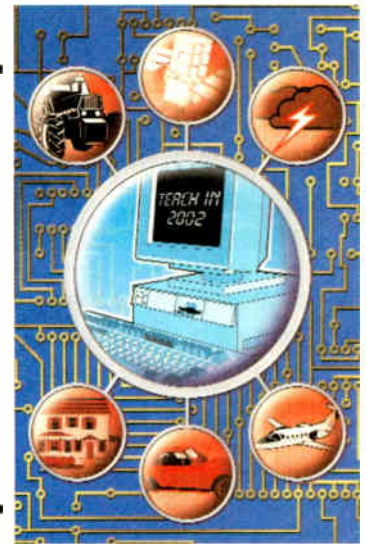

Making Sense of the Real World: Electronics to Measure the Environment

MOST of the sensing we have discussed so far in this series has been passive measurement of one parameter or another. However, we are not restricted to this approach; we may if we wish send a signal out into the environment and monitor the response with a sensor. We can call this a **sensor-actuator** combination (an actuator is something that does something or sends out a stimulus).

Our hands and feet are actuators and eyes and ears are sensors, but we can also use a combination approach. For example, we can “measure” the properties of a material by squeezing it and feeling and watching the response.

This month we will be briefly examining the idea of sensor-actuator combinations – we could have written an entire series on this topic so we only have space to look at it briefly. We will also be investigating sensors for smoke and gas, though we examine filters first.

FILTERS

Electronic filters are circuits that pass signals at certain frequencies (in the **pass-band**) while rejecting signals at other frequencies (in the **stop-band**). The frequency that divides the pass-band from the stop-band is a **cut-off frequency**.

Filters constructed from just resistors, capacitors and inductors are called **passive filters**, whereas filters that employ devices such as transistors or op.amps are called **active filters**.

We can make very good passive filters, but inductors are often bulky and expensive. They are also limited by non-ideal characteristics such as series resistance, and are susceptible to magnetic pickup of interference.

Filters using just resistors and capacitors cannot be used to make high performance filters due to their “soft” response and the high attenuation of the signal they cause. However, we do not always need high performance filters; a single resistor and capacitor filter occurs in many circuits. We have used this in many *Lab Work* circuits in previous parts of *Teach-in 2002*.

Filters can be classified according to the pass-band:

- **Low-pass** filters let low frequencies through
- **High-pass** filters let high frequencies through
- **Band-pass** filters let a specific range of frequencies through
- **Band-stop** filters reject a specific range of frequencies

As we will see next month, low-pass filters are of particular importance when we want to convert analogue sensor data into digital for computer storage or analysis. **Bandpass** filters are needed for the technique described above where we measure the response to stimulus at a particular frequency. A **notch filter** is a band-stop filter with a very narrow stop-band, which can be useful where our sensor signal is subjected to interference at specific frequencies (such as mains 50Hz/60Hz).

FILTER CHARACTERISTICS

The graph of gain (in dB) against frequency (on a logarithmic scale) is called the **frequency response** of the filter, an example of which is shown Fig.8.1. For an ideal filter the transition from pass-band to stop-band occurs at a single frequency. For real filters (see Fig.8.1) the transition from pass-band to stop-band occurs over a range of frequencies, thus the we need to define specifically what we mean by **cut-off frequency**.

The cut-off is usually defined to be the point where the filter’s gain is -3dB with respect to the pass-band gain. Other definitions could be used, particularly for responses where the pass-band gain is not flat.

The stop-band may also be specifically defined in terms of reduction in gain, although there is not a “standard” gain reduction for stop-band as there is with the -3dB point for cut-off. The range of frequencies between the pass- and stop-bands is the transition region.

If the pass-band gain does not vary much with frequency, it is described as **flat**. In some filters the pass-band gain has distinctive ripples as frequency varies, the depth of these ripples is usual-

ly measured in decibels. The stop-band may also have ripples.

In sensor applications where the frequency of the sensed signal varies and signal magnitude is of importance, a filter without a flat pass-band may lead to measurement errors.

The slope of the frequency response in the transition region, and possibly the stop-band, indicates how quickly the filter’s gain drops as the frequency moves away from the cut-off. The slope is measured in dB per octave, or dB per decade; this value is called the **fall-off** or **roll-off**.

The fall-off may be different near and far from the cut-off, thus we have *initial* fall-off and *ultimate* fall-off. Note that an octave is a range of frequencies in which the higher frequency is twice the lower (the same term is used in music). A decade is a range in which the upper value is ten times the lower.

The order of a filter determines the ultimate fall-off and can be calculated as $6n\text{dB/octave}$ (or $20n\text{dB/decade}$), where n is the filter order. For a first order filter this is 6dB/octave ; for a second order filter it is 12dB/octave , and so on.

The variation of **phase shift** with frequency (the phase response) is also an important characteristic of filters. Phase shift relates to the time delay of signals passing through the filter. If the delay is different at different frequencies the signal will be distorted. Constant delay

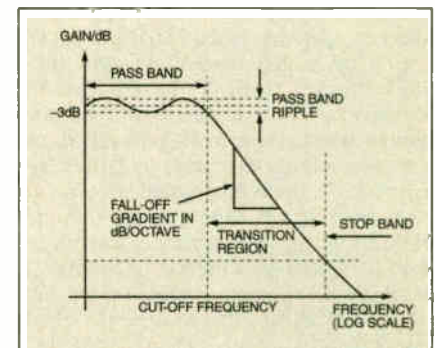

Fig.8.1. Describing a filter’s frequency response.

corresponds with a linear increase of phase shift with frequency. The terms constant-delay, or linear-phase are used to refer to filters that are ideal or have very good performance in this respect.

The time domain response of a filter can be obtained by applying a step change to the input (e.g. a sudden change from 0V to some other voltage). The response may have a number of features which are illustrated in Fig.8.2. The terms used can be defined as:

- **Rise time** is the time to get from 10 per cent to 90 per cent of the final value.
- **Overshoot** is the percentage of maximum value over the final value.
- **Ringing** is the decaying oscillation that may occur as the output settles to its final value.
- **Settling time** is the time the output takes to get within certain small percentage of final value. Settling time may be of importance in high speed sensor applications as we may not be able to get an accurate reading until the circuit has settled.

FILTER TYPES

Filter design is a compromise between requirements such as pass-band flatness, sharpness of cut-off, delay flatness (phase linearity), rise time, overshoot, etc. A number of well-known filter types provide different properties. Butterworth filters have a very flat gain response in the pass-band. Chebyshev filters have a very steep transition from pass-band to stop-band but have ripples (or a resonant peak) in the pass-band gain. Bessel filters have very good phase linearity.

There are many circuit configurations for active filter circuits, with variants for high-pass, low-pass, band-pass etc. We certainly do not have space to look at all of them in detail here! As an example, we have chosen an equal component Sallen and Key second order low-pass filter (see Fig.8.3), which can be set up to provide a variety of types of response as shown in Fig.8.4. Here you can see the flat, but relatively steep, response of the Butterworth filter, and resonant peaks in the Chebyshev responses.

The Sallen and Key part of the name comes from names of the engineers who first described it and the "equal component" bit refers to the fact that the two frequency selection capacitors and resistors have the same value (labelled R and C on the schematic).

The high-pass version of the circuit is obtained by swapping the locations of R

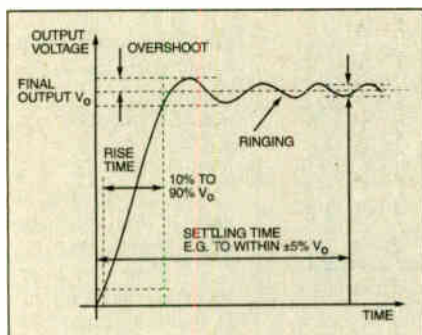

Fig.8.2. Filter time domain response.

and C. Sallen and Key filters are examples of a more general class of filters called single amplifier biquadratic (SAB) filters. Biquadratic (*biquad* for short) is a term relating to the mathematics behind the filter characteristics.

SELECTING COMPONENT VALUES

To complete the design of a filter, first select your cut-off frequency, f_c . Then choose the type of filter you want (Bessel, Butterworth etc., depending on the response shape required) based on the characteristics of each type.

Using a table, such as that in Table 8.1, establish the damping factor ζ (Greek letter xi) and the resonant frequency f_0 . The damping factor in this context states the filter's ability to respond without ringing occurring. Tables of filter parameter values are published in cook-books on filter design.

You are now ready to find the actual component values. Select the values of R and C to give the required resonant frequency f_0 . Resistor values of around 10k Ω are appropriate, but higher values (e.g. 100k Ω) may be better for low cut-off frequencies as the size of the capacitors is reduced. Use:

$$f_0 = \frac{1}{2\pi RC} \text{ so } C = \frac{1}{2\pi R f_0}$$

So, for example, if we want a Butterworth filter with a cut-off frequency of 1kHz (and the same resonant frequency) and we decide to use 10k Ω resistors, we need capacitors of value 0.016 μ F.

The value of ζ sets the gain required from the amplifier and hence the values of the op.amp feedback resistors. These values can be set completely independently of the frequency component values, but the best value for R_A is one that gives about the same resistance seen at the inverting and non-inverting inputs.

This happens when the parallel combination of the gain resistors equals the series combination of the frequency resistors. From which we get the best value for R_A as

$$R_A = \frac{(3 - 2\zeta)}{(1 - \zeta)} R$$

Hence, for example, if the frequency-setting resistors are both 10k Ω and we

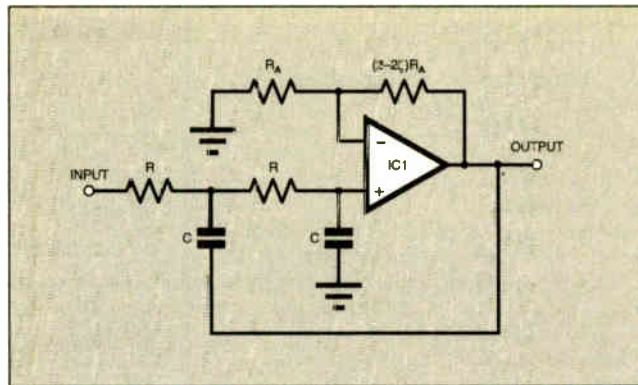

Fig.8.3. Equal component Sallen and Key second order low-pass filter circuit.

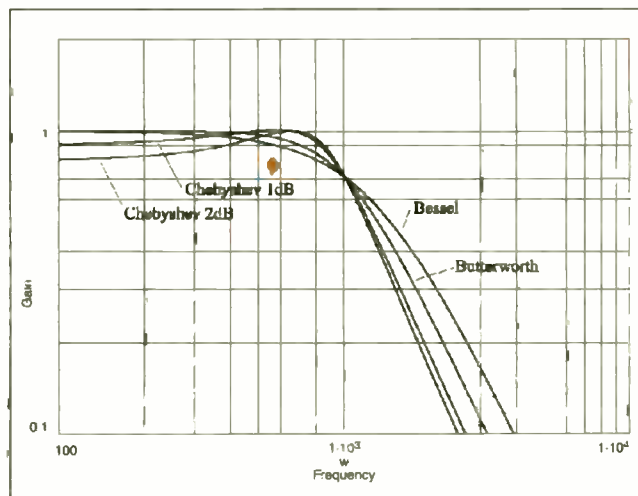

Fig.8.4. Typical responses from a second order Sallen and Key low-pass filter.

want $\zeta = 0.707$, we get the best value for R_A as about 54k Ω . Calculate the other resistor value using $(2 - 2\zeta)R_A$ (e.g. 32k Ω for $\zeta = 0.707$ and $R_A = 54k\Omega$).

If the "best value" for R_A is not close to a preferred value it does not matter if you change it a bit, but given your value for R_A the other gain resistor must be as close as possible to $(2 - 2\zeta)R_A$ in order to get the right filter characteristic.

FILTER DESIGN GUIDELINES

The gain due to op.amp IC1 (Fig.8.3) is set to $(3 - 2\zeta)$ by the damping factor, ζ . If you need a specific gain, say G, add an ordinary op.amp amplifier with gain $G/(3 - 2\zeta)$. This could be at the input to provide the d.c. bias path for the filter and act as a buffer for the input signal (see later).

The filter gain should not usually be much greater than 2, above this we get a very high Q but the circuit response becomes very sensitive to component values.

Table 8.1 – Parameters for 2nd order low-pass Sallen and Key filter. f_c is -3dB (cutoff) frequency. The frequency responses of these filters are shown in Fig.8.4.

Characteristic	Name	Resonant Frequency (f_0)	Damping (d or 2ζ)
Best Delay	Bessel	1.274 f_c	0.866
Flattest Pass-band	Butterworth	1.000 f_c	0.707
1dB Ripple	Chebyshev	0.863 f_c	0.523
2dB Ripple	Chebyshev	0.852 f_c	0.448

The input to the filter must have a reasonably low impedance d.c. path to ground (i.e. it should *not* be directly capacitively coupled to the input signal). This is in order to make sure that the op.amp is provided with bias current. If your signals are large, make sure that the input signal will not saturate the op.amp.

If you want your filter to deal with relatively high frequency (tens to hundreds of kilohertz) or large magnitude (several volts) then there is an op.amp parameter you need to take note of.

Slew rate specifies the maximum rate of change of output voltage for an op.amp. The higher the frequency and the larger the signal magnitude, the faster the op.amp output has to change to "keep up with" the required output signal. If this speed exceeds the op.amp's slew rate the op.amp will fail to keep up, resulting in distortion of the signal.

If the required peak output voltage is V_M and the slew rate is s (in volts per second, from the op.amp's datasheet) then the maximum frequency sinewave that can be output without distortion is:

$$f = \frac{s}{2\pi V_m}$$

For example, for a slew rate of $2V/\mu s$ and $V_M = 15V$, the maximum frequency is 21kHz, not a particularly high one. The slew rate of the OP177 op.amp is quite low at $0.3V/\mu s$ (the 741 is $0.5V/\mu s$). This is because the device is optimized for very accurate processing of relatively low level and low frequency signals.

Far faster op.amps are available if you need them; in fact, we need to use an LF351 ($13V/\mu s$) to amplify the output of the sinewave generator in Lab 8.1 because it has a reasonable gain. You could easily see the effect of slew rate by exchanging the LF351 in Lab 8.1 for an OP177 and varying the frequency of the sinewave.

COMPUTER AIDED DESIGN

There are a number of low cost and even free software packages available for the design of filters. These remove the need for laborious calculations and searching of filter parameter tables, and of course it is very quick if you want to change one or two parameters.

With such software packages you often have the further advantage of getting the schematics and responses drawn for you. A screenshot from a free package called Filter Free from Nuhertz Technologies (www.nuhertz.com) is shown in Fig. 8.5.

The filter schematic and response curves resulting from the design parameters in Fig. 8.5 are shown in Figs. 8.6 and 8.7. Note that this circuit is a single amplifier biquad and is in fact a Sallen and Key filter, but without the simplifying "equal component" feature which our previous circuit had in order to make manual design easier.

SWITCHED CAPACITOR FILTER

It is fairly obvious that the circuit becomes quite complex if we need high order filters (one op.amp and at least four components for each second order filter).

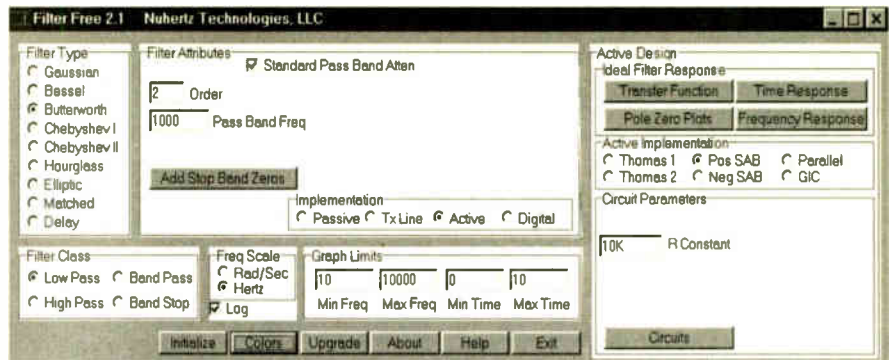

Fig.8.5. Example filter design software.

There is, however, an alternative solution – a **switched capacitor filter**. A switched capacitor filter uses analogue switches to rapidly switch between two different capacitors – controlling the duty cycle changes the effective capacitance.

Such devices allow fine control of capacitor values and can be manufactured on silicon. There are many integrated circuit filters from Linear Technology, Maxim, etc. available as low-pass, high-pass, band-pass filters, even Butterworth, Chebyshev, etc. They have many advantages, including small size, programmability and ease of use. However, they suffer from one problem – their need for clocking to control the capacitor switching. The clock, often 100 times the cut-off frequency, can appear at the output of the filter, albeit at low levels, and can interfere with low level signals.

The device we will be using in Lab 8.1 is an LTC1062 from Linear Technology which is a 5th order maximally flat (Butterworth) low-pass filter with an internal clock. The ratio of clock to cut-off frequency is 100:1 and can be generated externally from an oscillator or even a microcontroller. This means we can vary the cut-off frequency. The i.c. itself is 4th order and an additional RC section is added to provide the 5th order. A full datasheet can be found at www.linear.com/pdf/l1062.pdf.

SENSORS AND ACTUATORS

In electronic sensing the sensor-actuator combination is often used to make it easier to ignore interference signals – we know the properties of the signal we sent out so we can ignore irrelevant parts of the sensor response. The most obvious example is to use a stimulus at a particular frequency and

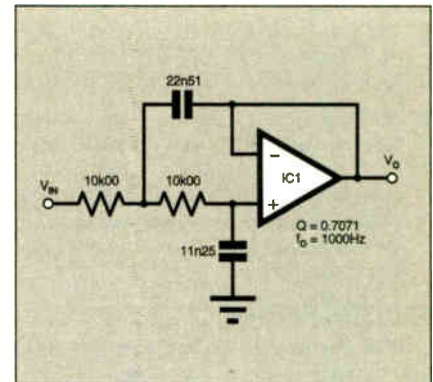

Fig.8.6. Single amplifier biquad Sallen and Key filter.

only measure responses from the sensor at that frequency. In order to extract the frequency of interest we need filter circuits, which, as you have seen, is one of our topics this month.

Next month we see that filters are also very important when we want to digitize the signals from sensors for processing by a microcontroller or computer.

Sensor actuator combinations are essential for some measurement processes. For example, we may need to apply heat or electrical signals to a substance for chemical sensing. Indeed, many gas sensors need to be heated to around $350^{\circ}C$ and this is best achieved if the heating controller is actively controlled so that any deviations from the optimum temperature are counteracted.

The simplest way of achieving this is to feed back the difference between the sensor's actual temperature and its desired temperature in such a way as to reduce the difference to zero. Any changes in sensor temperature are detected and the optimum temperature is reached.

A simpler and more familiar feedback circuit is in controlling the temperature of a room where the heater is turned on until the desired temperature is reached, when it is turned off. This is a simple on-off control and is suitable for many applications.

We often need more accurate control where, as above, the difference is fed back and the output is a function of the

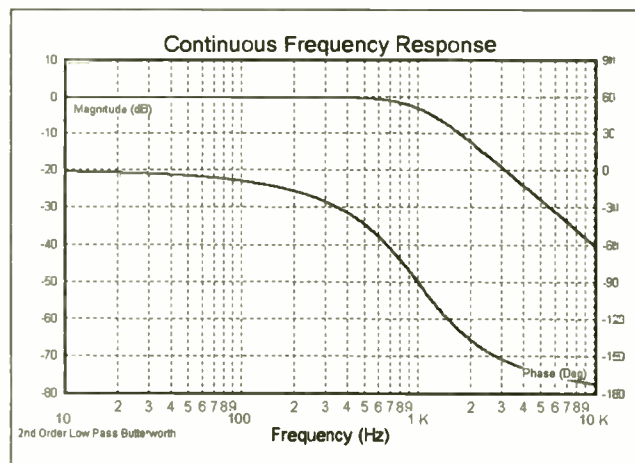

Fig.8.7. Frequency response of the circuit in Fig.8.6.

difference. So, in the heater example, we would vary the amount of power to the heater depending on the difference – the larger the difference, the more power applied. Feedback control is found just about everywhere, from controlling the speed of an engine, to an autofocus on a camera.

SMOKE DETECTORS

Everyone is familiar with smoke detectors, but how do they work? There are actually two basic types – photoelectric and ionization detectors.

The most common form of photoelectric smoke detector relies on the detection of light scattered from smoke particles. The principle of light scattering is also used in measuring the turbidity (cloudiness) of water, an important factor in many aquatic applications. Such an instrument is called a **Nephelometer** and is widely used in the water industry.

The way in which light is scattered by small particles is quite complex and involves the size of the particle and the wavelength of light (remember the equation relating wavelength, frequency and speed, $\lambda = fc^{-1}$ where f is the frequency and c the speed of light, $\approx 3 \times 10^8 \text{ms}^{-1}$).

Basically, the shorter the wavelength in comparison to the size of the particle, the more the light is scattered. In fact, if the particle size is smaller than the wavelength, the amount of scattering increases by the fourth power of the wavelength, and short wavelengths are scattered much more than longer wavelengths.

This explains why the sky is blue and the setting sun is red – blue light is scattered from air molecules much more than red light and it is scattered sideways so the sky looks blue. At sunset, the light from the sun has to pass through more atmosphere and the blue is scattered even more, increasing its apparent red content. If you look carefully at the sky when the sun is on the horizon, you will actually see all the colours ranging from red to violet as you look further away from the sun. (Never look directly at the sun.)

At the opposite extreme, when the particles are much larger than the wavelength of light, all wavelengths are scattered equally. This is why thin clouds appear to be white. When a cloud becomes very thick, the light is attenuated and it becomes grey.

PRACTICAL TEST

One of the best ways of illustrating the idea of light scattering is to use a torch and two glasses of water. Put a couple of drops of milk into one glass of water. If you look through the glass at right angles to the torch beam, you will not be able to see the beam in the glass only containing water, but will see it in the water-milk mixture. Try increasing the number of drops of milk and see the effect.

In addition to the effect of particle size on scattering, the chemical nature of particles also changes the amount of scatter. This has application in monitoring of gases emitted from chimneys, which can be carried out at a distance using a telescope and laser, as indicated in Fig.8.8.

The laser illuminates the pollution cloud and light scattered back from particles is detected by sensitive detectors in the telescope. The chemical makeup of the cloud can be found out from the received signal. It is also possible to plot the pollution in the cloud by moving the telescope

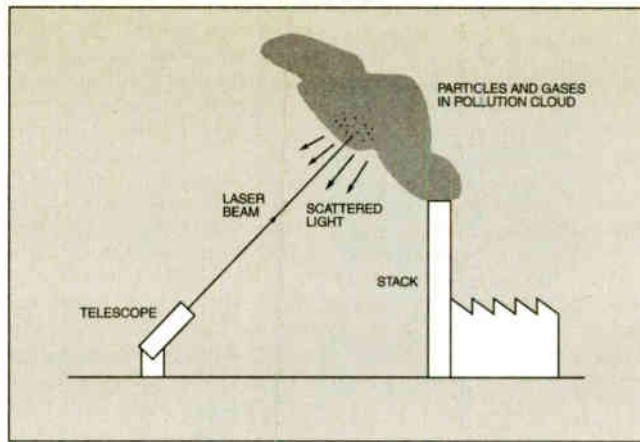

Fig.8.8. Principle of a LIDAR system.

and measuring the time taken for each laser pulse to return (the longer the time, the further away the scattering particles). This system is known as a **LIDAR**, which stands for Laser Radar.

PHOTOELECTRIC SMOKE DETECTORS

The principle of operation of a photoelectric smoke detector is simple, as shown in Fig.8.9 where a beam of light (usually infra-red – IR) is passed along a tube and a photodiode is placed at right angles to the beam. Under normal conditions, the photodiode will not pick up any light, but if smoke is present, the light is scattered by the smoke particles and the photodiode will detect the light.

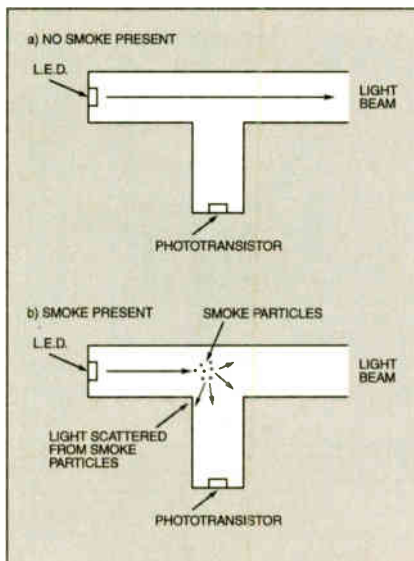

Fig.8.9. Photoelectric smoke detector.

Photoelectric smoke detectors are commercially available but are not as common as the ionization chamber devices. We discuss the building a simple photoelectric smoke detector in this month's *Lab Work*.

As said earlier, smoke is detected by light being scattered. Detecting small changes in light can be difficult, especially if there is a lot of ambient light around. We can reduce the ambient light in two ways – placing the whole detector in a dark box or using IR light. The problem with a dark box is that we need to allow smoke to enter but not light!

To use IR is the best option since IR detectors are usually encased in a black

package which is opaque to visible light but transparent to IR light. Even so, we need to reduce the overall light to a minimum because there is usually quite a lot of ambient IR light around.

In the Lab, we will be building a sensor from discrete components and some digital circuits. If we wished, we could have used commercially available integrated circuits which contain all circuitry including

piezo-buzzer drivers. Examples are the Motorola MC145010 and Allegro A5366 (both functionally identical). All they need are a few resistors and capacitors, and an IR l.e.d. and photosensor. They are also capable of being interconnected (e.g. 40 on a common signalling bus).

IONIZATION CHAMBER DETECTORS

Ionization chamber detectors are very different from photoelectric detectors and they rely on detecting changes in a current caused by a radiation source. The schematic diagram of a typical ionizing chamber is shown in Fig.8.10, consisting of a radioactive source and two plates across which is a voltage.

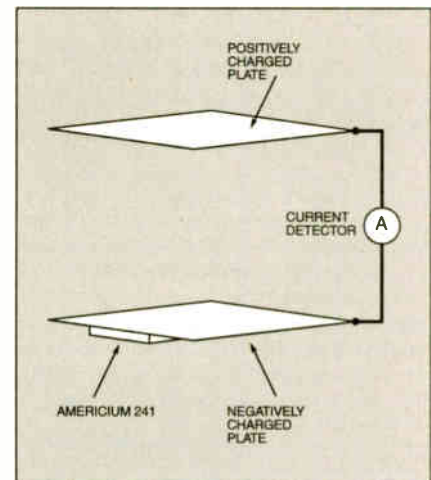
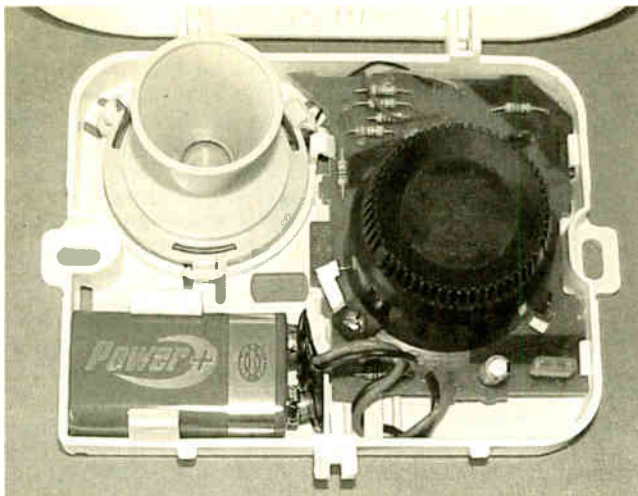

Fig.8.10. Ionization chamber.

The principle of operation is as follows. The radioactive source (a very small quantity of Americium-241) produces alpha particles which are helium nuclei. These particles ionize air molecules within the chamber by knocking electrons of the atoms, causing them to have a positive charge, the free electrons being attracted to the positive plate and the ions to the negative plate. A current is therefore created which is amplified by electronics. When smoke particles enter the chamber the ion current is disrupted and the electronics detect the drop in current.

Ionization chamber detectors are more sensitive than photoelectric detectors and are completely safe. The amount of radioactive material is very small, typically $200\mu\text{g}$ and even a piece of paper will completely absorb alpha particles. The only thing you should



Left: Example of a smoke detector for domestic use.

not do is disturb the Americium and cause it to become airborne.

GAS SENSORS

Gas detection and monitoring has taken on an ever-increasing importance due to the awareness of the damaging effects that some volatile gaseous compounds have on the environment and our health. There are many gas sensors available and Capteur provides a good range. Table 8.2 gives examples of some sensors and their sensitivity. Full details can be found on the Capteur website www.capteur.co.uk.

Another company, Figaro Inc., has been in the business for more than 30 years and details of their sensors can be found at www.figarosensor.com. Sensor cost is quite high, from £10 to over £25 depending on the gas to be detected. The sensor we will be using next month is about £10 and is capable of detecting a range of gases, as we will see later.

The range of gases for which sensors are available is very large, ranging from combustible gases such as methane, propane and hydrogen through toxic gases (chlorine, carbon monoxide) to organic solvents such as alcohol, toluene and xylene.

How do they work? There are several types depending on the material used. The simplest types utilizing a special tin dioxide semiconductor coated on a ceramic tube. The conductivity of the tube varies in

response to its exposure to a wide range of detectable gases.

These sensors need to be heated to operate and they incorporate an internal heating element which must be maintained at 350°C or so, depending on the sensor. The most common circuit used is a bridge where the sensor forms one arm of the bridge. The other arm of the bridge is either an accurate resistor or a compensator. In fact, the sensor we will be using next month comprises two separate devices – a sensor and a compensator.

USING GAS SENSORS

Many gases are heavier than air so the sensors are best placed low down when general monitoring is being undertaken;



Example of a gas sensor from Figaro.

Table 8.2 Some Gas Sensors from Capteur and Figaro

Gas	Concentration Range (Capteur)	Concentration Range (Figaro)
Ammonia	0-100ppm	30-300ppm
Carbon Monoxide	0-400ppm	50-1,000ppm
Hydrogen	0-10,000ppm	50-1,000ppm
LPG	0-1%	500-10,000ppm
Methane	0-1%	500-10,000ppm
Ozone	0-300ppb	–
Propane	0-1%	500-10,000ppm
VOCs (volatile organic compounds)	0-10ppm	–
Oxygen	–	0-100%

ppb = parts per billion (10⁸) ppm = parts per million (10⁶)

different sensors can be selected for an improved response to particular gases. The ability to respond to carbon monoxide also means that some sensors will respond well to smoke, acting as a smoke or fire alarm.

One disadvantage is that the heater element draws a high current, e.g. the Figaro TGS813 needs typically 160mA or more at 5V, and they are also easily damaged by the presence of some chemicals, including silicone and salts (boat owners take note).

Sensors incorporate a fine stainless steel mesh which acts as a flame arrestor. You are probably aware of the principle of intrinsic safety by which a gas detector system is designed in such a way that it cannot create a spark or ignition hazard anywhere, or cause an explosion when a flammable gas is detected.

Ignition sparks can be caused in many different ways, including the arcing of electrical switches or relay contacts, faulty insulation, loose plugs and sockets, the operation of electric buzzers or even static electricity discharge from nylon clothing. Sources of ignition also include light fittings (fluorescent and incandescent) and electric heaters.

For this reason, if ever you detect a gas leak, you should never turn any electric lights on or off (including torches/flashlights) or operate any electrical item, because any sparks may cause an explosion. Likewise, mobile phones are banned from use at petrol filling stations in case the high frequency transmissions induce sparks in electrical equipment and cause a fire in any pockets of gas.

TEACH-IN 2002 – Lab Work 8

DAVE CHESMORE

FILTER AND SMOKE DETECTOR EXPERIMENTS

Lab 8.1 Signal Generator

In this Lab we build a sinewave generator so that we can test the filter circuits in Labs.8.2 to 8.5 and to illustrate aliasing which will be described in Part 9. The circuit in Fig.8.11 is based on an Intersil ICL8038 waveform generator (IC1). This device is easy to use and can generate sine,

square and triangular waves between 0.001Hz and 300kHz. A full descriptive datasheet for the 8038 can be downloaded from www.intersil.com/data/FN/FN2/FN2864/FN2864.pdf.

You could alternatively use a Maxim MAX038 instead as it is pin-compatible with the 8038 but operates up to 20MHz.

However, here we are only interested in audio frequencies and the circuit has been designed to operate up to 20kHz.

Op.amp IC2 provides gain and output buffering since the sinewave output has a relatively high impedance. It is connected to the 8038 via potentiometer VR3 which allows the output amplitude to be varied.

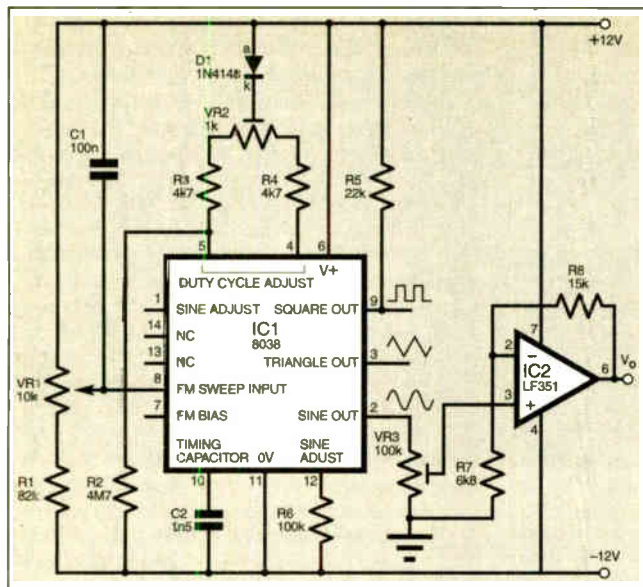

Fig.8.11. Signal generator circuit.

Notice that IC2 is a type LF351 – this is a wide bandwidth op.amp (high slew rate).

Later, if you want to see why this device is recommended, try replacing it with an OP177 or 741 and increase the frequency to 10kHz or more. The op.amp's output will become a triangular wave instead of a sinusoidal one, due to the low slew rate of the amplifier (see Tutorial section).

ASSEMBLY

Build the circuit of Fig.8.11 on breadboard or, alternatively on stripboard if you wish to make a more permanent circuit (see photograph). There are three potentiometers, which control frequency (VR1), duty cycle (VR2) and output amplitude (VR3).

Once the circuit is built, set VR1 and VR3 to halfway (VR3 in our circuit is a preset). Connect the Picoscope and check to see that the waveform looks like that in Fig.8.12. You will notice that it doesn't actually look particularly sinusoidal because of the steps – we will explain this next month.

The shape can be altered with VR2 – adjust it until the shape is as close to a sinusoid as possible. The next stage is to calibrate VR1, at least at the low frequency end by measuring the frequency with the Picoscope and noting the wiper position. Be aware that at very low frequencies, the output becomes non-sinusoidal as the positive peaks become flattened.

Whilst all we need is the sinewave output, the circuit is versatile and you could add a three way switch to allow selection of sine, triangle or square wave and change VR3 to a panel mounting potentiometer to give easier control of the output amplitude.

Lab 8.2 Low-pass Filters

In Fig.8.13 is shown the circuit for a Butterworth second order low-pass filter based on the Sallen and Key filter described in this month's tutorial section. The cut-off frequency is set at approximately 1kHz. Build the circuit and test it using the signal generator from Lab 8.1 and the Picoscope to measure the output signal.

Set the signal generator's output amplitude to about 6V peak-to-peak. The filtered

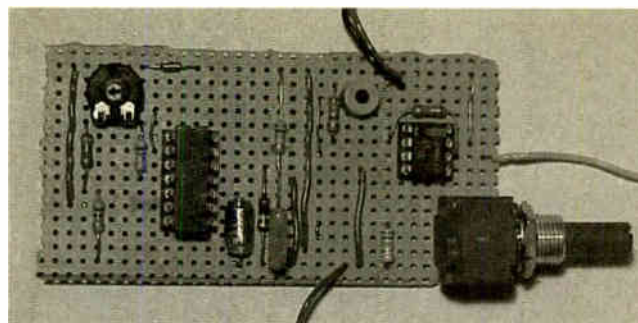

Stripboard assembly for the signal generator circuit in Fig.8.11.

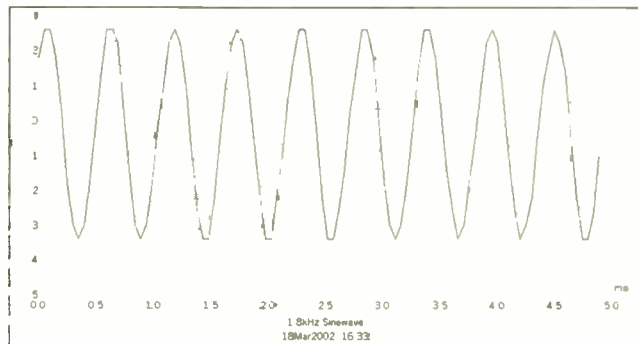

Fig.8.12. Sinewave output of the signal generator at 1.8kHz, as viewed on the Picoscope

COMPONENTS

Approx. Cost Guidance Only £23 excl. hardware

<h3 style="text-align: center; margin: 0;">Lab 8.1 Signal Generator</h3> <p>Resistors</p> <table border="0"> <tr><td>R1</td><td>82k</td></tr> <tr><td>R2</td><td>4M7</td></tr> <tr><td>R3, R4</td><td>4k7 (2 off)</td></tr> <tr><td>R5</td><td>22k</td></tr> <tr><td>R6</td><td>100k</td></tr> <tr><td>R7</td><td>6k8</td></tr> <tr><td>R8</td><td>15k</td></tr> </table> <p>All 0.25W, 5% carbon film</p> <p>Potentiometers</p> <table border="0"> <tr><td>VR1</td><td>10k rotary carbon lin.</td></tr> <tr><td>VR2</td><td>1k min. carbon preset</td></tr> <tr><td>VR3</td><td>100k min. carbon preset</td></tr> </table> <p>Capacitors</p> <table border="0"> <tr><td>C1</td><td>100n polyester</td></tr> <tr><td>C2</td><td>1n5 polyester</td></tr> </table> <p>Semiconductors</p> <table border="0"> <tr><td>D1</td><td>1N4148 signal diode</td></tr> <tr><td>IC1</td><td>ICL8038 waveform generator (see text)</td></tr> <tr><td>IC2</td><td>LF351 bifet op.amp</td></tr> </table> <p style="text-align: center;">Lab 8.2 Low Pass Filters</p> <p>Resistors</p> <table border="0"> <tr><td>R1, R2,</td><td></td></tr> <tr><td>R5, R6</td><td>1k5 (4 off)</td></tr> <tr><td>R3, R7</td><td>15k (2 off)</td></tr> <tr><td>R4, R8</td><td>18k (2 off)</td></tr> </table> <p>Capacitors</p> <table border="0"> <tr><td>C1 to C4</td><td>100n polyester (4 off)</td></tr> </table> <p>Semiconductors</p> <table border="0"> <tr><td>IC1, IC2</td><td>LF351 bifet op.amp (or LF353 dual bifet op.amp)</td></tr> </table>	R1	82k	R2	4M7	R3, R4	4k7 (2 off)	R5	22k	R6	100k	R7	6k8	R8	15k	VR1	10k rotary carbon lin.	VR2	1k min. carbon preset	VR3	100k min. carbon preset	C1	100n polyester	C2	1n5 polyester	D1	1N4148 signal diode	IC1	ICL8038 waveform generator (see text)	IC2	LF351 bifet op.amp	R1, R2,		R5, R6	1k5 (4 off)	R3, R7	15k (2 off)	R4, R8	18k (2 off)	C1 to C4	100n polyester (4 off)	IC1, IC2	LF351 bifet op.amp (or LF353 dual bifet op.amp)	<div style="text-align: center; font-size: 1.2em; font-weight: bold; margin-bottom: 10px;">See SHOP TALK page</div> <h3 style="text-align: center; margin: 0;">Lab 8.4 Switching Filter</h3> <p>Resistors</p> <table border="0"> <tr><td>R1</td><td>56k</td></tr> <tr><td>R2</td><td>22k</td></tr> <tr><td>R3</td><td>680k</td></tr> <tr><td>R4, R5</td><td>27k (2 off)</td></tr> </table> <p>All 0.25W 5% carbon film</p> <p>Capacitors</p> <table border="0"> <tr><td>C1</td><td>1n5 polyester</td></tr> <tr><td>C2, C3</td><td>10n polyester (2 off)</td></tr> <tr><td>C4</td><td>10µ elect. 16V</td></tr> </table> <p>Semiconductors</p> <table border="0"> <tr><td>IC1</td><td>4093 quad Schmitt trigger NAND Gate</td></tr> <tr><td>IC2</td><td>LTC1062 5th order switched capacitor low pass filter</td></tr> </table> <p style="text-align: center;">Lab 8.5 Photoelectric Smoke Detector</p> <p>Resistors</p> <table border="0"> <tr><td>R1, R5, R8</td><td>1k5 (3 off)</td></tr> <tr><td>R2</td><td>1k</td></tr> <tr><td>R3</td><td>12k</td></tr> <tr><td>R4</td><td>470k</td></tr> <tr><td>R6</td><td>8k2</td></tr> <tr><td>R7</td><td>470k</td></tr> </table> <p>All 0.25W 5% carbon film.</p> <p>Capacitors</p> <table border="0"> <tr><td>C1</td><td>1µ elect. 16V</td></tr> <tr><td>C2, C4</td><td>100n polyester</td></tr> <tr><td>C3</td><td>4µ7 elect. 16V</td></tr> </table> <p>Semiconductors</p> <table border="0"> <tr><td>D1/TR1</td><td>QPE1113 IR emitter-detector pair</td></tr> <tr><td>TR2</td><td>BC184 npn transistor</td></tr> <tr><td>IC1</td><td>4093 quad Schmitt trigger NAND Gate</td></tr> <tr><td>IC2</td><td>4538 monostable</td></tr> </table> <p>Miscellaneous</p> <table border="0"> <tr><td>X1</td><td>Piezoelectric buzzer</td></tr> </table>	R1	56k	R2	22k	R3	680k	R4, R5	27k (2 off)	C1	1n5 polyester	C2, C3	10n polyester (2 off)	C4	10µ elect. 16V	IC1	4093 quad Schmitt trigger NAND Gate	IC2	LTC1062 5th order switched capacitor low pass filter	R1, R5, R8	1k5 (3 off)	R2	1k	R3	12k	R4	470k	R6	8k2	R7	470k	C1	1µ elect. 16V	C2, C4	100n polyester	C3	4µ7 elect. 16V	D1/TR1	QPE1113 IR emitter-detector pair	TR2	BC184 npn transistor	IC1	4093 quad Schmitt trigger NAND Gate	IC2	4538 monostable	X1	Piezoelectric buzzer
R1	82k																																																																																								
R2	4M7																																																																																								
R3, R4	4k7 (2 off)																																																																																								
R5	22k																																																																																								
R6	100k																																																																																								
R7	6k8																																																																																								
R8	15k																																																																																								
VR1	10k rotary carbon lin.																																																																																								
VR2	1k min. carbon preset																																																																																								
VR3	100k min. carbon preset																																																																																								
C1	100n polyester																																																																																								
C2	1n5 polyester																																																																																								
D1	1N4148 signal diode																																																																																								
IC1	ICL8038 waveform generator (see text)																																																																																								
IC2	LF351 bifet op.amp																																																																																								
R1, R2,																																																																																									
R5, R6	1k5 (4 off)																																																																																								
R3, R7	15k (2 off)																																																																																								
R4, R8	18k (2 off)																																																																																								
C1 to C4	100n polyester (4 off)																																																																																								
IC1, IC2	LF351 bifet op.amp (or LF353 dual bifet op.amp)																																																																																								
R1	56k																																																																																								
R2	22k																																																																																								
R3	680k																																																																																								
R4, R5	27k (2 off)																																																																																								
C1	1n5 polyester																																																																																								
C2, C3	10n polyester (2 off)																																																																																								
C4	10µ elect. 16V																																																																																								
IC1	4093 quad Schmitt trigger NAND Gate																																																																																								
IC2	LTC1062 5th order switched capacitor low pass filter																																																																																								
R1, R5, R8	1k5 (3 off)																																																																																								
R2	1k																																																																																								
R3	12k																																																																																								
R4	470k																																																																																								
R6	8k2																																																																																								
R7	470k																																																																																								
C1	1µ elect. 16V																																																																																								
C2, C4	100n polyester																																																																																								
C3	4µ7 elect. 16V																																																																																								
D1/TR1	QPE1113 IR emitter-detector pair																																																																																								
TR2	BC184 npn transistor																																																																																								
IC1	4093 quad Schmitt trigger NAND Gate																																																																																								
IC2	4538 monostable																																																																																								
X1	Piezoelectric buzzer																																																																																								

N.B. Some components are repeated between Lab Works.

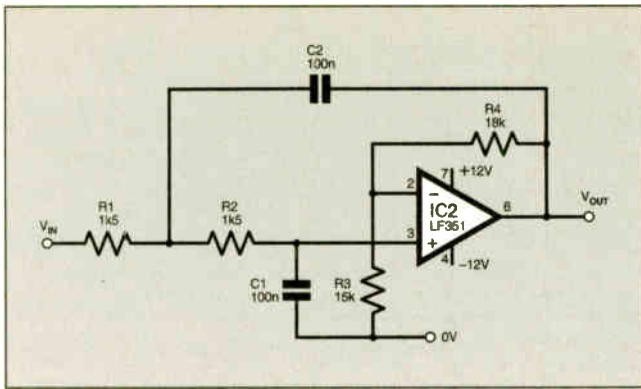
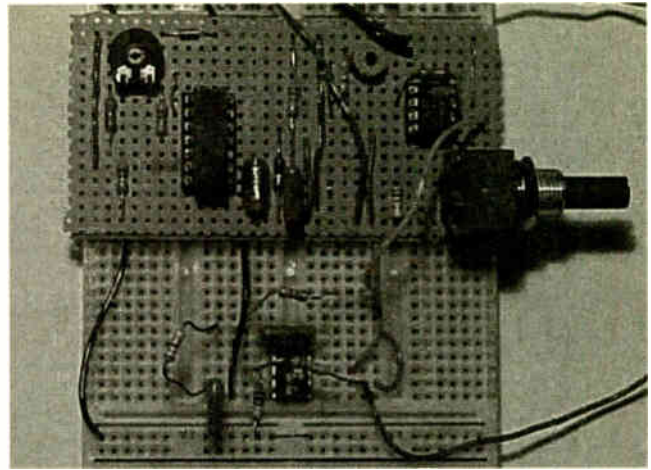

Fig.8.13. Second order low-pass filter.



Right: Breadboard assembly for the circuit in Fig.8.13, also showing the sinewave generator assembly.

peak-to-peak output voltage from IC1 should decrease as the signal frequency increases. You can plot a graph of output voltage against frequency by setting the input voltage to 1V peak-to-peak and measuring the output voltage at different frequencies.

The most common form of graph shows decibels (dB) plotted against frequency as shown earlier in Fig.8.7. The value in dB can be calculated from:

$$\text{value in dB} = 20 \log_{10}(V_{\text{out}}/V_{\text{in}})$$

where \log_{10} is the log function on a calculator (not the \ln function).

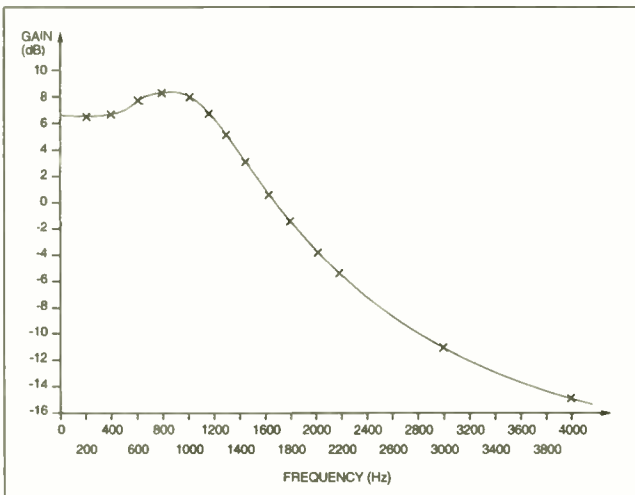

Fig.8.14.. Frequency response for the circuit in Fig.8.13, plotted from actual measurements.

The value of 20 is present because we are using signal *voltages*; it should be changed to 10 if signal *power* is measured.

For example, if $V_{\text{out}} = 2\text{V}$ and $V_{\text{in}} = 1\text{V}$ then the output is 6dB; if $V_{\text{out}} = 10\text{V}$ and $V_{\text{in}} = 2\text{V}$, the output is 14dB. Conversely, if the output is smaller than the input, then the value is -dB, e.g. $V_{\text{out}} = 2\text{V}$, $V_{\text{in}} = 5\text{V}$, the decibel value is -8dB.

Plot the output in dB for frequencies between 10Hz and 2kHz. As the frequency increases, you should see the output remaining constant until 1kHz or so when it will start decreasing. The shape of the curve shows that the filter is a low-pass type. As discussed in the tutorial, the rate at which the output drops is called the **roll-off** and can be calculated as 6ndB per octave (or 20ndB per decade) where n is the order of the filter.

In our case, $n = 2$, so the roll-off should be 12dB per octave, or 40dB per decade. Fig.8.14 shows the frequency response graph for the circuit.

Build the circuit in Fig.8.15 and repeat the measurements. Now you should see that the roll-off has increased to 24dB per octave (80dB per decade) because the filter is now 4th order.

Lab.8.3 High-pass Filters

It is a simple matter to change the circuits in Figs.8.13 and 8.15 to high-pass by swapping R (R1, R2) for C (C1, C2). Try this using the circuit in Fig.8.13 and plot the graph. You should now see that the filter is high-pass.

Changing the cut-off frequency requires recalculating R and C as we described in the tutorial section. Note that the resistor and capacitor values must be close to the calculated values otherwise the filter response will not be accurate.

You can build a band-pass filter by cascading high- and low-pass filters. For example, say we wanted to create a 300Hz to 3kHz band-pass filter, we design a 300Hz high-pass filter and connect its output to the input of a 3kHz low-pass filter.

Lab 8.4 Integrated Circuit Filter

The device we are using in this Lab is a 5th order low-pass filter based on a switched mode capacitor device whose cut-off frequency is controlled by an oscillator clock, and is 100th of the clock frequency. So, to use it we only need to provide a clock 100 times that of the cut-off frequency, ideal for circuits where the cut-off frequency needs to be changed.

These switched mode devices are often used for anti-aliasing filters and in micro-controller applications where the micro-controller directly produces a clock from one of its timers.

The complete circuit diagram for a clocked filter is shown in Fig.8.16. It is less complex than even the 2nd order

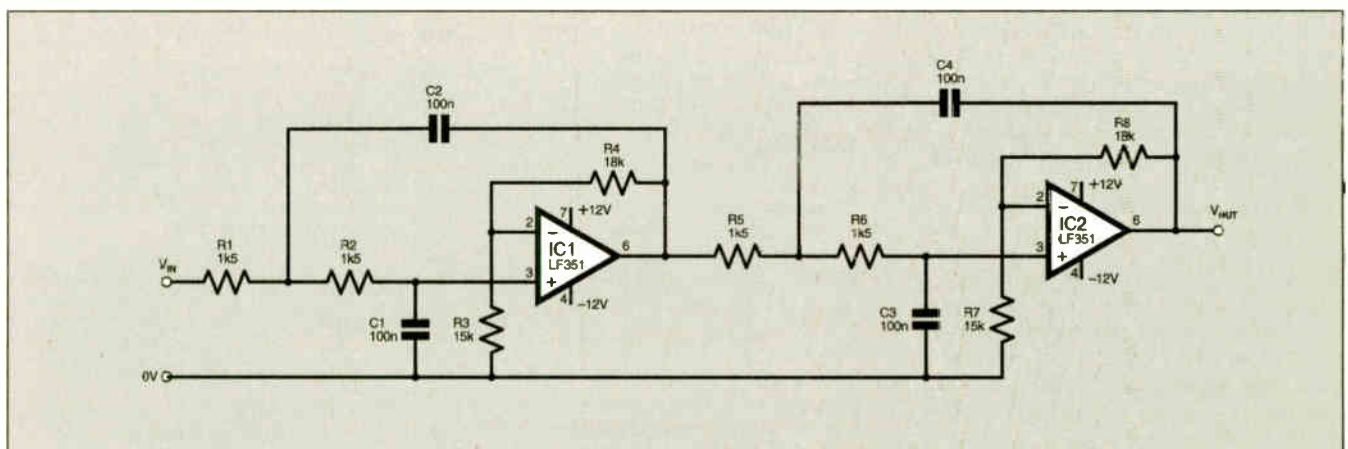

Fig.8.15. Fourth order low-pass filter circuit.

filter! The LTC1062 filter device (IC2) can operate on single or dual power supplies but only to $\pm 8V$ so we are operating the circuit at +5V only. This means that the "ground" pin (pin 2) has to be biased at half of the supply, created by resistors R4 and R5.

The clock signal is generated by Schmitt NAND gate IC1a/IC1b and is set to approximately 50kHz to give a cut-off frequency of 500Hz. There are two outputs, from pin 8, which is buffered, or from pin 7 via C3, to give an accurate d.c. output.

You can plot the frequency response which will now be steeper than the others (30dB/octave). Note that the input signal should be less than 2V peak-to-peak. Changing the value of resistor R2 allows the cut-off frequency to be changed.

We will be returning to filters and this filter in particular next month, when we examine aliasing and analogue-to-digital conversion.

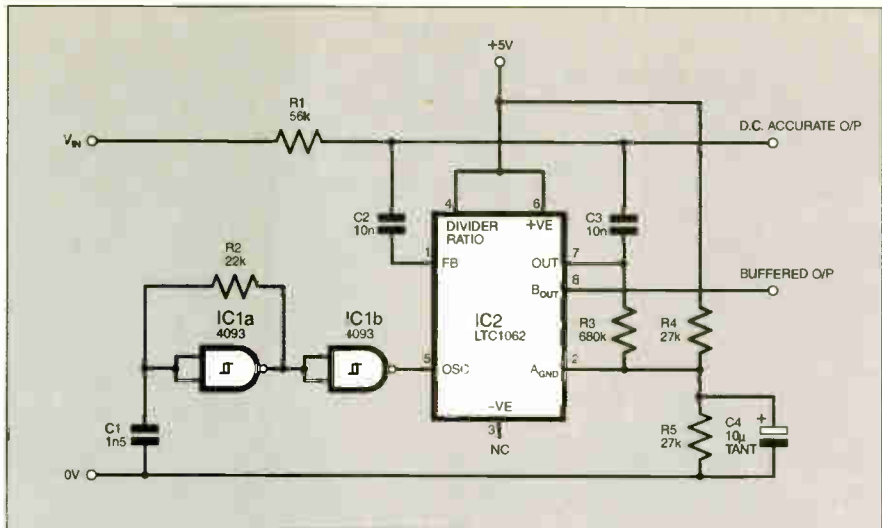
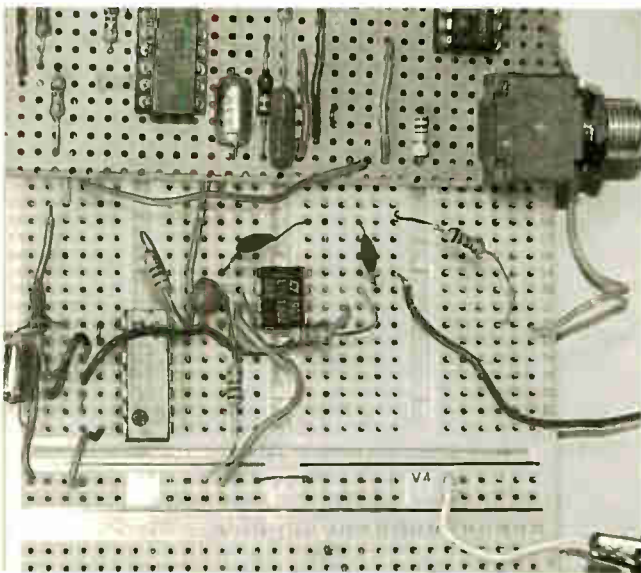
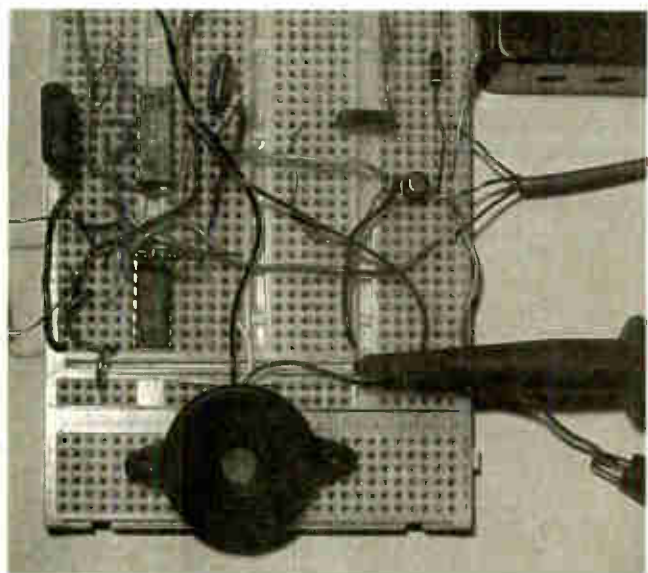

Fig.8.16. Switched capacitor filter circuit.



Breadboard assembly for the circuit in Fig.8.16.



Breadboard assembly for the circuit in Fig.8.18. The sensor is mounted on a separate stripboard and housed in the box at top right.

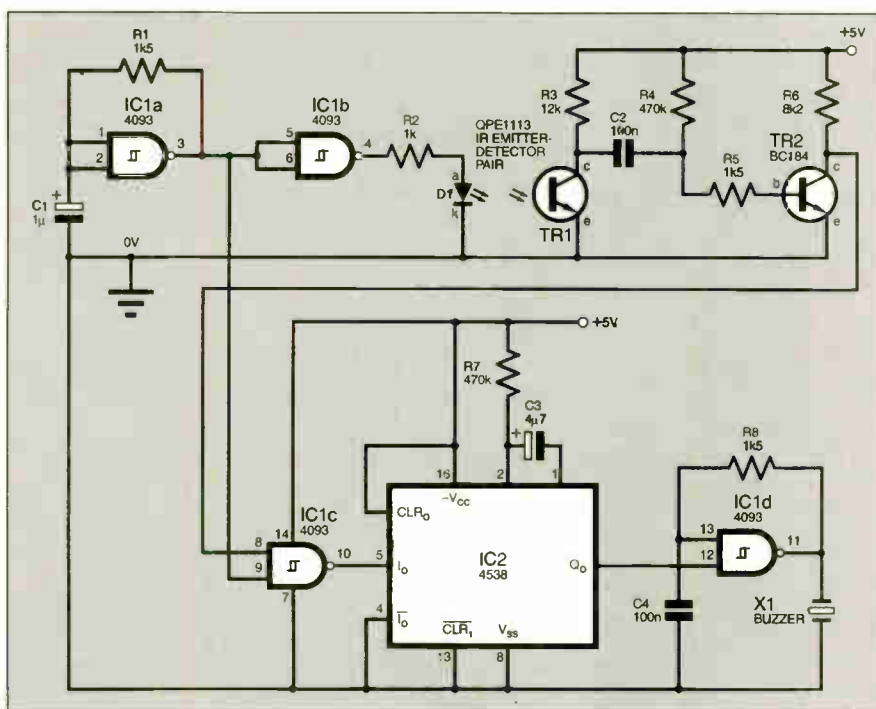

Fig.8.17. Circuit diagram for the smoke detector.

The filter is maximally flat (Butterworth response) if the RC components are calculated as follows:

$$\frac{1}{2\pi R1C} = \frac{fc}{1.84}$$

$$C3 = C2$$

and $R3 \cong 12R1$

Lab 8.5 Photoelectric Smoke Detector

In this Lab we build a photoelectric smoke detector using the light scattering method. Fig.8.17 shows the circuit diagram which consists of a 1kHz oscillator based around Schmitt NAND gate IC1a. Its output is buffered IC1b which drives IR i.e.d. D1. The light scattered from any smoke particles is detected by phototransistor TR1 and amplified by TR2 to give a digital output. i.e. either fully high or fully low.

The IR emitter and phototransistor are usually purchased as a pair, in our case a QPE1113. Others can be used (e.g. CH10L and CH11M) but the values of R3 to R5 may need to be adjusted if the phototransistor's gain is different.

The output of TR2 is fed into NAND gate IC1c, with the other input taken from

the output of IC1a. Its output feeds into monostable IC2. Normally (no light), no pulses will appear at the output of IC1c. When sufficient light is scattered, the pulses on the collector of TR2 (see Fig.8.18) become large enough for gate IC1c to produce pulses, causing the monostable to trigger. The monostable is continually retriggered until the output of TR2 drops again.

The output of the monostable goes high when it is triggered and turns on the oscillator

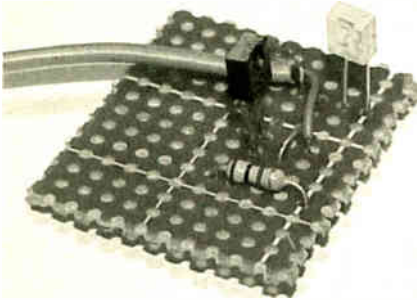

Stripboard assembly for the smoke detector sensor pair.

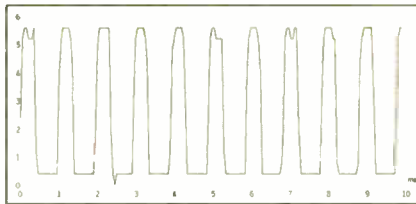

Fig.8.18. Output at TR2 when smoke detected.

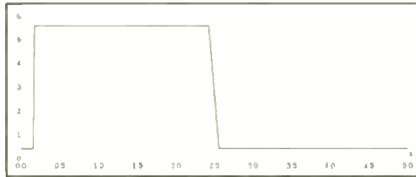

Fig.8.19. Output of monostable when triggered.

based around IC1d, which produces an audible output from piezo buzzer X1. The monostable's period is set to a few seconds to give a reasonably long audio output (see Fig.8.19). The period can be lengthened by increasing the value of C3.

When building the circuit, mount the phototransistor and l.e.d. at right angles to

each other and about one centimetre apart. As discussed in the theory section, you should place the assembly inside a container to reduce the ambient light level as much as possible. The accompanying photographs show a typical configuration.

When setting up the circuit, you should monitor the output of gate IC1c using the Picoscope and twist the l.e.d. until pulses just stop – any object scattering light towards the phototransistor will cause the light level to increase.

Finally, test the circuit using smoke and re-adjust the l.e.d. until it gives reliable detection.

Note that this circuit is for illustrative purposes only and should not be used for actual smoke detection as a substitute for a commercial device.

NEXT MONTH

In Part 9 next month, we continue looking at filters and then discuss data sampling and digital converters.

If you have any queries directly related to this series, you can write to the authors c/o the Editorial address, or you can email them at teach-in@epemag.demon.co.uk (no file attachments or general electronic queries please).

MAKE IT A GIFT EVERY MONTH – AND SAVE UP TO 68p AN ISSUE

**NEXT MONTH WE CALL THE TUNE –
DON'T MISS OUT MAKE SURE OF YOUR COPY NOW!**

★ EPE STYLOPIC ★
★ INFRA-RED AUTOSWITCH ★
★ SIMPLE AUDIO CIRCUITS-3 ★

Annual subscription rates:

- 6 Months: UK £15, Overseas £18 (standard air service),
£27 (express airmail)
- 1 Year: UK £28.50, Overseas £34.50 (standard air service)
£52 (express airmail)
- 2 Years: UK £52.00, Overseas £64.00 (standard air service)
£99 (express airmail)

To: Everyday Practical Electronics,
Wimborne Publishing Ltd., 408 Wimborne Road East,
Ferndown, Dorset BH22 9ND

Tel: 01202 873872 Fax: 01202 874562

E-mail: subs@epemag.wimborne.co.uk

Order from our online shop at:
www.epemag.wimborne.co.uk/shopdoor.htm

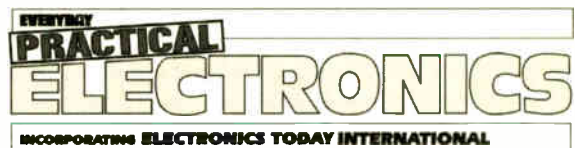

SUBSCRIPTION ORDER FORM



I enclose payment of £
(cheque/PO in £ sterling only),

payable to Everyday Practical Electronics



Name

My card number is:

Please print clearly, and check that you have the number correct

Address

Signature

Card Ex. Date Switch Issue No.

Post code Tel.

Subscriptions can only start with the next available issue.
For back numbers see the Back Issues page.

If you do not wish to cut your issue, send a letter or a copy of this form.

06/02

Measure pH, Voltage, Humidity, Sound & Light, on your PC!

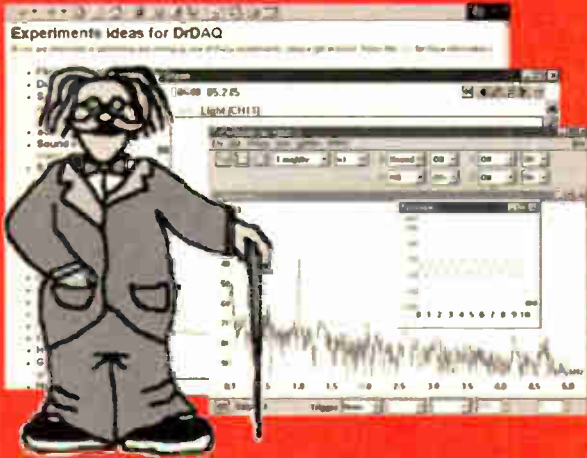

- ✓ Very low cost
- ✓ Built in sensors for light, sound (level and waveforms) and temperature
- ✓ Use DrDAQ to capture fast signals (eg sound waveforms)
- ✓ Outputs for control experiments
- ✓ Supplied with both PicoScope (oscilloscope) and PicoLog (data logging) software

Only £59!
+ VAT

The DrDAQ is a low cost data logger from Pico Technology. It is supplied ready to use with all cables, software and example science experiments.

DrDAQ represents a breakthrough in data logging. Simply plug DrDAQ into any Windows PC, run the supplied software and you are ready to collect and display data. DrDAQ draws its power from the parallel port, so no batteries or power supplies are required.

As well as the built in sensors, DrDAQ has two sockets for external sensors. When a sensor is plugged in, the software detects it and automatically scales readings. For example, if a temperature sensor is plugged in, readings are displayed in °C. Details are provided to allow users to develop their own sensors.

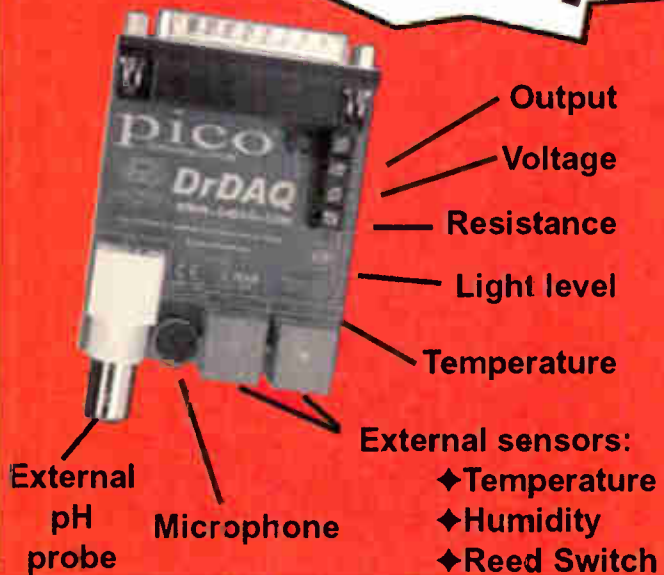

To order the DrDAQ please choose one of the following options:

- i) Visit our web site and place an order over the Internet,
- ii) Place an order over the phone by ringing the number below, or,
- iii) Fill out the order form and either fax it, or post it back to Pico Technology.

DrDAQ Order Form:			
Quantity	Package	Price inc VAT	Total
	DrDAQ + Software	£69.32	
	DrDAQ + 2 Temp Sensors	£92.85	
	DrDAQ + 2 Temp, pH Electrode, Humidity + Reed Switch Sensors	£175.08	
	Delivery	£4.11	£4.11
Grand Total		£	

Name			
Address			
Post code			
Phone			
Credit Card	Visa / Mastercard / Switch / Amex		
Card Number			
Expiry Date	/	Start Date & or Issue No.	
Cheque with order	<input type="checkbox"/>		

A Data Logging Breakthrough

PICO
Technology Limited

Pico Technology Ltd, The Mill House, Cambridge Street, St Neots, Cambridgeshire. PE19 1QB
Tel: 01480 396395, Fax: 01480 396296, E-mail: post@picotech.com, Web: www.drdaq.com

DIRECT BOOK SERVICE

NOTE: ALL PRICES INCLUDE UK POSTAGE

FREE *Electronics Hobbyist Compendium* book with Teach-In 2000 CD-ROM



EPE TEACH-IN 2000 CD-ROM

The whole of the 12-part *Teach-In 2000* series by John Becker (published in *EPE* Nov '99 to Oct 2000) is now available on CD-ROM. Plus the *Teach-In 2000* interactive software covering all aspects of the series and Alan Winstanley's *Basic Soldering Guide* (including illustrations and Desoldering).

Teach-In 2000 covers all the basic principles of electronics from Ohm's Law to Displays, including Op.Amps, Logic Gates etc. Each part has its own section on the interactive software where you can also change component values in the various on-screen demonstration circuits.

The series gives a hands-on approach to electronics with numerous breadboard circuits to try out, plus a simple computer interface which allows a PC to be used as a basic oscilloscope.

ONLY **£12.45** including VAT and p&p

Order code Teach-In CD-ROM

Circuits and Design

PRACTICAL REMOTE CONTROL PROJECTS

Owen Bishop

Provides a wealth of circuits and circuit modules for use in remote control systems of all kinds; ultrasonic, infra-red, optical fibre, cable and radio. There are instructions for building fourteen novel and practical remote control projects. But this is not all, as each of these projects provides a model for building dozens of other related circuits by simply modifying parts of the design slightly to suit your own requirements. This book tells you how.

Also included are techniques for connecting a PC to a remote control system, the use of a microcontroller in remote control, as exemplified by the BASIC Stamp, and the application of ready-made type-approved 418MHz radio transmitter and receiver modules to remote control

160 pages

Order code BP413

£6.49

systems.

ELECTRONICS PROJECTS USING ELECTRONICS WORKBENCH plus FREE CD-ROM

M. P. Horsey

This book offers a wide range of tested circuit modules which can be used as electronics projects, part of an electronics course, or as a hands-on way of getting better acquainted with Electronics Workbench. With circuits ranging from 'bulbs and batteries' to complex systems using integrated circuits, the projects will appeal to novices, students and practitioners alike.

Electronics Workbench is a highly versatile computer simulation package which enables the user to design, test and modify their circuits before building them, and to plan PCB layouts on-screen. All the circuits in the book are provided as runnable Electronic Workbench files on the enclosed CD-ROM, and a selection of 15 representative circuits can be explored using the free demo version of the application.

FREE CD-ROM

the floor. Learn to use additional types of sensors including rotation, light, temperature, sound and ultrasonic and also explore the possibilities provided by using an additional (third) motor. For the less experienced, RCX code programs accompany most of the featured robots. However, the more adventurous reader is also shown how to write programs using Microsoft's VisualBASIC running with the ActiveX control (Spirit.OCX) that is provided with the RIS kit.

Detailed building instructions are provided for the featured robots, including numerous step-by-step photographs. The designs include rover vehicles, a virtual pet, a robot arm, an 'intelligent' sweet dispenser and a colour conscious robot that will try to grab objects of a specific colour.

298 pages

Order code BP902

£14.99

PIC YOUR PERSONAL INTRODUCTORY COURSE SECOND EDITION John Morton

Discover the potential of the PIC microcontroller through graded projects - this book could revolutionise your electronics construction work!

A uniquely concise and practical guide to getting up and running with the PIC Microcontroller. The PIC is one of the most popular of the microcontrollers that are transforming electronic project work and product design.

Assuming no prior knowledge of microcontrollers and introducing the PICs capabilities through simple projects, this book is ideal for use in schools and colleges. It is the ideal introduction for students, teachers, technicians and electronics enthusiasts. The step-by-step explanations make it ideal for self-study too: this is not a reference book - you start work with the PIC straight away.

The revised second edition covers the popular reprogrammable EEPROM PICs: P16C84/16F84 as well as the P54 and P71 families.

270 pages

Order code NE36

£13.99

INTRODUCTION TO MICROPROCESSORS

John Crisp

If you are, or soon will be, involved in the use of microprocessors, this practical introduction is essential reading. This book provides a thoroughly readable introduction to microprocessors, assuming no previous knowledge of the subject, nor a technical or mathematical background. It is suitable for students, technicians, engineers and hobbyists, and covers the full range of modern microprocessors.

After a thorough introduction to the subject, ideas are developed progressively in a well-structured format. All technical terms are carefully introduced and subjects which have proved difficult, for example 2's complement, are clearly explained. John Crisp covers the complete range of microprocessors from the popular 4-bit and 8-bit designs to today's super-fast 32-bit and 64-bit versions that power PCs and engine management systems etc.

222 pages

Order code NE31

£18.99

Contents: Some basic concepts; Projects with switches, LEDs, relays and diodes; Transistors; Power supplies; Op. amp projects; Further op.amp circuits; Logic gates; Real logic circuits; Logic gate multivibrators; The 555 timer; Flip-flops, counters and shift registers; Adders, comparators and multiplexers; Field effect transistors; Thyristors, triacs and diacs; Constructing your circuit; Index.

227 pages

Order code NE29

£16.99

DISCOVERING ELECTRONIC CLOCKS

W. D. Phillips

This is a whole book about designing and making electronic clocks. You start by connecting HIGH and LOW logic signals to logic gates. You find out about and then build and test bistables, crystal-controlled astables, counters, decoders and displays. All of these subsystems are carefully explained, with practical work supported by easy to follow prototype board layouts.

Full constructional details, including circuit diagrams and a printed circuit board pattern, are given for a digital electronic clock. The circuit for the First Clock is modified and developed to produce additional designs which include a Big Digit Clock, Binary Clock, Linear Clock, Andrew's Clock (with a semi-analogue display), and a Circles Clock. All of these designs are unusual and distinctive.

This is an ideal resource for project work in GCSE *Design and Technology: Electronics Product*, and for project work in AS-Level and A-Level *Electronics and Technology*.

194 pages, A4 spiral bound

Order code DEP1

£17.50

DOMESTIC SECURITY SYSTEMS

A. L. Brown

This book shows you how, with common sense and basic do-it-yourself skills, you can protect your home. It also gives tips and ideas which will help you to maintain and improve your home security, even if you already have an alarm. Every circuit in this book is clearly described and illustrated, and contains components that are easy to source. Advice and guidance are based on the real experience of the author who is an alarm installer, and the designs themselves have been rigorously put to use on some of the most crime-ridden streets in the world.

The designs include all elements, including sensors, -detectors, alarms, controls, lights, video and door entry systems. Chapters cover installation, testing, maintenance and upgrading.

192 pages

Order code NE25

£15.99

MICROCONTROLLER COOKBOOK

Mike James

The practical solutions to real problems shown in this cookbook provide the basis to make PIC and 8051 devices really work. Capabilities of the variants are examined, and ways to enhance these are shown. A survey of common interface devices, and a description of programming models, lead on to a section on development techniques. The cookbook offers an introduction that will allow any user, novice or experienced, to make the most of microcontrollers.

240 pages

Order code NE26

£21.99

A BEGINNER'S GUIDE TO TTL DIGITAL ICs

R. A. Penfold

This book first covers the basics of simple logic circuits in general, and then progresses to specific TTL logic integrated circuits. The devices covered include gates, oscillators, timers, flip/flops, dividers, and decoder circuits. Some practical circuits are used to illustrate the use of TTL devices in the 'real world'.

142 pages

Order code BP332

£5.45

ELECTRONIC MODULES AND SYSTEMS FOR BEGINNERS

Owen Bishop

This book describes over 60 modular electronic circuits, how they work, how to build them, and how to use them. The modules may be wired together to make hundreds of different electronic systems, both analogue and digital. To show the reader how to begin building systems from modules, a selection of over 25 electronic systems are described in detail, covering such widely differing applications as timing, home security, measurement, audio (including a simple radio receiver), games and remote control.

200 pages

Order code BP266

£4.45

PRACTICAL ELECTRONICS CALCULATIONS AND FORMULAE

F. A. Wilson, C.G.I.A., C.Eng., F.I.E.E., F.I.E.R.E., F.B.I.M.

Bridges the gap between complicated technical theory, and 'cut-and-ried' methods which may bring success in design but leave the experimenter unfulfilled. A strong practical bias - tedious and higher mathematics have been avoided where possible and many tables have been included.

The book is divided into six basic sections: Units and Constants, Direct-Current Circuits, Passive Components, Alternating-Current Circuits, Networks and Theorems, Measurements.

256 pages

Order code BP53

£5.49

Computing & Robotics

WINDOWS XP EXPLAINED

N. Kantaris and P. R. M. Oliver

If you want to know what to do next when confronted with Microsoft's Windows XP screen, then this book is for you. It applies to both the Professional and Home editions.

The book was written with the non-expert, busy person in mind. It explains what hardware requirements you need in order to run Windows XP successfully, and gives an overview of the Windows XP environment.

The book explains: How to manipulate Windows, and how to use the Control Panel to add or change your printer, and control your display; How to control information using WordPad, Notepad and Paint, and how to use the Clipboard facility to transfer information between Windows applications; How to be in control of your filing system using Windows Explorer and My Computer; How to control printers, fonts, characters, multimedia and images, and how to add hardware and software to your system; How to configure your system to communicate with the outside world, and use Outlook Express for all your email requirements; How to use the Windows Media Player 8 to play your CDs, burn CDs with your favourite tracks, use the Radio Tuner, transfer your videos to your PC, and how to use the Sound Recorder and Movie Maker; How to use the System Tools to restore your system to a previously working state, using Microsoft's Website to update your Windows set-up, how to clean up, defragment and scan your hard disk, and how to backup and restore your data; How to successfully transfer text from those old but cherished MS-DOS programs.

268 pages

Order code BP514

£7.99

INTRODUCING ROBOTICS WITH LEGO MINDSTORMS

Robert Penfold

Shows the reader how to build a variety of increasingly sophisticated computer controlled robots using the brilliant Lego Mindstorms Robotic Invention System (RIS). Initially covers fundamental building techniques and mechanics needed to construct strong and efficient robots using the various 'click-together' components supplied in the basic RIS kit. Explains in simple terms how the 'brain' of the robot may be programmed on screen using a PC and 'zapped' to the robot over an infra-red link. Also, shows how a more sophisticated Windows programming language such as Visual BASIC may be used to control the robots.

Detailed building and programming instructions provided, including numerous step-by-step photographs.

288 pages - large format

Order code BP901

£14.99

MORE ADVANCED ROBOTICS WITH LEGO MINDSTORMS - Robert Penfold

Covers the Vision Command System

Shows the reader how to extend the capabilities of the brilliant Lego Mindstorms Robotic Invention System (RIS) by using Lego's own accessories and some simple home constructed units. You will be able to build robots that can provide you with 'waiter service' when you clap your hands, perform tricks, 'see' and avoid objects by using 'bats radar', or accurately follow a line marked on

Testing, Theory and Reference

Bebop To The Boolean Boogie

By Clive (call me Max) Maxfield
Specially Imported by EPE –
Excellent value

An Unconventional Guide to Electronics
Fundamentals, Components and Processes

This book gives the "big picture" of digital electronics. This indepth, highly readable, up-to-the-minute guide shows you how electronic devices work and how they're made. You'll discover how transistors operate, how printed circuit boards are fabricated, and what the innards of memory ICs look like. You'll also gain a working knowledge of Boolean Algebra and Karnaugh Maps, and understand what Reed-Muller logic is and how it's used. And there's much, MUCH more (including a recipe for a truly great seafood gumbo!).

Hundreds of carefully drawn illustrations clearly show the important points of each topic. The author's tongue-in-cheek British humor makes it a delight to read, but this is a REAL technical book, extremely detailed and accurate. A great reference for your own shelf, and also an ideal gift for a friend or family member who wants to understand what it is you do all day. . . .

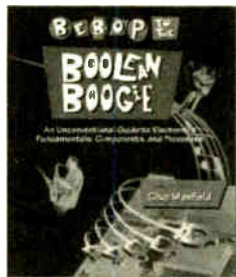

470 pages – large format

Order code BEB1

£26.95

BEBOP BYTES BACK (and the Bebop Computer Simulator) CD-ROM

Clive (Max) Maxfield and Alvin Brown

This follow-on to *Bebop to the Boolean Boogie* is a multimedia extravaganza of information about how computers work. It picks up where "Bebop I" left off, guiding you through the fascinating world of computer design . . . and you'll have a few chuckles, if not belly laughs, along the way. In addition to over 200 megabytes of mega-cool multimedia, the CD-ROM contains a virtual microcomputer, simulating the motherboard and standard computer peripherals in an extremely realistic manner. In addition to a wealth of technical information, myriad nuggets of trivia, and hundreds of carefully drawn illustrations, the CD-ROM contains a set of lab experiments for the virtual microcomputer that let you recreate the experiences of early computer pioneers. If you're the slightest bit interested in the inner workings of computers, then don't dare to miss this!

Over 800 pages in Adobe Acrobat format

Order code BEB2 CD-ROM

£18.95

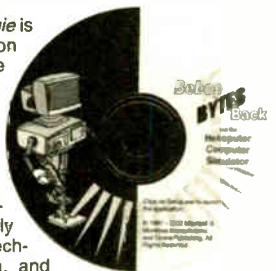

DIGITAL ELECTRONICS – A PRACTICAL APPROACH With FREE Software: Number One Systems – EASY-PC Professional XM and Pulsar (Limited Functionality)

Covers binary arithmetic, Boolean algebra and logic gates, combination logic, sequential logic including the design and construction of asynchronous and synchronous circuits and register circuits. Together with a considerable practical content plus the additional attraction of its close association with computer-aided design including the FREE software.

There is a 'blow-by-blow' guide to the use of EASY-PC Professional XM (a schematic drawing and printed circuit board design computer package). The guide also conducts the reader through logic circuit simulation using Pulsar software. Chapters on p.c.b. physics and p.c.b. production techniques make the book unique, and with its host of project ideas make it an ideal companion for the integrative assignment and common skills components required by BTEC and the key skills demanded by GNVQ. The principal aim of the book is to provide a straightforward approach to the understanding of digital electronics.

Those who prefer the 'Teach-In' approach or would rather experiment with some simple circuits should find the book's final chapters on printed circuit board production and project ideas especially useful.

250 pages

Order code NE28

£17.99

DIGITAL GATES AND FLIP-FLOPS

Ian R. Sinclair

This book, intended for enthusiasts, students and technicians, seeks to establish a firm foundation in digital electronics by treating the topics of gates and flip-flops thoroughly and from the beginning.

Topics such as Boolean algebra and Karnaugh mapping are explained, demonstrated and used extensively, and more attention is paid to the subject of synchronous counters than to the simple but less important ripple counters.

No background other than a basic knowledge of electronics is assumed, and the more theoretical topics are explained from the beginning, as also are many working practices. The book concludes with an explanation of microprocessor techniques as applied to digital logic.

200 pages

Order code PC106

£9.95

EDA – WHERE ELECTRONICS BEGINS

By Clive "Max" Maxfield and Kuhoo Goyal Edson

EDA, which stands for *electronic design automation*, refers to the software tools (computer programs) used to design electronic products. EDA actually encompasses a tremendous variety of tools and concepts. The aim of this book is to take a 30,000-foot view of the EDA world. To paint a "big picture" that introduces some of the most important EDA tools and describes how they are used to create integrated circuits, circuit boards and electronic systems. To show you how everything fits together without making you want to bang your head against the nearest wall.

"Did you ever wonder how the circuit boards and silicon chips inside your personal computer or cell phone were designed? This book walks you through the process of designing a city on an alien planet and compares it to designing an electronic system. The result is a fun, light-hearted and entertaining way to learn about one of the most important – and least understood – industries on this planet."

John Barr, Managing Director, Robertson Stephens

SPECIALLY IMPORTED BY EPE – EXCELLENT VALUE

98 pages – Large format

Order code EDA1

£29.95

UNDERSTANDING ELECTRONIC CONTROL SYSTEMS

Owen Bishop

Owen Bishop has produced a concise, readable text to introduce a wide range of students, technicians and professionals to an important area of electronics. Control is a highly mathematical subject, but here maths is kept to a minimum, with flow charts to illustrate principles and techniques instead of equations.

Cutting edge topics such as microcontrollers, neural networks and fuzzy control are all here, making this an ideal refresher course for those working in industry. Basic principles, control algorithms and hardwired control systems are also fully covered so the resulting book is a comprehensive text and well suited to college courses or background reading for university students.

The text is supported by questions under the headings Keeping Up and Test Your Knowledge so that the reader can develop a sound understanding and the ability to apply the techniques they are learning.

228 pages

Order code NE35

£17.99

HOW ELECTRONIC THINGS WORK – AND WHAT TO DO WHEN THEY DON'T

Robert Goodman

You never again have to be flummoxed, flustered or taken for a ride by a piece of electronics equipment. With this fully illustrated, simple-to-use guide, you will get a grasp on the workings of the electronic world that surrounds you – and even learn to make your own repairs.

You don't need any technical experience. This book gives you: Clear explanations of how things work, written in everyday language. Easy-to-follow, illustrated instructions on using test equipment to diagnose problems. Guidelines to help you decide for or against professional repair. Tips on protecting your expensive equipment from lightning and other electrical damage. Lubrication and maintenance suggestions.

Covers: colour TVs, VCRs, radios, PCs, CD players, printers, telephones, monitors, camcorders, satellite dishes, and much more!

394 pages

Order code MGH3

£18.99

The books listed have been selected by *Everyday Practical Electronics* editorial staff as being of special interest to everyone involved in electronics and computing. They are supplied by mail order direct to your door. Full ordering details are given on the last book page.

FOR A FURTHER SELECTION OF BOOKS
SEE THE NEXT TWO ISSUES OF EPE

All prices include UK postage

Audio and Music

PREAMPLIFIER AND FILTER CIRCUITS

R. A. Penfold

This book provides circuits and background information for a range of preamplifiers, plus tone controls, filters, mixers, etc. The use of modern low noise operational amplifiers and a specialist high performance audio preamplifier i.c. results in circuits that have excellent performance, but which are still quite simple. All the circuits featured can be built at quite low cost (just a few pounds in most cases). The preamplifier circuits featured include: Microphone preamplifiers (low impedance, high impedance, and crystal). Magnetic cartridge pick-up preamplifiers with R.I.A.A. equalisation. Crystal/ceramic pick-up preamplifier. Guitar pick-up preamplifier. Tape head preamplifier (for use with compact cassette systems).

Other circuits include: Audio limiter to prevent overloading of power amplifiers. Passive tone controls. Active tone controls. PA filters (highpass and lowpass). Scratch and rumble filters. Loudness filter. Mixers. Volume and balance controls.

92 pages

Order code BP309

£4.49

HIGH POWER AUDIO AMPLIFIER CONSTRUCTION

R. A. Penfold

Practical construction details of how to build a number of audio power amplifiers ranging from about 50 to 300/400 watts r.m.s includes MOSFET and bipolar transistor designs.

96 pages

Order code BP277

£4.49

ELECTRONIC MUSIC AND MIDI PROJECTS

R. A. Penfold

Whether you wish to save money, boldly go where no musician has gone before, rekindle the pioneering spirit, or simply have fun building some electronic music gadgets, the designs featured in this book should suit your needs. The projects are all easy to build, and some are so simple that even complete beginners at electronic project construction

can tackle them with ease. Stripboard layouts are provided for every project, together with a wiring diagram. The mechanical side of construction has largely been left to the individual constructors to sort out, simply because the vast majority of project builders prefer to do their own thing.

None of the designs requires the use of any test equipment in order to get them set up properly. Where any setting up is required, the procedures are very straightforward, and they are described in detail.

Projects covered: Simple MIDI tester, Message grabber, Byte grabber, THRU box, MIDI auto switcher, Auto/manual switcher, Manual switcher, MIDI patchbay, MIDI controlled switcher, MIDI lead tester, Program change pedal, Improved program change pedal, Basic mixer, Stereo mixer, Electronic swell pedal, Metronome, Analogue echo unit.

138 pages

Order code PC116

£10.95

Testing, Theory, Data and Reference

SCROGGIE'S FOUNDATIONS OF WIRELESS AND ELECTRONICS – ELEVENTH EDITION

S. W. Amos and Roger Amos
Scroggie's Foundations is a classic text for anyone working with electronics, who needs to know the art and craft of the subject. It covers both the theory and practical aspects of a huge range of topics from valve and tube technology, and the application of cathode ray tubes to radar, to digital tape systems and optical recording techniques.

Since *Foundations of Wireless* was first published over 60 years ago, it has helped many thousands of readers to become familiar with the principles of radio and electronics. The original author Sowerby was succeeded by Scroggie in the 1940s, whose name became synonymous with this classic primer for practitioners and students alike. Stan Amos, one of the fathers of modern electronics and the author of many well-known books in the area, took over the revision of this book in the 1980s and it is he, with his son, who have produced this latest version.

400 pages **Order code NE27** £21.99

ELECTRONICS MADE SIMPLE

Ian Sinclair

Assuming no prior knowledge, *Electronics Made Simple* presents an outline of modern electronics with an emphasis on understanding how systems work rather than on details of circuit diagrams and calculations. It is ideal for students on a range of courses in electronics, including GCSE, C&G and GNVQ, and for students of other subjects who will be using electronic instruments and methods.

Contents: waves and pulses, passive components, active components and ICs, linear circuits, block and circuit diagrams, how radio works, disc and tape recording, elements of TV and radar, digital signals, gating and logic circuits, counting and correcting, microprocessors, calculators and computers, miscellaneous systems.

199 pages (large format) **Order code NE23** £13.99

TRANSISTOR DATA TABLES

Hans-Günther Steidle

The tables in this book contain information about the package shape, pin connections and basic electrical data for each of the many thousands of transistors listed. The data includes maximum reverse voltage, forward current and power dissipation, current gain and forward trans-admittance and resistance, cut-off frequency and details of applications.

A book of this size is of necessity restricted in its scope, and the individual transistor types cannot therefore be described in the sort of detail that maybe found in some larger and considerably more expensive data books. However, the list of manufacturers' addresses will make it easier for the prospective user to obtain further information, if necessary.

Lists over 8,000 different transistors, including f.e.t.s.
200 pages **Order code BP401** £6.45

ELECTRONIC TEST EQUIPMENT HANDBOOK

Steve Money

The principles of operation of the various types of test instrument are explained in simple terms with a minimum of mathematical analysis. The book covers analogue and digital meters, bridges, oscilloscopes, signal generators, counters, timers and frequency measurement. The practical uses of the instruments are also examined.

Everything from Oscillators, through R, C & L measurements (and much more) to Waveform Generators and testing Zeners.
206 pages **Order code PC109** £9.95

GETTING THE MOST FROM YOUR MULTIMETER

R. A. Penfold

This book is primarily aimed at beginners and those of limited experience of electronics. Chapter 1 covers the basics of analogue and digital multimeters, discussing the relative merits and the limitations of the two types. In Chapter 2 various methods of component checking are described, including tests for transistors, thyristors, resistors, capacitors and diodes. Circuit testing is covered in Chapter 3, with subjects such as voltage, current and continuity checks being discussed.

In the main little or no previous knowledge or experience is assumed. Using these simple component and circuit testing techniques the reader should be able to confidently tackle servicing of most electronic projects.

96 pages **Order code BP239** £4.49

NEWNES ELECTRONICS TOOLKIT – SECOND EDITION

Geoff Phillips

The author has used his 30 years experience in industry to draw together the basic information that is constantly demanded. Facts, formulae, data and charts are presented to help the engineer when designing, developing, evaluating, fault finding and repairing electronic circuits. The result is this handy workmate volume: a memory aid, tutor and reference source which is recommended to all electronics engineers, students and technicians.

Have you ever wished for a concise and comprehensive guide to electronics concepts and rules of thumb? Have you ever been unable to source a component, or choose between two alternatives for a particular application? How much time do you spend searching for basic facts or manufacturer's specifications? This book is the answer, it covers resistors, capacitors, inductors, semiconductors, logic circuits, EMC, audio, electronics and music, telephones, electronics in lighting, thermal considerations, connections, reference data.

158 pages **Order code NE20** £17.99

PRACTICAL ELECTRONIC FAULT FINDING AND TROUBLESHOOTING

Robin Pain

This is not a book of theory. It is a book of practical tips, hints, and rules of thumb, all of which will equip the reader to tackle any job. You may be an engineer or technician in search of information and guidance, a college student, a hobbyist building a project from a magazine, or simply a keen self-taught amateur who is interested in electronic fault finding but finds books on the subject too mathematical or specialized.

The book covers: Basics – Voltage, current and resistance; Capacitance, inductance and impedance; Diodes and transistors; Op-amps and negative feedback; Fault finding – Analogue fault finding, Digital fault finding; Memory; Binary and hexadecimal; Addressing; Discrete logic; Microprocessor action; I/O control; CRT control; Dynamic RAM; Fault finding digital systems; Dual trace oscilloscope; IC replacement.

274 pages **Order code NE22** £21.99

AN INTRODUCTION TO LIGHT IN ELECTRONICS

F. A. Wilson

This book is not for the expert but neither is it for the completely uninitiated. It is assumed the reader has

some basic knowledge of electronics. After dealing with subjects like Fundamentals, Waves and Particles and The Nature of Light such things as Emitters, Detectors and Displays are discussed. Chapter 7 details four different types of Lasers before concluding with a chapter on Fibre Optics.

161 pages **Order code BP359** £5.45

UNDERSTANDING DIGITAL TECHNOLOGY

F. A. Wilson C.G.I.A., C.Eng., F.I.E.E., F.I. Mgt.

This book examines what digital technology has to offer and then considers its arithmetic and how it can be arranged for making decisions in so many processes. It then looks at the part digital has to play in the ever expanding Information Technology, especially in modern transmission systems and television. It avoids getting deeply involved in mathematics.

Various chapters cover: Digital Arithmetic, Electronic Logic, Conversions between Analogue and Digital Structures, Transmission Systems. Several Appendices explain some of the concepts more fully and a glossary of terms is included.

183 pages **Order code BP376** £5.45

Project Building

ELECTRONIC PROJECT BUILDING FOR BEGINNERS

R. A. Penfold

This book is for complete beginners to electronic project building. It provides a complete introduction to the practical side of this fascinating hobby, including:

Component identification, and buying the right parts; resistor colour codes, capacitor value markings, etc; advice on buying the right tools for the job; soldering; making easy work of the hard wiring; construction methods, including stripboard, custom printed circuit boards, plain matrix boards, surface mount boards and wire-wrapping; finishing off, and adding panel labels; getting "problem" projects to work, including simple methods of fault-finding.

In fact everything you need to know in order to get started in this absorbing and creative hobby.

135 pages **Order code BP392** £5.45

45 SIMPLE ELECTRONIC TERMINAL BLOCK PROJECTS

R. Bebbington

Contains 45 easy-to-build electronic projects that can be constructed, by an absolute beginner, on terminal blocks using only a screwdriver and other simple hand tools. No soldering is needed.

Most of the projects can be simply screwed together, by following the layout diagrams, in a matter of minutes and readily unscrewed if desired to make new circuits. A theoretical circuit diagram is also included with each project to help broaden the constructor's knowledge.

The projects included in this book cover a wide range of interests under the chapter headings: Connections and Components, Sound and Music, Entertainment, Security Devices, Communication, Test and Measuring.

163 pages **Order code BP378** £5.45

30 SIMPLE IC TERMINAL BLOCK PROJECTS

R. Bebbington

Follow on from BP378 using ICs.

117 pages **Order code BP379** £5.49

HOW TO DESIGN AND MAKE YOUR OWN P.C.B.S

R. A. Penfold

Deals with the simple methods of copying printed circuit board designs from magazines and books and covers all aspects of simple p.c.b. construction including photographic methods and designing your own p.c.b.s.

80 pages **Order code BP121** £4.49

IC555 PROJECTS

E. A. Parr

Every so often a device appears that is so useful that one wonders how life went on before without it. The 555 timer is such a device. It was first manufactured by Signetics, but is now manufactured by almost every semiconductor manufacturer in the world and is inexpensive and very easily obtainable.

Included in this book are over 70 circuit diagrams and descriptions covering basic and general circuits, motor car and model railway circuits, alarms and noise makers as well as a section on 556, 558 and 559 timers. (Note. No construction details are given.)

A reference book of invaluable use to all those who have any interest in electronics, be they professional engineers or designers, students of hobbyists.

167 pages **Order code BP44** £4.49

BOOK ORDERING DETAILS

All prices include UK postage. For postage to Europe (air) and the rest of the world (surface) please add £1 per book. For the rest of the world airmail add £2 per book. Send a PO, cheque, international money order (£ sterling only) made payable to **DIRECT BOOK SERVICE, WIMBORNE PUBLISHING LIMITED, 408 WIMBORNE ROAD EAST, FERNDOWN, DORSET BH22 9ND.**

Books are normally sent within seven days of receipt of order, but please allow 28 days for delivery – more for overseas orders. *Please check price and availability (see latest issue of Everyday Practical Electronics) before ordering from old lists.*

For a further selection of books see the next two issues of *EPE*.

Tel 01202 873872 Fax 01202 874562. E-mail: dbs@epemag.wimborne.co.uk

Order from our online shop at: www.epemag.wimborne.co.uk/shopdoor.htm

BOOK ORDER FORM

Full name:

Address:

.....

.....

..... Post code: Telephone No:

Signature:

I enclose cheque/PO payable to DIRECT BOOK SERVICE for £

Please charge my card £ Card expiry date

Card Number Switch Issue No.....

Please send book order codes:

Please continue on separate sheet of paper if necessary

PCB SERVICE

Printed circuit boards for most recent *EPE* constructional projects are available from the PCB Service, see list. These are fabricated in glass fibre, and are fully drilled and roller tinned. All prices include VAT and postage and packing. Add £1 per board for airmail outside of Europe. Remittances should be sent to The PCB Service, *Everyday Practical Electronics*, Wimborne Publishing Ltd., 408 Wimborne Road East, Ferndown, Dorset BH22 9ND. Tel: 01202 873872; Fax 01202 874562; E-mail: orders@epemag.wimborne.co.uk. On-line Shop: www.epemag.wimborne.co.uk/shopdoor.htm. Cheques should be crossed and made payable to *Everyday Practical Electronics* (Payment in £ sterling only).

NOTE: While 95% of our boards are held in stock and are dispatched within seven days of receipt of order, please allow a maximum of 28 days for delivery – overseas readers allow extra if ordered by surface mail. Back numbers or photostats of articles are available if required – see the Back Issues page for details.

Please check price and availability in the latest issue.

Boards can only be supplied on a payment with order basis.

PROJECT TITLE	Order Code	Cost
Scratch Blanker	JAN '00 250	£4.83
Flashing Snowman (Multi-project PCB)	932	£3.00
★ Video Cleaner	FEB '00 251	£5.63
Find It	252	£4.20
★ Teach-In 2000 – Part 4	253	£4.52
High Performance Regenerative Receiver	MAR '00 254, 255 } 256 } Set	£5.49 Set
★ EPE Icebreaker – PCB257, programmed PIC16F877 and floppy disc	Set only	£22.99
Parking Warning System	258	£5.08
★ Micro-PICscope	APR '00 259	£4.99
Garage Link – Transmitter Receiver	261 } 262 } Set	£5.87
Versatile Mic/Audio Preamplifier	MAY '00 260	£3.33
PIR Light Checker	263	£3.17
★ Multi-Channel Transmission System – Transmitter Receiver Interface	264 } 265 } 266 } Set	£6.34
★ Canute Tide Predictor	JUNE '00 267	£3.05
★ PIC-Gen Frequency Generator/Counter g-Meter	JULY '00 268 269	£5.07 £4.36
★ EPE Moodloop	AUG '00 271	£5.47
Quiz Game Indicator	272	£4.52
Handy-Amp	273	£4.52
Active Ferrite Loop Aerial	SEPT '00 274	£4.67
★ Remote Control IR Decoder	Software only	–
★ PIC Dual-Channel Virtual Scope	OCT '00 275	£5.15
Handclap Switch	NOV '00 270	£3.96
★ PIC Pulsometer	Software only	–
Twinkling Star	DEC '00 276	£4.28
Festive Fader	277	£5.71
Motorists' Buzz-Box	278	£5.39
★ PICtogram	279	£4.91
★ PIC-Monitored Dual PSU-1 PSU Monitor Unit	280 281	£4.75 £5.23
Static Field Detector (Multi-project PCB)	932	£3.00
Two-Way Intercom	JAN '01 282	£4.76
UFO Detector and Event Recorder	283 } 284 } 285 } Set	£6.19
★ Using PICs and Keypads	Software only	–
Ice Alarm	FEB '01 287	£4.60
★ Graphics L.C.D. Display with PICs (Supp) Using the LM3914-6 L.E.D. Bargraph Drivers	288 289 } 290 } 291 } Set	£5.23 £7.14
★ PC Audio Power Meter	Software only	–
Doorbell Extender: Transmitter Receiver	MAR '01 292 293	£4.20 £4.60
Trans/Remote Rec./Relay	294 295	£4.28 £4.92
EPE Snug-bug Heat Control for Pets	APR '01 296	£6.50
Intruder Alarm Control Panel	297	£6.97
Main Board External Bell Unit	298	£4.76
Camcorder Mixer	MAY '01 299	£6.34
★ PIC Graphics L.C.D. Scope	300	£5.07
Hosepipe Controller	JUNE '01 301	£5.14
Magfield Monitor (Sensor Board)	302	£4.91
Dummy PIR Detector	303	£4.36
★ PIC16F87x Extended Memory	Software only	–
Stereo/Surround Sound Amplifier	JULY '01 304	£4.75
Perpetual Projects Uniboard-1	305	£3.00
Solar-Powered Power Supply & Voltage Reg. MSF Signal Repeater and Indicator	306	£4.75
Repeater Board	307	£4.44
Meter Board	308	£5.39
★ PIC to Printer Interface	309	£4.99
Lead/Acid Battery Charger	AUG '01 310	£5.07
Shortwave Loop Aerial	311	£6.50
★ Digitimer – Main Board – R.F. Board	312	£4.36
Perpetual Projects Uniboard-2	305	£3.00
L.E.D. Flasher – Double Door-Buzzer		

PROJECT TITLE	Order Code	Cost
Perpetual Projects Uniboard-3	SEPT '01 305	£3.00
Loop Burglar Alarm, Touch-Switch Door-Light and Solar-Powered Rain Alarm	313	£6.10
L.E.D. Super Torches – Red Main	314 } Set	£6.10
– Display Red	315	£4.28
– White L.E.D.	316	£5.94
★ Sync Clock Driver	317	£4.91
★ Water Monitor		
Camcorder Power Supply	OCT '01 318	£5.94
PIC Toolkit Mk3	319	£8.24
Perpetual Projects Uniboard-4, Gate Sentinel, Solar-powered Bird Scarer and Solar-Powered Register	305 } 305 }	£3.00
Teach-In 2002 Power Supply	NOV '01 320	£4.28
Lights Needed Alert	321	£5.39
Pitch Switch	322	£5.87
Capacitance Meter – Main Board (double-sided)	323	£12.00
– Display Board (double-sided)	324	–
★ ★ PIC Toolkit TK3 – Software only	–	–
4-Channel Twinkling Lights	DEC '01 325	£6.82
Ghost Buster – Mic	326	Set
– Main	327	£5.78
★ PIC Polywhatsit – Digital	328	Set
– Analogue	329	£7.61
Forever Flasher	JAN '02 330	£4.44
Time Delay Touch Switch	331	£4.60
★ PIC Magick Musick	332	£5.87
Versatile Bench Power Supply	333	£5.71
★ PIC Spectrum Analyser	FEB '02 334	£7.13
Versatile Current Monitor	335	£4.75
Guitar Practice Amp	336	£5.39
★ PIC Virus Zapper	MAR '02 337	£4.75
RH Meter	338	£4.28
★ PIC Mini-Enigma – Software only	–	–
★ Programming PIC Interrupts – Software only	–	–
★ PIC Controlled Intruder Alarm	APR '02 339	£6.50
★ PIC Big Digit Display	MAY '02 341	£6.02
Washing Ready Indicator	342	£4.75
Audio Circuits-1 – LM386N-1	343	£4.28
– TDA7052	344	£4.12
– TBAB20M	345	£4.44
– LM380N	346	£4.44
– TDA2003	347	£4.60
– Twin TDA2003	348	£4.75
World Lamp	JUNE '02 340	£5.71
Simple Audio Circuits-2 – Low, Med and High Input Impedance Preamplifiers (Single Trans.)	349	£4.60
Low-Noise Preamplifier (Dual Trans.)	350	£4.75
Tone Control	351	£4.60
Bandpass Filter	352	£4.75
Frequency Standard Generator – Receiver	353	£4.12
– Digital	354	£6.82
★ Biopic Heartbeat Monitor	355	£5.71

EPE SOFTWARE

Software programs for *EPE* projects marked with a single asterisk ★ are available on 3.5 inch PC-compatible disks or free from our Internet site. The following disks are available: *PIC Tutorial* (Mar-May '98); *PIC Toolkit Mk2 V2-4d* (May-Jun '99); *EPE Disk 1* (Apr '95-Dec '98); *EPE Disk 2* (1999); *EPE Disk 3* (2000); *EPE Disk 4* (2001); *EPE Disk 5* (Jan 2002 issue to current cover date); *EPE Teach-In 2000*; *EPE Spectrum*; *EPE Interface Disk 1* (October '00 issue to current cover date). ★ ★ PIC Toolkit TK3 software (Nov '01) is on CD-ROM. The 3.5 inch disks are £3.00 each (UK), the CD-ROM is £6.95 (UK). Add 50p each for overseas surface mail, and £1 each for airmail. All are available from the *EPE PCB Service*. All files can be downloaded free from our Internet FTP site: <ftp://ftp.epemag.wimborne.co.uk>.

EPE PRINTED CIRCUIT BOARD SERVICE

Order Code Project Quantity Price

Name

Address

Tel. No.

I enclose payment of £..... (cheque/PO in £ sterling only) to:



Everyday
Practical Electronics



MasterCard, Amex, Diners
Club, Visa or Switch



Card No.

Card Exp. Date..... Switch Issue No.....

Signature.....

NOTE: You can also order p.c.b.s by phone, Fax, E-mail or via our Internet site on a secure server:

<http://www.epemag.wimborne.co.uk/shopdoor.htm>

Everyday Practical Electronics reaches twice as many UK readers as any other UK monthly hobby electronics magazine, our sales figures prove it. We have been the leading monthly magazine in this market for the last seventeen years.

If you want your advertisements to be seen by the largest readership at the most economical price our classified and semi-display pages offer the best value. The prepaid rate for semi-display space is £8 (+VAT) per single column centimetre (minimum 2.5cm). The prepaid rate for classified adverts is 30p (+VAT) per word (minimum 12 words).

All cheques, postal orders, etc., to be made payable to Everyday Practical Electronics. VAT must be added. Advertisements, together with remittance, should be sent to Everyday Practical Electronics Advertisements, Mill Lodge, Mill Lane, Thorpe-le-Soken, Essex CO16 0ED. Phone/Fax (01255) 861161.

For rates and information on display and classified advertising please contact our Advertisement Manager, Peter Mew as above.

Valve Output Transformers: Single ended 50mA, £4.50; push/pull 50W, £38; 100W, £53. Mains Transformers: Sec 220V 30mA 6V 1A, £3; 250V 60mA 6V 2A, £5; 250V 80mA 6V 2A, £6. High Voltage Caps: 50µF 350V, 68µF 500V, 150µF 385V, 220µF 400V, 330µF 400V, 470µF 385V, all £3 ea., 32+32µF 450V £5, 4µF 800V oil filled paper block £10, 10H 200mA choke £14. Postage extra. Record Decks and Spares: BSR, Garrard, Goldring, motors, arms, wheels, headshells, spindles, etc. Send or phone your want list for quote.

RADIO COMPONENT SPECIALISTS

337 WHITEHORSE ROAD, CROYDON SURREY, CR0 2HS. Tel: (020) 8684 1666
 Lots of transformers. High volt caps, valves, output transformers, speakers, in stock. Phone or send your wants list for quote.

Test Equipment



Service Manuals.

Contact
www.cooke-int.com
 Tel: +44 01243 55 55 90

THE BRITISH AMATEUR ELECTRONICS CLUB

exists to help electronics enthusiasts by personal contact and through a quarterly Newsletter.

For membership details, write to the Secretary:
Mr. M. P. Moses,
 5 Park View, Cwmaman,
 Aberdare CF44 6PP
Space donated by Everyday Practical Electronics

Z88 NOW AVAILABLE WITH 128K AND 512K - OZ4

ALSO SPECTRUM AND QL PARTS

W. N. RICHARDSON & CO.
 PHONE/FAX 01494 871319
 E-mail: wnr@compuserve.com
 RAVENSMEAD, CHALFONT ST PETER, BUCKS, SL9 0NB

X-10® Home Automation
 We put you in control™

Why tolerate when you can automate?
 An extensive range of 230V X-10 products and starter kits available. Uses proven Power Line Carrier technology, no wires required.

Products Catalogue available Online.
 Worldwide delivery.

Laser Business Systems Ltd.
 E-Mail: info@laser.com
<http://www.laser.com>
 Tel: (020) 8441 9788
 Fax: (020) 8449 0430



BTEC ELECTRONICS TECHNICIAN TRAINING

VCE ADVANCED ENGINEERING ELECTRONICS AND ICT
 HNC AND HND ELECTRONICS
 NVQ ENGINEERING AND IT
Next course commences 16th SEPTEMBER 2002
FULL PROSPECTUS FROM

LONDON ELECTRONICS COLLEGE
 (Dept EPE) 20 PENYVERN ROAD
 EARLS COURT, LONDON SW5 9SU
 TEL: (020) 7373 8721

2002 CATALOGUE
 PLEASE SEND SAE FOR A FREE COPY TO
FML ELECTRONICS
 FREEPOST NEA 3627 BEDALE
 NORTH YORKSHIRE DL8 2BR
 TEL: 01677 425840
 SPECIALIST SUPPLIERS OF SEMICONDUCTORS, RESISTORS, CAPACITORS AND OTHER ELECTRONIC COMPONENTS AT COMPETITIVE PRICES.

OLIMEX

<http://www.olimex.com/pcb>

PCB prototypes for \$26

FR-4, 1.5 mm, 35/35 um copper, 160x100 mm, double side, PTH, soldermask, component silkscreen production in 3-5 working days
 made in Bulgaria
 no import tax to Europe, UK and US

SURPLUS ELECTRONIC TEST EQUIPMENT FOR SALE

All in calibrated and working condition
 Write or phone/fax for list to:
INDEPENDENT TECHNICIANS
 6 HILLSIDE PLACE
 NEWMILNS KA16 9EH
 PHONE/FAX 01560 323222

Miscellaneous

FREE PROTOTYPE PRINTED CIRCUIT BOARDS! Free prototype p.c.b. with quantity orders. Call Patrick on 028 9073 8897 for details. Agar Circuits, Unit 5, East Belfast Enterprise Park, 308 Albertbridge Road, Belfast BT5 4GX.

EDUCATIONAL ELECTRONIC KITS, GCSE, Physics, Hobbyist. 2 x 1st class stamps for catalogue. Electrotech, PO Box 2594, Cannock, WS12 4YH.
www.electroteach.com.

PRINTED CIRCUIT BOARDS - QUICK SERVICE. Prototype and production artwork raised from magazines or draft designs at low cost. PCBs designed from schematics. Production assembly, wiring and software programming. For details contact Patrick at Agar Circuits, Unit 5, East Belfast Enterprise Park, 308 Albertbridge Road, Belfast, BT5 4GX. Phone 028 9073 8897, Fax 028 9073 1802, Email agar@argonet.co.uk.

G.C.S.E. ELECTRONICS KITS, at pocket money prices. S.A.E. for FREE catalogue. SIR-KIT Electronics, 52 Severn Road, Clacton, CO15 3RB. www.geocities.com/sirkituk.

VALVES AND ALLIED COMPONENTS IN STOCK - please ring for free list. Valve equipment repaired. Geoff Davies (Radio). Phone 01788 574774.

RADIO SPARES, Parcel £16, 200 new components and assorted amplifiers/power supply modules. K.I.A., 1 Regent Road, Ilkley LS29.

BUILD A COMMUNICATIONS RECEIVER! Fascinating projects from £10.50. Free catalogue, 33p s.a.e.: QRP, 27 Amberley Street, Bradford, W. Yorkshire BD3 8QZ.

EPE NET ADDRESSES

EPE FTP site: <ftp://ftp.epemag.wimborne.co.uk>
 Access the FTP site by typing the above into your web browser, or by setting up an FTP session using appropriate FTP software, then go into quoted sub-directories:
 PIC-project source code files: /pub/PICS
 PIC projects each have their own folder; navigate to the correct folder and open it, then fetch all the files contained within. *Do not try to download the folder itself!*
 EPE text files: /pub/docs
 Basic Soldering Guide: solder.txt
 Ingenuity Unlimited submission guidance: lng_unlit.txt
 New readers and subscribers info: epe_info.txt
 Newsgroups or Usenet users advice: usenet.txt
 Ni-Cad discussion: nicadfaq.zip and nicad2.zip
 Writing for EPE advice: write4us.txt
 You can also enter the FTP site via the link at the top of the main page of our home site at:
<http://www.epemag.wimborne.co.uk>
 Shop now on-line:
www.epemag.wimborne.co.uk/shopdoor.htm

Ensure you set your FTP software to ASCII transfer when fetching text files, or they may be unreadable.
 Note that any file which ends in .zip needs unzipping before use. Unzip utilities can be downloaded from:
<http://www.winzip.com>
 Ensure you use the latest version

TRAIN TODAY FOR A BETTER FUTURE

Now you can get the skills and qualifications you need for career success with an ICS Home Study Course. Learn in the comfort of your own home at the pace and times that suit you. ICS is the world's largest, most experienced home study school. Over the past 100 years ICS have helped nearly 10 million people to improve their job prospects. Find out how we can help YOU. Post or phone today for FREE INFORMATION on the course of your choice

Electrical Contracting & Installation
Electrical Engineering
C&G/ICS Basic Electronic Engineering
C&G/ICS Basic Mechanical Engineering
TV and Video Servicing
Radio and Hi-Fi Servicing
Refrigeration Heating & Air Conditioning
Motorcycle Maintenance

FREephone 0500 581 557

Or write to: International Correspondence Schools, FREEPOST 882, 8 Elliot Place, Clydeway Skypark, Glasgow, G3 8BR. Tel: 0500 581 557 or Tel/Fax: Dublin 285 2533

Please send me my Free Information on your Electronics Courses.

Mr/Ms/Ms/Miss
(BLOCK CAPITALS PLEASE)

Date of Birth / /

Address

Postcode

Occupation

Tel. No.

From time to time, we permit other carefully screened organisations to write to you about products and services. If you would prefer not to hear from such organisations please tick box

Dept. ZEEVC1E2

Metal Enclosures

Kit Builder or Project Developer

Off the shelf singles or multiples from our standard range
Specials by arrangement. Please Email your requirements



Wellberry Cases

(Manufacturers to the trade since 1971)

Ion Farm

Lower Gravenhurst

Beds MK45 4HH

Fax/Phone 01525 860081

Now Available Mail Order

Direct From Manufacturer

Online order form & Catalogue

www.wellberry.co.uk

Email sales@wellberry.co.uk

SHERWOOD ELECTRONICS

FREE COMPONENTS

Buy 10 x £1 Special Packs and choose another one FREE

SP1	15 x 5mm Red LEDs	SP135	6 x Miniature slide switches
SP2	12 x 5mm Green LEDs	SP136	3 x BFY50 transistors
SP3	12 x 5mm Yellow LEDs	SP137	4 x W005 1-5A bridge rectifiers
SP6	15 x 3mm Red LEDs	SP138	20 x 2.2/63V radial elect. caps.
SP7	12 x 3mm Green LEDs	SP140	3 x W04 1-5A bridge rectifiers
SP8	10 x 3mm Yellow LEDs	SP142	2 x CMOS 4017
SP10	100 x 1N4148 diodes	SP143	5 Pairs min. crocodile clips (Red & Black)
SP11	30 x 1N4001 diodes	SP145	6 x ZTX300 transistors
SP12	30 x 1N4002 diodes	SP146	10 x 2N3704 transistors
SP20	20 x BC184 transistors	SP147	5 x Stripboard 9 strips x 25 holes
SP21	20 x BC212 transistors	SP151	4 x 8mm Red LEDs
SP22	20 x BC549 transistors	SP152	4 x 8mm Green LEDs
SP23	20 x BC549 transistors	SP153	4 x 8mm Yellow LEDs
SP24	4 x CMOS 4001	SP154	15 x BC548 transistors
SP25	4 x 555 timers	SP156	3 x Stripboard, 14 strips x 27 holes
SP26	4 x 741 Op.Amps	SP160	10 x 2N3904 transistors
SP28	4 x CMOS 4011	SP161	10 x 2N3906 transistors
SP29	3 x CMOS 4013	SP165	2 x LF351 Op.Amps
SP34	20 x 1N914 diodes	SP166	20 x 1N4003 diodes
SP36	25 x 10/25V radial elect. caps.	SP167	6 x BC107 transistors
SP37	12 x 100/35V radial elect. caps.	SP168	6 x BC108 transistors
SP39	10 x 470/16V radial elect. caps.	SP172	4 x Standard slide switches
SP40	15 x BC237 transistors	SP175	20 x 1/63V radial elect. caps.
SP41	20 x Mixed transistors	SP177	10 x 1A 20mm quick blow fuses
SP42	200 x Mixed 0.25W C.F. resistors	SP182	20 x 4.7/63V radial elect. caps.
SP47	5 x Min. PB switches	SP183	20 x BC547 transistors
SP49	4 x 5 metres stranded core wire	SP187	15 x BC239 transistors
SP102	20 x 8-pin DIL sockets	SP189	4 x 5 metres solid core wire
SP103	15 x 14-pin DIL sockets	SP192	3 x CMOS 4066
SP104	15 x 16-pin DIL sockets	SP193	20 x BC213 transistors
SP109	15 x BC557 transistors	SP195	3 x 10mm Yellow LEDs
SP112	4 x CMOS 4093	SP197	6 x 20 pin DIL sockets
SP115	3 x 10mm Red LEDs	SP198	5 x 24 pin DIL sockets
SP116	3 x 10mm Green LEDs	SP199	5 x 2.5mm mono jack plugs
SP124	20 x Assorted ceramic disc caps	SP200	5 x 2.5mm mono jack sockets
SP126	8 x Battery clips - 4 ea. PP3 + PP9		
SP130	100 x Mixed 0.5W C.F. resistors		
SP131	2 x TL071 Op.Amps		
SP133	20 x 1N4004 diodes		
SP134	15 x 1N4007 diodes		

RESISTOR PACKS - C.Film

RP3	5 each value - total 365 0.25W	£3.00
RP7	10 each value - total 730 0.25W	£4.25
RP10	1000 popular values 0.25W	£6.15
RP4	5 each value-total 365 0.5W	£4.00
RP8	10 each value-total 730 0.5W	£6.65
RP11	1000 popular values 0.5W	£8.40

2002 Catalogue now available £1 inc. P&P or FREE with first order. P&P £1.25 per order. NO VAT

Orders to:

Sherwood Electronics,
7 Williamson St., Mansfield,
Notts. NG19 6TD.

Radio Bygones

WHETHER your interest is in domestic radio and TV or in amateur radio, in military, aeronautical or marine communications, in radar and radio navigation, in instruments, in broadcasting, in audio and recording, or in professional radio systems fixed or mobile, RADIO BYGONES is the magazine for you.

ARTICLES on restoration and repair, history, circuit techniques, personalities, reminiscences and just plain nostalgia - you'll find them all. Plus features on museums and private collections and a full-colour photo-feature in every issue.

IT'S MOSTLY about valves, of course, but 'solid-state' - whether of the coherer and spark-gap variety or early transistors - also has a place.

FROM THE DAYS of Maxwell, Hertz, Lodge and Marconi to what was the state-of-the-art just a few short years ago...

THERE IS ALSO a selection of free readers' For Sale and Wanted advertisements in every issue.

Radio Bygones covers it all!

THE MAGAZINE is published six times a year, and is only available by postal subscription. It is not available at newsagents.

TO TAKE OUT a subscription, or to order a sample copy, please contact:

RADIO BYGONES, Wimborne Publishing, 408 Wimborne Road East, Ferndown, Dorset BH22 9ND.

Tel: 01202 873872. Fax 01202 874562. Web sites:
www.radiobygones.co.uk www.radiobygones.com

Watch Slides on TV.

Make videos of your slides. Digitise your slides (using a video capture card)

"Liesgang diatv" automatic slide viewer with built in high quality colour TV camera. It has a composite video output to a phono plug (SCART & BNC adaptors are available). They are in very good condition with few signs of use. More details see www.diatv.co.uk.

£91.91 + VAT = £108.00



Board cameras all with 512 x 582 pixels 8.5mm 1/3 inch sensor and composite video out. All need to be housed in your own enclosure and have fragile exposed surface mount parts. They all require a power supply of between 10V and 12V DC 150mA.

47MIR size 60 x 36 x 27mm with 6 infra red LEDs (gives the same illumination as a small torch but is not visible to the human eye) £37.00 + VAT = £43.48

30MP size 32 x 32 x 14mm spy camera with a fixed focus pin hole lens for hiding behind a very small hole £35.00 + VAT = £41.13

40MC size 39 x 38 x 27mm camera for 'C' mount lens these give a much sharper image than with the smaller lenses £32.00 + VAT = £37.60

Economy C mount lenses all fixed focus & fixed iris

VSL1220F 12mm F1.6 12 x 15 degrees viewing angle £15.97 + VAT £18.76

VSL4022F 4mm F1.22 63 x 47 degrees viewing angle £17.65 + VAT £20.74

VSL6022F 6mm F1.22 42 x 32 degrees viewing angle £19.05 + VAT £22.38

VSL8020F 8mm F1.22 32 x 24 degrees viewing angle £19.90 + VAT £23.38

Better quality C Mount lenses

VSL1614F 16mm F1.6 30 x 24 degrees viewing angle £26.43 + VAT £31.06

VWL813M 8mm F1.3 with iris 56 x 42 degrees viewing angle £77.45 + VAT = £91.00

1206 surface mount resistors E12 values 10 ohm to 1M ohm

100 of 1 value £1.00 + VAT 1000 of 1 value £5.00 + VAT

866 battery pack originally intended to be used with an orbital mobile telephone it contains 10 1.6Ah sub C batteries (42 x 22 dia. the size usually used in cordless screwdrivers etc.) the pack is new and unused and can be broken open quite easily

£7.46 + VAT = £8.77



Please add £1.66 + vat = £1.95 postage & packing per order

JPG Electronics

Shaws Row, Old Road, Chesterfield, S40 2RB.

Tel 01246 211202 Fax 01246 550959

Mastercard/Visa/Switch

Callers welcome 9.30 a.m. to 5.30 p.m. Monday to Saturday

N. R. BARDWELL LTD (Est. 1948)

100	Signal Diodes 1N4148	£1.00
75	Rectifier Diodes 1N4001	£1.00
50	Rectifier Diodes 1N4007	£1.00
10	W01 Bridge Rectifiers	£1.00
10	555 Timer I.C.s	£1.00
4	741 Op Amps	£1.00
50	Assorted Zener Diodes 400mW	£1.00
12	Assorted 7-segment Displays	£1.00
25	5mm I.e.d.s. red, green or yellow	£1.00
25	3mm I.e.d.s. red, green or yellow	£1.00
75	5mm I.e.d.s. green, 6-5mm legs	£1.00
50	Axial I.e.d.s. 2mod red Diode Package	£1.00
20	Asstd. High Brightness I.e.d.s. var coils	£1.00
20	BC182L Transistors	£1.00
25	BC212L Transistors	£1.00
30	BC237 Transistors	£1.00
20	BC327 Transistors	£1.00
30	BC328 Transistors	£1.00
30	BC547 Transistors	£1.00
20	BC547B Transistor	£1.00
30	BC548 Transistors	£1.00
25	BC549 Transistors	£1.00
20	BC557 Transistors	£1.00
30	BC558 Transistors	£1.00
30	BC559 Transistors	£1.00
20	2N3904 Transistors	£1.00
100	1nF 50V wkg Axial Capacitors	£1.00
100	4N7 50V wkg Axial Capacitors	£1.00
80	Asstd capacitors electrolytic	£1.00
80	Asstd. capacitors 1nF to 1µF	£1.00

200	Asstd. disc ceramic capacitors	£1.00
50	Asstd. Sikel Presets (sm, stand, cermet)	£1.00
50	Asstd. RF chokes (inductors)	£1.00
50	Asstd. grommets	£1.00
80	Asstd. solder tags, p/conn, terminals	£1.00
10	Asstd. crystals - plug in	£1.00
8	Asstd. di switches	£1.00
20	Miniature slide switches sp/co	£1.00
100	Asstd. beads (ceramic, teflon, fish spine)	£1.00
30	Asstd. di sockets up to 40 way	£1.00
10	TV coax plugs, plastic	£1.00
40	metres very thin connecting wire, red	£1.00
20	1in. glass reed switches	£1.00
100	Any one value ¼W 5% cf res istors range 1R to 10M	£0.45
10	7812 Voltage Regulators	£1.00
300	Asstd. resistors ¼W/½W, mostly on tapes	£1.00
8	Asstd. push-button switches, multi-bank, multi-pole	£1.00

288 Abbeydale Road, Sheffield S7 1FL
 Phone: 0114 255 2886 ★ Fax: 0114 255 5039
 e-mail: sales@bardwells.co.uk ★ Web: www.bardwells.co.uk
 Prices include VAT. Postage £1.65
 44p stamp for lists or disk
POs, Cheques and Credit Cards accepted

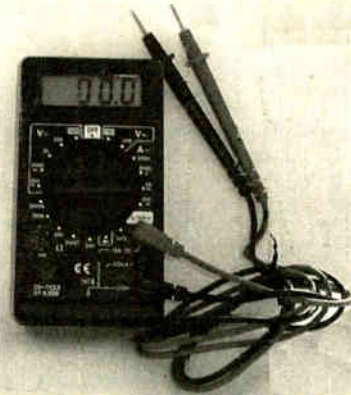

DIGITAL TEST METER

Built-in transistor test socket and diode test position.
 DC volts 200mV to 1000V.
 AC volts 200V to 750V.
 DC current 200mA to 10A.
 Resistance 200 ohms to 2000K ohms.

£5.99 incl. VAT

SEE OUR WEB PAGES FOR MORE COMPONENTS AND SPECIAL OFFERS
www.bardwells.co.uk

Bowood Electronics Ltd

Suppliers of Electronic Components

Batteries, Buzzers, Capacitors, Connectors, Diodes, Cases, Ferrites, Fuses, Heatshrink, ICs, Inverters, L.E.D.s, P.C.B., Potentiometers, Power Supplies, Presets, Rectifiers, Relays, Resistors, Soldering Equipment, Stripboard, Switches, Test Meters, Thermistors, Thyristors, Tools, Transistors, Triacs ...

Catalogue available **NOW**

Send 41p stamp or visit our website

Website: <http://www.bowood-electronics.co.uk>
 sales@bowood-electronics.co.uk



Mail Order Only
 7 Bakewell Road, Baslow, Derbyshire, DE45 1RE, UK
 Telephone/Fax: 01246 583777

ADVERTISERS INDEX

AUDON ELECTRONICS	.428
N. R. BARDWELL	.464
BITZ TECHNOLOGY	.441
B.K. ELECTRONICS	.Cover (iv)/428
BOWOOD ELECTRONICS	.464
BRUNNING SOFTWARE	.414
BULL ELECTRICAL	.Cover (ii)
CRICKLEWOOD ELECTRONICS	.428
CROWNHILL ASSOCIATES	.Cover (iii)
DISPLAY ELECTRONICS	.386
ESR ELECTRONIC COMPONENTS	.394
ICS	.463
JPG ELECTRONICS	.463
LABCENTER	.405
MAGENTA ELECTRONICS	.392/393
MILFORD INSTRUMENTS	.417
NATIONAL COLLEGE OF TECHNOLOGY	.431
PICO TECHNOLOGY	.457
QUASAR ELECTRONICS	.388/389
SHERWOOD ELECTRONICS	.463
SKY ELECTRONICS	.464
SQUIRES	.431
STEWART OF READING	.407

ADVERTISEMENT MANAGER: PETER J. MEW

ADVERTISEMENT OFFICES:

EVERYDAY PRACTICAL ELECTRONICS, ADVERTISEMENTS,
 MILL LODGE, MILL LANE, THORPE-LE-SOKEN,
 ESSEX CO16 0ED.

Phone/Fax: (01255) 861161

For Editorial address and phone numbers see page 395

ELECTRONICS 2002

FREE 304-page colour catalogue

Great value for Speakers, Microphones, Headphones, Aerials, Transmitters, TV Amps, Plugs, Sockets, Leads, CD Storage Cases, CCTV, Security, Connectors, Adaptors, Switch Boxes, Gadgets, Disco Lighting & Effects, Mixers, Amplifiers, Turntables, Musicians' Leads, Car Audio, Test Equipment, Hobby Kits, Computer Leads & Accessories, Power Supplies, Inverters, Transformers, Battery Chargers, Tools, Soldering, Switches, Fuses, Indicators, Cable & Wire, Crossovers, Speaker Hardware, PA Amps, and a great deal more ... all for the price of a stamp.

Sky Electronics
 40-42 Cricklewood Broadway,
 London, NW2 3ET
 Tel: 020 8450 0995
 Fax: 020 8208 1441
 Email: sales@cricklewoodelectronics.com
www.skyelectronics.co.uk

The Catalogue is FREE to shop callers or send stamps to the value of £1.85 to cover postage.

ELECTRONICS 2002

PIC BASIC COMPILERS

Crownhill Associates
smart electronic solutions

PIC Basic Plus & PIC Basic Pro Compilers

PIC BASIC Plus, supports the popular 14 bit Microchip PIC-Microcontrollers, allowing the user to write professional programs in BASIC. The compilers produce fast, tight machine code to load directly into the PIC-Microcontroller. The Compiler produces code that is guaranteed 100% compatible with Microchips MPASM assembler. The compiler allows direct comparison between the BASIC program and the assembly listing. Two compilers are available, the PIC Basic Pro, entry level compiler and PIC BASIC Plus, professional compiler. Both produce fast assembly code from BASIC. The Compilers run under Windows 95,98,NT,ME and XP and are supplied with a comprehensive, Windows based editor with Syntax highlighting and just two key clicks to compile and program and detailed manuals with worked examples. The Compilers support a range of programmers including the Microchip PICStart-plus and our own development programmers. For a free demo of the Pro compiler visit our web site www.letbasic.com, or join our web based forum to hear what other users think of our compilers and supporting products... (PIC BASIC Pro is supplied with the book "Experimenting with the LET Basic Pro compiler" by Les Johnson, an invaluable guide for the beginner. See the web site for an example chapter).

£49.95 - PRO
£99.95 - PLUS

Free updates throughout product life

Technical support is provided online via our web based forum, www.picbasic.org, or to tutors via telephone direct from the Author. Additional support can be provided to tutors using our development system for educational purposes.



Development system

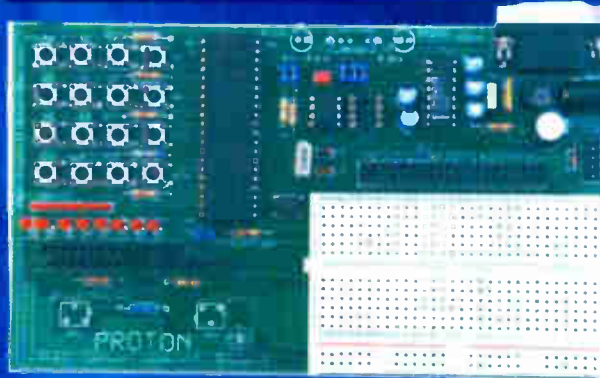

Prototype PCB system

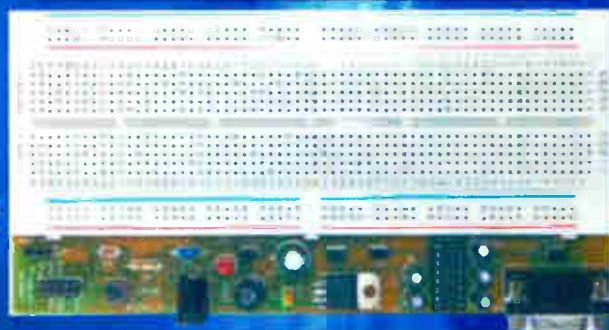

Supplied with source code and documentation for 20 Educational projects. Supports LCD displays from 2x16 Chrs to 128x64 dot matrix Graphics panel

Programmers



All supporting components stocked at competitive prices
e.g PIC 16F84 04 /P - £1.80 each, PIC 16F877 04 /P £3.95 each
LCD 2x16 Chrs, £7.50 each LCD 128x64 dot matrix £15.95 each
Many more items stocked, email sales@crowhill.co.uk for prices

World Radio History

Visit our web sites: www.picbasic.org
www.letbasic.com

32, Broad Street, Ely
Cambridge, CB7 4AH

Tel: +44 (0) 1353 666709
Fax: +44 (0) 1353 666710
sales@crowhill.co.uk

All prices exclude:
VAT, postage and packing



POWER AMPLIFIER MODULES-LOUDSPEAKERS-MIXERS 19 INCH STEREO AMPLIFIERS-ACTIVE CROSS/OVERS.

* PRICES INCLUDE V.A.T.
* PROMPT DELIVERY

OMP MOS-FET POWER AMPLIFIERS HIGH POWER, TWO CHANNEL 19 INCH RACK

10,000's
SOLD
TO PRO
USERS



THE RENOWNED MXF SERIES OF POWER AMPLIFIERS

FOUR MODELS:- MXF200 (100W + 100W) MXF400 (200W + 200W)
MXF600 (300W + 300W) MXF900 (450W + 450W)

ALL POWER RATINGS ARE R.M.S. INTO 4 OHMS, WITH BOTH CHANNELS DRIVEN
FEATURES:- * Independent power supplies with two toroidal transformers
* Twin L.E.D. Vu Meters * Level controls * Illuminated on/off switch * Jack / XLR inputs *
Speakon Outputs * Standard 775mV inputs * Open and Short circuit proof * Latest Mos-Fets
for stress free delivery into virtually any load * High slew rate * Very low distortion * Aluminium
cases * MXF600 & MXF900 fan cooled with D.C. Loudspeaker and thermal protection.

USED THE WORLD OVER IN CLUBS, PUBS, CINEMAS, DISCOS ETC

SIZES:-
MXF200 W19" D11" H3 1/2" (2U)
MXF400 W19" D12" H5 1/4" (3U)
MXF600 W19" D13" H5 1/4" (3U)
MXF900 W19" D14" H5 1/4" (3U)

PRICES:- MXF200 £175.00 MXF400 £233.85
MXF600 £329.00 MXF900 £449.15
SPECIALIST CARRIER DEL £12.50 Each



FLIGHTCASED LOUDSPEAKERS

A new range of quality loudspeakers, designed to take advantage of latest loudspeaker technology and enclosure designs. All models utilise high quality studio cast aluminium loudspeakers with factory fitted grilles, wide dispersion constant directivity horns, extruded aluminium corner protection and steel ball corners, complimented with heavy duty black covering. The enclosures are fitted as standard with top hats for optional loudspeaker stands. The FC15-300 incorporates a large 16 X 6 inch horn. All cabinets are fitted with the latest Speakon connectors for your convenience and safety. Five models to choose from.

WEDGE MONITOR



PLEASE NOTE:- POWER RATINGS
QUOTED ARE IN WATTS R.M.S. FOR
EACH INDIVIDUAL CABINET ALL
ENCLOSURES ARE 8 OHMS

15-15 Inch speaker
12-12 Inch speaker

- ibf FC15-300 WATTS Freq Range 35Hz-20kHz, Sens 101dB, Size H695 W502 D415mm
Price:- £299.00 per pair
 - ibf FC12-300 WATTS Freq Range 45Hz-20kHz, Sens 96dB, Size H600 W405 D300mm
Price:- £249.00 per pair
 - ibf FC12-200 WATTS Freq Range 40Hz-20kHz, Sens 97dB, Size H600 W405 D300mm
Price:- £199.00 per pair
 - ibf FC12-100 WATTS Freq Range 45Hz-20kHz, Sens 100dB, Size H546 W380 D300mm
Price:- £179.00 per pair
 - ibf WM12-200 WATTS Freq Range 40Hz-20kHz, Sens 97dB, Size H418 W600 D385mm
Price:- £125.00 Each
- SPECIALIST CARRIER DEL:- £12.50 per pair, wedge monitor £7.00 each
Optional Metal Stands PRICE:- £49.00 per pair Delivery:- £6.00

CATALOGUE 2001-2002

Robots
Test & Tools
Electronic Kits
The Sky's The Limit Catalogue
Communication
Security
Accessories

B.K. Electronics
Unit 1, Comet Way, Southend-on-Sea, Essex, SS2 6TR
Tel: 01702-527572 Fax: 01702-420243
E-mail: sales@bkelec.com
Web: www.bkelec.com

FREE Our Sky over 3000 items. The catalogue is free with any item ordered from this advert and to personal callers or £4.00 to cover P&P if ordered separately. This is fully refundable with your first order.

100 WATT ACTIVE SUB BASS AMPLIFIER PANEL



AN ACTIVE SUB BASS AMPLIFIER WITH A TRUE 100W RMS OUTPUT SUPERB CONSTRUCTION WITH THE FACILITIES TO INTEGRATE SEAMLESSLY INTO MOST HI-FI OR HOME CINEMA SETUPS. USE THIS PANEL PLUS ONE OF OUR LOUDSPEAKERS TO MAKE YOUR OWN SUB WOOFER THAT WILL MATCH OR BEAT MOST COMMERCIALY AVAILABLE SUB WOOFERS.

FEATURES:- * 100W RMS INTO 8 OHMS * HIGH AND LOW LEVEL INPUTS * TOROIDAL TRANSFORMER * SHORT CIRCUIT PROTECTION * D.C. SPEAKER PROTECTION * FREQUENCY ROLL OFF, LOWER 10Hz, UPPER 60Hz TO 240Hz (FULLY ADJUSTABLE) * AC3 COMPATIBLE FILTER CAN BE BYPASSED FOR 5-1 FORMATS. * AIRTIGHT CONSTRUCTION * TENS OF THOUSANDS OF OUR PANELS ALREADY IN USE. * COMPLETE WITH LEADS

SPECIFICATIONS:- * POWER 100W RMS @ 8 OHMS * FREQ RESP. 10Hz 15kHz -3dB * DAMPING FACTOR >200 * DISTORTION 0.05% * S/N A WEIGHTED >100dB * SUPPLY 230V A.C. * WEIGHT 2.7kg * SIZE H254 X W254 X D94mm

THERE ARE 2 VERSIONS OF THE ABOVE PANEL AVAILABLE :- **BSB100/8 8 OHM VERSION** **BSB100/4 4 OHM VERSION** BOTH PANELS ARE PRICED AT £117.44 + £5.00 P&P INCL. V.A.T. CHECK WEBSITE FOR PANELS UP TO 500W

OMP X03-S STEREO 3 WAY ACTIVE CROSSOVER SWITCHABLE 2-WAY



FEATURES:-
Advanced 3-Way Stereo Active Cross-Over (Switchable two way), housed in a 19" x 1U case. Each channel has three level controls: Bass, Mid & Top. The removable front fascia allows access to the programmable DIL switches to adjust the cross-over frequency: There are two versions available:- X03-S Bass-Mid 125/250/500Hz, Mid-Top 1.8/3/5kHz, all at 24 dB per octave. X03 Bass-Mid 250/500/800Hz, Mid-Top 1.8/3/5kHz, all at 24 dB per Octave. Please make sure you ask for the correct model when ordering. The 2/3 way selector switches are also accessed by removing the front fascia. Each stereo channel can be configured separately. Bass Invert Switches are incorporated on each channel. Nominal 775mV input/output. Fully compatible with the OMP Rack Amplifier and Modules.

BOTH MODELS PRICED AT £117.44 + £5.00 P&P

OMP MOS-FET POWER AMPLIFIER MODULES

These modules now enjoy a world-wide reputation for quality, reliability and performance at a realistic price. Four models are available to suit the needs of the professional and hobby market. Industry, Leisure, Instrumental and Hi-Fi etc. When ordering please, NO. 1 at all models include toroidal power supply, integral heatsink, glass fibre P.C.B. and drive circuits to power a compatible Vu meter. All models are open and short circuit proof.

- THOUSANDS OF MODULES PURCHASED BY PROFESSIONAL USERS
- OMP/MF 100 Mos-Fet Output Power 110 watts R.M.S. into 4 ohms, frequency response 1Hz - 100kHz -3dB, Damping Factor >300, Slew Rate 45V/uS, T.H.D. typical 0.002%, Input Sensitivity 500mV, S.N.R. 110dB. Size 300 x 123 x 60mm. Price:- £42.85 + £4.00 P&P
 - OMP/MF 200 Mos-Fet Output Power 200 watts R.M.S. into 4 ohms, frequency response 1Hz - 100kHz -3dB, Damping Factor >300, Slew Rate 50V/uS, T.H.D. typical 0.001%, Input Sensitivity 500mV, S.N.R. 110dB. Size 300 x 155 x 100mm. Price:- £66.35 + £4.00 P&P
 - OMP/MF 300 Mos-Fet Output Power 300 watts R.M.S. into 4 ohms, frequency response 1Hz - 100kHz -3dB, Damping Factor >300, Slew Rate 60V/uS, T.H.D. typical 0.001%, Input Sensitivity 500mV, S.N.R. 110dB. Size 330 x 175 x 100mm. Price:- £83.75 + £5.00 P&P
 - OMP/MF 450 Mos-Fet Output Power 450 watts R.M.S. into 4 ohms, frequency response 1Hz - 100kHz -3dB, Damping Factor >300, Slew Rate 75V/uS, T.H.D. typical 0.001%, Input Sensitivity 500mV, S.N.R. 110dB. Fan Cooled, D.C. Loudspeaker Protection, 2 Second Anti Thump Delay. Size 385 x 210 x 105mm. Price:- £135.85 + £6.00 P&P
 - OMP/MF 1000 Mos-Fet Output Power 1000 watts R.M.S. into 2 ohms, frequency response 1Hz - 100kHz -3dB, Damping Factor >300, Slew Rate 75V/uS, T.H.D. typical 0.001%, Input Sensitivity 500mV, S.N.R. 110dB. Fan Cooled, D.C. Loudspeaker Protection, 2 Second Anti Thump Delay. Size 422 x 300 x 125mm. Price:- £261.00 + £12.00 P&P
- NOTE MOS-FET MODULES ARE AVAILABLE IN TWO VERSIONS:- STANDARD - INPUT SENS 500mV/BANDWIDTH 100kHz OR PEC (PROFESSIONAL EQUIPMENT COMPATIBLE) - INPUT SENS 775mV/BANDWIDTH 50kHz ORDER STANDARD OR PEC

DELIVERY CHARGES:- PLEASE INCLUDE AS ABOVE, TO A MAXIMUM AMOUNT £30.00. OFFICIAL ORDERS FROM SCHOOL, COLLEGES, GOVT. PLCs ETC. PRICES INCLUSIVE OF V.A.T. SALES COUNTER. CREDIT CARD ORDERS ACCEPTED BY POST PHONE OR FAX.

B.K. ELECTRONICS REF D5
UNIT 1 COMET WAY, SOUTHEND-ON-SEA, ESSEX, SS2 6TR.
TEL.: 01702-527572 FAX.: 01702-420243
Web:- <http://www.bkelec.com> E-Mail sales@bkelec.com