

To be Completed in about 32 weekly parts.

# NEWNES PRACTICAL ELECTRICAL ENGINEERING

## IN THIS PART

ELECTRICAL  
MEASURING  
INSTRUMENTS

RECORD-CHANGING  
ELECTRIC  
GRAMOPHONE  
MOTORS

REPAIR OF ELECTRIC  
IRONS

ACCUMULATORS

1½

PART  
24

A PRACTICAL WORK WRITTEN BY EXPERTS

STUDY  
AT  
HOME

YOU CAN HAVE A COLLEGE  
TRAINING IN ALMOST ANY  
CAREER FOR A FEW  
SHILLINGS MONTHLY

IN  
YOUR  
SPARE  
TIME

FOUNDED 1900.

32 YEARS OF SUCCESS.



**THIS IS THE BENNETT COLLEGE - - ALL OF IT**

The Bennett College is not a Rented Room in a well-known street—it is a College. Over 31 years ago the Founder took as his motto what has now become a household slogan:

**LET ME BE YOUR FATHER**

In many trades and professions there are more vacancies than trained men to fill them. We do not profess to act as an employment agency, but our gigantic organisation certainly does tell us where the demand exists, thus enabling us to give **FATHERLY ADVICE ON ALL CAREERS AND THE POSSIBILITY OF EMPLOYMENT, FREE.**



*J.H. Bennett*

WE TEACH ALL BRANCHES OF THE FOLLOWING VOCATIONS AND SPECIALISE IN ALL EXAMINATIONS CONNECTED THEREWITH.

**THE MOST SUCCESSFUL AND MOST PROGRESSIVE CORRESPONDENCE COLLEGE IN THE WORLD**

...tion Engineering.  
Boiler Engineering.  
Boiler Making.  
B.Sc. (Engineering).  
Civil Engineering:  
A.M.I.C.E.  
Quantities—Specifications.  
Commercial Art

Concrete and Steel.  
Draughtsmanship:  
Electrical or  
Mechanical.  
Electrical Engineering:  
A.M.I.E.E.  
City and Guilds.  
Engineering Mathematics.  
Foundry Work.  
Heat Engines.

Heating, Ventilating and Lighting.  
Internal Combustion Engines.  
Machine Designs:  
Theory of Machines.  
Marine Engineering:  
Motor.  
Steam.  
Mechanical Engineering:  
A.M.Inst.B.E.  
A.M.I.Mech.E.  
City and Guilds.  
Pattern Making.

Mechanics.  
Metallurgy of Steel.  
Mine Electrician:  
A.M.E.E.  
Mining (all examinations).  
Motor Engineering:  
A.M.I.A.E.  
Municipal and County Engineers:  
M. and C.E.  
Naval Architecture  
Pumps and Pumping Machinery.  
Radio Reception.  
Shp Building.  
Structural Engineering.  
Telegraphy and Telephony.

IF YOU DO NOT SEE YOUR OWN REQUIREMENTS ABOVE, WRITE TO US ON ANY SUBJECT. IT COSTS NOTHING TO ENQUIRE.

Also ask for Our New Book (FREE OF CHARGE),

**THE HUMAN MACHINE**

SECRETS OF SUCCESS

WE TEACH BY POST IN ALL PARTS OF THE WORLD

Note Address Carefully:

The BENNETT COLLEGE, Ltd., Dept. 119, Sheffield



are usually placed externally to the instrument and great care must then be taken either to use the shunt leads supplied by the maker or leads of very nearly the same resistance. If this precaution is not taken the correct proportion of the total current will not be shunted and the readings will be unreliable.

### Rectifier - Operated Ammeters and Voltmeters.

Recent improvements in the dry (Westinghouse copper-oxide) metal rectifiers now make moving-coil instruments available for A.C. measurements also, although with certain limitations. The price of such rectifier-operated instruments is considerably higher than that of the corresponding moving-iron pattern, so that, except for the measurement of very small alternating currents or voltages, the latter hold the field for all industrial purposes.

### Induction Ammeters, Voltmeters and Wattmeters.

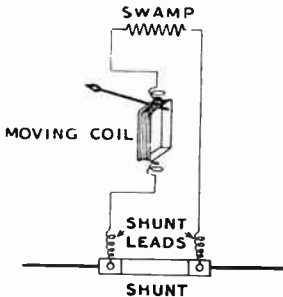

Fig. 4.—CONNECTION DIAGRAM OF A MOVING-COIL SHUNTED AMMETER.

Note that such an instrument is really a millivoltmeter and that, consequently, for it to read correctly, the resistance, both of the shunt and of the moving-coil circuit, must remain constant under all conditions of temperature. Hence the "swamp."

These instruments operate on much the same principle as the induction watt-hour meters described on page 1048, except that, instead of the disc being allowed to revolve continuously, it is attached to a spring, so that the deflection is dependent upon the current flowing.

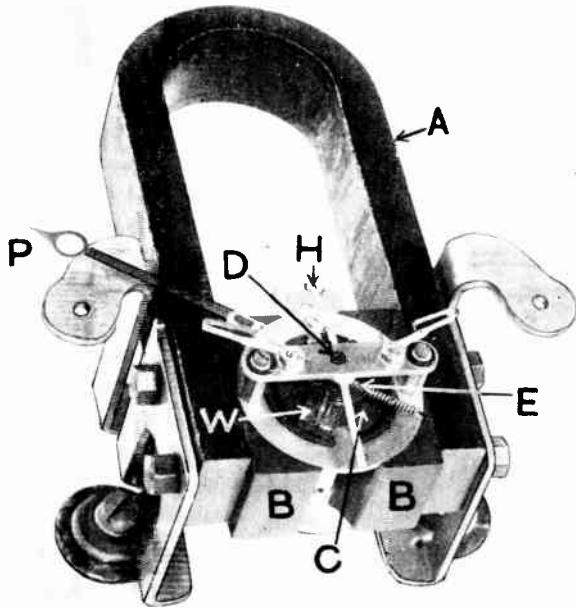

Fig. 3.—TYPICAL MOVING-COIL MOVEMENT WITH SCALE REMOVED.

A magnetic shunt variable by means of the screw head H enables the readings to be adjusted, should this be required.

The chief advantage of these instruments is that the scale can be extended to perhaps three-quarters of a full circle, thus making it easy to read at a distance.

### Hot-Wire Ammeters and Voltmeters.

In these instruments a stretched wire carries the current to be measured or one proportional to it. The wire is heated thereby and in expanding allows the pointer to be drawn across the scale to an extent dependent upon the heating effect of the current. Although little used at power frequencies, they have a considerable field of usefulness for radio, diathermy and similar high frequency purposes.

### Electrostatic Voltmeters.

Fig. 5 shows the construction of a small electrostatic voltmeter for 2,500 volts. The very light aluminium vane carried by the jewel-pivoted spindle is drawn by electrostatic attraction into the narrow gap formed by the two fixed vanes, the motion being opposed by a very fine spiral spring. The higher the voltage applied to



Fig. 5.—GROUP OF "DWARF" ELECTROSTATIC VOLTMETERS. (Everett, Edgcumbe.)

The movement held inverted in the left hand has just been removed from the bakelite base. The moving vane assembly from a similar voltmeter is lying on the bench to the right.

the terminals, the greater will be the force of attraction and therefore the further will the moving vane be drawn in and the larger the deflection of the pointer over the scale.

For voltages higher than about 7,000, condensers are often connected in series with electrostatic voltmeters and this forms a convenient method of extending the range.

#### Thermo-Couple Ammeters.

Mention should be made of these ammeters since they are much used for radio measurements. When the junction of two dissimilar metals is heated, an E.M.F. is generated which is very closely proportional to the temperature. This principle is applied to the construction of an ammeter by causing the current to be measured to heat the thermo-couple formed by the junction of two dissimilar alloys, for example, constantan and manganin. The temperature reached is proportional to the square of the current and the resulting thermo E.M.F. is measured on a sensitive moving-coil milliammeter. The couple may be mounted in the instrument or separate from it.

#### Dynamometer Wattmeters.

Another group of instruments is the so-called electro-dynamic or dynamometer pattern. Although at one time dynamometer ammeters and voltmeters were extensively used, they have now been almost entirely displaced by the precision moving-iron pattern, so that only wattmeters need here be considered.

#### How a Wattmeter Works.

Fig. 6 shows a typical electro-dynamic wattmeter. The two fixed coils (of which one has been removed in the figure) carry the current and the small flat coil attached to the pivoted spindle is connected through a swamping resistance (as in Fig. 2B) and forms the voltage circuit. The electro-magnetic interaction between the currents in the fixed and moving windings produces a deflecting force proportional to the power and this is opposed by a spiral spring, so that the movement of the pointer is proportional to the watts consumed by the load.

#### How to Connect up a Wattmeter.

Fig. 7 shows how an electro-dynamic wattmeter should be connected to the

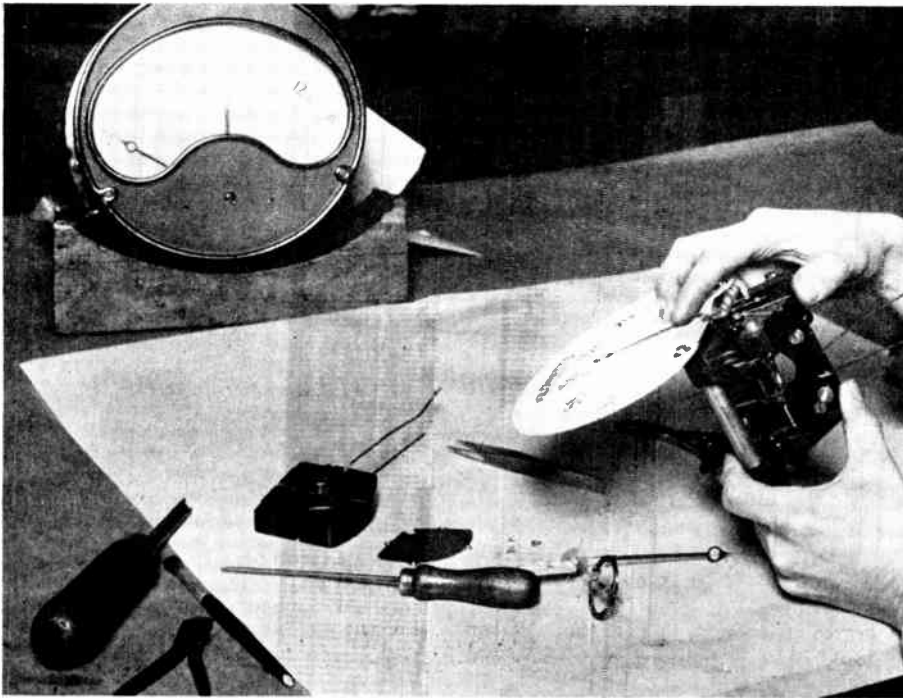
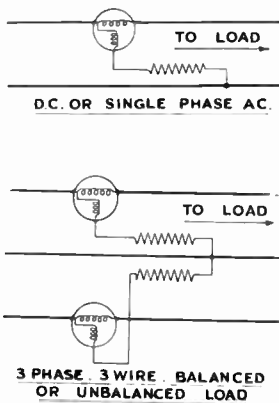

Fig. 6.—DYNAMOMETER WATTMETER MOVEMENT.

One of the current coils has been removed and lies on the bench. A spare moving volt coil assembly is seen in the middle. The cover of the damping box has been removed and a complete switchboard wattmeter is to be seen at the back.

circuit for the measurement of power, four typical cases being given. The two upper diagrams are self-explanatory. With the third system, i.e., the three-phase, three-wire unbalanced load, the readings on the wattmeters (which are two exactly similar instruments) must be added together to obtain the total power. If the "power factor" of the circuit is less than 0.5, one of the wattmeters will read in the reverse direction and the



current terminals of that instrument must be reversed in order to make it read up the scale once more. In this case, in order to obtain the total power, the reading of this latter watt-

meter must be deducted from that of the other.

In order to obviate the necessity for adding or subtracting the readings in this way, the two wattmeter elements are sometimes contained in one case with the volt coils mounted on a common

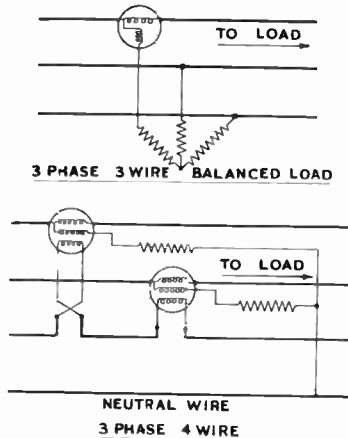
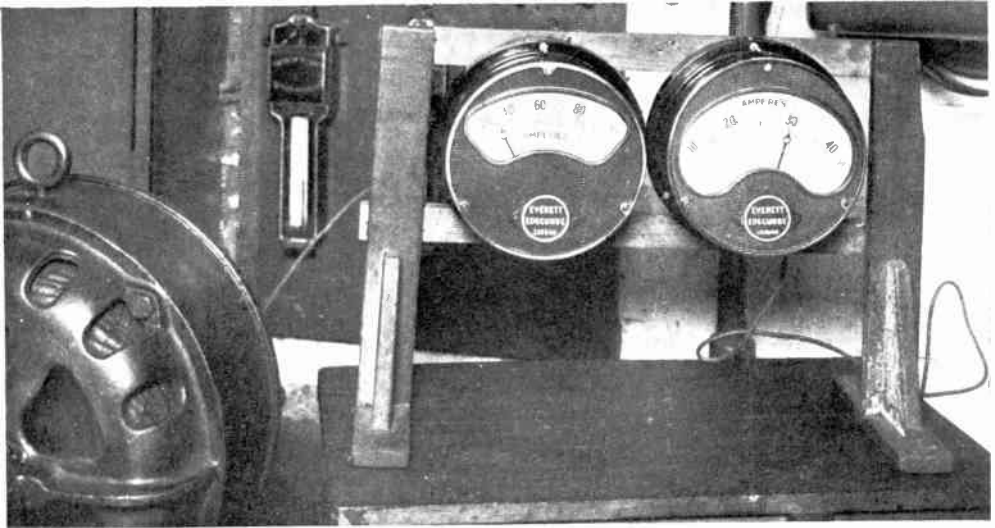
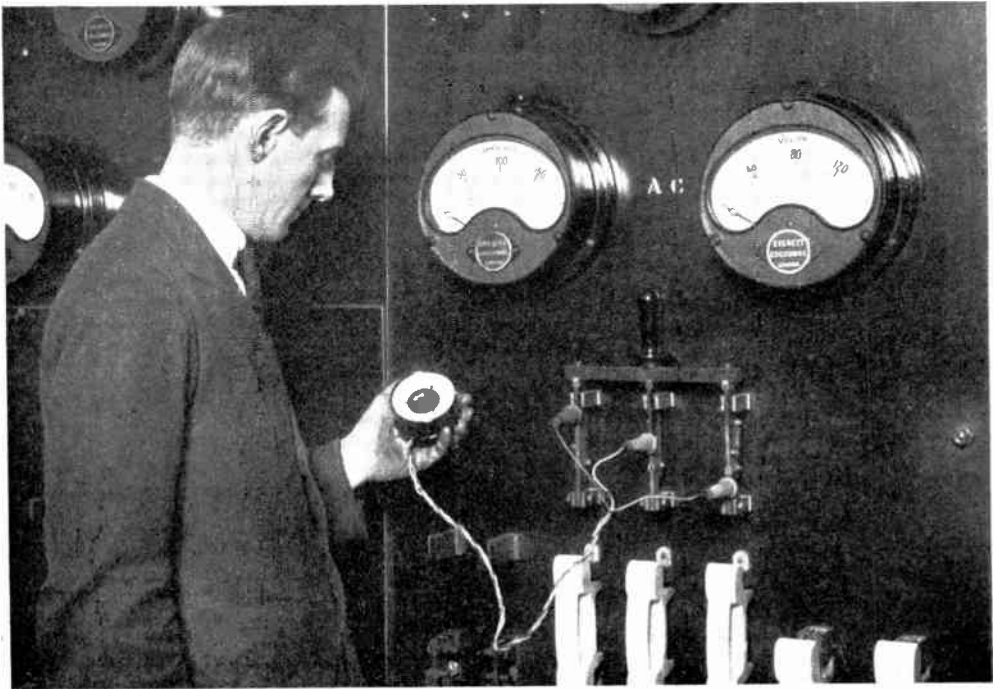

Fig. 7.—CONNECTION DIAGRAMS FOR ELECTRODYNAMIC WATTMETERS.



*Fig. 8.*—MEASURING THE CURRENT CONSUMPTION OF A MOTOR.

For comparison, a modern "Superscale" ammeter (right) and an obsolete ammeter (left) have been connected in series. Note (1) the clear and open dial of the modern ammeter as compared with the 90 degree instrument, and (2) the relative width of the scale divisions, due both to the extra scale length and to the more suitable range chosen.



*Fig. 9.*—DETERMINING THE ORDER OF PHASE SEQUENCE BY A PHASE SEQUENCE INDICATOR.

spindle, which carries the pointer. The deflection is then the true sum or difference, as the case may be, of the readings of the individual elements and therefore indicates the total power on the scale.

In the fourth diagram of Fig. 7, the current winding of each element is divided into two parts, which must be highly insulated from one another, since the full line voltage exists between them.

### How to Decide Upon the Most Suitable Range for a Measuring Instrument.

Having settled upon the type of movement to be used, the range has still to be considered. It is a good rule never to make the maximum scale reading more than 10 per cent. or 20 per cent. greater than the highest value likely to be measured. Any higher scale reading than this means that the readings will have to be taken at an unnecessarily low part of the scale. For the same reason it is convenient if the upper divisions of the scale are somewhat closed up, so that a large proportion of the range may be available for the lower readings. Clearly, also, the modern  $120^\circ$  scale instrument is vastly superior to one of the older ones in which the scale usually subtended only  $85^\circ$  or at most  $90^\circ$  degrees. These points are brought out in Fig. 8, which shows two ammeters each measuring the current taken by a motor. In the one on the right the scale is long and open; in the other—an out-of-date ammeter with twice the range—the measurement being made at a cramped part of the scale. There is little or no advantage in extending the length of scale beyond  $120^\circ$ , since, although such an instrument may be somewhat easier to read at a great distance, the intrinsic accuracy is always less.

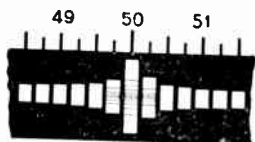
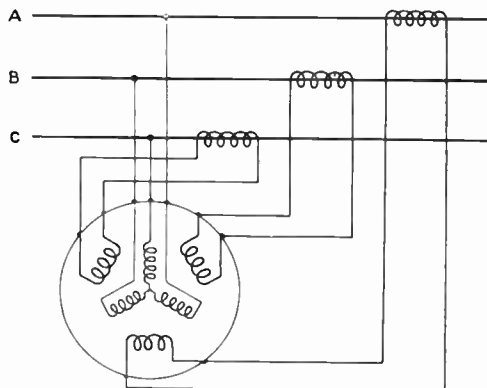

Fig. 11.—PART OF THE SCALE OF A VIBRATING REED FREQUENCY METER.

The frequency may be estimated from the relative amplitude of swing as 50.1 cycles per second.

### Power-Factor Meters.

The power-factor of the load is of such importance from the point of view of the economical generation of



THE VOLTAGES ARE ASSUMED TO REACH A MAXIMUM IN THE ORDER A B C

Fig. 10.—CONNECTION DIAGRAM FOR A THREE-PHASE UNBALANCED LOAD (THREE OR FOUR-WIRE) POWER-FACTOR METER.

power that many systems of charging take it into account, either in the form of a bonus to consumers showing a good power-factor or as a fixed charge based upon the maximum kilovolt-amperes taken during any quarter. In order that a consumer may reduce his kilovolt-ampere demand without reducing the power consumed he must "improve" (raise) the power-factor of his load; since —

volt-amperes = watts / power-factor.

For example, if the power-factor is increased from 0.7 to 0.87 the kilovolt-amperes for a given kilowatt loading will be reduced by 20 per cent. For these reasons the use of power-factor meters, both indicating and graphic, is extending rapidly.

### Principles of a Power-Factor Meter.

The underlying principles of the power-factor meter are somewhat complicated, but the resulting instrument is simple and comprises volt and current windings, as does the wattmeter. For single-phase systems there is one volt and one current circuit; for three-phase balanced load systems there may be either three volt and one current or three current and one volt circuit, and for three-phase unbalanced load instruments there will be three volt and three current circuits.

Modern power-factor meters have  $360^\circ$  scales, the pointer standing in the upper or

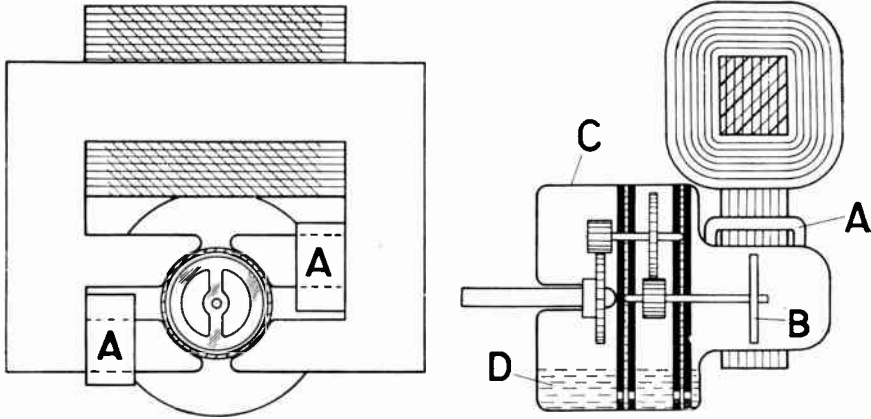

Fig. 12.—A SECTION THROUGH THE WARREN (SYNCKLOCK) MINIATURE SYNCHRONOUS MOTOR, WHICH MEASURES ABOUT  $2\frac{1}{2}$  INCHES SQUARE.

A, shading rings producing a rotating field. B, steel disc drawn round thereby. C, Brass housing protecting the gearing and forming an oil bath, D.

lower half of the scale according to the direction of the flow of power in the circuit in which it is connected.

#### How to Connect up a Power-Factor Meter.

Fig. 10 shows the connections for a power-factor meter suitable for a three-phase system in which the three phases may or may not be carrying equal currents and of which the power-factors may differ from phase to phase. The instrument has accordingly three volt circuits and three current circuits. It will be observed that the diagram is marked "Voltages are assumed to read a maximum in the order A B C," which implies that the line A reaches full voltage relatively to earth one-third of a period before line B and that full voltage on line B is followed one-third of a period later by full voltage on line C, followed again by line A and so on. It is most important that the connections should be made correctly both as regards direction and phase sequence, and the only way of ensuring that this is correct is by the use of a phase sequence indicator.

#### Phase Sequence Indicator.

One of these instruments (Everett, Edgcombe) is shown in use in Fig. 9, and consists of an iron disc, lightly pivoted and acted upon by three electro-magnets, each connected to a length of flex terminating in an insulated clip, the other ends of the windings being joined together. The clips

may be attached to any convenient terminals, as shown in the figure, and the disc then indicates by the direction of its rotation in which order the voltages are reaching their maximum at these three terminals. The windings are so proportioned that the instrument will operate at any voltage between say, 60 and 450 volts.

#### Frequency Meters.

These instruments may be of the deflectional or of the vibrating reed pattern. In the former a pointer deflects over a scale as with an ammeter or voltmeter, but in the latter a number of thin flat springs or reeds, each terminating in a white flag, are fixed side by side close to an electro-magnet, and each is tuned to a frequency differing slightly from that of its neighbour. The reed which happens to be tuned to the frequency of the current in the winding of the electro-magnet, that is, to the supply to which the meter is connected, will be set in "resonant" vibration, and will show quite a large swing, whilst the remaining reeds will hardly vibrate at all. The flags appear under a slot in the dial, the frequency to which each responds being marked against it in the form of a scale.

#### Reading a Frequency Meter.

Such instruments are not altogether easy to read, since the frequency may lie between the values to which two neigh-



bouring reeds are tuned. Fig. 11 shows such a case. The reeds are tuned a quarter-cycle apart, and it will be observed that the one next below 50 cycles is vibrating slightly more than that above 50 cycles, so that the frequency may be read as about 50.1 cycles per sec. Such instruments, whilst accurate, are clearly not nearly so convenient to read as the deflectional pattern and the majority of modern frequency meters take the latter form.

### Mean Frequency Meters.

Frequency meters of both these patterns measure the value of the frequency at any instant; but in the control rooms of modern power stations, the operator regulates the speed of his turbo-alternators so as to keep a correct *average* frequency. Not only is this advantageous from the point of view of correctly sharing the load between the various power stations connected to the "grid," but it affords the inestimable boon of an accurate time service for all consumers connected to the A.C. mains by merely plugging in a synchronous clock.

### How Frequency is Controlled at the Power Station.

The frequency is controlled at the power stations by means of an Everett-Edgcumbe master frequency meter in which the speed of a synchronous motor (Fig. 12) connected to the system whose frequency is to be controlled is compared with the speed of an accurate master clock by means of two concentric hands moving over a common dial (Fig. 13). If the hands

revolve exactly together, the frequency is correct, but if one gains over the other, it is high or low according to which one is leading. The mean frequency, as compared with time, can be kept correct by this instrument to within a few seconds at all times, so that the accuracy of the domestic Synclock connected to any wall-socket is as high as that of the best spring-driven clock, besides requiring no winding or regulating.

### Ohmmeters and Other Resistance Measuring Instruments.

The ohmmeter for the measurement of insulation or resistance is made in many forms, known by various trade names. On page 167 is given a diagram illustrating the general principle of an insulation testing ohmmeter, sometimes spoken of as a "Megger," although, strictly, this name, coined by Mr. Sydney Evershed many years ago, applies to his particular form only. Another pattern is shown in use in Fig. 2 on page 168. Fig. 14 shows the essential parts of this instrument, and Fig. 15 the connections.

### How an Ohmmeter Works.

For the sake of clearness, the permanent magnets have been removed from the pole-pieces, A and B. The ohmmeter proper is mounted above the generator, E being the coil which is connected in series with the insulation to be tested, and D the voltage or control coil, connected through a high resistance, F, across the terminals of the generator, A, and serving to compensate for variations in the voltage.

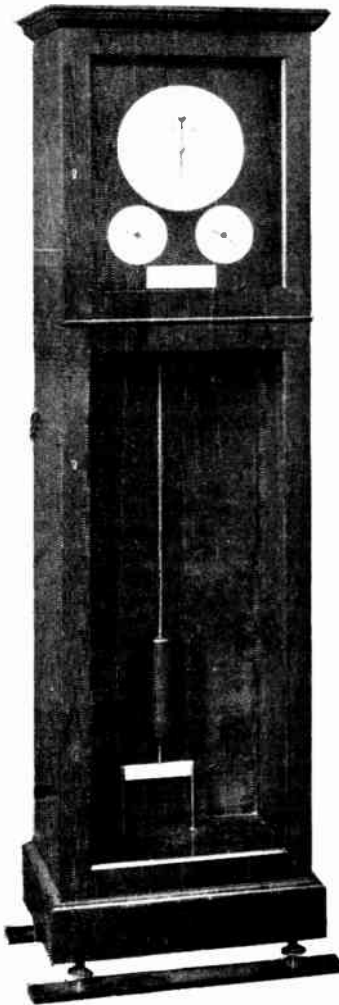

Fig. 13.—THE WARREN MASTER FREQUENCY METER, WHICH CONTROLS THE FREQUENCY OF THE GRID. (Everett, Edgcumbe.)

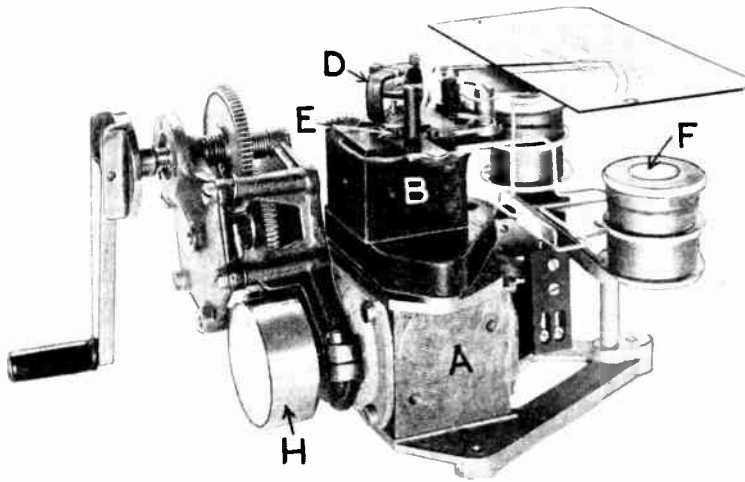

Fig. 14.—WORKING PARTS OF A MAGNETO OHMMETER (METROHM) WITH MAGNETS REMOVED.

installation and that the ohmic value thereof must not be more than 2 ohms. It was further pointed out that the test is difficult to carry out effectively. The conduit tester has been devised for this purpose and is shown in use in Fig. 16A. The instrument consists of a pocket

The revolving drum H contains a centrifugal slipping clutch, which ensures an almost constant voltage being applied to the resistance under test. This is important if the latter has any considerable capacitance, since although the average indication is quite independent both of the voltage and of the capacitance, the momentary charging current due to a change of voltage may cause an annoying flicker of the pointer. For this reason, a constant voltage ohmmeter, which does not cost much more than the variable voltage pattern, is always to be preferred.

**Using an Ohmmeter for Testing Resistance.**

Ohmmeters are also available for the workshop testing of resistances, both high and low, and their use is very much easier and quicker than that of the Wheatstone bridge which was at one time almost the only method available. Fig. 17 shows a number of similar coils having their resistance measured as a routine test by a workshop "Metrohm," a 4-volt accumulator being used as a source of current in place of the generator shown in Figs. 14 and 15.

**The Conduit Tester.**

It was pointed out on page 173 that the I.E.E. Rules insist upon a test of the resistance of the conduit in a completed

milliammeter mounted in the same box as a "torch" battery and press-key. A long pair of leads terminating in bull-dog clips is provided for making connection with the distant end of the conduit, and an earthed point respectively (see Fig. 16A). All that is necessary is to clip the leads in place, press the key and note the reading in ohms. If it is less than 2 ohms, the installation will pass; if not, the cause must be sought in a bad contact at one of the sockets or some other joint in the conduit, the position of which can be easily located by transferring the farther clip to other points of the conduit. A simple adjustment is provided on the tester which

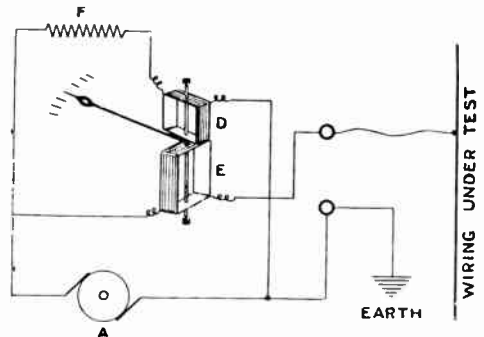

Fig. 15.—CONNECTION DIAGRAM OF INSULATION TESTING OHMMETER.

The letters refer to the same parts as in Fig. 14.

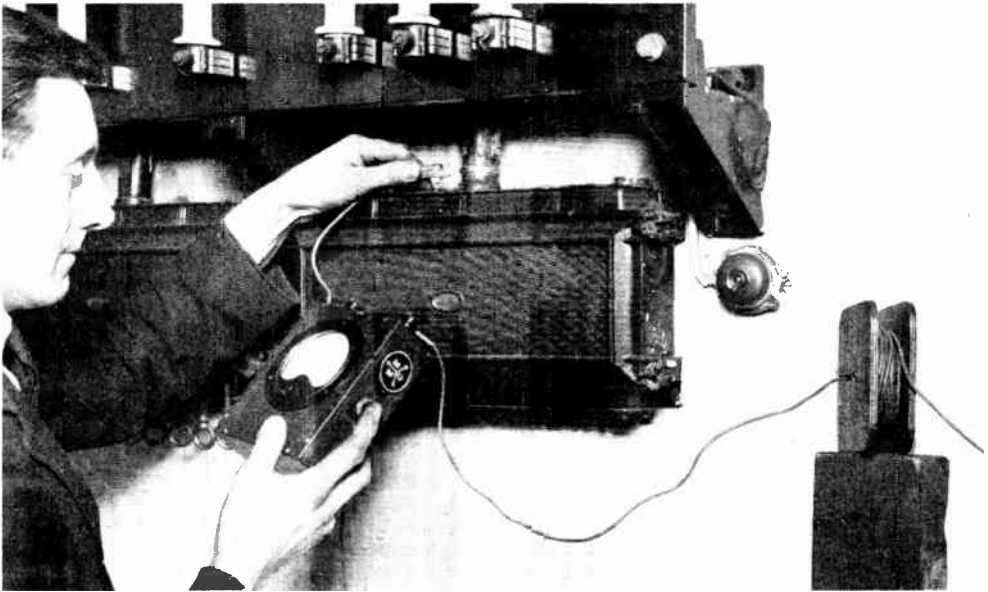

Fig. 16A.—THE CONDUIT TESTER IN USE.

One terminal of the tester has been connected to earth. The wooden spool at the right serves to carry the spare length of lead.

compensates for any fall in the voltage of the dry cell. This instrument may also conveniently be used for making rapid continuity tests and for this purpose it replaces the ammeter and accumulator battery shown in Fig. 8 on page 172.

#### The Earth Plate Tester.

The maintenance of an effective earth is of vital importance for many purposes and a simple means of measuring its resistance is essential. In Fig. 1 on page 599 is shown the testing of a lightning

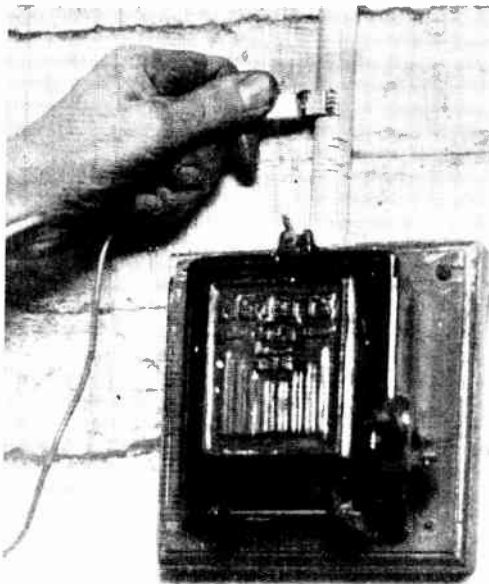

Fig. 16B.—THE CONDUIT TESTER IN USE.

Showing connections made with farthest point of the conduit.

arrester earth by means of a "Metrolm" earth plate tester. This instrument (see Fig. 18) consists of a hand-driven magneto-generator provided with a slipping clutch (see 11, Fig. 14), so as to give a constant voltage, connected in series with a self-contained milliammeter (MA). The generator and milliammeter are connected in series with the earth plate (EP) and a good earth (E), such as a water main. The instrument is scaled so as to read the earth plate resistance directly in



Fig. 17.—MEASURING THE RESISTANCE OF COILS AS A WORKSHOP ROUTINE TEST.

ohms. The resistance of two similar earth plates can be measured by connecting one to each terminal of the instrument and measuring the total resistance, that of each plate will then be half the dial reading. A connection to a domestic water-heating system does not make a suitable earth, nor should a gas-pipe be used for the purpose.

**Continuity of the Earth Return.**

Whilst the danger of a high resistance earth plate is self-evident, it is often forgotten that a defective joint in the earth return is equally dangerous, since in the event of a breakdown in the insulation between a conductor and this earth return, a high voltage to earth may ensue, sufficiently high, in fact, to be dangerous to life. For this reason, very great

stress is laid in all wiring regulations on the maintenance of perfect joints in earth return conductors and various instruments have been devised with which the continuity of a joint can be readily tested. One of these (Everett, Edgumbe) is shown in use in Fig. 2 on page 601. In underground installations the periodical testing of all such joints is insisted upon (see Mining Regulations).

Of the electrical movement little need be said, since it differs but slightly from that of an indicating instrument, except that larger working forces are essential in order to overcome the inevitable friction between pen point and paper.

**Inking Devices.**

The inking devices in use differ widely. In the older instruments a long pen arm hanging from the

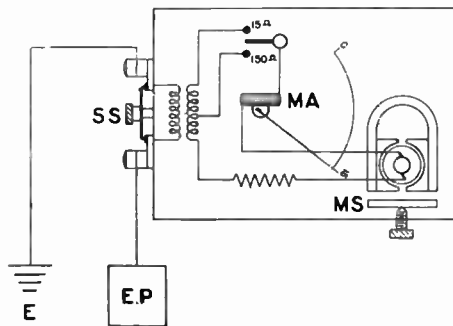

Fig. 18.—THE "METROHM" DIRECT READING EARTH PLATE TESTER.

The tester can be checked at any time by closing the short-circuiting switch SS and turning the handle of the generator, when the pointer should fly to 0 on the scale. If it does not, it must be brought there by an adjustment of the magnetic shunt, MS.

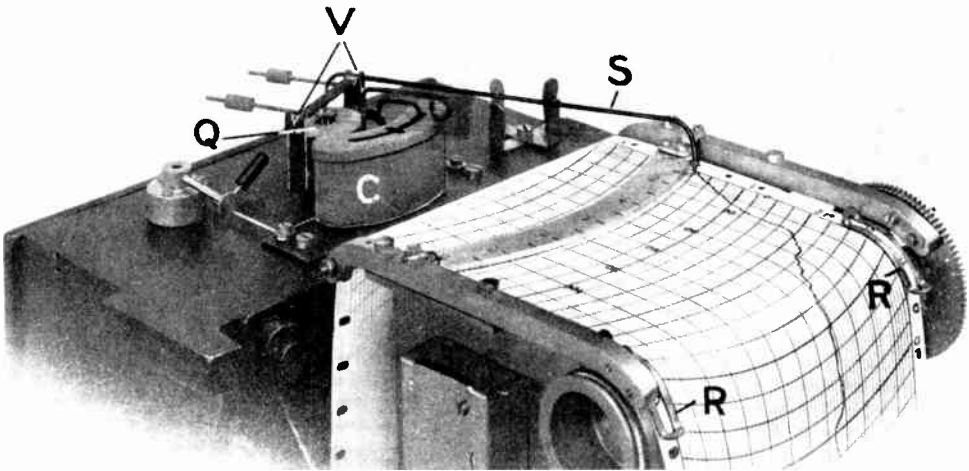

Fig. 19.—INKING AND CHART-DRIVING MECHANISMS OF THE "INKWELL" GRAPHER.

movement merely took the place of the ordinary instrument pointer. It carried a spoon or bucket-shaped pen at its lower extremity. This arrangement had many serious drawbacks. In one modern graphic instrument the pen is eliminated altogether and its place is taken by a fixed ink reservoir, having a small central hole, just large enough to allow the end of the tubular pen arm to pass through it. Fig. 19 shows the inking arrangements of this instrument, the "inkwell" being shown at Q. The tubular pen arm S is pivoted in notches V at the top of the uprights, which are carried by the electrical movement below them (not seen in Fig. 19, but shown in Fig. 20).

In this way the ink is si-

phoned from the inkwell, along the tubular pen, on to the paper chart, and since the arm moves in a horizontal plane the indications are quite unaffected by the amount of ink in the system. The inkwell, being fixed, can be made of ample size and contains enough ink for a month's

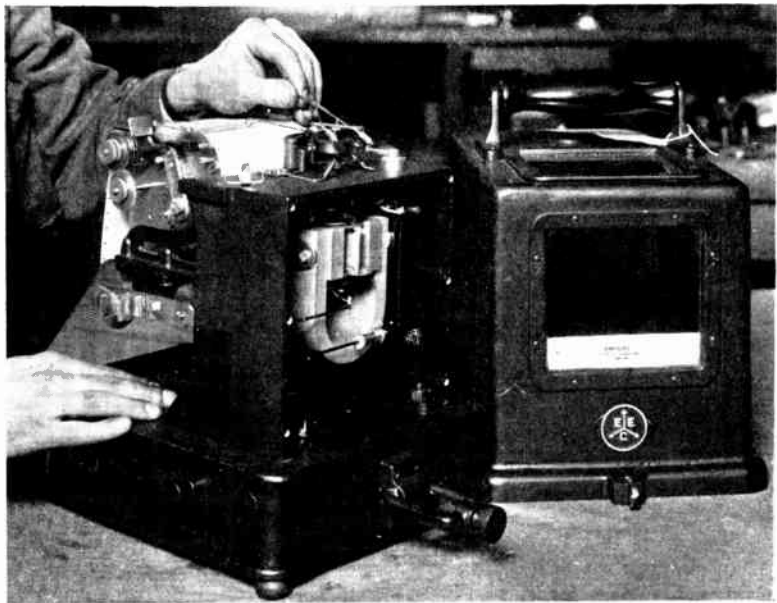

Fig. 20.—A METAL-CASED PORTABLE GRAPHER WITH THE BACK PLATE REMOVED SO AS TO EXPOSE TO VIEW THE MOVING-COIL AMMETER MOVEMENT.

The operator is replacing the pen in its supporting pivots.



Fig. 21.—CLEANING OUT THE TUBULAR PEN WITH GLYCERINE, AFTER LONG SERVICE.

run. The movement is rendered dead-beat by means of the oil chamber C, in which swings a small paddle moving with the pen.

#### Chart-driving Mechanism.

The chart itself usually takes the form of a continuous roll some 60 feet long, driven forward by a clock through the medium of holes punched along one or both edges, into which engage pins carried by driving wheels as shown at RR in

Fig. 19. In place of the spring-wound clock, it is now becoming common to drive graphic instruments by means of a synchronous motor, which, when connected to the mains, drives the chart at a constant speed.

Fig. 21 shows how the tubular pen should be cleaned out in case it has become choked after long use or if it has been allowed to dry. A small quantity of glycerine is put in the little basin and is drawn backwards and forwards through the pen tube by means of the small squirt which forms part of the equipment. The pipette lying on the table is used to draw ink through the pen after it has been put in position in the inkwell. When once filled, the inking becomes automatic.

#### General Hints Relating to Graphers.

See that the pen point is clean and unobstructed. This is best done by washing in methylated spirits. Never use force, or the pen may be ruined. A strip of paper can be drawn through a pen having parallel points.

Adjust the pressure between the inking point and the chart to a minimum, consistent with the tracing of a good line. If the pen has to move rapidly across the chart more pressure is needed than if the motion is slow.

When changing a chart take care not to damage the pen point or to bend the pen-arm.

If a grapher is to be laid aside for any length of time, the pen or the pen tube should be cleaned out and preferably left full of glycerine.

When the used chart is arranged to be wound up on a roller (a very convenient and usual arrangement), the latter is driven by friction, a light spring belt

being often used for the purpose. It is important that the drive should be sufficiently powerful to wind up the chart, but it must not be enough either to tear the paper as it passes on and off the driving pins or to pull up the clock.

Always empty the oil out of the oil damper before moving a switchboard grapher from its fixed position.

When ordering new charts, it is well to send a small sample of the existing chart. This will obviate any mistake.

Always use the ink and damping oil recommended by the maker.

If the quantity to be measured is varying so rapidly as to give a thick or blotted record, use a heavier oil in the damper. If this does not cure the trouble then the chart speed is too low.

### Electrical Speed Indicators.

The electrical speed indicator is the most convenient of all wherever the indication is to be made at more than, say, 6 feet away. These instruments commonly consist of a D.C. magneto-generator, the voltage generated in the armature of which is directly proportional to the speed of rotation, so that a voltmeter connected to its terminals may have a scale graduated in revolutions per minute, miles per hour or any other desired unit. The armature usually runs at from 1,500 to 3,000 revolutions per minute at full scale, the former being the better speed for continuous use. The terminal shaft may, by suitable gearing, be caused to run at any convenient speed according to the form of drive, whether direct, through external gearing, or by means of a belt or cham.

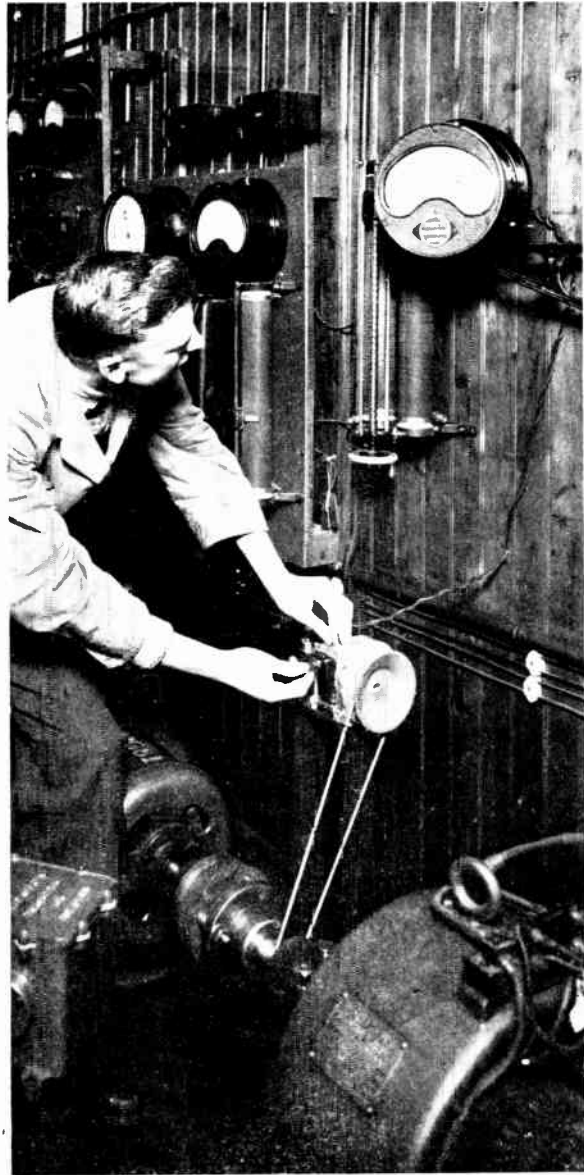
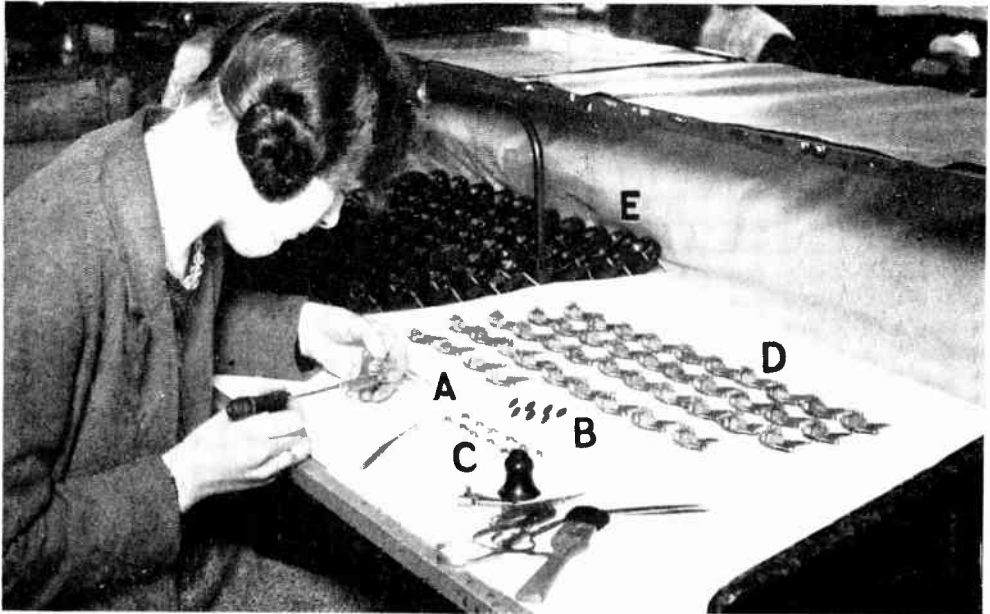

*Fig. 22.* ELECTRICAL SPEED INDICATOR WITH OPEN TYPE TRANSMITTER BELTED TO A MOTOR.

The indicator is in this instance close to the motor, but it may be placed at any distance away. Note the even scale. A similar transmitter, but in a watertight case, is seen to the left of the figure.

### Methods of Driving.

If the speed is suitable, the direct drive is convenient. It must be arranged so

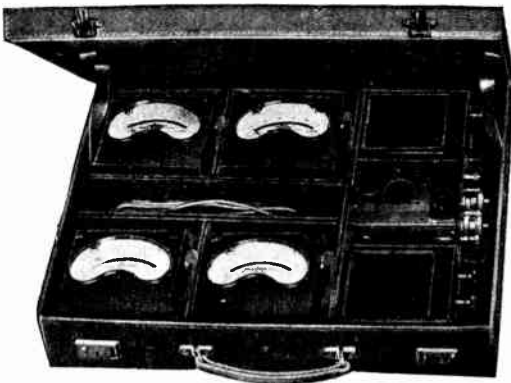

*Fig. 23.*—SOLDERING A HAIR SPRING ON TO A " DWARF " MOVING-COIL INSTRUMENT.

The springs used are of phosphor bronze, so as to be non-magnetic. At A is a group of springs; at B, a number of moving-coil assemblies; at C, the bridges to which the other end of the spring is to be soldered; at D, some completed movements; and at E, the moulded bases on which the movements are to be mounted.

that no strain is thrown on the generator shaft, which should run in ball bearings. External gearing is useful under certain conditions, but is liable to be noisy. A chain, like the direct drive, has the advantage of eliminating all slip, and if chain and sprockets are of good quality, is

very satisfactory. A belt forms a handy drive (Fig. 22) and may consist either of flat webbing, or, perhaps better, of a wire spiral running in grooved pulleys. This latter arrangement has the advantage of being elastic and therefore self-tightening and the slip is negligible.



*Fig. 24.*—SET OF " CADET " A.C. INSTRUMENTS IN LEATHER CARRYING CASE.



*Fig. 25.*—OMNI-RANGE CURRENT TRANSFORMER, WITH VARIOUS RANGES UP TO 1,000 AMPERES. As shown (with five turns), the ratio is 200/5 amperes.



It is important that no oil or grease should find its way on to the commutator of the generator and for this reason most electrical speed indicators bear some such legend as "Use oil sparingly."

### Making an Adjustment.

Fig. 22 shows an electrical speed indicator measuring the speed of a motor to which it is connected by a spiral wire belt. All the shafts run in ball bearings and so require no lubrication for long periods. When setting to work, it is well to check the correctness of the indications at one point on the scale of the indicator by comparison with a revolution counter, so as to ensure that the effective gearing ratio is correct. An external magnetic shunt is usually provided for this purpose, so that any discrepancy can be allowed for. Such an adjustment is in progress in Fig. 22, the magnetic shunt being operated by means of a hexagon nut. The transmitter in use is of the open type, but for many purposes a totally enclosed transmitter is to be preferred. One of these, of watertight pattern, is also seen in the figure.

### Portable Testing Instruments.

Almost all the types of measuring instruments so far described are available in both the switchboard and portable patterns, the latter usually in wooden cases. For workshop and outdoor testing, a wax finished oak case is probably the most suitable, since although it may not look quite so "smart" when new as a polished mahogany or walnut case, it will survive a year's average use very much better than either. For the test room, the comparative delicacy of a french polished case is probably an advantage in that it compels a certain amount of respect at the hands of the user.

Recently a number of very compact portable instruments have become available, such as can be contained in a leather despatch case for ease of transport. Fig. 24 shows a number of such instruments in their leather case, comprising two ammeters, a voltmeter, wattmeter and current transformer. This set of instruments enables the electrical

power and voltage to be measured, as well as the current, and the power-factor at different loads, etc. Other forms of portable instrument will have been observed in the various illustrations. Fig. 24 shows a still smaller instrument known as the "Minisquare" (Everett, Edgcombe).

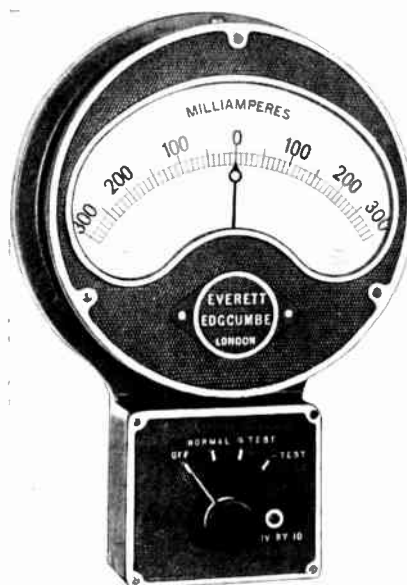

Fig. 26.—LEAKAGE INDICATOR FOR A DIRECT CURRENT TWO-WIRE SYSTEM, OF WHICH BOTH POLES ARE INSULATED FROM EARTH.

Satisfactory insulation is indicated by the pointer standing in a central position (as in the figure), and a fault by a deflection to right or left.

### How to Prevent Overloading.

When using a portable instrument which has more than one range, care is necessary to ensure that the instrument is not overloaded. To this end, if there is any doubt as to the value of the current or voltage to be measured, it is advisable to connect one of the high ranges in circuit first and to change to a lower range only after the approximate value has been ascertained.

### A Cell-testing Voltmeter.

A special form of portable instrument is the cell-testing voltmeter. Cell testers



Fig. 27.—AMMETER WITH HINGED CORE TRANSFORMER CLAMPED ROUND A CONDUCTOR CARRYING A.C. AND INDICATING THE VALUE OF THE CURRENT. The instrument shown has two ranges, 0-100 amperes and 0-500 amperes.

differ somewhat according to whether they are to be used for the testing of large cells, such as those in central stations, motor cars, or low tension wireless batteries, or for cells of small capacity such as wireless high tension batteries. For the former purpose it is no disadvantage for the voltmeter to consume a considerable current; in fact, properly to test an accumulator the voltage measurement should be made at a current approximately equal to the normal discharge rate, and for this purpose specially low resistance cell testers are made (see Fig. 2, page 998). For the testing of small cells, however, a high resistance is essential in fact, for use with high tension wireless batteries the current corresponding to full scale deflection should not exceed 2 milliamps. and for testing high tension battery eliminators a current of 1 milli-amp. or less is desirable. If the current consumption is greater, the voltage as measured may be

considerably lower than that on open circuit or in use.

**Leakage Indicators.**

These instruments, as their name implies, serve to indicate continuously the state of the insulation of a system, as evidenced by a leakage of current to earth. Their use has extended rapidly of late, since it is now recognised that "prevention is better than cure"—an early intimation of increased leakage often allowing an unsuspected defect to be located and removed before it attains the dimensions of a serious fault.

Fig. 26 shows a typical leakage indicator suitable for a D.C. system insulated throughout. A switch operated by a knob is left in the "normal" position and the pointer then instantly shows the development of a fault on either the positive or negative mains by a deflection to left or to right respectively.

Readings taken with the switch on the "+ test" and "− test" stops, enable the actual insulation of the positive and negative poles of the system to be read off from a table which accompanies the instrument.

**Current and Voltage Transformers.**

These are usually employed either because the current to be measured is too

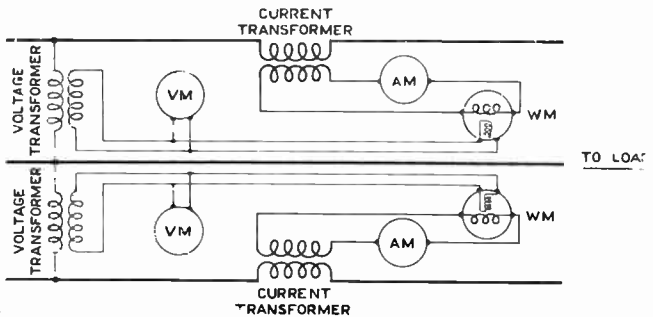

Fig. 28.—CONNECTIONS FOR THE MEASUREMENT OF THE VOLTAGE, CURRENT, POWER AND POWER-FACTOR ON A HIGH-VOLTAGE, THREE-PHASE CIRCUIT, IN WHICH THE LOAD MAY BE BALANCED OR UNBALANCED BETWEEN THE THREE PHASES.

large to be conveniently passed through the instrument or because the voltage of the system is too high to be safely indicated by it. Although the construction and design of current and voltage transformers differ fundamentally, yet from the user's point of view they are very similar. Each has a primary and secondary winding for connection in the main circuit and a secondary winding for connection to the measuring instrument, and each has a magnetic core made up of thin pieces of highly permeable iron or one of its alloys. The primary of a current transformer may consist of a number of turns if the current is low, or of a single conductor passing once through the core if the current is fairly high (say 600 amperes or more). If special precautions are taken, single turn or "bushing current transformers," as they are called, can now be constructed for currents as low as 50 or 100 amperes.

For portable use, current transformers are usually mounted in wooden cases and are insulated with bakelite. A convenient form of current transformer is one having a central hole, as shown in Fig. 25. Such a transformer is suitable for a wide range of current measurements, the one illustrated having fixed primary windings for 10 and 20 amperes and enabling further ranges to be obtained of 100, 200, 250, 500 and 1,000 amperes by threading the conductor carrying the current to be measured through the central opening, making 10, 5, 4, 2 and 1 turns respectively. A still smaller "omni-range" current transformer is shown among the group of instruments in Fig. 24.

#### **Precautions to Take When Using a Current Transformer.**

The satisfactory performance of a voltage or current transformer depends largely upon the value of the secondary burden; that is, upon the number and impedance of the measuring instruments connected to it. Care must, therefore, be taken that the rated burden shown on the nameplate is not exceeded. Another very important precaution is to ensure that the secondary circuit of a current transformer

is never opened so long as a current is flowing in the primary. *If this precaution is neglected, there is a grave risk of a high voltage being generated in the primary winding sufficient to break down the insulation of the transformer and even to cause danger to life.* It should be remembered that the value of the secondary current of a current transformer is determined by that of the primary current, so that there is no risk of damaging it by short circuiting the secondary terminals. With a voltage transformer, on the other hand, the secondary circuit may be broken with impunity, but must not be short circuited or it will be burnt out.

#### **Clip-on Current Transformer.**

Fig. 27 shows a form of portable current transformer in which the core can be opened by pressing the trigger and re-closed round a conductor. The ammeter will then read the value of the A.C. flowing through the conductor. A measurement can thus be made without breaking the primary circuit. The instrument shown in Fig. 27 has two ranges, 0-100 and 0-500 amperes.

When using current and voltage transformers with wattmeters or any other form of instrument, the connections are similar to those given for the various direct-connected instruments. For example, in Fig. 7 the primaries of the current transformers will take the place of the windings there shown, the secondary being connected to the instrument windings. As an example, Fig. 28 shows the connections for a high tension, three-phase, unbalanced load system, with two single-phase wattmeters, two ammeters and two voltmeters.

#### **PRECAUTIONS WHICH SHOULD BE TAKEN IN ERECTING AND CONNECTING UP ELECTRICAL MEASURING INSTRUMENTS.**

The majority of these precautions apply equally to supply meters as to indicating instruments (see also page 1054).

#### **Connecting Up.**

Examine the maker's diagram carefully before connecting up and check over the connections again before making the circuits alive.

**OUTSTANDING FEATURES OF VARIOUS TYPES OF MEASURING INSTRUMENTS.**

Type.	Scale Shape.	Advantages.	Disadvantages.	Suitable for.
Permanent-magnet moving-coil ammeters and voltmeters.	Even throughout.	Dead-beat, accurate, low power consumption, shows direction of current.	D.C. only. Ammeters must be shunted. Somewhat expensive.	D.C. switch-board and portable instruments of high accuracy.
Moving-iron ammeters and voltmeters.	Fairly even above 1/10 scale.	Inexpensive. Can be made dead-beat. Available for D.C. and/or A.C. If specially constructed can be made extremely accurate.	As usually constructed, not very accurate on D.C. Power consumption rather high. Not suitable for voltmeters below say 10 volts.	A.C. and / or D.C. Industrial switch-board for portable use. Also, when specially constructed, for accurate testing work.
Induction ammeters and voltmeters.	Reasonably even above 1/5th scale.	Robust construction; long circular scale.	Large power consumption. Somewhat expensive. Readings affected by any large changes of frequency, wave-form or temperature.	A.C. switch-board instruments only.
Induction wattmeters.	Even throughout.	Robust construction; long circular scale.	Readings affected by changes of frequency, wave form and temperature.	A.C. switch-board instruments only.
Electro-dynamic (dynamometer) wattmeters.	Almost even throughout.	Extremely accurate on A.C. and/or D.C. Fairly low power consumption.	Somewhat delicate in construction. Seriously affected by stray magnetic fields.	Switchboard or portable wattmeters for all purposes.
Rectifier-operated moving-coil ammeters and voltmeters.	Almost even throughout.	Lower power consumption and available for low current or low voltage A.C. measurements.	Only applicable to A.C. of sine wave forms. Liable to be affected by changes of temperature.	Particularly for A.C. Measurements of small currents or low voltages.
Hot-wire ammeters and voltmeters.	Cramped below 1/4 scale.	Give the same readings on A.C. and D.C. Available for use on high frequency circuits.	Uncertainty of zero. Liability to damage by overloads. Large power consumption.	High frequency measurements (e.g., radio or diathermy).
Electrostatic voltmeters.	Ditto.	No consumption of power. Equally accurate on D.C. and/or A.C.	Delicate movement and liable to damage by over-voltages.	Switchboard or portable use for any voltage up to 500 k.V.
Thermo-couple ammeters and voltmeters.	Ditto.	Equally accurate with A.C. and/or D.C. Also, with certain limitations at radio-frequencies.	Somewhat expensive. Liable to damage through moderate overloads.	Switchboard or portable instruments for radio-frequency measurements.

See that all accessory apparatus such as shunts, series resistances, current or voltage transformers, condensers, chokers, etc., which are shown in the diagram of connections, are in place.

#### **The Question of Levelling.**

Gravity-controlled instruments must be so levelled that the pointer stands at zero when no current is flowing. This is a precaution often overlooked in the erection of "controller" pattern instruments; that is, instruments mounted on a small pedestal having a flat base and suitable for erection on the top of a switch or control box. It is not easy to level up such instruments, since this entails levelling the whole switch box. For this reason "controller" instruments should always be specified to be spring controlled.

#### **Arrangement of Shunts.**

Shunts should, if possible, be erected with their longitudinal axes horizontal and with the leaves vertical, so as to give the maximum amount of ventilation. If the longitudinal axis must, for any reason,

be vertical, the current, if D.C., should enter by the lower terminal and leave by the upper.

See that good contact is made at all points or over-heating will ensue.

The accuracy of any shunted instrument depends upon the shunt leads having a certain resistance. Consequently, the leads supplied by the maker should be used or, if not, others closely equivalent to them in resistance.

#### **Current Transformer Precautions.**

On no account must the secondary circuit of a current transformer be opened so long as current is passing through the primary. As a safeguard, it is well to keep the secondary terminals short circuited until all the connections have been finally made (see page 1120).

#### **Special A.C. Instruments.**

Many instruments, such as power factor meters, polyphase wattmeters, etc., will only read correctly if the phase sequence is correct. To ensure this a phase sequence indicator should be used.

---

## QUESTIONS AND ANSWERS

#### **How does a wattmeter work ?**

Two fixed coils carry the current and a small flat coil attached to a pivoted spindle is connected through a swamping resistance, and forms the voltage circuit. The electro-magnetic interaction between the currents in the fixed and moving windings produces a deflecting force proportional to the power and this is opposed by a spiral spring, so that the movement of the pointer is proportional to the watts consumed by the load.

#### **What precaution should be taken to prevent overloading when using a portable measuring instrument which has more than one range ?**

If there is any doubt as to the value of the current or voltage to be measured, it is advisable to connect one of the higher ranges in circuit first and to change to a lower range only after the approximate value has been ascertained.

#### **How is frequency controlled at a power station ?**

By means of a master frequency meter in which the speed of a synchronous motor connected to the system whose frequency is to be controlled is compared with the speed of an accurate master clock by means of two concentric hands moving over a common dial. If the hands revolve exactly together, the frequency is correct but if one gains over the other it is high or low according to which one is leading.

#### **What special precautions must be taken when using a voltage or current transformer ?**

(1) Take care to see that the rated burden shown on the nameplate is not exceeded.

(2) See that the secondary circuit is never opened so long as a current is flowing in the primary.

**What would happen if the second of these precautions were neglected ?**

There would be a grave risk of a high voltage being generated in the primary winding sufficient to break down the insulation of the transformer and even to cause danger to life.

**For what purposes are the following ammeters and voltmeters suitable :—**

- (1) **Permanent magnet moving-coil ;**
- (2) **Moving-iron ;**
- (3) **Induction ;**
- (4) **Rectifier-operated moving-coil ;**
- (5) **Hot-wire.**

(1) D.C. switchboard and portable instruments of high accuracy.

(2) A.C. and/or D.C. industrial switchboard for portable use. Also, when specially constructed for accurate testing work.

(3) A.C. switch board instruments only.

(4) Particularly for A.C. measurements of small currents and low voltages.

(5) High frequency measurements (e.g., radio or diathermy).

**What is the difference between a watt-hour meter, and an ampere-hour meter ?**

A watt-hour meter takes account of variations in voltage whilst an ampere-hour meter does not.

**In selecting an ammeter for use in a factory to read up to 50 amperes, what requirements would you specify regarding the scale ?**

That it should be of the modern " open scale " type. That is, with the 25-ampere scale division reasonably near the centre point of the scale, and the scale fairly evenly spaced.

**What is a thermocouple ammeter ?**

This instrument is used for measuring very small currents and contains a small thermocouple of constantin and manganin. The current to be measured passes through the thermocouple and sets up an electromotive force which is measured on a sensitive moving coil milliammeter. Small

high frequency currents can be measured in this way.

**Can a permanent magnet and moving coil instrument be used for measuring alternating currents ?**

In the ordinary way an alternating current sent through a moving coil instrument would merely cause the needle to quiver. By incorporating in the instrument a suitable rectifier, such as the Westinghouse copper-oxide rectifier, these instruments can, however, be used to give a steady reading on an A.C. circuit.

**What is an earth-plate tester ?**

A special instrument for measuring the resistance of an earth connection on a lighting installation or for a lightning conductor. This instrument is calibrated to give a direct reading of the earth-plate resistance in ohms.

**What is the principle of the electrical speed indicator ?**

An electrical speed indicator consists of a small direct current generator giving a voltage directly proportional to the armature speed. A suitably calibrated voltmeter can then be used to give a direct reading of the speed in revolutions per minute.

**Why are power factor meters becoming of increasing importance in electrically driven works and factories ?**

Because many power supply companies make a special concession in price when the power factor of the load is kept high. The use of A.C. motors often leads to a bad power factor, and it is sometimes advisable to install special apparatus, such as a large condenser, to introduce a leading current and so bring up the power factor of the installation.

Proper use of a power factor meter in an installation of this type (where the electricity charges depend upon a good power factor) may easily be the means of effecting substantial economies in running costs.

# RECORD-CHANGING ELECTRIC GRAMOPHONE MOTORS

By A. E. WATKINS

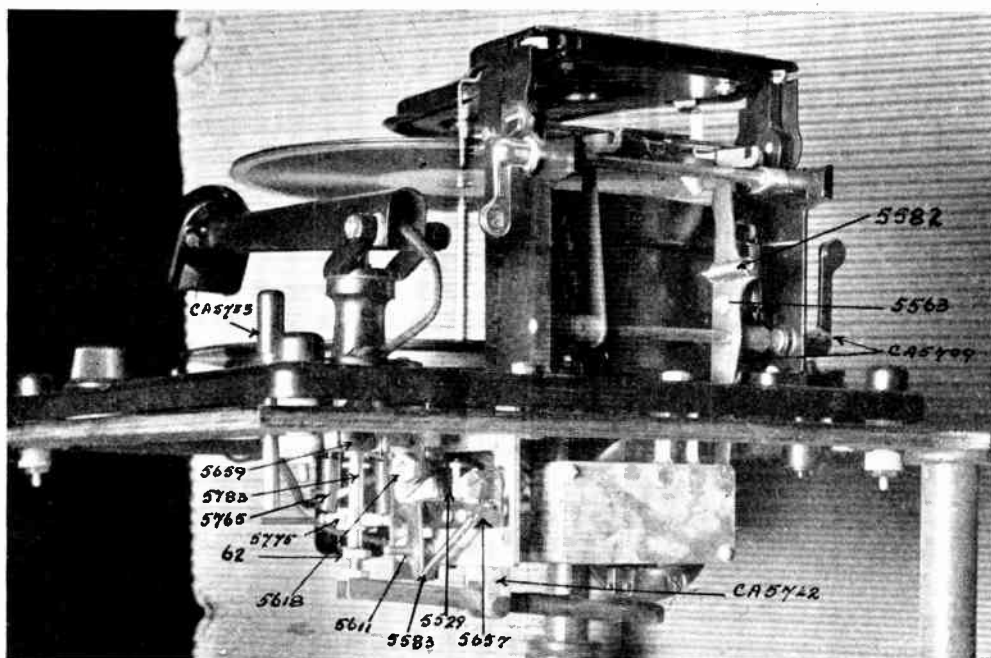

Fig. 1.—THE GENERAL APPEARANCE OF THE CAPEHART AUTOMATIC RECORD CHANGER.

This unit consists of an induction motor, turntable and pick-up, with a distinct feature that it incorporates a magazine device in which up to 10 records can be stored or played automatically. Note the cam which operates the lever to lift the tone arm.

**T**HIS instrument which is known as the Capehart Automatic Record-Changer Electric Gramophone Motor is of American origin and is marketed in this country by The Sun Electrical Co. It is the only automatic record-changing gramophone motor which can be purchased as a separate unit for building into any type of radio-gramophone. It is, however, the intention to have this machine made in this country.

This unit consists of an induction motor, turntable and pick-up, with a distinct feature that it incorporates a magazine device in which up to ten records can be

stored or played through automatically without any interference or attention. The general appearance is shown in Fig. 3.

The top record on the turntable is in the act of being played. Those left on the turntable have already been played, and the others in the magazine are awaiting release by the automatic feeding device.

## The Operation of the Magazine.

The action of the magazine can be seen from Fig. 2 which shows it in its loaded position. The central fixed spindle in the magazine is hooked at the end and the records are placed on the spindle held by

two spring attachments at the edges of the records. After loading, the magazine is lowered into place so that its hooked end rests on the spindle of the turntable. The record in the magazine is then kept in place by means of the hook on the magazine spindle, and by the stationary horizontal plate below the magazine. The tipping mechanism which comes into play at the end of playing one record pushes forward a movable plate which bears on the edge of the record. This, in turn, pushes the record off the turntable on to the stationary horizontal plate, and also pushes it over the hooked end of the magazine spindle, so that the record goes from the magazine on to the turntable. Before this occurs (the ordinary automatic operation of the changing), the pick-up has been swung clear of the turntable, so that the falling record has a clear path.

#### **The Pushing Plate.**

The pushing plate referred to is of such a width as to push only the bottom record in the magazine, so that the remaining records are still held on the hook spindle and stationary plate. The magazine is intended to accommodate either 10-in. or 12-in. records, but all records placed in the magazine must be of one size. Adjustment of the magazine for the size of record is by means of what is called the magazine control lever, as shown on the right side of Fig. 2. This has two positions marked 10 in. and 12 in. and adapts the stationary horizontal plate to the size of the records loaded on the magazine.

#### **Loading the Magazine.**

As the magazine is being loaded, it is also necessary to set the pick-up control lever to the corresponding position, either 10 in. or 12 in., as shown at the side of Fig. 3. This regulates the position at which the pick-up is dropped on to the turntable, which, of course, naturally varies with the size of record which is being played.

#### **Releasing the Push-off Device.**

The lever seen in Fig. 2 provides an independent manual control for releasing the push-off device. This is intended finally for unloading the records, one at a

time from the magazine on to the turntable, but it is not involved in the normal automatic running of the machine. When loading the magazine, one record can be placed on the turntable and any number up to ten records in the magazine. The magazine is then lowered into position and the machine is ready to work.

#### **How the Pick-Up is Placed on the Record.**

Switching on the main switch then starts the turntable motor. After a slight pause the pick-up is swung into position and starts on the outside of the record. The pick-up is then lowered on to the record, which then moves in a normal manner.

At the end of the record, the pick-up is raised and swung clear of the turntable. After a slight pause the tripping mechanism is released and drops the next record into position. In due order the pick-up is then swung back to the beginning of the record, lowered into place, and played through. This continues so long as the main switch is left on.

#### **What Happens When the Magazine is Empty.**

When the magazine is empty, the pick-up still continues to play the last record until the main switch is turned off; but should the main switch be switched off before the record has finished playing, it will continue playing the record before coming to rest, so that the pick-up is not left on a half-played record.

#### **Rejecting a Record.**

If at any time it is desired to reject a particular record which is being played, all that it is necessary to do is to press the button marked "Reject." This first shorts the pick-up so that the sound of the record ceases immediately and brings into operation the normal "end of record" mechanism, raising and swinging the pick-up and releases the next record and carries on automatically.

#### **Repeating a Record.**

If on the other hand, it is desired to repeat the record which is being played, it is only necessary to lift the magazine to an upright position. This prevents the



records in the magazine from being released.

Used either as a magazine device or as a player of single records, the Capehart changer is a remarkable, simple and convenient instrument, and it is certainly a great advantage to be able to load up ten or eleven records and leave the whole to run through with no more effort than is involved in listening to a continuous radio programme.

by three bolts, and mounted on rubber cushions.

The brace over the turntable spindle which is bolted to the base plate serves as an excellent gauge for aligning the motor in the centre.

When removing the two screws that hold the turntable locating plate over the turntable spindle, preparatory to operating the instrument, be sure that the locating plate lines up with the holes

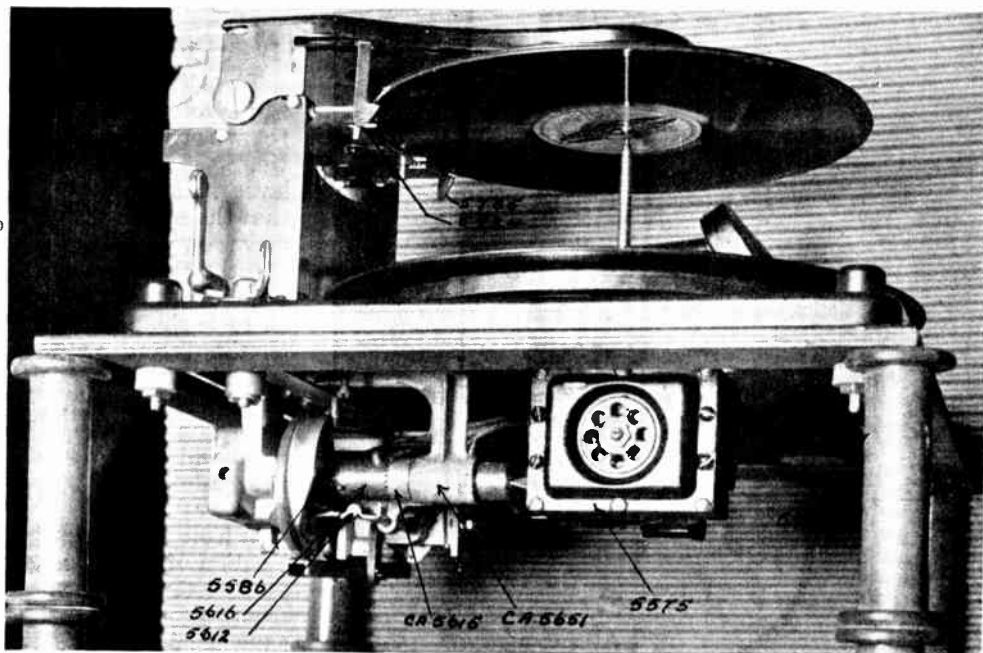

Fig. 2.—THIS SHOWS THE ACTION OF THE MAGAZINE.

The central fixed spindle is hooked at the end and the records are placed on the spindle held by two spring attachments at the edges of the records.

So that the reader may be fully acquainted with this device, the complete description of the mechanical construction is given in detail, and also the necessary adjustments should the reader ever be called upon for service or repair, as many of the manufacturers have adopted this record-changer in their standard radio-gramophone.

### SERVICE DETAILS FOR CAPEHART RECORD-CHANGER.

#### Assembly of Motor to Base Plate (Model 10-12-C).

The motor is attached to the base plate

that the screws have been removed from.

If the motor has become shifted in transit there will be a tendency for the holes in the locating plate and base plate to be imperfectly lined up.

In this case it is necessary to loosen slightly the three bolts holding the motor to the base plate and shift the motor to such position that the holes in the brace and the base plate align perfectly, and while the brace is still in place, tighten the suspension bolts to hold the motor in that particular position. The brace must then be removed before the turntable is mounted on the shaft.

### The Turntable.

In placing the turntable on the shaft, be certain that the rubber driving washer is in proper place with clips over the spindle pin.

After the turntable is put on the shaft, force it down by hand to be sure that the rubber washer and turntable are making perfect contact.

the motor by either of the suspension bolts being too loose.

### Tone Arm Adjustment.

Pick-up change lever No. 5509 in Fig. 3 is for changing the instrument from 10-in. to 12-in. record operation and vice versa.

The lever changes the position of the pick-up return lever in such a manner that the needle is let down for the 10-in. or the 12-in. record, as desired.

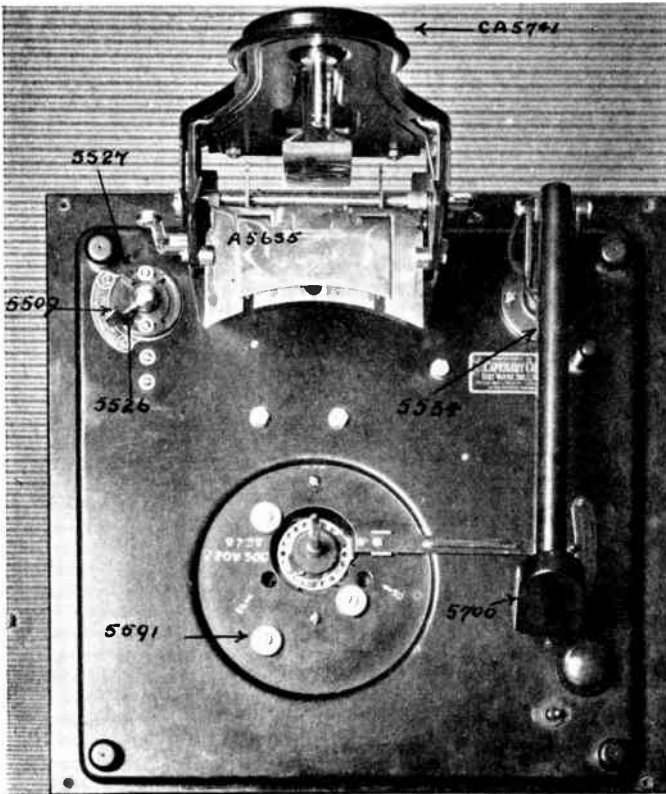

Fig. 3.—TOP VIEW OF THE AUTOMATIC RECORD CHANGER.

The turntable has been removed to show the adjustment of the speed regulator lever.

To level the turntable, place a straight edge across the turntable and adjust the three suspension bolts holding the motor to the base plate until the same distance is obtained from the bottom edge of the straight edge to the base plate near the three points where the suspension bolts are located.

This measurement should be approximately  $1\frac{1}{2}$  in. This adjustment must be made so that there is no free movement of

#### (1) For 10-in. Records.

To adjust for playing 10-in. records, loosen the forward lever stop No. 5526 and hold the lever in such a position that the needle will come down on a 10-in. record exactly  $4\frac{1}{4}$ -in. from the edge of the centring pin. (A scale should be placed on the record with the end of the scale against the centring pin in such a position that the needle point will come down on the scale at the  $4\frac{1}{4}$ -in. position.)

When the proper location of lever No. 5509 is ascertained, then the front stop may be set snug against this lever and the screw tightened, which will allow the lever always to be thrown over to that exact position when desiring to play 10-in. records.

#### (2) For 12-in. Records.

To adjust for playing 12-in. records, loosen the back lever stop No. 5527 and hold the lever in such position that the needle will come down exactly  $5\frac{1}{4}$  in. from the edge of the centring pin. (A scale should be placed on the record with the end of the scale against the centring pin in such position that the needle point will come down on the scale at the  $5\frac{1}{4}$ -in. position.)

**What to do if this Adjustment is Incorrect.**

If unable properly to adjust for either 10-in. or 12-in. records by the above method, make the adjustment as nearly correct as possible, then refer to instructions on tone-arm bracket lever adjustment, making certain the adjustment is correct.

Then loosen the lock nut holding the adjustment screw on the tone arm return lever No. CA5687, Fig. 4, and turn the adjusting screw either in or out, as required, to bring the needle to the proper location for the size of the record. It will then be necessary to readjust the lever stop which was originally set in position for the other size record.

The lever stop screws must be set tight so the lever stops will not be jarred out of position as the lever is thrown from one position to the other.

**Adjustment of Pick-up Weight.**

Make this adjustment while the music is being played, and only one record is on the turntable. With a delicate pair of scales, having a range of 0 to 12 ozs., catch the needle screw and lift the pick-up from the record until the audio quality breaks, at which time a reading of  $5\frac{1}{2}$  to 6 ozs. should be shown on the scales. Raising or lowering the spring support No. 5575, which is affixed to the tone arm lifting rod No. 5553, adjusts the weight of the pick-up.

**Governor Adjustment.**

If the turntable speed cannot be regulated to 78 r.p.m. by the speed control lever located under the turntable, then loosen the set screw holding the governor to the governor shaft and move the governor either in or out respectively, to increase or decrease the speed of the motor.

This adjustment must be made when the speed control lever under the turntable is in the centre position.

Do not, under any conditions, change the adjustment of the end thrust bearing screws.

An occasional drop of oil on the governor brake will assist in maintaining a constant speed.

**ASSEMBLY AND ADJUSTMENT OF OSCILLATING AND SPIRAL TRIP LEVER AND PICK-UP SILENCER.**

To time the automatic switch so the instrument will automatically trip and change records, proceed as follows:—

*First.*—Thoroughly acquaint yourself with the different part numbers.

*Second.*—Study the photographs carefully and note the relative location of the various parts.

*Third.*—Complete each of the following operations before going on to the next operation.

**Operation No. 1.**

Turn the master cam No. 5504 until the large timing mark is exactly above the timing mark on the tone arm lifting lever No. 5761.

**Operation No. 2.**

Hold the switch lever and cam assembly No. 5612 against the driven clutch No. 5616, so the radius of the cam will centre against the clutch. (Be sure that cam No. 5612 is directly under the driven clutch No. 5616.)

**Operation No. 3.**

Set the pick-up silencer switch No. 5643 against the casting bearing so the shaft of cam No. 5612 cannot be moved farther toward the automatic switch.

**Operation No. 4.**

Hold the tail of the cam No. 5612 against the lug on the inside of the master cam No. 5504 and adjust the trip lever No. 5611 until it is  $\frac{1}{16}$  in. beyond the catch in the oscillating trip lever No. 5657. (This adjustment is made while the tail of the cam No. 5612 is held against the outside of the lug inside the master cam No. 5504.)

**Operation No. 5.**

Care must be exercised to have the end play of the oscillating trip shaft just free. This is taken care of in adjusting the pick-up silencer switch No. 5643, so a good contact is made on the pick-up short circuiting switch *when the needle is on the record and the automatic switch has been tripped.*

After the pick-up silencer switch No. 5643 has been set according to the above instructions, the resetting of the automatic trip should allow the contacts on the pick-up silencing switch to open.

If the above operations are followed out in detail and adjustments properly made, the clutch will automatically disengage when the pin on the clutch No. 5616 has travelled approximately one-half of the distance of cam No. 5612.

At the time the pin has travelled one-half of the distance of the clutch release cam, the small timing mark on cam No. 5504 should be exactly above the timing mark on the tone arm lifting lever No. 5761.

### **Adjustment of the Spiral Trip Cam.**

To adjust the spiral trip cam, turn the master cam No. 5504 until the small timing mark is exactly above the timing mark on the tone arm lift lever No. 5761, at which time the automatic trip can be manually reset or tripped at will.

Lay a steel scale, graduated in 64ths, flat on the record under the pick-up, with the end of the scale against the turntable spindle in such position that the needle rests on the scale. By sliding the needle toward the centre of the record, the spiral cam should cause the automatic trip to operate when the point of the needle is  $1\frac{1}{4}$  in. from the edge of the turntable spindle.

If the automatic trip operates before the needle has come to  $1\frac{1}{4}$  in. position, then the spiral cam is set too far ahead and must be moved very slightly back; while, if the needle comes closer to the turntable spindle than  $1\frac{1}{4}$  in., then the spiral cam is set too far back and must be set ahead to the proper position.

### **Effect of Incorrect Adjustment.**

Failure properly to adjust the spiral trip cam to the automatic trip operates when the needle is  $1\frac{1}{4}$  in. from the edge of the turntable spindle, will cause the instrument to change records before the music is finished, or not to change records automatically.

To adjust the spiral trip cam No. 5529, slightly loosen the two screws holding the

cam to automatic switch lever No. 5657, and pry the cam forward or back as required to obtain the proper setting.

To test the position of the spiral cam, it is necessary to carry the pick-up back to the edge of the record each time to reset the automatic trip manually.

### **Assembly of Trip Bracket to Base Plate.**

The automatic trip bracket No. CA5742 is mounted to the base plate by two nickel-plated bolts and lock washers.

The end the bakelite panel is mounted on is to be mounted toward the front of the base plate in such a manner that the bearing aligns perfectly with the bearing in the drive bracket. The final alignment can be made when the trip lever shaft No. 5612 is being installed and adjusted.

### **Tone Arm Bracket Lever Adjustment.**

Set lever No. 5509 to 10-in. record operating position, and slightly loosen the clamp screw holding the bracket lever No. 5704 to the bracket under the tone arm base, and turn the bracket lever to such position that the slot, where the bracket lever clamps together around the bracket, is exactly centred on each side of the aligning notch cut in the lower rim of the bracket.

Then lay a scale, graduated in 64ths, on the turntable, placing the end of the scale against the turntable spindle in such position that, when the needle is automatically let down, the point of the needle will come to exactly  $4\frac{1}{8}$  in. from the edge of the turntable shaft.

If the needle does not automatically come down at the  $4\frac{1}{8}$  in. position, refer to page 1136 and make final adjustment at lever stop on lever No. 5509.

Care should be exercised to lock the tone arm return bracket lever, allowing .015-in. clearance between the cork insert and the tone arm base.

After the adjustment is properly made, tighten the clamp holding the tone-arm bracket lever No. 5704 in place, which should leave ample clearance between the cork insert and the tone arm housing to allow perfect freedom of the tone arm operation.

If the needle fails to feed into music groove, lift tone arm bracket lever No. 5704 tightly against tone arm housing and manually move tone arm back and forth to relieve any unevenness that might occur on the face of the cork inset.

### Assembly and Adjustment of Record Magazine.

The record magazine pin No. 5555, must be tightened in the elongated hole in the magazine top plate No. A5736 in such a manner that the offset at the bottom of the pin extends directly away from the record support shelf.

The magazine pin must also be adjusted to such a position that exactly  $\frac{1}{8}$ -in. clearance is obtained between the back centre of the offset at the bottom of the magazine pin, and the extreme right and left corners of the record support shelf. This adjustment is to be made when the record magazine is in 10-in. playing position.

### To Adjust the Record Support Hooks.

First, throw lever No. 5509 to the 10-in. position, and place a 10-in. record on the magazine pin, bringing the magazine down to the playing position.

The record support hooks are adjusted by bending to proper position.

The record support hooks must be kept  $\frac{1}{16}$  in. from the edge of the record support shelf and must be adjusted far enough back just to clear the edge of a 10-inch record, as the record is released from the record support shelf.

The record support hooks must also be low enough to clear the bottom side of the record, as it is supported on the magazine shelf.

The record support hooks should operate freely in either 10-in. or 12-in. position.

### Assembly of Record Magazine and Standard to Base Plate, and Alignment of Turntable Shaft.

Mount the magazine and standard on the base plate with four bolts, tightening the bolts only just enough to hold the complete magazine assembly in position. The magazine assembly must be so adjusted by shifting the standard on the base plate to bring the offset at the bottom end of the magazine pin exactly over the centre of the point of the turntable spindle.

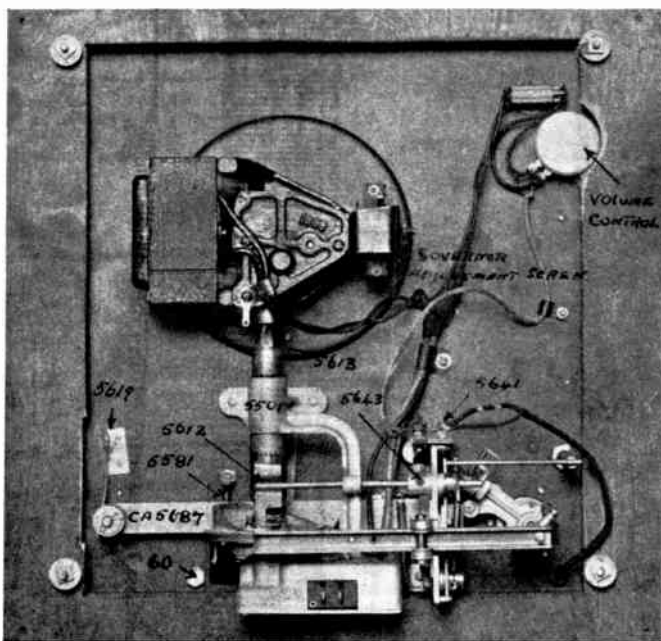

Fig. 4.—UNDERNEATH VIEW OF THE AUTOMATIC RECORD CHANGER.

Note the lever for lifting the tone arm.

This adjustment cannot be made until the motor has been aligned according to the instructions.

Enough clearance is allowed in the four holes to take care of this adjustment.

After the adjustment is made perfect, the bolts must be securely tightened with lock washers.

### Assembly and Adjustment of Record Slide Shelf and Finger.

First, set the master cam No. 5504 so the lug on the cam at the side of the large timing mark comes directly under the end

of the record release finger No. CA.5709.

The eccentric stud, No. 5563, affixed to the main record release finger, controls the adjustment of record release finger. Turn the eccentric stud No. 5563 until the record slide shelf No. 5521 is  $\frac{1}{4}$  in. past the front edge of record support shelf No. 5520, at which time it should be possible to obtain a slight amount of clearance between the end of the record release finger and the point of the lug on the master

the record slide shelf while in the 10-in. position, but comes low enough to hold one record in proper position for the slide plate to unload it on the turntable.

#### Assembly of Drive Bracket Assembly to Base Plate and Motor.

The drive bracket No. 5651 must be bolted to the base plate in such a manner as to align the drive shaft with motor shaft so the coupling is free. A flexible

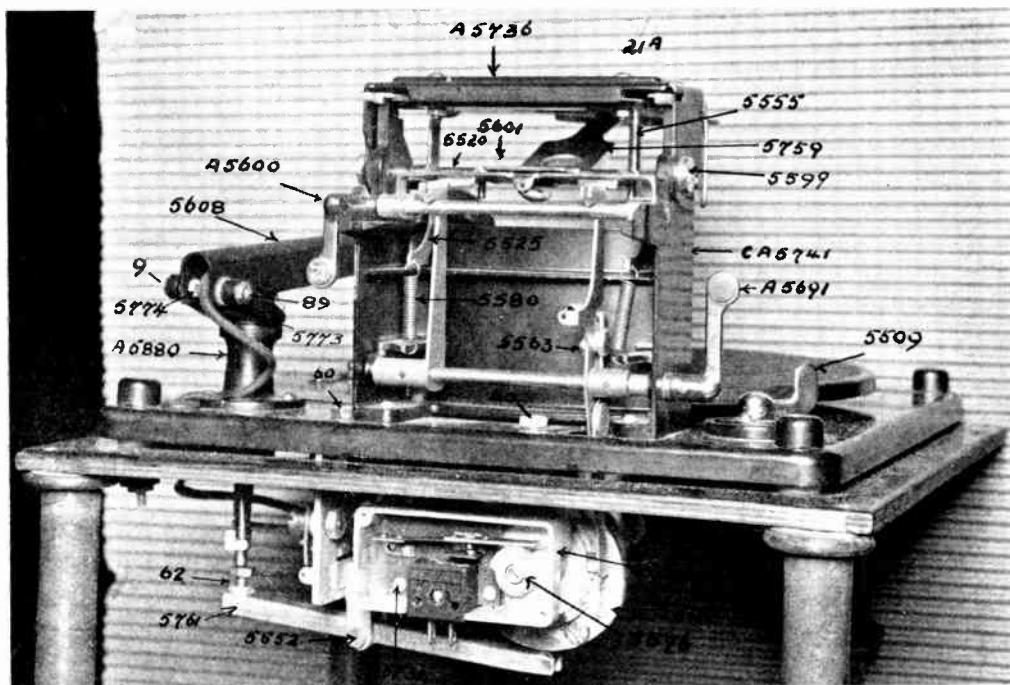

Fig. 5.—ANOTHER VIEW OF THE CAPEHART AUTOMATIC RECORD CHANGER.

Note the switch, which is closed while the record is playing. The switch is connected in parallel with the hand-operated switch.

cam without causing the safety spring (which is a part of this lever assembly) to give.

The two points on the record slide shelf must come to the edge of the radius on the record support shelf at the same time.

#### Record Weight Adjustment.

The record weight, No. 5759, must be so adjusted at the bearing pivot that the lower edge of the record weight does not touch

coupling No. 5613 takes care of any minor lack of alignment between the drive shaft and the motor shaft, because of the motor hanging on rubber cushions.

#### Assembly of Tone Arm Housing to Base Plate.

The tone arm base is attached to the base plate with three screws. This can be mounted only in the proper position.

The two pivot screws holding the tone arm to tone arm bracket must be so

adjusted that the pick-up is free to come down on the record by its own weight and still the points of bearing must be in good contact in such a manner that the tone arm cannot be twisted from side to side.

### To Adjust for Needle Playing Position.

Turn the master cam until the small timing mark is exactly above the timing mark on the tone arm lifting lever No. 5761, at which time there will be no pick-up weight on the tone arm lifting rod.

Then, without a record on the turntable, and the needle (of the length that is regularly going to be used with the instrument) properly inserted in the pick-up, the "T"-shaped tone arm rest No. 5534 should be adjusted to allow the tone arm to lower to such a position that the needle just clears the highest point of the turntable surface. *This adjustment properly made will eliminate the possibility of the needle damaging the turntable surface.*

### Tone Arm Lift Lever and its Adjustment.

Turn the master cam to such position that the small timing mark is directly above the timing mark on the tone arm lifting lever No. 5761.

Without a record on the turntable, and the needle in playing position, adjust the one arm lift lever screw No. 62 until a visiting card can be slid between the top of the lever screw No. 62 and the lower end of the tone arm lifting rod No. 5553.

### Timing of Cam No. 5576.

To time cam No. 5576, turn the master cam No. 5504 by hand, bringing the lug near the large timing mark on the cam, directly under the end of the record release finger No. CA.5709. Now hold the master cam in position and turn cam No. 5576 to the right until the corner of the cam touches but does not raise the switch contact lever on switch No. A.5732.

Care must be exercised that the switch contacts on switch No. A.5732 make perfect contact when cam No. 5576 is away from the switch lever, and when the cam is in the down position  $\frac{3}{4}$  in. clearance is maintained between the switch finger and

the low side of the cam. This should ensure a perfect contact at the switch points.

It is important, in the adjustment of cam No. 5576, that  $\frac{3}{4}$  in. clearance be allowed between the back side of this cam and the bearing through which the shaft passes.

After the above adjustment is made, check the instrument with one record on turntable, by shutting current switch off, and see that instrument comes to an automatic stop position when the lug on the master cam No. 5504 has completely passed under the end of record release finger No. CA.5709. If the lug has not entirely passed under the end of the record release finger, then move cam No. 5576 to the left as little as possible to allow the lug to clear the cam when instrument stops automatically with one record on turntable.

### Tone Arm Return Lever and its Adjustment.

The tone arm return lever No. CA.5687 is mounted on an eccentric pin with the bushing extended downward. The tone arm change and adjusting lever No. 5509 is mounted on the same shaft and located on the top back left corner of the chassis.

The sharp point of the cam, which is a part of the eccentric pin, is to be mounted toward the tension spring which is affixed to the base plate, so that when the lever is thrown to 10-in. or 12-in. position the spring will hold the cam in that particular position.

The coil spring No. 5585 is attached from the lug on the tone arm return lever to the lug on the automatic trip bracket in such a manner that the spring is held as far down as possible by the lugs.

NOTE.—The adjustment screw found on the tone arm return lever is covered in the instructions and, after once being properly set, should need no further adjustment.

Care must be exercised to have clearance between the high point of the master cam No. 5504 and the tone arm return lever.

### Mounting and Adjustment of Rejector.

The rejector button is located at the right of the tone arm and is for the purpose

of discontinuing a record before it has finished playing. With the automatic trip set and the instrument playing music, there should be  $\frac{1}{16}$  in. clearance between the bottom of the reject pin and the lateral pin affixed to the automatic trip lever No. 5657.

If this distance is too great, it will not be possible to reject a record. If this distance is too small, the automatic trip will not properly reset. Adjustment can be made by *carefully* bending the lateral pin to its proper position in relation to the rejector pin.

## WHAT HAPPENS IN A NEON TUBE?

**T**HE neon signs which are now coming into such wide use for advertising purposes form an interesting example of scientific research applied to industry.

Geissler, Crookes, Faraday and Fleming all conducted researches on the discharge of electricity through tubes containing various gases under low pressures. As a result of these researches it was found that neon possessed properties rendering it peculiarly adapted for use in large tubes which could be used for advertising signs. These were introduced by Claude in 1910.

In the illustration:—

(a) shows the effect contained

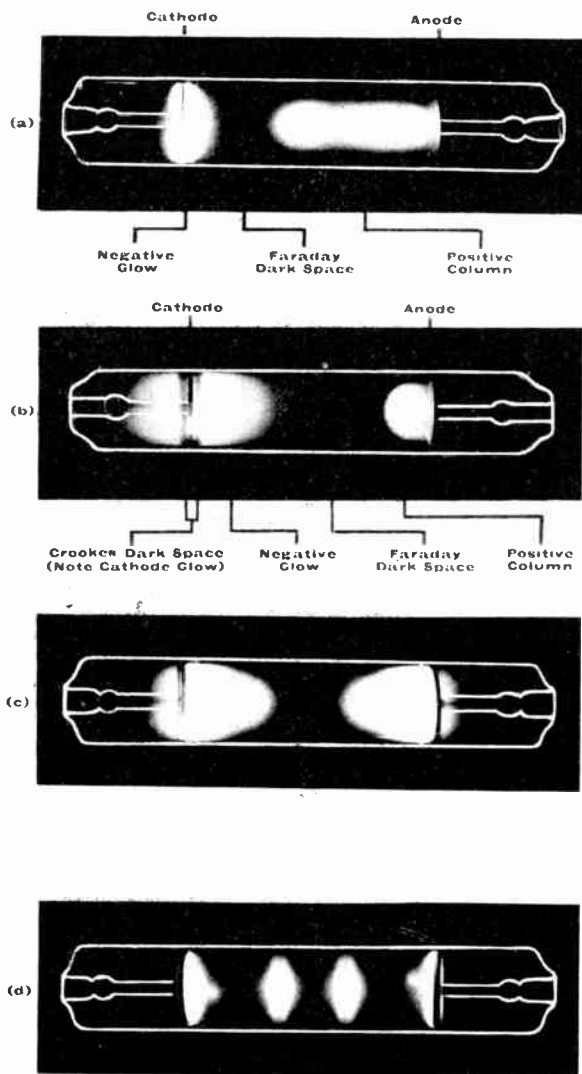

(Research Laboratories of the G.E.C.).

DISCHARGES THROUGH NEON TUBES.

*a* and *b* show direct current effects; *c* and *d* show alternating current effects.

by discharging a direct current through a tube of neon gas.

(b) shows how the appearance of the discharge is altered when the pressure inside the tube is decreased.

(c) shows the appearance of the glow when a high frequency alternating current is applied to the ends of the tube.

(d) shows how the high frequency discharge can be broken up into disks by the introduction of a slight impurity.

Where low frequency A.C. is used, the glow is practically the same as for D.C. The positive column and the negative glow are interchanged at each reversal.



# REPAIR OF ELECTRIC IRONS

By D. R. AULD

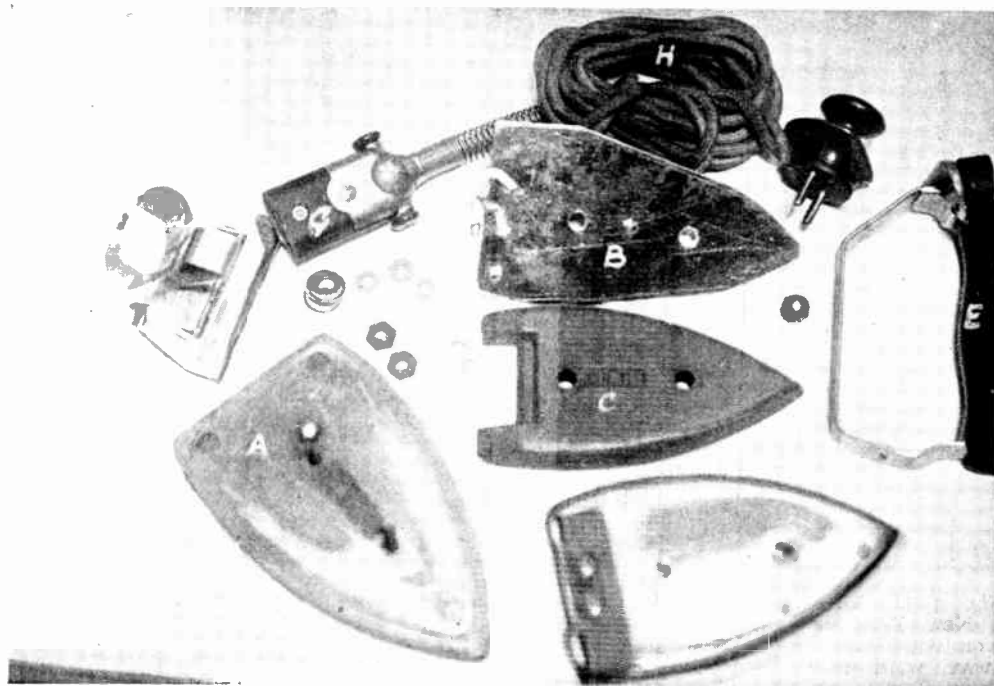

Fig. 1.—THE PRINCIPLE COMPONENTS OF AN ELECTRIC IRON.

A, flat, suitably shaped metal surface; B, electric heating element; C, cast-iron weight; D, cover with insulated terminals; E, handle; F, tilting stand; G, socket; H, flexible cord.

ALL electric irons, with one or two exceptions, are manufactured on the same principle. They consist of (a) a flat suitably shaped metal surface; (b) an electric heating element; (c) a cast-iron weight; (d) a cover with insulated terminals; (e) a handle; and (f) a tilting stand. By means of a suitable socket (g) the flexible cord (h) is led from the cover terminals to the source of supply of electricity. (See Fig. 1.)

## Faults.

The most common faults arising from the use of electric irons are (a) broken or short-circuited flex; (b) burnt-out element and (c) burnt or corroded terminals.

## The Flexible Cord.

The flex used should be of first-class quality (2,500-megohm grade), preferably of the round asbestos braided type and of ample carrying capacity. Where possible, a 3-core flex should be used as a safeguard against shocks due to short-circuiting in the iron itself, one end of the extra core being connected to the iron cover and the other end to the third (or thick) pin of a 3-pin plug. Where the iron is being used off the lighting circuit by means of the usual adapter this course is, however, unpracticable.

## Fitting New Flex.

When fitting a new length of flex, only

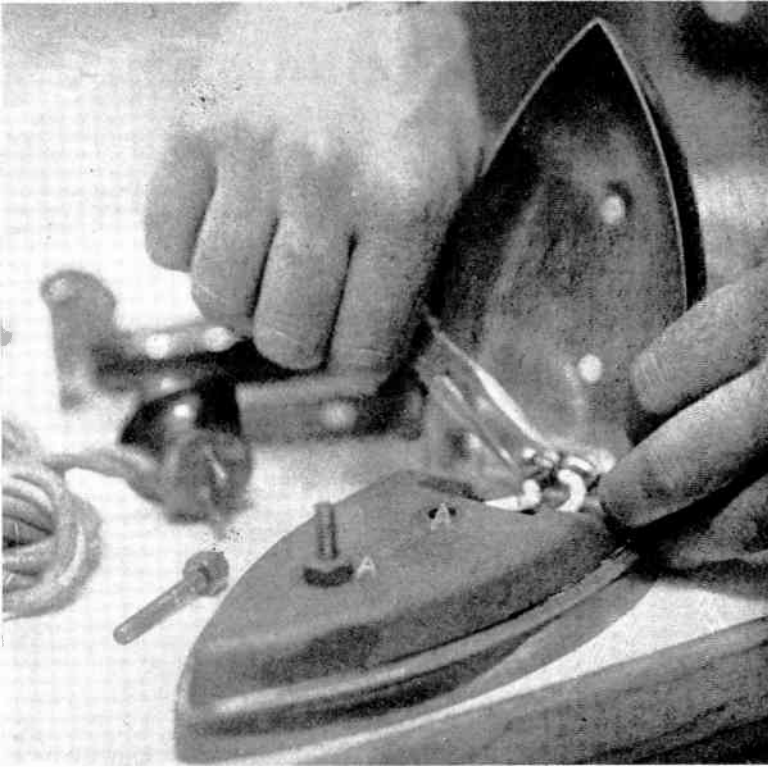
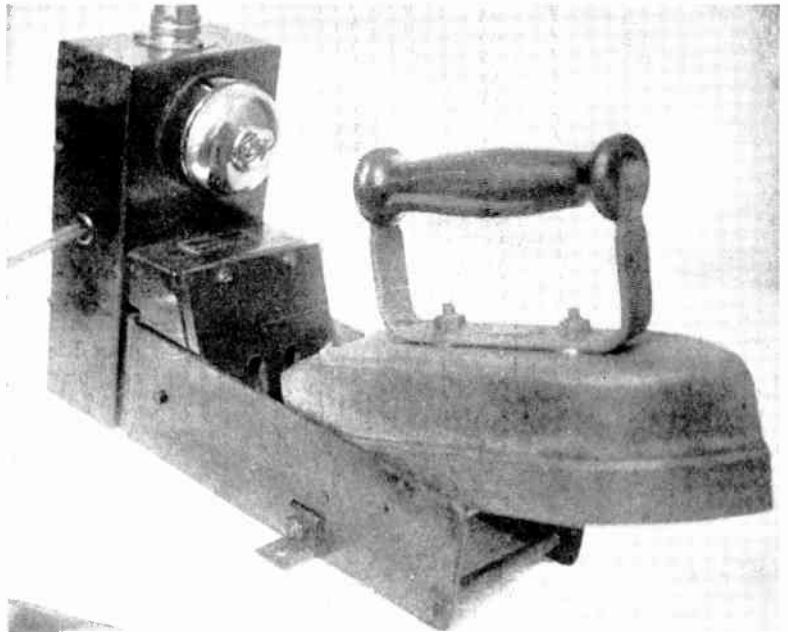

*Fig. 2 (Left).—*HOW TO FIT A NEW ELEMENT TO AN ELECTRIC IRON.

The cover can be removed by unscrewing the nuts holding the strips from the element on to the terminals. The two nuts A are removed so that the top weight can be lifted away, leaving the element exposed.

*Fig. 3 (Right).—*A NEW TYPE OF IRON WHICH DOES AWAY WITH THE CHIEF SOURCE OF TROUBLE, THE FLEXIBLE CORD.

This iron is called the Donaldson wireless iron and this photograph shows the commercial type. The incoming cable is taken to an insulated block in the interior of the stand, and thence through two brass springs to the carbon contacts, which are pressing on another slotted insulating block. The terminals of the iron are placed at the extreme end, and project horizontally instead of the usual semi-vertical.



approximately two-thirds of the braiding should be cut off, the remaining portion can be pushed back till the required length of rubber-covered wire is exposed. The rubber covering should only be stripped off the exact length necessary to make the eyelet, etc., for attachment to the plug or socket at the iron end, thus obviating any chance of shorting due to unnecessary exposed wire. A small piece of black insulating tape should now be wound round the end of the braiding; this in turn is held firmly in place by the socket when the two halves are screwed

pull out by gripping the insulated plug body.

#### Fitting New Element.

When the iron itself has to be dismantled for the fitting of a new element or new terminals, the two nuts or set screws holding down the handle should first be unscrewed and the handle removed. The cover can now be lifted up at the tip of the iron and the back of the terminals exposed. The nuts holding the strips from the element on to the terminals should now be unscrewed when the cover can be

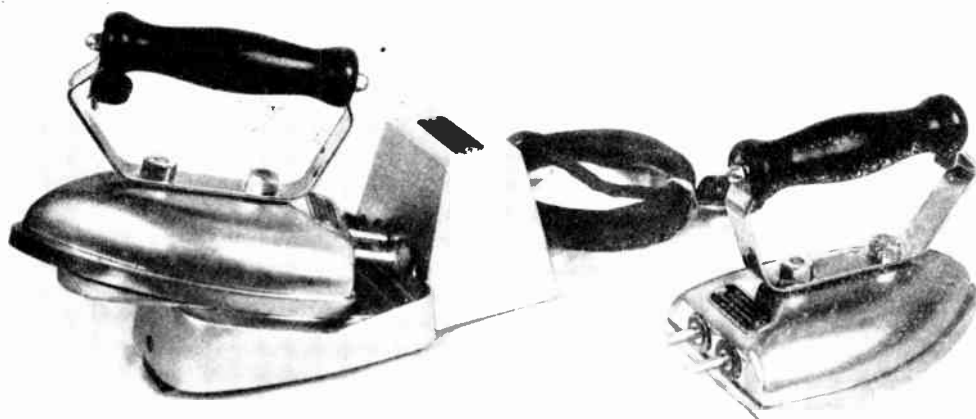

Fig. 4.—THE DONALDSON WIRELESS IRON FOR DOMESTIC USE.  
As explained in Fig. 3, this iron does away with the use of flexible cord.

together, or gripped by the upper portion of the metal covering if the socket is of the porcelain type. At the supply end, if a plug is used, the type having a side entry is to be preferred as the braiding can again be firmly gripped when the plug is assembled.

#### Use of Cable Reel.

In commercial work a light spring cable reel or counterweight fitting is often provided to take up the slack cable. This not only helps to prolong the life of the cable by preventing kinks but also keeps the cable from interfering with the efficient working of the iron.

Breakage of the cable is chiefly caused by pulling out the plug, or socket, at the iron end, by means of the cable. Always

completely removed. (See Fig. 2.) With some irons, i.e., the Cosmos, etc., the terminals are mounted on a separate block which is held on to the cover by two screws which pass through the tilting stand; if these two screws are undone the cover can be removed, leaving the terminals still attached to the element strips.

The two nuts holding down the top weight are now exposed (see *A* in Fig. 2), and on removal the top weight can be lifted away, leaving the element exposed.

The element is rather fragile, being made up of special resistance wire or tape wound round a suitably shaped mica former and then covered on either side with a sheet of mica. The element should, therefore, be carefully removed and

examined for breakage in the wire. If broken a new element of the correct voltage and shape should be procured from the manufacturers of the iron (always state the serial number usually found on the nameplate fixed to the handle).

### Reassembling the Iron.

The iron should now be reassembled by first placing the new element in position and then laying on the top weight and screwing down tight. The small strips from the element should now be fastened to the terminals on the terminal block or cover as the case may be, and the cover replaced. Great care must be taken to see that these strips are bent into such a position that they will not touch any part of the iron when the cover is fitted. The handle and tilting stand are now replaced when the iron is ready once more for use.

### The Terminals.

Corroded or burnt terminals are caused by the socket fitting too loosely. If not too badly burnt, they may be scraped or filed, but if badly damaged new terminals should be purchased from the manufacturer and fitted in position. The spring contacts in the socket should then be adjusted with a pair of pliers till a firm

contact with the terminals is obtained.

### Special Types of Irons.

An iron has recently been placed on the market designed specially to meet the chief source of trouble, i.e., the flexible cord. This iron, called the Donaldson Wireless Iron, is manufactured in two types, commercial (Fig. 3) and domestic (Fig. 4). In both cases the incoming cable is taken to an insulated block in the interior of the stand and thence through two brass springs to two carbon contacts which are pressing on another slotted insulating block. The terminals of the iron are placed at the extreme end and project horizontally instead of the usual semi-vertical. On placing the iron on the stand it slides down the sloping portion and the terminals pass through the slotted insulated block and make electrical contact with the carbons—thus the iron is heated in the ordinary way. Provision is made for earthing these stands in the ordinary manner, thus making the whole absolutely foolproof and safe.

The chief advantages of these irons are (a) complete freedom of movement due to the absence of flexible cord on the iron; (b) freedom from danger due to shorting or breaking of the flex; and (c) saving in current as no current is used while the iron is off the stand.

---

## QUESTIONS AND ANSWERS

### What are the most common faults arising from the use of electric irons?

- (1) Broken or short-circuited flex.
- (2) Burnt-out element.
- (3) Burnt or corroded terminals.

### What flex should be used for irons?

2,500-megohm grade, preferably of the round asbestos braided type and of ample carrying capacity.

### How can shocks due to short-circuiting in the iron itself be prevented?

By using a 3-core flex, one end of the extra core being connected to the iron

cover and the other end to the earth pin of a 3-pin plug.

### How would you fit a new element?

- (1) Remove the handle.
- (2) Lift up the cover so that the back of the terminals is exposed.
- (3) Unscrew the nuts holding the strips from the element on to the terminals so that the cover can be completely removed.
- (4) Unscrew the top nuts holding down the top weight.
- (5) Remove the top weight.
- (6) Remove the broken element, and insert a new one.

# ACCUMULATORS

## FOR CAR ELECTRICAL EQUIPMENT, WIRELESS AND OTHER PURPOSES

By E. HILL

### TYPES OF BATTERIES FOR DIFFERENT PURPOSES.

**S**TORAGE batteries are in general use for a great variety of purposes and the table on page 1148 gives a selection of these with range of capacities and types of cell.

In addition to these uses, extensive use is made of batteries for railway signalling, electric generating stations as reserve supply, submarines, lifeboats and other marine craft, and hand lamps. The notes regarding storage and first charge relating to automobile work apply to batteries for any other use.

### Maintenance of Lead-acid Cells.

The maintenance requirements of any lead-acid cell are:—

The cell must not remain in a discharged condition.

Have the cell charged whenever the voltage has dropped to 1.8.

Keep the cell clean and dry.

Top up with distilled water at regular intervals.

Test the specific gravity of the electrolyte periodically.

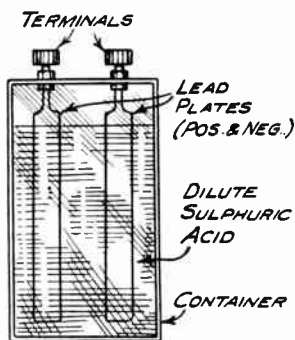

Fig. 1.—THE SIMPLEST FORM OF ACCUMULATOR.

Two lead plates immersed in dilute sulphuric acid form a simple accumulator. If a current is sent through in either direction, one of the plates becomes coated with lead oxide. When the cell is discharged the oxide returns to its original state of metallic lead. The capacity of such a simple cell would, however, be far too small for practical purposes. It is, however, interesting to note that all the modern types of lead accumulators have been developed from the above simple cell.

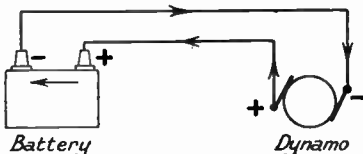

Fig. 2.—THE SIMPLEST BATTERY CHARGING CIRCUIT.

Note that the positive of the dynamo is connected to the positive of the battery during charging.

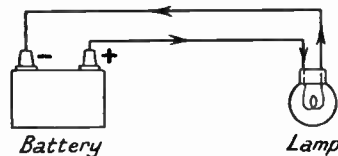

Fig. 3.—A SIMPLE DISCHARGING CIRCUIT.

Note the direction of flow of the current with reference to the positive and negative terminals of the battery.

Keep the terminal connections clean and tight.

### Maintenance of Alkaline Cells.

For alkaline cells the instructions are:—

Keep the cells clean and dry.

Top up with distilled water regularly.

Test the voltage and the specific gravity of the solution at intervals.

Keep the terminal connections clean and tight.

### Types of Cells Compared.

Each type of cell has its advantages. The lead-acid battery has a rather higher efficiency in a.h., a lower internal resistance, is less affected by low temperatures, and is less liable to self-discharge. Whereas the nickel-iron battery has a greater capacity per lb. of weight, requires less maintenance and has a longer life under normal conditions.

Most satisfactory results are likely from the lead battery given skilled attention, but when the attention is liable to be neglected, the alkaline has the advantage, and will also withstand higher temperature than the lead type.

TABLE SHOWING TYPES OF BATTERIES FOR DIFFERENT PURPOSES.

Purpose.	Volts.	Capacity Range.	Type of Cell.
Radio L.T. ..	2 to 6	10 to 30 a.h.	Lead acid
Radio H.T. ..	10 to 60	1 to 5 a.h.	Lead acid
Motor-cycles..	6	10 to 35 a.h.	Do. and N.I.
Pleasure cars	6 or 12	30 to 120 a.h.	Lead acid
Lorries and vans ..	6 or 12	30 to 120 a.h.	Lead acid
Passenger coaches ..	12 or 24	110 to 240 a.h.	Lead acid
Passenger coaches ..	12 or 24	35 to 140 a.h.	Nickel iron
Train lighting	24	90 to 300 a.h.	Lead acid
House lighting	50	90 to 300 a.h.	Lead acid
Electric trucks	80	60 to 360 a.h.	Lead acid
Electric delivery vans	60	75 to 450 a.h.	Nickel iron

### NOTES ON CAR BATTERIES.

The starting load on a car battery may be anything up to 600 amps. momentarily, rapidly decreasing to about 30 per cent. of the stalled current when the engine is turned at firing speed, say 120 r.p.m. This load may only be on for 5 seconds or so when the engine is warm, but may be for 20 to 30 seconds when the engine is cold.

#### Discharge.

It will readily be appreciated that frequent demands on the battery for starting operations quickly exhaust the available capacity. With a normal fully charged 75 a.h. starter battery upwards of 120 discharges of 100 amps. for 5 second periods, with 10 seconds interval between each discharge, can be obtained before exhausting the battery, these conditions approximating to starting conditions with a free or warm engine. On the other hand only 10 to 15 discharges of 100 amps. for 30-second periods and 30-second intervals are probable under tight or cold engine starting conditions. A smaller battery would necessarily give a less number of heavy discharges, whilst a larger battery would give more or stand higher discharge rates.

### Calculating the Running Load.

Allowing 3 amps. for each head lamp,  $\frac{1}{2}$  amp. for each side, tail and dash lamp and  $1\frac{1}{2}$  amps. for the ignition coil, a running load of  $9\frac{1}{2}$  amps. is arrived at during lighting periods. This load should be balanced by the generator output during running times and a small margin left to keep the battery charge up. Allowances must be made for the intermittent loads required for starting, horn, screen wiper and stop light, and also for standing time with lights on. A further time factor or safety factor is advisable to cover the time occupied in completing a journey after a breakdown of the generator.

Summing up these various factors, i.e., running load with lights on— $9\frac{1}{2}$  amps. plus  $1\frac{1}{2}$  amps. allowance for horn, screen wiper and stop lamp, plus 4 amps. starter motor allowance, a total of 15 amps. is arrived at, so that a 75 a.h. battery would provide a safety factor of approximately 5 hours at full load starting from a fully charged state.

### STORING AND PUTTING BATTERIES INTO COMMISSION.

#### Capacity.

In speaking of the capacity of a battery this is generally understood to mean the capacity at the 10-hour rate. That is to say that a battery of 75 a.h. would provide a current of 7.5 amps. for 10 hours in discharging from a fully charged state to a fully discharged state, which latter is considered to be when the voltage per cell has dropped to 1.8. American practice favours the 20-hour rating, which shows a capacity of approximately 10 per cent. more than the capacity at the 10-hour rating. In comparing the relative value of batteries this factor should be borne in mind, and adjustment made where the

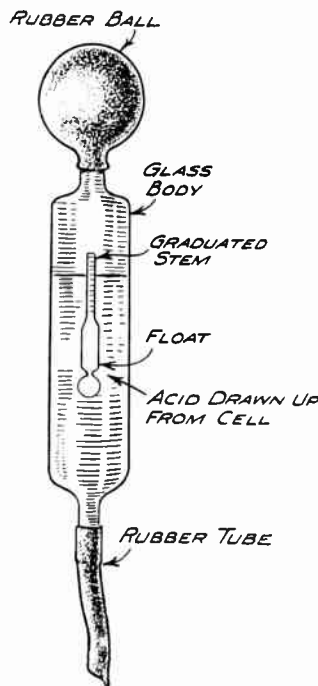

Fig. 4.—HYDROMETER FOR TESTING ACID STRENGTH OF BATTERIES.

ratings are different, in order to arrive at the true relative capacities. Discharges heavier than the 10-hour rating reduce the overall capacity, for instance, a battery of 75 a.h. at the 10-hour rate will only give about 37½ a.h. at the 1-hour rating.

**Thick or Thin Plates—And Their Effect on Capacity.**

The thickness of the active layer has a great influence upon the capacity. If the active substance is distributed in a thin layer with large surface (such as in a starter battery used in motor-cars) the acid can more easily penetrate into the plate than when the active material is in the form of a thick plate with a small surface, such as are used for wireless reception, etc., therefore the elements with thin plates have a considerably greater capacity than such of like weight with thick plates. Starter batteries, therefore require more careful attention during their useful life than any other battery, owing to the stresses of heavy discharges, when for instance the starter switch is closed to start an engine from cold.

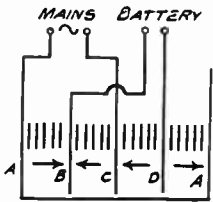

Fig. 6.—METAL RECTIFIER UNIT.

Showing similar arrangement to Fig. 5.

**How a Battery is Delivered.**

Batteries are usually delivered dry, i.e., before being filled with electrolyte. In this state, they can be stored indefinitely, but should be kept in a cool, dry room. Owing to the weight of the plates it is inadvisable to

store batteries one on another, and if floor space is limited adequate shelving should be provided. After a battery has been filled with electrolyte and given its first charge, it is necessary that it should receive regular attention. Delay in putting a battery into service after the first charge may cause serious harm and reduce the life of the battery considerably unless measures are taken to recharge the cells from time to time. It is of the utmost importance that the instructions of the

manufacturers in regard to the first charge should be strictly followed, and that the battery be put into active service as soon afterwards as possible.

**What to do when Storing a Battery.**

When it is necessary to store a battery after first charge, it is good practice to discharge the battery through a resistance or lamp load, then to recharge,

following this up with boosting charges at fortnightly periods. After a battery is installed on a car, further care is necessary to cover any period of warehousing by the car manufacturer or agent, and the boosting charges should be continued at regular intervals until the car is put into service. The battery should be inspected regularly during this period and distilled water added to the electrolyte as necessary to keep the acid level above the tops of the plates.

**Filling a Battery with Acid.**

The acid solution consists of pure brimstone sulphuric acid diluted with distilled water to the required specific gravity. Instructions regarding the correct specific gravity are usually attached to the battery, and should be carefully followed. The density specified has a

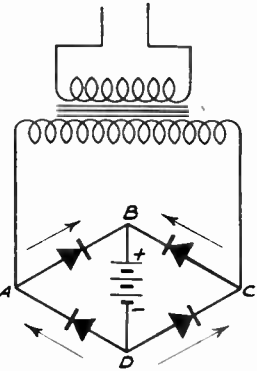

Fig. 5.—DIAGRAM OF TRANSFORMER AND METAL RECTIFIER.

A and C represent terminals on input side, while B and D represent positive and negative terminals on D.C. side of the rectifier.

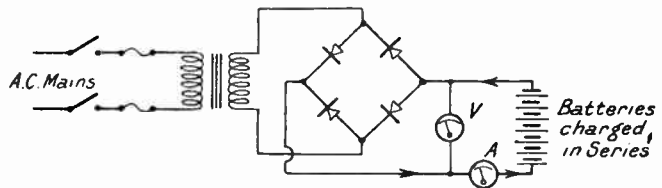

Fig. 7.—DIAGRAM OF CHARGING SYSTEM USING METAL RECTIFIER.

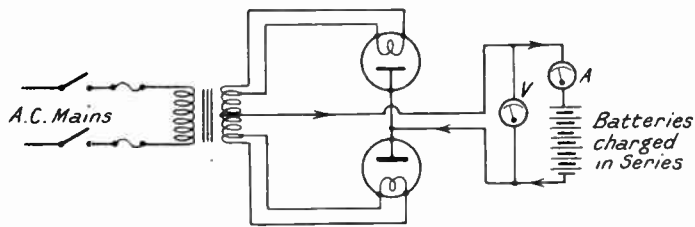

Fig. 8.—DIAGRAM OF CHARGING SYSTEM USING VALVE RECTIFIERS.

direct bearing on the battery condition, and acid of too low a density will reduce the capacity whilst too high a density decreases conductivity and sets up heating and local action in the plates. The specific gravity is affected by a rise or fall in the temperature of the acid solution, and an appropriate correction must be made before using the acid.

Density is normally stated as at 60° F. To correct for temperatures above 60° F. add .002 to the specific gravity for every 5° F. For temperatures below 60° F. deduct .002 for every 5° F., to obtain the requisite equivalent gravity at 60° F.

For cells in which the separators are wood it is necessary to make an allowance for the moisture content of the wood; this type of separator being kept in a wet condition for storage.

### How to Dilute Acid.

Pure brimstone sulphuric acid is supplied in carboys and can be obtained broken down to any specified density required for battery electrolyte, but as this density may alter owing to evaporation, it is preferable to dilute the acid as and when required. In mixing the solution, glass glazed earthenware or lead vessels should be used. The water must be poured in first, and the acid added gradually, stirring meanwhile with a glass rod. Violent and dangerous splashing of the acid is liable to occur if water is poured into acid.

A new battery should not be filled with solution until ready for charging, and before filling, the acid should be cooled to atmospheric temperature. After filling, the battery should be allowed to stand for 12 hours, before charging. The

acid should be tested periodically as impurities in it may lead to self-discharge, heating and other battery troubles.

### First Charge.

The first charge is of critical importance to the life of a battery, and the manufacturers' instructions should be followed implicitly. The usual period is 36 hours and the charging rate that of about half this period. The period and rate vary with different makes of cell, and depend on the formation of the plates and the density of the solution used. During the charge the temperature of the electrolyte should be kept below 100° F., and if this figure is exceeded the charging rate should be reduced or the charge suspended until normal temperature is regained. High temperatures cause the active material in the grids to expand and to loosen, resulting in flaking, loss of capacity and shorting of the plates. Batteries will give much better service and last longer if the temperature during charge or discharge periods is kept within the limits of 70° F. and 90° F. At the end of the charging period the cells should be gassing freely and the density of the acid have attained a maximum value. The vent plugs should be removed during the first charge, to allow the gas generated to disperse. This gas is highly inflammable and explosive and on no account should a naked flame be allowed to be brought near to the cells.

### Nickel-Iron-Alkaline Batteries.

The nickel-iron-alkaline battery as used

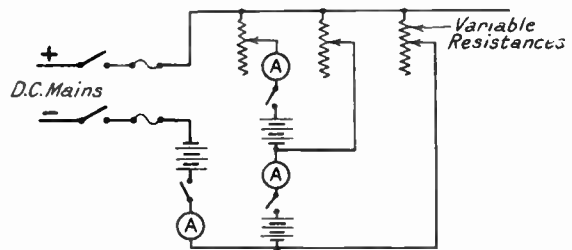

Fig. 9.—DIAGRAM OF CHARGING SYSTEM WITH RESISTANCE CIRCUITS IN CASCADE.



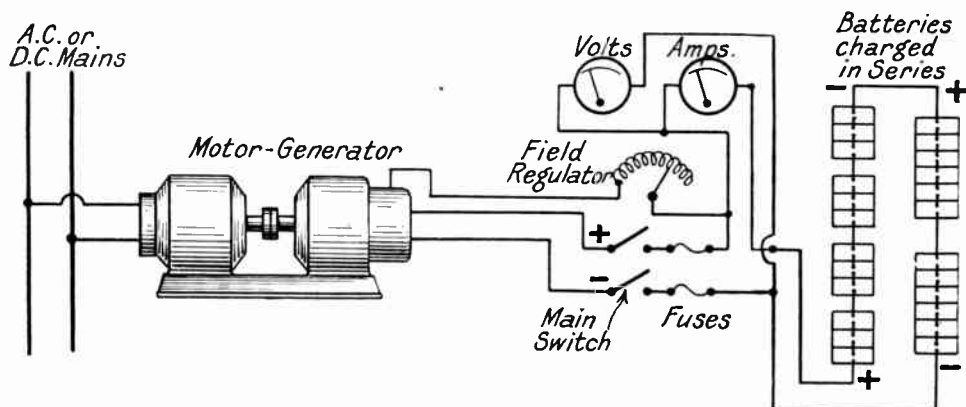

Fig. 10.—DIAGRAM SHOWING CHARGING PLANT WITH MOTOR GENERATOR.

Charging by means of a rotary transformer is similar to the above except that the motor generator is substituted by a single machine.

used for lighting and starting purposes on commercial vehicles, is capable of withstanding a considerable amount of neglect and rough usage. The state of charge when the cells are stored is not of very great importance, but the best conditions are maintained if the cells are fully charged and then half discharged before storing. The electrolyte consists of a solution of potassium hydrate in distilled water and is supplied at the correct density by the battery manufacturer. The specific gravity does not alter with the state of charge and gassing is not an indication of full charge.

#### Temperature of the Alkaline Solution.

The temperature of the solution is an important factor and should be kept within similar limits to that of the lead-acid type. Acid must not be allowed on or in an alkaline cell and considerable damage will result if this is permitted. Hydrometer tests are useful in determining whether a change of electrolyte is desirable. These tests should not be taken during a charge, nor after adding distilled water for topping up until after a further charge. The temperature of the solution should be noted and corrections made to obtain the density readings at 60° F. The correction constant is .0025 for each 10° F. variation, and this amount should be added to the density readings for temperatures above 60° F. and subtracted for temperatures below that value. The

normal specific gravity of the solution used in Ni-Fe cells is 1.190. This density will gradually decrease during the charge and discharge operations over a period of about 12 months until a specific gravity of 1.170 is reached. At this point the battery will have lost its efficiency and the electrolyte should be emptied out and renewed. The normal density of the solution as used in Edison storage cells is 1.200 and when this decreases to 1.160 it should be renewed. Alkaline cells must not be allowed to stand empty. Glass or enamel-ware should be used for filling purposes and vessels previously used for acids must not be allowed to come in contact with the solution.

Defective vent plugs may cause excessive swelling of the steel cell cases and the plugs should be tested periodically to ensure that efficient ventilation is maintained.

#### Charging Voltage of Alkaline Cells.

The charging voltage of alkaline cells commences at 1.4 volts and rises to 1.8 volts per cell, so that it is necessary for the charging voltage of the D.C. supply to be not less than 1.85 times the number of cells charged in series. The first charge must be at the normal current for double the normal period. On discharge, the voltage of this type of cell should not be allowed to drop below 1.0 volt per cell. When the cells are charged the cases are

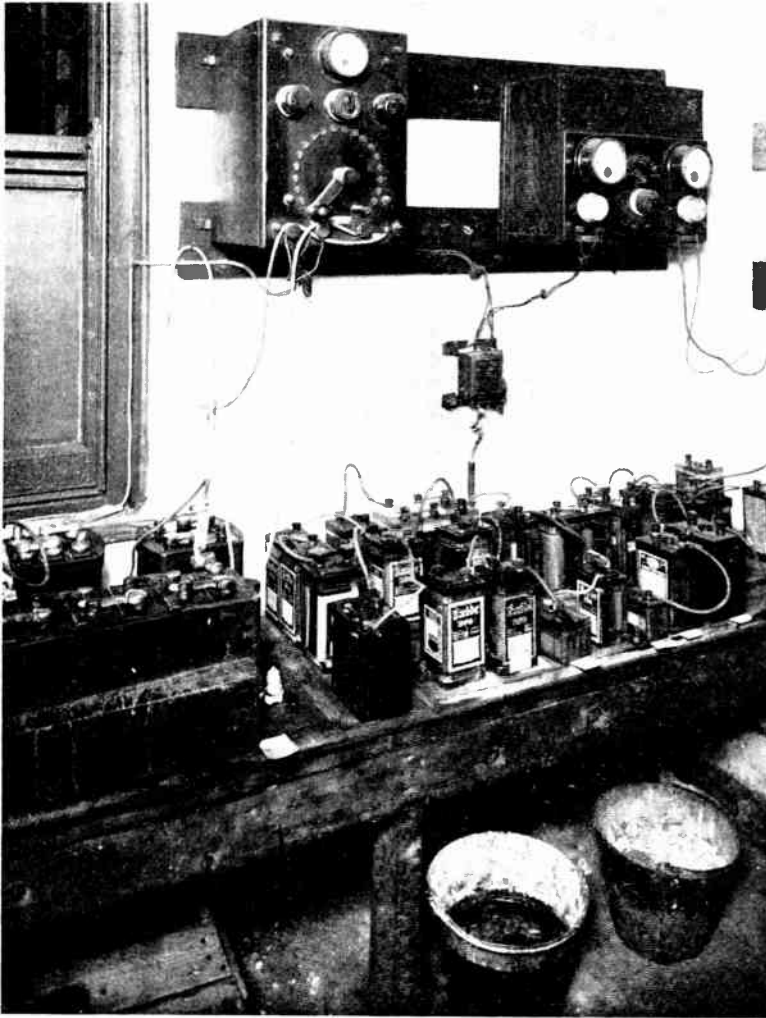

Fig. 11.—A TYPICAL BENCH AT A CHARGING STATION.  
Showing two charging boards fed from the D.C. mains supply.

electrified and short circuits will occur if contact is made between them by metal spanners used for tightening terminals or for other purposes, and extensive damage may result. The same types of charging equipment described for acid cells can be suitably applied for charging alkaline cells.

### CHARGING SYSTEMS.

The choice of a system of battery charging depends on whether electric mains supply is available and if so, whether this supply is A.C. or D.C. Where no electric

supply exists it will be necessary to install a D.C. generator which may be driven from any running shaft line if sufficient power is available, or by any prime mover such as a steam, gas, petrol or oil engine. Compact self-contained charging sets are manufactured in various sizes.

The current applied to the terminals of a battery for charging purposes must be D.C. so that when charging is from A.C. mains, the current must be rectified to D.C. before it can be used for this purpose. Several methods of rectification are possible viz. :—

(1) The motor generator in which the motor is run off the A.C. mains and the generator is wound to give

D.C. at a voltage suitable for the method of battery charging employed.

(2) The metal rectifier of the copper oxide type.

(3) The thermionic valve rectifier.

(4) The rotary or commutating type of rectifier.

When the mains supply is D.C. the charging circuit may be obtained by the use of :—

(1) Resistance boards having either lamps or wire resistances to reduce the mains voltage to a suitable value.

(2) Rotary transformers.

(3) Motor generators.

The following paragraphs give a brief summary of the advantages or disadvantages of the charging methods mentioned above, as they are dealt with more fully later in the article.

### THE MOTOR GENERATOR.

The motor generator for use on D.C. or A.C. mains is probably the most popular, and is applied in two ways:—

#### The Series Method.

(1) *The series method* in which the batteries to be charged are connected in series, i.e., the positive of one battery is connected to the negative of the next, and so on. For large sets this method has the advantage of low first cost and provides a reliable charging supply, especially for battery first charge and for restoring sulphated batteries. The current is constant throughout the charge unless the regulator is adjusted by hand, so that some attendance is necessitated. Disadvantages are that only batteries of similar charging rates can be adequately charged on the same circuit so that it is necessary to group batteries of similar capacity and make up separate circuits. The motor generator also requires a certain amount of maintenance, high speeds being usual, with resultant wear of brushes, commutators and bearings.

#### The Constant Potential Method.

(2) *The constant potential method* in which the batteries to be charged are connected in parallel across the bus bars of the charging system. In this type of system the voltage is set at the fully charged voltage of the battery and kept constant. As the back E.M.F. of the battery increases during the charging period, the current gradually drops. The current is therefore at a maximum at the commencement of a charge and at a minimum at the end. This provides excellent charging conditions when the

battery is in a normal state, and owing to the graduated charge it is possible to use higher currents and so reduce the time required to complete a charge. Batteries of various capacities can be charged at one time and disconnected without any adjustment of the charging rate being necessary. The charging circuit is of low voltage, 8 or 16 for car batteries, and therefore there is no risk of shock on the output side.

Disadvantages of the constant potential method occur when new or sulphated batteries have to be dealt with. Long period charges at low currents are necessary in these circumstances and the constant potential system is not readily adaptable to these conditions. Supplementary means, consisting of resistance leads, can be obtained for the purpose, and allow for suitable reduction of the current.

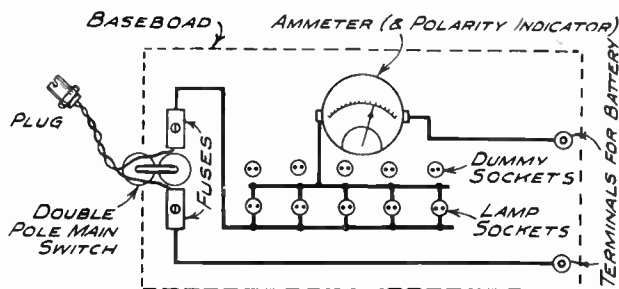

Fig. 12.—SIMPLE FORM OF CHARGING BOARD FOR CHARGING BATTERIES FROM D.C. MAINS.

Lamps removed from lamp sockets may be safely stored by plugging into the dummy sockets. See also Fig. 13.

When used in conjunction with a bus bar type of ammeter, these special leads are effective, but attention is necessary to avoid the overheating and other damage which careless charging of defective cells may engender.

#### Thermionic Valve Charges.

Charging sets embodying thermionic valves and others with copper oxide rectifiers have recently been developed. The series method of charging is employed and the sets are simple in operation, of good electrical efficiency and are noiseless and occupy little space. The primary cost is rather high, but upkeep is inexpensive.

#### Rotary Rectifiers.

The rotary rectifier as applied to charg-

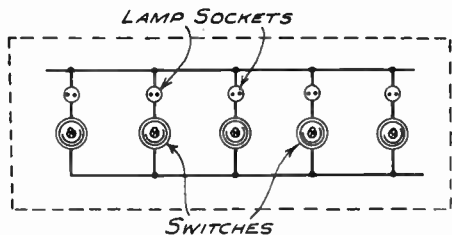

Fig. 13.—ADAPTATION OF THE ARRANGEMENT SHOWN IN FIG. 12.

Switches are provided so as to save removing the lamps.

ing sets also employs the series method of charging and has similar characteristics to the motor generator or rotary transformer but has rather higher electrical efficiency.

**Resistance Boards.**

Resistance boards with either lamp or wire resistances form the simplest method of battery charging, but are the least efficient. Economies can be effected by employing the cascade system of wiring circuits. The batteries are charged on the grouped or series system.

**PRACTICAL NOTES ON CHARGING.**

Normal charging procedure is similar for all types of cells. As previously stated, it is necessary for the charging current to be D.C.

**THE SERIES METHOD.**

For lead-acid cells charged by the constant current method, connect cells of approximately equal charging rates in series, i.e., the positive of one to the negative of the next and so on. The charging voltage available should be 2.8 times the number of cells, that is to say that the number of cells grouped is limited by the supply voltage. Separate groups can be made up of cells of other equal charging rates,

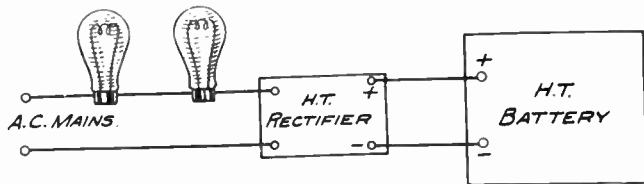

Fig. 15.—CHARGING HIGH TENSION BATTERY FROM A.C. MAINS.

providing the total supply current is not exceeded and provided separate regulation for each circuit.

**How to Connect up the Charging Circuit.**

The positive terminal of the charging circuit must be connected to the positive end of the battery group, and the negative of the group to the negative of the charging board. After switching on, maintain the charging current at the normal rate by adjustment of the resistance, lamp load or other regulation provided until the voltage reaches 2.3 per cell. After this, taper off the charging rate and maintain the finishing charge current until the cell voltage is 2.6. The temperature of the solution should be noted from time to time and the charge stopped immediately should this be above

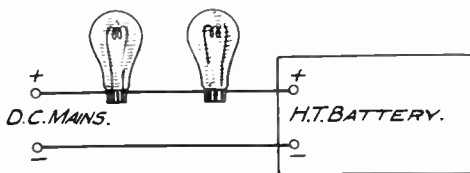

Fig. 14.—CHARGING HIGH TENSION BATTERY FROM D.C. MAINS.

100° F. After the cells have cooled down, the charge can be continued at a lower rate. The specific gravity of the electrolyte will give a direct indication of the state of charge of the cell, this being 1.150 when fully discharged and 1.280 when fully charged. Continue the charge for one hour after the density of the solution has attained a maximum.

**Methods of Switching Off.**

Automatic means for switching off are provided on some sets and an ampere-hour meter operates a trip for this purpose.

On simple sets it is necessary to switch off by hand. The cells should be examined for acid level and any shortage made up by the addition of distilled water, both before and after charging. An examination of the plates should show the positives to

be a deep chocolate colour, and the negatives a light grey. Batteries showing signs of sulphation should be given special treatment consisting of long periods of charge at very low charging rates. If this is not effective the density of the electrolyte should be reduced and further charging periods continued. Cell cases should be kept dry and protected from external damage, especially in cold weather. Celluloid cases require special care and it is a good plan to use shallow trays filled with water in which to stand the cells during charge.

*Nickel-iron cells charged by the c.c. method* are connected up in a precisely similar manner as for lead cells and grouped for the correct charging rates. They should be charged at the normal rate for 7 hours. The cells should then stand at 1.8 volts each. The charging circuit voltage should be at least 1.85 times the number of cells. Topping up with distilled water should be done as necessary before and after charging. Temperature tests are necessary and the electrolyte must not have a temperature exceeding 115° F.

**Switchboards for Charging Plants.**

Switchboards for charging plants are made up on angle iron framing for attachment to floor or wall, on which framing is mounted a slate or marble panel for the switches and instruments.

The layout for a motor generator set consists of a sub-panel on which, for D.C. supply, are mounted:—

A starting switch with no load and overload release.

A shunt regulator.

A D.P. main switch and D.P. fuses.

These items are the equipment for the motor side of the set.

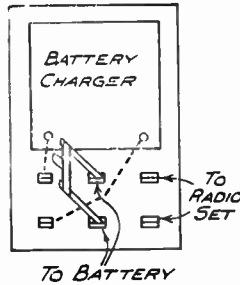

Fig. 16.—SIMPLE TRICKLE CHARGING ARRANGEMENT. A double-pole, double-throw switch is provided, and the battery is connected to the central pair of poles. It can thus be thrown over to "charge" or to "set," as desired.

The generator panel requires:—

- A voltmeter.
- D.P. main switch.
- 2 S.P. fuses.
- 1 shunt field regulator.

The charging panel may be split up to give a number of charging circuits providing these are kept within the capacity of the generator. Each charging circuit should have the following panel equipment:—

- Ammeter.
- Automatic cut-out.
- Variable resistance.
- 2 terminals.
- 2 S.P. fuses.
- 1 D.P. switch.

Say that the generator output is 15 amps. 50 volts, and that this is split up into 1-7½, 1-5 and 1-2½ amp. circuits, then from the 7½ amp. panel leads may be run to 50/2.8 = 18-2-volt cells connected in series, each cell requiring up to 7½ amp. charging rate. This charging rate can be varied by the resistance on the panel and reduced to approximately 25 per cent. of the full rate when necessary. The 5-amp. circuit can be likewise connected up with 18-2-volt cells requiring not more than 5 amps. charging rate, and the 2½-amp. circuit to 18-2 volt cells requiring not more than 2½ amps. A less number of batteries can, of course, be connected in either circuit and the resistance and shunt field regulator adjusted accordingly. More efficient charging will result if the number of cells on each circuit are nearly equal.

**Starting Up the Plant.**

To start up, engage the main switch on the motor panel, then the starter switch, and speed up with shunt regulator.

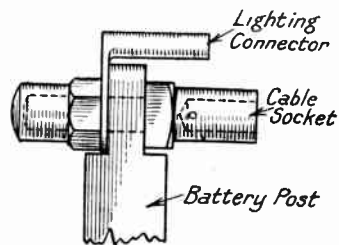

Fig. 18.—ANOTHER TYPE OF MOTOR-CAR BATTERY TERMINAL.



Fig. 17.—CONVENIENT TYPE OF BATTERY TERMINAL FOR MOTOR-CAR BATTERY.

When the generator voltage exceeds the battery volts on the circuit having the greater number of cells, switch on the generator main switch. Then switch on the charging circuit main switches with battery loads in position, and adjust shunt regulator to correct output of dynamo. Adjust panel regulator to charging currents required.

#### Adjustments During Charging.

When the charging panel main switches are switched on the cut-out will connect

reverse current through the windings of the cut-out will cause that instrument to break the circuit and prevent a reversal of current from the batteries to the generator. The generator will then run on open circuit at normal volts and no load until the regulator is adjusted to increase the generator voltage. The cut-out also operates if a battery on a series circuit becomes disconnected, that is with open circuit. When this happens the operator should switch off the battery circuit main switch before attempting to reconnect the battery.

#### When the Cut-out does not Function.

If for any reason the cut-out does not function and remains in with the battery volts high and generator volts low, there will be a reverse current from the battery through the generator armature circuit which will have the effect of assisting the motor. In this case, the ammeter readings will fall to zero on single scale meters or show a discharge on a centre zero instrument, thus giving an indication of the

fault. Adjustment of the regulator should restore normal charging conditions.

#### Withdrawing a Battery from a Series Circuit.

If it is necessary to withdraw a battery from any series circuit, shut off the charge circuit main switch and after reconnecting the battery circuit, switch on again,

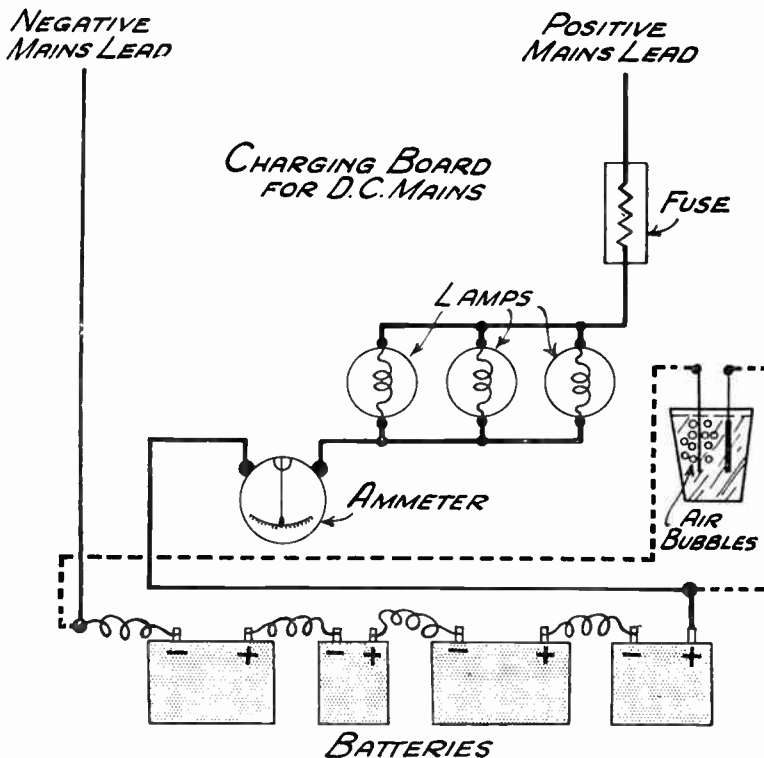

Fig. 19.—ANOTHER DIAGRAM OF CHARGING BOARD FOR D.C. MAINS. The dotted line shows how to test for polarity. (See also Fig. 12.)

up the generator circuit with the battery circuit, and the charge commenced. During the period of the charge it is necessary to make adjustments from time to time by means of the shunt field regulator, to maintain the charging rate against the rising back E.M.F. of the battery circuit.

Should this be neglected and the battery volts rise above the generator voltage the

re-adjust the current to the battery and proceed with the charge. It is necessary to switch off the charging circuits at the end of the charge, and this should be done before switching off the motor.

### Generators Driven from Line Shafting or from an Engine.

The same equipment for generator and charging circuits are necessary for generators driven from line shafting or from an engine, and the same procedure in regard to connecting up and charging should be carried out. With rotary transformers and A.C. motor generators the same applies, the only difference being on the motor control panel. For 3-phase supply a Star Delta starter with no volt and two overload releases and fuses is used. This starter has three positions, OFF, START and RUN, and incorporates a main switch, or the latter may be a separate item.

For single-phase supply the starter is of the graduated resistance type, the switch and fuses being a separate unit.

### CONSTANT POTENTIAL METHOD.

#### Charging Lead Acid Cells.

Lead-acid cells charged by the constant potential method require a supply current at a potential of 2.8 volts per cell of the battery. That is for a 12-volt battery, the supply voltage should be 16.8, and for an 80-volt battery, 112 volts.

Each circuit is suitable only for batteries of like voltage and those are connected in parallel across the bus bars of the charging system, the positive of the battery being connected to the positive bus bar.

The charge should commence at 2.3

volts per cell, independently of the charging current. This voltage should be maintained until the charge current is reduced to approximately  $\frac{1}{3}$  the initial value. Then gradually increase the voltage until the cells are at 2.6 volts each. The current at the end of the charge will have tailed off to a very low value. The same tests of specific gravity and temperatures as for the c.c. method of charging should

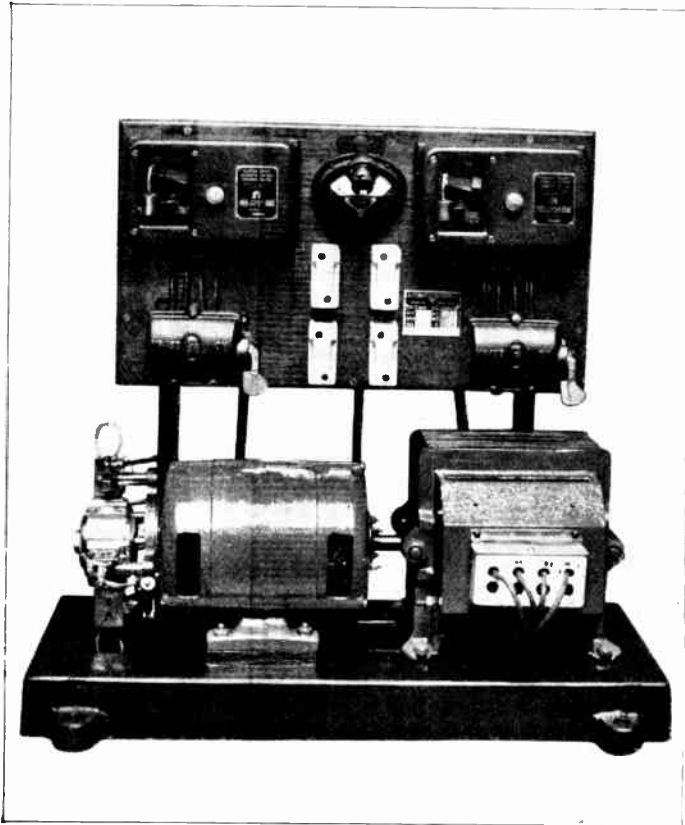

Fig. 20.—ROTARY TYPE RECTIFIER. (G.E.C.)  
This machine is suitable for use where not more than 20-26-volt or 10-12-volt batteries have to be charged at any one time.

be observed, and the topping up process carried out.

#### Charging Nickel-Iron Cells by Constant Potential.

Nickel-iron cells charged by the constant potential method require a charging voltage of 1.85 per cell of the battery to

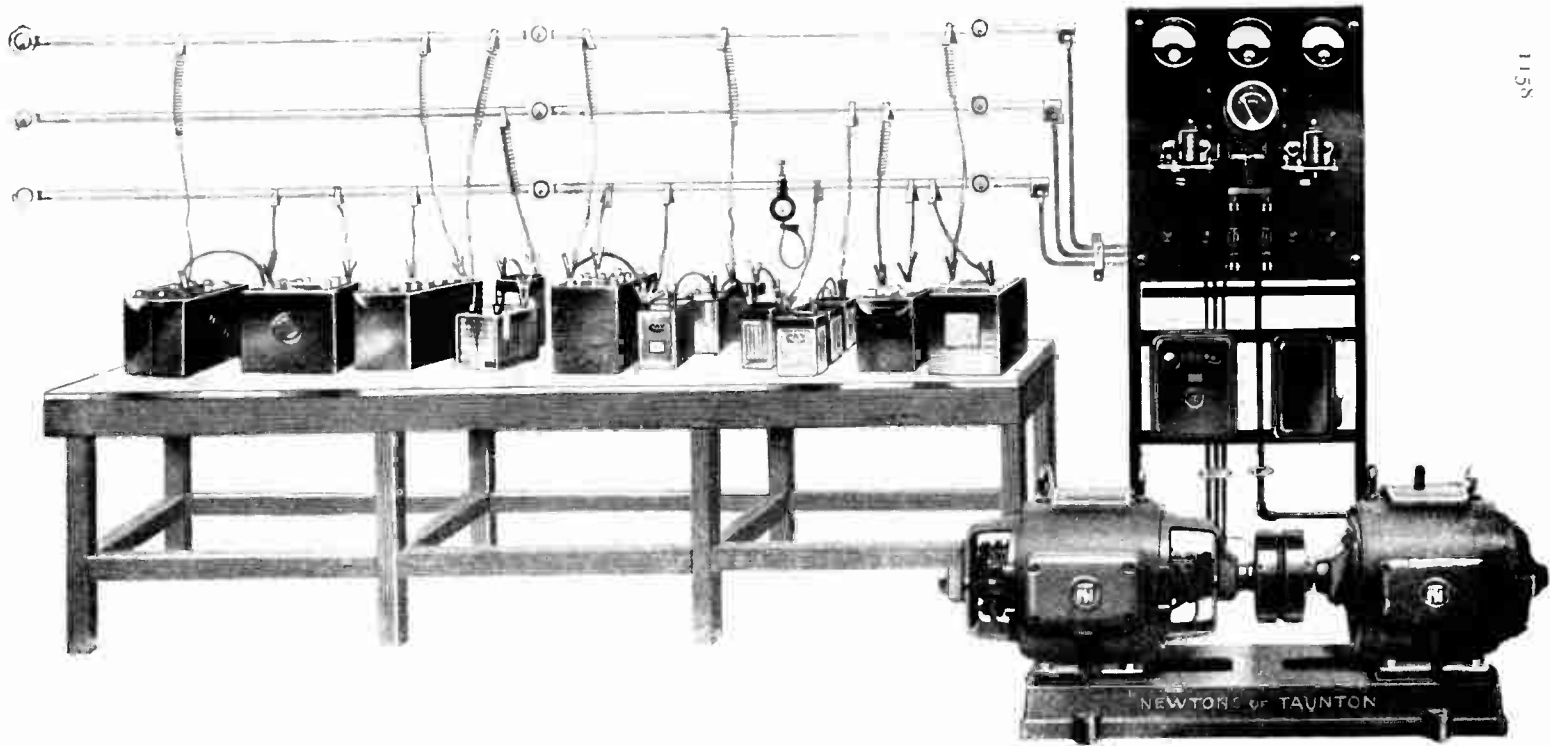

Fig. 21 (Above).—LAYOUT OF CONSTANT POTENTIAL CHARGING SET. (Newton.)

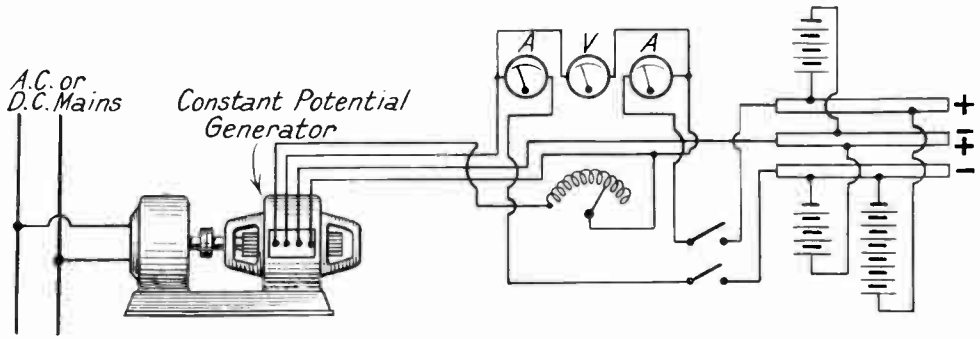

Fig. 22 (Left).—DIAGRAM SHOWING CONSTANT POTENTIAL SYSTEM, THREE BUS BAR METHOD. THE BATTERIES ARE CHARGED IN PARALLEL.



be charged. Connections are made as for lead-acid cells charged by the same method. The charges should commence at  $1\frac{1}{2}$  times the normal rate at a voltage of 1.7 per cell.

The charge rate will diminish gradually throughout the period of charge and after 7 hours the cells should stand at 1.7 volts each.

Special equalising charges are desirable for lead-acid traction batteries at fortnightly periods. After the completion of the ordinary charge continue at a low charging rate until there is no change in the specific gravity or voltage shown by hourly readings taken over a period of 3 or 4 hours.

**The Charging Set.**

Charging sets as used on the constant potential method of charging have the motor panel suitable for A.C. or D.C. supply, as required, and fitted with exactly the same starting equipment as described for motor generators. On the generator side also the controls are similar in every way for single charging circuits except that the current regulating resistance is unnecessary. Two bus bars are necessary and form the positive and negative connectors for the batteries. On a 15-volt set, six 2-volt cells can be charged in series across the two bus bars. Connections are usually made by means of a flexible connector having a clip at either end. Special leads can be obtained with a resistance incorporated between the two clips so that lower charging rates than normal can be obtained.

Three bus bars equipments employ controls for two charging circuits and  $7\frac{1}{2}$  volts is obtainable between the centre bus bar and either of the other two, and 15 volts across the two outer bars.

**Connecting Up Batteries.**

In connecting up batteries it is necessary to join the positive of a battery to the positive bus bar and the negative of the battery

to the negative bus bar. The bus bars should be prominently marked to avoid mistakes in this respect as permanent damage will occur to a battery should it be charged in the reverse way. Supposing the top bar to be positive and the bottom one negative, the centre bar will be negative to the top one and positive to the bottom bar. Thus 6-volt batteries connected across the top and centre bars should have the battery positive joined to the top bus bar and the negative terminal to the centre bar. 6-volt batteries connected across the centre and bottom bars should have the positive side joined to the centre bar and the negative to the bottom. 12-volt batteries connected across the outer bars should have the positive connected to the top bar and the negative to the bottom one.

**Disconnecting Batteries.**

Batteries can be disconnected at any time without shutting down the circuit although slight adjustment of the voltage controlling shunt regulator may be advisable. The field circuit of this type of generator is non-reversible, but the cut-out as used on motor generator panels should be employed to prevent motoring the generator by back feed from the batteries when the supply fails or is cut off without first switching off the charging circuits.

**CHARGING PANELS FOR VALVE OR METAL RECTIFIERS.**

On valve and metal rectifier charging panels practically the same provision is made on the output side as on the motor generator set described, but the cut-out is omitted as the system is non-reversible and in the case of open circuit on the battery side or failure of the input supply,

the set will not function on the output side. The ammeters and voltmeters used for this type of charging plant must be the moving coil type as the rectified direct current has a fluctuating value, the average

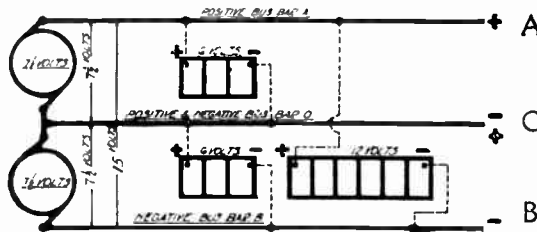

Fig. 23.—Circuit Diagram of Newton Constant Potential Charging System.

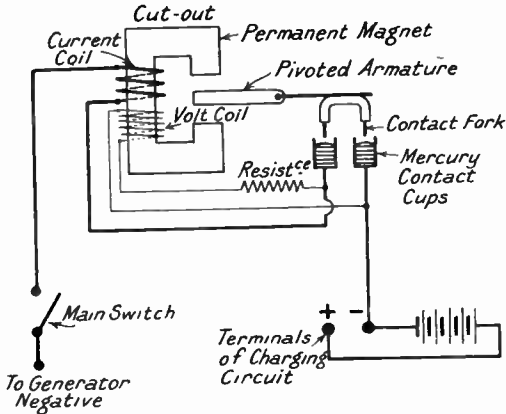

Fig. 24.—CUT-OUT AS USED ON BATTERY CHARGING PANELS.

of which is shown by the meter. On the input side there is a transformer with tappings to give alternative voltages. A change over switch on the panel connects up with these tappings, and enables the voltage of the battery charging circuit to be adjusted to suit the number of batteries on charge. A variable resistance in each charging circuit provides adjustment for the current between each voltage range. When smaller charging rates are required than the circuit rating, batteries can be connected in series parallel, thus reducing the charging rate to  $\frac{1}{2}$ ,  $\frac{1}{3}$  or  $\frac{1}{4}$ , according to whether two, three or four banks of batteries are connected in parallel.

## QUESTIONS AND ANSWERS

**What are the chief differences between lead-acid and nickel-iron batteries ?**

A lead acid has a rather higher efficiency in ampere hours ; a lower internal resistance ; is less affected by low temperature ; and is less liable to self-discharge.

A nickel-iron battery has a greater capacity per lb. of weight ; requires less maintenance ; and has a longer life under normal conditions.

**What is usually meant when speaking of the capacity of a car battery ?**

This is generally understood to mean the capacity at the 10-hour rate. That is to say that a battery of 75 ampere hours would provide a current of 7.5 amps. for 10 hours in discharging from a fully charged state to a fully discharged state.

**When is a battery considered to be fully discharged ?**

When the voltage per cell has dropped to 1.8.

**How would you correct the specific gravity of acid for temperatures other than normal (i.e., 60° F.) ?**

To correct for temperatures above 60° F., add .002 to the specific gravity for every 5° F. For temperatures below 60° F. deduct .002 for every 5° F., to obtain the requisite equivalent gravity at 60° F.

**What is the usual period for a first charge ?**

36 hours, and the charging rate that of about half this period.

**What should be the state of the cells at the end of the charging period ?**

They should be gassing freely and the density of the acid have attained a maximum value.

**What method of charging should be adopted where no electric supply exists ?**

A D.C. generator should be installed which may be driven from any running shaft line if sufficient power is available, or by any prime mover such as a steam, gas, petrol or oil engine.

**What methods are there for rectifying the current from A.C. mains for battery-charging purposes ?**

(1) The motor generator in which the motor is run off the A.C. mains and the generator is wound to give D.C. at a voltage suitable for the method of battery charging employed.

(2) The metal rectifier of the copper oxide type.

(3) The thermionic valve rectifier.

(4) The rotary or commutating type of rectifier.

# PRACTICAL ELECTRICAL ENGINEERING

Intended for Electric Lighting and Power Engineers.  
Electricians and Wiremen. Wireless Dealers.  
Students, Apprentices and Improvers in all Branches  
of the Electrical and Wireless Industries

*General Editor*  
EDWARD MOLLOY

## VOL. III

### *Contributors to Vol. III*

A. T. DOVER, M.I.E.E., Assoc.Amer.I.E.E.  
REGINALD O. KAPP, B.Sc., M.I.E.E.  
A. E. WATKINS.  
E. H. FREEMAN, M.I.E.E.  
M. G. SAY, Ph.D., M.Sc.  
L. J. GOOCH, A.M.I.E.E.  
H. E. J. BUTLER.  
T. J. BARFIELD.  
DAVID CHARLES.  
E. HILL.

KENELM EDGCUMBE, M.Inst.C.E., M.I.E.E.  
J. L. MARTIN, A.M.I.C.E.  
O. SIMONIS, M.R.I., M.I.W.E.  
H. W. JOHNSON.  
F. G. KIRBY, A.M.I.A.E., F.I.M.T.  
F. H. HOWELL.  
R. A. FAULKNER.  
A. W. JUDGE, A.R.C.Sc., D.I.C. (Whitworth  
Scholar).  
W. MERRY.  
D. R. AULD.

GEORGE NEWNES, LIMITED,  
SOUTHAMPTON STREET, LONDON, W.C.2

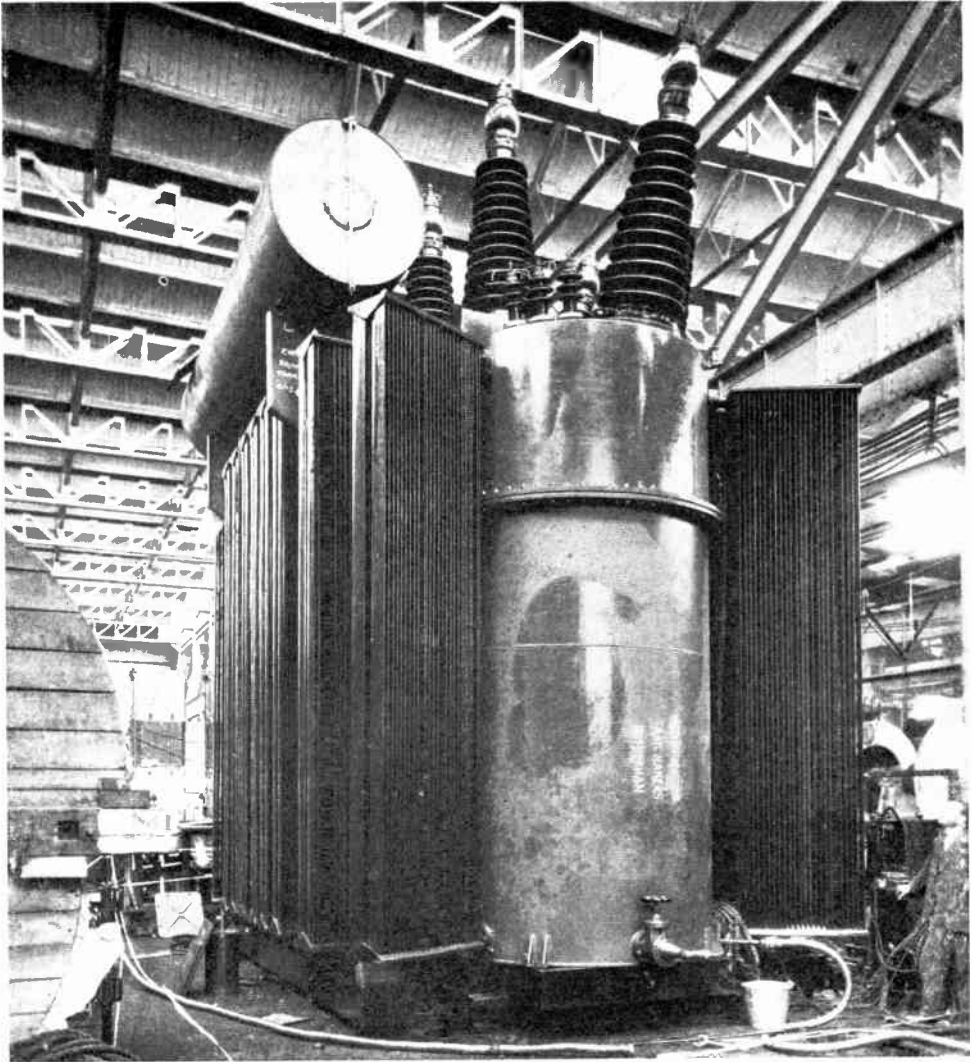

TRANSFORMER SUPPLIED FOR THE GRAMPAN ELECTRICITY SUPPLY COMPANY, SCOTLAND.  
RATING 20,000 K.V.A., THREE WINDING 125,000 VOLTS, 34,000 VOLTS, 132,000 VOLTS.  
(British Thomson-Houston Co., Ltd.)

## PREFACE TO VOLUME III

**T**HE first article in this volume is one which should interest everyone engaged in the Electrical Industry. It consists of a brief but authoritative survey of the Grid-System of Distribution which is now being put into operation all over the country. There can be little doubt that the introduction of this gigantic scheme will, during the next few years, prove to be an immense benefit not only to the Electrical Industry, but also to the country as a whole. All engaged in the manufacture of electric lamps, cables, machinery, fittings and switches, and electrical accessories of all kinds should during the next few years benefit directly by the far-sighted policy of the eminent engineers who advised the Government to put this scheme into operation.

As a consequence of the development of the Grid, an increasing number of supply areas will be operated on alternating current. This fact has given an added importance to the subject of A.C. Motors.

A few years ago A.C. Motors were not suited for general service because of their special characteristics and limitations. Recent advances in design have given these motors a flexibility which has led to their adoption for a much larger variety of work.

Every reader is therefore advised to study the interesting article by Mr. A. T. Dover, M.I.E.E., dealing with Types of A.C. Industrial Motors and their Applications. This is a subject which will become increasingly important during the next few years.

In the same category may be placed the subject of Distribution Switchgear. Mr. T. J. Barfield has dealt in a practical manner with this subject from the special point of view of the engineer who may be responsible for the installation or maintenance of high tension switchgear in electrically equipped factories and workshops.

The present volume contains also a splendid series of articles for the maintenance engineer. The article on Electric Lifts is by Mr. L. J. Gooch, A.M.I.E.E., who has specialized in this subject, whilst Mr. H. W. Johnson has contributed sections dealing with the Maintenance of Factories, Street Lighting Systems, and Electrically Equipped Stores.

Mr. Kenneth Edgcumbe's articles on Electricity Meters, Electrical Instruments, and Time Switches, will be found to deal with these three subjects in the thorough and yet practical manner in which one would expect, having in view the special qualifications of the author to deal with these subjects.

Gramophone Pick-Ups, Electric Gramophone Motors, and the Design and Construction of Main's Units for Wireless Receiving Sets are three articles in this volume which are of particular interest in relation to the rapidly developing subject of Radio Engineering.

An article which will be found of special interest to the engineer who likes to make things is that entitled "How to Make a Small Motor," by H. E. J. Butler. It is not an exaggeration to say that this is probably the most detailed article on the subject which has ever appeared, and we have no doubt that a great many engineers who have access to a small lathe will be tempted to make one of these fractional horse power motors. The data given enables the machine to be designed for any voltage from 100 to 250 either alternating current or direct current.

Mr. E. H. Freeman, M.I.E.E., continues his interesting series dealing with Illumination of Buildings. These articles are of direct interest not only to consulting engineers, but to the wiring contractor who will find that the expert advice which they contain will be invaluable in his own business.

E. M.



# CONTENTS

	PAGE
THE DISTRIBUTION OF ELECTRICITY. <i>By Reginald O. Kapp, B.Sc., M.I.E.E.</i>	777
Variations of Voltages and Frequencies—What Grid Lines are For—How Electric Supply Undertakings are Formed—Cost of Transmission Systems—Feeders and Distributors—How Electricity is Bought.	
PHOTO-ELECTRIC AND SELENIUM LIGHT CELLS. <i>By A. E. Watkins</i>	784
Controlling Switching for Signs—Photo-electric Cells for Wireless—Control of Light Sensitivity—Measuring the Value of Light Intensity—Types of Photo-electric Cells—Battery Connections—LIGHT SENSITIVE CELLS—How the Radiovisor Bridge is Constructed—Holding the Sensitive Surface in Position—How the Cells are Set Up—Selenium Cells for Sound Reproduction.	
THE ILLUMINATION OF A DOMESTIC INSTALLATION. <i>By E. H. Freeman, M.I.E.E.</i>	789
Maximum Number of Points Allowed—THE GROUND FLOOR—Entrance—Hall—Staircase—Hall—Study—Drawing-room—Brackets for the Drawing-room—Dining-room—Brackets for the Dining-room—Loggia—Pantry—Kitchen—Scullery—Stores and Larder—Maid's Sitting-room—Cloaks—Corridors—Garage—THE FIRST FLOOR—LIGHTING SCHEDULES—Three-wire Supply—Three-phase Supply—How the Load Should be Distributed.	
MAGNETIC CLUTCHES AND CHUCKS ON A.C.	801
A HANDY ELECTRICAL DISTRIBUTION BOARD. <i>By David Charles</i>	802
Making the Distribution Board—The Wiring—Fixing in a Workshop.	
ADJUSTING A NOISY FAN	804
COTTON, PAPER AND FIBRE. <i>By M. G. Say, Ph.D., M.Sc.</i>	805
Uses of Cotton—TREATED FABRICS—Bakelized Cloth—A Substitute for Metal Gears—PAPERS—How Paper is Made—Paper for Telephone Cables—TREATED PAPERS—Synthetic Resin—Paper Boards.	
TYPES OF A.C. INDUSTRIAL MOTORS AND THEIR APPLICATIONS. <i>By A. T. Dover, M.I.E.E., Assoc. Amer. I.E.E.</i>	809
CLASSIFICATION OF MOTORS—NUMBER OF PHASES—GENERAL PRINCIPLES OF OPERATION—Conductive and Inductive Methods of Transferring Energy—USE AND APPLICATIONS OF THE VARIOUS TYPES OF MOTORS—Three-phase Commutator Motors—Three-phase Synchronous and Synchronous-induction Motors—Single-phase Motors—Single-phase Series-wound Motors—Single-phase Repulsion Motors—MECHANICAL FEATURES—Screen Protected, Drip-proof, Pipe Ventilated and Totally Enclosed Induction Motors—CHARACTERISTICS AND APPLICATIONS OF THREE-PHASE INDUCTION MOTORS—How the Torque is Produced—Power Factor and Efficiency—CHANGEABLE POLE (MULTI-SPEED) INDUCTION MOTORS—DUAL FREQUENCY INDUCTION MOTORS—CHARACTERISTICS AND APPLICATIONS OF THREE-PHASE INDUCTION-COMMUTATOR MOTORS—Chief Parts and Electric Circuits—How Phase Compensation is Obtained—Speed and Starting Characteristics—Power Factor and Efficiency—Applications of Compensated Induction (Commutator) Motor—How Variable Speed May be Obtained Efficiently from an Induction Motor—How the Speed is Varied—CHARACTERISTICS AND APPLICATIONS OF SYNCHRONOUS-INDUCTION AND SYNCHRONOUS MOTORS—How the Synchronous-induction Motor Differs from the Induction Motor and the Synchronous Motor—SINGLE-PHASE MOTORS—CHARACTERISTICS AND APPLICATIONS OF SERIES-WOUND MOTORS—CHARACTERISTICS AND APPLICATIONS OF REPULSION MOTORS.	
INSTALLING ELECTRIC COOKERS. <i>By F. H. Howell and R. A. Faulkner</i>	845
Where to Stand the Cooker—The Cable and Switch—Fixing the Main Switch—How to Plan the Wiring—Why You Need a Control Board—"Barring" the Cables—Make Sure of a Good Earth—Testing—NOTES ON THE UPKEEP AND MAINTENANCE OF A SUNRAY TRICITY COOKER.	

	PAGE
DISTRIBUTION SWITCHGEAR. <i>By I. J. Barfield</i> . . . . .	853
Function of Switchgear—Electricity Regulations—Types of Switchboards—EQUIPMENT OF SWITCHBOARDS—ERECTOR OF SWITCHGEAR—Using Lifting Tackle—Oil Switches—Tripcoils—Time Lags—Approximate Fusing Current for Copper Wire—Insulation Tests—Cubicle Type Switchgear—Cover Cable Trenches—Trench Type Cubicles—Ironclad Switchgear—Assembling the Busbars—OPERATION AND MAINTENANCE—Oil Circuit Breaker—Cleaning Arcing Fingers and Plates—Renewing Fuses—CONNECTIONS FOR SWITCHGEAR INSTRUMENTS, ETC.—Simple Draw-out Type Unit—Two Ways of Arranging a Distant Push-button Trip—Operating Three Tripcoils from the Secondaries of Current Transformers—Connections for Overload and Leakage Protection—Checking Connections of Meter—Use of Potential Transformer—Medium Power Control Gear.	
MAGNETIC SUBSTANCES . . . . .	870
ELECTRICAL GRAMOPHONE PICK UPS. <i>By I. E. Watkins</i> . . . . .	871
How the Pick up Works—Rubber Dampers—Correct Weight of Armature—The Volume Control—Values of Resistances—Advantages of a Wire-wound Resistance—THE MARCONIPHONE PICK-UP—Volume Control Valve—Adjusting Relative Bass and Treble Output—Position of Pick-up—Inserting the Needle—SERVICE AND MAINTENANCE OF MARCONIPHONE PICK-UP—THE B.T.H. MINOR PICK-UP AND CARRIER ARM—THE B.T.H. SENIOR PICK-UP AND CARRIER ARM—ADAPTING AN EXISTING RECEIVER FOR A GRAMOPHONE PICK-UP—HOW TO OBTAIN PERFECT TRACKING.	
THE ELECTRICAL PROPERTIES OF PORCELAIN . . . . .	880
How Porcelain is Manufactured—Applications and Uses—STEATITE—BASALT AND STONEWARE—QUARTZ AND GLASS—SLATE—MARBLE.	
HOW ELECTRICITY HELPS THE RAILWAY ENGINEER. <i>By A. T. Dover, M.I.E.E.</i> . . . . .	883
THE SIGNALLING SYSTEM—Communication Between Cabins—Interlocking the Signals—Signal Arms or Semaphores—Automatic Repeaters for the Signals—Automatic Signalling—G.W.R. System of Automatic Train Control—THE LIGHTING OF TRAINS—ALL-ELECTRIC RESTAURANT CARS—HEATING—LIGHT ON THE PLATFORMS—ADVANTAGES OF ELECTRIC TRACTION—Mountain Railways—Suburban Railways.	
DOES A PHOTO-ELECTRIC CELL GENERATE CURRENT? . . . . .	892
FACTORY LIGHTING. <i>By E. H. Freeman, M.I.E.E.</i> . . . . .	893
Intensity of Illumination Required—General Description of Plan—Use of Factory—DESIGN FOR SOUTH BAY—Working Height—Distance Apart of Lighting Units—Lumens per Fitting—Crane Lighting—Wall Plugs—DESIGN FOR CENTRAL BAY—DESIGN FOR NORTH BAY—DESIGN FOR COMBINED BAYS—DESIGN FOR SOUTH SIDE EXTRA BAY—DESIGN FOR NORTH SIDE EXTRA BAY—Transformer Chamber and Switch Room—Boiler House—Store—Drawing Office—Manager's Office—Timekeeper, Waiting-room, Entrance Lobby and Corridor—Lighting Schedule—Distribution System—Main Switches—Main Cables—Voltage Drop—Fuse Boards.	
ELECTRIC LIFTS. <i>By L. J. Gooch, A.M.I.E.E.</i> . . . . .	905
AVOIDANCE OF ACCIDENTS—Things You Should Not Do—Winding the Lift by Hand—Releasing the Brake—Entering the Lift Shaft—How to Get on Top of the Lift Car—MAINTENANCE AND INSPECTION—Motor-room—Main Fuses—Care of the Motor—Adjusting the Brake—GEAR—Detecting Wear—End Play in Worm Shaft—Curing a Leaking Gland—Detecting Rope Slip—CONTROLLER—Operation of Relays—Time Lag Devices.	
MAINTENANCE OF AN ELECTRICALLY EQUIPPED FACTORY. <i>By H. W. Johnson</i> . . . . .	920
The Main Switchboard—Equipment of the Panels—Specimen Inspection Sheet—The Stores—The Repair Workshop—Ammeters and Voltmeters—Insulation Testing Set—Emergency Tools—MAINTENANCE WORK ON THE LIGHTING EQUIPMENT—MAINTENANCE WORK ON MOTOR AND MOTOR STARTER EQUIPMENT—D.C. MOTORS—The Brush Holders—The Brushes—The Commutator—Removing a "Flat" from Commutator Surface—The Field Magnet Windings—Re-insulating the Magnet Coils—A.C. MOTORS—WOUND ROTOR MOTORS—THE SWITCHGEAR MOTOR DRIVES INSULATION RESISTANCE TESTING.	
LIGHTING IN CHURCHES. <i>By E. H. Freeman, M.I.E.E.</i> . . . . .	947
Calculating the Number of Lumens Required—Choosing the System of Lighting—	



Central Pendants—Pendants Hanging from Arches—Reflectors—Bracket Fittings Attached to the Piers—SCHEDULE OF LIGHTING POINTS—Number of Fuse Boards Required.

THE RECORDING OF SOUND. *By J. J. Martin, A.M.I.C.E.* . . . . . 953  
 First Method of Recording Sound and Scene—NATURE OF SOUND—How Sensitivity Varies—Harmonic Motion and What it Is—How to Measure Frequency with a Tuning Fork—TRANSMISSION OF SOUND—How to Find Out the Length of a Sound Wave—Reflection of Sound—Effect of Sound on Uneven Surfaces—Motion Picture Sound Records—How the Recording is Done—FILM RECORDING—Variable Density—Variable Area—How Sound is Synchronised on the Film—SHEET RECORDING—How SOUND IS MEASURED.

TIN, LEAD, ZINC AND THEIR ALLOYS. *By A. W. Judge, A.R.C.Sc., D.I.C., Whitworth Scholar* . . . . . 961  
 The Leyden Jar—Fuse Wires—Hardening Effect of Tin—Tin-coated Steelplate—Electrical Bearings—Tin Solders—Lead-sheathed Cables—Zinc Electrodes in Cells—Zinc Coatings—Die-castings—Mazak Castings.

REPAIRS TO ELECTRIC COOKERS. *By F. H. Howell* . . . . . 967  
 How the Oven is Fitted in—Position of Switches and Fuses—Renewing a Fuse Wire—What to Do When a Fuse "Blows" Continually—Repairing a Broken Element Wire—Where to Look for Faults—How to Set About Tracing Faults.

ELECTRIC WELDING. *By O. Simonis, M.R.I., M.I.W.E.* . . . . . 972  
 Principle of Welding—TYPES OF ELECTRIC WELDING—PLANT—Plant for Factories—APPLICATIONS OF WELDING—In the Boiler and Tank Shop—In Industrial Manufacture—In Structural Engineering—Comparative Cost of Welded and Riveted Structures—For Repair Work—How TO WELD—Right and Wrong Way of Holding the Arc—Touch Welding—Position of the Electrode—How to Apply the Electrode—Circular Welding—THE ELECTRODE—Importance of Choosing the Right Electrode—STRENGTH CALCULATIONS.

STREET LIGHTING SYSTEMS. *By H. W. Johnson* . . . . . 983  
 The Maintenance and Cleaning Staff—Maintenance of Span Wires and Insulators—Maintenance of Brackets and Lantern Supports—Overhead Bare Lighting Wires—All-night and Half-night Circuits—Section Pillars—Street Lighting in the Suburbs—Traffic Signals—Method of Regulating the Time of the Signals—Pedestrian Road-crossing Signal Lights—White Line Illumination—Annual Cost.

REPAIRS TO ACCUMULATORS. *By F. G. Kirby, A.M.I.E.E., F.I.M.T.* . . . . . 996  
 Starter Batteries—High-rate Discharge Set—Cadmium Test for Faulty Plates—How to Remove a Cell—Testing for Leakage Between Cells—Reassembling a Container—Lead Burning—Filling the Battery with Acid—Celluloid Batteries.

ELECTRICAL ENGINEERING MATERIALS (COPPER). *By A. W. Judge, A.R.C.Sc., D.I.C., Whitworth Scholar* . . . . . 1003  
 Electrolytic Copper—Addition of Cadmium and Silicon—Electrical Properties of Copper—Conductivity Compared with Other Metals—Resistance to Corrosion—Weight—Heat Conductivity—Screening Electrical Parts—COPPER ALLOYS.

ELECTRIC GRAMOPHONE MOTORS. *By A. E. Watkins* . . . . . 1007  
 Correct Speed for Satisfactory Reproduction—How to Make a Speed Tester—Testing Motor for Sufficient Strength—NOTES ON THE COLLARDO INDUCTION ELECTRIC GRAMOPHONE MOTOR—Changing the Voltage—How the Mains Supply is Connected—NOTES ON THE GARRARD UNIVERSAL ELECTRIC GRAMOPHONE MOTOR, TYPE E.D.—NOTES ON THE GARRARD NO. 202 INDUCTION MOTOR—THE B.T.-H. ELECTRIC GRAMOPHONE MOTOR, TYPE YG—THE B.T.-H. GOLDEN DISC ELECTRIC GRAMOPHONE MOTOR—MARCONIPHONE MOTOR, TYPE 24 FOR ALTERNATING CURRENT—TROUBLE TRACING CHART—LUBRICANTS—NOTES ON REASSEMBLING MOTOR.

HOW TO MAKE A SMALL MOTOR. *By H. E. J. Butler* . . . . . 1020  
 Components and Materials—The Armature Spindle—Assembling the Stampings—HOW TO MAKE THE COMMUTATOR—The Commutator Micas and Copper Segments—Turning the Commutator—Assembling and Testing—WINDING THE ARMATURE—THE FIELD MAGNET.

ELECTRICITY SUPPLY METERS. *By Kenelm Edgcombe, M.Inst.C.E., M.I.E.E.* 1048  
 A.C. Induction Meters—Curve of Modern A.C. Meter—Tests at Various Loads—Correcting the Adjustment of a Meter—How Power Factor Adjustment is Effected

D.C. Meters—Double Tariff or Two-rate Meters—Prepayment Meters—Erecting a Supply Meter.	
<b>THE DESIGN OF APPARATUS FOR H.T. SUPPLY UNITS.</b> <i>By A. E. Watkins</i>	1055
Precautions to Take When Installing—H.T. SUPPLY UNITS FOR A.C. MAINS—Valve and Metal Rectifiers Compared—Smoothing Systems—MAKING A TRANSFORMER TO USE WITH WESTINGHOUSE METAL RECTIFIERS—Constructing a Simple Bobbin—Size of the Core—Winding on the Primary Wire—Winding the Secondary—TRANSFORMERS FOR VALVE RECTIFIERS—CONDENSERS FOR SMOOTHING THE RECTIFIER CIRCUIT—RESISTANCE FOR VOLTAGE DROPPING—Potential Divider Method—Anode Feed Method—CONSTRUCTIONAL DETAILS OF SMOOTHING CHOKE.	
<b>TIME SWITCHES AND PROGRAMME CLOCKS.</b> <i>By Kenelm Edgcombe, M.Inst.C.E., M.I.E.E.</i>	1068
Timing Mechanism—Using a Synchronous Motor—Time Switches for Street Lighting—The Solar Dial—Contact-making Systems—Marking of Time Switch Dial—FORMS OF TIME SWITCH—Time Switches for Domestic Water Heating—Mercury Switches—PROGRAMME CLOCKS.	
<b>MAINTENANCE OF AN ELECTRICALLY EQUIPPED STORES.</b> <i>By H. W. Johnson</i>	1073
THE LIGHTING EQUIPMENT—General Floor Lighting—Counter and Showcase Lighting—The Ventilating and Air-washing Plant—Heating and Cooking Appliances—The Switchboard—THE MAINTENANCE WORK—Wiring—Strip Lighting—Pendant or Bracket Fittings—Winding-gear Motors—Escalators—Telephone Installation—Bell Installation—Small Current Appliances.	
<b>FURTHER NOTES ON ELECTRO-PLATING.</b> <i>By W. Merry</i>	1081
ZINC AND CADMIUM PLATING—Electro Zincing—TINNING—Plating Small Articles—BRASS PLATING—Making the Solution—Conditions of Working—Redness of Deposit—Paleness of Deposit—BARREL PLATING—How the Barrels are Constructed—Notes on Barrelling—Voltage and Current—STRIPPING DEPOSITS—Nickel—Stripping Nickel Without Current—Silver and Gold, etc.—Stripping Copper from Steel—Removal of Brass After Bronzing.	
<b>ILLUMINATION OF OFFICE BUILDINGS.</b> <i>By E. H. Freeman, M.I.E.E.</i>	1091
General Lighting and Local Lighting—TYPICAL BUILDING—BANKING PREMISES—Arrangements for Spacing—Desk Lighting—INSURANCE—Voltage Drop—Cables to Use—LANDLORD'S LIGHTING—Corridor Lighting—Staircase Lighting—LETTABLE AREAS—Location of Building—Complete Scheme for the Building—Wiring Diagram.	
<b>ELECTRICAL MEASURING INSTRUMENTS.</b> <i>By Kenelm Edgcombe, M.Inst.C.E., M.I.E.E.</i>	1111
Moving-iron Ammeters and Voltmeters—Construction of a Voltmeter—Moving-coil Ammeters and Voltmeters—When "Shunting" is Necessary—Rectifier-operated Ammeter and Voltmeter—Induction Ammeters, Voltmeters and Wattmeters—Hot-wire Ammeters and Voltmeters—Electrostatic Voltmeters—Thermo-couple Ammeters—Dynamometer Wattmeters—Power Factor Meters—Frequency Meters—How Frequency is Controlled at a Power Station—Ohmmeters and Other Resistance Measuring Instruments—The Conduit Tester—The Earth Plate Tester—Inking Devices—General Hints Relating to Graphers—Electrical Speed Indicators—Portable Testing Instruments—Leakage Indicators—Current and Voltage Transformers—PRECAUTIONS WHICH SHOULD BE TAKEN IN ERRECTING AND CONNECTING UP ELECTRICAL MEASURING INSTRUMENTS.	
<b>RECORD-CHANGING GRAMOPHONE MOTORS.</b> <i>By A. E. Watkins</i>	1133
The Operation of the Magazine—The Pushing Plate—Loading the Magazine—Rejecting a Record—Repeating a Record—SERVICE DETAILS—The Turntable—Tone Arm Adjustment—Adjustment of Pick-up Weight—Assembly and Adjustment of Record Magazine—Mounting and Adjustment of Rejector.	
<b>REPAIR OF ELECTRIC IRONS.</b> <i>By D. R. Auld</i>	1143
Fitting New Flex—Use of Cable Reel—Fitting New Element—Reassembling the Iron—Special Types of Irons.	
<b>ACCUMULATORS.</b> <i>By E. Hill</i>	1147
TYPES OF BATTERIES FOR DIFFERENT PURPOSES—Types of Cells Compared—NOTES ON CAR BATTERIES—STORING AND PUTTING BATTERIES INTO COMMISSION—How a Battery is Delivered—How to Dilute Acid—CHARGING SYSTEMS—THE MOTOR GENERATOR—PRACTICAL NOTES ON CHARGING—SERIES METHOD—CONSTANT POTENTIAL METHOD.	

THIRD VOLUME NOW READY

# BINDING CASES

for

**“PRACTICAL ELECTRICAL ENGINEERING.”**

**W**ITH this Part the third volume of Newnes' "Practical Electrical Engineering" is complete. Lose no time in getting loose parts of this comprehensive work bound, for only in this condition can the contents be referred to quickly and easily. As long as parts remain unbound they are liable to get lost or damaged.

An attractive and durable binding is available which is oil, acid and water proof. This has been specially designed so that the volumes may be referred to at any moment without possibility of damage.

*The case is full-bound in Brown Rexine, which is acid, oil*  
**2/6** *and water proof. Edges are tinted and* **2/6**  
*EACH. the case is boldly lettered in 22 carat gold.* *EACH.*

**THIS PRICE DOES NOT INCLUDE COST OF BINDING.**

*For illustration and details of SPECIAL BINDING OFFER  
see Back Cover.*

*Binding Cases are obtainable from all Newsagents, Bookstalls and Booksellers, or  
by post 2/9 each from*

**GEORGE NEWNES, LTD.,**  
**8-11, SOUTHAMPTON STREET, STRAND, LONDON, W.C.2.**

*Geo. Newnes, Ltd.*

**Part 25 ready April 1st. Order your copy to-day.**

# HERE IS YOUR OPPORTUNITY TO HAVE THIS WORK ECONOMICALLY BOUND

IN THE PUBLISHER'S AUTHORISED COVERS

This Part completes Vol. 3

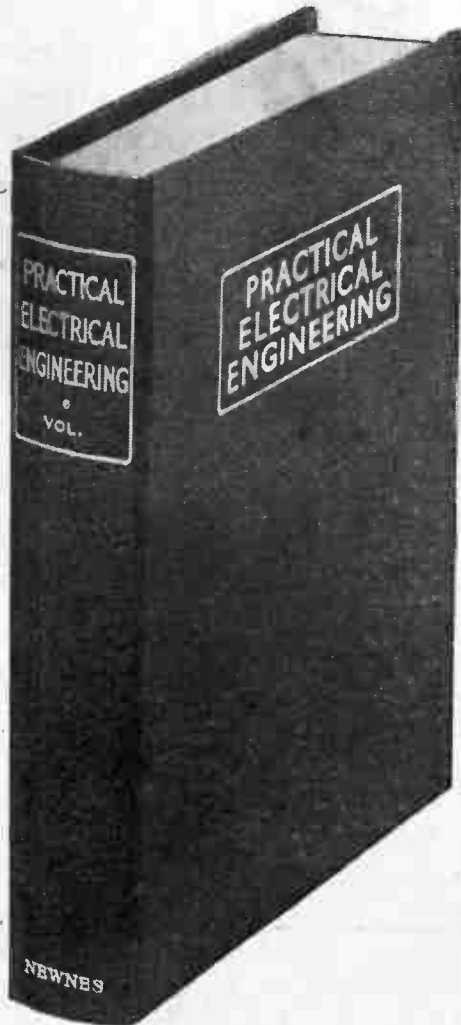

## Best Workmanship Reasonable Cost

WHEN conveniently bound in volume form, "Practical Electrical Engineering" will prove of lasting value to everyone connected with the electrical profession. Here is an easy way of getting your parts bound in the Publisher's Authorised Covers—which have been specially prepared to meet the requirements of subscribers to this invaluable reference work.

The cover, as illustrated here, is full-bound in Brown Rexine. Acid, oil and water proof, edges tinted, boldly lettered with 22-carat gold.

EACH **5/6** VOL.

(Return carriage paid in U.K.)

Don't delay—send your parts of each volume to-day, clearly marked with your name and address, to

**A. W. BAIN & CO.,**  
LIMITED. (Est. 1864)  
17-19, Bishop's Road, Cambridge Heath,  
London, E.2,

together with P.O. or cheque. If parcels are not clearly marked the binder cannot accept responsibility for delay or loss. Payments acknowledged and executed in strict rotation. Average time—three weeks.

**THE SOONER YOU SEND YOUR PARTS THE SOONER YOU WILL  
GET YOUR BOUND VOLUME TO ADD TO YOUR LIBRARY**