

To be Completed in about 32 weekly parts.

NEWNES PRACTICAL ELECTRICAL ENGINEERING

IN THIS PART

GRAMOPHONE
PICK-UPS

ELECTRICAL
PROPERTIES OF
PORCELAIN

HOW
ELECTRICITY
HELPS THE
RAILWAY
ENGINEER

FACTORY
LIGHTING

MAINTENANCE
AND REPAIR OF
ELECTRIC LIFTS

1/-

PART
19

A PRACTICAL WORK WRITTEN BY EXPERTS

STUDY
AT
HOME

YOU CAN HAVE A COLLEGE
TRAINING IN ALMOST ANY
CAREER FOR A FEW
SHILLINGS MONTHLY

IN
YOUR
SPARE
TIME

FOUNDED 1900.

32 YEARS OF SUCCESS.



THIS IS THE BENNETT COLLEGE -- ALL OF IT

The Bennett College is not a Rented Room in a well-known street—it is a College. Over 31 years ago the Founder took as his motto what has now become a household slogan:

LET ME BE YOUR FATHER

In many trades and professions there are more vacancies than trained men to fill them. We do not profess to act as an employment agency, but our gigantic organisation certainly does tell us where the demand exists, thus enabling us to give FATHERLY ADVICE ON ALL CAREERS AND THE POSSIBILITY OF EMPLOYMENT, FREE.



J. Bennett

WE TEACH ALL
BRANCHES OF
THE FOLLOWING
VOCATIONS
AND SPECIALISE
IN ALL EXAMINATIONS
CONNECTED THEREWITH.

**THE MOST SUCCESSFUL AND MOST PROGRESSIVE
CORRESPONDENCE COLLEGE IN THE WORLD**

Aviation Engineering.
Boiler Engineering.
Boiler Making.
B.Sc. (Engineering).
Civil Engineering :
A.M.I.C.E.
Quantities—Specifications.
Commercial Art

Concrete and Steel.
Draughtsmanship :
Electrical or
Mechanical.
Electrical Engineering :
A.M.I.E.E.
City and Guilds.
Engineering Mathematics.
Foundry Work.
Heat Engines.

Heating, Ventilating and
Lighting.
Internal Combustion Engines.
Machine Designs :
Theory of Machines.
Marine Engineering :
Motor.
Steam.
Mechanical Engineering :
A.M.Inst.B.E.
A.M.I.Mech.E.
City and Guilds.
Pattern Making.

Mechanics.
Metallurgy of Steel.
Mine Electrician :
A.M.E.E.
Mining (all examinations).
Motor Engineering :
A.M.I.A.E.
Municipal and County
Engineers :
M. and C.E.
Naval Architecture
Pumps and Pumping
Machinery.
Radio Reception.
Ship Building.
Structural Engineering.
Telegraphy and Telephony.

IF YOU DO NOT SEE YOUR OWN REQUIREMENTS ABOVE, WRITE TO US ON ANY SUBJECT.
IT COSTS NOTHING TO ENQUIRE.

Also ask for Our New Book
(FREE OF CHARGE)

THE HUMAN MACHINE

SECRETS OF
SUCCESS

WE TEACH BY POST IN ALL PARTS OF THE WORLD

Note Address Carefully:

The BENNETT COLLEGE, Ltd., Dept. 119, Sheffield



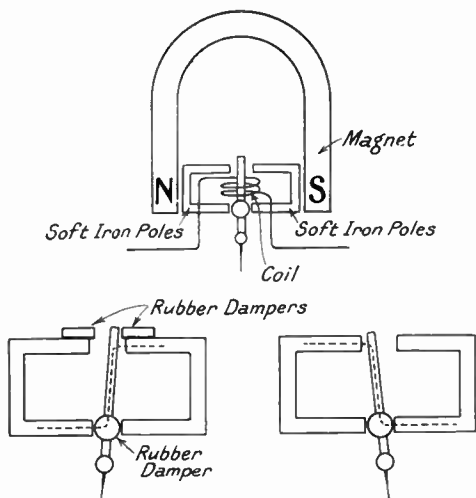

Fig. 3.—THE PRINCIPLE OF THE MODERN PICK-UP.

terminals of the pick-up, the contact arm being connected to the grid of the first valve of the amplifier, as in Fig. 4. One end of the winding of the volume control is connected to the grid bias battery or grid bias resistance in the case of an all-mains operated receiver. The value of the resistance of the volume control depends to a great extent upon the pick-up. Present-day pick-ups are usually designed to use a resistance rated from 10,000 to 50,000 ohms; this value is usually perfectly satisfactory, particularly if they are of the wire-wound type. Some pick-ups, however, require a resistance as high as 250,000 ohms. The particulars for the value of the resistances must be determined either from the maker's instructions or from experiments.

Values of Resistances.

Suggested values for the various types of pick-ups illustrated in this article are mentioned, and those values which are mentioned will be found to give satisfactory results under almost all conditions, and if the volume control is of the square law resistance, that is to say, if the winding or the resistance element is tapered, a more gradual variation of volume will be obtained than if the resistance is straight.

Advantages of a Wire-wound Resistance.

Another point also in favour of a wire-wound resistance is that owing to the great number of turns of wire on the former it is inductive and therefore helps to retain the high notes, whereas with a carbon resistance, being non-inductive, there is often a loss of high notes, particularly if the resistance is of the lower values. It is important that the volume control should be smooth in action and have perfect contact between the contact plate and the spring-arm. In any case, one should never choose a volume control in which electrical contact is made between the spindle and the bush; it should always have some supplementary system of contacts between the contact finger and terminal plate.

Types of Pick-up.

As it is not possible in this work to illustrate every type of pick-up at present manufactured; it is, therefore, decided to illustrate several well-known types, with particular notes relative to each. As all pick-ups are constructed on similar lines no difficulty will be found in adapting these notes to other pick-ups.

An Important Point in Design.

The most important point in the design of pick-ups is the weight of the armature and the position in which the screw for clamping the needle is placed. In all the later types the screw is passed through the centre pivot of the armature, so that the weight of the screw does not in any way affect the movement of the armature or introduce an undue load.

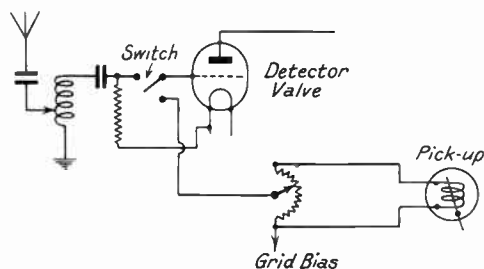

Fig. 4.—HOW TO CONNECT A PICK-UP TO AN EXISTING RECEIVER (1).

Showing connections to volume control and position of switch.

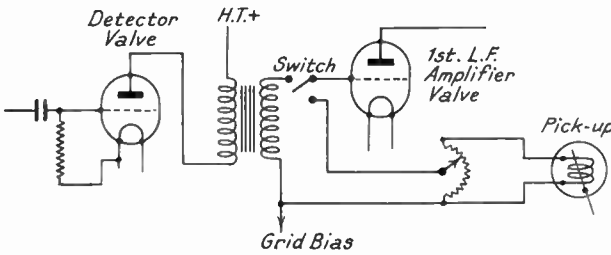

Fig. 5.—HOW TO CONNECT A PICK-UP TO AN EXISTING RECEIVER (2). Showing pick-up connected to first L.F. amplifier valve.

THE MARCONIPHONE PICK-UP.

The Marconiphone Pick-up, Type No. 17 (see Fig. 2), has an extraordinary good response, and will reproduce equally recorded music over the whole of the musical scale. This is due to the careful design of the armature and the general construction of the magnetic system.

The D.C. resistance is 6,000 ohms. A.C. impedance is 37,000 ohms at 800 cycles. The output in volts is 1 volt r.m.s.

The volume control should not be greater than 250,000 ohms.

Volume Control Value.

A volume control is essential as a high output from the pick-up may otherwise cause overloading in the first valve of the amplifier, with consequent distortions. The control recommended is 25,000 ohms and the winding is connected directly across the two outer leads of the pick-up, the contact arm being connected directly to the grid.

Adjusting Relative Bass and Treble Output.

The relative bass and treble output may be adjusted to suit individual requirements. For a three-electrode output valve no adjustment will be required, but if a pentode output valve is used the treble register may tend to be reproduced to a greater extent. To cure this trouble, a 35,000

ohms resistance RI is connected across the outer lead of the pick-up, as shown in the circuit diagram, Fig. 9. This will effectively emphasise the bass register by reducing the output of the treble register. If further reduction of the treble is necessary a 10,000-ohm resistance may be tried. It is essential in the case of every pick-up to earth the metallic carrier arm.

Position of Pick-up.

The pick-up should always be as near the receiver or amplifier as possible, and if the distance does not exceed from two to six feet ordinary switch flex may be used; but if the distance is up to five or six yards, it is advisable to employ a screened cable which is braided with copper wire, and the braiding connected to earth. Greater distances than six yards are not advised.

Inserting the Needle.

To insert the needle in the Marconiphone pick-up the head is rotated, thus exposing the needle-holder so that the needle may easily be slipped in. For the best result Tungstyle needles are advised. (Steel needles may also be used and should be changed after each record.) A Tungstyle needle may be used to play 100 times providing that it is not removed from the holder, as owing to the very free armature it will cause practically no

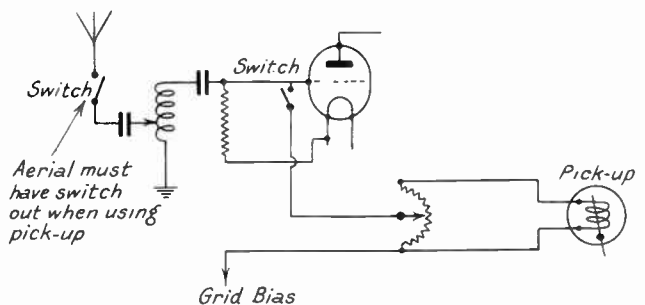

2. 6.—HOW TO CONNECT A PICK-UP TO AN EXISTING RECEIVER (3). Showing position of switch for switching out aerial when the pick-up is being used.

wear on the record. Be very careful, however, to see that the point does not become bent or broken; this may occur if the pick-up drops hard upon the record or catches the edge of any projection.

Adapting Pick-up to Different Circuits.

Various circuits are shown for adapting pick-ups to suit various receivers, and these circuits apply to every type of pick-up. When fitting a pick-up it is advisable in the first place to connect a milliamp. meter in the anode of the last valve so that the presence of overloading may be noticed.

so that the armature is held in a neutral position. The fixing hole for the rubber damper holder is elongated and can be adjusted from side to side until the correct position is found. This, however, should not be tampered with unless one is certain that the armature is not correctly adjusted. If this rubber has become hard or distorted in any way, a new piece can easily be fitted.

SERVICE AND MAINTENANCE OF MARCONIPHONE PICK-UP.

To Remove the Pick-up from Carrier.

1. Unscrew small screw on underside of

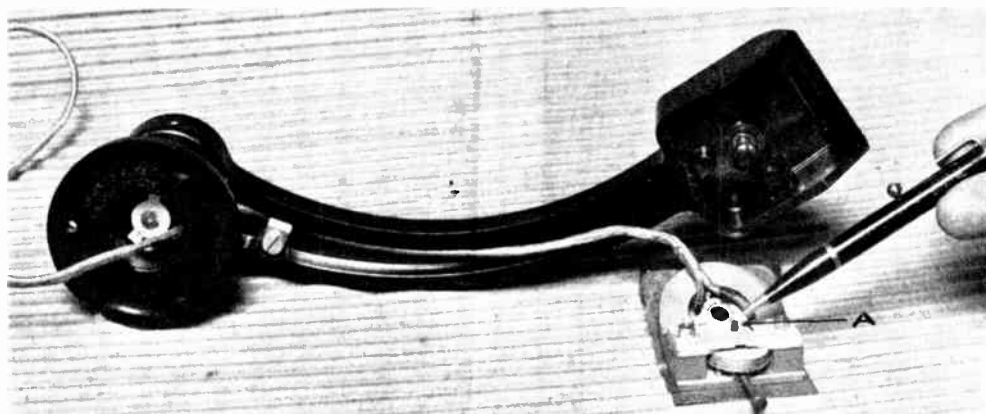

Fig. 7.—B.T.-H. MINOR PICK-UP.

The rubber damper "A" is held in the cross member and is not adjustable. The pick-up is removed from the case by unscrewing the centre screw.

The needle of the meter should remain practically steady. If this is not so, either alter the bias or substitute a valve capable of handling a greater input. Usually two stages of I.F. amplification is all that is required with the present type of pick-up, unless, of course, very large output is required, and this is then accommodated by the use of push-pull output, and will be dealt with in notes on the design of gramophone amplifiers.

Adjustment of Rubber Damper.

In the Marconiphone pick-up the armature is held in a central position by the rubber damper. This rubber damper has a small split in the centre, which engages in the flat of the armature. The holder for the rubber damper is easily adjusted

pick-up arm and withdraw. The leads to the soldering lugs may then be unsoldered if necessary.

2. Remove screw-retaining metal cover, and remove knurled needle screw.
3. Carefully move round horseshoe magnet so that it can be lifted off, and place on a suitable iron or steel "keeper." *Do not drop.* Wrap up carefully so that the magnet cannot collect any iron filings.
4. Unscrew metal clamping place of rubber damper.
5. Carefully remove rubber damper.

Note.—In certain instruments the lead may appear not to be connected to the coil. Examination, however, will show that the systoflex insulation is merely

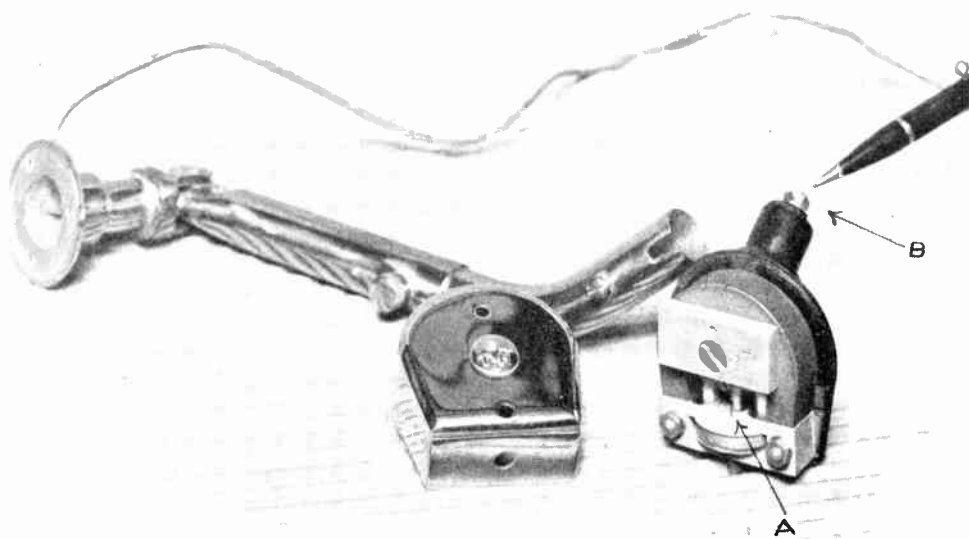

Fig. 8.—B.T.-H. SENIOR PICK-UP.

The rubber damper is the round rubber rod held in the position by the holder at "A." The pick-up is removable from the arm, contact being made to the leads by the contacts spring "B."

to protect the joint which is effected at the back of the coil.

Removal of Coil.

In the event of the coil being found faulty, it may be removed in the following manner:—

1. Unscrew the hexagonal bolts securing the solid pole pieces and carefully slide out pole pieces and coil, *taking care not to lose the small rubber damping sheets wrapped round the pivots of the armature.*
2. Slide the coil out of pole piece, test carefully, and if necessary replace by unsoldering green leads and re-soldering leads of new coil on flex, *taking care to replace the insulating strips over the joints.* DO NOT ALLOW THE SLIGHTEST TRACE OF DUST.

Reassembly of Pick-up.

1. Erect one pole piece on its end so that the coil is resting in it vertically; this will facilitate the insertion of the armature.
2. Insert armature so that the flattened portion enters through centre of

coil in such a manner that it will appear at the top and so that the screwed end of the armature appears at the outer side of the pole piece.

3. Carefully insert the rubber bearing strips on either side of the point where the armature pivots coincide with the curved recesses in the lower edge of the pole pieces and in such a manner that the two edges of the rubber strip do not come together at the point where the other pole piece will grip the armature pivots.
4. Carefully slide the second pole piece over the coil in such a manner that

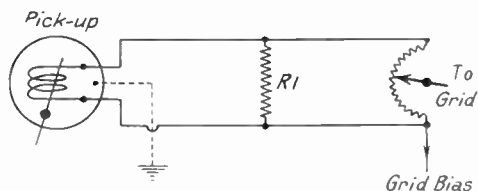

Fig. 9. HOW TO PREVENT EXCESSIVE REPRODUCTION OF THE TREBLE REGISTER.

A 35,000-ohms resistance is connected across the outer lead of the pick-up.

the end of the rubber bearing strips protrude outwards and away from the lower surface of the poles.

Note.—The point of a pin will be found useful to draw the rubber strips into correct position.

5. Holding the two pole pieces between the thumb and forefinger of the left hand, thus clamping the coil, reed and pole pieces together, adjust the flattened end of the armature so that it normally situates itself equidistant from either pole.
6. Screw up hexagonal nuts, thus securing poles in position in the moulded case, taking care that :

damping sheet locates between them, and screw down lightly.

9. Replace magnet *with ground surface downwards, having carefully wiped all traces of dust or filings from it with Plasticine.*
10. By lifting front edge of damping sheet, move clamping plate and damping sheet about until armature blade is exactly central between poles, otherwise the reproduction may be lacking in the top registers.
11. Exert pressure, tending to close the pole pieces, while finally screwing up the hexagonal bolts. Replace cover and securing-screw.

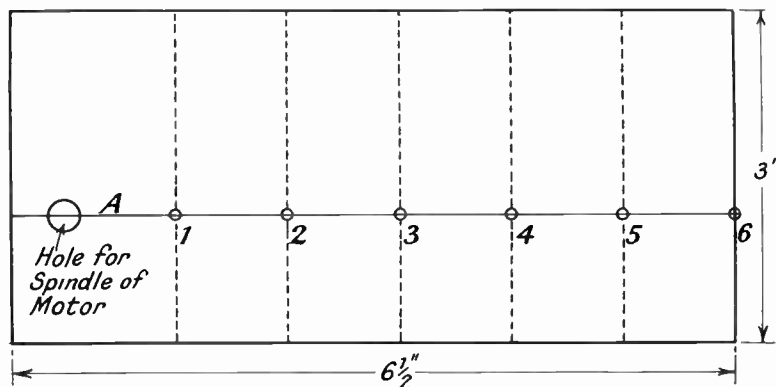

Fig. 10. — HOW TO MARK OUT THE TRACKING CARD.

By using this card as directed in the article the pick-up can be set in position for perfect tracking.

- (a) The recess for the needle is centred in the hole in the bakelite moulding.
- (b) The flattened end of the armature is situated exactly between the two poles.

Note.—It will be found advisable not to screw the hexagonal bolts up too far until some slight pressure has been exerted between the moulded case and the ends of one of the pole pieces, to see that the rubber-covered bearings of the armature are firmly gripped.

7. Replace the rubber damping sheet over the flattened end of armature so that slit in the sheet locates with blade of armature.
8. Replace clamping plate so that the flanges on it are downwards and the

See that no iron filings are present between the poles and reed.

THE B.T.-H. MINOR PICK-UP AND CARRIER ARM.

This pick-up, like the Marconiphone, is supplied complete with tone arm, or carrier (the term carrier being more correct, as there is no sound carried by the arm).

Construction of Rubber Damping.

The point of interest in the construction of this pick-up is the rubber damping having no adjustments, there being a round special rubber rod which passes through the top of the pole pieces into the centre of the armature, thereby holding the armature in a neutral position. The needle is clamped by a screw passing

through the centre pivot, which is mounted in rubber to allow a free movement of the pivot. The carrier arm is moulded bakelite, and is very light and rigid.

The leads of the pick-up are screened with metallic braiding, this braiding being connected to earth.

Value of Volume Control.

The value of the volume control advised is 10,000 ohms, but if brighter reproduction is required this value can be increased

It is important to ensure that the height of the record above the motor board of the gramophone is the standard distance of 1 inch for which the carrier arm is designed. If it is found that this cannot exist, then it is necessary that adjustments are made to the mounting so that the fixing base of the carrier arm is 1 inch below the surface of the record. This is very important, as otherwise the pick-up may foul the record and the angle of the needle will be incorrect.

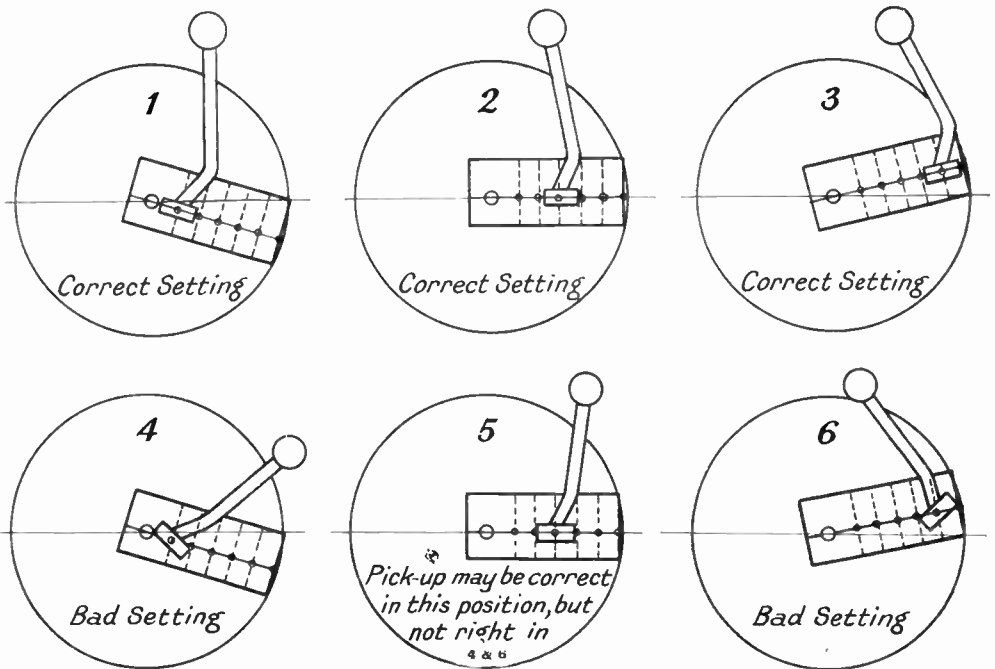

Fig. 11.—CORRECT AND BAD SETTINGS.

If the carrier arm and pick-up are correctly set the pick-up will be at right angles to the line A and dotted lines 1, 2, 3, 4, 5 and 6. Figs. 1, 2 and 3 above show the pick-up correctly set in three positions, while Figs. 4, 5 and 6 are incorrect. An error of three degrees would not matter. These drawings have not been done to scale, but will serve to show the approximate positions of the pick-up for correct and bad settings.

up to 100,000 ohms, but a value of round about 25,000 ohms usually suffices for most requirements, particularly if this volume control is of the square law type in which the resistance is tapered to give a gradual increase of volume. Full tone or medium needles are recommended for the best results.

THE B.T.-H. SENIOR PICK-UP AND CARRIER ARM.

The design of the pick-up is somewhat similar in general construction to the Minor, with the exception, however, that it is more robust and gives a higher output. The method of controlling the armature is similar to that of the Minor;

that is, it has a round rubber rod which passes through the centre of the armature and is held in position by an adjustable holder, so that in the case of this pick-up a slight adjustment can be made to centralise the armature.

The needle-clamping screw passes through the pivot, which is mounted in rubber.

Plug Fitting.

The pick-up is provided with a plug fitting which fits into the centre of the carrying arm, so that the pick-up can be quickly removed and replaced by another. This has a great advantage for the users of machines for public work as a faulty pick-up can readily be traced without any delay.

The front half of the carrier arm is made to rotate to facilitate needle changing.

The D.C. resistance of the Minor pick-up is 1,850 ohms.

The D.C. resistance of the Senior pick-up is 3,000 ohms.

The value of the volume control can be 25,000 ohms up to 100,000 ohms to suit the individual requirements.

ADAPTING AN EXISTING RECEIVER FOR A GRAMOPHONE PICK-UP.

When adapting a receiver for a pick-up, whichever valve is used it is essential to remember that this valve is now an amplifying valve and must have a grid bias. That is to say, if the detector valve is used as a first amplifier it must now have a grid bias so that this valve is virtually a L.F. amplifier. The switch should be connected as near as possible to the grid terminal of the valve holder, and it is better to adapt a switch controlled by a rod than to have a long lead, for while this long lead would not affect the pick-up it would have an effect on the radio reception. If the receiver has only one stage of L.F. amplification, it will be advisable to connect the pick-up to the detector valve. If the receiver has two stages of transformer coupled

L.F. amplification it may be advisable to connect the pick-up in the second stage of the L.F. amplification.

HOW TO OBTAIN PERFECT TRACKING.

A great deal of the efficient working of a pick-up depends on correctly setting the position of the pick-up for perfect tracking. This is how it should be done :—

1. Mark out a card as shown in Fig. 10.
2. Place the card over a record on the turntable.
3. Fit needle in pick-up (the pick-up is attached to carrier arm).
4. Place needle point at "o" on dotted line 3, adjust position of carrier base on the baseboard, so that the pick-up is at right angles to the lines as setting 2, Fig. 11.
5. Hold the base of carrier arm firmly, alter position of pick-up to setting 1, turn the tracking card until the needle points to "o," dotted line 1. If the base is in the correct position the pick-up will still be at right angles to the lines, or with a small error up to three degrees.
6. Now move the pick-up to line 6; moving the card until the needle is at point "o" the setting should still hold good, as setting 3.
7. The base of carrier arm must be moved about until the position is found with the smallest error.

Check all other points and then screw down base. Settings 4, 5 and 6 show that the pick-up may be correct as setting 5, but if the position of the base of the carrier is not correct will be out of line at 4 or 6.

Do not take any notice of the position at which the needle will be when the arm is swung to the centre spindle as this has no bearing whatsoever upon the correct tracking.

Many people believe that if the needle is near the centre of the spindle the tracking must be correct. This, however, is not so. The illustration will show the correct procedure, and too much care cannot be taken in arriving at the correct position, for the truer the tracking the longer the life of the record and the better the reproduction.

THE ELECTRICAL PROPERTIES OF PORCELAIN

WITH NOTES ON STONEWARE, GLASS AND QUARTZ

How Porcelain is Manufactured.

Porcelain is made by grinding together china clay ("kaolin"), quartz and felspar, with small additions of materials such as chalk to give colour, etc. China clay is obtained from decomposed granite; supplies are found in south-west England. Felspar acts as a "flux." It flows when the mixture is baked, or fired, and binds together the other materials, which are relatively infusible. Quartz is used in the form of sand, or flint. When the grinding process has proceeded far enough in water, the mixture is beaten and filtered, then turned on the potter's wheel, cast, or moulded. The pieces are slowly dried, then glazed and fired or "burned" in kilns. The process all through is difficult and requires great care. Porcelain shrinks considerably when fired, so that it is practically impossible to obtain exact dimensions.

Properties.

Porcelain is naturally white, but is often colour-glazed. It does not absorb water to any marked extent, especially when protected by a glaze (as is invariably the practice for electrical porcelain), which also enables the surface to be kept clean. Porcelain is brittle,

and does not readily withstand mechanical stresses or sudden blows. Thus care has to be taken when affixing porcelain-base switches, ceiling roses, etc., that the screws are not over-tight. The electrical qualities of porcelain are excellent. It withstands considerable electric stresses, and does not suffer unless the stress is raised to puncture value, or an arc occurs across the surface. In the latter case, the porcelain body may be chipped or fractured.

Applications and Uses.

A five per cent. tolerance has to be allowed in the dimensions of porcelain parts, and pressings of the material have to be fairly simple, with uniform thickness and ample corner rounding. The user of porcelain as an insulating material must always purchase his parts as needed; there is but little scope for "working-up" porcelain. The nature of the ceramic precludes any change of form except by the cementing of various parts together. This method is used for making up large transmission line insulators of the pin type, while the suspension type may have cast-iron clamping or hooking devices



Fig. 1.—Two EXAMPLES OF PORCELAIN BUSHINGS. The larger of these is suitable for voltages up to 220,000. (Steatite & Porcelain Products, Ltd.)

cemented on. Even this, however, is a process for the expert. The small expansion of porcelain with temperature relative to that of cast-iron necessitates a cement having a "cushioning" action to take up the various small changes in dimensions that occur with changes of temperature. Portland cement is a common material for this purpose.

Porcelain is poorly resistant to tension and bending (which, of course, involves tension), but is strong in compression. Its strength is usually ample in small parts, such as fuse-holders; but in large parts for transmission lines the bending becomes a serious problem. For higher voltages—such as those in use on the National "grid" network—pin-type insulators become so large that high values of bending stress are unavoidable. In this case suspension units, linked together to give the requisite length, are necessary. Although the link-pins are in tension, the load on the porcelain is chiefly compressive, and remarkably large loads can be supported.

STEATITE.

This material is a natural rock. Although a ceramic product, it contains no clay, but its plastic constituent is the familiar talc or soapstone, so called on account of its soapy, greasy feel. The best steatite rock is mined in Germany, which partly explains why its development has made most progress in that country. Formerly its chief use was in the manufacture of gas-mantle supports and burners, and an examination of the jet of, say, an acetylene cycle lamp will reveal the nature of the material.

Manufacture.

Large parts, such as insulators for busbars, may be sawn and turned from the natural rock, then "fired," after which process they are strong and hard. Waste from machining is powdered, and pressed into moulds by automatic machines, then fired.

Properties.

Steatite parts are stronger, have greater moulding accuracy and shrink less than porcelain parts. The mechanical strength is indeed remarkable, particularly (as with all ceramics) in compression. The electrical characteristics are similar to those of porcelain, but their maintenance at high temperature is a particularly valuable feature.

Applications and Uses.

As it takes more complicated shapes particularly well, steatite is used for small parts, bobbins, pieces with small holes, etc. One familiar use is the "S"-shaped pin-socket insulators in ordinary bayonet lampholders; another the grooved supporting insulators for small reflector electric fires. Steatite can be distinguished by its cream-yellow colour, sharp edges and opaque appearance. In the parts mentioned above it is generally employed without glazing. Its nature as a ceramic material precludes any working, machining or finishing of steatite after firing.

BASALT AND STONEWARE.

Although as yet of limited application mention should be made of basalt and stoneware as insulating materials.

Basalt is a natural mineral rock having insulating properties. It can be melted and cast into simple moulds for large insulating parts. It is punctured by an arc discharge, but "heals" subsequently, as the melted basalt flows back and fills up the hole. It is mechanically stronger, especially in tension, than porcelain, but its electrical strength is somewhat less.

Stoneware, or earthenware, is a clay product, rougher in texture than porcelain, and similar to bricks, cooking pots, drain pipes, etc. Its use is advantageous more particularly in very large pieces—such as high-voltage bushing insulators—since it is more easily handled in manufac-



Fig. 2.—CONDENSER BUSHINGS. Showing porcelain rain shield. (*Micanite and Ins. Co.*)

ture than large porcelain pieces. Engineers, in fact, are used to handling stoneware in very large sizes. Large basins, vats and pipes for the chemical industries are commonly manufactured. The ancient Romans used it for their ingenious aqueducts.

Both electrically and mechanically, stoneware is somewhat inferior to porcelain.

QUARTZ AND GLASS.

Quartz, or fused silica, has some small applications in electrical engineering. It is one of the most refractory substances known—i.e., it resists the application of heat up to very high temperatures. It is thus used for electric furnace insulation, large thermionic radio valves, etc.

Glass.—This age-old substance was the first insulating material used; it dates back to the glass-rod-and-catskin days. It is now used only to a small extent for insulation, except in connection with electric lamps and radio valves. "Pyrex" glass, however, which is specially manufactured to be heat-resisting (meaning in this case a low coefficient of expansion with temperature) has been applied, more particularly in America, to transmission line work.

SLATE.

Slate is another insulating rock. It is composed of a clay subjected to centuries of high natural pressure. Its chief mechanical characteristic is the ready formation of "cleavage planes," i.e., it is easily split up into thin sheets. Only a small portion of the slates mined finds an electrical use.

Only large slabs are applied for electrical use. These are sawn to size and split to thickness. The surface treatment is planing followed by sand or carborundum grinding.

Properties and Applications.

Slate is mechanically strong, fire-resisting and easily machined, if impact is avoided. Many slates are liable to contain metallic veins, and have to be avoided for switchboard use. Certain other impurities tend to cause splitting after the slate has been some time in use.

Slate is used particularly for switch-panels, terminal boards, rods and formers for winding on resistance wire.

Treatment.

Unfortunately slate tends to absorb water, which lowers its resistivity. To avoid this, some form of impregnation or surface treatment is used. First the slate is dried out by baking, then japanned, or oiled by immersion in hot transformer oil or melted paraffin wax. When it is necessary to drill holes or otherwise machine an enamelled slate slab (which can be done by means of ordinary metal-working tools such as drills, files, etc.), it is best to bake the slab for some hours after working, and then to apply a japan coating.

The liability of metallic veins is usually

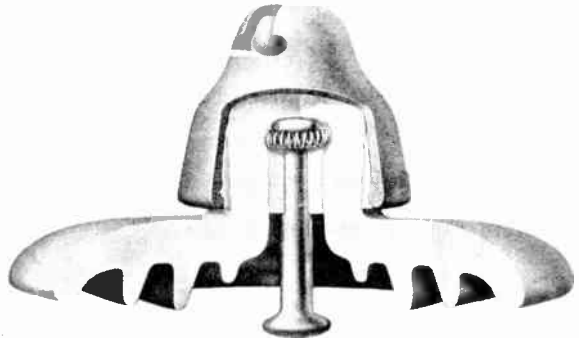

Fig. 3.—SECTION OF SUSPENSION TYPE INSULATOR. (Steatite & Porcelain Products, Ltd.).

met by bushing all holes with micanite, and wrapping all through bolts with empire cloth.

MARBLE.

Marble is a dense, compressed limestone. Its greatest use is for constructional purposes, for which its beautiful appearance is greatly admired. It has for long been used for switch-panels, but modern tastes do not appreciate its appearance so greatly as formerly, and black-enamelled slate has largely displaced it. The electrical characteristics of marble are rather better than those of slate, but it absorbs water more readily. The same methods of preventing this can be used.

The material can be drilled and turned, using water as a "lubricant." It is sometimes used for the parts of delicate instruments on account of its great permanence.

HOW ELECTRICITY HELPS THE RAILWAY ENGINEER

By A. T. DOVER, M.I.E.E. (Author of *Electric Traction*)

ELECTRICITY is a great asset to the general railway engineer who is concerned more with steam than electric railways. Its use ensures the safety of the travelling passengers by providing (1) quick and accurate means of communication between signalmen; (2) interlocking of signals and points; (3) safe lighting of the trains; and (4) adequate lighting of the stations. At the same time it enables the welfare of the passengers to be provided for by (1) electrically cooked food in restaurant cars; (2) adequate ventilation of restaurant cars; and (3) good and easily controllable lighting in passenger compartments and special cars.

In the engineering, construction and repair departments, warehouses, docks, etc., the use of electricity results in increased safety, more efficient working and a saving of time.

When the fullest use is made of electricity, as on electric railways, the services for which this agent may be utilised are very numerous indeed.

THE SIGNALLING SYSTEM.

Communication between Cabins.

Electrical methods of communication are used between signalmen in signal cabins for the acceptance of a train into a "block-section." A code of bell signals is employed. Single-stroke electric bells are used and are worked by ordinary wet Leclanché cells. On important lines telephone communication is also provided, the telephones being also worked by Leclanché cells.

Centralised Control of the Traffic.

On some of the larger railways in this country reports of all train movements are sent by telephone from the signal cabins to a central office, from which instructions to signalmen are issued concerning the despatching and working of the trains. The officer in charge (called the "train despatcher" or "traffic controller") has, therefore, complete knowledge of the position of every train on the lines under his control, and he can,

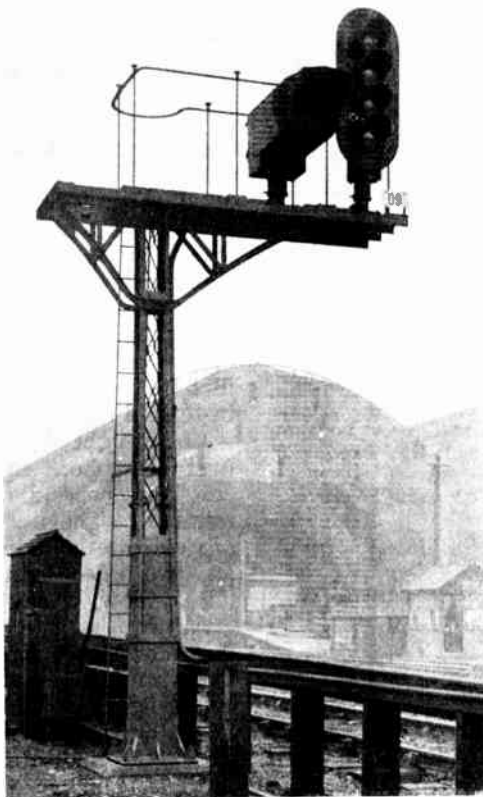

Fig. 1.—WESTINGHOUSE FOUR-ASPECT (VERTICAL TYPE) COLOUR-LIGHT SIGNAL AND OPTICAL ROUTE INDICATOR (ON LEFT).

Mounted on signal post originally fitted with semaphore signals. Victoria and Exchange Stations, Manchester, L.M.S. Railway. The colours are green (top), yellow, red, yellow (bottom). The optical route indicator is illustrated in Fig. 3. (*Westinghouse Brake and Saxby Signal Co.*)



Fig. 2. WESTINGHOUSE FOUR-ASPECT (CLUSTER TYPE) AND TWO-ASPECT (VERTICAL TYPE) COLOUR-LIGHT SIGNALS AND OPTICAL ROUTE INDICATOR (ON LEFT).

Victoria and Exchange Stations, Manchester, L.M.S. Railway. The colours in the cluster signal are green (left), yellow (top and bottom), red (right). The colours in the two-aspect signal are yellow (top) and red. (*Westinghouse Brake and Saxby Signal Co.*)

therefore, issue instructions to secure the most efficient working. This centralised method of traffic control was developed in America, where it is in general use.

Interlocking the Signals.

At important junctions and stations electrical methods are used for interlocking the signals to prevent incorrect operation. The track rails are used as protective conductors, the separate lengths of rails in a block section being made electrically continuous by lightly "bonding" the joints. The rails between adjacent block sections, however, are insulated from one another by means of special fish plates. A battery of low resistance Leclanché

cells is connected across the rails at one end (usually the leaving end) of a block section and a special relay is connected across the rails at the other end (usually the entering end) of this block section. Hence, when a train is on the rails of a section so protected the relay is short circuited and the armature is released. Contacts are then closed which energise the electro-magnetic interlocking mechanism on the signal levers and indicators, showing that the section is occupied by a train.

Signal Arms or Semaphores.

At large terminal stations the signal arms or semaphores may be worked electrically, either by electro-magnets or small motors. In some cases, the semaphores are combined with an electrically illuminated route indicator (which indicates the platform section into which the train is to run), and a considerable simplification of the signals is thereby obtained. Moreover, with power operation, three-position signals are possible, which again leads to simplification, as one three-position semaphore is equivalent to two two-position semaphores.

Alternatively, with all-electric working, light signals (i.e., fixed coloured lenses illuminated by electric lamps) may be used instead of semaphores.

Colour-light signals have the advantage over semaphore signals that two, three and four aspects may be used for the running signals. For example, four aspects are obtained with red, green and two yellow lights—thus red, "stop"; one yellow, "caution"; two yellow, "warning"; green, "proceed." Hence, one four-aspect light signal can replace two semaphore signals. Examples of colour-light signals and optical route indicators are shown in Figs. 1 and 2. The route indicator is shown in detail in Figs. 3 and 4. It consists of a darkened glass screen about 14 in. square on which is projected the number or letter indication required; the number or letter showing white on a dark background. A separate projector is used for each indication, and a maximum of 13 projectors can be accommodated. Each projector lamp is supplied at low voltage by a separate

transformer, and in the signal cabins indicator lamps are shunted across resistances connected in the primary circuits of these transformers, so that the signalman is always aware of the route indication given.

In all cases, electric signalling results in considerable saving of space in signal cabins, and reduces the physical exertion of the signalmen, as instead of having to pull heavy levers they have to operate small electric switches.

Illustrations of typical electric signal cabins are shown in Figs. 5 and 6. The cabin illustrated in Fig. 5 has mechanical locking frames, and that illustrated in Fig. 6 has all-electric interlocking. The latter represents the latest practice in electric signalling.

Electric signalling is employed on an extensive scale at the London termini of the Southern Railway, of which the installations at London Bridge, Charing Cross and Cannon Street are of outstanding interest.

Automatic Repeaters for the Signals.

At large terminal stations and at many places along the tracks in suburban districts, bridges and other obstructions may partially obscure the ordinary semaphores. In these circumstances, dupli-



Fig. 3.—WESTINGHOUSE OPTICAL ROUTE INDICATOR. FIGURES 11 INCHES HIGH.

These are shown in white on a dark screen. The visibility in bright sunlight is about 150 yards.

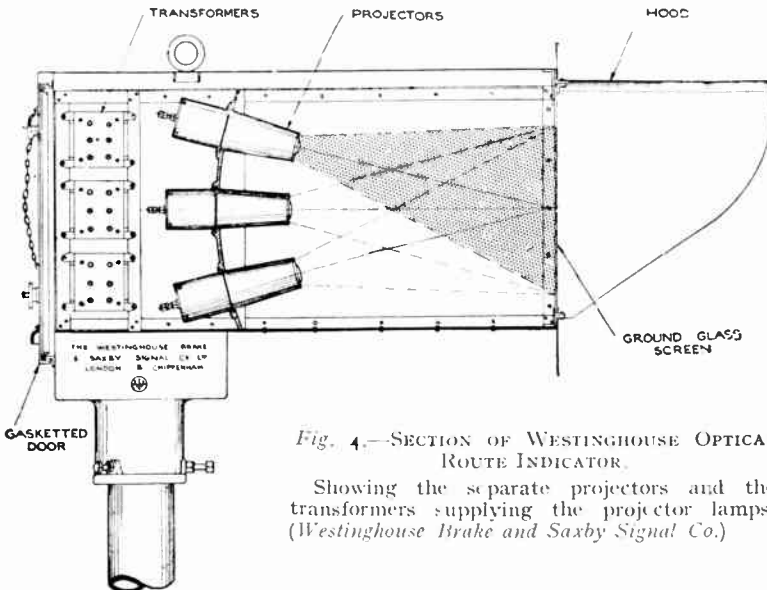

Fig. 4.—SECTION OF WESTINGHOUSE OPTICAL ROUTE INDICATOR.

Showing the separate projectors and the transformers supplying the projector lamps. (Westinghouse Brake and Saxby Signal Co.)

cation of the semaphores is necessary, such duplicate semaphores being called "repeaters." Here again electrical methods of operation possess many advantages over mechanical methods. The electric repeater consists of a miniature pivoted semaphore operated by an electromagnet. The movement is light and is en-

closed in a dust-tight case, with glazed front and opal back. It is controlled automatically by contacts on the main semaphore; the electrical energy being supplied by a battery of low-resistance Leclanché cells.

Repeaters are also used in the cabins for automatically repeating the positions of semaphores which cannot be seen by the signalmen. These repeaters are small electro-magnetic needle instruments which are controlled by contacts on the main semaphore. They give a clear indication of the position of the semaphore.

track. The most extensive installations in this country are on the Metropolitan and London Underground Railways.

Automatic Control of the Trains in Foggy Weather.

Fog is the greatest difficulty with which the operating engineers of a railway have to contend. Semaphores and fixed signals which depend upon visibility for their effectiveness are, of course, valueless. Two alternative methods of signalling in fog are possible: (1) by detonators placed on the track by hand; (2) by

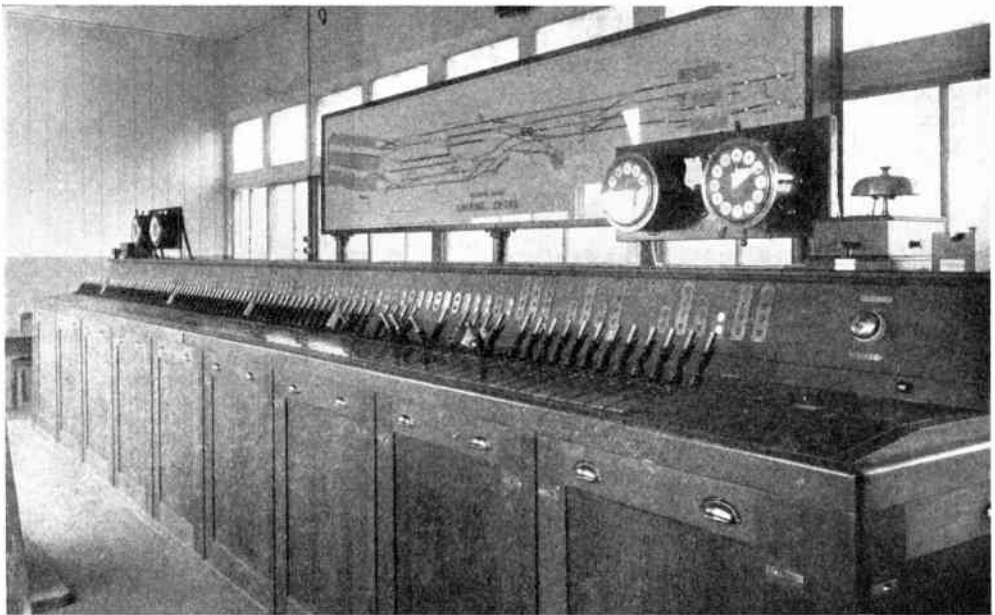

Fig. 5.—SIGNAL CABIN AT CHARING CROSS TERMINUS, SOUTHERN RAILWAY, EQUIPPED WITH 107 LEVERS FOR ELECTRIC COLOUR-LIGHT SIGNALS AND POINTS.

Notice the indicator lamps on the dashboard. These lamps are connected in series with the lamps of the colour-light signals, route indicators, etc., and give the signalman a visual indication of the positions of the signals and points. The signalling bells and push switches are to be seen at the extreme ends of the cabin, and the other (circular) instruments are "train describers." (*Westinghouse Brake and Saxby Signal Co.*)

Automatic Signalling.

This form of signalling, which dispenses with intermediate signal cabins, becomes possible with electricity. The arrangement is somewhat similar to that in track circuit protection, but the relay actuates the signal mechanism. Automatic signalling is essential when a large number of trains per hour have to be run over a given

audible signals in the cab of the locomotive. The first method has many obvious limitations and disadvantages, but the second method (which is an electrical one) possesses the important advantages that: (1) audible signals are given in the cab of the locomotive; (2) it can be arranged to give *automatic control* of the train, i.e., if a signal at "danger" is passed the

brakes will be applied automatically; (3) it is also suitable for normal service. Such a system of automatic cab signalling and train control is now used throughout the main lines of the Great Western Railway.

G.W.R. System of Automatic Train Control.

The equipment comprises: (1) insulated conductor rails or ramps located at intervals along the track and energised through contacts on the "distant" sema-

between the running rails. They are usually located 440 yards in advance of the "distant" signals. Each ramp is connected to an automatic switch via contacts on its associated "distant" semaphore. The automatic switch is actuated by an electro-magnet which is controlled by contacts on the signal lever in the cabin. Thus when this lever is moved to put the "distant" signal in the "off," or "proceed" position, the automatic switch closes (provided that the semaphore has responded correctly)

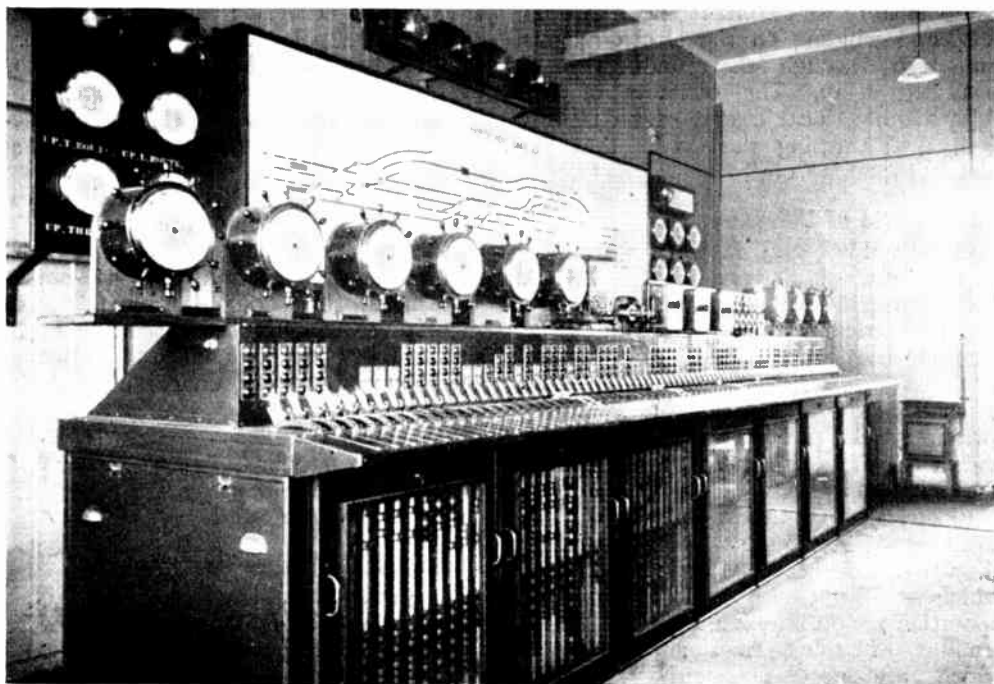

Fig. 6.—LATEST TYPE OF ALL-ELECTRIC SIGNAL CABIN AT NORTH KENT EAST JUNCTION, SOUTHERN RAILWAY.

This cabin has all-electric interlocking, whereas that illustrated in Fig. 5 has mechanical interlocking. It was the first of its kind to be erected anywhere in the world. Similar (larger) cabins are being supplied to Johannesburg and St. Enochs, Glasgow. (*Westinghouse Brake and Saxby Signal Co.*)

phore arm and its associated operating lever in the cabin; (2) a contact shoe and switch carried on the locomotive; (3) an electric bell and an electrically operated combined brake valve and siren in the locomotive cab, with their associated control relays.

The ramps are steel \perp bars, 40 ft. long, and are supported on baulks of timber

and connects one pole of a 16-volt battery to the ramp, the other pole of the battery being earthed.

When the contact shoe on the locomotive is in its lowest position (i.e., the locomotive is not on the ramp) a switch on the locomotive is closed and an electromagnet is energised which maintains the combined brake valve and siren inoperative. But

when the contact shoe is raised by the ramp this switch is opened, and if the ramp is not energised (i.e., the distant signal is in the "on" or "proceed with caution," position) the armature of the electromagnet is released and the brake valve and siren operate. Thus not only is the driver's attention called to the fact that caution is necessary but the brakes on the train are also applied automatically. Means are provided for stopping the application of the brakes if the driver so desires. If, however, the ramp is energised, a circuit is established (via the ramp battery and contact shoe) through a second winding on the electro-magnet and also through the windings of a polarised relay. The contacts of this relay close a local circuit of an electric bell, thus warning the driver that the distant signal is "off."

The Control of Points.

Closely allied, and, in fact, interlinked, with signalling arrangements is the operation and control of points. Here, again, electrical methods are advantageous for important junctions and large termini. The point mechanism is operated by either a small motor or a solenoid. Auxiliary switches make the circuit connections for the interlocking and indicating devices in the signal cabin.

Electrically operated points result in a considerable saving of space in the cabins; they enable cabins to be built in positions which would not be possible with manual operation; they eliminate the large amount of track rodding and levers which are necessary with manually operated points; and they relieve the signalmen from physical exertion. Electrically operated points are now used at several large stations, e.g., London Bridge, Victoria, York, Crewe, Manchester.

For further information on Automatic Railway Signalling, readers are referred to the article which begins on page 754.

THE LIGHTING OF TRAINS.

Electricity is not only the safest, but also the most convenient, form of train lighting. In the event of a collision there is no danger of an electric lighting system causing a fire, but with gas lighting several

disastrous fires have occurred as a result of collisions. Moreover, electric lighting is more convenient than gas lighting: the general lighting can be remote controlled by the guard, and the local lighting in the passenger compartments may be controlled by the passengers.

How the Light is Supplied.

In this country, the energy for train lighting on steam trains is supplied by an axle-driven dynamo working in conjunction with a storage battery. An automatic cut-out is necessary to cut in and cut out the dynamo according to the speed of the train, and a pole-changing switch is also required to provide for change of direction of motion of the train. Moreover, the dynamo must be provided with some device to maintain approximately constant current output and voltage over a wide range of speeds. This takes the form of a slipping belt in conjunction with a constant speed dynamo, or an automatic regulator, in conjunction with an ordinary variable speed dynamo, or a special self-regulating variable speed dynamo. Fig. 7 shows how the dynamo and batteries are mounted on the underframe of the coach.

On some railways abroad the train lighting is supplied by a small self-contained turbo-electric generating plant on the locomotive.

When Headlights are Necessary.

Locomotive headlights are necessary (for the illumination of the track) on railways abroad which run through open country with unfenced track. Such lights are fitted with special electric lamps and reflectors.

ALL-ELECTRIC RESTAURANT CARS.

Restaurant cars with all-electric equipment for cooking, etc., are an innovation on steam railways. They were first introduced on the London and North Eastern Railway in 1924, and are now used on the principal L.N.E.R. expresses. There are many obvious advantages of cooking by electricity on a railway train, but two special points are: (1) the cooler and purer atmosphere in which the chef works and in which the food is prepared; (2) electric-

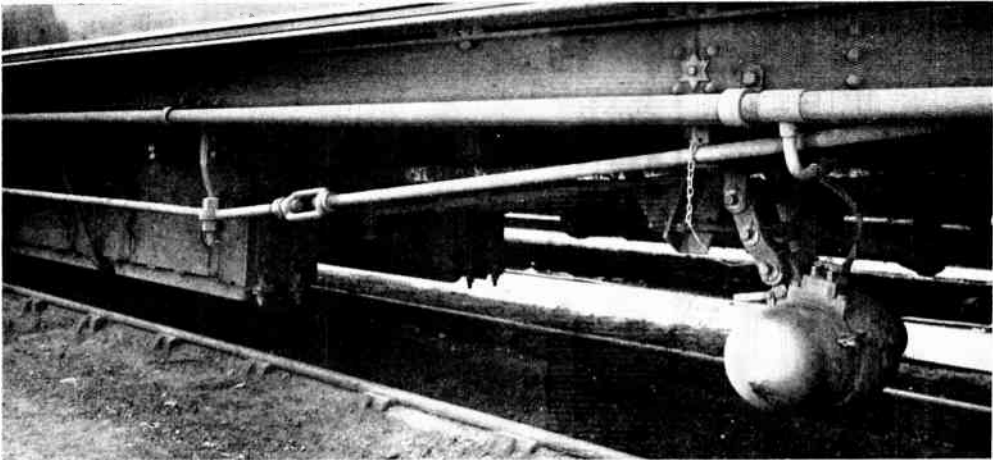

Fig. 7.—TRAIN LIGHTING DYNAMO AND BATTERIES MOUNTED ON UNDERFRAME OF A RAILWAY COACH.

The dynamo is driven by a belt and the suspension is designed so that the belt slips when the torque exceeds a predetermined value. In this manner the output and voltage of the dynamo are maintained constant with varying train speeds. This slipping-belt method of regulation is a special feature of Stone's system of train lighting. (*J. Stone and Co., Deptford.*)

ally cooked food is more palatable and more nutritious than food cooked by other methods (oil or gas).

The L.N.E.R. System.

The car-sets are of the articulated type (the design being due to Mr. H. N. Gresley, chief mechanical engineer) whereby three vehicles are carried on four bogies. Each car-set weighs 83 tons completely equipped and 78 passengers can be served at one sitting.

The electrical energy for cooking is supplied by two axle-driven dynamos (each 7.2 kw.) working in conjunction with a storage battery, this plant being similar (but of larger size) to that used for train lighting. The voltage is about 200.

The Electric Kitchen.

The electric kitchen is equipped with a cooking range (with 6 hot plates), roasting oven, steaming oven, grill and hot-water tank. Two urns and two 6-pint electric kettles are provided for teas, and an electrically heated cupboard is fitted in the serving hatch. Views of the kitchen are shown in Figs. 8 and 9.

The kitchen and dining compartments are ventilated by electric fans.

HEATING THE TRAINS.

The heating of steam-propelled trains, when necessary, is usually effected by steam-heated pipes supplied through a reducing valve. Such a system is liable to give trouble in cold weather due to the pipes and valves becoming frozen when the trains are standing overnight in open sidings. A far better, more convenient, and less wasteful system would be the provision of electric heaters in the passenger compartments (as in electric trains) and the installation of a small self-contained turbo-electric generating set, either on the locomotive or preferably in an adjoining luggage van coupled to the locomotive. Alternatively, the electric heaters could be supplied from axle-driven dynamos.

LIGHT ON THE PLATFORMS.

Electricity is the best illuminant for station lighting, as not only can adequate illumination be easily obtained, but decorative lighting, illuminated platform signs and train destination indicators become possible. Moreover, a well and attractively lit station promotes the goodwill of the passengers and induces people to travel on the railway.

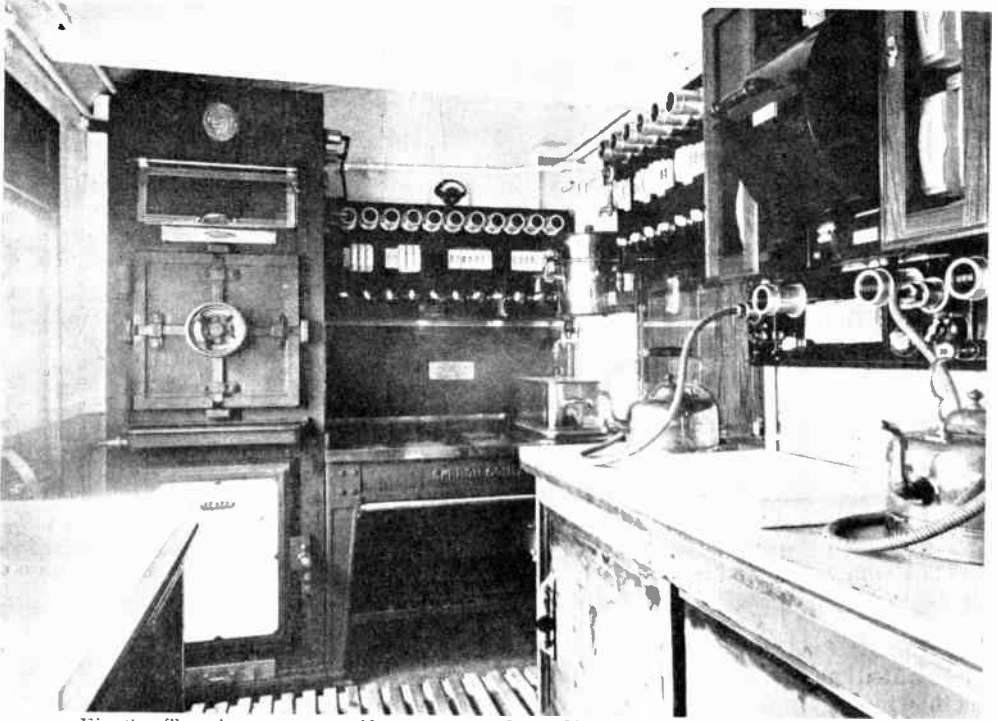

Fig. 8.—THE ALL-ELECTRIC KITCHEN OF A L. & N. E. RAILWAY RESTAURANT CAR.

This view shows the electric baking and steaming ovens and hotplates, with control panel above. The main control switchboard is on the right. (Courtesy of L. & N. E. Railway.)

ELECTRICITY IN WORKSHOP AND WAREHOUSE.

Electricity is now used for the handling of merchandise in warehouses where formerly hydraulic power was used. Large warehouses and goods stations require cranes and capstans, in addition to a good system of lighting which is immune from fire risk.

Docks require power for cranes, capstans and, in some cases, pumps. These services are best operated electrically. Electric lighting is obviously the only satisfactory system in this case. In locomotive and carriage works electric motors are used for driving the machine tools, cranes, etc.; and electricity is used for lighting.

TRACK REPAIRS AT NIGHT.

Night lighting for constructional work and track repairs has hitherto been provided by portable acetylene flares, but a much more satisfactory method is to use a number of electric floodlight projectors,

mounted on poles or tripods, and supplied by a portable generating plant (petrol-driven). With such a plant, better illumination is obtained than with the older method; consequently, the work will be done quicker and better, and there will be fewer accidents.

Removing Flood Water.

Pumping plants for removing flood water and for supplying storage tanks can, with advantage, be driven electrically, as fully automatic control (i.e., starting and stopping) is possible. This system possesses so many advantages over other systems that, in country districts, the erection of an electric transmission line from the nearest town or source of electric supply would be justified. Such a system is in actual use on railways abroad, and has replaced steam- and oil-driven plants.

THE ADVANTAGES OF ELECTRIC TRACTION.

The use of electricity for propulsion on

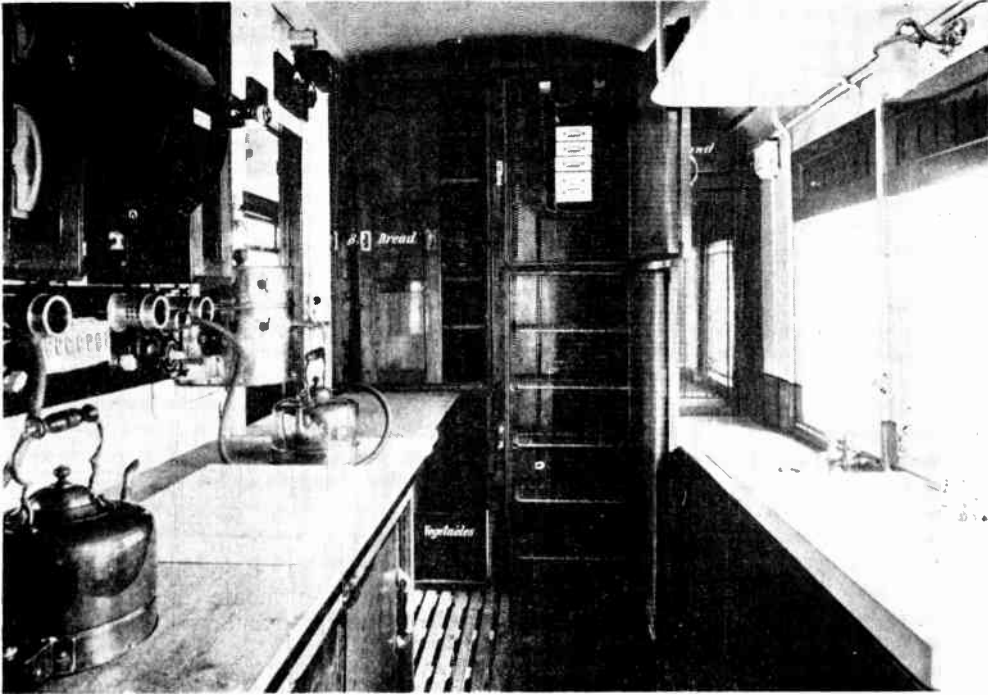

Fig. 9.—ANOTHER VIEW OF THE ALL-ELECTRIC KITCHEN OF A L. & N. E. RAILWAY RESTAURANT CAR.

This view shows the hot cupboard, storage cupboards and serving hatch. Also the main control switchboard, with auxiliary panel for electric kettles, urn, etc.

NOTE.—The electrical equipment is due to Messrs. J. Stone and Co., Deptford.

main lines eliminates smoke and enables train journeys to be made in comfort, cleanliness and ideal conditions. Moreover, the operating conditions in long tunnels are rendered safe owing to the better visibility, the freedom from sulphurous and obnoxious fumes, and the prevention of slippery rails due to the condensation of large volumes of steam in the tunnel. Again, underground and tube railways are only practicable with electric traction.

Electric traction possesses important advantages for terminal stations in large cities, as not only is the objectionable smoke nuisance eliminated, but the space *above* the tracks and platforms may be utilised for hotels, offices, etc. Such utilisation has actually been made in two of the largest railway termini in New York. In one case, viz., the Grand Central Station (which was originally built for steam trains), the original open space above the tracks and platforms was, at the

completion of electrification, built over to accommodate a large hotel. In the other case, viz., the Pennsylvania terminus, similar accommodation was provided, but as this terminus was built for electric traction, the whole of the tracks, platforms and superstructure was designed for the dual purpose. The site values of such buildings in large cities is very considerable, and the revenue obtained therefrom forms a valuable item on the credit side of the railway's accounts.

Mountain Railways.

In mountainous districts higher speeds and increased safety are possible with electric traction, as the electrical equipment of the locomotives may be used instead of the wheel brakes for controlling the speed of trains descending the gradients. Thus one of the greatest hazards in railway operation over mountain grades (viz., the overheating of the wheel brakes and tyres)

is removed. Moreover, the electrical energy generated during braking may be returned to the distribution system and utilised by trains on ascending gradients. The first such electric system with regenerative braking on a large scale was installed a number of years ago on the Giovi-Genoa lines of the Italian State Railways, owing to serious accidents with steam-hauled trains on the steep gradients. With electric traction the freight capacity of the lines has been trebled and considerable savings have been effected in the maintenance of wheel brakes, tyres and track rails. Needless to say, accidents are now unknown.

A further important advantage of electric traction on mountain railways is that the electrical equipment is not put out of commission by severe weather conditions. Thus the train service can be maintained during the severest winter. On the other hand, with steam traction it is very difficult to run the service in severe weather.

Other outstanding electrifications of mountain railways are now to be found all over the world, viz., in the United States of America, South America, South Africa,

India, New Zealand, Japan, France, Switzerland, Austria, Spain, Sweden.

Suburban Railways.

The traffic conditions on these railways are totally different from those on main-line railways. Large numbers of passengers must be handled during a relatively short time in the morning and evening, and relatively few passengers during the remainder of the day. The trains must stop at a number of stations which are, in many cases, only about a mile apart.

These conditions require rapid acceleration and short stops at the stations. They are difficult to meet with steam traction, but can be met easily with electric traction.

Again, with electric traction the congestion at the suburban terminal stations is much smaller than that with steam traction, as in the former case no locomotives are necessary (multiple unit trains being used) and, therefore, fewer signal and train movements are involved in getting trains into and out of the terminus.

Special thanks are due to the manufacturers and railway companies mentioned in the text for affording facilities and information relating to their manufactures and practice.

DOES A PHOTO-ELECTRIC CELL GENERATE CURRENT?

MANY electrical engineers are under the impression that a photo-electric cell generates minute currents. Actually, this is not so.

Although the action of the photo-electric cell is different from that of the selenium cell, the effect of light on both is to cause a change of resistance. In the latter case, the action of light causes molecular activity in a similar way to the action of heat on most elements, resulting in a change in electrical resistance.

The action of the photo-electric cell is similar to that of a thermionic diode or two electrode valve. In both cases, when subject to a polarising voltage, or an external E.M.F. is applied across the anode and cathode, *the amount of current*

or the electron flow from cathode to anode is dependent on the condition of the cathode.

In the case of the photo-electric cell it is dependent on the amount of light falling on the cathode, and in the case of the diode, it is dependent on the temperature of the cathode. This is tantamount to saying that the impedance or resistance is dependent on the amount of light falling on the cathode in the case of the photo-electric cell, and on the temperature of the cathode in the case of the diode.

It must be clearly understood that neither in the case of the photo-electric cell nor the diode are electric currents generated.

FACTORY LIGHTING

By E. H. FREEMAN, M.I.E.E.

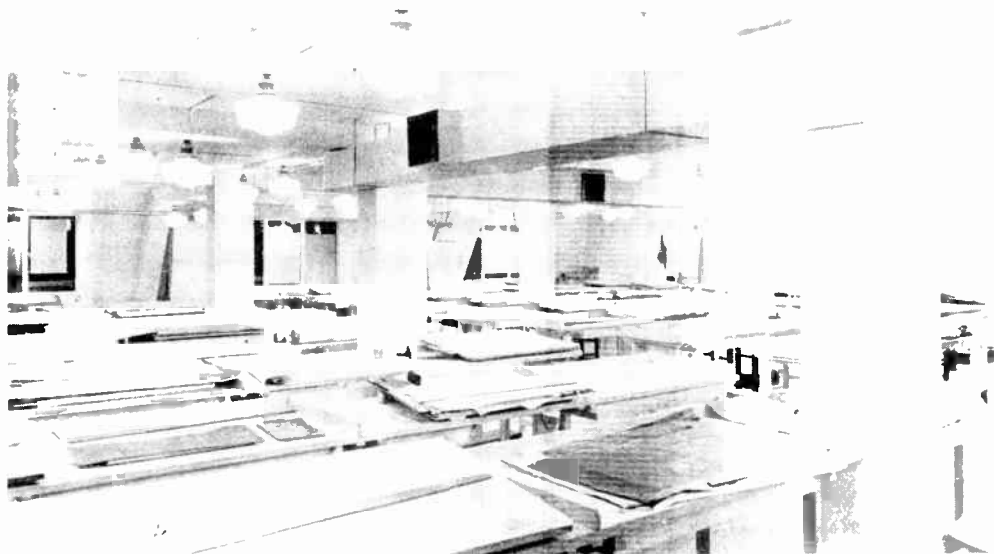

Fig. 1. —A DRAWING OFFICE IN A FACTORY LIT BY ENCLOSED UNITS. (E.L.M.A.)
The illumination in a drawing office should be about 30 candle feet.

THE design of a lighting scheme for a factory building calls for much more accurate calculation than is possible with many other classes of building. It has been noted in earlier articles that in domestic installations, in churches and in other classes of work, the design must be subject to the personal views of the owners or occupiers and that wide margins must be made in all calculations to meet their wishes. Such considerations rarely apply in factory design. The decorative treatment will be of the simplest character and will almost certainly include white or very light-coloured walls and ceilings as the factory owner will appreciate their reflective values, both for artificial light and day

light. No problems of spacing to suit decorative ceilings will arise beyond the practical aspect of finding convenient points of support. There will also be no need to consider alternative schemes such as whether pendants or brackets are preferred.

The whole scheme must be primarily economical in first cost and efficiency in working and accurate design is, therefore, not only possible, but essential.

Intensity of Illumination Required.

As in other examples, the first point to be decided is the intensity of illumination required and this depends on the kind of work to be carried out. In an earlier article (see page 565) typical intensities

were given for various factories, and these can be used as a guide. Some parts of the work to be done may need local lighting and this is desirable where very accurate work is being carried out in a limited area. It is not worth while designing the scheme for a high intensity of illumination over a wide area when the work is all carried out in one small area on a work bench or at a lathe or other machine tool.

The problems to be solved can again best be explained by working out the full details for an imaginary building such as the engineering factory shown on the drawing (see Fig. 2).

General Description of Plan.

The building shown in Fig. 2 consists of a main factory area made up of three main bays, each 24 ft. wide by 120 ft. long, with a north light roof, with supporting columns between the bays 20 ft. apart and with tie rods at 10 ft. intervals, these being 14 ft. up from ground level. These dimensions can all be scaled off the plan.

There is an added side bay on the north side, 24 ft. wide, divided up into offices, stores, etc., and a similar bay on the south side divided up into mess rooms, kitchen, lavatories, etc.

Of the factory bays, that on the right has a crane running the full length and carried on rails as high as possible, whilst the other two bays have no crane. The two side bays have the roof ceiled off so that though there is an ordinary roof construction the areas are mainly provided with flat ceilings.

Use of Factory.

The detailed planning of the various machine tools, benches, etc., should be arranged as far as possible before the lighting scheme is designed, and for the purposes of the installation, the following may be taken as a convenient layout.

MAIN AREA.

South Bay—Heavy tools not requiring local lights except for a few benches on the south wall.

Centre Bay—General assembly of parts—carried out all over area and requiring good lighting throughout.

North Bay—Benches throughout area requiring good lighting also.

DESIGN FOR SOUTH BAY.

For heavy tool work an intensity of 6 to 8 ft. candles should be suitable. The area of the shop is 24 ft. \times 120 ft., or 2,880 sq. ft. The total nett lumens required will, therefore, be 2,880 \times say 7, or 20,160.

Working Height.

The working height is decided by the fact that the lamps must be above the tie rods, but not much above them, as otherwise the tie rods will cast shadows. As the tie rods are 14 ft. up, the lamps can be 15 ft. from ground level or, say, 13 ft. above the work, which with heavy plant might be only 2 ft. above the ground.

Distance Apart of Lighting Units.

Reckoning on the use of a suitable form of dispersive reflector, the lighting units should be fixed so that their distance apart is about $1\frac{1}{2}$ to $1\frac{3}{4}$ times the working height—i.e., at about 19 ft. to 23 ft. The bays are 24 ft. wide and, as no special work is being carried out at the sides except where local lights are in use, slight unevenness in the lighting will not be important. It will thus be satisfactory to use only a single row of lamps down the centre and if one is fixed in each alternate span, the lamps will be 20 ft. apart in this direction, which will be quite satisfactory. Six lamps will thus be sufficient for this bay. The lamps might be raised slightly if the lighting is not found to be sufficiently even.

If it is desired to ensure more even lighting, brackets might be added, fixed to the stanchions.

Lumens per Fitting.

It was calculated earlier that 20,160 nett lumens would be required and to this must be added an allowance for losses in the reflectors, etc. In a factory a thoroughly efficient type will be installed and will presumably be properly maintained so that an efficiency of 60 per cent. should be obtainable. The actual lumens per fitting will therefore be:—

$$\frac{20160}{6} \times \frac{100}{60} = 5600 \text{ lumens per fitting.}$$

Reference to a lamp table will show that 500-watt lamps give 7,500 lumens and these should be used as the size smaller gives only 4,140 lumens, which is too small.

The lighting of the bay will be completed by the addition of brackets over the side benches and these should be wired for 60-watt lamps and spaced 6 to 8 ft. apart.

Crane Lighting.

A very convenient additional light can also be obtained by suspending two or three fittings below the crane. These will give a specially good light where it is often required and will obviate the difficulties that arise if the crane is in use directly below one of the main lighting units. Such lights on cranes cannot as a rule be connected to the lighting system as this would involve an extra trolley line and collector for the crane traveller. They must be connected two or three in series on the power wiring at 400 volts—which means special care in wiring and the use of suitable switches, etc.—and need not be considered in the lighting system.

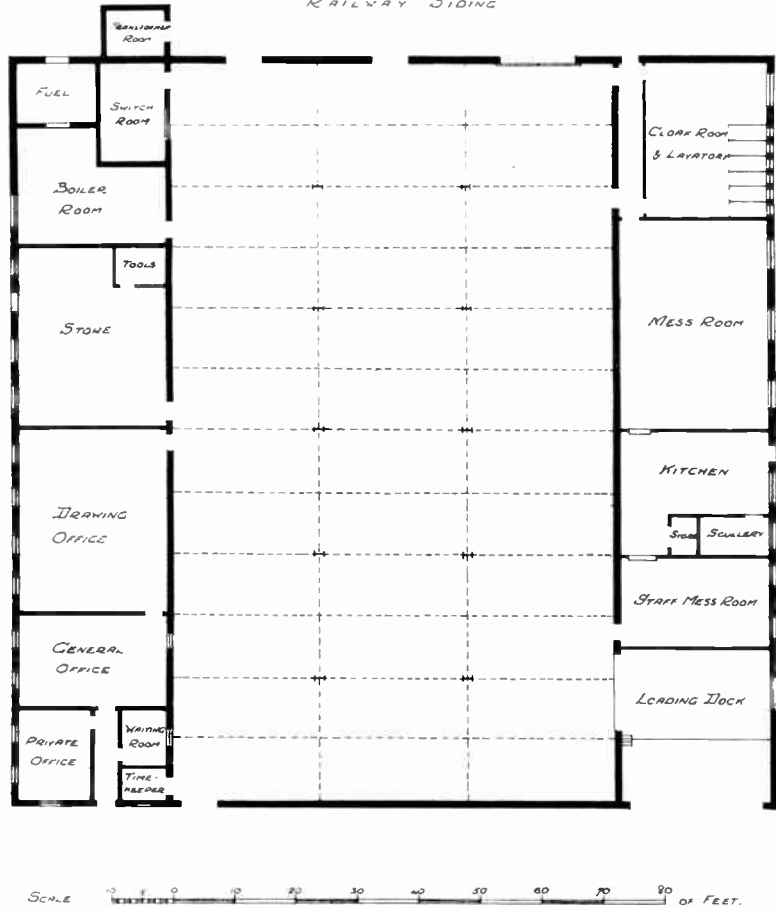
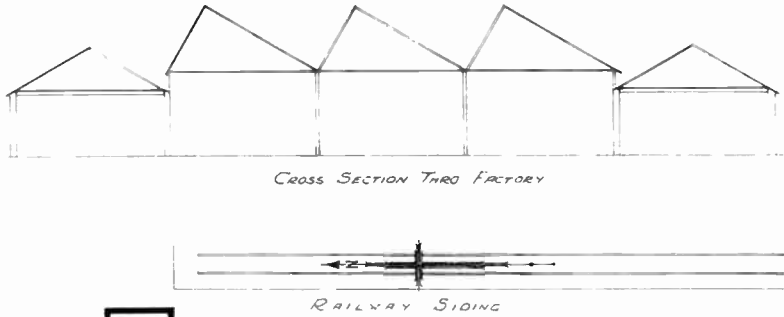

Fig. 2.—LAYOUT OF AN IMAGINARY ENGINEERING FACTORY. Suitable lighting for a factory such as this is described in the article

Wall Plugs.

It would be advisable to provide wall plugs for special work at convenient intervals, and one on each stanchion would be a suitable allowance.

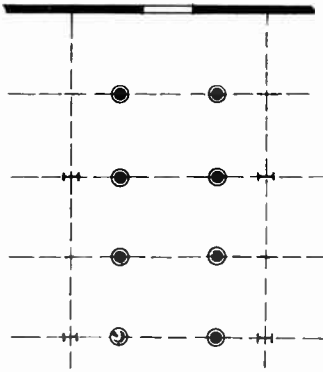

Fig. 3.—DESIGN FOR CENTRAL BAY (1).
Showing two fittings on each tie bar.

DESIGN FOR CENTRAL BAY.

As for the south bay, the area is 2,880 sq. ft., but the class of work to be done, viz., small assembly work, requires a higher intensity and more even lighting. From the earlier examples we can assume that about 10 to 12 ft. candles should be provided, necessitating a total of 34,500 nett lumens, or allowing for 60 per cent. efficiency in the fittings,

$$34,500 \times \frac{100}{60} = 57,600 \text{ lumens}$$

from all the lamps.

In this case it will be possible to fix the fittings on the tie bars and this will be convenient for cleaning fittings and changing lamps. If this is done, the working height with benches at 3 ft. from the floor will be 14 ft. less 3 ft. up to bench, and less 1 ft. from the bar to lamp, or say, 10 ft. The spacing for even lighting should thus be about $1\frac{1}{2} \times 10$ ft. or about 15 ft., and a little more or less than this will not matter.

Alternative Schemes—Lights on Tie Bars.

Various schemes can then be tried out:—

- (A) Two fittings on each tie bar—spacing 10 ft. in one direction and 12 ft. in the other. Lights unnecessarily close. (Fig. 3.)
- (B) Two fittings on alternate tie bars—spacing 20 ft. in one direction and 12 ft. in the other, i.e., too far apart in one direction and too close in the other. (Fig. 4.)
- (C) Two fittings on first tie bar and one on second and so on alternately.

This will give 20 ft. spacing along the shop, but only 12 ft. across and 12 ft. diagonally and will probably be the best solution (Fig. 5).

Areas near the stanchions will not be quite so well lit as the main part of the shop, but the difference should not be serious. With this layout the number of fittings will be 17 and the lumens required per lamp will be 3,950 so that 300 watt lamps giving 4,140 lumens will be suitable.

DESIGN FOR NORTH BAY.

In the north bay conditions are slightly different in that benches and tools are to be used along the north side with local lighting. The general lighting can be confined to a reduced width by, say, 3 ft. of bench and 3 ft. of gangway. The area to be lit is thus reduced to 120 ft. \times 18 ft. or 2,160 sq. ft., and with 12 candle ft., as the illumination required, the nett lumens will be 25,920 and the gross lamp output

$$25,920 \times \frac{100}{60} \text{ or } 43,200 \text{ lumens.}$$

The working height will be 10 ft. and the spacing about 15 ft., as in the centre bay.

Satisfactory results would be obtained with two rows of lights fixed to alternate tie bars with spacing about 11 ft. across the shop, 20 ft. along and about 15 ft. diagonally.

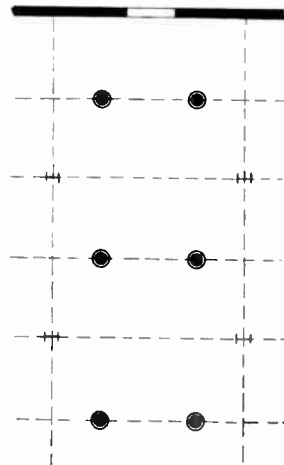

Fig. 4.—DESIGN FOR CENTRAL BAY (2).
Showing two fittings on alternate tie bars.

The number of lamps will be 11 and the lumens required

$$43,200 \times \frac{1}{11} \text{ or } 3,930$$

so that 300 watt lamps giving 4,140 lumens must again be used. (See Fig. 7.)

DESIGN FOR COMBINED BAYS.

It would probably be satisfactory to treat these two bays as one combined area. This must depend on whether they are divided by walls or partitions. This would not be the case as a rule, and it will be found that this will allow further alternatives.

The area will now be 120 ft. \times 48 or 5,760 sq. ft. Allowing 12 candle ft. and 60 per cent. efficiency as before, the total lamp lumens will be

$$5,760 \times 12 \times \frac{100}{60} = 115,200 \text{ lumens.}$$

The double width now allows a further alternative, with lights on the tie bars alternately 3, 2, 3, 2, as shown in Fig. 8.

With this layout the spacing will be 16 ft. across the shop, 20 ft. along the shop and 13 ft. diagonally—all rather high for even lighting. A better scheme would be four and three fittings alternately on the tie bars as in Fig. 9.

Spacing.

The spacing with this layout will be 12 ft. across the shop, 20 ft. long and about 12 ft. diagonally, and this should give very satisfactory results. The extra lamp in the centre between the bays overcome the previous defect of darker areas near the stanchions.

The total number of fittings for the two combined bays will be 38, so that each lamp should give

$$115,200 \times \frac{1}{38} \text{ or } 3,000 \text{ lumens.}$$

The nearest size larger is the 300-watt lamp, giving 4,140 lumens, or nearly 40 per cent. too much, whilst the next smaller lamps—200-watt—give 2,600 lumens or about 10 per cent. below what is desired. This should be large enough and the resulting illumination will be about 10 per cent. below the assumed figure of 12 candle ft. or say, 11 candle ft.

Wall plugs on the stanchions should be

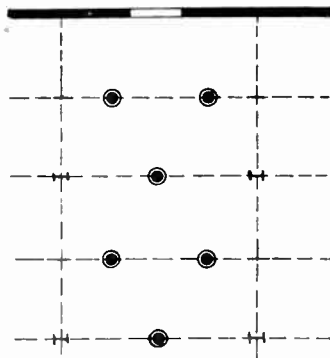

Fig. 5. —DESIGN FOR CENTRAL BAY (3).
Showing two fittings on first tie bar and one on second, and so on alternately.

provided as suggested for the south bay—with two plugs on the central stanchions, i.e., one for each bay.

DESIGN FOR SOUTH SIDE EXTRA BAY.

This is divided up into various service rooms and for none of them is very accurate illumination design necessary.

Cloaks.

Lighting in the cloak room and lavatories will depend on the views of the factory manager. Four large general lights of 100 watts each will do all that is necessary as the hat and coat racks will not be more than 6 ft. high and partitions between w.c.'s probably the same. If better lighting is desired, the scheme in Fig. 10 can be used and this would certainly be a better scheme, its only disadvantage being the higher cost.

Mess Room.

The area is about 35 ft. \times 24 ft. and if lamps are allowed at the rate of about 1 watt per sq. ft., it will be found sufficiently accurate for such a room. The lamps could conveniently be located opposite the windows and 6 lamps, each 150 watt will give sufficiently good illumination, though wiring might be with advantage arranged for 200-watt lamps.

Stores and Scullery.

One light in each of these will be sufficient.

Kitchen.

Lamps would be located to suit the furnishing, with good central lighting



Fig. 6.—LIGHTING SCHEME FOR LARGE FACTORY WITH CENTRAL LIGHTS ABOVE CRANE. (E.L.M.A.)
In this case the central lighting has been supplemented by brackets fitted to the side stanchions to give additional general lighting.

for the table and other lamps near the range, servery, etc.

Staff Mess Room.

Lighting may depend on furnishing, but probably two lamps will be sufficient.

Loading Dock.

Two lamps in the loading dock and two brackets outside should be provided as there is space for two lorries. Each will then have its own lighting—inside for sorting out the goods and outside over the lorry for packing, etc.

DESIGN FOR NORTH SIDE EXTRA BAY.

Transformer Chamber and Switch Room.

One lamp in each and a plug for a portable lamp will be suitable. The plugs and perhaps the pendants as well might with advantage be connected to a special switch and fuses connected direct to the bus bars and independent of the main lighting switchboard, which can then be cut off for repairs, etc., without cutting off the lights in these rooms.

Boiler House.

Lamps must be fixed to suit the boilers. Very little light will be required above the boilers and if lamps are placed to suit the stoking they will give enough light elsewhere. One or two plugs will be desirable and an extra lamp may be required above the pumps, if any.

Store.

The lighting of this must depend on the arrangement of the racks and bins, etc. Probably part of the area would be left as open floor space for unpacking goods, etc., and the remainder be occupied by rows of shelving or bins. The open area will require lighting to about 6 ft. candles and the bins must be lit by small lamps at about 10 ft. spacing. The arrangement shown in Fig. 11 would be suitable.

Drawing Office.

This must be by far the best lit area of the building and for really good lighting suitable for a drawing office the illumination should be about 30 candle ft.

The area is 24 ft. x 30 ft. or 720 sq. ft., so that the nett lumens required will be

21,600 and the lamp lumens about 40,000—allowing 50 per cent. efficiency only, as the fittings should preferably be of an enclosed type to avoid all risk of direct glare.

The office being ceiled in the height will be slightly less than that of the tie bars or, say, 10 ft. Uniformity of lighting and absence of shadow is also most important, so that fittings should be decidedly closer than standard. The working height will be, with lamps 1 ft. down and with a 3 ft. desk, about 6 ft. and lamps spacing should be reduced to 7 ft. 6 in. or 8 ft.

This will be attained with three rows of four lamps, which will give 8 ft. spacing from north to south, and 7 ft. 6 in. from east to west. (Fig. 12.)

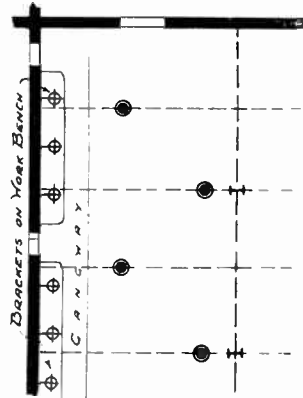

Fig. 7.—SUITABLE DESIGN FOR NORTH BAY.

For a total lamp output of 40,000 lumens and with 12 lighting units, each lamp

must give $40,000 \times \frac{1}{12}$, or 3,333 lumens

and it would be advisable to allow for 300-watt lamps giving 4,140 lumens. This will be about 25 per cent. more than necessary, but it will be easy to use smaller lamps in whole or in part if the class of work being done justifies this. If 200-watt lamps are allowed for, the illumination would be 20 per cent. down and this might not be sufficient for close work.

General Office.

The general office is only comparatively

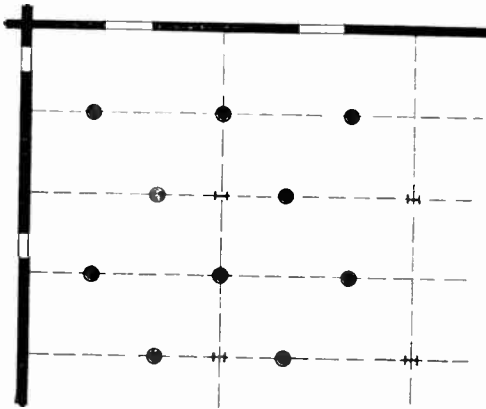

Fig. 8.—DESIGN FOR COMBINED BAYS (1). Showing lights on tie bars arranged alternately 3, 2, 3, 2.

small and does not call for special designing. Two alternatives are available — one with general lighting to give good illumination over the whole floor area, and the other with a few local lamps for individual desks — or the two schemes might be combined by providing reduced general lighting with local lights as required. This would, in such an office, probably be the best, as typists will certainly prefer local lights. These might also be best for desks along the windows. The disadvantage is, of course, the necessity of retaining the desks in the exact positions originally arranged or making alterations from time to time if these require to be moved.

The alternatives will be: —

- (1) *General Lighting only.*—Four lamps as in Fig. 13, each 100 watt.
- (2) *Local Lighting only.*—Six or eight lamps as in Fig. 14, each 40 60 watt.
- (3) *Combined Scheme.*—One central lamp for general lighting in central area with, say, six local lamps for desks.

Manager's Office.

A single central fitting and a plug for desk lamp will be suitable.

Timekeeper, Waiting Room, Entrance Lobby and Corridor.

A single lamp for each of these will be all that is required.

Lighting Schedule.

Having thus completed the calculations for all areas of the factory building, a detailed schedule of the lamps can be prepared preliminary to the design of the cables, fuse boards, etc.

Area.	Type of Fitting.	No. of Fittings.	Watts per Lamp.	Total Watts.
SOUTH EXTRA BAY.				
Cloaks	Pendants	15	40	600
Mess room	Pendants	6	150	900
Kitchen	Pendants	4	60	240
Scullery	Pendants	1	40	40
Store	Pendants	1	40	40
Staff mess room	Pendants	2	100	200
Loading dock	Pendants	2	100	200
	Brackets	2	100	200
SOUTH MAIN BAY.				
General lighting	Pendants	6	500	3,000
South wall benches	Brackets	10	60	600
On stanchions	Plugs	5	60	300
East Door	Bracket	1	100	100
CENTRAL AND NORTH BAYS.				
General lighting	Pendants	38	200	7,600
North wall benches	Brackets	12	60	720
On stanchions	Plugs	15	60	900
East Doors	Brackets	2	200	400
NORTH EXTRA BAY.				
Transformer room	Pendant	1	60	60
	Plug	1	40	40
Switch room	Pendant	1	60	60
	Plug	1	40	40
Boilers	Pendants	3	60	180
	Plugs	2	40	80
Tool store	Pendant	1	60	60
Store				
Tools	Pendant	1	60	60
Between bins	Pendants	7	40	280
Open area	Pendant	1	100	100
Desk	Pendant	1	60	60
Drawing office	Pendants	12	300	3,600
General office	Centre pendant	1	150	150
	Local pendants	6	60	360
Manager	Centre pendant	1	100	100
	Plug	1	60	60
Waiting room	Pendant	1	60	60
Time-keeper	Pendant	1	60	60
Lobby	Pendant	1	40	40
Corridor	Pendant	1	40	40

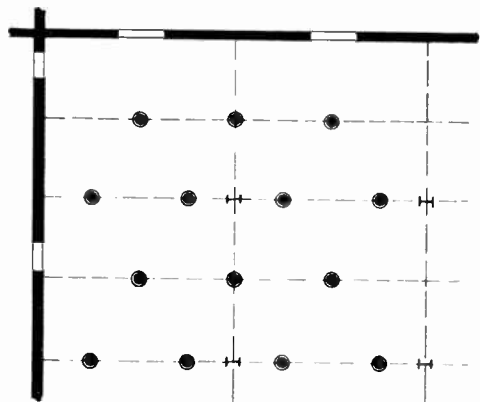

Fig. 9.—DESIGN FOR COMBINED BAYS (2).

This is a better scheme than that in Fig. 8, and shows four and three fittings alternately on tie bars.

Siding and Roadways.

Lighting will be required for the railway siding and an outside bracket with a 100-watt lamp above each door should be provided.

An outside lamp would also be required by the office entrance. Other road lamps may be necessary, depending on the other approaches to the factory, but these need not be included in this scheme.

Distribution System.

Having thus completed the illumination scheme the details of the distribution scheme—main switches, cables and fuse boards—can be worked out.

The supply is taken from the transformer, and the cables from here to the switchboard will deal with the total load for power, heating and lighting, and need not concern us.

Separate lighting switchgear would be provided on the main switchboard, and it can be assumed that the load must be balanced on a 230/400-volt 3-phase system.

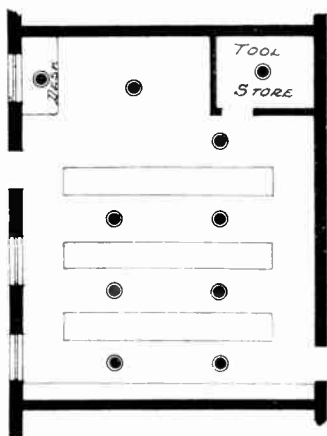

Fig. 11.—SUITABLE DESIGN FOR STORE ROOM IN NORTH SIDE EXTRA BAY.

This makes it necessary to divide it up into three more or less equal parts and the total loads for the various factory areas must be ascertained. They work out :—

- South Extra Bay—
2,420 watts or about 10.5 amps.
- South Main Bay—
4,000 watts or about 17.5 amps.

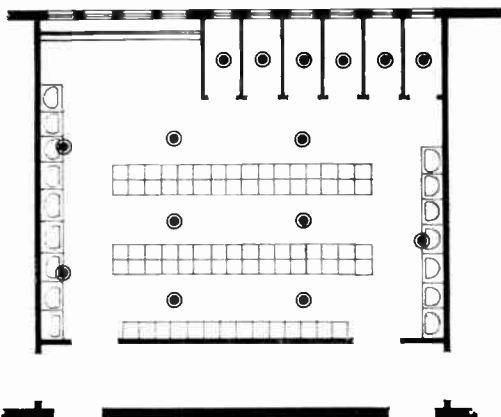

Fig. 10.—SUITABLE DESIGN FOR CLOAK ROOM IN SOUTH SIDE EXTRA BAY.

- Central and North Bays—
9,420 watts or about 42 amps.
- North Extra Bay—
5,490 watts or about 24 amps.

It is probable that the supply company will consider the balancing sufficiently accurate if we arrange the loading :

- Phase A—
South Extra and Main Bays, Total 28 amps.
- Phase B—
Central and North Bays . . . Total 42 amps.
- Phase C—
North Extra Bay Total 42 amps.

This is not at all a satisfactory balance, but as there will be a substantial motor load the scheme should be acceptable to the supply company.

Any closer balance would involve having two phases in close proximity and this would certainly be undesirable. To avoid this a small alteration must be made by transferring the plugs on the stanchions between the centre and south bays from phase B to phase A. This will avoid having plugs on two phases close together and will also slightly improve the balancing of the load.

Main Switches.

The main switches should deal with the total load as in a factory, a 100 per cent. load may easily be obtained. These will therefore be :—

- Phase A 30 amps.
- Phase B 60 amps.
- Phase C 30 amps.

These sizes are the nearest standards

larger than the actual loads and will in each case leave a margin for possible future extensions.

Main Cables.

Before deciding these the positions of the fuse boards must be decided. Those for the south extra bay and the three main factory bays can quite well be at the

For Phase A—	7/.044 or .01 sq. inch	.. Maximum load	31 amps.
For Phase B—	7/.064 or .0225 sq. inch	.. Maximum load	46 amps.
For Phase C—	7/.036 or .097 sq. inch	.. Maximum load	24 amps.

Of these the first two allow a small margin, but the third gives no margin at all, and it would be as well to increase this cable at least to the size larger (7/.044).

Voltage Drop.

The sizes must next be checked for voltage drop. The total drop from switch-board to any lamp must not exceed 3 per cent. +1 volt, or with a 230-volt supply, 7.9 volts. Contacts at main and sub-switches, in fuse boards, and in the fittings will probably account for from ¼ to ½ volt, so that the maximum drop on the whole of the wiring should not exceed 7½ volts. In very large installations careful calculation is required to decide how best to divide this allowance of 7½ volts between the mains and the circuit wiring. With circuits of widely differing lengths and loads it may be found advisable to run a few circuits with very large cables and to absorb most of the volts drop on the mains, as the shorter circuits will in any case not show more than a small voltage drop. The present scheme is not large enough to justify this and more approximate calculations will be sufficiently accurate.

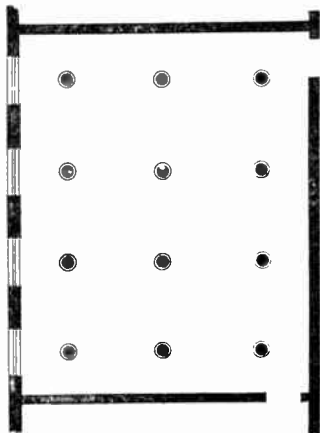

Fig. 12.—DESIGN FOR DRAWING OFFICE. (See also Fig. 1)

east end of the bays. To a certain extent this is decided by the best position for switches, as it will usually be found economical in first cost and convenient for operation to have the switches near the boards.

For the north extra bay, on the other hand, the board would be most conveniently placed in the offices, and as there might be objections to having it in the drawing office, involving the maintenance staff having access to this room, it will be best to arrange for the fuse board to be fixed near the west end. The corridor or the time-keeper's office would be a convenient position.

Having decided these positions the sizes of the main cables can be calculated. The minimum sizes possible to avoid overloading the cables, as in the I.E.E. Rules, would be:—

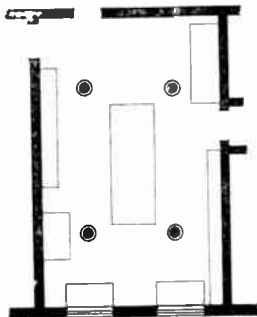

Fig. 13.—DESIGN FOR GENERAL LIGHTING IN THE GENERAL OFFICE.

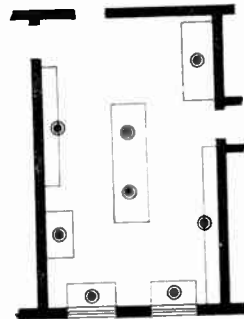

Fig. 14.—DESIGN FOR LOCAL LIGHTING ONLY IN GENERAL OFFICE.

Voltage Drop on Sub-circuits.

As an example, the circuits in the central and northern bays can be arranged with each row of lights on one circuit, i.e., either 5 or 6 lamps of 200 watts on a circuit. Taking a row of 6 lamps the load will be 1,200 watts or 5.2 amperes. The length of run from the fuse board will be, including the vertical runs from the fuse board and down to the switches, about 170 ft., but the load will be gradually reduced as the lamps are connected, being only 200 watts or under 1 ampere for the last 20 ft. The voltage drop on such a circuit at the last lamp will be, with sufficient accuracy, the same as if all the load were

Voltage Drop on Mains.

Calculations similar to the above can now be made on each of the main cables.

Phase A—

Length of main	..	100 ft.
Load	..	28 amps.
Proposed cable size	..	7'.044 (.01 sq. in.)
Length of cable for	}	39 ft. at Maximum
1 volt drop		

Voltage drop = $\frac{100 \text{ ft.}}{39 \text{ ft.}} \times \frac{28 \text{ amps.}}{31 \text{ amps.}} = 2.5 \text{ volts.}$

This is therefore quite satisfactory.

Phase B—

Length of main	..	10 ft.
Load	..	42 amps.
Proposed cable size	..	7'.094
Length of cable for	}	55 ft. at Maximum
1 volt drop		

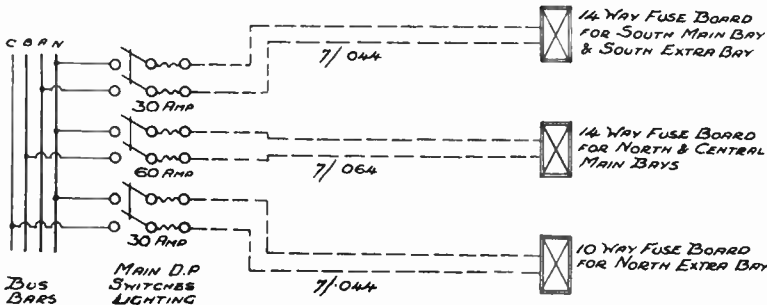

Fig. 15.—DIAGRAM SHOWING CONNECTIONS OF MAIN D.P. SWITCHES FOR LIGHTING, AND FUSE BOARDS.

concentrated halfway between the first and last lamp, and on this basis the effective length of the circuit will be about 120 ft.

Reference to I.E.E. tables will show that 3'.029 conductors loaded up to their maximum allowance of 7.8 amperes will give 1 volt drop for every 31 ft. of cable. The drop will vary inversely with the current and directly with the length of cable, so that with 120 ft. run and 5.2 amps., the actual drop on the circuit will be:—

$$1 \text{ volt} \times \frac{120 \text{ ft.}}{31 \text{ ft.}} \times \frac{5.2 \text{ amps.}}{7.8 \text{ amps.}} = 2.6 \text{ volts.}$$

Other sub-circuits can similarly be calculated, but taking this as typical, the voltage drop on the main cables that is permissible, if the total drop is not to exceed the I.E.E. allowance, is:—

7.9 volts total — 2.6 volts on sub-circuit = 5.3 volts, and this must be further reduced to allow for switch contacts, etc., as mentioned earlier, to, say, 4½ volts.

$$\text{Voltage drop} = \frac{10 \text{ ft.}}{55 \text{ ft.}} \times \frac{42 \text{ amps.}}{40 \text{ amps.}} = 1.05 \text{ volts.}$$

This also is quite satisfactory.

Phase C—

Length of main	..	130 ft.
Load	..	24 amps.
Proposed cable size	..	7'.039
Length of cable for	}	34 ft. at Maximum
1 volt drop		

Voltage drop = $\frac{130 \text{ ft.}}{34 \text{ ft.}} \times \frac{24 \text{ amps.}}{24 \text{ amps.}} = 3.85 \text{ volts}$

This is working rather close to the maximum allowance of 4½ volts and for this reason, as well as due to the fact that the cable would be loaded up to its capacity, it would be desirable to increase this main to 7'.044 to leave some margin for extensions or contingencies.

Fuse Boards.

Fuse board sizes should be arranged so that every circuit is left with some spare capacity. The maximum number of points allowed per circuit is 10, and

this rule decides the ways for all sections using lamps up to 60 watts.

With larger lamps the rules allow :—

- With circuits carrying not over 6 amps. 10 points.
- With circuits carrying not over 8 amps. 6 points.
- With circuits carrying not over 10 amps. 4 points.
- With circuits carrying not over 20 amps. 2 points.

With a 230-volt supply it would thus be permissible to run 6 points each 300 watts on one circuit as the total current would be 7.8 amps or just under 8 amps. It is desirable to work well below the maximum allowance and a suitable arrangement of the circuits for the present building would be :—

Phase A—

- Cloaks 2 circuits.
- Mess room 1 circuit.
- Kitchen, etc. 1 "
- Staff mess room loading dock. 1 "

South Bay—

- Centre pendants 3 circuits.
- Brackets 1 circuit.
- Plugs (including those in Central Bay) 2 circuits.
- Spares 3 "

Total 14 circuits.

Phase B—

- General lighting (2 Bays) 7 circuits.
 - Brackets 2 "
 - Plugs 2 "
 - Spare 3 "
- Total 14 circuits.

Phase C—

- Transformer room etc., Boiler house } 3 circuits.
 - Stores }
 - Drawing office 3 "
 - Other offices, etc. 2 "
 - Spare 2 "
- Total 10 circuits.

Rooms such as the boiler house, store, general office, etc., should have part of the lighting on each of two circuits so that the blowing of one fuse will not leave the room in darkness.

Wiring Diagram.

This completes the design of the whole lighting system and the final diagram of connections can now be made out for the complete scheme (see Fig. 15).

QUESTIONS AND ANSWERS

What are the most important requirements in any factory lighting scheme ?

The whole scheme must be primarily economical in first cost and efficient in working. Accurate design is, therefore, essential.

What intensity of illumination would be required for (1) offices; (2) textile factories, and (3) machine shops ?

- (1) Five to 6 candle feet if local lighting is also provided. Eight to 10 candle feet if only general lighting is provided.
- (2) Five to 10 candle feet according to class of work carried out.
- (3) For rough work, 6 to 8 candle feet; for fine work, 10 to 20 candle feet.

In a factory having tie rods running across upper part of the building what precautions must be taken in fixing lamps ?

The lamps must be above the tie rods,

but not much above them. If the tie rods are 14 feet up, the lamps should be 15 feet from ground level.

When an overhead travelling crane is used what special provision can be made for cases where the crane may obscure light from overhead lamps ?

Additional light can be obtained by suspending two or three fittings below the crane.

What special arrangements must be made in this case ?

The additional lamps must be connected in series on the power wiring at 400 volts, which means special care in wiring and the use of suitable switches.

What special precautions must be observed if above system is used ?

The power must always be switched off before any adjustments are made to the lamps.

ELECTRIC LIFTS

By L. J. GOOCH, A.M.I.E.E.

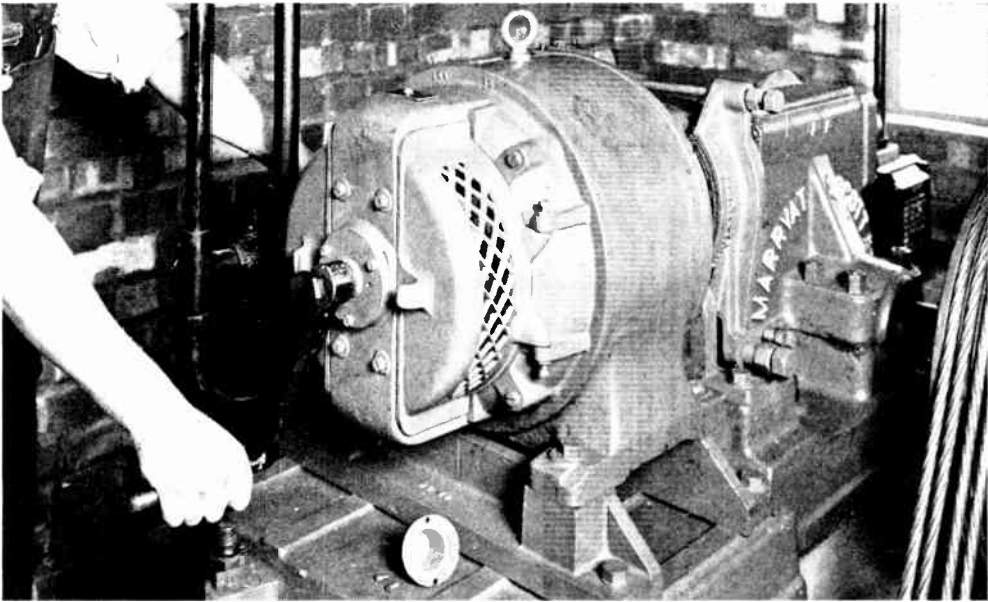

Fig. 1.—WINDING AN ELECTRIC PASSENGER LIFT BY HAND.

Note detachable cover for protecting squared end of motor shaft for normal running.

AVOIDANCE OF ACCIDENTS.

Entering the Motor-Room.

ACCIDENTS to engineers working on lifts are, unfortunately, all too frequent. They are, however, almost invariably due either to lack of knowledge or carelessness. To carry out almost any maintenance work or adjustments to a lift it is essential for you to have a good "mate," if it is to be carried out with safety and success.

Switch Off the Current.

When you enter a motor-room with which you are unfamiliar, the first thing you should do is to switch off the current, have a look at the motor or controller labels to ascertain the voltage (this will act as a warning to you to be careful), and generally take stock of your surroundings, particu-

larly as to the situation of naked live parts and naked moving parts. Having done this, it may be safe for you to switch on. If, however, there is any danger of your coming into contact with live or moving parts, then let people walk up the stairs while you are making adjustments. They will probably not die of heart failure on this account, but there is grave risk that you may be killed if you permit the lift to operate while you are working in a confined motor-room. Remember that an electric shock from a comparatively low voltage which might not normally be dangerous, may be sufficient to make you jump and come into contact with moving machinery.

Things You Should Not Do.

Don't attempt to clean or adjust the controller while it is alive.

Don't touch any part which moves when the lift operates, unless you have previously switched off.

Don't touch any part while it is moving.

Don't let any of your clothing touch moving machinery.

Don't, if the worm is situated above the worm wheel, lift the lid of the gear without first switching off, unless, of course, you want an oil bath.

Winding the Lift by Hand.

Probably the most useful thing to know about an electric lift is how to wind it by hand.

Most lifts are fitted with a square on the end of the motor shaft remote from the gear, to which a spanner or special handle may be attached. This square is frequently protected by a screwed cap which has to be detached before hand winding, see Fig. 1.

Before attempting to wind by hand, switch off the main switch.

Releasing the Brake.

It is then necessary to release the brake.

Some brakes are fitted with a small lever or

screw attachment for this purpose. If the brake is not so fitted, the operating lever may be tied in the "off" position, or the brake shoes may be wedged apart by a piece of wood cut for the purpose.

It is bad practice to slacken off the spring, as it will probably take a considerable time to reset the tension correctly.

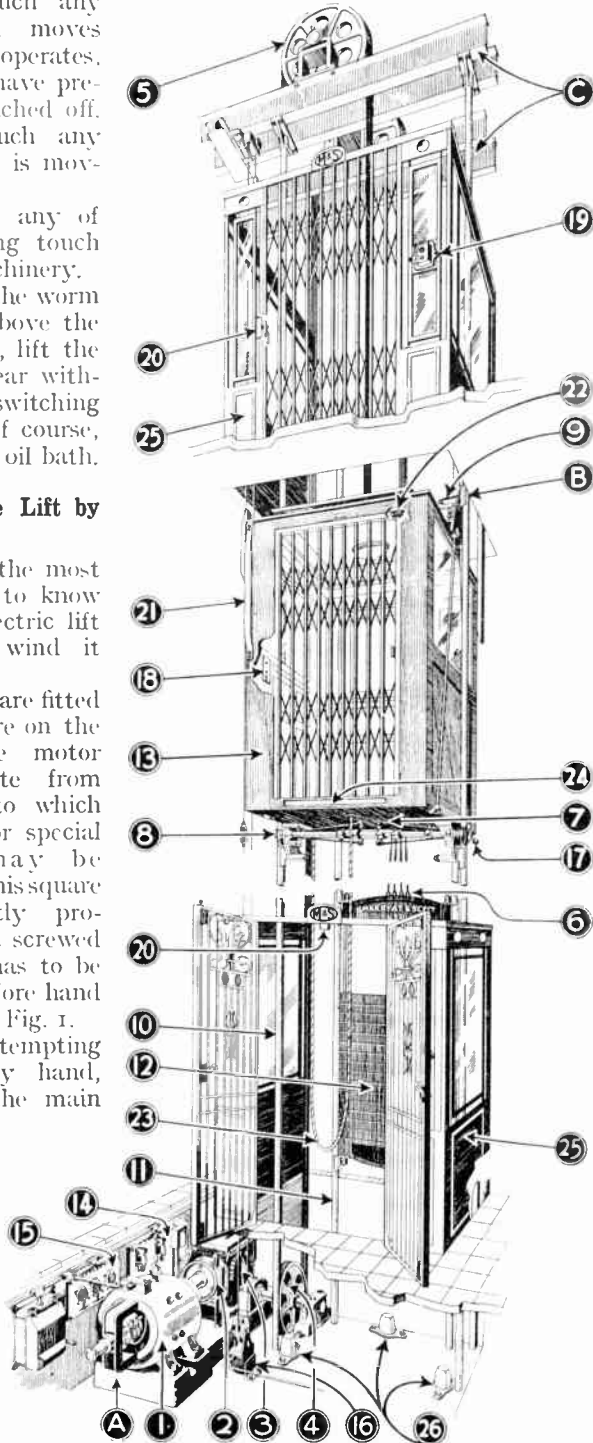

Fig. 2.—DIAGRAM SHOWING LOCATION OF PRINCIPAL COMPONENTS OF MODERN ELECTRIC LIFT.

- 1. Motor. 2. Brake.
- 3. Worm gear in oil bath case. 4. Traction drive sheave. 5. Live axle "U"-groove top sheave. 6. Rope anchorage to balance-weight. 7. Rope anchorage to car. 8. Rope safety gear. 9. Guide shoes. 10 and 11. Turned steel guides. 12. Adjustable balance-weight. 13. Car. 14. Controller. 15. Relays for floor-selecting control (push-button system). 16. Automatic main limit control, stopping lift and applying brake in case of over-running from overload or other cause. 17. Alternative limit acting on control circuit and having same effect. 18. Push-buttons in car. 19. Ditto on landings. 20. Gate lock. 21. Ramp, operating gate locks. 22. Car gate interlocking contact. 23. Multi-core high insulation flexible cable. 24. Threshold light. 25. Enclosure. 26. Buffers. A. Foundations. B. Fixings. C. Top girders.

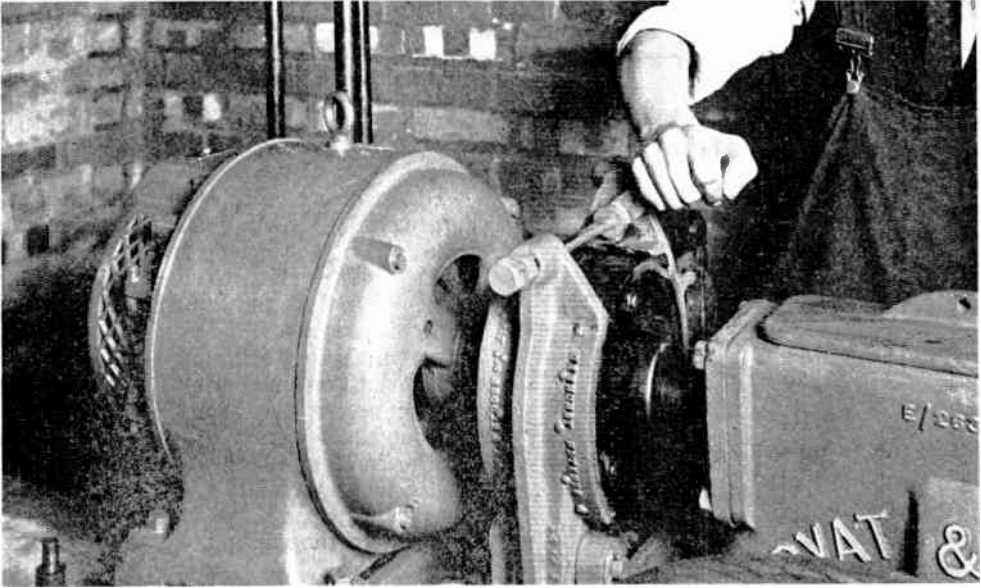

Fig. 3.—RELEASING THE BRAKE, PRIOR TO WINDING BY HAND OR MAKING BRAKE ADJUSTMENTS. The brake shown is fitted with special hand-release lever. If a brake is not so fitted, the shoes must be wedged apart by means of a piece of timber cut for the purpose. It is bad practice to release the brake by releasing the spring pressure, as this necessitates a considerable amount of work in regaining the proper spring adjustment.

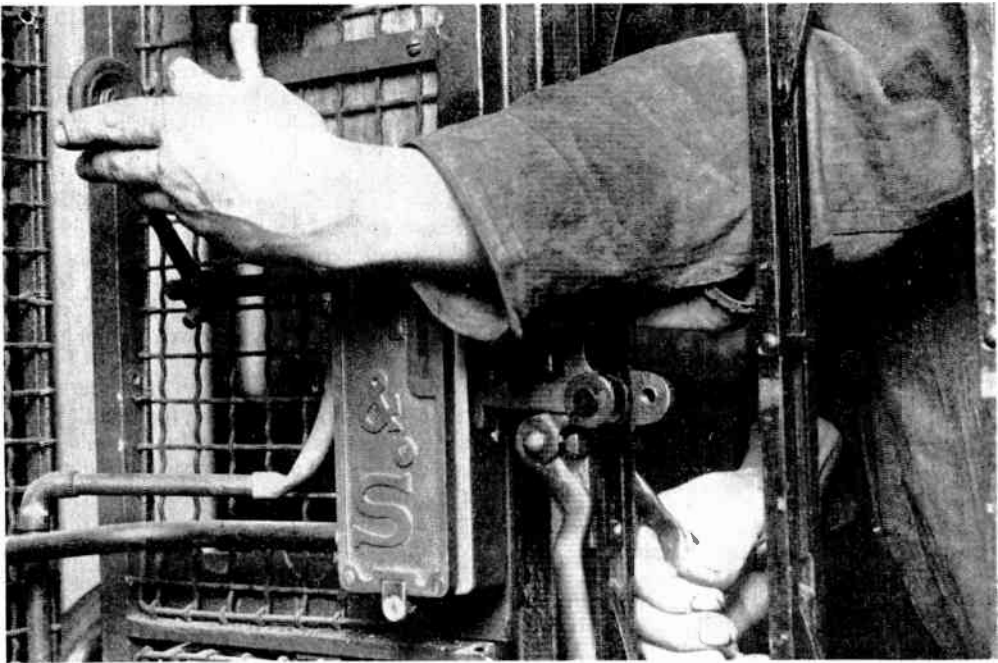

Fig. 4.—METHOD OF OPERATING THE LOCK LEVER BY HAND IN ORDER TO OBTAIN ACCESS TO THE LIFT SHAFT.

If this is done at any floor other than the bottom floor, the lift engineer's mate should be in the lift-car, which should be stopped with its top approximately level with the floor.

Turning the Brake Drum.

If no square is fitted to the motor shaft, it is possible to wind the lift by turning the brake drum by hand or barring it round with a lever.

If when you release the brake the lift starts to move, apply the brake again, and get your mate to hold the handle or coupling when you again release the brake. You may then, if desired, take over from him, and he is free to enter the

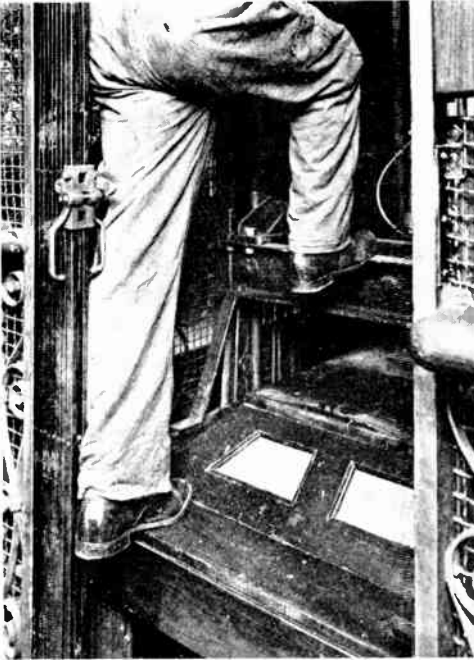

Fig. 5.—WHERE TO STEP ON TOP OF THE LIFT CAR.

Having opened the landing gates you may step on to the top of the lift car. Note where the engineer in the photograph places his foot—on the edge of the car, and then on to the cross-head of the sling to which the ropes are attached. If before placing his foot on the cross-head he had put it in the centre of the dome of the car, it is probable that he would have smashed the top of the lift car, as this is usually of quite light construction.

lift car if you wish to get on the top of it

Don't forget to switch off before attempting to wind by hand.

Don't forget to re-apply the brake the moment you have finished hand winding.

Don't forget to remove the winding

handle before switching on. The motor probably revolves at about 1,000 r.p.m., and if the handle flies off and hits you while the motor is turning at this speed, there will be a coroner's inquest.

Entering the Lift Shaft.

To perform certain operations on a lift, e.g., cleaning and adjusting landing gate locks, it is necessary to enter the lift shaft. If this has to be done at any point other than the lowest floor, the top of the lift car should be used as a platform from which to work. In order to enter the lift shaft on a modern lift, it is necessary to circumvent the safety devices which prevent the lift from being moved unless all the landing doors or gates are shut, and which prevent the landing gates from being opened unless the lift car is adjacent to the landing.

How to Get on Top of the Lift Car.

The best and safest method of getting on top of the lift car is to bring the car to the floor at which you wish to work, station your mate in the car with instructions to leave the landing door open. You, yourself, go to the motor-room and wind the machine down by hand until a shout from your mate tells you that the top of the car is level with the landing. You then re-apply the brake and switch on the current (only if you intend to travel on top of the car). If you do not intend to travel on the top of the car, do not switch on. You will then be able to remove covers of gear in the shaft without the danger of a shock or of accidentally connecting a "live" part to "earth" with your screwdriver or pliers, and thus blowing a fuse.

These remarks apply to machines situated in enclosed shafts, for if collapsible steel gates or wire grillwork enclosure are fitted, it is usually possible by means of a certain amount of contortion to operate the lock lever from outside. Having opened the door, you may step on to the top of the lift car. Don't attempt to operate the electrical contact by inserting a finger or a pencil, unless you are completely familiar with the internal mechanism of the particular type of lock fitted to the lift on which you are operating. (See Fig. 4)

Don't Tie Up the Lock Lever.

Do not, even as a last resource, attempt to tie up the lock lever — there is always some other way. If you make a practice of tying up lock levers, one day you will forget to untie one, and somebody will be killed by opening a door and falling down the lift shaft, when they confidently expect that they will not be able to open the lift door unless the lift car is at that floor.

Don't step in the middle of the top of the lift car, as with some lightly constructed cars you may put your foot through the roof. Step on the edge of the timber work, or on some convenient portion of the steel sling or cradle, see Fig. 5.

Clean Off Grease Marks.

Don't forget to take a piece of rag with you to wipe the soles of your boots when getting off the top of the car, and thus avoid damage to the landing floor.

Don't put your greasy hands on the paint work of the door or gate.

Don't forget to wipe the door handle after you have handled it with greasy hands.

Don't, having got on to the top of the lift, immediately shut the landing door. Look round and take stock of your surroundings, and use your imagination.

Travelling on Top of the Car.

If possible, travel in the *down* direction. Supposing however, while you are travelling on top of the car with your mate operating it, and for any reason he fails to stop when you are travelling in the "up" direction, how are you going to avoid being crushed to death against the girders at the top of the lift shaft? There are probably at least four ways of dodging this unhappy occurrence, some of which may be tried even if the others fail, if you keep your head and act quickly:—

1. As you pass a floor you may operate the lock lever with your hand and open

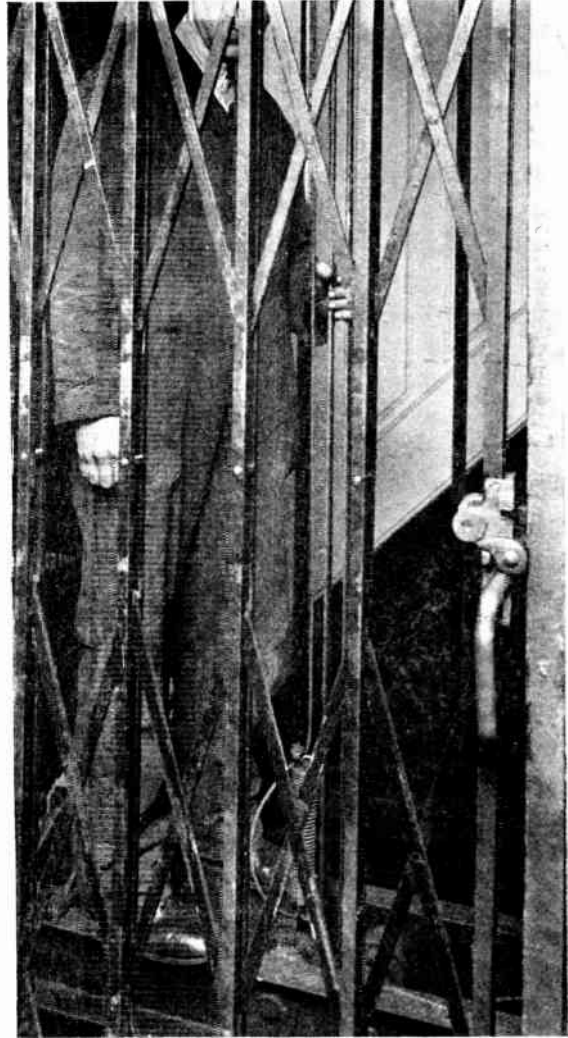

Fig. 5.—HOW TO TRAVEL ON TOP OF THE LIFT CAR.

The engineer is seen standing firmly on the cross-head of the sling. He steadies himself by holding the ropes with one hand. He is right in the centre of the lift shaft, and his clothing is not likely to be caught by anything projecting from the sides of lift shaft as he travels.

the gate. Don't, however, attempt to jump out until the lift has stopped. (Fig. 7.)

2. You may operate the control limit at the top of the shaft with your hand. (Fig. 8.)

3. You may operate the main limit

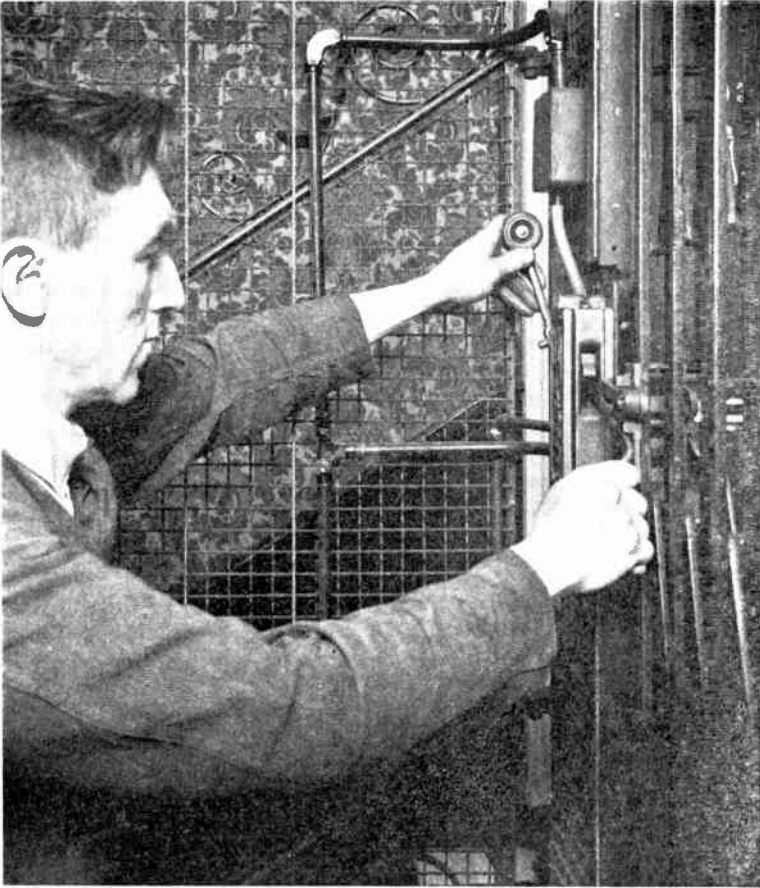

Fig. 7.—HOW TO SAVE YOURSELF IF YOUR MATE FAILS TO STOP THE LIFT WHEN YOU ARE TRAVELLING ON TOP OF IT IN THE "UP" DIRECTION (1).

Operate the lock lever and open the landing gates to break the control circuit and stop the lift.

and cut off the supply from the machine. (Fig. 9.)

4. There is frequently a space round the top joists through which your body may pass as the lift ascends (Fig. 10) or else a space in which you may crouch, when the balance weight has landed on its buffers at the bottom. Make a mental note of these points as soon as you enter the lift shaft before attempting to do anything else.

Don't travel up and down the lift shaft on top of the car if you can avoid it. If it is necessary, however, to do so, it is much safer to travel down than it is to travel up.

Beware of the Balance Weight.

Don't forget that half way down the lift shaft the balance weight passes the car, and never let any portion of your body project anywhere near the part of the shaft in which the balance weight runs. Balance weights have killed more lift engineers than any other one part of the mechanism.

Don't fail to steady yourself on top of the car by holding the suspension ropes (note Fig. 6) or, alternatively, sit down on the sling in the centre of the car.

Don't attempt to clean, oil or adjust while the car is moving.

Don't forget to ask your mate if he has opened the

car gate as an additional precaution against the lift moving when you have stopped to make an adjustment.

To a skilled lift engineer many of the foregoing remarks may appear to be elementary. The author has, however, endeavoured to set down the chief points which should be second nature to anyone who has to work on electric lifts. You may find "clever" lift engineers who do not pay attention to all the points enumerated. The advice given, however, is sound, and is backed by practical experience. You should always remember that it is better to be a little over-careful and live than to appear clever and die.

MAINTENANCE AND INSPECTION.

General.

In order to carry out the maintenance and inspection of electric lifts in an efficient manner it is essential that a definite sequence with regard to the various components of the lift be followed. If this is not done, something is sure to be missed, which may lead to a breakdown before the next regular maintenance visit.

Such a sequence is indicated by the questions asked in the schedule on page 913.

The obvious place to start is the motor-room.

Motor-Room.

The motor-room itself should be clean and tidy. Oil, grease, rag and waste should be kept in proper containers, and special tools, such as winding handles or grease guns, should be kept in a rack provided for the purpose, or else hung on hooks on the wall.

If a maker's instruction card is placed in the motor-room, make yourself completely familiar with it.

The motor-room should be dry. It will frequently be found, however, that motor-rooms at the top of the shaft suffer from condensation due to hot air rising up the lift shaft and the moisture condensing on the cold portions of the machinery, such as the controller panel, motor frame, etc. This may only occur during cold weather, and it may be cured by heating the motor-room either by a small electric radiator (250-watt is usually ample) or an ordinary fishtail gas jet left burning continuously.

Main Fuses.

The main fuses situated in the motor-room should, with a direct current lift, be capable of carrying twice the full load running current of the motor. With some alternating current machines of the high torque, squirrel-cage type, the fuses may have to be heavy enough to carry three to five times the full load running current in order that they may withstand the

heavy starting current necessary to develop the requisite torque to start the lift against full load.

If there are other fuses on the mains, e.g., at the point where the company's supply enters the building, these should be some 5 per cent. to 10 per cent. heavier than the fuses in the motor-room, to ensure that the motor-room fuses are the first to blow in event of a fault developing.

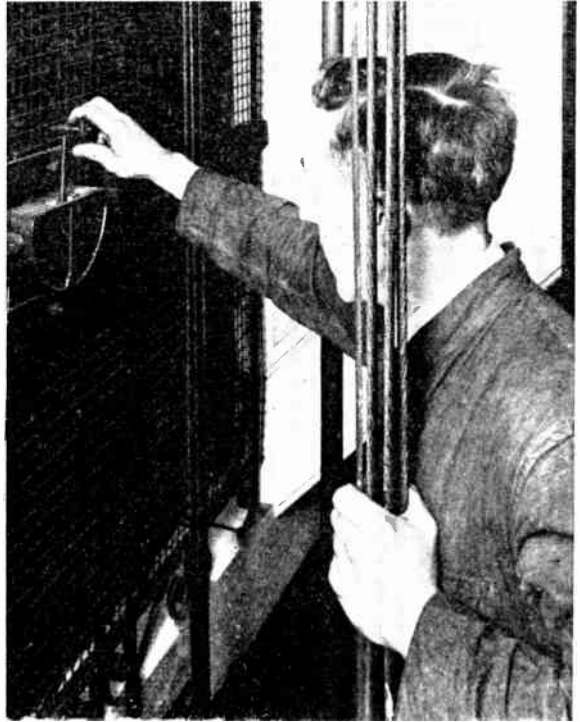

Fig. 8.—HOW TO SAVE YOURSELF IF YOUR MATE FAILS TO STOP THE LIFT WHEN YOU ARE TRAVELLING ON TOP OF IT IN THE "UP" DIRECTION (2).

Operate the direction switch or control limit. The engineer is here seen operating the direction switch at the top floor.

This will frequently save a weary walk from the motor-room to the company's point of entry and back. The company's own fuses should, of course, be heavier still.

Control Circuit Fuses.

The fuses in the control circuit are seldom, if ever, more than 5 amps. capacity, and are frequently as low as 2 amps.

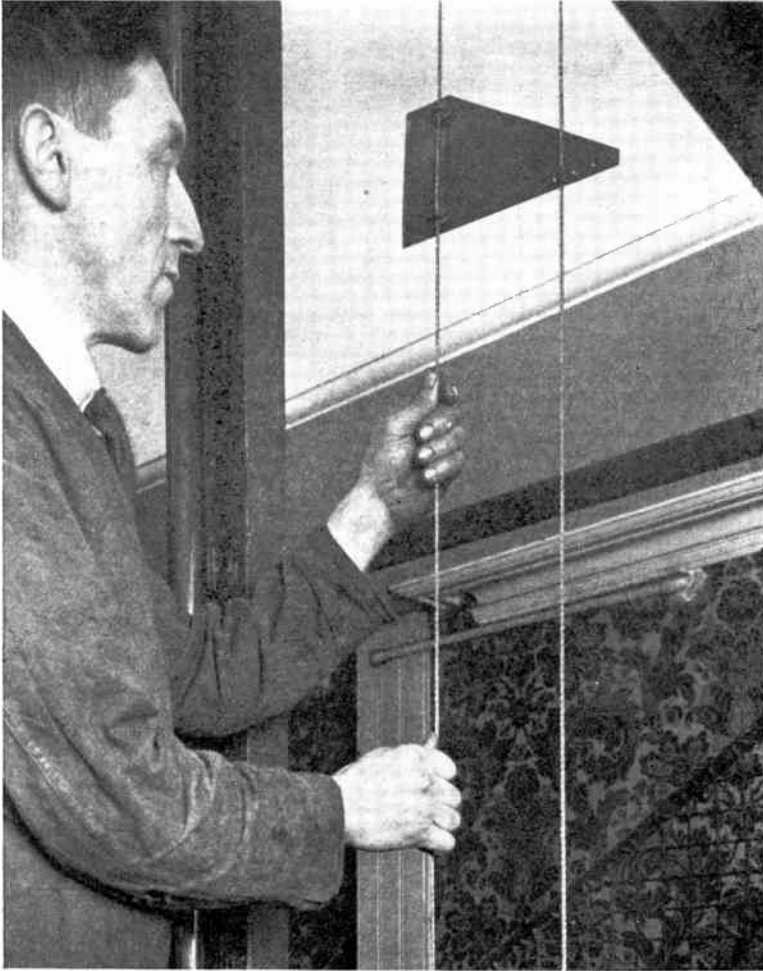

Fig. 9.—HOW TO SAVE YOURSELF IF YOUR MATE FAILS TO STOP THE LIFT WHEN YOU ARE TRAVELING ON TOP OF IT IN THE "UP" DIRECTION (3).

Operate the ultimate main limit. In this case, by catching hold of the main limit line, and giving it a vigorous pull. This is certain to stop the lift under practically any circumstances.

In any case, the maker's recommendation should be adhered to. They usually take the form of small cartridge fuses situated on the controller panel. (Fig. 12.)

Care of the Motor.

The care which a lift motor requires is in every way similar to that demanded by electric motors for other purposes, which is dealt with under a separate section.

The bearings, if of the sleeve type,

with ring lubrication, should be filled up to the overflow vent with light machine oil. Drain-plugs and gauges should be well fitted to avoid leakage. If the motor is of the ball or roller-bearing type, the bearings are packed with grease by the makers, and this requires replenishing at infrequent intervals.

Play in the motor bearings often makes itself apparent by a distinct knock, which is heard after the brake has been applied, and just as the machine comes to rest. It may, of course, also be detected by feeler gauges in the usual manner. Undue wear will lead to excessive strain on the coupling and also on the bearings of the gear which carry the worm.

How to Detect Coupling Faults.

Examine the coupling bolts and see that these are tightly locked, also the keys, to see that these have not worked loose. An indication of the keys having worked loose is obtained by watching the point at which the motor or gear shaft enters its half of the coupling at the instant when the machine starts or stops, in first one direction and then the other, when, if the key is loose, movement can be observed between the shafts and coupling. It may also be detected

by switching off the main switch, putting the handle on the end of the motor shaft and rotating it first in one direction and then the other. This will detect play between the motor shaft and the coupling. The gear-worm shaft may be tested in a similar manner, but in this case the brake must be released. A distinct "kick" will be felt if any play exists.

The coupling usually forms the brake drum, and for this reason, should run dead true, otherwise erratic stopping will occur.

Adjusting the Brake.

This is, generally speaking, the most badly adjusted component of the lift, and yet it is one of the easiest to adjust if the adjustment is carried out with due regard to the proper sequence. The sequence of adjustment may briefly be set out as follows:—

- (1) Adjust the gap between the brake shoes and the drum to a minimum by

MAINTENANCE INSPECTION REPORT*

Name of Job..... Maint. No..... Date of inst.....

Type of lift..... Visits Premium

MOTOR ROOM.

What was the general condition of Motor Room as you entered?

State particularly if any oil rags, oil cans, etc., were lying about.

Are there any spare parts in the Motor Room?

Are these carried in a box?

Is there an Instruction Card?

Is the Motor Room kept locked?

Who holds the key?

MOTOR.

Is commutator and interior of motor clean?

Is brush gear in good order?

Does machine run silently? If noisy, state cause.

Is oil in bearings at correct level?

Do bearings leak?

GEAR.

Give position of oil on gauge or distance from hand hole.

Is box oil-tight? If leak, state where.

Is gear silent?

State condition of main keyway and key.

BRAKE.

Are all nuts and hand release locked?

State condition of blocks.

State condition of coupling.

Is brake silent in action?

CONTROLLER.

Is slate of controller and rheostat clean?

Are all contacts clean?

What oil is used in dashpot?

Give level of oil in container.

If any coil is hotter than can be borne by back of hand, give temperature.

General condition.

LIFT SHAFT.

Is lift shaft clean?

Are guides clean and lubricated?

What lubricant is used?

If direction switches are fixed, are they silent?

Inspect one and report on its internal condition, and which one was inspected.

GATE LOCKS.

Are gate locks clean?

Do they operate easily?

Inspect one and report on its internal condition.

State which you examined.

CAGE.

Is cage clean internally and externally?

What is the condition of limit switches?

What is the condition of Car switch?

Are lights and bells in good order?

Is floor or floor covering worn?

Does car require re-polishing?

ROPES.

How many ropes are fitted?

Diameter.

Type.

Are the rope anchorages clean?

Report on condition of safety gear.

Give date of last maintenance inspection.

State here any suggestions which have occurred to, or been suggested to you to improve our maintenance service.

Signature.....

Date..... Time.....

* As used by Messrs. Murrell and Scott, Ltd., Lift Engineers.

adjusting the stops on the shoes. The brake shoes require to lift only, say, 1/64 in. off the drum. They are usually adjusted independently, and the adjustment should be equal on both. This should be done with the spring pressure released. (Fig. 13.)

- (2) Now adjust the solenoid plunger or armature to the minimum air gap which will permit the shoes to be lifted clear of the drum against their stops. (Fig. 14.)

Generally speaking, the "iron circuit" of the brake should just close as the shoes reach their stops.

With this adjustment, the maximum possible pull is obtainable from the solenoid, so that if necessary the maximum spring pressure for which

- the brake is designed is obtainable.
- (3) Now gradually apply the spring pressure by means of the tension screw until smooth, rapid stopping is obtained. Normally, the lift should not travel more than 4 in. to 6 in. for every 100 ft./min. of its running speed, after the current

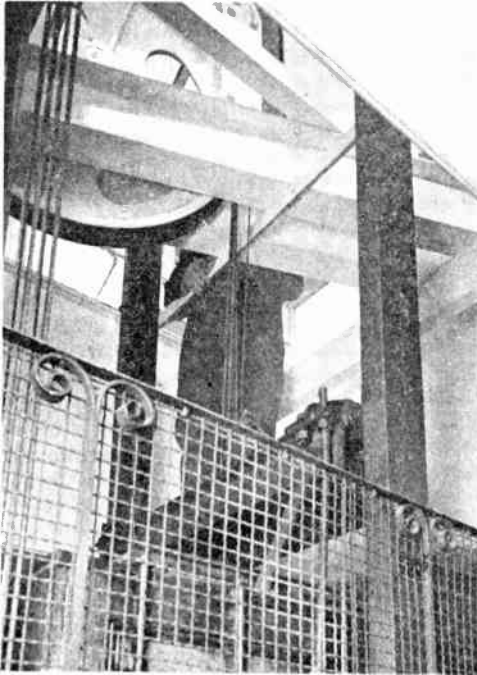

Fig. 10.—How to Save Yourself if Your Mate Fails to Stop the Lift when You are Travelling on Top of it in the "Up" Direction (4).

Should everything else fail, there is often a space through which your head and shoulders may pass as the lift-car reaches the top. You can steady yourself by placing your hands on one of the joists.

has been switched off by the controller, that is to say—if the lift is running at 150 ft./min. it should not travel more than 6 in. to 9 in. after the controller has cut off the current

Be sure that the lock nuts on all the adjustments are securely locked after the adjustment is completed or the brake will go rapidly out of adjustment.

Testing the Brake.

To test the distance which the car travels after current has been switched off, make a chalk mark on the car about eye level and one on a convenient point in the shaft (Fig. 16). Get in the lift and run the lift at full speed past this point, and at the moment that the chalk marks coincide switch off the car switch or press the "stop" button, according to the type of control. Then the vertical distance between the mark on the car and that on the shaft will be the distance run after the brake is applied. (Fig. 17.)

GEAR.

Lubrication.

Examine to see that the oil level is correct. If the worm is below the wheel, there should be sufficient oil in the gear case completely to immerse the worm. If the worm is above the wheel, then the worm wheel should dip some 3 in. to 6 in. into the oil. The great thing with this latter type of gear is that, when the gear is running, oil should reach all parts, as it is customary for troughs to be formed in the gear case to collect oil thrown by the rapidly revolving worm and feed it to the worm wheel shaft and worm shaft bearings. The oil passes through the bearings, and is then led by ducts back to the sump.

Gears with the worm below the wheel usually have the worm wheel shaft bearings lubricated by some external method, e.g., stauffer-type grease cap or ring or chain lubricators. In the latter case, the oil well should be filled to the level of the overflow plug, with machine oil as distinct from the heavier oil in the gear case.

In the gear case use the oil recommended by the makers. If there is no indication as to what oil should be used, then when the oil requires replenishing, drain the gear case and use first pressing pure castor oil. It is important not to mix different grades of oil in the gear case; in particular, castor oil should not be mixed with a mineral oil.

Detecting Wear.

Any wear in the gear is usually attended by a knock when the lift stops. Wear

may occur in any of the bearings, though it is more usual on the worm wheel shaft bearings. It may be detected by observation, or a knock may be heard when the lift stops, or feelers may be used to detect wear if it is expected.

Wear may also occur on the rubbing surfaces of the worm and worm wheel teeth. This can usually be detected by running the lift up and down once or twice, and listening at the side of the gear case for a knock when the lift stops. Another method is to load the car gradually at one of the floor levels, until the load in the car counterbalances the amount of the normal running load which is balanced by the balance weight. This is similar in effect to a see-saw which has been loaded more at one end than the other, and then load gradually applied to the lightly loaded end until it over-balances. If there is any distinct movement of the driving sheave or drum as the load in the car overbalances the balance weight, then there is probably backlash between the worm and worm-wheel teeth, and the gear should be examined by an expert. Care must be taken to discriminate between backlash in the worm and worm wheel and end play in the worm shaft.

End Play in Worm Shaft.

It must be appreciated that the thrust, due to the out-of-balance load of the lift, appears as a direct axial thrust on the worm, and has to be accommodated by some form of thrust bearing.

In modern lift gears a double ball thrust bearing is usually employed, while in some older gears a collar thrust bearing of the marine type is used. It is essential that any end play (which can readily be detected by observation of the coupling at starting and stopping in alternate directions) should be taken up as soon as it develops. If this is not done the

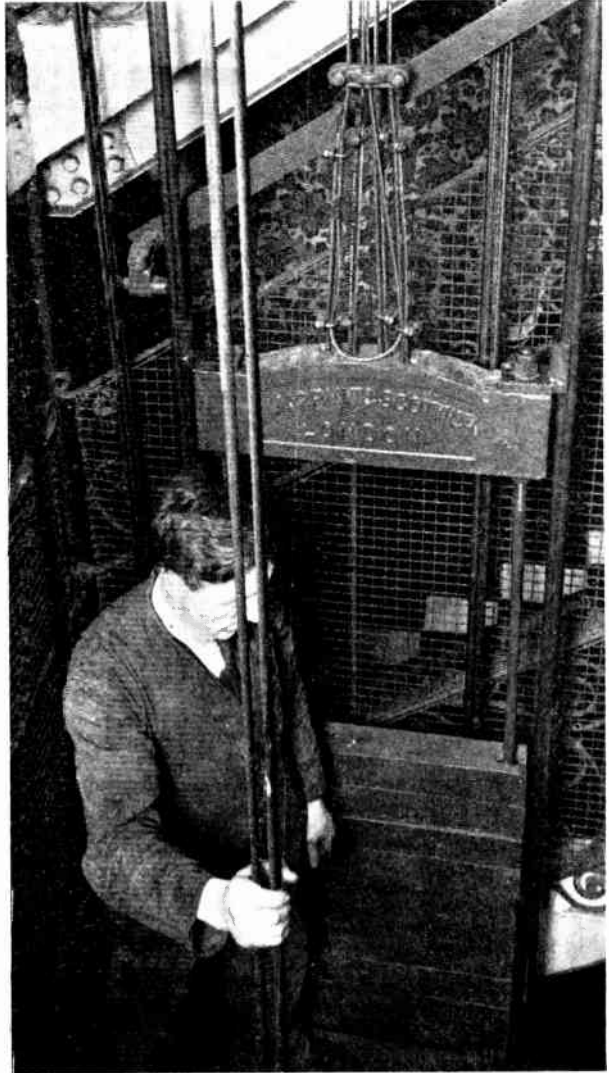

Fig 11.—HOW NOT TO TRAVEL ON TOP OF THE LIFT-CAR.

The engineer is here seen standing at the edge of the lift-car. He is not so comfortable as in Fig 6. A slight movement of his foot will bring it over the edge of the lift car, where it is liable to be caught by projections in the lift shaft. He is also in grave danger of being struck by the balance-weight as it passes the lift-car half way down the shaft.

end play will increase, until it exceeds the amount of "float" which has been allowed on the armature of the motor. If this has occurred, the end plates of the motor will be called upon to carry

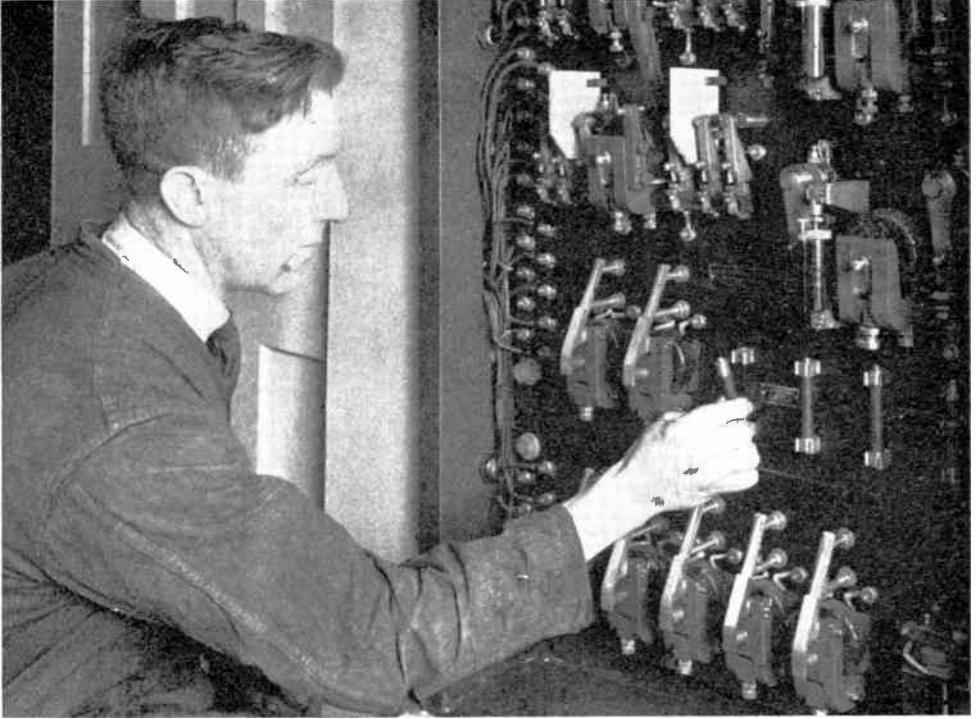

Fig. 12.—REPLACING A CONTROL FUSE.

It will be seen that these control fuses are mounted on the actual controller panel.

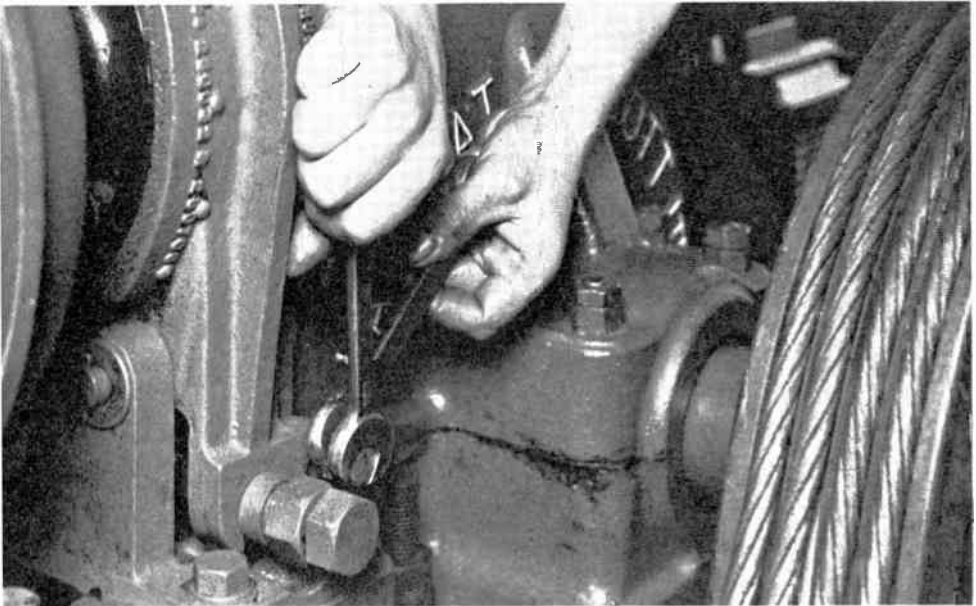

Fig. 13.—ADJUSTING THE AMOUNT OF MOVEMENT OF THE BRAKE SHOE.

The set screw and lock nut which is being adjusted acts as a stop, to limit the amount by which the brake shoe lifts clear of the drum. The clearance of each brake shoe must be adjusted independently.

the whole thrust of the machine, and not being designed to withstand this a serious breakdown is liable to occur.

The end play may also be detected, as previously described, by loading the car, when as the loaded car over-balances the balance weight a distinct axial movement of the coupling and worm shaft can be seen and a slight knock heard if end play exists. It is cured by removing the end cap and adjusting the thrust bearing, see Fig. 19

Curing a Leaking Gland.

If the worm is situated below the wheel, you may find on inspection that leakage is occurring at the gland on the worm shaft. Tighten up the gland with the nuts provided for the purpose, being careful to tighten each nut by exactly the same amount (Fig. 20). The best method is to tighten each nut in rotation, half a turn at a time, working round and round the gland until the leakage stops. The tightening should not be carried beyond this point, otherwise the packing will grip the shaft, causing additional load on the motor and, in extreme cases, seizure.

If there is any doubt as to whether the gland has previously been tightened up evenly, slack it right out, screw up the adjusting nuts till they are all just finger tight, then carry on with the spanners, tightening the nuts in rotation, as just described. It is best to adjust the gland while the lift is running, but care must be taken that you do not come into contact with the coupling, which is rotating at high speed in close proximity to the gland. When the gland has been tightened up to its fullest extent, and leakage still occurs, the stuffing box must be repacked, and this is dealt with later.

Curing Oil Leakage from Bearings.

If there is any leakage from any of the other bearings, it is probable that the ducts leading back into the sump are

choked up. They can be cleared by threading a piece of steel or iron wire through them, and raking it in and out. (Fig. 18.)



Fig. 14. —ADJUSTING THE AIR GAP OF THE BRAKE ARMATURE.

In the brake shown, the brake coil and yoke are attached to the shoe nearer to the engineer, while the armature is attached to the push rod which passes through the centre of the coil, and operates against the stop screw on the opposite brake shoe. By screwing the stop screw in or out, the air gap is varied. The adjustment is maintained by means of the lock nut.

If leakage is occurring at any of the joints in the gear case, then these should be "remade." This is dealt with later.

Driving Drum or Sheave.

This should be examined to see that



Fig. 15.— ADJUSTING THE SPRING PRESSURE.

In this case, the spring is a compression spring operating between the tails of the two brake shoes. The spring seats on the tail of one brake shoe and on the set screw which is attached to the tail of the other. By screwing the set screw in or out, the spring is compressed or released, according to whether more or less braking effect is required. The set screw is held by a lock nut when once the proper adjustment has been made.

it is securely keyed to the shaft. If play occurs at this point, serious damage will be done to the keyways in the sheave or the shaft if not rectified, and this will probably necessitate dismantling the machine and returning the part to the works to have the keyway recut.

Play of this sort may be detected by observation at starting and stopping, keeping the eyes fixed on the visible line of contact of the sheave or drum and its shaft. If there is any doubt about movement here, observation may be assisted by dropping a little machine oil round the point of contact, when the "bubbling" due to movement between the drum or sheave and the shaft will readily be observed.

Another method is to load the car as for detecting wear and play in the gear.

When the car over-balances the weight, the sheave or drum will be observed to rotate slightly on its shaft.

In the early stages this trouble may be cured by driving the key farther in, but if it again develops the load of the cage and balance weight should be taken off the gear and a new key fitted.

Detecting Wear in the Traction Sheave.

If the machine has sheave drive, the grooves of the sheave should be examined for wear. The angle of these grooves is usually 40° , and the sides of the grooves should be absolutely straight. Wear will in time produce ridges on the sides of the groove and will cause rope slip. A ridge on the side of the groove may be detected by observation or by running the point of a screwdriver down the side of the groove, when a distinct bump will be felt if wear has occurred (Fig. 21).

Detecting Rope Slip.

Rope slip may be detected by taking the lift car to a given floor, and drawing a chalk line across the sheaves and rope parallel to the axis of the sheave (Fig. 22).

The lift may then be run up and down once or twice, and on returning to its original position the chalk marks on sheave and ropes should coincide. If they do not, rope slip has occurred. In bad cases the slip will be visible when the brake is applied, the sheave coming to rest, while the ropes slip round it. Slight rope slip may be cured by slacking the pressure of the springs on the brake, though with automatic lifts this is liable to upset the accuracy of floor levelling. The only satisfactory cure for rope slip, due to a worn "V" sheave, is to dismantle the machine and have the sheaves re-turned in a lathe.

Rope-slip is occasionally caused by the "V" of the groove not having been made deep enough when the sheave was made, and a very slight wear in the groove

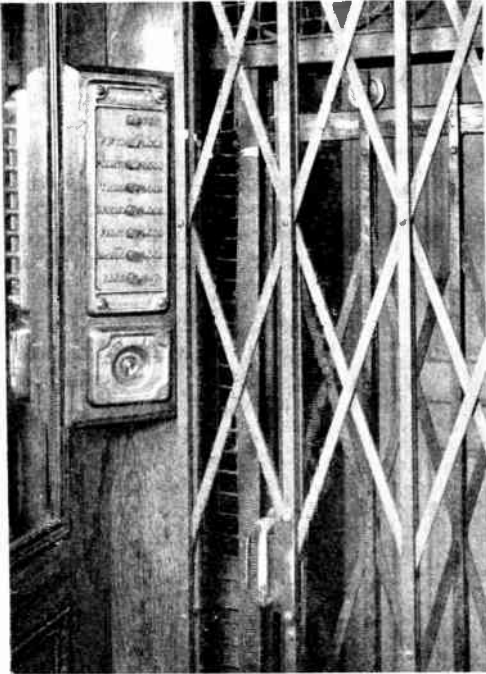

Fig. 16.—TESTING THE DISTANCE THE LIFT TRAVELS AFTER BRAKE IS APPLIED.

A mark is made about eye-level on the car and on a convenient point in the lift shaft. (View taken from inside lift.)

causing the rope to touch the bottom of the groove, or to ropes of too small a diameter having been fitted. This may be cured by dismantling the sheave, and turning up the "V" wheel with a deeper groove, or by fitting slightly larger ropes, so that they will not drop quite so far into the "V."

CONTROLLER.

Controllers vary very considerably in detail, but have marked similarities with regard to their general operation. The controller has to start up the motor in the required direction, and either automatically, or through the agency of the car switch, switch off the current when it is desired to stop. By watching its operation while someone is working the lift, it is easy to decide what each particular contactor is doing. Get your mate to run the lift, first in one direction, and then in the other, stopping at intervals in his travel, say, half a dozen steps in each

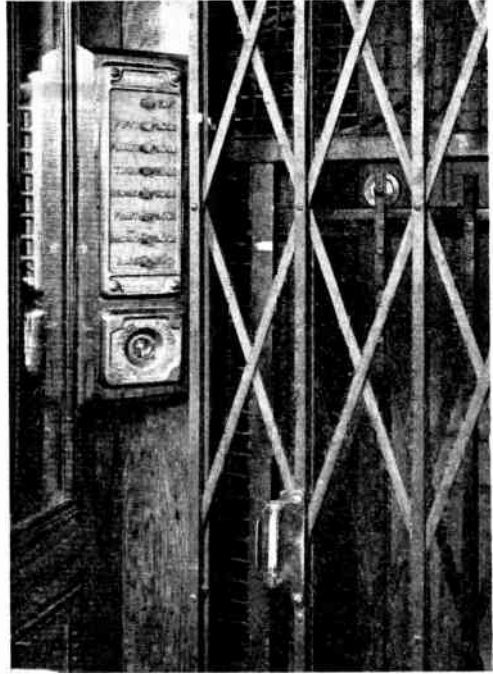

Fig. 17.—TESTING THE DISTANCE THE LIFT TRAVELS AFTER BRAKE IS APPLIED.

Move the lift away from the previous mark by a distance somewhat greater than that necessary for it to attain full speed from rest. Then run the lift towards the mark in the shaft, switching off the instant the two marks are opposite. Measure the vertical distance between the two marks when the car has come to rest. In this case the observation was made with the car travelling in the "up" direction.

direction. Some of the contactors will operate in both directions, others only in one direction. Obviously, those that operate in one direction only are the reversing contactors, while the others are the starting contactors. Additional to this, with some types of controllers there are also devices such as decelerator control, or dynamic brakes, which come into operation in both directions at stopping. Watch the controller at work until you are thoroughly familiar with the function of each part.

With an automatic lift there are also the floor relays which are easily discernible, as there is usually one relay for every floor, though some older systems employ two relays per floor, one for either direction. A

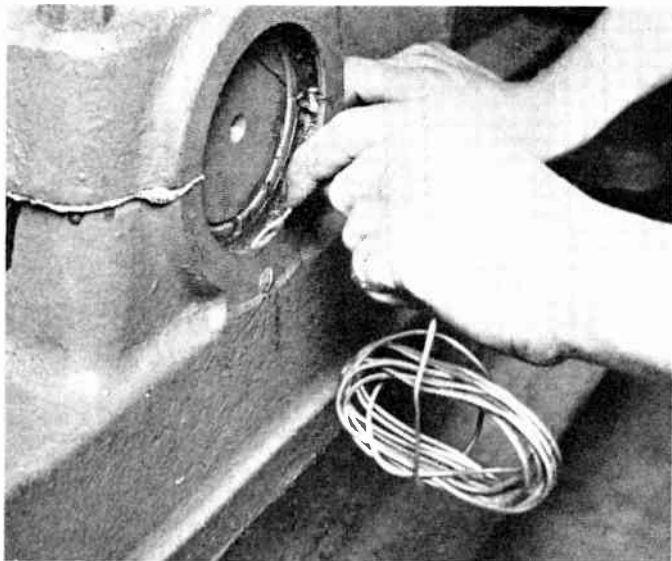

Fig. 18.—CLEARING A CHOKED OILWAY BY MEANS OF A PIECE OF WIRE.

If this return channel is choked, oil which escapes from the end of the bearing fills the well in the housing and overflows instead of running back into the sump. If it does not receive attention the oil will get on to the motor-room floor and may even get down the lift shaft, through the top of the cage, and do damage to passengers' clothing.

floor relay only operates when the button for its particular floor is pressed. It makes the control circuit when the button is pressed, and maintains it until the floor selecting device breaks it, as the lift car reaches the appropriate floor, or until the emergency stop button is pressed or the car gate opened.

The Controller Panel Must be Kept Clean

Do not attempt to clean the controller with the current switched on. In cleaning the controller panel, use a pad of rag rolled up in the hand. This is better than waste, as little shreds of cotton from the waste will adhere to the various portions of the controller, while if a trailing end of rag is left hanging out of the hand it is liable to catch in one of the somewhat delicate interlocking contacts and derange it.

The contacts should be clean and free from pits or blobs of metal. If copper contacts are dirty, they must be cleaned with fine emery cloth. If there are any blobs of metal due to fusion or arcing, these must be removed with a fine file.

Carbon contacts can be refaced by a piece of very fine emery cloth, stretched over a piece of wood so as to form a level surface.

The faces of the contacts should be even and the whole area of the contact surfaces should bed together when the contactor is closed.

Adjusting the Controller.

It is usually desirable to adjust the controller so as to give the maximum possible gap between the contacts when the circuit is open, consistent with reliable operation of the controller when the lift has been in operation for a considerable time and the controller coils are warm.

With some modern controllers, the moving contact is arranged to rub across the face of the fixed contact when the surfaces are together. This rubbing is caused by the final movement of the contactor armature, and prevents welding and sticking of the contacts. Make sure that if the controller is so arranged, the designers' intention is carried out. The method of adjustment varies, but is usually sufficiently obvious for a brief inspection to show how it should be carried out.

Oil the Pivot Pins.

The pivot pins about which the armatures of the various contactors move, and about which (in some controllers) the actual contact pieces move, should be absolutely free. They should be removed occasionally, say every three months (depending, of course, upon the amount of use the machine gets and also local conditions with regard to atmospheric dust or dampness), and should be given a smear of very light oil.

The direction contactors are almost invariably interlocked, sometimes electrically, sometimes mechanically, and some-

SUCCESS

FROM ALMOST TO THE

UTTERMOST



If you intend to **SUCCEED**—
 If you intend to get above the "Hammer and File" Brigade—
 If you intend becoming a **Qualified Electrical Engineer**, and not just an Electrician—

then you cannot *afford* to carry on without reading "**ENGINEERING OPPORTUNITIES.**"

This free book explains many ways of carving out a successful career in the rapidly growing field of

Electricity. For instance :—

Do you realise that there are Examinations open to you that lead definitely to jobs carrying a salary rising from £4 10s. per week to over £1,000 per year, without requiring any particular experience?

Our Handbook explains such opportunities, and is, in fact, filled with matter of vital importance to you from cover to cover.

The Handbook also outlines modern Home-Study Courses in all branches of Engineering, including :—

GENERAL ELECTRICAL ENGINEERING.	ELECTRICAL INSTALLATIONS.
ALTERNATING CURRENT ENGINEERING.	POWER HOUSE DESIGN AND OPERATION.
ELECTRIC TRACTION.	MAINS ENGINEERING.
TELEGRAPHY; TELEPHONY.	TALKING PICTURE ENGINEERING.
WIRELESS AND HIGH FREQUENCY.	TELEVISION, etc., etc.

Full particulars are also given of all recognised Engineering Examinations, including :—

I.E.E.	City and Guilds.
B.Sc.	G.P.O.
I.W.T.	A.Rad.A., etc., etc.

Our record of successes in the above Examinations is remarkable. *In the I.E.E. alone we have returned 100% successes at the past three Examinations*—a magnificent record.

WE ALONE GUARANTEE—"NO PASS—NO FEE."

We repeat, you cannot *afford* to carry on without reading "**ENGINEERING OPPORTUNITIES.**" Send for it to-day, stating the subject which is of most interest—FREE, and without obligation.

BRITISH INSTITUTE OF ENGINEERING TECHNOLOGY, LTD.,
 350, SHAKESPEARE HOUSE, 29/31, OXFORD STREET, W.1.

This article on Electric Lifts is continued in Part 20. Ready February 26th. Order your copy to-day.

Indispensable to every Electrical
Engineer, Designer and Manufacturer

THE
**ELECTRICAL ENGINEER'S
DATA BOOKS**

General Editor: E. B. WEDMORE, M.I.E.E.

(The Director of the British Electrical and Allied Industries Research Association.)

This important reference work contains much valuable new data that has hitherto been concealed in the journals of foreign institutions, in the unadvertised publications of research associations and the technical publications of manufacturers.

"The Electrical Engineer's Data Books" provide, in two handy volumes, a collection of all the most recent specialised knowledge, thus forging the necessary link between the scientist, the research worker and the practical engineer.

The detailed nature of the text and the wealth of original illustrations, tables and formulæ make this work indispensable to every Electrical Engineer, Designer and Manufacturer.

VOLUME I.—Lighting ; Switchgear ; Power Transmission and Distribution ; Distribution by Underground Cable ; Transmission by Overhead Lines ; Traction ; Electrical Machinery.

VOLUME II.—Insulation ; Magnetic Materials and Testing ; Properties of Metals and Alloys ; Measurement of Resistance, Inductance and Capacity ; Corona Discharge.

APPENDICES.—Mathematical and Miscellaneous Tables, List of Integrals, Electrical, Mechanical and Physical Tables, etc. ; Electricity and Magnetism ; Wiring Rules ; Home Office and Board of Trade Regulations, etc.

**EXAMINE THE WORK IN YOUR
OWN HOME FREE!**

In order to give you an opportunity of examining this invaluable work at your leisure, the Publishers are prepared to supply the two volumes on Five Days' Free Approval. Send p.c. to-day for full particulars and details of the generous deferred payment system, to : Dept. E.E.19. The Home Library Book Co., 23-24, Tavistock Street, London, W.C.2

Geo. Newnes, Ltd.

Printed in Great Britain for the Proprietors, **GEORGE NEWNES, LTD.**, 8-11, Southampton Street, Strand, W.C.2, by **WILLIAMS, LEA & Co., LTD.**, Clifton House, Worship Street, E.C.2. Sole Agents: Australasia: **GORDON & GOUGH (Australasia), LTD.** South Africa: **CENTRAL NEWS AGENCY, LTD.**