

To be Completed in about 32 weekly parts.

# NEWNES PRACTICAL ELECTRICAL ENGINEERING



**DEALING WITH**

ALL PRACTICAL APPLICATIONS OF ELECTRICITY IN EVERYDAY LIFE.

**INTENDED FOR**

ELECTRIC LIGHTING  
and  
POWER ENGINEERS.  
ELECTRICIANS AND  
WIREMEN.

WIRELESS DEALERS.

STUDENTS,  
APPRENTICES AND  
IMPROVERS IN ALL  
BRANCHES OF  
THE ELECTRICAL AND  
WIRELESS INDUSTRIES

1½

PART  
3

A PRACTICAL WORK WRITTEN BY EXPERTS

# YOU CAN HAVE A COLLEGE TRAINING IN ALMOST ANY CAREER FOR A FEW SHILLINGS MONTHLY

STUDY AT HOME

IN YOUR SPARE TIME

FOUNDED 1900.

31 YEARS OF SUCCESS.

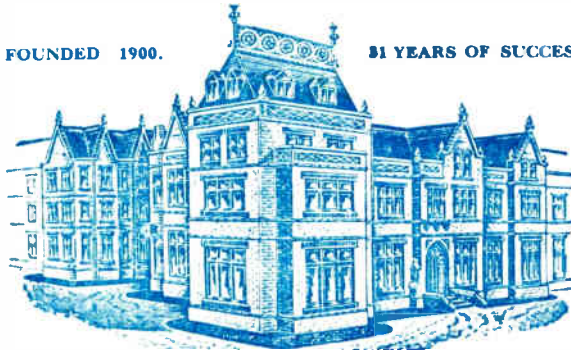

**THIS IS THE BENNETT COLLEGE - - ALL OF IT**  
 The Bennett College is not a rented room in a well-known street—it is a College. Over 30 years ago the Founder took as his motto what has now become a household slogan:

## LET ME BE YOUR FATHER

In many trades and professions there are more vacancies than trained men to fill them. We do not profess to act as an employment agency, but our gigantic organisation certainly does tell us where the demand exists, thus enabling us to give **FATHERLY ADVICE ON ALL CAREERS AND THE POSSIBILITY OF EMPLOYMENT, FREE.**



*J. Bennett*

WE TEACH ALL BRANCHES OF THE FOLLOWING VOCATIONS AND SPECIALISE IN ALL EXAMINATIONS CONNECTED THEREWITH.

### THE MOST SUCCESSFUL AND MOST PROGRESSIVE CORRESPONDENCE COLLEGE IN THE WORLD

Aviation Engineering  
 Boiler Engineering.  
 Boiler Making.  
 B.Sc. (Engineering).  
 Civil Engineering :  
 A.M.I.C.E.  
 Quantities—Specifications.

Commercial Art.  
 Concrete and Steel.  
 Draughtsmanship :  
 Electrical or Mechanical.  
 Electrical Engineering :  
 A.M.I.E.E.  
 City and Guilds.  
 Engineering Mathematics.  
 Foundry Work.  
 Heat Engines

Heating, Ventilating and Lighting.  
 Internal Combustion Engines.  
 Machine Designs :  
 Theory of Machines.  
 Marine Engineering :  
 Motor.  
 Steam.  
 Mechanical Engineering :  
 A.M.Inst.B.E.  
 A.M.I.Mech.E.  
 City and Guilds.  
 Pattern Making.

Mechanics.  
 Metallurgy of Steel.  
 Mine Electrician :  
 A.M.E.E.  
 Mining (all examinations).  
 Motor Engineering :  
 A.M.I.A.E.  
 Municipal and County Engineers :  
 M. and C.E.  
 Naval Architecture.  
 Pumps and Pumping Machinery.  
 Ship Building.  
 Structural Engineering.  
 Telegraphy and Telephony.

IF YOU DO NOT SEE YOUR OWN REQUIREMENTS ABOVE, WRITE TO US ON ANY SUBJECT. IT COSTS NOTHING TO ENQUIRE.

Also ask for Our New Book (FREE OF CHARGE)

### THE HUMAN MACHINE

SECRETS OF SUCCESS

WE TEACH BY POST IN ALL PARTS OF THE WORLD

Note Address Carefully:

The BENNETT COLLEGE, Ltd., Dept. 119, Sheffield



in Fig. 2. One movable contact is connected to earth and the corresponding bottom contact is connected to the aerial. This, of course, adds to the capacity between the aerial and earth.

**Remote Tuning.**

Remote tuning by means of relays has its limitations, because it necessitates multiplicity of relays, house wiring and switches. Up to a selection of five programmes remote tuning may be effected by having small pre-set condensers across the tuning inductances. Each condenser is set to give the required programme beforehand, so that, as each condenser is short-circuited by its respective relay from the remote control panel, the necessary change of

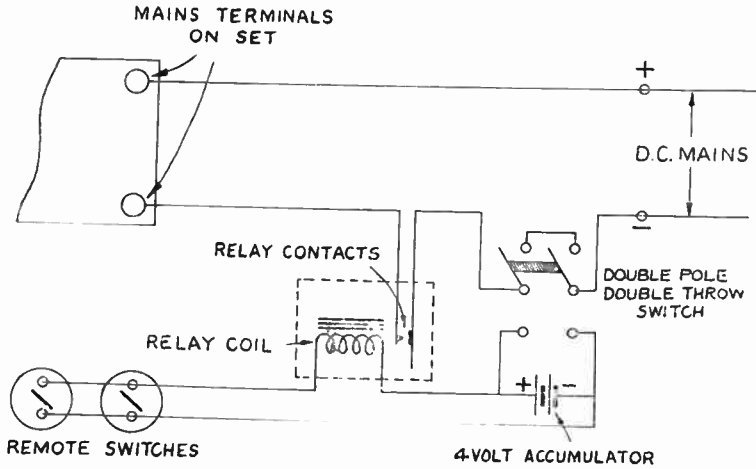

Fig. 11.—THE REMOTE CONTROL CIRCUIT OF A D.C. ALL-MAINS RECEIVER.

A change-over switch provides a ready means of charging the accumulator without any extra apparatus.

tuning is effected. Where the set has only one tuning inductance the relays have only one set of contacts each. One relay is necessary for each setting in addition to the relay used to switch the set on and off. For multi-valve sets, where there is more than one tuning condenser, a set of contacts will be required on each relay for each of the main tuning condensers.

Where band-pass tuning is employed the input filters require two sets of contacts in addition to those necessary for the high-frequency amplifiers. As the relays for controlling the amount of capacity across the tuning inductances have, in the instance of a multi-valve set, two or more

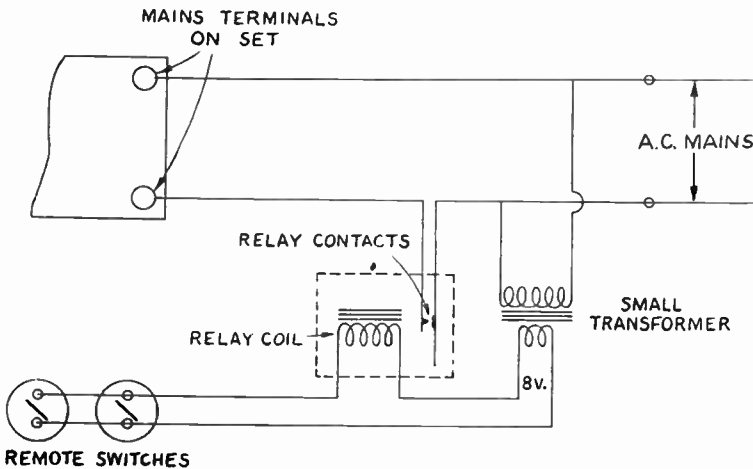

Fig. 12.—THE CIRCUIT ARRANGEMENT OF A.C. ALL-MAINS WIRELESS SET.

A relay designed to work on alternating current is used in conjunction with a small step-down transformer such as is used for house bells.

sets of contact in close proximity controlling high-frequency circuits in different stages of amplification, each set of contacts must be effectively screened. The wires of each set of contacts must also be screened from one another. This may be done by using metal braided leads and earthing the casing. The overall amplification will be reduced somewhat by the extra capacity introduced into the high-frequency circuits.

### **Mercury Break Relays.**

A type of relay particularly adapted to remote tuning control systems has, instead of the usual spring blades, small mercury switches. These consist of sealed glass tubes containing a small quantity of mercury, which forms the circuit when the tube is tilted. The single-throw type of switch has the platinum contacts sealed in one end of a straight tube so that a tilt of about  $6^\circ$  causes the mercury to run to the end of the tube in which the contacts are sealed. The change-over type is semi-circular in shape with three contacts so arranged that the centre one is alternately connected to the other two.

This type of switch has the advantage that it cannot become dirty and so give an unreliable contact. This is because the tube is not only sealed, but is filled with an inert gas which does not oxidise the mercury when a rupture arc takes place.

### **Remote Tuning by Motor.**

Continuously variable remote tuning can only be obtained by driving the condenser spindle with an electric motor. This method is practicable only when the tuning condensers are ganged; that is to say, when the tuning condensers are linked together on a common shaft.

The motor is geared to the spindle of the condensers by reduction gearing so as to give a slow-driving speed to the moving vanes. As modern types of condensers will not turn through a complete revolution the motor must be reversible. Where a series or shunt wound motor is used this is done by arranging the remote switch to reverse the motor field. The motor may be switched on and off by direct wiring or a relay may be used. The use of a relay is preferable because the wiring carrying the motor current may cause

interference with the loud speaker extension leads.

A small type of self-starting induction motor has been produced for the remote operation of the tuning and volume controls. Screening and earthing of the motor is essential. If a commutator motor is used it will cause interference with the tuning circuits unless it is screened, more particularly when the motor is driven by alternating current.

The National Company of America have perfected a combined remote tuning and volume control system, using small motors of a special type which are controlled by two knobs on the remote panel. The motors are rotated by turning the knobs on the control panel in the desired direction.

### **Remote Volume Control.**

Remote volume control may be effected by the use of small electric motors in the same way as for tuning. A limited amount of volume control can be obtained by connecting a potentiometer across the output circuit to the loud speaker. In order to obtain the maximum variation in volume, the set is tuned to the loudest station and then adjusted to give the maximum permissible volume without distortion. There is then no fear of the output valve being overloaded at any setting of the remote tuning control.

### **Conclusion.**

Later articles deal in detail with the selection, use and repair of all the chief components used in the construction of wireless receivers and radio gramophones.

Another article which will be of special interest in connection with remote control apparatus is one devoted to small electric motors. Many interesting varieties of small electric motors are now becoming available as the ingenuity of designers and manufacturers is turned in this direction. There can be little doubt that as electricity comes into more extended use, small electric motors designed for mains voltage will become increasingly important to the electrical engineer. Many opportunities for increased business and for worth-while inventions are likely to occur in this hitherto somewhat neglected side of the industry.

# ELECTRICITY AND ITS MANIFESTATIONS

By SIR AMBROSE FLEMING, F.R.S., Emeritus Professor of Electrical Engineering in the University of London.

A SCHOOL-MASTER once said to one of his boys, "Can you tell me what Electricity is?" The boy replied, "Please, Sir, I have heard, but I have forgotten." "Alas," said the School-master, "what a misfortune! The only person who ever knew what electricity is has forgotten it."

Thirty years ago we were all in the same state of ignorance, but now, thanks to the researches of eminent men, we do know something at least about electricity and its nature. We know, for instance, that it is composed of extremely small units which may be called atoms of electricity, and that these atoms are of two kinds which are called respectively



Fig. 1.—ARTIFICIAL LIGHTNING.

Lightning is a manifestation of electricity with which everyone is familiar. Here we see it in an artificial form, produced by a million volt flash-over between a metal plate and ball in the Extra High Voltage Laboratory of the Metropolitan Vickers Electrical Company.

*protons and electrons.*

The protons compose what we otherwise call positive electricity and the electrons are atoms of negative electricity.

The remarkable thing is that we cannot create one kind without at the same time creating an equal quantity of the other kind.

Yet there is a remarkable difference between them in many respects. For one thing the proton weighs 1,840 times as much as the electron and yet they are each equal in electric charge or quantity. If a proton and electron come together they annihilate or destroy each other as electricity and in place of it we have a flash of radiation of

some kind which is of the nature of light but cannot always affect the eye as light.

It had long been suspected, even from the time of the ancient philosophers, such as Democritus and Lucretius, that Matter—that is, anything we can feel or handle or that has weight—is built up of atoms, but it was not until the early part of last century that John Dalton (1766-1844) of Manchester reduced the idea to a scientific theory, and not until much more recently that we have gained unquestionable proof of the atomic structure of Matter. What is meant by this phrase is as follows.

If we could divide up a piece of metal, say silver, into smaller and smaller parts reaching at last little bits about one hundred millionth of an inch in size we should finally arrive at an ultimate particle which if divided would no longer be silver or have the properties of silver.

The progress of scientific knowledge has revealed to us that there are about 92 different kinds of material substances which are not apparently made up of or resolvable into anything else and we call these elementary substances.

Moreover there is an ultimate smallest particle of each which was called an atom of that element because it could not be cut or divided. All the thousands of various kinds of substance are now known to be built up of molecules or little groups or collections of some of these 92 elements, just as every written word in our language is made up of a group of some of the 26 letters of the alphabet.

### Two Remarkable Achievements of British Scientists.

These chemical atoms of the elements, as they are called, were until about the end of last century considered to be indivisible.

Then at that time Sir Joseph Thomson, the present Master of Trinity College, Cambridge, in a wonderfully able research proved that from all kinds of elementary chemical atoms we can extract the same kind of electrons or particles of Electricity.

Further researches by Lord Rutherford, who succeeded Sir Joseph Thomson as Cavendish Professor of Physics at Cambridge, enabled him to put forward the view that a chemical elementary atom

resembles the Solar system. There is at the centre a Sun, or nucleus as it is called, which consists of a tightly packed arrangement of protons and electrons and that round this at various distances other electrons circulate like planets.

This astronomical idea of the chemical atom has been of great use in suggesting and explaining other things.

### An Astonishing Conclusion.

The outcome of all this has been the conclusion that all Matter consists only of Electricity. This table at which I am now writing, this pen in my hand, nay, even my hand itself, consists of atoms each of which is nothing but a collection of particles of electricity—electrons and protons.

Everything in short is Electricity and there is nothing but protons and electrons held together by electric attractions in the physical Universe. Nevertheless we have not yet found out why the proton weighs so much more than the electron. Both of them, however, are very small compared with the overall size of an atom. Generally speaking we can say that about a hundred million atoms, say of copper, put in a close row would extend for about a distance of 1 inch. To count these atoms, if you worked at the job for 8 hours a day every day, would occupy you for nearly 8 years. Yet the proton and electron are no doubt very much smaller, as much smaller than a chemical atom as a pin's head is smaller than St. Paul's Cathedral. If we could see an atom sufficiently magnified it would probably appear to us merely like a swarm of a few dozen gnats flying round a pin's head in a space the size of Waterloo Station or any great railway terminus. An atom is in fact chiefly emptiness and what we call Matter only a collection of exquisitely small particles at great distances from each other compared with their size.

### A Step Further.

But we can go further. It has now been proved that what we call an electron is under some circumstances only some kind of wave. The word "wave" to ordinary persons merely suggests the

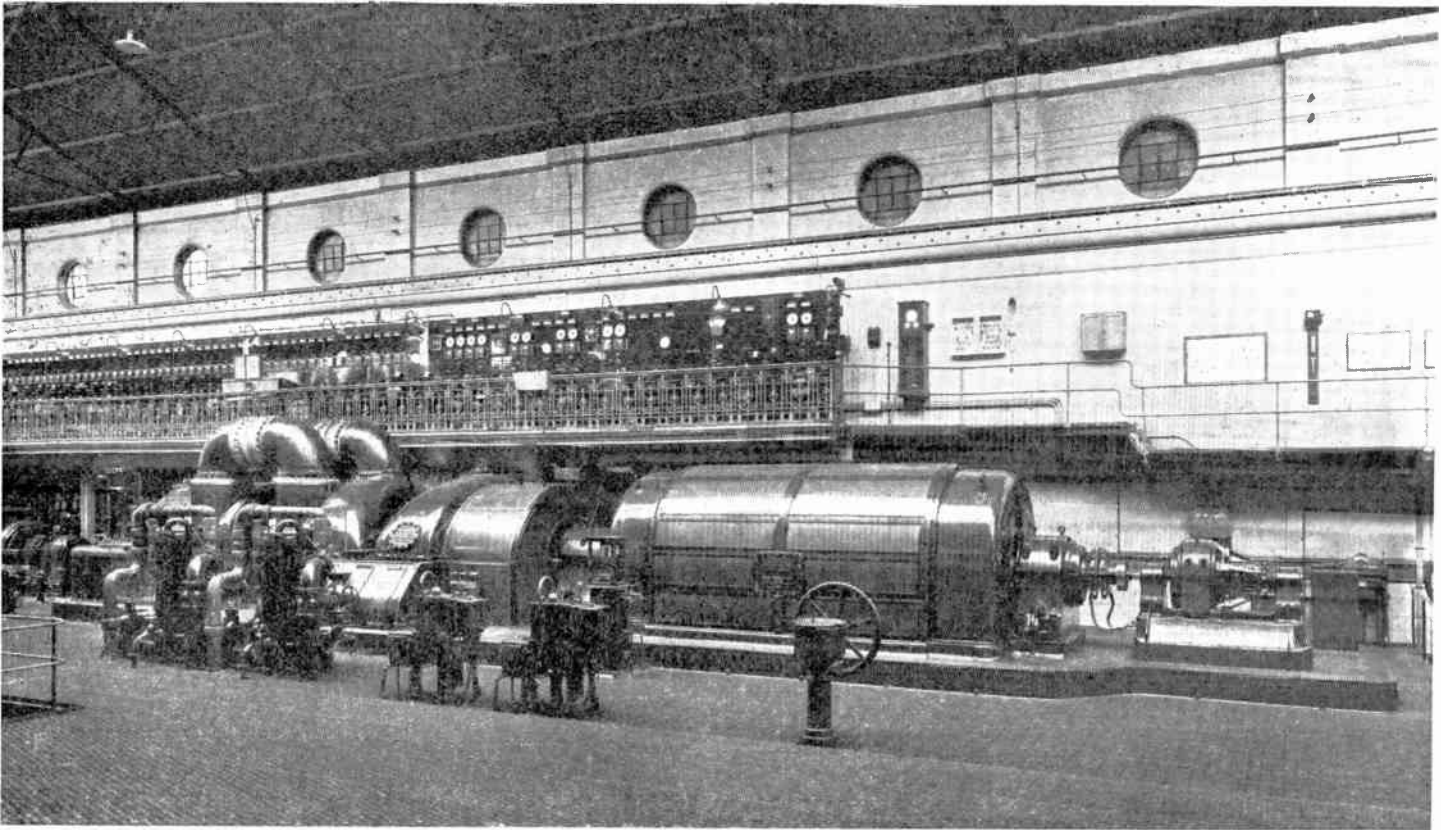

*Fig. 2.*—AN ELECTRIC GENERATING STATION.

The above illustration is a typical example of the immense machinery and equipment that is required to produce electricity in large quantities. It is a 30,000 kw. steam Turbo Alternator Set, working at 3,000 r.p.m. and forms part of the installation in the power station of the West Ham Corporation, and was manufactured by the English Electric Company, Ltd. This particular generating set is named "Elizabeth Reed," and was formally started by Mr. Herbert Morrison, M.P., in November, 1930.

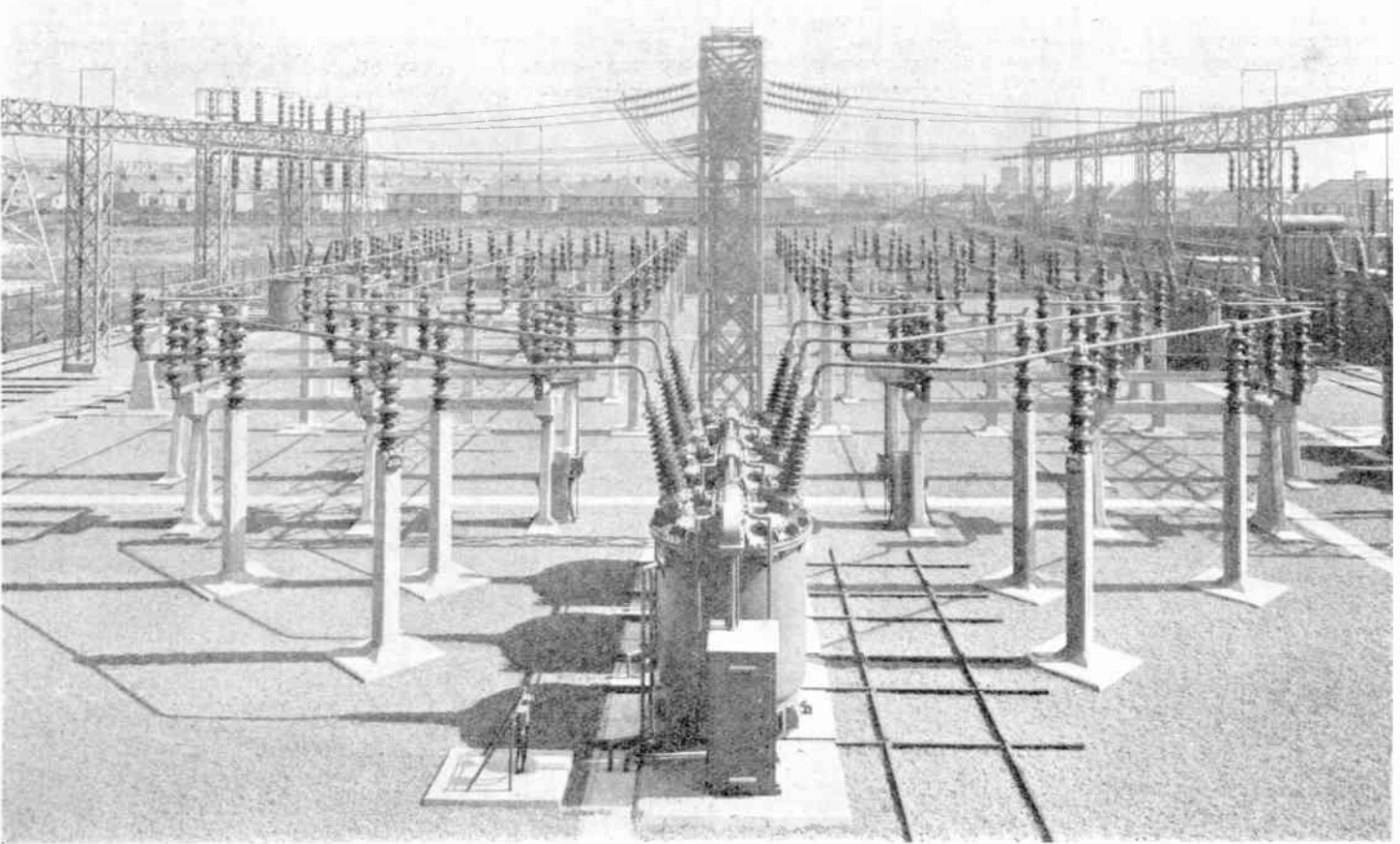

*Fig. 3.*—AN ELECTRIC SUBSTATION.

This vast network of wires and insulators is the "English Electric" 132-kv. Outdoor Switching Station at the Brighton Substation of the Central Electricity Board. In the foreground can be seen the Oil Circuit Breakers of  $1\frac{1}{2}$  million kv.A. rupturing capacity.



undulations on the surface of the sea or the splashing water on the beach.

In scientific work it has a much wider meaning. It means any kind of change which is repeated over and over again at the same place whilst the same kind of change is repeated again and again along a given line at the same time.

Thus for instance the air waves which create in our ears the sensation of sound and music consist of alternate condensations or compressions and rarefactions or expansions of the air at any one spot. The interval of time between two successive compressions at the same place is called the periodic time. On the other hand at any one instant the air along the direction of motion of the wave is at equidistant places alternately compressed and expanded.

The places of compression then shift along with a speed called the speed of the wave. Similarly an electric wave consists of a state called electric force which is periodic in space and time, that is, varies periodically. The waves we use in wireless broadcasting are of this nature, and the great philosopher Maxwell proved that what we call Light is only an electric wave, but the wave length is very much shorter than those used in wireless work. These electric waves are said to be waves

in the ether, but we do not know yet precisely their nature. Hence whatever part of Nature we investigate we find ourselves dealing with waves.

The wind raises surface waves on the sea. The splash of raindrops creates ripples or small waves on water pools. Musical instruments and explosions create waves of compression in the air. Electric discharges or sparks create waves of electric force in the ether. Now finally the most recent researches show that an electron probably consists of waves or at any rate behaves sometimes as a group of waves. But undulations or waves imply something that oscillates or undulates. What, then, is it that undulates to create an electron?

### **Fresh Fields to Conquer.**

We do not exactly know, but a name has been given to this unknown something. It is called *Psi*, which is a Greek letter ( $\psi$ ), and an electron is said to consist of a group of *Psi* waves.

The future will no doubt reveal to us the inner meaning of this mystery and carry us one stage further in penetrating into the wonders of Creation as exhibited to us by the explorations of Scientific research and especially the nature of Electricity and its manifestations.

## QUESTIONS AND ANSWERS

### **What is an Atom?**

An atom consists of a central nucleus with electrons circling round it like planets round the sun.

### **Can You Give an Illustration to Show the Size of an Atom?**

Yes. 100,000,000 atoms of copper in a row would extend for a distance of one inch.

### **What is a Nucleus?**

The nucleus of an atom consists of a tightly packed arrangement of protons and electrons.

### **What are Protons and Electrons?**

A proton is the smallest unit of positive electricity. An electron is the smallest unit of negative electricity.

### **In View of These Questions and Answers, What is Matter?**

Matter consists only of electricity. That is protons and electrons held together by electric attractions.

### **How Does the Weight of a Proton Compare With that of an Electron?**

A proton weighs 1,840 times as much as an electron.

### **What do the Latest Researches Tell Us About an Electron?**

That it probably consists of a group of waves.

### **In What Medium do these Waves Occur?**

This has yet to be discovered.



*Fig. 1.*—EARTHING THE CONDUIT.

Note how the earthing clip is used to connect the conduit to a water pipe. The surface of the conduit and of the pipe must first be scraped bright.

# ELECTRICAL INSTALLATION FAULTS, DANGERS AND REMEDIES

By T. LINSTEAD and H. E. J. BUTLER.

**T**HE efficiency of an electrical installation depends, to a very large extent, upon the quality of the insulating material used.

The principal insulators used in a household installation are rubber covering and its protective tape, porcelain and bakelite. The order in which they are given is that in which trouble is most likely to be found.

## Why Faults Develop in Rubber Insulation.

The faults likely to develop in this material are few, provided due care is taken in the original installation to prevent the covering being torn. After a period of time the rubber may perish and lose its insulating power, but this need only be looked for in houses that have been erected for a number of years. The majority of the troubles found are caused by the lack of proper preparation of the wire before connections are made. Binding tape carelessly cut and allowed to come into contact with live parts will give rise to leakage.

The ends of the conduit should be properly bushed as in Fig. 2 to prevent abrasion of the rubber by the rough edges. Flexible wires to heating appliances should be so placed that the direct heat is not focussed upon them, or this will tend to perish the rubber covering in a short time.

## When and How to Employ Porcelain as Insulation.

Where used as an insulating material, porcelain should be of the very best quality and highly glazed. This latter condition is essentially necessary where the porcelain is likely to be exposed to the slightest dampness. Unglazed porcelain

can be used effectively in heated positions such as fires or switches on fires, but if used in other places there is a likelihood that it will absorb moisture, and thus allow the current to leak.

## Bakelite.

This is possibly the most adaptable insulating material on the market at the present time. It is a chemical product of remarkable mechanical strength, and electrically its insulating properties are excel-

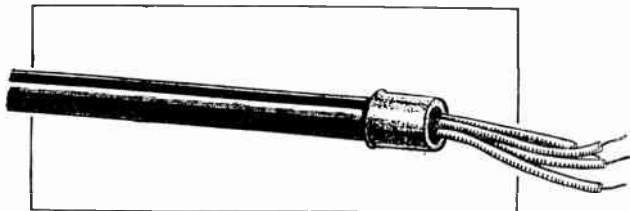

Fig. 2.—PREVENTING A LIKELY FAULT.

Showing how the ends of tubing should be bushed with brass or rubber to prevent abrasion of the insulation on the wires.

lent. In addition, it is light in weight and its texture is of such a nature as to render it waterproof for all practical purposes, and is admirably suitable for use in bathrooms and lavatories.

## Repairing Defects in the Insulation.

So much, then, for insulation. The only remedy for any defect in the two latter is replacement. In the case of rubber, should the general condition be poor and perished it is advisable to have the premises rewired, or if the condition is localised then the defective parts only need be replaced. Abrasion in the covering, if accessible, can be repaired by binding with rubber tape held in position by black adhesive tape.

## Naked Wires.

By naked wires we do not mean

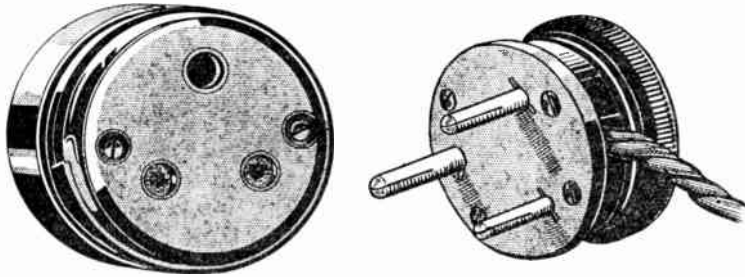

Fig. 2A.—A THREE-PIN PLUG AND SOCKET FOR THE BATHROOM.

The object of this is to allow the casing of appliances to be "earthed" by means of connection through the large pin. The top socket in the illustration on the left is connected to a water pipe.

uncovered by an insulating covering, but wiring that is not sheathed or enclosed in any protective metal such as lead or steel conduit. The existence of these in a building is evidence of slovenly workmanship, and, to say the least, is highly dangerous if such wiring is in a concealed position such as under floors or in roofs and walls. A broken wire in such a position may be the possible commencement of a serious fire caused by the current sparking from one broken end to the other and igniting the braid covering.

Most insurance companies now insist that all wiring shall be run in metal conduits with the exception of flexible wires connected to appliances.

**New Wires.**

When making additions to an existing installation, remember that wires are coloured for a purpose, all those "alive," and wires between switches and lights, should be red. All dead wires must be black. This is no idle precaution and will render the nature of your additions, i.e., "live" or "dead," as easily

the adjacent piece, either by direct fixed contact or by a connecting wire, and that at some point a wire shall be joined between the conduit and a suitable earth, invariably a main water pipe.

The reason for this connection is to allow the current to flow to earth, thereby melting the fuses in the event of the tubing becoming "live" through any fault in the wiring.

Without this earth connection, a person touching the tubing, in the event of fault, causing it to be live, would receive a severe shock.

The size of the wire used for earthing connections should be thicker than any

distinguishable to the person coming after as you wish to find those of the person before you.

**Earthing.**

The conduits must be electrically continuous and connected to earth, or, in other words, each separate length of tube or lead casing must be connected to

either by direct fixed contact or by a connecting wire, and that at some point a wire shall be joined between the conduit and a suitable earth, invariably a main water pipe.

The reason for this connection is to allow the current to flow to earth, thereby melting the fuses in the event of the tubing becoming "live" through any fault in the wiring.

Without this earth connection, a person touching the tubing, in the event of fault, causing it to be live, would receive a severe shock.

The size of the wire used for earthing connections should be thicker than any used in the installation to allow the current an easy path.

**Bathroom Appliances**

As we have seen that an earth connection is made *via* the water pipe, it will be a simple matter to explain a very common yet serious omission in the bathroom, namely, that of earthing, all switches and appliances. Such a state of affairs

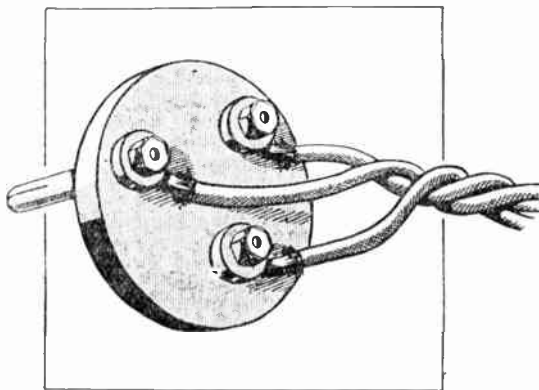

Fig. 3.—A THREE-PIN PLUG-CONNECTION.

The centre wire has its other end joined to a metal part of the casing of the appliance.

should be made compulsory, but failing this it would be as well for the individual to assure himself that he at least is not contributory to the negligence.

In the case of an ordinary electric fire connected by means of *two* wires only to a wall socket, there is a possibility that the metal casing of the fire may come into contact with the current through some fault, perhaps in the flexible connection. If this is touched by a person standing in the bath, or outside but in contact with it, the current immediately flows to earth *via* the person's body, the bath and water pipe, and often with fatal consequences.

Electricity will always flow to earth *via* the path of least resistance, if, therefore, we connect the metal casing direct to earth by means of a copper wire, any leakage would be diverted in this direction and not through the person. For this purpose a three-pin plug and socket is used as in Fig. 2A. The centre terminal of the socket is connected to the nearest water pipe, while the centre pin of the plug is connected to the metal casing of the appliance by means of a third wire plaited in the flexible cable as shown in Fig. 3.

### Switch Covers.

It is not always convenient to "earth" the lighting switches as explained above, and in such cases it is an advantage to have all exposed surfaces made of an insulating material such as bakelite.

### Words of Warning.

As a last precaution in the bathroom be sure that all switches and appliances are *fixed* in such a position that renders it impossible for them to be touched by anyone standing in the bath, and make a steadfast rule never to handle anything electrical with wet hands or when any part of the body is in water.

### Overloading of Lighting Fuses.

It is usual in an ordinary house for a lighting system to be wired capable of carrying five amps. on the complete installation, and to calculate the number of watts that may be used, the amps., namely five, are multiplied by the voltage of the supply, which, in this instance, we will assume is 200. The number of watts therefore is 1,000. There is, however, always a margin of safety above this limit. Such an installation is usually divided into two sub-circuits, and the fuses controlling these are of 3-amp. fuse wire. Now, as we have seen above, 3 amps.  $\times$  200 volts equals 600 watts, and the sum of the watts of all lamps

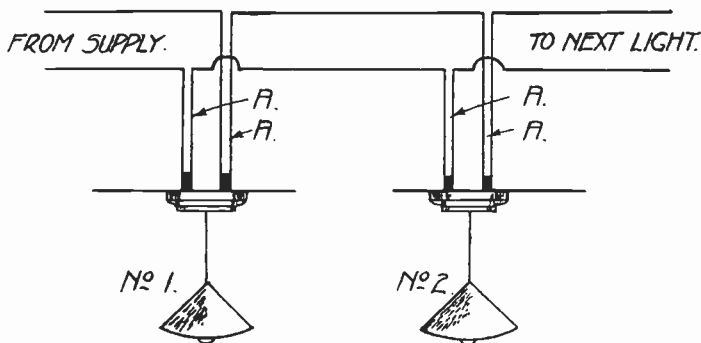

Fig. 4.—" LOOPED " WIRING.

The wires A A in light No. 1 are looped to supply No. 2, and those in No. 2 are looped to supply the next light, and so on.

and appliances carried on any sub-circuit should not exceed this number.

### Care in the Use of "Power."

The more current that is used throughout an electrical installation at one time, the more should be the care exercised in handling it. The reason for this being that the amperage of a current rises with the number of watts used, and in heavy current lies increased danger.

Too much care, therefore, cannot be taken when dealing with electric fires, cookers or coppers, etc., and additional connections should never be made without first calculating the amount of extra current that will be passed, ascertaining that the materials to be used are of the correct size, and, lastly, that the existing

fuses, wiring and switches, etc., are capable of carrying the additional load.

**Calculating the Current.**

To illustrate this let us assume that our house is wired with three power plugs of sufficient size to enable us to use only three 2-kilowatt fires. A kilowatt equals 1,000 watts.  $3 \times 2$  kw. therefore equals 6,000 watts. If our supply is 200 volts and all fires are switched on at the same time, our main switch and fuses are carrying  $\frac{6,000}{200}$  equals 30 amps.

We should find, however, that the three plugs were each separately connected to a distribution board and that each pair of fuses on this board would be carrying one-third of the load, namely, 10 amps. This would mean that the plug and socket connections to the fire should be of the 15-amp. type to allow a margin of safety.

**Increasing the Current.**

If we now decide to use three 3-kw. fires in place of the 2 kw., let us see what happens:  $3 \times 3 \times 1,000$  equals 9,000 watts.  $\frac{9,000}{200}$  equals 45 amps. This is 15 amps. more than our main fuses are designed to carry, and they would immediately fuse.

You may now consider replacing them with heavier fuses, which is decidedly wrong; for it is possible that the main switch and meter are installed to carry only 30 amps., the result being that heavier fuses would carry the excess current and cause the switch to get hot and eventually burn out with the probable commencement of fire.

**“Looped” Wiring.**

Lighting points are invariably looped, that is, the cables are carried from point to point as shown in Fig. 4 owing to the small amount of current carried. This practice should never be carried out in the case of “power” wiring.

The fault of this practice lies in the fact that two plugs looped are equal to one only in carrying capacity, therefore a 3-kilowatt fire may be used on one plug only and nothing on the other, provided the plugs are of the 15-amp. type.

If two fires are used the aggregate must not exceed 3 kilowatts.

Where there is likely to be any doubt regarding the amount of current to be carried it is best to remove the wiring from the loop between the two plugs and connect a new pair of wires with a separate pair of 15-amp. fuses between the second plug and the mains.

**Sizes of Wires.**

The accompanying table shows the sizes of wires together with their safe current-carrying capacity, and should be consulted before

executing any additional wiring:—

Number and Diameter of wires comprising the Conductor	Safe Amps. Carried	Used for
1/.044 inches	6.1	Lighting
3/.029 ”	7.8	
3/.036 ”	12.0	
1/.064 ”	12.9	Heating
7/.029 ”	18.2	

Also one can determine from the size of wires already installed the maximum current that may be passed through them.

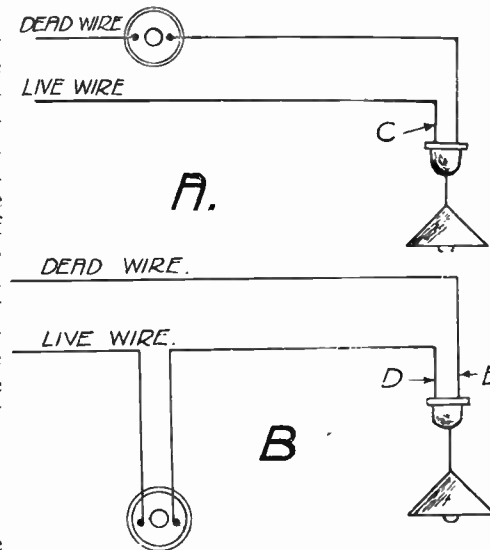

Fig. 5.—WHERE TO INSERT A SWITCH.

A shows the switch in the wrong position since point C is always alive whether the switch is on or off. B shows the correct position for when the switch is off both points D and E are dead.

**Flexible Cables.**

The sizes of flexible cables that should be used are also governed by the work they are required to do and often we find that little attention is given to this. For example, a bowl fire passing 3 amps. will be connected to a lighting pendant, the flexible cable of which is designed to carry, say, 1.8 amps., thus causing a 60 per cent. overload. This causes heat to be generated in the wire and in time will perish the insulation. If this fault is exaggerated and a 3-kilowatt fire connected to a power plug by means of the same size flex, the amount of heat generated would be so great as to burn the covering of the flex, melting the wire at the same time.

The following table will therefore be found a useful guide when requiring to make flexible connections:—

Number and Diam. of Wires comprising the Flexible Cable.	Maximum Amps.	Suitable for connecting to the following Appliances.
14/.0076 Inches	1.8	Lighting
23/.0076 ..	3.0	Lighting
40/.0076 ..	5.0	Irons or bowl fires.
70/.0076 ..	8.5	1 to 1½ kilowatt fires
110/.0076 ..	13.0	2 to 2½ kilowatt fires
162/.0076 ..	17.0	3-kilowatt fires

**Weight of Pendants.**

Another likely source of trouble is the overloading of the flexible cable by the weight of fittings suspended from them.

It can be readily understood that flex is not made to carry unlimited weight and that some rule must govern if trouble of breakage and the possible short circuit is to be avoided.

The recognised weights carried on respective size cables are:—

- 14/.0076 maximum weight 3 lb.
- 23/.0076 .. .. 5 lb.
- 40/.0076 .. .. 10 lb.

If a fitting to be suspended exceeds 10 lb. in weight, it should be supported by sufficient cords to ensure that each separate cord is not subjected to more than

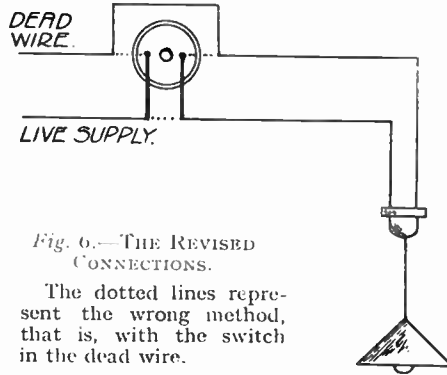

Fig. 6.—THE REVISED CONNECTIONS.

The dotted lines represent the wrong method, that is, with the switch in the dead wire.

the maximum applicable to it. For example, a fitting weighing 15 lb. could be suspended by means of three 23/.0076 cables, as each cord would be carrying its maximum weight of 5 lb. It is advisable, however, to use some safer means of support for the heavier fittings, and the majority are now supplied with chains.

**Switch connections.**

There are two main functions necessary in the action of a switch. The first is to break an electrical circuit or to make it at will, in other words, to switch the current on or off, and usually it will do this from any position in the circuit that it may be placed, as in Fig. 5, A and B.

The second function necessary is that the switch shall render all "exposed" points free from electricity when it is in the OFF position. Contrary to the last condition it *cannot* do this from any position, but must be placed between the "live" point of supply and the point to be protected. "A," Fig. 5, shows the switch in the wrong position, while "B" is the correct one.

If we examine "A," Fig. 5, we notice that the pin of the lampholder is always "alive" and therefore if touched by a person standing on the ground a shock would be felt owing to the connection being made to "earth." But if we examine "B" in Fig. 5 we see that when the switch is in the OFF position, no current can reach the lampholder or any wiring beyond the switch itself. If the switch is in perfect condition the cover must be removed before a live point is exposed, and this would not be done by accident.

**Testing for Wrong Connections.**

To satisfy oneself that the switches are correctly connected is an easy matter. An ordinary lampholder, to which has

been connected a piece of twin flex, and a lamp inserted in the holder, is all that is necessary. To test a lamp fitting, place the switch "off," and remove the lamp, fasten one end of the testing flex to the nearest water pipe or convenient earth—*NOT* a gas pipe—and with the other end of the flex carefully touch each pin of the holder in turn. If the lamp lights the switch is in the dead side, and is not serving its purpose.

#### The Remedy.

When making this test it will be found that the lamp will light from one pin

only, and the wire connected to this pin is the "live" one. Trace this wire back to a point near the switch and cut it. Join a piece of wire to each of the ends to extend to the switch. Disconnect the existing wires in the switch, and connect the new ones. Join the two ends together that have been removed and carefully insulate them with rubber and tape, or, better still, a china connector, and tuck them behind the switch. Fig. 6 shows the revised connections.

Plugs may be tested in the same way, and the remedy is similar. The switch must always be placed in the "live" wire.

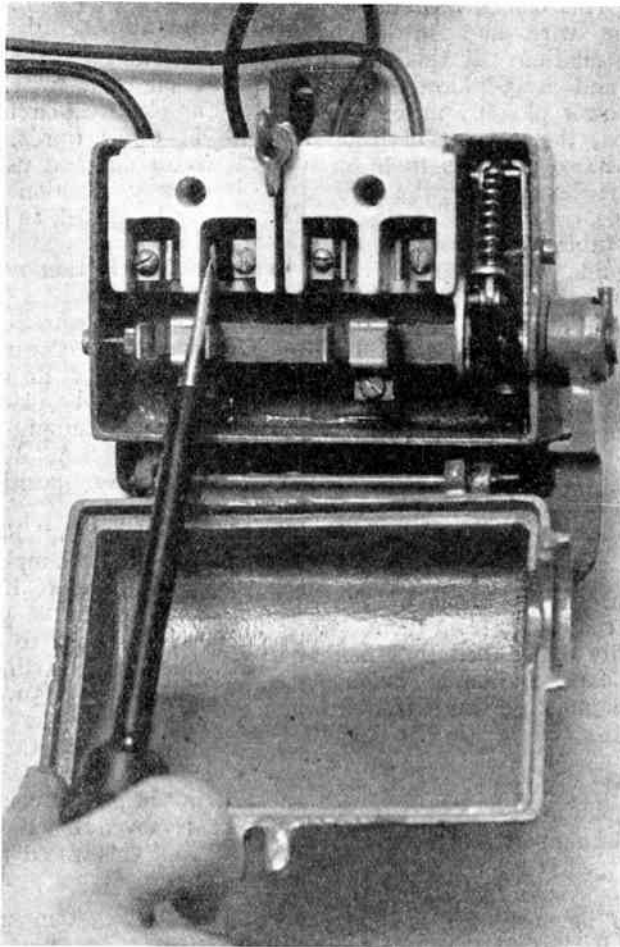

*Fig. 7.*—A FAULT ON THE MAIN SWITCH, And how to rectify it. Note that the slot for the switch blade is too wide for a good contact to be made. Use an insulated screwdriver to adjust it, as shown.



**One light fails suddenly while other lights in the same circuit are O.K.**

CAUSE.—Bulb burned out.

REMEDY.—Replace bulb with one known to be all right.

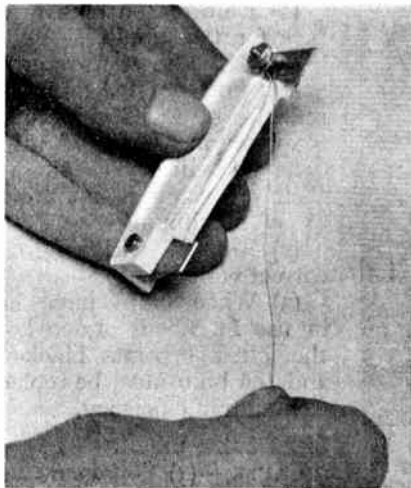

Fig. 8.—MENDING A FUSE. THE RIGHT WAY.

The fuse wire must be securely fixed underneath the terminal screws.

feeding the lights in question, or loose connections of cables at distribution box.

REMEDY.—Wiring must be replaced after cause of wire rupture has been remedied. This fault is uncommon

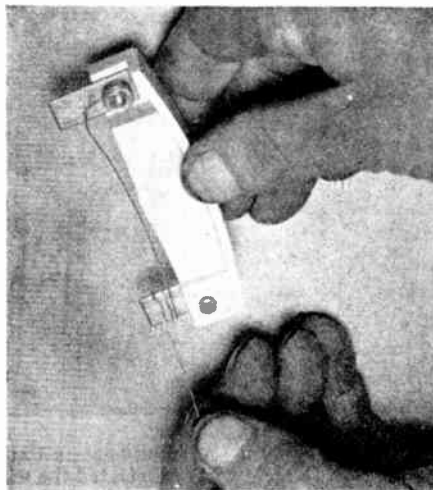

Fig. 9.—MENDING A FUSE. THE WRONG WAY.

Never replace the fuse wire in this careless fashion.

**New bulb does not light when placed in holder.**

CAUSE.—Cable or flex broken in the circuit particular to that light.

REMEDY.—Since several lights are branched off one pair of wires, the trouble is very unlikely to be in the conduit. New flex is the remedy.

**New bulb burns out quickly.**

CAUSE.—Voltage rating of bulb too low for the supply.

REMEDY.—Ascertain the correct voltage of the mains with a voltmeter, or from the supply company, if the voltage given on the supply meter is doubted.

**Several lights fail simultaneously.**

CAUSE.—Subordinate fuse on distribution box is blown.

REMEDY.—If the fuse has blown through an accidental short-circuit, replace fuse and all should be in order. (See also under fuses.)

**Several lights fail simultaneously, but the fuses are intact.**

CAUSE.—Break in wire of main circuit

in a properly protected installation.

**All lights flicker simultaneously.**

CAUSE.—Slight interruption in the supply, or loose connection of wiring at the distribution board or main switches.

REMEDY.—Examine all the terminals at the distribution board and tighten up any loose connections. If this does not cure the trouble examine the main switch and ensure that the blades are making firm contact.

**All lights fail simultaneously.**

CAUSE.—(1) Unless main switch has been opened this indicates the blowing of a main fuse. Failure of the main wiring is unlikely unless the system is badly overloaded.

(2) Failure of supply.

REMEDY.—(1) Replace main fuse.

(2) This is verified by connecting a bulb or voltmeter across the live terminals of the main switch. Where a public supply fails frequently and it is important to

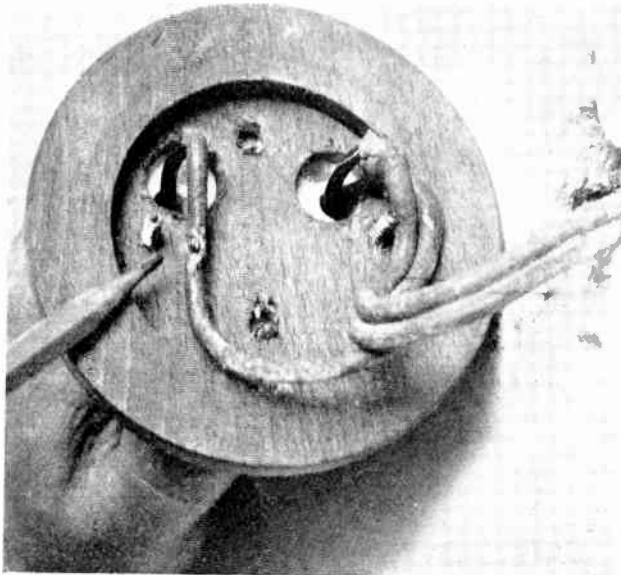

*Fig. 10.—A TROUBLESOME FAULT.*  
Note how the screw has penetrated the wire insulation.

maintain uninterrupted lighting, an automatic emergency lighting plant must be installed.

**Lights fail slowly (private lighting plant).**

**CAUSE.**—The battery is discharged, due to overcharging or failure of the dynamo to supply the demands of the system.

**REMEDY.**—Unless the batteries have a large reserve capacity the dynamo should be run at least part of the time during which the lights are in use. When the battery becomes discharged in spite of the fact that the dynamo is running when the lights are burning, then the dynamo is too small for the

demand of the system, and a bigger machine must be installed.

**Light dim.**

**CAUSE.**—(1) Bulb or reflector dirty.

(2) Bulb of too high a voltage for the supply.

(3) Bulb almost worn out.

**REMEDY.**—(1) Clean bulb or reflector by washing in slightly soapy warm water. If this is done periodically to all bulbs their efficiency is maintained at a maximum.

(2) Replace with bulb of correct voltage.

(3) When bulbs have been in use for about 1,000 hours the glass becomes blackened and the bulb must be replaced to maintain efficiency.

**Light extra bright.**

**CAUSE.**—(1) Voltage rating is too low.

(2) Voltage of supply abnormally high

**REMEDY.**—Replace with a bulb of correct voltage. The useful life of a bulb is considerably shortened by using it on a voltage higher than that for which it is rated.

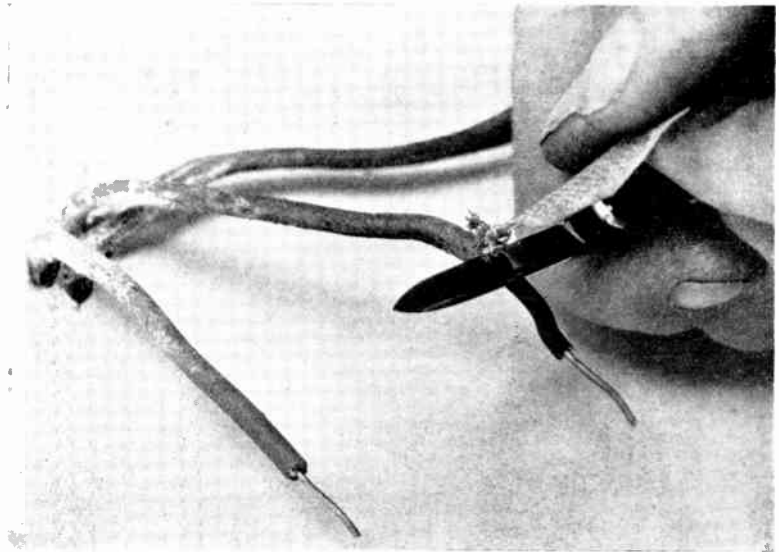

*Fig. 11.—STRIPPING BRAID. RIGHT AND WRONG WAY.*

**Light flickers when switched on.**

CAUSE.—Switch blades not making firm contact.

REMEDY.—Overhaul switch or replace by new one.

**Light flickers when bulb is knocked or blown about by the wind.**

CAUSE.—(1) Bad contact of the lamp-holder plungers on bulb cap.

(2) Loose connection of flex to holder.

(3) Flex worn at the point where it enters the cord grip.

REMEDY.—(1) Replace lamp-holder or dismantle it and improve the spring tension on plungers.

(2) Tighten connecting screws of lamp-holder. If the screws are stripped, the holder must be replaced.

(3) Cut off the defective end and re-connect.

**A bulb, known to be efficient, fails to light when inserted in a lamp-holder.**

CAUSE.—Clamping ring of holder loose, or porcelain piece cracked, allowing the plungers to twist out of registration with the bayonet fitting.

REMEDY.—Dismantle lamp-holder and reassemble, taking care to see that the grooves in the porcelain register with projections on the holder parts. If the porcelain is chipped so that it does not maintain its proper location in the case, the holder must be renewed.

**Bulb loose in cap, and when a bulb is twisted to remove from the holder, a short circuit is formed.**

CAUSE.—Heat from bulb has destroyed the efficiency of the cap cement; or the mechanical strength of the cement is low.

REMEDY.—This fault is usually confined to inferior grades of bulbs. The only remedy is to replace with a reliable make.

**Subordinate fuse blows.**

CAUSE.—(1) Accidental short-circuit.

(2) Fuse wire too thin.

(3) As a consequence of the fuse wire becoming corroded its fusing current is lowered after some considerable time.

REMEDY.—(1) Replace fuse and, if possible, remove the cause of the short-circuit to avoid a recurrence of the trouble.

(2) Replace with fuse wire of the correct gauge, making sure in so doing that the



Fig. 12.—SHOWING WORN FLEX.  
A frequent cause of a blown fuse.

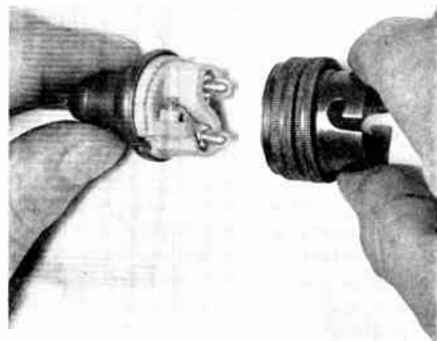

Fig. 13.—ASSEMBLING THE LAMP-HOLDER.  
THE RIGHT WAY.  
Note position of pins relative to bayonet cap.

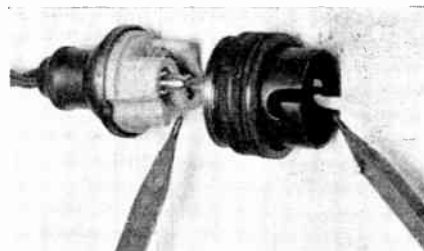

Fig. 14.—ASSEMBLING THE LAMP-HOLDER.  
THE WRONG WAY.  
Note position of pins relative to bayonet cap. (Compare with Fig. 13.)

wiring will stand the higher current.

- (3) Replace with new fuse wire.

#### **Subordinate fuse blows after being replaced.**

CAUSE.—Short circuit in that part of the system particular to the fuse in question.

REMEDY.—With the main switch open, disconnect the wires which feed these lamps from their fuses and remove all the bulbs from their holders. First, with the switches off and then with the switches on, test each pair of wires for the short-circuit with a voltmeter and battery. If there is no short-circuit indicated with the switches off, but a short-circuit is located with a switch on, then the fault lies between that switch and the light. If no short is indicated either with the switches on or off, then one of the bulbs is internally shorted. Test each bulb before replacing.

#### **Main fuse blows, but subordinate fuses are intact.**

CAUSE.—(1) If the main fuse is as heavy as the system will stand, then the installation is overloaded.

(2) Wire of subordinate fuses too heavy, with the result that total fusing current of all subordinate fuses exceeds the fusing current of the main fuse.

(3) Main fuse is copper and the subordinate fuses are lead or tin.

REMEDY.—(1) The system must be re-wired to withstand the extra demand before the rating of the main fuse is increased.

(2) Replace subordinate fuses with thinner wire so that the total fusing current of these does not exceed the fusing current of the main fuses.

(3) Copper wire of the same rating fuses quicker than lead or tin, so that it is possible under these conditions for a main fuse to blow on short-circuit, although the subordinate ones are correctly proportioned. The remedy is to have tinned copper fuses throughout, or tinned copper subordinate fuses and lead main ones.

#### **Fuse blows at regular intervals—say every ten days.**

CAUSE.—(1) The fuse wire is subject to some corrosive action such as acid fumes,

or the fuse box being too near to a gas cooker or furnace.

(2) The overloading of a fuse will also cause this defect where the load is steady.

REMEDY.—If it is impossible to move the fuse board away from the corrosive action of the fumes to which it is subject, airtight fuse boxes must replace the ventilated ones. A fuse should not be rated to blow at less than one and a half times the normal current required by the installation. It will not then run hot in use and corrode.

#### **Fuse box is overheated after lights have been running some time.**

CAUSE.—(1) System overloaded but not to a dangerous extent.

(2) Loose connection to fuse terminals which causes sparking or high resistance contact.

(3) Heat conveyed from adjacent faulty or overloaded switchgear.

REMEDY.—Although a large fuse, e.g., for a power circuit, becomes perceptibly warm when the installation is run at its maximum capacity, the heat should be quite bearable to touch. If on totalling up the loading of the fuse it is found that the circuit is not overloaded, dirty or insecure wiring must be looked for and remedied.

#### **Cables get hot.**

CAUSE.—Cables overloaded and fuses of too high a rating for the circuit.

REMEDY.—The overloaded part of system must be re-wired with heavier cables and the fuses proportioned to suit.

#### **Flex above light gets hot.**

CAUSE.—This is due to a large half-watt bulb conveying the heat to the flex. If excessive it may be found that the mica disc above the filament has become dislodged, which causes heat to be conveyed to the flex via the live metal parts of the lampholder.

REMEDY.—This is not usually a dangerous defect, although after some time it perishes the rubber insulation of the flex. Where the mica disc above the filament has become dislodged, a new lamp is fitted. This heat insulating disc is not found in bulbs under 150 watt rating.

**Supply meter registers when all switches are off.**

CAUSE.—Bad leak in the wiring caused by dampness or breakdown of the cable insulation. A very slight leak which must always exist is not sufficient to cause the meter to register.

REMEDY.—The leak must be located by systematically testing each circuit separately. Disconnect the main leads to the distribution box, after removing the main fuses. Do not rely on the main switch to isolate the supply from the system as this may be leaky. With the aid of a "Megger," or other type of portable megohm meter, measure the insulation resistance across each circuit individually at the points of distribution.

**"Megger" gives a reading of less than one megohm on an individual circuit.**

CAUSE.—Faulty insulation in some part of this circuit, either in the wiring or switches belonging to that circuit.

REMEDY.—Examine switches and wiring for dampness. If possible, examine the wiring for perished insulation. After making sure that no fittings connected with the faulty circuit are causing the leak, the old wire is renewed.

**"Megger" gives a reading of more than five megohms on each distribution circuit, but supply meter still registers with consumer's main fuses out.**

CAUSE.—(1) Low insulation confined to the fittings or wiring supplying the current to the distribution board.

(2) Fault in supply meter.

REMEDY.—Test the insulation of the main circuit between the live side and earth, with the main fuses removed. If the "Megger" still shows no leak, then

the fault must lie in the meter itself, in which case the supply company must be informed without delay.

**Supply meter does not register any consumption when lights are on.**

CAUSE.—Meter out of order.

REMEDY.—Supply company must be told immediately this is noticed, or the company may over-estimate the time which the meter has been out of order.

**A shock is felt when a light is switched off.**

CAUSE.—Knob is making contact with some live part of the switch, or insulation broken down.

REMEDY.—When this happens a switch is worn out and should be replaced, especially in a bathroom, where one is liable to receive a dangerous shock when the hands are wet.

**Shock felt from flex, especially with adjustable pendants.**

CAUSE.—Flex worn through the continual pulling up and down of the light, so that some of the strands protrude, although the insulation looks all right.

REMEDY.—Renew with a good quality flex and see that the wheels of the weight and ceiling rose are not rough, or stiff to rotate.

**Shock felt on touching some part of conduit.**

CAUSE.—Leak to earth of some part of the wiring and conduit not properly earthed.

REMEDY.—Trace leak as when meter registers when the lights are off. Examine earthing wires, if any, to ensure they make proper connection with the conduit and earth. Examine joints in conduit. Make good any missing or broken earthing wires.

# ELECTRICAL ENGINEERING MATERIALS

## ALUMINIUM AND ITS ALLOYS

By A. W. JUDGE, A.R.C.Sc., D.I.C., Whitworth Scholar

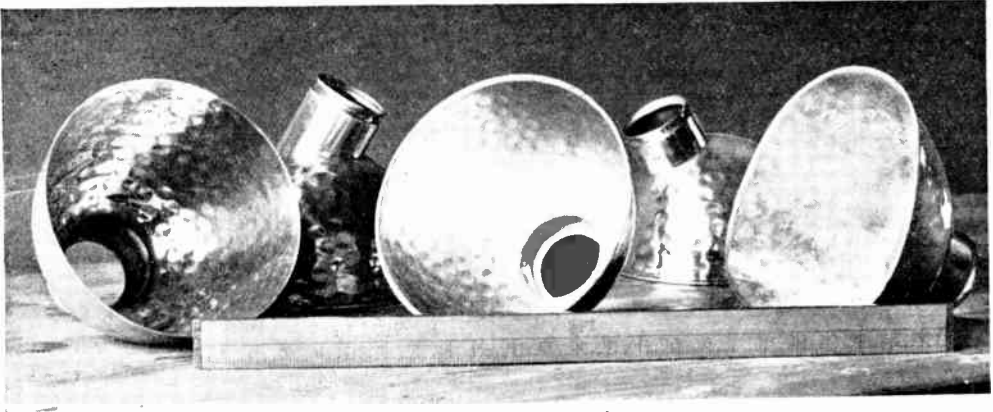

Fig. 1.—How ALUMINIUM HELPS ILLUMINATION.

Scientific illumination by electricity is largely a problem of reflectors, and aluminium reflectors such as those shown above are particularly useful for flood-lighting and direct display purposes. The absence of breakage in storing, handling and service increases their value when compared with glass reflectors. The rule in the foreground is 2 ft. in length. (*London Aluminium Co. Ltd.*)

**O**F all the commercial metals used in electrical engineering work, aluminium is one of the most important. Although inferior to copper in its electrical properties, the fact that it is only about one-third of the latter's weight actually gives it a superiority over copper for many electrical applications. It is for this reason that the use of aluminium for cables, conductors, bus-bars, field windings of coils, lamp-holders, etc., is extending fairly rapidly in electrical work.

### Some Properties of Aluminium.

Aluminium, after magnesium, is the lightest commercial metal available. It has a specific gravity of only 2.7 as against 8.9 for copper. Thus, a given volume—say, 1 cubic inch—of copper weighs about  $3\frac{1}{3}$  times as much as the same volume of aluminium.

On the other hand, copper is a better conductor of electricity than aluminium,

the two conductivities being as 100 to 60; copper, then, has  $\frac{100}{60}$  or  $1\frac{2}{3}$  better conductivity.

Let us express this fact more clearly by mentioning that an aluminium conductor of the same length and resistance as copper will have a cross-sectional area  $1\frac{2}{3}$  greater than that of the copper.

### Weight Only Half of Copper for Equal Conductivity.

Now, the important point here brought out is that although we require 66 per cent. greater area, the same length of aluminium conductor of this greater area will only weigh about *one-half* that of an equal length of the copper. Expressed in as simple a way as possible, an electrical conductor of aluminium will weigh only one-half as much as a copper conductor of equal electrical resistance and of the same length.

This big advantage of light weight is

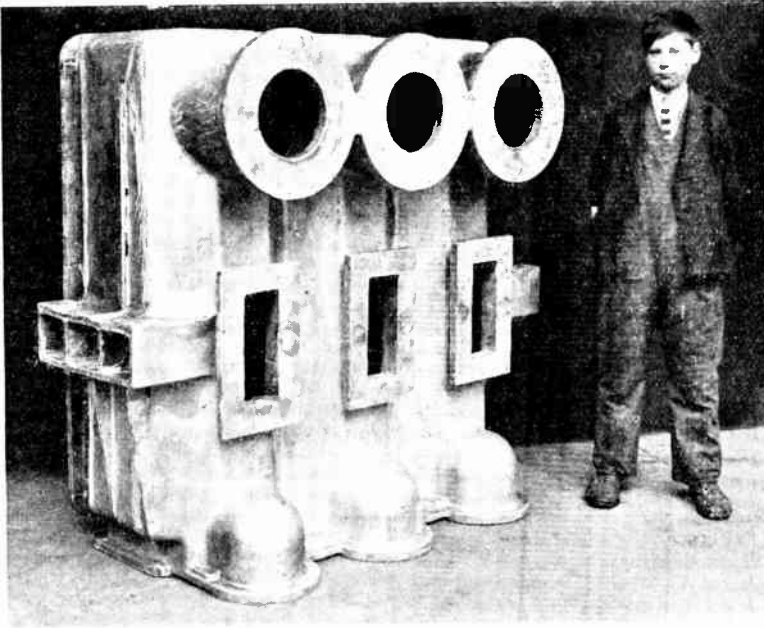

Fig. 2.—A HUGE ALUMINIUM ALLOY CASTING.

This oil-proof chamber for large metal-clad switchgear was cast in Wilmil Aluminium Alloy for the English Electric Company, Ltd., and some idea of its size can be obtained by the figure standing beside it. (*William Mills, Ltd.*)

one of the chief reasons why aluminium is being used to such a wide extent in favour of copper in many electrical applications.

### Strength in Tension

Aluminium in the form of drawn wire has a tensile strength of about 11 tons per sq. in., whereas drawn copper wire gives a strength of 20 to 24 tons per sq. in.

For electric overhead cables, therefore, copper

is stronger in tension and there is little to choose in regard to the weight of aluminium and copper cables of equal electrical resistance.

### Where Aluminium Cable is Used.

In order to utilise aluminium cables to a greater advantage they are now frequently made with an inner core of high tensile steel wire. Aluminium cables for overhead lines are now being used to an increasing extent; to mention but one



Fig. 3.—ALUMINIUM METER CASES.

Showing some types of casings and housings for watt-hour and other types of meter. (*London Aluminium Co., Ltd.*)

example, the Ontario hydro-electric scheme uses a 110,000-volt overhead aluminium strand cable.

### Corona Discharge Obviated.

Incidentally, the use of aluminium often entirely obviates the electrical loss in high voltage overhead cables, known as the "corona" discharge; the latter is caused by the breakdown of the resistance of the air surrounding the cable, due to the high voltages used.

### Aluminium for Bus-bars.

Aluminium is now being employed in switch-board work for bus-bars and similar conductors in large generating stations and sub-stations. In this case it is the temperature rise that determines the size and material of the conductor. Here aluminium is superior to copper as the larger cross-section, or volume, gives a greater surface from which to radiate the heat caused by the flow of current through the bus-bar.

### Windings.

Another important application of aluminium in electrical work is for the winding of electrical machines, e.g., dynamos, converters,

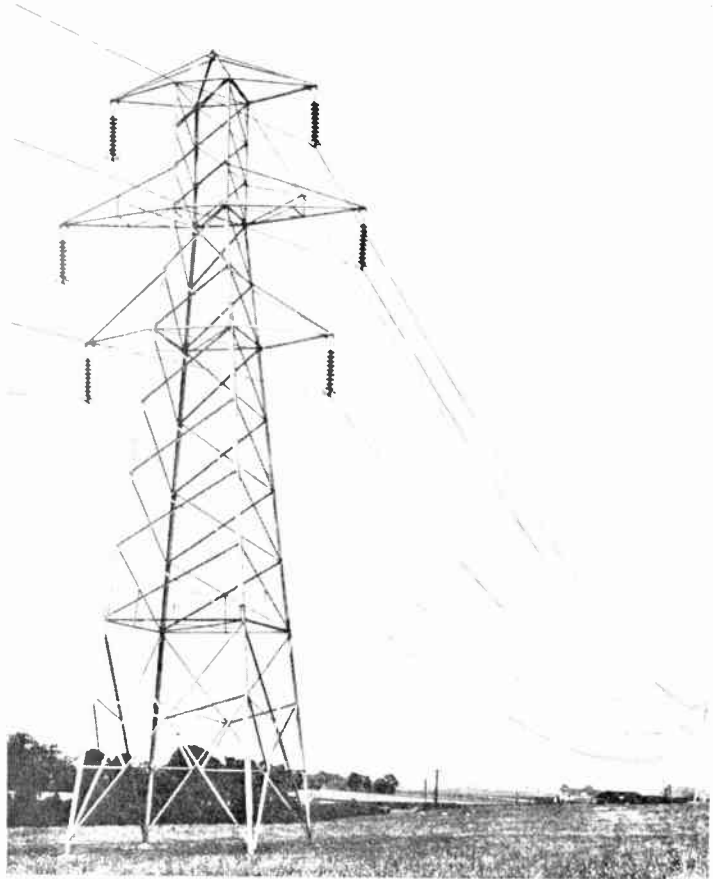

Fig. 4.—STEEL-CORED ALUMINIUM TRANSMISSION LINE. (*British Aluminium Co., Ltd.*)

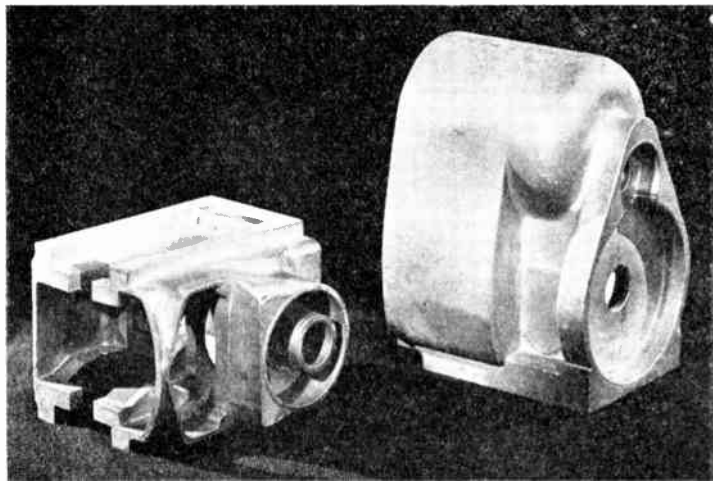

Fig. 5.—SHOWING A DIE FOR MAGNETO CARCASES CAST IN ALUMINIUM ALLOY. (*Messrs. Die Castings, Ltd.*)



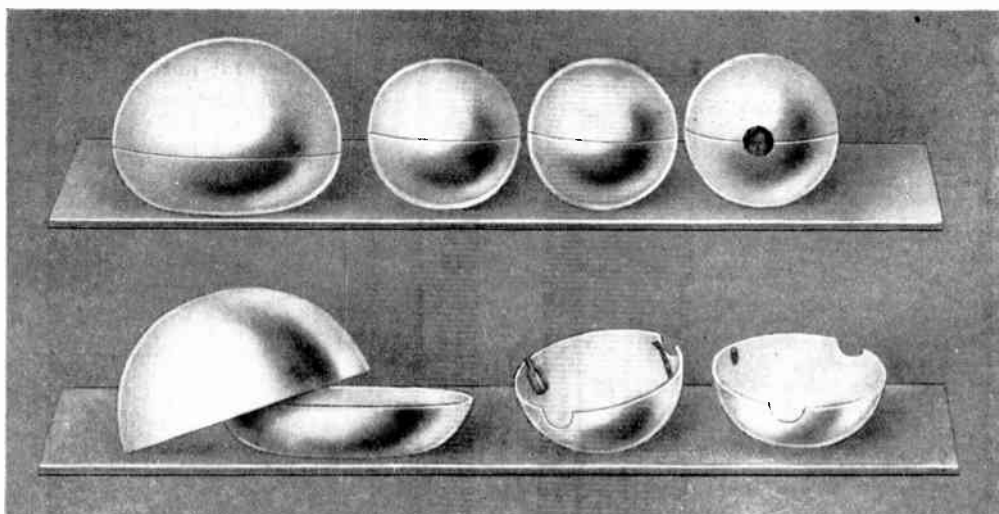

Fig. 6.—THE USE OF ALUMINIUM FOR MODERN HIGH-TENSION EQUIPMENT.

Aluminium stampings and spinnings are especially applicable for electro-static grading shields for transformers. (*London Aluminium Co., Ltd.*)

chokes and transformers. During the war, owing to the serious shortage of copper in Germany, aluminium wire was used for the winding of electrical machines. The latter proved so satisfactory that in view of the cheapness of this method it has since been used more widely. Coils wound with aluminium wire are not only cheaper than similar ones using copper wire, but are lighter and have better heat radiating qualities, thus permitting high current densities.

#### Oxide Coating as Insulation.

Nowadays, instead of using cotton and silk insulation coverings, methods have been adopted whereby the aluminium wire is given a coat of oxide which acts as the insulation. Incidentally, wire thus treated is practically immune from corrosion.

In one method it has been found commercially practicable to wind magnet and other coils with the oxide-coated bare aluminium wire, provided that extra insulation is used between the layers of the coils; many electro-magnets made by this method are now on the market. In a somewhat similar manner choke coils are wound with aluminium wire.

#### Uncertainty With Soldered Joints.

Aluminium cannot be soldered except with difficulty due to the formation of oxides in the joint. There are many so-called aluminium solders on the market, but very few of these give satisfactory joints. In many cases, although the soldered junctions appear to be sound, they are actually porous and will not stand the test of placing in boiling water, that has been rendered slightly salt, for an hour or so.

Although an experienced electrician can make a good soldered joint, by using the proper soldering composition and flux, he cannot as a rule guarantee that every joint will be sound. In this respect some joints that are apparently satisfactory soon after soldering experience a gradual deterioration so that after a few days the joint becomes weakened.

#### Satisfactory Welding.

Aluminium can, however, be welded with consistently good results, provided that suitable precautions are taken. The troublesome oxide film that forms under the welding heat is got rid of by means of suitable fluxes. The flux is often applied to the aluminium welding rods in the form

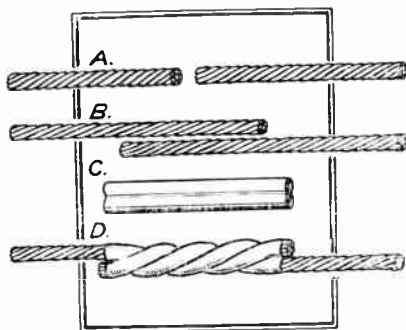

Fig. 7.—MAKING JOINTS IN ALUMINIUM CABLE.

- (a) Cables before joining.
- (b) Arranging the cables for the aluminium sleeve C.
- (c) Aluminium sleeve.
- (d) The twisted joint complete.

of a varnish coating so that as the rod is melted the flux flows automatically into the joint or weld. The oxy-acetylene flame is now much used for aluminium welding purposes. If pressure can be applied to the joint whilst still very hot any superfluous oxide can be squeezed out of the joint. Special machines have been invented for this purpose.

#### Some Important Aluminium Alloys.

Aluminium forms several important series of alloys with other metals. Most of these alloys, whilst possessing the advantages of the light weight of aluminium, are considerably tougher and stronger than the pure metal. Thus, the alloy known as Duralumin, which contains very small percentages of copper, manganese, magnesium and iron, has the tensile strength of mild steel, but is only about one-third of its weight.

An alloy consisting of 88 per cent. aluminium and 12 per cent. copper is much used for strong light castings; it is about 50 per cent. stronger than pure aluminium, and only slightly heavier.

Other well-known aluminium alloys now in commercial use are Y-alloy, Silumin, Dow-metal and Lynite. These are considerably stronger and harder than pure aluminium.



Fig. 8.—A STRIKING APPLICATION OF ALUMINIUM.

The coils of this electromagnet are wound with aluminium wire.

# LECLANCHE CELLS

## NOTES BY A PRACTICAL MAN

By HARDY PARSONS.



Fig. 1.—THE WRONG WAY OF MAKING UP SAL-AMMONIAC SOLUTION.

The careless workman just "bungs in" a handful of sal-ammoniac, lets loose crystals fall about, splashes some water into the jars and sticks the battery on a top shelf out of the way. Actually, the correct amount of crystals should be weighed (see Fig. 2), the solution made up and then poured into the jar by the method shown in Fig. 4.

**A** LECLANCHE battery properly housed and carefully erected will go for years without attention, excepting for the addition of water to replace that lost by evaporation, and for a similar period after careful cleaning and after, perhaps, new zinc rods are fitted.

It is so easy { just to be careful and not to spill liquid on the tops of the battery.  
to measure the right quantity of sal-ammoniac, and not to spill the grains.  
to do the thing properly and obtain perfect results.

### The Wrong Way.

The careless workman just "bungs in" a handful of sal-ammoniac, lets loose crystals fall about, splashes some water into the jars, and sticks the battery on a top shelf out of the way, and even then the willing cells do their best to perform their duty, till the terminals corrode, jars crystallise and dry up, sometimes in a few months.

If a good Leclanche battery does not give permanent service, in 99 cases out of 100 it is due to slovenly or careless handling or improper treatment.



*Fig. 2.*—HOW TO WEIGH UP SAL-AMMONIAC CRYSTALS.

It will be found that four and a half ounces of sal-ammoniac is sufficient for charging each three-pint Leclanche cell. Over-saturating the solution does not increase its efficiency.

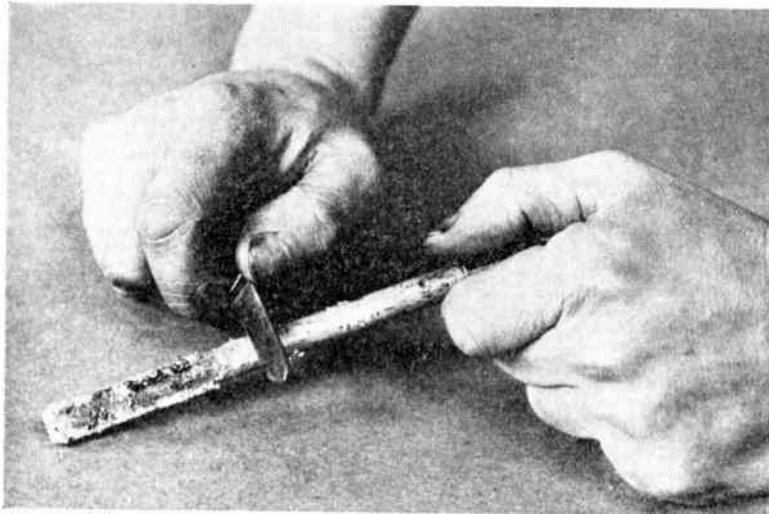

*Fig. 3.*—CLEANING A ZINC ROD.

Unless the zinc rods are clean they will not serve their purpose. When zinc rods are seen to be of a deep black colour, or to have crystals adhering which extend a good distance from the surface of the solution, they should be cleaned by scraping with a knife in the manner shown.

### Type of Cell to Use.

In all cases where primary batteries are used, super type Leclanche cells should be used if possible.

Great care must be taken to keep the terminals of the porous pots, and wires of zinc rods and battery leads, free from solution, because of its corrosive effect. Spilled crystals should also be removed from boxes or shelves.

### How "Creeping" Occurs.

The tops of the glass jars and the tops of the porous pots must not be splashed with solution or even water, because after once being moistened "creeping" of the solution is very liable to occur. When filling jars with solution or water, always use a vessel having a spout (a tea-pot or jug for instance, as the spout can be placed between the porous pot and glass jar). Never fill to the brim of the glass jar—within two inches of the top



*Fig. 4.*—THE CORRECT METHOD OF FILLING A JAR WITH SAL-AMMONIAC SOLUTION.

When filling jars with solution always use a vessel with a spout, such as a kettle or a jug, so that the spout can be placed between the porous pot and the glass jar.



*Fig. 5.*—HOW TO ADD WATER TO A CELL.

When adding water to compensate for the loss due to evaporation, do not add more sal-ammoniac. After about two years, however, a tablespoonful of dry sal-ammoniac may be added to each cell.

is sufficient. Never use a metal vessel even for a moment for holding the solution.

#### How Much Sal-ammoniac to Use.

Four and a half ounces of sal-ammoniac is sufficient for charging each three-pint Leclanche cell. Over-saturating the solution does not increase the efficiency. For light work such as impulse clock driving do not use a fully saturated solution—a solution which is half-saturated works much better.

#### RE-CHARGING LECLANCHÉ CELLS.

The zinc rods must be clean or they will not serve their purpose. Any crystals adhering to them must be removed by scraping. When much reduced in diameter, or badly corroded, or pitted, renew.

Zinc rods do not work nearly so well in over-strong solution and require more frequent attention.

#### A Sign of Trouble.

When zinc rods are seen to be of a deep black colour, or to have crystals adhering which extend a good distance from the surface of solution, it is an indication that the battery is being overworked from some cause or other—sometimes due to a leakage in the wiring. This leakage should be rectified immediately, or the battery will rapidly deteriorate.

If the solution develops a “milky” appearance, it is an indication that it contains insufficient sal-ammoniac and more should be added. The “milky”

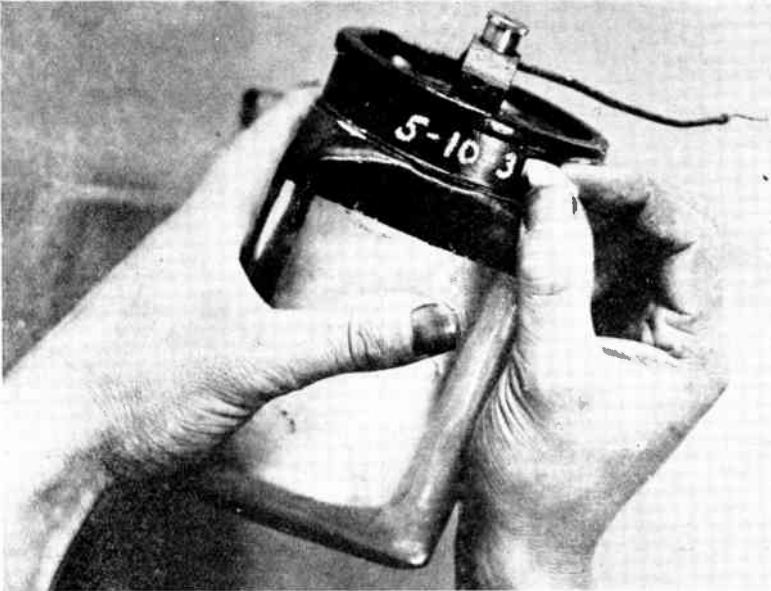

*Fig. 6.*—DATING THE JAR WHEN FILLED WITH SOLUTION.

It is a good plan to chalk or pencil the date on each jar, so that there is no mistake as to when water or new solution should be added.

appearance will disappear on added sal-ammoniac being dissolved. A deposit of undissolved sal-ammoniac crystals at the bottom of the cells is an indication that the solution is saturated and is too strong.

#### **When to Add Water.**

When adding water to compensate for the loss due to evaporation, do not add more sal-ammoniac. After eighteen months to two years' working, however, a tablespoonful to each cell may be added, but not more. After approximately three years' normal working, the complete solution should be renewed—also the porous pots and zincs, if necessary. It is a good plan to pencil the date on each porous pot.

#### **HOUSING LECLANCHE CELLS.**

The position chosen for the battery

must be cool and not excessively damp; a shelf in a cellar is often an ideal situation. On no account fix a battery in a hot and dry situation, or frequent attention will be needed because of water lost by evaporation. Near a ceiling is a very bad position, often chosen in spite of all warnings.

#### **Box or Cupboard for Batteries.**

There are two approved methods of housing Le-

clanche batteries—a battery box or a cupboard.

The battery box is recommended where a comparatively small battery is used, and the cupboard for larger installations. In either case, the cells are protected from damage and accumulations of dust, etc., while the loss due to evaporation is reduced to a minimum and the life of the battery at least doubled.

The shelves for the battery cupboard should be 6 inches wide and 12 inches should be allowed between shelves to give easy access. The cells must be in single rows for easy and efficient inspection.

Whether battery boxes or cupboard be employed, always let the location be both accessible and available to light. Cells pushed away in a dark corner never can maintain good service.

# THE USE OF ELECTRICITY IN THE HOME

## AND ITS IMPORTANCE TO THE ELECTRICAL TRADER.

By S. PARKER SMITH, D.SC., M.I.E.E.

**P**ERHAPS in no sphere has electricity made such rapid progress in the last ten years as in its applications to the home. As an indication of its present importance, it is no exaggeration to say that domestic electrification is one of the chief factors on which the financial success of the great national grid scheme depends.

### Early Development.

The fact that electricity could be employed for practically all domestic services has long been recognised, but time was needed to render such applications feasible. The cost of electric energy was a controlling factor, for until electricity could compete with gas, coal, etc., on economical grounds alone, other advantages such as

cleanliness, labour-saving and so on were not likely to be appreciated by the general public.

### Problems that Had to be Solved.

In connection with wiring systems and appliances for the various services of the household, capital cost, maintenance charges and suitability were all problems for which a satisfactory solution had to be found. Though costs fell appreciably as development proceeded, the initial costs remained beyond the means of many people. It was not until supply engineers took the matter in hand and introduced hiring, hire-purchase and other assisted schemes, that much of the work of recent years could be undertaken. Also the supply authorities, on their part, had



*Fig. 1.*—AN ELECTRIC IMMERSION HEATER.

This apparatus is extremely handy for use in bathroom and sickroom as it enables a glass of water to be heated with great rapidity. It is important to tell the purchaser that the heater should never be switched on until actually in the water, otherwise it is liable to burn out very quickly.

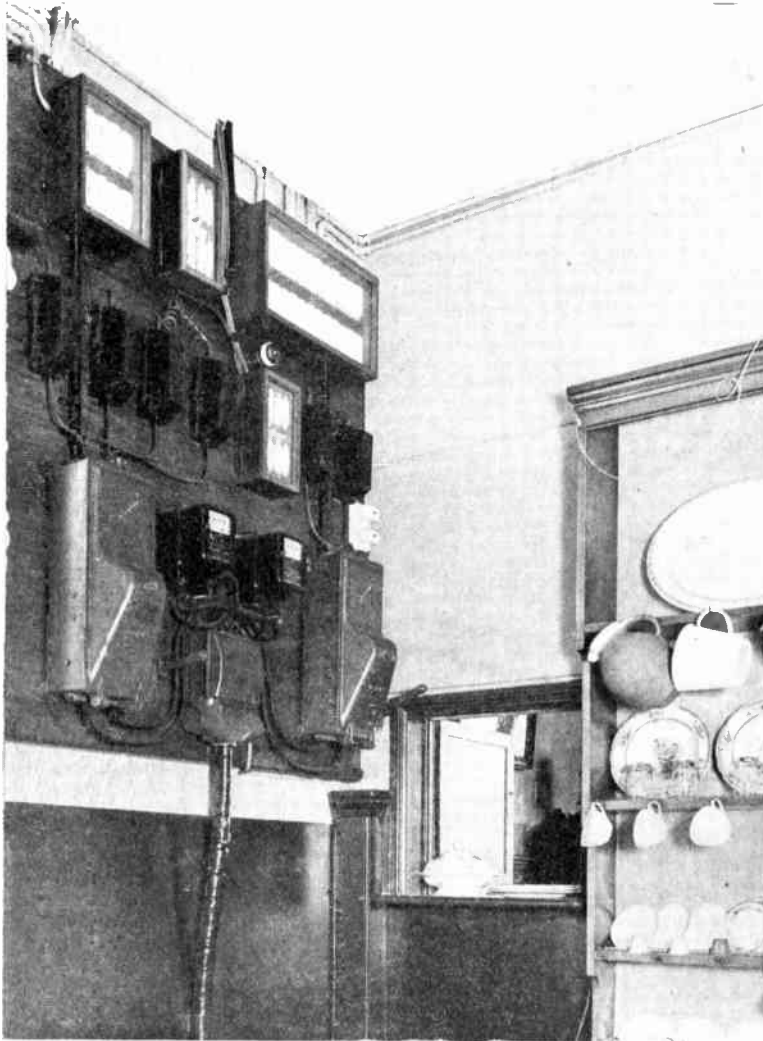

Fig. 2.—WHERE TO PLACE THE SWITCHBOARD.

Instead of hiding the main switches, fuses and meters of the electrical installation in some inaccessible cellar it is a better plan to group them together in the kitchen so that they are instantly available in any emergency.

to discover the advantages of supplying electricity for general domestic purposes, as distinct from lighting, and to evolve suitable tariffs therefor. In the case of new houses, especially where the number was considerable, the supply authorities could often deal with the matter in a rational manner. Frequently a more difficult case was that of converting an existing house to electric working. Many such houses, owing to

their construction, were inherently unsuitable for economical electric working, while, in addition, the electric installation had to replace an existing installation which gave more or less satisfactory service.

### Why Progress Lagged.

The education of the public to the advantages of domestic electrification was and is inevitably a slow process, owing to the healthy innate conservatism that has to be overcome. As regards electrical engineers themselves, so reluctant were many engaged in this business to set an example in their own homes, that prospective users might justifiably conclude electricity was not to be trusted in the home, except perhaps for lighting.

### Electricity as a Labour Saver.

Probably the greatest aid to the spread of domestic electrification has been the labour problem, both in homes where no outside domestic labour is employed, and in homes where such would be employed were it available. The charm of the coal fire loses much when the enthusiast becomes personally responsible for ash removal, dusting, early rising, etc. Moreover, public opinion regarding smoke and air pollution is changing, and the





Fig. 3.—THREE USES OF ELECTRICITY IN THE KITCHEN.

This illustration shows an electric iron which is operated from a two-way holder in the lamp pendant, and an electric kettle and a cooker, both of which obtain their current supply from a separate switchboard. By referring to the supplement of typical wiring diagrams, it will be seen that the cooker is usually connected direct to a small switchboard, while a three-pin plug and switch is provided for the kettle.



*Fig. 4.*—AN ELECTRIC IRONING-BOARD.

While the cost and size of this apparatus might be considered prohibitive in the smaller type of house, the progressive electrical trader can find a market for it at a laundry or hotel, where it would undoubtedly effect considerable saving in time and money.

domestic chimney has been proved to be a worse culprit in the aggregate than the factory and locomotive chimneys.

Education, too, is having its effect. The domestic science teacher is making her influence felt in the home, and the outlook of women is changing in consequence. Technical difficulties are no longer regarded as insuperable—the driving of an automobile by a woman has long been regarded as an ordinary matter; in the same way the manipulation of a few switches offers no difficulty.

#### Wiring for Houses.

A few points in connection with domestic wiring deserve special attention. As regards quality of workmanship, if the Wiring Rules of the I.E.E. are rigidly adhered to—as they should be—there is not

much to fear. Above all, the installation in the home must be safe. In places such as kitchens and bathrooms, risk of shock must be prevented. Earthing, non-metallic switchcovers, and such matters must not be overlooked. Special care should be taken to arrange a sufficient number of lighting and power points in each room and to ensure that these are conveniently situated.

Where gas and electric supplies exist

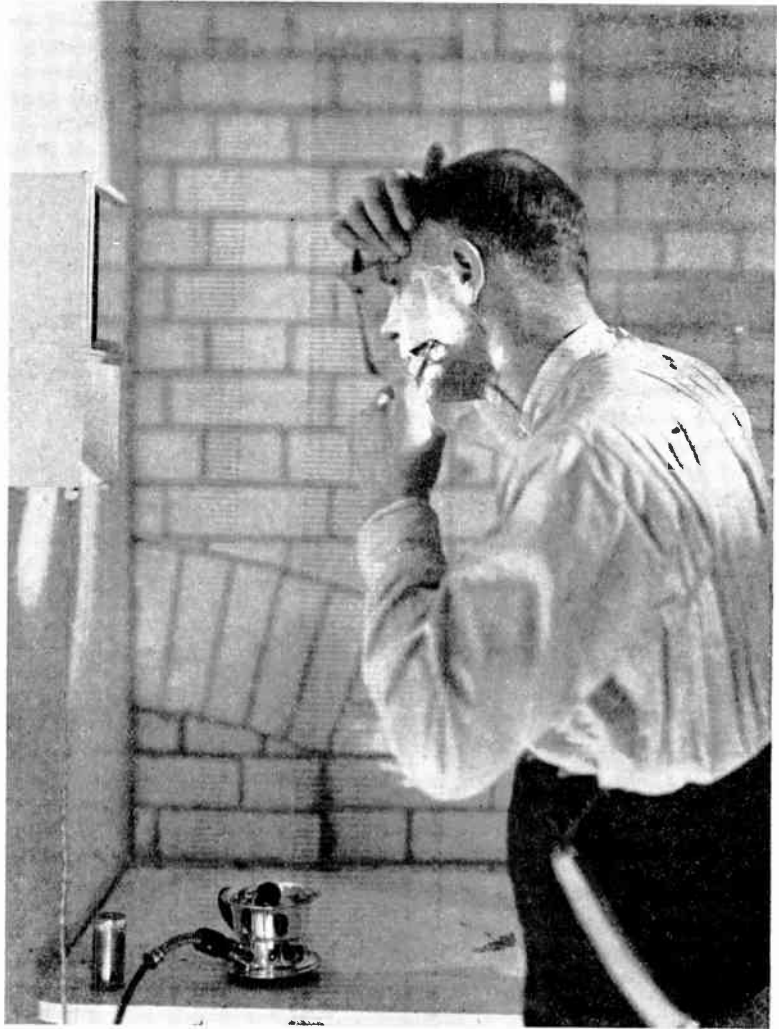
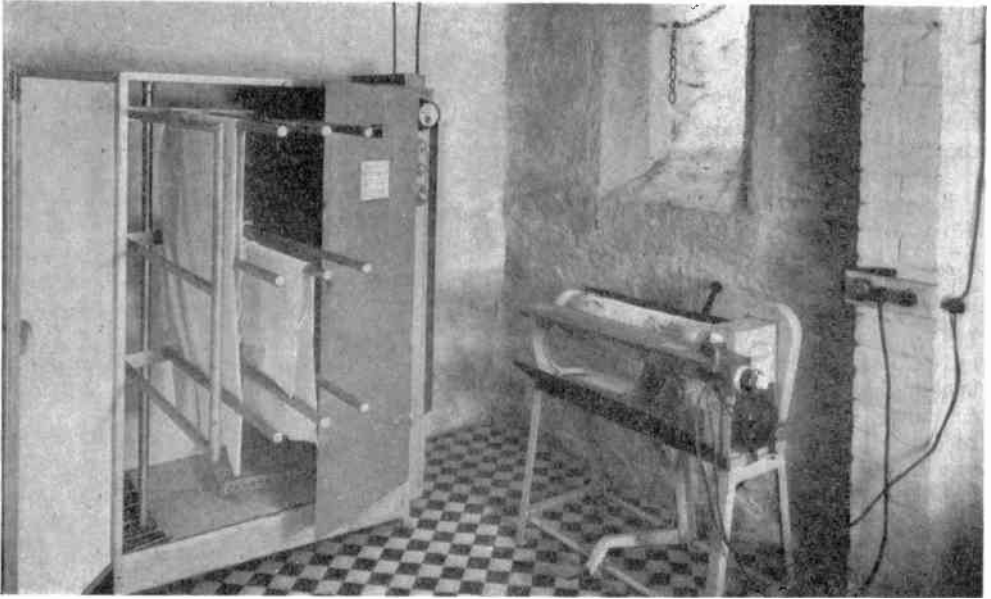

*Fig. 5.—HOW ELECTRICITY HELPS SHAVING.*

At the best of times shaving is a tedious business, but the electrically heated water container and shaving mirror here shown reduce the business to its pleasantest form. Another opportunity for the electrical man to increase his turnover and at the same time add to the general good.

in the same premises, care should be taken to keep the gas pipes and electric cables well apart. In no case should any parts of the two systems be in contact, nor should a gas pipe be used for earthing the electric system. Like every other service, the electric wiring must be maintained in good repair; and where there are neighbouring gas supplies, the insulation of electric cables must be properly maintained. In damp places periodical

C



*Fig. 6.*—AN ELECTRIC DRYING CABINET.

The drying cabinet shown in the above illustration is another appliance that offers the possibility of business with laundries. In actual practice, of course, clothes would be placed over two poles in order to enable the air to get to them. On the right will be seen another type of electric ironer.



*Fig. 7.*—USING ELECTRICITY IN THE BATHROOM.

On the left will be seen an electric heater, while below it is an electrically heated shaving outfit. The towel rack is also heated by electricity to remove dampness from towels after use.

inspection is essential if dangerous conditions are to be avoided.

### **The Importance of Switches.**

Two-way switches should be used wherever it is desirable to operate lights from two points. A user who has to walk in the dark from the door to the bed is not likely to form the most favourable opinion of electric lighting, nor of the man who installed it. Every socket should be controlled by a switch—preferably by one arranged so that the plug cannot be removed when the switch is on, nor made alive without the plug in position. A little thought will reveal how dangerous live sockets are for children and adults alike. One of the chief places where the contractor or wireman can show his skill is with the flexible cords and cables. By using heavy flexibles that will not kink nor easily break, particularly for appliances like the flat-iron, and by attaching these in a proper manner, a great boon is conferred on the user. With regard to the installation in general, it should be borne in mind that wiring has almost become a fine art, and exceptional skill can be shown in wiring of existing buildings. The use of screwed conduit involving the destruction of good plaster work and decorations need not be tolerated.

### **Fuses.**

With the systems now available there is no excuse for unsightliness or rough work. Care should be taken to place the distribution boards in an accessible position and to sub-divide the circuits in the best manner; while the replacement of fuses should be made as simple as circumstances permit.

### **Electric Services in the Home.**

The main services in a household that can be worked electrically are room heating, water heating, cooking and lighting. In all these the heating effect of the electric current is utilised. Among the auxiliary services, the flat-iron is probably first favourite. Vacuum cleaners, refrigerators, warming plates and pads, percolators, toasters, wash boilers, fans, sewing machines, ultra-violet lamps, etc.,

are all appliances which may be acquired sooner or later, and for which provision must consequently be made in the original wiring scheme. Similarly, the all-mains wireless set and gramophone and the synchronous clock should not be forgotten.

### **Electric Bells.**

Strange as it may sound, mention should be made of the electric bells. A great advantage derived from working the bells off the service mains is the proper wiring that is thereby entailed, but the same class of material—single core, if desired—can be used with the ordinary bell battery system. Wired in this way no trouble with bell circuits need be anticipated.

### **A Drying Closet and How to Make One.**

An important feature is the drying closet. A large cupboard or small room can easily be converted into a drying closet by arranging suitable inlet and outlet for the air. In the outlet a small exhaust fan (10 to 12-inch) provides the necessary air movement. Near the inlet for preference, an air warmer, in the form of a convector or electrically heated pipe, is provided for use in damp or cold weather. The clothes are hung over small poles—like broom handles—suitably polished, these poles being arranged in pairs to provide access for the air. A properly ventilated drying closet will be found to be a great boon in the home.

### **Energy Consumption and Cost.**

For an all-electric scheme, it may be stated that water and room heating each require about the same amount of electric energy, taken over the year. Cooking consumes about half of each of these and lighting is practically negligible in comparison. Likewise the remaining services consume very little energy when normally used.

The annual consumption in an all-electric household may be about 5,000 to 6,000 units with a house of four to five rooms, rising to about treble this amount for eight or ten rooms. Obviously, such figures can only be approximate, but those given are based on experience.



Fig. 8.—AN ELECTRIC REFRIGERATOR.

All kinds of perishable goods can be kept for long periods in any kind of weather, and the trader would be wise to draw his customers' attention to this sort of apparatus.

From these figures, it is possible to see at what price electricity must be obtainable to make its use competitive. Taking an overall charge of 1d. per unit, it is seen that the cost of 5,000 units works out at just over £20 per annum, or 8s. per week. Such a sum bears comparison with the cost of coal, gas, wood, etc., as alternatives. In thus basing an all-electric scheme on an overall cost per unit of 1d., no allowance has been made for any of the extra benefits such as cleanliness and labour saving claimed for electricity, but it must be remembered that electric lighting is included in our total.

When the cost of energy is appreciably higher than 1d. per unit, further considerations have to be taken into account. It is then that the sitting-room coal fire with combined boiler in small houses, and the coke boiler with central heating in large houses and institutions may have to be considered.

### What the Two-part Tariff Means.

The two-part tariff is a rational method of charging for electricity and it encourages the user to take full advantages of his electricity service. The important figure is the overall cost per unit of electric energy. As an example, suppose the consumer of 5,000 units per annum has a four-roomed house and is charged 15s. per room per annum and  $\frac{3}{4}$ d. per unit for all units consumed. The fixed charge is then £3 per annum, and the running charge is £15 12s. 6d., making a total

of £18 12s. 6d., giving an overall cost of 0.9d. per unit. Similarly, a five-roomed house using 6,000 units per annum on the same tariff would pay £21 15s. per annum, or an overall cost of 0.87d. per unit.

This example also shows the effect of using electricity too sparingly. Suppose that by using a coal fire only 3,000 units were used in the four-roomed house, the overall cost per unit would be 1d. On the other hand, the greater the amount of energy consumed the lower the overall price per unit.

The above example has been worked out for a running charge of  $\frac{3}{4}$ d. per unit,



Fig. 9.—AN ELECTRIC MINCER

The electrical trader who is anxious to increase his business will find apparatus of this type provides him with quite a profitable line of business with hotels or butchers' shops.

but many districts have long enjoyed a running charge of  $\frac{1}{2}$ d. per unit, and an even lower rate for night use. This running charge is combined with a fixed charge based on the rental, floor area or number of rooms.

### **Decorative Lighting.**

It scarcely needs to be mentioned that the use of electricity for lighting only is almost obsolete, while the inclusion of lighting in the general tariff permits the consumer not only to have ample lighting, but to indulge in decorative lighting, etc., almost without restriction.

### **Later Developments.**

In nearly every branch there is a certain amount of choice in the type of appliance that can be installed, and care should be taken to find the most suitable for each case.

For room heating there are many types of radiant fire—some suitable for fixed positions, others for moving from place to place, as required. In addition, there are cases where the advantage of panel heating are worthy of consideration. These electrically heated panels are built in or attached to the ceiling of the room and provide a surface temperature of some 100 to 110 deg. F. The panels may be used in conjunction with radiant fires, if desired; or they may be made sufficient to provide the necessary heating. Whatever form of electric heating is adopted, ventilation must be properly provided for.

Thermostatic control is now reliable and is becoming widely used for controlling the heating of rooms and of water tanks.

### **Hints About Heating Water.**

For the heating of water care should be taken to avoid waste. The tank should be well lagged, the pipe runs kept short and the temperature kept within

prescribed limits—e.g., 140 deg. F. Where the amount of hot water required is considerable, heat storage at a low tariff should be investigated.

### **Electric Cookers.**

The modern electric cooker is very different from the earlier type. Instead of so much heavy cast-iron construction, sheet steel is now widely employed with a high-class finish in enamel and electroplating.

Cooking utensils, kettles and other appliances are also now made so as to take advantage of the inherent cleanliness of electric working. With electricity the clock and thermometer replace guesswork and rule-of-thumb in cooking.

### **How to Obtain the Best Results with Electricity.**

Electricity has different properties from other forms of heating and attempts to use it in the same way as coal or gas will not produce the best results. Obviously circumstances exist where it is not possible to make the best use of electricity, but certain principles ought always to be observed. Thus in the matter of temperature control, whether for room heating, water heating or cooking, the temperature should be adjusted according to requirements. The portability of the electric fire ought to be made use of; likewise the freedom in arranging lights, switches, etc., in the best manner. Cooking by electricity is no longer a matter to be confined to the kitchen, for several appliances can be used wherever required. It is only when points of this kind are utilised that the great merits of electricity are appreciated. The ease with which electricity can be switched on and off permits the greatest economy to be exercised where necessary, and it is this which in certain cases makes the cost of electric working lower than that of coal, gas, or central heating.



# ULTRA-VIOLET RAY APPARATUS

By E. M. SUTTON.

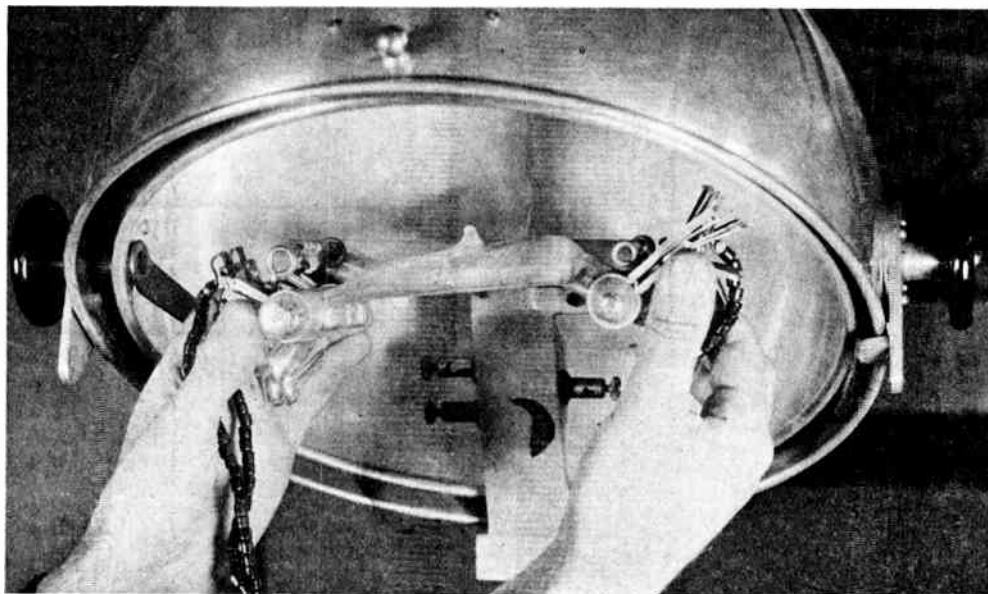

Fig. 1.—PLACING MERCURY VAPOUR BURNER IN POSITION.

Care must be taken not to handle the quartz glass tube. The burner is fitted with two pairs of metal eyelet holes, and these fit on to corresponding metal rods on the cradle mounted inside the "hood."

**T**HE sun's rays have been used from time immemorial for the alleviation of human suffering. With the knowledge now at our disposal we are able not only to reproduce the sun's rays exactly, but can also reproduce any special part of the spectrum which medical science shows is conducive to the cure of any particular disease. Only a comparatively small portion of the sun's spectrum is visible to the human eye, and it is mostly the invisible rays which are used for medical purposes.

## Lamps for Producing Invisible Rays.

In answer to the demand from the medical profession, a type of lamp was evolved to produce rays of a very short wave length. The type of lamp first put forward to meet this demand was

an arc lamp employing special carbons impregnated with certain minerals such as tungsten, iron and copper. These lamps had a fairly heavy consumption, (about 7 kilowatts) and had other disadvantages. They did not materially differ from the commercial type of arc lamp, as regards their operation, and we need not therefore consider them in detail.

## The Mercury Vapour Burner.

The most efficient means of generating ultra-violet rays, of wave lengths as low as 1,850 Angstrom units, is undoubtedly by means of the mercury vapour burner. This consists of a quartz glass tube which, after being evacuated of air, is hermetically closed. Two electrodes are sealed into

the ends of this tube which make contact with a small quantity of mercury inside the quartz tube. Current is led to these electrodes through a suitable resistance and switch. To put the burner into operation it is necessary to switch on the current, and then tilt the burner until the mercury flows across the tube. This completes the circuit and has the same effect as "striking the arc" in an ordinary arc lamp. When once contact

quartz burner is fitted on a cradle inside a polished metal reflector. This reflector or "hood" is mounted on a transverse arm moving up and down the vertical column. It is counterweighted so that the height of the burner from the floor may be easily adjusted. In some types of lamp the "hood" is fitted with an inner shield, which is so arranged that it can be swung forward in front of the burner. This shield is provided with

different sized apertures, ranging from about 1 inch diameter to 3 inches. These small openings are used when subjecting local areas of the body to ultra-violet radiation.

For general irradiation the shield is folded back inside the "hood."

#### Ceiling Lamp.

Another model of the same lamp is the ceiling suspension type.

This is electrically the same as the standard type, but the resistance or trans-

former, as the case may be, is mounted separately, and the hood containing the burner is suspended from the ceiling. A counter-weight is connected to the hood by means of a flexible steel cable, which is run over suitably placed pulleys in the ceiling and wall.

#### INSTALLATION.

##### Mercury Vapour Lamp Working from D.C. Mains.

It is first of all necessary to ascertain which is the negative and which is the positive pole of the supply. The easiest

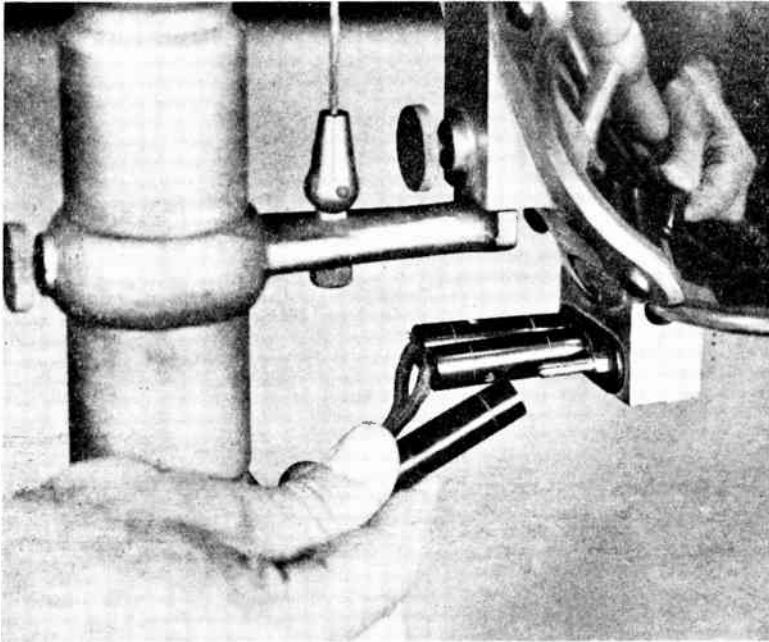

Fig. 2.—PIN AND SOCKET CONNECTIONS OF MERCURY VAPOUR LAMP.

The burner is fitted with three electrodes, the flexible connections being connected to their respective terminals inside the hood as marked.

is made the arc is maintained through the mercury vapour generated by the passage of the current.

#### Standard Lamp Type.

The lamp is made up in various forms, the most usual one being the "standard lamp" This consists of a vertical metal column, about 5 feet 6 inches high, mounted on a cast iron base fitted with castors. On this base is mounted the regulating resistance and switch. In the case of lamps working on A.C. mains a transformer takes the place of the resistance. The

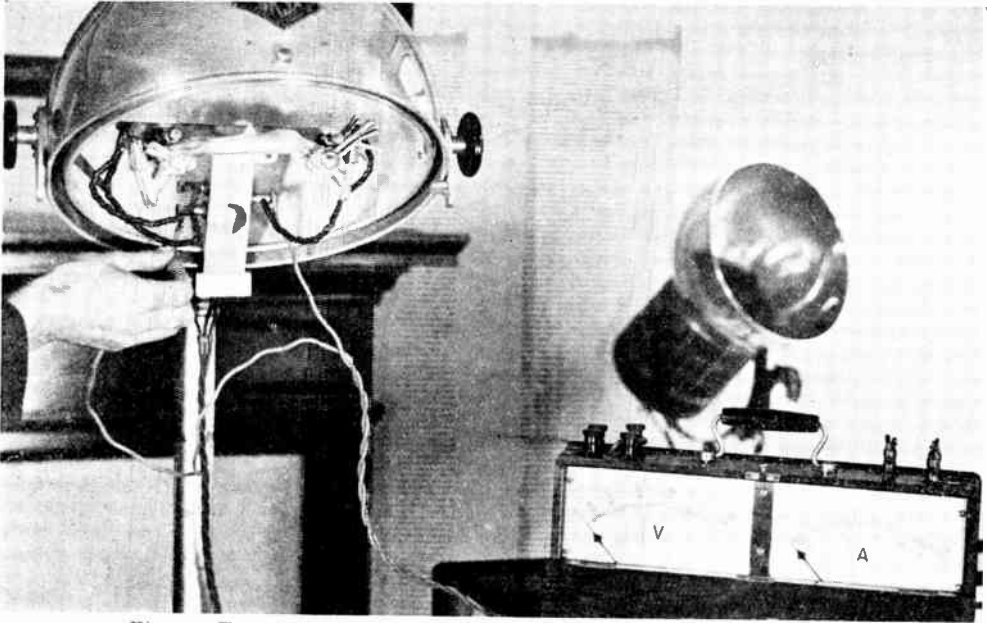

Fig. 3.—TESTING THE VOLTAGE ACROSS A MERCURY VAPOUR BURNER.

A voltmeter may be placed across the burner and the voltage noted after the lamp has been running for two or three minutes.

way of doing this is to place the two live main wires, coming from the plug, on to a moistened piece of pole finding paper. The negative lead will then leave a red mark on the paper. All the connecting cables supplied with the lamp are fitted with red and black terminal sockets. The negative of the main should be connected to the lead-in wire fitted with a black socket, and the positive of the main connected to the red socket. The plug, making connection to the main supply, should be of the non-reversible type, as it is important that the polarity should not be changed accidentally at any time.

#### Connecting Up the Wires.

One of these wires is connected to the resistance and one to the burner. A third wire runs from the burner back to the resistance. Thus the burner and resistance are in series with the main supply. These connections are made by merely pushing the red or black terminal sockets on to their respective pins, either in the top of the resistance cover or at the back of the "hood."

#### Assembling the Burner.

The burner should then be carefully unpacked from its crate, care being taken not to handle the quartz glass tube. The burner is fitted with two pairs of metal eyelet holes, one pair of which is of a smaller diameter than the other. These fit on to corresponding metal rods on the cradle mounted inside the "hood." This form of mounting ensures that the burner is placed in its correct position, the negative end being near the negative terminal and the positive end near the positive terminal. The burner is secured in position by means of two small knurled nuts.

#### Connecting Burner Wires.

Connection is made to the burner by means of flexible wires insulated with beads. These are permanently connected to the burner at one end; their free ends have to be connected to their respective terminals inside the hood. The current consumption of the lamp at the moment of switching on is about 12 amperes on a 200 volt supply. This drops to about 4 amperes after a few minutes.

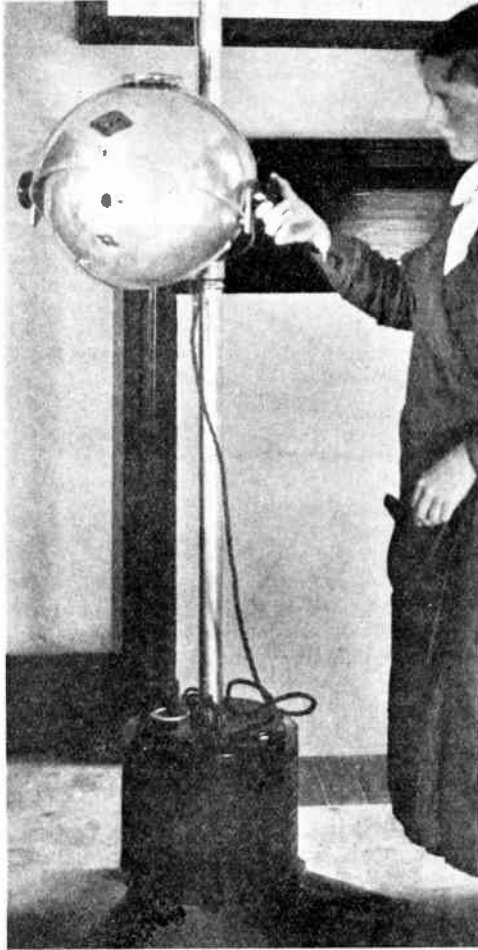

Fig. 4.—ADJUSTING THE SHIELD OF A MERCURY VAPOUR LAMP.

### Lamp Working from A.C. Mains.

In the case of the lamp to work from Alternating Current Mains, the above instructions apply with the following exceptions and additions:—

It is obviously not necessary to test the mains for polarity. The two main leads are led straight to the transformer. Three leads are then connected between the transformer and the connections at the back of the hood. These are marked red or black, and the pin connections are marked to correspond. The burner is fitted with three electrodes, the flexible connections being connected to their

respective terminals inside the hood as marked.

### OPERATION.

#### Lighting Up Burner.

The lamp is put into operation by switching on the current by means of the rotary switch fitted on the top of the resistance cover. The burner is then tilted by means of the handle provided for this purpose at the side of the hood. This handle should be carried over to the limit of its travel, and then gently released. The burner should then light up.

#### With Lamps Working from A.C. Mains.

On the top of the transformer cover, in addition to the rotary switch, will be found a plunger knob. This plunger should be depressed, after the burner has been in action for two or three minutes, and has the effect of cutting out some of the resistance used for starting purposes. It is held down magnetically and is released automatically immediately the current is switched off.

#### Mains Wrongly Connected.

When the lamp is in operation protective goggles must be worn by the operator, as the eyes are very sensitive to the ultra-violet rays. The burner can then be examined through the goggles and it will be seen that the quartz tube has a "cloudy" appearance and that the mercury is bubbling violently at the negative end of the burner. If this bubbling takes place at the positive end, it shows that the mains have been wrongly connected and the current should be switched off before any damage occurs. After two or three minutes' running the cloudy appearance mentioned above will clear away. Treatment should not be commenced until the burner has cleared.

Another type of mercury vapour lamp employs a Direct Current burner for both A.C. and D.C. models. In the case of A.C. a mercury vapour rectifier is embodied in the base of the lamp. This is set into action first and then the burner is started in the usual way.

### FAULTS AND THEIR REMEDIES.

#### Cracked Quartz Burner.

It will be obvious from the above

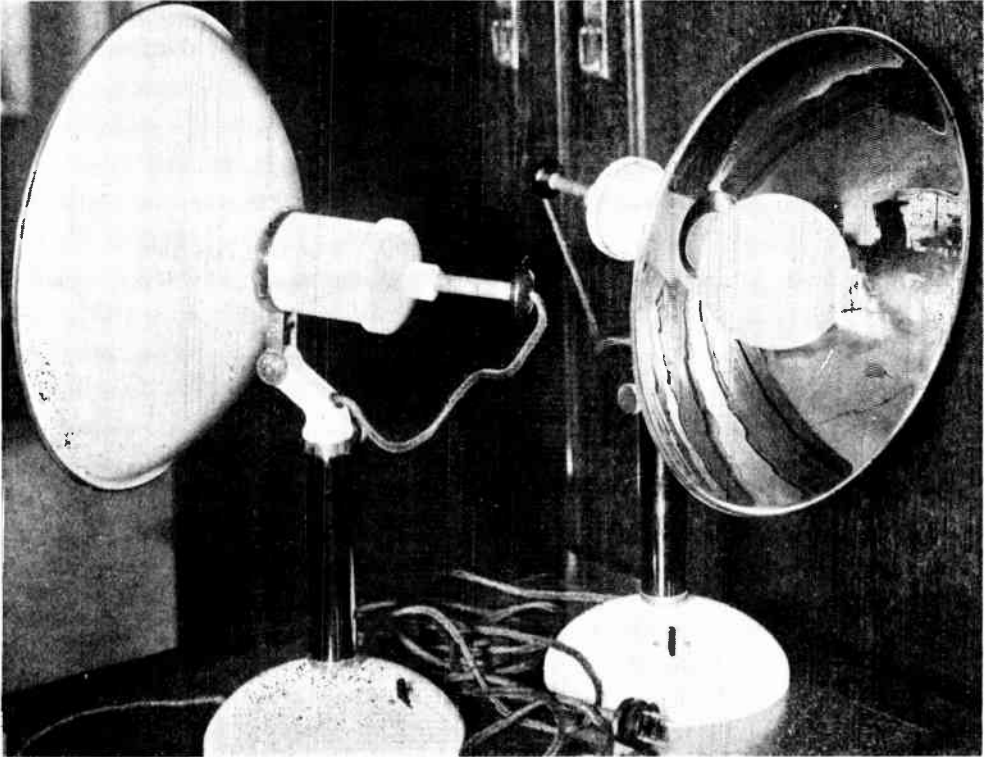

*Fig. 5.*—A "NERON-VITALUX" SUNLIGHT LAMP.

This lamp is designed to reproduce exactly the sun's rays and is particularly useful to the medical practitioner in cases where ultra-violet rays only are not sufficient to effect a cure.

description that the mercury vapour type of lamp is of very simple construction and therefore there are very few parts to give trouble. The most likely place for trouble to occur is, of course, the quartz burner. This is subjected to sudden variations of temperature which may result in a crack developing in the walls of the tube or where the wires are connected to the electrodes inside the tube. If this happens air enters the burner and the vacuum is destroyed. The burner will then refuse to light up and upon examination small bubbles of air will be seen in the mercury. When the vacuum is intact, the mercury will make a distinct metallic "click" as the burner is tilted. This metallic "click" is entirely absent if the quartz glass has been punctured. In the event of any damage to the burner, it should be returned to the manufacturers for repair.

#### **Voltage Too High.**

Care should be taken to see that the lamp is adjusted to suit the particular voltage from which it is to work. If the voltage across the burner is too high, it will overheat and go out. In this case the cover must be taken off the resistance or transformer, as the case may be, and an adjustable contact on the resistance moved to its desired position. In the case of A.C. lamps two resistances have to be adjusted. A voltmeter may be placed across the burner and the voltage noted after the lamp has been running for two or three minutes. This voltage will be approximately 170, depending upon the type of burner.

#### **In Electrical Apparatus.**

Other faults which may occur are those usually associated with electrical apparatus, such as broken wires or flexibles and

faulty contacts. These are easily discovered by means of a test lamp or voltmeter.

### **Burner "Run Down."**

After 500 or 600 hours' use the quartz tube slightly changes its composition, and this has the effect of filtering out some of the ultra-violet radiation. A careful check should therefore be kept and when the time approaches the burner should be renewed or returned to the manufacturers for internal cleaning and overhaul.

### **Cleaning the Burner.**

The burner should be wiped occasionally with a clean rag soaked in alcohol.

## **A SUNRAY LAMP FOR POPULAR USE.**

Lately there has been placed on the market a new type of lamp, which is designed to reproduce exactly the sun's rays. That is to say, it generates ultra-violet rays, visible light rays and infra-red rays. This lamp is particularly useful to the medical practitioner in cases where ultra-violet rays only are not sufficient to effect a cure. It is quite safe in the hands of inexperienced operators and for this reason is largely used for the treatment of children and for ordinary home use.

### **Construction.**

The burner consists of a bulb made of glass of special consistency which transmits ultra-violet rays. Inside this is a specially constructed tungsten filament. The bulb is supported by an ordinary Edison screw fitting, inside a polished metal reflector. This lamp is made up in three models:—

One can be placed on a table or convenient shelf while in use; another can be placed on the floor; and the third can be suspended from the ceiling.

### **Operation.**

It is not necessary to wear goggles when operating this lamp, but the eyes should be shielded as far as possible from direct radiation. The lamp consumes 500 watts and can be connected to any domestic current supply, either A.C. or D.C. A switch is provided on the lamp itself, and this is the only form of control necessary. Care must be taken in handling the bulb and this should be cleaned occasionally with alcohol. The burner has a useful life of about 400 hours.

### **A Warning.**

The foregoing describes the apparatus most generally in use. Different models vary in detail, but the essentials remain the same. A very important point to remember in connection with mercury vapour lamps is that a very painful "sunburn" or erythema can be produced if the skin is exposed to the rays for too long a period. This type of lamp therefore should only be operated under the supervision of a qualified medical practitioner.

The above instructions are intended to be of use to the engineer who may in the course of his every-day work have occasion to instal or readjust any of the standard types of violet ray apparatus in the home or for medical purposes. A later article will give details to enable the interested reader to construct a simple type of ultra-violet ray lamp for his own use.

## **WHEN CAN A MOTOR BE USED AS A DYNAMO?**

Most dynamos and motors are reversible in their functions, that is to say that without any change in the construction of the machine it is equally efficient either as a motor or as a dynamo. A motor will supply current to the circuit which normally feeds it, if it is mechanically driven at a higher speed than that at which it runs as a motor. A shunt wound machine runs in the same direction of rotation both

as a dynamo and as a motor, but a series wound machine runs in the reverse direction as a motor than it does as a dynamo.

A motor is essentially a dynamo in its action. When a motor has been run up to speed it generates a voltage only slightly lower than the mains voltage. This is known as the back-E.M.F. of a motor — it opposes the supply voltage and so regulates the current passed by the armature.

# TYPES OF D.C. MOTORS AND THEIR APPLICATIONS

By A. T. DOVER, M.I.E.E.

## General.

A DIRECT-CURRENT motor is similar in construction to a direct-current dynamo; but the type of enclosure, method of ventilation, form of bearing brackets and end shields are subject to greater variation in the motor than in the dynamo on account of the former having to be located at the machine or apparatus which it is to drive.

Moreover, the duty on a motor may be much more severe than that on a dynamo, and special construction may be necessary to obtain the requisite robustness. Again, the speed of a motor may require to be adjustable over a wide range, and this requirement may involve special features in the construction.

## Classification of Motors.

The classification may be made broadly according to (1) the type of enclosure, i.e., *mechanical features*; (2) the method of excitation, i.e., *electrical features*.

For industrial motors the types of enclosure are:—Protected, drip proof, pipe ventilated, totally enclosed.

## MECHANICAL FEATURES OF STANDARD MOTORS.

### Protected - Type (Enclosed - Ventilated) Motors.

The general appearance is shown in Fig. 1, and detail views of the frame, armature and commutator end bracket are shown in Figs. 2, 3, 4. The openings in the end bracket are fitted with a sheet

steel cover which protects the commutator and brush gear from dust, chips, etc., and from casual interference. Protection against electric shock, due to accidental contact, is also afforded to workers and individuals. The cover is in the form of a band, and is fastened with a hinged bolt and wing nut so as to be easily removed when necessary.

The armature is fitted with a fan at the rear or pulley end. Air is drawn into the machine through the openings in the front of the commutator end bracket, it is circulated over and through the armature and field coils,

and is expelled through screened openings in the rear end bracket.

### Screen-Protected Motors.

Alternative forms of protection are used in screen-protected motors. The arrangement is similar to that in Fig. 1, except that the band cover at the commutator

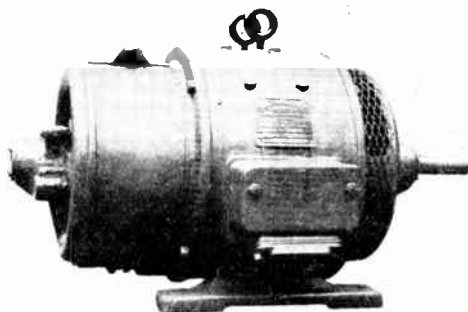

Fig. 1.—PROTECTED-TYPE MOTOR, MEDIUM SIZE. (Metropolitan Vickers.)

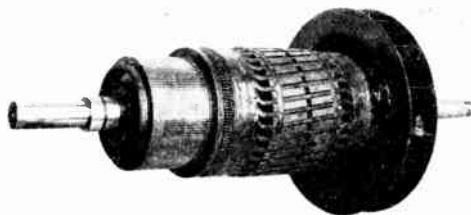

Fig. 2.—ARMATURE OF FOUR-POLE MOTOR ILLUSTRATED IN FIG. 1.

Showing the ventilating fan and the skewed slots (to reduce magnetic noises and hum). (Metropolitan-Vickers.)

end is perforated. The type of end bracket shown in Fig. 6 has been introduced to enable one pattern of end bracket to be adapted to a number of different types of enclosure, such as, screen-protected, pipe ventilated, drip proof, totally enclosed.

### Canopy-Protected or Drip-Proof Motors.

This form of enclosure is designed to prevent dripping water, etc., entering a fan-ventilated motor, i.e., this form of enclosure will not interfere with the ventilation. The protected type end brackets are fitted with either cowls, as shown in Fig. 7, or louvres, as shown in Fig. 8.

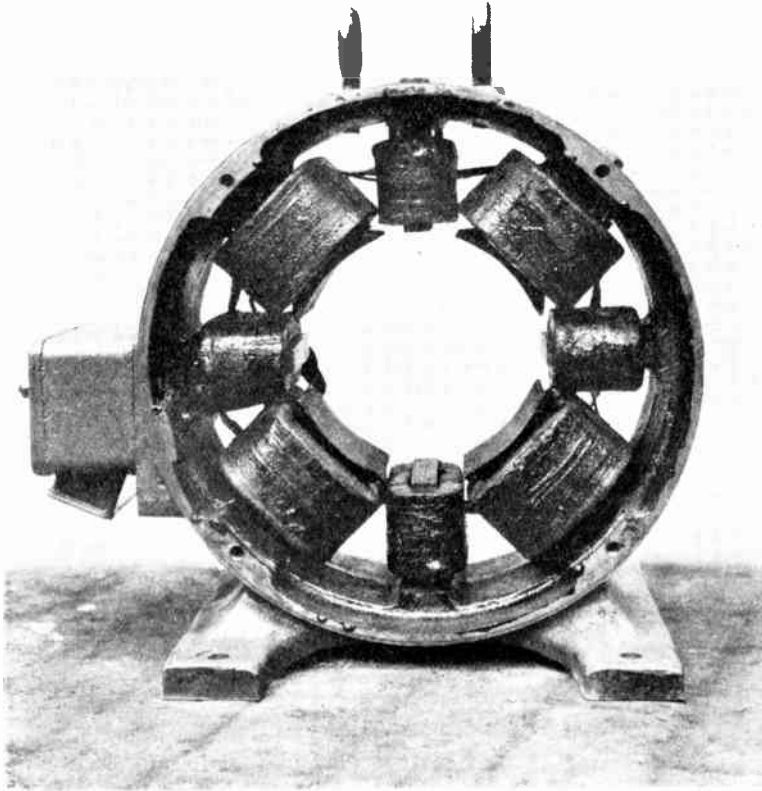

Fig. 3.—MAGNET FRAME OF MOTOR ILLUSTRATED IN FIG. 1.

Showing the laminated main poles, commutating poles, terminal box and feet.

Notice that the centre portion of the frame, to which the poles are bolted, is thicker than the end portions because the former has to carry the magnetic flux, whereas the latter are required for mechanical purposes only. (*Metropolitan-Vickers.*)

### Application of Protected and Screen-Protected Motors.

These motors are suitable for all ordinary applications in machine shops and general service. Examples are given later.

### Application of Drip-Proof Motors.

These motors are intended for laundries and for locations out of doors which are not too exposed to driving rain.

The principal applications are to outdoor cranes, laundries, etc.

### Pipe - Ventilated Motors.

This construction enables a fan-ventilated motor to be installed in places where the air immediately surrounding the motor is unsuitable (on account of dust, acid fumes, etc.) for passing through the machine for the purpose of ventilation. The end brackets are completely closed except for

flanged openings to which are fitted the pipes conveying the ventilating air to and from the motor. The ventilating air is drawn from a suitable place and is circulated by means of a fan on the armature shaft as in the other fan-ventilated types.



**Application of Pipe-Ventilated Motors.**

These motors are suitable for chemical works, paint and varnish factories, cotton mills, cement works, boiler houses, flour mills, paper mills, etc.

An important point to be kept in mind when installing a pipe-ventilated motor is that the length of the pipe line should be kept as short as possible, as the fan on the armature is not designed to produce the air pressure which would be necessary to pass the air through a long pipe line. A pipe-ventilated motor is more costly to install than any other type of motor, and the motor itself is slightly more costly than a protected machine, owing to the special end brackets. On account of these circumstances, and, in some cases, to the difficulties in arranging a short pipe line, a totally enclosed motor may have to be installed.

**Totally Enclosed Motors.**

This type of enclosure, in which no openings are provided for the circulation of air through the machine, is employed only in cases of necessity, where the other types of enclosure are unsuitable. In some cases no fan is fitted to the armature, but usually a fan is fitted just as in a protected-type machine, as the more effective circulation so obtained gives more uniform internal temperatures throughout the machine than when no fan is fitted. As the whole of the losses in the machine have to be dissipated by the external surface of the frame and end shields, the normal surface is, in some cases, supplemented by radiating fins or ribs.

Two examples of totally enclosed motors are shown in Figs. 9 and 10.

In consequence of the whole of the internal losses having to be dissipated by



Fig. 4.—COMMUTATOR END BRACKET OF MOTOR ILLUSTRATED IN FIG. 1.

Showing the circumferential and end openings, the former being covered by a steel band (see Fig. 1) and the latter being open to form inlets for the ventilating air.

Notice the self-oiling sleeve bearing, the inspection cover at the top, and the covered oil-level indicator at the side. A dust cover fits over the front end of the bearing. (*Metropolitan-Vickers.*)

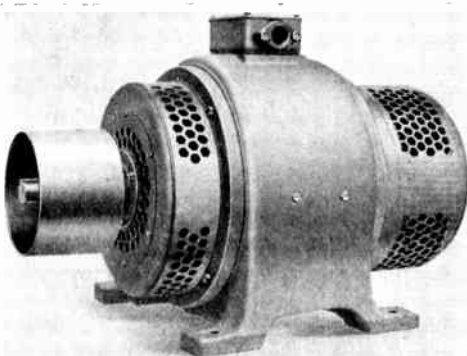

Fig. 5.—SCREEN-PROTECTED MOTOR.

Showing arrangement of end brackets and covers for small 2-pole motors. (*B.T.-H. Co.*)

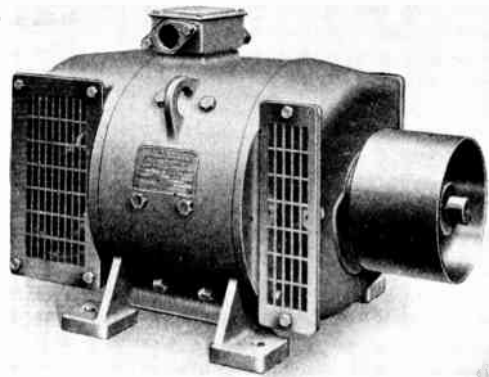

Fig. 6.—SCREEN-PROTECTED MOTOR.

Showing arrangement of end brackets and covers for 4-pole motors. (*B.T.-H. Co.*)

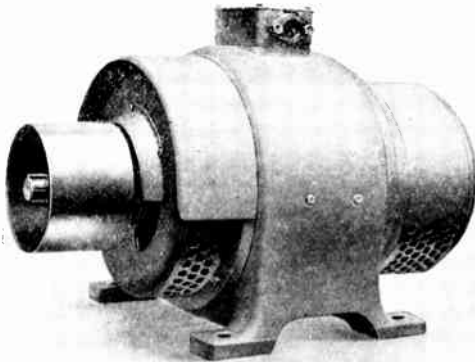

Fig. 7.—DRIP-PROOF MOTOR.

This illustration shows how the screen-protected motor of Fig. 5 is converted into a drip-proof motor. Canopies are fitted at the pulley end and a special cover is fitted at the commutator end. (*B.T.-H. Co.*)

the external surface of the frame and end shields the totally enclosed motor must always be built with a larger frame than a protected-type machine of equal output and rating.

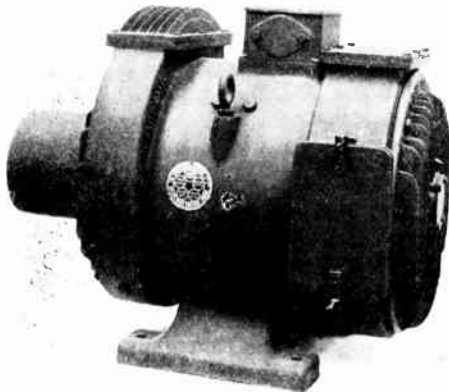

Fig. 9.—AN ALTERNATIVE FORM OF TOTAL ENCLOSURE ADOPTED BY THE ENGLISH ELECTRIC Co.

Special end brackets with ribs or radiating fins are used, and the circumferential openings in the frame are fitted with cast-iron shells (such as are used for pipe ventilation) with packed covers. (*English Electric Co.*)

With the object of improving the cooling of the frame, some recent designs of totally enclosed motors are fitted with an external fan on an extension of the armature shaft, and an outer hood which deflects the air drawn in by the fan over the ordinary enclosing covers.

#### Application of Totally Enclosed Motors.

In view of the relatively high cost of enclosed motors compared with other types, these machines are used only in cases of absolute necessity, e.g., gantry

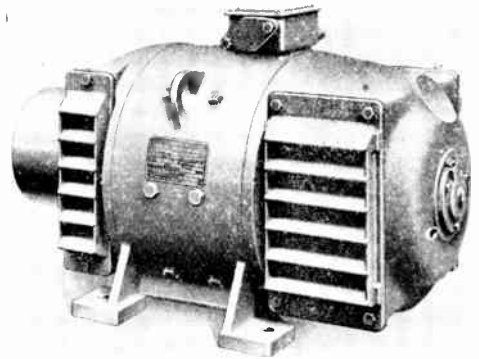

Fig. 8.—A COMMON FORM OF DRIP-PROOF ENCLOSURE IN GENERAL USE FOR MEDIUM-SIZE MOTORS.

This illustration shows how the screen-protected motor of Fig. 6 is converted into a drip-proof motor by replacing the grid covers with louvred covers. (*B.T.-H. Co.*)

cranes, marine service, capstans, cement works, coal-handling plant, coal-cutting machines, foundries, etc.

#### EXAMPLES OF INDUSTRIAL APPLICATIONS OF PROTECTED, PIPE-VENTILATED AND ENCLOSED MOTORS.

Figs. 11 to 14 show applications of screen-protected, pipe-ventilated, and totally enclosed motors in engineering and industrial works.

# Engineers' Guide

containing the widest selection of engineering courses in the world

Study at home with The T.G.E. for a well-aid post. Become an A.M.I.C.B., A.M.I.Mech.E., A.M.I.E.E., et: Training until Successful is Guaranteed. WRITE NOW for Free Guide, stating branch, post or qualification that interests you. THE TECHNOLOGICAL INSTITUTE OF GREAT BRITAIN.

221, Fennie Bar House, London, E.C.4. Founded 1817 17 000 Students



# To Success

NEWNES'

## ELECTRICITY SERIES

Electricity can now be put to a multitude of uses in the home, and these books show the many and diverse ways in which current may be profitably employed in cooking, heating, artistic lighting and so on, at a very low cost. Fully illustrated throughout.

*Titles Now Ready*

**THE ALL-ELECTRIC HOME.  
ELECTRIC LIGHTING AND LABOUR  
SAVERS FOR THE MODERN HOME.  
PERFECT COOKING BY ELECTRICITY.  
ONE SHILLING EACH**

On sale at all Newsagents and Bookstalls, or by post 1/2 each, from *George Newnes, Ltd.*, 8-11, Southampton Street, Strand, London, W.C.2.

*Geo. Newnes, Ltd.*

*Indispensable for your Bookshelf.*

# WIRELESS STEP BY STEP

By "DICTRON"

7th Edition

A book which shows the wireless enthusiast how to obtain the maximum enjoyment from his wireless set. Based on a series of articles published in *World Radio*. Its delightful simplicity and thoroughness will interest all, whether beginners or experts.

185 pages with numerous illustrations.

# 2/6

On sale at all Newsagents and Bookstalls, or by post 2/9 from *GEORGE NEWNES, LTD.*, 8-11, Southampton Street, Strand, London, W.C.2.

*Geo. Newnes, Ltd.*

# NEWNES' HOME MECHANIC BOOKS

*Clearly Written & Fully Illustrated*  
*each book contains 96 pages.*

## SIMPLE ELECTRICAL APPARATUS

An excellent little book for those who wish to make simple and useful electrical appliances, such as galvanometers; electric motors; dynamos and Leyden Jars. All these may be made by anyone, with the aid of a few tools and some inexpensive materials. Clear instructions are given in every case.

## MODEL BOAT BUILDING

There are few more fascinating hobbies than Boat Building. In this book there are designs for a battleship, a speed-boat, a paddle-steamer and yachts, from which excellent models may be built with the help of the simple directions and diagrams that are given. No elaborate tools are needed, and each model can be made at small cost.

### Other Titles

THE HANDYMAN'S ENQUIRE WITHIN  
THE HOME WOODWORKER  
25 SIMPLE WORKING MODELS  
MODEL AEROPLANES AND AIRSHIPS

# 1/- each

On sale at all Newsagents and Bookstalls or by post 1/2 each from *George Newnes, Ltd.*, 8-11, Southampton Street, London, W.C.2.

*Geo. Newnes, Ltd.*



*This article on Practical Applications of D.C. Motors is continued in Part 4, published November 6th. Order your copy to-day.*

---



---

# THE BEST INVESTMENT TO-DAY

---

# NEWNES POPULAR Home Book

To be completed in about 32 weekly parts.

## WHEN YOU HAVE TIME TO SPARE

HERE is your opportunity to practise real economy in the home—to save shillings and pounds in your housekeeping budget.

When you have time to spare, the HOME BOOK will show you how to use it in a pleasant and profitable manner.

## WHEN YOU HAVE MONEY TO SPEND

on your Home, the HOME BOOK will tell you how to get the best value. Whenever you wish to purchase a carpet, new bedding, window curtains, or to re-decorate you will be able to find in the HOME BOOK expert advice which will save your time and your money.

## WRITTEN FOR YOU

More than 30 clever craftsmen, experts on furnishing and decoration, designers in every branch of needlework, doctors and beauty specialists, have pooled their special knowledge to produce the articles which you will find in this work. Home arts and crafts, furniture and furnishing, home decoration, needlework and embroidery, health and beauty, are all dealt with in well-written and splendidly illustrated articles. In addition, the HOME BOOK contains hundreds of money-making ideas.

If you follow the instructions given in the articles you will be able to practise many interesting crafts and to make all kinds of things which would cost pounds to buy.

## NOW ON SALE.

Part 1.  
DESIGN SHEET IN 8  
COLOURS TO MAKE 3  
RUGS.

Part 2.  
CONSTRUCTION CHART  
FOR MAKING VELLUM  
LAMP SHADE.

Part 3. |  
TRANSFERS TO WORK  
EMBROIDERED TEA CLOTH

Part 4.  
HOUSEHOLD CHART IN 2  
COLOURS.

Contains Hundreds of Useful  
Facts.

Part 5.  
Special Articles on Ornamental  
Cement Work.

How to Use Transfers.  
How to Make an Embroidered  
Pochette.

Cane Basketry Work.  
How to Make Meringues.

Part 6.  
Special Articles on Simple  
Woodcarving.

A Leather Wallet with Embossed  
Decoration.

Loose Covers.  
Renovating Hats.

Stencilling on Paper and Wood.  
Embroidered Boxes.

## WONDERFUL ILLUSTRATIONS

During the past few months artists and photographers have been busy preparing drawings and taking special action pictures to show you exactly how to make or do the things described in the various articles. The complete work will contain about 3,000 specially-prepared pictures.

## WOULD YOU LIKE TO KNOW HOW TO

Cut Down Labour in Your Home?  
Plan a Colour Scheme for the Home?  
Get the Best Results from an Ideal  
Boiler?

Keep a Wireless Set in Good Running  
Order?

Keep Fit?  
Remove Tar Stains?

Select a Good Fur Coat?  
Make Chocolate Creams?  
Store Gramophone Records in the  
Best Way?

Straighten a Warped Record?  
Fit Shelves?

Stain and Polish Floors?  
Remove Blemishes on Furniture?

MAKE—  
A Simple Bookcase?  
A Coffee Table?  
A Vellum Lampshade?

A Barbola Mirror?  
A Pile Rug?  
A Tapestry  
Screen, etc.?

Loose Covers?  
50 Kinds of  
Sandwiches?

DO—  
Beadwork?  
Raffia?  
Sealing Wax  
Work?  
Passe Partout?  
Leatherwork, etc.?  
Simple and Oriental  
Lacquer  
Work?

Felt Appliqué?  
Quilting?  
Wood Carving?

These are just a few selections from  
Newnes' Popular HOME BOOK,  
showing the wide variety of subjects  
to be dealt with.

## ONE SHILLING WEEKLY.

The first six parts are now on sale at all Newsagents and Bookstalls. Post free rate 1/2 each part from Geo. Newnes, Ltd., 8-11, Southampton St., Strand, London, W.C.2.

---



---

# HUNDREDS OF MONEY SAVING IDEAS

---

Geo. Newnes, Ltd.

Printed by WILLIAMS, LEA & Co., LTD., Clifton House, Worship Street, E.C.2, and Published for the Proprietors by GEORGE NEWNES, LTD., 8-11, Southampton Street, Strand, W.C.2