

# Practical Computing

April 1982

Volume 5 Issue 4

**Computer-aided  
design and  
three-dimensional  
methods**

**Reviews:  
Oki IF-800  
Hewlett-  
Packard  
graphics  
Critical-path  
package**

**Pet bookie  
Shell and  
bubble sorting  
Hypercubes**



**NEW  
MODEL**

**LOWER  
COST**



## **Cromemco System One**

MicroCentre introduce Cromemco's new System One computer, available with an integral 5 megabyte Winchester hard disk, at a new low price.

The System One supports the full range of Cromemco interface cards, including high resolution colour graphics, and software packages. The choice of operating systems includes CDOS, CP/M and CROMIX—Cromemco's answer to Unix.

**Call MicroCentre for  Cromemco**

2

**MicroCentre Ltd**  
(Complete Micro Systems)

● Circle No. 101

**Britain's independent  
Cromemco importer**

**30 Dundas Street  
Edinburgh EH3 6JN  
Tel: 031-556 7354**





Computer-aided design — page 70

## Editor

**Peter Laurie**

Associate Editor

**Duncan Scot**

Deputy Editor

**Toby Wolpe**

Assistant Editor

**Bill Bennett**

Sub-editor

**John Liebmann**

Prestel Editor

**Martin Hayman**

Editorial Secretary

**Julle Milligan**

Consultants

Technical **Nick Hampshire**

Software **Chris Bidmead**

**Peter Wood**

Editorial: 01-661 3500

Advertisement Manager

**David Lake** 01-661 3021

Advertisement Executives

**Phillip Kirby** 01-661 3127

**Ken Walford** 01-661 3139

Midlands office:

**David Harvett** 021-356 4838

Northern office:

**Geoff Aikln** 061-872 8861

Advertisement Secretary

**Mandy Morley**

Publishing Director

**Chris Hipwell**

Published by IPC Electrical Electronic Press Ltd, Quadrant House, The Quadrant, Sutton, Surrey SM2 5AS. Tel: 01-661 3500. Telex/grams 892084 BIP-RESG.

Typeset and printed by Eden Fisher (Southend) Ltd, Southend-on-Sea.

Distributed by IPC Business Press (Sales and Distribution) Ltd, Quadrant House, The Quadrant, Sutton, Surrey SM2 5AS.

Subscriptions: U.K. £10 per annum;

Overseas £16 per annum; selling price in

Eire subject to currency exchange fluctuations and VAT; airmail rates available

on application to Subscription Manager, IPC Business Press (S & D) Ltd, Oakfield

House, Perrymount Road, Haywards

Heath, Sussex RH16 3DH. Tel: 0444

59188.

© IPC Business Press Ltd 1982

ISSN 0141-5433

Would-be authors are welcome to

send articles to the Editor but PC

cannot undertake to return them.

Payment is at £30 per published page.

Submissions should be typed or

computer-printed. Handwritten material

is liable to delay and error.

Every effort is made to check articles

and listings but PC cannot guarantee

that programs will run and can accept

no responsibility for any errors.

# CONTENTS

- 41 Editorial** / Canned thoughts
- 43 Feedback** / Portable graphics; genealogy on micros; DNA parallels
- 46 Printout** / Commodore's universal micro; ITT 3030; plug-in music module
- 53 Printout Extra** / Computer Fair preview
- 54 HP-83** / We review the Hewlett-Packard HP-83 computer with a special look at its graphics and plotting facilities
- 58 Oki Micro** / John Dawson reviews the Oki IF-800 colour computer which is supplied with high-resolution colour graphics, a built-in printer and two 5.25 in. drives
- 62 Hornet** / The Hornet critical-path analysis program tested by Peter Wood
- 70 CAD** / John Lewell brings us up to date with the latest developments in computer-aided design
- 77 3-D Graphics** / M S Khaira introduces interactive three-dimensional computer graphics
- 83 Pet bookie** / A day at the races on the Pet, a game by Philip Day
- 89 Art** / Brian Reffin Smith continues his series on graphics and design on the BBC Micro and the RML 380-Z
- 92 The Perfect Machine** / Fiction by David Haynes
- 94 Down on the farm** / Martin Hayman visits Bridgets experimental husbandry farm in Hampshire to discover how microcomputers are coping in the countryside
- 97 Hypercube** / Jonathan Bowen explores the possibility of a fourth dimension with a program for creating n-dimensional cubes
- 100 Education** / Mike and Wendy Cook develop a program to help in teaching children or adults with reading difficulties
- 106 Sorts** / Cliff Stanford and Eric Dale present two different routines — bubble sorting and shell sorting for string arrays
- 117 Open File** / A 13-page section of your programs, including Z-80 Zodiac, ZX-80/81 Line-up, 6502 Special, Pet Corner, Apple Pie and Tandy Forum
- 143 Micromouse** / British organiser, John Billingsley, sets the scene for this year's Micromouse final at the Computer Fair
- 144 Puzzle**
- 148 Payroll on the Pet** / Roger Valentine presents a complete payroll program for the Pet
- 159 Microcomputer Buyers' Guide**
- 175 The War Machine** / Zork — an advanced adventure game with a mixture of science fiction and fantasy.

Prestel page number 357

# PROTECH INSTRUMENTS & SYSTEMS

## DISC DRIVE SUB SYSTEM

PROTECH announce professional quality fully enclosed Dual 8" Disc Drives manufactured specifically with OEM and End Users in mind.

### STANDARD FEATURES INCLUDE:

- \* Stylishly designed rugged steel enclosure.
- \* Modular construction for easy maintenance.
- \* Filtered 240V over-volt protected power supplies.
- \* 50-way Bail Mounting connector, accessing all (not just a sub set) of disc drive I/O signals.
- \* Two Shugart 800/801 industry standard disc drives.
- \* 90 day parts and labour warranty.

### EXTRA ENGINEERING FACILITIES INCLUDE:

- \*\* Host to Drive Cables.
- \*\* 110V Mains power.
- \*\* Customer defined colours.
- \*\* Customised screen printed front panels.
- \*\* Alternative disc drives to customer specification.
- \*\* Complete systems from Micro's to Mini's.
- \*\* Maintenance Agreements.

OEM's and Quantity Users - please contact

Ray Albone at: 334 Selbourne Road, Luton, Beds. LU4 8NU. Phone: 0582 596181



1 off  
End User Price:  
**£1,179**  
for a standard  
dual drive

PROTECH - part of our product is ourselves! Manufacturing and Engineering facilities at our modern 30,000 sq.ft. factory in Luton ensure local expertise, high volume production benefits and fast response.

## and from PROTECH DATA SYSTEMS...

..a newcomer to our range... **'DAIZY'** for **WORD PROCESSING & DATA PROCESSING**



### FEATURING:

- \* Powerful 4MHz Z80 CPU.
- \* 64K RAM with Parity Check Bit.
- \* Interrupt structure; Real Time Clock.
- \* 8" Disc Drive controller.
- \* DMA Controller for even faster access.
- \* Auto System check on Power-Up.
- \* 3 Serial I/O's + Communications Controller.
- \* CP/M powerful World Wide operating system.
- \* Support Software such as enhanced Wordstar, MailMerge, DataStar, BASIC, COBOL, Assembler and much more.

All at a price no Company can ignore, i.e. Daisy + Daisy Wheel Printer + 8" Dual Disc Drives (0.5 Mega bytes of storage) with C/PM WordStar. Around £6000 or Lease Purchasing if you prefer.

PROTECH, particularly adept at problem solving, supply both Hardware and Software for Single User Micros' to Multi-User Minis'. Our standard Hardware includes: ANDROMEDA (our own in-house Z80 Micro); ALPHA MICRO (an 8/16 Bit Multi-User Micro); ELBIT DATA PACT (16 Bit Multi-User Mini); and, of course, the new DAIZY. We offer a wide range of Terminals and Printers, all to suit the End User.

For further details please contact: **Dave Siseman at Protech Data Systems Ltd., 25 Kneesworth Street, Royston Herts. Phone Royston 41676**

● Circle No. 257

PRACTICAL COMPUTING April 1982



# ZENITH

# data systems



## WHETHER YOU'RE A DEALER OR OEM-

Zenith can offer a product capability that includes:

- Microcomputers, CP/M based with storage to 10 Megabytes
- Systems that start from £1795\*
- Word processing, including letter quality printer from £2985\* (or lease from only £14 per week)
- A comprehensive range of Printers, VDU's, systems and applications software
- 12" green screen Monitor - in Apple colours. (Dealer/OEM's only)

Equally important Zenith is a company that:

- Is supported by the multi million dollar Zenith Radio Corporation of America
- Is committed to holding comprehensive UK stock
- Offers Country-wide service support
- Offers Dealer support including National Advertising Campaign
- Offers Realistic Discount Structures

\*Prices correct at time of going to press.

### NEW DEALER ENQUIRIES WELCOME

PC14182

I could be interested in a Dealership  I would like to receive details of your OEM terms

Name \_\_\_\_\_ Position \_\_\_\_\_  
Company \_\_\_\_\_ Address \_\_\_\_\_

Telephone \_\_\_\_\_

# ZENITH data systems

The quality goes in before the name goes on.

Or call Dave Taylor or Jim Detheridge at:-  
Zenith Data Systems Bristol Road, Gloucester. GL2 6EE. Telephone 0452 29451.

● Circle No. 103

But the real beauty of the CompuStar is its "shared logic" design concept. Each user station contains its own distinct microprocessor and RAM. The result is lightning fast program execution. Even when all 16 users are on-line. Even when all are performing different tasks! A special multiplexor circuit in the CompuStar ties all external users together to "share" the system's disk resources so that no single user ever need wait on another. An incredibly exciting concept!



A remarkable breakthrough in price/performance, the CompuStar boasts nearly 1 megabyte of on-line mini-disk storage (almost 2 megabytes on CompuStar II) and can be easily expanded to 20, 36 or 96 megabytes of hard-disk in just seconds. And since each user station can accommodate up to 64K or RAM, a total of over one million bytes can be incorporated into the system to tackle even your most difficult programming tasks.

CompuStar user stations can be configured in a countless number of ways. A series of three intelligent-type terminals are offered. Each is a perfect cosmetic and electrical match to the system. The CompuStar 10 - a 32K programmable RAM-based terminal (expandable to 64K) is just right if your requirement is a data entry or inquiry/response application. And, if your terminal needs are more sophisticated, select either our CompuStar 20 or CompuStar 40 as user stations. Both units offer dual disk storage in addition to the disk system in the CompuStar. The Model 20 features 32K of RAM (expandable to 64K) and 350K of disk storage. The Model 40 comes equipped with 64K of RAM and over 700K of disk storage. But, most importantly, no matter what your investment in hardware, the possibility of obsolescence or incompatibility is completely eliminated since user stations can be configured in any fashion you like - whenever you want.



Our New CompuStar™ 10 Megabyte Disk Storage System (called a DSS) features an 8 inch Winchester drive packaged in an attractive, compact desktop enclosure. Complete with disk, controller and power supply. Just plug it into the Z80 adaptor of your SuperBrain and turn it on. It's so quiet, you'll hardly know it's there. But, you'll quickly be astounded with its awesome power and amazing speed. The secret behind our CompuStar DSS is its unique controller/multiplexor. It allows many terminals to "share" the resources of a single disk. So, not only can you use the DSS with your SuperBrain, you can configure multiple user stations using our new series of CompuStar™ terminals, called Video Processing Units of VPU's™.

### G.W. COMPUTERS LTD, 01-636 8210 01-631 4818

#### \*\*\* THE NEW DBMS (DATABASE) \*\*\*

DBMS2 is a record relational as well as a file relational database management tool that is capable of being at different times, many different things. The one core program can be set up to perform tasks normally associated with the following list.

Accounting	Budgeting	Cashflow
Stock control	Address mailing	Letter writing
Simulations	Time recording	Filing
Calc-type predictions	Hospital indexing	Profit analysis
Bureaux services	General analysis	Mathematics
Answer what-if's	Employees records	Tabulate values
Print reports	Sort files	Edit records

Within hours perform all the above in French or German.

The list is as endless as that which meets the requirements of your own imagination.

Within the appropriate frames of reference you could ask questions like the following:

Find someone whose name begins with W, who is either in London or Birmingham, and available for work at a salary of less than 10,000.00; and is under 40 years of age, not married, of credit worthiness grade 1, with a car, prepared to travel, and who likes horses, does not mind the hours he works, is congenial and has good references. When you find such persons produce a printed list of them showing their names, telephone numbers, and what their salaries are as well as their salary if increased by 10% and show their availability for work. At the end of the list enumerate the total of such persons.

Find all stock items that are codes micro-computers that are either in warehouse 1 or warehouse 2, where the quantity on hand is more than 50 units, the cost is less than 1000.00, the selling price higher than 2000.00; that are not in cartons, bought from supplier 52, allocated more than 20, rated for tax at .15% and weigh less than 50 lbs. When you find such categories then print a report showing the description, cost price, quantity on hand, lead time for refills, what the selling price should be if raised by 12.3% as well as the profit in either percent or round figures of that projected selling price.

Find all patients who suffered from cold, that are either girls or women younger than 23 years old, and who live in London at a socio-economic grade higher than 3; do not smoke; have more than 3 children, are currently at work and where treatment failed to effect a cure in under 6 days. When you find such persons then print a list showing their age, marital status, income, and frequency of illness in the past 2 years.

Currently you can ask 5 types of questions 20 times for a single selection criterion, and then you can compute 10 mathematical relationships between the questions for the individual as well as for the total number of matches. In all some 60 bits of information relating to one record or a group or records on simply one permutation of the selection criterion, with a cross referencing facility as well.

Every word in the system, as well as the file architectures, print masks, and field attributes, is capable of alteration by you without programming expertise (but with some thought).

ALL IN ONE PROGRAM FROM G.W. COMPUTERS. THE DBMS2 II.

### G.W. COMPUTERS LTD, 01-636 8210 01-631 4818

#### \*\*\* ALL YOU NEED FROM A COMPUTER SYSTEM \*\*\*

##### DATABASE MANAGEMENT + WORD-PROCESSING + MODELLING + DIY INTERPRETER + SERVICE

	NORMALLY		NORMALLY
01 - SUPERBRAIN 64K RAM 320 K	1950.00*	01 - SUPERBRAIN OR N/STAR QD	2395.00
02 - EPSON MX80 FT (OR SIMILAR)	475.00	02 - NEC 5510 (OR SIMILAR)	1695.00
03 - CABLE	25.00	03 - CABLE ADAPTER	25.00
04 - 12 MONTH WARRANTY	235.00	04 - 12 MONTH WARRANTY	410.00
05 - DELIVERY IN U.K.	40.00	05 - DELIVERY IN U.K.	50.00
06 - TRAINING SESSION	50.00	06 - TRAINING SESSION	50.00
07 - CPM HANDBOOK	8.75	07 - CPM HANDBOOK	8.75
08 - 50 BASIC EXERCISES	8.75	08 - 50 BASIS EXERCISES	8.75
09 - BOX PAPER (2000 SHEETS)	20.00	09 - BOX PAPER (2000 SHEETS)	20.00
10 - DBMS2 (DATABASE)	575.00	10 - DBMS2 (DATABASE)	575.00
11 - MAGIC WAND	190.00	11 - MAGIC WAND	190.00
12 - MBASIC-80	150.00	12 - MBASIC-80	150.00
13 - SUPER CALC	150.00	13 - SUPER CALC	150.00
14 - 40 MEMOREX DISKETTES	114.00	14 - 25 DYSAN D/SIDE DISKETTES	150.00
15 - DOS+ AND DIAGNOSTICS	125.00	15 - DOS+ AND DIAGNOSTICS	125.00
16 - MSORT & DSORT	75.00	16 - MSORT & DSORT	75.00
17 - RECOVER + AUTOLOAD	25.00	17 - RECOVER + AUTOLOAD	25.00
18 - INSTANT BASIC	9.00	18 - INSTANT BASIC	9.00
19 - 50 GAMES ON DISK	100.00	19 - 50 GAMES ON DISK	100.00
(NOT INC VAT)	4325.50	(NOT INC VAT)	6320.50
OUR PRICE	2995.00	OUR PRICE	4950.00

(NOTE: ITEMS 1 AND 2 ARE MORE FLEXIBLE)

EXTRA SPECIAL SUPERBRAIN PROGRAM MAIL ORDER OFFER OF THE 5 MAIN PROGRAMS  
DBMS2 + SORTS + MAGIC WAND + MBASIC 80 + SUPER-CALC NORMALLY 1140 POUNDS

OUR PRICE \*\*\*\*\* 595.00 \*\*\*\*\* +VAT

WARRANTY NOTE: WE HANDLE ALL REPAIRS OURSELVES.

WARRANTY COVERS FREE REPLACEMENT EQUIPMENT IF DEFECTIVE IN FIRST THREE WEEKS.

THEREAFTER UP TO 12 MONTHS THE COVER PROVIDES INSURANCE ON ALL SPARE PARTS AND LABOUR COSTS (EXCLUDING CARRIAGE).

CALL OUT MAINTENANCE IS ALSO AVAILABLE AT 25.00 MINIMUM (LONDON) 50.00 MINIMUM ELSEWHERE IN U.K. PLUS MILEAGE.

CALL ONLY BY APPOINTMENT AT 55 BEDFORD COURT MANSION,  
BEDFORD AVENUE, LONDON W.C.1. TELEX 892031 TWC G





SuperBrain users get exceptional performance for just a fraction of what they'd expect to pay. Standard SuperBrain features include: two double density minifloppies with 350K bytes of disk storage, 32K of ram memory (expandable to 64K) to handle even the most sophisticated programs, a CP/M® Disk Operating System with a high powered text editor, assembler, debugger and a disk formator. And, with SuperBrain's S-100 bus adaptor, you can add all the programming power you will ever need . . . almost any type of S-100 compatible bus accessory.

SuperBrain's CP/M operating system boasts an overwhelming amount of available software in BASIC, FORTRAN, COBOL, and APL. Whatever your application . . . General Ledger, Accounts Receivable, Payroll, Inventory or Word Processing, SuperBrain is tops in its class. And the SuperBrain QD boasts the same powerful performance but also features a double-sided drive system to render more than 700K bytes of disk storage and a full 64K of RAM. All standard!

Whatever model you choose, you'll appreciate the careful attention given to every engineering detail. A full ACSII keyboard with numeric pad and user-programmable function keys. A non-glare, specially focused, 12-inch CRT for sharp images everywhere on the screen. Twin Z-80 microprocessors to ensure efficient data transfer to auxiliary peripheral devices. Dual universal RS-232 communications ports for serial data transmission. And, a single board design to make servicing a snap!

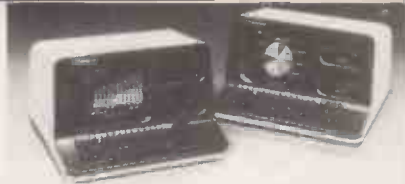

Integrated Desk Top Computer with 12 inch Bit-Mapped Graphics or Character Display, 64Kb RAM, 4 MHz Z80A®, Two Quad Capacity Floppy Disk Drives, Selectric® Style 87 Key Keyboard, Business Graphics Software.

The North Star ADVANTAGE™ is an interactive integrated graphics computer supplying the single user with a balanced set of Business-Data, Word, or Scientific-Data processing capabilities along with both character and graphics output. ADVANTAGE is fully supported by North Star's wide range of System and Application Software.

The ADVANTAGE contains a 4 MHz Z80A® CPU with 64Kb of 200 nsec Dynamic RAM (with parity) for program storage, a separate 20Kb 200 nsec RAM to drive the bit-mapped display, a 2Kb bootstrap PROM and an auxiliary Intel 8035 micro-processor to control the keyboard and floppy disks. The display can be operated as a 1920 (24 lines by 80 characters) character display or as a bit-mapped display (240 x 640 pixels), where each pixel is controlled by one bit in the 20Kb display RAM. The two integrated 5 1/4 inch floppy disks are double-sided, double-density providing storage of 360Kb per drive for a total of 720Kb. The n-key rollover Selectric style keyboard contains 49 standard typewriter keys, 9 symbol or control keys, a 14 key numeric/cursor control pad and 15 user programmable function keys.

## G.W. COMPUTERS LTD, 01-636 8210 01-631 4818

### ☆☆☆ BUS ☆☆☆ (BUSINESS EFFICIENCY)

WIDELY USED IN U.K./FRANCE/U.S.A. AND ENGLISH SPEAKING COUNTRIES FOR ITS OVERALL FLEXIBILITY AS A COMPLETE BUSINESS PACKAGE INCLUDES INVENTORY, DATABASE MANAGEMENT, INVOICING, MAILING ADDRESSES, STATEMENTS, SALES/PURCHASE LEDGER WITH OR WITHOUT AUTO STOCK UPDATE AND DOUBLE ENTRY JOURNALS INCLUDING NOMINAL LEDGER; PLUS A/C RECEIVABLE AND PAYABLE MAKING AUTO BANK ENTRIES.

01 = ADDRESS SECTION	10 = ORDER FILES	19 = NOMINAL ANALYSIS
02 = STOCK CONTROL	11 = 30/60/90 DAY AGE ANALYSIS	20 = AGED DEBTOR ANALYSIS
03 = A/C RECEIVABLES	12 = ARITHMETIC SECTION	21 = DISK DIRECTORIES
04 = SALES LEDGER	13 = PRINT CUSTOMER STATEMENTS	22 = FILE MANAGEMENT
05 = A/C PAYABLES	14 = PRINT SUPPLIER STATEMENTS	23 = SORTS
06 = PURCHASE LEDGERS	15 = PRINT AGENT STATEMENTS	24 = DISK SWAP/EXIT SYSTEM
07 = BANK UPDATE	16 = PRINT TAX STATEMENTS	WHICH OPTION . . .
08 = USER DATABASE AREA	17 = RUN SEPARATE PROGRAMS	(LEVEL 8.00 @875.00)
09 = INVOICE CREATION	18 = CHANGE VOCABULARY	

+++++ SUPER — BUS +++++ A NEW HIGHER LEVEL OF THE ABOVE PACKAGE . . . HAS BEEN REDUCED IN SIZE BY 50 PER CENT TO A SINGLE 15K BASIC PROGRAM, MAKING ALL FILE RETRIEVALS A MATTER OF NANoseconds. WORKS UNDER M/PM AND COMPUSTAR FOR COMMON DATA RETRIEVAL LEVEL 10.00..... \*\*\*\* 1475.00 \*\*\*\*

DBMS (DATABASE) HAS 01=, 02=, 04=, 06=, 07=, 08=, 17=, 18=, 21=, 24=. PRICE 475.00

DATABASE FEATURES ARE: . . . FOR ANY SIZE RECORD UP TO TWENTY FOUR FIELDS FILE ARCHITECTURES CAN BE DESIGNED WITH COMPLETE FREEDOM OVER THE LINGUISTIC CONVENTIONS ASSIGNED TO EACH FIELD. THE FILE THEN CAN STORE 32000 RECORDS WHICH CAN BE SEARCHED BY THE RANDOM ACCESS NUMBER (RETRIEVED IN LESS THAN ONE SECOND) OR 'KEY' RANDOM ACCESS ON SPECIFIED FIELD OR SEQUENTIALLY COMPARING FOR LEFT FIELD PARTS, FIELD-INKEYS, OR PARTS OF RECORD. AND THEN CHANGED, PRINTED, DELETED, SKIPPED.

GRAMA (WINTER) LTD./G.W. COMPUTERS LTD. ARE THE PRODUCERS OF THIS PACKAGE WHICH IS UNEQUALLED FOR ITS LEVEL OF TOTAL INTEGRATION, LINGUISTIC FLEXIBILITY AND MAXIMISED DISK/MEMORY CONSERVATION. AUTHOR TONY WINTER (M.D.; B.A.LIT; B.A.HON.PHIL; AND LECTURER)

## G.W. COMPUTERS LTD, 01-636 8210 01-631 4818

IMPORTANT!!! NO HARDWARE IS ANY VALUE WITHOUT THE SOFTWARE, AND OUR SOFTWARE IS UNEQUALLED. WE GIVE YOU A DISCOUNT TO SET YOU GOING. JUST DECIDE ON THE SYSTEM YOU INTEND PURCHASING, AND TAKE 10% OF ITS VALUE OFF THE PRICE YOU WOULD HAVE TO PAY FOR THE SOFTWARE. YOU COULD GET THE SOFTWARE FREE WITH THE HARDWARE IF YOU CHOOSE THE BEST SYSTEM WE SELL.

SUPERBRAIN	CORVUS DSK	NORTH STAR	COMPUSTAR	PRINTER	PRINTER
64K + 320 K DISK	1995.00	64K MDL 10 VPU	1695.00	OKI MICRO-82A	575.00
64K + 700 K DISK	2495.00	64K MDL 15 PRNT	1595.00	OKI MICRO-83	795.00
64K + 1.5 M DISK	2995.00	64K MDL 20 VPU	2495.00	OKI MICRO-83A	850.00
64K + 6.3 M DISK	4595.00	64K MDL 30 VPU	2795.00	EPSON MX80FT	475.00
N*STAR & GRAPHICS	2395.00	64K MDL 40 VPU	2995.00	EPSON MX100	575.00
5.7-MG CORVUS DSK	2250.00	10 MEG INTERTEC	3250.00	TEXAS 810	1395.00
10 MEG CORVUS DSK	3250.00	BUS VER 8.00	875.00	NEC 5510	1695.00
20 MEG CORVUS DSK	4250.00	BUS MANUAL	25.00	NEC 5525	1895.00
CORVUS MULTIPLEX	695.00	DBMS2	575.00	QUME 9/45	1695.00
CORVUS MIRROR	695.00	N*STAR QD & CPM	2395.00	QUME 5/55	1950.00
ADVANTAGE N/STAR	2395.00	OKI MICRO 80	295.00	DRE 8830	1675.00
SYSTEM 1	2395.00	SYSTEM 2	4595.00	FORTRAN-80	200.00
64K+750 K DISK		64K+5.6 MEGABYTE CORVUS		PASCAL UCSD	475.00
CRT AND GRAPHICS CP/M		MICRO-WINCHESTER & CRT		SUPER SORT	120.00
IN 1 'N/STAR' UNIT		IN 1 'SUPERBRAIN' UNIT		BASCOMPILER 190.00	
IF YOU WISH TO MAKE THE WARRANTY TO 1 YEAR THEN ADD 5% OF HARDWARE COST. OTHERWISE NO MAINTENANCE SCHEDULE, SIMPLY ADD-HOC CHARGES AFTER WARRANTY EXPIRATION, SAME QUALITY SERVICE. (SITE MAINTENANCE ON APPLICATION).		SYSTEM 3	2950.00	MAGIC CALC (CPM)	155.00
MAIL ADDRESS: G. W. COMPUTERS LTD, 55 BEDFORD COURT MANSIONS, BEDFORD AVENUE, LONDON WC1. TELEX 892031 TWC G . . . . . BOSTON OFFICE TELEX 94-0890.		64K+1.5 MEG		BUS VER 8.00	975.00
		CRT AND TWIN 5"		LETTERRIGHT	100.00
		IN COMPUSTAR UNIT		COBOL-80	320.00
		MBASIC 80	150.00	WORD-STAR	250.00
		CIS COBOL	420.00	CBASIC	75.00
		MAIL MERGE	55.00	MAGIC WAND	190.00
		DATASAR	190.00	T/MAKER	150.00
		DBMS (DATABASE)	475.00	BUS VER 9.00	975.00
		DBMS (EXTENDED)	575.00	UTILITIES	75.00
		MSORT & DSORT	75.00		

DUE TO LONG TERM CONTRACTUAL COMMITMENTS, WE ARE ONLY GIVING RESTRICTED DEMONSTRATIONS BY APPOINTMENT AT ONE OF OUR LONDON OFFICES. WE EXPORT TO ALL COUNTRIES. CONTACT TONY WINTER ON 01-636 8210 OR 01-631 4818 AND IF UNAVAILABLE THEN LEAVE A CALL-BACK MESSAGE (CLEARLY STATING YOUR TELEPHONE NUMBER AND NAME) ON THE 24 HOUR ANSWER-PHONE, WE CALL BACK ANYWHERE IN THE WORLD. OR SIMPLY LEAVE YOUR ADDRESS AND WE'LL MAIL YOU A STANDARD INFORMATION PACK. MAIL ADDRESS: 55 BEDFORD COURT MANSIONS, BEDFORD AVENUE, LONDON WC1.

CALL ONLY BY APPOINTMENT AT 55 BEDFORD COURT MANSIONS,  
BEDFORD AVENUE, LONDON W.C.1. TELEX 892031 TWC G

# Practical Computing



Olivetti DM 5100 – Price: £900.00



Olivetti DM80/180cps – Price: £1995.00

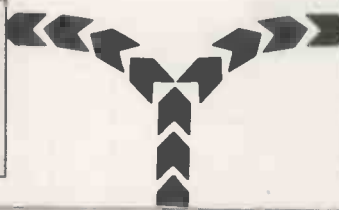

Olivetti DY211 – Price: Only £900.00!



Qume Sprint 5 Range – Prices from: £1700.00



Olivetti DY311 – Price: £1050.00

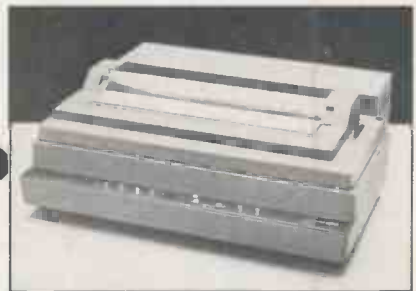

Olivetti DY811 – Price: £1995.00

Practical Computing is not only the name of a magazine. It is also a philosophy about which we feel strongly at Millbank Computers.

Practical computing solutions which meet the needs of the user is the basis on which we have built up our range of hardware, software and services.

We start with the **Millbank System 10** – the 'heavy duty' micro computer available exclusively from us and our appointed dealers. With 700K, 1.6 MB and hard disc options, the **Millbank System 10** is arguably the most reliable micro available in the UK – supported,

naturally, by twelve months full warranty.

Our range of printers covers dot matrix and letter quality printing at virtually every acceptable speed, specification and price point.

The CP/M disc operating system opens up a vast range of readily available software – including 'Financial Director' – a British Accounting suite of stunning quality and E.A.M.I.S. a new Management System for Estate Agents.

Service and support is an integral part of our practical computing philosophy.

Call us today.

**MILLBANK  
COMPUTERS**

Millbank Computers Limited, Millbank House, Amyand Park Road, Twickenham TW1 3HN. Tel: 01-891 4691.



# -and where to find it.

## BIRMINGHAM

Based in the heart of the professional area of Birmingham, Midland Micro Ltd provides a comprehensive computer service to users in the Midlands.

We supply everything from a single diskette to an advanced network or Mini-computer system using standard software and tailor-made packages.

Services provided by our experienced staff include consultancy, training, maintenance, and full after-sales service.

**Contact:** Ernest Willcox or Ian Willcox  
Midland Micro Ltd  
George House, George Road  
EDGBASTON, Birmingham B15 1PG  
Telephone: (021) 455 7431

## CALNE, Wiltshire

Suppliers of accounting and related business software in particular, the Financial Director package incorporating bought and sales ledgers, cash book, nominal ledger, budgets and monthly management accounts.

Other software, eg. order entry, invoicing and stock control, tailored to individual user requirements.

Microshade provides a total sales and support service for the System 10.

**Contact:** Bryon Horton  
Microshade (Business Computers) Ltd  
Westhill House, 4 Market Hill  
CALNE, Wiltshire  
Telephone: (0249) 814879

## CAMBRIDGE

The Avery Computer Company showroom caters specifically for the needs of local small businesses. A wide range of systems cover applications from financial modelling, forecasting, payroll etc. to large multi-user systems which can carry out all the functions of the electronic office.

We supply standard and customised software, special computer-aided learning courses and, above all, maintain close client liaison before and after installation.

**Contact:** Michael Avery or David Spry  
The Avery Computer Company  
13 The Mall, Bar Hill  
CAMBRIDGE CB3 8DZ  
Telephone: (0954) 80991

## CHELtenham

'We won't blind you with science' is the basis of this locally owned company's services to businesses, institutions and individuals.

Partners have wide-ranging business and computer experience and have built up an impressive range of books, manuals, personal computers, business computers, standard software and consumables.

**Contact:** David Lewis,  
Robin Phelps or Don Price  
The Computer Shack  
14 Pittville Street  
CHELTENHAM, Gloucestershire  
Telephone: (0242) 584343

## EXETER

Teffont Business Systems have specialised in 'word communication' equipment throughout south-west England for the past three years.

The computer division markets Micro and Mini computers. We put strong emphasis on well-proven business software, word-processing, telecommunication, and professional service/training by experienced engineering and training staff.

We also supply 'Europe's No.1' range of facsimile machines and are Prestel dealers.

**Contact:** Stephen Taylor  
Teffont Business Systems Ltd  
48-49 High Street, EXETER EX4 3DJ  
Telephone: (0392) 30438/9

## EPSOM, Surrey

The primary business of Bryan Wright Ltd is the production of programmes to meet specialised and individual needs, exclusively for the Millbank System 10 Micro-computer range.

Consultancy and advice to potential Micro-computer users.

Specifications, analysis and programming. A personal after-sales service for users' operational problems, for changing requirements in programming, and system upgrading.

Address labels and mailing-list service, with statistical analysis by areas or other criteria including delivery within a reasonable distance from Epsom.

**Contact:** Bryan Wright or Denis Wright  
Bryan Wright Ltd  
1st Floor, 57 South Street  
EPSOM, Surrey KT18 7PX  
Telephone: (78) 22653

## MANCHESTER

Calderbrook Technical Services (CTS) moved successfully into the Micro computer business in the mid 1970s and now offer a wide range of products from personal to business systems, plus a vast software library.

CTS apply a very high level of technical and engineering skills to system design, installation, training and after sales service & maintenance.

**Contact:** Peter Fawthrop  
Calderbrook Technical Services  
31-33 Church Street  
LITTLEBOROUGH, Lancs OL15 8DA  
Telephone: 0706 74342/79332

## SWANSEA

Croeso Computer Services is a well established Micro computer systems house specialising in turnkey systems for financial companies, bakeries, licenced trade stock-taking and petrol stations.

We design specialist software systems for individual requirements in business, industry and the professions. A wide range of computer equipment is available.

**Contact:** Simon Shellard or  
Michael Breach  
Croeso Computer Services  
516 Mumbles Road, MUMBLES  
Swansea, West Glamorgan  
Telephone: (0792) 61555/6

## LONDON (C)

Forte Data Systems offer a complete business computer service from feasibility study to implementation. We provide a wide range of evaluated business packages based on cost-effective solutions to user requirements, using customised software if necessary.

First-time users find our free consultation service an ideal starting point, existing users may be more interested in our main-frame and distributed data processing software development service.

**Contact:** Mr V. Sippy  
Forte Data Systems  
27 Rathbone Street, LONDON W1  
Telephone: (01) 637-0164

## LONDON (N)

B D Computer Systems brings 'mainframe' levels of skills and professionalism to the Micro market. Our experience in selling and installing large computers now provides full operational systems solutions in the Micro market.

Our customers range from a small professional user to a large Government department.

We are ideally placed to serve all London and Home Counties organisations north of the Thames.

**Contact:** Hugh Benham,  
Susan Weitzkorn or Peter Hines  
B D Computer Systems  
2 Old Brewery Mews  
Hampstead High Street  
LONDON NW3 1PZ  
Telephone: (01) 435-4442

## LONDON (S)

Micro Automation Computing Ltd was formed in 1979 with over fifty man years of computer experience to provide and support systems and software based on Micro and Mini technology.

Special emphasis is placed on real time systems for commercial, industrial and engineering applications. Services available include the supply of complete computer systems, tailored turnkey systems and packages, data base applications, specialised drivers for word-processing and colour graphics, and systems software for Micros.

**Contact:** David Shorter  
Micro Automation Computing Ltd  
207 Putney Bridge Road  
LONDON SW15 2NY  
Telephone: (01) 874 2535

This is not a comprehensive list of Millbank dealers so if your area is not covered by any of the dealers listed here call us direct.

**Millbank Computers Limited**  
Millbank House Amyand Park Road  
TWICKENHAM TW1 3HN  
Telephone: 01-891 4691

# Gemini MultiBoard

# THE

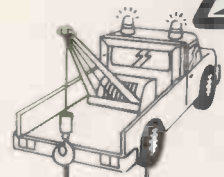

**CHEAPSKATE ROUTE**

**ESOTERIC ROUTE**

**GM 807**

3 amp PSU for the smaller system

**GM 810**

5 amp PSU with an 8-slot Motherboard

**STOP & PICK UP ANY MULTIBOARDS ON YOUR WAY**

**nascom OWNERS START HERE**

**GM 811 CPU**

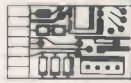

Utilising the powerful 4MHz Z80A Microprocessor the GM811 CPU card can be used as either a stand alone controller or as the heart of a complex microcomputer system. Four 'Byte-wide' sockets allow great flexibility in the type and size of memory devices chosen. Input and output facilities include both programmable serial and parallel interfaces - RS232, 1200 baud CUTS cassette interface, Z80A PIO, and an eight bit input port. In an expanded system the unique on-board RP/M monitor allows the creation of cassette or Eprom based programs or files which are upwards compatible with a disk based CP/M system.

Similar to the popular GM811 CPU card, the new GM813 CPU/RAM card has 64K of dynamic RAM replacing the 'byte-wide' sockets. An extended addressing mode facilitates future memory expansion up to 2 megabytes! The RP/M 2 monitor retains full RP/M - CP/M compatibility.

**GM 813 CPU/RAM**

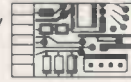

With a 59 key full QWERTY layout, this ASCII encoded keyboard includes cursor control keys, caps. lock, two key rollover and auto-repeat.

**GM 821 KEYBOARD**

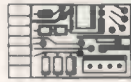

## 80 BUS STATION

### ROUTE

The Gemini MultiBoard concept is the logical route to virtually any microcomputer system you care to name. Whether you require a business system, an educational system, a process control system or any other system, there is a combination of MultiBoards to fulfil that function.

This concept ensures maximum flexibility and minimal obsolescence. Maintenance and expansion is greatly enhanced by the modular board design. MultiBoard is based on the 80-BUS structure, which is finding increasing acceptance among other British manufacturers; thus broadening the product base.

### FARES

#### Hardware (Built & tested)

GM802	64K RAM card	£140
GM803	EPROM/ROM card	£65
GM807	3A PSU	£40
GM808K	EPROM programmer	£29.50
GM809	FDC card	£125
GM810K	5A PSU/8 slot motherboard	£69.50
GM811	Z80 CPU card	£125
GM812	Z80 IVC card	£140

#### Software

GM512	CP/M 2.2 for MultiBoard	£90
GM517	Gem-Zap edit/asm tape	£45
GM518	Gem-Zap edit/asm disk	£45
GM519	Gem Pen editor/text formatter tape	£45
GM520	Gem Pen editor/text formatter EPROM	£45
GM521	Gem Pen editor/text formatter disk	£45

GM813	Z80 CPU/64K RAM card	£225
EV814	IEEE 488 card	£140
GM815-1	Single drive disk unit with PSU (350K)	£325
GM815-2	Double drive disk unit with PSU (700K)	£550
GM816	Multi I/O board	£125
AM819	Speech board	£85
AM820	Light Pen	£35
GM821	ASCII keyboard	£57.50

GM524	Gem Dis disassembler/debugger tape	£30
GM525	Gem Dis disassembler/debugger disk	£30
GM526	Comal-80 tape	£100
GM527	Comal-80 disk	£100
GM528	APL disk	£200



# LOGICAL ROUTE

**GM 812**  
-IVC

The GM812 Intelligent Video Controller card features an on board Z80A processor to provide independence of the host processor and the ability to redefine the functions and parameters of the display.

Normally used in an 80 x 25 mode the card contains a programmable character generator allowing three additional modes of operation - inverse characters, 160 x 75 block graphics, or user defined characters.

A keyboard socket allows buffered character input, and a light pen socket is provided for specialist applications. Being I/O mapped the card does not occupy any system memory space.



**GM 809**  
FDC

**GM 809 FDC**

The GM809 floppy disk controller card can support up to four disk drives in either single or double density modes. The card uses the Western Digital 1797 controller and has variable write precompensation and phase locked loop data recovery circuitry.

**GM 815**  
DRIVE UNIT

**GM 815 Drive unit**

The GM815 floppy disk housing contains one or two 5 1/4" double density, double sided Perfec FD 250 drives. This gives a storage capacity of 350K per drive. Power for the drives is provided by an integral supply unit.



**AUTO-EXCHANGE**  
All your RP/M software automatically transferred to CP/M



The GM802 RAM board provides a full 64K of dynamic memory. The 80 BUS RAMDIS signal is fully supported so that any EPROM in the system is given priority over the RAM, preventing any possibility of bus contention. Page Mode is also supported by the card which, with the appropriate software, allows up to four memory boards to be used in a system.

**GM 802**  
RAM

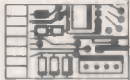

**FILL-UP WITH SOFTWARE**



RP/M software is available on tape and includes Editor/Assembler; Text Editor/Formatter; Disassembler/Debugger; Pascal and Comal-80. These packages can also be run under CP/M.



A CP/M 2.2 package is available with the GM 809 card and Perfec drives. On-screen editing auto single/double density selection and parallel or serial printers are supported. Running under CP/M is a wide range of utilities, application software and languages.



**ONE WAY**

The GM803 Eprom Board will accept up to 16 2708 or 2716 Eprom devices. This allows the addition of up to 32K of firmware to the system. The board supports the Page Mode system and consequently need not occupy any memory space when not in use.

**GM 803**  
EPROM BOARD



A number of manufacturers are busy working on additional 80-BUS boards which will progressively increase the potential of your MultiBoard system.

**MEN AT WORK**

80 BUS compatible prototyping boards are available from both Vero and Winchester Technology. These allow the user to easily add a card of their own design to the system.

**PROTO-TYPING BOARDS**

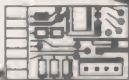

**GM 816**  
I/O BOARD

The Gemini I/O board provides a unique solution for interfacing to "the real world". The board contains 3 PIO's, a CTC and a real time clock with battery back up.

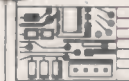

"Daughter" boards may also be added and these include A-D, D-A, opto-coupling and serial interface boards.

**GM 808**  
EPROM PROGRAMMER



The GM808 Eprom programmer connects to the PIO on the CPU card and allows the user to program 2708 or 2716 type Eproms.

**AM 819**  
SPEECH BOARD



The Arfon Microelectronics speech board utilises the National Semiconductor Digitaltalker chip set. This gives a vocabulary of over 140 words and sub sounds. Output is from an on-board speaker.

**AM 820**  
LIGHT PEN



This low cost light pen can be used with the GM812 IVC for many applications, including answer selection, editing, menu selection and movement of displayed data blocks.

**EV 814**  
IEEE 488



The EVC IEEE 488 Controller card has been designed to fully implement all IEEE 488 interface functions. This card gives the user a very versatile method of controlling any equipment fitted with a standard IEEE 488 or GPIB interface at minimal cost.

**GEMINI MULTIBOARDS - BUY THEM AT YOUR LOCAL MICROVALUE DEALER**

All the products on these two pages are available while stocks last from the MicroValue dealers listed on right (Mail order enquiries should telephone for delivery dates and post and packing costs.) Access and Barclaycard welcome.



**INTERFACE COMPONENTS LTD.**  
Oakfield Corner, Sycamore Road,  
Amersham, Bucks.  
Tel: (02403) 22307. Tlx: 837788.

**COMPUTER INTERFACING & EQUIPMENT LTD.,**  
The MICRO-SPARES Shop,  
19 Roseburn Terrace,  
Edinburgh EH12 5NG  
Tel: (031) 337 5611

**E. V. COMPUTING**  
700 Burnage Lane, Burnage,  
Manchester M19 1NA.  
Tel: (061) 431 4866.

**ELECTROVALUE LTD.**  
28 St Judes, Englefield Green,  
Egham, Surrey TW20 0HB.  
Tel: (0784) 33603. Tlx: 264475.

**SKYTRONICS,**  
2 North Road, The Park,  
Nottingham.  
Tel: (0602) 45053/45215

**TARGET ELECTRONICS**  
16 Cherry Lane, Bristol BS1 3NG.  
Tel: (0272) 421196.

**BITS & PC'S**  
4 Westgate, Wetherby,  
W. Yorks.  
Tel: (0937) 63774.

**HENRY'S RADIO**  
404 Edgware Road, London W2.  
Tel: (01) 402 6822.  
Tlx: 262284 (quote ref: 1400).

**LEEDS COMPUTER CENTRE,**  
62 The Balcony,  
Merrion Centre, Leeds.  
Tel: (0532) 458877

● Circle No. 106

# ANGLIA COMPUTER CENTRE

SPECIALISTS IN MICROCOMPUTERS FOR BUSINESS,  
AND SCIENCE

88 ST. BENEDICT'S STREET, NORWICH NR2 4AB.

TELEPHONE: (0603) 29652

From the **LARGEST EAST ANGLIAN**  
Microcomputer specialists and **APPLE II DISTRIBUTORS:**

Trade in your "PET" for something better!!!  
Apple II still only £799.00 at ANGLIA plus  
**FREE** 'Anglia Invaders' or 'Microchess' programme.

**ANGLIA FOR  
APPLES AND  
MUCH MORE!!**

## SPECIALIST EQUIPMENT AND PROGRAMMES FOR APPLE II

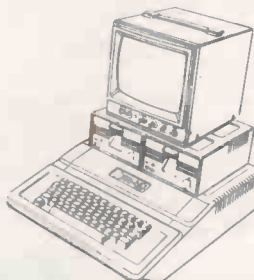
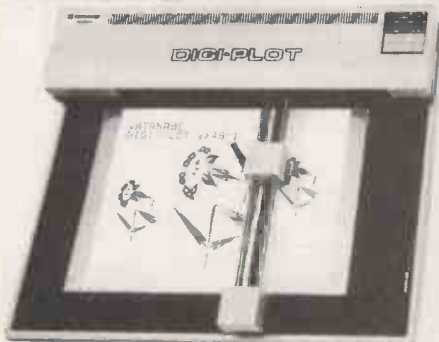

### No. 1 UNIQUE GRAPH PLOTTING SOFTWARE FOR THE DIGIPLLOT!!!

To plot graphs created by 'Apple Plot' and 'Visicalc'

DIGI PLOT .....	£895.00
APPLE PLOT .....	£37.00
VISICALC .....	£111.00
DIGI PLOT SOFTWARE .....	£105.00

(FREE when you purchase 'Digiplot' from us)

No. 2. SOFTWARE INTERFACE BETWEEN 'GRAPHICS TABLET' AND 'DIGI PLOT' .....	£95.00
---	--------

(FREE when you purchase either 'Graphics Tablet' or 'Digiplot' from us)

No. 3. Get the most versatile and low cost printers for your Apple II and take advantage of its versatile character set from within 'Apple Writer' by using the **EPSON/APPLE WRITER ADVANCED CHARACTER GENERATOR** .....£49.00  
(FREE if you purchase an Epson Printer and Apple Writer from us)

No. 4. **CASHBOOK PROGRAMME** suitable for personal, departmental, societies or institutional use .....£95.00

No. 5. **COSTING** your production of **ASSEMBLED PRODUCTS** includes Stock Control and Price Update of individual items (written in Pascal) .....£650.00

No. 6. **PROPERTY RENTAL** — suitable for Estate Agents.

No. 7. **EXAM TIME** — save yourself time in preparing Multiple Choice Questions and After Exam Tuition. Suitable for schools, colleges and industry training .....£49.50



### EPSON PRINTERS

Epson MX80 F/T .....	£399.00
Above with graphics .....	£450.00
Epson MX100 .....	£575.00
EPSON MX130 .....	CALL
Epson Apple Interface with cable .....	£60.00

## APPLE III—STILL WAITING??? THEN GET IN TOUCH WITH US



APPLE II's are hard at work .....on **THE HARD DISK NETWORK**

SEE IT RUNNING at our showroom and save your company £1000s on Minicomputers or Mainframes



INVOICING  
& SALES



PURCHASES



WORD  
PROCESSING



FINANCIAL  
PLANNING



BASIC



PASCAL



COBOL

HARD DISC

Are you still trying to grasp computing with a ZX80/81? — we will trade your ZX80 OR ZX81 for something better!!!

## Starting with **ACORN ATOM**

We are full stockists of all Acorn Atom products and programmes plus our own.



The **ANGLIA ATOM MONITOR** to help you into the heart of machine code computing .....£14.95  
(FREE with every assembled Atom purchased from us **FAST DELIVERY.**)

We also stock the Seikosha GP80 Printer and Atom connecting cables.

## ENGINEERS! DRAUGHTSMEN! DESIGNERS! ARCHITECTS!

Enter the drawing office of the future today with this revolutionary Microcomputer-based draughting machine for as little as £1.00 per hour.

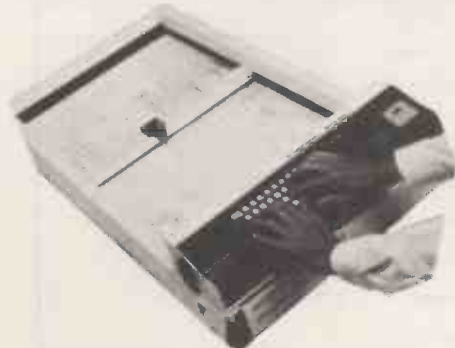

WE ALSO DISTRIBUTE: Anadex ... Tandy TRS-80 ... Tangerine ... Tantel ... North Star ... Video Genie ...  
Gume ... Paper Tiger ... Olympia ... Centronics ... Starwriter ... Sharp ... Texas Instruments TI/99/4.  
TELEPHONE: (0603) 29652. All prices quoted exclude VAT.

Note: Soon opening other branches in East Anglia and London. Sales and Technical Staff required. Interested parties please apply in writing.



# NOW YOUR HP-85 IS COMPLETE



## WITH THE MSC-9800H 5.0Mb WINCHESTER DRIVE

- 45ms access time.
- 22 bit error detection/11 bit error correction.
- 256 byte data buffer.
- Software compatible with HP9895 floppy drive.
- Compact desk top unit measuring 6¾" x 10½" x 12".
- Low cost per byte.

JUST PLUG IN AND RUN!! . . . OTHER MODELS AVAILABLE.  
 MSC-9800 — STANDARD IEEE-48/MSC-9800 L-HP9800 SERIES COMPATIBLE.

U.K. DISTRIBUTORS:

### ANGLIA COMPUTER CENTRE

88 ST. BENEDICTS STREET,                      TEL: (0603) 29652/26002.  
 NORWICH NR2 4AB.

AS SHOWN AT COMPEC 1981  
 DEALER ENQUIRIES  
 WELCOME

# Tired of hearing about PASCAL?

**We think you've waited long enough.**

At last, there is an easy to understand Pascal sampler to help you learn Pascal programming, LinkSampler. And to fill the needs of the Pascal programmer, two Pascal utility programs to increase your programming productivity, LinkVideo and LinkDisk.

Link Systems backs its commitment to quality Pascal software with fifteen years of mainframe and micro computer programming experience.

## The Easiest Way to Learn Pascal

● **LinkSampler** is an entertaining Pascal learning tool, supplied with easy to understand documentation. LinkSampler includes a full diskette of games, math procedures and financial programs.

LinkSampler I will help you put into practice what you have read in books. **£49.95**

## An Interactive Pascal Utility

● **LinkDisk** fills the needs of the programmer for manipulating individual bytes of Pascal mass storage media. It compares, examines and changes any byte on an Apple Pascal disk and translates DOS Basic into Pascal.

**Compare.** This function enables you to insure that a disk copy was performed without error, and the copy is readable. Good for Pascal and Basic.

**Examine.** Enables you to examine and change data on mass storage, change data byte by byte and alter any nibble of data.

**Translate.** Enables you to translate DOS 3.3 text and Binary files into Pascal. **£54.95**

## A Multi Function Programmers Aid

● **LinkVideo** saves valuable input, output programming time, and provides terminal independence for essential screen functions.

- Erase to End of line.
- Erase to End of Screen. ● Clear Screen.
- Cursor Moves (both input and output).
- Line and Screen Erasure.
- Filters, Validated and prompts input for Strings, Fields, Boolean, Social Security Numbers, Telephone Numbers, Dates, Integers, Pseudo-Reals. **£44.95**

# LINKO SYSTEMS

U.K. DISTRIBUTORS:

### ANGLIA COMPUTER CENTRE

88 ST. BENEDICTS STREET,  
 NORWICH NR2 4AB.

TELEPHONE:  
 (0603) 29652/26002.  
 (All prices exclude VAT)

DEALER ENQUIRIES  
 WELCOME



# Apple & Atari hardware at hard-checked prices\*

\*Hardware or software, you don't have to shop around. We continually check all our prices and we're certain they are as competitive as you will find anywhere.



	NET	VAT	TOTAL
<b>PACKAGE SYSTEMS</b>			
Apple Executive System	1950.00	292.50	2242.50
Apple Top Secretary System	2150.00	322.00	2472.50
Apple Education System	1425.00	213.75	1638.75
<b>APPLE HARDWARE</b>			
Apple 48K Video Output only	625.00	93.75	718.75
16K Add on	45.00	6.75	51.75
Disk Drive with Controller (16 sec)	345.00	51.75	396.75
Disk Drive without Controller	275.00	41.25	316.25
<b>ACCESSORIES</b>			
Programmers Aid 1	25.00	3.90	29.90
Auto Start ROM Pack	33.00	4.95	37.95
Graphics Tablet	399.00	59.85	458.85
Appletel System	525.00	78.75	603.75
TV Modulator	14.00	2.10	16.10
<b>INTERFACE CARDS</b>			
Prototype/Hobby Card	12.00	1.80	13.80
Parallel Printer Card	79.00	11.85	90.85
Communications Card	100.00	15.00	115.00
High Speed Serial Card	90.00	13.50	103.50
Centronics Card	100.00	15.00	115.00
Integer Card	90.00	13.50	103.50
Language Card	95.00	14.25	109.25
Controller Card	95.00	14.25	109.25
Eurocolour Card	65.00	9.75	74.75
IEEE - 48 Card	200.00	30.00	230.00
16K RAM Card (48K to 64K)	60.00	9.00	69.00
<b>SOFTWARE</b>			
Disk Utility Pack	12.00	1.80	13.80
Apple Post Program	27.00	4.05	31.05
The Shell Games	15.00	2.25	17.25
Elementary My Dear Apple	16.00	2.40	18.40
Apple Bowl Diskette	13.00	1.95	14.95
3.3 Operating System	34.00	5.10	39.10
DOS 3.3 Tool Kit	41.00	6.15	47.15
Apple Writer 1.1	34.00	5.10	39.10
Stellar Invader	13.00	1.95	14.95
Apple Plot	34.00	5.10	39.10
Apple Adventure	19.00	2.85	21.85
<b>APPLE DISTRIBUTED SOFTWARE</b>			
The Go Between (Centronics)	26.50	3.98	30.48
Micro Modeller	375.00	56.25	431.25
Visicalc 3.3	105.00	15.75	120.75
VisiFile	135.00	20.25	155.25
VisiPilot	95.00	14.25	109.25
VisiTrend/VisiPilot	135.00	20.25	155.25
VisiTerm	80.00	12.00	92.00
VisiDex	105.00	15.75	120.75
Desktop Plan II	105.00	15.75	120.75
<b>LANGUAGES</b>			
Pascal Language System	225.00	33.75	258.75
Apple Pilot	75.00	11.25	86.25
Apple Fortran	95.00	14.25	109.25
CIS Cobol with Forms -2	410.00	61.50	471.50

	NET	VAT	TOTAL
<b>PRINTER &amp; ACCESSORIES</b>			
Silentype Printer	170.00	25.50	195.50
10 Rolls Thermal Paper	28.00	4.20	32.20
10 Blank Disks SS/SD	17.00	2.55	19.55
<b>VIDEO MONITORS</b>			
BMC 12" Green Screen	120.00	18.00	138.00
9" Black & White Monitor	100.00	15.00	115.00
Cables	5.00	0.75	5.75
<b>OTHER ITEMS</b>			
Z80 Softcard	170.00	25.50	195.50
<b>INTEGRATED ACCOUNTING PACKAGES SYSTEMATICS</b>			
Sales Ledger	150.00	22.50	172.50
General Ledger	150.00	22.50	172.50
Purchase Ledger	150.00	22.50	172.50
Stock Control	150.00	22.50	172.50
Payroll	150.00	22.50	172.50
Invoicing	150.00	22.50	172.50
Financial Planning	150.00	22.50	172.50
<b>ATARI</b>			
400 16K Computer	250.00	37.50	287.50
800 16K Computer	480.00	72.00	552.00
410 Tape Recorder	50.00	7.50	57.50
810 Disk Drive	260.00	39.00	299.00
822 Thermal Printer	200.00	30.00	230.00
825 80 Column Printer	400.00	60.00	460.00
850 RS 232 Interface	110.00	16.50	126.50
16K Ram Upgrade	50.00	7.50	57.50
Conversational French	30.00	4.50	34.50
Conversational German	30.00	4.50	34.50
Conversational Spanish	30.00	4.50	34.50
Conversational Italian	30.00	4.50	34.50
Assembler Editor ROM	30.00	4.50	34.50
Microsoft Basic	45.00	6.75	51.75
Visicalc	105.00	15.75	120.75
Word Processor	73.00	10.95	83.95
Video Computer System	69.56	10.43	79.99

## HARDWARE GUARANTEE

All advertised products are guaranteed one year from date of purchase against defects in materials and workmanship.

During the guarantee period, Metrotech will repair or replace, at no extra charge, components that prove defective - providing that the product is returned, shipping or postage prepaid, stating when bought and enclosing proof of purchase.

This guarantee does not apply if, in the opinion of the Company, the product has been damaged by accident, misuse or misapplication.

## CONDITIONS OF BUSINESS.

We accept cheques or Access, Barclaycard, American Express and Diners Club Cards. All prices, specifications and terms are subject to change without notice at the discretion of the management. All offers subject to availability.

Prices correct at time of going to press. E. & O.E.

Hardware Post and packaging subject to confirmation.





# New CP/M software at hard to beat prices



## NEW WORDSTAR 3

WORDSTAR™ Version 3.xx has now been released. New features include: column move capabilities, horizontal scrolling—up to 240 columns and even clearer menus. Also released is MicroPro's own spelling checker—SPELLSTAR.

WORD-STAR 3.xx **£195/£30**

MAILMERGE 3.xx (optional) **£55/£10**

SPELLSTAR (optional) **£105/£10**

IN ADDITION METROTECH SUPPLIES A TRUE ENGLISH DICTIONARY, REPLACING U.S. WORDS WITH ENGLISH.

## NEW \* RECORDS MANAGEMENT

Ideal for office records including personnel, stock, clients and accounts. Features include:

- Comprehensive calculation
- Record selection on updates and reports
- Full sorting facilities
- WORDSTAR INTERFACE—for selective mailing.

COMPSOFT DMS **£345/£25**

## NEW \* MICROPLAN

If you have any problem that you would normally solve with a pen, paper and a calculator, then MicroPlan will help you. MicroPlan will perform most types of calculations working on rows and columns, as well as advanced financial analysis.

MICROPLAN **£245/£20**

## NEW CALCSTAR

CalcStar is MicroPro's new electronic Spread sheet and financial modelling Program—a sophisticated, yet easy to use calculating and planning tool. CalcStar also links with WordStar, so you can easily include your final calculations within your report.

CALCSTAR **£120/£20**

## POINTS TO REMEMBER

- All software is Ex-Stock except MDBS and available on standard 8" disks or 5" disks for Vector MZ, Superbrain, Dynabyte and NEC PC 8000.
- Prices shown as Software with manual/Manual only.
- tmi WORD-STAR is a trademark of Micropro.
- METROTECH are sole U.K. distributors for DYNABYTE micro-computer systems.

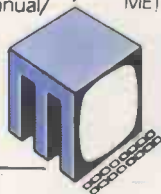

## LANGUAGES/UTILITIES

SUPERSORT I **£105/£20**

WORD-MASTER SUPERIOR TEXT EDITOR **£60/£20**

MET/TWAM INDEX SEQUENTIAL FILE ACCESS IN CBASIC II **£55/£20**

CBASIC II COMMERCIAL DISK EXTENDED BASIC **£75/£30**

SBASIC COMPILER STRUCTURED BASIC **£175/£30**

MICROSOFT BASIC 80 INTERPRETER **£155/£25**

MICROSOFT BASIC COMPILER **£195/£25**

MICROSOFT FORTRAN 80 **£215/£25**

MICROSOFT COBOL 80 **£315/£25**

## MICRO DATA BASE SYSTEMS

MDBS is a database system offering full network CODASYL—orientated data structures, variable length records, read write protection, one-to-one, one to many and many to many set relationships. Add on features are an interactive report writer and query system, a dynamic restructuring system and a recovery transaction logging system.

MDBS prices start from **£600/30**

Primer manual **£5**

## NEW BCPL \*

BCPL CINTCODE is a full and extended implementation of the popular Systems programming language BCPL CINTCODE gives a dramatic reduction in the space required for programs, requiring about a third of the store of fully compiled Z80 code.

BCPL **£250/£35**

## DATA MANAGEMENT

SELECTOR III-C2  
An easy to use Information Management System requires CBASIC II **£185/£30**

SELECTOR IV  
An advanced Information Management System, requires CBASIC II **£275/£35**

DATASTAR  
Powerful data entry, retrieval and update system **£150/£30**

## COMMUNICATIONS

BISYNC-80/3780 and BISYNC-80/3270 are full function IBM 2780, 3780 and 3270 emulators for micro computers. BISYNC-80/3780 gives you a Remote Job Entry terminal for the price of a micro! BISYNC-80/3270 combines the local processing power of a micro with a sophisticated screen capability. Make your dumb terminal smart!

MET/TTY will connect your micro to a Timesharing service in simple teletype emulation.

BISYNC-80/3780 **£445/£20**

BISYNC-80/3270 **£445/£20**

MET/TTY **£95/£20**

## FINANCIAL REPORTING

REPORT WRITER You input the values. Report Writer will perform your calculations and produce a report with your headings, totals and summaries. **£70/£10**

GLECTOR General ledger option in Selector III, requires Selector III and CBASIC II **£125/£30**

## Newly released software

INFOSTAR from MICROPRO **TBA**  
CB 80 **£295/£30**

## HOW TO ORDER

- State disk type and size ● Add 15% VAT
- Include £2 per Software item for Postage and Packing
- Enclose cheque/PO's payable to METROTECH

Mail to METROTECH MAIL ORDER,  
WATERLOO ROAD, UXBRIDGE,  
MIDDLESEX UB8 2YW

CREDIT CARDS Telephone orders welcome  
Tel: 0895 58111 Ext 247 or 269.

Trade Enquiries Welcomed

# METROTECH

A MEMBER OF THE GRAND METROPOLITAN GROUP

Vic 20	Colour Computer	£199.99*
C2N	Cassette Unit	£44.95*
4016	16K Computer	£550
4032	32K Computer	£695
2031	171K Single Drive Floppy Disk	£395
4040	343K Dual Drive Floppy Disk	£695
4022	Tractor Feed Printer	£395
8032	32K Computer	£895
8096	96K Computer	£1195
8050	950K Dual Drive Floppy Disk	£895
8023	Tractor Feed Printer	£895
8422	22 Megabyte Winchester Disk	£3495
9000	SuperPet 134K Multilanguage Computer	£1495

\*Price inclusive of VAT. All other prices VAT extra.  
All prices are correct at time of going to press.

## At Commodore we leave you no choice



Send to: Commodore Information Centre, 675 Ajax Avenue, Slough, Berks., Tel. Slough 79292.  
I'd like to know more about how Commodore can help me make the right choice.

Name \_\_\_\_\_ Position \_\_\_\_\_  
 Nature of Business \_\_\_\_\_ Company \_\_\_\_\_  
 Address \_\_\_\_\_  
 \_\_\_\_\_ Tel. \_\_\_\_\_



**commodore**  
COMPUTER

Quite simply, you benefit from our experience

10PR2



# Commodore Official Dealer List

London  
 Adda W13  
 01-579 5845  
 Capital Computer Systems W1  
 01-636 3863  
 Logic Computer Systems SW1  
 01-222 1122/5492  
 Merchant Systems Ltd EC4  
 01-583 6774  
 Micro Computation N14  
 01-882 5104  
 Microcomputer Centre SW14  
 01-878 7044/7  
 Sumlock Bondain Ltd EC1  
 01-250 0505  
 Informex-London Ltd SE13  
 01-318 4213/7  
 CSS (Systems) Ltd E8  
 01-254 9293  
 Meares Consultants Ltd NW3  
 01-431 3410  
 Data Base NW2  
 01-450 1388

Surrey & Middlesex  
 Douglas Moore Ltd Kingston-Upon-Thames  
 01-549 2121  
 Micro Facilities Ltd Hampton Hill  
 01-979 4546/941 1197  
 PFM Ltd Woking  
 04867-801117  
 Datalect Computers Ltd Croydon  
 01-680 3581  
 Datalect Computers Ltd Woking  
 04862-25995  
 Johnson Microcomputers Camberley  
 02762-0446  
 Wego Computers Ltd Caterham  
 0883-49235  
 Cream Computer Shop Harrow  
 01-863 0833  
 Da Vinci Computer Shop Edgware  
 01-952 0526  
 L & J Computers Stanmore  
 01-204 7525/206 0440

Kent, Sussex & Hampshire  
 Amplicon Micro Systems Brighton  
 0273-562163/608331  
 Business Electronics Southampton  
 0703-738248  
 HSV (Microcomputers) Ltd Hants  
 0256-62444/0703-331422  
 Millhouse Designs Ltd Alton  
 042-084517  
 The Computer Room Tonbridge  
 0732-355962  
 Scan Computers Storrington  
 09066-5432

Essex  
 Dataview Colchester  
 0206-865835  
 CS3 Ltd Ilford  
 01-554 3344  
 DDM Brentwood  
 0277-229379  
 Stuart R Dean Ltd Southend-on-Sea  
 0702-62707

Berkshire, Buckinghamshire, Oxfordshire & Wiltshire  
 Commonsense Business Systems Ltd High Wycombe  
 0494-40116  
 Orchard Computer Services Wallingford  
 0491-35529  
 Wymark Micro-Computer Centre Salisbury  
 04254-77012  
 Alphacan Ltd Banbury  
 029575-8202  
 J R Ward Computers Ltd Milton Keynes  
 0908-562850  
 The Computer Shop Oxford  
 0865-722872  
 Kingsley Computers High Wycombe  
 0494-449749

Hertfordshire & Bedfordshire  
 Alpha Business Systems Ware  
 0920-68926  
 Bromwall Data Services Old Hatfield  
 07072-60980/63295  
 Computer Plus Watford  
 0923-33927  
 HB Computers (Luton) Ltd Luton  
 0582-454466  
 Photo Acoustics Watford  
 0923-40698/32006  
 MMS Ltd Bedford  
 0234-40601  
 Brent Computer Systems Rickmansworth  
 87-71306/70329

East Midlands, South Humberside & Derbyshire  
 Davidson Richards Ltd Derby  
 0332-3669304  
 Roger Clark (Business Systems) Ltd Leicester  
 0533-20455  
 Arden Data Processing Leicester  
 0533-22255  
 Betos Systems Ltd Nottingham  
 0602-48108  
 Caddis Computer Systems Ltd Hinckley  
 0456-613544  
 AJR Ltd Arnold Nottingham  
 0602-206647

East Anglia, Lincolnshire & Northamptonshire  
 Arden Data Processing Peterborough  
 0733-47757  
 HB Computers Ltd Kettering  
 0536-520910  
 Sumlock Bondain Ltd Norwich  
 0603-26259/614302  
 Dataview Norwich  
 0603-616221

West Midlands, Staffordshire & Warwickshire  
 Joseph Ware Associates Birmingham  
 021-643 8033  
 Camden Electronics Ltd Birmingham  
 021-773 8240  
 Micro Associates Birmingham  
 021-328 4574  
 Taylor Wilson Systems Dorridge, Solihull  
 05645-6192  
 Walters Computer Systems Ltd Stourbridge  
 03843-70811

CBS Consultants Ltd Birmingham  
 021-772 8181  
 Peach Data Services Burton-on-Trent  
 0293-44968  
 Computer Services Midlands Ltd Birmingham  
 021-382 4171  
 Business Equipment Rentals Ltd Rugby  
 0788-65756  
 Business Equipment Rentals Ltd Coventry  
 0203-20246

North Wales, Cheshire & Merseyside  
 Rockliff Micro Computers Mold  
 0352-59629  
 North Wales Computer Services Colwyn Bay  
 0492-33151  
 Office & Business Equipment (Chester) Ltd Queensferry  
 0244-816803  
 Catlands Information Systems Wilmstow  
 0625-527166  
 Rockliff Micro Computers Liverpool  
 051-521 5830

Manchester  
 Cytek (UK) Ltd Old Trafford  
 061-872 4682  
 Executive Reprographic Manchester  
 061-228 1637  
 Sumlock (Manchester) Ltd Manchester  
 061-834 4233  
 P Kippings Saltard  
 061-834 6367/9  
 Computastore Ltd Manchester  
 061-832 4761

Lancashire  
 Preston Computer Centre Preston  
 0772-57684  
 Tharstern Ltd Burnley  
 0282-813299

Yorkshire & Humberside  
 Ackroyd Typewriter Co Ltd Bradford  
 0274-31835  
 Alcor Computer Systems Ltd Huddersfield  
 0484-512352  
 Deans Computer Services Leeds  
 0532-452966  
 Halbrook Business Systems Sheffield  
 0742-484466  
 Holdene Ltd Leeds  
 0532-459459  
 Microware Computers Hull  
 0482-562107  
 Mitre Finch Fishergate  
 0904-52995  
 Yorkshire Electronics Morley  
 0532-522181  
 Computer Centre (Sheffield) Ltd Sheffield  
 0742-53519/588731  
 Microprocessor Services Hull  
 0482-23146  
 Ram Computer Services Ltd Bradford  
 0274-391166

North East  
 Currie & Maughan Gateshead  
 0632-774540  
 Dysons Instruments Houghton-Le-Spring  
 0783-260452  
 Intex Datalog Ltd Eaglescliffe  
 0642-781133  
 Key Computer Services Ltd Jesmond  
 0632-815157

Avon, Wales & West Country  
 Calculator Services & Sales (Bristol) Ltd Bristol  
 0272-719452/3  
 Computer Supplies (Swansea) Sketty  
 0792-290047  
 McDowell Knaggs & Associates Worcester  
 0905-28466  
 Somerset Business Computers Taunton  
 0823-52149  
 Milequip Ltd Gloucester  
 0452-411010  
 Reeves Computers Ltd Carmarthen  
 0267-32441/2  
 Welsh Computer Centre Bridgend  
 0656-2757  
 Sigma Systems Ltd Cardiff  
 0222-21515/34869  
 Reeves Computers Newport  
 0633-212331/2  
 Computer Shack Ltd Cheltenham  
 0242-584343  
 Midland Micro Stourport-on-Severn  
 02993-77098/6706  
 Sumlock Tabdown Ltd Bristol  
 0272-276685/6  
 Radan Computational Ltd Bath  
 0225-318483

Devon & Cornwall  
 AC Systems Exeter  
 0392-71718  
 Devon Computers Paignton  
 0803-526303  
 Jeffrey Martin Computer Services Ltd Turo  
 0872-71626  
 AC Systems Plymouth  
 0752-260861  
 JAD Integrated Services (Plymouth) Ltd Plymouth  
 0752-662616/29038

Scotland  
 Ayrshire Office Services Ltd Kilmarnock  
 0563-24255/20551  
 Holdene Microsystems Ltd Edinburgh  
 031-557 40603  
 Robox Office Equipment Ltd Glasgow  
 041-221 8413/4  
 Gate Microsystems Ltd Dundee  
 0382-28194  
 Gate Microsystems Ltd Glasgow  
 041-221 9372  
 Mac Micro Ltd Inverness  
 0463-712774

Eire & Northern Ireland  
 Northern Ireland Computer Centre Co. Down  
 02317-6548/9  
 Crowley Computers Ltd Dublin 2  
 0001-600681

Isle of Man  
 Resource Planning Ltd Douglas  
 0624-4247/8



# MORE FROM MICROSOURCE

MICROSOURCE sells mainly APPLE software, peripherals and books. We cannot list all our products in a short space, so look in back issues and other magazines. We can get hold of most of your wants quickly, and at a competitive price. We specialise in the specials, what you need but cannot get elsewhere. Write or ring for a quote or more information — you can't lose!

## SPECIAL OFFERS

Valid until 31 May

### DIGITEK EXPANDER CARDS — 25% OFF

ALL PRICES INCLUDE VAT. ADD £2 post and packing per card

COLOUR CARD	£90
RAM CARD	£78.50
Z80 SOFTCARD	£95
PARALLEL PRINTER CARD	£59.60
SERIAL PRINTER CARD	£62

APPLE SPELLER is only one of a series of spelling verifiers coming on to the market. We have decided to sell this one because it received the best review in SOFTALK. It makes any of the following word processor packages into something approaching the power of a dedicated word processor. It interfaces with APPLEWRITER, APPLE PIE, EXECUTIVE SECRETARY, LETTER PERFECT, MAGIC WINDOW, and SUPERSCRIBE II. You can make your own dictionary, besides using the 30,000+ one provided. Proof reading is fast. What more can one say except the special offer price is £48.50 incl VAT and P&P.

## BOOKS

For ASSEMBLY LANGUAGE PROGRAMMERS we recommend the following two books for beginners—  
**APPLE MACHINE LANGUAGE** by Inman and Inman £10.50  
**ASSEMBLY LANGUAGE** by Randy Hyde (contains introduction to the SWEET 16 routines) £11.95  
 For BUSINESS USERS we recommend both for content and range of listings.  
**APPLE BASIC FOR BUSINESS** by Parker and Stewart which contains details of file handling as well as general business programming £12.50  
**APPLE BASIC DATA FILE PROGRAMMING** by Finkel and Brown is a self teaching guide at £10  
 For GRAPHICS programmers:  
**GRAPHICS SOFTWARE FOR MICROCOMPUTERS** by Korites takes you from basic plotting a point to perspective and hidden line removal in easy stages, building up the programs as you go £15.95  
 Just generally:  
**WHAT'S WHERE IN THE APPLE** £9.95  
**BENEATH APPLE DOS** £11.95  
**ALL ABOUT APPLESOFT** £9.95

## SOFTALK

Softalk is THE APPLE magazine in the USA and up to now has not been available except to registered APPLE users in the USA only. By special arrangement, we can now offer subscriptions to you.  
 For a trial issue, of the BUMPER CHRISTMAS EDITION, send £3 to MICRO-SOURCE at the address below. For a six month subscription starting with the January issue, send £17.  
 If you want the Christmas edition, plus a subscription, send £19.

## SPECIAL SOFTWARE

As well as being able to get almost any existing APPLE SOFTWARE or peripheral quickly, we have a team of writers producing the software that we, as users ourselves, wish was available. This month's new offering is:—

## NEW! XMON EXTENDED MONITOR

Written by Colin Richardson

XMON extends the Apple II System Monitor to offer a number of new commands for example:—  
 — S — single step  
 — T — trace  
 — M — improved move command  
 — (CTRL-R) — relocate machine language programs  
 — (CTRL-F) — comprehensive find command  
 plus many more.

Powerful new editing features are provided, and text page two can now be used in exactly the same way as page one.

XMON comes with comprehensive documentation, making it both effective and simple to use.

£22.00 INCL VAT

PRESTEL is going to take off on micros this year. We can be reached through PRESTEL on 0727 72917. We hope to have TELESOFTWARE for sale soon, and other PRESTEL software e.g. printing pages on a graphics printer. We are interested to hear if you have anything to market in this area.

ALL PRICES INCLUDE VAT UNLESS SPECIFIC MENTION IS MADE. ALL PRICES INCLUDE P&P

**MICROSOURCE**  
 Tel: Park Street (0727) 72917

1 Branch Road,  
 Park Street  
 St. Albans.

# FORCE 2

READY TO USE • EASY TO LEARN

*Professional business computers at realistic prices.*

*FORCE 2 is no toy — it's the full-force, industry standard, S-100 small business computer with everything the first time user needs to get into computing.*

*FORCE 2 is low priced and starts paying for itself immediately, because it has all the FORCE-POWER you'll need for your accounting applications and specialized information tasks. It even comes with WORDSTAR for word processing, included in its low price.*

*FORCE 2 is upward compatible with INTA'S other FORCE Computer Systems, so your computer can grow along with your business.*

*FORCE 2 computer includes:*

## *All the Hardware you need*

**Microcomputer:** S-100 compatible single-board Z-80A-based CPU with up to 4K of onboard EPROM for storage of bootstrap and diagnostics; 158 instructions; full vectored interrupt capability (8 bit plus NMI.)

**Memory:** 64K x 8 bits of dynamic RAM on single card, expandable up to 8 cards for a total of 512K; memory access time is 250 nanoseconds.

**Floppy Disk Controller:** single board interface based on NEC HPD 765 floppy-disk controller LSI chip; DMA interface transfers data to and from memory at 500K bits/second; accommodates up to 4 floppy drives.

**Power Supply:** highly reliable open-framed linear supply with fully protected outputs; designed to accommodate fully expanded system.

**Motherboard and Chassis:** nine-card slot board with gold connectors for highest reliability; fully terminated signal lines for improved performance. Chassis is fabricated of rugged metal and has highly efficient cooling system and removable air filter. Front panel features Reset and lighted Power On/Off switch.

**Cables:** two RS-232 cables — expandable to 6 total — and one 50-pin floppy disk system interface cable provided with standard system.

**Floppy Drives:** 2 IBM-compatible 8-inch double-density double-sided floppy disk drives mounted in self-contained chassis; online storage of 2.4 megabytes (IBM format), expandable to 4.8 megabytes.

**Power Supply and Chassis:** open-framed linear supply in panel has lighted AC Power On/Off switch.

**CRT:** standard 24 lines by 80 characters; typewriter keyboard with separate numeric keyboard, full range of display attributes and editing capabilities.

**Desk:** Elegant wood and metal desk custom designed for FORCE computer systems.

## *All the Software you want*

**CP/M — Operating System**  
Digital Research's CP/M 2.2 has become the standard of the micro-computer industry because of its tremendous versatility, efficiency and ease of use. FORCE 2 can utilize any CP/M-compatible operating system, which allows you, the user, to select the very best software to do your special computing jobs.

**WordStar Word Processing Application:**  
INTA recommends and supplies MicroPro's WordStar Word Processing Software System, because it's been designed for easy use by non-technical clerical personnel — yet it transforms FORCE 2 into a very sophisticated, highly flexible word processing system.





FORCE 2 SYSTEM (Does not include printer or chair)

*Other Software available includes:*

**DataStar Data Entry and Retrieval System**

MicroPro also has produced an all-purpose software system for helping you standardize the entry, retrieval, updating and printing out of all your records — it's called DataStar and it allows you to decide how you want your forms set up according to the way you do business.

**And a Full Complement of Business Applications**

INTA has developed a host of specialized application programs for all kinds of businesses and professions, and can help you evaluate the relevancy of these programs to your business. All programs sold by INTA are pre-configured to run immediately and reliably on your FORCE 2 computer.

**Cost:**

FORCE 2: £5,499  
 FORCE 10: £7,499

*Prices include shipping and handling. There are no V.A.T. charges.*

# FORCE10

*The Three-User System to grow with*

FORCE 10 is the ideal system for business environments involving simultaneous accounting and word processing requirements. FORCE 10 has plenty of forcepower to handle sales order entry for one operator, while another is updating your mailing list, and a third operator is preparing a special report for your next meeting. And FORCE 10 is fully compatible with the entire INTA FORCE Computer Systems line, so you can add on satellite FORCE 2 Systems and more FORCE 10 Systems — or eventually expand up to the even bigger FORCE 35 System and beyond.

**Inta Corporation**  
**Computer Products Division**  
 Plaza La Reina Office Tower  
 6033 West Century Boulevard  
 Fourth Floor  
 Los Angeles  
 California 90045 U.S.A.  
 Telephone: 213-417-8432  
 Telex: 664611 HQLAX CTRLSA  
 Telecopier: 213-645-6654

# INTA CORPORATION

● Circle No. 112







## semicomps

NORTHERN LIMITED  
Semicomps Northern Ltd.,  
East Bowmont Street,  
Kelso, Roxburghshire. Tel: (0573) 24366

## Eley Electronics

Eley Electronics, 100/104 Beatrice Road,  
(off Fosse Road North), Leicester. Tel: 0533 871522

## MID-SHIRE'S COMPUTER CENTRE

68 Nantwich Road, Crewe, Cheshire  
Tel: (0270) 211086

ELECTRICAL ELECTRONIC & MICROCOMPUTING  
RETAIL & REPAIR

18 Station Road Lower Parkstone  
Poole Dorset BH14 8UB  
Tel Parkstone (0202) 746555



## Micro Comms

Amateur radio C.B. radio  
Electronics Computers

372-374 George Street Aberdeen  
Telephone: 0224 633385

## JPS

9 East Street, Colne,  
Nr. Huntingdon, Cambs.  
Tel: Ramsey (0487) 840710  
Contact Paul Jephcott



## SRS MICROSYSTEMS

161 Bramley Road, Oakwood,  
London N14  
Telephone: 01-363 8060

58 Battersea Rise,  
Clapham Junction  
London SW11 1HH  
Tel: 01-2237730

## OFF Records

## SKYTRONICS LTD.

2 NORTH ROAD, THE PARK, NOTTINGHAM NG7 1AG  
TELEPHONE (0602) 45053

## authorized stockists



In the heart  
of the Nascom  
country lies  
**Business & Leisure**

**Business & Leisure**  
**Micro Computers** We specialise in tailoring  
systems to your specific  
requirements.

16 The Square, Kenilworth, CV8 1EB.  
Tel: Kenilworth (0926) 512127



Stationstraat,  
6241 CL,  
Bunde (L),  
Netherlands.  
Tel: 043 641147

## OTHER NASCOM PRODUCTS

Kits from £125 + VAT

Built from £140 + VAT

Systems from £376 + VAT

### NEW

- ★ Advanced video controller from £155 + VAT
- ★ Enhanced BASIC from £40 + VAT
- ★ Pascal compiler from £45 + VAT
- ★ Compiled BASIC from £150 + VAT

## SPECIAL OFFER

Imp Printers £199 + VAT  
including graphics ROM  
12 months warranty

### LUCAS LOGIC LIMITED

NASCOM MICROCOMPUTERS DIVISION,  
Welton Road, Wedgnoek Industrial Estate,  
Warwick CV34 5PZ, England.

To Lucas Logic Ltd., Nascom Microcomputers Division, Welton Road,  
Wedgnoek Industrial Estate, Warwick CV34 5PZ, England

Please send:

Literature  Dealer List  Prog. Book Form

Dealer enquiries welcome

Name .....

Position .....

Establishment .....

Address .....

Tel. No .....

PCI

**Lucas Logic**



# ZX81 USERS

From "BYG BYTE" comes a fully compatible, assembled, tested and guaranteed

## 16k RAM PACK PLUG-IN MEMORY

*Send to* Name .....

Address .....

.....

.....

*All cheques and postal orders made payable to*

**CAPS LTD**  
Dept D

*And forward to* 28 The Spain  
Petersfield, Hampshire GU32 3LA

Allow 28 days for delivery

## ***WHY PAY MORE?***

Fully inclusive price each

# **£34.95**



# Word processing for the businessman of letters: £3135.

Like all Adler products, the Alphatronic is built to the highest technical standards. It is supported by a nationwide dealer network who are on hand just when you need them, whether it be for advice, assistance or technical service.

So if you want a word processor (with a free microcomputer) - Trust Adler.

Price exclusive of VAT.

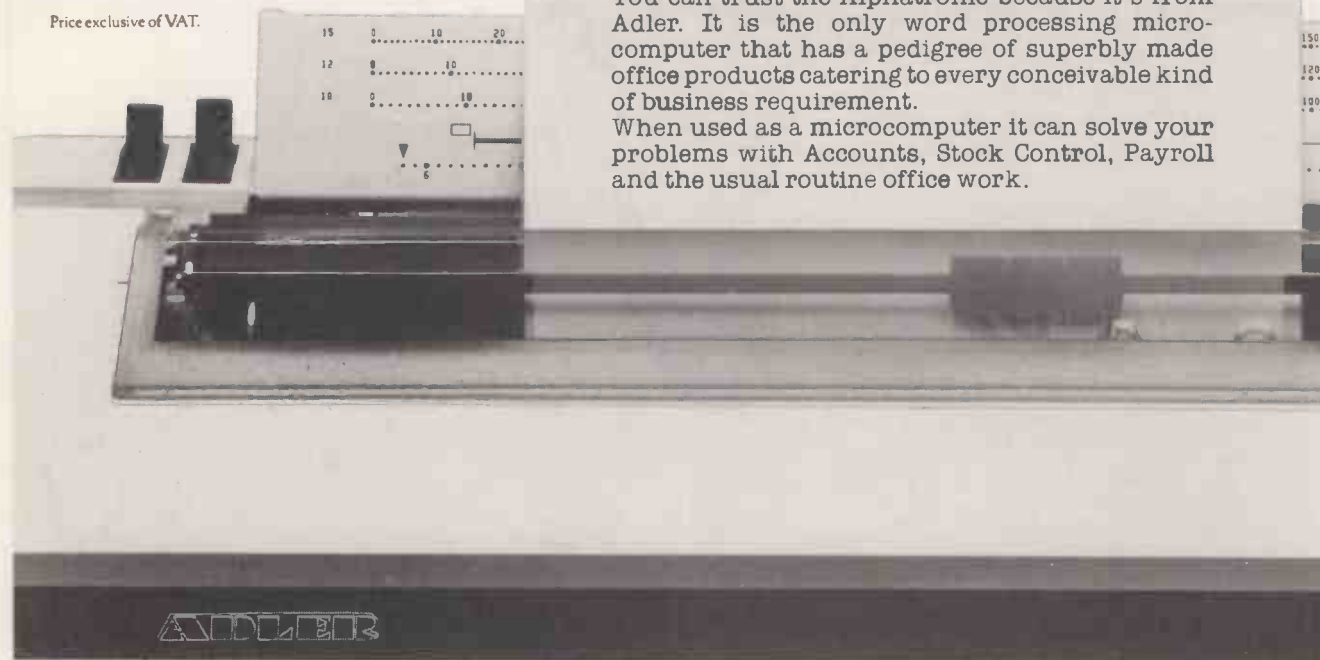

TRIUMPH ADLER (U.K.) LIMITED  
formerly Adler Business Systems Ltd.,  
27, Goswell Road, London EC1M 7AJ  
Telephone: 01-250 1717 Telex: 897772

**TA** TRIUMPH ADLER

It's true - not only is the Alphatronic an impressive word processor but it is also a very versatile micro-computer.

It produces the kind of typing that keeps the fussiest of managing directors happy - thanks to the success proven daisy wheel printer.

You can trust the Alphatronic because it's from Adler. It is the only word processing micro-computer that has a pedigree of superbly made office products catering to every conceivable kind of business requirement.

When used as a microcomputer it can solve your problems with Accounts, Stock Control, Payroll and the usual routine office work.

**TA** TRIUMPH ADLER

Triumph Adler (U.K.) Ltd.,  
27 Goswell Road, London EC1M 7AJ.  
Telephone: 01-250 1717.



Please give me more information on the Adler Alphatronic Microcomputer.

Name \_\_\_\_\_

Company \_\_\_\_\_

Address \_\_\_\_\_

Telephone \_\_\_\_\_

WP2

PC 4/82

**ANOTHER TRIUMPH FROM ADLER**

# Wherever you are in the UK there's a Genie dealer nearby



## Genie I & II Approved Dealers

**AVON** Microstyle, Bath, 0225 334659/319705. **BEDFORD** Conserve, Bedford, 0234 216749. **BERKSHIRE** P.C.P. Reading, 0734 589249. **BIRMINGHAM** Ward Electronics, Birmingham, 021 554 0708. Consultant Electronics, Birmingham, 021 382 7247. A. E. Chapman and Co., Cradeley Heath, 0384 66497/8. **BUCKINGHAMSHIRE** Photo Acoustics, Newport Pagnell, 0908 610625. **CAMBRIDGESHIRE** Cambridge Micro Computers, Cambridge, 0223 314666. **CHESHIRE** Hewart Electronics, Macclesfield, 0625 22030. Mid Shires Computer Centre, Crewe, 0270 211086. **CUMBRIA** Kendal Computer Centre, Kendal, 0539 22559. **DORSET** Blandford Computers, Blandford Forum, 0258 53737. Parkstone Electronics, Poole, 0202 746555. **ESSEX** Emprise, Colchester, 0206 865926. **GLOUCESTERSHIRE** Computer Shack, Cheltenham, 0242 584343. **HERTFORDSHIRE** Photo Acoustics, Watford, 0923 40698. Q Tek Systems, Stevenage, 0438 65385. Chrislid Systems and Software, Berkhamstead, 044 27 74569. **KENT** Swanley Electronics, Swanley, 0322 64851. **LANCASHIRE** Harden Microsystems, Blackpool, 0253 27590. Sound Service, Burnley, 0282 38481. Computercat, Leigh, 0942 605730. **LEICESTERSHIRE** Kram Electronics, Leicester, 0533 27556. **LONDON** City Microsystems, EC2, 01 588 7272/4. Wason Microchip, N18, 01 807 1757/2230. Premier Publications, Anerley SE20, 01 659 7131. **NORTH EAST** Briers Computer Services, Middlesbrough, 0642 242017. General Northern Microcomputers, Hartlepool, 0783 863871. HCCS Associates, Gateshead, 0632 821924. **NOTTINGHAMSHIRE** Midland Microcomputers, Nottingham, 0602 298281. Mansfield Computers, Mansfield, 0623 31202. East Midland Computer Services, Arnold, 0602 267079. Electronic Servicing Co., Lenton, 0602 783938. **NORFOLK** Anglia Computer Centre, Norwich, 0603 29652. Bennetts, Dereham, 0362 2488/9. **OXFORDSHIRE** Micro Business Systems, Whitney, 0993 73145. **SCOTLAND** Computer and Chips, St Andrews, 0334 72569. Scotbyte Computers, Edinburgh, 031 343 1005. Victor Morris and Co., Glasgow, 041 221 8958. **SHROPSHIRE** Tarrant Electronics, Newport, 0952 814275. **SOUTH WEST** Diskwise, Plymouth (0752) 267000. West Devon Electronics, Yelverton, 082 285 3434. Bits and Bytes, Barnstaple, 0271 72789. **SUFFOLK** Elgelec Ltd., Ipswich, 0473 711164. **SURREY** Croydon Computer Centre, Thornton Heath, 01 689 1280. **WALES** Tryfan Computers, Bangor, 0248 52042. **WEST MIDLANDS** Allen TV Services, Stoke on Trent, 0782 616929. **WILTSHIRE** Everyman Computers, Westbury, 0373 823764. **YORKSHIRE** Advance TV Services, Bradford, 0274 585333. Huddersfield Computer Centre, Huddersfield, 0484 20774. Comprite, Bradford, 0274 668890. Superior Systems Ltd., Sheffield, 0742 755005. Photo Electronics, Sheffield, 0742 53865. **NORTHERN IRELAND** Business Electronic Equipment, Belfast, 0232 46161. Britain Laboratories, Belfast, 0232 28374.



Sole Importers:

# LOWE electronics

Chesterfield Road, Matlock, Derbyshire DE4 5LE.  
Telephone: 0629 4995. Telex: 377482 Lowlec G.



# MICROCOMPUTER PRODUCTS MPI

INTERNATIONAL LTD.

ROOM PC, 11 CAMBRIDGE HOUSE, CAMBRIDGE ROAD, BARKING, ESSEX IG11 8NT, ENGLAND

Telephone: 01-591 6511 Telex: 892395

## GENERAL

### Hardware orientated:

Some Real Microprocessors	£20.85
6 Updating Supplements for Some Real Microprocessors	£20.85
Some Real Support Devices	£13.00
6 Updating Supplements for Some Real Support Devices	£20.85
Microprocessors from Chips to Systems	£11.45
Microprocessor Interfacing Techniques	£13.10
IC OP-AMP Cookbook	£9.85
RTL Cookbook	£4.25
IC Timer Cookbook	£7.50
Gateways Circuit Cellar	£6.00
8089 I/O Processor Handbook	£4.95
The CRT Controller Handbook	£5.95
The 68000 Microprocessor Handbook	£5.95
16 Bit Microprocessor Handbook	£15.95
4 and 8 Bit Microprocessor Handbook	£15.95

### Software Listings:

Computer Programs that Work	£3.95
Home & Economics Programs	£16.50
Education and Scientific Programs	£23.00
Some Common BASIC Programs	£9.85
Practical BASIC Programs	£10.25
Professional Programs: Chess, Medbil, Wdproc	£25.00

### Business:

Accounts Payable and Accounts Receivable	£14.85
General Ledger	£14.85
Small Business Programs (Microsoft Basic)	£39.95

### Other:

PIMS: Personal Information Management System	£6.50
Buyers Guide to Microsoftware	£2.40
Program Design	£4.75
Programming Techniques: Simulation	£4.75
Numbers in Theory and Practice	£6.00
K2 FDOS	£15.50
CP/M Handbook	£12.10
CP/M Primer	£8.45
CP/M Users Guide	£10.10
Calculating with BASIC	£4.95
Dr Dobbs Journal Vol 1	£15.50
Dr Dobbs Journal Vol 2	£15.50
Dr Dobbs Journal Vol 3	£15.50
Best of Interface Age: Software	£9.95
Programming the Z8000	£12.10
Z8000 Assembly Language Programming	£14.85

### FOR THE Z80, TRS-80, ZX81, 380Z

Z80 Programming for Logic Design	£6.30
Z80 Assembly Language Programming	£13.50
Z80 Instruction Handbook (Wadsworth)	£3.50
Programming the Z80 (Zacs)	£11.95
Z80 Software Gourmet Guide and Cookbook	£10.25
32 BASIC Programs for the TRS-80 (Level II) 16K	£11.10
Introduction to the T-Bug	
(Guide to TRS-80 Machine Language Monitor)	£7.60
30 Programs for the Sinclair ZX80	£6.95
Cambridge Collection for the ZX81	£4.95

### CONCERNING LANGUAGE

Beginners Guide for the UCSD PASCAL Systems	£9.50
A Practical Introduction to PASCAL	£4.95
The PASCAL Handbook	£13.95
Introduction of PASCAL (including UCSD PASCAL)	£11.50
SCELBAL—BASIC Language Interpreter (Source Code)	£10.00
BASIC BASIC	£7.00
Advanced BASIC	£6.50
Users Guide to North Star BASIC	£10.00
Microsoft BASIC (a guide)	£7.15
Secret Guide to Computers	£4.00
Fifty BASIC Exercises	£10.25
PASCAL Programs for Scientists & Engineers	£17.70

### FOR THE 6502 (PET, APPLE, ATARI etc.)

First Book of ATARI	£TBA
Best of Micro. Vol 2	£5.50
Programming the 6502 (Zacs)	£10.75
6502 Applications	£10.25
6502 Instruction Handbook	£3.50
The PET Revealed	£10.00
Library of PET Subroutines	£10.00
32 BASIC Programs for the PET	£11.10
First Book of KIM	£7.00
PET/CBM Personal Computer Guide (2nd edition)	£11.00
Apple II Users Guide	£11.50
PET and the IEEE (GPIB) Bus	£10.95
6502 Assembly Language Programming	£11.85
Some Common BASIC Programs (PET CBM)	£9.85
PET Graphics	£TBA

### NEW BOOKS

Don't (or How to) Care for your Computer	£9.65
Science & Engineering Programs for the Apple II	£11.60
Some Common BASIC Programs for the Atari	£11.10
Interfacing to S-100/IEEE 696 Microcomputer	£11.10
Introduction to Word Processing	£9.95

### DR DOBBS JOURNAL

Volume 1	£15.50
Volume 2	£15.50
Volume 3	£15.50

#### Special Deal on Prepaid Orders

All 3 Volumes £40.00 plus £3.45 p.p (inc. VAT).

These volumes are reprints from the early issues of Dr Dobbs Journal. Covering such areas as

- An 8080 Disassembler
- Extended Accuracy Arithmetic Routines
- A SC/MP Subroutine Supervisor
- An Interactive Programming Language for Control of Robots
- Computer Applications for the handicapped
- A High-Speed Memory Test Program for the 6502
- Palo Alto Tiny BASIC
- Floating Point Routines for the 6502
- FORTH Oump Programs
- Autodump
- Z80 RAM Tester

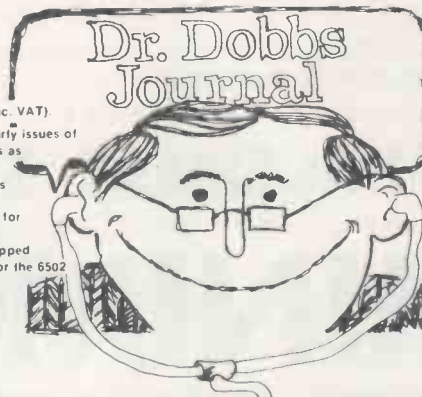

These volumes are for the Micro enthusiast who is concerned with improving his programming technique examining specialized applications and utilities, as well as making full use of program listings. Most articles were contributed by readers willing to share their solutions and ideas with you. If you wish to develop your own understanding and skill can you afford to be without these volumes? All prepaid orders will be despatched by return of post.

### FOR FUN

8080 Galaxy Game	£6.95
SUPER-WUMPUS—A Game in 6800 Assembler Code & BASIC	£4.25
Computer Music Book	£6.75
Computer Rage (a Board Game)	£6.95
Introduction to TRS-80 Graphics	£6.30
Take My Computer Please... (Fiction)	£3.25
Introduction to Low Resolution Graphics for PET, Apple TRS-80	£6.00
6502 Games	£10.25
Inside BASIC Games	£11.50

### FOR THE NOVICE

Getting Down to Business with Your Microcomputer	£5.50
Getting Involved with Your Own Computer	£5.50
How to Profit from Your Personal Computer	£6.50
Microcomputer Polpourri	£1.95
Hobby Computers are Here	£3.00
New Hobby Computers	£3.00
Understanding Microcomputers and Small Computer Systems	£7.50
Understanding Microcomputers and Small Computer Systems and Audio Cassette	£9.25
From the Counter to the Bottom Line	£10.00
Buying a Business Computer	£9.75
You Just Bought a Personal What?	£8.75
How to Make Money with Your Microcomputer	£7.00

### MAGAZINE BACK ISSUES

Micro 6502 Journal	£3.00
Personal Computing	£3.00
Interface Age	£3.25
Dr Dobbs Journal	£2.15
Computer Music Journal	£3.75
Recreational Computing	£2.15
BYTE	£3.60
Creative Computing	£4.25
Calculators and Computers	£1.95
Kilobaud Microcomputing	£4.25
Compute—for the 6502	£3.75
68' Micro	£2.50
80-Microcomputing	£4.95
On Computing	£1.95
S-100 Microsystems	£2.50
99'ER	£3.00
99'ER Subscription (6 issues)	£13.00
Magazine Storage Box (holds 12)	£2.15

### BYTE NIBBLE REPRINTS:

a) A TMS-9900 Monitor	£3.50
b) BASIC Cross-Reference Generator	£1.25
c) 'Tiny' PASCAL in 8080 Assembly Language ('d needed to use this)	£13.00
d) A 'Tiny' PASCAL Compiler	£13.50
e) An APL Interpreter in PASCAL	£13.00
f) Computer Assisted Flight Planning	£2.35
g) Computerised Wine Cellar	£2.00
h) The Design of an M6800 Lisp Interpreter	£13.00

### ORDER INFORMATION

MAGAZINES: Magazine back issues that are not currently in stock are often difficult to obtain. For unavailable back issues there is a photocopying service at 15p per page plus 25p p.p plus VAT.

BOOKS: Most books are published in the USA and stocked in Britain by Microcomputer Products International Ltd. We aim to keep all of these books in stock and as a result of this, most prepaid orders are despatched by return of post. Please add £1.00 towards postage plus 15p VAT for EACH book purchased. If purchasing more than 3 books at any one time, please add 25p plus 4p VAT for each extra title (over the 3).

PAYMENT: All payment must be in sterling and drawn against a UK Bank. Send cash, cheques, postal orders, IMO, Access or Barclaycard No. to: Microcomputer Products International Ltd., Room PC, 11 Cambridge House Cambridge Road, Barking, Essex IG11 8NT. Telephone: 01-591 6511. Telex: 892395.

Retailer and OEM terms

MAIL ORDER TELEPHONE CREDIT CARD ORDER

\* VISIT \*

Full descriptive Catalogue: available £1 — deductible from first purchase

Trade Enquiries Welcome

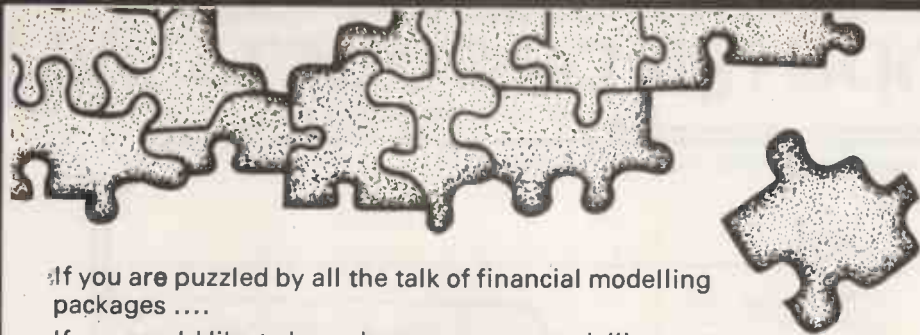

If you are puzzled by all the talk of financial modelling packages ....  
 If you would like to know how computer modelling on a micro could help your business ....  
 Then come to one of our HALF DAY

# MANAGEMENT SEMINARS

on the use of computer modelling in business by means of

# MINIMODEL

the most powerful, flexible and easy-to-use micro-computer modelling package available today.  
 For booking form send a copy of this advert with your letterhead or business card to

The Seminars cost £20 + VAT per person. They run from 9.30 to 12.30 plus discussion time on the following days:  
 Birmingham May 11  
 Leeds May 12  
 London May 13

The seminars are for Financial Directors, Chief Accountants, Managers and Entrepreneurs who want to run their business better.

MINIMODEL helps answer your **WHAT IF** questions ....  
**WHAT IF** petrol goes up 5p?  
**WHAT IF** the pound moves 3% against the dollar?  
**WHAT IF** the Chancellor alters National Insurance in the Budget?

**GREAT NORTHERN** Computer Services Limited  
 116 Low Lane, Horsforth, Leeds LS18 5PX. Telephone (0532) 589980



● Circle No. 119

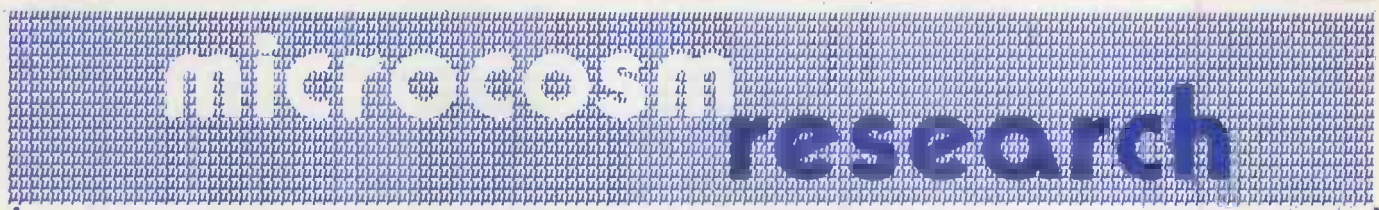

1, Montague Street, Holborn, London WC1B 5BP ● Telephone: 01-580-9792 ● Telex: 24263 TARDIS G

# MICROCACHE

*This innovative package will transform your microcomputer into an extremely powerful machine. Consider these features:*

- \* Microcache will improve the speed of your microcomputer by up to 50,000%
- \* Microcache is transparent to the user and his programs
- \* No modification of existing applications programs is required
- \* Microcache improves reliability and results in quieter running
- \* Available for virtually all disk based microcomputers

Unbelievable? Consider your system. What restricts its speed? The answer is almost invariably disk accessing rather than processor speed. Microcache very substantially reduces the number of disk accesses required. This is achieved by means of a highly intelligent RAM buffer placed between your disk drives and processor. The effect is staggering. It is available either as an add-on box of hardware and software, or software only (CP/M and MP/M systems only) for those wishing to use their own RAM boards.

The Silicon Disk System (another Microcosm Research first) is also available for those seeking to add a "RAM disk" to their system rather than speed up their existing drives via Microcache.

The Microcache Box (hardware plus Microcache and/or Silicon Disk System software) costs from £495 (for a 64K Silicon Disk System) but varies according to the amount of RAM required and the microcomputer used. Ring Peter Cheesewright for details.

Software only:                      **Microcache £395**                      **Silicon Disk System £295**

**\*Special offer\*: 20% discount on all orders receive before 1st June**

Microcosm Ltd. specialises in operating systems, communication software, utilities and other systems software. \*NEW\* — MP/M II is here. We can configure it for your hardware and help you design your multi-user business system to make full use of it.

● Circle No. 120



# The Printer People

**IF YOU NEED A PRINTER TOMORROW,  
CALL US  
TODAY.**

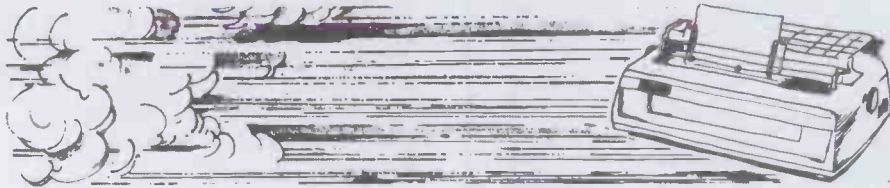

## PRINTERS

NEC SPINWRITER | OKI MICROLINE | ANACOM | TALLY | TEXAS  
TEC STARWRITER | QUME SPRINT 9 | QANTEX | RICOH | EPSON

## SCREENS

HAZELTINE | TVI  
DEC VT 100 | BMC

## ADD-ONS

PRINTER BUFFERS (16k)  
SINGLE SHEET FEEDERS

## QUME

### SPRINT 9



The Daisywheel Printing Terminal series that sets a new standard for print quality, reliability and serviceability. Unbeatable performance at a realistic price.

## NEC

### 3500



35 CPS  
Impeccable print quality printers utilising the NEC print "thimble". KSR and RO versions available all with a whole host of impressive features you have come to expect from NEC.

## OKI

### 82A

### 83A



Small, light, quiet, dot matrix printer, 40, 80 or 132 columns, 6 or 8 lines per inch, 96 ASCII characters plus 64 graphics characters, Centronics int.

## EPSON



### MX80 RANGE

The unbelievable quality printer from the world's largest print head manufacturer. A whole stable of machines to suit a wide variety of applications: MX80, MX82, MX 80FT/1 & MX80 FT/New Type 2. MX100

## MICRO-CUE

### PRINTER BUFFER

Multi-port printer buffer means one to four printers can be interfaced with one to four computers in any combination to allow all machines to be in operation at same time



16K

## BDT

### ASF 160/560



BDT automatic sheet feeders automate the only thing left in word processing that needs automation. No word processing system is truly automatic if an operator is required to hand feed sheets into the printer, or resort to perforated continuous stock. This handling individual sheets can now be a thing of the past.

## TVI

### 910/920/925/950



Green Screen Fully intelligent terminals with 24x80 display & dual intensity, blinking, reversed, underlining and protect fields, 96 ASCII chrs etc.

## HAZELTINE

### ESPRIT

Green Screen

The Hazeltine Esprit is a buffered terminal capable of displaying the complete 128 ASCII character set. Based on a 12" diagonal non-glare CRT, the video is crisp and clear with each character presented on a large matrix to reduce eye fatigue.



**NORTHAMBER LIMITED**  
3 & 4 DAWES COURT,  
ESHER, SURREY.

Tel: Esher (0372) 66397 or  
62071 (from 01 nos dial  
78-66397 or 78-62071

Importers, Distributors & Wholesalers of quality Computer products.

**0372 66397 / 62071**

*You've come this far to find a printer supplier - don't blow it now.*



# PET PRINTER GRAPHICS

by COMPUTACE LTD. PLUS North Star Horizon

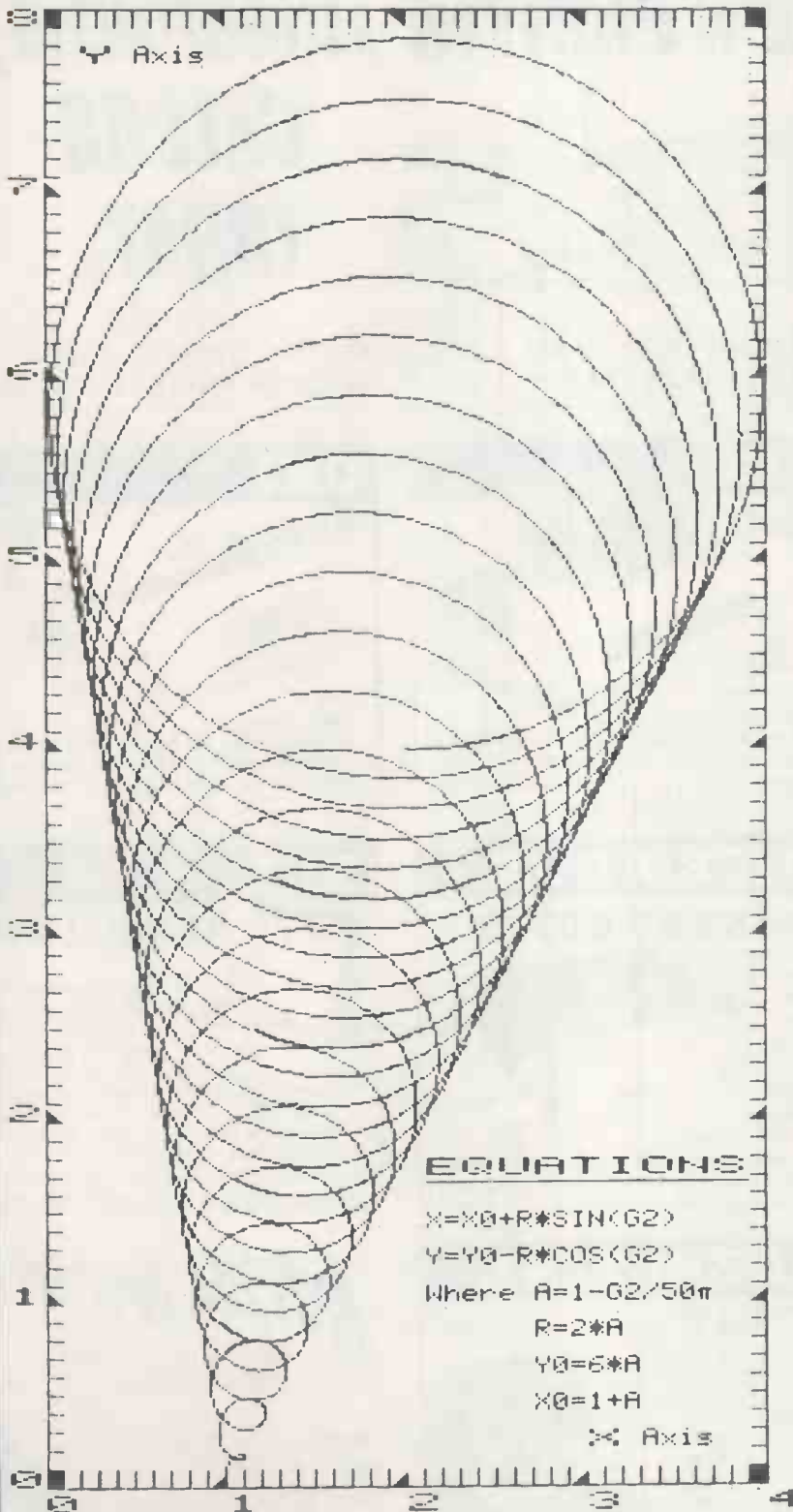

### EQUATIONS

$$X=X_0+R*\text{SIN}(G2)$$

$$Y=Y_0-R*\text{COS}(G2)$$

Where  $A=1-G2/50\pi$

$$R=2*A$$

$$Y_0=6*A$$

$$X_0=1+A$$

X Axis

This graph is a typical example printed by AUTOGRAPH on a STANDARD COMMODORE 3022 or 4022 PRINTER. (Please specify when ordering) No disk drive or plotter required. Simple to use. Hard copy. Fully flexible graph dimensions and position on page. Automatic scale option. Variable background formats. Plots any X,Y function. Multiple graphs on same axes. Full Alphanumeric labelling for professional quality presentation:

**AUTOGRAPH** is supplied with extensive documentation. Send for Brochure.

**AUTOGRAPH 1** (16K, 32K only)  
Plots any function as illus. or in spaced dots. **£39.50 incl.**

**AUTOGRAPH 2** (16K, 32K only)  
As AutoGraph 1 but includes data point plot option with joining lines and marking circles. AutoGraphs 1 and 2 combined pack. **£49.50 incl.**

**CURVE FIT 1** (32 K only)  
Powerful Linear and Non-Linear Regression of any function to a least squares data fit. Complete with plot of regressed curve & data. **£55.50 incl.**

**CURVE FIT 0**  
As Curve Fit 1 plus Cubic Spline Fit, Integrals and Gradients throughout. **£65.50 incl.**

Send for Brochure and details of combined packs at reduced prices. Including: Epson Printers and Oxford Computer Systems Compiler.

COMPUTACE LTD., INFABCO GROUP, International Base, Greenwell Rd., East Tullos, ABERDEEN AB1 4AX  
TEL: (0224) 876622.

For fastest reply use:-  
COMPUTACE LTD.,  
PO BOX 50D  
NEW MALDEN, SURREY KT3 3BD



# Electronic Brokers Ltd

## VDU & PRINTER OFFERS

## DEC SALE

a selection from our huge stocks

### HAZELTINE H2000 VISUAL DISPLAY UNIT

27 x 74 Display, 64 ASCII, RS232, full half duplex and full editing XY cursor addressing and batch mode, green phosphor CRT, detachable keyboard.

#### SPECIAL QUANTITY DISCOUNT OFFER

1-2 £299.00 5-9 £255.00  
3-4 £275.00 10+ £250.00

Also a few remaining H1000 12x80 display RS232, 110/300 or 300/1200 baud £199.00

### AJ212 ACOUSTIC COUPLERS

Special Purchase of Anderson-Jacobson Acoustic Couplers suitable for use with RS232 or 20mA devices, full or half duplex, at speeds up to 300 baud. Attractive wooden case. £125.00

### VT50 AND VT52 DECSCOPE VDUS

VT50 DECscope, 12 x 80 upper case ASCII, 9 switch-selectable baud rates 75-9600 baud, 20mA or RS232 interface. £250.00  
VT52 DECscope, 24 x 80 upper/lower case ASCII, 9 switch-selectable baud rates 75-9600 baud, 20mA or RS232 interface. £525.00

### AJ832 DAIBY WHEEL PRINTER / PLOTTER

Scoop purchase of Anderson-Jacobson AJ832 Daisy Wheel Printers complete with full keyboard integral stand and RS232 interface

Utilising the famous GUME Printer Mechanism

1-4 £995.00  
5-9 £950.00  
10+ £895.00

### DEC LA35/LA36 and LA180 MATRIX PRINTERS

LA36 30cps keyboard printer with integral stand, 132 column tractor-feed, upper/lower case ASCII

LA36 with 20mA £450.00

LA36 with RS232 £495.00

LA35 — Receive only version of LA36 — AMAZING VALUE:

LA35 with 20mA £250.00

LA35 with RS232 £275.00

LA180 high-speed output printer with 180 cps printing, 132 column tractor-feed, upper lower case ASCII, Integral stand [NEW]

LA180 printer standard parallel [Centronics type] interface £495.00

LA180-ED with optional RS232 or 20mA interface £670.00

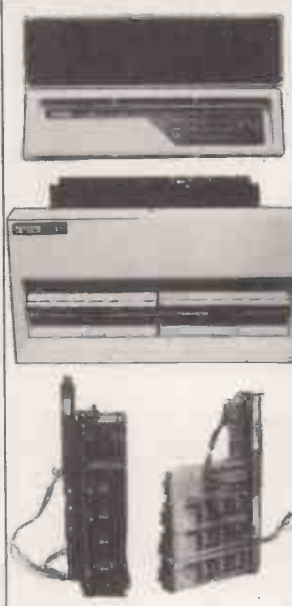

### PROCESSORS

11/04 10 1/2 in, 32KB MOS £3625.00  
11/35 32KW Core, 6ft cab £2750.00  
11/35 96KW Core, KT11D, £5000.00  
11/45 32KW Core, 4ft Cab £5950.00  
11/45 96KW Core, 4ft Cab £7450.00  
11/70 64KW Core, 2 Cabs, LA36 £18000.00  
11/70 512KB MOS, 2 Cabs, VT100 £30000.00  
8A-205-BR 32KW MOS £17500.00

### FLOPPY DISK DRIVES

#### SPECIAL PURCHASE — BRAND NEW SURPLUS

RX1180 Dual Floppy & Ctl £895.00  
RXV1180 Dual Floppy & Ctl £895.00  
RX8E Dual Floppy & Ctl £895.00

### OPTIONS

BA11FE Expander Box £895.00  
DB11A/B Unibus Repeater £525.00  
DD11A/B Backplane £125.00  
DJ11AA Multiplexor [NEW] £1250.00  
DL11W Asynchronous interface £395.00  
DR11W DMA Interface [NEW] £625.00  
FP11E Floating Point [11/60] £1975.00  
KE11A Extended Arithmetic £625.00  
KE11B Extended Arithmetic £598.00  
KT11D Memory Management £750.00  
M725D Printer Interface £325.00  
M9301 Bootstrap module £325.00  
M9312 Bootstrap module £395.00

All items reconditioned, unless otherwise stated  
ADD 15% VAT to ALL PRICES  
Carriage and Packing extra



Electronic Brokers Ltd., 61/65 Kings Cross Road, London WC1X 9LN. Tel: 01-278 3461. Telex 298694

● Circle No. 123

## ROCK SOLID TRAINING SYSTEMS FROM BRITAIN'S BRIGHTEST EXPERTS

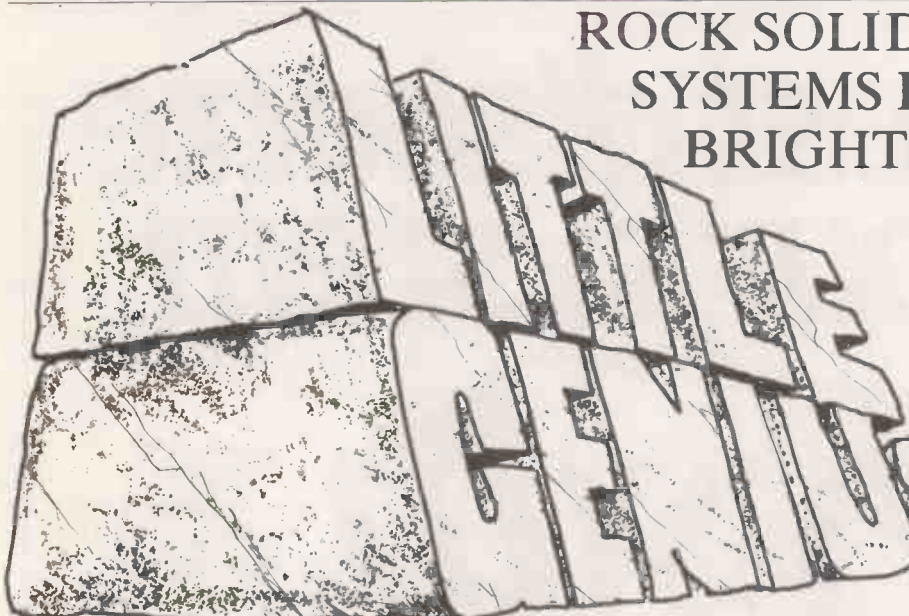

Teach yourself BASIC in 12 hours. Our LITTLE GENIUS self-instruction courses on floppy disk will teach you to master your Micro in 3 easy stages.

Each course consists of well-structured fully interactive lessons and is available in 3 separate disk modules.

1. Beginners 2. Advanced 3. Disk operating system at £19.95 each + VAT  
OR take advantage of our SPECIAL OFFER—3-in-one pack price £49.95 + VAT

BE A LITTLE GENIUS YOURSELF

Courses in BASIC for Apple, ITT 2020, PET and RML 380Z.  
Also PASCAL for Apple.

Available from most computer retailers or direct

In the U.K. write to:  
Little Genius, Suite 504, Albany House,  
324, Regent Street, London W1R 5AA.  
England. Tel: 01-580 6361

In the US write to:  
Little Genius, 34-38 83rd Street,  
Jackson Heights, New York, U.S.A.

● Circle No. 124

PRACTICAL COMPUTING April 1982

Rush me my order for/send information on:

\*BASIC/PASCAL for Machine . . . . .  
Stage Nos. 1, 2, 3 or 3-in-One (Ring as Required)

Name . . . . .

Address . . . . .

Cheque enclosed/Purchase Order Enclosed/Send C.O.D.\*

\*Delete as required



## BUGS EAT MONEY!

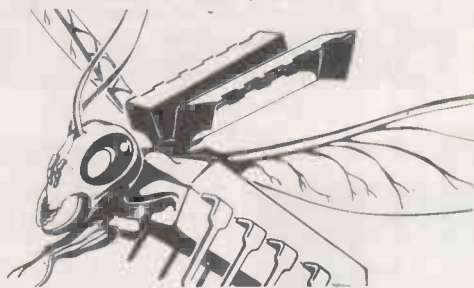

**SO NOW THERE'S DISKTOOLS®  
ONE FAMILY  
ONE AIM**

### TO OVERCOME THE BUG

Recover lost files easily  
Dispose of 'bad sectors'  
Organise jumbled disks  
The best CP/M disk editor in the world  
— modifies any byte on a disk!  
Intelligent multifile spooler  
saves console o/p in file

**DISK REVIVER  
DISK KLENE  
DISK ORGANISER**

**DISK EDIT II  
DISK SPOOL  
DISK LOG**

PHONE OR WRITE FOR BROCHURE



WHETHER YOU HAVE:-  
HARD OR FLOPPY DISKS,  
Z80 OR 8080,  
CP/M V1 OR V2 OR MP/M.  
DISKTOOLS WILL SAVE  
YOU TIME AND MONEY.

48 Hedley St, Maidstone, Kent, ME14 5AD Tel 0622 679595

● Circle No. 125

## LEARN PROGRAMMING AND MICROS IN CAMBRIDGE

"PROGRAMMING IN BASIC"

Dates: 10-12 March & 5-7 April

"PROGRAMMING IN PASCAL"

Dates: 22-26 March & 26-30 July

"INTRODUCTION TO DESIGN OF MICROPROCESSOR  
SYSTEMS"

Dates: 29 March-2 April & 10-14 May

"ADVANCED SYSTEMS DESIGN USING PASCAL"

Dates: 26-30 April & 21-25 June

"Z8000 WORKSHOP"

Dates: 24-27 May

Write or phone for Course Prospectus  
and Booking Form

**CAMBRIDGE MICRO COMPUTERS LTD**

Cambridge Science Park  
Milton Road  
Cambridge  
CB4 4BN

Telephone: 0223-314666

● Circle No. 126

# The best diskette for your system

# Dysan

**DISKETTES — AND DISC PACKS**

- \* All IBM formats
- \* AES/Lanier
- \* Apple II
- \* Atari
- \* CPT 8000
- \* Diamond

- \* Nexos 2200
- \* P2000
- \* P5002/Micom
- \* Wang
- \* Zenith
- \* — among others

We keep stocks of 30,000 for immediate  
delivery to dp and wp users

FOR YOUR RECORDS THE DYSAN HOTLINE IS: 0252 517171

**HAL Computers Limited**  
Invincible Road, Farnborough  
Hants. GU14 7QU  
Telephone 0252 517171



● Circle No. 127

# microware

Microware (London) Ltd., 5 Western Court,  
Huntly Drive, London N3 1NX  
Tel: 01-346 8452



# USE YOUR BRAIN

Does it make sense to pay more when Superbrain gives exceptional performance for just a fraction of what you would expect to pay.

Standard Superbrain has from 350K bytes of disk storage and 64K of ram memory.

Its CP/M operating system gives you an overwhelming amount of readily available software in BASIC at £145, FORTRAN, COBOL & APL.

Microware prices are from:

# £1599

## SOFTWARE

Why throw money away when you can buy WORDSTAR at £175.00.

Microware supply a complete range of popular software at prices that are hard to beat including DATASTAR, D BASE II, MAIL MERGE, MAGIC WAND and FULL ACCOUNTING PACKAGES!

any popular software supplied.

## PRINTERS

EPSON  
MX 80  
MX 100

from  
**£275**

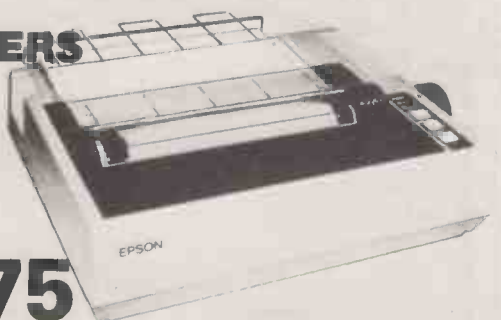

Also available

SUPERBRAIN™  
QD £1895

SUPERBRAIN™  
1-6M bytes £2195

SUPERBRAIN™  
HD £3195

Plus Limited Supplies at:

# £995

And you should see the prices we can offer on Daisy Wheel Printers. Including QUME, TEC Starwriter, NEC and RICOH.

# THINKING ABOUT BUYING A COMPUTER SYSTEM? TALK TO DATALECT FIRST!

## COMMODORE<sup>®</sup>

No. 1 best seller in the U.K. Tackles your bookkeeping, stock control and word processing. This system is reliable and superb value.



## APPLE<sup>®</sup>

One of the most versatile on the market. Expandability up to 48 kbytes of user memory, supported by a large range of programs and peripherals.

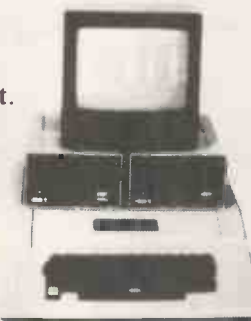

## HEWLETT PACKARD<sup>®</sup>

A portable (only 20 lbs) specialist computer with a fully integrated keyboard, display and printer.



## ACT 800 series<sup>®</sup>

A large microcomputer system supported by an excellent range of programs. Expandable to multitasking up to 20 meg.



<sup>®</sup> Registered trademarks of Commodore, Apple Inc., Hewlett Packard, ACT.

...because who else provides all this—at a price you can afford

We offer you a choice of these budget priced, easy to operate microcomputers. Starting in price from an amazing £200 for a computer, £1,500 for a complete system. All come with a versatile range of programs to meet today's modern business needs.

### Try one out for yourself

If you're not sure how a microcomputer can help, call in at our WOKING or CROYDON SHOWROOMS.

### Keeping you going

Fast reliable SERVICE if you're based in London and the South.

### Buying your system

Attractive terms, leasing and the best deals available in London and the South.

Remember, when you buy from Datalect you're getting 10 yrs EXPERTISE, SERVICE, ADVICE and TRAINING and the best after-sales care.

### SHOWROOMS:

CROYDON. 7, St. Georges Walk, Croydon, Surrey.  
Tel: 01-680 3581  
WOKING. 32, Chertsey Road, Woking, Surrey.  
Tel: 04862 63901

**THE BEST PRICES AND THE BEST SERVICE IN THE SOUTH**

# DATALECT COMPUTERS

Your computer company for London and the South

Please send me details and price list.

Name \_\_\_\_\_  
Company \_\_\_\_\_  
Position \_\_\_\_\_  
Address \_\_\_\_\_  
Post Code \_\_\_\_\_

DATALECT Computers.  
Dept. PC, 33/35 Portugal Rd., Woking, Surrey GU21 5JF

● Circle No. 129



# CUMANA

## TRS 80 MODEL III

### DUAL DENSITY DISK DRIVES



**FOR DEPENDABILITY  
AND QUIET OPERATION**



#### INTERNAL DRIVE PRICES CAPACITY

1 x 40 Track Drive	£420	184K Bytes
2 x 40 Track Drives	£599	368K Bytes
1 x 80 Track Drive	£460	368K Bytes
2 x 80 Track Drives	£695	737K Bytes
1 x 80 Track Double Sided Drive	£620	737K Bytes
2 x 80 Track Double Sided Drive	£999	1474K Bytes

Internal Drive prices include Disk Controller Board, Power Supply Unit and all Cables and Connectors required for installation.

#### EXTERNAL DRIVE PRICES

1 x 40 Track Drive	£219
2 x 40 Track Drives	£399
1 x 80 Track Drive	£285
2 x 80 Track Drives	£539
EXTERNAL 2 Drive Cable	£15

External Drives are directly compatible with the TRS 80 Model I and Video Genie Expansion Interfaces.

You can depend on **Cumana**; we scour the world markets for top quality products to give you efficient, trouble free operating. Like DISKS from TEAC of Tokyo and other leading names. Cumana are alert for the latest proven developments and promise you attentive service. Write or 'phone for Data Sheets.

**Call your nearest dealer for a demonstration:**

**RADIO SHACK LTD.**,  
188, Broadhurst Gardens,  
London NW6  
Tel: 01-624-7174

**COMP SHOP LTD.**,  
14, Station Road,  
New Barnet, Herts  
Tel: 01-441-2922

**COMP SHOP LTD.**,  
311, Edgware Road,  
London W2  
Tel: 01-262-0387

**COMP SHOP LTD.**,  
19, Herbert Street,  
Dublin 2  
Tel: 604165

**LONDON COMPUTER  
CENTRE**, 43, Grafton  
Way, London W1  
Tel: 01-388-5721

**N.I.C.**,  
61, Broad Lane,  
London N15  
Tel: 01-808-0377

**CROYDON COMPUTER  
CENTRE**, 29a, Ringstock  
Road, Thornton Heath,  
Surrey.  
Tel: 01-689-1280

**P J EQUIPMENT LTD.**,  
3, Bridge Street,  
Guildford.  
Tel: 0483-504801

**R.D.S. ELECTRICAL  
LTD.**, 157-161, Kingston  
Road, Portsmouth.  
Tel: 0705-812478

**TANDY HASTINGS  
LTD.**, 48, Queens Road,  
Hastings  
Tel: 0424-431849

**MICROWARE  
COMPUTING  
SERVICES**, 57, Queen  
Charlotte Street, Bristol.  
Tel: 0272-279550

**BLANDFORD  
COMPUTERS**, Higher  
Shaftsbury Road,  
Blandford Forum,  
Tel: 0258-53737

**TAPE SHOP**,  
32, Viaduct Road,  
Brighton.  
Tel: 0273-609099

**PARWEST LTD.**,  
18, St. Mary Street,  
Chippenham.  
Tel: 0249-2131

**COMPUTER SHACK**,  
14, Pittville Street,  
Cheltenham  
Tel: 0242-584343

**TANDY  
GLOUCESTER**,  
13, Clarence Street,  
Gloucester  
Tel: 0452-31323

**COMSERVE**,  
98, Tavistock Street,  
Bedford.  
Tel: 0234-216749

**CLEARSTONE  
COMPUTERS**, Prince of  
Wales Ind. Estate,  
Abercarn, Gwent.  
Tel: 0495-244555

**EMPRISE LTD.**,  
58, East Street,  
Colchester  
Tel: 0206-865926

**MAGNUS MICRO-  
COMPUTERS**,  
139 The Moors,  
Kidlington, Oxford.  
Tel: 08675-6703

**CAMBRIDGE  
COMPUTER STORE**,  
1, Emmanuel Street,  
Cambridge  
Tel: 0223-65334

**I.C. ELECTRONICS**,  
Flagstones,  
Siede Quarter,  
Biddenden, Kent.  
Tel: 0580-291816

**MICRO CHIP SHOP**,  
190, Lord Street,  
Pleethwood, Lancs.  
Tel: 03917-79511

**HARDEN MICRO-  
SYSTEMS**, 28-30, Back  
Lord Street, Blackpool.  
Tel: 0253-27590

**AMBASSADOR  
BUSINESS COM-  
PUTERS LTD.**,  
Ashley Lane Works,  
Shipley, W. Yorks.  
Tel: 0274-595941

**Q-TEK SYSTEMS LTD.**,  
2 Daltry Close, Old  
Town, Stevenage, Herts.  
Tel: 0438-65365

**COMPUTER & CHIPS**,  
Feddinch Mains House,  
St. Andrews, Fife,  
Scotland.  
Tel: 0334-72569

**HEWART MICRO-  
ELECTRONICS**,  
95, Blakelow Road,  
Macclesfield,  
Tel: 0625-22030

**KARADAWN LTD.**,  
2 Forest Way,  
Great Sankey,  
Warrington.  
Tel: 0925-572668

**PHOTO-ELECTRICS**,  
459 London Road,  
Sheffield,  
Tel: 0742 53865

**ARC ELECTRONICS**,  
54 Heron Drive, Sandal,  
Nr. Wakefield,  
W. Yorks WF2 6SL  
Tel: 0924-253145

**VICTOR MORRIS  
LTD.**, 340 Argyle  
Street, Glasgow,  
G2 8LY.  
Tel: 041-221 8958

**COMPRITE LTD.**,  
Thorite House,  
Laisterdyke,  
Bradford.  
Tel: 0274-663471

**GNOMIC LTD.**,  
46, Middle Street,  
Blackhall,  
Hartlepool  
Tel: 0783-863871

**BRIERS COMPUTER  
SERVICES**, 1, King  
Edward Square,  
Middlesbrough,  
Cleveland,  
Tel: 0642-242017

**3 LINE COMPUTING**,  
36, Clough Road, Hull.  
Tel: 0482-445496

**H.C. COMPUTER  
SALES LTD.**, 182,  
Earlsway, Team Valley  
Trading Estate,  
Gateshead,  
Tel: 0632-874811

**EWL COMPUTERS LTD.**,  
8, Royal Crescent,  
Glasgow,  
Tel: 041-332-7642

**EVERYMAN  
COMPUTING**,  
14 Edward Street,  
Westbury, Wilts.  
Tel: 0373-864644

**CUMANA LTD**

35 Walnut Tree Close, Guildford, Surrey, GU1 4UN.  
Telephone: (0483) 503121. Telex: 858306

Please add VAT to all prices.  
Delivery at cost will be  
advised at time of order.

# Wida Software

Specialists in Educational Software For Schools and Colleges

<b>APFELDEUTSCH</b>	Computer Assisted Course in German: Beginners to O'Level: Textbook: Workbook; 6 Language Lab Cassettes; 9 Apple diskettes of teaching and testing routines. Apple only: Complete set: £120.00 (20% discount for schools)
<b>GERMAN ROUTINES</b>	Individual Testing Routines: article and adjective endings, pronouns, word order, etc. Send s.a.e. for details. Any four routines: Apple Disk £15.00 Pet Cassette £10.00
<b>TEACHER'S TOOLKIT</b>	Starter Pack for building up library of tests. No knowledge of computing needed. Suite of 5 programmes: Tester, Testmaker, Editor, Multiple Choice Specimen, Directory of Tests. Apple Disk £20.00 Pet Cassette £15.00
<b>APPLE PILOT</b>	The Ultimate Language for Teachers: Mix sound graphics and text for questions on screens Disks & Manuals £84.00
<b>ARISTOTLE'S APPLE</b>	Tutor and Test Mode; fill-in, multiple choice, matching; includes alternative answers Apple only Disk & Manual £20.00
<b>PEDAGOG AIDS</b>	Life Raft for Teacher Thrown Into Depths of Computer Studies. 20 Apple programs to O'Level 10 Apple Disks £60.00
<b>FRENCH &amp; GERMAN CHIP</b>	Plug-in Replacement Chip for (New ROM) Pet Gives Umlauts, accents, etc. Full instructions. Kit (Pet only) £35.00
<b>THE LOWBROOK TAPES</b>	Suite of 6 Numeracy programmes for the primary school (fractions, carrying over, etc) Pet cassette £10.00
<b>SHAPE MANAGER</b>	Does for shapes what a word processor does for words. From Sinta Software. Kit (Apple) £39.95
<b>TYPE-RIGHT</b>	Lower-Case word processing with Apple Writer. Full shift key operation. Plug-in fitting with disable switch. Manual, fitting instructions, software on disk. Apple only £46.50

All prices incl. VAT:



WIDA SOFTWARE 2 Nicholas Gardens, London W5 5HY. Tel: 01-567 6941

● Circle No. 130

# ATG COMPUTERWARE

P.O. BOX 34, CHEADLE, CHESHIRE. SK8 4PT

THIS MONTH'S SPECIAL OFFER:

**EPSON MX-80FT/2 £465**

(Includes V.A.T. & Carriage)

Features include:

- 9x9 DOT MATRIX
- TRUE DESCENDERS
- FRICTION FEED or PIN FEED
- BIT IMAGE PRINTING
- BI-DIRECTIONAL WITH LOGIC SEEKING
- VERSATILE INTERFACE OPTIONS
- 8 INTERNATIONAL CHARACTER SETS
- HIGH RESOLUTION GRAPHICS

\*\* OFFER CLOSES MAY 30th 1982 \*\*

## QUALITY 5.25" DISKS

- SSDD PER PACK OF 10 £19.50
- DSDD PER PACK OF 10 £25.50

- FREE LIBRARY CASE WITH EVERY 10 PACK

## PRINTERS

EPSON • TEC • INTEGREGX • MICROLINE • NEC • BUTEL • QUME • FUJITSU • OLYMPIA • RICOH

## DISK DRIVES 5.25"

for TRS80 I & III, VIDEO GENIE I & II, ATOM, HEALTHKIT & PROTON

- SINGLE SIDED 35/40 TRACK £200.00
- DUAL SINGLE SIDED 35/40 TRACK £350.00
- SINGLE SIDE 80 TRACK £265.00
- DUAL SINGLE SIDE 80 TRACK £520.00
- APPLE II SINGLE DRIVE £270.00

## CX80 COLOUR PRINTER

features include:

- 7 COLOURS • PET GRAPHICS
  - INVERSE DOUBLE SIZE CHARACTERS
  - COLOUR COMPUTER NOT NECESSARY FOR USE
  - SWITCHABLE BAUD RATE
  - CENTRONICS INTERFACE (STANDARD)
  - OPTIONAL — APPLE II, TRS80, IEEE 488 & RS232
  - APPLE SCREEN DUMP CARD AVAILABLE
  - SEND FOR COLOUR BROCHURE
- PRICE £875.00

## MONITORS: B/W OR COLOUR

- ALL PRICES EXCLUDE V.A.T.
- S.A.E. FOR FURTHER DETAILS
- PAYMENT BY CHEQUE OR BANKERS ORDER
- CARRIAGE AT COST

**TEL: 061 428 2014**

● Circle No. 131

Epson MX80 F/T Printer only £347

# Mr. RETAILER POINT OF SALE

## MENU

- |                             |                       |                         |
|-----------------------------|-----------------------|-------------------------|
| 01= NAMES & ADDRESSES       | 11= BANK ACCOUNT      | 21= HISTORY FILE        |
| 02= STOCK CONTROL           | 12= CASH SALES        | 22= SALES ENQUIRIES     |
| 03= RE-ORDER REPORTS        | 13= CREDIT SALES      | 23= PURCHASE ENQUIRIES  |
| 04= STOCK ON DEPOSIT        | 14= CREDIT CARD SALES | 24= VAT ACCOUNT         |
| 05= STOCK VALUE             | 15= DEPOSIT SALES     | 25= SALES STATEMENTS    |
| 06= PURCHASE LEDGER         | 16= CREDIT NOTES      | 26= PURCHASE STATEMENTS |
| 07= OPEN PURCHASE LEDGER    | 17= REFUNDS           | 27= SALESMAN STATEMENTS |
| 08= GENERAL PURCHASE LEDGER | 18= PAYMENTS RECEIVED | 28= DAY CLOSE DOWN      |
| 09= OPEN SALES LEDGER       | 19= PAYMENTS OUT      | 29= END MONTH PROCEDURE |
| 10= GENERAL SALES LEDGER    | 20= DISPUTED INVOICES | 30= RUN A NEW PROGRAMME |

As it's name implies a programme dedicated to the retail trade. Turn any micro that works on CPM into a POINT OF SALE Till and Complete Bookkeeping System. Every aspect of the retail trade has been incorporated i.e.: 'sales section'; cash sales, credit sales, credit card sales, deposit sales, credit notes, refunds, payments on account, account enquiries, which of course is the most important thing you need. Once invoked all you have to do is input stock number, asks quantity, shows price and description. If correct you can total sale or continue. If you total, Mr. Retailer will ask amount tendered. Then shows you change given. Then prints invoice/receipt showing the above mentioned in greater detail. As invoice is printing Mr. Retailer automatically adjusts stock, automatically enters double entry ledgers, automatically enters salespersons account, automatically enters VAT, automatically enters weeks sales, automatically enters months sales, automatically enters years sales. All this done from POINT OF SALE. No other further book keeping required and its fast, so no customer frustration! Does not require special trained operators.

Multi-user systems available.

S.A.E. for printouts or make an appointment for a demonstration.

ACCESS  
COMPUTERS  
2 ROSE YARD  
MAIDSTONE  
KENT  
ME14 1HM  
Tel: (0622) 58356

Mr. Retailer Programme  
£975 + vat  
Complete System:  
Superbrain, Epson MX80  
F/T Printer,  
Backup service,  
including Mr. Retailer  
programme £3,395

● Circle No. 132

# PET SPEED

## Put some zipp into your programs



Petspeed compiled programs just ZIPP through your Commodore computer.

To illustrate the point Oxford Computer Systems (Software) Ltd., have produced an enlightening demonstration disk entitled "Life in the Fast Lane", which gives objective comparisons between Pet Basic, Petspeed and the alternative Basic Compiler.

Petspeed is the only **optimising** Basic Compiler available for any microcomputer, which is only one of its **other** advantages.

**FASTER** – Petspeed is capable of double the speed of the DTL Basic Compiler and up to 40 times the speed of Pet Basic.

**SHORTER PROGRAM SIZE** – the size of long programs is considerably reduced.

**COMPATIBLE** – Petspeed will compile ANY Pet Basic program.

**OPTIMISATION** – Petspeed is the only optimising Basic Compiler available for any microcomputer, because of its optimisation, programs run much faster.

**SECURITY** – Your programs belong to YOU. Oxford Computer Systems (Software) Ltd. makes no claim on Petspeed Compiled programs. No key or security device is required for compiled programs and users can build in their own protection. Petspeed code is unlistable and compiled programs cannot be tampered with.

**PRICE** – we will leave you to compare prices.

Also available **COMPILED INTEGER BASIC** – 150 to 200 times the speed of Basic Compiled. Compiled Basic is for those applications where the speed of the machine is required without the inconvenience of assembly level programming. Ideal for scientific and educational users. Compatible with Petspeed.



Petspeed for 8000 series ..... £240  
Compiled Basic ..... £165

**Special Offer:** Petspeed for 8000 series PLUS Compiled Basic for just £320.

Prices do not include VAT or postage & packing.

Write or phone today for a free copy of the 'Life in the fast lane' demonstration disk.

Oxford Computer Systems (Software) Ltd.  
7 & 8 Park End Street, Oxford OX1 1HH  
Telephone Oxford (0865) 49597

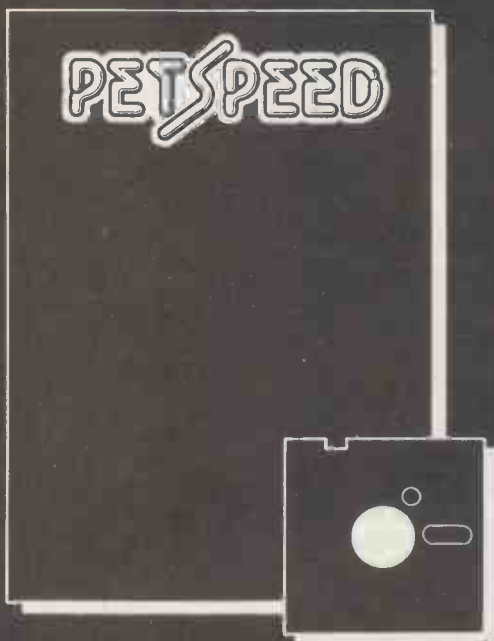

**SPECIAL OFFER FOR EDUCATIONAL USERS**  
Volume discount on all orders placed by accredited educational users before 31st May 1982. Consult your local dealer or ring Oxford 49597.



# COLUMBIA ~ a complete range of microcomputers from 320K ~ 80M

Single and multi-user upgradeable/expandable microcomputer systems from Columbia Data Systems offer the disk storage capacity that's exactly right for you. Single user machines to take 5¼" or 8" floppy disks giving 320K-2.4M capacity and multi-user machines with up to 80M on hard disk. Up to 5 users can work on different programs simultaneously while sharing a single processing system. Ideal for word processing, general accounting or other special purpose business applications.

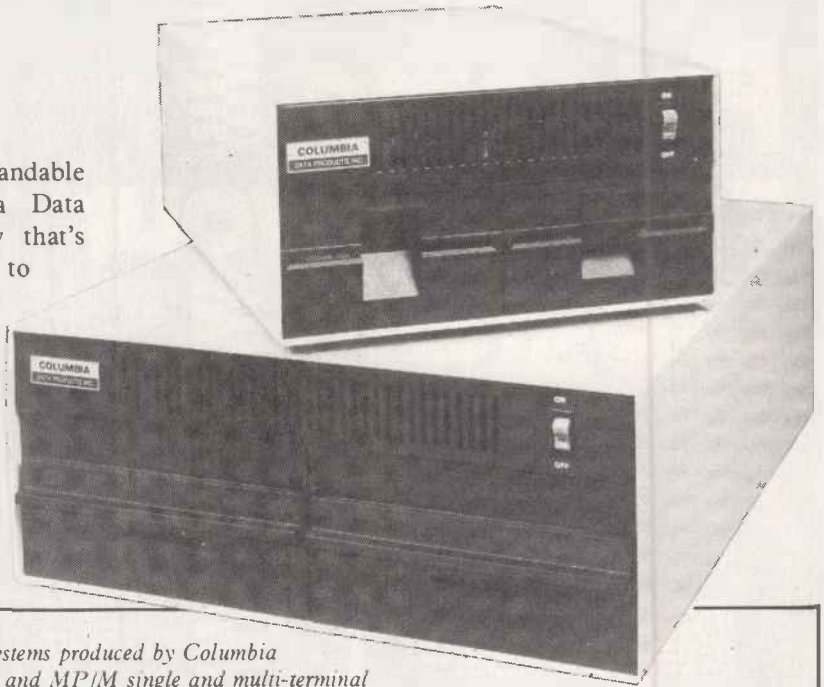

*Icarus handle the whole range of microcomputer systems produced by Columbia Data Systems of the U.S.A. This includes CP/M and MP/M single and multi-terminal units with hard and floppy disk storage capacities. It is adaptable to suit each and every micro-based application there is. So whenever you need a microcomputer, for whatever purpose, Columbia and Icarus have the answer.*

## The Icarus dealer network

**ABRAXAS COMPUTER EMPLOYMENT**, 357 Euston Road, LONDON NW1 3AL. Tel: 01 388 2061

**A.P. LTD.**, Maple House, Mortlake Crescent, CHESTER CH3 5UR. Tel: 0244 46024

**AMCO LTD.**, Playfair Road, LEEDS LS10 2GP. Tel: 0532 708321

**BASIC BUSINESS SYSTEMS**, 61 Loughborough Road, WEST BRIDGEFORD, Nottingham. Tel: 0602 819713

**BUSINESS INFORMATION SYSTEMS**, 602 Triumph House, 189 Regent Street, LONDON. Tel: 01 437 1069

**BORDER COMPUTING LTD.**, Dog Kennel Lane, BUCKNELL, Shropshire. Tel: 054 74 368

**CAMBRIDGE MICRO COMPUTERS**, Cambridge Science Park, Milton Road, CAMBRIDGE. Tel: 0223 314666

**COMMONSENSE COMPUTING 2LTD.**, P.O. Box 7, BIDEFORD, Devon. Tel: 02372 4795

**CONQUEST COMPUTER SALES LTD.**, 92 London Road, BENFLEET, Essex. Tel: 03745 59861

**CULLOVILLE LTD.**, Thornfield, Woodhill Road, SANDON, Chelmsford, Essex. Tel: 024 541 3919

**DATA PROFILE.** Lawrence Road, Green Lane, HOUNSLOW, Middlesex. Tel: 01 446 1917

**DATA WARE**, 48 Eaton Drive, KINGSTON, Surrey KT2 7QX. Tel: 01 546 2984

**DAYTA**, 20b West Street, Wilton, SALISBURY, Wilts. Tel: 0722 74 3898

**DRAGON SYSTEMS LTD.**, 17 Walter Street, SWANSEA, W. Glam. Tel: 0792 749486

**DUPLEX COMMUNICATIONS**, 2 Leire Lane, Dunton Bassett, Lutterworth, LEICESTERSHIRE. Tel: 0455 209131

**EASIBEE COMPUTING LTD.**, 133/135 High Street, LONDON E6 1HZ. Tel: 01 471 4884

**ESCO COMPUTING LTD.**, 154 Cannongate, EDINBURGH. Tel: 031 557 3937

**ESCO COMPUTING LTD.**, 40a Gower Street, GLASGOW G51 1PH. Tel: 041 427 5497

**EFFICIENT BUSINESS SYSTEMS**, 9 Clarence Street, BELFAST 1, N. Ireland. Tel: 0232 647 538

**EMTEK**, 40 South Furzeham Road, BRIXHAM, Devon. Tel: 08045 3566

**FARMAX LTD.**, 17 Hylton Road, PETERSFIELD, Hants. Tel: 0730 66123

**B. FITTON**, 97 Melbourne Road, ROYSTON, Herts.

**G.T. OFFICE SYSTEMS**, 12 Clovelly Road, LONDON W5 SHE. Tel: 01 567 9959

**G.I.C.C.**, P.O. Box 519, Manama, Bahrain.

**JAEMMA LTD.**, Unit 24, Lee Bank House, Holloway Head, Lee Bank, BIRMINGHAM. Tel: 021 643 1609

**JENNINGS COMPUTER SERVICES**, 55/57 Fagley Road, BRADFORD, W. Yorks. Tel: 0274 637867

**LONDON COMPUTER CENTRE.** 43 Grafton Way, LONDON W1. Tel: 01 388 5721

**M.G. ENTERPRISES**, 32 Rue Victor Hugo, 92800 Puteaux, France.

**MASS MICROS**, Wellson House, Brownfields, Welwyn Garden City. Tel: 96 31436

**MICROAGE LTD.**, 53 Acton Road, LONG EATON, Nottinghamshire. Tel: 06076 64264

**MICROSERVE LTD.**, 811 Kennedy Way, Pelham Road, IMMINGHAM. Tel: 0469 72346

**MICRO SOLUTION LTD.**, Park Farm House, Heythrop, CHIPPING NORTON, Oxon. Tel: 0608 3256

**OMEGA ELECTRIC LTD.**, Flaxley Mill, Flaxley Road, MITCHELDEAN, Glos. Tel: 045 276 532

**RANMOR COMPUTING LTD.**, Nelson House, 2 Nelson Mews, SOUTHERN-ON-SEA. Tel: 0702 339262

**ROGIS SYSTEMS LTD.**, Keepers Lodge, Frittenden, NR. CRANBROOK, Kent. Tel: 058 080 310

**S.D.M. COMPUTER SERVICES**, Broadway, BEBINGTON, Merseyside L63 5ND. Tel: 051 608 9365

**S.M.G. MICROS**, 39 Windmill Street, GRAVESEND, Kent. Tel: 0474 55813

**SAPPHIRE SYSTEMS**, 19-27 Kents Hill Road, BENFLEET, Essex. Tel: 03745 59756

**SHEFFIELD COMPUTER CENTRE**, 225 Abbeydale Road, SHEFFIELD S7 1FJ. Tel: 0742 53519

**SORTFIELD LTD.**, E. Floor, Milburn House, Dean Street, NEWCASTLE-UPON-TYNE. Tel: 0632 329593

**SPOT COMPUTER SYSTEMS LTD.**, New Street, Kelham Street Indus. Estate, DONCASTER, S. Yorks. Tel: 0302 25159

**STAG TERMINALS LTD.**, 30 Church Road, Teddington, Middlesex. Tel: 01 943 0777

**STUKELEY COMPUTER SERVICES**, Barnhill, STAMFORD, Lincs. Tel: 0780 4947

**TERMACRE LTD.**, 126 Woodwarde Road, LONDON SE22 8TU. Tel: 01 693 3037

**THAMES VALLEY COMPUTERS**, 10 Maple Close, MAIDENHEAD, Berks. Tel: 0628 23532

**TURNKEY COMPUTER TECHNIQUE**, 23 Calderglen Road, St. Leonards, EAST KILBRIDE. Tel: 03552 39466

**THE COMPUTER ROOM**, 87 High Street, Tunbridge, Kent. Tel: 0732 359962

**WELSH BUSINESS SYSTEMS LTD.**, 1 Windsor Chambers, Windsor Arcade, PENARTH. Tel: 0222 700059

**WORD PERFECT**, 40 Rose Street, WOKINGHAM, Berkshire. Tel: 0734 782148

*For further details, or if you want to become a dealer yourself, contact:*

# ICARUS

Computer Systems Ltd.

Icarus Computer Systems Ltd. Deane House 27 Greenwood Place London NW5 1NN Tel: 01-485 5574 Telex: 264209

● Circle No. 134

PRACTICAL COMPUTING April 1982



**WHAT OTHER MICRO FINANCIAL PLANNING  
PACKAGES LEAVE OUT.**

At Comshare, while we're developing our software, we're also developing our biceps.

(As we're No.1 suppliers of financial packages in Europe, it's important to have both.)

Fastplan is our powerful new menu driven micro based financial planning system, at a cost effective £395.

However, add 24 offices throughout Europe, custom-built training schemes, a free enhancement service, as well as our Helpline and you'll

appreciate that brains aren't everything.  
Muscle counts as well.

James Lascelles, Comshare Ltd.  
32-34 Great Peter Street, London SW1.

PC4/4/82

I want to know more now. Please send me your Fastplan Factsheet.

Name: \_\_\_\_\_

Company: \_\_\_\_\_

Address: \_\_\_\_\_

**FASTPLAN  
FROM COMSHARE**

Making the computer make sense.

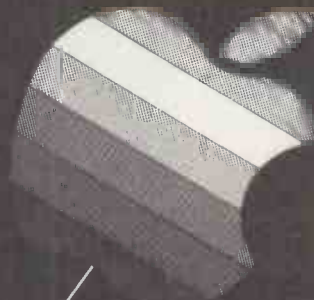

# GET YOUR APPLE INTO ORBIT

With the help of ORBIT software you can give your Apple the performance of a £2,500,000 mainframe computer. Because ORBIT is parameter driven it can be configured to suit *your* requirements without the expense of a tailor-made package.

ORBIT includes:

SALES LEDGER  
PURCHASE LEDGER  
GENERAL LEDGER

STOCK CONTROL  
INVOICER  
SALES ORDER CONTROL

The ORBIT design philosophy means that any of these modules can be used stand alone or as part of an integrated business control system. The capacities are set by the disk storage attached to your system.

Before you make a decision about management or accounting software send for our full operating manuals. Price is refundable on purchase of an ORBIT program.

Vlasak also produce the highly successful PAYROLL 2 BETA, MEGASTOR high capacity 8-inch disk drive, PRO-TECT to back up the Apple Profile hard disk and are specialists in the provision of personalised continuous stationery.

APPLE is the registered trade mark of APPLE COMPUTER INC.

**Vlasak  
Computer  
Systems**



3 YEARS EXPERIENCE WITH  
APPLE COMPUTERS AND  
ACCOUNTING/MANAGEMENT  
CONTROL PROGRAMS

VLASAK HOUSE, STUART ROAD, HIGH WYCOMBE, BUCKS HP13 6AG  
TEL (0494) 448633 TELEX 837413 VLASAK G

NATIONWIDE DEALER NETWORK

For more details about ORBIT software please tick box(es) and return coupon to us

- |   |  |
|---|--|
| <input type="checkbox"/> Please send me details about ORBIT System  | <input type="checkbox"/> Please send me the ORBIT Ledger System Manuals (Purchase, Sales, General Ledger) at £35.00 (inclusive of postage & packing) |
| <input type="checkbox"/> Please send me the ORBIT Stock Manual at £12.00 (inclusive of postage & packing) |  |
| <input type="checkbox"/> Please send me details of other products (specify)                               |  |

I enclose a cheque/postal order for £ \_\_\_\_\_

NAME: \_\_\_\_\_

COMPANY: \_\_\_\_\_

ADDRESS: \_\_\_\_\_

TELEPHONE: \_\_\_\_\_

● Circle No. 136



# Software for CP/M™

MICRO PRO	LIST
Wordstar™ 3-X	£250
Mail Merge	£ 60
Data Star	£170
Supersort I	£120
Spellstar (USA dictionary)	£120
Calcstar	£150

MICRO SOFT	LIST
Basic-80 Interpreter	£150
Basic Compiler	£190
Fortran-80	£210
Cobol-80	£310

MISC		LIST
Compiler Systems	CBasic-2	£ 65
	CB 80	£280
Sorcim	Pascal/M	£120
Sorcim	Supercalc	£170
Ashton Tate	d Base II	£380
Ecosoft MicroStat		£150
Organic	Milestone	£160
	(critical path)	

CP/M is TM of Digital Research. WORDSTAR is TM of Micro Pro  
Other Products constantly being added to our range.  
Send *large* s.a.e. for latest list

## TRADE ENQUIRIES WELCOME

Ordering Instructions:

Cash with order. Specify disk format.  
Add £3.00 per item P&P. Add 15% VAT



the  
**soft**  
option

BAMBERPLAN LTD  
PO BOX 11 CRANBROOK KENT  
TN17 2DF Tel: (058 080) 310

● Circle No. 137

PRACTICAL COMPUTING April 1982

# Don't Gamble when there's so much at stake!

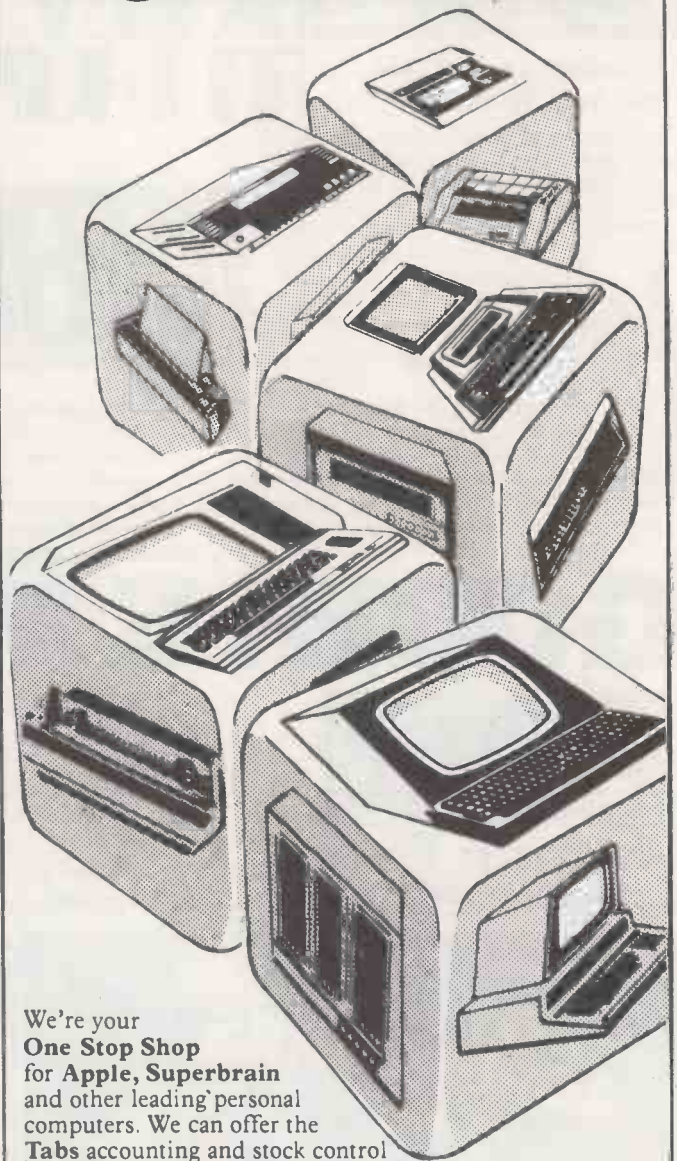

We're your  
**One Stop Shop**  
for **Apple, Superbrain**  
and other leading personal  
computers. We can offer the  
**Tabs** accounting and stock control  
packages, **Wordstar** for word processing and **Visicalc**  
for financial modelling. We provide on-site maintenance  
and tailored programming services second to none. We  
pride ourselves on giving first class customer support  
and training.

*Call us now and arrange a demonstration or ask for details  
of our free weekly seminars.*

# SYSTEM LOGIC

COMPUTER SALES AND SERVICES  
**make sure you get it right**

260 Cambridge Heath Road, London E2 9DA  
Telephone: 01-981 7311 Telex: 8952578

● Circle No. 138

# The Essential Software Company

47 Brunswick Centre, London WC1N 1AF

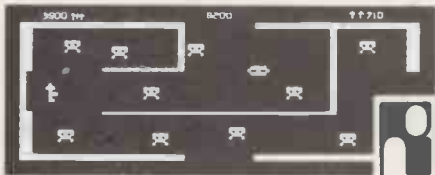

TRS 80 Levels II 16 K Tape  
Video Genie 16 K Tape

The Newest and Most Astounding Arcade Game that TALKS has just Reached Planet Earth. You can't help yourself. You have to stop them at all cost. Don't let up. Written especially for high quality graphics you'll simply be dazed and excited by the action.

## ROBOT ATTACK



TRS80  
VIDEO  
GENIE

## DEFENSE COMMAND

TRS80 Levels II 16K Tape  
-Video Genie 16K Tape

It is the year 2734. Our planet has chosen you to carry out the most important mission of the decade. The following is your top-secret mission briefing!

Several months ago the Kromorkrom Empire invaded our planet and stole some of our newly developed and highly efficient "Krotium" Star Cruiser fuel cells. Your mission is to infiltrate the Kromorkrom Empire and pass yourself off as commanding officer of one of their fuel transport vessels. Once you have accomplished this, you must recover the fuel so that one of our Star Cruisers can warp in and take it back to our planet. You will be given a small shuttle armed with a powerful laser device. Eventually the aliens will uncover your plot and you will be forced to shoot and destroy them to protect the fuel. While you are defending at least one fuel cell, the aliens will be unable to use any of their high-powered battle equipment, for fear of accidentally destroying a fuel cell. Once the aliens have reclaimed all of the fuel cells they will then be able to unleash their newest and most terrifying weapon ever: the Solar Waster!

## GOBBLE MAN

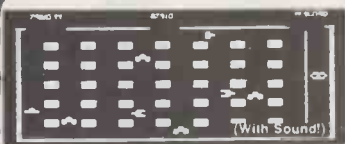

### Attack Force

Dodge the alien Ramships and fire missiles to destroy them before they get you. The alien Flagship uses his deadly laser bolt to transform a Ramship into another Flagship or into your ship's double. Look out! Destroy your double and you could destroy yourself.

TRS80 Level II 16K Tape  
Video Genie EG3003 16K Tape



Watch out behind you! As you hurry through the maze collecting modules you score points. But don't let the Gobblenmen catch you. If you are crafty, sneak up behind them and neutralise them to gain extra points. Just keep a watch. When they attack you they come in fast. Just don't lose your nerve.

TRS 80 Levels II 16 K Tape  
Video Genie 16 K Tape

## SCOTT ADAMS ADVENTURES

1-10

and

## 3D Adventures

for  
TRS 80  
LEVEL II  
16K

3-D means that as you wander through the mazes and buildings, full screen graphic display constantly shows your position in a perspective format as though you were actually there! This "rat's eye" view adds an entirely new dimension to adventure.

English language commands can be entered at any time to manipulate your environment. The command sets are extensive and sophisticated. Dozens of objects are scattered throughout the mazes and buildings. You can pick them up, burn them, throw them, etc. You may need the sword to fight off an ugly little man. Or a steel rod to hold apart crushing walls. Deathmaze 5000 and Labyrinth allow the traditional one and two word commands. Asylum incorporates our Advanced Language Interpreter (ALI), which allows full sentence input.

Deathmaze and Labyrinth consist of over 550 locations!

Asylum tops 1200 locations!

## Cosmic Fighter



Your fighter appears below a convoy of Aliens! If you destroy them another set appears who seem to be slightly cleverer than before! Soon your space station nears but before you can dock the station comes under attack! Survival is up to you! The excitement is just beginning!!

TRS80 Level II 16K  
Video Genie 16K Tape

All Tapes **£10** ea

ASYLUM Tape £12

THE ESSENTIAL SOFTWARE COMPANY  
(Viscounti Ltd.) 01-837 3154  
47 Brunswick Centre, London WC1N 1AF

I have a ..... microcomputer.  
Please send me your software catalogue. I  
enclose a stamped self addressed envelope.  
Please send me .....  
I enclose a cheque/postal order for £ .....  
(plus 50p post & packing)

Signature .....

Name .....

Address .....

Postcode .....

My ACCESS No is .....



# Canned thoughts

SOFTWARE AUTHORS' stock in trade is, or should be, canned thought. Yet, too often, what they wish on their unfortunate victims is a can of worms.

What are the symptoms of brain damage induced by software? We all know the archetypal programmer — the withdrawn antisocial being, silent or wildly enthusiastic by turns, sullen, argumentative, pedantic and incapable of rational conversation or interest in anyone else's ideas. The worms have burrowed deep into the heads of these unfortunates.

William Blake wrote on this subject, and was of the opinion:

Oh head, thou art sick  
The invisible worm  
That flies in the night  
In the howling storm  
Has found out thy bed  
Of crimson joy  
And his dark secret bag  
Does thy life destroy

The discriminating observer has to admit that Blake understands the symptoms. But where do these worms come from? The fundamental problem is, as so often in human affairs, no-one's fault. The things that computers can do are so much more complicated than the things people can do that the user needs a complete outfit of new concepts to handle them. These concepts are much harder to grasp than say, the concept "tree" because there is nothing to see. A recent editorial recalled the horrors of first trying to come to grips with computing. For weeks "files", "bytes", "floating-point arithmetic", "vectors", "indexes" "string pointers" and a whole host of ill-digested intellectual phantasms swirl about in your poor head. Only after a good deal of experience does some substrate of reality emerge, on to which to tack these words.

The worms hatch out of the conflict between the ideas already comfortably installed in one's head and the new ones that have to be forcibly constructed out of such unpromising, invisible materials. The conflict makes the worms. If you are not all that keen on worms, the question to ask is, "Could we reduce the conflict?" This is a hard one to answer because it depends on so many things.

Think, for instance, of the steps you have to go through as a newcomer to develop an idea of a disc file. You might start with a paper file in a filing cabinet. You have to make it invisible and continuous. You have to get away from pages of paper and move over to . . . well, there are pages, but they are not quite the same. You have to spread this invisible, continuous file over a piece of black plastic that you are not allowed to touch and then get to grips with the idea that parts of it are in RAM and parts are not, and that if it is not closed at the end of everything there is nothing there next time you look.

The whole process is an agonising business of making something out of nothing. It is not unlike trying to plaster a ceiling. You get a good solid lump of concept on your trowel, slap it up, and wait for it to fall on your head. If it stays up you have to get some more up beside it quick before it dries out and then, nine times out of ten, they will both fall off.

The difficulty of the whole business is compounded by language. Practically all the words used in computing have perfectly good meanings already: sector, record, memory, processor, bus. In relearning them you have to throw away hundredweights of perfectly good associations.

It improves matters a little if the concepts are well explained, but in the end, explanations of computing are about as much practical use as explanations of bicycling. You have to get on the thing and wobble into the ditch. So how could we

improve the mental ergonomics, spread pesticide on the worms, and help the naive user?

The problem is largely historical. Computing started with operations on bits. The complexities of bytes, files, languages, output were grafted on to the central concept of the processor. They arose in ways that made sense to the engineers who built the machines and the systems programmers who made them go. We, obedient users, 40 years down the road, docilely assume that we have to learn all these tough ideas too, even though they correspond only vaguely to the ideas we want to manipulate.

Let's start with the idea of screen and file in the context of word processing. You might expect the letter corresponding to the key you hit to appear on the screen as it would on paper. You then expect the document you have created to be "in the computer's memory banks". This is not at all unreasonable. Yet how many word-processing packages start out with exotic questions about the number of disc sectors to allocate? How many more, which avoid that difficulty, expect the user to manage the business of writing RAM to disc and paging in new buffers full of text for editing? Most of us have met the word processor that leaves the files empty if you do not go through some absurd rigmarole of closing them? Even those that spare us these troubles are quite capable of allowing a text to be edited that cannot, in the end, fit on to the disc.

Even though the user must, by virtue of the power word processing gives you, understand and manipulate more ideas than you need simply to type on paper, there are no word processors that restrict their concepts to those the user actually needs. Of course, if every software package requires the user to make decisions about disc files, it is hard to realise that the user need not necessarily know or care about them.

A great American aircraft builder used to advise his designers to "simplify and add more lightness". This is no bad advice for the software author too; the difficulty is that simplification is very much harder work than complication. Yet this is work that urgently needs doing at this stage of the game.

One easy way of simplifying things is to go through the manual of whatever software is to get the treatment, and look for the word "must". "If there is not enough disc space you must erase . . ."; "To open a file you *must* . . .". Whenever something "must" be done the computer ought to do it. The user ought only to be asked when choices are to be made and the choices should be presented in understandable terms. "Do you want to keep your back-up version of this text, or erase it?" Ideally, anything in memory should also be on disc and the user should be unaware that RAM exists. When hard discs become commonplace it may be unnecessary for the user to know explicitly about either RAM or files: it might be better to present some in-between concept — just as the idea of a CP/M file conceals the ideas of sector directories and random access.

Ultimately, this all comes down to marketing. You do not sell computers or software: you sell power, speed, convenience, prestige — in the customer's terms. If the customer cannot understand what it is you're trying to sell, then you will never sell it. You have to offer concepts that are already properly understood. You certainly cannot assume that the intellectual scrap-heap we have come to accept is already there.

The time is ripe for some powerful, simplifying ideas that start with the user rather than the machine. Let us ask what concepts are actually needed to manipulate the kind of information that people want to put on micros. Then we ask how they can be made to work using the available hardware and software. If only one-tenth of the passion that goes into the language debate could be focused on this much more important problem, we would make startling progress. □



# TURBOCHARGED PERFORMANCE: when you need speed without crashing

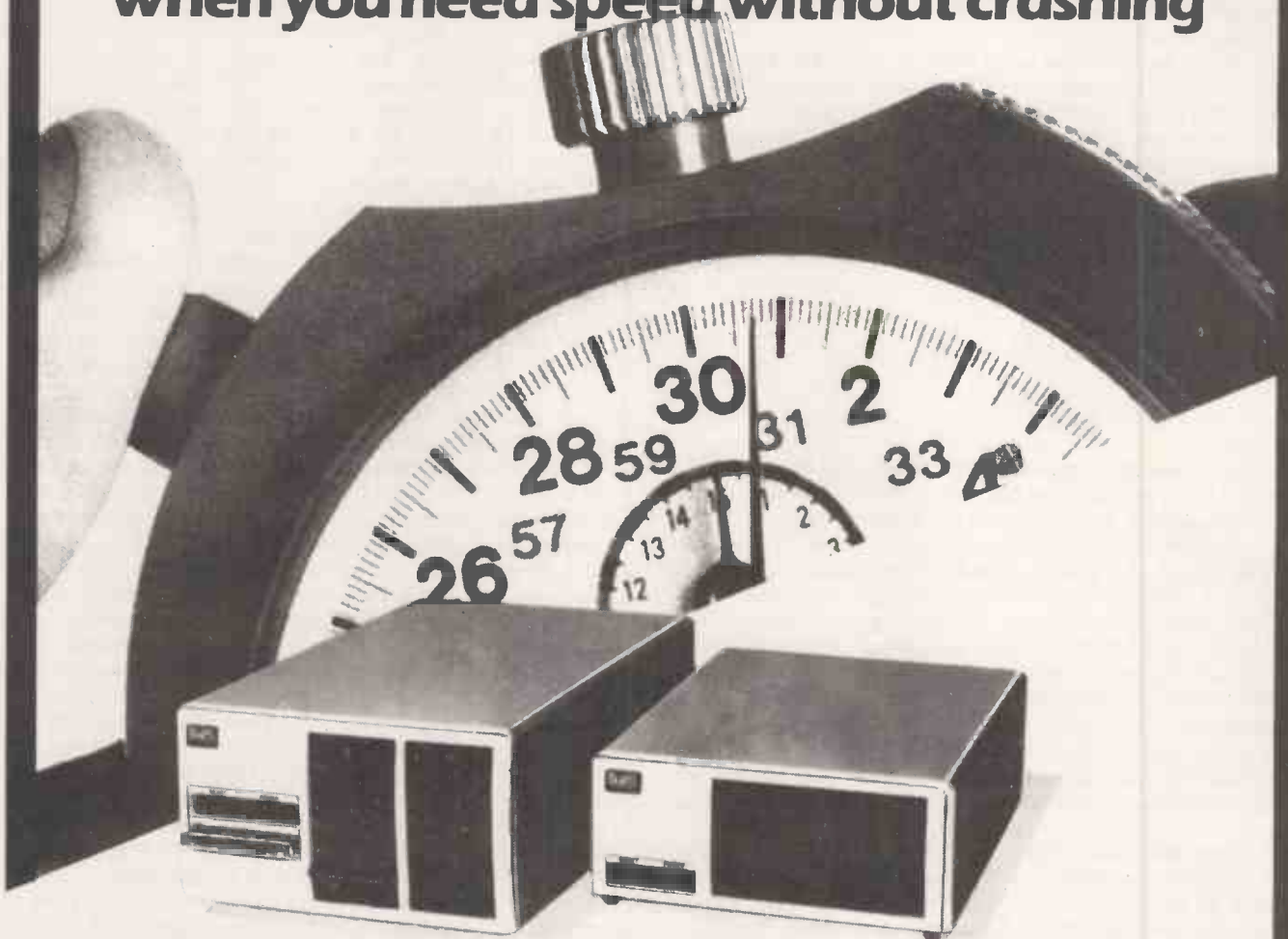

Start a stopwatch on our new Turbocharged Series 5000SX and Series 8000SX microsystems and watch them run rings around other systems.

Built to the highest standard of reliability, they support a mixture of 5In and 8In floppy and Winchester drives with tape back-up units. In other words, a storage capability extending from 400KB to 130MB.

But what makes the Series 5000SX and Series 8000SX really pull away from the rest of the field is their unique and exceptionally powerful disk operating system – TURBOdos. Written specifically for the Z80, TURBOdos loads programs up to six times quicker than CP/M\*. And processes files up to five times faster.

TURBOdos gives the new systems many of the features available only on minicomputers. In multi-user mode, it allows multi-processor network users to share mass storage, printers and other peripherals. And its advanced

failure detection and recovery facility makes a TURBOdos system virtually crash-proof! Other features include:

- Full CP/M compatibility even in multi-user/network systems.
- Up to 30% more data can be stored on each floppy disk, compared to CP/M.
- Support for up to 2000MB of hard disk storage.
- Random access to files up to 67MB.
- Up to 16 users supported in multi-processor mode.
- Automatic concurrent print-spooling support for up to 16 printers.
- File and record-locking facilities.
- Complete diagnostic self-test is performed at every start-up.
- Read after write verification of all disk update operations.
- When errors are detected, operator is given clear diagnostic messages and a variety of recovery options.
- User-defined program auto-load at cold or warm start.
- Disks can be changed at any time without warm start delays.
- Command files may be nested to any depth.
- User programs may activate command files for execution.
- Communications channel interface.
- Real-time clock support.
- Systems are easy to configure due to modular construction.

\*CP/M is a trademark of Digital Research

**EQUINOX**  
**TURBO SX range**  
Kleeman House, 16 Anning Street, New Inn Yard,  
London EC2A 3HB. Tel: 01-739 2387 & 01-729 4460  
Telex: 27341

OEM, system house and dealer enquiries are invited.

● Circle No. 140

**Our Feedback columns offer readers the opportunity of bringing their computing experience and problems to the attention of others, as well as to seek our advice or to make suggestions, which we are always happy to receive. Make sure you use Feedback—it is your chance to keep in touch.**

## Improved graphics

LIKE R J GREENHILL, Feedback, January 1982, I found the Portable Graphics series by Wynford and Jane James most useful and certainly the best published games for some time. However, Greenhill's random-movement selector does not eliminate all the difficulties of Wallball.

I find that the computer tends to find itself in dead ends of its own making relatively quickly, so my improvements may be of interest.

I have incorporated a speed-up arrangement in line 350. This line is simply a time delay from which 5 is subtracted at each pass. It is reasonably simple to replace the 5 with a variable which is changed by the setting of the skill level entered in line 1060. So, at skill level 1, a larger number is subtracted than at lower skill levels. This causes the movement of the trails to accelerate, and before long you will find you need plenty of skill to avoid a crash.

In addition, I have incorporated a scoring system. This is a simple counter which increments at each move made by the computer. When one game ends, line 360, the score is added to a running total if the player wins, and subtracted from the running total if the computer wins.

The final score is printed after the final run, in line 440. The increments can be fixed or made variable in the skill-level line — higher increments for more skill.

The effect of these two improvements is that the player tries a high skill level for a higher score and lets the computer run for as long as possible before trapping it so as to build up the score. By this time, however, the acceleration has built up so that it is much more difficult to control the player's trail.

In addition to these changes to Wallball, perhaps I might point out two errors in other programs of the same series which readers may not have found. In Head on Crash, November 1981, I found that after clearing the board the first time the score continues, but subsequent clearings will not reset the board and the score. This is quickly remedied as follows.

Eliminate `NH=0` in line 85 and re-insert it as line 81 `NH=0`.

In Alien Maze, December 1981, line 650 has a misprint and should start with:

```
650 IF CB=0 THEN POKE, etc
not 650 ECB=0 THEN POKE, etc
```

**B L Hensman,  
Keighley,  
West Yorkshire.**

## Maze corrections

I SUCCESSFULLY used the maze-making program on "Portable Graphics" *Practical Computing* December 1981 — on my UK 101. There appears to be an error in line 650, which should read:

```
650 IF CB=0 THEN POKE P1, W3: POKE P2,
W3: POKE P3, W3
```

A repetitive division-by-zero error tended to occur in line 105, which I prevented by inserting a new line:

```
104 IF LD=0 THEN LD=2
```

Other UK 101 users may be interested in this amendment to line 950, for which experiments were recommended in the article:

```
950 TL=53332: BL=54164: TR=53357:
BR=54189: LL=64: DW=2: CD=3
```

**Simon Talbot,  
Garston,  
Hertfordshire.**

## Authors reply

R J GREENHILL's letter in January 1982 Feedback was a constructive criticism of our portable graphic series which started in the October 1981 issue. It was clear from several letters we received that we should have clarified the keyboard-control command used by the Superboard. We feel that Greenhill's own explanation should resolve these problems for readers.

Regarding Rem statements within programs, it is sometimes difficult to include these when only 4K RAM is available. We concede that on shorter programs we should not omit Rems — a bad habit.

We had already begun to incorporate the keyboard-control commands into subroutines in later programs and — as Greenhill said — this should aid portability.

We are currently working on a collection of portable programs which we hope to have published in 1982. If any reader feels that features in the previous programs made transfer to their own micro a problem, we would be pleased to hear from them. Any other suggestions for improving portability would also be welcomed.

**Wynford and Jane James,  
Royal Tunbridge Wells,  
Kent.**

## Family tree

THE ARTICLE "Climbing the Family Tree" in the November 1981 issue is a reminder that family records represent an

almost ideal database which is more easily handled by computer than manually. Yet few serious genealogists will be satisfied with no more than 30 direct ancestors. So often it is the collaterals which provide the clues to extend the main line further back.

There must be many people tackling these wider problems for themselves and thereby reinventing the appropriate wheels for organising the data about relatives or indexing the names in public records.

The time is ripe for them to meet and share their experiences. The Society of Genealogists plans to organise in June this year a seminar to provide an opportunity for that exchange. The director of the Society, A J Camp, would like to hear from anyone wishing to attend or contribute to such a meeting. Write to him at the Society, 37 Harrington Gardens, London SW7 4JX, mentioning any special interest or progress you have made. The detailed program will depend on the response and will be sent to you in due course.

Similarly, the Society is considering a newsletter on the applications of computers to records of genealogical interest. If you would like to subscribe or contribute to it, please let the director know.

**A Sandison,  
Chairman, Computer Committee,  
Society of Genealogists,  
London SW7.**

## DNA twist

WE VERY MUCH enjoyed the article 'DNA the First Machine Code' by John Leach, in the January 82 issue. However, we feel that we must attempt to rectify certain slight misconceptions expressed by Leach, in aspects of the genetic code as it is understood today. Also, we wish to point out certain program errors and modifications.

Firstly, and most importantly, what Leach says about messenger RNA is misleading. He implies that mRNA is made by attaching itself to the start codon, and is copied along the DNA from that. This is not so.

A simplified explanation of what generally happens is this: mRNA is made by an enzyme RNA polymerase which binds to a reconision site on the DNA before the coding part of the gene — or program — called the 'promotor'. The enzyme moves down the DNA, making an exact complementary copy of that strand of DNA, except that it makes the copy in

(continued on page 45)



# ATLANTIC COMPUTER STORE

**BUY... RENT... LEASE... BUY... RENT... LEASE... BUY... RENT... LEASE... BUY... RENT... LEASE...**

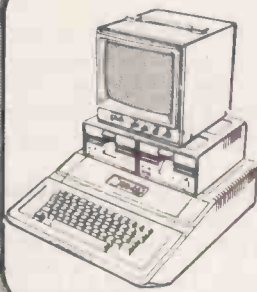

## APPLE II

48K Apples £650.00  
 Double Disk Drives with  
 Controller Card £550.00  
 Monitors from £ 99.00  
 Z80 Soft Card £195.00  
 Serial/Parallel  
 Cards £ 65.00  
 Visicalc 3.3 £100.00  
 Full Range of software —  
 too numerous to mention!



## COMMODORE

Commodore 8032 CBM £755.00  
 Commodore 4032 PET £595.00  
 Commodore Printer 4022 £395.00  
 Commodore 8050 £795.00  
 Bags of Software  
 Special Offer:-  
 D.M.S. £200.00  
 Visicalc £100.00

## PRINTERS

Microline 80 £295  
 Epson MX80 £350.00  
 Anadex DP  
 9500 £875.00  
 Centronics £299.00

### SPECIAL OFFER RICOH

£1295.00 60 c.p.s.

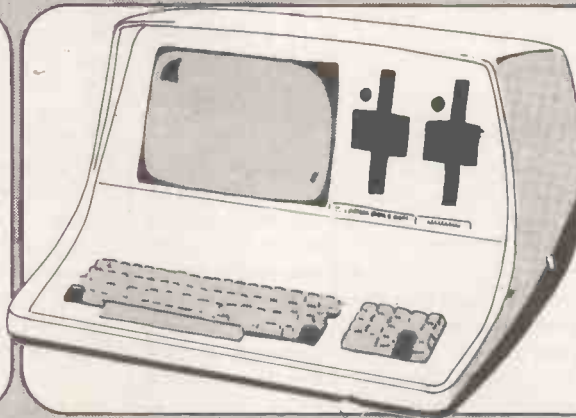

## SUPERBRAIN From £1750

Integrated Accounting System —  
 Stock Control @ £350. Order Entry  
 and Invoicing @ £350. Sales Ledger  
 @ £350. Purchase Ledger @ £350.  
 General/Nominal @ £400. Name &  
 Address @ £250. Complete Package  
 so far @ £1650 plus Payroll @ £500.

### SPECIAL OFFER

Letter quality word processing  
 system. **£2,995**  
 includes 1 days training.

### Buy a typewriter which you can use with your computer

Silver Reed/Olivetti RS232 —  
 Centronics — IEEE interfaces now  
 available  
**SPECIAL OFFER**  
 Olympia Scripta  
 K.S.R.  
 £850.00 + VAT



### TELEVIDEO NETWORK HAS ARRIVED!

System II: supports up to six users. Single board design. Z80A, 64K of  
 Ram memory. 4K EPROM. 10 Mbytes 5 1/4" Winchester disk drive.  
 1.0Mbyte mini-floppy disk back-up unit. Parallel port and two serial  
 ports for printer attachment and servicing. With one T880 £5,130.00  
 Each additional 64K terminal £1026.00

**A MUST FOR  
MULTI USERS**  
 will run your  
 existing cp/m software.



## SPECIAL PURCHASE

British micro  
 64k cpm  
 Dual Drives. 350 Kb  
 per drive.  
**£1350** ex-stock

### ATLANTIC SERVICE FACILITIES

The company provides full servicing cover throughout the entire country on a 24  
 hour call-out basis. Additionally, the company has its own hardware  
 engineering team based at the main office in London.

### ATLANTIC CONSULTANCY

The Company also retains the services of highly experienced computer  
 consultants who are readily available to design a system to meet your special  
 business requirements.

### ATLANTIC TRAINING SERVICES

Atlantic Micro Systems provide a modern, 3,000 sq. ft. professional training  
 centre capable of training up to 250 people a week using the latest teaching  
 aids. **DEALER ENQUIRIES WELCOMED**

### SOFTWARE

dBase II	£375
Basic	£175
Cobol	£350
*Micromodeller	£585
Supercalc	£185
D.M.S.	from £200
Spellbinder	£250
*Wordstar	£250
Mailmerge	£ 75
Supersort	£120
Redword	£340

\*Available on Apple

## LOW-COST MAINTENANCE INSURANCE

for Atlantic customers  
**£50.00** per annum.  
 PETS, APPLES,  
 SUPERBRAINS.

# ATLANTIC

ATLANTIC MICRO SYSTEMS

70-72 Honor Oak Park, London SE23 1DY. ask for Trade Desk.  
 Telex: 896691 1RG ATLANTIC  
 Overnight deliveries. Telephone orders  
 welcome on all credit cards. All prices  
 are exclusive of VAT and delivery.  
 ATLANTIC prices subject to dollar  
 fluctuation.



● Circle No. 141



(continued from page 43)

RNA, which contains the base uridine instead of thymine.

This mRNA contains a good deal of material additional to the coding part of the gene, including the start and stop codons. It also contains an area recognised by the ribosome. The ribosome attaches to this site, but starts to translate the message into protein from the start codon.

The best comparison of this with the way a computer program works that we can think of is that the promotor region acts as the name of a program. The program is called up by its name, from whatever form of storage, disc, tape or chromosome, to a short-lived copy — the program loaded into the computer's RAM or the mRNA. The start codon acts as the first line number, anything else is not read. The program is run from that copy and not the original.

Whilst on the subject of analogy, the computer mimics genetics in other ways. Perhaps the most interesting is the use of library routines. A kind of library is used by certain specialised genes, such as the immunoglobulin genes. These code for the proteins protecting us from infections caused by bacteria, viruses, and other foreign bodies. These genes are bizarre in that each gene is constructed by a combination of several pieces of DNA from various sets. In other words, there is a series of programs, any of which may be selected, and which may use a combination of two library routines, one from each set.

This leads to an enormous variety of related proteins coded for by a relatively small amount of DNA. Every time man thinks he has been clever, life has beaten him to it.

Other niggles with Leach's article are that; transfer RNA is not a hairpin structure. It has a clover leaf appearance, with the anti-codon on the second leaf. This consists of the triplet of bases which complement exactly, and therefore pair with the codon.

Leach is correct when he states that three-dimensional structures play an important role, since shape defines function in proteins. However, he implies that if just any one of the amino acids in haemoglobin is changed, sickle-cell anaemia results. The change causing sickle-cell anaemia is a very specific one. The glutamine in position 6 in the B chain is replaced by a valine.

Other amino acid changes in haemoglobin may have profound effects on its function, but will not necessarily result in sickle-cell anaemia. Altogether, about 150 kinds of mutant haemoglobin have been found in humans. Nearly all are the results of a single amino acid change.

Here are one or two points about the program listing. a) In line 330 the Goto 340 statement is not required. b) In line 2520 the first D\$ should be E\$.

```
Add 2625 IF EP=0 AND DP=0 THEN PRINT
"Enzyme and DNA not selected":
```

```
GOSUB 2860: GOTO 2200
and in line 2320 alter 2630 to 2625. Alter
line 2590 to read:
```

```
2590 GOSUB 1740: FOR 1 = 1 TO 12:
PRINT :NEXT I :GOSUB 2800: GOTO 2200
```

David and Linda Priestley,  
Henton,  
Oxfordshire.

### Micros in schools

THE ARTICLE by Tony West in the January 1982 edition on the use of microcomputing in primary schools gave a reasonable description of a program which he obviously finds helpful and stimulating for the children in his charge. However, the article, although an adequate description of one particular program, never attempted to answer the one question which teachers who have had no experience of computers ask: why use a computer?

To moderate the rush of teachers who read this article to the micro shops, I feel I must give some reasons why the micro should not be used for this particular job, at least not in this form.

If this program were guaranteed to meet the aims and objectives which the teacher had set out to achieve, how could 35 children in one class make use of it? The only answer for this program would be for each child to have access to the machine.

We have two microcomputers in the school where I teach, and we have great difficulty in coaxing the children into using them. It is not that they do not want to; we have not the time to let them. Some advice on how to overcome this problem would be more useful than a fairly technical description of a program.

Tony West says: "Numerical accuracy in adding the digits is ignored and the child can correct any such mistakes". I hope I have not taken this quotation out of context, but what a statement for a teacher to make. Supposing the child did not realise he had made a mistake?

The second quotation I would like to draw attention to is: "Should he make a mistake when entering these digits, the computer waits until the correct digit is pressed". If the child knows the correct digit then the program is wasted on him; if he does not then ignoring his attempts does not help him.

The rest of the article describes the programming tricks which make the program run. They are the trivial parts. What is much more important is how they allow the child to learn. In a program which is a test where wrong answers are not allowed, there seems to be little scope for learning.

Before we make computing attractive to primary schools, we must make it right. The process which Tony West is trying to teach with the program under question is only one part of the complete addition

algorithm which primary schools traditionally teach. The whole process must undergo much greater analysis before we decide if the use of a micro is justified.

There is no doubt in my mind that the microcomputer offers a challenge to primary education. I think it has enormous potential which we are only just beginning to appreciate. However, there is a great deal of hard work to be done to realise that potential, and programming is only a very small part of that work.

Colin Watkins,  
Primary Computing Co-ordinator,  
Birmingham Educational Computing  
Centre,  
Birmingham.

### Comal again

HAS ANYONE a Data-statement generating program for the TRS-80 level III? I need it for machine code and assembly language programming. Also, I would be very interested in corresponding with anyone trying to implement Comal on a TRS-80. Since receiving a copy of the Pet 6502 version, I have been very impressed with its simplicity and structured approach.

When defending Basic many claim that it is easy to learn; but what they do not mention is that it is easy to learn badly. Comal is easy to learn but it forces the user to analyse problems and to write programs in a more disciplined manner.

By adopting a hotch-potch of the two for its otherwise sophisticated machine, the BBC is doing present and future computer users a great disservice. Why is there no 'While Do' facility for example?

In today's modern businesses the keyword for efficiency is 'structure'. It is sad that the BBC educates the population in computer programming with little emphasis on this vital approach. How long will it take to re-teach all these people to reach the level of the rest of Europe where Comal and structured programming is already so widely taught from schools upwards.

C J Brady,  
Shoreham,  
West Sussex.

### Unix group

I HAVE BEEN asked by the American commercial Unix organisation user group to form a similar group in the United Kingdom. Since the Computer Retailers' Association also has an interest in Unix, we will hold a session for all interested parties in commercial Unix. All parties wishing to attend should write to: Dr Keen, Chairman of Technical Group, Computer Retailers Association, Owles Hall, Buntingford, Hertfordshire. SG9 9PL.

Tim Keen,  
Buntingford,  
Hertfordshire. ☐

# Universal appeal of CBM's new micros

COMMODORE Business Machines is about to upset the microcomputer applegart with the introduction of a "universal microcomputer". The new machine will be capable of running software originally written for rival machines. In addition there will be two new personal computers, and a video game which will double as a microcomputer will also be released.

The universal microcomputer will initially be able to emulate the Apple, Tandy and IBM microcomputers, thus opening up the machine to a

large sector of the microcomputer software market. It will feature as an option on the Commodore 64, using plug-in modules. The beauty of the move is that it means Commodore users will now be able to implement packages developed by rivals, after they incurred the expensive development costs. The target price of this machine will be under \$1,000, grossly undercutting the opposition.

The new computers are all aimed at the lower end of the personal micro market. It appears that Commodore is

making an attempt to produce a range that is both cheaper and more accessible than any other. One of the "fun" personal computers will be little more than an intelligent music synthesiser, though it will not be on sale in Europe until later in the year.

The move by Commodore into emulators is unprecedented in the world of microcomputers but is a well-established part of the mainframe computer business. There are a host of companies offering IBM plug-compatible products, allowing them to ride on the back of the larger company's success and market penetration.

There are a couple of side-effects of this trend. Firstly the price of hardware tends to drop significantly — because of the intense competition, manufacturers try to recoup profits by software and systems sales. Secondly there is a tendency for the manufacturers to attempt to protect themselves by inventing ever more complex protocols. All this goes very much against the traditions of the microcomputer industry, so it will be interesting to see what the response to Commodore's move will be. □

## Building up knowledge

ARCHITECTS involved in computing will be able to build on their knowledge at the RIBA computer conference and exhibition. The exhibition will cover those aspects of computing that are relevant to the architect and other building-industry professionals.

The conference will take place on each of the three days, but each day's session will be self-contained, allowing delegates to attend only the parts that are relevant to them.

Day one of the conference will deal with how to choose and use a computer for your office. The speakers will deal with the packages available and cover topics in general terms, allowing a more detailed treatment on days two and three. The second day will concentrate on the practical application of the technology, with papers being presented that are based on users' experience of various computer applications. The third and final day will take the topic of computer-aided design and drafting a stage further. The conference will cost around £45 per day. It runs from April 20 to 22 at the Bloomsbury Crest Hotel, Coram Street, London WC1. The organisers can be contacted on 01-637 8991. □

CBM founder Jack Tramiel — plans in the pipeline.



## Cheaper RAM for ZX-81

BYG BYTE is an alternative 16K RAM pack for the ZX-81 microcomputer. Costing only two-thirds the price of the Sinclair memory add-on, the Byg Byte is fully compatible with the ZX-81. Each pack is fully assembled and tested before leaving the factory, and it is cased to avoid handling problems.

At only £34.95 including VAT, postage and packing, together with the maker's full guarantee, the Byg Byte must represent considerable value. Delivery time is currently within 28 days. Byg Byte is available from Computer Aided Printing Services, 56 Trafalgar Avenue, Broxbourne, Hertfordshire EN10 7DL. □

Noise pollution is the price we have to pay for microcomputers and word processors. The rasp of the dot-matrix printer is as common as the tap of the typewriter these days, but often it is much louder. To remove these unpleasant noises Ventguard has developed a range of printer covers. They are available for the Commodore 4022 and 3022 tractor printers, as well as a number of the popular word-processor printers — Qume, Nec and Diablo among others. All functions of the printer remain accessible with the cover in place. Contact Ventguard, Unit 12, High View Avenue, Keyworth, Nottinghamshire. Telephone (06077) 5856. □







The new ZX-81 desk console unit from Traffic Technology should prove to be a neat answer to the "Where-did-I-put-that" question. Moulded in a heavy-gauge, black, grained ABS plastic the console arrives fully assembled and ready to plug in. There are recesses to accept the ZX-81 micro-computer, the 16K RAM pack, the printer, power unit, a cassette recorder and assorted cassettes and pencils. Underneath is a detachable base cover with non-slip feet. At the rear of the console is a switch panel with a three-position slide switch for Save/Run-List/Load which earths the unused inputs to the cassette recorder and the computer. There is also a switch for the 9V power supply. The console measures 19.25in. by 13.5in. by 3in. and weighs just over three pounds. It costs £33.33 from Traffic Technology, P.O. Box 2, Warminster, Wiltshire BA12 7QX. 

## Champion's winning ways

AMONG commercially-available chess computers, the world champion is the Chess Champion Mark V. The machine has been proving its worth and pitting its "brains" against those of the human champions Karpov and Korchnoi. When key positions in the recent world championship match were fed into the Mark V, the computer came up with a few surprises.

Chess commentator Raymond Keene — who was Korchnoi's second in the two Russians' previous clash — commented: "The Mark V's results were remarkable. On several occasions the machine was able to improve on the play in the match and once it succeeded in seeing more than the commentators. Naturally if the Mark V had to face Karpov now it would be slaughtered, but it is still a remarkable machine".

The Mark V also recently uncovered two alternative solutions to a set problem said to have only one answer.

Contact SciSys of Suite 8, 266 Fulham Road, London, SW10 9EL. 

# ITT 3030 puts the accent on expansion

THE ITT 3030 is a microcomputer with the emphasis on expansion. Although the ITT 2020 used the 6502 processor — the machine was similar to the Apple II — the new micro is Z-80 based. Based on a modular construction, the 3030 can be upgraded into a much more powerful system simply by changing the plug-in printed-circuit boards in the central processor cabinet.

Manufactured in West Germany, where it was developed, the 3030 is of totally European conception and has been designed for the small and medium-sized business. The basic machine includes the CP/M operating system — which means it will have a wide base of available user software. In addition, the U.K. division of ITT Consumer Products has reached an agreement with a software house, MPSL, to develop a range of software using the machine's own operating system BOS.



The price and specification of the 3030 indicate that it is a machine destined for the more serious application. The manufacturer claims that it will be able to begin work within hours of delivery. For the basic end-user price of £2,500 the purchaser receives the central processor, 64K of RAM, twin mini-floppy drives, a separate keyboard that has been specially extended for word processing, the CP/M operating system, the BOS operating system, the Autowriter word-processing package, and the Autoindex database package.

The 3030 can be upgraded to a 16-bit machine simply by removing the CPU board and replacing it with another con-

## SimpliCalc answers 'what if?' questions

SIMPLICALC is a 134-line Basic program which performs a host of "what if?" projections and other routines. The powerful program will run on an 8K or larger Pet. It was developed by Mark Turner of the Cronite Group, whose major problem was compressing of the program into a small enough memory that, once loaded, there would still be sufficient RAM left for the complicated and numerous calculations.

The program is not a Basic version of machine-code VisiCalc but a new program which recognises that in small computers, program and data fight for memory space. With SimpliCalc you can get a lot more data in than you could using more traditional calculating routines, without the need for a costly disc drive.

The designer believes that

among the many people who will find the program useful will be accountants with their own Pets who, it is envisaged, will find SimpliCalc an efficient way of working out such problems as when to advise clients to seek separate tax elections for husband and wife.

The program was originally written for the Pet, but is now being prepared for the Vic-70 and the Apple microcomputers. Versions for the Sinclair and the BBC Micro are under way.

SimpliCalc is available either on cassette at £29.90 or on disc at £39.80 including VAT and postage and an instruction manual. For further information contact Mark Turner, The Cronite Group Limited, Montgomery Street, Birmingham B11 1DT. Telephone 021-773 8281. 

taining the Intel 8086. In a similar way the memory can be expanded from 64K to 256K. Other upgrades include doubling the density of the mini-floppy disc, and the addition of hard discs which can offer a total of 10Mbyte on-line.

A multiple RS-232 interface card allows the ITT 3030 to become a multi-access, multi-programming computer, both these functions are supported by the BOS operating system. Up to four users can access files or undertake processing at the same time.

The BOS operating system uses the MicroCobol language, and a UCSD Pascal-supporting operating system is also available. Among the packages already prepared for the machine are the usual ledgers, a payroll program, stock control, and a program generator. For more details about the ITT microcomputer contact ITT Consumer Products (U.K.), Chester Hall Lane, Basildon, Essex. 



The new Transdata **Cx 502-S SUPERSPEED Microcomputer** offers CP/M performance up to 5 times faster than conventional floppy disc systems. The unique high speed master processor and intelligent disc controller combine to give unrivaled processing power; superior to many Winchester disc based systems.

#### High Speed Master Processor

The Z80B 6MHz Master Processor gives a 50% increase in throughput over more conventional Z80A systems.

#### Intelligent Floppy Disc Controller

The Cx 502-S exploits the full power of the FLEXIBUS multi-processor architecture common to all members of the Cx 500 family of Microcomputers. The Z80 based floppy disc controller features a 10Kb full track cache buffer, advanced DMA and automatic error recovery. The twin 8" double-sided double-density disc drives provide 2Mb of storage with software selectable single density for IBM compatibility.

## CP/M × 5 = Cx502

#### Load 20Kb in 1 Second

The Cx 502-S programme load performance outstrips many Winchester Disc competitors and response times for disc I/O bound applications are dramatically reduced.

#### MP/M on Floppies?

By applying the sophisticated and proven technology of the advanced Cx 500 hard disc systems, the new Cx 502-S offers viable multi-user capabilities. For those applications where large on-line storage is not required and cost per user is an important consideration the answer is the Cx 502-S.

#### A True Member of the Growing Cx 500 Family

Transdata's Cx 500 Family of Business and Scientific Microcomputers features upgrade potential from single-user floppy disc based systems to multi-user hard disc systems with cartridge tape back-up. Experienced End Users, Computer professionals and Distributors will value the quality, reliability and after sales support offered with these advanced U.K. manufactured Microcomputers.

**OEM Discounts available**  
**Dealer and Distribution enquiries**  
**welcome**

**Cx500 Microcomputers —**  
established through  
success

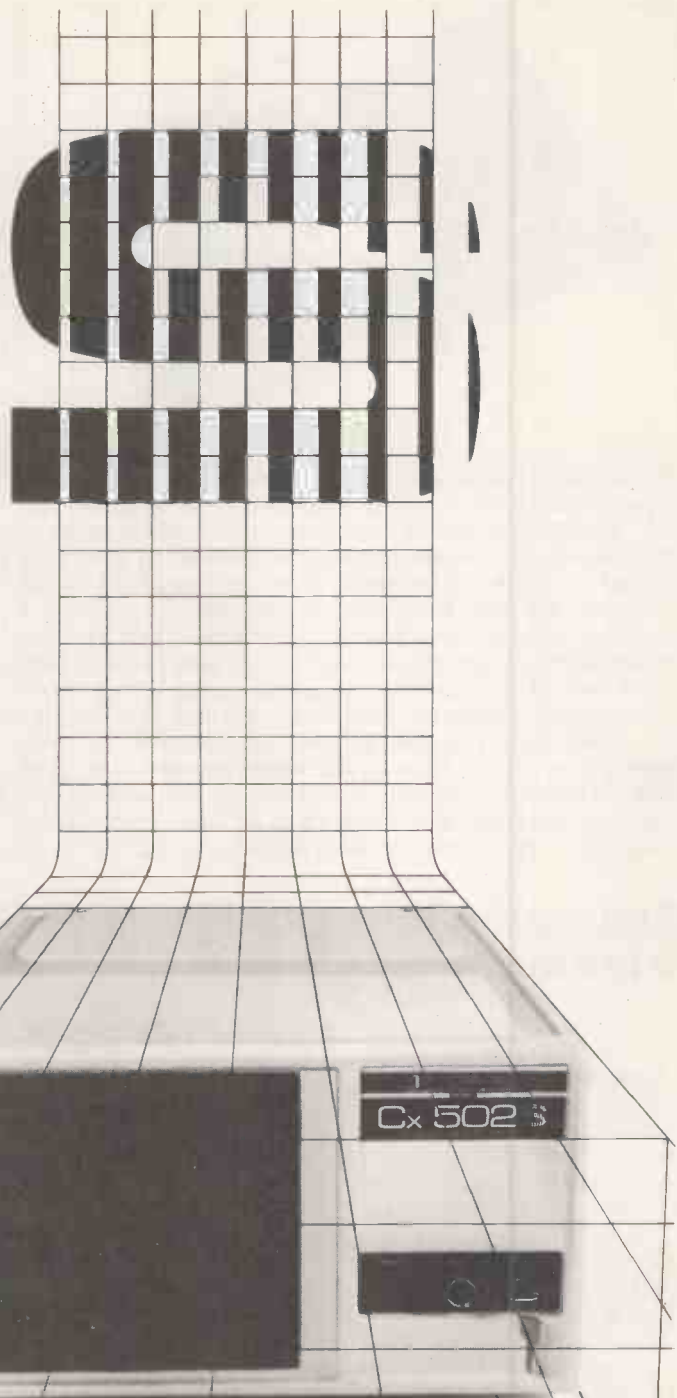
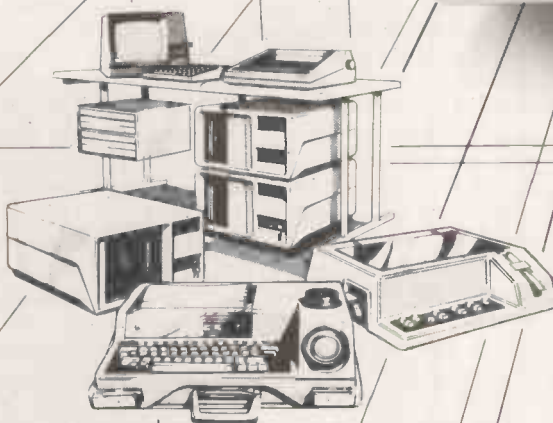

**TRANSDATA LIMITED**  
DATA TERMINALS AND MICROCOMPUTER SYSTEMS

Transdata Limited, Battlebridge House 87-95 Tooley Street,  
London, SE1 2RA Telephone: 01 403 5115 Telex: 8952068

# The speed to rival Winchester systems

THE NEW Z-80B processor chip which runs at a fast 6MHz gives the Superspeed micro-computer its name. The CP/M performance of this machine is up to five times that of other floppy-disc-based systems and can provide more power than many of the Winchester hard-disc systems. The 6MHz operation of the processor provides a 50 percent increase in throughput over conventional Z-80A systems, loading a 20K program in one second.

The CP/M operating system gives the user a wide base of applications software to choose from, but if this is not

enough the user can add MP/M together with Winchester hard discs to provide a multi-user system. The floppy-disc controller features a 10K buffer, advanced direct memory access and automatic error recovery. The twin 8in. double-sided, double-density disc drives provide 2Mbyte of storage with software-selectable single-density for IBM compatibility.

The one-off price of the system is £3,500, that is for the minimum configuration which also features 160K of RAM and four I/O ports. The machine is part of Transdata's

Cx500 family of CP/M-based microcomputer systems.

Languages available include Basic, Fortran, Cobol, PL/1 and APL. Also available is a fully-comprehensive, on-site maintenance contract employing Transdata's own field-service engineers. Transdata is at 87-89 Tooley Street, London, SE1 2RA. Telephone 01-403 5115. □

## Fast Episode fits the desk-top bill

THE EPISODE is a microcomputer with "micro" dimensions — it occupies about as much desk space as a sheet of foolscap paper. Even so it is a powerful stand-alone system based on the Z-80A processor running at 4MHz. The Episode is capable of running CP/M packages markedly faster than other systems.

The Episode will work with virtually any VDU and printer and can be used as a station in a network linked to other equipment. It is an extremely

## Typewriter solution

OLIVETTI daisywheel typewriters make excellent micro-computer printers — the only problem is interfacing them. The £250 Discom interface is approved by Olivetti and will allow a typewriter to interface all the common buses — RS-232, IEEE and Centronics.

Details can be obtained from Discom, Old Manor Farm, Ashton-under-Hill, Worcestershire. Telephone Evesham (0386) 8819, extension 62. □

## Stitch in time for clothing industry

CLOTHMAN is an integrated system developed for use by the clothing industry. It has been developed by Taunton Electronics, a microcomputer systems house that specialises in providing computer systems for the clothing and allied trades.

There are five areas in which the Clothman system can improve or simplify tedious bookwork. These are: providing piece-work calculations which can be extended to year-end reports; production of work-in-progress reports with up to 10 process points; order processing, enquiry and status reporting; work-ticket printing on special copy-through tickets; and style rate book reporting and printing.

The system has been produced with the co-operation of a clothing manufacturer and is already fully operational in a number of factories, varying in size from 55 to 250 employees. Clothman runs on an Apple II computer or can put on the Nestar system with up to 64 Apples connected to a large disc back-up.

Clothman has been developed and conceived so that the system can be used by non-specialists, though the price of the package includes a

week of operator training at the company's training centre in Taunton, Somerset.

Clothman costs £2,250 and is available direct from Taunton Electronics. Telephone Bishops Lydeard (0823) 433142. □

Equipped with the standard RS-232 serial output, this analogue/digital/analyse board enables almost all microcomputers to interface with the analogue signals of the real world. Featuring eight-bit resolution of any signal in the range 0-2.5V, the board can handle both DC and AC currents. Output can also be in the 0-2.5 range, with a load driving capability of 25mA. The baud rate can be any one of 15 standard rates between 50 and 19,200. The kit version costs £39.50 and the built version £49 from Ambit International, 200 North Service Road, Brentwood, Essex. □

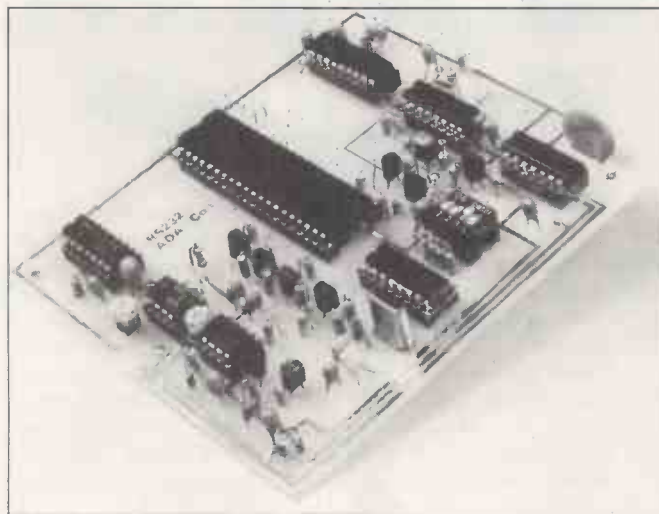

mobile computer: weighing only 15 pounds it can be carried easily to the place where you want to use it. The other dimensions of the Episode are the 7.5 inches height, 9.5 inches width and the 14.5 inches depth.

The mass integral storage is provided by twin mini-floppy disc drives of either single, double or quad density. A maximum of 1.6Mbyte of on-line storage is thus available. Other features of the system are two RS-232C serial interfaces, a Centronics compatible parallel interface, a battery-operated calendar clock, and 64K of RAM.

Episode is available from Equinox Computers, who will market the machine with a number of applications packages. Software includes word processing; invoicing stock control; sales, purchase and nominal ledgers; and a sales-management package.

The Episode microcomputer costs £1,995 plus VAT. For further details contact Equinox Computers, 16 Anning Street, New Inn Yard, London EC2 3HB. Telephone 01-739 2387/9. □



## Next One hits routine tasks

THE NEXT ONE is a program generator that costs only £100 plus VAT. Written for the Apple II microcomputer the program will also run on the ITT 2020 and there is a CP/M version too.

The Next One writes to a disc file the program statements which make up the created program. It is really a tool to take all the drudgery out of programming by writing the tedious input/output sub-routines between the keyboard and the disc, and the disc and the memory. It is not intended to replace programmers.

Target programs generated by the Next One are written in a structured form, which is ready for use within a few minutes of creation. There are many diagnostic features built in to the program and its structured nature makes it easy to read and understand. The Next One is available from Logical Computing, 26 Wide Lane, Swaythling, Southampton. Telephone Southampton (0703) 583857. □

## Composing oneself with Music Maker

THE PLUG-IN Music Maker module for the Texas Instruments TI-99/4A computer allows music to be composed, edited and played. It assists the creation of musical compositions by serious musicians and beginners alike.

Notes can be entered, one measure at a time, into the microcomputer's memory. Music can then be replayed at the touch of a key.

Serious musicians will be attracted by the system's method of composing, placing notes on the traditional treble and bass staves. Novices can compose using sound graphs. Either method allows the user access to three voices.

There is a flexible choice of key- and time-signatures, and a total of 30 different speeds at which the music can be played. Any note can be accepted, provided that it is in the three-octave range from the second A below middle C to the second A above middle C.

There is a facility for repeating passages of music, and if a

printer is added to the system, the music can be printed. Computer owners who consider themselves to be in the musical avant-garde will find the system capable of many interesting sound effects. The Music Maker module costs £34.95 and is available from Texas dealers. For details ring Texas Instruments on 0234-67466. □

## How to make Tandy run as terminal

TERMINAL is a product which allows the Tandy TRS-80 range of microcomputers to act as remote terminals to larger mini- or mainframe computers. The emulator runs under the standard Tandy DOS operating system, but a CP/M version is planned.

Under Terminal, the baud rate used will be software-selectable between 110 and 9,600baud. Also software-selectable are the word length,

## Economy of Cintcode

BCPL CINTCODE is a new implementation of an established systems programming language, BCPL. It permits larger and more complicated systems to be built and maintained on microcomputers.

It adds a number of extra features and only uses one-third of the space used by fully compiled systems such as Pascal. Telephone RCP, Blewbury (0235) 850218. □

the number of stop-bits and the parity. There are input and output translation tables for total control over all transmitted and received data, and screen-print facilities. Echoing, flashing cursor, lower case, and error checking are all provided for, and so are programmable break sequences.

Translation tables are provided for IBM, Univac, ICL 2900 and ICL 1900. Terminal costs £45 for TRS-80 models I and III, and £55 for model II. The CP/M version will be available soon. Contact MTW Computer Services, 4 Wyvern, Tamworth, Staffordshire, B77 2RL. Telephone Tamworth (0827) 61320. □

# Zilog chip makes huge power savings

THE Z-80L is the latest version of the well-proven Z-80 microprocessor. The new chip is still an eight-bit device, but it consumes only 10 percent of the power of the standard Z-80.

The Z-80L is available for operation at three speeds: 1MHz, 1.5MHz or 2.5MHz in the L1, L2, L3 versions. The low power consumption of the Z-80L family — 75mW — means that they are ideally suited for use in hand-held or portable battery-powered products. On the other hand, the low power consumption allows battery back-up to be implemented easily in systems where the data being processed is of a critical nature or where the application relies on continuous processing.

In other respects the chip is fully compatible with the stan-

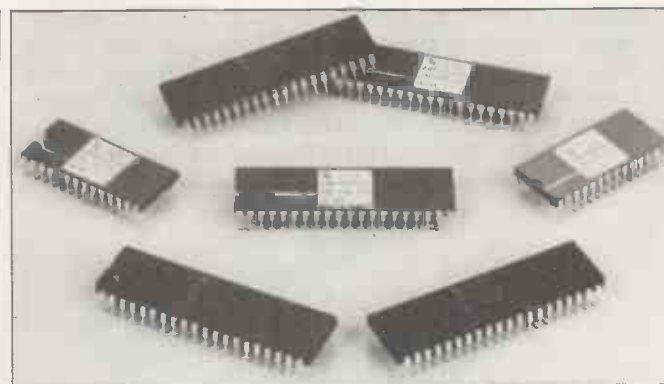

dard Z-80, allowing it to be replaced directly in circuit boards without any redesigning. Additionally the device is fully supported by Z-80 development systems and in-circuit emulators, allowing products to be developed, tested and debugged quickly.

The Z-80L can be used in conjunction with all the

eight-bit peripheral devices currently offered by Zilog. Low-power versions of the peripheral chips will be available in the future. The Z-80L is produced in both ceramic or plastic packages. For further details contact Zilog, Babbage House, King Street, Maidenhead, Berkshire. Telephone Maidenhead (0628) 36131. □

## Source of TRS-80 facts

TANDY TRS-80 microcomputer users will find the TRS-80 software sourcebook an invaluable aid. The first volume of the sourcebook lists the details and sources of over 500 applications programs, written in the U.K. for the TRS-80 models I, II, III, the Tandy Colour Computer and the Pocket Computer.

Entries are indexed by a series of seven categories: Business, Inventory Control, Education, Games, Home-Personal, Statistics-Maths, and specific industrial-professional programs. The book also contains an entry form for those who wish to submit their own software packages. The book costs £3.95 and is available at Tandy stores.



# First time on Earth.

## SHARP MZ-80B

Sharp bring you the MZ80B. A machine that offers you functions previously only associated with more powerful, more expensive computers; that gives you versatility to handle a huge range of software and hardware applications in scientific, business and personal use.

The MZ80B opens up a new world of graphic display potential, more flexible data storage and retrieval, and ease of operation.

Here is the computer from the future. Available today.

### Stunning Graphic Display.

Seeing is believing. The large-screen, high-focus, green-face display incorporated in the MZ80B gives you high-resolution graphics of 320 x 200 dots.

An additional graphic RAM can be added which allows another 320 x 200 dot resolution pattern to be displayed.

This dual high-resolution graphic ability is especially useful for simulating and displaying a dynamic picture. It can display 40 characters x 25 lines or 80 characters x 25 lines via software switching.

In addition there are facilities for full, on-screen editing, reverse video, partial scrolling and a full range of graphic symbols.

### Character and Graphic Printer.

This fast, quiet printer will reproduce your graphic displays and, of course, print-out upper and lower case letters and symbols. A tractor/friction feed version is also available.

### Data Storage/retrieval.

The MZ80B has a remarkable memory. 64K of RAM. And that constitutes all the memory area, giving flexible storage of any computer language and its software. The cassette deck is electromagnetically-controlled, with a data transfer speed of 1800 bits/sec combined with a unique

programme search facility to make data storage and retrieval super-fast.



A typewriter-style keyboard incorporates characters and symbols plus a numeric key-pad and ten user-definable keys for fast and simple operation.

BASIC is, of course, provided with Z-80 Assembler Packages, PASCAL and a BASIC compiler.

### Floppy Disk Drive.

A twin Floppy Disk Drive unit can be added which will give you 560 bytes of storage on double-sided, double-density disks.



### Comprehensive Documentation.

Each MZ80B comes complete with a full set of documentation including an owners' manual giving full circuit diagrams, a monitor reference manual and programming manuals.

### Interfaces

RS-232C and IEEE Interfaces are available from January 1982 allowing the MZ80B to communicate with scientific instruments and other peripherals.

### CP/M\*2.2

CP/M\* is also available making a wide range of packages immediately available including wordprocessing, financial modelling, data base management to mention but a few. CP/M\* also increases the disk capacity to 680K.

(CP/M\* is a Trade Mark of Digital Research Ltd.)

# SHARP

*First, and foremost*

SHARP ELECTRONICS (UK) LTD., COMPUTER DIVISION,  
SHARP HOUSE, THORP RD., NEWTON HEATH,  
MANCHESTER M10 9BE. TELEPHONE: 061-205 2333.

### Why on Earth don't you find out more?

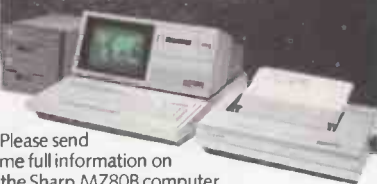

Please send me full information on the Sharp MZ80B computer.

PC 4/82

Name

Address

Tel:

To: Sharp Electronics (UK) Ltd., Computer Division,  
Sharp House, Thorp Road, Newton Heath,  
Manchester M10 9BE. Telephone 061-205 2333.

● Circle No. 143



# “Give me one good reason why I should choose a VIC 20 home computer.”

1. VIC is outstanding value for money. No other colour home computer can give so much for under £200.
2. Total standard memory 25K made up of 20K ROM and 5K RAM.
3. Fully expandable to 32K of user RAM.
4. Microsoft Basic interpreter as standard.
5. Accessible machine language as standard.
6. Connects direct to monitor or standard television.
7. Full size typewriter-style keyboard.
8. Full colour and sound.
9. All colours directly controllable from the keyboard.
10. 62 predefined graphic characters direct from the keyboard.
11. Full set of upper and lower case characters.
12. 512 displayable characters direct from the keyboard.
13. High resolution graphics capability built into the machine.
14. Programmable function keys.
15. Automatic repeat on cursor function keys.
16. User-definable input/output port.
17. Machine bus port for memory expansion and ROM software.
18. Standard interfaces for hardware peripherals.
19. VIC 20 is truly expandable into a highly sophisticated computer system with a comprehensive list of accessories (see panel below).
20. Full range of software for home, education, business and entertainment on disk, cassette and cartridge.
21. Books, manuals and learning aids from Teach Yourself Basic to the VIC programmers' reference guide (a must for advanced programmers).
22. Full support for VIC owners – their own magazine 'VIC Computing' as well as a national network of VIC user groups.
23. National dealer network providing full service and support to VIC owners.
24. Expertise and experience – Commodore are world leaders in microcomputer and silicon chip technology.
25. Commodore is the leading supplier of micro-computers in the UK to business, schools, industry and the home.
26. VIC 20 is the best-selling colour home computer in the UK.

How many reasons was it you wanted?

**Accessories include:**

- Cassette tape unit.
- Single drive 5¼" floppy disk unit (170 K bytes capacity).
- 80-column dot matrix printer.
- 3K, 8K and 16K RAM expansion cartridges.
- Programming aid packs; machine code monitor cartridge; programmers' aid cartridge; high resolution graphics cartridge.

- Plug-in conversion box for a full 32K, 40-column x 25 lines VIC including Prestel compatibility.
- Prestel/Tantel interface package.
- RS 232C communication cartridge.
- Memory expansion board
- IEEE/488 interface cartridge.
- Joysticks, light pens, paddles and motor controllers.

**commodore**  
**VIC 20**  
**The best home computer in the world.**



The 1982 Computer Fair, being held at London's Earls Court exhibition centre on April 23-25, provides a showcase for the whole gamut of small business systems and home computers. We look ahead to the highlights of the Fair.

# Computer Fair preview

THE COMPUTER Fair will be the biggest show of its kind ever held in the U.K. The Fair will be concentrating on the microcomputers that are becoming a part of our everyday lives, and to avoid confusion, it will be divided into two areas, one for the business microcomputer user and a fun section for the more frivolous home user.

In the business section, the main exhibitors will be displaying a variety of microcomputers aimed at the serious computer user. A number of leading companies will be displaying their pro-



The IBM micro can be seen at the Fair.

ducts to the public for the first time. One of the more interesting products to be shown at the fair will be the IBM personal computer which is on sale in Britain through Microcomputerland.

The IBM personal computer represents an important trend in microcomputing. In the past, the industry has been dominated by smaller companies with rapid growth. Now the larger, more established equipment manufacturers are moving in, bringing with them new standards in hardware and software, as well as reliability and support.

## Industrial charm

These advances have been made at the expense of some of the charm of the industry, but are well worth the price. If you would like an opportunity to see the IBM personal computer at first hand, then call in at the Microcomputerland stand, number 407.

Tangerine expects to be launching the new Tigress microcomputer at the Computer Fair. The Tigress is a major new British microcomputer that will compete on far from equal terms with the better-known imported machines. The micro is aimed at the businessman and the top-of-the-range hobbyist. One of the most

attractive features of the Tigress is the built-in Prestel unit and its telephone answering facility. This enables the computer to connect directly with Prestel and download pages. All current or projected Prestel standards are catered for.

## Tigress processors

In addition each Tigress will be able to act in a telephone-answering mode, accepting messages from other terminals or computers over the telephone network. It will be possible to connect the machines using the integral Econet communications network.

The Tigress employs three processors — the main CPU is the Z-80 which runs CP/M. A 6809 will be in control of all the input, output and communications functions of the machine, while a separate dedicated chip will control the real-time high-resolution graphics. The target price of the basic Tigress system will be around the £600 to £700 mark; discs will be extra.

In addition to this exciting new machine, Tangerine is showing a range of software. Marketed under the Tansoft label, this software is designed to run on the new Tangerine disc units and will include a disc-operating system. There is also some utilities software covering such functions as reformatting. The focal point of interest will no doubt be the Tangerine Forth package.

## The ZX Village

Home and hobby computer users will find much to their taste at the show, with the finals of the U.K. Micromouse competition and the ZX Village. Ever mindful that this just might be the time and the place for the launch of the ZX-82, the Fair's organisers have allocated a whole section of the show for the Village which will be, to all intents and purposes just like a space-age market.

The ZX Village will be an ideal place for users to bring themselves up to date with the latest developments on the Sinclair scene. Sinclair Research is exhibiting at the Computer Fair and in the past Sinclair has produced a few surprises. In this area of the show user groups and clubs will be able to use stands free of charge.

If the ZX Village combines the excitement of the eastern bazaar with the technology of the space age then the Micromouse competition combines the same technology with the flavour of a Roman circus. As tiny robotic mice endeavour to find their way through labyrinths of

Minotaurian proportions, baying crowds of supporters will cheer on the heroes and offer a "thumbs down" to the vanquished in the time-honoured tradition of the amphitheatre.

If it all sounds a little too light-hearted for you, the techniques and technology used in building and running these Micromice are some of the most sophisticated around. The competition is not really about mice at all, but about building ever-better robots, to specification. The strength of such a competition is represented in the interest shown in it by top engineering concerns. To find out more about the *Practical Computing* Micromouse finals, you can read the rules of the competition on page 143 of this issue of *Practical Computing*.

## Package deal

The Computer Fair is to be held at the giant Earls Court exhibition centre in the heart of the nation's capital. It is the first time a major computer show of this size has been held at that venue. If you are intending to stay over night in London for the Fair, you might be interested to know that Pharoah Hughes Associates Ltd is offering a special package deal.

In the best tradition of business package deals the offer can include both

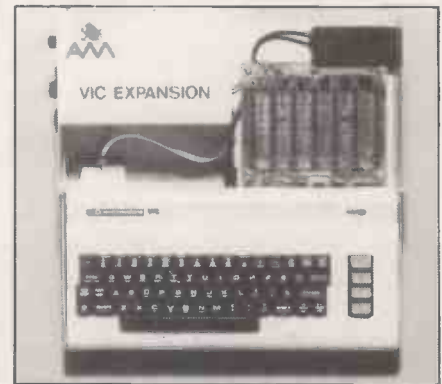

Home computers are amply catered for.

reasonably-priced accommodation in twin-bedded hotel rooms and reduced-rate rail travel. There is a choice of either two-star or three-star hotel accommodation, and both include continental breakfast and admission to the show. Two-star accommodation costs £13.80 per person and three-star £15.30. For more details telephone Pharoah Hughes Associates on 01-995 8995.

The Computer Fair is being organised by IPC Exhibitions Ltd, in conjunction with *Practical Computing* and *Your Computer*. For more details telephone 01-643 8040.



# Plotting to put HP-83 graphics on to paper

**Exploded pie segments and clustered bar charts are child's play for the Hewlett-Packard graphics plotting package. David Watt reviews this tablet and plotter which turn statistical data into shaded and coloured hard copy for permanent display.**

HEWLETT-PACKARD is renowned for producing equipment of very high quality, which is particularly respected by members of the scientific and engineering community. The equipment for this review was provided by Microdigital — now a subsidiary of Laskys, the hi-fi chain — and consisted of an HP-83 computer, a 9111A graphics tablet, a 7225A plotter, dual mini-floppy disc drives, VisiCalc Plus, and graphics demonstration software. The system also included a 16K add-on memory module, HP-IB interface and cables, mass-storage ROM, and plotter/printer ROM.

The equipment was connected using the HP-IB interface bus, invented by Hewlett-Packard and since adopted as the IEEE-488-1978 standard. The HP-IB interface allows several devices to be connected on a common bus. Each device has a unique address which may be set by adjusting switches at the back. Up to 15 devices may be connected on one bus. The IEEE-488 interface is also used by the Commodore Pet.

All the equipment worked well, with the exception of an apparent fault on the plotter. The pen did not always lift clear of the paper when being moved between plots, and therefore drew faint traces on the paper.

## **Attractively styled**

The equipment looks extremely well made, and is styled attractively in matching light-grey plastic cabinets, with dark-grey front panels. The HP-83 computer is the same as the HP-85, but without the integral tape cassette drive and printer. It is very pleasant to use: the keyboard design, in particular, is excellent with a number of useful special functions keys. The 5in. display screen is easy to read, despite its small size, though it is only possible to display 16 lines of 32 characters. The HP-83 has a larger display memory, a total of 64 lines, which can be displayed by scrolling up or down.

The graphics tablet has a large, white ceramic platen, a stylus attached by a thin cable, and four lights marked Digitise, Menu, Error and Line. The platen is marked out with a large rectangular plotting area, measuring 11.9 by 9.36 in. and 16 square "softkeys" grouped in fours above the plotting area. In the bottom, right-hand corner of the plotting area is a small dot called the self-test dot, used for testing the platen and stylus circuits.



When the tablet is switched on, all the lights flash on and off and a sequence of notes is sounded on the tablet's tone generator. The tone generator may be programmed to give an auditory acknowledgement when an operation is performed — when a softkey is selected, for example — or if an error occurs.

At the rear of the tablet there is a row of switches used for setting the device address on the HP-IB interface. The tablet may also be connected to a non-intelligent device for data logging, in which case the switches may be set to "talk-only". One of the switches is used to initiate the graphics tablet self-test, which makes all the lights flash and start-up tones play. If the stylus is touched on the self-test dot, the start-up sequence will be played again.

### Tracing lines

The stylus contains a ball-point pen cartridge which may be either inked or inkless and has a spring-loaded micro-switch which operates when the pen is pressed on the platen. It can be used in two ways. For single-point digitising the X, Y co-ordinates of the pen are transmitted when the pen is pressed on the platen and the switch closes. The alternative mode, continuous digitising, is useful for tracing lines. In switch-normal mode, a line is started by pressing the pen once and points are taken continuously until the pen is pressed again. In switch-follow mode, points are taken only while the pen is kept pressed down, on the tablet.

The Digitise light indicates when the graphics tablet is ready to receive a location. The Menu light comes on when one of the softkeys is to be selected. As the name suggests the softkeys can be used to select options from a menu; they are used by many of the programs in the graphics demonstration software.

The plotter has several push-buttons along the front, which are used for setting it up. The Chart Load switch causes the pen to move up to the top-right corner, and releases the electrostatic hold-down on the plotter so that a sheet of paper or mylar may be placed on the platen. The electrostatic hold-down feature makes sure the paper lies flat and does not move about.

### Pen movements

The pen may be moved about the platen and raised or lowered using ←, →, ↑, ↓, and Pen Up or Pen Down. There is also a button marked Fast to move the pen more quickly. The lower-left and upper-right limits of the plotting area can be set, if you do not want to use the default values, by moving the pen to the required positions and pressing Enter, followed by the buttons marked Lower Left or Upper Right. The button at the rear of the plotter marked Confidence Test generates a test plot.

The pen can be moved in increments of

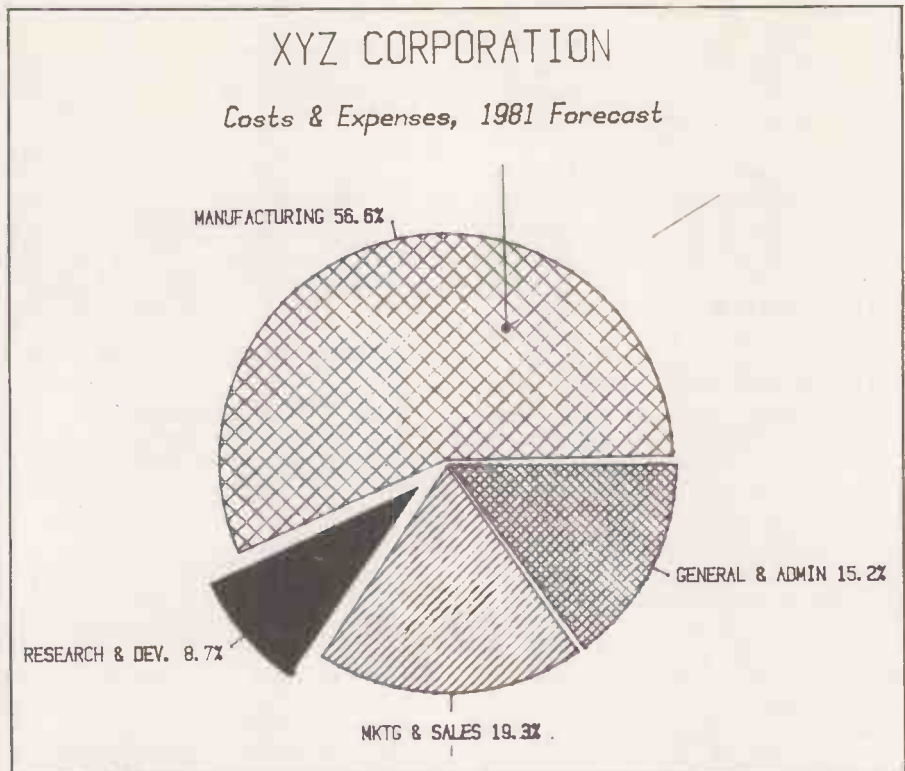

The tablet and plotter can deftly transform statistics into graphical form.

0.032mm. which the plotter will take charts up to 210 by 297mm. A4-sized paper. The pen velocity can be varied between 10 and 250mm./s. and labels can be printed at up to three characters per second. Five character sets are available. Two use the £ sign instead of "#", and one has the symbols Ø, Æ, ø, æ.

The printer/plotter and input/output ROMs provide a number of extensions to Basic for use both with the graphics tablet and the plotter. Amongst these are Limit, Scale, Digitise and Cursor, Printer Is and Plotter Is from the Printer/Plotter ROM; and Output and Enter instructions provided by the input/output ROM. The I/O ROM was not supplied for review, but all the software provided worked perfectly

Figure 1. Plotter/printer ROM statements.

AXES	LINETYPE
BLINIC	LOCATE
BPLOT	LOGR
BREAD	MOVE
CLIP	MSCALE
CRT IS	NOBLINIC
CSIZE	PDIR
CURSOR	PEN
DIGITISE	PENUP
DRAW	PLOT
EPROM	PLOTTERIS
ERASE	PRINTERIS
FRAME	RATIO
GCLEAR	RPLOT
GRAPHICS	SCALE
GRID	SETGU
IDRAW	SET I/O
IMOVE	SETUU
IPLOT	SHOW
LABEL	TRANSLATE
LABLE USING	UNCLIP
LAXES	WHERE
LDIR	XAXIS
LGRID	YAXIS
LIMIT	

without it and so does not depend on it.

HP-85 Basic has a powerful set of graphics commands. Graph switches the screen to the graphics-display area, GClear clears the screen below a specified line, and Frame draws a line round the edge of the screen.

### Scale command

The Scale command sets the horizontal and vertical, X and Y, units. The default values for scale are zero 0 to 100 in both directions. The ranges for X and Y can be set independently, and can range over any values; they do not have to start at zero.

The screen has a resolution of 256 dots horizontally by 192 dots vertically, so when using the default scale, the y units are shorter than the x units. However, setting the scale so that the number of Y units is three-quarters the number of X units gives equal-sized units, which make it easier to draw regular shapes like circles or polygons.

Points are plotted according to the current scale, and mapped automatically on to the graphics display, so it is easy to expand or contract a display.

The X-Axis, Y-Axis statements may be used to draw axes specifying where to position ticks; Plot is used to set a point on the display; Move moves the pen without drawing a line; Draw is used to draw a line. IMove and IDraw are the same as Move and Draw except that they move the pen a number of units relative to the last pen position.

Labels may be written anywhere on the display using the Label command, and

(continued on next page)

(continued from previous page)

can be written vertically or horizontally by specifying the label direction with LDir. Another powerful feature of HP-85 Basic is the ability to create your own characters using BPlot.

These features are considerably enhanced by the use of the plotter/printer ROM. A list of all the commands it provides the plotter/printer ROM is shown in figure 1.

The Plotter Is and Printer Is commands are used to direct output to specified devices: 1 is the address of the HP-83 CRT; 705 is the default address of the graphics tablet, and 706 the default address of the plotter on the HP-IB interface. A plot can first be displayed on the CRT and if it is satisfactory it can then be output on the plotter.

The Limit, Scale, Show, Locate and MScale commands allow considerable flexibility in defining the plotting limits. The Limit statement allows a program to set the physical plotting area for the HP-7225A plotter, as an alternative to setting them using the buttons on the front panel. The Show statement allows the ranges for X and Y units to be defined, and scales the plotting area automatically so that X and Y units are the same size. MScale sets the user units to millimeters, so that precisely-scaled objects can be drawn or measured. You can specify windows in the plotting area using the Locate statement: for example, you can define a part of the plotting area to contain your main plot while another portion is reserved for labels.

### Dots and dashes

Lines can be plotted using varying combinations of dots and dashes with the Linetype statement. Eight combinations are available, and the length of the repetitive pattern can be specified.

The plotter/printer ROM provides several new commands for drawing axes and labels. The Axes statement allows both the X-axis and Y-axis to be specified, together with major and minor tick marks. Thus it combines all the features of the XAxis and YAxis statements in one. The Grid command allows a grid to be drawn instead of the axes alone. In addition to the standard Label statement the plotter/printer ROM has a Label Using statement which operates in a similar fashion to Print Using; a format mask is defined which governs the position and print format of the data specified in the rest of the statement.

For labelling it is possible to specify the character size, the ratio of character height to width, and the slant of characters, all using the CSize statement. When using the plotter, labels can be drawn in any direction — not just horizontally and vertically — with the LDir statement.

For digitising, Digitise, Cursor and Where are statements that interrogate the plotter or graphics tablet to find the

### The review system

HP-83 computer	£1,486.35
16K memory module	£194.88
ROM drawer	£29.73
Mass-storage ROM	£98.19
Plotter/printer ROM	£98.19
Input/output ROM	£199.77
HP-IB interface	£260.94
7225A plotter with personality module for HP-IB interface	£2,115.00
9111A graphics tablet	£1,355.00
Dual mini-floppy disc drive	£1,693.00
TOTAL	£7,351.05

HP-85 computer	£2,146.95
----------------	-----------

HP-85, 16K memory module, ROM drawer, plotter/printer ROM, I/O ROM, HP-IB, plotter and graphics tablet	£6,400.66
--	-----------

### Software

Graphics presentation	£135.44
VisiCalc Plus	£135.44

X,Y co-ordinates of the pen or cursor. The plotter/printer ROM provides some additional facilities for use with the CRT graphics. BPlot has been improved so that your characters can be as large as you like, filling the whole screen if you wish, and BRead allows a character created on the screen to be stored for re-display by BPlot.

Both the plotter and the graphics tablet have internal microprocessors, and will execute commands given in Hewlett-Packard's graphic language, HPGL. This enables you to use features not available through the plotter/printer ROM, such as changing the speed of the pen or using a different character set on the plotter, and obtaining information on the status of the graphics tablet. To use many of these functions it is necessary to have the input/output ROM.

### Practical value

The Graphics Presentation software and VisiCalc Plus was provided to test the system. The Graphics Presentation package consists of six programs: a drawing program; an area- and distance-measuring program; a continuous line-drawing program; a graphic data-entry program; a music-demonstration program which plays "Daisy Bell" using the sound generators of both the HP-83 and the 9111A; and an asteroid game. They were great fun to use, and effectively demonstrated the facilities of the graphics tablet. The first four programs have a practical value as well.

The programs all display help instructions, the HP-83's CRT to tell you how to use the softkeys, but they tended to scroll off the screen too quickly. You have to be ready with your finger on the Pause key to be able to read the information.

VisiCalc Plus is the ubiquitous VisiCalc program with the addition of some very useful programs which take data stored

by VisiCalc and generate line graphs, bar charts, pie charts or fit regression curves. It showed up well in the example described in the VisiCalc manual which produced the various charts on the plotter. The bar and pie charts could be shaded in various ways, stacked or clustered bar charts could be drawn, and exploded pie segments could be drawn to emphasise a particular sector.

The review system was supplied with special paper for plotting, four different coloured pens and mylar for producing overhead-projection slides. One obvious application for the plotter is in preparing material for presentations, lectures or reports.

The detailed documentation supplied with the system was of very high quality: diagrams and examples were provided in abundance. The sheer quantity of documentation was daunting at first, but you should soon learn to find your way around it.

You may be amused by the following item from the introduction to the Plotter/Printer ROM Manual: "By the time you get the plotter/printer ROM and the manual, you will have accumulated a stack of literature at least 1.8 m. tall. And you are wondering where to dig in". It clearly caters for every level of user from the absolute beginner to the experienced programmer.

### Conclusions

- All the Hewlett-Packard equipment is made to a very high standard. It looks good and feels good to use. The documentation is also extremely good.
- The plotter has many very useful features and it was possible to produce excellent graphs with it. It is even possible to digitise information by positioning the pen — a special digitising sight is available — and pressing the Enter button.
- The strength of the graphics tablet is the ease with which it can be used to enter data from charts or graphs. It can also be used as a design tool for creating drawings.
- Hewlett-Packard has an extensive service network and a good reputation for reliability.
- The VisiCalc Plus programs provide powerful extensions to VisiCalc, and the graphics demonstration software would be useful for digitising drawings and graphs, and possibly as design tools. The source code was supplied for the VisiCalc Plus programs — not VisiCalc itself — and the graphics demonstration programs, so they could be easily enhanced. The packages are reasonably priced.
- The hardware is rather expensive by normal standards, and seems to be aimed primarily at scientific, engineering and business users demanding high-quality equipment and service.
- The system is particularly suited for use in business graphics, statistics, medicine, numerical control, surveys and design. □



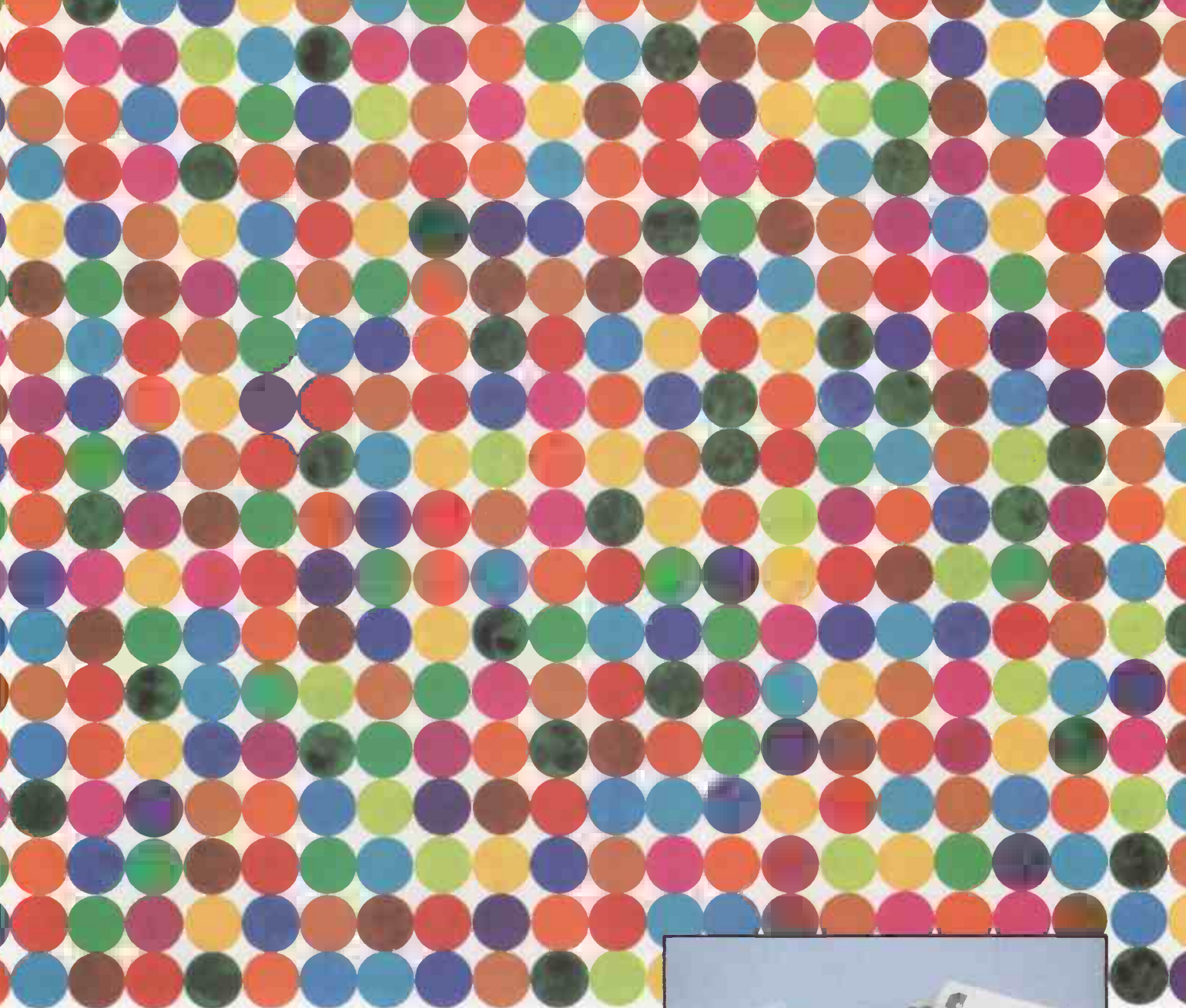

# Colour me Prism



Hard copy in colour? It's here today, with a range of 400 shades at a price you can afford. Teleprinter Equipment's Prism printer brings colour within reach of every business, engineering and scientific work station.

Think what this means in speed of recognition, range of variables and graphic presentation.

As well as colour, the Prism printer comes with a host of other advanced features, including

- Single sheet feed
- Graphics with additional 2K buffer
- High speed print mode (in excess of 200 cps)
- Correspondence quality print

Opt for Prism colour now, and bring a whole new dimension to your work.

*Trade enquiries welcome.*



**Teleprinter Equipment Limited** –  
*the peripheral people*

70-82 Akeman Street, Tring, Herts. HP23 6AJ. U.K.  
Tel. Tring (0442 82) 5551/9 & 4011/9 Telex: 82362 BATECO G.

● Circle No. 145

PC14/82

Please send full details of the Prism printers

Name \_\_\_\_\_

Company \_\_\_\_\_

Address \_\_\_\_\_

Tel. \_\_\_\_\_

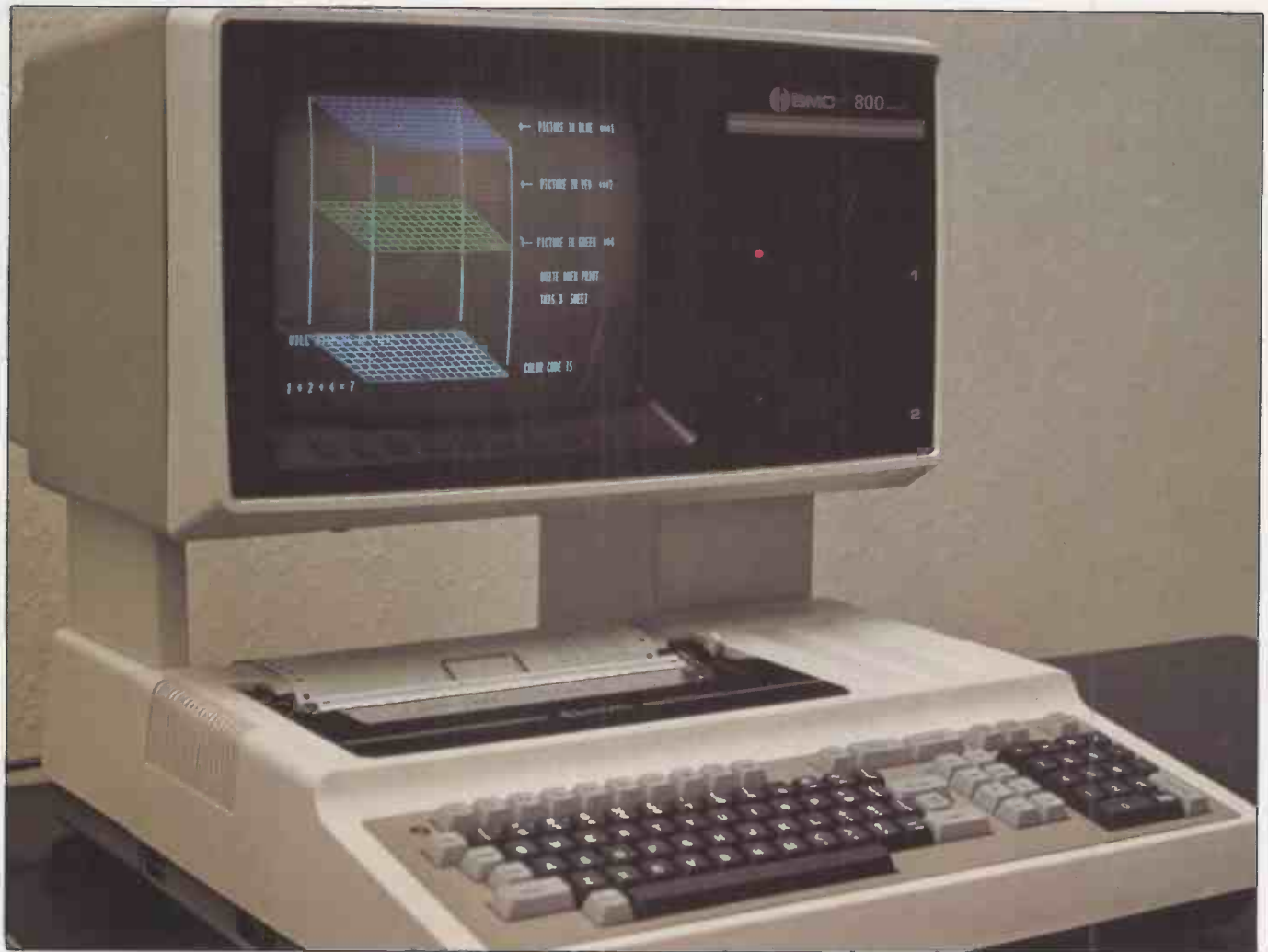

**Equipped with an unusually high level of sophisticated hardware, this integrated microcomputer system is clearly designed to appeal to a wide range of business and technical users. John Dawson finds out whether its practical performance matches up to the advanced specification.**

THE OKI IF-800 Model 20 personal computer is an eight-bit machine intended as a small business computer, for scientific purposes, and for diverse applications such as instrument control and running business colour-graphics software. It uses a Z-80A CPU running at 4MHz, backed up by 64K of dynamic RAM for program store and 16K for the monochrome display, or 48K if you have the colour monitor. There is a 2K bootstrap ROM.

The IF-800 has a built-in printer which uses a five-by-seven-dot matrix, and consequently produces no lower-case descenders. The printer provides for both tractor and friction paper feed. The other input/output facilities for the computer are listed in table 1.

Two 5in. double-sided, double-density

mini-floppy disc drives are built into the computer. Each drive has a capacity of 280K, giving a total on-line storage capability of 560K. With four floppy-disc drives in place, the machine can access 1.12Mbyte. A brochure accompanying the computer, dated November 1981, offers a 5.25in. hard-disc drive with a capacity of five or ten megabytes.

The computer is delivered as two units: the first incorporates the keyboard, printer and CPU/memory. The second unit contains the VDU and the two floppy-disc drives mounted on a plinth to raise them above the keyboard. Power and data connections are brought neatly down the inside of one leg of the plinth to plug into the back of the computer/keyboard unit.

### **Eight-colour image**

The computer is supplied with a mains lead wired directly to the machine and a continental three-pin plug at the far end of the lead. Despite this, the IF-800 contains a 240-volt power supply and the first job you will have to undertake after unpacking the computer is to cut off the plug to substitute a standard U.K. plug.

An eight-colour image is available on the IF-800 with a high-resolution display — 640 horizontal by 200 vertical pixels.

# OKI

Alternatively the machine can be supplied with a green monochrome display with the same resolution.

The story, however, does not end there. The colour mask in the colour cathode-ray tube is perceptible to an operator using the computer, and the effect of this is to lower the apparent resolution. When this is combined with the absence of lower-case descenders in the VDU type font, the result is to make the machine unsuitable for use over extended periods by, for example, a word-processor operator.

Any computer should have an easily-legible character set that will not cause fatigue when used for a number of hours at a stretch — nothing less is acceptable, certainly not in the prestige, up-market product range to which the IF-800 aspires. The poor quality of the 80-character IF-800 alpha-numeric display is a serious shortcoming.

In addition to the normal typewriter-keys on the IF-800 keyboard, there are 10 user-programmable "soft keys" and 32 special-function keys, including a numeric keypad. Three keys are dedi-



cated to printer functions: to print the current contents of the VDU on the printer; eject a "form" length of paper from the printer; and echo whatever is typed in at the keyboard to the printer.

The soft keys are repeated along the bottom edge of the VDU screen, and some of the CRT control options allow a label field to be displayed across the bottom of the VDU indicating the function of the 10 programmable soft keys. The keys along the bottom edge of the VDU are particularly useful when a menu of commands is provided for a user to choose from. The first three characters of the command are displayed when the CRT display is in 40-character mode, and the first seven characters of a maximum of 15 are displayed when the VDU is in the 80-character mode.

A reset switch and a key to break into the operation of a Basic program are located on the left-hand edge of the computer. A diverse and comprehensive set of sockets scattered round the computer will allow you to plug in additional peripheral devices such as a light-pen, an acoustic coupler or British Telecom Modem, laboratory instruments, a printer with a Centronics interface, or the two additional floppy-disc drives.

## Hard information

Two manuals are supplied with the computer. The Operation Manual contains 200 pages packed with hard information about the system and example Basic programs. The second manual is the Basic Reference Manual which

Two built-in mini-floppy double-sided, double-density disc drives — 280K per disc. An extra two disc units can be connected.

Loudspeaker: Can switch a tone on and off with a frequency range from 65Hz to 1,976Hz.

Calendar clock: A hardware clock is fitted, powered by a NiCad battery. It displays the year, month, day, hour, minute, second and day of the week on request.

ROM cartridge: Holds 20K, the interface is said to be addressable to 1Mbyte.

RS-232C interface: From 110 to 9,600 baud under software control.

External I/O interface: Three slots for optional cards to give a Centronics-type parallel interface, an IEEE-488 interface, and a two-channel, 12-bit D-to-A board or an eight-channel, 12-bit A-to-D board.

Audio cassette I/O: Uses non-standard BMC protocol; cassette recorder motor control by Basic instruction.

Printer: Five-by-seven-dot matrix; tractor/friction feed; paper up to 9.5in. wide; no lower-case descenders.

Dimensions: width 20in. (51cm.); depth 26.7in. (68cm.); height 19.9in. (50cm.). Weight: 77lb. (35kg.) with monochrome display; colour display weighs an extra 11lb. (5kg.).

Table 1. Dimensions and input/output channel specifications.

devotes about 30 pages to a general explanation of the Oki Basic interpreter, and a further 100 or so to a more detailed description of the use of each command and intrinsic function.

The IF-800 is likely to be marketed into offices, scientific and hospital laboratories, and possibly executive conference rooms. Many of the machine's users will be intelligent and capable people who are quite ignorant about computers. The documentation supplied with the machine is crucially important, particularly where small detail is concerned, because this group of users is unlikely to have the accumulated wisdom that will allow them to disregard red lights and to cope with unexpected error messages when following programs in the Operation Manual.

For example, there is a caution that you should not attempt to remove a disc from the disc drive when the drive-select

light is on. Yet the red light remains on the whole time on drive 1, presumably to indicate that the drive is selected rather than that the head is in contact with the disc, reading or writing material. Even if it were possible to select the second drive manually this is an incredibly clumsy way of removing a disc. There is no cross-reference in the manual to tell you how to overcome the problem.

## Additional boards

The Operation Manual does improve when it reaches the technical description of the various additional boards that can be attached to the basic system. There is plenty of information, well set out, on the pin connections, voltage levels and timing patterns that are expected by the D-A and A-D boards, the IEEE-488 interface and so on. A technician in a polytechnic or university laboratory should be able to interface the IF-800 to other equipment without difficulty after consulting these sections of the manual.

There are, however, numerous other small discrepancies in the Operation Manual and generally too little attention has been given to a user approaching the computer for the first time. The poor introduction to the documentation has been overcome to some extent by an impressive training program supplied on disc. The program demonstrates some of the Graphics Macro Language commands, described later, and many of the other Basic commands concerned with drawing on to the screen. The screen photographs were taken while this program was running and you should be able to see the command in the lower portion of the screen, with explanatory comments and the effect of the command in the upper half. Training by the company supplying the machine is still necessary for other aspects of the computer's operation.

The IF-800 is supplied with an extended Basic interpreter based on Basic-80 developed by Microsoft. The version of the language supplied allows various screen formats with either abrupt or

(continued on next page)

# IF-800

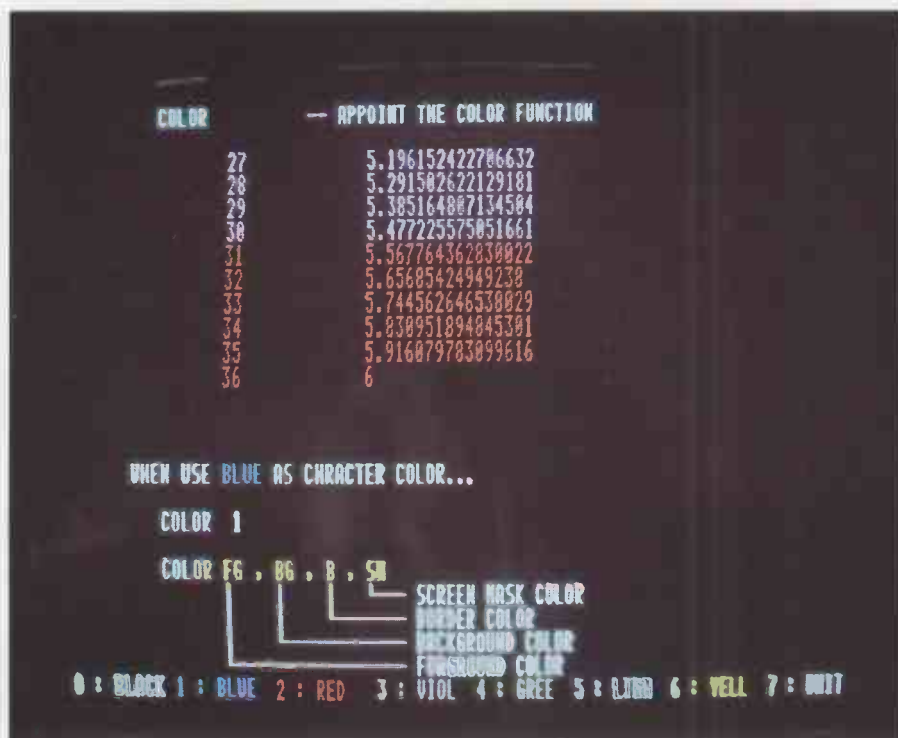

(continued from previous page)

smooth scrolling, and a Basic command which will access a Graphic Macro Language. Circle, for example, will draw a circle or arc on the screen, given coordinates for the centre, the radius of the circle and the colour of the line.

A further parameter allows you to set the elongation of the vertical axis of the circle, and the ratio of the vertical to the horizontal axes can be set between zero and one. Zero will make the computer draw a straight line while, a ratio of one will draw an ellipse. In the same way, the angle of arc that is to be drawn can be set, where zero represents 90 degrees, 0.25 represents 180 degrees, and 0.5 starts or stops an arc at 270 degrees.

Another basic command, DEF CHR\$, allows you to redefine the graphics characters held in the machine. The eight-by-eight screen matrix can be controlled by a character string consisting of eight bytes expressed in hexadecimal notation, concatenated into a string.

The Basic interpreter contains many commands peculiar to the machine. Although the machine runs CP/M and has a vast quantity of software available through Lifeboat Associates, it is unlikely that WordStar, Fortran-80, Pascal, muSimp/muMath or the Peachtree financial packages will make adequate use of the special hardware and software features available on the IF-800.

For example, the Pen commands in Oki Basic will return the horizontal and vertical position of the light-pen on the screen to a resolution of one pixel. It should be possible to use the light-pen for editing purposes in a word-processor program, selecting first a command at the top of the screen such as Delete, and then selecting the character or word to be deleted anywhere on the screen.

In the same way, it should be possible to scroll the screen in any direction merely by placing the light-pen on the appropriate boundary. Obviously WordStar does not have this facility in the form

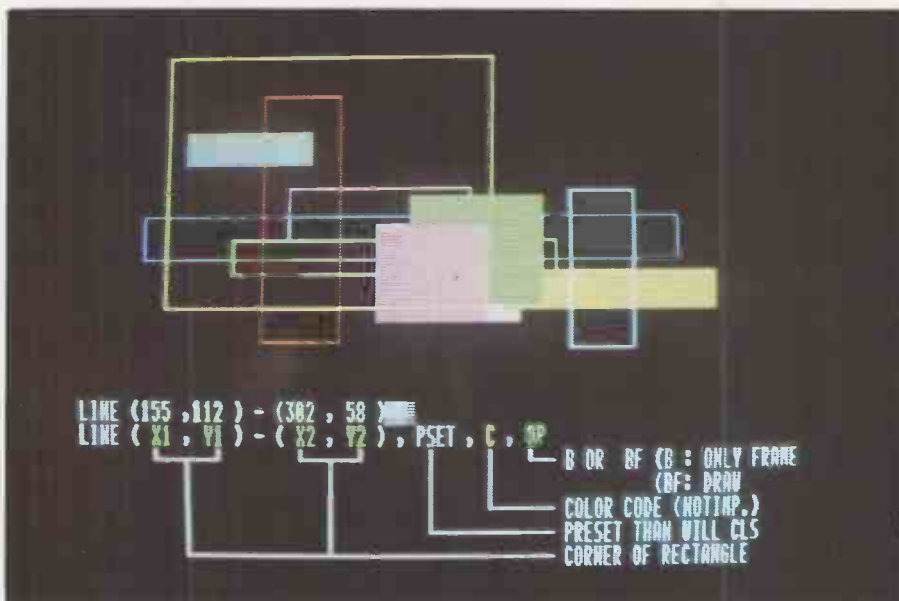

in which it is implemented on a Superbrain or Cromemco. In the absence of software designed specifically for the IF-800 it is constrained into the mould of a straightforward business computer with a colour display.

The Oki Basic interpreter has two commands for storing and retrieving machine-code programs from disc, and has both Call and USR commands which transfer program execution to a user machine-code subroutine. There are no details in the manual to tell you how to return to the Basic program at the end of the machine-code subroutines.

VARPTR returns the address of the first byte of data identified with a variable name. VARPTR can be used to obtain the address of the variable array so that it can be passed to an assembly-language subroutine. For example the instruction VARPTR (A (ZERO)) identifies the lowest element of the array.

## Conclusions

● The IF-800 costs £4,300, including VDU, printer and double disc drive.

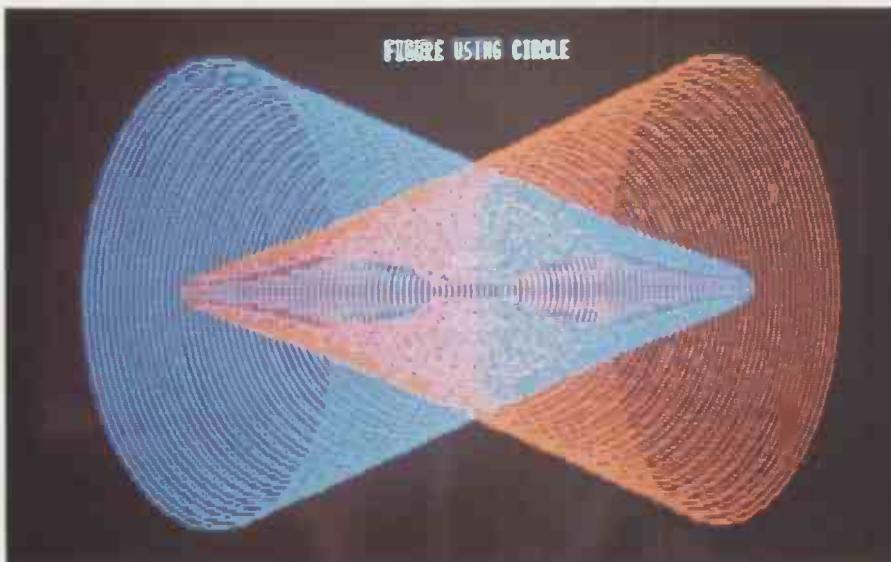

● The comprehensive input/output facilities on the IF-800 will be attractive to scientists wishing to gather and display complex information in graphic form. Business executives may find the colour display a useful presentation device for their colleagues.

● The tidy appearance of the computer must be set against the fixed relationship between the keyboard and the VDU which is poor ergonomic design.

● Operation of the machine is quite separate from programming it, and the confusion over details such as the orientation of the label on a floppy disc and the drive-select light on the floppy disc units is an unnecessary burden on a small business looking for a robust system for the first time.

● The 80-character display is not backed up by a sufficiently high-resolution display on the colour VDU to make it acceptable for prolonged use as a word processor or for other applications which demand reading or correcting text.

● Dot-matrix print is acceptable for memoranda and papers that will be used within an office, but the lack of lower-case descenders on the IF-800 printer makes documents tiring and annoying to read.

● Despite its length, the documentation supplied is inadequate to allow anyone unfamiliar with microcomputers to operate the machine successfully.

● A wide choice of C/PM software should be available, but this is unlikely to take advantage of the sophisticated hardware features of the IF-800. Software that is specific to the machine will take longer to emerge, but when available will provide a powerful and versatile system.

● The IF-800 appears to be strongly made and should be reliable in operation.

● If the price/performance ratio is attractive to you, and if you have the facilities to write appropriate software without needing too much support from the system manuals, the IF-800 is worth considering. A



# FREE MICRO COMPUTER SOFTWARE

(with complete hardware system price)

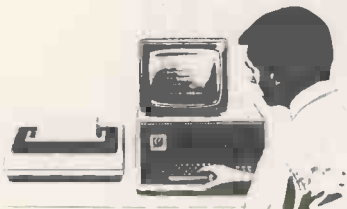

## ADLER ALPHATRONIC

**£2495** + VAT

(prices subject to change)

Includes: Adler Alphonetic P2 Micro Computer, Daisy Wheel Printer, O.C.S.C. Financial Accounting/Book-keeping/Incomplete Records, O.C.S.C. Payroll System, General Data Management System, Word Processing System or Invoice and Sales Ledger System.



## NEC PC800:

from  
**£2150** + VAT

(prices subject to change)

Includes: 64K Business System, Twin Disk Drives, NEC Dot Matrix Printer, O.C.S.C. Financial Accounting/Book-keeping/Incomplete Records, O.C.S.C. Payroll System, Wordstar, Mailmerge & CPM System



## SUPERBRAIN

from  
**£2550** + VAT

(prices subject to change)

Includes: 64K RAM/320 Disks, Epson MX 80 Printer, O.C.S.C. Financial Accounting/Book-keeping/Incomplete Records O.C.S.C. Payroll, Wordstar and Mailmerge.

Other software and peripherals purchased of which prices can be adjusted in the above.

We were established in 1969 as a consultancy and software house, our consultants are well qualified and members of several professional institutes.

We undertake consultancy and contract work at a very reasonable fee and our systems can be tailored to meet your requirements at a nominal fee.

Other micro manufacturers, distributors and dealer enquiries are welcomed.

Also we are looking for distributors abroad and commission agents in the U.K. Please ring for details Watford 48580.

## OVERSEAS COMPUTER SYSTEMS CONSULTANTS

182a QUEENS ROAD, WATFORD, ENGLAND

CALLERS BY APPOINTMENT PLEASE

# SYSTEMS FOR BUSINESS...

As business system specialists we're able to offer a full range of software adapted to low cost hardware, so even the smallest business can benefit from computerisation at a comparable cost — and as you grow so can your computer system.

*Apple II from £1895*

*Apple III from £2900*

*Sharp PC3201 from £2895*

*Commodore 4000 from £1875*

*Commodore 8000 from £2995*

*Systime 500 from £7000*

Choose from our comprehensive software packages including the widely acclaimed FMS Accounting System, financial modelling, payroll, filing systems and asset register; or take advantage of our software expertise with a package tailor-made for your requirements. Full leasing facilities available including software.

## ...COMPUTERS FOR PEOPLE

The same expertise we offer to businesses is also available to our home computer customers. You can select from our range of hardware, accessories, games, books and educational programs — and we'll demonstrate any system before you purchase.

### \* VIC 20 COLOUR COMPUTER

*3½K user memory*

*24 colour variations*

*3 x 3 octave sound voices*

*4 programmable function keys*

PLUS — games cartridges; extra RAM packs: 3K, 8K, 16K; light pen; games paddles; printer; disk drive

### \* SHARP MZ80K COMPUTER

*48K memory*

*3 octave sound range*

*Multiple graphic character set*

INCLUDES — keyboard, screen with 40 characters & 24 lines, and cassette unit with tape counter.

PLUS — printers, disk drives, interface cards and choice of BASIC, FORTH, PASCAL, ASSEMBLER or MACHINE CODE.

**2 year guarantee on most products**

*Ring for current prices!*

**COD SERVICE AVAILABLE —  
ring for details**

**OPEN MONDAY — SATURDAY**

**9.00 am to 5.30 pm**

**RAM  
COMPUTER  
SERVICES LTD**

15-17 North Parade BRADFORD BD1 3JL  
Tel (0274) 391166

INSTANT CREDIT  
UP TO  
£1,000!

In these days of recession and tight monetary controls, many companies look to micros to improve efficiency and profitability. Peter Wood tests **Hornet**, a package designed to appeal to any firm aiming at effective project planning.

ONE APPLICATION of particular interest to manufacturing and building industries, and also to any company involved in project planning, is Precedence Network Analysis. Traditionally available on mainframes, Claremont Controls has brought this application to the Pet.

Hornet is a precedence-network analysis program written for the Commodore 8032 computer, 8050 disc unit and any suitably-interfaced printer, preferably with 132-column print width. Using Hornet, complex sequences of activities can be analysed to determine how much delay, if any, may be tolerated in each activity. This information can help with the assignment of priorities on a project, and lead to better use of resources. An up-to-date record of work completed may be kept, so that future events and activities are simultaneously rescheduled.

The program is available in four levels

Program level	1	2	3	4
Number of activities	256	512	1024	1024
Bar chart	no	yes	yes	yes
Printer width	80	80/132	80/132	80/132
Actual starts/finishes	no	yes	yes	yes
Target starts/finishes	no	no	yes	yes
Real run date	no	no	yes	yes
Shutdowns	no	no	yes	yes
Time-base options	no	no	yes	yes
User-defined sorts	no	no	yes	yes
Resources	no	no	no	yes

Table 1

of sophistication — Hornet 1, 2, 3 and 4 — which differ only in the number of facilities offered — see table 1. It is possible to use Hornet without being familiar with basic precedence-network theory, but understanding the principles involved will probably allow more efficient use of the program and lead to more satisfactory results.

All projects are made up of sequences of distinct activities or tasks, each of which is dependent on other activities. There will, therefore, be a particular sequence in which the various activities must be completed. In figure 1 there are four activities A, B, C and D. Activity C cannot possibly start until A and B have both been completed. It is also dependent on D, which is shorter than the total length of A and B, and can be carried out at the same time as A and B.

The boxes are divided into six compartments. The top-centre indicates the activity reference and the bottom-centre shows the duration of the activity. The

# Hornet takes the critical path to completion

top-left and top-right compartments show the earliest possible start and finish dates, while the bottom-left and bottom-right compartments show the latest allowable start and finish dates. Any activity which has the same early and late start and finish dates cannot be delayed without extending the network completion time. Such activities are termed critical. In figure 1, A, B and C are all critical, but D has a "float" of 2 days.

As well as analysing simple networks, Hornet contains several special facilities to allow large and complicated networks to be analysed. Apart from the normal "end of precedent/start of successor" link — known as link type — used in figure 1, four other link types may be used:

Link type 1 is a "lead link", where the start of a successor is tied to the start of the precedent, usually with a delay period built-in. It

logic. If it is impossible to achieve a target, it will be ignored and reported to the output. Target dates can be used to move individual events within their period of float to optimise available resources, which is particularly powerful when used in conjunction with the resources module in Hornet 4.

Nearly all projects are subject to shutdown periods, such as holidays or temporary suspensions in work. The program allows up to 32 such shutdowns to take care of lost days in calculating start and finish dates and precedence delays. Since not all activities are subject to shutdowns, each activity can be specified as insensitive, as required.

The analysis of a network is initially concerned with the prediction of when each activity must be carried out in order to achieve the required completion date. As the project progresses true start and finish dates become known and may be substituted for the estimated or predicted dates. When these actual dates are entered, all other considerations for the particular activity are overruled, and succeeding activities are calculated from the known date references.

The program provides a "real run date" facility. Whenever the calculation mode is selected, a current or analysis date may be entered and any activities not yet started are automatically delayed until the current date. Activities with both an actual start and finish date are labelled "historic", while activities with only an actual start date are labelled "working". At any stage in the project a report may be produced on past performance, future schedules, and the status of activities which are under way.

## The 40-day week

Activities of zero duration are accepted by Hornet and handled in the same way as normal activities. They may be used as milestones within the network and are useful in defining individual sub-projects within a large network. They may also be used to extend the number of precedents on any one activity beyond the five allowed on the screen display.

The program will run under any of three time scales, called Units, Weeks and Calendar. The Unit scale starts from 1 and runs through to project completion. The scale may be taken as hours, weeks or even years. The Weeks scale offers a weeks/days division, where the number of

may be used where a shared resource is necessary to start each activity, and avoids the need to split the precedent into two activities.

Link types 2 and 3 are "premature start" links, allowing a successor to start before the precedent is complete, so that an activity could start before transfer of a shared resource. These two links are essentially similar, but the delay is measured on the precedent for type 2, and on the successor for type 3.

Link type 4, the "lag" link, specifies that the finish of a precedent must precede the finish of the successor by a specified period.

Often the lead and lag links will be used together to represent a series of activities which follow each other but are in part concurrent.

Frequently the periods during which activities can take place are prescribed by external constraints. The package allows the specification of such conditional start and/or finish dates, known as "target" dates, for individual activities. A target constraint will not override the analysis



days in a week may be defined by the user, up to a maximum of 40 days. The Calendar time scale works on real dates, with a maximum of seven working days in a week; true calendar dates are given on all reports. A clever piece of programming allows the user to switch between any of the time scales at any time without having to re-enter data or re-calculate. It is therefore possible to plan a network on a Weeks timescale, then convert it to real dates when the start date is known.

Three types of report may be generated: Time Analysis, Bar Chart and List of the Activity data. Each type may be printed with the activities arranged in a number of ways, e.g., activities with no float first, or arranged in order of start date, or normal numeric sequence. It is also possible to print a range of activity numbers — 100 to 299, for instance — or to include only those active over a defined period. Any combination of these sort facilities may be used simultaneously.

### Main menu options

Each activity is referenced by a 25-character description as well as an activity number. Within this description, a "search string" may be defined, for selective report printing. This character string may be of any length and positioned anywhere within the description field. Whenever a report is specified it is possible to select activities on a full or partial match with this search string, which could be very useful if a number of individual jobs or orders make up the complete network.

If a simple coding is used, it is possible to select all activities concerned with a particular job, or a summary of all jobs, or individual activities associated with a particular task across all jobs. This may be of specific interest to factory production or office management where several distinct jobs are active at the same time, each at a different stage of development.

Hornet uses the same type of screen display for all data entry. Fields are defined within triangular brackets into which the user may key the data. This type of screen handling, probably originated on the Pet by Anagram Systems, enables simple, fast data entry with a minimum of mistakes.

As usual with Pet-based business software, the program disc is inserted in drive

SSSSSSSSSS	Scheduled activity, non-critical.
CCCCCCCCCC AAAAAAAAAA	Critical activity. Activity with specified actual start and actual finish.
WWWWWWWWWWW	Working activity, which has an actual start date but no actual finish date. Activities are shown as working up to real run date.
XXXXXXXXXXX	Overrunning activity: a critical activity which has actual start but no actual finish, and should have been completed and is therefore delaying project completion.
----- ///////// < >	Float for the activity. Shutdown periods. Target start and finish markers, showing exclusive dates.
DDDDDDDDDD	Dummy activities which may be overwritten by a target finish marker.
*	Real run date, printed on preceding time unit week or period-division marker.

Table 2

zero and the data disc in drive one, and the program is loaded and run with one keystroke. While the program performs its initialisation routines it displays a rather pretty windmill, followed by the standard copyright information. The main menu is then displayed, with nine options:

- Add Activities
- Update Activities
- Delete Activities
- View Activities
- Resource Module Menu — on Hornet 4 only
- Calculate Network
- Print Network Report
- System Status
- Format Network Report

The top line of the screen shows, in reverse video, the job name of the network currently under analysis and the name of the task currently being performed. The bottom line, also in reverse, gives the current status — either what the program is doing or what it expects you to do, together with two reference numbers

showing the number of activities entered into the network and the last activity number that was modified.

The cursor is positioned to the left of the first menu option, and may be moved down the screen by pressing any key. When it is next to the required option, this option is selected by pressing shift-return. This method of selection is consistent throughout the package, and insures against any unintentional selections that would otherwise waste time. Hornet 4 allows the user to interrupt any of the calculation or printing functions by means of the shift key, after which the process may be continued or aborted.

Each full screen of data is entered by the operator field by field, and checked for validity by the system when shift-return is pressed. If any data is incorrect the offending entry is highlighted, and the user is invited to correct it before continuing. If a search string has been defined, then those character positions within the description field are underlined for ease of identification.

Pressing Escape followed by a letter will perform certain special functions — for instance, A for add mode, U for update — which makes for very fast data entry. Both entry of new and updating of existing activities is very straightforward, thanks to the well thought-out screen design and data-entry routines. Deletions are also possible, but are protected against accidental erasure by the requirement to press Escape followed by D before any deletions can take place.

In several places throughout the package, a "progress bar" is displayed. It looks rather like a horizontal thermometer which indicates how far the machine has progressed through a certain procedure, and reassures the user that the computer has not "died" during a long calculation routine.

### Error reports

The Calculate Network or Report Printing options will recalculate the network if the activity data has been updated. The reports follow the format set up by the user with the Format Network Report option. If the network has already been analysed, the user is invited to alter the real run date if required.

The calculations are made up of four distinct parts, each performed automatically. The first stage, Data Checking, works through the activities locating the relevant precedent. Any activities not found generate a detailed error message on the printer and a note on the screen. The second stage finds the order in which the activities are to be calculated and checks for logic errors in the precedence. If a logic loop is detected, a list of all activities that cannot be printed is produced on the printer and a note appears on the screen. The sequence of actual dates is also checked at this stage: if an

*(continued on next page)*

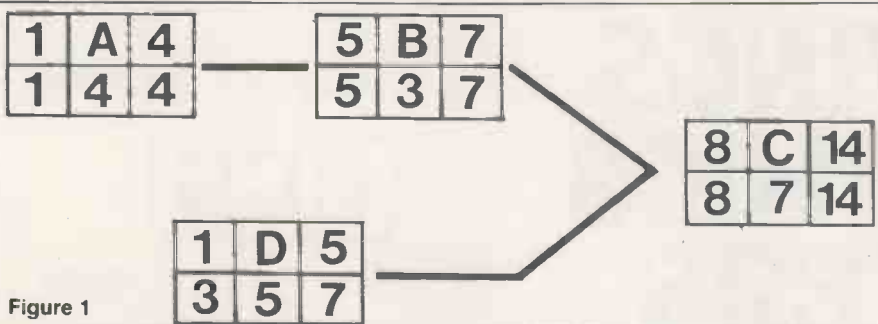

Figure 1

(continued from previous page)

activity has been given an actual date the preceding activities must also have actual dates. Errors are reported on printer and screen.

The analysis proper then begins. It is made up of both a forward and a backward pass, to give both the early and late start and finish dates. Once the forward pass has been completed, the project-completion time is displayed on the screen. When the analysis is complete the results are stored on disc. If report printing has been selected, the reports are then produced.

Formatting of reports is simple, and the user may set up these parameters:

**Printout Title** to be printed in the heading of the report, up to 35 characters long.

**Output required.** The three types of report possible are time analysis, bar chart, and activity data-listings. They are specified for printing by Y for yes or N for no.

**Printout Sequence.** This sets the priority of the sort criteria available — Numeric, State date, Critical and Float — such that the first selection is the main sort criterion. Any activities with equal priority are sorted on the second criterion, and so on.

**Printout Range** allows the user to define a range of activity numbers to be printed from the entire network.

**String Search.** If a string search has been set up in the System Status, then activities may be selected for printing on the basis of a full or partial match within the defined area of the activity description.

**Auto Paging** is a simple yes/no selection for page headings. If auto paging is selected, the reports take care of perforations and reprint the headings on each page, assuming a 66-line page.

The **System Status** option from the main menu permits the user to specify any one of the following system-level parameters:

**Password.** If a password is provided at this stage by the user then the suite cannot be run unless the correct password is entered.

**Printer Width** sets the maximum print width to either 80 or 132 columns.

**Shutdown Periods** allows up to 32 shutdown periods to be defined.

**Timescale** sets the timescale to be used to Units, Weeks or Calendar.

**Week Length.** If either Weeks or Calendar have been selected, this parameter sets the number of working days per week.

**Commencement Date.** If Calendar timescale has been selected this will be entered as the first working day of the project.

**Activity Search String.** This defines the position and length of the search string within the activity description field. When the search string option is used, the program allows "wild card" or "pattern matching" to be used in the same way as the Pet DOS: "?" can be used to represent any individual character, and "\*" may be used to represent the remainder of any string.

The bar chart uses the symbols shown in table 2, with one character representing one period unit. The activity data printout lists all details on network activities. The data printed is :

- Activity number
- Activity description
- Duration
- Non-shutdown status
- Actual dates
- Remaining duration
- Target start
- Scheduled delay
- Preceding activities with link type and delay

## Conclusions

- The program does its job very efficiently and is very easy to use.
- The data-entry routines and screen layouts are excellent.
- Most business users will probably buy the Hornet 3 or Hornet 4 program, as they give the range of facilities required for the majority of applications.
- Hornet 1 and 2 will most likely suit educational users, especially technical colleges, polytechnics and universities.
- A resources module is available but was not reviewed.
- The program was a pleasure to use.
- The manual is well-written and accurate.
- Hornet provides yet another marketplace for the business microcomputer as a cost-effective alternative to larger machines.
- Hornet 3 is priced at £990, Hornet 4 at £1,500, and is available from Commodore Key Dealers. Details from Roy Stephenson at Claremont Controls. Telephone 0669 21081.

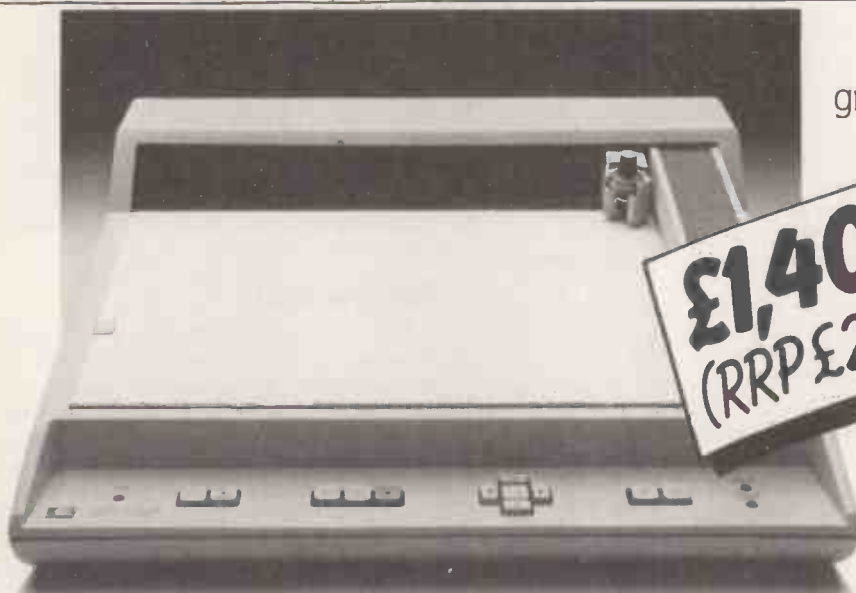

Plot your data — drawings, graphs etc.

Due to overstocking we are able to offer at greatly reduced prices, brand new, boxed, Hewlett Packard A4 Plotters with 1EEE 488 interface.

Compatible with PET Commodore and Hewlett Packard 85 computers — (other models not tested) — these excellent high quality A4 size Plotters offer a range of advanced features at a genuinely reduced price.

Write today for further details.

# BIG SAVINGS ON GRAPHICS PLOTTERS



**Engineering Computer Services Limited,**  
Piccadilly, Tamworth, Staffs. B78 2ER.  
Telephone (0827) 873300.

● Circle No. 148

PRACTICAL COMPUTING April 1982



# PEARCOM

The new, APPLE-II compatible Euro-PAL colour microcomputer now available  
ex stock **£975\***

excl. VAT

#### MAIN FEATURES:

Compact computer with the famous 6502 CPU, APPLE-II compatible, so one can use all the APPLE-II hardware and software without any modification.

Many interesting features give the PEARCOM an enormous technical lead.

Just to name a few:

- 14 I/O expansion slots as standard
- On board expandable to 96 Kbyte of RAM, 32K standard
- 6 ROM/EPROM sockets jumper adjustable.
- Professional reed-switch keyboard with numeric pad
- 7 Function keys
- Built-in HF modulator with HF PAL-colour output
- Sound through TV signal and through built-in loudspeaker
- LED indicators for the main-units
- An industrial type, 5 Amp. power-supply
- Bus compatible with the Applesoft Card and the Z80 Softcard from Microsoft, which comes with CP/M and Microsoft BASIC (optional)



#### PEARCOM Ltd.

Riverside 1a - Stanstead Abbots - Ware, Herts SG12 BAP - UK

#### PEARCOM International Marketing & Publicity Dept.

PO Box 350 - 3720 AH Bilthoven - Tlx 70375 - Holland

#### VERGECOURT Ltd. (Distributor)

17 Nobel Square - Basildon - Essex SS13 1LP England - Tel. 0268-728484 - Tlx 995323

DEALER INQUIRES INVITED

\*Apple-II - Trademark of  
Apple Computer Inc. USA.

#### PEARCOM

Int. Marketing & Publicity

P.O. Box 350

3720 AH Bilthoven

● Circle No. 149

# SEEING IS BELIEVING

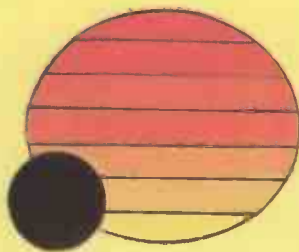
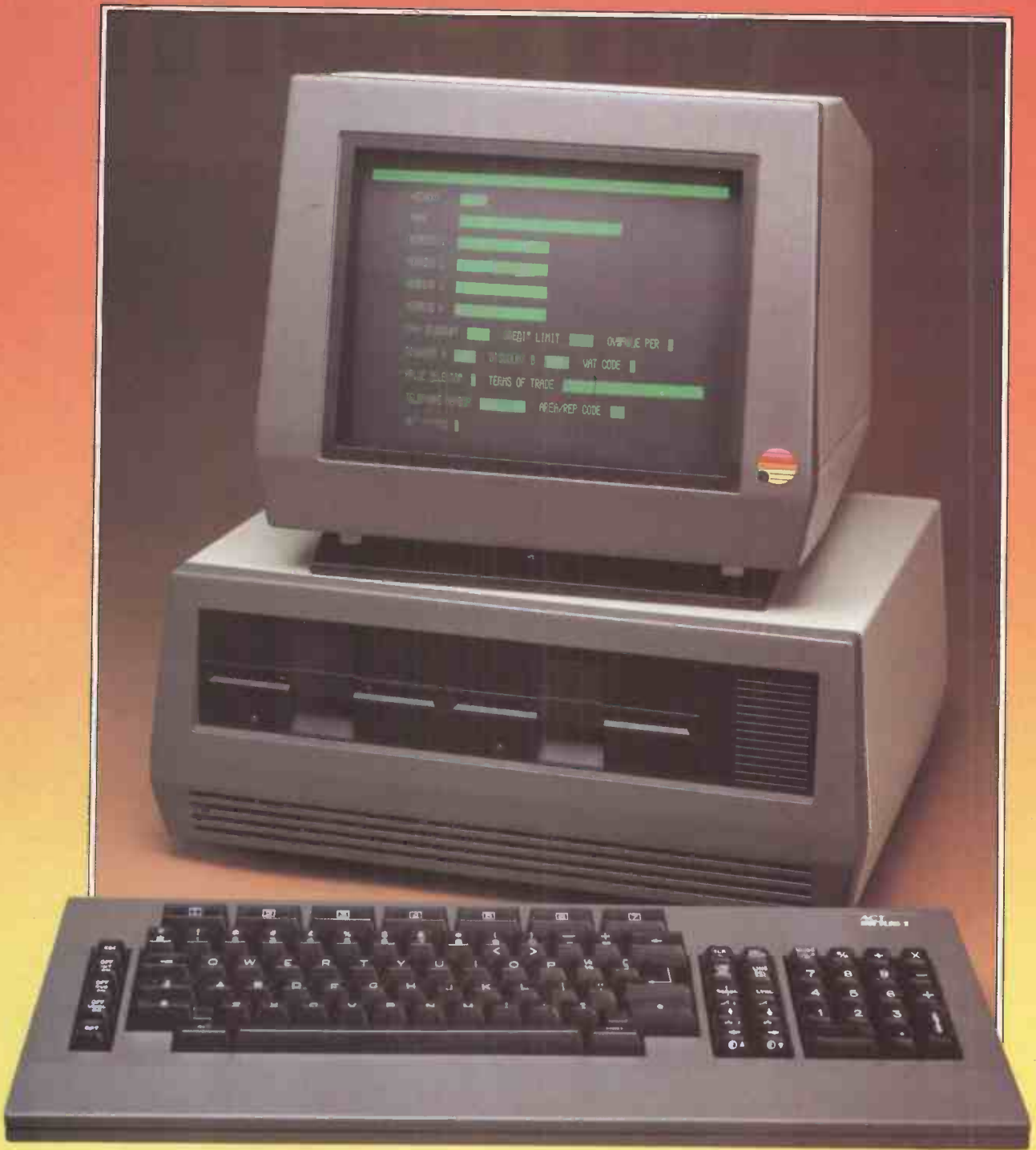

## ACT SIRIUS 1



# NEW ACT SIRIUS 1

## Minicomputer Performance. Personal Computer Price.

### 16 bit processor: £2,395

**The best price/performance ratio you've ever seen on a personal computer.**

	ACT Sirius 1	Typical Personal Computers	Typical Business Systems
Memory	128K-1024K	32K-64K	48K-256K
Disk Capacity	1.2Mb-10 Mb	140K-1Mb	1.2Mb-10 Mb
Processor	16 bit	8 bit	8 bit
Operating Systems	CP/M-86, MSDOS	CP/M or Machine Specific	Usually Machine Specific
Languages	Microsoft BASIC Compiled BASIC COBOL PASCAL FORTRAN	Microsoft BASIC perhaps one or two others, eg PASCAL	BASIC and perhaps one or two others
Price	£2395	£1800-£3000	£4500-£8500

ACT Sirius 1 is a new generation personal computer. Quite simply, it has no competition at the price.

It's the first personal computer developed from the outset for business and professional use.

It's launched with more software than anything before it.

It's supported and distributed solely by ACT — the biggest name in personal computer software.

And it's developed by Chuck Peddle, formerly of Commodore and generally regarded as the father of personal computing.

## SOFTWARE SPELLS SUCCESS

ACT Sirius 1 has more software than any other new personal computer:

A choice of two operating systems — CP/M-86 or MSDOS, from Microsoft.

## For Software Houses

The ACT Sirius 1 has a language for you. Microsoft BASIC 80, two BASIC Compilers, two COBOLS, PASCAL and FORTRAN.

## For Applications

Wordstar, Mailmerge, Pulsar, SuperCalc and MicroModeller — all the best sellers.

And the ACT Sirius 1 can run any software written for CP/M — that means hundreds of specialised packages.

## THE BODY IN QUESTION

Ergonomics play a vital part in the design of ACT's Sirius 1.

The screen tilts and swivels to suit the user and glare is eliminated.

The display is razor sharp; and the brilliance and contrast can be adjusted using keys on the low-profile detachable keyboard.

## STAYING OUT IN FRONT

The ACT Sirius 1 is designed to keep you out in front. Winchester, networks, multi-user facilities and colour graphics are all scheduled during the next twelve months. And all at the same record-breaking price levels of the ACT Sirius 1.

## SEEING IS BELIEVING

The ACT Sirius 1 goes through the most exhaustive quality control process of any microcomputer — including the much vaunted Japanese products.

ACT Sirius 1 has been successfully operating in testing field trials for over 6 months already. And now it's at your nearest ACT Dealer — ready to revolutionise your ideas on personal computers.

Clip the coupon for literature. Better still, call David Low now on the hot line 021-454 8585, get the name of your nearest dealer and see a demonstration as soon as you can — because seeing is believing.

To: ACT (Microsoft) Ltd, FREEPOST,  
Birmingham B16 8BR.

Please send a brochure and name of my nearest dealer

I am interested in dealership — send the dealer pack and ask your sales director to contact me.

Name \_\_\_\_\_

Position \_\_\_\_\_

Company \_\_\_\_\_

Address \_\_\_\_\_

Telephone \_\_\_\_\_

**ACT No.1 in Total Computing.**

● Circle No. 150

PC 4

67

**Cash price**  
 ONLY £595 + VAT  
 BEAT THAT FOR VALUE

# The DAI Personal Computer is for

**\*High Performance\***  
**\*High Value\***

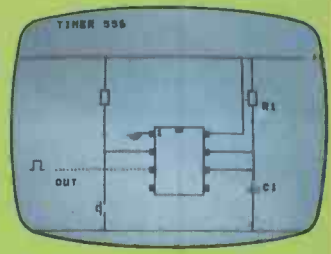
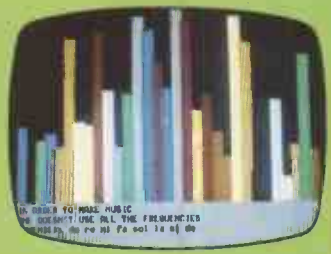
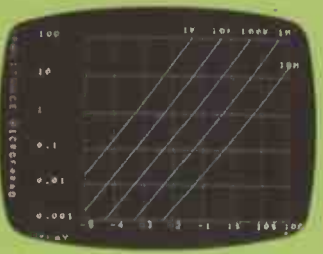
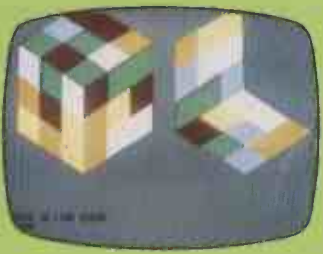

## Standard Features

- \* 24k Resident High-Speed Basic
- \* 16 Colour High-Resolution Graphics (255 x 335)
- \* Scrolling Screen Editor
- \* Sound Commands for Music Generation
- \* Very High Speed Hardware Maths Option
- \* Resident Monitor for Machine Language Programming
- \* 3 Programmable Parallel Ports
- \* Standard TV Interface via Aerial Socket
- \* RS232 Serial Port and Dual Cassette Interfaces

Manufactured by:

# DAI

THE  
 MICROCOMPUTER  
 ENGINEERING  
 COMPANY  
 Brussels, Belgium.

Available from:

## Data Applications (UK) Ltd.

Personal Computer Division  
 16b Dyer Street  
 Cirencester  
 Gloucestershire  
 GL7 2PF  
 Tel: Cirencester  
 (0285) 61902

For further information please complete and post to:  
 Data Applications (UK) Ltd, 16b Dyer Street, Cirencester, Glos GL7 2PF

NAME \_\_\_\_\_

ADDRESS \_\_\_\_\_

MY INTEREST IS: \_\_\_\_\_

● Circle No. 151



# ...Three star printers

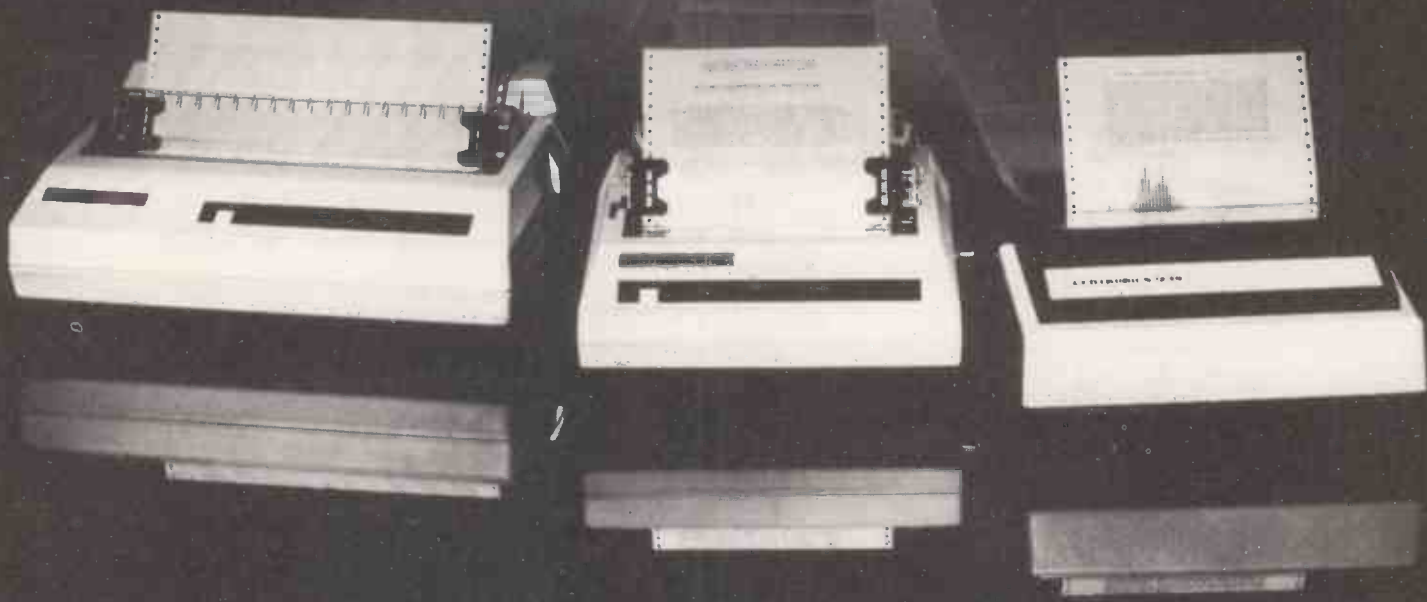

## 152 NEW

**Economical general purpose printer**

- 132 column, 150 cps at 10 cpi
- bi-directional, logic seeking
- quick change cartridge ribbon
- fan-fold, cut sheet paper
- adjustable tractors
- 100% duty cycle
- rugged, versatile, dependable

**FANTASTIC VALUE  
AT UNDER £700**

## 150 NEW

**Ideal microcomputer printer**

- 80 column, 150 cps at 10 cpi
- bi-directional, logic seeking
- quick change cartridge ribbon
- roll, cut sheet, fan-fold paper
- snap-on tractors
- 100% duty cycle
- rugged, versatile, dependable

**FULL PROFESSIONAL  
SPECIFICATION  
FOR UNDER £500**

## 739 NEW

**Versatile, compact printer**

- correspondence quality print
- proportional and fixed spacing
- true descenders, subscripts and superscripts
- pin addressable graphics
- roll, cut sheet and fan-fold paper
- 100% duty cycle
- compact and quiet

**ALL THE FEATURES  
YOU NEED  
FOR AROUND £500**

## ...with a five star bonus

★Performance. ★Reliability. ★Versatility. ★Service. ★Economy.

Your Centronics Qualified Retailer

**AVON**  
Descent Business Machines  
Descent House, Thomas Lane, Bristol Tel: 0272 294591  
C.B. & Computer Group  
25, 18 Melton Street, Weston Super Mare Tel: 0834 41724  
Target Electronics  
6, Cherry Lane, Bristol Tel: 0272 47916  
Bristol Computing Centre  
51, Moulton Hill, Bristol Tel: 0272 23430  
Milesdale  
44, Cam Street, Bristol Tel: 0272 276767

**BED-FORDSHIRE**  
Centronics Computer Services  
98, Tavistock Street, Bedford Tel: 0234 216749

**BIRMINGHAM**  
Biers General  
8, The Birchwood, Little Heath Road, Leamington, Reading Tel: 0734 25276  
Sough, Midway  
120, High Street, Slough Tel: 0753 27895

**BUCKINGHAMSHIRE**  
Interface Components  
Cotton Corner, Tettersham Road, Amersham Tel: 0290 22807

**CAMBRIDGE**  
Cambridge Computer South  
1, Cambridge Road, Cambridge Tel: 0223 85338  
System Computer Services  
173, Millbrook Road, Southampton Tel: 0703 38864

**CHANNEL ISLANDS**  
Channel Island Computer  
Computations  
The Mount, 15, Queen Elizabeth, St Peter Port, Guernsey, Tel: (088) 20155  
Channel Limited  
44, Esplanade, St Helier, Jersey Tel: 023 71914

**DEVON**  
C.B. & Computer Group  
South Devon House, Newton Abbot Tel: 0826 62101  
AC Systems  
53, Magdalen Road, Exeter Tel: 0392 71718

**DORSETSHIRE**  
Comcast  
7, Porton Close, Two Dairs, Ware, Tel: 0246 28996

**DORSET**  
South Coast Business Machines  
South Coast House, Wimborne Road, Fernham Tel: 0209 89180

**ESSEX**  
The Computerist  
621, London Road, West Wick, Essex Tel: 0702 335298  
Aurthur  
57, High Street, Inghamston Tel: 07775 4022  
Curren Computer Services Ltd  
West Hendon Industrial Park, West Hendon Tel: 0277 81133  
GLOUCESTERSHIRE  
Screen Scenes  
114, St Georges Road, Cheltenham Tel: 0242 28979

**GREAT MANCHESTER**  
The Brite Shop  
11, Colmore House, Piccadilly, Manchester Tel: 061 236 4737  
Ectrovision  
680, Burnley Lane, Burnage, Manchester Tel: 061 432 4945  
Executive Reproduction  
27, Dwyer Street, Manchester Tel: 061 226 1637

**HANTS**  
Great Business Services Ltd  
West Gate Road, Southampton Tel: 0703 39061  
HSV Ltd  
22, Southampton Road, Southampton Tel: 0703 331422  
Pulsed Computer Services  
75, 1, Deer Road, Fareham Tel: 0253 4 21892  
System Computer Services  
173, Millbrook Road, Southampton Tel: 0703 38864

**HERTS**  
Digital Services Ltd  
13, London Road, Southborough, Luton, Beds Tel: 0892 37877  
D.J. Hermet  
42, Gurney Road, Turpin, Luton Tel: 0897 22442  
Practical Computer Products  
114, Wilmore Road, Brimsley, Beds Tel: 01 400 2540  
Telecomputing Ltd  
Turberville Road, Tel: 0892 883105  
The Computer Room  
87, High Street, Luton, Beds Tel: 0132 359962  
Micro Systems Group  
9, Church Street, Wotton, Oxon Tel: 0345 63071

**HERTS**  
Digital Services  
89, Ramsey Street, Hemel Hempstead Tel: 0992 57425  
Data & Process Ltd  
Mareux Road, Marlow, Bucks Tel: 0492 51137  
Computer  
14, Sutter Road, New Barnet Tel: 01 441 2922  
Bromley Data Services  
25, Park Street, Old High Road, 9, SAT Tel: 0702 60980  
Local Business Technology  
Hornsey House, 67, High Road, Hornsey, Bournemouth EN10 8DU  
Tel: 0932 88137  
Roadside Link Ltd  
24, Market Square, Sharnage, SG1 1EG Tel: 0438 70668  
Ramsay Medical Ltd  
51, St Andrews Street, Hertford Tel: 0992 58211  
Hertfordshire Ltd  
276, Bechtelton Lane, Bechtelton, Bedford, Bedfordshire Tel: 0278 813059

**KENT**  
Digital Services Ltd  
13, London Road, Southborough, Luton, Beds Tel: 0892 37877  
D.J. Hermet  
42, Gurney Road, Turpin, Luton Tel: 0897 22442  
Practical Computer Products  
114, Wilmore Road, Brimsley, Beds Tel: 01 400 2540  
Telecomputing Ltd  
Turberville Road, Tel: 0892 883105  
The Computer Room  
87, High Street, Luton, Beds Tel: 0132 359962  
Micro Systems Group  
9, Church Street, Wotton, Oxon Tel: 0345 63071

**LONDON**  
Informatics Ltd  
8, 12, Lee High Road, SE1 7LQ Tel: 01 314 4213  
The Service Store  
77, High Holborn, Tel: 01 405 5699  
88, Finsbury, Tel: 01 529 2046  
110, Moorgate, Tel: 01 588 1531  
Lark Ltd  
170, 132, London Road, EC2 Tel: 01 729 4555  
Tramway Components Ltd  
68, Throgmole Road, WC1 Tel: 01 405 5240  
Hobby's Radio (Dickens) Ltd  
404, Abchurch Lane, EC4 Tel: 01 773 1109  
Hawthornes  
275, White Horse Road, W6 Tel: 01 348 3275  
277, Tottenham Court Road, W1P Tel: 01 580 7383  
8 & B Computers  
107, Hove Road, Queensbury, Harrow Tel: 01 204 7425  
Mareux Data  
Old Street, London EC1 Tel: 01 739 5889  
The Data Shop  
124, Euston Road, W1 Tel: 01 887 0905  
Signet Ltd  
101, 18, Bedford Street, WC2 Tel: 01 378 6968  
Lapp Ltd  
23, Finsbury Street, SMI Tel: 01 222 1122  
Lansare Reference  
Churchill Chambers, 42, Gower Lane, E16 Tel: 01 989 3799

**Office Installation Ltd**  
111, The Mall, Ealing, W5, Tel: 01 578 6771  
Personal Computers Ltd  
194, 200, Euston Road, ECW 4NH Tel: 01 626 6121

**LANCASHIRE**  
Fable Microcomputers  
104, St. Andrew's House, Woodland Green, Blackburn, BB3 9E1  
Tel: 0251 301306

**MERSEY**  
Rack-Lite Brothers Ltd  
Long Lane, Anfield, Liverpool Tel: 051 521 5830

**MIDDLESEX**  
Independent Computer  
Engineering  
10, 111, Euston Road, Bedford Tel: 07842 47171  
De Vics Computers  
65, High Street, Epsom Tel: 01 952 0326  
Or-Mate Products  
Century House, Haydock Road, Southport  
Tel: 0507 64764

**NOTTINGHAMSHIRE**  
The Brite Shop  
624, Upper Parliament Street, Nottingham Tel: 0602 40576  
MICRO AGE LTD  
53, Action Road, Long Eaton Tel: 06076 64764

**SURREY**  
Apex Computers  
171, Church Street, Molding Tel: 04862 22861  
Computerisation (SRL) Ltd  
21, Church Street, Ringway Tel: 07372 22284

**Fairglen Computer Services**  
4, Wyndham Road, West Byfleet, Surrey Tel: 03123 45380  
T & V Johnson  
Aurthur House, Park Street, Exeter Tel: 0276 20446  
North Amber Ltd  
Central Oak House, Albany Close, Exeter Tel: 0372 60711  
Quaker Systems  
41, Exeter Road, Sutton Tel: 01 841 6279  
Pulsed Micro  
32, Chertsey Road, Brackley Tel: 04862 67901  
Surrey Electronics  
80, Manor Road, Wokingham Tel: 01 589 9483  
Ectrovision Ltd  
29, St James Road, Epsom, Surrey Tel: 0784 3601

**SUSSEX**  
Robert Harding Ltd  
63, 1, London Road, Brighton Tel: 0273 68844  
Guesnet Ltd  
45, Grand Parade, Brighton Tel: 0273 699764  
Apex Computing Services  
5, Kings Road, Worthing Tel: 0903 35411

**WARWICKSHIRE**  
Business & Leisure Services  
16, The Square, Kenilworth Tel: 0926 512127

**WEST MICHIGAN**  
Lapport  
700, Centre Road, Birmingham Tel: 021 350 5272  
Mere Associates  
47, 1, Leam Road, Acocks Tel: 021 328 4774  
Westwood Computers  
117, 118, Sennel Street, Farnham, Birmingham Tel: 021 632 5824

**WILTSHIRE**  
Cable  
20, Wyke Road, Mangrove Tel: 0423 91275  
Huddersfield Computer Centre  
1, Cross Church Street, Huddersfield HD1 3PT Tel: 0484 20716  
Hullam Computers  
11, Hinton, Ipswich, East Angles Road, Shaftesbury Tel: 0423 661275  
MCC Computer Ltd  
PO Box 51, Patten Bridge, Mangrove Tel: 0423 711878  
The Data Shop  
4, Westgate, Wymondley Tel: 0317 63744

**SCOTLAND**  
Scotcrete Computers Ltd  
The House, 226, Queen's Road, Edinburgh EH4 2UD  
Tel: 031 3631225

# CENTRONICS

Your partner in print.

Centronics Data Computer (UK) Ltd., Victoria Way, Burgess Hill, Sussex RH15 9NU Telephone 04446-45011 Telex: 877801

Computer-aided design techniques are already well established as tools for  
Computer methods are now poised to move out of the drawing office to take

# This CAD has plans for factories of the future

THERE IS MORE to computer-aided design than meets the eye. This dynamic, fastest-growing sector of the computer industry heralds a total change for the industrial world. Senior management in every company that manufactures something had better take notice of CAD: to ignore it will be akin to having ignored the Industrial Revolution of the last century.

CAD is not simply an aid in the relatively simple task of producing an engineering or architectural drawing. It is an electronic medium in its own right which is fast, intelligent and interactive. Blueprints — diagrams on paper — are a medium which belongs to an earlier age.

## Uncomfortable transition

For the moment, we are stuck in the uncomfortable period of transition. Manufacturers are still geared to basing their product on familiar and reassuring "working diagrams". They lie around the office or factory, constant and visible proof that work is in progress.

Even when the new oil refinery is on stream or when that neat little extension to the clubhouse is completed, then the builder makes yet another set of drawings — what the Americans call "as-builts" — to act as a guide for repairs and maintenance. Drawings have been around in one form or another for 20,000 years, but now, suddenly, they are not at all essential.

CAD systems must be able to handle all the relevant design information.



The most far-sighted people in the computer-graphics industry are aware that the present craze for hard-copy devices — printers and plotters — is but a passing phase along the road to total automation. The destination is the completely integrated factory in which the process of design and manufacturing is a single task. Karl Marx and his concept of the division of labour — an accurate analysis in its time — will be finally discredited as computers and robots team up to create all the necessary products of the future.

This vision is not mere science fiction. In the United States they already have a

by John Lewell

name and an acronym for it: computer-integrated manufacturing or CIM. It is the next step beyond CAD/CAM — computer-aided design and manufacturing. Just as we are getting used to the idea of CAD/CAM, at least to the extent of understanding what the initials stand for, along comes CIM. You can be sure that it

is coming because it is market forces which provide the motivation for the change.

The keys to economic survival are efficiency, competitiveness and productivity. The world's population is expected to double and treble before it finally stabilises, and the emphasis will be placed on the most efficient uses of energy and materials. Our present use of resources is so wasteful because industry is not organised on a rational basis. Under the influence of those same market forces it has evolved like a Gothic cathedral, each generation tacking on its own contribution.

Now the time has arrived when industry has to increase its efficiency and productivity. It can do it only by the complete integration of computers into the industrial process. Piecemeal computerisation will not work in the long run. If you streamline one part of the operation, then you tend to create a bottleneck somewhere else. To get rid of the bottleneck you have to use a computer.

Everyone who has used a computer for even a simple task realises the importance of understanding the process which is being computerised. When a system has been analysed rationally, you may find that you do not need a computer at all. Yet no individual can keep in mind every one of the millions of operations that go on in a factory and so the best, simplest, the most rational manufacturing solution can never be achieved. What is needed is integration, and this will be the keyword to the future.

## Agent provocateur

Why is CAD proving to be the *agent provocateur* in this leap towards the future? After all, industry has been using computers for years. So far, word processing, payroll accounting and even numerical control have not provoked a total rethink of how to run an entire manufacturing process.

The reason is simply that design is an "upstream" operation, whereas those parts of a business which are often the first to be computer-assisted are mainly "downstream" operations. Word processing is downstream of management



## design engineers, yet they are still far from having reached their full potential. charge of the average factory's entire design and manufacturing process.

instructions. Invoicing is done after you have made and delivered the product. Payroll is the most downstream operation of all: everyone is paid in arrears. But this downstream computerisation does not have a knock-on effect. It does not necessarily force us to make other changes. CAD, by contrast, does.

Frank Lloyd Wright was one of America's greatest architects, yet some of his greatest buildings were designed on the back of an envelope. He and his

sophisticated, so the number of visual representations increases. For instance, with a model of the human body a display might one day be able to show the skeleton, or perhaps the nervous system, or the blood circulation, or the familiar skin-covered figure itself. More easily displayed with current technologies are engineering designs which involve structural, electrical, piping or instrumentation models. All these models are related to each other. You cannot change

pen you can magnify, rotate or move the image — or any part of it — and make additions and improvements. Using the keyboard you can type in facts and figures, descriptions and dimensions. You can ask the system to automatically retrieve the previous drawings, and there is always an instant library of symbols at your command, ready to be pasted into any position on the screen.

Even when it is being used as a high-class drafting aid or as an expensive "ideas pad" the average CAD system is an effective and impressive tool. Shortly after it is installed, senior company men will murmur approvingly about high productivity ratios — that is to say: how much more work is being done as a result of using the new toy. It is not unusual to find that the work is completed in a fraction of the time. A piping diagram may have a 2:1 ratio, a mechanical diagram 4:1, an instrument diagram 5:1, and others may be even higher.

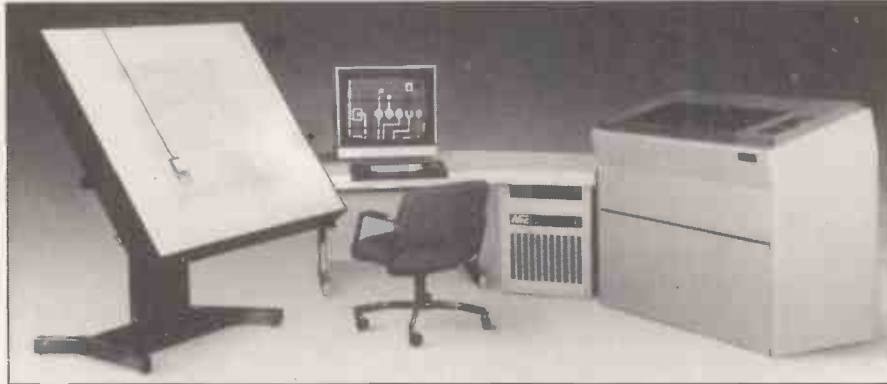

A typical stand-alone system is based on a minicomputer with VDU and plotter.

assistants would fill in the details later on, in the conventional way. The design took shape in Frank Lloyd Wright's head. It was a synthesis of experience, of knowledge of materials, of the environment and of architectural forms. More than that, it also contained the vital element of originality. A Frank Lloyd Wright building had all the elements of good design.

Being an exceptional sort of man, Wright did not spend much time developing his concepts diagrammatically. The model was in his head. The secret of design is in conceiving the model, and not at all in making a representation of the model on, for instance, a piece of paper.

The essence of CAD is in the creation of the model. If computers are going to be really useful in assisting us with designs then they have to assume the role of Frank Lloyd Wright's head.

The computer has to contain the model. Where else could you put it? On paper? That would be far too complex. In our own heads? We are not all Frank Lloyd Wright, and the design capability of even his brain would not be sufficient for a high-technology product, such as a car or a space shuttle. The machine has to be programmed with all the relevant information about the properties of materials, about the environment in which a product will be used, with appropriate marketing information — not to mention a whole library of existing designs.

Graphics are one of the windows into the model. They are a communications link which provides a visual representation of it. As graphics displays become more

one without changing the others. The great advantage of CAD is that the computer can be programmed to make many of the changes automatically, and to warn you if something is not possible. The truth of my opening statement should now be apparent. There is, literally, more to CAD than meets the eye.

### Graphics displays

Nevertheless, for the time being, CAD is mainly concerned with producing diagrams. Early graphics displays could show only the outlines of objects, conveniently echoing the tradition of engineering drawings. This does not necessarily mean that vector displays, or even drawings themselves, will be with us forever. In the last two years, raster displays have made great strides, bringing with them all the benefits of full colour and fully-shaded surfaces. They point us in a new direction: the computer model itself need not be related to "wire-frame" drawings at all.

Much of what passes for computer-aided design would be better described as computer-aided drafting. By the time the operator sits down at the terminal most of the work has already been done. A decision has been made to build a particular product, the shape and function of which is largely known. The CAD system is used to tidy up the details, put in all the symbols, put lettering in the right places, and then to print out sets of isometric and orthographic drawings.

Operators can, of course, refine and modify the designs. With a stroke of the

### The bottleneck

What used to take a week to design on paper may take only a couple of hours with a little help from your friendly computer. Suddenly, the rest of the manufacturing process seems to be abysmally lethargic. The whole factory has become one long bottleneck. At this point, CAD has to be extended to CAD/CAM. A design is created with computer assistance, then the computer automatically instructs the machine-tools to start turning out the new product.

Those companies that have already made a heavy investment in CAD/CAM are beginning to reap the rewards: indeed, many of them could not survive without it. In the United States particularly, there is such a shortage of fully-trained design staff that it would be impossible to handle a large defence contract without CAD. Automated manufacturing carries the process one stage further as components are produced with only a fraction of the highly-paid workforce which was previously needed. The time between design and production shrinks dramatically, while last-minute changes can be made without escalating cost.

### Best answer

CAD/CAM is seen in the United States as being the best answer to the Japanese lead in manufacturing techniques. At present still in its early stages, CAD/CAM usually means that the computer design station has been linked up to some numerical-control machinery. The machine-tools are placed under the control of punched tape which comes directly from the designers. Though this is a leap

*(continued on next page)*

(continued from previous page)

forward, it is still a long way from the goal of CIM, where all the operations of the factory are plugged into a common database.

CAD/CAM not only provides increased productivity, there is often an outstanding increase in product quality as well. Machine-tool paths are generated more quickly and more accurately. The numerical-control programmer no longer has the task of making hundreds of error-prone calculations in specifying tool path motions, and is provided with a visual feedback guide at each stage.

### Product testing

Other benefits include the ability to test a product before it has been manufactured. CAD deals with a model rather than an image, and models can simulate processes. This is particularly useful when physical tests might be dangerous or impractical. Much has been learned from flight-simulation techniques — which are now so advanced that in some countries an airline pilot can theoretically qualify for a licence without setting foot in a real plane. Trucks and cars can be tested in simulated bad weather conditions while many design variants are tried out in order to find the best solution.

Introducing CAD into a company usually implies a long-term commitment to CAD/CAM. A good example is the Hughes Tool company which manufactures equipment for the drilling industry. CAD has already helped to give Hughes Tool a competitive edge by halving the time needed to design a new product. A single designer, using a CAD system, can now produce a design for a new rock-drilling bit in under two weeks. It is an industry in which speed is essential, because drilling bits are often custom-made to cope with a specific problem which a drilling team has just encountered on site. Work is held up until the new bit arrives. Using an Applicon special-purpose graphics computer, Hughes Tool's designers in Houston, Texas maintained their lead in the market. Once the CAD system was working successfully the company was able to extend the program to include design analysis and structural analysis — the next steps along the road to CIM.

### First steps

A company's first step in CAD might be to use a service bureau to produce some of the routine drawings. Royal Graphics of San Francisco and Houston is one such bureau, and has grown dramatically since introducing computer graphics in 1970. Most of its clients are architects. Using a Calma system, with standard software and specially-written subroutines, Royal Graphics produces more than 1,000 drawings a month.

Over the years a vast library of symbols

has been created which can be slotted into the design. Architects can be provided with data such as the gross area or the gross volume of a building. Instant tile-count or brick-count can also save the client time and effort. With an 80 percent annual growth rate — and no CAD sales force — Royal Graphics proves that the bureau service is in demand.

After using a bureau and becoming familiar with the new techniques, a company may want to buy a CAD system to use in-house. The simplest approach is to buy a turnkey system from a manufacturer such as Computervision, Calma, Auto-trol, Applicon or Summagraphics. These companies, and others like them, will specify and deliver a complete, packaged system to meet your needs. Full training for the operators is supplied along with the equipment and software; no previous experience of computers is necessary.

A typical CAD system is modular, allowing you to add to it as your needs change. A stand-alone system would include a minicomputer and mass storage with its system software. The work station consists of a digitiser, a graphics tablet, a function keyboard, an alphanumeric keyboard, and a VDU. An appropriate hard-copy device such as a flatbed plotter will be linked to the system. Larger systems may have extra output devices such as a film recorder or an electrostatic plotter. Several additional work stations can often be supported by one central-processing facility. Individual users can create their own design databases on a single system while each person works on a different project.

### Interesting art-form

The design of CAD work stations is an interesting art-form in itself. Operators have to spend many hours at a time at the work stations and it is very important that it should be as comfortable as possible. Once they have tried it, most designers prefer using a computer to working with passive instruments. The constant interaction usually increases concentration.

There has been a steady stream of innovations in work-station design. For example, Calma Corporation was the first manufacturer to introduce a voice-control unit. The operator wears a headset with a lightweight microphone attachment, which provides up to 50 functions under voice control. These can include commands such as Zoom, Pan, Multiple View, or Composite Image — all achieved without a keyboard, pen or menu. Calma claims a 99.8 percent accuracy rate for the input commands, and the technique reduces eye movements and achieves a faster operational speed.

Another graphics company, Genisco, has produced a three-dimensional display called Spacegraph. On this system you

can actually see the model suspended in space, so that it looks like a real object rather than an image; for this three-dimensional effect you do not even have to wear special spectacles.

Once it has been decided to use CAD, one of the first questions to ask is whether you need a customised system or a general-purpose system. The fastest-growing segment of the CAD industry is in providing general-purpose systems, though purpose-built systems may still be the best buy for some users, particularly for firms with printed-circuit designers on the staff.

Building your own CAD system to cope with exacting specialised work — such as printed-circuit board design — can give you an increased throughput of work. Britain has many small system houses which could design a purpose-built CAD system.

### Industry boom

Outside consultants can frequently be helpful. In the computer-graphics world there are two sorts of consultant: generalists and specialists. A good generalist who knows the industry can save a client a considerable sum of money. New products come on to the market almost daily — this is a booming industry. Your consultant should establish a broad picture of what you are trying to achieve, and point you towards specialists or to appropriate manufacturers. Since CAD demonstrations tend to be somewhat lengthy, and manufacturers are scattered round the country, "shopping around" can be time-consuming and expensive.

A complete, self-contained turnkey system for professional designers costs between £20,000 and £500,000 and there are some signs that the minimum price will come down this year. In 1981, Ramtek, the market leader in raster displays, launched a desk-top terminal in the U.S. at just under \$6,000.

### The micro future

It will be a few years before micro-computers have the speed and memory capacity to cope with the millions of calculations needed in a useful graphics display. Personal computers can produce interesting and colourful presentation graphics, but they are not yet serious contenders in the professional design market. They are, however, ideal training tools, since many of the techniques used in the larger systems can be performed by a micro — but without the speed and resolution which are necessary in most design tasks.

Computer-aided design is not a panacea for all the problems of ailing manufacturing industries. What the planned introduction of CAD can do is to help many engineering and architectural firms to increase their productivity and reduce their costs. All companies in these areas should at least take a look at CAD and evaluate its usefulness. □



# Beelines give your VIC

## a 40 column display with 32K of extra RAM as well!



12 months  
parts and  
labour  
guarantee.

The Colour Writer VIC Expansion gives you the most cost effective way of expanding your VIC to 35K AND we give you the added bonus of a 40 Column display free of charge. Now you can have the luxury of a 32K Pet AND Colour to enhance your programs. The Colour screen consists of 960 characters in a 40 column by 24 row layout (to Viewdata standard) with the 25th line for status information. The programmable features include 7 foreground and background colours, flashing, double height characters, block graphics and any combination you care to name; and not content with a 35K VIC, we give you an extra motherboard slot for further expansion.

<b>PRICE:</b>	<b>Nett</b>	<b>VAT</b>	<b>TOTAL</b>
	<b>£220.00</b>	<b>£ 33.00</b>	<b>£253.00</b>



**BEELINES (Bolton) LTD**  
**FREEPOST (No stamp required)**  
**Bolton BL3 6YZ**  
**Telephone (0204) 382741 & 384599**

24 hour answer phone: 0204 385299  
 Reg. office: 124 Newport St., Bolton BL3 6AB.  
 Dealer enquiries welcome.

Please send me:

Qty.	Item	Price
	Beelines VIC 35K + 40 Column Expansion Unit @ £220 + £33 VAT	

I enclose cheque/P.O.

OR Please debit my:

Access 5224

Barclaycard 4929

Expiry Date \_\_\_\_\_

Name \_\_\_\_\_

Address \_\_\_\_\_

Code \_\_\_\_\_

Tel. (day) \_\_\_\_\_

Official orders welcome – we will ship to approved account holders on receipt of firm order.

Delivery free within mainland UK  
 Access and Barclaycard welcome.

Telephone answering machine for 24hr/7 day  
 credit card orders 0204 385299

Freepost: Beelines, FREEPOST,  
 Bolton BL3 6YZ

PC 4/82



● Circle No. 153

# The *if* 800 - Colour

## FEATURES

- Powerful Z-80A 4MHz Processor
- Memory 64K - 256K
- High Resolution Multi-Colour Graphics CRT
- CP/M\*
- Versatile, 'Easy-to-Use' BASIC
- Twin set of Programmable Function Keys
- Integral 80 cps Printer
- 400K x 2 Floppy disks

## OPTIONS

- 8 inch Floppy Disk Unit
- 10 mb Winchester Drive
- I/O Expander Unit
- 132 Column Printer
- Paper Tape Reader & Punch
- 5 inch Floppy Disk Unit
- XY Plotter
- Digitizer
- Light Pen
- ROM Cartridge

## INTERFACES

- RS-232C
- Centronics Parallel Interface
- IEEE-488 Instrumentation Interface
- Analogue-Digital and Digital-Analogue converters

## SOFTWARE

- Extensive range of business application software to meet all requirements.



**KGB Micros Ltd** 14 Windsor Road, Slough,  
Berks. SL1 1EL. Tel: Slough 38581/38310  
**Encotel Systems Ltd** 530-539 Purley Way,  
Croydon, Surrey. Tel: 01-686 9687



# in your Computing

The if 800 brings a new and colourful dimension to business and personal computing. Now you can enjoy and benefit from extensive multi-coloured graphics and a CP/M\* environment on the same compact system.

Built around a CPU using the high speed Z-80A processor, the if 800 combines

keyboard, hard-copy 5 x 7 dot 80 cps printer, twin 400K 5 inch floppy disk drives, high resolution colour display, and every type of interface into one complete unit.

Just look at some of the fantastic features, facilities, and options offered on the if 800 .....a truly versatile and fully integrated computer system

that more than meets the demands and varied applications in today's world of business information processing.

To discover the exciting new horizons of if 800 Multicolour Graphics computing, complete the coupon below or telephone us or our Distributors.

\* CP/M is a registered trade mark of Digital Research

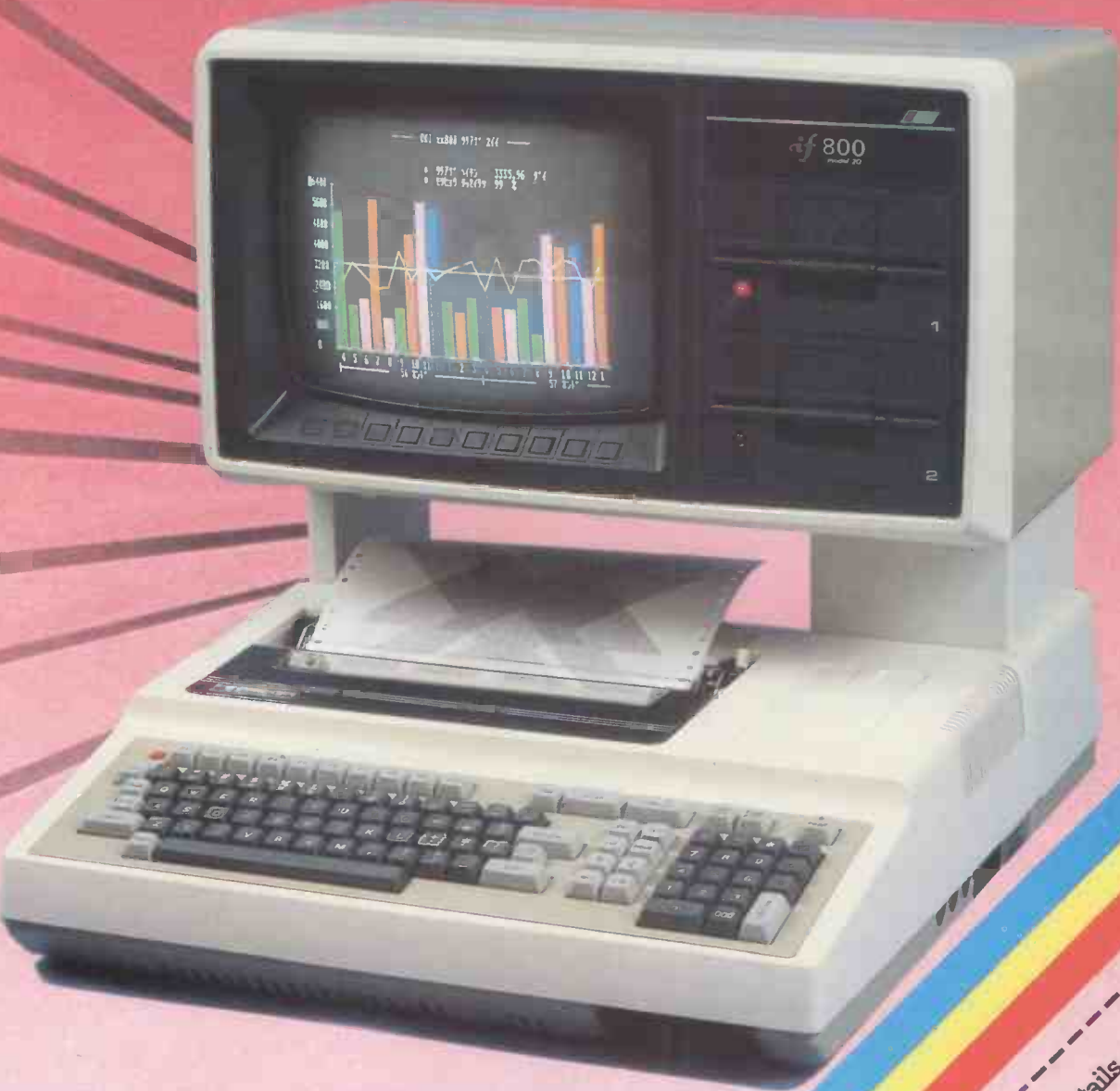

**COMPUTERS**  
 Copse Road, St Johns,  
 Woking, Surrey GU21 1SX  
 Tel: (04862) 23411 Telex: 859592

----- ✂ -----

Please contact me with details of the if 800 today!

Name \_\_\_\_\_

Address \_\_\_\_\_

Company \_\_\_\_\_

Tel. \_\_\_\_\_

● Circle No. 154

# THE MICROPUTE CHALLENGE:— FIND A COMPUTER TO COMPARE WITH THE *Sig/Net* ... NEVER.

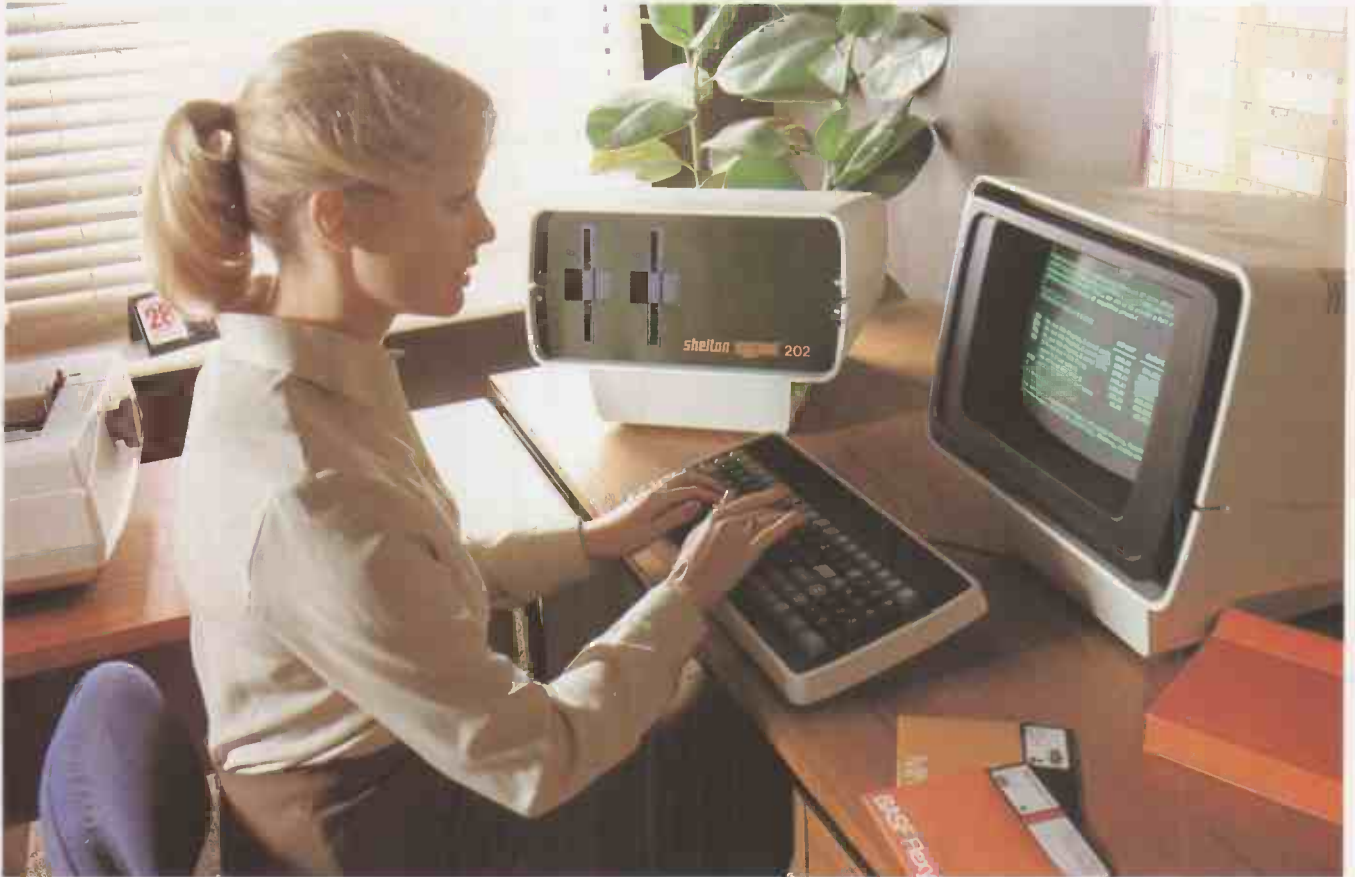

... Because the SIG/NET offers the price advantage of the low cost systems together with the flexibility and infinite expansion capabilities of the high cost systems.

Or in other words a great deal more for a great deal less.

For just **£1,299.00** the standard SIG/NET offers the flexibility to choose the terminal best suited to your requirements, the printer to give the speed and quality you need and disk capacity from 400,000 to 40 Million characters.

The standard SIG/NET 202S .....	£1,299.00
5 Megabyte hard disk system .....	£3,100.00
10 Megabyte 4 User .....	£6,000.00
10 Megabyte 10 User .....	£9,500.00

FOR FURTHER TECHNICAL DATA AND THE NAME OF YOUR NEAREST DEALER SEND THE COUPON **NOW!**

**MICROPUTE**  
Catherine Street, Macclesfield, Cheshire, SK11 6OY. Tel: (0625) 612759.

NAME \_\_\_\_\_ POSITION \_\_\_\_\_

COMPANY NAME \_\_\_\_\_

COMPANY ADDRESS \_\_\_\_\_

TEL NO \_\_\_\_\_

Dealer enquiries invited for certain areas of the Midlands and North.

## THERE'S JUST NONE TO COMPARE.

- Unbeatable value for money.
- Advanced and innovative **BRITISH** design.
- **BRITISH BUILT.**
- Unrivalled expansion.
- Faster than comparable systems.
- Full 64K of memory.
- Sold only through approved dealers.
- CP/M compatible.

# MICROPUTE



**MICROPUTE**

microcomputer systems

Catherine Street,  
Macclesfield,  
Cheshire,  
SK11 6OY.  
Tel: (0625) 612759.

● Circle No. 155



# Data manipulation for 3D displays

THE PROCESSES of defining, storing, manipulating, interrogating and finally outputting pictorial information are the essence of computer graphics. The graphics operation is essentially passive, and the observer has no direct control over the picture being presented. Interactive graphics also use the computer to prepare and present pictorial information, while allowing the user to influence the picture as it is being prepared.

From the user's point of view, computer graphics can be divided into the following areas:

- Representing pictures to be presented.
- Preparing pictures for representation.
- Presenting previously prepared pictures.
- Interacting with the picture.

The word "picture" is used in its broadest sense to mean any collection of lines, points, text, etc., to be displayed on a graphics device. It may be anything from a line to a fully-scaled representation of an aircraft, ship, or building.

## Textual material

Pictures represented in computer graphics can be considered as a collection of lines, points, and textual material. A line can be represented by the co-ordinates of its end points  $X_1, Y_1, Z_1$  and  $X_2, Y_2, Z_2$ , a point by a single co-ordinate triplet  $X_1, Y_1, Z_1$ , and textual material by collections of lines or points.

A series of points, each of which is a position vector relative to a local co-ordinate system, may be stored in a computer as a matrix of numbers. The position of these points can be controlled by manipulating the matrix which defines the points. Appropriate computer hardware or software can be used to generate lines, curves or pictures as output.

Pictures ultimately consist of points whose co-ordinates are stored in a file — an array — prior to being used to present the picture. This file is called a database. Very complex pictures require correspondingly complex databases and a complex program to access them. These databases may involve ring structures, tree structures, etc., and may contain points, substructures, and other non-graphic data.

Figure 1. Windowing techniques.

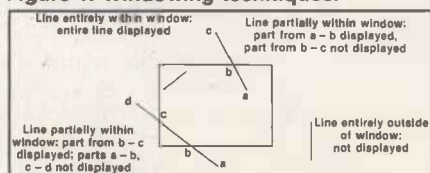

## Interactive displays are available through arithmetic operations on the graphics database. R S Khaira provides the transformations on which to base your graphics algorithms.

Points are the basic building blocks of a graphic database. There are three basic methods or instructions for treating a point as a graphic geometric entity:

- Move the beam, pen, cursor, plotting head to the point.
- Draw a line to that point.
- Draw a dot at that point.

The best way to specify the position of a point is to use homogeneous co-ordinates in which an N-dimensional space is represented by N+1 dimensions. If the position of a point in three dimensions is given by the triplet X, Y, Z, it is represented by four co-ordinates  $hX, hY, hZ, h$ , where h is an arbitrary number.

A database used to prepare the picture for representation is hardly ever the same as the display file used to present the picture. The database represents the total picture, while the display file represents only some position, view, or part of the picture. The display file is created by transforming the database.

The picture contained in the database may be resized, rotated, translated, partially removed, or viewed from a particular point to obtain necessary perspective before being displayed. Many of these operations can be accomplished by using simple linear transformations involving matrix multiplications. Among these are rotation, translation, scaling, perspective and stereoscopic views. Homogeneous co-ordinates are very convenient for accomplishing these transformations.

A four-by-four matrix can be used to perform any of these individual transformations on points represented as a matrix in homogeneous co-ordinates. When a sequence of transformations is desired, each individual transformation can be sequentially applied to the points to achieve the desired result. If, however, the number of points is large, this is inefficient and time-consuming.

An alternative method is to multiply together the individual matrices representing each required transformation and then to finally multiply the matrix of points by the resulting four-by-four transformation matrix. This matrix operation

is called concatenation and saves a significant amount of time when performing compound matrix operations on sets of data points.

In some graphics applications the complete database is displayed, but frequently only portions of the database are needed. This process of displaying only a part of the complete picture database is called "windowing". It is not easy to achieve, particularly if the picture database has been transformed.

In general there are two types of windowing — clipping and scissoring. Clipping involves determining which lines or portions of lines in the picture lie outside the window — see figure 1. Those lines or portions of lines are then discarded and not displayed. In the scissoring technique, which is not used here, the display device has a larger physical drawing space than is required.

In two dimensions, a window is specified by values for the left, right, top and bottom edges of a rectangle. Clipping is easiest if the edges of the rectangle are parallel to the co-ordinate axes. When this is not the case, the rotation of the window can be compensated for by rotating the database in the opposite direction.

## The final step

As a final step in the picture presentation process it is necessary to convert from the co-ordinates used in the picture database, called user co-ordinates, to those used by the display device, called display co-ordinates. In particular, it is necessary to convert co-ordinate data which passes the windowing process into display co-ordinates such that the picture appears in some specified area on the display, called a viewport.

The viewport can be specified by giving its left, right, top and bottom edges if two-dimensional, and if three-dimensional by specifying a near and far boundary too. In the most general case, conversion to display co-ordinates within a specified three-dimensional viewport requires a linear mapping from a six-sided frustum of vision to a six-sided viewport.

To interact with the picture you need some type of interactive device to communicate with the program while it is running. In effect this interrupts the program so that new or different information can be used to accomplish the task. The simplest is, of course, the alpha-numeric keyboard. More sophisticated devices

(continued on next page)

(continued from previous page)

include light pens, joysticks, and so on. The ability to represent or display a three-dimensional object is fundamental to the understanding of the shape of that object. Furthermore, the ability to rotate, translate, and project views of that object is also, in many cases, fundamental to the understanding of its shape.

This is easily demonstrated by picking up a relatively complex, unfamiliar object. You naturally rotate it, hold it at arm's length, stand back from it, etc., in order to obtain an understanding of its shape.

To do this with a computer we must introduce an analysis of the shape in three dimensions, and we immediately introduce homogeneous co-ordinates. Hence a point in three-dimensional space  $[x \ y \ z]$  is represented by a four-dimensional position vector  $[x \ y \ z \ 1]$  or  $[X \ Y \ Z \ H]$ . Again the transformation from homogeneous co-ordinates to ordinary co-ordinates is given by

$$[X \ Y \ Z \ H] = [x \ y \ z \ 1] \times T$$

$$\text{and } [x' \ y' \ z' \ 1] = \begin{bmatrix} X & Y & Z \\ H & H & H \end{bmatrix}$$

where  $T$  is some transformation matrix and  $x'$ ,  $y'$ , and  $z'$  are the transformed co-ordinates.

The generalised four-by-four transformation matrix for three-dimensional homogeneous co-ordinates is

$$T = \begin{bmatrix} a & b & c & p \\ d & e & f & q \\ h & i & j & r \\ l & m & n & s \end{bmatrix}$$

It can be partitioned into four separate sections:

$$\begin{bmatrix} 3 \times 3 & 3 \times 1 \\ 1 \times 3 & 1 \times 1 \end{bmatrix}$$

The three-by-three matrix produces a linear transformation in the form of scaling, shearing, and rotation. A linear transformation is one which transforms an initial linear combination of vectors into the same linear combination of transformed vectors. The one-by-three row matrix produces translation and the three-by-one column matrix produces perspective transformation. The final

Figure 3. Three-dimensional rotation.

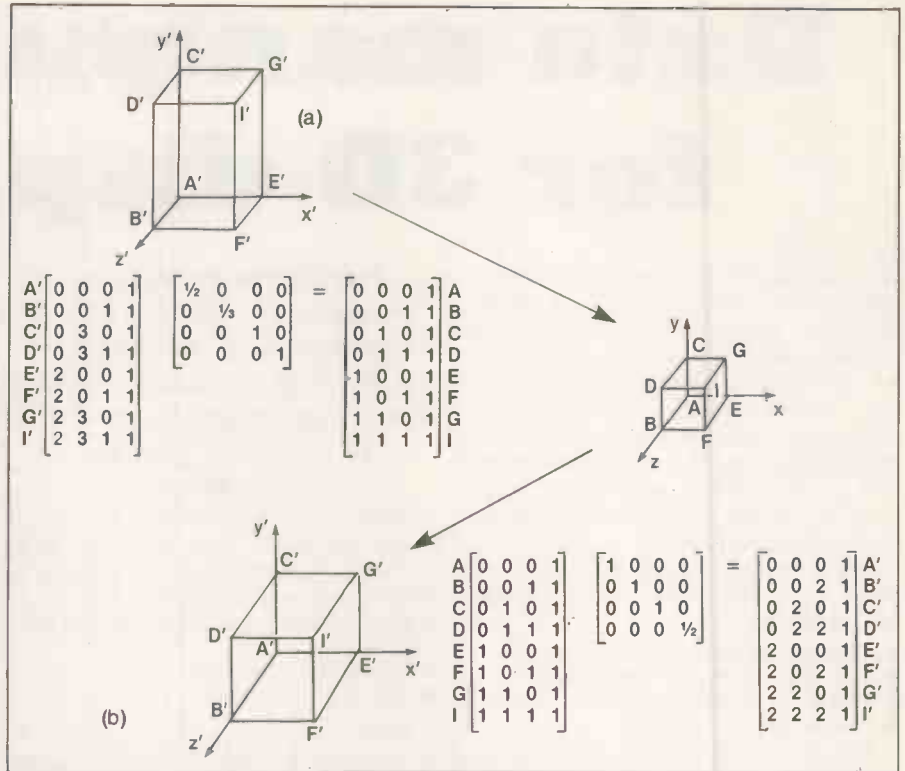
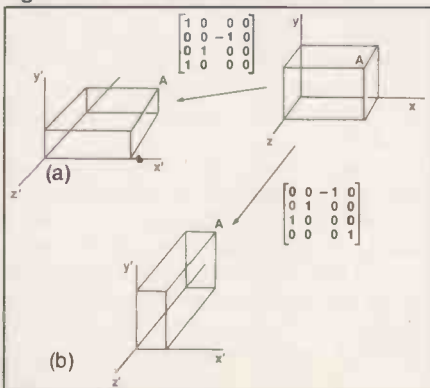

Figure 2. Rescaling a parallelepiped.

single-element matrix produces overall scaling.

The total transformation obtained by operating on a position vector with the four-by-four matrix and normalising the transformed vector is called a bilinear transformation. It gives a combination of

- shearing
- local scaling
- overall scaling
- rotation
- reflection
- translation
- perspective

The diagonal terms of the general four-by-four transformation matrix produce local and overall scaling. The product

$$[x \ y \ z \ 1] \times \begin{bmatrix} a & 0 & 0 & 0 \\ 0 & e & 0 & 0 \\ 0 & 0 & j & 0 \\ 0 & 0 & 0 & 1 \end{bmatrix} = [ax \ ey \ jz \ 1] = [x' \ y' \ z' \ 1]$$

which shows the local scaling effect. Figure 2a shows a parallelepiped rescaled as a unit cube. Overall scaling is obtained by using the fourth diagonal element, i.e.,

$$[x \ y \ z \ 1] \times \begin{bmatrix} 1 & 0 & 0 & 0 \\ 0 & 1 & 0 & 0 \\ 0 & 0 & 1 & 0 \\ 0 & 0 & 0 & s \end{bmatrix} = \begin{bmatrix} x & y & z & s \\ x' & y' & z' & 1 \\ x & y & z & 1 \\ x & y & z & 1 \end{bmatrix}$$

This effect is shown in figure 2b.

If the determinant of the three-by-three component matrix is +1, then it produces a pure rotation about the origin. Before considering the general case of three-dimensional rotation about an arbitrary axis, consider several special cases.

In a right-handed co-ordinate system, a point may be rotated clockwise by degrees around the x axis by

$$x' = x$$

$$y' = y \cos \theta + z \sin \theta$$

$$z' = z \cos \theta - y \sin \theta$$

i.e., the x-dimensions do not change. Thus the transformation matrix will have zeros in the first row and first column, except for unity on the main diagonal. The transformation matrix for rotation around the x-axis is

$$T = \begin{bmatrix} 1 & 0 & 0 & 0 \\ 0 & \cos \theta & \sin \theta & 0 \\ 0 & -\sin \theta & \cos \theta & 0 \\ 0 & 0 & 0 & 1 \end{bmatrix}$$

Rotation is assumed to be positive in a right-hand sense as you look from the origin outward along the axis of rotation. Figure 3a shows a  $-90^\circ$  rotation about the x-axis.

Rotation about the y-axis is carried out by

$$x' = x \cos \theta - z \sin \theta$$

$$y' = y$$

$$z' = z \cos \theta + x \sin \theta$$

In this case zeros appear in the second row and second column of the transformation matrix, except for unity on the main diagonal. The complete matrix is

$$T = \begin{bmatrix} \cos \theta & 0 & -\sin \theta & 0 \\ 0 & 1 & 0 & 0 \\ \sin \theta & 0 & \cos \theta & 0 \\ 0 & 0 & 0 & 1 \end{bmatrix}$$

Figure 3b shows a rotation about the y-axis.

Rotation about the z-axis is carried out by

$$x' = x \cos \theta + y \sin \theta$$

$$y' = y \cos \theta - x \sin \theta$$

$$z' = z$$

The complete transformation matrix is

$$T = \begin{bmatrix} \cos \theta & \sin \theta & 0 & 0 \\ -\sin \theta & \cos \theta & 0 & 0 \\ 0 & 0 & 1 & 0 \\ 0 & 0 & 0 & 1 \end{bmatrix}$$



' Some orientations of a three-dimensional object require reflections. In three dimensions the simplest reflections occur through a plane. For a rigid body the determinant of the reflection transformation will be  $-1$ .

In a reflection through the  $xy$ -plane, only the  $z$ -co-ordinate values of the position vectors of the object will be changed: in fact they will be reversed in sign. Thus the transformation matrix for a reflection through the  $xy$ -plane is

$$T = \begin{bmatrix} 1 & 0 & 0 & 0 \\ 0 & 1 & 0 & 0 \\ 0 & 0 & -1 & 0 \\ 0 & 0 & 0 & 0 \end{bmatrix}$$

The reflection of a unit cube through the  $xy$ -plane is shown in figure 4.

For a reflection through the  $yz$ -plane

$$T = \begin{bmatrix} -1 & 0 & 0 & 0 \\ 0 & 1 & 0 & 0 \\ 0 & 0 & 1 & 0 \\ 0 & 0 & 0 & 1 \end{bmatrix}$$

and for a reflection through the  $xz$ -plane

$$T = \begin{bmatrix} 1 & 0 & 0 & 0 \\ 0 & -1 & 0 & 0 \\ 0 & 0 & 1 & 0 \\ 0 & 0 & 0 & 1 \end{bmatrix}$$

Three-dimensional translation is obtained by writing

$$[X Y Z H] = [x y z 1] \begin{bmatrix} 1 & 0 & 0 & 0 \\ 0 & 1 & 0 & 0 \\ 0 & 0 & 1 & 0 \\ l & m & n & 1 \end{bmatrix}$$

When expanded this yields

$$[X Y Z H] = [(n + l)(y + m)(z + n)1]$$

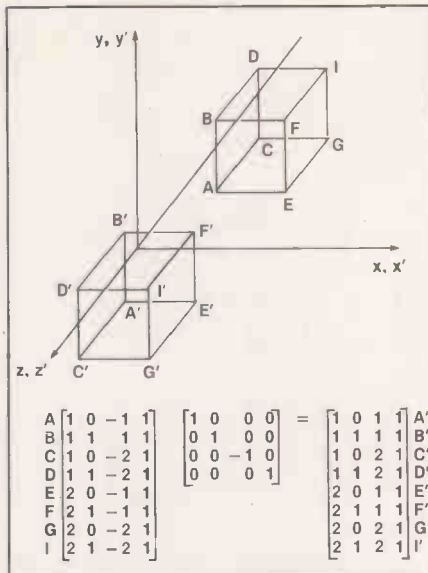

Figure 4. Three-dimensional reflection.

It follows that

$$\begin{aligned} x' &= \frac{X}{H} = x + l \\ y' &= \frac{Y}{H} = y + m \\ z' &= \frac{Z}{H} = z + n \end{aligned}$$

The procedure for rotations about an arbitrary axis is to translate the object and the desired axis of rotation so that the rotation is made about an axis passing through the origin of the co-ordinate system. The method involves a three-dimensional translation, a rotation about the origin, and a translation back to the

initial position. If the axis about which rotation is desired passes through the point

$$A = [l m n 1]$$

then the form of the transformation matrix is

$$[X Y Z H] = [x y z 1] \times \begin{bmatrix} 1 & 0 & 0 & 0 \\ 0 & 1 & 0 & 0 \\ 0 & 0 & 1 & 0 \\ -l & -m & -n & 1 \end{bmatrix} \times \begin{bmatrix} R & & & \\ & R & & \\ & & R & \\ & & & R \end{bmatrix} \times \begin{bmatrix} 1 & 0 & 0 & 0 \\ 0 & 1 & 0 & 0 \\ 0 & 0 & 1 & 0 \\ l & m & n & 1 \end{bmatrix}$$

where the elements in the four  $\times$  four rotation matrix  $R$  are, in general, given by matrix  $A$ . The generalised three-dimensional rotation is a very important capability. A derivation for determining the elements of the rotation matrix  $R$  is given by Rogers and Adams in chapter 3 of their book.

Non-zero elements in the first three rows of the last column of the four-by-four transformation matrix yield a perspective transformation. A perspective projection is obtained by concatenation of a perspective transformation followed by a projection on to a two-dimensional viewing plane. A perspective projection is given by the transformation

$$[X Y Z H] = [x y z 1] \begin{bmatrix} 1 & 0 & 0 & 0 \\ 0 & 1 & 0 & 0 \\ 0 & 0 & r & 0 \\ 0 & 0 & 0 & 1 \end{bmatrix} = [x y 0 (rz+1)]$$

(continued on next page)

```

2000 REM SCALE OPTION
2001 REM =====
2010 ? CHR$(12) + " SCALE OPTION."?
2020 GOSUB 9000:REM SETS F3,4,L3,4
2025 INPUT "X-STRETCHING FACTOR";A
2030 INPUT "Y-STRETCHING FACTOR";E
2040 INPUT "Z-STRETCHING FACTOR";J1
2050 INPUT "OVERALL SCALING FACTOR";S
2055 GOSUB 3500:REM ZEROIZE T(4X4)
2060 FOR I=F4 TO L4
2070 U(I,1)=X(I):U(I,2)=Y(I)
2080 U(I,3)=Z(I):U(I,4)=1
2085 NEXT I
2090 T(1,1)=A:T(2,2)=E:T(3,3)=J1
2100 T(4,4)=1/S
2110 GOSUB 9500:REM MATRIX U*T
2120 FOR I=F4 TO L4
2130 X(I)=V(I,1):Y(I)=V(I,4)
2140 V(I)=V(I,2):V(I,4)
2150 Z(I)=V(I,3):V(I,4):NEXT I
2160 GOTO 500
3000 REM ROTATE ABOUT AXIS OPTION
3001 REM =====
3010 ? CHR$(12) + " ROTATE OPTION."?
3020 GOSUB 9000:REM SETS F3,4,L3,4
3025 INPUT "ROTATION ANGLE";T1
3027 T2=T1/57.2957795
3030 ?"WHICH AXIS OF ROTATION (X,Y,Z) "
3040 INPUT B$
3045 GOSUB 3500:REM ZEROIZE T(4X4)
3050 IF B$="X" THEN 3200
3060 IF B$="Y" THEN 3300
3070 IF B$="Z" THEN 3400
3080 ?"NO SUCH AXIS .....TRY AGAIN"
3090 GOTO 3040
3100 FOR I=F4 TO L4
3105 U(I,1)=X(I):U(I,2)=Y(I)
3110 U(I,3)=Z(I):U(I,4)=1
3120 NEXT I
3130 GOSUB 9500:REM MATRIX V=U*T
3135 FOR I=F4 TO L4
3140 X(I)=V(I,1):Y(I)=V(I,2):Z(I)=V(I,3)
3145 NEXT I
3150 GOTO 500
3200 REM X-AXIS ROTATION
3210 T(1,1)=1:T(4,4)=1
3220 T(3,3)=COS(T2):T(2,2)=T(3,3)
3230 T(2,3)=SIN(T2)
3240 T(3,2)=-T(2,3)
3250 GOTO 3100
3300 REM Y-AXIS ROTATION
3310 T(1,1)=COS(T2):T(3,3)=T(1,1)
3320 T(3,1)=SIN(T2)
3330 T(1,3)=-T(3,1)
3340 T(2,2)=1:T(4,4)=1
3350 GOTO 3100
3400 REM Z AXIS ROTATION
3410 T(2,2)=COS(T2):T(1,1)=T(2,2)
3420 T(1,2)=SIN(T2)
3430 T(2,1)=-T(1,2)
3440 T(3,3)=1
3450 T(4,4)=1
3460 GOTO 3100
3500 REM ZEROIZE THE T(4X4) MATRIX
3510 FOR I=1 TO 4
3520 FOR J=1 TO 4
3530 T(I,J)=0
3540 NEXT J:NEXT I
3550 RETURN
9000 REM A SUBROUTINE WHICH READS IN
9001 REM S$ AND FINDS IT IN N$(SHAPES)
9002 REM IT SETS F3-L3(RANGE OF LINES)
9003 REM AND L3-L4(THE RANGE OF POINTS)
9010 INPUT"NAME OF SHAPE OR @ FOR ALL";S$
9020 IF S$="" THEN 9410
9030 FOR I=1 TO N7-1
9040 IF S$=N$(I) THEN 9100
9050 NEXT I
9060 ?"NO SUCH SHAPE" GOTO 9010
9100 F3=F(I) L3=L(I)
9110 REM SEARCH L1,L2 FOR RANGE F4-L4
9115 F4=32000:L4=-1
9120 FOR I=F3 TO L3
9130 IF L1(I,1)<F4 THEN F4=L1(I,1)
9140 IF L1(I,2)<F4 THEN F4=L1(I,2)
9150 IF L1(I,1)>L4 THEN L4=L1(I,1)
9160 IF L1(I,2)>L4 THEN L4=L1(I,2)
9170 NEXT I
9180 IF F4=32000 OR L4=-1 THEN ?"POINTS ERROR" GOTO 9010
9190 RETURN
9200 F3=1:F4=1:L3=N8-1:L4=N9-1
9450 RETURN
9500 REM MATRIX MULTIPLICATION
9505 REM ALL POINTS FROM F4 TO L4
9506 REM ARE MULTIPLIED BY THE MATRIX
9507 REM CALLED T(4X4), INTO V(F4:TL4)
9508 A=0
9510 FOR I=F4 TO L4
9520 FOR K=1 TO 4
9530 FOR J=1 TO 4
9540 A=A+U(I,J)*T(J,K)
9550 NEXT J
9560 V(I,K)=A
9570 A=0
9580 NEXT K:NEXT I
9590 RETURN
9999 END

```

(continued from previous page)

The ordinary transformed co-ordinates are then

$$\begin{aligned} x' &= \frac{X}{H} = \frac{x}{rz+1} \\ y' &= \frac{Y}{H} = \frac{y}{rz+1} \\ z' &= \frac{Z}{H} = \frac{0}{rz+1} \end{aligned}$$

The geometrical effect of this transformation can be indicated with the aid of Figure 5.

The non-transformed point P is transformed to P' by the above operation with  $r = 1/k$ . In figure 5 the centre of projection is located at  $[0\ 0\ -K]$  and the plane of projection is  $z = 0$ . Since this operation produces no translation, the origin is unchanged and the  $xy$ - and  $x'y'$ -co-ordinates share the same origin. By using the similar triangles shown in figure 5 it follows that

$$\frac{x'}{k} = \frac{x}{(z+k)} \text{ or } x' = x / \left( \frac{z}{k} + 1 \right)$$

Considering the  $yz$ -plane in a similar manner gives

$$y' = y / \left( \frac{z}{k} + 1 \right)$$

These are the transformed co-ordinates produced by the matrix operation with  $r = 1/k$ . This operation produces a perspective projection on the  $z = 0$  plane from a centre of projection located at  $z = -k$ .

Perspective can help distinguish the ambiguous interpretations of a wire-frame drawing. In some cases it helps to exaggerate the perspective, equivalent to distorting the objects, though the distortion may have undesirable side-effects.

Once an object has been transformed to a desired position, many techniques can be used to display it. Shading, colouring, etc., are frequently device-dependent, while other methods such as hidden-line removal and clipping can be accomplished in either software or hardware.

Stereo pairs can be used to create an illusion of depth in place of hidden-line removal. In a stereographic projection, a

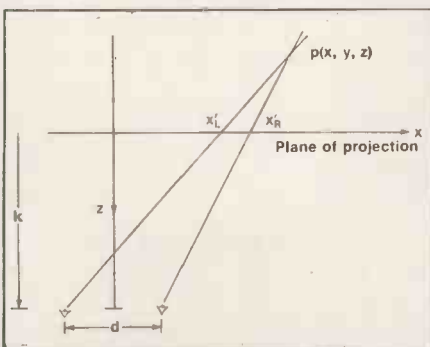

Figure 6. Stereographic perspective. Rotation matrix R.

$$R = \begin{bmatrix} n_1^2 + (1-n_1^2)\cos\theta & n_1n_2(1-\cos\theta) + n_3\sin\theta & n_1n_3(1-\cos\theta) - n_2\sin\theta & 0 \\ n_1n_2(1-\cos\theta) - n_3\sin\theta & n_2^2 + (1-n_2^2)\cos\theta & n_2n_3(1-\cos\theta) + n_1\sin\theta & 0 \\ n_1n_3(1-\cos\theta) + n_2\sin\theta & n_2n_3(1-\cos\theta) - n_1\sin\theta & n_3^2 + (1-n_3^2)\cos\theta & 0 \\ 0 & 0 & 0 & 1 \end{bmatrix}$$

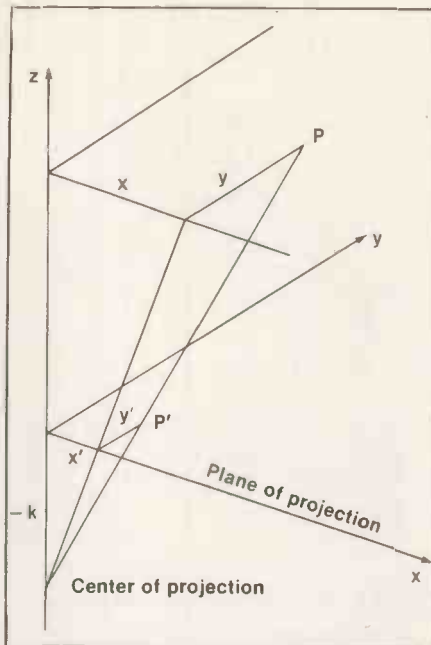

Figure 5. Perspective transformation.

separate perspective view must be created for each eye. A stereo viewer is then used to view the apparent single three-dimensional object. For a human with average eyesight, the strongest stereo effect occurs at a distance of about 50cm. in front of the eyes. Thus for an eye separation of 5cm, the stereo angle is

$$\epsilon = \tan^{-1}(5/50) = 5.71^\circ$$

For a stereo viewer, let  $d$  be the scaled separation distance between the eyes — see figure 6. If the viewer has a focal length of  $k$  units, then the value of  $d$  is fixed by the requirement

$$\tan^{-1}(d/k) = 5.71^\circ$$

so  $d$  must equal  $k/10$  to maintain the correct stereo angle  $\epsilon$ .

To obtain this scaled eye-separation distance from a single view of the object, a  $+d/2 = +k/20$  horizontal translation is performed before creating the right-eye view. To create a stereo pair, the matrix containing the new position vectors is transformed by use of the two matrices:

$$\begin{bmatrix} 1 & 0 & 0 & 0 \\ 0 & 1 & 0 & 0 \\ 0 & 0 & 0 & -1/k \\ k/20 & 0 & 0 & 1 \end{bmatrix} \quad \begin{bmatrix} 1 & 0 & 0 & 0 \\ 0 & 1 & 0 & 0 \\ 0 & 0 & 0 & -1/k \\ -k/20 & 0 & 0 & 0 \end{bmatrix}$$

which create two separate perspective views, one for the left eye and one for the right eye.

At this intermediate step the left-eye view is to the right of the origin, and the right-eye view is to the left, as shown in figure 7. The last operation is to separate the two perspective views by the proper distance along the  $x$ -axis in order to place each view directly in front of the proper eye.

In figure 7,  $(\bar{x})_R$  is the average value between the largest and smallest value of  $x'_R$ ;  $(\bar{x})_L$  is the average value between the largest and smallest value of  $x'_L$ . If  $D = (\bar{x})_L - (\bar{x})_R$ , then the value of  $D$  must be calculated by searching the normalised  $x'$ -values of each perspective view. A final horizontal translation in the  $x$ -direction of

$$L = D + (E - D)/2$$

for the right-eye view, and  $-L$  for the left-eye view places the stereo pair in the proper position.

The value of  $E$  is the actual eye-separation distance for the human observer, measured in the scale of the output device. For example, if the final points for the left-eye view fall between

$$-4 \leq x'_L \leq -2,$$

and the final points for the right-eye view fall between

$$2 \leq x'_R \leq 4,$$

then you might choose to plot these two views on a standard sheet of paper, using a 10-unit scale between  $-5 \leq x' \leq 5$ . Then  $E$ , the actual 5cm. distance between human eyes, measured on this scale would be about 2.5.

The two programs are written for the Research Machines 380-Z, and exemplify how the matrix transformations can be manipulated using Basic. The transformation algorithms assume that the

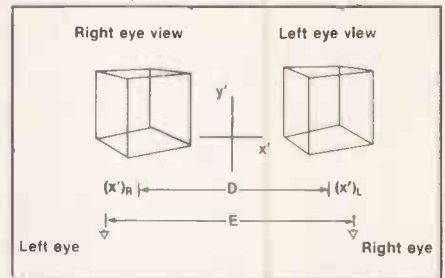

Figure 7. Intermediate stereo position.

database is presented in ordinary co-ordinates. They then develop the necessary homogeneous co-ordinate representation, perform the transformation, and return to ordinary co-ordinates.

To implement the transformations you should fully understand the mathematical theory presented, as well as the graphical capabilities e.g., the co-ordinate system, of your computer system. High-resolution graphics are necessary for satisfactory results. Satisfactory displays were achieved on a Tektronix-4010 VDU with a resolution of 1,024 by 780.

## References

- Interactive Computer Graphics* by B S Walker, J R Gurd and E A Drawneek, published by Edward Arnold, 1976.
- Principles of Interactive Computer Graphics* by W M Newman and R Sproull, second edition published by McGraw-Hill Kogakusha, 1978.
- Mathematical Elements for Computer Graphics* by D F Rogers and J A Adams, published by McGraw-Hill, 1976.



# THOUGHT PROCESS

 Commodore

 Apple

 Data General

 Future Technology Systems



COMMODORE



APPLE



DATA GENERAL



FUTURE  
TECHNOLOGYSYSTEMS

Gate Microsystems have thought it out for you first.

A range of small computers to cover every conceivable practical application.

Star names that are all star performers:

COMMODORE, the popular multi-function professional.

APPLE, the most versatile of micro-computers.

Superb interactive single and multi-terminal business data processing systems from DATA GENERAL.

The powerful Series 88 from FUTURE

TECHNOLOGY SYSTEMS, combining high performance with advanced distributed processor architecture.

From this comprehensive armoury our experts can cover your every hardware and software requirement, off the shelf or tailor-made, with full training facilities and a prompt, caring after-sales service. Word processing to payroll, stock control to statistics, invoicing to information analysis... in a host of different contexts—we've given ourselves the complete range of options first.

Now we present them all to you.

 GATE MICROSYSTEMS LTD

The Nethergate Centre, 35 Yeaman Shore, DUNDEE DD1 4BU. Tel: 0382 28194.  
Abbey House, Bothwell Street, GLASGOW. Tel: 041-221 9372.



## ...now on the IBM Personal Computer.

TABS unique business software is a flexible package designed to maximise business efficiency and profitability.

TABS is also **modular**. Each IBM module may be run individually or together. Modules currently include System Generation, Sales Ledger, Purchase Ledger, Nominal Ledger, Stock Control and Payroll.

The system is **fully integrated** so that updated information on one module automatically updates information on a related module e.g. items entered on the Sales Ledger would deplete Stock Control.

Each module is **parameter driven** enabling end users to adapt each module to suit their unique accounting requirements.

The TABS system is **upgradeable**. It bridges the gap between micro and mini computers facilitating expansion from the single user system to the multi user system on SYSTIME and D.E.C.

Finally, TABS is **universal**. The modular system currently running on the IBM Personal Computer, PET, Apple and Superbrain will shortly be available on most CPM microcomputers.

We would, however, like to add a word of caution to the end user. Naturally a package as flexible as this is a sophisticated product and although simple to operate we strongly advise professional help either from your Dealer or from TABS during its installation.

For more details about TABS software and hardware, please tick box(es) and return coupon to us. We are pleased to offer credit card facilities to our customers.

#### Dealer enquiry

Please send me details of your Dealer Plan

#### User enquiry

Please send me details about TABS accounting systems

Please send me the TABS User Manual £20 inc p&p

I enclose cheque/postal order for £ \_\_\_\_\_

Signature \_\_\_\_\_

Name \_\_\_\_\_

Address \_\_\_\_\_

Tel. No. \_\_\_\_\_

TABS Ltd, Sopers House, Chantry Way, Andover Hants. SP10 1LU  
Telephone: Andover (0264) 58933

PC IBM



Accounting Business Systems

**TABS**

● Circle No. 157





# PET BOOKIE

If you enjoy the excitement of an occasional flutter on the horses, this simulation will allow you to gain experience of the racetrack, without losing any real money. The object of Philip Day's game is to become a millionaire.

THE PROGRAM generates a random number of horses from three to eight, calculates the odds against each horse, accepts bets to win on all races, and also each-way and place bets if six or more horses are in the race. There is the opportunity to amend or cancel a bet before the

"off" to allow flexibility, e.g., to correct keying-in errors.

Any number of horses can be backed, but you must stay within your credit. Each-way bets cost double the amount keyed in. A financial statement is pre-

sented after each race showing how much you have won or lost. Each race is a unique combination of horses and odds, and you require both judgement and luck to be successful.

(continued on next page)

```

50 REM*** GRANDSTAND PARK RACE GAME ***
60 REM*** BY PHILIP. H. DAY ***
70 REM*** SEPTEMBER 1981 ***
80 K$=" " : C$=" "
90 N$="BACK YOUR HORSE"
100 J$=" " : D$=" "
110 CR=10000:F$=" 2:1 ON":G$=" EVENS":I$=" " : P$=" "
120 TS=0:A=0:B=0:C=0:T=T+1:PRINT"J$"TAB(6)"GRANDSTAND PARK - RACE NO" T
130 PRINT"RSTART"TAB(34)"FINISH":TP=0:X=RND(-TI)
140 N=INT(RND(1)*6+3):FORJ=1TON:P(J)=RND(1):TP=TP+P(J):NEXT:Z=1
150 FORJ=1TON:O(J)=INT(TP/P(J))-1:IF O(J)>30THENO(J)=30
160 IF O(J)=0THENO(J)=.5
170 GOSUB660:PRINT" "O$:H(J)=32888+80*J:POKEH(J),J
180 B(J)=0:L(J)=0:F(J)=0:G(J)=0:NEXT:PRINTC$N$
190 GOSUB640:IFA$="X"ANDCR>TSTHEN360
200 PRINTC$N$ " "J$: IFA$>CHR$(N+64)ORA$<"A"THEN190
210 M=ASC(A$)-64
220 PRINTI$:FORJ=1TOM:PRINT" ":NEXT:POKEH(M),M+128:IFN<6THEN290
230 PRINTD$ "?"J$:GOSUB640:IFA$="W"THEN290
240 IFA$="E"THENPRINTD$"EACH WAY":B(M)=69:GOTO300
250 IFA$="P"THENPRINTD$"PLACE " : B(M)=80:GOTO300

```

(listing continued on next page)

(continued from previous page)

A perfectly fair set of odds against a win is one in which

$$\sum_{i=1}^N (\text{prob}) = 1,$$

that is, the sum of all the probabilities is unity, where the probability for any horse is given by

$$\text{Prob} = 1/(\text{Odds} + 1)$$

The first problem when writing this program therefore was to devise a simple way of generating random odds for the horses, but such that the

$$\sum (\text{prob}) = 1$$

condition was satisfied to give a reasonably fair game. This was neatly solved by generating random numbers in the range 0 to 1, then dividing each by their sum to obtain the relative probability for each horse. The odds are then calculated using the equation:

$$\text{Odds} = \text{INT}(1/\text{prob}) - 1$$

The truncation effect of the INT function gives a slight advantage to the Pet on some bets to win. In a real race, the bookie lowers his odds such that

$$\sum (\text{prob}) > 1$$

to give him sufficient advantage to enable him to make a living. The equations could be amended along the same lines to make the game tougher if required. Maximum odds are limited to 30:1 for outsiders, while low odds are catered for by strings "2:1 ON" and "EVENS", as appropriate.

The next problem is form. If all races ran to form the favourite would win every time and the rank outsider would always come in last. In the real world this obviously does not happen, and must be allowed for in the program.

### Form weighting

A random "form" weighting parameter in line 370 determines the extent to which the horses will run to form in any particular race. The punter is, of course, unaware in advance of how well his choices will run, adding the excitement to the game. This tantalising effect is achieved by the conditional part of line 410:

```
IF X < (.5 + Z/10 + .5 * FM * P(J)/TP) THEN ...
```

which determines the progress of each horse on a partly random, partly form basis. The first .5 is a fixed element, which Z/10 encourages a close and therefore more exciting finish, FM is the form weight for that race, while the remainder is the form for each horse. These factors were found by trial and error to give a satisfactory compromise between predictable and random results, but they could easily be altered to give different racing conditions.

The next aspect of the program con-

cerns the finishing order. Arrays G(J) and F(Z) capture each horse as it reaches the post and stores its identity. Lines 470 to 520 compute the win, each-way and place winnings and return the stake money for successful bets, a place bet pays at one-quarter odds. The last part of the program prints out the account.

Substantial use of For-Next loops, strings for Printing and Gosub limits the amount of memory needed to 3K, permitting a quick load from cassette or allowing the game to be one of several on a menu.

### Checking the stakes

The stake Input function is reasonably well-protected against invalid entries. Note that lines 120 and 530 are the only ones with the reverse-heart clear-screen symbol, which can easily be confused with the cursor-up symbol found elsewhere in the program. Although written for the 32K Pet, the program could be adapted for other machines by changing the Peek and Poke values, etc.

The game runs as follows:

- Type Run and Return to begin. You start with £10,000 credit. The screen then displays the horses and their odds.
- Type the letter of the horse of your choice.

The horse identity then changes into reverse field to indicate that you have chosen it. If there are five or fewer horses in the race then, WIN will be displayed automatically.

- If there are six or more horses, press W to bet to win, E for each-way, or P for place as required.
- Type in the amount of your stake, then press Return. You must stay within your current credit. Larger or illegal entries will not be accepted.
- To cancel a bet, type the appropriate horse letter and press Return.

Extra bets or changes can be made by repeating the last four steps as necessary.

- Press key 'X' to start the race. You can keep an eye on the horses that you backed because they are in reverse field. When the race is over, the screen displays the first three horses, their odds and your winnings, if any, the profit or loss on the race and the updated credit figure.

Races can be run indefinitely, but you drop out of the game if your credit falls below £1.

Although the game is designed for one player, a group of people could hold a competition, each person taking his turn on the machine, until he is either bankrupt or wins a £1,000,000.

(listing continued from previous page)

```
260 IFA$=CHR$(13)THEN280
270 GOTO230
280 P(M)=0:L(M)=0:POKEH(M),M:PRINTD$J$:GOTO330
290 PRINTD$"WIN"J$:B(M)=87
300 INPUT"*****";L$
310 L(M)=VAL(L$)
320 IFL(M)<=0ORINT(L(M))<L(M)THEN280
330 TS=0:FORJ=1TON:TS=TS+L(J):IFB(J)=69THENTS=TS+L(J)
340 NEXT:PRINT"TAB(22)";IFTSCRTHEM710
350 GOTO190
360 PRINTI$:FORJ=1TO18:PRINT"###"J$K$:POKE32887+40*J,103:NEXT
370 PRINTC$"UNDER STARTER'S ORDERS":FM=RND(1)*2:IFFM<.2THENFM=0
380 FORJ=1TO1500:NEXT:PRINT"###"J$K$:THEY'RE OFF"K$
390 FORJ=1TON:D=PEEKH(J):X=RND(1):IFH(1)=32927THENPRINT"###"J$K$
400 IFH(J)>=32927+80*JTHEN440
410 IFX<(.5+Z/10+.5*FM*P(J)/TP)THENPOKEH(J),32:H(J)=H(J)+1:POKEH(J),D
420 NEXT:IFZ<NTHEN390
430 GOTO460
440 IFG(J)=0THENF(Z)=J:G(J)=1:Z=Z+1
450 GOTO420
460 PRINT"TAB(29)";"RACE OVER":FORJ=1TO1500:NEXT
470 U=F(1):V=F(2):W=F(3):IFK6THEN520
480 IFB(U)=80THENA=L(U)*(O(U)/4+1)
490 IFB(V)=69THENA=L(U)*(O(U)*5/4+2)
500 IFB(V)=69ORB(V)=80THENB=L(V)*(O(V)/4+1)
510 IFB(W)=69ORB(W)=80THENC=L(W)*(O(W)/4+1)
520 IFB(U)=87THENA=L(U)*(O(U)+1)
530 CR=CR-TS+A+B+C:PRINT"*****RESULTS FOR RACE NO";T
540 PRINT"### HORSE ODDS STAKE BET WINNINGS"
550 E=A:J=U:H$="FIRST":GOSUB660
560 E=B:J=V:H$="SECOND":GOSUB660
570 E=C:J=W:H$="THIRD":GOSUB660
580 GOSUB700:PRINTTAB(30)A+B+C:PRINTTAB(8)"LESS TOTAL STAKES";TS
590 GOSUB700:PRINTTAB(8)"PROFIT/LOSS THIS RACE";A+B+C-TS
600 GOSUB700:PRINTP$"YOUR CREDIT NOW STANDS AT";CR
610 IFCR>=1E6THEN720
620 IFCR<1THEN730
630 PRINTP$"PRESS ANY KEY FOR THE NEXT RACE":POKE158,0:GOSUB640:GOTO120
640 GETA$:IFA$=" "THEN640
650 RETURN
660 O$=STR$(O(J))+":1":IFO(J)=.5THENO$=F$
670 IFO(J)=1THENO$=G$
680 IFZ=1THENRETURN
690 PRINTH$CHR$(J+64)";O$TAB(18)L(J)TAB(26)CHR$(B(J))TAB(30):RETURN
700 PRINTTAB(30)";":RETURN
710 PRINTC$"EXCEEDS CREDIT"CR"CHANGE BETS":GOTO190
720 FORJ=1TO22:PRINT"CONGRATULATIONS - MILLIONNAIRE !":NEXT:END
730 FORJ=1TO2000:NEXT:FORJ=1TO8
740 PRINTP$"YOU ARE BANKRUPT - END OF GAME":NEXT:END
```



# MAKE FRIENDS WITH A MICRO AT LASKYS

Laskys is the friendly store, the ideal place to come and meet the microcomputer. See our superb range of hardware, from pocket computers to complete business systems. Hear expert advice on which machine will suit your needs and your pocket. Try your hand at programming with our careful guidance. Select from our growing range of software and peripherals, and finally buy the system of your choice with the help of our easy cash or credit terms.

All of our computers are fully guaranteed, some for two years, and when it comes to after-sales service we have no rivals. Faulty products can be returned to any Laskys store in the U.K. and be repaired by experienced technicians in one of our six Nationwide Service Centres.

It's so easy to buy from Laskys. Visit a store near you, or telephone our head office for advice on 01-200 0444.

## 11 Shops Across the U.K. OPEN 6 DAYS A WEEK 9-6

**NOW  
OPEN  
AT...**

**7-9 Queensway  
(off Bayswater Road)  
London W2 3RX  
Tel: 051-229 6425**

**NOW  
IN  
STOCK!**



**OSBORNE**

	NETT	V.A.T.	TOTAL
Osborne 1 Computer .....	1250.00	187.50	1437.50
Osborne 12" Monitor .....	165.00	24.75	189.75

Laskys, the retail division of the Ladbroke Group of Companies.

**MICROCOMPUTERS**

**AT LASKYS**

### Birmingham

19/21 Corporation Street, Birmingham, B2 4LP. Tel: 021-632 6303. Manager: Peter Siallard. 300 yards from Bullring Centre.

### Bristol

16/20 Penn Street, Bristol, BS1 3AN. Tel: 0272 20471. Manager: Steve Heynes. Between Holiday Inn and C&A

### Chester

The Forum, Northgate Street, Chester, CH1 2BZ. Tel: 0244 317667. Manager: Jeremy Ashcroft. Next to the Town Hall.

### Edinburgh

4 St. James Centre, Edinburgh, EH1 3SR. Tel: 031-556 6717. Manager: Colin Draper. East end of Princes Street, St. James Centre.

### Preston

1/4 Guildhall Arcade, Preston, PR1 1HR. Tel: 0772 59264. Manager: Jim Comisky. Directly under Guild Hall.

### Manchester

12/14 St. Mary's Gate, Market Street, Manchester, M1 1PX. Tel: 061 837 6087. Manager: Lesly Jacobs. Corner of Deansgate.

### Glasgow

22/24 West Nile Street, Glasgow, G7 2PF. Tel: 041-226 3349. Manager: David Livingstone. Between Buchanan Street and Central Station.

### Sheffield

58 Leopold Street, Sheffield, S1 2GZ. Tel: 0742 750971. Manager: Justin Rowles. Top of the Moor, opposite Town Hall.

### Liverpool

33 Dale Street, Liverpool, L2 2HF. Tel: 051-236 2828. Manager: Mark Butler. Between the Town Hall and Magistrates Courts.

### London

42 Tottenham Court Road, London, W1 9RD. Tel: 01-636 0845. Manager: Vass Demosthenis.

# MAKE FRIENDS WITH A MICRO

## AT LASKYS

PRICES  
MARCH/APRIL 82

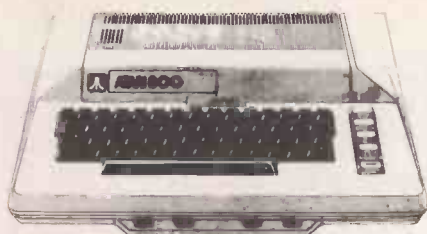

### ATARI

400 16K Computer	345.00
• 400A Computer	299.95
800 16K Computer	599.95
410 Tape Recorder	66.95
810 Disk Drive	365.00
822 Thermal Printer	265.00
825 80 Column Printer	550.00
850 RS 232 Interface	145.00
16K RAM Upgrade	65.00
Light Pen	45.00
Pair Paddles	12.00
Pair Joysticks	12.00
I/O Cable	12.95
Printer Cable	28.50
Interface Cable	25.00
RS 232 Cable	25.00
Monitor Cable	25.00
Thermal Paper	4.00
Master Disk	21.95
5 Blank Disks	16.00
Word Processor	95.95
Inv. Prog. 1	15.95
Conversational French	39.95
Conversational German	39.95
Conversational Spanish	39.95
Conversational Italian	39.95
Music Composer ROM	35.95
Touchtype	15.95
Calc/Tor	24.50
Graphit	13.95
Statistics	13.95
Eng. Czar	9.50
Hangman	9.95
Kingdom	9.95
States and Capitals	9.95
States Europe	9.95
Scram	17.50
Telelink ROM	19.95
Asteroids ROM	35.95
Base/Ball ROM	29.95
Blackjack	9.95
Chess ROM	29.95
Missile Command ROM	35.95
Space Invaders ROM	29.95
Space Invaders	12.95
• Star Raiders ROM	
Super Breakout ROM	35.95
Assembler Editor ROM	39.95
Pilot ROM	79.95
Microsoft Basic	59.95

## PRINTERS

### Epson - Spring Special

MX80 T Newtype 2	390.43	58.57	449.00
MX80 FT/1	346.95	52.05	399.00
MX80 FT Newtype 2	390.43	58.57	449.00
MX100	564.34	84.66	649.00

### Epson Interfaces

Epson/Sharp Cassette	65.00	9.75	74.75
Epson/Sharp Disk	120.00	18.00	138.00
Epson/Apple	85.00	12.75	97.75
Epson/TRS 80 Bus	59.00	8.85	67.85
Epson/TRS 80 Expansion	25.00	3.75	28.75
Epson Ribbons	7.00	1.05	8.05
Epson MX100 Ribbons	8.50	1.28	9.78

• Microline 80	270.00	40.50	310.50
• New Microline 82A	395.00	59.25	454.25
Microline 80 Tractor	45.00	6.75	51.75
Diplomat Card (Apple-Microline)	85.00	12.75	97.75
Microline Ribbons	2.25	0.34	2.59

### Seikoshia

• Seikoshia GP80A	195.00	29.25	224.25
• Seikoshia GP80D (for MZ-80)	252.13	37.82	289.95
• Seikoshia GP100	215.00	32.25	247.25

### Seikoshia Interfaces

Seiko/Apple	59.00	8.85	67.85
Seiko/Pet	59.00	8.85	67.85
Seiko/Video Genie (EG3016)	33.00	4.95	37.95
Seiko/RS232	79.00	11.85	90.85
Seiko/TTL Serial	43.00	6.45	49.45
Seiko/IEEE 488	59.00	8.85	67.85
Seiko/Sharp (Disk)	59.00	8.85	67.85
Seiko/Ribbons	4.00	0.60	4.60
Seiko Paper 8 1/2" X 11" 2000 Sheets	12.00	1.80	13.80
Paper Delivery	3.00	0.45	3.45

## VIDEO MONITORS

	NETT	V.A.T.	TOTAL
<b>BMC 12" Green - Spring Special</b>	<b>120.86</b>	<b>18.14</b>	<b>139.00</b>
New 12" Green Screen	125.00	18.75	143.75
VM129 12" B/W	183.00	27.45	210.45
VM906 9" HI-RES B/W	150.00	22.50	172.50
VM910 9" B/W			
	125.00	18.75	143.75
9" B/W Monitor	85.00	12.75	97.75
Cables	5.00	0.75	5.75

### Colour Monitors 14" New!

## Terms & Conditions

**Our Conditions of Business**  
In addition to cash we accept Access, Barclaycard, Stereo Club, American Express, Diners Club and cheques covered by a bankers card.  
Official orders welcome - please contact your nearest Laskys store.  
All previous Laskys Advertisements are superseded by this. Not all stores carry every advertised item.  
Prices correct at time of going to press. E & OE.  
**A Better Guarantee**  
The products are warranted against defects in material and workmanship for a period of one year from the date of purchase, two years for Apple and Sharp products.  
During the warranty period, the company will repair (or at its own option replace) at no charge, components that prove defective. This is provided the product is returned, shipping prepaid, or by person, stating when it was bought and enclosing proof of purchase.  
This warranty does not apply if, in the opinion of the company, the product has been damaged by accident, misuse or misapplication.

## The Memory

Guaranteed quality - thousands already supplied. Any faulty chips should be returned to us within 12 months of purchase with proof of purchase for replacement by return of post.

4116 **66p + V.A.T.** 200 nanoseconds  
2114 **Low power 300 nanoseconds**  
**100p + V.A.T.**



## AT LASKYS



# MAKE FRIENDS WITH A MICRO

PRICES  
MARCH/APRIL 82

AT LASKYS

## MZ-80K SPECIAL OFFER!

A proper full size microcomputer for less than the real cost of a toy microcomputer. The Sharp comes with 48k of RAM and the screen and cassette are built in, instead of being expensive extras.



2 year parts and labour guarantee on all Sharp products supplied by LASKYS

Nett 347.00 VAT 52.00 Total 399.00

NEW!

## PC 1500 Pocket Computer

A new upgraded pocket computer with expanded capacity and greater convenience for use in business, management, engineering and hobbies.

PC 1500 New Pocket Computer . . . . . 169.95  
CE 150 4 pen printer/plotter . . . . . 149.95



## SHARP MZ 80B



MZ 80K	NETT	V.A.T.	TOTAL
MZ 80K Computer 48K . . . . .	347.00	52.00	399.00
MZ 80FD Dual Disks . . . . .	560.00	84.00	644.00
MZ 80P3 Dot Matrix Printer . . . . .	365.00	54.75	419.75
MZ 80F I/O Disk Interface . . . . .	52.00	7.80	59.80
MZ 80 FMD Master Disk and Manual . . . . .	20.00	3.00	23.00
MZ 80 F15 Disk Cable . . . . .	8.00	1.20	9.20
MZ 80 FO5 Extra Disk Cable . . . . .	7.00	1.05	8.05
MZ 80 I/O Expansion Box . . . . .	96.00	14.40	110.40
MZ 80 BM Basic Manual . . . . .	6.60		6.60
MZ 80 TIOB Basic Tape . . . . .	9.50	1.43	10.93
MZ 80 T20C Machine Language . . . . .	18.00	2.70	20.70
MZ 80 TU Assembler . . . . .	36.00	5.40	41.40
MZ 80 I/O-1 Universal Interface Card . . . . .	40.00	6.00	46.00
MZ 8T70 AE FDOS for MZ 80K . . . . .	67.00	10.05	77.05
MZ 8T70BE Basic Compiler for MZ80K . . . . .	40.00	6.00	46.00
MZ 8T40E Pascal for MZ80K . . . . .	40.00	6.00	46.00
MZ-80 DPK - Double precision Basic . . . . .	38.00	5.70	43.70

## New MZ80K Cassette Software

	NETT	V.A.T.	TOTAL
WDPRO - Professional Word Processor . . . . .	39.13	5.87	45.00
Appola - Word Processor . . . . .	24.95	3.75	28.70
Cassette Database . . . . .	29.47	4.43	33.90
ZEN Editor/Assembler . . . . .	19.47	2.93	22.40
ZEN MOD . . . . .	10.43	1.57	12.00
CESIL III . . . . .	14.95	2.25	17.20
Music Composer/Editor . . . . .	10.43	1.57	12.00
Camelat . . . . .	5.47	0.83	6.30
Cosmecad 12K . . . . .	8.00	1.20	9.20
Home Budget . . . . .	5.47	0.83	6.30
Space Invaders . . . . .	5.47	0.83	6.30
Star Trek . . . . .	5.47	0.83	6.30
UFO . . . . .	5.47	0.83	6.30

## PC1211

	NETT	V.A.T.	TOTAL
PC1211 Pocket Computer . . . . .	69.52	10.43	79.95
CE121 Cassette Interface . . . . .	11.00	1.65	12.65
CE122 Printer/Cassette Interface . . . . .	60.86	9.13	69.99
CSR700 Paper Rolls (40) . . . . .	5.00	0.75	5.75
EA 800R Ink Ribbons . . . . .	1.80	0.27	2.07

MZ 80B	NETT	V.A.T.	TOTAL
MZ 80B Computer 64K . . . . .	1095.00	164.25	1259.25
MZ 80 FD Dual Disks . . . . .	560.00	84.00	644.00
MZ 80 P5 Dot Matrix Printer . . . . .	387.00	58.05	445.05
MZ 80 P6 Dot Matrix Printer . . . . .	440.00	66.00	506.00
MZ-8BP51 - P6 Interface . . . . .	30.00	4.50	34.50
MZ-8BP5C - P6 Cable . . . . .	24.00	3.60	27.60
MZ 80 FI Disk Interface . . . . .	94.00	14.10	108.10
MZ 80 MDB Master Disk and Manual . . . . .	30.00	4.50	34.50
MZ 80 F15 Disk Cable . . . . .	8.00	1.20	9.20
MZ 80 FO5 Extra Disk Cable . . . . .	7.00	1.05	8.05
MZ 80 BJC Disk Cable Jainter . . . . .	15.00	2.25	17.25
MZ 80 EU Expansion Box . . . . .	47.00	7.05	54.05
MZ 80 GMK Graphics Option . . . . .	112.00	16.80	128.80
MZ 80 I/O-2 Universal Interface Card . . . . .	40.00	6.00	46.00
MZ 80 T10C K-B Converter . . . . .	7.00	1.05	8.05
MZ 8 BD02 FDOS for MZ 80B . . . . .	67.00	10.05	77.05
MZ 8 BT03 Basic Compiler for MZ 80B . . . . .	40.00	6.00	46.00
MZ 8 BT02 Pascal for MZ 80B . . . . .	40.00	6.00	46.00
MZ-80 DPB - Double Precision Basic . . . . .	38.00	5.70	43.70

**You can buy a Sharp MZ80K for as little as £17 per month through Laskys Stereoclub!**

the handy way to buy, from Laskys. Multiply your monthly payment by 24 to find out your credit limit! For instance, for the minimum monthly payment of £5 you would get credit up to £120. In some cases you may be able to get instant credit by paying a deposit of 10% of a purchase price. Current Stereoclub interest rate is 2.75% monthly, equivalent to an APR of 33.5%. Rates may vary, finance by Unicredit!

If you pay by Bankers' Order, apart from the extra convenience, you'll enjoy a LOWER INTEREST RATE - currently 2.45% monthly, equivalent to an APR of 33.2%.

As a Stereoclub member, we'll send you regular news and literature from Laskys. Laskys' Stereoclub is probably the best thing that's happened to Microcomputers since the invention of the chip!



**MICROCOMPUTERS**  
AT LASKYS

# MAKE FRIENDS WITH A MICRO

PRICES  
MARCH/APRIL 82

AT LASKYS

2 year parts  
and labour  
guarantee on all  
Apple products  
supplied by  
**LASKYS**

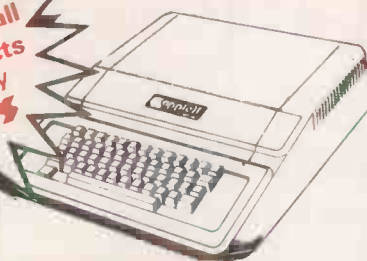

## APPLE II + 48K £799.00 inc. V.A.T.

### APPLE

	NETT	V.A.T.	TOTAL
• Disk Drive Plus Controller*(3.3)	375.00	56.25	431.25
• Disk Drive	295.00	44.25	339.25
DOS 3.3 Upgrade	39.00	5.85	44.85
Autostart Rom Pack	33.00	4.95	37.95
Graphics Tablet	485.00	72.75	557.75
Apple Tel System	575.00	86.25	661.25
Pascal Language System	245.00	36.75	281.75
Applesoft Firmware Card	95.00	14.25	109.25
Integer Card	95.00	14.25	109.25
Language Card	97.50	14.63	112.13
Apple Pilot	79.00	11.85	90.85
Apple Fortran	105.00	15.75	120.75
Apple Prototype/Hobby Card	12.00	1.80	13.80
Vera Prototype/Hobby Card	10.00	1.50	11.50
Parallel Printer Interface Card	87.50	13.13	100.63
Communications Card	103.00	15.45	118.45
High Speed Serial Interface Card	94.75	14.21	108.96
Centronics Card	103.00	15.45	118.45
Controller Card	100.00	15.00	115.00
• Eurocolour Card	69.00	10.35	79.35
IEEE 488 Interface	230.00	34.50	264.50
Thermal Paper for Silentye	2.75	0.41	3.16
Vinyl Carrying Case	16.00	2.40	18.40
Apple Ties	6.00	0.90	6.90

## LASKYS SPRING SPECIALS!

	NETT	V.A.T.	TOTAL
Omnivision	185.00	27.75	212.75
16K RAM Card (48K-64K)	69.48	10.42	79.90
Z80 Soft Card	173.04	25.96	199.00
Silentye Printer	195.65	29.35	225.00

### APPLE III

	NETT	V.A.T.	TOTAL
Apple III	2520.87	378.13	2899.00
Disc III	381.74	57.26	439.00
Pro-file	2251.30	337.70	2589.00
Silentye III	216.52	32.48	249.00
Universal Parallel Interface	134.78	20.22	155.00
Pascal III	146.96	20.04	169.00
Visicalc III	146.96	20.04	169.00
• Mail List Manager	86.09	12.91	99.00
Vinyl Carry Case	47.83	7.17	55.00

## MICROCOMPUTERS

AT LASKYS

### APPLESOFTWARE

	NETT	V.A.T.	TOTAL
• Micro Modeller	425.00	63.75	488.75
• Visicalc (3-3)	105.00	15.75	120.75
Visidex	110.00	16.50	126.50
Visiplot	98.00	14.70	112.70
Visi Trend/Plot	140.00	21.00	161.00
Visi Term	82.00	12.30	94.30
Desktop Plan II	110.00	16.50	126.50
CCA Datamanagement	56.00	8.40	64.40
• D.B. Master V.2.4.	105.00	15.75	120.75

#### Word Processing

Apple Writer	39.00	5.85	44.85
Magic Window Text Editor	49.00	7.35	56.35
Easywriter (80 Col.)	155.00	23.25	178.25
Mailmerge (80 Col.)	68.50	10.28	78.78
Easywriter (40 Col.)	51.30	7.70	59.00
The Address Book	27.00	4.05	31.05

#### Games/Aids

Animation Pac	31.00	4.65	35.65
Saturn Navigator	15.00	2.25	17.25
Higher Graphics II	20.50	3.08	23.58
Higher Text	20.50	3.08	23.58
3D Super Graphics	22.25	3.34	25.59
Apple World	33.00	4.95	37.95
Memory Management System	25.25	3.79	29.04
Alien Rain/Typhoon	15.43	2.32	17.75
Sneakers	16.30	2.45	18.75
• Gorgon	16.30	2.45	18.75
Galaxy Wars	14.28	2.14	16.42
Raster Blaster	16.30	2.45	18.75
A.B.M.	15.22	2.28	17.50
Falcons	16.30	2.45	18.75
Pegasus II	17.17	2.58	19.75
Space Raiders	16.30	2.45	18.75
Mychess	23.00	3.45	26.45

### HEWLETT PACKARD

#### HP-80 Series Mainframes

HP-83 Computer	1486.35	222.95	1709.30
HP-85 Computer	1816.52	272.48	2089.00
16K Memory Module	164.35	24.65	189.00

#### ROMS

Input/Output ROM	199.77	29.97	229.74
Assembler ROM	199.77	29.97	229.74

#### Interfaces & Accessories

HP-IB	260.94	39.14	300.08
RS232 Serial Int.	260.94	39.14	300.08
GP-IO	335.21	50.28	385.49
BCD	335.21	50.28	385.49
Parallel Printer Int.	199.77	29.97	229.74

#### Plotter & Accessories

Plotter	1619.00	242.85	1861.85
Personality Module	496.00	74.40	570.40
Vinyl Carrying Case	151.80	22.77	174.57

#### Printers & Accessories

Printer Impact	637.81	95.67	733.48
Printer Line	2611.00	391.65	3002.65
Printer Stand	227.00	34.05	261.05

#### Application packs

Graphics Presentation	135.44	20.31	155.75
Visicalc Plus	135.44	20.31	155.75
Surveying	135.44	20.31	155.75

#### Flexible Disc Unit

Dual Master (540K bytes) 5 1/4" Disk	1693.00	253.95	1946.95
Dual Add-On (540K bytes) 5 1/4" Disk	1489.84	223.48	1713.32
Single Master (270K bytes) 5 1/4" Disk	1015.80	152.37	1168.17
Single Add-On (270K bytes) 5 1/4" Disk	858.78	128.82	987.60
Dual Master (2400K bytes) 8" Disk	4515.00	677.25	5192.25
Dual Add-On (2400K bytes) 8" Disk	3821.00	573.15	4394.15
Single Master (1200K bytes) 8" Disk	3299.00	494.85	3793.85
Single Add-On (1200K bytes) 8" Disk	2605.00	390.75	2995.75

#### Graphics Tablet

Graphics Tablet	1355.00	203.25	1558.25
-----------------	---------	--------	---------



In these pages Brian Reffin Smith keeps you up to date with computer-based art and design and lays the foundations for graphics routines to use on your own micro.

## The direct route

THE BBC's computer-literacy series *The Computer Programme* is already well under way, and you may already have seen programme 6 on graphics and sound, with which I was involved as a technical consultant. It will be shown again on BBC-1 at 11.35 pm on Monday April 26.

### Convincing proof

The programme should provide a convincing demonstration for any doubters you may know who still believe that computers are confined to number-crunching and text. After all, simple graphics are a much simpler route from the machine into the human brain — and the possibilities of sound have hardly been explored yet. This month's competition may encourage you to change that lamentable state of affairs.

For now, let us merely celebrate the fact that the high-resolution graphics on

the BBC Microcomputer go up to 640 by 256 points in two colours. You need maximum memory to handle it, and a monitor rather than a TV for a proper display, but at least we do have something which begins to live up to the description "high-resolution".

It is absurd to call a display of around 100 units square "high-resolution", as some manufacturers do, and those nasty little graphics characters are no help either. To anyone seriously interested in computer graphics, a display of less than 256 by 256 is low. You really need 512 by 512, and a monitor to display it on.

For storage, laser videodiscs may seem rather exotic, but they will eliminate videotape recorders quite soon. At present, you can only play them, not record, but for less than £1,000 you can get your own disc made up from film, videotape, colour slides or photos which you supply. Pressings then cost about £3 each.

A popular disc player is not available in the U.S for less than £500. As for the U.K. market, if I were cynical, I would think the manufacturers were trying to sell us all videotape machines before introducing discs. On each side of a mundane disc, you can store 54,000 colour images — heaven knows how many megabytes of data. A project at the Royal College of Art connects a disc machine up to a computer, able to call up or run any sequences from an art and design visual database of thousands of images.

### Canada exhibition

Finally, an invitation. I have organised a show of Canadian artists and musicians who use computers, at the Canada House Gallery, Trafalgar Square, London. Opening on March 24, it continues daily, except Saturday, for about a month. There will be the work of several artists, including graphics, paintings, robots and video, all done by, with or in spite of computers. M

## Competition

THIS MONTH'S competition — the one with fame and a fiver as the exhilarating spurs to excellence — is about sound. I know that many computers do not make sounds, and that those that do use a wide variety of commands to control them. But that does not matter because we only want a short description — an algorithm in words — of how to do something.

Think about how to use sound instead of, or as well as, graphics to present information to a user. The sort of information could be trends, quantities, qualities — the kind of thing a business person or manager might need. You can choose any context, from education to ICI, from a small business to a hospital.

In less than 200 words, explain how a computer could use sound to replace or to enhance other information. The address is Art, *Practical Computing*, Room L306, Quadrant House, The Quadrant, Sutton, Surrey, SM2 5AS. As usual, do not send anything you want back; and no tapes, please. M



### BEGINNING GRAPHICS

## Round in circles

SO FAR we have looked, in quite simple terms, at the way in which images are stored and manipulated in the computer. We have seen that images are related to an internal symbolic representation which is held inside the machine and can be manipulated there, thus changing the image that is the resulting output.

This month, for a change, we look at how a simple routine for drawing circles can be expanded into a more general program. You will see that there is a metaphor here: you can quite often get a routine from a magazine like this, or a

book, or from a friend, and adapt it to do something that seems to go way beyond

(continued on next page)

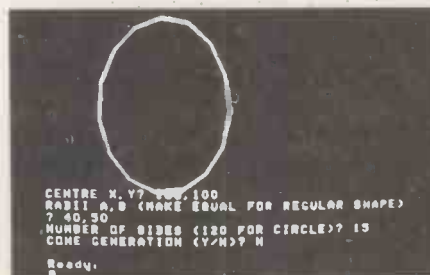

```

100 REM***POLYGON DRAWING WITH CONE FORMATION - B.R.SMITH 1982
110 CALL"RESOLUTION",0,2: REM*** SET UP GRAPHICS
120 PUT12: REM***CLEAR SCREEN
130 INPUT"CENTRE X,Y";HS,VS
140 INPUT"RADI A,B (MAKE EQUAL FOR REGULAR SHAPE)";A,B
150 INPUT"NUMBER OF SIDES (120 FOR CIRCLE)";N
160 INPUT"CONE GENERATION (Y/N)";ZC$: IFZC$="N"THEN180
170 INPUT"POINT OF CONE X,Y";PX,PY
180 ANGLE=2*3.142/N
190 C=COS(ANGLE):S=SIN(ANGLE)
200 XA=1:YA=1
210 FORI=1TON+1
220 X=XA*C-YA*S
230 Y=XA*S+YA*C
240 XA=X:YA=Y
250 IF I>1 THEN P$="LINE" ELSE P$="PLOT"
260 CALL P$,A*XA+HS,B*YA+VS,3
270 IF ZC$="N" THEN 290
280 CALL"LINE",PX,PY,1: CALL"PLOT",A*XA+HS,B*YA+VS,16
290 NEXT I

```

(continued from previous page)

the original intention. It is the way many graphics programs and routines emerge.

The whole story is in the program listing. A simple circle routine at lines 180 to 290 has been expanded first to draw ellipses, then to draw polygons of any number of sides, then to draw cones. The circle routine was, itself, first developed from a polygon-drawing routine.

Lines 220 and 230 simply generate each new point from the last one, using a few sines and cosines. Line 260 adds on HS and VS, the horizontal and vertical shift, give the centre of the figure, having multiplied the X and Y points by A and B to give the two radii of the ellipse. Make them equal, and you get a circle — or a regular polygon, if using less than about 120 sides, entered at line 150.

The program was written on the Research Machines 380-Z — which has a screen of about 300 by 200 pixels, with the origin at bottom left. If you operate another computer you need only plot points and lines, with any resolution. Line 260 plots a point when I is 1; otherwise it draws a line to the new point from where you were before. The third parameter to the plot commands — 3, 1 or 16 — merely give the colour; 16 means no line.

### Mustering courage

If you answer "Y" to the question at line 160 — you do want cones — then line 280 draws from each point on the "rim" of the circle or polygon to a fixed point, entered at 170, which becomes the tip of the cone. The second half of line 280 moves back to the rim, but without drawing a line, and is thus ready to connect up the next part of the rim.

If you are feeling courageous, try writing a program that will draw two polygons, each with the same number of sides, and will connect each point on the first to the corresponding point on the second. In other words, if you use four-sided, regular polygons — otherwise known as squares — you end up with a box. Beware of jumping in and out of loops. □

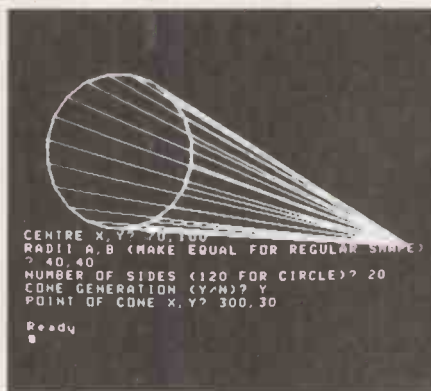

## ANALOGY BOX

Conceptual art, in its heyday in the 1960s, was "art about art", which often consisted of words and diagrams or descriptions. One masterpiece was a framed message, black on white, reading "This is not a Work of Art", another consisted of a radio wave — invisible, of course — beamed through a gallery at a certain time on a certain day, or so they said. What is the computer-graphics equivalent of this sort of art?

## Book choice

WHEN PEOPLE ask for advice on books about computers and art, or just computer graphics, I have to tell them that there are very, very few books on either topic which are any good at all. Most of them are expensive too. You are likely to gain at least as much knowledge from the pages of computer periodicals as from many books. However, there are a few which are worth having, and if the cost seems prohibitive, you could ask your library if Mrs Thatcher has left them any money for a book that is, after all, related to her Information Technology Year.

Strictly in the library class, or at least a group purchase, is *Visual Art, Mathematics and Computers*, edited by Frank J Malina and published by Pergamon Press, Oxford in 1979. It is big, wide-ranging, and costs, believe it or not, £31. It consists of reprints, over several years, from the journal about art, science and technology called *Leonardo*. I cannot think of any existing book that is more likely to stimulate the imagination. Though short on techniques as such, it is long on ideas and has plenty of pictures.

Then there is an excellent book edited by David Clark, who works in the audio-visual centre at London University. Called *Computers for Imagemaking*, it is, for the most part, simply presented. Yet if

you digest it thoroughly, you will know as much as most people about the area it covers. It deals with technical, practical, theoretical and psychological aspects of computer graphics. The paperback edition costs £6.50. It was published in 1981 by Pergamon Press.

*Mathematical Elements of Computer Graphics* by D F Rogers and J A Adams is a superb book crammed with routines, and with an appendix of Basic listings. However, it does become very advanced, and assumes that your Basic can manipulate matrices; certainly a book to aspire to. It is an import from the United States, published by McGraw-Hill at £12.95.

### Expensive items

I realise that all these titles are quite expensive items, but there is really no point messing around with anything inferior. You might get together with some friends to share a copy — something which we do not do enough.

Finally, for the purists, there is Newman and Sproull's computer-graphics bible, *Principles of Interactive Computer Graphics*. Personally I find it hard going, though many people swear by it. The second edition, published in 1978 by McGraw-Hill Kogakusha, costs £9.95 in paperback. □



# THE PROFESSIONAL'S CHOICE

## Act Sirius 1

16 Bit Stand Alone micro with superb features. 128K, 1.2MB Floppies, CPM86 as standard - £2395.

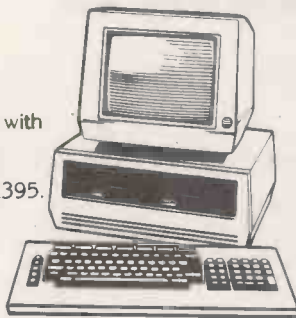

## Altos

Up to 4 terminals and 40MB of Winchester Disc. One of the biggest selling small business systems starting at £2350.



16 Bit system with 8 terminals available soon.

## OKI 1F800

Quality graphics micro with full colour screen and integral printer. 64K and Basic are standard - £4750. Wide range of peripherals available.

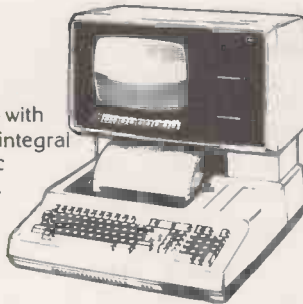

## LSI M3

High specification Stand Alone micro. CPM, 64K and up to 10MB of Winchester in one package. Very easy to use. Detachable keyboard. User programmable function keys. From £2250.

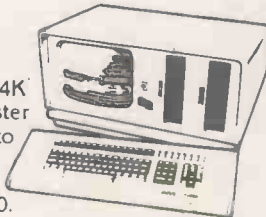

## Superbrain

Still a leader in 8 bit price performance. KGB having sold over 400 Superbrains has unbeatable experience on them. From £1875.



## Word Processing - Wordstar £250, Mailmerge £75.

Full on-screen facilities enabling the printing of standard letters and preparation of mail shots.



## Accounting - From £300 per module.

Integrated accounting systems with Invoicing, Sales, Purchase and Nominal Ledgers.



## Financial Modelling - Micromodeller £645.

Budgets, forecasts and accounting data become easy to prepare. Allows "what if" projections.



## Calculation - Supercalc £175.

Electronic worksheet for preparation of budgets and tables of data.



## Record Keeping - DMS £400.

Personnel, stock or any other records with quick retrieval, sorting and reporting.



## Sales Office Management - Sales Desk £300.

For the busy sales office to manage sales leads and marketing lists.



## Accounts - IRIS £750.

Incomplete records and time recording systems.



## Payroll - Graffcom £500.

Up to 500 employees both weekly and monthly paid. Automatic deduction for items like company pensions.



## Graphics - Price depends on application.

Full on-screen graphics both colour and black and white.



## Engineering - SPERT £450.

Suite of programmes for PERT analysis and civil engineering applications.



## Communications - Liberator £250.

Enables a micro-computer to act like a mainframe terminal and transfer data from Floppy disc to another computer.



## Languages - From £175.

Most major computer languages are available: Basic, Cobol, Fortran, Pascal and Assembler.



## Solicitors - Solace £1600.

Solicitors accounting, client accounting and time recording.



## Multi-terminals - MP/M and Oasis from £350.

Multi-user systems available.



# KGB

## MICROS LIMITED

14 Windsor Rd. Slough, Berks. Tel: Slough (0753) 38581/38319

# THE PERFECT MACHINE

"Garbage in, garbage out", muttered Amadeus. Above him the main frame of the rotating Analyser trembled slightly, and he watched as one green ball dropped in a gentle arc, popped like a heavy pea from its churning mechanical pod, to land on and crack the stone flags near his feet. It rolled a short distance and stopped. A second ball did the same.

The great wooden machine did not stop, however, but began in its insistent way to pull one of its bearings from the massive wall. Amadeus looked up sadly as the bearing wobbled and a tiny trickle of dust fell twenty feet to the floor.

Fifty feet above him a stone gallery spanned the great hall, clearing the moving wooden structure by inches. Sullivan was up there, his signalling arms silhouetted against the roof lights, his mouth open but his words lost in the roar from the rotating machine.

Amadeus pulled the stop lever and the great contraption began to slow as Sullivan clanged down his long iron ladder. They stood for a moment in the shadows cast by the tilting beams and watched as the machine came to a standstill. Sullivan broke the silence.

"The same bearing as before, Doctor?"

"Yes, the same".

Sullivan nodded to the few overalled workmen standing by and the offending section was dismantled. Long bolts clanged to the ground, timbers were noisily disassembled, and a hammering began that echoed around the hall.

At the same time Bishop Widred and his entourage entered down the main stone staircase. The entourage sniffed at the dust and the noise. The bishop adjusted his crimson cloak and looked displeased. "Another bearing problem, my Lord", called Amadeus, half turning but more interested in the work than the bishop's presence. The entourage managed to project a communal stare of disapproval across the hall while the bishop spoke.

"We must have results, Amadeus, and we must have them soon. I am under considerable pressure from the rest of the College. They are talking of withdrawing funds. You know it goes against the grain with them to investigate such matters. Your experiments have aroused great controversy". The bishop stared into the dark shadows of the Analyser. The workmen's hammering continued to echo. After a pause he spoke again.

"Perhaps the others are right after all. Perhaps this is heresy".

Amadeus interrupted.

"It is not heresy, my Lord, and it will work. I know it will".

"Yes. Yes. I understand your enthusiasm but —". The entourage behind him looked sufficiently sceptical.

Bishop Widred walked slowly towards the workmen, who hammered less loudly in deference to his presence but did not look up.

"Tell me again, Amadeus", he called without turning, "Tell me what it is that you seek".

Amadeus spread his arms towards the Analyser and explained.

"The main frame. This large outer one.

---

by David Haynes

---

It spins on axes that are fixed in the structure of the building. The angles of rotation are adjustable. Within this we have other frames which become progressively smaller like a nest of dolls. These inner frames vary in shape according to calculations made by me, and they are linked by adjustable axles one to another. They turn easily on their bearings. The angle of pivot and the gearing of one frame to another are calculated and fixed before each run. That is a skilled adjustment which Sullivan takes care of".

The bishop nodded and asked him to continue.

"Well, my Lord, within the whole structure run channels, tubes and hatchways which we can preset as well. The machine is turned by a steam engine under the floor, and once the correct speed of rotation is reached, Sullivan inserts the spheres at the top. After a while, if we are lucky, the spheres eventually drop into this cage here", he pointed, "where the numbered troughs indicate the answer".

"Yes, yes. The answer. But what is the question, Amadeus?"

"There are numbers which we use every day, my Lord. Numbers of this world such as 1, 2, 3, 7, 9, and so on. They account for real things. We assume that they go on for ever. There are also negative numbers. We use these often in calculations".

Amadeus bent down and lifted the green ball from the floor. It was the size of a baby's head.

"We colour the spheres to represent

individual numbers. Some green, some red. Many, many colours and combinations of colours. You can see some of these lying around on the floor. They are definite numbers. What we seek are numbers that seem somehow more real than these and yet continue to remain unknown. They must have a precise value and yet they remain imprecise within our numbering system. They slip through the nets fashioned by our minds, and yet within nature they are basic. As though our way of counting things is based on the wrong system to start with. This great machine has been designed to find such numbers".

"Give me an example, Amadeus".  
"The most needed number is that relating to the truths regarding circles and spheres".

"Religious truths"?

"I believe that truths will always lead to God, certainly".

"But you will never find God in that way, Amadeus". The bishop looked hard at him.

"I can try, my Lord."

"You believe that you can measure Him with numbers"? the bishop asked. "In any case we know the number that you seek. It has been established as a standard by the Church for many years".

"But the standard is not exact. There is more to learn of this number's nature. Men should know such things. We must make the attempt".

"If you would pin God down to a number, then that is heresy, Amadeus".

"I seek only the truth about the world. Let me continue to try — just one more attempt my Lord".

The workmen had reassembled the frames. The bishop stared for a while at the dark oil stains that they had left on the floor. Without looking up he nodded.

Sullivan climbed to his crow's nest and began to assemble the coloured balls in their delivery hopper, while Amadeus pulled a lever to start the steam engine. The floor rumbled as the drive spindle turned. A second lever was pulled and the main frame began to turn. The noise grew louder. Dark shadows from the massive timbers of the outer structure moved jaggedly around the walls, and the light from the roof scattered and broke into shards as the smaller frames and cages spun and tumbled within it. Sullivan released the cascade of coloured balls which rolled and banged, clattering through the ever-changing wooden maze



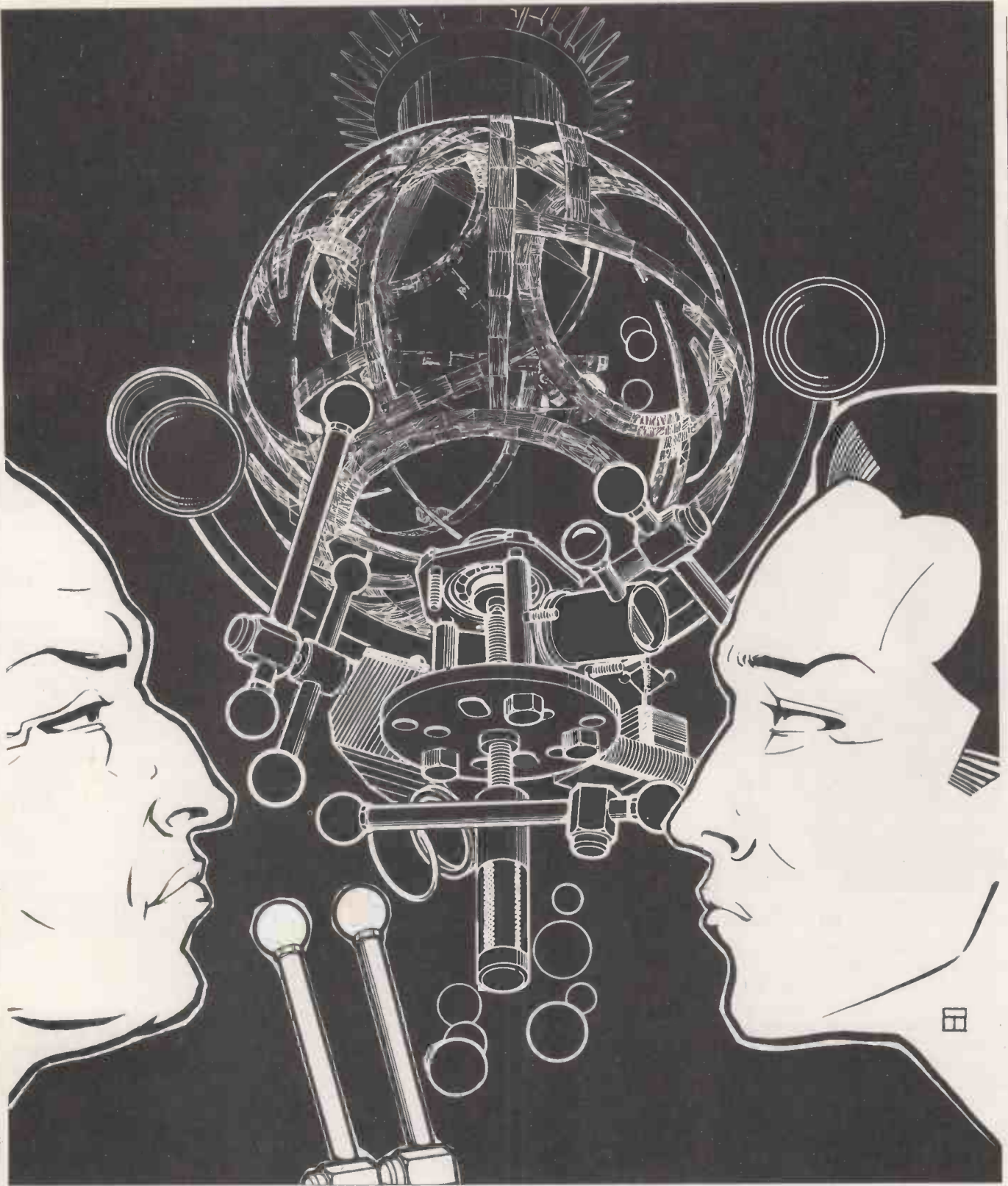

as it turned, strained bearings whining.

At last one ball fell into the counting troughs, then another, and another. With great excitement Amadeus crouched to note the results. More balls fell, heavily and noisily, and still others — and then no more.

Amadeus stood slowly and handed the paper to the bishop. The paper trembled in each man's fingers.

The bishop read aloud:

"3 and 1 4 1 5 9 2 6 5 3 5 8 9 7 9 3 2 8".

Both men began to laugh as Amadeus pulled the stop lever.

"You've done it, my boy? Is this it?"

Amadeus nodded, still smiling.

"You will need to run checks of course, but — this is wonderful news".

He beckoned to the entourage.

"We have done it! We have done it! I shall get an Archbishop's chair for this! Amadeus you're a genius".

But Amadeus had his eyes closed and was no longer listening. If we can apply these results, he was thinking, to improve the accuracy of the machine's bearings and rotating parts then we can achieve an even more accurate result. Then we can continue until we have a machine that is almost perfect. His smile broadened as he dared the thought that he could not utter. Why not a machine that *is* perfect? A machine that is never wrong?

Never wrong about anything? 

ONE OF THE most inimical environments imaginable for the microcomputer is on the farm: mud, moisture, unsympathetic use by horny-handed sons of toil to whom a tractor printer is likelier to evoke wheeled machinery than electronic. Nowhere would this seem to be truer than in the cowshed.

To the expected problems of human heavy-handedness are added those of bovine indifference. In a milking parlour, all machinery must be built to withstand regular washing-down with high-pressure hoses, frozen winter and scorching summer alike.

Nevertheless, dairy management is one of the biggest growth areas in on-farm computing, which itself is no mean performer in the systems-sales stakes. Where a year ago there were only six firms supplying agricultural systems and soft-

# 'Pastures new' for micros

**Martin Hayman, never afraid to get his boots dirty, visited ADAS's experimental farm to inspect its micro-based system, which actively monitors the health and performance of a large dairy herd.**

Advisory Service's Bridgets Experimental Husbandry Farm, near Winchester, Hampshire, is directed.

Borrowing some techniques from industrial process control, the National Institute of Agricultural Engineers, in collaboration with Ellesmere Electronics, has developed a system known as Automated Farm Management System for the 1980s (AFMS-80) to identify automatically each cow on its arrival in the milking stall, record its milk yield, deliver a pre-programmed quantity of feed into the manger, and to weigh the cow on its exit. These operations are managed by three dedicated microprocessors and a purpose-built micro based on a 54K Motorola 6800 processor with software developed by NIAE's Dr Allen Burgess.

The interfacing hardware between the cow and the micro is interesting. It was an important consideration that any system implemented should not require substantial modification of existing work practices based on the so-called "herringbone" milking parlour, not least because Ellesmere Electronics is a division of the milking-equipment manufacturer Fullwood and Bland which builds them.

The first obvious sign that this is no ordinary dairy operation is when the cows arrive for milking. Slung around their necks on a bright-yellow, plasticised ribbon is a blue box about the size of a large bar of chocolate. This is the cow's electronic identity card.

Each of these transponders, as they are known, can be programmed with one of 65,000 identities — enough for any conceivable herd, or aggregation of herds, since the system is eventually intended for distributed control of several farms via Modem-landline links.

The transponder is energised by a coil on the front of each manger and transmits its identity as a radio signal to the cow-identification processor and the milk-yield processor, alerting the latter to record the yield against the cow's identity number, and the former to deliver the appropriate predetermined quantity of feed for her. But how to persuade the cow to lower her head and eat and thus energise the whole system? Elementary — a small quantity of feed is delivered to the manger as a "carrot".

The milk is weighed on a strain gauge and the figures for each individual cow's yield are recorded against its identity in the main farm-management system,



Agricultural officer Chris Laycock keys in a cow identity. The 40-character display reads out information from the management system.

ware, now there are more than 20 and their number is growing.

Dairying seems to have been one of the first areas of farming to receive concerted attention from computer people. Reading University's mainframe has had its Daisy herd-management program running for nearly 10 years, but it's not particularly useful to a farmer who essentially wants to eliminate some of the guesswork from his everyday business and has been told that this is the kind of task to which a computer is ideally adapted. A dairy herd of about 300 cows, can be said to be substantial. This is approximately the number of records that a medium-sized micro can manage comfortably, given that the information the farmer wishes to have about each beast is as follows:

- the quantity of milk delivered at each milking, hence
- the appropriate weight of feed it needs;
- its weight on leaving the milking parlour;
- details of pedigree, where it was purchased, veterinary records.

The first three items can be considered as monitoring programs, and will ideally be used on-line; the last is more of a database system and can be expanded according to the way the farmer wishes to manage his herd.

In human terms, the problem of implementing such a system, which from a purely computing point of view seems not so difficult, is input of data. How do you identify an individual cow, measure its milk yield, mete out the right quantity of feed into its manger, and weigh it as it exits from the milking parlour, and at the same time enter all that data into the micro?

It is impracticable to have cowmen in their white aprons — the only people who become intimate enough with each cow to read the freeze-brand number on its rump — dashing in and out of the messy work area to key details into a keyboard. It's clearly a case for automatic data collection, and this is where the work at the Agricultural Development and



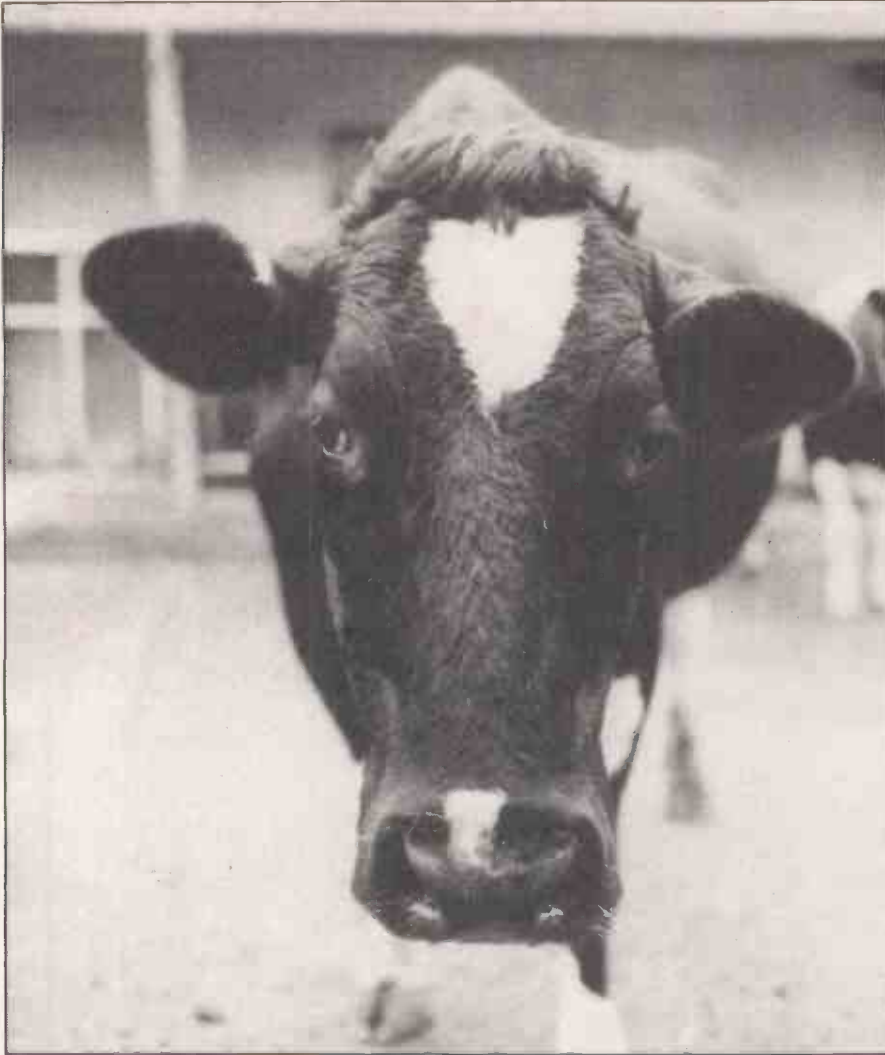

which is a conventional-looking micro away from the dairy parlour. Here the data can be printed out at the time of milking, and averaged to give a weekly mean. This part of the system is now working, with a 99 percent success rate in identity capture, says agricultural officer Chris Laycock.

Concurrently with the milk-weighing operation, the cow-identification processor signals the required balance of feed required by each cow to the gravimetric feeding hoppers and the rest of its dinner cascades down over its nose. In productivity terms, this is the single most important operation of AFMS-80.

Layout of the farm office.

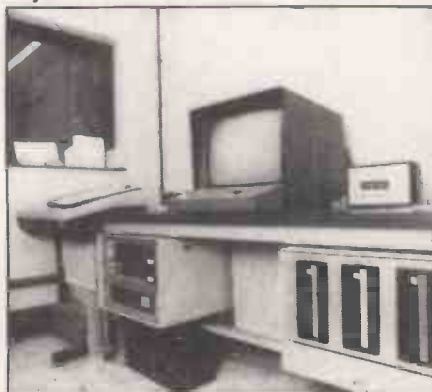

The traditional skill of the dairyman is to judge how much feed to give to a cow during its lactation period in order to obtain the best margin of return. A cow's milk yield grows and declines over a 10-month period, with two months drying-off, when it does not produce milk.

When Tess of the D'Urbervilles was a milkmaid, this was all done by the skill born of observation and experience. Now the farmer has immediately at his disposal the exact figures of each of the twice-daily milkings, and of the weekly mean. Further, any significant shortfall can help detect disease in the individual cow, or to assess the quality of feeds.

Chris Laycock showed me a weekly printout which indicated that average yields, for the week in which I visited, were down by around 15 percent for a substantial proportion of the herd. This was attributable, he says, to a change to a different feed silo with a rather poorer grade of silage. In an experimental farm such as Bridgets this is useful for test purposes; for the average dairyman, it represents an important step in improving his management judgement by putting more precise and useful information at his fingertips, and detecting illness as early as possible.

By contrast the weighing operation, which is undertaken as the cows leave the milking parlour, has attained only a 60 to 70 percent success rate. The processor is programmed, however, to reflect a figure with a variance in weight, after positive identification on the weighbridge, of greater than 30kg. Cows are not by nature unruly beasts but they cannot be trained to step up in an orderly human fashion, one by one, on to the weighbridge. Nevertheless, over the course of a week, the success rate attains 93 percent.

The farm's director, Edwin Mundy, enters the usual caveat with respect to micros used in a traditional field of activity: "It is reasonable to expect that if used intelligently, AFMS-80 should make parlour operation easier, but one could foresee difficulties if it is viewed with suspicion by any operator who is called on to work with it".

This is to say no more than that any computer-based system needs expert human skill. To this end there is a monitor in the dairy parlour itself, giving a 40-character, single-line display of prompts such as "Cow number y Dump Milk (mastitis)" and "Feeder number 4 failed". System fault conditions can then be rectified, either by hand, or by punching in data on the two keypads.

It also permits data to be entered or retrieved by hand. If, for example, the system fails to capture an identity, the dairyman would then enter by hand the freeze-brand number, which is twinned with the transponder's identity.

The most ambitious part of the AFMS-80 is the microcomputer station, which is in an office overlooking the dairy parlour at Bridgets, but might well be elsewhere, connected to a telephone line. Data gathered from both the automatic parlour equipment and the parlour-control equipment is stored on 8in. floppies, and further specific data may also be entered via the keyboard.

Obviously the database work has to be typed in manually — details of where the stock came from, of its pedigree, its medical history. Once at this point, herd data may be manipulated and processed in the conventional way.

One neat touch is the automatic digital clock which switches on the whole system ready to run — along with a memory test — at 4.30am. One of the interactive programs which should shortly be running is the Daily Events and Action List, which will highlight, via the parlour unit, those cows which need veterinary attention, cows due on heat, due to be served and due to calve.

AFMS-80 is still in its development, although many farmers have expressed a strong interest — the farm receives more than 5,000 visitors a year. With the increasing size of dairy herds and the cost of skilled hands, it is not surprising that automation has its attractions for forward-thinking farmers. □

# MAKE FRIENDS WITH AN ATARI AT LASKYS

**ATARI 400**  
**£345.00**



**ATARI 800**  
**£599.95**



## ATARI PRICES

	TOTAL
400 16K Computer	345.00
400A Computer	299.95
800 16K Computer	599.95
410 Tape Recorder	66.95
810 Disk Drive	365.00
822 Thermal Printer	265.00
825 80 Column Printer	550.00
850 RS 232 Interface	145.00
16K RAM Upgrade	65.00
Light Pen	45.00
Pair Paddles	12.00
Pair Joysticks	12.00
I/O Cable	12.95
Printer Cable	28.50
Interface Cable	25.00
RS 232 Cable	25.00
Monitor Cable	25.00
Thermal Paper	4.00
Master Disk	21.95
5 Blank Disks	16.00
Word Processor	95.95
Inv. Prog. 1	15.95
Conversational French	39.95
Conversational German	39.95
Conversational Spanish	39.95
Conversational Italian	39.95
Music Composer ROM	35.95
Touchtype	15.95
Calc/Tor	24.50
Graphit	13.95
Statistics	13.95
Eng. Czar	9.50
Hangman	9.95
Kingdom	9.95
States and Capitals	9.95
States Europe	9.95
Scram	17.50
Telelink ROM	19.95
Asteroids ROM	35.95
Bank/Ball ROM	29.95
Blackjack	9.95
Chess ROM	29.95
Missile Command ROM	35.95

	TOTAL
Space Invaders ROM	29.95
Space Invaders	12.95
Star Raiders ROM	35.95
Super Breakout ROM	35.95
Assembler Editor ROM	39.95
Pilot ROM	79.95
Microsoft Basic	59.95
Technical Notes	17.95
Operating System Lists	11.95
DOS Lists	3.95
DOS 2 Manual	5.95

**NOW OPEN AT...** **11 Shops Across the U.K.**  
7-9 Queensway (off Bayswater Road)  
London W2 3RX Tel: 051-229 6425

### Birmingham

19/21 Corporation Street, Birmingham, B2 4LP. Tel: 021-632 6303. Manager: Peter Stallard. 300 yards from Bullring Centre.

### Manchester

12/14 St. Mary's Gate, Market Street, Manchester, M1 1PX. Tel: 061-832 6087. Manager: Lesly Jacobs. Corner of Deansgate.

### Bristol

16/20 Penn Street, Bristol, BS1 3AN. Tel: 0272 20421. Manager: Steve Heynes. Between Holiday Inn and C&A

### Glasgow

22/24 West Nile Street, Glasgow, G7 2PF. Tel: 041-226 3349. Manager: David Livingstone. Between Buchanan Street and Central Station.

### Chester

The Forum, Northgate Street, Chester, CH1 2BZ. Tel: 0244 317667. Manager: Jeremy Ashcraft. Next to the Town Hall.

### Sheffield

58 Leopold Street, Sheffield, S1 2GZ. Tel: 0742 750071. Manager: Justin Rowles. Top of the Moor, opposite Town Hall.

### Edinburgh

4 St. James Centre, Edinburgh, EH1 3SR. Tel: 031-556 6217. Manager: Colin Droper. East end of Princes Street, St. James Centre.

### Liverpool

33 Dale Street, Liverpool, L2 2HF. Tel: 051-236 2826. Manager: Mark Butler. Between the Town Hall and Magistrates Courts.

### Preston

1/4 Guildhall Arcade, Preston, PR1 1HR. Tel: 0772 59264. Manager: Jim Comisky. Directly under Guild Hall.

### London

42 Tottenham Court Road, London, W1 9RD. Tel: 01-636 0845. Manager: Vass Demosthenis.



# MICROCOMPUTERS

## AT LASKYS

Laskys, the retail division of the Ladbroke Group of Companies

● Circle No. 160

PRACTICAL COMPUTING April 1982



Jonathan Bowen strikes out beyond our familiar, solid world with a program to generate projections of cubes of four, five and more dimensions.

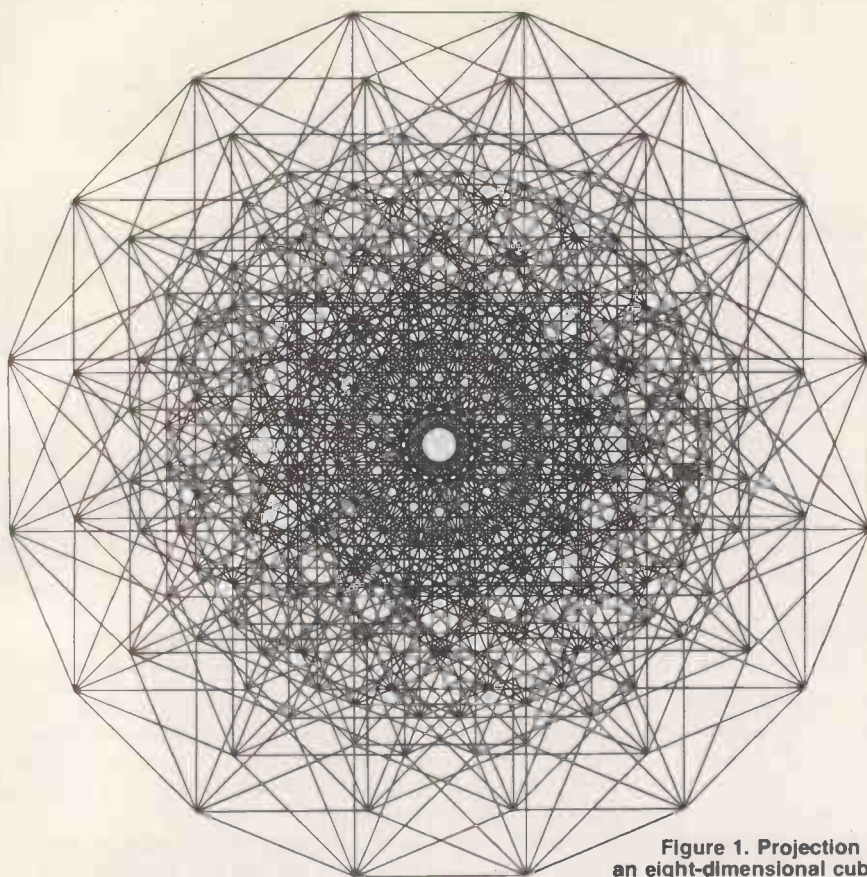

Figure 1. Projection of an eight-dimensional cube.

## HYPERCUBE

EVER SINCE the concept of a three-dimensional, physical world has been understood there has been a fascination with the possibility that there might be fourth, and further, dimensions. Henry More (1614-1687) considered that spirits have four dimensions. In *The Time Machine*, H G Wells suggested that the fourth dimension is time, which can be misleading since time is somewhat different from the other three, spatial dimensions we know.

Abbott's *Flatland* is probably nearer the mark, Abbott considers the life of a two-dimensional square which suddenly has the chance to travel in three dimensions. This gives the square the ability to see inside objects in its two-dimensional world, something it previously thought was impossible. Using this analogy from three to four dimensions, we would be able to see inside solid objects if we were able to break out of our own three-dimensional world into the fourth dimension.

Taking the analogy further, when a three-dimensional object crosses a two-dimensional world, its inhabitants simply see an object appear from nowhere, grow in size, changing its shape in a rather odd

manner if the object is irregular, and then decrease in size until it disappears again. In our world this would be the equivalent of an object suddenly appearing somewhere, growing in size, shrinking and then disappearing without trace. If this sounds disturbing it is because we do not fully understand the fourth dimension.

We may define a dimension as being a direction which is at right angles to any other dimension. In our world we simply run out of directions after we have defined three dimensions — length, width and height, for example.

### Added dimension

There is no reason why there should be anything special about three dimensions, apart from the fact that we live in a three-dimensional world. Thinking in terms of three dimensions is simply of the most practical use to us. We are quite willing to project three-dimensional objects into two dimensions when we draw or photograph them — again, this is because it is useful to us.

There is no reason why we may not project objects of more than three dimensions. Note that in this case we also have the choice of projecting them into

three dimensions if we wish. Probably the simplest and most interesting objects to consider for projection are "polytopes", which are geometrical figures bounded by portions of lines, planes or hyperplanes, for polytopes of two, three, and four or more dimensions respectively.

In two dimensions the polytope is known as a polygon and in three dimensions it is known as a polyhedron. For simplicity we shall restrict ourselves to regular polytopes in which all the vertices, edges, faces, etc. are the same. In two dimensions they are the equilateral triangle, square, regular pentagon etc. — there are an infinite number of them.

In three dimensions there are only five regular solids, known as the Platonic polyhedra: they are the tetrahedron, cube, octahedron, dodecahedron and icosahedron. A complete description of these and many other polyhedra may be found in *Mathematical Models* by H M Cundy and A P Rollett.

### Regular polytopes

In four dimensions there are six regular polytopes, five of which may be considered as the four-dimensional equivalents of the Platonic polyhedra. They are described in H S M Coxeter's *Regular Polytopes*. It turns out that the tetrahedron, cube and octahedron have similar equivalents in any number of dimensions.

A simple algorithm may be used to generate the polytope for the next dimension up in each case, and they may be projected in two dimensions. The cube was chosen here since it produces more interesting projections, with square rather than triangular sides. For those interested in investigating more complicated polytopes, Coxeter's *Regular Complex Polytopes* is recommended.

A cube of  $N$  dimensions may be generated from a cube of  $N-1$  dimensions in the following manner. Take the  $(N-1)$ -dimensional cube and redraw it, displaced by a distance equal to length of one of its sides along a new dimension. Join the corresponding vertices of each of the old cubes to form the new cube.

You can demonstrate the process by starting with a "cube" of zero dimensions. It consists of a single point, as does any zero-dimensional object. Displace the point along any dimension by a given distance — say a distance  $L$  from the origin along the  $X$ -axis, see figure 2. You now have a line of length  $L$  or a one-dimensional cube.

Next, displace the line a distance  $L$  along a new dimension — say the  $Y$ -axis — and join the corresponding ends as in figure 3. You have now formed a square, which is a two-dimensional cube.

Now expand along the  $Z$ -axis, join the

(continued on next page)

(continued from previous page)

corresponding corners, and form the standard three-dimensional cube — see figure 4.

By displacing the cube along a new axis — say the W-axis — and joining the corresponding vertices, you form what is generally known as a hypercube or four-dimensional cube — see figure 5. You may continue this process as many times as you wish to form a multidimensional cube of any given number of dimensions.

The listed program draws N-dimensional cubes. It was written for a Research Machines 380-Z microcomputer with high-resolution graphics, but could be adapted to run on any computer with Basic and a line-plotting facility of some sort. The number of dimensions that can be plotted is limited by the resolution of the plotting device. Above about eight dimensions the cube becomes too complex to be viewed on the 380-Z screen.

Other systems may be able to plot more or fewer dimensions than this. Below three dimensions the figure is no longer a true cube. The program draws the cubes symmetrically, so that above about four dimensions some very pretty and interesting patterns are produced — see figures 1 and 6.

The program works as follows. First the desired number of dimensions is read into the variable N in line 170. Lines 260 to 400 initialise the arrays XM and YM which contain the co-ordinate offsets necessary to plot each possible direction of the cube's sides. Lines 410 to 520 calculate the origin co-ordinates X0,Y0 and the size factor F. Line 530 positions the origin.

The For loop from lines 540 to 830 calculates the start and finish positions of each side of the cube and draws a line

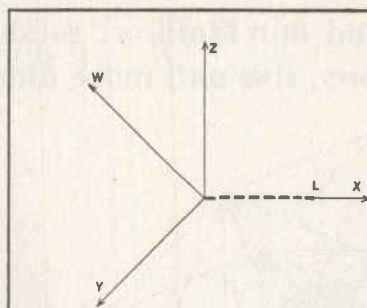

Figure 2. Generating a line.

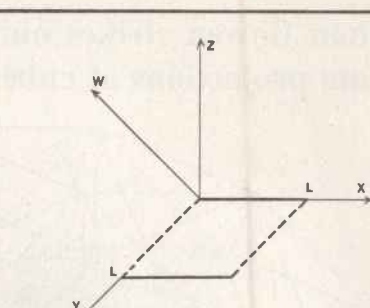

Figure 3. Generating a square.

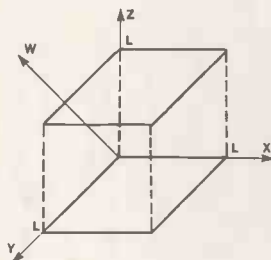

Figure 4. Generating a cube.

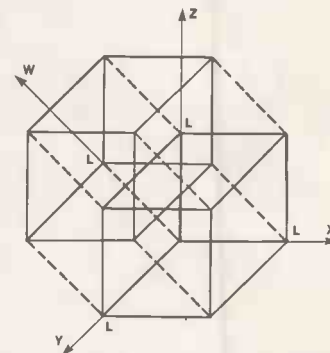

Figure 5. Generating a hypercube.

between them. Arrays JA and JB contain flags — with values of 0 or 1 — which are used to indicate which co-ordinate offsets are to be used for the beginning and end co-ordinates of each side plotted. Lines 610 to 660 calculate the starting position, and line 670 positions the current co-ordinates at that position. Lines 680 to 730 calculate the end position and line 740 draws a line to that position. Finally the program loops back to line 90, displays the number of dimensions of the cube — line 140 — and prompts the user for a new value of N. The program may then be rerun if desired or terminated by

typing a carriage-return on a blank line.

The following lines contain special calls and commands to control graphics on the Research Machines 380-Z, and must be changed for other systems:

Line 90 puts the 380-Z into graphics mode in which only the last four lines are used to display text while the rest of the screen is used for plotting.

Line 180 sets the resolution and clears the screen.

Line 230 resets the screen to normal mode.

Line 530 sets the position of the origin on the screen. For other systems the values of X0, Y0 and F — the co-ordinates of the new origin, and the size factor — will probably need to be adjusted. Change lines 410 to 520 as necessary.

Line 670 moves the current position to the co-ordinates X, Y. It also draws a point at that position, but this is not necessary for the program to work.

Line 740 draws a line from the current position to a new position at co-ordinates X, Y.

In line 260 the value of  $\pi$  is specified as 3.14159. It may be given to more or fewer decimal places, depending on the accuracy of your Basic. Alternatively, it may be calculated using the expression  $4.0 * ATN(1.0)$ .

The program is written in a standard Basic, and there should be few problems transferring the program to another computer with the necessary hardware and software graphics capabilities.

*Flatland* by E A Abbott, sixth edition, Blackwell, 1950.

*Mathematical Models* by H M Cundy and A P Rollett, second edition, Oxford University Press, 1961.

*Regular Polytopes* by H S M Coxeter, second edition, Macmillan, 1963.

*Regular Complex Polytopes* by H S M Coxeter, Cambridge University Press, 1974.

#### N-dimensional cube-drawing program.

```

10 REM N-dimensional cube program
20 REM to run on Research Machines 380Z
30 REM with high resolution graphics.
40 REM Written by Jonathan Bowen.
50 REM Imperial College, London SW7 2AZ.
60 REM Date 22-Oct-81
70 REM COPYRIGHT (C) 1981 J.P.BOWEN
80 DIM X1(10),Y1(10),I1(10),I2(10)
90 GRAPH 1
100 PRINT
110 IF N>0 GOTO 140
120 PRINT "N-dimensional cube program"
130 GOTO 150
140 PRINT TAB(8);N;"dimensional cube"
150 PRINT
160 PRINT
170 INPUT "Enter no of dimensions (2-10)";N
180 CALL "RESOLUTION",0,1
190 IF N>1 THEN 250
200 PRINT
210 PRINT
220 PRINT "End of cube program"
230 GRAPH 0
240 END
250 IF N>10 GOTO 170
260 P=3.14159/N
270 I=-1
280 FOR J=1 TO N STEP 2
290 I=I+1
300 C=I*P
310 X1(J)=COS(C)
320 Y1(J)=SIN(C)
330 NEXT J
340 I=N
350 FOR J=2 TO N STEP 2
360 I=I-1
370 C=I*P
380 X1(J)=COS(C)
390 Y1(J)=SIN(C)
400 NEXT J
410 F=0
420 FOR J=1 TO N
430 F=F+Y1(J)
440 NEXT J
450 X0=0
460 FOR J=1 TO N
470 IF X1(J)<0 THEN X0=X0+X1(J)
480 I1(J)=0
490 NEXT J
500 F=190/F
510 X0=X0-40/F
520 Y0=0
530 CALL "OFFSET",X0*F,Y0*F
540 FOR I=1 TO 2^N-1
550 FOR J=1 TO N
560 I2(J)=I1(J)
570 NEXT J
580 FOR J=1 TO N
590 IF I1(J)=1 GOTO 760
600 I2(J)=1
610 X=0
620 Y=0
630 FOR K=1 TO N
640 X=X+I1(K)*X1(K)
650 Y=Y+I1(K)*Y1(K)
660 NEXT K
670 CALL "PLOT",X*F,Y*F
680 X=0
690 Y=0
700 FOR K=1 TO N
710 X=X+I2(K)*X1(K)
720 Y=Y+I2(K)*Y1(K)
730 NEXT K
740 CALL "LINE",X*F,Y*F,3
750 I2(J)=0
760 NEXT J
770 J=1
780 IF I1(J)=0 GOTO 820
790 I1(J)=0
800 J=J+1
810 GOTO 780
820 I1(J)=1
830 NEXT I
840 GOTO 90
D>

```



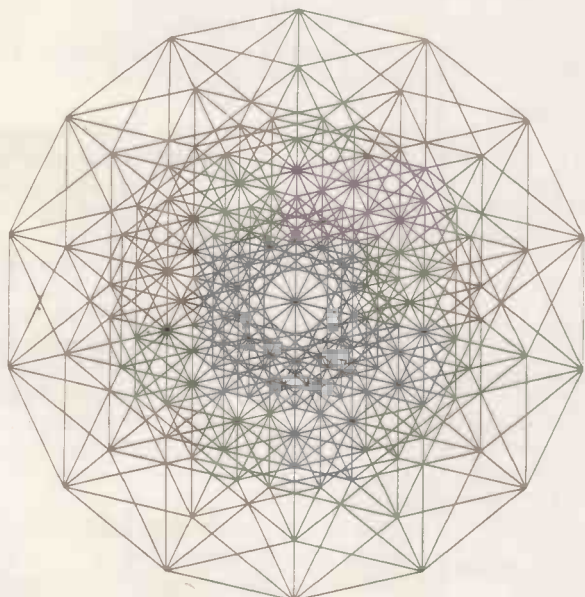
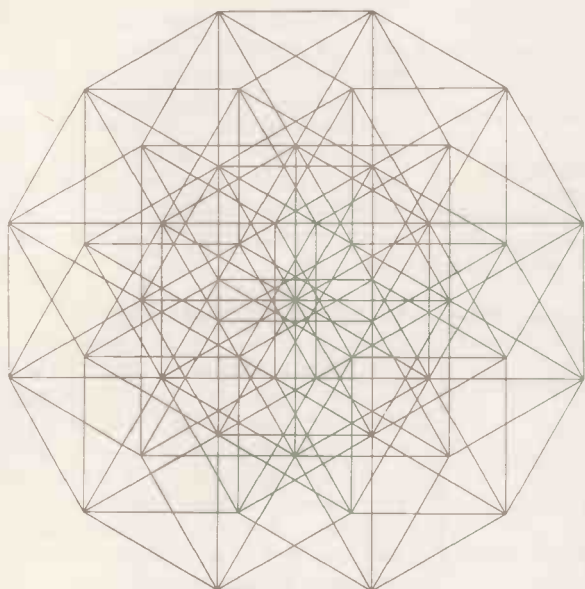
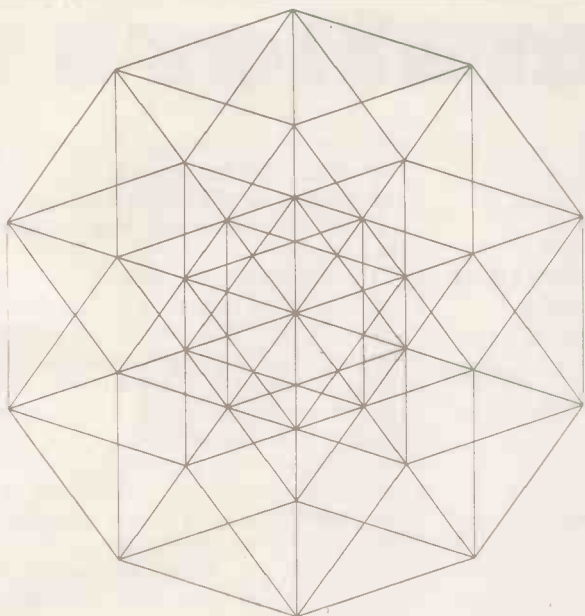

Figure 6. Projections of cubes in five, six and seven dimensions.

## KEELE CODES

### CUT MEDIA COSTS SAVE TIME

### MICRO, MINI & MAINFRAME USERS

with Keele Codes unique **E.40** compression utility.

- If you — make back-up copies from Winchester or floppy disk
- archive your database files
  - save reports or correspondence on tape or disk
  - need more media space accessible from the terminal
  - send written material via line or telephone

then Keele Code **E.40** could halve your disk costs and save transfer time by compressing natural English to about 40% of its original size. Through compression you achieve more than twice as much material on each disk in the same time as it would take to make a copy.

Optimised for English — **E.40** will compress any written/data/program material and all 256 ASCII characters can be coded and faithfully restored. Numeric tables too!

Available for most CP/M machines including Xerox 820, Superbrain, North Star, IMS 5000, Equinox, RARE, Osborne, CPM Apple, Vector, Sharp, NEC, 8" IBM Format.

Also available for PDP 11 and GEC 4080 series.

Other languages to follow.

Write or phone for full details.

**Keele Codes Limited,**  
**University of Keele, Keele, Staffs. ST5 5BG**  
**Tel: 0782-629221. Telex: 36113**

**ORDER NOW**

PC 4/82

Cut out the coupon

Access accepted You may phone your order

**24-hour service. Guaranteed despatch within 72 hours**

Please  
send me

**E.40** for CP/M .....£100+VAT  
(inc. postage)

tick

CP/M manual only .....£5  
further details

Name \_\_\_\_\_

Address \_\_\_\_\_

I enclose a cheque for \_\_\_\_\_ ACCESS No. \_\_\_\_\_

My computer is: \_\_\_\_\_

Year of purchase: \_\_\_\_\_

● Circle No. 161

# Reading matters

SPECIFIC DIFFICULTIES in acquiring reading skills can be a cause of distress to parents, exasperation to teachers and downright misery to the student. The problem often does not lie with the amount of effort the student is making but with the lack of some specific skill. Children, or for that matter adults, experiencing difficulty with acquiring reading skills will often not know why they are failing to make progress.

Research has shown that reading difficulties are often associated with an inability to recognise shapes and patterns, since reading depends fundamentally on the ability to recognise letter shapes. Although recognition problems can be easy to appreciate in young children and those with severe difficulties, they can be overlooked once a reader has achieved some proficiency. Where these difficulties persist they can lead to "hiccups" in the flow of reading causing loss of contextual cues and leading to further confusion. For example, a student reading "dent" in place of "bent" can be thrown into confusion over the rest of the sentence.

Slowness in recognising letters also affects reading speed. It is generally acknowledged that slow reading speeds are not only inefficient but also disrupt comprehension.

Remedial techniques such as teaching specific rules or approaches — e.g., magic e or word division — can themselves be hindered by poor letter recognition. The magic e rule relies specifically on knowledge of the names and sounds of the vowels. Difficulties with either of these, even if confined to just one letter, mean the student's use of the rule will be ineffective and frustrating.

## Difficulties masked

As a reader acquires skill, it becomes more difficult to detect specific problems. Often this is because the speed of reading can mask minor difficulties or because the student uses a reading technique which ensures that any problems are kept as private as possible.

The conventional way of diagnosing problems in letter recognition is to use flash cards. Flash cards are like a pack of large playing-cards. On each one, a single letter is printed in large print. The teacher holds up one card at a time and the pupil is asked to identify it. This method can be used to see if any gross difficulty is being experienced. Its major drawback is that it will not detect the child who requires only slightly longer than average to recognise the letter; the speed and timing of presentation cannot be sufficiently quick or accurate. To overcome these limitations the profes-

**Turn your micro into a tachistoscope — a device which displays letters or figures on the screen at a given rate to help children or adults over reading difficulties. Mike and Wendy Cook show you how to make the software transformation.**

sional research worker turns to a tachistoscope.

A tachistoscope is a machine much used by research workers in the field of psychology. It is a device for presenting a series of letters or figures on a screen with an accurately-controlled display time and display rate. These devices were designed before the advent of interactive computers and have tended to be expensive and

## PROGRAM FUNCTIONS

100-160	Sets up initial variables and turn on real-time clock.
180-200	Reads in the prepared groups; there may be up to 20 groups as defined by Data statements in lines 1280-1340.
210-330	Titles and the inputting of the number of characters required for display.
340-410	Selecting the type of letter group required.
380	Defines full alphabet.
420-600	Enters keyboard-defined letter group.
610-750	Picks letter group from your defined set.
760-780	Converts letter group to lower case if necessary.
790-860	Tests whether letter group has more than one type of letter in it: with only one type of letter this would crash the program at lines 1020-1030.
870-1000	Enters the display time and gap time.
1010-1040	Makes up random letters from chosen group for display. Consecutive letters are tested to ensure that they are not the same.
1050-1140	Draws box on display for the characters as a guide to where the letters will appear.
1140-1240	Runs tachistoscope.
1250-1260	Pauses until a key is pressed and loop for another run.
1280-1340	Data statements for prepared groups. Those shown are the ones that have been found to be useful. They may be altered or added to by putting extra Data statements in front of line 1340. For clarity, use one data statement per group and always end the group with the number zero.

only used by professionals. Careful use of this instrument has helped to diagnose specific reading difficulties, and to devise a course of treatment to help overcome them.

The tachistoscope enables letters to be presented for a very short length of time, much shorter than would be possible manually. The rate of presentation can be accurately controlled, whereas with manual presentation there is always a tendency to pause until the pupil has made an attempt. A tachistoscope can show each letter for such a short time that recognition has to be almost subliminal; the delay between each letter can be long enough for the brain to process the information and for the student to respond.

Our program enables a computer to act as a tachistoscope, and as such it is much more flexible than many conventional tachistoscopes. It is written for a TRS-80 disc-based system or Level-II Basic, though no disc commands are used. A real-time clock is used to control display times; it can be replaced by timing loops as shown with only a small loss in accuracy.

## For non-specialists

For best use of the program, the lower-case modification should be installed, but it will run perfectly on upper-case-only machines. The ideas it embodies can easily be adapted to any personal computer — there are no essential special graphics or commands. The program is written to be used by non-specialist and is particularly difficult to crash so it is slightly longer than a "bare bones" program. Though the menu system is often considered to make a program easy to use, the binary tree question-and-answer system was chosen for this program. It was found that it forced the user to think about changing parameters which might have been overlooked, and for testing, this was considered to be a more suitable form of operation for the program.

The program asks for each parameter that is to be used: the display times; the letter set required; the number of letters in the run; and the timing required. The program then draws a box in the centre of the screen, and the letters are flashed within it. The student has to say the letter name, or the letter sound — depending upon the exercise — at sufficient speed as to keep up with the display.

At the end of the predetermined number of characters, any or all of the parameters may be changed. Any parameter can be left unaltered simply by pressing Enter.

The practical operation of the program



consists of diagnosis and training phases. In the diagnosis phase, the program allows letters to be presented at realistic rates so that difficulties can be detected. The rate can be altered to suit the needs of individual students. Two components determine the overall speed of presentation:

- the length of time for which the letters are presented,
- the delay between presentation of successive letters.

both of which can be individually controlled using options provided in the program.

The computer program can be used to detect slowness in letter recognition, or to pin-point specific difficulties such as b/d, j/g confusion, or problems naming vowels, etc. Alternatively it can be used to make a detailed analysis of patterns of difficulties with the aim of discovering specific areas of weakness. For example, n,u,m,w confusion would indicate visual difficulties; confusing a,e,i,o indicates auditory difficulties; confusing b,d,p,q indicates confusion over orientation, and so on. On the basis of such analysis, appropriate remedial techniques can be implemented.

For training, the computer program can be used to increase a student's speed in recognising letters, or to aid discrimination of specific letters. Overall slowness can be improved by practising the full alphabet — option F in the program — at increasing speeds. In such cases, where there are no discrimination problems, we recommend fast presentation times of 0.05 to 0.1s., and gradually-

### Glossary

**Magic e:** The rule which states that an e at the end of the word makes the previous vowel say its name rather than its sound, for example hat/hate or cod/code.

**Word division:** The word is split into its component parts, each of which is read separately before the whole word is attempted. For example, "preliminary" becomes PRE+LIM+IN+ARY.

decreasing delay times beginning 1.5s. and working towards 0.3s.

Where there are specific difficulties, the prepared-group — option P in the program — is useful. A problem group can be pre-programmed so that the student is given practice in discrimination. Slower presentation times in the range 0.3 to 0.7s. are necessary, but the delay times can be shorter at 0.2 to 0.6s.

Diagnosis of problems obviously requires the parent or teacher to be present, but for training purposes the program can be used by students working alone. Only a brief explanation of the program should be necessary.

It has been found that 30 is the best number of characters for a run if the full alphabet is being used, while 15 seems sufficient for smaller groups.

There are three choices for the type of character group:

- F, the full alphabet is useful for diagnosis and general speed training.
- P, prepared groups, are used when emphasis is to be placed on a subset of letters. They are stored in Data statements at the end of the program and can be added to or changed by altering these statements. This mode is useful for training on specific difficulties.
- D, defined groups, allows the operator to define a set of characters from the keyboard. This is useful in experimenting with groups for subsequent inclusion in the prepared group list. The frequency of occurrence of any particular letter is governed by the number of times it appears in

the group. As the letters are picked out of the group at random — with the constraint that the letter picked must not be the same as the last letter — it is usual to have at least three different letters in the group. The program will prevent you from putting only one letter in a group. Note the back-space arrow still works, and so it is possible to delete an entry.

U/L allows the characters to be presented in either upper or lower case. The lower-case hardware modification has to be installed for this to work, but no software driver is needed. Upper case can be more readable, but lower case occurs more frequently in reading and so is preferable. More difficulties show up  
*(continued on next page)*

```

100 *TACHISTOSCOPE BY M.K.COOK 1982
110 CLEAR 1000
120 DIM RS(101),G$(20)
130 CLS : RANDOM
140 CMD"R"
150 N=10 : DT=.3 : GT= 1.5
160 NM=1
170 READ A$
180 IF A$ <> "0" THEN G$(NM)=G$(NM)+A$ : GOTO 170
190 READ A$
200 IF A$ <> "0" THEN NM=NM+1 : GOTO 180
210 PRINT"RANDOM LETTER TACHISTOSCOPE - PRESS ENTER AFTER EACH ANSWER"
220 PRINT
230 T1=0
240 IF D$="" THEN 280
250 INPUT"SAME AGAIN OR CHANGE SOMETHING ( S/C ) ";A$
260 IF A$="S" THEN 1010
270 IF A$ <> "C" THEN PRINT "PLEASE ANSWER ONE LETTER S OR C " : GOTO 250
280 PRINT"LAST RUN YOU HAD ";N;" CHARACTERS"
290 INPUT"ENTER NEW FIGURE OR PRESS ENTER FOR SAME NUMBER ";T1
300 IF T1 <> 0 THEN N=T1
310 IF N > 100 THEN PRINT"100 IS THE MAXIMUM" : GOTO 290
320 IF N < 1 THEN PRINT "STOP MESSING ABOUT" : GOTO 290
330 IF D$="" THEN 370
340 INPUT"DO YOU WANT THE SAME GROUP OF LETTERS ( Y/N ) ";A$
350 IF A$="Y" THEN 760
360 IF A$ <> "N" THEN PRINT"PLEASE ANSWER ONE LETTER ( Y OR N ) "; GOTO 340
370 INPUT"FULL ALPHABET / PREPARED GROUP / DEFINE GROUP ( F/P/D )";R$
380 IF R$="F" THEN D$="ABCDEFGHIJKLMNPOQRSTUVWXYZ" : GOTO 760
390 IF R$="P" THEN 610
400 IF R$ <> "D" THEN PRINT"PLEASE ANSWER ONE LETTER ( F,P OR D )":GOTO 370
410 IF DF$="" THEN GOTO 470
420 IF DF$ <> "" THEN PRINT : PRINT"CURRENT LETTERS ARE - ";DF$
430 INPUT"DO YOU WISH TO ADD LETTERS OR INPUT A NEW SET ( A/N )";A$
440 IF A$="N" THEN DF$="" : GOTO 460
450 IF A$ <> "A" THEN PRINT"PLEASE ANSWER ONE LETTER ( A OR N )":GOTO 430
460 PRINT
470 PRINT"PLEASE ENTER LETTERS - PRESS ENTER TO FINISH"
480 IF DF$="" THEN 520
490 FOR A=1 TO LEN(DF$)
500 PRINT MID$(DF$,A,1); " ";
510 NEXT
520 A$=INKEY$ : IF A$="" THEN 520
530 T=ASC(A$)
540 IF T > 90 THEN 520
550 IF T = 8 AND LEN(DF$) > 0 THEN PRINT A$;A$; : DF$=LEFT$(DF$,LEN(DF$)-1) : GOTO 520
560 IF T = 8 THEN 520
570 IF T = 13 AND LEN(DF$) > 1 THEN PRINT : DF$=DF$ : GOTO 760
580 IF T <> 13 THEN DF$=DF$+A$ : DF$=DF$+A$
590 IF LEN(DF$) > 25 THEN PRINT"MAXIMUM NUMBER OF LETTERS REACHED" ELSE GOTO 520
600 GOTO 760
610 PRINT"YOU HAVE PREPARED ";NM;" GROUPS"
620 INPUT"PRESS R TO REMOVE YOUR GROUPS OR THE GROUP REQUIRED ";A$
630 IF LEN(A$) > 2 THEN PRINT"PLEASE TYPE JUST R OR GROUP NUMBER"; GOTO 620
640 IF A$ <> "R" THEN VAL(A$) : GOTO 730
650 FOR A=1 TO NM
660 PRINT"GROUP ";A;" IS - ";
670 FOR A1=1 TO LEN(G$(A))
680 PRINTMID$(G$(A),A1,1); " ";
690 NEXT
700 PRINT
710 NEXT
720 GOTO 620
730 IF NG > NM THEN PRINT"THIS IS OUTSIDE THE RANGE OF YOUR PREPARED GROUPS " : GOTO 610
740 IF NG=0 THEN A$=A$+"XXX" : GOTO 630
750 D$=G$(NG)
760 INPUT"UPPER OR LOWER CASE ( U/L ) ";C$
770 IF C$="U" OR C$="L" THEN 780 ELSE 760
780 IF C$="U" THEN T$=D$ : GOTO 830
790 T$=""
800 FOR A=1 TO LEN(D$)
810 T$=T$+CHR$(ASC(MID$(D$,A,1))+32)
820 NEXT
830 IF LEN(T$) < 2 THEN PRINT"THIS GROUP IS TOO SHORT " :GOTO 370
840 A=2
850 IF LEFT$(T$,1) <> MID$(T$,A,1) THEN 870

```

*(listing continued on next page)*

(listing continued from previous page)

```

860 IF A < LEN(T*) THEN A=A+1 : GOTO 850 ELSE PRINT"THIS GROUP OF LETTERS IS ALL
THE SAME" : GOTO 370
870 PRINT"CURRENT DISPLAY TIME IS ";DT;" SECONDS"
880 T1=0
890 INPUT"INPUT NEW TIME OR PRESS ENTER TO KEEP CURRENT TIME ";T1
900 IF T1 <> 0 THEN DT=T1
910 TD=INT(DT*40)
920 IF TD > 252 THEN PRINT"DISPLAY TIME TOO LONG " :GOTO 890
930 IF TD < 2 THEN PRINT"DISPLAY TIME TOO SHORT " :GOTO 890
940 PRINT"TIME BETWEEN DISPLAYS IS CURRENTLY ";GT;" SECONDS"
950 T1=0
960 INPUT"INPUT NEW TIME OR PRESS ENTER TO KEEP CURRENT TIME ";T1
970 IF T1 <> 0 THEN GT=T1
980 TG=INT(GT*40)
990 IF TG > 252 THEN PRINT"TIME GAP TOO LONG " : GOTO 960
1000 IF TG < 2 THEN PRINT"TIME GAP TOO SHORT " : GOTO 960
1010 FOR A=1 TO N
1020 RS(A)=ASC(MID$(T$,RND(LEN(T*)),1))
1030 IF RS(A) = RS(A-1) THEN 1020
1040 NEXT
1050 CLS
1060 PRINTCHR$(23)
1070 X1=36: X2=73: Y1=20: Y2=29
1080 FOR A=X1 TO X2
1090 SET(A, Y1):SET(A, Y2)
1100 NEXT
1110 FOR A=Y1 TO Y2
1120 SET(X1, A):SET(X2, A)
1130 NEXT
1140 FOR A=1 TO 800:NEXT
1150 TS=16448 ' TICK STORE
1160 CP=538+15360
1170 FOR A=1 TO N
1180 POKE(CP),RS(A)
1190 POKE(TS),0
1200 IF PEEK(TS) < TD THEN 1200
1210 POKE(CP),32
1220 POKE(TS),0
1230 IF PEEK(TS) < TG THEN 1230
1240 NEXT
1250 PRINT 960, "PRESS ANY KEY FOR ANOTHER RUN";
1260 IF INKEY$="" THEN 1260 ELSE CLS : GOTO 210
1270 'DATA STATEMENTS FOR GROUPS EACH GROUP TO END WITH ZERO
1280 DATA A,E,I,O,U,O
1290 DATA B,D,B,D,A,C,O
1300 DATA Z,X,Z,X,T,K,O
1310 DATA J,G,J,G,S,R,O
1320 DATA U,V,U,Y,V,T,O
1330 DATA Q,V,W,Q,V,O
1340 DATA O
    
```

(continued from previous page)

when using lower case; for example, b/d confusion is common but B/D confusion is rare. The quality of the display can be improved by carefully adjusting the brightness control of the monitor.

This program has been found to be very helpful in both diagnosis and training. When using a new teaching method there is always some doubt whether the student is responding to the method or the novelty of the situation, but whatever the reason, this program works. It is intended as a tool for remedial teaching, to help teachers or parents to diagnose and teach, though it is not a teaching machine which will diagnose and overcome letter-recognition difficulties by itself.

The program listing is for disc Basic using the real-time clock. For Level II Basic, remove line 140 and replace the following two lines:

```

1200 FOR A1 = 1 TO 10 * TD : NEXT
1230 FOR A1 = 1 TO 10 * TG : NEXT
    
```

Lines 920 and 990 may then be removed to allow a longer time to be specified.

Any educational establishment which would like a machine-readable copy of this program should write on headed note-paper, enclosing a cassette tape or formatted disc with return postage to M K Cook, Department of PMC, John Dalton Building, Manchester Polytechnic, Oxford Road, Manchester. 

# BUSINESS SOFTWARE FOR CPM AND TANDY II

## ACCOUNTING

Sales, Purchase, Nominal (CP/M & Tandy) each. . . . .	£400
Stock Control (CP/M & Tandy) . . . . .	£400
Invoicing (CP/M & Tandy) . . . . .	£150
Transport System (Tandy) . . . . .	£1100
Retailing System (Tandy) . . . . .	POA

## SPECIALIST

SNAP - Survey Analysis Package. . . . .	£1200
SIGTEST - Significance Testing . . . . .	POA
AJACS - Architects Job Control. . . . .	£990
CONECAL - Consulting Engineers Job Control (Tandy). . . . .	£990
CONESALES - Engineers' Sales Daybook (Tandy). . . . .	£200
LEGALTIME - Solicitors Time Recording . . . . .	Dec '81
AUCTION - Auction Room System . . . . .	£750
MICROMODELLER Financial Planning. . . . .	£645
VISICALC (Tandy) . . . . .	£115
Project Management Programs . . . . .	POA

## UTILITIES & LANGUAGES

DBase II - Powerful database program . . . . .	£385
DATASTAR - Data Management . . . . .	£195
WORDSTAR - Word Processing . . . . .	£255
MAILMERGE. . . . .	£75
Basic Interpreter . . . . .	£170
Basic Compiler . . . . .	£195
Fortran Compiler . . . . .	£250
Cobol . . . . .	£355
CP/M (Tandy). . . . .	POA

Dealer enquiries welcome.  
 Demo packs available for some software.  
 All programs are CP/M unless stated as Tandy.  
 Send for full software catalogue.  
 All software supplied on 5¼" Superbrain or 8" Tandy disks.  
 Tailored software undertaken on Superbrain, ABC, Altos, Heath and Tandy.  
 Verbatim Datalife Disks £20-35 per ten.

**MERCATOR of BRISTOL**  
**3 WHITELADIES ROAD, CLIFTON, BRISTOL**  
**Telephone 0272 312079/731079**



# HOW TO GET MORE FROM YOUR MICRO

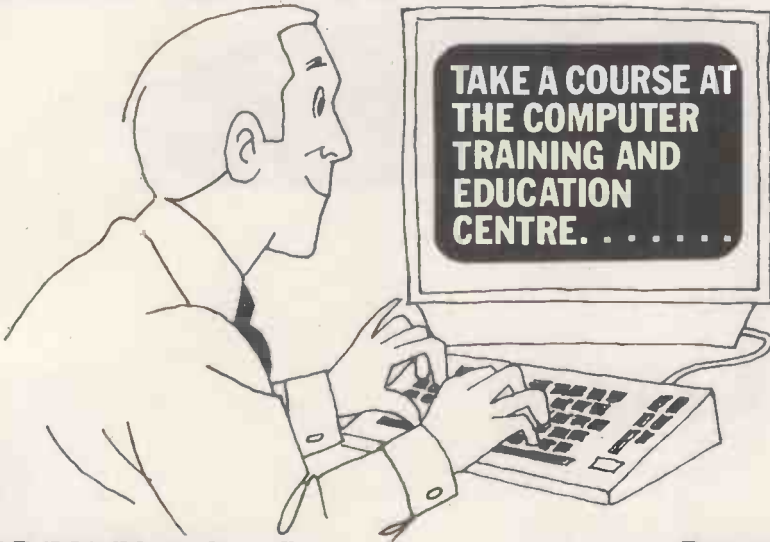

## **CP/M\* (User level)**

**2 days**

A practical course designed for those unfamiliar with CP/M, familiarising the new user with the operation of the typical hardware attached to a disc-based Z80 microprocessor system, and giving an understanding of the facilities available and of its management of disc files.

## **Advanced CP/M**

**2 days**

This course is designed for those who wish to modify the standard CP/M operating system and includes a detailed investigation of BIOS and its interaction with CCP and BDOS. Previous assembler experience is essential.

## **Programming in BASIC**

**1 week**

Giving a thorough understanding of the BASIC language and enabling the student to put this knowledge into practical use, facilitated by hands-on sessions and practical exercises.

## **Programming in PASCAL**

**3 days**

Giving an understanding of structured programming techniques as used in PASCAL and providing practical experience on a microcomputer.

## **Wordstar† Wordprocessing**

**2 days**

Giving the user an understanding of the facilities available in the Wordstar/Mailmerge Wordprocessing System and hands-on experience which enables this knowledge to be put to practical use.

**All courses are in London.** A wide range of hardware is available for practical work.

**Contact** The Courses Secretary, Computer Training & Education Centre Ltd, 102-108 Clerkenwell Road, London EC1. 01-251 4010/4019.

# CTEC

A professional organisation with first class training facilities in Central London.

\*CP/M is the T/M of Digital Research Corp.  
†Wordstar is the T/M of Micropro Corp.

Please send me further information on the course(s) about.....

Name.....

Position.....

Company.....

Address.....

Tel. No.....

PC1

**Now you can do all  
accounting with...**



**without...**





# the filing, typing and

**Silicon Office** is the latest microcomputer software program from the Bristol Software Factory.

Designed specifically for use with the Commodore PET 8096, it'll help you run your office with the minimum amount of effort and maximum efficiency.

Think of it like three normal software packages in one, each separate package totally interactive with the other.

For around £4,500, you can have the complete electronic office, the solution to practically all your business problems. The price includes Commodore hardware, a high quality daisy wheel printer and Silicon Office software.

Silicon Office is made up from a flexible information management system which lets you create and maintain an extensive filing arrangement. Allowing you to search quickly through your records, making cross references between files in order to gain the facts you require.

A highly sophisticated word processing program allows you to generate letters, documents and reports. Letting secretaries get on with the more important tasks.

And a fully comprehensive calculator means you can handle all the number crunching you're ever likely to do in a business situation. Leaving the

accounts department to concentrate on more profitable things.

But that's not all by any means.

Silicon Office also has a special programmability feature which means you or your dealer can expand and tailor the Silicon Office program to your business.

When Silicon Office is used in an everyday business situation, certain command sequences are inevitably repeated. By writing short, very simple programs which are entered into the computer's memory, Silicon Office can perform the necessary tasks, automatically.

And last, but by no means least is an optional communications facility.

It doesn't take much imagination to see the potential of Silicon Office in virtually any line of business.

So to get a better grasp, send away for our brochure. It'll only cost you a stamp. And it could save you a fortune. Or talk to your local Commodore dealer who has all the facts at his fingertips.

You'll soon see how you're much better off with Silicon Office. Than without.



**SILICON OFFICE**



I can't wait to get my hands on a free copy of the Silicon Office brochure.

Name \_\_\_\_\_

Position \_\_\_\_\_

Company \_\_\_\_\_

Address \_\_\_\_\_

APC 1

I own a Commodore PET (Please tick box) YES  NO



Send to: Bristol Software Factory, PO Box 14, Horley, Surrey.

**SILICON OFFICE**



# FAST BUBBLES



A large part of any business package's working life is spent sorting information. Cliff Stanford shows how even the common bubble sort can be streamlined for efficiency.

THE MOST COMMON sort routine is the bubble sort. In this method, adjacent pairs of strings in an array are compared with one another and, if necessary, exchanged. This is tedious since in each pass of the array, a particular string may only move one place upwards. Conversely, one string only will move — or bubble — to the end of the array on each pass.

An example of the bubble sort is given in the program listing, starting at line 9000. In this particular implementation — which was written for Commodore microcomputers — rather than using two For-Next loops, *b* is used to indicate the bottom of the part of the array which has not yet been sorted. This prevents the time-wasting sorting of elements which are already known to be in the correct order.

## Batcher's method

However, to create a sort algorithm whose running time is notably faster than the bubble sort, non-adjacent elements of the array must be selected for comparison. This means that strings may move in both directions more quickly than the single step at a time possible with the bubble-sort algorithms. Such an algorithm was devised by K E Batcher in 1964. Not surprisingly it has become known as the Batcher sort.

Batcher's method involves setting various pointers into the array and comparing the elements pointed to. The main pointer in the implementation shown is *p* which starts as the largest exact power of two which is less than the number of elements to sort. For example, with 100 elements to sort, *p* would start at 64. Other pointers are *q*, *r* and *d* which take various values as the sort progresses.

The algorithm specifies precisely which two strings are to be compared and, if necessary, exchanged. It follows therefore, that as many comparisons are necessary to sort an array which is already in order as for one which is random.

## Six main stages

The code for the Batcher sort starts at line 10000 in the program listing. You will note that six steps are highlighted:

- **Step 1:** *T* is set to the least integer, such that  $2^t$  is greater than or equal to *n*, where *n* is the number of elements to be sorted. The value of *t* is used to set *p* to the largest exact power of 2, less than *n*.
- **Step 2:** *0* is initialised at the largest exact power of 2, less than *n*. *R* is set to zero and *d* is set to *p*. At this stage, *q*, *d* and *p* are all equal but it will soon be apparent that this situation does not remain.



```

10 REM*****
11 REM**
13 REM**          BATCHER / BUBBLE SORT ROUTINES          **
14 REM**
15 REM**    IMPETUS COMPUTER SYSTEMS                      **
16 REM**    CLASSIC OFFICES, HENDON CENTRAL                **
17 REM**    LONDON NW4 3NN                                DATED:  7 JULY 1981  **
18 REM*****
19 REM
20 INPUTN:DEFFNRU(I)=INT(I)-(I<>INT(I)):DIMAS(N),B$(N)
30 DEFFNRD(I)=INT(RND(1)*I+1)
90 GOTO60000
9000 B=N
9010 T=0:FORJ=1TOB-1:IFB$(J)>B$(J+1)THENT$=B$(J):B$(J)=B$(J+1):B$(J+1)=T$:T=J
9020 NEXT:IFTTHENB=T:GOTO9010
9030 RETURN
10000 T=FNRU(LOG(N)/LOG(2)):P=2^(T-1)                      :REM  STEP 1
10020 Q=2^(T-1):R=0:D=P                                    :REM  STEP 2
10030 S=P/RR:G=N-D-1:FORK=RTOGSTEPS*2:H=K+S-1:IFG<HTHENH=G :REM  STEP 3
10040 FORI=KTOH:J=I+1
10050 IFAS$(J)>AS$(J+D)THENT$=AS$(J):AS$(J)=AS$(J+D):AS$(J+D)=T$ :REM  STEP 4
10060 NEXT
10070 NEXTK
10080 IFO<>PTHEND=0-P:Q=Q/2:R=P:GOTO10030                  :REM  STEP 5
10090 P=INT(P/2):IFPTHEN10020                              :REM  STEP 6
10100 RETURN
60000 REM          BENCH TEST
60010 FORI=1TON:AS$="":FORJ=1TOFNRD(4)+2:AS$=AS$+CHR$(FNRD(26)+64):NEXT
60020 AS$(I)=AS$:B$(I)=AS$:PRINTAS$:NEXT:PRINT
60030 PRINT"BATCHER",:TIS$="000000":GOSUB10000:X$=TIS
60040 PRINT"BUBBLE",:TIS$="000000":GOSUB9000:Y$=TIS
60060 X=0:FORI=1TON:IFAS$(I)<AS$(I-1)THENX=1
60070 NEXT:FORI=1TON:IFB$(I)<B$(I-1)ORAS$(I)<>B$(I)THENX=1
60080 NEXT:IFX=0THENPRINT"ARRAYS SORTED CORRECTLY":GOTO60100
60090 PRINT"ERROR DISCOVERED IN CHECKING ARRAYS":STOP
60100 PRINT"BATCHER SORT TOOK: "X$:PRINT"BUBBLE SORT TOOK: "Y$

```

- **Step 3:** The algorithm should read at this point: for  $l = 0$  to  $n-d-1$ : if  $(i$  and  $p) = r$  then do step 4. This is however wasteful as it means that, each time through the loop,  $i$  must be incremented at all stages between 0 and  $n-d-1$ . It becomes clear on studying the operation of this algorithm that  $i$  follows a set pattern. It is, possible, therefore, to obviate the need to test  $i$  at all. We set  $s$  equal to  $p$  or  $r$ , and  $g$  equal to the top limit of  $n-d-1$ .  $K$  then becomes the various starting points for the  $i$  loop and  $h$  is the end of each small loop. The only test necessary is to check before entering the loop that  $h$  is not greater than  $g$ . Lines 10030 and 10040, although longer than the line above, operate very much faster.  $J$  is simply  $i + 1$  to avoid 1 being added in six times on line 10050.
- **Step 4:** This is the straightforward test and exchange using the elements pointed to by  $j$  and  $j + d$ . It is possible to use  $i$  instead of  $j$  in this line but I had decided that I did not wish the zero element of the array to be included in the sort.
- **Step 5:** 0 is now tested against  $p$ . If they are not yet equal, then  $d$  becomes the difference between  $q$  and  $p$ ,  $q$  is halved and  $r$  is set to  $p$ . We must then return to step 3 for the new values of  $q$ ,  $d$  and  $r$ .
- **Step 6:** When  $q$  and  $p$  become equal, we halve  $p$  and return to step 2. The reason for the integer function is that it forces  $p$  to end at 0 giving us a clean exit.

The program lines from 60000 onwards compare the Batcher sort with the speeded-up version of the bubble sort. When the program is run, the user is prompted for a value of  $n$ . Line 60010 then generates  $n$  random strings of length between 2 and 6. These are put into  $a$(i)$  and  $b$(i)$ . The Batcher method then sorts the  $a$$  array and the bubble sort the  $b$$  array. The time taken to sort each array is recorded in  $x$$  and  $y$$  respectively.

### Time trials

Line 60060 checks that the  $a$$  array is correctly sorted. Similarly, line 60070 checks that the  $b$$  array is correctly sorted and that the two arrays still contain identical data. If any discrepancy is discovered then an appropriate message is printed. Otherwise, the message

Arrays sorted correctly  
is printed and the timings for the two sorts are listed.

If the program is run for values up to about 25 elements, it will be seen that the bubble sort is indeed quicker. This is simply because the Batcher spends a good deal of time setting pointers and initialising variables. However, from about 25 elements onwards, the Batcher

sort moves into its own. When sorting 40 strings, the bubble sort takes about twice as long as the Batcher: for 100 strings the time saving becomes something like 70 percent and for 1,000 strings, the Batcher takes about 10 minutes as opposed to marginally less than three hours for the bubble sort. These timings were made under Basic 4.0.

Under Basic 2.0 the times saved would be substantially greater because of the garbage-collection problems in moving the strings so many times. Interestingly, for large arrays a Batcher sort written in Basic may even out-perform a bubble sort written in assembler. On the other hand, the machine-code version of the Batcher sort which I have developed will sort an array of 1,000 elements in less than 10 seconds.

The Batcher sort is a most efficient algorithm for sorting volumes of data *in situ*. If anyone would like a copy of the assembler sort, send a cheque for £15 plus VAT — £17.25 — and I will send him a disc with both the source code and absolute code. Please state the disc format — 3040, 4040 or 8050. Basic 2.0 and Basic 4.0 versions will be included on the disc. □

# How shell method orders strings

**Eric Dale scrutinises the shell algorithm as a solution for faster sorting.**

TO ORDER a list alphabetically is an everyday requirement in data processing. For efficient use of computing time, the ordering routine should be very fast in its response. Certain string-sorting techniques require data to be moved about in memory until it is positioned correctly. Such an upheaval can be compared to moving house, lock stock and kitchen sink.

For example, a street of five homes, which house families C, A, D, B, and E, has been selected for reorganisation in such a way that family A will live at number 1, family B at number 2 and so on. Imagine the uproar and chaos such a move would cause.

A simple solution to the problem is that the door numbers should be altered so that the new street numbers appear as 3, 1, 4, 2 and 5. This answer is sometimes used in string sorting, especially where long strings are involved. At first data must be compared letter by letter, but then on completion of the comparison only the addresses need be changed.

Having decided on the method of mobilising data, it is important to choose an algorithm or set of rules for selecting the pieces of data for comparison and when this will take place. The sorting algorithm I have chosen is a shell sort.

In brief, the idea is to start with a coarse adjustment to the list and as rapidly as possible make finer and more detailed movements until the sort is completed. In a list of 20 elements the sort

starts by comparing entries displaced by 10 positions and ordering them. Having completed the cycle through the list, the displacement is halved and the sort begins again. The whole operation is repeated until the order is alphabetic.

If two strings are out of order, the exchange is treated as an interrupt and the current position in the list is stored — a case of "Mind my place in the queue while I am away". The addresses of the strings are exchanged and a reverse-direction comparison begins, allowing the misplaced element to bubble up the list.

The servicing of the interrupt is terminated when the element has achieved its rightful position, and the proceedings can continue as before — "I have returned to claim my place in the queue".

To time any program sort is very difficult, since it depends so much on the original data. You can, however, use the times taken to complete the sorting with the original data in the following orders:

- Alphabetic — already sorted
- Random order
- Reverse order

The test data should be of the worse possible type. It should have two properties:

- strings all the same length
- only the last letter is different

For example,

```
aaaaaaaaaaaaaaaaah
aaaaaaaaaaaaaaaaab
aaaaaaaaaaaaaaaaa
```

would take longer to sort into order than

```
h
aaaaaaaaaaaaaaaaab
aaaaaaaaaaaa
```

The program should be stored in the top of memory at 32000 — 7D00 hexadecimal — and appropriate protection should be given to it by changing locations 49, 51 and 53 to 124 (7C). Entry is made by a Sys call. The string array to be ordered is stored with the title A\$, but this can be altered by changing the contents of locations H and H+1.

The program begins by finding the location of the start-of-string storage and searches for the required string-array name — A\$ in this case. Failure to find the array returns the user to Basic. If the name A\$ is encountered, the data concerning the number of members is stored and used to compute the first offset for comparing the members. Each member of the array called A\$ has its details stored in three bytes,

- The first byte contains the string length.
- The second byte contains the low-byte address of the start of the string
- The third byte contains the high-order byte.

Two members are compared letter by letter. Some strings will be longer than others and in such a case the number of letters in the shorter string will be the maximum number of comparisons to be considered. For example,

```
          9999
will require three comparison operations
when considered against
          999
The outcome will be
          999
          999
          9999
```

Very fast times for sorting have been recorded with this program and there may be scope for its use with floating-point numbers.

```
0001 0000 ;SOURCE FOR STRING SORT USING SHELL METHOD
0002 0000 ;MODIFIED STRINGS FOR 32K PET
0003 0000 ;NEW NAME STRINGS
0004 0000 ;PROG TO SORT STRING A$ STARTING
0005 0000 ;AT A$(C1)
0006 0000 ;14 AUGUST 81 ED
0007 0000
0008 0000
0009 0000
0010 7D00 A5 20 LO = #57
0011 7D02 85 57 HI = #58
0012 7D04 8D 82 7F *=#7D00 ;START ADDR 32000
0013 7D07 A5 20 LDA #2C ;LO ADDR START OF STRINGS
0014 7D09 85 58 STA LO
0015 7D0B 8D 83 7F STA LODUP ;DUPLICATE
0016 7D0E A5 20 LDA #2D ;HI ADDR START OF STRINGS
0017 7D0E A8 00 STA HI ;DUPLICATE
;PICK UP 7 BYTES
LDY #0 ;CLEAR Y REG (continued on page 111)
```



# WHEN IT COMES TO MICROCOMPUTER SOFTWARE WE WROTE THE BOOK

How do you stay up-to-the-minute with the rapidly changing world of microcomputer software? Get the Lifeboat Catalogue.

**The latest innovations** The new Lifeboat Catalogue is packed with the latest state-of-the-art software. And if we publish a new program after the latest catalogue has gone to press, we enclose a flash bulletin in your copy.

### The greatest selection

Because Lifeboat is the world's largest publisher of microcomputer software, our catalogue offers you the greatest selection of programs for business, professional and personal use. Our more than 200 programs range from the integrated accounting and professional practice systems to office tools for book-keepers and secretaries to sophisticated tools for programmers. Included are business systems, word processors, programming languages, database management systems, application tools and advanced system utilities.

We specialise in software that runs on most small business computers. Our more than 60 media formats, including floppy disks, data cartridges, magnetic tape and disk cartridges, support well over 100 different types of computer.

**Get full service** We give the crucial dimension of after-sales service and full support to everything we sell.

That includes:

- An update service for software and documentation.
- Telephone, telex and mail-order services in the London office and at overseas offices in the United States, France, Switzerland, West Germany and Japan.
- Subscriptions to Lifelines,™ the monthly magazine that offers comparative reviews, tips, techniques, identified bugs and updates that keep you abreast of change.

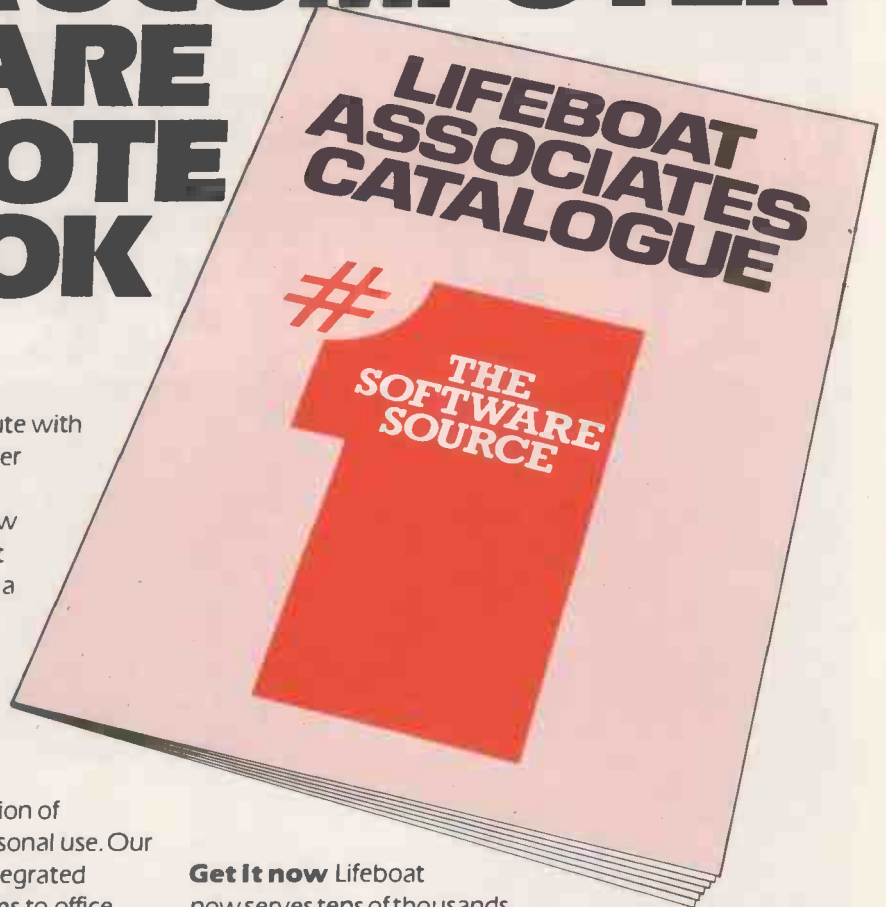

### Get It now

Lifeboat now serves tens of thousands of satisfied customers with our breadth of up-to-date, fully tested, fully supported and competitively priced software.

You may not need all we offer, but we offer just what you need. After all, we wrote the book.

**Lifeboat Associates**  
World's foremost software source

### Mall coupon to: Lifeboat Associates

PO Box 125, London WC2H 9LU or call 01-836 9028

Please send me a free lifeboat catalogue.

Name

Title

Company

Address

Postcode

Copyright © 1981, by Lifeboat Associates.

**Lifeboat Worldwide** offers you the world's largest library of software. Contact your nearest dealer of Lifeboat.

**USA** Lifeboat Associates 1651 Third Ave. New York NY 10028 Tel (212) 860-0300 Telex 640693 (LBSOFT NYK) TWX 710 581-2524 **JAPAN** Lifeboat Inc. OK Bldg. 5F 1-2-8 Shiba-Daimon Minato-ku Tokyo 105 Japan Tel 03-437-3901 Telex 2423296 (LBJTYO) **ENGLAND** Lifeboat Associates Ltd PO Box 125 London WC2H 9LU England Tel 01-836 9028 Telex 893709 (LBSOFTG) **SWITZERLAND** Lifeboat Associates GmbH Hinterbergstrasse Postfach 251 6330 Cham Switzerland Tel 042-36-8686 Telex 865265 (MICO CH) **W GERMANY** Intersoft GmbH Schlossgartenweg 5 D-8045 Ismaning W. Germany Tel 089-966-444 Telex 5213643 (ISOFD) **FRANCE** Lifeboat Associates SARL 10 Grande Rue Charles de Gaulle 92600 Asnieres France Tel 1-733-08-04 Telex 250303 (PUBLIC X PARIS)

# A POWERFUL MULTI-USER SYSTEM FOR UNDER £6,600.

Enter the world of multi-user distributed processing with the CLENLO ACE MULTI-USER SYSTEM.

The only genuine Micro multi-processor system readily available with the full range of multi-user facilities.

With the CLENLO ACE multi-user system up to sixteen users each have exclusive use of a Z-80A processor and 64K RAM mounted on a S-100 board, each with a serial RS-232 I/O port to which the user's VDU is attached.

The multi-user system is housed in a standard S-100 mainframe chassis enabling individual users to run programs independently and simultaneously, while still having access to shared resources (hard disc storage, printers etc.) - via the S-100 BUS Inter Processor Communication channel.

All this activity is controlled by a DPC/OS multi-user operating system running in a Service Processor and creating a complete CP/M Ver 2.2 environment for each user.

- Full back-up of all record levels.
- Facility to designate files - private, group or public.
- Full 4MHz speed for each user.
- Fast memory to memory data transfer.
- Enhanced batch submit facility.
- Floppy disc storage, or Winchester hard disc storage up to 100 Megabytes.

- Automatic print spooling and de-spooling.
- Tape back-up facilities available... backed up by the exceptional CLENLO service and highly competitive prices.

Whether you want a basic two user system incorporating floppy disc storage or the facility of a full sixteen user hard disc based system with high performance, CLENLO can provide the system you need.

For more details of the best, lowest cost multi-user system on the market and our complete range of Microcomputer and business services contact CLENLO COMPUTING SYSTEMS, Telephone 01-670 4202/3.

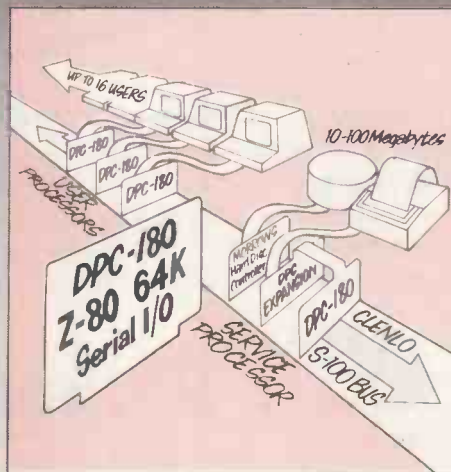

**CLENLO**  
Microcomputers  
designed for business

To: CLENLO COMPUTING SYSTEMS LIMITED,  
Crown House, 18 Gypsy Hill, London SE19 1NL.  
Telephone: 01-670 4202/3.

- Please send me details of your ACE MULTI-USER SYSTEM.
- Please send me details of the complete CLENLO range.

Name \_\_\_\_\_

Position \_\_\_\_\_

Company \_\_\_\_\_

Address \_\_\_\_\_

\_\_\_\_\_

Telephone \_\_\_\_\_



(continued from page 108)

0018	7D10	B1 57	L1	LDA (LO),Y	
0019	7D12	99 86 7F		STA RD1,Y	
0020	7D15	C8		INY	
0021	7D16	C8 07		CPY #7	
0022	7D18	00 F6		BNE L1	
0023	7D1A	AD 86 7F		LDA RD1	
0024	7D1D	CD 70 7F		CMP H	;IS IT THE RIGHT HEADER
0025	7D20	D0 29		BNE L2	;NO
0026	7D22	AD 87 7F		LDA RD1+1	
0027	7D25	CD 71 7F		CMP H+1	;IS RIGHT TYPE
0028	7D28	D0 21		BNE L2	; NO
0029	7D2A				;THIS IS THE RIGHT STRING
0030	7D2A	AD 8B 7F		LDA RD1+5	;GET DATA ON STRING
0031	7D2D	8D 75 7F		STA NH	;ELEMENT NUMBERS
0032	7D30	AD 8C 7F		LDA RD1+6	
0033	7D33	8D 74 7F		STA NL	;& STORE IT (HI & LO)
0034	7D36	18		CLC	
0035	7D37	AD 88 7F		LDA RD1+2	;SET UP NEXT STRING-
0036	7D3A	65 57		ADC LO	;ADDRESS SO AS NOT TO-
0037	7D3C	8D 84 7F		STA NSL	;OVERRUN
0038	7D3F	A5 58		LDA HI	
0039	7D41	6D 89 7F		ADC RD1+3	
0040	7D44	8D 85 7F		STA NSH	
0041	7D47	18		CLC	
0042	7D48	4C 66 7D		JMP RETR	;RETURN
0043	7D4B	18	L2	CLC	;LOOK FURTHER ON
0044	7D4C	AD 88 7F		LDA RD1+2	
0045	7D4F	65 57		ADC LO	
0046	7D51	85 57		STA LO	
0047	7D53	AD 89 7F		LDA RD1+3	
0048	7D56	65 58		ADC HI	
0049	7D58	85 58		STA HI	;SET UP NEW SEARCH AREA
0050	7D5A	18		CLC	
0051	7D5B	A0 00		LDY #0	
0052	7D5D	A5 2F		LDA #2F	;CHECK IF GONE TOO FAR
0053	7D5F	69 01		ADC #1	
0054	7D61	C5 58		CMP HI	
0055	7D63	10 AB		BPL L1	;ACC-HI SHOULD BE +
0056	7D65				;IF NOT STOP
0057	7D65	60		RET RTS	
0058	7D66			;RETRIEVAL SBR	
0059	7D66	18		RETR CLC	;START TO PRODUCE S=(N+1)/2
0060	7D67			;BUT 1ST SEE IF A*(0) EXISTS	
0061	7D67	AD 82 7F		LDA LODUP	
0062	7D6A	69 07		ADC #7	
0063	7D6C	85 57		STA LO	
0064	7D6E	A9 00		LDA #0	
0065	7D70	6D 83 7F		ADC HIDUP	
0066	7D73	85 58		STA HI	
0067	7D75	18		CLC	
0068	7D76	A0 00		LDY #0	
0069	7D78	B1 57		LDA (LO),Y	
0070	7D7A	F0 05		BEQ L19	;NO A*(0) DOES NOT EXIST
0071	7D7C	A9 07		LDA #7	;YES IT DOES
0072	7D7E	8D AD 7D		STA L21+1	;MOD PROG ACCORDINGLY
0073	7D81	AD 74 7F	L19	LDA NL	;1ST TIME THRO
0074	7D84	8D 76 7F		STA SL	;
0075	7D87	AD 75 7F		LDA NH	
0076	7D8A	8D 77 7F		STA SH	
0077	7D8D	4C A1 7D		JMP L5	
0078	7D90	18	L10	CLC	;OTHER THAN 1ST TIME
0079	7D91	AD 76 7F		LDA SL	
0080	7D94	69 01		ADC #1	
0081	7D96	8D 76 7F		STA SL	
0082	7D99	A9 00		LDA #0	
0083	7D9B	6D 77 7F		ADC SH	
0084	7D9E	8D 77 7F		STA SH	
0085	7DA1	18	L5	CLC	
0086	7DA2	4E 77 7F		LSR SH	;DIVIDE S HI BY 2
0087	7DA5	6E 76 7F		ROR SL	; " LO
0088	7DA8	18	L4	CLC	(continued on next page)
0089	7DA9	AD 82 7F		LDA LODUP	;SET PRIMARY POINTER=1ST
0090	7DAC	69 0A	L21	ADC #10	;OFFSET DEPENDS ON THE EXISTANCE

# OSBORNE 1

The portable business computer with a difference

# £1250

+ VAT  
INCLUDES SOFTWARE VALUE £800+



Osborne 1 – The personal business computer for small businesses and busy executives on the move.

- Compact and mobile – The Osborne 1 simply packs into its own carrying case. Take it wherever your work takes you.
- Comes complete – Z80A 64K computer, dual 100KB disc drives, typewriter keyboard with numeric keypad and 5" screen.
- Capabilities include word processing, data processing and financial planning.
- CP/M operating system allows user choice from a wide range of existing written programs.
- Connects to a variety of printers.

Included in the amazing price of just £1250 is over £800 worth of FREE software:—

WORDSTAR for word processing.  
MAILMERGE for name/address database.  
SUPERCALC for financial planning.  
MBASIC & CBASIC for programming.

REGISTERED TRADEMARKS:

CP/M: Digital Research  
WORDSTAR, MAILMERGE: MicroPro International  
MBASIC: Microsoft  
CBASIC: Compiler Systems, Inc.

All prices exclusive of VAT and carriage

# EQUINOX

Systems for Business  
Kleeman House, 16 Anning Street, New Inn Yard,  
London EC2A 3HB. Tel: 01-739 2387 & 01-729 4460  
Telex: 27341

(continued from previous page)

```

OF #*(0)
0091 7DAE 80 78 7F STR PL
0092 7DB1 80 7A 7F STR PLOUP ;TAKE DUPLICATE
0093 7DB4 AD 83 7F LDA HI0UP
0094 7DB7 80 79 7F STR PH
0095 7DBA 80 7B 7F STR PHDUP ;TAKE COPY
0096 7DBD 18 CLC
0097 7DBE ;SET COMPARISON POINTER
0098 7DBE ; C=P+S (SHELL SORT)
0099 7DBE
0100 7DBE
;MULTIPLY BY 3 SBR
0101 7DBE AD 76 7F MUL LDA SL
0102 7DC1 2A ROL A
0103 7DC2 80 72 7F STR DUM1 ;#2
0104 7DC5 AD 77 7F LDA SH
0105 7DC8 2A ROL A
0106 7DC9 80 73 7F STR DUM2
0107 7DCC 18 CLC
0108 7DCC AD 76 7F LDA SL
0109 7D00 6D 72 7F ADC DUM1 ;#3
0110 7D03 80 72 7F STR DUM1
0111 7DD6 AD 77 7F LDA SH
0112 7DD9 6D 73 7F ADC DUM2
0113 7DDC 80 73 7F STR DUM2
0114 7DDF 18 CLC
0115 7DE9 AD 72 7F L15 LDA DUM1 ;RETURN FROM #3 SBR
0116 7DE9 AD 76 7F ADC PL
0117 7DE6 80 7C 7F STR CL
0118 7DE9 AD 73 7F LDA DUM2
0119 7DEC 6D 79 7F ADC PH
0120 7DEF 80 7D 7F STR CH
0121 7DF2 18 CLC
0122 7DF3 AD 76 7F LDA PL
0123 7DF6 85 57 STR LO
0124 7DF8 AD 79 7F LDA PH
0125 7DF8 85 58 STR HI
0126 7DFD A0 00 LDV #0 ;CLEAR OFFSET
0127 7DFF
;GET SECTION
0128 7DFF GET1 LDA (LO),Y
0129 7DFF B1 57 NOP
0130 7E01 EA STR RD1,Y
0131 7E02 99 86 7F INH
0132 7E05 C8 CPY #3;GET 3 BYTES
0133 7E06 D0 03 BNE GET1
0134 7E08 D0 F5 LDA CL
0135 7E0A AD 7C 7F STR LO
0136 7E0D 85 57 LDA CH
0137 7E0F AD 7D 7F STR HI
0138 7E12 85 58 LDV #0
0139 7E14 A0 00
;GET SECOND 3 BYTES
0140 7E16 GET2 LDA (LO),Y
0141 7E16 B1 57 STR RD1+3,Y
0142 7E18 99 89 7F INH
0143 7E1B C8 CPY #3
0144 7E1C D0 03 BNE GET2
0145 7E1E D0 F6
;COMPARE LENGTHS OF STRINGS
0146 7E20 LDA #0
0147 7E20
0148 7E20 A9 00
0149 7E22 8D 6D 7F STR A
0150 7E25 AD 59 7F LDA RD1+3 ;FLAG FOR 2ND STRING BEING SHORTER
0151 7E28 C8 CPY #0
0152 7E2A D0 03 BNE L14 ;IS IT EMPTY?
0153 7E2C 4C 58 7F JMP EXIT1 ;IF NOT EMPTY
0154 7E2F CD 86 7F CMP RD1 ;IF EMPTY
0155 7E32 10 06 BPL L3
0156 7E34 EE 6D 7F INC F ;2ND SHORTER
0157 7E37 4C 3D 7E JMP ON
0158 7E3A AD 86 7F LDA RD1
0159 7E3D EA ON
0160 7E3E 8D 6F 7F STR J
0161 7E41 AD 87 7F LDA RD1+1 ;SET UP CHARACTER COUNTER
0162 7E44 8D 5C 7E STR STRP+1
0163 7E47 AD 88 7F LDA RD1+2
0164 7E4A 8D 5D 7E STR STRP+2 ;SETUP ADDR OF 1ST STRING
0165 7E4D AD 8A 7F LDA RD1+4
0166 7E50 8D 5F 7E STR STRC+1
0167 7E53 AD 8B 7F LDA RD1+5
0168 7E56 8D 60 7E STR STRC+2 ;SETUP ADDR OF 2ND STR
0169 7E59 A2 00 LDX #0
0170 7E5B 8D 00 80 STRP LDA #0000,X
0171 7E5E CD 00 80 CMP #0000,X
0172 7E61 EA NOP
0173 7E62 F0 07 BEQ ON1 ;SAME SO CONTINUE TEST
0174 7E64 EA NOP
0175 7E65 10 17 BPL REV ;WRONG ORDER, SO SWAP
0176 7E67 EA NOP
0177 7E68 4C 01 7F JMP EXITN ;IN ORDER, SO EXIT
0178 7E68
;ON1
0179 7E68 EB ON1
0180 7E6C 5C 6F 7F INX CPY J
0181 7E6F D0 EA BNE STRP ;NO
0182 7E71 A9 00 LDA #0
0183 7E73 CD 6D 7F CMP F ;WHICH IS SHORTER
0184 7E76 8D 6D 7F STR F ;CLEAR FLAG
0185 7E79 D0 03 BNE REV ;2ND WAS SHORTER
0186 7E7B 4C 01 7F JMP EXITN ;EXIT NORMAL
0187 7E7E
;
0188 7E7E
;REVERSE ORDER
0189 7E7E REV LDV #0
0190 7E7E A0 00
0191 7E80 AD 78 7F LDA PL ;PRIMARY LO
0192 7E83 85 57 STR LO ;READY TO SWAP
0193 7E85 AD 79 7F LDA PH ;# HI
0194 7E88 85 58 STR HI
0195 7E8A B9 89 7F PUT1 LDA RD1+3,Y
0196 7E8D 91 57 STR (LO),Y
0197 7E8F C8 INH
0198 7E90 C0 03 CPY #3
0199 7E92 D0 F6 BNE PUT1
0200 7E94 A0 00 LDV #0
0201 7E96 AD 7C 7F LDA CL ;THIS IS GOING TO WHERE PL WAS
0202 7E99 85 57 STR LO
0203 7E9B AD 7D 7F LDA CH
0204 7E9E 85 58 STR HI
0205 7E99 B9 86 7F PUT2 LDA RD1,Y
0206 7E93 91 57 STR (LO),Y
0207 7E95 C8 INH
0208 7E96 C0 03 CPY #3
0209 7E98 D0 F6 BNE PUT2
0210 7E9A ;ALL DONE
;
0211 7E9A EXITR LDA #1 ;SET RF FLAG TO 1
0212 7E9A A9 01 NOP
0213 7E9C EA NOP
0214 7E9D CD 6E 7F CMP RF ;REVERSED BEFORE?
0215 7E98 F0 18 BEQ L26 ;YES
0216 7E9B 8D 6E 7F STR RF
0217 7E95 AD 7D 7F LDA CH ;SAVE YOUR PLACE
0218 7E98 8D 7F 7F STR CHWAS
0219 7E9B AD 7C 7F LDA CL ;SAVE YOUR PLACE
0220 7E9E 8D 7E 7F STR CLWAS

```



DEALER ENQUIRIES WELCOME

## EPISODE

The NEW compact 1.5MB Standalone Computer

# £1995

+ VAT

INCLUDING VISUAL DISPLAY UNIT\*\* AND KEYBOARD

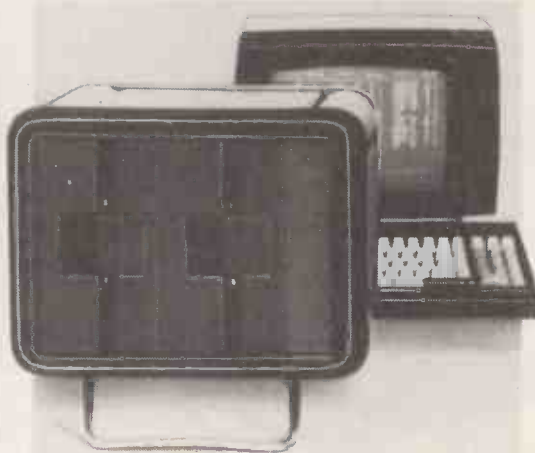

**EPISODE – A high performance standalone computer at a down to earth price. Capable of sharing data bases.**

■ FLEXIBLE – COMPACT – ADAPTABLE. The Episode allows user choice of VDU's and printers, takes up the desk space of a legal document and under its CP/M operating system ensures availability of technical and business software for both technical and non-technical user.

■ Word processing/ mailing ■ Financial planning  
 ■ Integrated accounts ■ Stock control  
 ■ Payroll ■ Information management

■ A wide range of languages and utilities is available under CP/M to the technical user. BASIC, FORTRAN, COBOL, PASCAL, etc.

■ Can be used with existing mainframe terminals.

### Standard features

Z80A Processor, 64K RAM, Diagnostic PROM, Dual 5" double sided double tracked drives (1.5 MB total), Dual RS232c ports, Centronics parallel port, battery calendar clock.

\*\*Adds viewpoint VDU or similar. (This offer is for a limited period only and applies only to this particular Episode model. Other Episode models from just £1450).

REGISTERED TRADEMARKS: CP/M - Digital Research

All prices exclusive of VAT and carriage

# EQUINOX

Systems for Business

Kleeman House, 16 Anning Street, New Inn Yard, London EC2A 3HB. Tel: 01-739 2387 & 01-729 4460. Telex: 27341

● Circle No. 167

```

0221 7EC1 AD 78 7F      LDA PL          ;SAVE YOUR PLACE
0222 7EC4 80 80 7F      STA PLHWS
0223 7EC7 AD 79 7F      LDA PH         ;SAVE YOUR PLACE
0224 7ECA 80 81 7F      STA PHHWS
0225 7ECD AD 79 7F      LDA PH         ;DROP BACK ONE & RETEST
0226 7ED0 80 7D 7F      STA CH
0227 7ED3 AD 78 7F      LDA PL
0228 7ED6 80 7C 7F      STA CL        ;COMPARISON TAKES CURRENT
0229 7ED9 38           SEC           ;PRIMARY POINTER VALUE
0230 7EDA ED 72 7F      SBC DUM1      ;SET UP DOUBLE PRECISION
0231 7EDD 80 78 7F      STA PL        ;SUBTRACTION
0232 7EE0 AD 79 7F      LDA PH        ;CL-S=PL
0233 7EE3 ED 73 7F      SBC DUM2
0234 7EE6 80 79 7F      STA PH
0235 7EE9             ;CHECK IF NEW PRIMARY POINTER STILL IN RANGE
0236 7EE9             ;THE NEW PRIMARY POINTER MUST BE >=
0237 7EE9             ;TO THE ORIGINAL (PHDUP+PLDUP)
0238 7EE9 AD 78 7F      LDA PL        ;SO PH/PL - PHDUP/PLDUP
0239 7EEC 38           SEC           ;SHOULD BE POSITIVE
0240 7EED ED 7A 7F      SBC PLDUP
0241 7EF0 AD 79 7F      LDA PH
0242 7EF3 ED 7B 7F      SBC PHDUP
0243 7EF6 EA           NOP
0244 7EF7 EA           NOP
0245 7EF8 EA           NOP
0246 7EF9 10 03       BPL L10       ;OK
0247 7EFB 4C 01 7F      JMP EXITN    ;NOT OK
0248 7EFE 4C F2 7D     L10          JMP L8
0249 7F01 18           EXITN        ;EXIT NO REVERSAL
0250 7F02 A9 00       LDA #0       ;HAS PREVIOUS OP A REVERSAL?
0251 7F04 CD 6E 7F      CMP RF
0252 7F07 F0 1B       BEQ L22
0253 7F09 80 6E 7F      STA RF
0254 7F0C AD 80 7F      LDA PLHWS
0255 7F0F 80 78 7F      STA PL
0256 7F12 AD 81 7F      LDA PHHWS
0257 7F15 80 79 7F      STA PH
0258 7F18 AD 7F 7F      LDA CHHWS
0259 7F1B 80 7D 7F      STA CH
0260 7F1E AD 7E 7F      LDA CLHWS
0261 7F21 8D 7C 7F      STA CL
0262 7F24 AD 78 7F      LDA PL
0263 7F27 18           CLC
0264 7F28 69 03       ADC #3
0265 7F2A EA           NOP
0266 7F2B 8D 78 7F      STA PL        ;INCREMENT PRIMARY POINTER
0267 7F2E 90 04       BCC L6
0268 7F30 EE 79 7F      INC PH        ;THERE WAS CARRY
0269 7F33 18           CLC
0270 7F34 AD 7C 7F      LDA CL        ;INCREMENT COMPARISON PTR
0271 7F37 69 03       ADC #3
0272 7F39 8D 7C 7F      STA CL
0273 7F3C 90 04       BCC L7
0274 7F3E EE 7D 7F      INC CH
0275 7F41 18           CLC
0276 7F42 AD 7C 7F      LDA CL
0277 7F45 CD 84 7F      CMP NSL
0278 7F48 F0 03       BEQ L11
0279 7F4A 4C F2 7D     L11         JMP L8
0280 7F4D AD 7D 7F      LDA CH
0281 7F50 CD 85 7F      CMP NSH
0282 7F53 F0 03       BEQ EXIT1    ;YES
0283 7F55 4C F2 7D     EXIT1       JMP L8        ;NO
0284 7F58 AD 77 7F      LDA SH
0285 7F5B C3 00       CMP #0       ;YES DONE ONE RUN.
0286 7F5D F0 03       BEQ L12
0287 7F5F 4C 90 7D     L12         JMP L10
0288 7F62 AD 76 7F      LDA SL
0289 7F65 C9 01       CMP #1
0290 7F67 F0 03       BEQ RBAS
0291 7F69 4C 90 7D     RBAS       JMP L10
0292 7F6C 60           RTS
0293 7F6D 60           F           ;FLAG FOR SECOND STRING SHORTER T
0294 7F6E 00           RF          ;.BYTE 0
0295 7F6F 00           J           ;FLAG FOR REVERSAL/RECYCLE
0296 7F70 41           H           ;LETTER COUNTER FOR COMPARING STR
0297 7F71 80           H           ;.BYTE #41
0298 7F72 00           H           ;.BYTE #80
0299 7F73 00           DUM1       ;.BYTE 0
0300 7F74 00           DUM2       ;.BYTE 0
0301 7F75 00           NH         ;.NUMBER OF ELEMENTS
0302 7F76 00           SL         ;.BYTE 0
0303 7F77 00           SH         ;.BYTE 0
0304 7F78 00           PL         ;.BYTE 0
0305 7F79 00           PH         ;.BYTE 0
0306 7F7A 00           PLDUP      ;.BYTE 0
0307 7F7B 00           PHDUP      ;.BYTE 0
0308 7F7C 00           CL         ;.BYTE 0
0309 7F7D 00           CH         ;.BYTE 0
0310 7F7E 00           CLHWS     ;.BYTE 0
0311 7F7F 00           CHHWS     ;.BYTE 0
0312 7F80 00           PLHWS     ;.BYTE 0
0313 7F81 00           PHHWS     ;.BYTE 0
0314 7F82 00           LODUP     ;.BYTE 0
0315 7F83 00           HIDUP     ;.BYTE 0
0316 7F84 00           NSL       ;.BYTE 0
0317 7F85 00           NSH       ;.BYTE 0
0318 7F86 00           RDI       ;.BYTE 0
0319 7F87 00           ;.BYTE 0
0320 7F88 00           ;.BYTE 0
0321 7F89 00           ;.BYTE 0
0322 7F8A 00           ;.BYTE 0
0323 7F8B 00           ;.BYTE 0
0324 7F8C 00           ;.BYTE 0
0325 7F8D 00           ;.BYTE 0
0326 7F8E 00           ;.BYTE 0
0327 7F8F           .END

ERRORS = 0000
SYMBOL TABLE
SYMBOL VALUE
CH 7F7D CHHWS 7F7F CL 7F7C CLHWS 7F7E
DUM1 7F72 DUM2 7F73 EXIT1 7F58 EXITN 7F01
EXITR 7E9A F 7F6D GET1 7DFF GET2 7E16
H 7F70 HI 0058 HIDUP 7F03 J 7F6F
L1 7D10 L10 7D90 L11 7F4D L12 7F62
L14 7E2F L15 7DE0 L18 7EFE L19 7D81
L2 7D40 L21 7D9C L22 7F24 L26 7ECD
L3 7E3A L4 7D98 L5 7D91 L6 7F34
L7 7F42 L8 7D72 L0 0057 LODUP 7F82
MUL 7DBE NH 7F75 HL 7F74 NSH 7F85
NSL 7F84 ON 7E30 ONI 7E6B PH 7F79
PHDUP 7F7B PHHWS 7F81 PL 7F78 PLDUP 7F7A
PLHWS 7F80 PUT1 7E9A PUT2 7EA0 RBAS 7F6C
RF 7F86 RET 7D65 RETR 7D66 REV 7E7E
RDI 7F6E SH 7F77 SL 7F76 STRC 7E5E
STRP 7E5B
END OF ASSEMBLY
    
```

# CHROMASONIC electronics

48 JUNCTION ROAD, ARCHWAY LONDON N19 5RD 100 yds FROM ARCHWAY STATION & 9 BUS ROUTES  
 TELEPHONE: 01-263 9493/01-263 9495 TELEX: 22568.

## YOUR SOUNDEST CONNECTION IN THE WORLD OF COMPUTERS

### VIC 20

- \* 24 Colours, 8 for Characters, 8 for Border, 16 for screen mixed as you wish.
  - \* 3 tone Generator for sound.
  - \* Uses Pet Basic \* Plugs into T.V.
  - \* Memory expandable to 32K
  - \* VIC complete with T.V. Modulator and Power Supply
- ONLY £165.00**

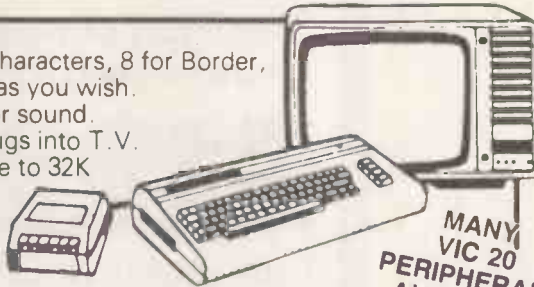

VIC Cassette Deck  
**ONLY £34.00**

Available soon  
 VIC Dot Matrix Printer  
 80 Column, 30 CPS,  
 Tractor Feed  
**ONLY £199.95**

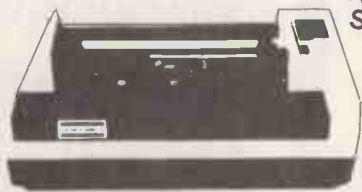

MANY  
 VIC 20  
 PERIPHERALS  
 AVAILABLE  
 SEND FOR  
 LIST

### UK101

DOWN  
 IN PRICE

- UK101 Kit inc 8K memory £125
  - Ready Built inc 8K memory £175
  - 4K Expansion 8x2114 £10
  - Parallel Printer Interface £24.50
  - Chromasonics Sound Kit £24.50
  - Colour Kit £69.95
- NEW NEW NEW**
- 32K Dynamic Memory Board only £89.95
  - P.I.O. and Eprom Programmer Kit only £24.50
  - J1 Expander £12.50

### APPLE II PLUS

- AUTOSTART "EUROPLUS"  
 48K Apple Computer **649.00**  
 Disc Drive with Controller **349.00**  
 Disc Drive without Controller **299.00**  
 Colour Card **69.00**  
 Silentye Printer **199.00**  
 Graphics Tablet **425.00**  
 TV Modulator **14.00**
- A range of APPLE accessories and Software are available.



### PET

- 4016 16K RAM 445.00
- 4032 32K RAM 560.00
- 8032 32K RAM 755.00
- 8096 96K RAM 1040.00
- 4040 Disk Drive 560.00
- 8050 Disk Drive 755.00
- 4022 Printer 80 Col 350.00
- 8023 NEW Printer 785.00
- 8026 Printer/Typewriter 835.00
- 2031 Single Drive 349.00



A range of PET accessories and software available

### PRINTERS



**EPSON MX80 £359**  
 Dot-matrix printer with Pet graphics interface. Centronics parallel and serial. Pet and Apple compatible. True bidirectional, 80 cps.

**EP80 MX82 £389**  
 As MX80 plus high Resolution Graphics

INTERFACES AND CABLES FOR APPLE II, PET, TRS80, RS232, UK101, SHARP SUPERBOARD ALL AVAILABLE.

**EPSON MX80 FT/1 £399**  
 Dual single sheet friction and tractor feed, 9 wire head, true descenders.  
**EPSON-MX80 FT/2 £440**  
 An FT/1 with high resolution graphics.

**SEIKOSHA GP80A £195**  
 Dot matrix 5 x 7, 80 columns, 30 cps graphics, double width characters.

**EPSON MX100 only £575**

### VIDEO GENIE

Utilises Z80, 12K level II Basic, Integral Cassette Deck, UHF O/P, 16K RAM, all TRS80 features. Simply plugs into monitor of UHF TV. With V.U. Meter. NOW WITH LOWER CASE AND SOUND.

- GENIE I £299
- PARALLEL PRINTER INTERFACE INC CABLE £38.00
- CHROMASONICS PROGRAMMABLE SOUND KIT £24.50
- SOUND KIT (FITTING EXTRA) £8.20
- LOWER CASE KIT (FITTING EXTRA) £29.80
- COLOUR KIT (FITTING EXTRA) £36.00
- EXPANSION BOX INC 16K RAM £199
- 16K/32K RAM BOARD £94/£129
- NEW GENIE II NOW AVAILABLE £310**

### MONITORS

- 9" £99.95
- 12" £149.00
- 9" Green Screen £99.00
- 12" Green Screen £125.00
- 12" BMC Green Screen £159.00

HITACHI PROFESSIONAL



ALL ITEMS CARRY 1 YEAR GUARANTEE

### TANTEL

**PRESTEL BY TANTEL**  
 COMMUNICATIONS AT YOUR FINGERTIPS  
 FOR BUSINESS & HOME. UP TO DATE INFO

180,000 pages of information on Travel, News, Investment, Holidays, Hotels Etc., Etc. £159  
 TANTEL IS POST OFFICE APPROVED. SEND FOR DETAILS.  
 DEMONSTRATION AVAILABLE AT OUR SHOWROOM.

SEE US AT **THE Computer Fair**  
 Personal computers  
 Home computing  
 Small business systems



Please add VAT 15% to all prices. Postage on computers, printers and cassette decks charged at cost, all other items P&P 30p. Place your order using your Access or Barclaycard (Min. tel. order £10). Export enquiries welcome. Official orders welcome. Prices valid for cover date of this magazine only.



● Circle No. 168



# expanding your horizons ?

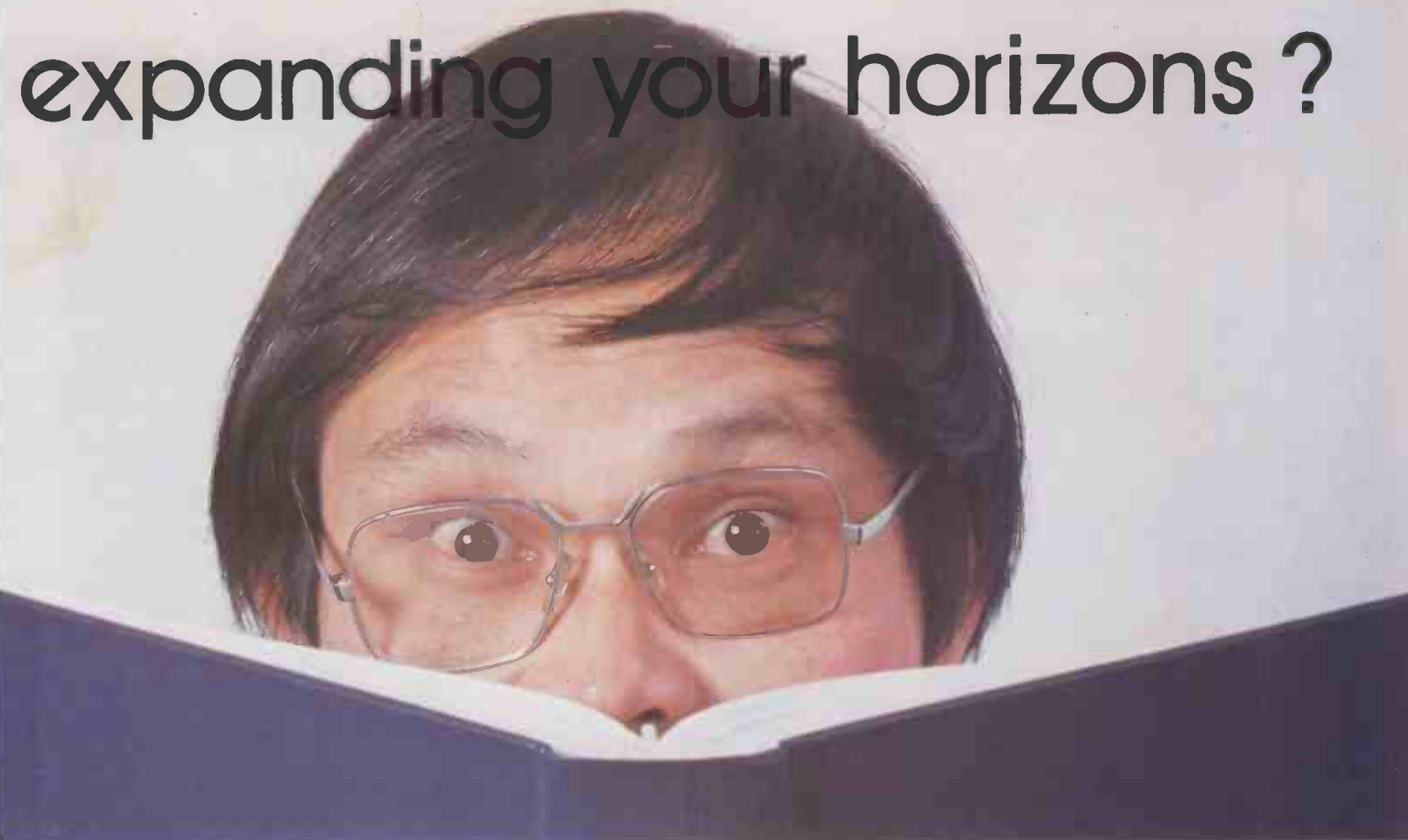

Now available from Interam, the highly regarded North Star Horizon with mini-winchester disk drive. This integral hard disk gives you a massive 3, 6, 9 or 12 million character storage capacity sufficient for virtually all applications. However if you require even further capacity then up to four M26 Winchester hard disks can be added externally giving access to over an incredible 100 million characters of data.



Using Starlink, our enhanced CP/M compatible multi-user operating system this data storage can be accessed by one or more users in a time sharing or multi-processing environment.

Starlink, — Multi-User CP/M Compatible Operating System — Developed by Dr. Lee of Interam, is at the heart of system expansion. Starlink logically integrates the North Star Horizon with a range of Winchester disks and/or additional I/O, memory and processors. Features include independent login and logout, print spooling, file lock and unlock for



common files, five priority levels, two-way private communications, mail/news/message facilities etc. In all, over 20 utilities are incorporated in the Starlink package.

The following components are recommended for use with Starlink:-

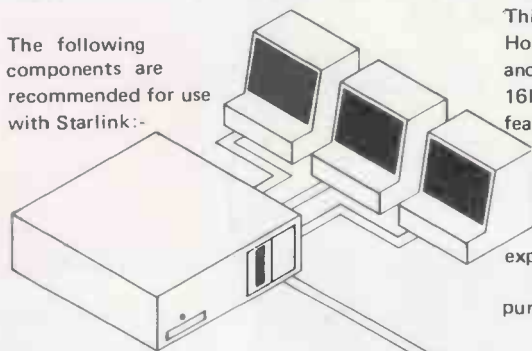

Rodime Mini-Winchester hard disk—This impressive unit achieves it's drive performance through elegant and reliable engineering design. The RO 100 series provides formatted capacities from three to twelve megabytes. Fast access times enable you to obtain the information you require at great speed and the increased storage capacity will give you plenty of scope for database expansion to cope with your growing needs.

Action Computers Single Board Computer — For dedicated multi-user processor power. One DPC180 card is devoted to each user providing exclusive use of the on-board Z80A CPU, 64K RAM and serial I/O. The obvious benefit of distributed processing is very limited loss of CPU time per user facilitating expansion to a larger number of users than would be possible with timesharing.

Interam Serial I/O — Our brand new four serial input/output card. Each board has all the necessary features to operate in a powerful interrupt driven, real-time, multi-user system. The board includes four 2661 programmable synchronous/asynchronous serial devices

for communicating with terminals, modems or printers. Two and three serial I/O port versions also available.

North Star's 64K HRAM Memory Card — This card offers increased utilisation of the Horizon address space, increased reliability and lower cost. HRAM utilises individual 16K x 1K dynamic RAM chips. These boards feature memory parity checking and bank switching, designed to optimise operation of North Star hardware and software products.

Existing North Star Horizon users can expand their systems all these new purchasing the upgrade package. to take advantage of products by relevant

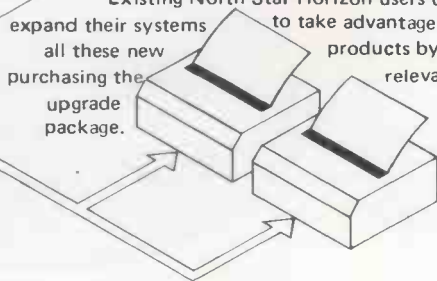

Horizon is a trade mark of North Star Computers Inc. CP/M is a trademark of Digital Research Inc. Starlink is a trademark of TTE & Interam Ltd.

Send off the coupon today and expand your horizons.

## INTERAM

Microcomputer Specialists  
46 Balham High Road London SW12 9AQ Tel: 01-675 5325

Name	
Position	
Company	
Address	
Tel No.	
PLEASE SEND ME DETAILS OF THIS AND OTHER PRODUCTS	

1,200,000 more bytes at your  
 **apple PET SUPERBRAIN TRS-80**  
 For a mere **£1,950**



And  
**10,000,000**  
 more for just **£3,950**



Meet Lisiar 1 and Lisiar 2—the most potent plug-ins ever to break through the price barrier.

LISIAR 1 uses floppies to give you 1.2 Megabytes for £1,950. 2.4 Megabytes available as an optional extra.

LISIAR 2 is the most powerful Winchester you can buy at anywhere near £3,950.

And both models plug in to your personal computer. No fuss, no fiddling adaptations.

Just INSTANT conversion to full professional potential, with all the space and capacity you need for really professional programs.

**PHONE JANETTE BROOKS  
 ON 0925-810828 or  
 SEND COUPON  
 AND GET THE FACTS  
 NOW!**

To: Lisiar Computers Ltd., Genesis,  
 Birchwood Science Park South,  
 Risley, Warrington, Cheshire WA13 7BH

Please send full details of LISIAR plug-in memories.

Please tick as required.

LISIAR 1 – 1.2 Megabytes   
 LISIAR 1a – 2.4 Megabytes   
 LISIAR 2 – 10 Megabytes

My computer is:

APPLE  PET  SUPERBRAIN   
 TRS 80  OTHER

NAME

ADDRESS

TELEPHONE

**DEALER ENQUIRIES INVITED**

● Circle No. 170



# Open File

This new section of *Practical Computing* will be appearing in the magazine each month, incorporating Tandy Forum, ZX-80/81 Line-up and the other software interchange pages.

Open File is the part of the magazine written by you, the readers. All aspects of microcomputing are covered, from games to serious business and technical software, and we welcome contributions on CP/M, BBC Basic, Microsoft Basic, Apple Pascal and so on, as well as the established categories.

Each month the best contribution will be awarded £20; others receive £6. Send contributions to: Open File, *Practical Computing*, Quadrant House, The Quadrant, Sutton, Surrey SM2 5AS.

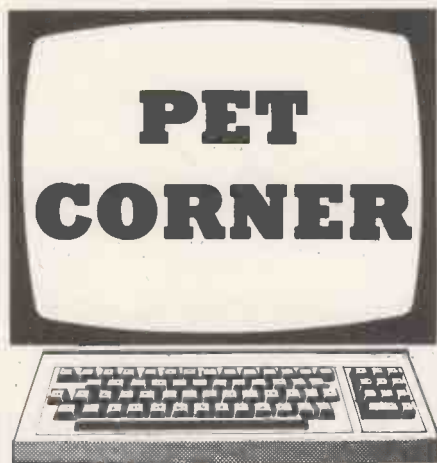

## Cassette files

I ENCOUNTERED recently an interesting bug in the way the Pet opens cassette files, writes David Haslam of Stockport, Greater Manchester. One program I was

<b>Pet Corner:</b> Cassette files bug; Screen Print for 4000 series; Going down for the lower-case descenders; Othello; Kaleidoscope	117
<b>Z-80 Zodiac:</b> Solving polynomials on Nascom	120
<b>Apple Pie:</b> Developing menu routines	125
<b>Tandy Forum:</b> Tape catalogue; Function-input routine; Binary clock	127
<b>6502 Special:</b> Extending Basic; Double-vision hardware modification; Random Poke for graphics	133
<b>ZX-80/81 Line-up:</b> Bar-chart plotter; Line-drawing routine; Print At program suite; Card shuffle; Think quick; Flight of fancy; Read data routine; The money program; Hex loader	135



## Guidelines for contributors

Programs should be accompanied by documentation which explains to other readers what your program does and, if possible, how it does it. It helps if documentation is typed or printed with double-line spacing — cramped or handwritten material is liable to delay and error.

Program listings should, if at all possible, be printed out. Use a new ribbon in your

printer, please, so that we can print directly from a photograph of the listing and avoid typesetting errors. If all you can provide is a typed or handwritten listing, please make it clear and unambiguous; graphics characters, in particular, should be explained.

We can accept material for the Pet, Vic and Sharp MZ-80K on cassette, and material for the larger machines can be sent on IBM-format 8in. floppy discs.

working on stored as lines of text as a Basic file. I wrote the following subroutine to read the line numbers into L3 and the line of text into L\$.

As I was not interested in using the link bytes, line 50 merely skips those in passing, they are in LA\$,LB\$ if needed. Lines 60 and 70 are needed because the Get statement interprets a zero as a null string. I use this property to terminate line 90 on the end of line zero byte of the Basic text.

This routine worked satisfactorily on all subsequent lines, except for the first line of text in the stored file. The file in F\$ had been opened for read by the command Open 1,1,0,F\$.

Here is the bug. The first line would read correctly if I deleted LA\$ from line 50, thus indicating that the first cassette buffer pointer is one byte too high immediately after the Open command. So the solution which worked was to have this on the same line as the Open command.

POKE 187, PEEK(187) -1

Finally, for those who might wonder why I did not use Input # instead of Get # on line 90, the reason is simply that although it would be satisfactory on lines of text with no embedded quotation marks — it would terminate on the zero byte — problems arise when the line of

(continued on next page)

```

50 L$= "": GET#1,LA$,LB$,LL$, LH$: REM STRIP LINK BYTES & LINE NUMBER
60 IF LL$="" THEN LL$=CHR$(0)
70 IF LH$="" THEN LH$=CHR$(0)
80 L3=ASC(LL$)+256*ASC(LH$) : REM LINE NUMBER = L3
90 GET#1, Q$: IF Q$<>" THEN L$=L$+Q$:GOTO 90
95 RETURN : REM LINE OF TEXT = L$

```

(continued from previous page)

text contains, say, just one embedded quotation, in which case there is a continued read until usually a file data error occurs.

### Screen print

MAY I offer a small contribution to the excellent screen printer program by J Dick and M Valentine which appeared in Pet Corner last June, writes D A Harris of Surbiton, Surrey. Altering a few lines allows the program to be used with a series 4000 Pet and 4022 printer. The listing shows the lines which need to be altered.

```

27 DATA A9,04,20,E2,F2,A9,06,20
28 DATA E2,F2,A5,35,35,02,60,EA
33 DATA 18,20,46,BB,20,A6,F2,A9
37 DATA 05,A9,11,20,46,BB,18,B1
46 DATA 69,40,85,0F,A9,92,20,46
47 DATA BB,4C,BD,XX,85,0F,A9,12
48 DATA 20,46,BB,A5,0F,20,46,BB
50 DATA D0,9C,20,DF,BA,A2,00,A5
53 DATA A6,F2,60,A5,D2,A6,D3,A9
55 DATA 63,F5,A6,D2,20,FE,F7,60

```

### Going down

THE DOT-MATRIX printers supplied by Commodore for use with the Pet, though robust and reliable, are in some ways annoying and quixotic, writes A D Maude at Aberystwyth, Dyfed. One of their shortcomings is the inability to print characters with tails which go below the line, known as "descenders", such as q,g or p.

Some models, such as the 3022, have the facility to move the paper on by a fraction of a line separation, and to print special characters designated by software. This program uses these facilities to produce descenders at the cost of a slower rate of printing.

As the main line and descenders are printed on separate sweeps of the printer head, paper in a traction-feed printer must be under a slight tension. Otherwise, it may not move on by quite the correct

### Going down

```

1 REM PRINTING WITH DESCENDERS
10 CLR:GOSUB 5000
20 DIM X$(7)
30 PRINT#6,CHR$(29):FOR K=1 TO 7:READ X$(K):PRINT#4,X$(K):NEXT K
40 PRINT#4:PRINT#4:PRINT#4
50 FOR K=1 TO 7:A$=X$(K):GOSUB 4000:NEXT K
60 CLOSE 4:CLOSE 5:CLOSE 6:STOP
4000 REM
4010 REM *** SUBROUTINE FOR PRINTING A$ ***
4020 CP=1:B$="":REM CP=1/0 FOR UPPER/LOWER CASE
4030 FOR N=1 TO LEN(A$):C$=MID$(A$,N,1)
4040 IF C$="I" THEN CP=1
4050 IF C$="M" THEN CP=0
4060 IF CP=1 THEN 4090
4070 IF C$="P" OR C$="Q" OR C$="Y" OR C$="G" THEN C$=" "
4080 IF C$="J" THEN C$=CHR$(254):REM THE DOT FOR A J
4090 B$=B$+C$:NEXT N
4100 PRINT#5,D1$(0):PRINT#6,CHR$(5):PRINT#4,B$
4110 REM PRINT DESCENDERS
4120 CP=1
4130 FOR J=1 TO 5:FOR N=1 TO LEN(A$):C$=MID$(A$,N,1):D$=" "
4140 IF C$="I" THEN CP=1:GOTO 4180
4150 IF C$="M" THEN CP=0:GOTO 4180
4160 IF C$=C1$(J) AND CP=0 THEN D$=CHR$(254)
4170 PRINT#4,D$:
4180 NEXT N
4190 PRINT#5,D1$(J):PRINT#6,CHR$(1):PRINT#4:NEXT J
4200 PRINT#6,CHR$(12):PRINT#4:RETURN
5000 REM
5010 REM *** SET UP SPECIAL CHARACTERS AND PREPARE PRINTER ***
5020 DIM D1$(5),C1$(5)
5030 OPEN 4,4:OPEN 5,4,5:OPEN 6,4,6:RESTORE
5040 FOR J=0 TO 5:D1$(J)=" "
5050 FOR N=1 TO 6:READ A:D1$(J)=D1$(J)+CHR$(A):NEXT N
5060 READ C1$(J):NEXT J:RETURN
5100 REM
5110 REM SPECIAL CHARACTER DATA
5120 DATA 0,0,0,64,0,0," "
5130 DATA 2,1,1,126,0,0,"J"
5140 DATA 127,40,68,68,56,0,"P"
5150 DATA 56,68,68,40,127,0,"Q"
5160 DATA 113,9,5,9,126,0,"Y"
5170 DATA 56,69,69,69,62,0,"G"
5200 REM
5210 REM TEXT TO BE PRINTED
5220 DATA "COMMODORE PRINTING WITH DESCENDERS"
5230 DATA "-----"
5240 DATA "A.D.MAUDE, UNIVERSITY COLLEGE OF WALES, ABERYSTWYTH,"
5250 DATA "THE DOT MATRIX PRINTERS SUPPLIED BY COMMODORE FOR USE WITH"
5260 DATA "THE PET) ARE ROBUST AND RELIABLE, BUT IN SOME WAYS ARE JUST A"
5270 DATA "LITTLE ANNOYING AND QUIXOTIC. ONE OF THEIR SHORTCOMINGS IS THEIR"
5280 DATA "INABILITY TO PRINT CHARACTERS WITH TAILS WHICH GO BELOW THE LINE."

```

distance, and so the descenders may be slightly displaced.

### Othello

TWO PEOPLE can play Othello on the program from Stephen Cronk of Litlington, near Royston, Hertfordshire. The program checks for legal moves and scores and

outputs suitable verbal remarks and instructions at various points during the game via the wideband Speakeasy speech synthesiser.

If you do not have the Speakeasy unit, delete line 60010. The £ sign in line 80 is the graphic character " - " and the % in the following lines is the character "I".

### Othello

```

0 POKE59459,255:POKE59468,205
1 P=33005:K1=33085:Y1=33125:W1=33205:B1=33285:P1=2:BT=2:WT=2
2 GOSUB6000
5 PRINT"":DIMB(9,9,2)
10 REM OTHELLO: NOT BY SHAKESPEARE
20 REMARKABLY COMMITTED BY S.CRONK 15/5/1981
21 REM CONNECT WIDEBAND SPEAKEASY SPEECH UNIT
22 REM---IF YOU DARE!!!!-----
23 REM-----
30 PRINTSPC(16);"OTHELLO"
40 PRINTSPC(15);"EEEEEEEEEE"
50 PRINTSPC(12);"BY STEVE CRONK"
60 PRINT
70 PRINTSPC(11);"1 2 3 4 5 6 7 8 PLAYER"
80 PRINTSPC(10);"OEEEEEEEEEEEEEE EEEEEEEEEEE"
90 PRINTSPC(9);"A%";SPC(23);"X"
100 PRINTSPC(10);"%";SPC(23);"Y"
110 PRINTSPC(9);"B%"
120 PRINTSPC(10);"% "
130 PRINTSPC(9);"C%"
140 PRINTSPC(10);"% "
150 PRINTSPC(9);"D%";PRINTSPC(10);"%";PRINTSPC(9);"E%";PRINTSPC(10);"% "
160 PRINTSPC(9);"F%";PRINTSPC(10);"%";PRINTSPC(9);"G%"
170 PRINTSPC(10);"%";PRINTSPC(9);"H%"
180 DATA33020,33100,33180,33260,33340
190 DATA33420,33500,33580
195 RESTORE
200 FORJ=1TO8
210 READA:A=A+39:FORK=ATO(A+15)STEP2:L=L+1
220 B(L,J,1)=K:B(L,J,2)=46
230 NEXTK:L=0:NEXTJ
240 GOSUB5000
250 B(4,4,2)=87:B(5,4,2)=81:B(4,5,2)=81:B(5,5,2)=87
260 GOSUB5000
270 P1=1:GOTO276
275 P1=2
276 REM
280 GOSUB6000:IF G=1 THEN 510
290 IFB(XM,YM,2)=46THEN301
300 GOSUB10200:POKE33078,133:FORJ=1TO500:NEXT:POKE33078,32:GOTO280
301 C=87:C1=B1:R=0
305 IFP1=1THENC=81:C1=87
310 XT=XM:YT=YM
315 R=0
316 IFRND(1)>.9THENGOSUB10400
320 W=0:Z=0:GOSUB7000
330 Z=1:GOSUB7000
340 Z=-1:GOSUB7000
350 W=1:Z=0:GOSUB7000
360 Z=1:GOSUB7000
370 Z=-1:GOSUB7000
380 W=-1:Z=0:GOSUB7000
390 Z=-1:GOSUB7000
400 Z=1:GOSUB7000
410 IFR=OTHEN300
420 R1=R+1:GOSUB5000
500 IFR1=6OTHEN9500
510 IFP1=1THEN275
520 IFP1=2THEN270
525 FORJ=1TO2000:NEXT
530 PRINT"":SPC(10);
535 IFWT>BTTHEN560
540 PRINT"BLACK WON BY";BT-NT
550 GOTO570
560 PRINT"WHITE WON BY";WT-BT
565 GOSUB10300
570 END
5000 FORX=1TO8:FORY=1TO8
5010 POKEB(X,Y,1),B(X,Y,2)
5020 NEXTY:NEXTX:RETURN
6000 IFP1=1THENPOKEP,49
6001 G=0:GOSUB10100
6009 POKEY1,32
6010 IFP1=2THENPOKEP,50
6020 POKEX1,32:GETA$:IFA$<" "THEN6040
6030 POKEX1,102:GOTO6020
6040 IFA$="N"THENB=1:RETURN
6045 IFA$<"1"OR"2"OR"3"THEN6020
6050 POKEY1,VAL(A$)+4B1XM=VAL(A$)
6060 POKEY1,32:GETA$:IFA$<" "THEN6080
6070 POKEY1,102:GOTO6060
6080 IFA$<"A"OR"2"OR"3"THEN6060

```

(continued on next page)



(continued from previous page)

```

6090 POKEY1,ASC(A*)-64:YM=ASC(A*)-64
6100 RETURN
7000 XT=XM:YT=YM:F=0
7010 XT=XT+Z:YT=YT+W
7020 IFB(XT,YT,2)=CORB(XT,YT,2)=46THEN7500
7025 IFYT<1DRYT>8DRXT<1DRXT>8THEN7500
7030 XT=XT+Z:YT=YT+W
7040 IFB(XT,YT,2)=CTHENF=1
7050 IFYT>8DRXT<1DRYT>8DRYT<1THEN7070
7060 GOTD7030
7070 IFF=0THEN7500
7080 XT=XM:YT=YM:B(XM,YM,2)=C
7090 XT=XT+Z:YT=YT+W
7100 IFB(XT,YT,2)=CTHENF=1
7110 B(XT,YT,2)=L:R=R+1
7120 GOTD7090
7500 RETURN
8000 PRINT" ";SPC(13);"INSTRUCTIONS"
8005 GOSUB10000
8010 PRINTSPC(12);"EEEEEEEEEEEEEE"
8020 PRINT
8030 PRINT"THE PLAYER MUST PLACE A COUNTER IN A"
8040 PRINT"FREE SQUARE ADJACENT TO AN OCCUPIED"
8050 PRINT" SQUARE IN SUCH A WAY THAT AT LEAST ONE"
8060 PRINT"OF THE OPPONENT'S COUNTERS LIES BETWEEN"
8070 PRINT"THE CURRENT COUNTER AND ANOTHER OF HIS"
8080 PRINT"OWN COUNTERS IN STRAIGHT LINE"
8090 PRINT"ALL THE OPPONENTS COUNTERS SO"
8100 PRINT"SANDWICHED BECOME CAPTURED"
8110 PRINT:PRINT" PLAYER 1=0"
8120 PRINT:PRINT" PLAYER 2=W"
8130 PRINT:PRINT" PRESS ANY KEY TO START"
8140 GETA$:IFA$=" "THEN8140
8150 RETURN
9000 GOTD9000
9500 PRINT" GAME OVER":FORX=1TO8:FORY=1TO8
9510 IF B(X,Y,2)=B1THENWT=WT+1
9520 IF B(X,Y,2)=B7THENBT=BT+1
9530 NEXT: NEXT: RETURN
10000 RESTORE
10010 READ A5: IFA5<>230THEN10010
10020 READA5: IFA5<-1THENRETURN
10030 GOSUB60000
10040 GOTD10020
10100 RESTORE
10110 IFF1=2THEN10160
10120 READA5: IFA5<>240THEN10120
10130 READA5: IFA5<-1THEN10150
10140 GOSUB60000: GOTD10130
10150 FORA6=1TO7: READA5: NEXTA6: GOTD10180
10160 READA5: IFA5<>250THEN10160
10170 READA5: IFA5<-1THEN10180
10175 GOSUB60000: GOTD10170
10180 READA5: IFA5<-1THENRETURN
10190 GOSUB60000: GOTD10180
10200 RESTORE
10210 READA5: IFA5<>270THEN10210
10220 READA5: IFA5<-1THENRETURN
10230 GOSUB60000: GOTD10220
10300 RESTORE
10310 READA5: IFA5<>290THEN10310
10320 READA5: IFA5<-1THENRETURN
10330 A5=A5+64: GOSUB60000: GOTD10320
10400 RESTORE
10410 READA5: IFA5<>300THEN10410
10420 READA5: IFA5<-1THENRETURN
10430 GOSUB60000: GOTD10420
60000 POKES9457,A5: POKES9468,237: POKES9468,205
60010 IF PEEK(59469)/4=INT(PEEK(59469)/4) THEN60010
60020 RETURN
61000 DATA30, 52,57,59,24,38,63,14,21,0,41,63,31,42,44,15,2,13,63
61010 DATA25,25,23,61,13,25,27,63,-3
61015 DATA240,45,35,0,41,42,27
61020 DATA-3,250,14,24,47,0,25,-3,42,54,55,55,63,12,55,55
61030 DATA15,63,-3
61040 DATA270,56,2,0,42,31,63,16,44,42,10,20,63,-3
61050 DATA290,25,50,13,27,92,87,111,94,26,35,152,134,33,17,35,13,18,63,63
61080 DATA-3
61090 DATA300,56,39,31,63,139,137,146,63,29,50,49,13,63,-3
READY.

```

## Kaleidoscope

THIS GAME has been devised on the Pet 4032 by Ian Payton of Winnersh, Berkshire. Kaleidoscope is fully portable and requires no special graphics or cursor controls. All that needs to be changed are the variables:

TL — top-left of VDU, SD — screen depth, SL — screen length, RW — reverse blank, BD — half-density block, OB— ordinary blanks.

You are asked first whether you would like a negative or positive kaleidoscope effect. If you choose 'Negative' the screen is filled with reverse blanks, if not, it is simply cleared.

A border is then drawn around the screen in half-density blocks and the arrays are set up.

The program then goes through a routine which plots reverse blanks on the screen, or ordinary blanks if the space is already occupied. After you press the space key, it waits for another key.

```

READY.
100 REM ***** KALEIDOSCOPE *****
110 TL=32768
120 SD=24
130 SL=40
140 TR=TL+(SL-1)
150 BL=TL+((SD-1)*SL)
160 BR=BL+(SL-1)
170 RW=160
180 BD=102
190 OB=32
200 FORX=1TOSD/2
210 PRINT
220 NEXTX
230 PRINTTAB((SL-12)/2)"KALEIDOSCOPE"
240 PRINT
250 PRINT
260 PRINTTAB((SL-12)/2-1)"BY I.P. PAYTON"
270 FORX=1TOSD/2
280 PRINT
290 NEXTX
300 FORX=1TO1500
310 NEXTX
320 PRINT"DO YOU WANT A NEGATIVE OR POSITIVE"
330 PRINT
340 PRINT"KALEIDOSCOPE EFFECT (N/P) ?"
350 FORX=1TOSD/2
360 PRINT
370 NEXTX
380 GETNP$
390 IFNP$="N" THEN420
400 IFNP$="P" THENGOSUB900: GOTD460
410 GOTD380
420 GOSUB900
430 FORNL=TLTOBR
440 POKENL,RW
450 NEXTNL
460 FORPL=TLTOTR
470 POKEPL,BD
480 NEXTPL
490 FORPL=TLTOBLSTEPSL
500 POKEPL,BD
510 POKEPL+(SL-1),BD
520 NEXTPL
530 FORPL=BLTOBR
540 POKEPL,BD
550 NEXTPL
560 FORZ=1TO4
570 LC(Z)=TR
580 LC(3)=BL
590 LC(4)=BR
600 D1(1)=1
610 D1(2)=-1
620 D1(3)=1
630 D1(4)=-1
640 D2(1)=SL
650 D2(2)=SL
660 D2(3)=-SL
670 D2(4)=-SL
680 XX=INT((SL-1)/2)
690 YY=INT((SD-1)/2)
700 FORX=1TO4
710 L2(X)=LC(X)
720 NEXTX
730 X=INT(XX*RND(1)+1)
740 Y=INT(YY*RND(1)+1)
750 FORZ=1TO4
760 L2(Z)=L2(Z)+(X*D1(Z))+(Y*D2(Z))
770 NEXTZ
780 IFPEEK(L2(1))<>OBTHENCR=OB: GOTD800
790 CR=RW
800 FORZ=1TO4
810 POKEL2(Z),CR
820 NEXTZ
830 GETGG$
840 IFGG$<>" " THEN890
850 GETGG$
860 IFGG$=" " THEN890
870 IFGG$="S" THENGOSUB940: END
880 GOTD850
890 GOTD700
900 FORX=1TOSD/2
910 PRINT
920 NEXTX
930 RETURN
940 FORX=1TOSD
950 PRINT
960 NEXTX
970 RETURN
READY.

```



### Solving polynomials

THE SCIENTIFIC use of a computer usually concerns Numerical Analysis, writes Daniel Zlatnik of Mozkin, Israel. Most commercial systems software contains Numerical Methods as an important part of their library.

I am using my Nascom 2 micro-computer to run numerical methods with much success. This short program calculates the roots of a given polynomial. The simplest example is the linear equation of the form:

$$ax + b = 0$$

where a and b are known constants and  $a \neq 0$ .

The root of the equation will be  $x_0$ , the value of x that will satisfy the equation. For this equation  $x_0 = -b/a$ .

Another simple standard equation is the quadratic equation:

$$ax^2 + bx + c = 0$$

where  $a \neq 0$ , and b and c are given constants. For this second order equation we have two roots:

$$x_1 = \frac{-b + \sqrt{b^2 - 4ac}}{2a}$$

$$x_2 = \frac{-b - \sqrt{b^2 - 4ac}}{2a}$$

These roots will be identical when  $b^2 - 4ac = 0$

or

$$b^2 = 4ac$$

For  $b^2 < 4ac$  there are two other roots called-complex roots.

Two more complex examples are the trigonometric equation

$$x^2 + x \sin x = \cos x$$

and the polynomial equation in the common form:

$$P_n(x) = a_n x^n + a_{n-1} x^{n-1} + \dots + a_{\mu-1} x + a_{\mu} = 0$$

This program for the Nascom 2 computer is based on a method that is good for any sort of one-variable equation as well as for polynomial equations, which is defined in line 350. Any other equation

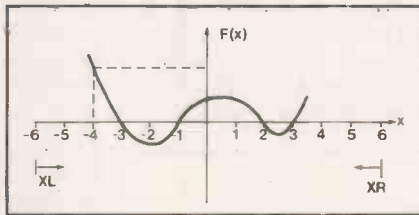

Figure 1.

can be defined in this statement, using the algebraic functions provided by the computer. The initialised printing formats will have to be changed as well, according to the equation structure and constants.

Figure 1 shows a graph of a function  $F(x)$  which crosses the x-axis at  $x = -3$ ,  $x = -1$ ,  $x = 2$ , and  $x = 3$ . These values are roots of this function for starting to search for the first root of this function. The program asks for an  $X_L$  defined as the left limit of x.  $X_R$ , the right limit of X is equal to  $-X_L$ . If for example you take

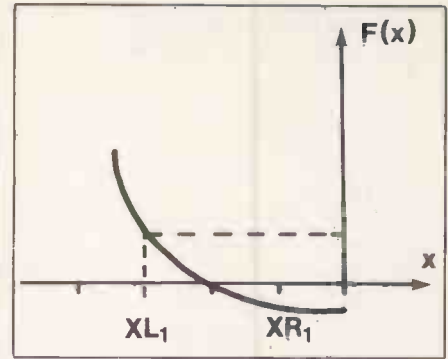

Figure 4.

$X_L = -6$ , the program will search for roots which are between  $X_L = -6$  and  $X_R = +6$ .

The program starts by putting  $X_{L1} = X_L$ ,  $X_{R1} = X_{L1} + 1$ , it calculates the values of  $F(X_{L1})$  and  $F(X_{R1})$  and then it checks the three possible cases. First, if  $F(X_{L1}) * F(X_{R1}) = 0$ , then  $X_{L1}$  or  $X_{R1}$  is an exact roots of the function, the root is printed and the search to the right is carried on.

Secondly, if  $F(X_{L1}) * F(X_{R1}) > 0$ , then there is no root between  $X_{L1}$  and  $X_{R1}$  because they are both positive, and the search to the right is carried on — see figure 3. If  $F(X_{L1}) * F(X_{R1}) < 0$ , then there is a root between these limits ( $X_{L1}$ ,  $X_{R1}$ ) so the program starts a loop successively approximates to the root.

Each step of the loop halves the interval between  $X_L$  and  $X_R$ . The loop ends when the statement

$$X_R - X_L < EPS$$

is true.

Figure 3.

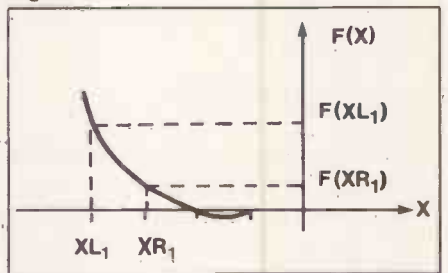
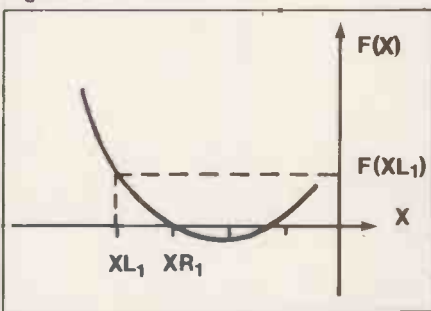

Figure 2.



```

10 REM*** INITIALIZATION ***
20 CLS
30 PRINT" *****"
40 PRINT" * POLINOMIAL ROOTS *"
50 PRINT" *****"
60 PRINT" WRITTEN BY D. ZLATNIK."
70 PRINT" THIS PROGRAM FINDS THE ROOTS OF A-"
80 PRINT" GIVEN POLINOM WITH THE FOLLOWING"
90 PRINT" FORM:"
100 PRINT"      5 4 3 2 1 0"
110 PRINT" P(X)=AX +BX +CX +DX +EX +FX"
120 PRINT
130 PRINT" DATA REQUESTED IS:A,B,C,D,E,F"
140 PRINT" AS REAL OR INTEGER CONSTANTS, AND"
150 PRINT" EPS (REAL NUMBER LESS THAN : 1)THE"
160 PRINT" DEGREE OF ACCURACY(ERROR LIMIT)"
170 REM *** INPUT DATA ***
180 PRINT" ENTER DATA: A=";:INPUT A
190 PRINT"      D=";:INPUT D
200 PRINT"      C=";:INPUT C
210 PRINT"      E=";:INPUT E
220 PRINT"      F=";:INPUT F
230 PRINT
240 PRINT
250 PRINT" ENTER EPS (AS 0.1,0.01 ETC.)"
260 PRINT" EPS=";:INPUT EPS

270 PRINT
280 PRINT" FOR FINDING THE ROOTS ENTER"
290 PRINT" XL (XL<0) FOR THE LEFT LIMIT OF X."
300 PRINT" XR (THE RIGHT LIMIT) IS TAKEN AS:"
310 PRINT" XR=XL. THE ROOT IS SUPPOSED TO"
320 PRINT" BE FOUND BETWEEN THESE LIMITS"
330 PRINT" XL=";:INPUT XL
340 REM *** MAIN PROGRAM ***
350 DEF FNP(X)=A*X^5+B*X^4+C*X^3+D*X^2+E*X+F
360 CLS
370 X1=ABS(XL)
380 YL=FNP(XL)
390 XR=XL+1
400 YR=FNP(XR)
410 IF YL*YR=0 THEN GOTO 640
420 IF YL*YR>0 THEN GOTO 600
430 XS=XR
440 X=(XL+XR)/2
450 Y=FNP(X)
460 IF YL*Y=0 THEN GOTO 520
470 IF YL*Y>0 THEN GOTO 550
480 XR=X
490 YR=Y
500 IF XR-XL<EPS THEN GOTO 520
510 GOTO 440

520 PRINT" ROOT IS BETWEEN:XL=";XL,"AND:XR=";XR
530 XL=XS
540 GOTO 580
550 XL=X
560 YL=Y
570 GOTO 500
580 IF XL>X1 THEN GOTO 710
590 GOTO 380
600 IF XR>X1 THEN GOTO 710
610 XL=XR
620 YL=YR
630 GOTO 390
640 IF YL=0 THEN GOTO 690
650 PRINT" ROOT IS: XR=";XR
660 IF XR>X1 THEN GOTO 710
670 XL=XR+1
680 GOTO 380
690 PRINT" ROOT IS: XL=";XL
700 GOTO 600
710 PRINT" LIMITS EXCEEDED. IF MORE ROOTS ARE"
720 PRINT" TO BE FOUND, ENTER: RERUN WITH"
730 PRINT" LARGER LIMITS. IF NOT PRINT END."
740 INPUT AS
750 IF AS="RERUN" THEN GOTO 330
760 END
    
```



# sinclair ZX81 PERSONAL COMPUTER



# Sinclair ZX81 Personal Computer the heart of a system that grows with you.

1980 saw a genuine breakthrough – the Sinclair ZX80, world's first complete personal computer for under £100. Not surprisingly, over 50,000 were sold.

In March 1981, the Sinclair lead increased dramatically. For just £69.95 the Sinclair ZX81 offers even more advanced facilities at an even lower price. Initially, even we were surprised by the demand – over 50,000 in the first 3 months!

Today, the Sinclair ZX81 is the heart of a computer system. You can add 16-times more memory with the ZX RAM pack. The ZX Printer offers an unbeatable combination of performance and price. And the ZX Software library is growing every day.

## Lower price: higher capability

With the ZX81, it's still very simple to teach yourself computing, but the ZX81 packs even greater working capability than the ZX80.

It uses the same micro-processor, but incorporates a new, more powerful 8K BASIC ROM – the 'trained intelligence' of the computer. This chip works in decimals, handles logs and trig, allows you to plot graphs, and builds up animated displays.

And the ZX81 incorporates other operation refinements – the facility to load and save named programs on cassette, for example, and to drive the new ZX Printer.



New BASIC manual

Every ZX81 comes with a comprehensive, specially-written manual – a complete course in BASIC programming, from first principles to complex programs.

## Kit: £49.<sup>95</sup>

### Higher specification, lower price – how's it done?

Quite simply, by design. The ZX80 reduced the chips in a working computer from 40 or so, to 21. The ZX81 reduces the 21 to 4!

The secret lies in a totally new master chip. Designed by Sinclair and custom-built in Britain, this unique chip replaces 18 chips from the ZX80!

### New, improved specification

- Z80A micro-processor – new faster version of the famous Z80 chip, widely recognised as the best ever made.
- Unique 'one-touch' key word entry: the ZX81 eliminates a great deal of tiresome typing. Key words (RUN, LIST, PRINT, etc.) have their own single-key entry.
- Unique syntax-check and report codes identify programming errors immediately.
- Full range of mathematical and scientific functions accurate to eight decimal places.
- Graph-drawing and animated-display facilities.
- Multi-dimensional string and numerical arrays.
- Up to 26 FOR/NEXT loops.
- Randomise function – useful for games as well as serious applications.
- Cassette LOAD and SAVE with named programs.
- 1K-byte RAM expandable to 16K bytes with Sinclair RAM pack.
- Able to drive the new Sinclair printer.
- Advanced 4-chip design: micro-processor, ROM, RAM, plus master chip – unique, custom-built chip replacing 18 ZX80 chips.



## Built: £69.<sup>95</sup>

### Kit or built – it's up to you!

You'll be surprised how easy the ZX81 kit is to build: just four chips to assemble (plus, of course the other discrete components) – a few hours' work with a fine-tipped soldering iron. And you may already have a suitable mains adaptor – 600 mA at 9 V DC nominal unregulated (supplied with built version).

Kit and built versions come complete with all leads to connect to your TV (colour or black and white) and cassette recorder.





ter-



## Available now- the ZX Printer for only £49.<sup>95</sup>

Designed exclusively for use with the ZX81 (and ZX80 with 8K BASIC ROM), the printer offers full alpha- numerics and highly sophisticated graphics.

A special feature is COPY, which prints out exactly what is on the whole TV screen without the need for further instructions.

At last you can have a hard copy of your program listings – particularly useful when writing or editing programs.

And of course you can print out your results for permanent records or sending to a friend.

Printing speed is 50 characters per second, with 32 characters per line and 9 lines per vertical inch.

The ZX Printer connects to the rear of your computer – using a stackable connector so you can plug in a RAM pack as well. A roll of paper (65 ft long x 4 in wide) is supplied, along with full instructions.

## 16K-byte RAM pack for massive add-on memory.

Designed as a complete module to fit your Sinclair ZX80 or ZX81, the RAM pack simply plugs into the existing expansion port at the rear of the computer to multiply your data/program storage by 16!

Use it for long and complex programs or as a personal database. Yet it costs as little as half the price of competitive additional memory.

With the RAM pack, you can also run some of the more sophisticated ZX Software – the Business & Household management systems for example.

### How to order your ZX81

**BY PHONE** – Access, Barclaycard or Trustcard holders can call 01-200 0200 for personal attention 24 hours a day, every day.

**BY FREEPOST** – use the no-stamp-needed coupon below. You can pay

by cheque, postal order, Access, Barclaycard or Trustcard.

**EITHER WAY** – please allow up to 28 days for delivery. And there's a 14-day money-back option. We want you to be satisfied beyond doubt – and we have no doubt that you will be.

To: Sinclair Research, FREEPOST, Camberley, Surrey, GU15 3BR.

Order

Qty	Item	Code	Item price £	Total £
	Sinclair ZX81 Personal Computer kit(s). Price includes ZX81 BASIC manual, excludes mains adaptor.	12	49.95	
	Ready-assembled Sinclair ZX81 Personal Computer(s). Price includes ZX81 BASIC manual and mains adaptor.	11	69.95	
	Mains Adaptor(s) (600 mA at 9 V DC nominal unregulated).	10	8.95	
	16K-BYTE RAM pack.	18	49.95	
	Sinclair ZX Printer.	27	49.95	
	8K BASIC ROM to fit ZX80.	17	19.95	
	Post and Packing.			2.95

Please tick if you require a VAT receipt

TOTAL £

\*I enclose a cheque/postal order payable to Sinclair Research Ltd, for £

\*Please charge to my Access/Barclaycard/Trustcard account no.

\*Please delete/complete as applicable.

Please print.

Name: Mr/Mrs/Miss

Address:

FREEPOST – no stamp needed.

PRC 04

**sinclair**  
**ZX81**

6 Kings Parade, Cambridge, Cambs., CB2 1SN.  
Tel: (0276) 66104 & 21282.

# How the ZX81 compares with other personal computers

SYSTEM IDENTIFICATION		ZX81	ZX80	ACORN ATOM	APPLE II PLUS	PET 2001	TRS 80 LEVEL I	TRS 80 LEVEL II
ROM		8K	4K	8K	8K	14K	4K	12K
GUIDE PRICE	Basic unit - inc. VAT	£70	£100	£175	£630	£435	£290	£375
	Unit plus 16K RAM (*12K RAM)	£120	£150	£285*	£630	£530	£360	£375
COMMANDS	LIST, LOAD, NEW, RUN, SAVE	●	●	●	●	●	●	●
STATEMENTS	PRINT, INPUT, LET, GOTO, GO SUB/RETURN, FOR/NEXT IF/THEN	●	●	●	●	●	●	●
	STEP	●		●	●	●	●	●
	TAB	●			●	●	●	●
ARITHMETIC	ABS, RND	●	●	●	●	●	●	●
FUNCTIONS	INT	●			●	●	●	●
	ATN, COS, EXP, LOG, SGN, SIN, SQR, TAN	●			●	●		●
	ARCSIN, ARCOS	●						
STRING FUNCTIONS	CHR\$	●	●		●	●		●
	LEN	●		●	●	●		●
NUMBERS	ASC(CODE), STR\$, VAL, INKEY\$	●				●		●
	FLOATING PT ±10 <sup>-38</sup>	●			●	●	●	●
NUMERIC VARIABLES	INTEGERS		●	●	●	●		●
	A-Z			●			●	
STRING VARIABLES	AA-ZØ				●	●		●
	An-Zn, n= any alphanumeric string	●	●					
NUMERIC ARRAYS	A\$ & B\$						●	
	A\$ to Z\$	●	●	●				
DISPLAY	An\$ to Zn\$, n= any alphanumeric character				●	●		●
	SINGLE DIMENSIONAL		●	●			●	
SPECIAL FEATURES	MULTI DIMENSIONAL	●			●	●		●
	ROWS	24	24	16	24	25	16	16
SPECIAL FEATURES	COLUMNS	32	32	32	40	40	64	64
	LOW RES GRAPHICS (<7000 pixels)	●	●	●	●	●	●	●
	HI RES GRAPHICS (>40000 pixels)			●	●			
SPECIAL FEATURES	USR (CALL, LINK)	●	●	●	●	●		●
	PEEK, POKE (OR EQUIV)	●	●	●	●	●		●

## Sinclair software on cassette.



The unprecedented popularity of the ZX Series of Sinclair Personal Computers has generated a large volume of programs written by users.

Sinclair has undertaken to publish the most elegant of these on pre-recorded cassettes. Each program is carefully vetted for interest and quality, and then grouped with others to form single-subject cassettes.

Software currently available includes games, junior education, and business/household management systems. You'll receive a Sinclair ZX Software catalogue with your ZX81 - or see our separate advertisement in this magazine.

## The ultimate course in ZX81 BASIC programming.



Some people prefer to learn their programming from books. For them, the ZX81 BASIC manual is ideal.

But many have expressed a preference to learn *on the machine, through the machine*. Hence the new cassette-based ZX81 Learning Lab.

The package comprises a 160-page manual and 8 cassettes. 20 programs, each demonstrating a particular aspect of ZX81 programming, are spread over 6 of the cassettes. The other two are blank practice cassettes.

Full details with your Sinclair ZX81.

## If you own a Sinclair ZX80...

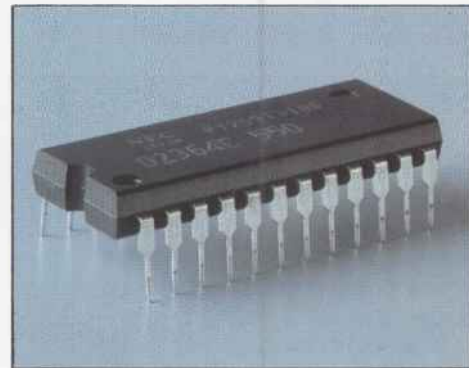

The new 8K BASIC ROM used in the Sinclair ZX81 is available to ZX80 owners as a drop-in replacement chip. (Complete with new keyboard template and operating manual.)

With the exception of animated graphics, all the advanced features of the ZX81 are now available on your ZX80 - including the ability to drive the Sinclair ZX Printer.

# sinclair ZX81

6 Kings Parade, Cambridge, Cambs., CB2 1SN.  
Tel: (0276) 66104 & 21282.





## Menu drive

WHEN YOU want a menu for your new program, says F Williams of Llangollen, Clwyd, you should be able to go back to that rather successful routine you used last time, and with your renumber utility patch parts of the old program into your new one. After a few changes it ought to work well and — more important — it is free from bugs. Program 1 is a skeleton for a typical menu routine.

All this is fine as far as it goes, but it is not really as easy as all that. In reusing an old routine you will still have to make a number of alterations especially if you want a tidy layout. Because you have skimped on planning the bugs come swarming in.

Program 2 is therefore the next stage. It provides a standard routine that you can patch straight into any program: all you need do then is write the required words into the Data lines. The program first reads strings from the Data statements in lines 1340 onwards. The main title is read first, as  $MS(0)$ , followed by the words of each "choice" line. The string "-" terminates this operation. The Read operation takes Data in the order it occurs anywhere in the program, so if you have more than one Read operation in the program you may find it reading the wrong list of data.

While reading the strings, the length of the longest one is measured in line 1110. The program jumps out of the Read loop when it reads a string as "-", and the variable X is adjusted to become the number of lines. S is used to denote the number of unused lines on the screen — line 1140 — and then to denote the size of the three free spaces in the layout.

H is the size of left-hand margin, calculated to put first the title, then the longest string, symmetrically on the screen. Then the title is printed, followed finally by each line of the menu in a loop in lines 1240 to 1290.

Lines 1310 and 1320 input the number of your choice, and verify it. This is carried back to the main program because the action to be taken will vary from program to program. It could be covered in a simple ON I GOSUB -,-,-...

statement or could be much more complex.

General-purpose routines like this one can be used to build into a library of useful subroutines. You can even put the whole library in, the first few thousand lines of every program you write.

Routines to read and write random-access files are particularly useful, though certain standardisation of the file-record structure is necessary. The disadvantages are that your finished program is unnecessarily long and complex and some routines may not even be called by every

program. These snags can be reduced if the program is "crunched".

The best alternative is to write a program-writing program. Using the Apple's Exec command, such a program will write the simple subroutine itself, and splice just the simple subroutine — not the general-purpose one — into your program. This sort of program-writing can be recommended for steadying the nerves.

Though no other micro will do it, the Apple accepts direct commands from a

(continued on next page)

### Program 1.

```

10 REM EXAMPLE PROGRAM
100 REM MENU SUBROUTINE
110 HOME : VTAB 3: HTAB 11: PRINT "---- MENU NO.1 ----"
120 HTAB 11: FOR Y = 1 TO 17: PRINT "-";: NEXT : PRINT
130 VTAB 8
140 HTAB 6: PRINT "1. YOUR FIRST ALTERNATIVE."
150 PRINT
160 HTAB 6: PRINT "2. ANOTHER ALTERNATIVE."
170 PRINT
180 HTAB 6: PRINT "3. OR THIS ONE."
190 PRINT
200 HTAB 6: PRINT "4. OR TRY AGAIN."
210 PRINT
220 HTAB 6: PRINT "5. END."
230 PRINT
240 PRINT : HTAB 20: INPUT "ENTER ITEM NO. ";AE
250 IZ = VAL (AE): IF IZ < 1 OR IZ > 5 THEN VTAB PEEK (37) -
      2: GOTO 2 40
260 RETURN

```

### Program 2.

```

1000 REM MENU SUBROUTINE NO.2
1010 REM GENERAL PURPOSE ROUTINE
1020 REM
1030 DIM ME(20)
1040 REM READ LINE WORDING
1050 HOME : RESTORE : J = 0
1060 READ ME(0)
1070 FOR X = 1 TO 20
1080 : READ ME(X)
1090 : IF ME(X) = "-" THEN GOTO 1130
1100 : IF LEN (ME(X)) > 35 THEN PRINT CHR$ (7);"LINE ";X;" IS TOO LONG
      . MAX IS 35 CHRS": STOP
1110 : IF LEN (ME(X)) > J THEN J = LEN (ME(X)): REM FIND LONGEST LINE
1120 NEXT
1130 X = X - 1
1140 S = 20 - X: IF X < 8 THEN S = 20 - (2 + X)
1150 S = INT (S / 3): FOR Y = 1 TO S: PRINT : NEXT : REM SPACE
1160 H = (40 - LEN (ME(0))) / 2: HTAB H: PRINT ME(0): REM H IS LEFT MAR
      GIN WIDTH
1170 HTAB H: FOR L = 1 TO LEN (ME(0)): PRINT "-";: NEXT
1210 FOR Y = 1 TO S: PRINT : NEXT
1220 H = 18 - (J / 2)
1230 REM PRINT MENU LINES
1240 FOR Y = 1 TO X
1250 : HTAB H: PRINT Y;" ";
1260 : IF Y < 10 THEN PRINT " ";
1270 : PRINT ME(Y)
1280 : IF X < 8 THEN PRINT
1290 NEXT
1300 PRINT : PRINT
1310 VTAB 22: HTAB (22 + J / 2): INPUT "";AE
1320 I = VAL (AE): IF I < 1 OR I > X THEN GOTO 1310
1330 RETURN
1340 DATA MENU NO.2
1350 DATA FIRST CHOICE.
1360 DATA OR THIS.
1370 DATA OR ADD MORE YOURSELF!
1380 DATA -

```

(continued from previous page)

text file, instead of from the keyboard, and in exactly the same way. To write a program from the text file, it must contain all the same key strokes you would make if you were writing the program yourself. When you sit down at your keyboard to write a new subroutine into the program you are working on your type:

```
LOAD XXXXXX
1500 REM MENU ROUTINE
1510 PRINT
```

and so on, and that, letter for letter, is what must be Printed into the text file. Because you cannot write text files directly from the keyboard, the next job is to write a program that will write that file.

To summarise:

- Your program works everything out and then writes the text file.
- The text file commands the Apple, and keys in the routine.
- The routine is, at that stage, in Apple's memory. Save it to disc before running it.

The first part of the program 3 is a straight forward Input section. It Inputs from the keyboard the menu title and the words to go on each line, and also Inputs the name of the main program you want to add your routine to, and the line at which you want to add it.

It is followed by a short section that calculates the line spacings and margin settings, as in program 2. Text-file handling is done in lines 340, 350 and 570 just as in any other file writing. Note the  $D\$$  in the commands, and do not confuse these lines with the lines that actually write the text into the file.

For the other lines, think exactly what you do when you key in a new program, and make your program Print those key strokes into the text file. Include the commands you would use to insert this new routine into your main program.

You can use variables in this program, and the Apple will substitute values for them when it Prints to the file. Just include the variables among the strings in the Print statements, with the usual use of the quote marks and semicolons between them.

Because the quote marks are used to mark the beginning and end of strings, the Apple cannot also accept them as part of a string — it obeys them instead of Printing them. However, you must enter quote marks into your file somehow, so that it can output them later. The Apple will accept them if they are called by  $CHR\$(34)$ . To avoid typing  $CHR\$(34)$  every time, you can call it  $C\$$ .

$L$  is the variable used for the line number, and is incremented by 10 each time it is used.  $S$  and  $H$  are the same as in Program 2, and  $M\$(0..)$  are the strings of words.

From line 360 to line 560, all the initial Prints are instructions to write the line to the text file, and all the remainder of the

line is interpreted by the computer and then written to the file.

When run, this program writes the text file. It then commands EXEC TEXT FILE and the Apple abandons your program — so be sure to save it first — and looks to the text file for all its input instructions.

It accepts these as direct commands, and loads your main program, writes the new lines as dictated by the text file, and even tidies up by deleting the text file itself. It renames your program "Original ..." in case anything has gone wrong, and saves the completed program. 

#### Program

```
10 REM MENU EXAMPLE 3.
20 DIM L$(20)
30 REM PROGRAM TO WRITE A MENU PROGRAM
40 REM
50 REM FIRST INPUT STRINGS
60 HOME : VTAB 6: HTAB 10: PRINT "WRITE A MENU SUBROUTINE"
70 HTAB 6: PRINT "-----"
80 VTAB 9: PRINT "ENTER THE NAME OF YOUR PROGRAM:-"
90 VTAB 12: PRINT "INSERT MENU ROUTINE AT WHICH LINE?"
100 VTAB 15: PRINT "ENTER:- MENU HEADING:"
110 VTAB 18: HTAB 20: INPUT " ";NE: REM PROGRAM
120 IF LEN (NE) > 33 THEN PRINT CHR$ (7);"TOO LONG. MAX LENGTH IS 33
    CHR$." : GOTO 110
130 VTAB 13: HTAB 20: INPUT " ";AE:L = VAL (AE): IF L < 1 OR L > 65999 GOTO
    130: REM LINE
140 VTAB 16: HTAB 20: INPUT " ";M$(0): REM HEADING
150 VTAB 22: HTAB 10: PRINT "(ENTER -- TO STOP.)"
160 POKE 35,21: VTAB 18
170 FOR X = 1 TO 20
180 : PRINT "LINE ";X;" WORDING: ";: INPUT " ";M$(X)
190 : IF M$(X) = "-" THEN GOTO 230
200 : IF LEN (M$(X)) > 33 THEN PRINT CHR$ (7);"TOO LONG. MAX LENGTH IS
    33 CHR$." : GOTO 180
210 : IF LEN (M$(X)) > J THEN J = LEN (M$(X))
220 NEXT
230 X = X - 1: POKE 35,24: CALL - 958
240 PRINT : HTAB 10: INPUT "ARE ALL ENTRIES CORRECT? ";AE: IF LEFT$ (AE
    ,1) < > "Y" GOTO 60
250 REM
260 REM NEXT CALCULATE VARIABLES
270 S = 20 - X: IF X < 8 THEN S = 20 - (X + 2)
280 S = INT (S / 3)
290 H = INT ((40 - LEN (M$(0))) / 2)
300 DE = CHR$ (4):CE = CHR$ (34): REM CTRL-D & "
310 REM
320 REM FINALLY WRITE THE TEXT FILE
330 REM ENTER LINE 'HOME' & 'PRINT DE;"MON I,C,O"' HERE IF YOU WANT TO
    SEE THE ACTION
340 PRINT DE;"OPEN TEXT FILE"
350 PRINT DE;"WRITE TEXT FILE"
355 REM PRINT TO TEXT FILE
360 PRINT "NEW"
370 PRINT "LOAD ";NE
380 PRINT L;" REM MENU SUBROUTINE":L = L + 10
390 PRINT L;" HOME:VTAB ";S;":HTAB ";H;":PRINT ";CE;M$(0);CE:L = L + 10
400 PRINT L;" HTAB ";H;":FOR Y = 1 TO "; LEN (M$(0));":PRINT ";CE;";";CE
    ";":NEXT:PRINT":L = L + 10
410 PRINT L;" VTAB ";(S * 2) + 2:L = L + 10
420 H = INT ((35 - J) / 2)
430 FOR Y = 1 TO X
440 : PRINT L;" HTAB ";H;":";
450 : PRINT "PRINT ";CE;Y;". ";
460 : PRINT M$(Y);CE
470 :L = L + 10
480 : IF X < 8 THEN PRINT L;" PRINT":L = L + 10
490 NEXT
500 PRINT L;" PRINT: HTAB 20: INPUT ";CE;"ENTER ITEM NO. ";CE;":AE":L =
    L + 10
510 PRINT L;" IX = VAL(AE): IF IX < 1 OR IX > ";X;"THEN VTAB PEER(37) -
    2: GOTO ";L - 10:L = L + 10
520 PRINT L;" RETURN"
530 REM NOW DO HOUSEKEEPING
540 PRINT "RENAME ";NE;" ORIGINAL ";NE
550 PRINT "SAVE ";NE
560 PRINT "DELETE TEXT FILE"
565 REM TEXT FILE WRITTEN
570 PRINT DE;"CLOSE TEXT FILE"
580 STOP : REM REMOVE THIS LINE AND SAVE PROGRAM ON DISK BEFORE RUNNING
    IT
590 PRINT DE;"EXEC TEXT FILE"
```

For "E" read "S" throughout this listing.





## Tape catalogue

THIS PROGRAM was written to run a mail-order catalogue, writes Gavin Smith of Farnham, Surrey, and greatly eased the number of sheets of paper which were scattered across the table whenever it was time to send in the collected money. It can be used for other purposes with very little modification.

On running the program you are given ten options:

- Load file from tape.
- Save file on to tape.
- List of all the customers in memory.
- Examine a file from the customer's name.
- Examine a file from the account number.
- Alter a customer's file.

- Create a file.
- Clear all files from memory.
- Delete a single file.
- End program.

The first two options are routines to load to and from tape, and are machine-dependent. Anyone modifying these sections for their machines will have to change the command Input#-1 to their equivalent command to load a variable from tape; the command Print#-1 is used to load a variable on to tape.

The third routine lists the names of all the customers which are currently stored in the computer. If more than ten names are stored the computer will stop after every ten names and wait for you to read the names and then press Enter before continuing to the next ten names.

The fourth and fifth routines are similar, except that the program first asks for the name of the customer. It then scans through the names until what was typed in corresponds with the first part of the customer's name. So if you have a customer named John and you want to find his file, you could type Joh: it would find it unless there was a second file, which was before John's, and also started with the letters Joh. The fifth option asks you to type in the customer's account number. It then scans through all the account numbers in memory until a match is found. When a match is found in either this routine or the routine which

uses the name of the customer, the program displays all the information which is stored for that customer.

The sixth option first asks you for the customer's name whose file you wish to alter. It then displays all the information on that person, and asks you which item you wish to change and how you wish to change it.

The seventh option asks you to input all the information about the customer to the list of other customers, but will not clear the other customers which are stored in memory.

The eighth option is used when you wish to delete all the files in memory so that you can start afresh. Before deleting the files, the program asks you to confirm that you want it to destroy the files. If you type "Y" it will destroy the files; any other input will return you to the menu.

The ninth option is used to delete a file for which you have no more use. If at anytime you type 10 for your option before saving the files on to tape, you should type Goto 30 rather than Run if you wish to retrieve them.

## Input functions

THIS SUBROUTINE for the TRS-80 lets you input a function to the program that you are running, writes R J Broughton of Grantham, Lincolnshire. The function is converted to the code by which the com-

*(continued on next page)*

```

0 CLEAR 6000
5 PRINT "*** CATALOGUE INFORMATION *** (C) G. SMITH 3/4/81 ***"
6 FOR Z=1 TO 2000: NEXT
10 DIM NA$(50), AN$(50), AD$(50), TE$(50), AO$(50), WI$(50), DA$(50)
20 NF=0
30 PRINT "---MENU---"
40 PRINT "1-LOAD FILES FROM TAPE"
50 PRINT "2-SAVE FILES FROM TAPE"
60 PRINT "3-LIST OF THE CUSTOMERS IN MEMORY"
70 PRINT "4-EXAMINE A FILE FROM A CUSTOMERS NAME"
80 PRINT "5-EXAMINE A FILE FROM AN ACCOUNT NUMBER"
90 PRINT "6-ALTER A CUSTOMERS FILE"
100 PRINT "7-ADD ANOTHER FILE"
110 PRINT "8-CLEAR ALL FILES FROM MEMORY"
120 PRINT "9-DELETE A SINGLE CUSTOMER"
130 PRINT "10-END PROGRAM"
140 INPUT "TYPE IN THE NUMBER OF YOUR CHOICE": CH
150 CH=INT(CH): IF CH=10 THEN END
160 IF CH<1 OR CH>9 THEN 30
170 ON CH GOSUB 1000,2000,3000,5000,6000,7000,8000,9000,10000
180 INPUT "HIT ENTER TO CONTINUE": AA$
190 GOTO 30
1000 INPUT "POSITION THE TAPE, PRESS ENTER WHEN THE TAPE IS IN POSITION": X$: INPUT
#-1, NF
1010 FOR X=1 TO NF
1020 INPUT#-1, NA$(X), AN$(X), AD$(X), TE$(X), AO$(X), WI$(X), DA$(X)
1030 NEXT
1040 RETURN
2000 PRINT "HIT ENTER WHEN THE CASSETTE IS READY": AS$: PRINT#-1, NF
2010 FOR X=1 TO NF
2020 PRINT#-1, NA$(X), AN$(X), AD$(X), TE$(X), AO$(X), WI$(X), DA$(X)
2030 NEXT
2040 RETURN
3000 FOR X=1 TO NF
3010 PRINT NA$(X)
3020 IF X/10=INT(X/10) THEN 3050
3030 NEXT
3040 RETURN
3050 INPUT "HIT ENTER TO CONTINUE": AA$
3060 GOTO 3030
5000 INPUT "WHAT IS THE NAME OF THE FILE YOU WANT TO SEE": H$:
5010 FOR X=1 TO NF
5020 IF LEFT$(NA$(X), LEN(H$))=H$ THEN 5060
5030 NEXT
5040 PRINT "FILE NOT FOUND"
5050 RETURN
5060 PRINT "FILE FOUND"
5070 PRINT NA$(X); " ACCOUNT NUMBER": AN$(X)
5080 PRINT AD$(X)
5090 PRINT "TELEPHONE NUMBER": TE$(X)
5100 PRINT "AMOUNT OWING $": AO$(X)
5110 PRINT "WEEKLY INSTALLMENTS $": WI$(X)
5120 PRINT "THE LAST PAYMENT WAS MADE ON": DA$(X)
5130 RETURN
6000 INPUT "WHAT IS THE ACCOUNT NUMBER OF THE CUSTOMER": H$:
6010 FOR X=1 TO NF
6020 IF AN$(X)=H$ THEN 6060
6030 NEXT
6040 PRINT "FILE NOT FOUND"
6050 RETURN
6060 PRINT "FILE FOUND"
6070 PRINT NA$(X); " ACCOUNT NUMBER": AN$(X)
6080 PRINT AD$(X)
6090 PRINT "TELEPHONE NUMBER": TE$(X)
6100 PRINT "AMOUNT OWING $": AO$(X)
6110 PRINT "WEEKLY INSTALLMENTS $": WI$(X)
6120 PRINT "THE LAST PAYMENT WAS MADE ON": DA$(X)
6130 RETURN
7000 INPUT "WHAT'S THE NAME OF THE FILE YOU WANT TO ALTER": H$:
7010 FOR X=1 TO NF
7020 IF LEFT$(NA$(X), LEN(H$))=H$ THEN 7060
7030 NEXT
7040 PRINT "FILE NOT FOUND"
7050 RETURN
7060 PRINT "FILE FOUND"
7070 PRINT "THE FILE BEFORE ALTERATION:"
7080 PRINT NA$(X); " ACCOUNT NUMBER": AN$(X)
7090 PRINT AD$(X)
7100 PRINT "TELEPHONE NUMBER": TE$(X)
7110 PRINT "AMOUNT OWING $": AO$(X)
7120 PRINT "WEEKLY INSTALLMENTS $": WI$(X)
7130 PRINT "THE LAST PAYMENT WAS MADE ON": DA$(X)
7140 INPUT "WHICH ITEM DO YOU WISH TO CHANGE,
1=NAME, 2=ACCOUNT NO., 3=ADDRESS, 4=TEL. NO., 5=AMOUNT OWING,
6=WEEKLY INSTALLMENTS, 7=LAST PAYMENT DATE": ICH
7150 CH=INT(CH): IF CH<1 OR CH>7 THEN 7070
7160 ON CH GOTO 7170,7190,7210,7230,7250,7270,7290
7170 INPUT "WHAT IS THE NEW NAME": FN$(X)
7180 GOTO 7300
7190 INPUT "WHAT IS THE NEW ACCOUNT NUMBER": AN$(X)
7200 GOTO 7300
7210 INPUT "WHAT IS THE NEW ADDRESS": AD$(X)
7220 GOTO 7300
7230 INPUT "WHAT IS THE NEW TELEPHONE NUMBER": TE$(X)
7240 GOTO 7300
7250 INPUT "WHAT IS THE NEW AMOUNT OWING": AO$(X)
7260 GOTO 7300
7270 INPUT "WHAT IS THE NEW WEEKLY INSTALLMENTS": WI$(X)
7280 GOTO 7300
7290 INPUT "WHEN WAS THE LAST DATE A PAYMENT WAS MADE": DA$(X)
7300 INPUT "WHAT TO CHANGE ANYTHING ELSE(Y/N)": AA$
7310 IF AA$="Y" THEN 7080
7320 RETURN
8000 NF=NF+1
8010 INPUT "WHAT IS THE CUSTOMERS NAME": NA$(NF)
8020 INPUT "WHAT IS THE ACCOUNT NUMBER": AN$(NF)
8030 INPUT "WHAT IS THE ADDRESS": AD$(NF)
8040 INPUT "WHAT IS THE TELEPHONE NUMBER": TE$(NF)
8050 INPUT "HOW MUCH DO THEY OWE": AO$(NF)
8060 INPUT "WHAT ARE THE WEEKLY INSTALLMENTS": WI$(NF)
8070 INPUT "WHEN WAS THE LAST PAYMENT MADE": DA$(NF)
8080 RETURN
9000 INPUT "ARE YOU SURE YOU WANT ALL THE FILES DELETED(Y/N)": AA$:
9010 IF AN$(X)="Y" THEN RETURN
9020 NF=0: PRINT "FILES DELETED"
9030 RETURN
10000 INPUT "WHAT IS THE NAME OF THE FILE YOU WANT DELETED": H$:
10005 IF NF="" THEN PRINT "ILLEGAL": GOTO 10000
10010 FOR X=1 TO NF
10020 IF LEFT$(NA$(X), LEN(H$))=H$ THEN 10060
10030 NEXT
10040 PRINT "FILE NOT FOUND"
10050 RETURN
10060 PRINT "FILE BEING DELETED"
10065 IF X=NF THEN NF=NF-1: GOTO 10160
10070 FOR V=X+1 TO NF
10080 NA$(V-1)=NA$(V)
10090 AN$(V-1)=AN$(V)
10100 AD$(V-1)=AD$(V)
10110 TE$(V-1)=TE$(V)
10120 AO$(V-1)=AO$(V)
10130 WI$(V-1)=WI$(V)
10140 DA$(V-1)=DA$(V)
10150 NEXT: NF=NF-1
10160 PRINT "FILE DELETED": NA$(NF+1)="" : AN$(NF+1)=0
10170 RETURN

```

(continued from previous page)

puter stores program lines, and placed in line 40 of the subroutine.

You access the function by a Gosub command further down the program. You enter the function in the form that you want it, e.g.,

$$Y = \text{SIN}(X)$$

$$T = U*V+W/3$$

or you can even enter sequential steps,

$$S + \text{SIN}(X): A = (S+4)/2.5$$

The subroutine can be repeated as often as is necessary as each new function will overwrite the previous one, and a new colon and Rem is placed at the end of that new function.

The TRS-80 Basic remembers its arithmetic functions in specific codes, so it is necessary to search the inputted string for these functions. Line 110 performs this task, with the arithmetic functions stored in array F2\$(n). If one such function is found, the respective code is stored in the array F3(n). This loop then repeats for the next letter in the inputted string.

If an arithmetic function is not found, the program moves on to the next line 120, and compares the character with the arithmetic operator codes in the array F1\$(n). If there is a match, the specific code is stored in array F3(n) and the program moves on to the next character in the string F\$.

If the operator is not found, the program moves on to line 130 and checks the ASCII value of the character. If it lies in the valid range, the value is stored in the array F3(n).

The program takes the next character in the inputted string and repeats the process until the entire string has been coded. The program now moves on to line 150 and Pokes the array F3(n) values into the space left in line 40, beginning at address 17241. A colon and Rem are Poked in immediately afterward to make all the remaining dots valid.

There are 55 dots in line 40 after the Rem. If you anticipate entering a function with more than 55 characters, put more dots in line 40. Poking out the five-byte code for the line number is fatal.

If you run line 170, it will show the contents of line 40 as stored by the computer, 10 lines at a time. When using the subroutine as part of a program, the program can be placed from line 160 onwards. If you miss out the Rem statements in lines 10 and 30 you must change the Poke address numbers in line 150 to suit the new placing of line 40 in the memory.

The following variables and arrays are used:

- I%: integer counter for F\$, data, & Poke routines,
- I1%: integer counter for F1\$ array,
- I2%: integer counter for F2\$ array,
- I3%: integer counter for F3 array,
- F1: array for arithmetic operator codes,
- F2: array for arithmetic function codes,
- F3: array of F\$ codes to be Poked into line 40,

```

10 REM *** SUBROUTINE TO INPUT LINE INTO THE PROGRAM ***
20 GOT060
30 REM *** FUNCTION WILL BE PUT INTO LINE 40
40 REM.....
50 RETURN
60 REM *** SUBROUTINE TO INPUT FUNCTION
70 CLEAR 500 : DIM F1$(12),F1(12),F2$(13),F2(13),F3(50)
90 DATA =,213,+,205,-,206,*,207,/;208,C,209,SGN,215,INT,216,ABS,217,SQR,221,RND,
222,LOG,223,EXP,224,COS,225,SIN,226,TAN,227,ATN,228,RND,222,FIX,242
90 FOR I%=1 TO 6:READ F1(I%),F1(I%):NEXT I%:FOR I%=1 TO 13:READ F2$(I%),F2(I%):
NEXT I%
100 INPUT"ENTER FUNCTION REQUIRED ";F$:I3%=1
110 FOR I%=1 TO LEN(F$):FOR I2%=1 TO 13:IF MID$(F$,I%,3)=F2$(I2%) THEN F3(I3%)=F
2(I2%):I3%=I3%+1:I%=I%+2:NEXT I2%:ELSE NEXT I2%
120 FOR I1%=1 TO 6:IF MID$(F$,I%,1)=F1$(I1%) THEN F3(I3%)=F1(I1%):I3%=I3%+1:NEXT
I1%:ELSENEXT I1%
130 F4%=ASC(MID$(F$,I%,1)):IF F4%>=35 AND F4%<=90 THEN F3(I3%)=F4%:I3%=I3%+1
140 NEXT I%
150 FOR I%=1 TO I3%-1:POKE17240+I%,F3(I%):NEXT I%:POKE17240+I%,58:POKE17241+I%,14
7
160 REM *** START OF MAIN PROGRAM
170 REM A%=0:FOR I%=17236 TO 17295:PRINT I%,PEEK(I%),CHR$(PEEK(I%)):IF A%=10 THEN INPUT
X%:A%=0:NEXT I%:ELSE A%=A%+1:NEXT I%:REM DISPLAYS CONTENTS OF LINE 40
In the listing ↑ is represented by ↓ (line 80)

```

- F\$: inputted function to be Poked into line 40,
- F1\$: array of arithmetic operators,
- F2\$: array of arithmetic functions.

## Binary clock

THE IDEA for this binary clock program first occurred to Killian McCourt of Avoca Lawns, Warrenpoint, County Down, while he was working on a base converter.

The decimal-binary converter is contained in the subroutine from line 5000 onwards. It works by dividing the integer part of the variable T by 2. If the result is a whole number, 0 is added to T, otherwise

I is added. After several loops when T is less than one, T contains the binary equivalent of the initial decimal value of T.

Lines 290 to 340 contain the routine which formats the display, using strings to make the time display neater. The clock part of the program is in lines 360 to 420, where the hours, minutes and seconds are calculated and added up.

The program is intended as a novelty only. The For-Next loop in line 350 gives approximately a one-second delay after all the conversions and calculations have been done in the other parts of the program. The speed of the program depends on the length of the strings. □

```

10 REM *****
20 REM * 24-HOUR BINARY CLOCK *
30 REM * VERSION 4 1.9K *
40 REM * COPYRIGHT (C) *
50 REM * KILLIAN MC COURT *
60 REM * 16-8-1981 *
70 REM *****
80 CLEAR 150
90 CLS :PRINT CHR$(23); :PRINT@151,"24-HOUR" :PRINT@216,"BINARY CLOCK" :PRINT
CHR$(28);
100 FOR I= 1 TO 1000 :NEXT
110 PRINT@513,"ENTER THE CORRECT TIME IN THE FORM OF HOURS, MINUTES & SECONDS"
:PRINT
120 INPUT"THE HOUR (IN DECIMAL) IS":OH
130 OH=INT(OH) :IF OH<0 OR OH>23 THEN 120
140 INPUT"THE MINUTES (IN DECIMAL) ARE":OM
150 OM=INT(OM) :IF OM<0 OR OM>59 THEN 140
160 INPUT"THE SECONDS (IN DECIMAL) ARE":OS
170 OS=INT(OS) :IF OS<0 OR OS>59 THEN 160
180 FOR I=1 TO 3
190 OH I GOTO 200, 210, 220
200 T=OH :GOSUB5000 :H=T :GOTO230
210 T=OM :GOSUB5000 :M=T :GOTO230
220 T=OS :GOSUB5000 :S=T :GOTO230
230 NEXT
240 REM *****
250 REM * START OF CLOCK ROUTINE *
260 REM * STRINGS ARE USED *
270 REM * TO FORMAT DISPLAY *
280 REM *****
290 H$=STR$(H) :M$=STR$(M) :S$=STR$(S)
300 LH=LEN(H$)-1 :LM=LEN(M$)-1 :LS=LEN(S$)-1
310 RH$=RIGHT$(H$,LH) :RM$=RIGHT$(M$,LM) :RS$=RIGHT$(S$,LS)
320 HH$=STRING$(5-LH,"0") :MM$=STRING$(6-LM,"0") :SS$=STRING$(6-LS,"0")
330 H%=HH$+RH$ :M%=MM$+RM$ :S%=SS$+RS$
340 CLS :PRINT@402,H%+" " :"+M%+" " :"+S%
350 FOR I=1 TO 230 :NEXT :*** APP. 1 SECOND COUNT
360 IF S=111011 THEN 380
370 OS=OS+1 :T=OS :GOSUB5000 :S=T :GOTO230
380 IF M=111011 THEN 400
390 S=0 :OS=0 :OM=OM+1 :T=OM :GOSUB5000 :M=T :GOTO230
400 IF H=10111 THEN 420
410 S=0 :OS=0 :M=0 :OM=0 :OH=OH+1 :T=OH :GOSUB5000 :H=T :GOTO230
420 H=0 :OH=0 :S=0 :OS=0 :M=0 :OM=0 :GOTO230
5000 REM *****
5010 REM * DECIMAL TO BINARY CONVERSION ROUTINE *
5020 REM *****
5030 T$=""
5040 T=T/2 :IF T=INT(T) THEN T$="0"+T$ ELSE T$="1"+T$
5050 IF T<1 THEN 5070 ELSE 5060
5060 T=INT(T) :GOTO5040
5070 T=VAL(T$) :RETURN

```



# PRISM-THE LOW COST QUALITY COLOUR PRINTER

The new Prism 132C  
colour printer

manufactured  
by Integral Data  
Systems is the latest  
addition to the DE range of  
printers.

Combining reliability with  
many high quality features such  
as microprocessor driven  
controller, correspondence  
quality print, six software  
selectable character sizes and  
auto sheet feed. The Prism  
prints the four basic process

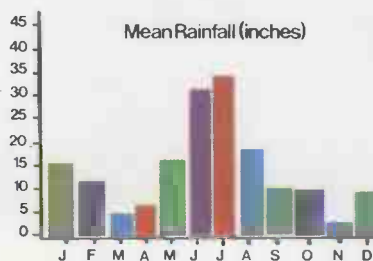

colours and mixes too, allowing  
superb colour reproduction for  
all kinds of charts and graphs.

- Full colour ● Sprint mode  
(200 cps) ● Auto sheet feed
- Pin addressable high-res.  
graphics

The Prism 132C full option  
model comes complete at  
**ONLY £1,395**



## SPECIAL OFFER ON PAPER TIGER PRINTERS

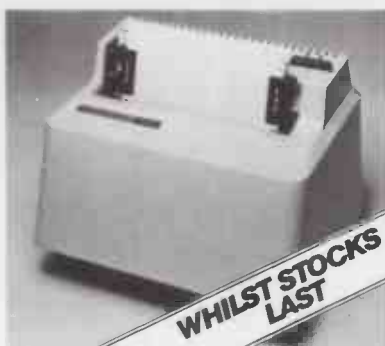

T 445 92 cps.  
Serial/Parallel Interface.  
Graphics

**£450**

T 460 152 cps.  
Serial/Parallel Interface.  
Graphics.

**£550**

Data Efficiency Ltd  
Finway Road,  
Hemel Hempstead,  
Hertfordshire, HP2 7PS  
Tel: (0442) 40571/2  
Telex: 825554 DATEFF G

Ring for details of your  
nearest stockist (0442) 40571/2

**DE**  
Data Efficiency Ltd

*Dealer enquiries welcome*

● Circle No. 172

# PERSONAL COM

age  
and  
way  
man,  
ian,  
ese,  
r a  
ge.  
s, Se

nt  
DIY  
or a  
Way,

**LONELY** Genie I Microcomputer, early eighties, with large peripheral family but currently unattached, would like to meet interesting, attractively packaged software, Genie or Tandy specification, for programming, problem solving, entertainment and long-lasting friendship. Reply in confidence. Box No RS232.

LON  
intel  
vatec

ATT  
wish  
may  
marr

SO  
me  
(m  
tion.  
hum

MAL  
to  
war  
wis

ANSWERING MACHINES  
Office certified



**ingenious  
...but lonely!**

Buying your first Genie I microcomputer is just the start of a long and enthralling adventure, for it won't be long before you will want to expand your system with some of the wide range of peripherals which make up the complete Genie System.



Firstly there is the **Expansion Box**, which immediately expands your Genie's capacity to 32K RAM, and up to 48K RAM if required. It can be connected to 4 disk drives, a printer, RS232 interface or S100 cards.

Then there is the **Printer**, a compact unit with 80 column, 5 x 7 matrix print-out, which connects to your Genie through the Expander, or via the Parallel Printer Interface.



The **Disk Drive** gives you greater storage capacity and full random access file handling, with the option of double-density through a special adapter. New Dual Disk Drive now available!

Finally, there is Genie's very own **12" Monitor**, a must if you want to let the rest of the family watch their T.V. in peace! Available in B & W or green tube.



The supreme advantage of the Genie I system is its compatibility with the TRS 80, which means that literally 1000's of pre-recorded programs are already available, just waiting to be plugged into your Genie!

The recent improvements in the Genie system, including Extended Basic, sound unit and machine language monitor, make it the ideal system for the committed hobbyist, and an excellent and easy-to-use educational tool.



**SPECIAL TECHNICAL GENIE  
HOT - LINE ON 0629 4995**

for all your technical advice and service back-up on any aspect of the Genie system direct from the experts!

Please send me FREE, 16 page colour brochure on the Genie Computer System. I enclose 25p postage.

Name

Address

Telephone  PC-82

**LOWE** electronics  
Chesterfield Road,  
Matlock,  
Derbyshire DE4 5LE.  
Telephone: 0629 4995.  
Telex: 377482 Lowlec G.



# ANNOUNCING THE NEW SORCERER



1.2 Megabyte

**ONLY £2,680**  
or **£16 per week rental**  
(exclusive of VAT)

The **VIDEO DISK UNIT**  
can be linked with any  
printer and comes with  
a **FULL YEAR'S**  
guarantee from **EMG**

Dealers invited

Educational discounts

For Wordprocessing  
and Accountancy

**DISTRIBUTED BY EMG AT EMG MICRO CENTRES**

The **LONDON**  
**MICRO CENTRE**  
47 Lower Belgrave Street  
**LONDON SW1**  
Telephone: 01-730 8791

The **SOUTH LONDON**  
**MICRO CENTRE**  
30 Heathfield Road  
**CROYDON**  
Telephone: 01-688 0088

*Contact us today for further information*

**An EMG Company**

# MicroComputerLand



## The IBM Personal Computer

*available now from*

**MicroComputerLand**

### Starting at £2800

- \* Extensive Business Packages
- \* Fully Supported
- \* Easy-to-read Manuals
- \* Compatible Terminal
- \* Full Colour Graphics
- \* Choice of Printers
- \* Highest Quality Specification
- \* Large Memory Capacity

For further information contact:  
MicroComputerLand, Shropshire House, 2-10 Capper Street  
London WC1E 6JR Tel: 01-637 4078

NAME .....  
POSITION .....  
COMPANY .....  
ADDRESS .....

TEL: .....



# 6502 SPECIAL

## Extending Basic

TO ALLOW my UK 101 to control a TRS-80 Line Printer VII I wrote this program by using added Basic com-

mands, writes R A Shackelford of Hamilton. It also illustrates a method of extending Basic by adding user commands to it.

The TRS-80 Line Printer VII is a dot-matrix Printer similar to the Seikosha GR-80. In addition to the Centronics interface it has a 600 baud serial interface as standard. By providing switching between 300 and 600 baud on a UK 101 or Superboard, and adding some circuitry to indicate to the UART, through the CTS line, when the Printer is busy, control of the Printer can be effected through the use of the Save flag. Printer-mode selection, head positioning and other control functions can be controlled by turning on the Save flag by a Poke 517,0 and then using PrintChr\$(X) statements where X is the required control code for printing.

A better way to control the printer would be to create Basic commands which could be embedded as statements

in any Basic program. One method of doing this without excessively slowing the execution of Basic is by attaching a command Parser to the Control-C check routine to check each statement for the presence of added commands. Adding a machine-code routine of about 240 bytes allows the addition of eight commands to Basic to control printer output.

The program uses two bytes of page-zero memory \$EE and \$EF for temporary storage. It only requires changes to two bytes to relocate it to another area in memory. To use the routine

- Press Reset.
- Press C. answer memory size with 7900.
- Press Reset.
- Press M then key in program from "1F00".
- Enter "021C/0B, Carriage-return then 1F".
- Enter "0000G to return to Basic via the Warmstart routine".

The additional commands are then available in Basic. After any Reset, re-enter the monitor and execute the last two steps to point the Control-C vector back to the new routine.

The program operates by intercepting the jump to the routine for the Control-C key check which is stored at locations 21C/D. It first tests to see if the computer is in immediate mode. If it is, it skips the additional command routines. To speed up the routine, a check is made only if a colon is found, since the beginning of a new line is a special case which would require much more code to implement and would, in consequence, run more slowly. This also means that if an added command is to be used at the beginning of a line of code it is necessary to precede it by a colon.

The routine then looks at the first character following the colon to see if it is the letter P which is used to precede all the added commands. Otherwise the statement is re-scanned by the normal interpreter for execution.

If a P is found, the program checks for one of a series of command tokens to decide what action is required. These tokens are those generated by the interpreter from the normal Basic keywords to speed up program execution. If no valid token is found, an error is indicated.

The program uses a number of routines in the Basic interpreter as well as some entry points in the monitor. Users of monitors other than the Synmon and MonUK01 may have to change some of the monitor entry points.

The following are added:

PON. All subsequent output goes to the printer and not the screen.

PSTOP. All subsequent output goes to the screen and not the printer.

PPRINT. Prints contents of the printer buffer and performs carriage return without line feed.

PDEF S. Sets printer to single-width print mode.

```

20 0000 ;CODE IN 6502 ASSEMBLY LANGUAGE
30 0000 ;TO ADD COMMANDS TO BASIC.
40 0000 ;COPYRIGHT R A SHACKLEFORD
50 0000 ; 24 JAN 1982
60 1F00 * = $1F00
90 1F00 ;STOP LINE FEED FROM PRINTING
100 1F00 C90A POUTV CMP #10A
110 1F02 D004 BNE NOLF
120 1F04 ;EXPANSION LINK FOR FORM FEED CONTROL
130 1F04 EA NOP
140 1F05 EA NOP
150 1F06 EA NOP
160 1F07 60 RTS
170 1F08 4C91FC NOLF JMP $FCB1
180 1F08 ;CONTROL-C VECTOR BREAK FOR ADDED COMMANDS
190 1F08 A588 CVECT LDA $88
200 1F0D C9FF CMP #FF
210 1F0F D003 BNE NOTIMM
220 1F11 4C3BFF JMP #FF9B
230 1F14 ;SAVE PRESENT C3,C4 POINTER VALUES
240 1F14 A5C3 LDA #C3
250 1F16 85EE STA $EE
260 1F18 A5C4 LDA #C4
270 1F1A 85EF STA $EF
280 1F1C ;CHECK FOR COLON
290 1F1C 20C200 JSR #00C2
300 1F1F C93A CMP #3A ; CHECK
310 1F21 D02A BNE RSTOR2
320 1F23 ;RESTORE UNLESS NEXT IS "P"
330 1F23 20BC00 JSR #00BC
340 1F26 C950 CMP #50 ;P CHECK
350 1F28 D01B BNE RSTORE
360 1F2A ; "ON" TOKEN ?
370 1F2A 20BC00 JSR #00BC
380 1F2D C990 CMP #90 ;ON TOKEN
390 1F2F F01F BEQ PON
400 1F31 ; "STOP" TOKEN ?
410 1F31 C98F CMP #8F ;STOP TOKEN
420 1F33 F02C BEQ PSTOP
430 1F35 ; "PRINT" TOKEN ?
440 1F35 C997 CMP #97 ;PRINT TOKEN
450 1F37 F034 BEQ PPRINT
460 1F39 ; "DEF" TOKEN ?
470 1F39 C995 CMP #95 ;DEF TOKEN
480 1F3B F037 BEQ PDEF
490 1F3D ; "POKE" TOKEN ?
500 1F3D C996 CMP #96 ;POKE
510 1F3F F054 BEQ PPOKE
520 1F41 ; "POS" TOKEN ?
530 1F41 C9B2 CMP #B2 ;POS
540 1F43 F071 BEQ PPOS
550 1F45 ;RESTORE IF NO VALID TOKEN
560 1F45 A5EE RSTORE LDA $EE
570 1F47 85C3 STA #C3
580 1F49 A5EF LDA $EF
590 1F4B 85C4 STA #C4
600 1F4D 4C3BFF RSTOR2 JMP #FF9B
610 1F50 ;
620 1F50 ;
630 1F50 ;
640 1F50 ;
650 1F50 ;
660 1F50 ;
670 1F50 ;
680 1F50 ;*****COMMAND HANDLERS*****
690 1F50 ;PON
700 1F50 ;OUTPUT TO PRINTER NOT SCREEN
710 1F50 A900 PON LDA #00
720 1F52 8D1A02 STA #021A
730 1F55 A91F LDA #1F
740 1F57 8D1B02 STA #021B

```

(listing continued on next page)

(continued on next page)

(continued from previous page)

PDEF D. Sets double-width print mode on the printer.  
 PDEF G. Sets printer graphic mode.  
 PPOS (X). Positions print head to character position defined by variable X.  
 PPOKE (X). Positions head to dot X.

### Double vision

WHILE EXAMINING the character-generator chip of my UK 101 I found that joining pins 23 and 24 together gives a permanent lower case, writes Chris Thompson of Orpington, Kent. Characters 65 to 90 appear in lower case, as do characters 97 to 122. Other characters, including the cursor, also changed position.

Joining pins 1, 2, and 3 of IC 70 create inverse video reminiscent of the ZX-80 screen, without the flicker. If pins 2 and 3 are joined, about 80 percent of the screen appears normal, while the remainder contains a repeated image of the last line and half of the top section.

### Random Poking

WHEN I WAS asked to write a graphical program for the UK 101, writes Jonathan Sunderland of Berkhamsted, Hertfordshire, I came up with a program that generates four random characters and Pokes them so that the first character is repeated to fill a quarter of the screen. The next character fills the next quarter and so on.

Once the process is complete it starts over again using four more random characters.

```

LIST
20 A=INT(RND(130)*254+1)
30 B=INT(RND(130)*254+1)
40 C=INT(RND(130)*254+1)
50 D=INT(RND(130)*254+1)
60 IFA=BORA=CORA=DTHEN20
70 IFB=AORB=CORB=DTHEN30
80 IFC=AORC=BORC=DTHEN40
90 IFD=AORD=BORD=CTHEN50
100 FORU=53259T053282:POKEU,A:NEXTU
110 FORU=53323T053346:POKEU,A:NEXTU
120 FORU=53387T053410:POKEU,A:NEXTU
130 FORU=53451T053474:POKEU,A:NEXTU
140 FORU=53515T053538:POKEU,A:NEXTU
150 FORU=53579T053602:POKEU,A:NEXTU
160 FORU=53643T053666:POKEU,A:NEXTU
170 FORU=53707T053730:POKEU,A:NEXTU
180 FORU=53771T053794:POKEU,C:NEXTU
190 FORU=53835T053858:POKEU,C:NEXTU
200 FORU=53899T053922:POKEU,C:NEXTU
210 FORU=53963T053986:POKEU,C:NEXTU
220 FORU=54027T054050:POKEU,C:NEXTU
230 FORU=54091T054114:POKEU,C:NEXTU
240 FORU=54155T054178:POKEU,C:NEXTU
250 FORU=54219T054242:POKEU,C:NEXTU
260 FORU=53283T053306:POKEU,D:NEXTU
270 FORU=53347T053370:POKEU,D:NEXTU
280 FORU=53411T053434:POKEU,D:NEXTU
290 FORU=53475T053498:POKEU,D:NEXTU
300 FORU=53539T053562:POKEU,D:NEXTU
310 FORU=53603T053626:POKEU,D:NEXTU
320 FORU=53667T053690:POKEU,D:NEXTU
330 FORU=53731T053754:POKEU,D:NEXTU
340 FORU=53795T053818:POKEU,B:NEXTU
350 FORU=53859T053882:POKEU,B:NEXTU
360 FORU=53923T053946:POKEU,B:NEXTU
370 FORU=53987T054010:POKEU,B:NEXTU
380 FORU=54051T054074:POKEU,B:NEXTU
390 FORU=54115T054138:POKEU,B:NEXTU
400 FORU=54179T054202:POKEU,B:NEXTU
410 FORU=54243T054270:POKEU,B:NEXTU
420 GOTD20
DK
  
```

(listing continued from previous page)

```

750 1F5A 20BC00 PEKIX JSR $00BC
760 1F5D D0B5 POPOS BNE NOTIMM
770 1F5F F0B3 BEQ NOTIMM
780 1F61 ;PSTOP
790 1F61 ;OUTPUT TO SCREEN,STOP PRINTING
800 1F61 A969 PSTOP LDA #$69
810 1F63 8D1A02 STA $021A
820 1F66 A9FF LDA #$FF
830 1F68 8D1B02 STA $021B
840 1F68 D0ED BNE PEKIX ;ALWAYS BRANCH
850 1F6D ;PPRINT
860 1F6D ;CARRIAGE RETURN WITHOUT LINE FEED
870 1F6D A91A PPRINT LDA #$1A
880 1F6F 20B1FC JSR $FCB1
890 1F72 D0E6 BNE PEKIX
900 1F74 ;PDEF A
910 1F74 ;REPLACE A BY S,D OR G TO DEFINE MODE
920 1F74 20BC00 PDEF JSR $00BC
930 1F77 C953 CMP #$53 ;S
940 1F79 F00B BEQ SINGLE
950 1F7B C944 CMP #$44 ;D
960 1F7D F00B BEQ DOUBLE
970 1F7F C947 CMP #$47 ;G
980 1F81 F00B BEQ GRAFIC
990 1F83 4C9BFF JMP $FF9B ;ERROR OUTPUT
1000 1F86 A91E SINGLE LDA #$1E ;CONTROL CODE
1010 1F88 D006 BNE OPUT
1020 1F8A A91F DOUBLE LDA #$1F ;DOUBLE CONTROL
1030 1F8C D002 BNE OPUT
1040 1F8E A912 GRAFIC LDA #$12 ;GRAPHICS MODE
1050 1F90 20B1FC OPUT JSR $FCB1
1060 1F93 D0C5 BNE PEKIX
1070 1F95 ;
1080 1F95 ;
1090 1F95 ;
1100 1F95 ;PPOKE (X)
1110 1F95 ;OUTPUTS DOT POSITION FOR NEXT PRINTING
1120 1F95 ;BASED ON VARIABLE X,RANGE 0<X<479.
1130 1F95 20BC00 PPOKE JSR $00BC
1140 1F98 A91B LDA #$1B ;ESC
1150 1F9A 20B1FC JSR $FCB1
1160 1F9D A910 LDA #$10 ;POS
1170 1F9F 20B1FC JSR $FCB1
1180 1FA2 20F5AB JSR $ABF5
1190 1FA5 2005AE JSR $AE05 ;H/L IN RE/AF
1200 1FAB A9AE LDA $AE
1210 1FAD 20B1FC JSR $FCB1 ;H
1220 1FAF A9AF LDA $AF
1230 1FAF 20B1FC JSR $FCB1 ;L
1240 1FB2 D0A9 PLINK BNE POPOS
1250 1FB4 F0A7 BEQ POPOS
1260 1FB6 ;
1270 1FB6 ;
1280 1FB6 ;
1290 1FB6 ;
1300 1FB6 ;
1310 1FB6 ;PPOS (X)
1320 1FB6 ;POSITIONS PRINTER TO CHARACTER LOCATION
1330 1FB6 ;DEFINED BY X. RANGE 0<X<79
1340 1FB6 20BC00 PPOS JSR $00BC
1350 1FB9 A910 LDA #$10
1360 1FB8 20B1FC JSR $FCB1 ;POS
1370 1FBE 20F5AB JSR $ABF5
1380 1FC1 2005AE JSR $AE05
1390 1FC4 A9AF LDY $AF
1400 1FC6 A900 LDA $A0
1410 1FC8 F8 SED
1420 1FC9 18 BCDCON CLC
1430 1FCA 6901 ADC #$01
1440 1FCC 88 DEY
1450 1FCD D0FA BNE BCDCON
1460 1FCF D8 CLD
1470 1FD0 48 PHA
1480 1FD1 29F0 AND #$F0
1490 1FD3 4A LSR A
1500 1FD4 4A LSR A
1510 1FD5 4A LSR A
1520 1FD6 4A LSR A
1530 1FD7 0930 ORA #$30
1540 1FD9 20B1FC JSR $FCB1
1550 1FDC 68 PLA
1560 1FDD 29F0 AND #$0F
1570 1FDF 0930 ORA #$30
1580 1FE1 20B1FC JSR $FCB1
1590 1FE4 D0CC BNE PLINK
1600 1FE6 F0CA BEQ PLINK
1610 1FE8 .END
;D1F00,1FE8
0 1 2 3 4 5 6 7 8 9 A B C D E F
1F00 C9 0A D0 04 EA EA EA 60 4C B1 FC A5 98 C9 FF D0
1F10 03 4C 9B FF A5 C3 85 EE A5 C4 85 EF 20 C2 00 C9
1F20 3A D0 2A 20 BC 00 C9 50 D0 1B 20 BC 00 C9 90 F0
1F30 1F C9 8F F0 2C C9 97 F0 34 C9 95 F0 37 C9 96 F0
1F40 54 C9 B2 F0 71 A5 EE 85 C3 A5 EF 85 C4 40 9B FF
1F50 A9 00 8D 1A 02 A9 1F 8D 1B 02 20 BC 00 D0 B5 F0
1F60 B3 A9 69 8D 1A 02 A9 FF 8D 1B 02 D0 ED A9 1A 20
1F70 B1 FC D0 E6 20 6C 00 C9 53 F0 08 C9 44 F0 0B C9
1F80 47 F0 0B 4C 9B FF A9 1E D0 06 A9 1F D0 02 A9 12
1F90 20 B1 FC D0 C5 20 6C 00 A9 1B 20 B1 FC A9 10 20
1FA0 B1 FC 20 F5 AB 20 05 AE A5 AE 20 B1 FC A5 AF 20
1FB0 B1 FC D0 A9 F0 A7 20 BC 00 A9 10 20 B1 FC 20 F5
1FC0 AB 20 05 AE A4 AF A9 00 F8 19 69 01 88 D0 FA D9
1FD0 48 29 F0 4A 4A 4A 4A 09 30 20 B1 FC 68 29 0F 09
1FE0 30 20 B1 FC D0 CC F0 CA
  
```





### Bar chart

THE HISTOGRAM PLOTTER program from Darren Moseby of Clay Cross, Derbyshire, fits into the ZX-81's rather limited memory. When Run, the program comes up with the prompt "No. columns", and a number between 0 and 11 should be entered. The prompt "Input No. n columns" comes up, where n is a number between 1 and a specified column number. A number between 0 and 20 should be entered in response.

When all the column values have been entered there is a short pause and the screen clears. The graph is then plotted, using two different graphics characters for the alternating columns.

The program can easily be expanded if more memory is available, and can be implemented on other micros that have a Print At X, Y command.

### Line draw

A STRAIGHT LINE from a point with co-ordinates X1, Y1 to a second point X2, Y2 is constructed by the program from M Saiepour of Nottingham. It also determines whether a third point X3, Y3 lies on the line. The ZX-81 must be fitted with the 16K RAM.

```

Bar chart
10 REM * BAR-CHART *
20 SCROLL
30 PRINT "NO. COLUMNS ?"
40 INPUT A
50 SCROLL
60 PRINT TAB 6;A
70 DIM Z(A)
80 FOR B = 1 TO A
90 SCROLL
100 PRINT "INPUT NO.
";B;"COLUMN":
110 INPUT Z(B)
120 PRINT Z(B)
130 NEXT B
140 PAUSE 50
150 CLS
160 FOR E=0 TO 20
170 PRINT AT E,0;20-E
180 NEXT E
190 FOR C = 1 TO B-1
200 FOR D = 1 TO Z(C)
210 LET A$ = " "
220 IF C-2*INT(C/2)=0 THEN LET
A$ = "graphic H"
230 PRINT AT 20-D,c+1;A$
240 NEXT D
250 NEXT C
  
```

### Line draw

```

5 REM PROGRAM BY M.SAIEPOUR B.Sc. M.Sc
10 INPUT X1
20 INPUT Y1
30 INPUT X2
40 INPUT Y2
50 LET X=X2-X1
60 LET Y=Y2-Y1
70 LET Z=ABS X
80 IF ABS Y>Z THEN LET Z=ABS Y
90 LET G=0
100 LET H=0
110 FOR F=1 TO Z
120 PLOT G+X1,H+Y1
130 LET G=G+X/Z
140 LET H=H+Y/Z
150 NEXT F
160 INPUT X3
170 INPUT Y3
180 IF (Y3-Y1)/(X3-X1)=(Y2-Y1)/(X2-X1)THEN GOTO 185
183 GOTO 190
185 IF X3>X1 AND X3<X2 OR X3<X1 AND X3>X2 THEN GOTO
188
186 GOTO 190
188 IF Y3>Y1 AND Y3<Y2 OR Y3<Y1 AND Y3>Y2 THEN GOTO
210
190 PRINT AT 0,0;" NO"
200 GOTO 160
210 PRINT AT 0,0;"YES"
220 GOTO 160
  
```

If the gradient of the line is equal to the gradient of the line from X1, Y1 to X3, Y3, and X3 lies between X1 and X2, and Y3 lies between Y1 and Y2, then the point X3, Y3 lies on the line. For values of X and Y which are off the screen, the plot statement must be removed from line 120.

### Print At programs

A SUITE of programs demonstrating the use of the Print At statement comes from D Stocqueler of Exeter. The programs were originally written for an 8K-Rom ZX-80 and can be converted for use on a ZX-81 by slight alterations to the Pause statements.

An adequate explanation of the Print At statement is given in the Sinclair manual, it does away with calculating the address of the shifting display RAM and then having to Poke characters into this area.

The Etch-a Sketch program simulates the simple, children's drawing toy. A line

### Etch-a-sketch

```

10 LET A=11
20 LET B=16
30 PRINT AT A,B;
"graphic space"
40 PAUSE 10
50 LET A$=INKEY$
60 IF A$="5" THEN LET B=B-1
70 IF A$="6" THEN LET A=A+1
80 IF A$="7" THEN LET A=A-1
90 IF A$="8" THEN LET B=B+1
100 IF A$="0" THEN CLS
110 IF A$="1" THEN PAUSE 200
120 GOTO 30
RUN
  
```

### Skier

```

10 LET S=0
20 LET B=11
30 PRINT AT 20,RND*20;"Y"
40 SCROLL
50 IF B>2 THEN LET B=B-1
60 IF B<3 THEN LET B=B+4
70 IF INKEY$="B"
THEN LET B=B+2
80 IF B>20 THEN LET B=B-4
90 PRINT AT 10,B;.."
100 PAUSE 10
110 LET S=S+1
120 IF NOT PEEK
(PEEK 16398+256*PEEK
16399)=62 THEN GOTO 30
130 FOR F=1 TO 7
140 PRINT AT 7,5;"CRASH"
150 PAUSE 5
160 CLS
170 NEXT F
180 PRINT "YOUR SCORE IS ";S
190 PAUSE 100
200 RUN
  
```

is drawn in the direction of the arrows on keys 5,6,7 and 8 every time one of these keys is pressed. Pressing key 0 clears the screen and key 1 stops the flicker on the ZX-80 for long enough for you to examine what you have drawn. Do not draw lines to the very top, sides and bottom of the screen as weird thing begin to happen if you try.

The object of Skier is to manoeuvre yourself down a ski slope without colliding with any trees. As with most arcade games, there is no way of beating the machine; the object is to beat your own high score.

(continued on next page)

(continued from previous page)

The game auto-starts itself to save continually pressing Run, Newline etc. The skier automatically travels to the left and only moves to the right if B is pressed. The skill level can be changed by altering the value in line 100. Beware of trying to avoid the trees by moving to the edge of the screen as the program counters this tactic.

The short routine in Sliding Letters produces a most interesting display. The computer accepts a string input, prints it on the screen at different places and then scrolls. It will work on an 8K ZX-80 as long as

45 PAUSE 10

is added. For an effective display the inputted string should consist of inverse-video characters.

### Sliding letters

```
10 INPUT A$
20 FOR F=1 TO 20
30 PRINT AT F,RND
   30:A$
40 SCROLL
50 NEXT F
60 GOTO 20
```

### Card shuffle

THE FOLLOWING ROUTINE, entitled Card Shuffle will be useful to those intending to write their own card-game programs, writes Gary Nugent of Dublin, Ireland. The routine shuffles suited cards, which are required in Poker, for example.

Line 10 should be the first line of the program. Lines 11 to 20 can be placed anywhere within the main card-game program.

The cards and their suits can be read by Peeking locations 16427 to 16530; 16427 is the address of the first character after the Rem keyword.

The numerical values of the cards are found by Peeking the odd-numbered locations, and the suits are found by Peeking the even-numbered locations, starting at 16428.

Since ten is the only number in the deck which has two digits, it is represented by T, since this simplifies the routine. The suits are represented by their initial letters.

### Card shuffle

```
10 REM AC2C3C4C5C6C7C8C9CTCJCK
   CKCAD2D3D4D5D6D7D8D9D10DQDKD
   AS2S3S4S5S6S7S8S9S10SJSQKSAH2
   H3H4H5H6H7H8H9HTHJH0HKH
11 LET Z=16427
12 FOR I=0 TO 51
13 LET J=RND(52)-1
14 LET X=PEEK(Z+2*I)
15 LET Y=PEEK(Z+2*I+1)
16 POKE Z+2*I,X
17 POKE Z+2*I+1,Y
18 POKE Z+2*I+1,PEEK(Z+2*I+1)
19 POKE Z+2*I+1,Y
20 NEXT I
```

### Think quick

THE GAME of Vitesse tests the participant's ability to think quickly, writes Douglas Fyffe of Exeter, Devon. When the program is run, an asterisk appears in one of 10 positions along the screen.

The first asterisk remains on the screen for one second and, in that time you must find the correct firing key and press it. The firing keys are

1 2 3 4 5 6 7 8 9 0

If you have chosen the right key, the asterisk explodes and the game speeds up. If you are wrong the game slows down.

After 15 asterisks have appeared, the game finishes and you are told how many you destroyed.

### Vitesse

```
1 LET T=50
2 LET N=0
3 FOR S=1 TO 15
4 PRINT AT 83,P*3-1;"*"
6 PAUSE T
7 POKE 16437,255
8 LET C#=INKEY$
9 IF C#="0" THEN LET C#="10"
10 IF C#=STR$ P THEN GOTO 16
11 LET T=T*1.1
12 CLS
13 NEXT S
14 PRINT "YOU GOT ";N
15 STOP
16 PRINT AT 8,P*3-1;"inv*inv"
17 LET T=T*0.9
18 LET N=N+1
19 GOTO 12
```

### Flight of fancy

SPIREFIRE puts you into the cockpit of a Second World War fighter. Ahead you see a squadron of hostile aircraft: By carefully manoeuvring your plane, you must line your targets up with the cross-

### Spiritfire

```
1 LET H=100
2 LET S=0
3 LET Y=INT (RND*22)
4 LET X=INT (RND*30)+1
5 CLS
7 LET X=X+INT (RND*3)-1
8 LET Y=Y+INT (RND*3)-1
9 PRINT AT 9,14; "anaphYanaph"
10 PRINT AT 9,16; "anaphTanaph"
11 PRINT AT 11,14; "anaphTanaph"
12 PRINT AT 11,16; "anaphYanaph"
15 PRINT H
16 IF H<1 THEN GOTO 35
17 PRINT AT Y,X-1;
   "anaphTGyanaph"
20 LET A$=INKEY$
21 IF A$="6" THEN LET Y=Y-2
22 IF A$="5" THEN LET X=X+2
23 IF A$="7" THEN LET Y=Y+2
24 IF A$="8" THEN LET X=X-2
25 IF INT (RND*6)+1=1 THEN LET
   H=H-INT (RND*15)+1
26 IF A$="1" THEN GOTO 28
27 GOTO 5
28 IF X=15 AND Y=10 THEN GOTO 30
29 GOTO 5
30 PRINT AT 10,14; "inv***inv"
31 LET S=S+1
32 PAUSE 50
33 POKE 16437,255
34 GOTO 3
35 PRINT "YOU GOT ";S
```

hairs on the canopy and blast it with your guns.

The aim is to shoot down as many enemy craft as possible before you are finally destroyed yourself. You should control your craft, not the enemy.

If you lose sight of the enemy squadron, you are forced to return to base.

The controls are

1 — Fire  
5 — Left  
6 — Down  
7 — Up  
8 — Right

The length of the game can be altered by changing the value of H in line 1, or changing the 6 in line 25.

### Read data

STEPHEN CARSON-ROWLAND'S Read Data routine for the ZX-81 — ZX-80/81 line-up, December 1981 — is very pretty but it is not really necessary, explains J Arotzky of St Helens, Merseyside. The Sinclair instruction book gives a hint of how to do it. There are two relevant points to consider:

- The ZX-81 allows a string of any length. The only limitation is the amount of memory available.
- Sinclair Basic has superb string handling.

These two factors can be used to provide a very acceptable substitute for Read Data. For example, the program shown here is a machine-code load routine, with all the appropriate Poke values accommodated in a string. A full-stop is used as a data separator as it is easier to type than a comma. Obviously you can use any separator that you wish.

The program is an adaptation of Christopher Clarke's program from the December ZX-80/81 line-up. When it has run, remove all the lines except line 10 and proceed as described in the article. The same method can also be used with strings. For example, the program in listing 2 still leaves 500 bytes free.

If you want to edit line 10, then stepping along it is extremely tedious. Does anyone know how to use machine code to

(continued on page 141)

### Read data — listing 1.

```
10 REM 123456789123456789
20 LET B=1
30 LET C=16514
40 LET A$="237 115. 54. 64. 42. 54. 64.
   237. 75. 28. 64. 237. 66. 68. 68. 77. 77.
   201. 201."
50 FOR A=1 TO LEN A$
60 IF A$(A)=". " THEN GOSUB 200
70 NEXT A
80 STOP
200 POKE C,VAL(A$(B TO A-1))
210 LET B=A+1
220 LET C=C+1
230 RETURN
```

### Read data — listing 2.

```
10 LET A$="JANUARY .FEBRUARY .MARCH
   .APRIL .MAY .JUNE .JULY .AUGUST
   .SEPTEMBER .OCTOBER .NOVEMBER .DECEMBER
   ."
20 LET B=1
30 FOR A=1 TO LEN A$
40 IF A$(A)=". " THEN GOSUB 200
50 NEXT A
60 STOP
200 PRINT A$(B TO A-1)
210 LET B=A+1
220 RETURN
```



# 0 to 60<sup>ch's</sup> in one second



## THE RICOH 1600S

If it's high performance you're looking for, the Ricoh 1600S is for you, offering an amazing 60 characters in just 1 second. An updated version of the tried-and-tested 1600, the new S model has been re-designed and fitted with all sorts of extras. Yet one thing hasn't changed — the price, making the 1600S cheaper than any equivalent model on the market. This superb performer incorporates the Z80 micro-processor, auto bidirectional printing and look-ahead logic, increasing speed and efficiency. Other capabilities include proportional spacing, graph plotting and word processing enhancements. The printer includes a standard centronics interface, and RS232 and IEEE options are available.

The Ricoh 1600S is available only from Micropute and their authorised dealers, all backed up with a nationwide service network. If you're interested in the 1600S either as a customer or as a dealer, send the coupon now.

\*\*Picture shows 1600s fitted with tractor feed option\*\*

Please send me details on the Ricoh 1600S

Name \_\_\_\_\_  
 Position \_\_\_\_\_  
 Company \_\_\_\_\_  
 Address \_\_\_\_\_  
 Tel. No \_\_\_\_\_

**RICOH 1600S THE PERFORMANCE HAS RISEN — THE PRICE HASN'T**

### FEATURES      COMPETITORS

	DIABLO 630	QUME SPRINT 5	SPIN-WRITER	RICOH RP.1600 (10 DATA)	RICOH RP.1600S
PRINT SPEED (CPS)	40	45/55	55	60	60
PRINT ELEMENT	DAISY-WHEEL	DAISY-WHEEL	THIMBLE	DOUBLE DAISY-WHEEL	DOUBLE DAISY-WHEEL
AUTO BIDIRECTIONAL	Yes	No	No	No	Yes
AUTO LOGIC SEEKING	Yes	No	Yes	No	Yes
PROPORTIONAL PRINT CAPABILITY	Yes	Yes	Yes	No	Yes
EXTENDED CHARACTER SET	No	No	Yes	Yes	Yes
LETTER QUALITY PRINT	Yes	Yes	Yes	Yes	Yes
CUSTOM INTERFACE OPTION	No	No	No	No	Yes
PRICE	£1675	£1950	£1950	£1450	£1450

The above information was gathered from distributors and abstracted from their current literature. Prices shown are those advertised at the present time.

**MICROPUTE**  
microcomputer systems

Catherine Street, Macclesfield, Cheshire.  
SK11 6QY. Tel: Macclesfield 612759

● Circle No. 176

# KONTRON: LOOK TO TOMORROW

## AND GET ON THE ROAD TO SUCCESS

Yet another dimension has been added to the immensely flexible PSI  $\psi$  80! With KOBUS, high speed, multiuser access, to a common database is now available over very long distances at a most affordable price bringing the results you want, where you want, **fast**.

At Kontron we support all our systems with a wide range of software and hardware tools; a multitasking operating system (CP/M\* compatible); high level languages; applications and utilities; and a vast number of hardware expansion options.

KOBUS brings them all together into the most powerful and flexible of systems, in a unit that any businessman would like to see on his desk; to have a real impact on **your** business.

Truly an OEM's delight.

Let us show you how the PSI  $\psi$  80 and KOBUS can solve your problems—quickly, reliably—as we've done for so many others.

\*Registered Trademark of Digital Research.

## KOBUS

The distributed processing system for the PSI  $\psi$  80



**KONTRON**  
COMPUTERS  
ADVANCED MICROCOMPUTER SYSTEMS

PO Box 88, Kontron House,  
Campfield Road,  
St. Albans, Herts. AL1 5JG  
Tel: (0727) 66222  
Telex: 267102

In Scotland contact:  
Strathand Ltd.,  
44, St. Andrews Square,  
Glasgow G1 5PL  
Tel: 041-552 6731



**Add mass  
storage to Apple  
and the sky's  
the limit . . .**

**. . . but we can  
keep the price  
right down to  
earth!**



## **Apple and Mass Storage – the REAL\* partnership**

### TECHNICAL DATA

- 5¼ inch Winchester disk drive
- 3, 6, 9 and 12 Mbyte capacities
- Compact design
- Variable configuration – hard disk or hard+ std. Apple 5¼" floppy drive
- Whisper quiet
- Apple support software for DOS 3.3, CP/M and Apple Pascal



**REAL**

Products and Systems  
available only from:-

**Prices from £1800**

# **COMPUTERFACTS (U.K) LTD**

83 LALEHAM ROAD, STAINES, MIDDLESEX. TEL. STAINES 62501

# NEC PC 8000 PERSONAL COMPUTER.

**"THE ELECTRONICS ARE EXCELLENT  
AND IT IS SUPERB VALUE FOR MONEY."**

**PERSONAL COMPUTER WORLD.**

Eight colour graphics, ten programmable function keys, a full qwerty keyboard with numeric key pad, alternative graphic and character sets, and superb editing facilities including definable scroll area.

Now at last you can have all the features you want in one expandable system with memory from 32K up to 190K for user application and prototyping facilities for industrial and scientific use.

As well as powerful N-Basic by Microsoft,\* full CPM compatibility gives access to a large library of software including Wordstar and compilers for Fortran, Pascal, Cobol and Basic 80 languages.

N-Basic packages are already available for sales, purchase and nominal ledgers, invoicing, stock control, payroll, information retrieval and word processing.

And when you consider the cost/performance ratio, NEC is even further ahead.

The NEC PC8000 Personal Computer is available through your local dealer now.

Complete the coupon or call the distributor IBR Microcomputers on Reading (0734) 664111 for the name of your nearest dealer.

\*Microsoft is a trade mark.



Please send me complete details on the NEC PC8000 series and the  
Name \_\_\_\_\_  
Company \_\_\_\_\_  
Address \_\_\_\_\_  
address of my local dealer.  
Tel. \_\_\_\_\_

## IBR

**MICROCOMPUTERS**

Suttons Industrial Park, London Road, Earley, Reading.  
Tel: 0734 664111. Telex: 848215.

A MEMBER OF THE IBR ELECTRONICS GROUP.



## Read data — listing 3.

```

10 LET A$=" "
20 INPUT B$
30 IF B$="END" THEN
   GOTO 100
40 LET A$=A$+B$+"."
50 GOTO 20
100 PRINT A$

```

(continued from page 136)

Poke an alteration in the line? This is easy enough if you wish merely to alter a character, but if you want to alter the length of A\$. This is a particular problem if you want to use the string as a data base, storing the words and clues for Hangman for example.

One way round this problem is to create the string not a program line — see listing 3, which produces an A\$ which can readily be altered though, Run destroys all your words and clues for Hangman.

### The money program

A RECENT Apple-Pet item gave a routine for printing sums of money in conventional £.p form so that columns line up, notes WE Thomson. A ZX-81 cannot use the same method because of its different string-handling procedures, but these, plus the ZX-81's logical functions, provide a neat solution to this problem.

In this test program, the four lines 100 to 130 constitute the line-up procedure. The routine has two operands: D, the column in which the decimal point has to appear; and F, a positive sum of money expressed in pounds and fractions of a pound that do not necessarily correspond to whole numbers of pence. Line 100 converts F to pence, rounded off to the nearest integer.

Lines 30 to 60 allow the input, and printing in the form in which it is input, of an expression such as

69.95/1.15

the basic cost of an item whose cost including VAT is £69.95. It is followed by its value in pounds and fractions of a pound, and its value in pounds and pence correctly lined up.

The routine always prints at least one pound figure: 50p becomes 0.50; 5p becomes 0.05, 0p becomes 0.00. If the forms .50, .05, .00 are preferred, delete

("0" AND F < 100) +

in line 110.

### Hex loader

IN RESPONSE to G J Langford's letter — Feedback, January 82 — J Chalmers of East Grinstead, West Sussex has written a hex loader program for the ZX-81.

The program was written using 3K of RAM, but can be converted to fit into 1K by reducing the amount of information displayed at any one time. This is achieved by making the display file a maximum of one line long just before every scroll is executed. Poking the sys-

### Money program

```

10 PRINT AT 1,28;"$. F"
20 LET D=29
30 INPUT E$
40 PRINT E$
50 LET F=VAL E$
60 PRINT F;
95 REM START OF LINE-UP ROUTINE
100 LET F=INT (100*F+0.5)
110 LET F$=("0" AND F<100)+("0" AND F<10)+STR$ F
120 LET L=LEN F$-2
130 PRINT TAB D-L;F$(TO L);".";F$(L+1 TO)
135 REM END OF LINE-UP ROUTINE
200 GOTO 30

```

tem variable DF-SZ (16418) with 23 performs this task.

Operation of the program is simple. After Run, a string-input prompt is displayed along with a decimal address and the present contents of that address. If you wish to change the byte, enter the new byte in hex and press Newline; otherwise just press Newline. To stop the programming mode press S and a message will appear inviting you to check the program. Pressing L will set the counter to the start of your program and it can be stepped through and be inspected byte by byte. It can also be altered if necessary.

A special feature of the program is the inbuilt decimal to hex converter. During machine-code programming, entering H will access this routine. On access you simply enter a decimal number smaller

than 65535, and it will be automatically printed along with its hex equivalent.

When your machine code has been perfected, the hex loader program can be deleted, leaving only line 1 which contains the code. To run machine code you must use the USR function. If the statement

LET L = USR X

is executed, where X is the starting address of your machine code, the code will be executed until a return is found indicating a return to Basic. A full set of machine-code instructions can be found in appendix A of the Sinclair manual, and an appropriate return — e.g. C9h — can be selected from there. On return to Basic in this example the variable L will contain a value corresponding to the contents of the bc register pair.

### Hex loader

```

1 REM (PUT HERE ONE X PER BYTE OF MACHINE CODE)
2 REM MACHINE CODE LOADER FOR ZX
10 LET X=16514
20 LET A=PEEK X
30 GOSUB 1000
40 SCROLL
50 PRINT X;A$;
60 INPUT A$
70 IF A$(1)="H" THEN GOTO 400
80 IF A$(1)="S" THEN GOTO 200
90 IF A$(1)=" " THEN GOTO 130
110 PRINT " ";A$
120 POKE X,16*CODE A$ + CODE A$(2)-476
130 LET X=X+1
140 GOTO 20
210 SCROLL
220 PRINT "PRESS""L"" TO CHECK"
230 IF INKEY$ ="L" THEN RUN
240 GOTO 230
410 SCROLL
420 INPUT A
430 PRINT A;
440 GOSUB 1000
450 PRINT A$
460 GOTO 20
1000 REM DECIMAL TO HEX CONVERSION
1010 DIM A$(4)
1020 LET D=4096
1030 FOR I = 1 TO 4
1040 LET A$(I)=CHR$(INT(A/D)+28)
1050 LET A = A-D*INT (A/D)
1060 LET D = D/16
1070 NEXT I
1080 IF A$(1) ="0" AND A$(2) ="0" THEN LET A$ = A$(3 TO 4)
1090 RETURN

```



# Duplex ← Communications →



Northern Office: Dean House · Dean Hall Lane · Shaw Green · Euxton · Nr. Chorley · Lancs. Tel: 0257 453360  
Midlands Office: 2 Leire Lane · Dunton Bassett · Nr. Lutterworth · Leicestershire. Tel: 0455 209131

● Computer Interfacing ● Equipment Design ● Systems Analysis ● Software Development ●

## PRESENTS The OCTET 121™ a multi-use communicating terminal and electronic typewriter

OLIVETTI ET121

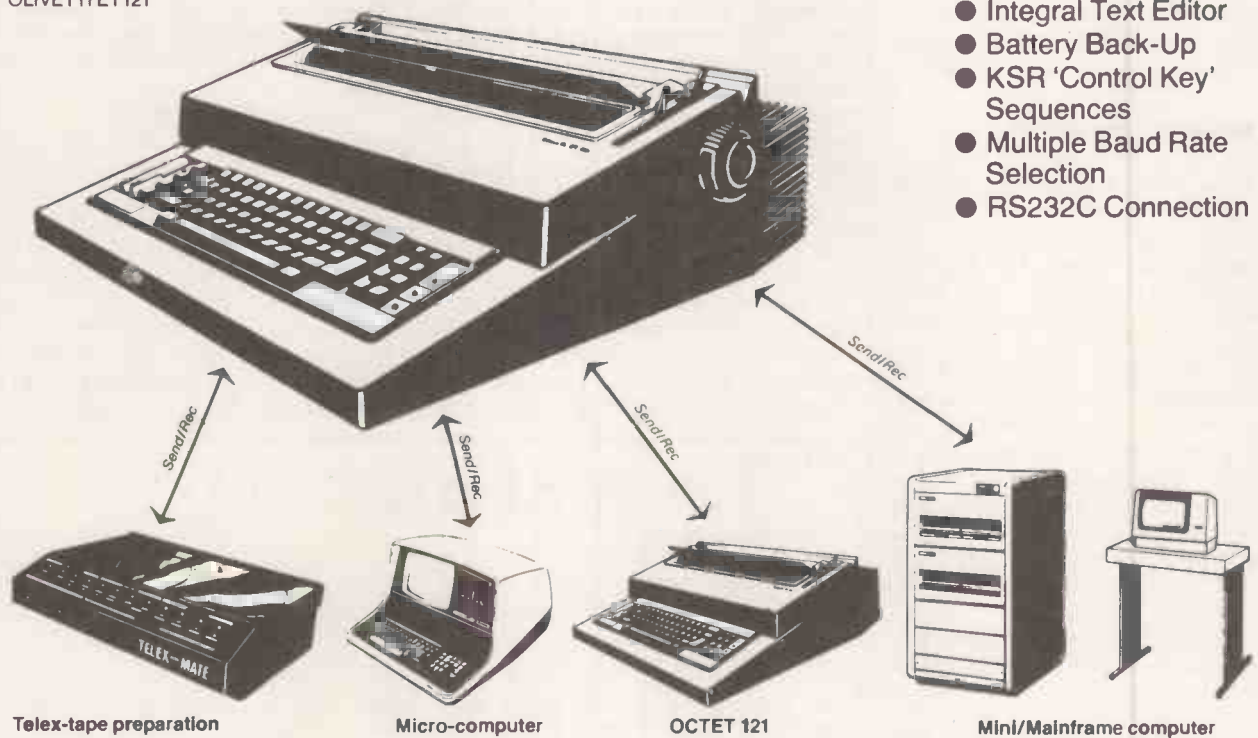

- 4,000 char. memory
- Integral Text Editor
- Battery Back-Up
- KSR 'Control Key' Sequences
- Multiple Baud Rate Selection
- RS232C Connection

The OCTET 121 is capable of punching man-readable 'headers'. The full 4K of memory can be text-edited prior to punching. The OCTET 121 will also read in tapes where fast telex tape handling is required. Multiple OCTETs to one tape punch station is also available.

Use the OCTET 121 as a letter quality printer. A wide selection of Daisy Wheel typefaces are available. Terminal protocols to control the buffer are standard features.

OCTET 121 communication is achieved by simple cable connection or through an acoustic modem. Ideal for remote offices who would like to use the main office telex facilities. Prepare text at the remote office and transmit to main office to cut tape for forward transmission.

The OCTET 121 is a true KSR with all standard control sequences for operating system use. Ideal for the user who requires 'letter quality' print at all times. Use as a standard typewriter or telex prep. when not in KSR mode.



**OCTET 121** has many uses and can be installed very easily in your office.  
Call Duplex Communications Ltd. for more details. Telephone: Leire (0455) 209131 (Leicestershire)

© OCTET 121 is a trade mark of Duplex Communications

● Circle No. 180



# The heat is on

Micromouse maze enthusiasts all over the U.K. are counting down to this year's Euromicro Euromouse Contest. The lucky winners will be sponsored to compete in the European Finals at Haifa, Israel in September. John Billingsley reports.

THE MICE WILL BATTLE it out at the Computer Fair in London's Earls Court from April 23 to 25, 1982, after "limbering up" a week earlier at the London Computer Club's own Computer Fair in the theatre of the Polytechnic of North London.

The contest was originally modelled on the Micromouse Maze Contest, first devised by IEEE Spectrum, in which mice entered the maze at one corner and left by another. Simple-minded wall followers could find their way through.

The Euromicro Contest demanded more intelligence from the mice by setting the target at the middle of the maze so that a cunning arrangement of passageways would have the wall followers running in circles.

The maze consists of 16 by 16 squares and each mouse starts in the bottom left corner so that the location of the centre target is well defined. The 1980 maze was built to accommodate American micromice in the hope of tempting one or two of them across the Atlantic. Although a few registered for the contest, none arrived to compete.

In the 1980 maze the walls were supported between pegs inserted into holes in the base. Unfortunately the manufacturer bonded hardboard to the bottom of the chipboard, causing the whole base to warp slightly, which was enough to baffle one or two particularly fastidious mice.

## Honourable bunch

Mouse builders are on the whole an honourable bunch, and the judges have a relatively easy time. Nevertheless, there have been one or two points of contention in the past. When a mouse has a dazzling array of control buttons it is always possible that the handlers are pul-

ling a fast one by choosing a bias towards left or right-handedness, or by signalling "that last route wasn't bad, go flat out and don't try to improve it".

The starting procedure must therefore be written down before the beginning of the contest so that matters of strategy are left to the mouse, not to the handler.

Although it is not mentioned in the rules, the judges' job will be made much easier if a mouse announces its arrival at the centre either audibly or by simply flashing an LED. The mouse must not pollute or damage the maze — one or two mice have a reputation for hurling themselves against the maze walls, and this practice will be strongly discouraged.

## EUROMOUSE Maze Contest — British Heat, Earls Court, April 23 to 25 1982. Rules of competition.

### 1. Dimensions

The maze consists of 16 by 16 squares. The squares are based on a 7in./18cm. matrix. The walls of the maze are 0.5in/12mm. thick, and the passageways are thus 6.5in./16.5cm. wide. The walls are 2in./5cm. high, painted white with red tops. The target post at the centre, 1in./2.5cm. square, is 8in./20cm. high, and can be removed if desired. The starting square is at the 'bottom left' corner of the maze, and the mouse is initially orientated so that the target is diagonally to its right. The running surface is chipboard, sprayed with black paint.

### 2. Tolerances

Dimensions should not be assumed to be more accurate than five percent: the maze may be made up to metric or imperial dimensions, and quoted figures may be approximations (to five percent). Joins in the maze base will not involve steps of greater than 0.5mm. — possibly covered with tape. However, warping of the maze base during transport or storage may result in a change in gradient at a join of as much as 4°.

### 3. Contest rules

(a) Each mouse is allowed a maximum total of 15 minutes to perform. The judges have the discretion to request a mouse to retire early if by its lack of progress it has become boring, or if by erratic behaviour it is endangering the state of the maze.

(b) If the mouse can succeed in finding its way from the start to the maze centre, the time is noted. The handlers can then restart the mouse, so that it can profit from any learning ability in making a second run. Within the 15-minute limitation any

number of runs can be made, and the mouse is credited with the shortest time of a successful run.

(c) If a mouse "gets into trouble", the handlers can ask the judges for permission to abandon the run and restart the mouse at the beginning. If any other handling occurs, the judges may impose an appropriate time penalty, and a mouse which has been so handled will be beaten by any other mouse which has reached the centre without handling. A mouse may not be restarted merely because it has taken a wrong turning — the judges decision is final. The judges may add a time penalty for a restart.

(d) Within reason, and at the judges' discretion, battery changes and minor repairs may be made — however the 15-minute timer must continue running.

(e) If no successful run has been made, the judges will make a qualitative assessment of the mouse's performance, based on distance achieved, "purposefulness" versus random behaviour and quality of control.

(f) If a mouse elects to retire before three minutes have elapsed, the judges may at their discretion permit it to perform again, with a 10-minute limit, later in the contest.

(g) The judges will use their discretion to award the prizes, which in addition to the major prize may include prizes for specific classes of mouse — perhaps lowest cost, most ingenious, best presented, etc.

(h) Before the maze is unveiled the mice must be accepted and caged by the contest officials. The handlers will place the mice at the start under the officials' instructions.

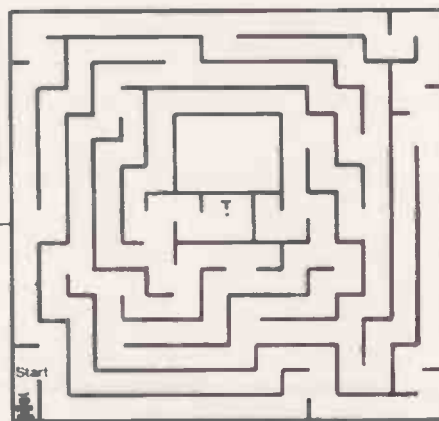

Sample competition maze.

(i) Although the superstructure of the mice may "bulge" above the top of the maze walls, mice must be subject to the following size constraints — width 25cm., length 25cm. There is no height limit but beware of toppling! Mice must be completely self-contained and must receive no outside assistance. The method of wall sensing is at the discretion of the builder, however, the mouse must not exert a force on any wall likely to cause damage. The method of propulsion is at the discretion of the builder provided that the power source is non-polluting — internal-combustion engines would probably be disqualified on this count. If the judges consider that a mouse has a high risk of damaging or sullyng the maze they will not permit it to run. Nothing may be deposited in the maze. The mouse must negotiate the maze; it must not step over or otherwise illegally cross any maze wall. The means of locomotion of the mouse is again at the discretion of the designer.

### 4. Virtuoso Display

Mice have 10 minutes to display their abilities. Their dimensions must be such that they could run in the maze. Their performance must be limited in travelling range to be accommodated either within the maze, or on an eight foot (2.4 metre) square surface of hardboard. Handling will be discouraged.

The Micromouse Maze Contest was first held in the U.S. by IEEE Spectrum.

# Crossing the hexagons

by Tony Roberts

**Clues**

Across →

1. Square.
3. Cube.
4. See 7U.
5. Square.
6. Twenty more than the sum of all the three-figure numbers, 5U and 2D.

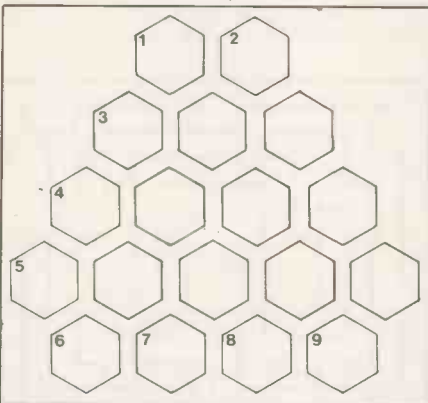

Up ↓

5. Same digits as 2D but in a different order.
6. See note below.
7. Sum of three times the total of all two-digit numbers, the total of all the three-digit numbers, 3D, 4A, and half 9U.
8. Cube.
9. Square.

Down ↓

1. See note.
2. See 5U.
3. See 7U.
4. Cube.
5. Square.

Notes

- 2-digit numbers are consecutive squares.
- 3-digit numbers are consecutive cubes.
- 5-digit numbers are each made up of digits sharing a common total.

**Solution to February puzzle**

Remember the numerical bees? They managed to fill that honeycomb after all — even without the hive's new Bee Bee Cee computer, which really is due for delivery any day now.

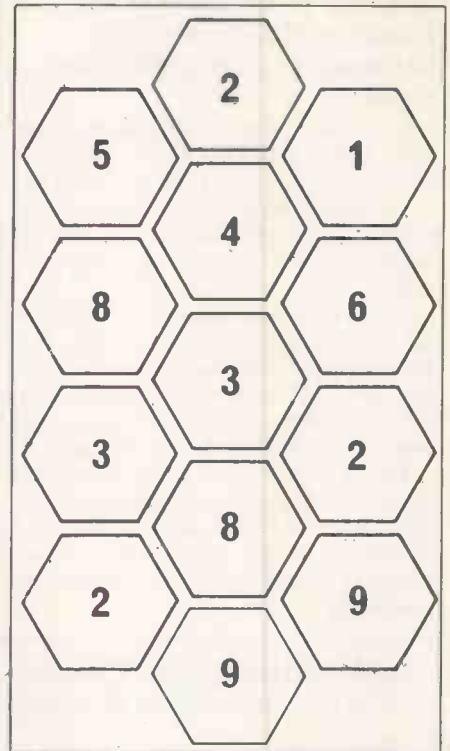

## Mailing Floppy Disks?

Use Swan Disk Mailers — and get Safety in the Mail

Now used by over 1,000 computer companies, Swan Disk Mailers provide outstanding postal security at economical prices.

Combining great strength with simplicity of use, Swan Disk Mailers are manufactured from rigid white corrugated, holding up to four disks.

There are two sizes available: 8.75" x 8.75" & 6" x 6"



ring  
01-607 9938  
for Free samples  
and prices

● Circle No. 181

## MACHINE LANGUAGE MADE SIMPLE ZX80 AND ZX81

This new book is a must for any **SINCLAIR** user who wants to make full use of his **SINCLAIR ZX80** and **ZX81**. Go beyond Basic into the world of **MACHINE LANGUAGE PROGRAMMING** and open computer horizons you never thought possible! Learn how to use the **SINCLAIR** computer's own language and finally find out what PEEK and POKE is all about!

**MORE COMPUTING POWER IN LESS SPACE! FASTER RUNNING PROGRAMS!**

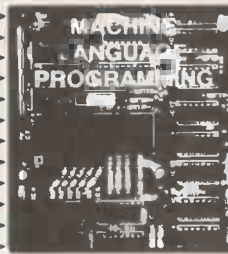

Written for the complete beginner as well as for the experienced **SINCLAIR** user, **MACHINE LANGUAGE MADE SIMPLE** has over 120 pages packed with programming techniques, hints and tips.

**WRITE YOUR OWN MACHINE LANGUAGE PROGRAMS...**

\* USEFUL BASIC PROGRAM TO EDIT MACHINE LANGUAGE \* COMPLETE DESCRIPTION OF THE INSTRUCTIONS GROUPED BY SUBJECT AND BY USEFULNESS \* NUMEROUS SAMPLE MACHINE LANGUAGE ROUTINES DESIGNED SPECIFICALLY FOR THE SINCLAIR 80 & 81 \* SIMPLE EASY TO USE LOOK UP TABLES.

**£8.95 (plus 50P p&p)**

Please send me ..... copies **MACHINE LANGUAGE MADE SIMPLE FOR YOUR ZX80 & ZX81.**

Orders to: Melbourne House Publishers, 131 Trafalgar Rd, London SE10  
Correspondence: Glebe Cottage, Glebe House, Station Rd, Cheddington, Leighton Buzzard, Bedfordshire LU7.

Please enclose cheque or P.O. for £9.45 per copy. Orders outside the UK £9.95.

NAME .....  
ADDRESS ..... PC4/82

● Circle No. 182



# DO NOT ADJUST YOUR SET!

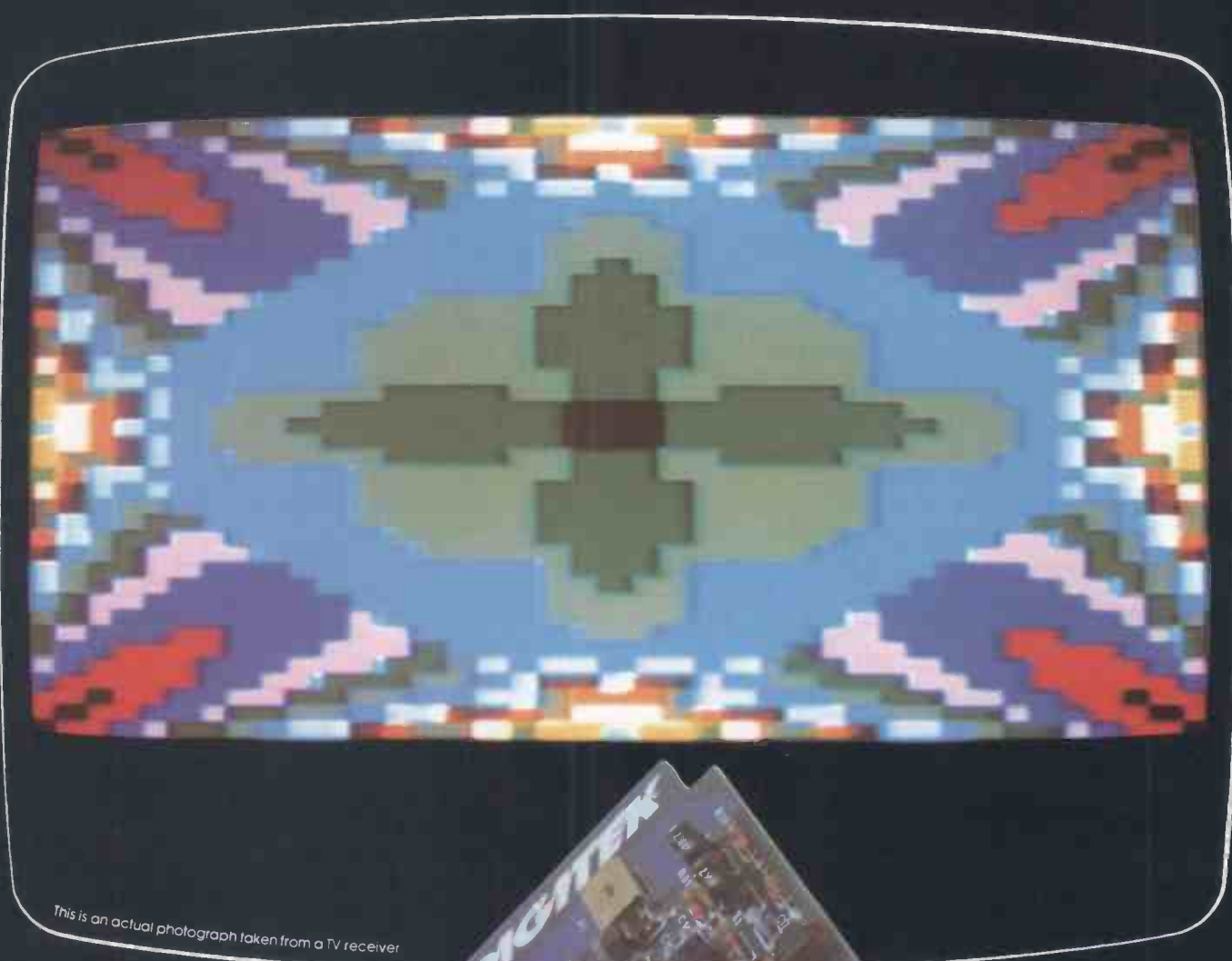

This is an actual photograph taken from a TV receiver

## That's the colour of the Digitek PAL Encoder Card for APPLE II computers.

Featuring an on-board UHF modulator and the unique Digitek 'Safety Tab' for sure, easy handling.

This principal member of the Digitek range of Apple expander cards not only gives the best quality PAL version of the Apple's colour graphics capabilities, but is also simplicity itself to install.

One plug-in card is all it takes to transform your dull display into a techni-colour masterpiece.

Also in the Expander Range are a 16k Ramcard, Z80 Expansion card, High speed serial interface, and more!

Send in the coupon for details and your nearest stockist.



# DIGITEK

EXPANDER CARD SERIES

The people who are really into Apples.

Please send me further details on your range of Apple Computer Expander Cards.

Name \_\_\_\_\_  
Address \_\_\_\_\_  
Post Code \_\_\_\_\_

Digitek International Ltd., Unit 14, Grafton Place, Dukes Park Industrial Estate, Chelmsford, Essex, England

# Make the most of your Sinclair ZX Computer... Sinclair ZX software on cassette. £3.<sup>95</sup> per cassette.



The unprecedented popularity of the ZX Series of Sinclair Personal Computers has generated a large volume of programs written by users.

Sinclair has undertaken to publish the most elegant of these on pre-recorded cassettes. Each program is carefully vetted for interest and quality, and then grouped with other programs to form a single-subject cassette.

Each cassette costs £3.95 (including VAT and p&p) and comes complete with full instructions.

Although primarily designed for the Sinclair ZX81, many of the cassettes are suitable for running on a Sinclair ZX80 - if fitted with a replacement 8K BASIC ROM.

Some of the more elaborate programs can be run only on a Sinclair ZX Personal Computer augmented by a 16K-byte add-on RAM pack.

This RAM pack and the replacement ROM are described below. And the description of each cassette makes it clear what hardware is required.

## 8K BASIC ROM

The 8K BASIC ROM used in the ZX81 is available to ZX80 owners as a drop-in replacement chip. With the exception of animated graphics, all the advanced features of the ZX81 are now available on a ZX80 - including the ability to run much of the Sinclair ZX Software.

The ROM chip comes with a new keyboard template, which can be overlaid on the existing keyboard in minutes, and a new operating manual.

## 16K-BYTE RAM pack

The 16K-byte RAM pack provides 16-times more memory in one complete module. Compatible with the ZX81 and the ZX80, it can be used for program storage or as a database.

The RAM pack simply plugs into the existing expansion port on the rear of a Sinclair ZX Personal Computer.



## Cassette 1 - Games

For ZX81 (and ZX80 with 8K BASIC ROM)

**ORBIT** - your space craft's mission is to pick up a very valuable cargo that's in orbit around a star.

**SNIPER** - you're surrounded by 40 of the enemy. How quickly can you spot and shoot them when they appear?

**METEORS** - your starship is cruising through space when you meet a meteor storm. How long can you dodge the deadly danger?

**LIFE** - J.H. Conway's 'Game of Life' has achieved tremendous popularity in the computing world. Study the life, death and evolution patterns of cells.

**WOLFPACK** - your naval destroyer is on a submarine hunt. The depth charges are armed, but must be fired with precision.

**GOLF** - what's your handicap? It's a tricky course but you control the strength of your shots.

## Cassette 2 - Junior Education: 7-11-year-olds

For ZX81 with 16K RAM pack

**CRASH** - simple addition - with the added attraction of a car crash if you get it wrong.

**MULTIPLY** - long multiplication with five levels of difficulty. If the answer's wrong - the solution is explained.

**TRAIN** - multiplication tests against the computer. The winner's train reaches the station first.

**FRACTIONS** - fractions explained at three levels of difficulty. A ten-question test completes the program.

**ADDSUB** - addition and subtraction with three levels of difficulty. Again, wrong answers are followed by an explanation.

**DIVISION** - with five levels of difficulty. Mistakes are explained graphically, and a running score is displayed.

**SPELLING** - up to 500 words over five levels of difficulty. You can even change the words yourself.

## Cassette 3 - Business and Household

For ZX81 (and ZX80 with 8K BASIC ROM) with 16K RAM pack

**TELEPHONE** - set up your own computerised telephone directory and address book. Changes, additions and deletions of up to 50 entries are easy.

**NOTE PAD** - a powerful, easy-to-run system for storing and

retrieving everyday information. Use it as a diary, a catalogue, a reminder system, or a directory.

**BANK ACCOUNT** - a sophisticated financial recording system with comprehensive documentation. Use it at home to keep track of 'where the money goes,' and at work for expenses, departmental budgets, etc.

## Cassette 4 - Games

For ZX81 (and ZX80 with 8K BASIC ROM) and 16K RAM pack

**LUNAR LANDING** - bring the lunar module down from orbit to a soft landing. You control attitude and orbital direction - but watch the fuel gauge! The screen displays your flight status - digitally and graphically.

**TWENTYONE** - a dice version of Blackjack.

**COMBAT** - you're on a suicide space mission. You have only 12 missiles but the aliens have unlimited strength. Can you take 12 of them with you?

**SUBSTRIKE** - on patrol, your frigate detects a pack of 10 enemy subs. Can you depth-charge them before they torpedo you?

**CODEBREAKER** - the computer thinks of a 4-digit number which you have to guess in up to 10 tries. The logical approach is best!

**MAYDAY** - in answer to a distress call, you've narrowed down the search area to 343 cubic kilometers of deep space. Can you find the astronaut before his life-support system fails in 10 hours time?

## Cassette 5 - Junior Education: 9-11-year-olds

For ZX81 (and ZX80 with 8K BASIC ROM)

**MATHS** - tests arithmetic with three levels of difficulty, and gives your score out of 10.

**BALANCE** - tests understanding of levers/fulcrum theory with a series of graphic examples.

**VOLUMES** - 'yes' or 'no' answers from the computer to a series of cube volume calculations.

**AVERAGES** - what's the average height of your class? The average shoe size of your family? The average pocket money of your friends? The computer plots a bar chart, and distinguishes MEAN from MEDIAN.

**BASES** - convert from decimal (base 10) to other bases of your choice in the range 2 to 9.

**TEMP** - Volumes, temperatures - and their combinations.

## How to order

Simply use the order form below, and either enclose a cheque or give us the number of your Access, Barclaycard or Trustcard account. Please allow 28 days for delivery. 14-day money-back option.

# sinclair ZX SOFTWARE

Sinclair Research Ltd,  
6 Kings Parade, Cambridge,  
Cams., CB2 1SN. Tel: 0276 66104.

To: Sinclair Research, FREEPOST, Camberley, Surrey, GU15 3BR. Please print  
Please send me the items I have indicated below.

Qty	Code	Item	Item price	Total
	21	Cassette 1 - Games	£3.95	
	22	Cassette 2 - Junior Education	£3.95	
	23	Cassette 3 - Business and Household	£3.95	
	24	Cassette 4 - Games	£3.95	
	25	Cassette 5 - Junior Education	£3.95	
17		*8K BASIC ROM for ZX80	£19.95	
18		*16K RAM pack for ZX81 and ZX80	£49.95	
		*Post and packing (if applicable)	£2.95	
			Total £	

\*Please add £2.95 to total order value only if ordering ROM and/or RAM.

I enclose a cheque/PO to Sinclair Research Ltd for £

Please charge my Access\*/Barclaycard/Trustcard no.

\*Please delete as applicable.

Name: Mr/Mrs/Miss

Address:

PRC04



NOW YOU HAVE AN  
APPLE MICROCOMPUTER  
YOU'LL NEED

# OMNIS<sup>®</sup>



All you've ever wished for in an  
information management  
system.

OMNIS sets new standards in database programs and levels of performance that you never believed were possible on a microcomputer.

- **OMNIS** is written in UCSD Pascal+, this means a better structured, faster running set of programs than could ever be possible using Basic — We believe that UCSD Pascal+ is the best microcomputer language available — OMNIS proves it —
- **OMNIS** is structured around powerful file handling modules. These modules give you the flexibility to store and retrieve your information in the way that you want. Full multi-key indexed access is available to all your database files, you say what you want — OMNIS does the rest.
- **OMNIS** provides you with a versatile report generating module that enables you to define your own reports, lists, mailing labels etc.
- **OMNIS** has unparalleled search facilities to allow you to be selective. Those hours of fruitless searching through rows of card indexes becomes a thing of the past.
- **OMNIS** lets you design your own screen layouts for data entry and inspection — you may have up to 10 screens per file.

OMNIS has an application waiting for it in every business, school and laboratory and workshop. Wherever information needs to be stored and retrieved. OMNIS is available for both APPLE II and APPLE III. We can also supply OMNIS for use on APPLE microcomputer networks (yes, with true multi-user record locking). Trade enquiries welcome.

All registered users of OMNIS will be sent **FREE BACKUP** disc and you will be kept informed of all updates and upgrades. Free help will be given to all registered users via an OMNIS hotline.

OMNIS — All you ever wanted

**APPLE II\* version - £174.00 (incl VAT & pp)**

**APPLE III\* version - £225.75 (incl VAT & pp)**

BLYTH COMPUTERS LIMITED  
Wenhaston, Halesworth, Suffolk  
IP19 9DH

 **050 270 565**

**24 hour phone service**

\*trademarks of APPLE Computer Inc  
+ trademark of the Regents of the University of California, San Diego



® Registered Trade Mark

To: Blyth Computers Ltd., Wenhaston, Halesworth, Suffolk IP19 9DH

PLEASE SEND ME  APPLE II VERSION  APPLE III VERSION

Cheque enclosed or please charge my Access/Barclaycard no.

\*Diners as appropriate

Name

Address

Tel. No

PC 4

● Circle No. 185

## RAM BARGAINS

4116-200ns.	80p each
100+	68p each
2114-200ns.	85p each
100+	75p each
2114-450ns.	80p each
100+	70p each
2716 Single +5V	£2.20 each
50+	£2.00 each
2532-450ns.	£4.20 each
50+	£4.00 each
8080A	£1.90 each
8212	£1.40 each

Other IC's available.  
Add 50p P&P + VAT at 15%.

## ATHANA FLOPPIES

Minis with free plastic library case + Hub rings		
S/S-S/D		£17.95 for 10
D/S-D/D		£23.50 for 10
S/S-Quad D		£26.50 for 10
8" discs.		
S/S-S/D		£15.50 for 10
S/S D/D		£24.50 for 10
D/S-D/D		£25.50 for 10

All other disks available.  
Add 85p P&P + VAT at 15%.

## 24-HOUR TELEPHONE SERVICE FOR CREDIT CARD USERS

QUANTITY DISCOUNTS AVAILABLE — OFFICIAL ORDERS WELCOME

## OPUS SUPPLIES

Access **10 BECKENHAM GROVE, SHORTLANDS, KENT.** 

● Circle No. 186

## TOTTLEBANK

MICROCOMPUTING COURSES

"... microcomputing ..."

- what's it all about?
- good for your business?
- wish to keep up with the kids?
- want to be better-informed?
- ... etc.

Come on a 1-week residential course for BEGINNERS in a peaceful Lake District setting

**Peter Gardner,**  
Tottlebank, Blawith,  
Near Ulverston,  
Cumbria, LA12 8EN.  
Tel: Lowick Bridge 660  
(Code 022 985)

● Circle No. 187

## TRS-80 COLOR COMPUTER

### "C.C. WRITER" A WORK PROCESSOR FOR YOU

"C.C. IS E.C." Designed from scratch to be easy to use this powerful program complete with a superb instruction manual is just what the user wants! No experience needed here and no short cuts either! Features include: A CLEAR MENU, INSERT, DELETE, MOVE, SAVE, LOAD, CHAIN, PAUSE (insert single sheet of paper), FORM FEED, DOUBLE SPACE, PAGE HEADER, PAGE NO, JUSTIFY (right margin), SET LEFT MARGIN, SET LINE LENGTH, SET PAGE LENGTH, SET PARAGRAPH INDENTATION, SET FIRST LINE POSITION (new page, PLUS, FORCE (new page), CENTRE, SKIP (a no of lines) INDENT (both margins), NEW LINE, SEND (ASCII codes to printer), if that's not enough then try the LINE SEEKER or the GLOBAL EDIT features. "C.C. WRITER" will drive any printer that can be connected to the COLOR COMPUTER. Every one of these useful features is well documented and explained in the manual supplied with "C.C. WRITER". If you're not convinced then the MANUAL is available separately at £6.00. REFUNDABLE on purchase of the program: "C.C. WRITER" is written in EXTENDED BASIC and will run in 16 or 32k. Priced at £29.95 it represents good value for money. If you order NOW we will pay the VAT and postage. PAYMENT with order please to the sole U.K. distributors

DEPT CC, WORK FORCE  
140 WILSDEN AVE  
LUTON, BEDS LU1 5HR

● Circle No. 188

# Pet holds the purse-strings

The idea of writing your own business software should not necessarily fill you with trepidation. Roger Valentine and John Hartopp turned their hands to the task and created a complete payroll suite, which they present here.

IN A CHOICE likened by many to re-inventing the wheel, we decided at the outset that we would write all our own business software. As a bureau offering professional services, we needed a program which could handle a large number of clients with diverse problems. More importantly, we were not at all impressed by the programs available on cassette from software suppliers.

## The rest is free

After much shopping around and budget-stretching we had decided to buy a 32K Pet, a Commodore printer and a cassette unit. With the advent of inexpensive micros such as the Vic, it becomes increasingly likely that many more small, low-budget companies will consider taking a tentative step towards computerisation.

Cheap and effective business software is therefore a must. If you buy a computer just to run this program, you can produce a year's payroll for under £20 a week, which is about what we would charge our clients. The advantage of doing it yourself is that you have the computer for other jobs too and subsequent payrolls cost you nothing.

Anyone opting to write their own A sample pay-slip.

NAME	D. BROWN	
PAY. NO.	5	
INS. NO.	LT 62 66 60 B	
TAX CODE	175T	
WEEK NO.	35	
W/E	05.12.81	
PAY - NORMAL TIME	30.00	
OVERTIME (1)	1.88	
OVERTIME (2)	20.00	
SICK PAY	10.00	
HOLIDAY PAY	10.00	
BONUS/ADJUSTMENT	25.00	
GROSS PAY	96.88	
TAX	18.90	
N.I.	7.50	
ADJUSTMENT	.30	
TOTAL DEDUCTIONS	26.70	
NET PAYABLE	70.18	
GROSS PAY TO DATE	1296.88	
TAX TO DATE	33.60	



payroll program from scratch should start by obtaining the specifications laid down by the Inland Revenue and the Department of Health and Social Security for computerised payroll routines. They are extremely complex, but you must follow them to the letter.

It is simple to write a program which is technically more accurate than the manual tax and national-insurance tables, but unfortunately this is not what is required. The manual tables incorporate a number of roundings and approximations designed to make life simple for the non-computer user, so a computer routine must use the same approximations as would a manual system.

Although the variety of tax codes that you are actually likely to encounter in practice is rather limited, there are three different types of code, all of which must be catered for:

Numeric codes with suffix are by far the most common, and many employers could probably manage with a program which covers these alone. They present no real problem, except that, because manual tables only go up to code 360, a special routine must be included to cover higher codes; otherwise the computer's results will be "too accurate".

Numeric codes with prefix are rather rare, D and F prefixes do sometimes occur, and each requires a separate routine.

The non-numeric codes are NT, BR, and OT. NT means no tax is deducted and usually — but not always — that no tax should be refunded. BR means that the whole of the pay is taxed at the basic rate, and is not the same as OT, which means that the whole of the pay is taxed, but at whichever rate is normally applicable. Note that though OT is really a normal suffix code, it may be read as "OT", so it is safer if your program accepts it as a valid non-numeric code.

All the above code types may be either Week 1 or cumulative. Anyone who operates a payroll, or who has ever paid





EMPLOYEE PAY SUMMARY - WEEK NO. 35 W/E 05.12.81					
NAME	GROSS	TAX	N.I. (EE)	N.I. (ER)	N.I. (TOT)
N. CLARK	100.00	2.10	7.77	13.73	21.50
B. BROWN	96.88	18.90	7.50	13.25	20.75
MS. J. BROWN	.00	.00	.00	.00	.00
<b>TOTAL</b>	<b>196.88</b>	<b>21.00</b>	<b>15.27</b>	<b>26.98</b>	<b>42.25</b>

The tabulated printout of an employee's pay summary.

too much tax, will be familiar with what this means. D codes are never cumulative; F codes may very rarely be. Fortunately, special Week-1 tables, W1, are no longer in use, so Week 1 codes can be treated exactly the same as the others, but on a non-cumulative basis. There are six different NI rates, a to f, but since this program is designed only for not-contracted-out employers, it uses only rates a, b, and c.

The program requires about 22K, most of which is taken up by the employee arrays. A 32K machine will hold data for more than the 100 employees, but we have chosen that number to allow ample room for modifications to the program.

The screen display is for a 40-column Pet. The 3 cursor right; \*, 3 cursor left routine which appears first in line 210 is a standard Pet trick to avoid crashing the program with Return. There are no Peeks, Pokes or other machine-dependent features, but you must be able to use massive two-dimensional arrays which may be difficult on old-ROM Pets. In the program all arrays have been dimensioned even though this is not essential on a Pet. Val should return zero for a non-numeric string otherwise some of the validation routines must be modified.

### Special formats

The printer formatting should be adjusted for your particular printer. Most of the formatting — subroutine 7500 in program 1; 9500 in program 2 — is conventional, but for the weekly summary in lines 12000 to 14300 of program 2 we have cheated by using the Pet printer's own formatting facilities. These involve using a template, defined by the row of 9s and As in lines 13060 and 14070.

The Pet defines device number 3 as the screen, and 4 as the printer. We have used this to copy information directly from screen to printer, but you may have a Copy facility to do this even more simply.

Variables used in the program are listed in table 1, and the arrays are listed at the end of program 1. This is more than just a service to the user: the Pet's chaining facility is dependent on the second program being shorter than the first. Rather than adjust the various pointers at addresses 44 to 49 to make program 1 artificially long, we have simply extended the listing. For that reason, Pet users should not omit the Rems or lines 12000

on words, unless they are adding a routine of equivalent length.

The most interesting feature of program 1 is subroutine 6000 which searches for an employee by name, or by part of a name. For example, "Smith" will find A Smith, Smith A., B. Smithson, etc. If all names have initials with at least one full stop, "." will find them all. Otherwise program 1 is a standard database routine.

Program 2 opens with a long list of tax and NI parameters, most of which should be instantly recognisable to payroll users. All the data which is likely to be amended in successive budgets is held here, so up-dating is easy. Line 6180 relates to the old W1 tables. It has been pushed out of the way with a Rem statement, rather than deleted, just in case it is needed again. GPTR, short for GPoint

(continued on next page)

Table 1.

All arrays used are listed at the end of program one.

T, Q, T\$, Q\$, AND T() are local variables which occur throughout the programs.

- N\$ Week number -->W
- D\$ Date of run
- DA\$ Date temporary
- CL\$ Company name
- NE\$ Number of employees -->NE
- Q1\$ Formatting string
- Q2\$ Formatting string
- T\$ Standard input to questionnaire (numeric)
- Q\$ Standard input to questionnaire (alphabetic)
- H\$ Standard input to payroll
- GP (also called GPTR) GPointer
- X Number of bandwidths
- Z Number of pay-slips to be printed — set to 1
- W Week number of run
- N Week number (temporary)
- NN Week number for tax
- NE Number of employees
- EN Employee number
- NI Employee's NI
- ER Employer's NI
- G Gross pay
- G1 Gross pay for tax
- GN Gross pay for NI
- B Band
- F Free pay
- TP Taxable pay
- TA Tax
- DV Logical device number
- O Obligatory print flag

K, L and M are loop-control variables  
 J is the main loop-control variable, which usually defines the employee being processed  
 Sample printouts  
 Listings

### VIC 20 domestic cassette interface

Why purchase a special cassette deck at twice the price when you may use our interface on your existing home cassette player? £19.55 inclusive of VAT plus £1.50 p&p.

VIC 20 3K, 8K and 16K RAM expansion packs at £24.50, £40.25 and £63.25 respectively, including VAT plus £1.50 p&p each.

The 3K attaches to the enhanced 16K RAM pack costing £74.75 to give 19K RAM.

The 8K RAM pack may easily be expanded to the 16K by the simple insertion of additional I.C.s, as the sockets are provided on board in the price. £5.75 for each 2K.

Battery RAM backup is available. All contained in neat specially designed cases.

CEL Customised Electronics Limited,  
 Winker Green Mills, Stanningley Road, Armley, Leeds,  
 LS12 3BB. Telephone 0532 782332.  
 155 Marton Road, Middlesbrough, Cleveland, TS4 2EN.  
 Telephone 0642 247727.

● Circle No. 189

### SEARCHING FOR 'BEST PRICE' ...

FOUND 'BEST PRICE' .. GOTO

PET		RRP	OUR PRICE
4016	16K	£550	£467
4032	32K	£695	£590
8032	32K	£895	£760
8096			£935
DISK DRIVES			
2031	170K	£395	£335
4040	343K	£695	£590
8050	1M	£895	£760
PRINTERS			
4022	80COL	£395	£335
8023	136COL	£895	£760
8026	DAISY	£995	£845

VAT to be added @15%

Carriage — £5 per item

If you know what you want why wait?  
 These are the prices you need

### ORCHARD COMPUTER SERVICES

Orchard House, 21 St. Martins St.,  
 Wallingford, Oxon.  
 Tel. Wallingford (0491) 35529  
 Open 6 days per week.



● Circle No. 190

## PET HI-RES

The new HR-40 board offers —

- 8k of its own RAM
- 64,000 individually addressable points
- 320 by 200 resolution
- machine code utility software in EPROM
- existing PET features unaffected
- easily fitted, no soldering necessary
- low price of £149 plus VAT

There's no limit to what you can do when you have the HR-40 board fitted to your PET. The single dot resolution allows you to draw smooth curves, accurate diagrams and much more. If you've got one of the new 4000 machines with a 12 inch screen then you'll need the HR-40B, but it won't cost a penny more.

The HR-80 board for the 8032 is now available at the same low price.

SUPERSOFT are PET/CBM software specialists. Other top quality products include MIKRO, the assembler in a chip (£50) and SUPERCHIP, the biggest selling British chip (£45).

Our catalogue is available free to PET owners.

### SUPERSOFT

Dept P1, 10-14 Canning Road,  
 Wealdstone, Harrow, Middlesex.  
 Tel: 01-861 1166



● Circle No. 191

## SUPERBRAIN SOFTWARE (64K:DD OR QD)

(Available shortly on other CPM based machines)

### 'THE TYPING MASTER'

The tutor that puts you in a class of your own

1. Full documentation on disk.
2. Contains a full typing course.
3. 'Sight & Type' facility for easy keyboard introduction.
4. 'Touch-typing' facility to increase speed.
5. A total of 29 multi-line Practice exercises for use in Non-timed or Timed modes.
6. Built-in error-checking on all facilities.
7. Exercise print-outs (with results attached).

Designed by a typing instructor, written as a sophisticated package and offered at a realistic price.

**£35.00 (No Vat or postage to pay)**

Dealer enquiries welcome: Ask about the Business Version.

**Now a computer keyboard need not deter you**

Please send cash with order, stating DD or QD to: ANTHONY ASHPITEL, 56 LONDON ROAD, HARLESTON, NORFOLK, IP20 9BZ. (Tel. (0379) 852807).

● Circle No. 192

## COLOUR AND SOUND!



### 'SIMPLY FILE' RECORDS SYSTEM (DBMS).

Select by any key. Print alphabetic lists, mailing labels. Calculate, total, average columns. Fast, easy, robust and VERY versatile. DISK ONLY: £65

### 'SIMPLY WRITE' FAST WORK PROCESSOR

Some £300-£400 programs have no more facilities. Tape or disk, any printer, 40-80 column PET. Needs 16K. TAPE £40, DISK £45

### GOTTA PET? ADDA VIC!

High resolution graphics, programmable characters, colour and sound on your PET? All this PLUS a complete extra computer using your PET's drives, printer etc? Under £200 including VIC and our super PET-VIC LINK! (Available separately).

PRICES PLUS VAT BUT INCLUDING P&P. SEND FOR DETAILS, MORE UNUSUAL ITEMS. GET OUR FREE 'MICROMAIL' PET NEWSLETTERS.

SIMPLE SOFTWARE LTD.,  
15 Havelock Road,  
Brighton, Sussex BN1 6GL  
(0273) 504879



● Circle No. 193

## SHARP

*True and foremost*



Sharp MZ-80K, 48K

**£399. INC VAT**  
DISKS & PRINTER NOW AVAILABLE

## Cowlings

26 BELVOIR STREET

Tel: 553232  
LEICESTER

● Circle No. 194

## THE COMPANY

NAME	N. I.	TAX
A. SMITH	16.08	14.45
SMITH A. J.	278.85	217.15
TOM L. SMITHSON	97.50	32.70
R. JONES	42.88	27.85
A. N. OTHER	434.16	408.00
B. BLOGGS	429.00	327.00
N. CLARK	450.50	417.30
D. BROWN	214.45	14.70
MS. J. BROWN	171.57	239.10
TOTAL	2134.99	1698.25

Company tax and National Insurance details.

(continued from previous page)

ter, is a parameter used for BR and D codes. X is the number of bandwidths.

The heart of the program is in lines 5000 to 6320 and subroutine 8000 where the tax and NI calculations are performed. Line 6700 starts the routine for D codes, 6800 to 6850 for F codes. Subroutine 7000 is a tedious way of dealing with codes above 360, using one of the spare arrays. T() has been dimensioned to 10 — line 10 in program 1 and line 500 in program 2 — so will hold codes up to 3600. If you ever have to handle a code greater than this, simply re-dimension T().

### Copies required

Subroutine 8000 advances the week, e.g., for holiday pay in advance, and 8400 requests a date for such pay-slips. Only the current pay date is actually stored. Lines 9000 to 9260 print the pay-slips, first to the screen and then to the printer, using variable DV to decide which. Lines 10000 to 10140 update the employee data, and lines 10200 to 10205 update the weekly summary. Note that the period summary is not updated until lines 11500 to 11540.

Business programs should be able to make countless copies of everything. The routine at lines 16150 to 17000 in program 2 and option 7 in program 1 allow security copies of the data tape to be made at will. Similarly, all printouts can be duplicated. Only the number of pay-slips printed is not under the user's control; it is pre-defined by variable Z in line 900 of program 2, and we have set this to 1 so that you can race through the payroll in no time at all. If you do not use carbonised stationery you may set this to whatever you like.

Formatting is for either individual or continuous A5 pay-slips. They need not be pre-printed, but you will probably adjust the formatting to suit your own stationery. Note that the variable O is the obligatory print flag. Only the obligatory lines, for which O=1 will be printed unless there is actually an amount to print that, for example, those employees who are not paid overtime, holiday pay, etc.

need never know that they exist. On the other hand, if you have pre-printed stationery, or simply want all pay-slips to have the same format, set O permanently to 1.

Program 1 sets up and amends payroll data, and when you first start you will use option 1. All other options lead to the dead-end of asking for a data tape; though option 7 at least has the courtesy of returning you to the menu. Option 1 leads to a question-and-answer routine, where you are asked for two pages of data for each employee. At the end of each page you have the option of correcting that page or continuing.

There are three distinct classes of user:

- New companies setting up a payroll for the first time.
- Existing companies bringing in the computer payroll from Week 1 of a tax year.
- Existing companies bringing in the computer payroll at any other time in a tax year.

If you are in the first two categories, page two of the data questionnaire is easy. Users in the third category must be sure to transfer all their existing manual records on to the computer including data for employees who have already left, otherwise the program will not provide accurate end-of-year information.

The "paid to week" question is to prevent the inadvertent double-payment of employees who, for example, have already received holiday pay in advance. If therefore refers to the week number for which you have paid each employee. For new starters, enter 0, not the week shown on their P45, as double-payment by different employers is quite normal.

At the end of the questionnaire — as at the end of all options which allow you to change data — you may record a data tape, or return to the menu. Do not forget to record the tape later, of course, using Option 7.

Option 2 uses the same routine to add new employees. Option 3 deletes employees by reference to either their name or number. Note that "deleting" an employee does not involve destroying any data; the employee is merely flagged as having left, and is omitted from future payroll runs. Data for ex-employees can





be examined as easily as that for current employees.

Option 4 allows any employee's data to be examined, amended, or printed out, again by reference to name or number. You may amend any one of the 16 fields of data per employee. Any change to pay, tax, or NI, details will not be incorporated into the current-period summary, so fraudulent alterations will show up as unexplained imbalance at the period end. Key in 17 to exit from this mode or to examine next employee.

Option 5 prints out an up-to-date P35 listing. This is not just a year-end facility, but may be used at any time to check payroll controls you may be keeping.

Option 6 is used only rarely. It enables you to change certain suffix tax codes *en masse*, which will be necessary only on instructions from the tax office. Only codes L, H, P, and V may be changed in this way, as they are the only codes which will be covered by such a blanket instruction. Instructions of this kind are frequently issued after a budget.

### Play it safe

Option 7 allows you to record a data tape. Option 8 loads and runs the payroll program itself. You can use both programs without this option, but you will often find it necessary to make some last-minute data amendments just before the payroll run. You can run straight into option 8 without first recording any amendments — whether or not you do so is up to you. In general it is safer not to do this in case a major disaster in the payroll run forces you to start over again.

Program 2 asks first for the tax week and current pay date. It must be eight characters long so use DD.MM.YY If it has not been run from program 1 it will request your data tape.

Each current employee will then be

displayed in turn, together with a full menu if the employee has not yet been paid, or a very much abbreviated menu otherwise. Option 1 enables you to run quickly through the payroll in all simple cases. It will pay the employee the normal gross wage, and print a pay-slip immediately. Options 2 to 8 allow you to compile a pay-slip in the normal way, and Option 9 prints out the compiled pay-slip.

The pay-slip is first displayed on the screen. You may either key C to cancel it and return to make adjustments; or key P to print it out. Alternatively press R to record the pay details while skipping the printing, should you ever need to do this.

### Cassettes available

The other two options on the full menu, and the only two on the abbreviated menu, are W to advance the week — e.g., to pay holiday pay in advance — or X to skip to the next employee. On a full menu, use of option 9 on its own will result in the employee receiving no pay but possibly a tax refund. Option X will simply leave an employee off the current week's payroll, and he will receive any tax rebate which may be due when he is next paid.

At the end of the payroll run, print out the weekly summaries, period summary if required — it will be zeroed after printing, otherwise carried forward — and lastly record the data tape. The average run time for 100 employees is 45 minutes, or 25 minutes if Option 1 is applicable.

Copies of these programs are available on cassette for £5 for the two programs from: R G Valentine, c/o V&H Accountancy Services, 182c Kingston Road, Staines, Middlesex. Anyone using the programs, can receive free up-dates whenever tax or NI changes occur by sending a stamped, addressed envelope to the same address.

### Program 1.

```

1 REM ***** PAYROLL: TWO PROGRAMS BY R.G.VALENTINE: 1981 *****
4 GOTO10
5 PRINT"PRESS SPACE WHEN READY"
6 Q$="":GETQ$:IFQ$="":THEN$
7 RETURN
10 DIME(100,14),E$(100,3),P(6),T$(4),T(10)
20 X=5:GPTR=1:REM:SEE LINE 8325 & PROG 2
100 PRINT"*****V&H PAYROLL: SET-UP AND AMMENDMENTS"
101 PRINT"*****"
110 PRINT"NO 1: SET UP NEW PAYROLL"
120 PRINT"NO 2: ADD EMPLOYEE"
130 PRINT"NO 3: DELETE EMPLOYEE"
140 PRINT"NO 4: AMMEND/INSPECT EMPLOYEE DETAILS"
141 PRINT"NO 5: P35 LISTING"
142 PRINT"NO 6: 'BLANKET' TAX CODE CHANGES"
143 PRINT"NO 7: RECORD CHANGES"
144 PRINT"NO 8: RUN PAYROLL"
145 GOSUB5
150 IFQ$<"1"ORQ$>"8"THEN145
160 ONVAL(Q$)GOTO200,1000,2000,3000,7600,9000,3900,10000
200 PRINT"*****"
210 INPUT"COMPANY NAME *****":CL$
215 IFCL$="":THEN210
220 INPUT"NO. OF EMPLOYEES *****":NE$
225 IFNE$="":THENPRINT"TY":GOTO220
230 NE=VAL(NE$):IFNE>100ORNE<1THENNE$="":GOTO225
235 EN=1:GOSUB240:GOSUB3950:GOTO100
240 PRINT"ENTER DETAILS OF ALL CURRENT EMPLOYEES"
245 PRINT"AND EMPLOYEES WHO HAVE LEFT DURING THE"
250 PRINT"
255 PRINT"CURRENT TAX YEAR.":GOSUB5
260 FORJ=ENTONE
270 PRINT"EMPLOYEE NUMBER":J
280 INPUT"NAME *****":E$(J,1)
    
```

(continued on next page)

## ACORN ATOM

### PROGRAMMER'S TOOL-BOX

A packed 4K EPROM (fits Utility Socket)  
1200 BAUD CASS. OP. SYSTEM  
Visible Load & Save Routine  
PLUS  
\*TRACE(X) — controlled execution.  
\*STEP — single step execution.  
FIND — any string of chars. in program.  
VAR — list variables.  
LVAR — print variables.  
AUTO X,Y — automatic line numbering  
RENUMBER X,Y — any start, any step.  
DELETE X to Y — any range of line nos.  
HEX — HEX & ASCII dump  
IHEX — HEX dump in instruction format.  
(\*VIA chip required).  
PLUS Additional BASIC statements  
READ, DATA & RESTORE  
KEY X — scans keyboard-input to variable.  
INKEY SX — scans keyboard-input to string.  
IF... THEN... ELSE  
WHILE... ENDWHILE  
CURSOR X,Y — position cursor as required.  
ON ERROR  
BEEP X,Y — sound any duration, any pitch.  
ZERO — zeros all basic variables.  
POP — close out sub-routine.  
STOP — useful de-bugging instr.  
Real value at £24.50 + VAT & 25p P & P. Sae for details & cat.



### \* NASCOM MAGAZINE \* "MICRO-POWER"

1982 subscription 6 copies £5.95 Europe £9.80  
Other overseas £11.80 Issues 1-4 (1981) £3.95  
Europe £6.60 Other overseas £7.80



Send Sae for details & cat.  
PROGRAM POWER  
5 Wensley Road, Leeds LS7 2LX.  
Tel. (0532) 683186.

● Circle No. 195

## INSURE YOUR COMPUTER

Impact damage, Fire & Theft Insurance  
for your Computer, Equipment:

£1 to £1,500 cover ..... £8.00 p.a.  
£10 (excess) x/s  
£1,500 to £2,500 ..... £16.00 p.a.  
£15 x/s.

For details:  
KGI Insurance Brokers,  
6 Hagley Road, Stourbridge,  
West Midlands, DY8 1QG  
Tel (03843) 5333/2545

● Circle No. 196



## JOYSTICK

TAMARISK JOYSTICK  
£22.50 inclusive

GAME EXTENSION SOCKET  
£6.50 inclusive.

from TAMARISK DESIGN SERVICES  
290 Brooklands Rd, Manchester M23  
061-969 8729

● Circle No. 197



## MICROCOMPUTER ENGINEER

Self starter with drive and initiative, able to take considerable responsibility, required for a leading micro-computer company. Excellent salary and conditions and exceptional prospects for career advancement.

**GECAS MICROCOMPUTERS LIMITED**  
21-22 GREAT CASTLE STREET, LONDON W1N 7AA

TEL: 01-629 0220/1546, 01-493 4958

● Circle No. 198

## ZX81 16K Games & Business Cassettes

**NASTY INVADERS** £4.95  
Get them before your bosses get you!

**NASTY MOUNTAIN** £4.95

**VERY NASTY MOUNTAIN** £6.95  
Adventures on your way through the Mountain. If that's too easy, try the Very Nasty Game with its 16 Levels of Play.

**PETTY CASH/VAT** £10.00

Enter Date, Narrative and Gross Value of each Cash Purchase. Classifies into 20 Sub- and 13 Main-Headings and gives Gross, VAT, Net and Exempt Subtotals and Totals.

**VAT BOOK INPUTS** £12.00

As the Petty Cash/VAT Program but with the facility to add in your Non-Cash Items to give Inputs Bottom Line Totals.

- user program test facility
- prices include VAT and P&P

Cheques/P.O.s to:- GILTROLE LTD.,

DEPT. PC, P.O. BOX 50, RUGBY, WARKS. CV21 4DH

● Circle No. 199

## TRS-80 Compiler Work-Station

Model I and III, and Video Genie

Speed up your Basic Program Development

**EDIT** — Full-screen BASIC editor with floating cursor and auto repeat. 30 commands and functions let you find, change, insert, delete, replicate, copy, or move BASIC text at the character, string, line, or block level. Improved program visibility, fewer errors. £17.50

**EXEC** — Command-list processor. Speeds up and simplifies repetitive procedures such as power-up, file reorganisation. £9.50

Speed up your Basic Program Execution

**ACCEL2** — Compiler for Model I and III BASIC (disk and non-disk). Execution speed-ups of 20-30 times for integer operations, 5-7 times for string handling, less if I/O limited. Very easy to use. Professionals note: Full instructions for selling derived code on tape or disk. No royalties! Ask for more details. £39.95

**TSAVE** — Writes compiled code to SYSTEM tape. Makes core-image backups of any machine-language programs. £4.95

**southern software**

PO Box 39, Eastleigh, Hants, England, SO5 5WQ

● Circle No. 200

(continued from previous page)

```

285 IFE$(J,1)="*"THENPRINT"TT":GOTO280
290 INPUT"MN.1. NUMBER";E$(J,2)
295 IFE$(J,2)="*"THENPRINT"TT":GOTO290
300 INPUT"MTAX CODE";Q$
310 EN=J:GOSUB8300
320 IFQ$="*"THENPRINT"TT":GOTO300
335 E$(J,3)=Q$
340 INPUT"MWEEK 1 (Y/N)";Q$
350 IFQ$="Y"THENE(J,4)=1:GOTO370
360 IFQ$="N"THEN370
365 PRINT"TT":GOTO340
370 INPUT"MFOUNDS / HOUR";T$
375 IFT$="*"THENPRINT"TT":GOTO370
377 E(J,1)=VAL(T$)
380 INPUT"MNORMAL WEEKLY PAY";T$
385 IFT$="*"THENPRINT"TT":GOTO380
387 E(J,5)=VAL(T$)
390 INPUT"MN.1.RATE A/B/C";Q$
400 IFQ$="A"THENE(J,3)=1:GOTO420
405 IFQ$="B"THENE(J,3)=2:GOTO420
410 IFQ$="C"THENE(J,3)=3:GOTO420
415 PRINT"TT":GOTO390
420 PRINT"MPRESS C TO CANCEL : SPACE TO CONTINUE":GOSUB6
421 IFQ$="C"THEN270
425 INPUT"MGROSS PAY TO DATE";T$
426 IFT$="*"THEN425
427 E(J,7)=VAL(T$)
430 INPUT"MTAX TO DATE";T$
435 IFT$="*"THENPRINT"TT":GOTO430
436 E(J,8)=VAL(T$)
440 INPUT"MG.P.-PREV.EMPLOYMENT";T$
445 IFT$="*"THENPRINT"TT":GOTO440
446 E(J,11)=VAL(T$)
450 INPUT"MTAX -";T$
455 IFT$="*"THENPRINT"TT":GOTO450
456 E(J,12)=VAL(T$)
460 INPUT"MPRID TO WK.NO.(OR 0)";T$
465 IFT$="*"THENPRINT"TT":GOTO460
466 E(J,13)=VAL(T$)
470 INPUT"MN.1.(A)TO DATE(OR 0)";T$
475 IFT$="*"THENPRINT"TT":GOTO470
476 E(J,9)=VAL(T$)
480 INPUT"MN.1.(B)TO DATE(OR 0)";T$
481 IFT$="*"THENPRINT"TT":GOTO480
482 E(J,10)=VAL(T$)
485 INPUT"MN.1.(E)TO DATE(OR 0)";T$
486 IFT$="*"THENPRINT"TT":GOTO485
487 E(J,14)=VAL(T$)
490 INPUT"MHAS THIS EMPLOYEE ALREADY LEFT(Y/N)";Q$
495 IF Q$="Y"THENE(J,6)=0:GOTO500
496 IF Q$="N"THENE(J,6)=1:GOTO500
497 PRINT"TT":GOTO490
500 PRINT"MPRESS C TO CANCEL : SPACE TO CONTINUE":GOSUB6
501 IFQ$="C"THEN425
510 NEXTJ
515 RETURN
1000 IFCL$=""THENGOSUB5000
1010 NE=NE+1:IFNE>100THENNE=100:GOTO100
1015 EN=NE:GOSUB260
1020 PRINT"MMANY MORE?"
1030 GOSUB6
1040 IFQ$="Y"THEN1010
1050 IFQ$="N"THEN1070
1060 GOTO1030
1070 GOSUB3950:GOTO100
2000 IFCL$=""THENGOSUB5000
2005 PRINT"MMANY MORE?"
2010 INPUT"EMPLOYEE NUMBER (N=N/K)";T$
2020 IFT$="*"THENPRINT"TT":GOTO2010
2030 IFT$="N"THENGOSUB6000
2040 EN=VAL(T$):IFE(EN,3)=0THENT$="*":GOTO2020
2050 E(EN,6)=0
2060 PRINT"MMANY MORE?"
2070 GOSUB6
2080 IFQ$="Y"THEN2010
2090 IFQ$="N"THEN1070
2110 GOTO2070
3000 IFCL$=""THENGOSUB5000
3005 PRINT"MMANY MORE?"
3010 INPUT"EMPLOYEE NUMBER (N=N/K)";T$
3020 IFT$="*"THENPRINT"TT":GOTO3010
3030 IFT$="N"THENGOSUB6000
3040 EN=VAL(T$):IFE(EN,3)=0THENT$="*":GOTO3020
3050 GOSUB8000
3060 PRINT"MMANY MORE?"
3070 GOSUB6
3080 IFQ$="Y"THEN3010
3090 IFQ$="N"THEN1070
3110 GOTO3070
3900 IFCL$<>"*":GOTO3910
3905 PRINT"NO DATA TO RECORD":FORM=1TOS00:NEXTM:GOTO100
3910 GOSUB4000:GOTO100
3950 PRINT"MPRESS R TO RECORD"
3960 PRINT"MR M TO RETURN TO MENU"
3970 GOSUB6
3980 IFQ$="M"THENRETURN
3990 IFQ$<>"R"THEN3970
4000 PRINT"MR RECORD DATA TAPE"
4010 GOSUB5
4020 OPEN1,1,1

```





```

4030 PRINT"*****WRITING ";CL$
4040 PRINT#1,CL$
4050 PRINT#1,NE
4055 FORJ=1TO6:PRINT#1,P(J):NEXTJ
4060 FORJ=1TONE
4070 PRINT#1,E$(J,1)
4080 PRINT#1,E$(J,2)
4090 PRINT#1,E$(J,3)
4100 NEXTJ
4110 FORJ=1TONE
4115 FORK=1TO14
4120 PRINT#1,E(J,K)
4125 NEXTK
4130 NEXTJ
4140 CLOSE1
4150 RETURN
5000 PRINT"*****LOAD DATA TAPE"
5010 GOSUB5
5020 OPEN1,1,0
5030 INPUT#1,CL$
5040 PRINT"*****READING ";CL$
5050 INPUT#1,NE
5055 FORJ=1TO6:INPUT#1,P(J):NEXTJ
5060 FORJ=1TONE
5070 INPUT#1,E$(J,1)
5080 INPUT#1,E$(J,2)
5090 INPUT#1,E$(J,3)
5100 NEXTJ
5110 FORJ=1TONE
5115 FORK=1TO14
5120 INPUT#1,E(J,K)
5125 NEXTK
5130 NEXTJ
5140 CLOSE1
5150 RETURN
6000 PRINT"*****"
6010 INPUT"EMPLOYEE NAME *****";T$
6020 IFT$="*"THENPRINT"IT":GOTO6010
6030 FORJ=1TONE
6040 FORK=1TOLEN(E$(J,1))-LEN(T$)+1
6050 T=0:IFMID$(E$(J,1),K,LEN(T$))=T$THENGOSUB7000
6055 IFT=1THENG100
6060 NEXTK
6070 NEXTJ
6080 PRINT"*****NAME NOT FOUND":GOTO6010
6100 T$=STR$(J):RETURN
7000 PRINT"*****FOUND":E$(J,1)
7020 PRINT"IS THIS CORRECT?"
7030 GOSUB6
7040 IFO$="Y"THENF=1:RETURN
7050 IFO$="N"THENRETURN
7060 GOTO7030
7500 IFO<>E(EN,1)THENQ=INT(Q*100+.5)/100
7505 Q1$=STR$(Q)
7510 FORK=1TOLEN(Q1$):IFMID$(Q1$,K,1)="."THEN7540
7520 NEXTK
7530 Q1$=Q1$+"."00":GOTO7560
7540 K=LEN(Q1$)-K
7550 IFK=1THENQ1$=Q1$+"0"
7560 IFO=1THENPRINTQ$;Q1$
7570 RETURN
7600 IFCL$="*THENGOSUB5000
7602 PRINT"*****LISTING P35"
7604 OPEN4,4
7605 PRINT#4,CHR$(1)CL$
7606 PRINT#4
7608 PRINT#4," NAME N. I. TAX"
7609 PRINT#4
7610 L=0:M=0:FORJ=1TONE
7620 Q$=E$(J,1):Q=E(J,8):L=L+Q:GOSUB7500:Q2$=Q1$:Q=E(J,9)+E(J,10)+E(J,14):M=M+Q
7625 GOSUB7500
7630 GOSUB7700
7640 NEXTJ
7643 PRINT#4
7645 Q$="TOTAL":Q=L:GOSUB7500:Q2$=Q1$:Q=M:GOSUB7500:GOSUB7700
7650 CLOSE4
7660 GOTO100
7700 IFLen(Q$)<25THENQ$=Q$+" ":GOTO7700
7710 IFLen(Q1$)<10THENQ1$=" "+Q1$:GOTO7710
7720 IFLen(Q2$)<10THENQ2$=" "+Q2$:GOTO7720
7730 PRINT#4,LEFT$(Q$,20);Q1$;TAB(40-(20+LEN(Q1$)));Q2$
7740 RETURN
8000 IV=3:O=1:PRINT"IV";
8005 OPEN4,IV:CMD4
8010 PRINT"EMPLOYEE NUMBER ";EN
8015 PRINT" 1:NAME ";E$(EN,1)
8020 PRINT" 2:N. I. NO ";E$(EN,2)
8030 PRINT" 3:TAX CODE ";E$(EN,3)
8040 PRINT" 4:WK.1 ";IFE(EN,4)=0THENT$="NO"
8041 IFE(EN,4)=1THENT$="YES"
8045 PRINTT$
8050 Q$=" 5:PAY/HOUR ";Q=E(EN,1):GOSUB7500
8060 Q$=" 6:PAY/WEEK ";Q=E(EN,5):GOSUB7500
8070 PRINT" 7:NI RATE ";
8080 IFE(EN,3)=1THENT$="A"
8081 IFE(EN,3)=2THENT$="B"
8082 IFE(EN,3)=3THENT$="C"
8085 PRINTT$
8090 Q$=" 8:GP TO DATE ";Q=E(EN,7):GOSUB7500
8100 Q$=" 9:TAX TO DATE ";Q=E(EN,8):GOSUB7500
    
```

(continued on next page)

## MICROCASE

"turns a board into a real computer"  
**For NASCOM 2  
 COMPUKIT  
 SUPERBOARD  
 ALSO UNCUOT FOR NASCOM 1  
 ZX81 EXPANSIONS ETC.**  
 Direct from us or from your dealer —  
 but make sure you see a  
**GENUINE MICROCASE**

SIMPLE SOFTWARE LTD  
 15 HAVELOCK ROAD  
 BRIGHTON, SUSSEX BN1 6GL  
 (0273) 504879



● Circle No. 201

## NASCOM/SHARP MZ80K

Pascal for Nascoms and Sharp MZ80K  
 Hisoft offer a very fast 12K Pascal compiler producing  
 Z80 object code directly i.e. no P-code.  
 STATEMENTS: CASE .. OF, IF .. THEN .. ELSE,  
 REPEAT .. UNTIL, WHILE .. DO,  
 BEGIN .. END  
 TYPES: INTEGER, REAL (7 sig. figs.), CHAR,  
 BOOLEAN, ARRAY, SET, COLOUR.

Many standard procedures and functions are supported including trigonometric functions and all procedures and functions may be used fully recursively. The object programs run very fast and require only the runtime routines (4K) to be present.

Price: Nascom Pascal £35  
 Sharp MZ80K Pascal £37

**New Monitor for Nascoms**  
 NASMON is a new 4K monitor incorporating a powerful 'front panel' display of memory, registers and flags together with an extended screen editor. We supply a range of software to run under NASMON; BAS12K, a 12K BASIC Interpreter with 11 digit floating point arithmetic, NASGEN, a very fast Z80 assembler, NASNEM, a 2½K disassembler and NASPAS, the 12K Pascal compiler described above.

Prices: NASMON £30  
 NASGEN in EPROM £25  
 NASGEN on tape £15  
 BAS12K on tape £25  
 NASNEM in EPROM £15  
 NASNEM on tape £10

**Z80 Development Package for Gemini G805 Disk Owners**

The package comprises an extended screen editor, a fast Z80 assembler and a debugger with a 'front panel' mode and a Z80 disassembler. All supplied on one 5¼ inch diskette with full documentation. Price £50.

All prices are fully inclusive.  
 Full details may be obtained from:

### HISOFT

60 Hallam Moor, Liden, SWINDON, SN3 6LS.  
 Tel: Swindon 26616  
 (answering machine service).

● Circle No. 202

## ZX81 16K RAM EXPANSION PACK

Quite simply good value for money at £34.50 including VAT plus £1.50 P&P. Contained in a neat specially designed case.

Junior Maths Pack One to run on 1K RAM ZX81 — five helpful programmes on cassette for £5.75 inclusive. Logic, Sums, Nimb, Division and Money.

### CEL Customised Electronics Limited

Winker Green Mills, Stanningley Road, Armley, Leeds, LS12 3BB  
 — telephone 0532 792332.  
 155 Marton Road, Middlesbrough, Cleveland, TS4 2EN  
 — telephone 0642 247727.

VIC 20 — RAM Expansion Packs — see separate advertisement in this issue.

● Circle No. 203







```

12300 :P(3)=TOTAL N.I. FOR PERIOD
12310 :P(4)=EMPEE. N.I. FOR PERIOD
12320 :P(5)=EMPR. N.I. FOR PERIOD
12330 :P(6)=TOTAL N.I. & TAX FOR PERIOD
12340 :
12350 :ARRAYS C,K,R,N FOR TAX/N.I.DATA
12360 :
12370 :C( )=CUMULATIVE BANDWIDTHS
12380 :R( )=TAX RATES
12390 :K( )=CUMULATIVE ANNUAL TAXES
12400 :N(1)=N.I.RATE A
12410 :N(2)=N.I.RATE B
12420 :N(3)=N.I.RATE C
12430 :N(4)=N.I.RATE (EMPLOYER)
12440 :
12450 :ARRAYS T$,T,G FOR TEMPORARY STORAGE
READY.
    
```

### Program 2.

```

4 GOTO100
5 PRINT"PRESS SPACE WHEN READY"
6 Q$="":GETQ$:IFQ$=""THEN6
7 RETURN
100 REM: I.R. & D.H.S.S. DATA
110 X=5
115 DIMC(X),R(X+1),K(X),N(4)
120 C(1)=11250
121 C(2)=13250
122 C(3)=16750
123 C(4)=22250
124 C(5)=27750
130 R(1)=.3
131 R(2)=.4
132 R(3)=.45
133 R(4)=.5
134 R(5)=.55
135 R(6)=.6
140 K(1)=3375
141 K(2)=4175
142 K(3)=5750
143 K(4)=8500
144 K(5)=11525
150 GPTR=1
170 N(1)=.0775
171 N(2)=.0275
172 N(3)=0
173 N(4)=.137
180 NU=200
181 NL=27
490 DIMS(100,5),G(7)
495 IFCL$<" THEN900
500 DIME(100,14),E$(100,3),P(6),T(10)
900 Z=1:REM**NO. OF COPIES OF PAYSLIP**
1000 PRINT"*****PAYROLL
1001 PRINT"*****"
1005 GOSUB8500
1010 D$=DA$
1020 PRINT"D$"
1025 INPUT"ENTER WEEK NO *****";N$
1030 IFN$=""* THEN1025
1035 W=VAL(N$):IFW<10R>54THENN$=""*:GOTO1025
1037 IFCL$<" THEN1110
1040 PRINT"D$"
1045 PRINT"LOAD PAYROLL TAPE":GOSUBS
1050 OPEN1,1,0
1055 INPUT#1,CL$
1060 PRINT"*****LOADING *****";CL$
1065 INPUT#1,NE
1066 FORJ=1TO6:INPUT#1,P(J):NEXTJ
1070 FORJ=1TONE
1075 FOR K=1TO3
1080 INPUT#1,E$(J,K)
1085 NEXTK:NEXTJ
1086 FORJ=1TONE
1087 FORK=1TO14
1090 INPUT#1,E(J,K)
1095 NEXTK
1100 NEXTJ
1105 CLOSE1
1110 FORJ=1TONE
1111 IFE(J,6)=0THEN11000
1115 FORK=1TO7:G(K)=0:NEXT
1116 N=W
1120 PRINT"J";E$(J,1);
1121 PRINTTAB(30);"WEEK";N
1122 IFE(J,13)>NTHENPRINT"PAID TO WEEK";E(J,13):GOTO1165
1125 PRINT"01: PAY AS NORMAL"
1130 PRINT"02: HOURS WORKED"
1135 PRINT"03: OVERTIME AT TIME AND A HALF"
1140 PRINT"04: OVERTIME AT DOUBLE TIME"
1145 PRINT"05: SICK PAY (HOURS)
1150 PRINT"06: HOLIDAY PAY (HOURS)
    
```

(continued on next page)

## LOW PRICE — HIGH QUALITY SOFTWARE FOR COMMODORE PET

**PURCHASE AND SALES CONTROL £50 + VAT**

Runs purchase and sales ledgers with VAT typed in or calculated from either the gross or the net amount. Purchase and sales analysis by accounting period with totals for net, gross, VAT and 99 analysis codes. Due for payment report.

**INVOICE PRINT £50 + VAT**

Prints invoices on your own stationery, laid out according to your own instructions which you key in on the first run. This programme is an optional add-on to be used in conjunction with purchase and sales control.

**STOCK CONTROL £40 + VAT**

Keeps detailed stock record including stock location, recorder level, quantity on order, cost and selling prices and stock valuation.

**NOMINAL LEDGER £40 + VAT**

Produces trial balance and up to 20 reports in addition to profit and loss and balance sheet from up to 1000 nominal accounts. This programme is intended for use on its own, but it can read files set up by our purchase and sales control and stock control programmes.

### ELECTRONIC AIDS

(Tewkesbury)

Mythe Crest, The Mythe, Tewkesbury,

Glos. GL20 5EB

Phone: (0386) 831020 or (0684) 294003

● Circle No. 207



★ 14" DECCA COLOUR MONITORS ★  
INC. COLOURCARD FOR APPLE II  
LIMITED NUMBER AVAILABLE £295

Altos CP/M & MP/M Systems from £4,500  
Apple II Systems from £1,800  
Payroll program with Batch Input  
for CP/M & MP/M — £600

All enquiries to:

**ACTION COMPUTER SERVICES LIMITED**  
28 CHURCH HILL, LOUGHTON, ESSEX  
01-502 1311

All prices subject to VAT

● Circle No. 208

## PROGRAMMERS

— to take playing  
games seriously

If you have micro-programming experience, especially in 6502 Assembler and are interested in writing entertainment software,

Please ring

**MISS L. HOWIE**  
**PERSONNEL OFFICER**  
**THORN EMI VIDEO**  
**PROGRAMMES**

01-836 2444 Ext. 217 or 154.

● Circle No. 209

**RADEC**

## Professional Products for Practical People

### ASCII Keyboards

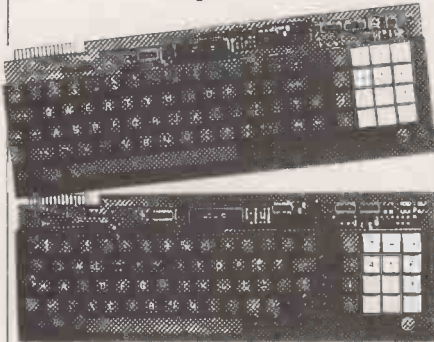

- Upper & Lower Case plus Control
- Low Power Consumption
- Shift & Alpha Lock
- Autorepeat (Model 777)
- Parallel Data Output
- Metal Mounting Frame
- Suitable for Tuscan, Tangerine etc.

Model KB756A	56 key	£39.50
KB710	Numeric Pad	£ 7.50
KB771	72 key	£55.00
KB777	77 key	£62.50

Accessories available include:-

Metal Case	£12.95
Edge Connector	£ 1.95
DC to DC Converter	£ 5.00

(for operation off single 5V supply)

## High Resolution Computer Monitor

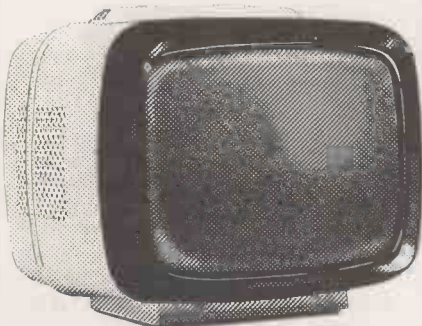

- 12" Green P31 Phosphor
  - 80 Character Line Capability
  - 22 MHz Video Bandwidth
  - 240V AC Input
  - Toroidal Transformer
  - Composite Video Input
  - Ideal for Apple, Gemini, Nascom, Tuscan etc.
- MODEL 101 £129.50

U.K. Orders add 15% VAT on order total  
Orders under £15 add £1.50 p&p. plus VAT  
Overseas orders add £2.50 p&p

FULL DATA SHEETS ON REQUEST

### Citadel Products Ltd

Dept. P.C. 50 High Street Edgware  
Middlesex HA8 7EP Tel:01-951 1848

● Circle No. 210

(continued from previous page)

```

1155 PRINT"07: BONUS PAY (POUNDS)
1160 PRINT"08: POST-TAX ADJUSTMENTS
1162 PRINT"09: NO MORE ENTRIES
1165 PRINT"0A: SKIP (NO PAY:NO REFUND)
1167 PRINT"0B: CHANGE WEEK
1170 GOSUB6:Q=VAL(Q$)+1
1171 IFQ$="X"THEN11000
1172 IFQ$="W"ANDQ<2000>10THEN1170
1175 ONQGOTO2000,1200,1210,1250,1300,1350,1400,1450,1550,5000
1200 G(1)=E(J,5):GOTO5000
1210 PRINT"01";E$(J,1);"0000"
1220 INPUT"02 HOURS";H$
1225 IFH$="*"THEN1220
1235 G(1)=INT(VAL(H$)*E(J,1)*100+.5)/100
1240 GOTO1120
1250 PRINT"01";E$(J,1);"0000"
1255 INPUT"03/T HOURS (1.5X)";H$
1260 IFH$="*"THEN1255
1270 G(2)=INT(VAL(H$)*E(J,1)*1.5*100+.5)/100
1275 GOTO1120
1300 PRINT"01";E$(J,1);"0000"
1305 INPUT"04/T HOURS (2X)";H$
1310 IFH$="*"THEN1305
1320 G(3)=INT(VAL(H$)*E(J,1)*2*100+.5)/100
1325 GOTO1120
1350 PRINT"01";E$(J,1);"0000"
1355 INPUT"05 SICK HOURS";H$
1360 IFH$="*"THEN1355
1370 G(4)=INT(VAL(H$)*E(J,1)*100+.5)/100
1375 GOTO1120
1400 PRINT"01";E$(J,1);"0000"
1405 INPUT"06 HOLIDAY HOURS";H$
1410 IFH$="*"THEN1405
1420 G(5)=INT(VAL(H$)*E(J,1)*100+.5)/100
1425 GOTO1120
1450 PRINT"01";E$(J,1);"0000"
1455 INPUT"07 BONUS PAYMENT";H$
1460 IFH$="*"THEN1455
1470 GOSUB1700
1475 G(6)=T
1480 GOTO1120
1550 PRINT"01";E$(J,1);"0000"
1560 PRINT"ADJUSTMENT IS NORMALLY A DEDUCTION"
1565 PRINT"08 USE LEADING MINUS SIGN FOR ADDITION"
1570 INPUT"09 AMOUNT OF ADJUSTMENT";H$
1575 IFH$="*"THEN1570
1580 GOSUB1700
1585 G(7)=T
1600 GOTO1120
1700 FORK=1TOLEN(H$)
1710 IFMID$(H$,K,1)=". "THEN1730
1720 NEXTK:GOTO1740
1730 H$=LEFT$(H$,K)+MID$(H$,K+1,2)
1740 T=VAL(H$):RETURN
2000 N=N+1:IFN>54THENN=1
2010 GOTO1120
5000 G=G(1)+G(2)+G(3)+G(4)+G(5)+G(6)
5010 G=INT(G*100+.5)/100
6000 NI=0:ER=0
6010 IFG<NLTHEN6100
6020 GN=NU
6030 IFG<NLTHENGN=INT(G*2)/2+.25
6040 IFG<NLTHENGN=NL
6050 NI=INT(GN*N(E(J,3))*100+.49)/100
6060 ER=INT(GN*N(4)*100+.49)/100
6100 IFLEFT$(E$(J,3),1)="D"THEN6700
6103 IFLEFT$(E$(J,3),1)="F"THEN6300
6105 T=E(J,2):IFT>360THENGOSUB7000:GOTO6120
6110 GOSUB8000
6120 G1=G+E(J,7):IFE(J,4)=1THENG1=G
6130 NN=N/52:IFE(J,4)=1THENNN=1/52
6140 IFF>61THENNTA=0:GOTO6310
6150 TP=INT((G1-F)*100+.0001)/100
6160 IFTP>INT((C(1)*NN+1)ANDT<>0)THEN6200
6170 TA=INT(TP)*R(1)
6180 REM:N/A 81:IFE(J,4)=1THENNTA=(INT(TP*4)/4)*R(1)
6190 GOTO6300
6200 B=1:FORK=2TOX
6210 IFTP>INT((C(K)*NN+1)THENB=K
6220 NEXTK
6230 TA=ABS((INT((C(B)*NN*10^4)/10^4)-INT(TP))
6240 TA=TA*R(B+1)
6250 TA=TA+(INT((C(B)*NN*10^4)/10^4)
6300 TA=INT(TA*20)/20
6310 IFE(J,4)=1THEN6500
6320 TA=INT((TA-E(J,8))*100+.5)/100
6500 PRINT"01":GOTO9000
6700 TA=INT(G)*R(GP+E(J,2)+1):GOTO6300
6800 TP=G
6810 IFE(J,4)=0THENTP=G+E(J,7)

```





```

6830 TP=INT(G*4)/4
6850 TA=TP*((E(J,2)/2)/100):GOTO6300
7000 L=INT(T/360)+1
7010 T(1)=INT(T/L):T(0)=0
7020 FORK=1TOL:T(K)=T(1):T(0)=T(0)+T(K):NEXTK
7030 IFT(0)=TTHEN7100
7040 FORK=1TOL
7050 T(K)=T(K)+1:T(0)=T(0)+1:IFT(0)=TTHEN7100
7060 NEXTK
7070 GOTO7040
7100 T(0)=0:FORM=1TOL
7110 T=T(M):GOSUB8000:T(0)=T(0)+F:NEXTM
7120 F=T(0):RETURN
8000 NN=N:IFE(J,4)=1THENNN=1
8005 F=NN*INT((INT(T*10+9)/52*10+4)/10+4+.049)*20)/20
8010 IFT<1THENF=0
8020 RETURN
8400 PRINT"PAYROLL TAX WEEK":N;"0000"
8500 INPUT"ENTER DATE (DDMMYY)":DA$
8510 IFDA$="*"THEN8500
8520 IFLEN(DA$)<>8THENDDA$="*":GOTO8510
8530 RETURN
9000 DA$=D$:IFN<D$THEN8000:PRINT"0"
9001 FORM=1TO2+1
9002 DV=3:IFM>1THENDV=4
9005 OPEN4,DV:IFDV=3THEN9030
9010 PRINT#4,CHR$(1)CL$
9020 PRINT#4
9030 PRINT#4,"NAME";E$(J,1)
9035 IFDV=3THEN9090
9037 PRINT#4,"PAY.NO. ";J
9040 PRINT#4,"INS.NO. ";E$(J,2)
9050 PRINT#4,"TAX CODE ";E$(J,3)
9055 PRINT#4
9060 PRINT#4,"WEEK NO. ";N
9070 PRINT#4,"W/E ";DA$
9075 PRINT#4
9080 PRINT#4
9090 Q=1:Q$="PAY - NORMAL TIME":Q=G(1):GOSUB9500
9100 Q=0:Q$="OVERTIME (1)":Q=G(2):GOSUB9500
9110 Q$="OVERTIME (2)":Q=G(3):GOSUB9500
9120 Q$="SICK PAY":Q=G(4):GOSUB9500
9130 Q$="HOLIDAY PAY":Q=G(5):GOSUB9500
9140 Q$="BONUS/ADJUSTMENT":Q=G(6):GOSUB9500
9145 PRINT#4
9150 Q=1:Q$="GROSS PAY":Q=G:GOSUB9500
9160 PRINT#4
9170 Q$="TAX":Q=TA:GOSUB9500
9180 Q$="N. I. ":Q=NI:GOSUB9500
9190 Q=0:Q$="ADJUSTMENT":Q=G(7):GOSUB9500
9200 Q=1:Q$="TOTAL DEDUCTIONS":Q=INT((TA+NI+G(7))*100+.5)/100:GOSUB9500
9205 PRINT#4
9210 Q$="NET PAYABLE":Q=INT((G-Q)*100+.5)/100:GOSUB9500
9215 PRINT#4
9220 Q$="GROSS PAY TO DATE":Q=E(J,7)+G:GOSUB9500
9230 Q$="TAX TO DATE":Q=E(J,8)+TA:GOSUB9500
9250 CLOSE4
9260 IFDV=4THEN9300
9270 PRINT"PRESS C TO CANCEL: P TO PRINT
9280 PRINT"PRESS R TO RECORD WITHOUT PRINTING"
9285 GOSUB6
9287 IFQ$="C"THEN1115
9289 IFQ$="P"THEN9300
9290 IFQ$="R"THEN10000
9295 GOTO9285
9300 NEXTM
9350 GOTO10000
9500 IFQ=0ANDQ=0THENRETURN
9510 Q1$=STR$(Q)
9520 FORK=1TOLEN(Q1$):IFMID$(Q1$,K,1)="."THEN9525
9521 NEXTK
9522 Q1$=Q1$+",".00":GOTO9535
9525 K=LEN(Q1$)-K
9530 IFK=1THENQ1$=Q1$+"0"
9535 H=30-LEN(Q1$):IFDV=4THENH=H-LEN(Q$)
9540 PRINT#4,SPC(5)Q$TAB(H)Q1$
9550 RETURN
10000 E(J,7)=E(J,7)+G
10005 E(J,8)=E(J,8)+TA
10010 IFE(J,3)=3THEN10030
10020 E(J,E(J,3)+8)=E(J,E(J,3)+8)+NI
10030 E(J,14)=E(J,14)+ER
10040 E(J,13)=N
10100 E(0,7)=E(0,7)+G
10110 E(0,8)=E(0,8)+TA
10115 E(0,1)=E(0,1)+G(7)
10120 IFE(J,3)=3THEN10140
10130 E(0,9)=E(0,9)+NI
10140 E(0,14)=E(0,14)+ER
10200 S(J,1)=G+S(J,1):S(J,2)=TA+S(J,2):S(J,3)=NI+S(J,3)
    
```

(continued on next page)

## TELESSOR ELECTRONICS

### RS232C INTERFACE

The interface, which has full handshaking, is supplied complete with an EPROM containing the necessary utilities for use in one of the spare ROM sockets in the PET. It is housed in a single unit which attaches to the user port and programmes for terminal emulation etc. are provided on disk or cassette for 3000 or 4000 PETs. (Please state.)



ONLY £65

### POWER FAILURE?

Our low cost standby supplies are completely self contained utilising sealed lead/acid batteries in a single case and will supply a system comprising 32K PET, dual disk drive and printer for in excess of 30 minutes with no interruption of the supply during switchover. The output is 240V at 50Hz which is available at the multiple sockets on the front panel and a power failure lamp is also included.

PRICE £225

### EPROM PROGRAMMING

The programmer is self contained and includes its own power supply, the only connection to the PET being to the user port. It is unique in that no "personality modules" are required since different memories are accommodated by the use of a switch which can select one of the following: 2704/08/58/16, 2532, 6654/58 (CMOS) and, as an option, the INTEL single chip microcomputer 8748/49 and their CMOS counterparts. Software is supplied on disk only and is available for 3000 & 4000 PETs.

**STANDARD PROGRAMMER PRICE £185**  
**WITH OPTION £195**

DATA SHEETS AVAILABLE FOR ALL PRODUCTS, PLEASE ADD VAT TO ALL PRICES.

**TELESSOR ELECTRONICS,**  
**14 BRIDGE CLOSE,**  
**THURMASTON,**  
**LEICESTER.**  
**TEL. (0533) 693583.**

● Circle No. 211

## BEEBUG FOR THE BBC MICRO

INDEPENDENT NATIONAL USER GROUP FOR THE BBC MICRO

IF YOU OWN A BBC MACHINE, OR HAVE ORDERED ONE, OR ARE JUST THINKING ABOUT GETTING ONE, THEN YOU NEED BEEBUG

BEEBUG runs a regular magazine devoted exclusively to the BBC Micro (10 issues per year). New program listings in each issue:

3.D. Noughts and Crosses and Full Colour Moon Lander in April issue. Latest news on the BBC project. What you should know before you order your machine. Hardware and Software Hints and Tips:

What the Manual doesn't tell you. How to upgrade the A option. How to add joysticks and games paddles.

Beginners Guide to Basic starting in the April issue. Reviews of the latest software.

Discount software and hardware. Regular advice Clinic to answer your queries.

BEEBUG Software Competition with Cash Prizes. All this and much more when you join BEEBUG

Membership:  
Introductory offer  
6 months £4.50  
1 year £8.50  
S.A.E. for further details

**BEEBUG**  
35 St. Julians Rd.  
St. Albans  
Herts

● Circle No. 212

## MILLFIELD SCHOOL

offers 300 courses in 60 different games coaching, creative arts and other activities, including

## COMPUTING

in the summer holidays, for young people, adults and families.

for 30 page prospectus, contact:-

**JOHN DAVIES, MILLFIELD SCHOOL,  
STREET, SOMERSET.  
Street (0458) 42291**

● Circle No. 213

## ROTTEN APPLE?

Anita Electronic Services (London) Ltd are specialists in the repair and service of the Apple II Micro Computer, Apple Disk Drive and associated printers including Apple Silent Type, Centronic, Anadex, NEC, Qume, Ricoh and Empson.

We offer a fast on-site service or alternatively repairs can be carried out at our workshops should you wish to bring in your Apple.

Apple Maintenance Contracts are available at very competitive prices. Trade enquiries welcome.

For further information telephone or write to:-

**MR E. J. HALPIN**  
Anita Electronic Services Ltd.,  
15 Clerkenwell Close,  
London E.C.1.  
01-253 2444

● Circle No. 214

(continued from previous page)

```

10205 S(J,4)=ER+S(J,4):S(J,5)=NI+ER+S(J,5)
10500 PRINT"*****PRESS S FOR SAME EMPLOYEE"
10510 PRINT"***OR SPACE FOR NEXT EMPLOYEE"
10520 GOSUB6
10530 IFQ$="S"THEN1115
10540 IFQ$<" " THEN10520
11000 NEXTJ
11400 FORJ=1TONE:FORK=1T05:S(0,K)=S(0,K)+S(J,K):NEXTK,J
11500 P(1)=P(1)+E(0,7)
11510 P(2)=P(2)+E(0,8)
11520 P(3)=P(3)+E(0,14)+E(0,9)
11530 P(4)=P(4)+E(0,9)
11535 P(5)=P(5)+E(0,14)
11540 P(6)=P(2)+P(3)
12000 PRINT"*****PRESS SPACE FOR FINAL SUMMARY"
12010 GOSUB6
12020 PRINT"J"
13000 OPEN4,4:OPEN3,4,2:OPEN2,4,1
13010 PRINT#4,CHR$(1)CL$
13020 PRINT#4
13030 PRINT#4,"WEEKLY SUMMARY - WEEK NO."W W/E "D$
13040 PRINT#4
13050 PRINT#4
13060 PRINT#3,"AAAAAAAAAAAAAAAAAAAAA 99999.99-"
13070 PRINT#2,"GROSS PAY THIS WEEK"CHR$(29),E(0,7)
13080 PRINT#2,"TAX PAID THIS WEEK"CHR$(29),E(0,8)
13090 PRINT#2,"N. I. -EMPLOYEE"CHR$(29),E(0,9)
13095 PRINT#2,"(ADJ.)"CHR$(29),E(0,1)
13100 PRINT#2
13105 T=INT((E(0,7)-E(0,9)-E(0,1)-E(0,8)+.0001)*100)/100
13115 PRINT#2,"N. I. -EMPLOYER"CHR$(29),E(0,14)
13120 PRINT#2,"N. I. COMBINED"CHR$(29),E(0,9)+E(0,14)
13130 PRINT#2
13135 PRINT#2,"NET PAYABLE"CHR$(29),T
13140 FORJ=1T010:PRINT#2:NEXTJ
14000 PRINT#4,"EMPLOYEE PAY SUMMARY - WEEK NO."W W/E "D$
14010 PRINT#4
14020 PRINT#4,"";
14030 PRINT#4,"N. I. N. I. N. I."
14040 PRINT#4,"NAME GROSS TAX ";
14050 PRINT#4,"(EE) (ER) (TOT)"
14060 PRINT#4
14070 PRINT#3,"AAAAAAAAAAAAAAAAAAAAA 99999.99- 99999.99-";
14080 PRINT#3,"9999.99- 9999.99- 9999.99"
14090 FORJ=1TONE
14095 IFE(J,6)=0THEN14110
14100 PRINT#2,E$(J,1)CHR$(29) S(J,1) S(J,2) S(J,3) S(J,4) S(J,5)
14110 NEXTJ
14115 PRINT#4
14120 PRINT#2,"TOTAL"CHR$(29) S(0,1) S(0,2) S(0,3) S(0,4) S(0,5)
14300 CLOSE2:CLOSE3:CLOSE4
14400 PRINT"*****PRESS R TO REPEAT SUMMARY"
14410 PRINT"***OR SPACE TO CONTINUE"
14420 GOSUB6
14430 IFQ$="R"THEN13000
14440 IFQ$=" " THEN14460
14450 GOTD14420
14460 PRINT"*****PRESS P TO PRINT PERIOD SUMMARY"
14470 PRINT"***OR SPACE TO FINISH"
14480 GOSUB6
14490 IFQ$="P"THEN14520
14500 IFQ$=" " THEN15060
14510 GOTD14580
14520 DV=4:OPEN4,IV
14530 PRINT#4,"PERIOD SUMMARY"
14540 PRINT#4
14550 Q=1:Q$="GROSS PAY FOR PERIOD":Q=P(1):GOSUB9500
14560 Q$="P. A. Y. E. TOTAL":Q=P(2):GOSUB9500
14570 Q$="N. I. TOTAL":Q=P(3):GOSUB9500
14580 PRINT#4
14590 Q$="N. I. (EMPLOYEE)":Q=P(4):GOSUB9500
14600 Q$="N. I. (EMPLOYER)":Q=P(5):GOSUB9500
14605 PRINT#4
14610 Q$="TOTAL TAX AND N. I.":Q=P(6):GOSUB9500
14670 CLOSE4
14700 FORJ=1T06:P(J)=0:NEXTJ
15060 PRINT"*****NOW RECORD NEW DATA TAPE"
15070 GOSUB5
16000 OPEN1,1,1
16010 PRINT"*****WRITING ";CL$
16020 PRINT#1,CL$
16030 PRINT#1,NE
16035 FORJ=1T06:PRINT#1,P(J):NEXTJ
16040 FORJ=1TONE
16050 PRINT#1,E$(J,1)
16060 PRINT#1,E$(J,2)
16070 PRINT#1,E$(J,3)
16080 NEXTJ
16090 FORJ=1TONE
16100 FORK=1T014
16110 PRINT#1,E$(J,K)
16120 NEXTK
16130 NEXTJ
16140 CLOSE1
16150 PRINT"*****PRESS R FOR SECURITY COPY"
16160 PRINT"***OR SPACE TO FINISH"
16165 GOSUB6
16170 IFQ$="R"THEN16000
16180 IFQ$=" " THEN17000
16190 GOTD16165
17000 PRINT"J":END
READY.

```



# BUYERS' GUIDE

The Buyers' Guide to microcomputers is a summary of low-cost computers available in the U.K. It appears every third month; we add new computers and amend existing information, as required, to keep it up-to-date. Systems are listed by manufacturer.

## Microcomputers

### ACORN COMPUTERS

**Systems 1, 2, 3, 4, 5:** 6502-based. 1-32K RAM COS or DOS. Hex or full keyboard. Personal, scientific business or educational use. Disc module, CMOS RAM Card, 80-by-25 character VDU interface, 8K static memory, analogue interface, daisywheel printer interface, cassette interface, VDU, laboratory interface, in-circuit emulator, universal interface, PROM program, Econet interface, switched-mode PSU. Software includes, Pascal, Lisp, Forth, floating-point extension, ONLI extension. System 1-3 Reviewed September 1979.

**Atom:** 6502, 2-12K RAM, up to 40K external memory, full keyboard, Basic in ROM, high-resolution graphics, cassette and TV interface, parallel port, I/O lines. Should eventually be able to link into a ring. Acorn Computers Ltd., 4a Market Hill, Cambridge CB2 3NJ (0223) 312772. Reviewed November 1980.

**BBC Micro:** 6502A or Z-80, 2MHz, second-processor option with up to 96K RAM, 32K in normal operation, full keyboard, cassette and disc interfaces, Centronics type interface, A-D interface, integral loudspeaker and sound generator. Options include: clock, voice synthesiser, Econet, teletext adapter and a 16-bit processor. VDU; eight modes including text and colour. Reviewed January 1982.

### ALAN PEARMAN LTD

**Maple:** Z-80A, 16-64K RAM, S-100 bus, CP/M, 8in. discs, RS232 serial and parallel. Sold mainly as Micro-APL system. Alan Pearman Ltd., Maple House, Mortlake Crescent, Chester CH3 5UR. (0244) 46024.

### ALPHA MICRO

**AM-1010, AM-1051:** WD-16, 64K-16MB RAM, S-100, four 8in. up to 90MB hard discs, RS232 up to 20 ports. Alpha Micro, 13 Brunswick Place, London N1 6ED. (01) 250 1616.

From £65 for  
System 1 kit;  
£285 for  
System 2 kit;  
£670 for  
System 3 kit

From £130

£229 and £399

From £2,450

From £7,500



### MONOPOLY

TANDY V. GENIE

- ★ Computer challenges you at Monopoly as a player.
  - ★ For up to 6 players (including computer).
  - ★ Unique system featured whereby computer detects the skill of best player then adjusts its skill automatically to match that player.
  - ★ Computer's game at highest level is 'strong'.
  - ★ Every game different, close, exciting and challenging.
  - ★ Game data can be saved on tape to continue game at another time.
  - ★ Easy fool-proof entry ideal, even for children to use.
  - ★ 2 versions of Monopoly included. 'Standard' — as to rules. 'Popular' — slight variation to rules.
  - ★ Many, many hours of fun for all the family.
- On tape for the VIDEO GENIE and TRS-80. Model 1 & 3. Level 2. 16k. £9.95 inclusive.

COMPUTICS 1 BELL LANE  
MICROSOFT WHEATLEY  
OXFORD OX9 1XY

● Circle No. 215

### PARTRIDGE & MAY LTD COMPUTER SERVICES

#### PRINTER STATIONERY

Standard 9½" x 11" with sprocket holes. Box of 2,000 sheets, plain or striped, £12.65 incl VAT (local) cwo. Self-adhesive labels 4" x 1½" x 1,000, £7.50 incl VAT (local) cwo. Postage UK mainland £1.50.

Stockists of Verbatim/Shugart diskettes, printer ribbons and wide selection of printers and Acorn Atom — Further details on request.

Hardware & Software Consultants.  
0268-781017.

7, MANNS WAY, RAYLEIGH, ESSEX SS6 9QB.

● Circle No. 216

### Call COMPUTALINE on (01) 840 1177/3444

For Printers eg Oki matrix from £245  
Daisywheel from £730  
For Computers eg Superbrain\* from £1910  
Apple\* £Call

For Value, whether you need hardware, software or full systems, call

#### COMPUTALINE

St James' House, 105-113 The Broadway,  
Ealing, London W13 9BL

● Circle No. 217

### AD HOC software.....

Introducing the DAVSORT for the Apple. A machine code routine to sort or merge and sort Real, Integer or String arrays.

#### Features:

- \* Linear time scale, approx 500 entries per sec.
- \* Uses original array space.
- \* Easily incorporated in Applesoft programs.
- \* Demonstration programs and documentation. £24 (incl)

Send for details of:

Machine code utilities including, Rem Maker, Change Variables, Binary Catalog, Selective Catalog, Restore Deleted Files, Rename 'Hello'.

Educational programs available on request.  
AD HOC SOFTWARE,  
462 Cottingham Road, Hull HU6 8QR.

● Circle No. 218

# SHOP WINDOW

## \* BIG EARS \* STOP GO! LEFT! RIGHT!

SPEECH  
INPUT  
FOR ANY  
COMPUTER



Hugely successful Speech Recognition System, complete with microphone, software and full instructions.

BUILT TESTED & GUARANTEED ONLY **£49**

PLEASE STATE COMPUTER UK101 SUPERBOARD NASCOM2 Vic 20, Micron, BBC Micro ZX8031, PET, TRS80, MZ80K, APPLE II

## ZX80 ZX81

MUSIC SYNTHESISER  
+ 16 LINE CONTROL PORT



Play 3-part music, sound effects, drums etc. Full control of attack, decay and frequency. Input/Output lines provide control and monitor facility for Home Security, Robot Control, Model Railway, etc. etc. Works with or without 16K RAM.

Add keyboard to make a live performance polyphonic synthesiser! Full instructions/software included

AMAZING VALUE AT ONLY **£19.50 (KIT)**  
Extra Connector at £2.50 **£25.50 (BUILT)**

COLOUR MODULATOR KIT £12  
RGB in, PAL/UF out BUILT £18

UK101/NASCOM COLOUR GRAPHICS KIT £45  
Inc. Modulator. Still the best selling system! BUILT £60

Please add VAT at 15% to all prices. Barclay/Access orders accepted by telephone

**WILLIAM STUART SYSTEMS Ltd**  
Dower House, Billericay Road, Herongate, Brentwood, Essex CM13 3SD  
Telephone: Brentwood (0277) 810244

● Circle No. 219

## SUSSEX

SUPERBRAIN FROM £1550\*  
NEW TELEVIDEO SYSTEMS  
multi-user, multi-tasking and  
communications

RANGE OF CP/M SOFTWARE  
PRINTERS FROM EPSOM TO  
SANDERS

WE ARE ALSO A WORD PROCESSING  
BUREAU

\* Subject to \$ surcharge

**THE ELECTRONIC OFFICE**

Phoenix Buildings  
Regency Road ● 32 West Street  
Brighton ● Tel: Brighton (0273) 722248/9

● Circle No. 220

AT LAST!

ALL PRICES INCLUSIVE  
TELEPHONE: 051-227 2642

## VIC SOFTWARE

### VICMEN

A full-feature version of the popular "Puckman" arcade game for the UNEXPANDED VIC. Written entirely in machine-code for fast action. SUPPLIED ON CASSETTE at £7

### VICGAMMON

Standard Backgammon game for the VIC with 3K expansion. Rapid computer responses. Instructions on how to play are included. SUPPLIED ON CASSETTE at £7

More VIC software will be available by the time you read this. Phone 051-227 2642 for details. Generous DEALER DISCOUNTS available — phone Dave on 051-227 2299 for details.

## BUG-BYTE

98-100 THE ALBANY, OLD HALL STREET,  
LIVERPOOL L3 9EP

● Circle No. 221

## ALTOS

**ACS-8000 series:** Z-80, 64K RAM dual 8in. disc, single user. Z-80, 208K RAM, single floppy disc, 10-40 Mbyte hard disc, magnetic cartridge tape back-up, CP/M or MPM. Business and scientific use. *From £2,300 and £6,800*

**ACS-8600 series:** 8086 based, with 8089 DMA, 128K to 1Mbyte RAM, 10-80Mbyte hard disc, magnetic tape back-up, up to eight users, Xenix or MP/M-86. Business and educational use. *From £8,950*

## APPLE COMPUTER

**Apple II Plus:** 6502, 16-48K RAM, 8K ROM, colour graphics, 5¼ in. discs, general use. Own bus. Reviewed October 1979. *From £695*

**Apple III:** 6502A with supporting chips, giving it a superset of 6502 instruction set. 96-128K RAM, colour graphics, integral 5¼ in., RS232, four 50-pin expansion slots. Apple Computer (U.K.) Ltd., Finway House, Hemel Hempstead, Hertfordshire HP2 7PS. (0442) 48151. *P.O.A.*

## ATTACHE

**Attache:** 8080, 64K RAM, S-100, parallel port, 8in. discs, business system. Colt Computer Systems, Fairfield Works, Fairfield Road, Hounslow, Middlesex. (01) 577 2686 *From £1,737 to £7,000*

## BASF

**System 7100:** Z-80A, 64K RAM, RS232, 5¼ in. discs, business systems. MPR, 4 Fitzroy Square, London W1. (01) 388 4200. *From £4,937*

## BILLINGS

**BMS:** Z-80A, 64K RAM, 8in. 200MB hard discs, business system. Mitech Data Systems, 8 Guildford Road, Woking, Surrey. (04862) 23131. *From £4,295*

## BL MICROELECTRONICS

**Biproc:** Z-80 or TMS9980 kit, 1K RAM, 2K monitor, RS232, cassette, TV. BLM, 1 Willow Way, Loudwater, High Wycombe, Buckinghamshire HP11 1JR. (0494) 443073. *From £150*

## BLEASDALE COMPUTER SYSTEMS

**UDS:** 8080, Z-80, 6809, 32K-1MB, Multibus, CP/M, 5¼ in., 8in., hard, RS232, four parallel ports, IEEE 488, development system. Bleasdale Computer Systems, Francis House, Francis Street, London SW1. (01) 828 6661. *P.O.A.*

## BMG MICROSYSTEMS

**BMG MS 5000 range:** 8085 or 8086, 64-768K RAM, CP/M, MP/M, BOS 8in. discs or Hard Disc — 40Mbytes, 20Mbytes of which are in an exchangeable cartridge. Up to 8 remote VDU's and printers. BMG Microsystems Ltd., Micro House, Hawksworth, Swindon, Wiltshire SN2 1DZ. (0793) 37813. *From £6,000*

## BRUTECH ELECTRONICS

**BEM:** Single-board processor with 6502 and no RAM. Data Precision Equipment, 81 Goldsworth Road, Woking, Surrey GU21 1LJ. (04862) 67420. *From £133*





## BYTRONIX MICROCOMPUTERS

**Megamicro:** 8080/Z-80, 64K RAM, 8in. discs, CP/M. Business and University use. Bytronix, 83 West Street, Farnham, Surrey GU9 7EN. (0252) 726814.

## CANON BUSINESS MACHINES

**Canon BX-1/BX-1d:** 6800, 64K RAM, 5¼in. integral, RS232, V24 ports, business use. Canon Business Machines, Wadden House, Stafford Road, Croydon, Surrey. (01) 680 7700. *From £3,250*

## COMART

**Communicator range:** Z-80A, 64K RAM, S-100 bus, scientific, educational, research and business use. CP100/200; twin 5.25in. drives, CP-500; single 5.25in. and mini-Winchester hard disc giving 4.8byte CP/M, MP/M-II. Reviewed June 1981. *From £1,995*

## COMMODORE BUSINESS MACHINES

**Pet:** 6502, 8-32K RAM, IEEE ports, integral 9in. screen, personal and general use. Reviewed August 1979. *From £460*

**8000 Series — SuperPet:** Upgrade of original Pet. 12in. screen, 5¼in. discs, business and general use. Reviewed October 1980. *From £895*

**Vic 20:** 6502, 5K RAM, 16K ROM, keyboard, personal and game use, IEEE interface, uses special cassette £35, disc and printer soon, RS-232, Modem use, low-resolution colour graphics. Commodore Business Machines, 818 Leigh Road, Slough Industrial Estate, Slough, Berkshire. (75) 74111. *From £165*

## COMP SHOP

**UK101:** 6502, 4-8K RAM, TV interface, RS232, full keyboard, single-board, personal use, similar to Ohio Superboard. Comp-shop, 14 Station Road, New Barnet, Hertfordshire EN5 1QW. (01) 441 2922. Reviewed May 1980. *From £199 for kit*

## COMPUCOLOR

**Compucolor II:** Z-80, 8-32K RAM, 5¼in. integral discs, 13in. colour VDU, RS232. General use. Dyad Developments, The Priory, Great Milton, Oxfordshire OX9 7PB. (08446) 729. Reviewed June 1979. *From £998*

**Copernicolor II:** 8080A, 8-32K RAM, 5¼in., 8in. and Winchesters available, VDU, RS232 bus, standard ASCII keyboard with optional keyboards available, graphics 128 by 128, Basic, assembler, Fortran. Based on Compucolor II, wide range of software. General use. Copernicus Ltd., 7 Wey Hill, Haslemere, Surrey. (0428) 52888. *From £1,200*

## COMPUCORP

**655-675:** Z-80, 60K RAM, own OS but will run CP/M with modifications, RS232, IEEE and others optional. 1-4 5¼in. discs, 16 by 80 VDU. Business use. Barnet House, 120 High Street, Edgware, Middlesex. (01) 952 7860. *From £2,595 to £4,750*

### UK101 SOFTWARE ON TAPE

from the guy who wrote "La Passe Temps"  
**GALACTIC HITCHHIKER (8K)** An Adventure, all in machine code. A beauty! (£7.00)  
**SUPERTREK (8K)** Sail boldly through the universe zapping moving Klingons in real time. Superb graphics. (£7.00)  
**LUNAR LANDER** A real challenge. You won't get in under less than three hours. (£3.00)  
**LE-PASS-TEMPS** This is what a computer game SHOULD be like (£3.00)  
**STARTREK (8K)** The old favourite, beautifully presented. Not real time but great graphics nonetheless (£6.00)

#### \* NEW \*

Please phone for details of the exciting range of TAQWA ADD ONS:  
 Others available include a **BASIC TUTOR** (8 x 4K Programs) £12.00 and lots more games.

Each program comes on its own cassette by return 1st Class Mail. Available for 16 x 48 or 32 x 48 display and compatible all monitor ROMs. All inclusive from:

**A. KNIGHT (DEPT PC)**  
 28 SIMONSDALE WALK, ORMESBY, CLEVELAND  
 Tel: (0642) 321266

● Circle No. 222

## SHARP MZ-80K

LOWEST PRICE  
 ON THE  
 SOUTH COAST

CASH  
 PRICE **£347** + VAT



XITAN SYSTEMS LTD  
 23 CUMBERLAND PLACE  
 SOUTHAMPTON SO12BB  
 TEL 0703 38740

● Circle No. 223

## THE POWER BANK

Plug your micro computer video unit and Printer into the POWER BANK and forget about a disabling break in the electricity supply. This unit will continue to run your system for up to one hour in the event of a mains failure. **WITH NO INTERRUPTION TO YOUR WORK!**



Batteries included

Vital when running business systems. This unit will of course suppress MAINS SPIKES and SURGES.

**SIGNWAVE OUTPUT**

Retail price **£320** + VAT  
 Weight 13Kgms Size 43cms x 20cms x 9cms

**POWER TESTING LTD**

1 St Mary's Lane, Uplminster  
 Tel: Uplminster 26938

● Circle No. 224



TEL:  
 01-337 4541

**PET PARTS**

**EASIVIEW COPYHOLDER** £24.00 plus V.A.T.  
 Fitted to any model PET in seconds. No tools required.

**EPROM PROGRAMMER** For all 5V. Eproms.  
 Own power supply and user port connector.

**CONCORDIA AUTOMATION  
 COMPONENTS LTD.**

6 Central Road, Worcester Park, Surrey.

● Circle No. 225

## PUBLIC APOLOGY

We would like to apologise for our extremely low prices but we can't help it. Our 5¼" Library Cases really are only £1.90 each; our MX80/Commodore 4022 ribbons are only £5.95 each; our BASF SSSD 5¼" discs are only £15.00 per ten; our Verbatim Datalife SSSD discs are only £17.00 per ten; our 11" x 9½" Listing Paper is only £10.00 per box of 2000 sheets; our mailing labels start from £7.00 per 1000 labels; and we could go on. In fact you would be hard put to find better value for money than ConSup when you need consumables for your computer.

We would also like to apologise for having two of the best 4K Eproms ever developed for the Commodore PET. "BASMON" is an assembler and disassembler with extended monitor functions including Interrupt driven M/C Trace; Hex/Dec Convert; Dump; Screen Dump; and many more. "PLUSDOS" has all the usual functions such as Auto-Number; Renumber; Find; as well as many new ones including Join and Merge new programmes. Both chips reside inside the PET and are outstanding value at £35 each or both for £65. (Dealer enquiries welcomed).

We faithfully promise to continue to give good value and reliable service. We've always sold the Commodore system and now we can also supply the new SIRIUS I — Circle the number below and we'll rush you details. Alternatively, write or phone us today.

### ConSup

62 Tritton Road, London, SE21  
Tel: 01-6704411 (40 lines)

(One last apology — prices do not include VAT or P & P so check with us first).

● Circle No. 226



## Giggleswick

### Summer Courses July 18-24 / 25-31

#### Practical Computing Intensive Introduction to Computing

with Peter Ford, B.Sc. and Derek Seed, B.Sc.

Further details of courses, accommodation etc. from:

Projects Director, Giggleswick School,  
Settle, North Yorkshire BD24 0DE  
Tel: Settle (072 92) 3545

● Circle No. 227

## VETS FOR PETS

Anita Electronic Services (London) Ltd. are specialists in the repair and service of Commodore Pets, Commodore and Computhink Disk Drives and compatible printers, including Anadex, NEC, Qume, Ricoh and Empson.

We offer a fast on-site service or alternatively repairs can be carried out at our workshops should you wish to bring in your pet.

Pet Maintenance Contracts are available at very competitive prices. Trade enquiries welcome.

For further information telephone or write to:—

**JOHN MEADE**  
Anita Electronic Services Ltd.  
15 Clerkenwell Close  
London E.C.1.  
01-253 2444

● Circle No. 228

## COMPUTER CENTRE

**Minikit:** Z-80, 16K RAM, serial and parallel, 5¼in., CP/M, S-100. *From £800*

**Maxikit:** Z-80, 16K RAM, serial and parallel, 8in., CP/M, S-100. *From £911*  
Computer Centre, 9 De la Beche Street, Swansea SA1 3EX.

## COMPUTERMART

**Computermart 2000 range:** Z-80A, single/multiple, 16-256K, CP/M, S-100 bus, graphics, 8in. single-density double-sided 180MB hard disc, general/business use. Computermart, 60 St. Faiths Lane, Norwich, Norfolk. Norwich 615089. *From £6,000*

## CROMEMCO

**Single Card Computer:** Z-80, S-100, 1K RAM, 20mA/RS232. OEM and industrial use. *From £273*

**Z2:** Z-80, 31A power supply, motherboard, 21 sockets, serious hobbyist and OEM use. Reviewed February 1979. *From £573*

**Z2-H:** Z-80A, 64-512K RAM, S-100 bus, CDOS, IOMB formatted fixed disc, two 5¼in. discs, hard discs up to 70MB. *From £5,373*

**System 1:** Z-80A, 64K RAM, S-100 bus, model CS-1; 790K storage, model CS-1H; 5.5Mbyte storage, CDOS and Cromix. *P.O.A.*

**System 2:** Z-80A, 64-512K RAM, S-100 21 slots, CP/M, VDU, two 5¼in. discs, hard discs up to 70MB. Multi-channel interface available. General/business use. *From £2,095 to £6,408 for seven users*

**System 3:** Z-80A, 64-512K RAM, S-100, CP/M, two or four 8in. discs, hard discs up to 70MB, general/business use. Datron Microcentre, 2 Abbeydale Road, Sheffield S7 1FD. (0742) 585490. Microcentre, 30 Dundas Street, Edinburgh EH3 6IN (031) 556 7354. Comart, P.O. Box 2, St. Neots, Huntingdon, Cambridgeshire PE19 4NY. (0480) 215005. *From £3,568 to £8,304 for seven users*

## DATA APPLICATIONS

**DAI Personal Computer:** 8080, 48K RAM, colour graphics, 20 Eurocard industrial interface modules, RS232, industrial use. Data Applications, 168 Dyer Street, Cirencester, Gloucestershire GL7 2PF. (0285) 2588. Reviewed February 1981. *From £595*

## DIGITAL DATA ELECTRONICS

**SPC/1:** 8085, 32-48K RAM, own OS, COMAL, Assembler and Pascal, graphics, up to three 5¼in. drives, up to four 8in. drives, 10MB Winchester, up to four 20MB cartridge, many ports. DDE, Clark House, Pump Lane, Hayes, Middlesex. (01) 573 8891. *From £1,995*

## DIGITAL MICROSYSTEMS

**DSC-3:** Z-80, 64K RAM, CP/M, 8in. discs, hard discs up to 28MB, RS232/V24, business and general use. *From £3,445*





**DSC-4:** Z-80, 128-512K RAM, CP/M, 8in. discs, hard discs up to 28MB, RS232, RS422, business and general use. *From £3,995*

**Hex-29:** AMD 2900, 16-bit, 64K-1,024K RAM, Hex bus, 8in. discs, hard discs up to 28MB. Eight to 32 Ports, RS232. Modata, 30 St. Johns Road, Tunbridge Wells, Kent TN4 9NT. (0892) 41555. Extel, 73/5 Scrutton Street, London EC2A 4TA. (01) 739 2041. *From £6,445*

## DURANGO

**F85:** 8085, 64K RAM, own bus and OS, graphics, four RS232 ports, integral 9in. VDU, 9 x 9 printer, keyboard and two 5¼in. disc drives. General use. Comp Ancillaries, 64 High Street, Egham, Surrey. (07843) 6455. *From £7,500*

## DYLE HOUSE

**System 2000:** Z-80, 64K RAM, dual 8in. discs, own OS, business use. Dyle House, 36 Abbot Way, Wellingborough, Northamptonshire. (0933) 79135. *P.O.A.*

## DYNABYTE

**Dynabyte 5000:** Z-80, 32-64K RAM, S-100, CP/M, MP/M, CP/Net, RS232, 5¼ or 8in. discs, hard discs up to 96MB, expands to multitask/user system. Business use. Microtech Ltd., Waterloo Road, Uxbridge, Middlesex UB8 2YW. (0895) 58111. *From £1,600 to £12,000*

## EACA

**Video Genie EG3003:** Z-80, 16-48K RAM, S-100, CP/M, 5¼in. discs, RS232, personal and general use. Lowe Electronics, Bentley Bridge, Chesterfield Road, Matlock, Derbyshire DE4 5LE. (0629) 4995. Reviewed February 1980. *From £369*

## ECS MICROSYSTEMS INC

**Aristocrat:** Z-80A, 32-180K RAM, 12K PROM, dual 5¼in. drives, 964K. Three RS232 and one parallel port, CP/M, wide range of protocols, business and general use. Telecomputing Systems Ltd., Seacourt Tower, Westway, Oxford. (0865) 723621. *From £3,950*

## EQUINOX

**200:** Z-80, 64-512 RAM, S-100 bus, CP/M, Omnix, MicroCobol, MVT FAMOS, cartridge disc, six serial and one parallel port, business use. *From £7,500*

**300:** WD-16, 64-256K RAM, S-100 bus, CP/M, Omnix, MicroCobol, MVT FAMOS, cartridge disc drive, six serial ports, business use. Equinox, 16 Anning Street, New Inn Yard, London EC2A 3HB. (01) 729 4460/(01) 739 2387. *From £10,500*



QUME  
EPSON  
ANADEX  
DYSAN

All Business Applications  
Full Personal Attention

Hugh S. O'Neill Computers  
111 High Street, Selsey,  
CHICHESTER, SUSSEX.  
Tel. Selsey (024361) 5856

● Circle No. 229

**5 DAY MICROCOMPUTER  
PROGRAMMING COURSES  
START EVERY MONDAY  
INCLUSIVE COST £170**

*Part-time courses  
seven days a week*

**MICROTEACH**  
160 Edmund Street,  
Birmingham  
Tel: 021-236 4322

● Circle No. 230

## PAPERMATE PLUS

A super word processor for all  
16/32K PETs. £45 on tape  
£46.50 on disk.

## FLEX-FILE

A low priced database for CBM  
disk owners. Can be linked to  
Papermate and Papermate  
Plus. £65 (disk only).

Add VAT to all prices

**SUPERSOFT**

Dept. P1, 10-14 Canning Road,  
Wealdstone, Harrow, Middlesex  
Tel: 01-861 1166



● Circle No. 231



## ZX-81

### CASSETTE ONE

"I had your Invaders/React cassette ... I was delighted with this first cassette"

— P. Rubython, London NW10

"I have been intending to write to you for some days to say how much I enjoy the games on 'Cassette One' which you supplied me with earlier this month. Please let ... into the secret of your first time load every time!"

— E. H., London SW4

### CASSETTE ONE SIDE ONE 1K MACHINE CODE PROGRAMS

React, Invaders, Phantom aliens, Maze of death, Planet lander, Bug splat, Bouncing letters

### CASSETTE ONE SIDE ONE 1K BASIC PROGRAMS

I Ching, Mastermind, Basic hangman, Robots

### CASSETTE ONE SIDE TWO

has large screen versions of Invaders and Maze of Death, ready for when you get 16K. All on Cassette One for £3.80.

### CASSETTE TWO

— just out, ten 16K Basic games.

OTHELLO

AWARI

LASER BASES

WORD MASTERMIND

RECTANGLES

All on Cassette Two for £5

Recorded on quality cassettes, sent by first class post.

From:

Michael Orwin, 26 Brownlow Road, Willesden, London NW10 9QL

● Circle No. 232

## TRS 80 MODEL III

### GRAPHICS & ANIMATION — 48K

Disc or tape

Obtain the full potential of your machines graphics capability with this m/c code programme. Only £12

Limited quantity 4 1/2" electrostatic printer paper for Tandy or Centronics quick printer £7.40 per roll including postage and packing.

Send SAE for overview to

R. Hopkinson

Iliffe House, Oadby Ind Estate, Leicester.

● Circle No. 233

### TEXAS INSTRUMENTS TI-99/4 + 4/A

#### "THE CUBE"

No not just another cube program but a 3D graphic simulation designed to demonstrate the graphics available on this M/C. this program permits all the same moves as the mechanical puzzle along with scrambling and unscrambling commands. The user can spin the cube to view the reverse and record up to 30 moves for a quick unscramble. If all else fails a scrambled cube can also be saved on tape at any time. Excellent graphics and good documentation.

#### "QUADCUBE" (TM)

When you've solved "The Cube" then try "Quad-cube" very similar in style but based on a 4 x 4 grid rather than the more usual 3 x 3. Increased enjoyment, complexity and frustration are the differences, with all the cube's facilities available. More squares more moves. Each program is available on tape at £9.00. Both are ideal demonstration programs showing clearly the graphics ability of this micro whilst giving the viewer an easy reference to the complexity of the problem being solved. Includes VAT + post.

### WORK FORCE

140 Wilsden Avenue,  
Luton, Beds LU1 5HR

● Circle No. 234

## EUROCALC

**Euroc:** 8080, 64K RAM, 8in. discs, 15in. VDU, CP/M, business use. *From £8,000*  
**Eurocalc,** 55/56 High Holborn, London WC1. (01) 405 3113.

## EXIDY

**Sorcerer:** Z-80, 48-55K RAM, S-100, RS232, CP/M, 5 1/4 in. discs, *From £749*  
MBasic, CBasic, Pascal, Algol, Fortran, Cobol, plug-in ROM pack programs, Separate VDU. Liveport, The Ivory Works, St. Ives, Cornwall TR26 2HF. (0736) 798157. Reviewed May 1979.

## GNAT

**System 10:** Z-80, 65K RAM, own bus, CP/M, graphics, 5 1/4 in. discs, *From £2,995*  
RS232, RS449, 12in. VDU, full keyboard, optical IEEE. Business use. Millbank Computers, 98 Lower Richmond Road, London SW16. (01) 788 1083. Reviewed December 1980.

## HAYWOOD

**Systems 1000-8000:** Z-80, 32-65K RAM, 6000 is S-100, 3000 single-board, CP/M, graphics, 5 1/4 in. discs, three serial and parallel ports. *From £2,359*  
Business, scientific and general use. Haywood Electronics Assoc., 11 Station Approach, Northwood, Middlesex. (01) 428 9831.

## HEATH/ZENITH

**H8:** Single-board WH8 assembled, 8080, 16K-65K RAM. Heathbus nine slots, cassette interface, nine-digit LED. *From £321*

**Z89:** Z-80, 16-48K RAM, CP/M, integral 5 1/4 in. drive, optional dual external, two RS232, full keyboard, 12in. VDU. *From £1,570*

**WH-11A:** LSI-II, 16-bit 16-32K RAM, own bus and OS, optional dual 8in. drives, serial and parallel ports. Heath Ltd., 11b Bristol Road, Gloucester GL2 6EE. (0452) 29451. (01) 636 7349. *From £1,250*

## HEWART

**6800Mk II:** 6800 single-board, 1K monitor, 1K user RAM, 1K VDU RAM, 128byte scratchpad, education and home user. S-50 bus. *From £155*

**6800S:** 6800, 16K monitor, 8K Basic in ROM, graphics, 5 1/4 in. drive. *From £229*  
Hewart, 95 Blakelow Road, Macclesfield, Cheshire. (0625) 22030.

## HEWLETT-PACKARD

**85A:** 16-32K RAM, 32K ROM, IEEE 488, RS232, graphics, 5 1/4 in. drives, integral 32 by 16 VDU, integral thermal printer, QWERTY and numeric keypad. Scientific use. Hewlett-Packard, King Street Lane, Winnersh, Wokingham, Berkshire. (0734) 784774. *From £1,830*



## HYTEC MICROSYSTEMS

**H-3000:** Z-80A, 4MHz, 32-128K RAM, two minifloppy discs, standard I/O, two parallel, three serial ports, single board. *From £2,381-£2,640*

**H-4500:** Z-80, 64-208K, two minifloppy discs, standard I/O, two parallel, three serial ports. 4MHz option. *From £3,110*

**H-7000:** Z-80A, 4MHz, 32-128K, two 8in. floppy discs, standard I/O, two parallel, three serial ports. *£3,350*

## IMAGE DATA PRODUCTS LTD

**Image Data Eight:** 6802, 4-40K RAM, 43-way bus, own OS, Basic assembler and editor, viewdata-style graphics, up to four 5¼in. discs, up to 12 RS232 ports. Image Data Products, 1-4 Portland Square, Bristol BS2 8RR. (0272) 40248. *£500-£4,000*

## INDUSTRIAL MICROSYSTEMS

**Series 5000:** Z-80, 16-56K RAM, CP/M, S-100, two or three 5¼in. discs, two serial and one parallel port, desk unit, business and general use. *From £1,500*

**Series 8000:** Z-80, 64-256K RAM, S-100, CP/M, MicroCobol, MVT FAMOS, Omnix, two, three or four 8in. disc drives, two serial and one parallel port, desk unit, business and general use. Equinox, 16 Anning Street, New Inn Yard, London EC2A 3HB. (01) 739 2387/(01) 729 4460. *From £2,500*

## INSTAR

**Omegar:** 16-bit, 48-256K RAM, dual floppies, hard discs, up to 12 simultaneous users, business use. *From £7,500*

**Asatayd:** Z-80, 16-56K RAM, dual floppies, CP/M, S-100 bus, business use. Instar, 61 High Street, Croydon, Surrey CR0 1QD. (01) 680 5330. *From £4,950*

## INTERTEC

**Superbrain:** Z-80, 64K RAM, 256 static RAM, dual Shugart, optional hard disc, CP/M, S-100 bus, business and general use. Encotel, Succombs Hill, Upper Warlingham, Surrey. (820) 5701. Sun, 138 Chalmers Way, North Feltham Trading Estate, North Feltham, Middlesex. (01) 751 6695. KGB, 88 High Street, Slough, Berkshire. (75) 38581. Icarus Computer Systems Ltd., 27 Greenwood Place, London NW5 1NN. (01) 485 5574. Reviewed April 1980. *From £1,495*

## ITHACA INTERSYSTEMS

**Pascal Micro DPSI:** Z-80, 64K-1MB RAM, full IEEE S-100 bus, CP/M version 2.2, graphics, 8in. and hard discs, RS232, four parallel and two serial ports per S-100 board. Ithaca Intersystems, 58 Crouch Hall Road, London N8 8HG. (01) 341 2447. *From £4,258*

## ASSEMBLY for PET LANGUAGE for VIC

PET from 8K: VIC 20 from 3.5K  
Both books cover WHOLE 6502  
Instruction set, AND CONTAIN

### FULL 6502 ASSEMBLER

PRICES: 2/3/4000 PET & VIC BOOK £10  
ALL PET & VIC: book + ASSEMBLER —  
ON TAPE £15: ON DISK £17.

VIC BOOK CONTAINS M/C LANG MONITOR

SAE details from: DR P HOLMES (P)  
21 Colin Drive  
LONDON NW9 6ES  
State Machine.

● Circle No. 235

## SHUGART

### MINI FLOPPY DISC DRIVES

\*\* THE LOWEST PRICES ANYWHERE \*\*

SA 400 5¼" £105

BRAND NEW — 3 MONTH LABOUR  
& PARTS WARRANTY.

Also available Tandon TM100 — 1 drives

ENCOTEL SYSTEMS LTD  
530 PURLEY WAY, CROYDON, S7  
01-686 9687

● Circle No. 236



Brilliantly simple

On our launch we are pleased to offer you

## £1350 OF FREE MICROCOMPUTER

software and services which includes: Incomplete Record/Book-keeping/Financial Accounting and Payroll, General Data Management, Invoicing, Letter Writing or Word Processing systems and one day training with first 50 ADLER-ALPHATRONIC MICROCOMPUTERS sold at £2,345 each, leasing from £15.60 a week excluding VAT.

Please telephone for a demonstration to Watford 48580.

### OVERSEAS COMPUTER SYSTEMS CONSULTANTS

182a, Queens Road, Watford.

● Circle No. 237

# SHOP WINDOW

## CSS CHRISALID SYSTEMS AND SOFTWARE

### TRS80/GENIE SOFTWARE:

**POOLPLAN** — the ultimate in football analysis and pools prediction. YOU set the forecast parameters, based on your own results analysis. Keeps the league records. Works for Aussie and amateur teams. Min system: 16k+printer.  
2 tapes and manual: £29.50.

**FREEZER MANAGER** — a must for all hoteliers, caterers, schools and the large family. Can save ten times its cost, avoiding "past-date" food.  
Tape and manual: £15.75.

**LUNAR LANDER** — but with a big difference! Pseudo real-time and very exciting graphics.  
Tape: £5.50.

**BUSINESS & HOBBY SOFTWARE**  
GENIE DEALERS — ALL ACCESSORIES ETC.  
Cheques/PO's to: "Chrisalid",  
15 Kestrel Close, BERKHAMSTED, HP4 2HY.

● Circle No. 238

## 80 X 24 VDU

Assembled and tested printed circuit board provides the electronics part of a 24 lines by 80 characters Visual Display Unit for any computer with RS232 interface.

Microprocessor based — 55 software selectable functions — 16 baud rates to 9600 baud — X, Y cursor addressing — 96 ASCII (true descendants) 32 graphics characters (continuous) 8x12 matrix — character generation in Eprom — real CTRL-G beep — requires ASCII encoded keyboard and video monitor (U.K. standard).

VDU-1 Assembled and tested P.C.B. £135  
PSU-1 Power supply (for above) £32  
All prices subject to £2 Registered Delivery, plus VAT.

We also sell SS-50 printed circuit boards (memory, graphics, prototyping, clock, sound synthesiser)

Send 20p stamps for further information.



**SIRIUS CYBERNETICS LTD,**  
7 EUSTON PLACE, LEAMINGTON SPA,  
WARWICKSHIRE.  
TEL: (0926) 316110.



● Circle No. 239



Your local Fruit and Nut

**NORTHERN COMPUTERS**  
Churchfield Rd, Frodsham,  
Warrington WA6 6RD.  
**0928 35110**

● Circle No. 240

## MICRO SERVICING AND REPAIRS

APPLE · PET · VIC · BBC · ITT  
and other makes

Micro Malfunction? Send or drop your micro in to us. We'll repair it in our workshops and return it. Our staff are fully qualified and we are Main Dealers and Software Specialists for most leading makes.

**ALSO FULL MICRO SERVICE CONTRACTS**  
IN LONDON AND EAST ANGLIA

**MICROSTORE MICRO MANAGEMENT**  
327 King's Rd, LONDON 32 Princes St, IPSWICH  
SW3. Tel: 01 352 9291 Suffolk. Tel: 0473 57871

● Circle No. 241

## ITT

**2020:** Built under licence from Apple. See entry under Apple II. *From £827*  
ITT, Star House, Mutton Lane, Potters Bar. (77) 51177.

## KEMITRON ELECTRONICS

**UDS 3000:** Z-80, 1-64K RAM, Kbus, own OS, CP/M, 8in. and hard discs, ports up to 256. Kemitron Electronics. (0244) 21817. *From £640 to £4,000*

## LOGABAX

**LX-500:** Z-80, 32K RAM, S-100, CP/M dual 5¼in. drives, business use. LogAbax Ltd., 1-7 Wesley Avenue, London NW10. (01) 965 0061. *From £3,000*

## LSI COMPUTERS

**M-One:** 8080, 8-16K RAM, own OS, dual Shugart 8in. drives, two serial and one parallel port, 12in. VDU and full keyboard. Business use. *From £5,995 with software package*

**M-Two:** 8085, 64K RAM and 4K EPROM. Launched in December 1980. LSI Computers, Copse Road, St. Johns, Woking, Surrey GU21 1SX. (04862) 23411. *P.O.A.*

## LUXOR

**ABC 80:** Z-80, 16-40K RAM, 12in. VDU, IEEE 488, RS232, 5¼in. drives, loudspeaker, personal and education use. CCS Microsales, 7 The Arcade, Letchworth, Hertfordshire ST6 3ET. (04626) 73301. *From £795*

## MICRO V

**Microstar:** 8085, 64K RAM, three RS232, serial inputs, StarDOS, twin 8in. drives, general use. Data Efficiency Ltd., Maxted Road, Maylands Avenue, Hemel Hempstead, Hertfordshire. (0442) 63561. *From £4,950*

## MICROMATION

**Z-Plus:** Z-80, 64K RAM, S-100 bus, CP/M, MP/M two serial and six parallel ports, business use. Rostronics, 115-117 Wandsworth High Street, London SW18 4HY. (01) 874 1171. Reviewed May 1980. *From £3,950 to £8,550*

## MICRONEX

**MX-100:** Z-80A, 64K RAM, S-100 bus, RS232, CP/M, Pixel graphics display system, twin 8in. drives. Micronex, Harford Square, Bristol BS18 8RA. (027) 589 3042. *From £3,485*

## MICROSOLUTION

**British Genius range:** Z-80, 64K RAM, CP/M, Basic, BCPL, Fortran, Cis-Cobol, dual 5.25in or 8in. discs or hard disc. RS 232 and Centronics interface, separate keyboard, 24-x-80-character screen. MicroSolution Ltd., Park Farm House, Heythorp, Chipping Norton, Oxfordshire, OX7 5TW. (0608) 3256. *From £2,850 to £7,000*





## MIDWEST SCIENTIFIC INSTRUMENTS

**MSI 6800:** 6800, 16K-56K RAM, 5¼ or 8in. or hard discs up to 10MB. Systems 1,2,7 and 10. System 7 runs Flex, MSI, DOS and SDOS, RS232. System 10 is System 7 with hard disc. Business use. Strumech (SEED), Portland House, Coppice Side, Brownhills, Walsall, West Midlands. (279) 4321. Reviewed March 1980. *From £1,100 to £12,000*

## MITREFINCH

**MF 3000:** 16bit, 64K to 1.25Mbyte RAM, Cartridge hard disc, up to 32 simultaneous users; business users. Mitrefinch Ltd., Tower House, Fishergate, York. YO1 4KA. (0904) 52995. *From £7,500*

## MODULAR BUSINESS SYSTEMS

**Tutor:** 8085, 32-64K RAM, Intel Multibus, CP/M, optional graphics, twin 5¼in. drives or four 8in., two RS232 serial ports. *From £2,500*

**Elite:** 8085, 32-256K RAM, Intel Multibus, CP/M, 5¼in. to 24MB hard discs, RS232, 24-bit TTL programmable port. Modular Business Systems, 21 Chappel Lane, Yeadon, Leeds LS19 7NX. *From £5,400 to £25,000*

## NASCOM

**Nascom 1:** Z-80, 2-64K RAM, serial and up to 16 parallel ports, 8K Microsoft Basic, 1K monitor in EPROM. Personal use. Reviewed January 1979. *From £125*

**Nascom 2:** Z-80, 1K RAM expandable to 256 with Nascom System 80 case. Nasbus, 8K Basic, 2K monitor and 2K character generator, low/high resolution graphics and colour. 5¼in. single or twin floppy discs, RS232, parallel port, Kansas City cassette port. Lucas Logic Limited, Warwick, CV34 5PZ. *From £295*

## NATIONAL MULTIPLEX

**Pegasus:** Z-80, 48K RAM, S-100 bus, 5¼in., 8in. drives, CP/M, 12in. VDU, business use. London Computer Store, 43 Grafton Way, London W1. (01) 388 5721. *From £2,700*

## NEWTRONICS

**Elf II:** Single-board on 1802, 256bytes to 64K RAM, Hex keypad, RS232 I/O and VDU interface, optional keyboard, machine code, tiny Basic, full Basic, assembler/disassembler, Text Ed, personal, R & D, and educational. *From £50 for kit*

**Explorer 85:** 8085, 4-64K RAM, S-100 bus, RS232, VDU interface, CP/M, TV and cassette interface, personal and full business system. Newtronics, 255 Archway Road, London N6. (01) 348 3325. *P.O.A.*

## ACCOUNTS-CP/M

Payroll	£400
Sales ledger & invoicing	£400
Job analysis, payments and nominal	£400.

**ESTATE AGENTS:** MATCH-AND-MAIL

**DATA PROFILE LTD.** APEX HOUSE

LAWRENCE ROAD HOUNSLOW MIDDX  
01-572 6381

● Circle No. 242

## Come in on the homecomputer boom

For £1,000 we can provide you with an agency selling home computers into an exciting new market with massive growth potential - and give all the training, technical and marketing support required. Now's the time to stake your claim and secure your future in your own exclusive territory. And you could start part-time. For further information write with full details to Russel Price, Adda Computers Ltd., Unit 8, 1-7 Broomfield Road, West Ealing, London W13 9AP.

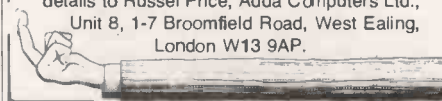

● Circle No. 243

## Sintrom Sale

Micropolis Disks (5.25")

1027T Tandy single density inc PSU and case	(no cable) PND5 160
1037T Dual disk version of above	PND5 320
1023T Tandy double density inc PSU and case	(no cable) PND5 300
1033T Dual disk version of above	PND5 600
1015 MOD1 35 track, no PSU, no cable, no case	PND5 95
1041 MOD1 As above, with S100 controller and MDOS	PND5 295
1053 MOD2 Dual disk, double density unit with PSU, case, S100 controller and MDOS (suitable for sorcerer with S100 expansion chassis)	PND5 750

MISC S100 cards

OM6400 M, S and C inc 64K dynamic RAM card	PND5 295
OMB 6400 as above with bank switching	PND5 395

Prices are fob reading 90 day warranty, add PND5 10 p + p + VAT terms: Cheque with order

SINTROM ELECTRONICS LTD

14 Arkwright Road, Reading, Berks, RG2 0LS.

● Circle No. 244

For those interested in Computing in Medicine

## 2ND SYMPOSIUM ON DATA PROCESSING IN CARDIOLOGY

HARROGATE

May 18th-20th, 1982

Topics include office technology, data base management, E.C.G. processing, image processing, ultrasound analysis, real time signal processing etc.

Comprehensive equipment exhibition. Enquiries for company exhibition facilities or applications to attend as a delegate/speaker contact: Dr. G. Williams, Consultant Cardiologist, Killingbeck Hospital, York Road, Leeds LS14 6UU.

● Circle No. 245

3RD

## ZX MICROFAIR

CENTRAL HALL WESTMINSTER,  
LONDON SW1

FRIDAY 30 APRIL 1982 (12.30-8.30pm)

SATURDAY 1 MAY 1982 (10.00-6.00pm)

(By tube to St James Park Underground)

EVERYTHING FOR THE ZX80/81

STILL THE BIGGEST SELECTION ANYWHERE.

Hardware, Software, Books, Mags, New Products, Bring & Buy, User Groups, Buffet, Showguide.

Low price admission: Adults 50p, Children (under 14) 40p.

ADVANCE TICKETS (Friday 30th April ONLY): Adults £1, Children 50p.

(Cheques to 'ZX Microfair' from:

Organiser: Mike Johnston, 71 Park Lane, London N17 0HG.

Apologies to visitors who had to wait to see the 2nd show. This time there will be more space and TWO

DAYS to see everything.

Low cost to exhibitors

Enquiries welcome.

● Circle No. 246

## LYNC 2.0—

### Communications Program

LYNC 2.0, from Midnight Software, is a powerful communication program for CP/M micros, using an RS232 serial link.

- Full error checking protocol.
- Transfers at up to 9600 baud.
- Allows display of local AND remote directories.
- Can send and fetch files WITH NO OPERATOR AT THE REMOTE END.
- May also be used as an intelligent terminal.
- Only £85.00 + VAT (8" Single Sided, Single Density)

(Other formats, please phone)

Taylor Micro Systems Ltd, Hamstead Ind. Estate, Old Walsall Rd, Great Barr, Birmingham B42 1D. Tel: 021-358-2436

● Circle No. 247

## CF81 CASSETTE FILTER

FOR SINCLAIR ZX81

Having trouble loading programs?  
**DONT** fiddle endlessly with the volume.  
**DONT** modify your recorder or ZX81.  
**DONT** buy a new recorder.  
**JUST** plug in the NEW CF81 and  
**LOAD** your programs RELIABLY.

ONLY £9.99 incl VAT, P&P

G M HARRIS  
28 Ridgway Rd, Farnham, Surrey.

● Circle No. 248

## VIDEO MONITORS AND KEYBOARDS

£39.50

PLUS VAT  
PLUS CARRIAGE £7.50

Secondhand factory reconditioned professional 9" video monitors — complete with power supply — fully tested but unguaranteed. Composite video input — suitable Nascom, UK 101, Atom etc. Complete with circuit and instructions.

Separate secondhand matching keyboards  
£21.75 plus VAT, carriage £3.50.

BOX NO. 500

● Circle No. 249

## NORTH STAR

**Advantage:** Z-80A plus 8035, 64K RAM with 20K display RAM, twin 5.25in. discs. 12in. screen, 24 x 80 characters, 240 x 640 pixels, 87-key keyboard, graphics CP/M or graphics Basic/DOS, provided with Busigraph, diagnostic and graphics demo software.

From £2,195

**Horizon:** Z-80A, 16-56K RAM, 5¼in. twin drives, S-100 bus, own OS, business, educational or scientific use. Comart, PO Box 2, St Neots, Huntingdon, Cambridgeshire PE19 4NY. (0480) 215005. Equinox, Kleeman House, 16 Anning Street, New Inn Yard, London EC2A 3HB. (01) 729 4460. Reviewed April 1979.

From £995 to  
£2,500

## OHIO SCIENTIFIC

**Ohio Superboard and Challenger 1:** 6502, 8K Basic in ROM, 2K monitor, 4K RAM, full keyboard and VDU interface. Hobbyist use. Reviewed June 1979.

From £160

**Challenger 2:** 6502, 48K RAM, dual 8in. drives, serial port, low-cost business use.

From £1,500

**Challenger 3:** 6502, Z-80 and 6800, 48-56K RAM, OSI 48-pin bus, serial port for VDU, CP/M, expands to eight users, 10, 20 and 75MB hard disc, business use.

From £2,300

**Challenger 4:** Similar to Challenger 1 but 64 by 32 display, colour and sound option. U-Microcomputers, Winstanley Industrial Estate, Long Lane, Warrington, Cheshire WA2 8PR. (0925) 54117/8. CTS (0706) 79332. Millbank, 98 Lower Richmond Road, London SW16. (01) 788 1083. Reviewed September 1979. Mutek, Quarry Hill, Bath, Wiltshire. (0225) 743289.

From £450

## PANASONIC

**Panasonic:** 8085, 56K RAM, full keyboard, integral 24 by 80 VDU, integral twin 5¼ or 8in. floppy drives. Three RS232, business use. Panasonic Business Systems, 9 Connaught Street, London W2. (01) 261 3121. Reviewed June 1979.

From £4,150

## RAIR

**Black Box:** 8085A, 64-512K RAM, mini-floppy discs, up to sixteen RS232C serial ports, 5MB and 10MB hard discs, IEEE 488 interface, CP/M and MP/M, general and business use. Rair, Wellington House, 6-9 Upper St. Martins Lane, London WC2H 9EQ. (01) 836 6921. Reviewed November 1979 and August 1980.

From £2,750

## RCA

**Cosmac:** 1802 micro with Hex pad and TV interface. Machine-code programming with Tiny Basic option. HL Audio, 255 Archway Road, London N6 5BS. (01) 348 3325.

From £79 for  
kit

## RESEARCH MACHINES

**380-Z:** Z-80, 4-56K RAM, RS232, CP/M, twin 5¼ or 8in. discs, high-resolution graphics. Sold principally to higher and secondary education. Reviewed December 1978.

From £830 to  
£3,500



**280-Z:** Board version of 380-Z. Research Machines, PO Box 75, Mill Street, Oxford. (0865) 49791. *From £722 for 4K version*

## ROCKWELL

**Aim-65:** 6502, 1-4K RAM, full keyboard, RS232, discs, hobby use. *From £250*  
Portable Microsystems, Forby House, 18 Market Place, Brackley, Northamptonshire NN13 5SF. (0280) 702017. Reviewed July 1979.

## SALMON ELECTRONICS

**Archives:** Z-80 at 4MHz, CP/M, S-100, serial and parallel I/O, 12in. display, 5¼in., 8in. or 19MB hard disc or 8in. Winchester, 104 keys including 23 configured for Wordstar. Salmon Electronics, PO Box 26, Croft-on-Tees, Darlington. (0325) 721368. *£3,400*

## SATTCO

**Databoard 4680:** Z-80, 16-64K RAM, own bus, full-colour graphics, 5¼in., 8in. and hard discs up to 10MB, 64 interface units. General use. Microsystems Technology, PO Box 5, Knutsford, Cheshire WA16 9DU. (0565) 52911. *P.O.A.*

## SD SYSTEMS

**SBC-100:** Z-80, 1-48K, S-100 bus, Basic in 8K ROM, four ROM sockets, optional 5¼in. drives, RS232 serial and parallel, single-board. Reviewed January 1981. *From £155*

**SD-100/200:** Z-80, 64-265K RAM, 8K PROM, S-100 bus, RS232, CP/M, 12in. VDU, twin 8in. drives, business, industrial and general use. Barcellos, Kimberley House, Vaughan Way, Leicester. (0533) 26584. *From £3,750*

## SEN ELECTRONICS

**Organiser:** Intel 8085, 64K RAM, multi-user Basic, 8in. drives or 20MB hard discs, three RS232, business use. SEN, 5 London Street, Chertsey, Surrey KT16 8AP. (09328) 66744. *From £7,500*

## SGS-ATES

**Nanocomputer:** Z-80, 6-64K RAM, Gamma bus, 2K NC-2 monitor in ROM, Basic as option, RS232, cassette interface, Hex keypad. Midwich, Hewitt House, Northgate Street, Bury St Edmunds, Suffolk IP33 1HQ. Reviewed October 1979. *From £350*

## SHARP ELECTRONICS

**MZ-80K:** Z-80, 16-48K RAM, 10in. integral VDU, integral cassette, loudspeaker, 5¼in. disc optional, general use. *From £480*



# WESTERN

Western Computers Limited



comart

North Star Horizon

**Cromemco**

PLEASE CONTACT US FOR DETAILS

Blackpool Airport,  
Blackpool, Lancs.

Phone Blackpool 404676/42660

● Circle No. 250



Brilliantly simple

On our launch we are pleased to offer you

## £1350 OF FREE MICROCOMPUTER

software and services which includes: Incomplete Record/Book-keeping/Financial Accounting and Payroll, General Data Management, Invoicing, Letter Writing or Word Processing systems and one day training with first 50 ADLER-ALPHATRONIC MICROCOMPUTERS sold at £2,345 each, leasing from £15.60 a week excluding VAT.

Please telephone for a demonstration to  
**Watford 48580.**

**OVERSEAS COMPUTER SYSTEMS CONSULTANTS**

182a, Queens Road, Watford.

● Circle No. 251



### ZX80/81 INTERFACE

At last — a well designed interface that allows you to use the ZX80 or ZX81 as a controller.

It provides:

- 24 programmable I/O lines.
- Units can be daisy chained up to 96 I/O lines.
- Can be used in Basic or machine code.
- Screw terminals and ribbon cable header provided.
- Design eliminates mechanical linkage problems.
- Provision for external power supply.
- Does not interfere with Sinclair expansion units.
- Detailed notes and software provided.

£45.00 PLUS V.A.T.  
Cheque with order please to:



**BYTRONIC ASSOCIATES**

88 RUSSELL BANK ROAD  
SUTTON COLDFIELD, WEST MIDLANDS B74 4RJ  
Tel: 0675 81448

Bytronic Associates also provide a wide range of equipment for learning how to use micros as controllers, e.g. steppers, DC motors, ADC, DAC, pneumatic units etc.  
Brochure available on request

● Circle No. 252

#### MICRO ADS

are accepted from private readers only, pre-paid and in writing, 20p per word, minimum charge £2.

Please make cheques payable to Practical Computing and send to Room L310, Quadrant House, The Quadrant, Sutton, Surrey SM2 5AS.

**ZX 81 (16K) SOFTWARE. CHAMPIONS QUIZ** — it's fun for all ages. Four quiz programs on one cassette. All questions use RND function. £4.50. **ROSE CASSETTES**, 148 Widney Lane, Solihull, West Midlands B91 3LH.

**PET 3032 with BASIC 4 ROMs.** Complete with Command-O, separate cassette, & manuals £625. Also CommWordPro 3 disk and Invader £55. Woking 61082 or 01-839 2401 (evenings only).

**VIDEO GENIE 16K.** 6 months old, virtually unused, excellent condition. Selling because upgrading. £275. Day 01-568 1185. Night 09904 2698.

**MZ-80K BUSINESS SOFTWARE.** Cassette based. Invoicing & Statements, S.A.E. for full details. M. Bellwood, 6 Barlow Road, Sheffield S6 5HR.

**NASCOM SOFTWARE.** 2K position independent, relocatable disassembler. Requires NAS-SYS. Tape £8.00. I. R. Lowman, 6 Victoria Avenue, Hull HU5 3DR.

**ACORN ATOM . . . 12kRam, 14KROM, 3AMP PSU, MANUALS ETC.** 20 Plus programs inc Acorn Disassembler, Soft VDU. £220 TEWKESBURY 296494. Evenings.

**SOL 8080A-based complete working system,** with 4 16K S100 memory boards, NorthStar disk controller board, 2 mini-floppy drives, screen, 50 diskettes, So-Star, NorthStar BASIC, CP/M. Cost £3,955. £950 ono, might split. 01-602 2446.

**VIEWDATA/PRESTEL add-on adaptors** for your microcomputer or any television. Only £185.95. Also Teletext adaptors. Bristol (0272) 502008.

**PC-1211:** Pocket computer. Programmable in Basic with cassette interface. Sharp Electronics, Sharp House, Thorp Road, Newton Heath, Manchester M10 9BE. (061) 205 2333. Reviewed July 1980.

From £85

**PC-3200:** Z-80, attractive package for business use with separate keyboard and computer unit, printer, display and twin 5¼in. drives. Software now available on-line and conversion for CP/M being developed.

From £3,500

## SINCLAIR RESEARCH

**ZX-80:** Z-80A, 1-16K RAM, 4K Basic in ROM, cassette and TV interface, touch-sensitive keyboard, educational use, 22 graphics. Sinclair Research, 6 Kings Parade, Cambridge CB2 1SN. Reviewed July 1980.

From £79 for kit

**ZX-81:** Z-80A, 1-16K RAM, 8K Basic in ROM, cassette and TV interface, thermal printer at £49, touch-sensitive keyboard, educational and games use. Animated-display facility. Two modes, fast with screen blinking, slow without. Reviewed June 1981.

From £49 for kit

## SINTROM ELECTRONICS

**Periflex 630/48:** Z-80A, 32-48K RAM, S-100, CP/M, twin Micro-polis 5¼in. discs, two serial and three parallel ports.

From £1,995

**Periflex 1024/64:** Z-80, 64K, S-100, CP/M, dual 8in. discs, two serial and three parallel. Sintrom Electronics, Arkwright Road, Reading, Berkshire RG2 0LS. (0734) 85464.

From £2,750

## SIRTON COMPUTERS

**Midas Range:** Z-80, from 8K RAM, S-100 or IEEE bus, CP/M, MP/M, graphics, up to four 5¼in. or 8in. drives, hard disc, RS232, 8-bit parallel, IEEE 488. Sirton Computers, Unit 14, 29 Willow Lane, Mitcham, Surrey CR4 4NA. (01) 640 6931.

£785-£2,150

## SMOKE SIGNAL

**Chieftain 511-821:** 6800/6809, 32-64K RAM, S-50 bus, Flex DOS68/68d/69 dual 5¼in., 8in., dual RS232, video board, wide range of options, general use. Windrush Micro Designs, Gaymers Way, North Walsham, Norfolk. (069) 245189.

From £1,807

## SOLID STATE TECHNOLOGY

**Athena:** 8085, integral dual mini-floppies and mini-cassette, and matrix printer, can be expanded with 10 micros beyond CPU. Memory to 1.2GB. Claims performance similar to DEC PDP-11/34. Butel-Comco, Unit 10, Garrick Industrial Centre, Garrick Road, London, NW9 6AQ. 01-202 0262.

From £3,000

## SORD COMPUTER SYSTEMS

**M200 Range:** Z-80A, 64K RAM, S-100 bus, Sord OS, graphics, 5¼in., 8in. or hard discs, two RS232, integral 80x 24 VDU. Business use. Midas Computer Services Ltd, 2 High Street, Steyning, Sussex. (0903) 814523.

From £1,850 to £6,950





## SOUTHWEST TECHNICAL PRODUCTS

**C/09:** 6800, 56K RAM, Flex OS, 5¼in., 8in. or 15MB hard discs, business, educational and scientific packages. *From £3,000 to £10,000*

**S/09:** 6800, 128K RAM — 380K RAM, Uniflex, OS, support up to 16 users in foreground and background mode. Southwest Technical Products, 38 Dover Street, London W1X 3RB. (01) 491 7507.

## TANDBERG DATA

**TDV Series:** 8080A, 32-64K RAM, Intel bus, 4K Basic disc system in ROM, one plus three 8in. discs, or 2.5MB disc cartridge, eight ports, semi-graphics, CP/M version available, educational use. Tandberg Data, 81 Kirkstall Road, Leeds, LS3 1HR. (0532) 35111. *From £4,000*

## TANDY

**Model 1:** Z-80, 4-48K RAM, RS232, Level I and Level II Basic in ROM, separate keyboard and 12in. VDU, small business and personal use. Reviewed November 1978. *From £349*

**Model 2:** Z-80, 64K RAM, integral 8in. disc, integral 12in. VDU, detachable keyboard, CP/M serial and parallel ports, Level III Basic, business use. Tandy, TRS-80 Division, Bilston Road, Wednesbury, West Midlands WS10 7JN. (021) 556 6101. Reviewed March 1980. *From £1,995*

**Model 3:** Z-80, 4-48K RAM, 12in. display, integral unit with slots for two 5¼in. drives, 65-key keyboard, 12-key data pad, printer interface, compatible with Model 1 software. *From £499*

## TANGERINE COMPUTER SYSTEMS

**Microtan 65:** 6502, 1-48K RAM, Tanbus, IEEE 488, Tanbug in ROM (1K), Pixel graphics, 5¼in. discs, 32 I/O lines and three serial ports, from single-board upwards. Tangerine Computer Systems, Forehill, Ely, Cambridgeshire. (0353) 3633. *From £69*

## TECHNALOGICS

**TECS:** 6800, 56K RAM, Basic and Prestel terminal software, RS232, two cassette ports, two parallel ports, 5¼in. discs. Technalogs, Windmill Works, Station Road, Swinton, Manchester M27 2BU. (061) 793 6323. Reviewed November 1979. *From £895 for kit*

## TERODEC MICROCOMPUTER SYSTEMS

**TMZ-80:** Z-80, 64K RAM, CP/M, MP/M, CP/Net, twin 8in., up to 32MB hard discs, multi-user business use. Terodec, Unit 58, Suttons Park Avenue, Earley, Reading, Berkshire, RG6 1AZ. (0734) 664343/6. *From £3,000*

## TEXAS INSTRUMENTS

**TI-99/4:** 990 16-bit, 16K RAM, Basic in 26K ROM, high-resolution, colour graphics, up to three 5¼in. discs, joystick, cassette and other ports, RS232, personal use. Texas Instruments Ltd., Manton Lane, Bedford MK41 7PU. (0234) 67466. Reviewed August 1980. *From £299*

**FOR ZX81 WITH 16K RAM.** Three programs: Flight Demonstration, Flight Simulation and Flight Test. These are semi-serious programs using an aircraft flight instrument panel and are suitable for teaching situation, flying clubs or entertainment. £5 cassette. Sqn Ldr Peter Evans, 5 Broadmeadow, Bolton BL7 9AY.

**PET 16K,** large keyboard, 100 programs, manuals, cassette, sound. £425. Gerrards Cross 83175.

**ACORN ATOM 12k.** In/out chip. v.g.c. P.S.U. Creed teletype + paper. Book + Invaders. £195. Ashford (Middx) 58992.

**ZX81, 16K,** rebuilt in stylish case with proper keyboard. Books on games and machine code: Programs (including defender). Worth around £200, only £130. 67, Boileau Road, Ealing. 997 6967.

**CROMEMCO SYSTEM THREE.** Dual disk drives, single side single density Hazeltine 1500 V.D.U. Centronics 779 Printer. £2,500. Phone: (049481) 5950 (evenings).

**KIM 1** single board micro computer wanted. Non runner considered. Tel: 01-995 6470.

**Anadex DP-8000 LINE PRINTER.** Pet Interface. V. good condition, £275. 01-985 7061 (N. K. Gibbs).

**WANTED.** Apple dual disc drive(s) and daisy wheel printer. 0604 35217 office hours; 9-3 Saturdays.

**HP41C.** Calculator with many accessories. Phone for details (01) 556 3150.

**TRS-80 MACHINE CODE GAMES** cassette featuring "BREAKOUT", "INVADERS" & "SUBMARINE BATTLE" — £5 inclusive. Money with order, delivery by return. A. Moseley, 59 Plymstock Road, Plymstock, Plymouth, Devon PL9 7NX.

**TELETYPE 43 Printer** with keyboard. RS232 interface. £250 including a full box of paper. David Pike, Rivendell, Birch Way, Storrington. Tel: Storrington 2663.

**SHARP MZ80K Educational Software.** Calorimetry £5, Galvanometers £5, Gas Laws £5, German Vocabulary Test (2 volumes) £7.50 per volume. Send for full details to Quality Software, 21 Dunes Drive, Formby, Merseyside L37 1PE.

**TANGERINE BASIC ACCELERATOR.** Pseudo-compiler and interpreter make floating point programs 2 to 4 times faster. £30 for tape plus instructions or send SAE for details B. Przybyla, 15 Brixham Ave., Swindon SN3 1E.

**"ATOM" TOUCH TYPING TUTOR** £4.50. "NASCOM 2" TOUCH TYPING TUTOR £5.50. Both progs on cassette with instructions P&P free: from Lloyd's, 35 Magheraboy Road, Portrush, Co. Antrim BT56 8NX. (0265) 823101.

**TRS 80 Mod I Expansion Interface (OK).** Brand new and warranted. Surplus to requirements. Tel 041-639 3822.

**DOCTOR DARK'S SMOOTHWARE.** Programs for Nascom/Gemini G805 with CP/M. Chris Blackmore, 31 Herne Rise, Ilminster, Somerset TA19 0HH for details.

**TRS-80 L2/VIDEO GENIE SOFTWARE** on cassette: Full screen editor — many powerful features (state memory size) £5. Adventure games, exciting real-time graphics: Nightmare Park, popular park of doom £5. Dive Bomber, raid simulation 3 skill levels £5. M. A. Morling, The Mount, Hatfield Heath, Essex CM22 7DR.

**APPLE II PLUS 48K.** 1 year old £500. Cramlington (near Newcastle) 0670 712952.

**ITT 2020 DISC DRIVE.** Used only a few times as second drive. £175. Phone South Benfleet 52147.

**FOR SALE.** 64K, disk, TRS-80, expansion interface with all manuals, system disk and green screen monitor £900. Tel. (0443) 690174 night or (0685) 74397 day.

**5 VIC PROGRAMS.** Killer Park, Life, Starseed, Gobbler, Vic Musik: all for £6.50 on cassette or see for details and free game to: Soft Toys, 14 Lockharton Avenue, Edinburgh.

**ACORN ATOM 12K + 12K, PSU, MANUAL, BOOK, SOFTWARE.** £280 ono. Tel: 0573 24516. After 5.00.

**ATOM (8KROM + 1KTEXT) SOFTWARE.** O's & X's, Battleships, Mathstest, 4 off household accounts. £4 for cassette. Cheques payable to Charles Towns 27 West Avenue, Gosforth, Newcastle NE3 4ES.

**UK101 AND SUPERBOARD PROGRAM BOOK.** 17 high quality utilities and games in assembler and basic. £2.50 inc. p&p, or S.A.E. for details. Dr Mike Whittle, 1 Old Croft Close, Kingston Blount, Oxford.

**VIC20 NIGHT DRIVER 5K.** Listing £1. Cassette £2. 21 Pict Lane, Princes Risborough, Bucks.

**FOR SALE ZX80.** New 8K ROM, both manuals, leads + programs. Good condition £60 ono. Phone 01-551 0621 after 5pm.

**MICROCOTAN 65.** Expanded to 24k with TANRAM/BASIC/XBUG/TANBUG V2.3 BASIC TOOLKIT, Games and Forth on tape. £325 ono. Tel: Uxbridge 51166 ext 228 (office hours) or St. Albans 60432 (evenings), Denis Field.

**UK101, 8K, cased, sound, new monitor, software, tape recorder.** £175 ono Hatfield, Hertfordshire 64826.

**ATOM SUPER SOUND SYNTHSISER.** 9 tone channels, 3 noise channels, 6 parallel ports, amp and speaker. Envelope, volume, pitch all under Software control, plugs into ATOM expansion socket £79.95. 8 WAY Joystick

**VIC-20 PROGRAMS!!!** Six Great programs on one cassette (including Bandit & Apollo Disaster). For instant despatch send cheque/P.O. for £4.95. To "Titan Programs" at 83 Ashwood Road, Rudloe, Corsham, Wiltshire SN13 0LG.

**SMALL BUSINESS SYSTEM.** Intelligent terminal. 56K memory. Twin 8" floppy discs. Centronics 702 Printer (165 cps — upper and lower). Operator's table and cabinet for printer. Various software. Offers around £2,800. For details phone Frinton-on-Sea 4554.

## TRANSAM COMPONENTS

**Triton:** 8080, 32K RAM, CP/M, 1K TBIOS in ROM, up to three 5¼ in. discs, or four 8in., serial and parallel ports. Reviewed December 1979. *From £296*

**Tuscan:** Z-80, 8-64K RAM, S-100 bus, CP/M, RS232, TV and cassette interface, from single-board, personal use to full business system. Transam, 59 Theobalds Road, London WC1. (01) 405 5240. *From £150*

## TRANSDATA LIMITED

**Cx502:** Z-80A, 64K RAM, CP/M, MicroCobol, 8in. floppy discs, four V24/RS232 interfaces, "flexibus" multi processor architecture. Professional business and scientific use. Communications software available. *From £3,495*

**Cx503:** Z-80A, 64K-208K RAM, CP/M, MP/M, MicroCobol 20MB Winchester disc, 8in. floppy disc for back-up, four V24 serial interfaces. Business and general use. *From £6,490*

**Cx504:** Z-80A, 64K-208K RAM, CP/M, MP/M, MicroCobol 20MB Winchester disc, cartridge tape back-up, 8in. floppy disc, four RS232 interfaces. Business and general use. Transdata Limited, Battlebridge House, 87-95 Tooley Street, London SE1. (01) 403 5115. *From £7,990*

## ULBRICH AUTOMATION

**Powerhouse II:** Z-80, 16-32K RAM, RS232, 5in. internal VDU, integral mini-cassette, 2K monitor, IEEE, 14K Basic DOS, OEM users. Powerhouse Microprocessors, 5 Alexander Road, Hemel Hempstead, Hertfordshire HP2 5BS. (0442) 42002. *From £1,200*

## VECTOR GRAPHIC

**MZ:** Z-80, 48K-64K RAM, CP/M, 5¼ in. discs, optional graphics, serial and parallel ports. Business and general use. Almarc Data Systems, 906 Woodborough Road, Nottingham (0602) 52657. Reviewed October 1980. *From £2,300*

## WESTERN DIGITAL

**Pascal Microengine:** MCP1600, executes P-code directly, 64K RAM, own bus, 5¼ in., 8in. or hard discs up to 18MB, two RS232, two parallel ports. Pronto Electronics Systems, 466-478 Cranbrook Road, Gants Hill, Ilford, Essex IG2 6LE. (01) 554 6222. *From £2,295*

## ZENTEC

**ZMS-70:** 8080A-1, 32-64K RAM, up to 12K ROM, dual integral 5¼ in. discs, 600MB, RS232, integral 15in. VDU, 16 function keys. Zigal Dynamics Ltd., Bank Chambers, 13 High Street, Chesham, Buckinghamshire. (02405) 75681. *From £4,000*

## ZILOG

**MCZ Series:** Z-80, 64K RAM, RIO OS, Zilog bus, optional graphics, 8in. discs, and hard discs, four RS232, one parallel, stand-alone or networking. Zilog (U.K.) Ltd., Babbage House, King Street, Maidenhead, Berkshire. (0628) 36131. *From £3,000*



ZX81 Listings (16K). Nightmare Park £2.00, Rat Trap £1.00. SAE for catalogue and free program. Andrew Rushton, 194 Shay Lane, Walton, Wakefield WF2 6NW.

Nascom 2 16K, cased, graphics, toolkit, zeap, nas-dis, xtal Basic. Much software £325. Tel: 0323 57572

VIC 20!! Games/educational programs in full colour/sound. Also programs/instructions for user characters/high resolution graphics. All for 3.5K RAM. Phone 0634 814118 for full details.

Sharp MZ-80K, 48K, extended Basic, many games, 1 year old (as new), £330. Telephone 0625 22649.

S100 boards, SD-sales 3 card set, CPU, FDC, RAM also other assorted S100 boards. ASR-33 TTY etc. delivery possible. Phone 0294 822634, 7-9pm.

Apple II Europlus 48K with one disk drive, controller, manuals, software £875. Tel: Rickmansworth 78335 after 6 pm.

Sharp MZ80K. Now available, a program which allows single stepping through a machine code program, whether in RAM or ROM. After each step the status of the registers, the flags and the stack are displayed. Also the last step and the next step are disassembled and displayed. Registers modifiable between steps. Other options include Disassemble, Modify Memory, Find, Save, Load, Goto, Continue and Breakpoints with loop counter. Ideal for debugging or learning machine code. £17.50. Also, excellent high resolution chess board display (and associated software) for use with MZ80Ks with high resolution modification. £12.50. Easy to use but quite comprehensive word processor, includes repeat key. £12.00. Tel: 0268 26703 for details.

Acorn Atom, extra floating point ROM, colour board, PSU, manual, £175. Halifax 62124.

16K ZX81, PSU, leads, manual, books, Sinclair tapes, other software tapes, £95. Tel: 01-455 1652 evenings.

TRS-80 m/c program, fast 3-D representation Rubik's cube, £3.50. (0270) 584493.

Pet 32K. Toolkit, arrow etc plus extensive software and books. Includes cassette deck. £650 ono. Tel: 04465 3684.

Apple II plus (48K) and games and support, £550. Martin Stamp 01-251 1577 x54.

8K Pet old ROM small keyboard, £240. Bristol 292685.

VIC20 games, superb Splat and Cybernauts, colour and sound £2.50 each or both for £4 P&P and cassette included. Arthur 0204 655393.

Pet (8K) Pelmanism, Roadsweeper, Space Shuttle simulation on same cassette £5. S. Kearon, 17 Northend Lane, Sunningdale SL5 0EB.

Superior Yahtzee by professional programmer for 16K VG/TRS-80 including sound and graphics. Hours of family fun for only £3.50. Cheques/PO to If... Then... Software, 28 Whitecastle, Swindon.

TRS-80 Model 1 16K Level II complete: CPU, tape deck, monitor, manuals, instruction tapes, £325. Phone Ross Bunnet, Windsor 60283.

Wanted. Computer with disc drives under £1,000. Chris Laycock, 10 Linden Grove, Telford TF1 1QS. Telford 55041.

Nascom 2 RAM 'B' board 32K, graphics ROM, tool kit ROM, case for keyboard/power supply, TV. cassette, £400. Berkhamsted 74182.

8K Superboard, metal cased, 48x32 display, 2-speed cassette interface, Cegmon, OSI/UK newsletters, manuals, 5 program cassettes, vgc. £120. Phone 041-881 1342.

TRS-80/Video Genie, 16K. Double precision mathematic and trigonometric subroutines. Twenty one functions. Cassette, listing, instruction, £8 plus 38p P&P. Enquiries welcome. Snell, 45 Chiltern Gardens, Stanley, Co. Durham DH9 6QS.

Tandy CTR80A cassette recorder — brand new and boxed, completely unused. Green screen 9" monitor, superior metal cased type — six months old. Both items for £95. Phone 0202 873442.

Pet 3032 upgraded to Basic 4+ using Disk-0-Pro, 4022 printer, 2031 disk drive, Visicalc, space-saver board, SW32 word-processor, 12 floppies and numerous books. £1,550 o.n.o. Tel: Reading (0734) 791770 after 5.30 pm and w/ends.

As new Aculab floppy tape with extended Basic and tapes for TRS-80 Level II. Cost £200 will accept £125. Tel: 03596 498.

TRS80 and Video Genie quality software at a fraction of the usual prices. Send s.a.e. for comprehensive lists. P. Wilson, 9 Cotswold Terrace, Chipping Norton, Oxon.

Disk drive for your PET. 800K Computhink disk drive complete. First offer of £250+, secures buyer to collect. Call Welwyn Garden City (07073) 31983.

TRS-80. 48K, Level II with Hitachi 12" VDU, cassette, manuals, etc. £499 ono or will split. High Wycombe (0494) 444612.

VIC-20 games, full sound and colour. Special introduction offer — 5 original action games on one cassette — £7.50 will run on Standard machine. C.W.O. or S.A.E. for details to R. Titley, 18 Huntingdon Gardens, Fairmile, Christchurch, Dorset.

Video Genie: Games/educational programs. SAE for details. T. Smith, 26 Wesley Grove, Portsmouth, Hants PO3 5ER.

ZX81 Toppix. Detailed DIY graphics update, £2. 16K m/c easyloaders, load REMS without spaces anywhere in listing. Hex and decimal £4 or £2.50 each. All plus SAE. N. J. Petry, 3 Lester Drive, Worle, W-s-M BS22 0NG.

For sale: printers Creed 7E ex telex, £120 ono, IBM Selectric 725 Golfball £140 o.n.o. Both for conversion for use with micros. Richard 0527 33272.

Controller plugs into one of the Synthesiser ports £14.95. 5V5A power supply £44.95. All built and cased. All prices fully inc. For more details send SAE to: R. Shillito, 5 Ingarfield Road, Holland, Clacton, Essex.

8K PET, integral cassette, manuals, TIS Basic Workbooks, as new, £300 ono. Tel: 021-706 2601.

TRS-80 MODEL 1, 16K, Green screen and numeric keypad. Cassette Recorder and various software. £250. Tel: 042 482 417.

CENTRONICS 737-2 PRINTER. £300. Sprinter 20 high speed thermal printer/plotter £110. Phone: Bedford (0234) 85942 any time.

PET ADVENTURES — CAVERN 1/2/3 very complex sequence of underground adventures, each 16K, complex labyrinth, many commands. Treasures, monsters, magic! Decisions are yours! 1-£5, 1/2-£8, 1/2/3-£10. I. Gray, 175 Pershore Road, Evesham, Worcs.

ZX81 1K Munchie-Man M/c version with two monster chasing you. Displays score. Speed variable. £3.50. V. C. Vinyard, 53 Bloomfield St., Ipswich, Suffolk IP4 5JH.

NOT JUST A RANDOM MAZE. Nor just a mini adventure. But both and more. "Warrior" for the ZX81 16K. Also improved "Startrek" terrific. £4.00 each or £7.00 for both. J.W.V. 139 Allington Drive, Strood, Kent.

VIDEO GENIE. 16K, V.V. meter and extra keys second cassette included Crofton video monitor. Sound joysticks Z80 assembler arcade games, chess + other s/w many books all in excellent condition £500. Tel: 0234 741169.

Casio FX-501P/FX-502P software: excellent quality, original software available for both calculators!! Mathematical/games/educational etc. Listings for cassettes. SAE for details. Also interested in contacting good calculator programmers. SAE: Jonathan Gerson, 2 Princes Crescent, Hove, Sussex BN3 4GS.

TRS-80 Model I Level II 48K, VDU, tape, lower case, RS232C, books, games. Six months old, original boxes, £650. Cumana (Teac) twin discs, TRSDOS, LDOS, Scripsit, £500. Wilmslow (0625) 524596.

Cassette 1: 10 games includes: Blackjack, Bomber, UFO and Artist. Cassette 2: Graphic-text put any character anywhere. Save data on cassette. Both for 1K ZX81. Each cassette £2.99, both £5.00. Send cheque to A. Southall, Withymore Cottage, Bliss Gate Road, Rock, Kidderminster, Worcs.

TRS-80 MODEL 2 64K with dual 8" expansion drive unit. Software includes CP/M, Wordstar 3.0, Mailmerge & Spellstar. £2,750.

VISTA 300 DAISYWHEEL PRINTER, Interface cables for TRS-80 Mod 1 or 2. £900. All equipment complete with cables, etc and as new, virtually unused. Tel: 042 482 417.

APPLE 11 PLUS 48K, with 9" Hitachi Bew monitor, 6 months old £720 ono. Tel: 01-367 5164.

# LEEDS COMPUTER CENTRE

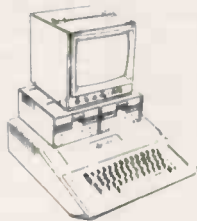

**Apple II EUROPLUS**

48K ..... **£675** + VAT  
 Disk with controller ..... **£360** + VAT  
 Disk without controller ..... **£275** + VAT  
 Monitors b/w or green.  
 Full range of Peripherals, Epson and Paper Tiger printers all discounted, Post & Packing £4.

**VIC-20** **£150** + VAT  
 P/P £3.00

FREE 6 programme tape with each C2N cassette recorder £40 inc VAT. Price includes fully tested unit with fitted plug. Complete range of Vic-Peripherals.

## SHARP MZ 80K

48K MODEL  
 £345 + VAT  
 P/P £5.00

## **COMMODORE PET**



**4000SR. WITH LARGE 12" GREEN SCREEN**

32K MODEL  
 P-P- £5.00 **£520**+ VAT

Full range of printers Ricoh RP160. Daisy. Epson MX. Range. Walters BD80P.

**COMPLETE RANGE OF COMMODORE EQUIPMENT EX-STOCK**

Official orders welcome: goods dispatched 24hr delivery. Please phone for our lowest prices.

SALES

SERVICE

SATISFACTION

## ADVANCED COMPUTER EQUIPMENT (LEEDS) LTD

95 MEADOW LANE, LEEDS 11

PHONE: 0532 446960

ACCESS AND BARCLAYCARD WELCOME

TELEX: 335909

● Circle No. 255

# ARE YOU LOST IN THE WORLD OF ELECTRONICS?

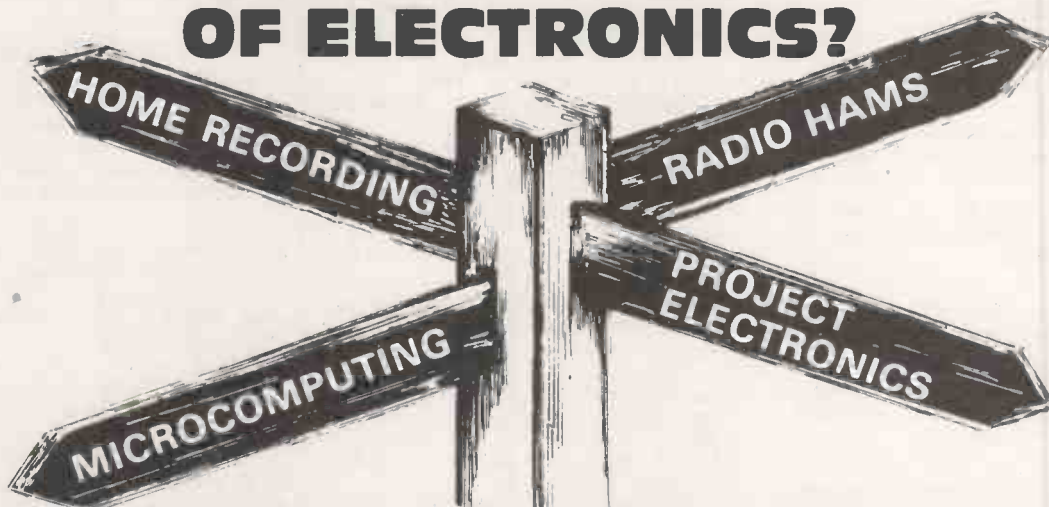

THEN THE NEW STYLE

# HOBBY ELECTRONICS

CAN SHOW THE WAY!

April issue out  
**NOW!**

Price only 70p  
**BUY YOUR COPY TODAY**

● Circle No. 256



# ZORK

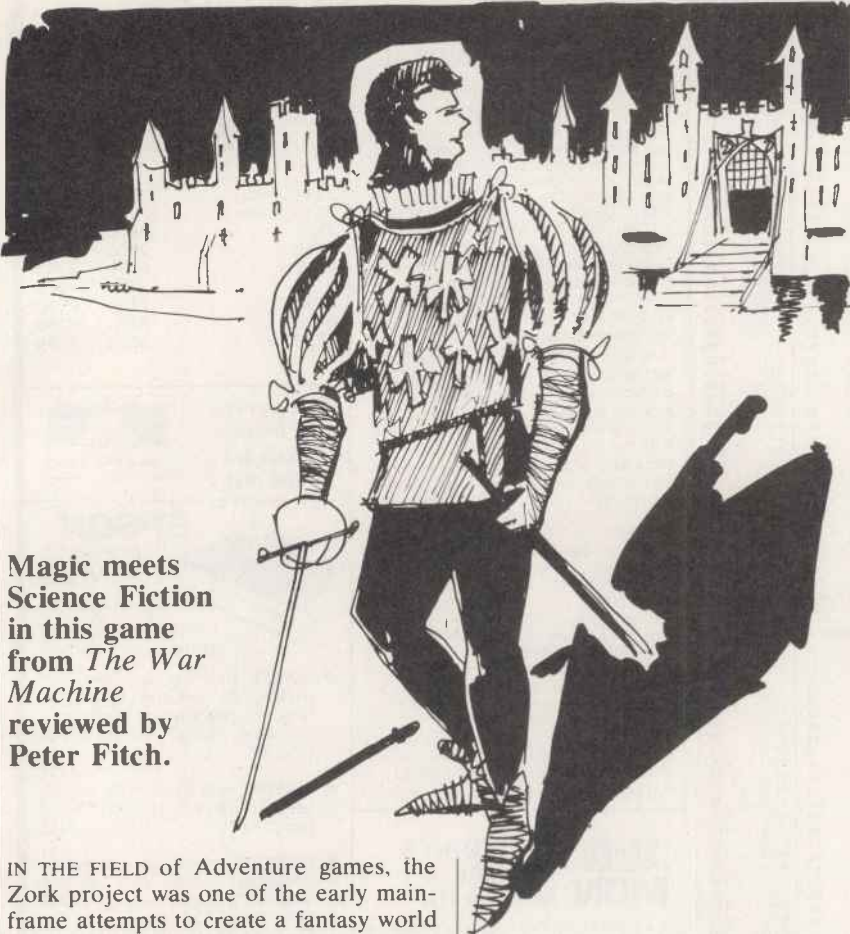

**Magic meets  
Science Fiction  
in this game  
from *The War  
Machine*  
reviewed by  
Peter Fitch.**

IN THE FIELD of Adventure games, the Zork project was one of the early main-frame attempts to create a fantasy world that a player could wander through and manipulate. Subsequent microcomputer Adventures owe a great deal to it.

Unfortunately, Zork itself — which has now been condensed to fit on to disc-based micro systems — suffers by comparison with more recent Adventures. They have improved on features originally devised by the Zork programming team, and they incorporate flashier graphic effects which make the games more visually appealing although, inevitably, less complex and rewarding. Only so much can be crammed into a given amount of memory, and an Adventure programmer never has enough.

## Unfair to Trolls

Zork is a 48K game marketed on floppy disc for the Apple II and other computers. It is a classic machine-code Adventure type game and leans heavily on the original. I have never had the pleasure of playing Adventure on a main-frame, so I cannot compare Zork with it. I can only say that it is the best of the class I have come across.

It is an open-ended Adventure without any in-built time limit, though there are the normal internal time limitations. It is a game of points for objects and actions, which is rather a pity. I would have preferred a more substantial goal.

The game is supplied in a plastic zip-lock bag containing the disc and a well-printed explanatory booklet. There is an evil Troll-like entity on the cover which I

assume is the one I keep killing near the beginning of the game. He is being intimidated by a sword-carrying Hero type. It is a pity that no-one has started a "Save the Trolls" campaign. At the rate Adventure players go through them, the population must be dropping very rapidly since the advent of micros.

The disc loaded without problems, giving a standard description/action screen display. The booklet explains the context and aims for the uninitiated and the grammar for inputting commands to the puppet in the Adventure world. As movement occurs in the world, the computer updates from the disc, but not so often or so much as to upset the flow of the game.

## Conclusions

Zork is an enjoyable Adventure game, though it is not very original apart from its presentation.

- As a puzzle it is good but it would have been improved by a few new ideas.
- After playing Zork for three months there were still some areas of the game which remained unsolved.

● <b>Ratings:</b>	
Physical quality	Very good
Perceived complexity	Very good
Subject complexity	Fair
Realism	Fair
Play balance	Very good
Overall	Good

The puppet is manipulated as one has come to expect in this type of game. Commands such as "Go west", "W", "tie rope" and "take skull" can be inputted and obeyed. It is pleasing that the grammar is sophisticated enough to allow more complex orders to be inputted in what approximates to English, for example, "Go west and take rope"; "Tie rope to railings and climb down".

A sequence of orders can be inputted and obeyed although each action counts as a time unit. Handling is tremendously improved. The vocabulary is very large too, compared to many other Adventure games, and there is little searching for the correct word as in some games. Active response from the puppet is limited.

There is no bartering for equipment at the beginning of the game. This is unfortunate since this useful part of the game could easily be chained in.

## Sufficiently complex

The surface environment is quite large and well-described and laid out. It does not seem like rooms, which can sometimes happen in other games which use the surface. It is bounded by the usual impenetrable woods and mountains, and contains a river, a dam with power station, a lake, a falls and other atmospheric touches. This is a complete contrast to other games where you are forced to crawl round dank tunnels all the time, without a sight of sunlight. The underground part of the game which, thanks to the foresight of the programmer, sometimes comes to the surface, is large enough, complex enough and varied enough for many hours of pleasure.

Magic plays some part in the game and not always in context, which could be annoying. Magic should be logical and not arbitrary if it is to exist. There is a Troll quite near the beginning of the game but little else in the way of dangerous beings.

The only other mobile danger is that other well-tried character, the thief. He is quite lethal if attacked, and steals a little too often and at times illogically. Can you really believe that he could take away your only light without you noticing or attempting to stop him? He is also very difficult to kill.

There are no major bugs, though I would suggest that you avoid inserting elements out of context. They seem to hang around in the background even when they have disappeared for the purposes of the game. □

The War Machine is published monthly by Emjay, 17 Langbank Ave, Rise Park, Nottingham, NG5 5BU. £1.25 an issue, £13 for an annual subscription, postage and packing included.



# WATFORD ELECTRONICS

33/35, CARDIFF ROAD, WATFORD, HERTS, ENGLAND

Tel Watford (0923) 40588. Telex: 8956095

MAIL ORDER CALLERS WELCOME

COMPUTER IC's	280CTC	300	7492	30	LS09	15	LS299	420	4072	20	
1702	299	280ACTC	325	7493	30	LS10	15	LS300	157	4073	20
1802CP	700	Z80D5A	£999	7494	34	LS11	15	LS302	175	4075	20
2101-2	110	Z80D10-1	£15	7495	50	LS12	15	LS320	270	4076	60
2112-2	250	Z80AS10	£23	7496	45	LS13	30	LS323	270	4077	26
2114L-300n	87	Z80DART	775	7497	120	LS14	48	LS423	200	4078	26
2114L-200n	87	Z80ADART	775	7498	87	LS15	15	LS523	270	4081	26
2118-3	250	ZN419CE	190	74104	54	LS20	15	LS324	200	4132	21
2118-4	200	ZN423E	138	74105	65	LS21	15	LS325	320	4085	26
2137-3	425	ZN424E	130	74107	32	LS22	15	LS326	330	4086	70
2532-450n	360	ZN425E	345	74109	35	LS26	18	LS327	315	4089	140
2564	£20	ZN426E	300	74110	40	LS27	15	LS347	150	4093	43
2708	175	ZN427E	600	74111	45	LS28	15	LS348	190	4094	95
2716-5V	400	ZN428E	478	74112	170	LS30	18	LS352	185	4095	90
2732-450n	400	ZN429E	210	74116	88	LS32	15	LS353	186	4096	90
2764	£17	ZN1034E	200	74118	80	LS33	16	LS365	37	4097	320
4027	240	ZN1040E	675	74119	90	LS37	16	LS366	37	4098	88
4116-150n	95	74S132	110	74120	75	LS38	16	LS367	37	4099	95
4116-200n	80	74S138	180	74122	45	LS42	35	LS373	75	4161	99
4116-250	400	74S186	210	74123	50	LS47	40	LS374	75	4162	99
4184-200	400	74S189	158	74125	42	LS48	80	LS375	48	4173	99
4315-4K	795	74S194	320	74126	40	LS49	60	LS377	90	4174	99
4334-3	325	74S201	390	74128	42	LS51	15	LS378	40	4175	105
(CMOS2114)	325	74S211	850	74132	48	LS54	15	LS379	65	4194	105
4864-364K	785	74S262	390	74136	35	LS55	30	LS384	395	4408	790
5101	270	74S287	300	74141	70	LS63	150	LS385	378	4409	790
5116-3	540	74S288	210	74142	190	LS73	25	LS390	62	4410	725
5502-CPU	600	74S471	620	74143	25	LS74	25	LS393	60	4411	695
5503	600	74S472	1150	74144	250	LS75	28	LS41	135	4412	800
5504-250	550	74S475	825	74145	70	LS76	20	LS399	220	4415	480
5505	600	74S571	620	74147	99	LS78	24	LS445	140	4419	280
5521	150	75150	125	74148	75	LS83	50	LS471	620	4422	770
5522 VIA	350	75106	99	74150	80	LS85	70	LS490	245	4433	770
5530 RR10T	1350	75182	99	74151	45	LS86	38	LS541	135	4434	950
5532 R10T	1650	75183	99	74153	45	LS90	35	LS640	228	4440	999
5545-CRTC	1650	75189	55	74154	75	LS91	80	LS641	225	4450	350
5551 ACIA	785	75182	99	74155	75	LS92	36	LS645	210	4451	350
5592-PC	£20	75188	55	74156	75	LS93	36	LS668	175	4430	350
6800	300	75189	55	74157	75	LS95	45	LS659	160	4500	675
6802	400	75322	140	74159	99	LS96	120	LS670	175	4501	675
6803	£12	75450	140	74160	60	LS107	43	LS673	550	4502	90
6804	160	75451/2	80	74161	60	LS109	30	LS674	750	4503	50
6805	670	75454	65	74162	62	LS112	30			4504	105
6808	520	75491/2	65	74163	64	LS113	40			4506	65
6809	999			74164	65	LS114	35			4507	40
6810	120			74165	62	LS122	44			4508	265
6821	150			74166	65	LS123	55			4502	14
6840	420			74167	185	LS124	105			4506	66
6843	£16			74170	168	LS125	30			4507	18
6848	850			74171	65	LS126	30			4508	62
6849	150			74172	72	LS127	35			4509	35
6850	850			74173	65	LS132	35			4510	40
6852	255			74174	72	LS133	35			4510	40
6875	500			74175	72	LS136	28			4511	15
8080A	550			74176	55	LS138	35			4512	18
8085A	90			74177	75	LS139	38			4513	19
81LS95	90			74178	65	LS145	75			4514	75
81LS97	90			74179	68	LS147	199			4515	198
8166	125			74180	65	LS148	99			4516	75
8123	125			74181	140	LS151	39			4517	48
8202	£25			74182	75	LS153	39			4518	68
8212	170			74183	65	LS155	39			4519	62
8215	425			74184	65	LS156	39			4520	61
8216	200			74185	99	LS157	35			4521	150
8224	200			74186	290	LS158	36			4522	66
8226	250			74187	65	LS160	41			4523	20
8228	250			74188	65	LS161	41			4524	130
8251	320			74189	65	LS162	41			4524	130
8253	799			74190	70	LS163	41			4526	130
8255	395			74191	65	LS164	48			4527	38
8257	395			74192	190	LS165	145			4528	58
8276A	99			74193	65	LS166	95			4529	77
8277	150			74194	150	LS167	170			4530	50
8278A	115			74195	65	LS170	72			4531	170
8313	350			74196	65	LS172	72			4532	170
8395N	99			74197	80	LS173	72			4533	170
8397N	99			74198	80	LS174	72			4534	170
9364AP	99			74199	99	LS175	58			4535	299
AM26L531C	125			74200	150	LS181	130			4536	195
AM26L532A	125			74201	150	LS182	275			4537	95
AY-3-1015	300			74202	150	LS183	275			4538	95
AY-3-8910	600			74203	150	LS184	275			4539	95
AY-3-8912	600			74204	150	LS185	275			4540	95
AY-5-1013	300			74205	150	LS186	275			4541	95
AY-5-2376	600			74206	150	LS187	275			4542	95
FD1771	£18			74207	150	LS188	275			4543	95
IM6402	360			74208	150	LS189	275			4544	95
MC1488	55			74209	150	LS190	275			4545	95
MC1489	55			74210	150	LS191	275			4546	95
MC14411	695			74211	150	LS192	65			4547	95
MC14412	795			74212	150	LS193	65			4548	95
MM5280D	695			74213	150	LS194	40			4549	180
RO-3-2513L	700			74214	150	LS195	40			4550	180
RO-3-2513U	600			74215	150	LS196	58			4551	320
SFF96364E	800			74216	150	LS197	95			4552	175
SFC71301	820			74217	150	LS198	95			4553	260
TMS2716-3V	875			74218	150	LS199	95			4554	175
TMS5011	365			74219	150	LS200	345			4555	175
ULN2003	100			74220	150	LS202	345			4556	175
ULN2004	90			74221	150	LS204	96			4557	250
Z80CPU25	350			74222	150	LS241	85			4558	99
Z80ACPU4M	385			74223	150	LS242	85			4559	99
Z80P10	290			74224	150	LS243	80			4560	88
Z80AP10	320			74225	150	LS244	80			4561	88
				74226	150	LS245	90			4562	95
				74227	150	LS247	40			4563	78
				74228	150	LS248	65			4564	125
				74229	150	LS249	68			4565	125
				74230	150	LS251	40			4566	120
				74231	150	LS252	40			4567	1915
				74232	150	LS257	48				





# 'CFACC'

(Pronounced 'Saefack')

"THE BEST ACCOUNTS PROGRAMME ON THE MARKET" — £1200

(Fully tailored to your own requirements — £300 if you buy the hardware from us, otherwise + £600)

## MAIN MENU

- |                          |                                  |
|--------------------------|----------------------------------|
| 1. ADDRESS PROGRAMME     | 16. BANK RECONCILIATION          |
| 2. SALES INVOICES        | 17. PURCHASE LEDGER              |
| 3. PURCHASE INVOICES     | 18. SALES LEDGER                 |
| 4. STOCK CONTROL         | 19. END OF MONTH PROCEDURE       |
| 5. ORDER CONTROL         | 20. VAT STATEMENTS               |
| 6. PAYROLL               | 21. MANAGEMENT FINANCIAL REPORTS |
| 7. PAYMENTS MADE         | 22. PROFIT & LOSS ACCOUNT        |
| 8. PAYMENTS RECEIVED     | 23. BALANCE SHEET                |
| 9. CREDITORS             | 24. CAPITAL ASSETS               |
| 10. DEBTORS              | 25. DEPENDING ON VERSION         |
| 11. SUPPLIER STATEMENTS  | 26. DISK DIRECTORIES             |
| 12. CUSTOMER STATEMENTS  | 27. ALTER INCORRECT FILE ENTRIES |
| 13. AGENTS STATEMENTS    | 28. PRINT LEDGER CODES           |
| 14. PRINT CUSTOMER INDEX | 29. PRINT STOCK LIST             |
| 15. PRINT SUPPLIER INDEX | 30. FINISH USING 'CFACC'         |

PLEASE ENTER SELECTION NUMBER

## 'CFACC' ACCOUNTS PROGRAMME — COPYRIGHT COMPUTERS FOR ALL LTD

1. The Programme resides totally "in core" leaving BOTH DISKS FREE for files and enabling disks to be changed during use.
2. Every Programme issued is "PERSONALISED" with your Company's details. Our "After Sales Service" is positive, giving you constant access to the Author of "CFACC". — We arrange Nationwide hardware support.
3. You need only enter Invoices and other payments in and out and "CFACC" will produce all the DATA for the MENU Programmes (it will ask the user for any other information it needs).
4. All relevant information is stored for CUSTOMERS, SUPPLIERS, EMPLOYEES and others.
5. Automatic VAT Calculations.
6. Automatic calculations of WAGES and SALARIES. This section would normally cost £500.
7. INVOICES can be produced automatically using Customers' names and addresses from file and Stock items from file — all calculations are automatic.
8. INVOICES are automatically printed on plain paper or on your own stationery. Invoices entered are retained for automatic printing at the end of the day, lunchtime etc.
9. STOCK FILE is automatically UPDATED whenever a Purchase of Sales Invoice is entered and the User's attention is drawn to any item which has reached RE-ORDER LEVEL.
10. Customer Statements printed on demand showing Current, 1 Month, 2 Months, and 3 Months and over figures. These are automatically updated as payments are entered. The User's attention is drawn to any Customer exceeding his CREDIT LIMIT. REMITTANCE NOTES are produced of invoices selected for payment — CHEQUE PRINTING optional.
11. "Open Item" ledgers retain all invoices until they are paid (Purchase and Sales).
12. Outstanding Orders are retained on file until invoiced (Purchase and Sales).
13. Automatically calculates COMMISSION due to Agents and Salesmen.
14. DEBTOR and CREDITOR lists available on demand with individual Aged Debt Analysis.
15. PROFIT & LOSS ACCOUNT, BALANCE SHEET and TRIAL BALANCE printouts on demand.
16. MANAGEMENT FINANCIAL REPORTS include:
  - i) GROSS PROFIT RATIO.
  - ii) RATE OF STOCK TURNOVER.
  - iii) NET PROFIT as a PERCENTAGE OF SALES.
  - iv) INCOME STATEMENTS.
  - v) AGE OF DEPT ANALYSIS.
17. CAPITAL ASSETS STATEMENT on demand.
18. INCOME & EXPENDITURE is analysed into 70 ledger classifications and the amounts in any one of these can be called at any time — classifications can be changed by the user.
19. ENVELOPES or ADDRESS labels can be printed from Address Files.
20. Full Random Access to any record in any file — No Limit on Record Lengths.
21. Ledgers are automatically updated after every transaction.
22. All sections of the Programme and files are fully integrated.
23. Some Programmes on the market claim to be easy to use with no need for a manual (BUT TO THE LAYMAN THEY SIMPLY ARE NOT). "CFACC" really is USER ORIENTATED — WE ARE PREPARED TO LET YOU PROVE THIS FOR YOURSELF. MONEY REFUNDED IN FULL IF YOU CAN SHOW US A BETTER MICROCOMPUTER ACCOUNTS PROGRAMME WITHIN 7 DAYS OF USE.
24. The PRICE makes "CFACC" the best VALUE FOR MONEY on the Market.
25. Fully tested and debugged.
26. All Equipment is fully tested by us prior to installation — Normal Guarantees on all Equipment Service Contracts available — Finance and Leasing can be arranged.
27. DELIVERY and INSTALLATION FREE within UK.
28. We have examples of other Accounts Programmes on the market which you are welcome to try, and compare them with "CFACC".
29. PETS, TANDY'S & APPLES taken in part exchange for complete systems.
30. Automatic Loading — You simply insert the Disk.
31. "CFACC" will run on any CP/M Micro with a true 64K.
32. Special versions available with 'Back Order Files', Job Cost Files', Raw Finished Stock Files for manufacturers, Client Account Files with time allocation for Service Industries.
33. We also stock other Software such as Calcstar, Datastar, various languages, Supersort etc.

64K 'SUPERBRAIN' (350K DISK STORAGE) — DAISYWHEEL PRINTER WITH KEYBOARD  
— "CFACC" ACCOUNTS — "WORDSTAR" Word Processing.

★ ★ ALL FOR £4,286 ★ ★

Computers For All Ltd, Stratford on Avon (0789) 840064

Ring for our information folder which will tell you the questions to ask the Others.

● Circle No. 259



# LONDON COMPUTER CENTRE



## NEW! from Tele Video the 802 £2,250

- ★ Expandable to multi-user system and hard disks.
- ★ Superbrain compatability.
- ★ CPM operating systems 64K Ram. Real Time Clock.
- ★ Detachable keyboard with 12 function keys (Wordstar option).
- ★ Expandable up to 6 users, multi-tasking system with Emperor 20 (10m byte hard disk) 64K processor, back-up floppy disk £4,500.
- ★ Plus each user terminal with 64K Ram, only £1,050.
- ★ Green screen — true decenders.
- ★ Built in 1 Mbyte dual disk drives.
- ★ Full graphic capabilities.
- ★ OPTIONS.
- ★ 10m Hard disk £1,995.



## ACT SIRIUS 1

SIRIUS 1  
16 bits for the price of 8 bits

£2,395  
128K RAM  
1.2M storage

### The SPECIAL LCC APPLE SYSTEM

48K Apple Dual 40 Track Disk Drives & 12" Green Screen Monitor £1,395  
80 Column card with Decenders £135  
CPM Softcard £95  
16K (Integer) Card £65  
Centronics Parallel Card £75  
Serial Printer/Communications Card £75



EPSON  
MX-80 FT  
MX-80 FT2  
MX-100

### SUPERBRAIN WITH NEW EXTRA FEATURES FROM £1,795



AUTO SHEETFEEDER £580

New! 12" wide Automatic Sheet Feeder fits all below

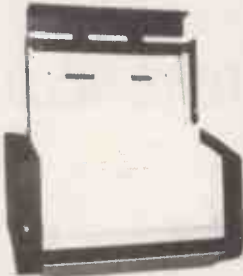

## AUTHORISED TANDY DEALERS

Model I 48K System 2 Disk Drives Green Screen Complete £995	Model II with CPM and TRS DOS at no extra charge from £1,995	Model III 16K £650 48K £695 48K with disk drives £1,350
---	--	---

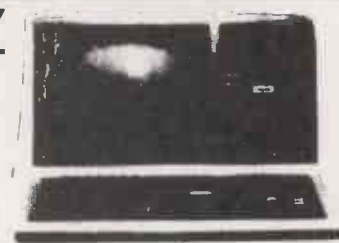

## PET! APPLE! TRS80! HORIZON! OWNERS!

Let LCC — the BIG COMPUTER CENTRE —  
put you a cable's length away from

### LETTER QUALITY PRINTING with 7 Star Printers.

Olivetti ET21. 20 CPS. Doubles as typewriter	£795
TEC 40. 40 CPS. JAPANESE DIABLO 630 uses Diablo Daisy Wheel & Ribbons	£1,235
Daisy Wheel II 60 CPS. RICOH 1600 Daisywheel	£995
Qume SPRINT 5: 45 CPS.	£1,350
FLOWRITER RP 1600 60 CPS.	
The most intelligent Daisy	
8K Buffer/Bi Directional Printing	
X ON/OFF. Right justify Repeat Built-in	£1,500
NEC. 55 CPS.	£1,650
FUJITSU 80 CPS. Plastic/Metal wheels	£1,695

DEMONSTRATIONS ON ALL MODELS

ALL PRICES ARE EXCLUSIVE OF VAT AND DELIVERY  
DEALER ENQUIRIES INVITED ON ALL PRODUCTS

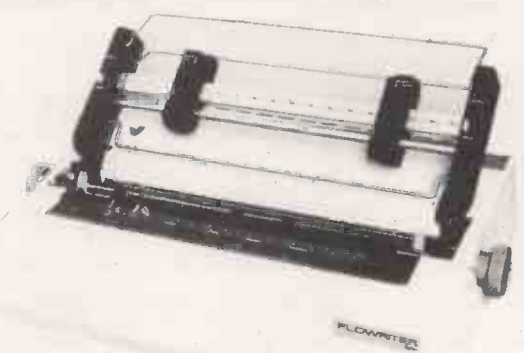

43 GRAFTON WAY, LONDON W1P 5LA (Opposite Maples )  
OPENING HOURS: 11-7 MON-FRI 12-4 SAT Tel: 388 6991/2  
24 hour answer phone: 01-388 5721



## PROFESSIONALS IN APPLICATIONS

FOR

- ★ ACCOUNTING, INVOICING & STOCK CONTROL
- ★ FINANCIAL MODELLING AND PLANNING.
- ★ WORD PROCESSING AND MAILING.
- ★ PROJECT CONTROL & COSTING.
- ★ DATABASE & TAILORED SOFTWARE.
- ★ APPLE AND CP/M.
- ★ SINGLE AND MULTI USER.
- ★ UK AND INTERNATIONAL EXPORTS.

KOMPUTATION AUTOMATION INFORMATION LTD  
203A Belsize Road, London NW6

01 328 7038      01 328 3968

24 hour personal answering service 01 486 4808



PLUS OTHER GOOD MICROS

● Circle No. 261

## FINAL RADIO AND ELECTRONICS EXHIBITION AT BELLE VUE

by the Northern Amateur Radio Societies Association  
in the

## LANCASTER HALL, BELLE VUE, MANCHESTER

on Sunday 4th April 1982, doors open at 11 a.m.

The North's Premier Amateur Radio and Electronics Event

### Features

Inter club quiz, Grand raffle, Construction contest  
Amateur computer stands, RSGB bookstall  
Radio Society stands and Trophy, Home Office and  
Raynet stands

The following traders have booked space

Eurova Ltd	Amateur Radio Exchange	Stevens James Ltd
J Birkett	The Amateur Radio Shop	Isherwood Electronics
Radiotronics	Microwave Modules	Bredbury Electronics
Lowe Electronics	John's Radio	Display Electronics
PM Electronic Services	New Cross Radio	SGS Electronics
PKG Electronics	W. H. Westlake	The Computer Junk Shop
US Electronics	Telecom	Arrow Electronics Ltd
Thanet Electronics	Leeds Amateur Radio	Royd Electronics
Electrovalue Ltd	Newton Engraving	Ace Mailtronix Ltd
Elphan Electronics	Packer Communications	Gemini Electronic Components
J Peterson	Micro Print Ltd	Tony's Radios
Elkan Electronics	Chris Moulding	J. M. G. Electronics
Sutton Electronics	Gemini Communications	Sota Comm. Syst. Ltd
S.M.C. (Jack Tweedy) Ltd	R.S.G.B. Books	M K Electronics
Wilson Valves	Scorpio Amateur Aerials	

Belle Vue has ample car parks

FM Talk in on GB3NRS & G8NRS/A on 145MHz CkS22 R2 R6  
and on 433MHz Chs SU8 RB4 RB4

ADMISSION 60p BY RAFFLE TICKET AND EXHIBITION PLAN  
ENTER AT REAR OF BELLE VUE OPPOSITE MAIN CAR PARK OFF HYDE ROAD A57

● Circle No. 262

## MICROMAS GENERAL ACCOUNTING

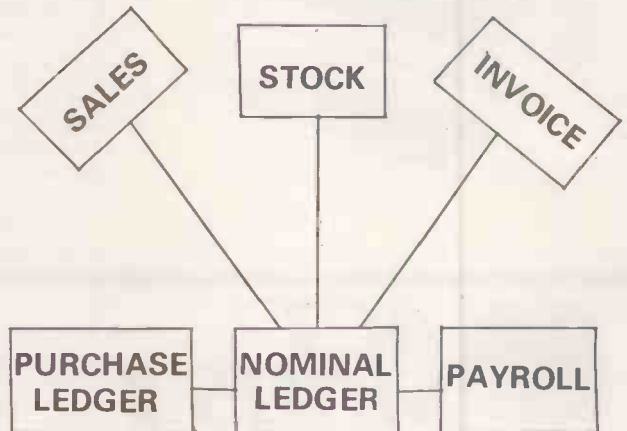

## CONTRACT COSTING

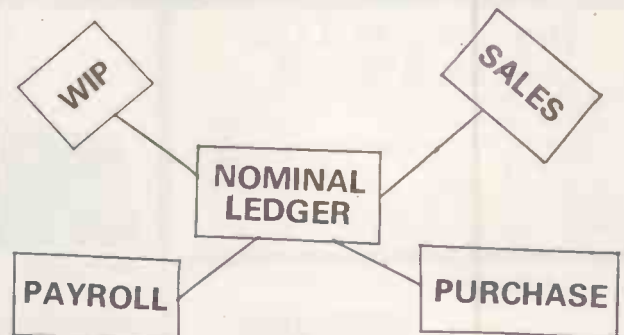

## SOLICITORS ACCOUNTING

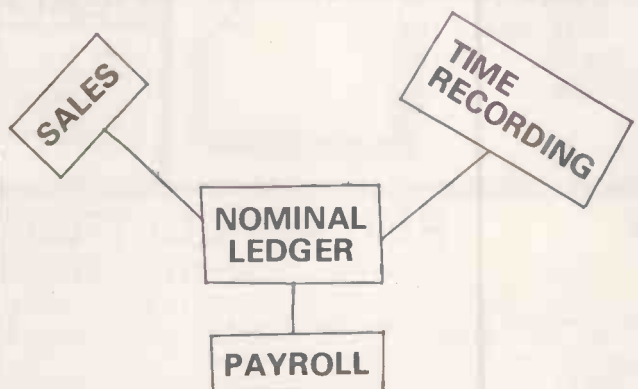

For use as a complete system or in module form for any CP/M with Microsoft BASIC from a European and nationwide dealer network trained in system implementation.



Contact us for your nearest dealer.

**P. R. Daly & Co. Limited**

*Systems Consultants*

Oaklands Gate,  
Northwood,  
Middx.

Tel. Northwood (09274) 29815 or 28683

● Circle No. 263





# CP/M Z80/8080 SOFTWARE now on mail order from digital devices ltd

## SuperSoft

### EXCLUSIVE EUROPEAN DISTRIBUTORS

#### C COMPILER

The compiler supports most of version 7 Unix standard C. • Macro expansions • Include files • Inline assembly code • Object code may be ROMed • Programs may be ORGed for any location • Completely dynamic memory allocation is supported • A two pass compiler, the first pass of the compiler produces an intermediate code • Pass two contains both the translator and the optimizer • An important feature of the compiler is that assembly code is produced • "Hand optimization" of critical sections is possible • Re-entrant code • Relocatable  
Requires: 48K CP/M, (more recommended)  
C compiler: £115.00 Manual only: £15.00  
Z8000 cross-compiler: £265.00 CP/M to Z8000 code.  
Requires Z8000 assembler: £270.00 (CP/M)  
Manuals only: £15.00

#### FORTRAN IV & RATFOR

The SSS FORTRAN compiler is fast, efficient, and complete (full 1966 ANSI standard with extensions). RATFOR compiler compiles into FORTRAN allowing the user to write structured code while retaining the benefits of FORTRAN • Many advanced features supported • complex arithmetic • character variables • functions • SSS RATFOR allows the use of contemporary structured programming techniques • REPEAT...UNTIL...WHILE IF...THEN...ELSE • SSS RATFOR is supplied with source code.  
Requires: 32K CP/M, Z80 only.  
SSS FORTRAN (Signed licence required) £140.00  
RATFOR (For SSS FORTRAN only) £65.00  
Manuals only: RATFOR £5.00 FORTRAN £15.00

#### FORTH

StackWork's FORTH is full, extended FORTH interpreter/compiler that produces COMPACT, ROMable code • As fast as compiled FORTRAN • As easy to use as Interactive BASIC • SELF COMPILING includes every line of source code necessary to re-compile itself; EXTENSIBLE, add functions at will; CP/M COMPATIBLE; Z80 & 8080 ASSEMBLERS included. (Please specify).  
£115.00 Manual only: £25.00

#### DIAGNOSTICS II

A complete program package designed to check every major area of your computer. • Memory Test • CPU Test (8080/8085/Z80) • Printer Test • Disk Test • CRT Test • Every test is "submit"-able • All output can be directed to a log file for unattended operation • A quick test for immediate verification of the working of your system • Memory test includes • Default to the size of the CP/M Transient Program Area • Printout of a graphic memory map • Burn in test • Bank selection option • Memory speed test • Spinwriter/Diablo/Qume test. (Serial interface).  
Requires: 32K CP/M  
£65.00 Manual only: £10.00  
DIAGNOSTICS I: £52.00 Manual only: £10.00

#### DISK DOCTOR

DISK DOCTOR for CP/M: a program to recover "crashed" discettes AUTOMATICALLY! • DISK DOCTOR does not require any knowledge of CP/M file structure! If you can operate CP/M, then you can use DISK DOCTOR • Verifies discettes and locks out bad sectors without touching the good files that remain • Copies whatever can be read from a "crashed" file and places it into a good file. • Copies discettes without stopping for bad sectors. • "Un-erases" files.  
Requires: 48K CP/M. Two drives are needed for complete operation.  
£65.00 Manual only: £5.00  
UTILITY PACK I General utilities £45.00  
UTILITY PACK II General utilities £45.00  
(See earlier issues for details)

#### ENCODE/DECODE III

A sophisticated encryption system to protect your files • Needs user supplied; • password • and 10 digit combination • 10,000,000,000 combinations • Version II does second pass hash • Unrecoverable.  
Requires: 32K CP/M  
ENCODE/DECODE I: £40.00  
ENCODE/DECODE II: £65.00  
Manuals only: £15.00

#### TERM II

The TERM II subsystem is an interactive program allowing any CP/M computer to communicate with other TERM II user and other computers in general. • Users may "talk" easily to one another • Users may transmit selected ASCII files to one another and with an external computer system by emulating an ASCII terminal • Perform, under user control, character translation • Distributed as an 8080 assembler source file and requires the user to patch the modem ports into the program.  
Requires: 32K CP/M  
£115.00 Manual only: £20.00  
TERM I £90.00 Manual only: £5.00

#### TINY PASCAL

Chung/Yuen • Random & sequential Disk I/O • Compiles completely into 8080 code • Complete source code for compiler and library • 36K CP/M  
£65.00 Manual only: £5.00

#### SCRATCHPAD

ELECTRONIC WORK SHEET • A user interactive data modelling program suitable for; • financial planning • General purpose modelling • For executives, researchers or family budgets • Numeric correlations for sound decision making • Provides labels and corresponding numeric entries • Cross referenced by row and column • Entries defined as dependent variables • User-created algebraic formulae • Changes affect one another • Multiple screen splitting • Immediate algebraic calculation modes • Easily changed data table column width • Results not continually viewed, quickly brought to screen • On split screen viewing • Print any part of the STAT-GRAPH performs statistical analysis • Displays in graphic form • Scatter Graph • Scatter Graph • Standard Deviation • Median • Max and Min • Standard deviation • Regression • Easy to run and interact • DATA-VIEW easy to use, free format system for organising information • Electronic filing cabinet • Date book • Easy editing • Retrieval by file, string or keyword.  
SCRATCHPAD £115.00 STAT-GRAPH £115.00  
DATA-VIEW £115.00 Total package £300.00  
Manuals only: £20.00 each. All three £50.00

#### MAG

PRISM is a complete information management system integrating the best features of a versatile database system with those of a sophisticated program development system • PRISM/IMS is the database management section • No programming whatsoever is required; applications include • Patient records • Information control • Customer lists • Entirely menu operated, yet uses multi-keyed files • Powerful browse and query capability.  
PRISM/ADS is a complete development tool for specialized applications: • User defined menus • Screen management functions • Complete library of fully debugged routines (e.g. entry & edit) • Complete file management system provided. PRISM/ADS includes PRISM/IMS

PRISM/LMS is the ultimate multipurpose list management system. • 1001 uses — mailing lists, customer lists, parts lists etc. • Store the information you require • Menu driven • Fully formatted • No programming or technical expertise. PRISM requires: 48K CP/M & CBASIC-2. Cursor addressing CRT with clear screen.  
PRISM/ADS £585.00 Manual only: £80.00  
PRISM/IMS £380.00 Manual only: £68.00  
PRISM/LMS £210.00 Manual only: £60.00

#### MAGSAM

Picks up where your BASIC leaves off by providing it with a powerful Keyed File Management System that is quick and easy to use, providing features

seldom found on any computer micro, mini or mainframe • Sophisticated access techniques, random, sequential and generic retrievals by key. • Secondary indexing with any number of keys • Key and record deletes with auto reclaim of freed space • Concatenated keys • File structures are dynamically allocated, and compatible with BASIC file facilities • Interactive tutorial and file dump facilities. MAGSAM III CBASIC-2, Microsoft BASIC 80 compiler/Interpreter 8080 or Z80.  
£136.00 Manual only: £55.00  
MAGSAM IV high performance assembler version 75% faster than III.  
CBASIC-2 only Source 8080 assembler.  
£240.00 Manual only: £55.00  
Magsam needs 32K, 48K recommended if memory is critical, telephone hot-line for exact details.

#### MAGSORT

Full feature Sort/Select/Merge • Interfaces to CBASIC-2, Microsoft BASIC, FORTRAN-80 • Only 2 statements • No dedicated memory, relocation or special interfacing • Runs stand alone • Written in 8080/Z80 assembler uses entire user memory for buffer • Fastest possible sorting.  
£240.00 Manual only: £55.00

#### ECOSOFT

MICROSTAT 2. Advanced stats pack for use in research, education and industry. • Complete Data Management Subsystem. • Includes edit, sort, rank order and many more. • Data transforms, arithmetic and logarithmic. • Hypothesis tests. • ANOVA. • Simple & multiple regression. • Correlation analysis. • 11 Non-parametric tests. Also includes • Moments • Skewness • Kurtosis • Stepwise multiple regression • Faster sort • Longer file names • Ability to declare each data file's numeric precision • Expanded manual giving equations and file structures.  
Available in CBASIC-2, Microsoft BASIC 80, & North Star DOS.  
£175.00 Manual only: £25.00

#### NORTH STAR HORIZON

MATCHMAKER I & II from SoHo • converts N\*BASIC programs to run under CP/M. Converts BASIC to a COM file • Programs convert by loading and restoring • Version II for DOS 5.2 • Version I for DOS 5.1 • Totally self-installing under CP/M 2 • North Star Horizon only.  
MATCHMAKER I £65.00 Manual only: £5.00  
MATCHMAKER II £75.00 Manual only: £10.00

NORTH STAR BUS from SZ Software • Global line editor with scrolling • 26 commands for locate, change, line, insert, copy, append, line move, erase columns, etc. • Packs programs. • Formatted printing with full cross-referencing of all variables, strings, arrays, functions and subroutines • Co-resident with BASIC or ROMable.  
NORTH STAR SORT • Adds "SRT" statement • Co-resident or ROMable • Sorts 1800% faster • Sorts 1 & 2 dimensional arrays and strings.  
North Star BUS £50.00 North Star SORT £60.00  
Manuals only: £10.00

#### TERMS AND CONDITIONS

Software available from stock on North Star 5.25 in SS/DD, 8 in IBM 3740 SS/SD, and on Superbrain DD/QD, other formats available please enquire.

CASH WITH ORDER for goods by return. Unless account customer, Post & Packing at £1.50 per item, plus VAT at 15%. All orders sent 1st class post. The manual cost is deductible on subsequent software purchases. No VAT on manuals. Dealer terms available on request. 5+ 20%, 10+ 25% etc.

Technical advice HOT-LINE (0892) 20307, answered only when technician available.

BARCLAYCARD, ACCESS, DINERS CLUB, AMERICAN EXPRESS, ACCEPTED.

DIGITAL DEVICES LIMITED  
134 LONDON ROAD, SOUTHBOROUGH  
TUNBRIDGE WELLS, KENT

Tel: (0892) 37977-9/39546-9

Telex: 95582

The following are registered trademarks: Z80 and Z8000 of Zilog Inc., CP/M of Digital Research, UNIX of Bell Laboratories, CBASIC-2 of Compiler Systems, Microsoft BASIC 80 and FORTRAN-80 of Microsoft Inc., North Star of North Star Computers Inc., PRISM, MAGSAM and MAGSORT of Micro Applications Group, MICROSTAT II of Ecosoft Inc.

April 23-25, 1982  
Earls Court, London

Friday & Saturday: 10am – 6pm  
Sunday: 10am – 5pm

Admission £2.00 adults  
£1.00 children under 16.

# THE Computer Fair

Personal computers  
Home computing  
Small business systems

The computer is with us and soon to be as familiar in the home as your television, video or hi-fi. But much more versatile!

A home computer can be the family's resident teacher, accountant, home economics expert, memory bank and endless source of amusement! It can do anything you programme it to do – from teaching mathematics to the children or computing the most economic use of household fuels for yourself, as well as providing hours of fun on a rainy afternoon. Most important of all, the home computer will teach you and your family about computers – and this is the technology that your children are growing up with.

In the office, the personal computer is rapidly replacing the obsolete mound of box files, adding machines and notebooks on thousands of desk tops. Microchip streamlining means increased efficiency in hundreds of different fields.

*Sponsored by  
Practical Computing  
and  
Your Computer*



**HALF PRICE  
ADMISSION  
VOUCHERS**



# Bringing computers to everyday life

At The Computer Fair you can see and compare an enormous range of personal and home computers. Find out what they can do and which one would suit you best. Talk to the experts and discover for yourself how much – or how little – you need to spend. Choose from an amazing abundance of software programs and packages, cassette units, VDU terminals and scores of computer games.

Swap your views and know-how with hundreds of other home computer enthusiasts – and find out a whole lot more from computer professionals.



Plus – The Micro Mouse Contest.

Come and watch the incredible ingenuity of computer controlled "mice" and how they find their way (or not!) to the centre of a maze. The knockout heats and the Euromicro British Final can all be seen at The Computer Fair!

Bring the whole family – don't miss this opportunity of bringing computers into your everyday life.



for readers of  
**Practical  
Computing**



# WHY ARE 45 MULTINATIONALS C/WP CUSTOMERS?

C/WP is a long established service company based in Rochester Row, London SW1.

C/WP Computers is an Apple authorised level 1 service centre.

C/WP now offers Practical Computing readers the chance to buy at its special prices.

Contact C/WP if you are interested in:

Financial forecasting  
Communications  
CP/M on Apple

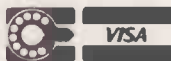

## Apple/Visicalc offer

Apple 48K Europlus	£ 579
Disc drive with controller	£ 310
12" green monitor	£ 110
Silentype printer	£ 180
Visicalc 3.3	£ 100
<hr/>	
VAT and installation extra 12 months guarantee	£1279

# C/WP

C/WP Computers  
01-828 3127  
108 Rochester Row  
London SW1P 1JP



# MAPLIN the people for Atari



## 3 Consoles available:

**Atari 400 with 16K RAM(AF36P) £345**

**Atari 400 with 32K RAM(AF37S) £395**

**Atari 800 with 16K RAM (AF02C) £645**

### Lots of other hardware:

Cassette Recorder	(AF28F)	£50.00
Disk Drive	(AF06G)	£345.00
Thermal Printer	(AF04E)	£265.00
Printer Interface for 400	(AF41U)	£49.95
Printer Interface for 800	(AF42V)	£49.95
Interface Module	(AF29G)	£135.00
Versawriter	(AF43W)	£169.00

16K RAM Module	(AF08J)	£64.00
32K RAM Module	(AF44X)	£125.35
32K Upgrade for 400	(AF45Y)	£75.00
Floppy Disk	(YX87U)	£2.75
Le Stick	(AC45Y)	£24.95
Joystick Controllers	(AC37S)	£13.95

For full details ask for our hardware leaflet (XH54J) SAE appreciated

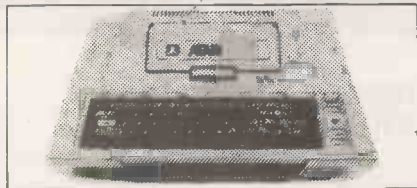

**NOW YOU CAN JOIN THE U.K. ATARI COMPUTER OWNER'S CLUB. An independent user's group.  
Four issues of the club magazine for only £1.60! Address your subscription to Graham.**

## THE CHOICEST GEMS OF ATARI SOFTWARE FROM MAPLIN

### Adventure Games

Star Warrior	C-32K-(B0248)	£28.95
Rescue At Rigel	C-32K-(B021X)	£22.45
Invasion Orion	C-32K-(B023A)	£18.95
Datestones of Ryn	C-32K-(B022Y)	£14.95
Galactic Empire	C-24K-(B014Q)	£14.95
H-Res Adventure // 2	D-48K-(B025C)	£24.95
Analog Adventure	D-32K-(B033L)	£24.95
Adventure Land	C-24K-(B000A)	£14.95
Pirates Adventure	C-24K-(B001B)	£14.95
Mission Impossible	C-24K-(B002C)	£14.95
Voodoo Castle	C-24K-(B003D)	£14.95
The Count	C-24K-(B004E)	£14.95
Strange Odyssey	C-24K-(B005F)	£14.95
Mystery Fun House	C-24K-(B006G)	£14.95
Pyramid of Doom	C-24K-(B007H)	£14.95
Ghost Town	C-24K-(B008J)	£14.95
Savage Island I	C-24K-(B009K)	£14.95
Savage Island II	C-24K-(B010L)	£14.95
Golden Voyage	C-24K-(B011M)	£14.95
Energy Czar	C-16K-(YG53H)	£8.95
Kingdom	C-8K-(YG55K)	£8.95

### Teach-Yourself Programs

Conversational French	5C-16K-(YG44X)	£32.50
Conversational German	5C-16K-(YG45Y)	£32.50
Conversational Spanish	5C-16K-(YG46A)	£32.50
Conversational Italian	5C-16K-(YG47B)	£32.50
Touch Typing	2C-16K-(YG49D)	£14.95
States & Capitals	C-24K-(YG56L)	£8.95
European Countries & Capitals	C-16K-(YG57M)	£8.95

### Learn Programming

Invitation to Programming	C-8K-(YG43W)	£11.95
Basics of Animation	C-32K-(B057M)	£9.95
Basics of Animation	D-32K-(B058N)	£10.95
Player Missile Graphics	C-16K-(B059P)	£18.95
Player Missile Graphics	D-24K-(B060Q)	£19.95
Display Lists	C-16K-(B051F)	£9.95
Display Lists	D-24K-(B052G)	£10.95
Horiz/Vertical Scroll	C-16K-(B053H)	£9.95
Horiz/Vertical Scroll	D-24K-(B054J)	£10.95

Page Flipping	C-16K-(B055K)	£9.95
Page Flipping	D-24K-(B056L)	£10.95
Master Memory Map	Wallchart-(XH57M)	£4.00

### Business Programs

Visicalc	D-32K-(YL39N)	£119.95
Word Processor	D-32K-(YG42V)	£85.00
Calculator	D-24K-(YG50E)	£16.95
Graph-It	C-16K-(YG51F)	£11.95
Statistics	C-16K-(YG52G)	£11.95

### Arcade Games

Star Raiders	E-8K-(YG66W)	£29.95
Asteroids	E-8K-(YG60O)	£29.95
Space Invaders	E-8K-(YG70M)	£24.50
Missile Command	E-8K-(YG64U)	£29.95
Super Breakout	E-8K-(YG67X)	£29.95
Tari Trek	C-24K-(YL36P)	£8.95
Tari Trek	D-32K-(YL37S)	£11.95
Star Trek 3.5	C-32K-(B015R)	£14.95
Race In Space	C-16K-(B035O)	£14.95
Shooting Gallery	C-16K-(B036P)	£14.95
Mountain Shoot	C-16K-(B012N)	£10.95
Jawbreaker	D-48K-(B026D)	£22.95
Basketball	E-8K-(YG61R)	£29.95
Tank Trap	C-16K-(YL34M)	£8.95
Tank Trap	D-32K-(YL35O)	£11.95

### Home Game Programs

Scram	C-16/24K-(YG58N)	£12.95
Cypher Bowl	C-32K-(B020W)	£22.45
Thunder Island	C-16K-(B037S)	£10.95
Rotating Tilt	C-16K-(B048C)	£14.95
Lunar Lander	C-16K-(B016S)	£10.95
Jumbo Jet Lander	C-16K-(B046A)	£29.95
Submarine Commander	C-16K-(B047B)	£24.50
Sunday Golf	C-16K-(B013P)	£10.95
Darts	C-16K-(B042V)	£19.95
Tournament Pool	C-16K-(B045V)	£19.95
Snooker & Billiards	C-16K-(B044X)	£19.95
Chess	E-8K-(YG63T)	£29.95
Microchess	C-16K-(YL40T)	£15.95
Checker King	C-16K-(YL41U)	£15.95
Cribbage & Dominoes	C-16K-(B043W)	£14.95

Poker Solitaire	C-16K-(B017T)	£10.95
Blackjack	C-8K-(YG62S)	£8.95
Fast Gammon	C-8K-(YL33L)	£9.95
Reversi (Dthello-type)	C-16K-(B019V)	£14.95
Gomoko	C-16K-(B018U)	£14.95
Hangman	C-8K-(YG54J)	£8.95
Humpty Dumpty & Jack & Jill	C-16K-(B038R)	£19.95
Hickory Dickory Dock	C-16K-(B039N)	£19.95
British Heritage		
Jig-Saw Puzzles	C-16K-(B040T)	£19.95
European Scene		
Jig-Saw Puzzles	C-16K-(B041U)	£19.95
Atari Safari (25 Programs)	C-16K-(B049D)	£18.95
Atari Safari (25 Programs)	D-16K-(B050E)	£24.95
Mind Bogglers (3 Programs)	C-16K-(YL38R)	£8.95

### Music Programs

Music Composer	E-8K-(YG48C)	£32.50
Movie Themes (use with Music Composer)	C-16K-(B034M)	£9.95

### Computer Languages

Basic A+	D-48K-(B031J)	£52.50
Operating System A+	D-48K-(B030H)	£52.50
Basic A+ & Operating System A+	D-48K-(B032K)	£99.50
OS Forth	D-24K-(YL29G)	£44.90
Pilot	E-8K-(YG68A)	£49.50

### Utilities

3D-Super Graphics	D-48K-(B028F)	£29.95
3D-Super Graphics	C-48K-(B029G)	£29.95
Atari World (Graphics)	D-48K-(B027E)	£43.95
Assembler Editor	E-8K-(YG66Y)	£34.50
Assembler	C-16K-(YL32K)	£14.95
6502 Disassembler	C-8K-(YL30H)	£8.95
6502 Disassembler	D-8K-(YL31J)	£11.95
Character Generator	C-16K-(YL27E)	£9.97
Character Generator	D-16K-(YL28F)	£12.50
Teletink	E-8K-(YG59P)	£14.95

Key: C = Cassette, D = Disk, E = Cartridge.  
2C = 2 Cassettes etc. 8K: 16K etc. shows minimum memory requirement.

Send sae now for our new software leaflet with details of all the above programs. Order As XH52G — Issue 2.

Lots of exciting new software titles available soon. Keep in touch with Maplin!

Subscribe now to America's leading Atari-only magazine — Analog — 6 issues per year for just £9.00. Order as GG24B.

# MAPLIN

Maplin Electronic Supplies Ltd  
P.O. Box 3, Rayleigh, Essex.  
Tel: Southend (0702)  
552911/554155.

Demonstrations at our shops NOW  
See the amazing Atari's in action at  
159-161 King St., Hammersmith W6  
Tel: 01-748 0926  
or at 284 London Road,  
Westcliff-on-Sea, Essex.  
Tel: (0702) 554000

Note: Order codes shown in brackets. Prices firm until 15th May, 1982 and include VAT and Postage and Packing (Errors excluded).

# THREE PET TITLES

## from

# Nick Hampshire

### LIBRARY OF PET SUBROUTINES

A book which will save the software designer considerable time by providing 55 proven subroutines to integrate with his own programmes.

Each subroutine is preceded by a page of general information describing its purpose and implementation and possible problems that may arise. Basic, machine language and a combination of both, are used throughout this publication.

"... We like this book very much and thoroughly recommend it."

*Printout*

"... well prepared, fun to use, and will help in better program development."

*Compute*

### THE PET REVEALED

A reference book which details everything you need to know about the workings of the PET. Containing information helpful to writing more elaborate programmes, which in turn create more interesting functions.

"... Should be congratulated. Supplies some much needed, useful and correct documentation."

*Compute*

"... 'PET Revealed' will save you an awful lot of time. I rate this book as good value for money."

*Printout*



All 3 publications are widely used by Commodore Business Machines.

### PET GRAPHICS

This book has two objectives. One, to provide the reader with an introduction to the programming techniques used to generate graphic displays.

Two, providing the programmer with a complete package of machine code routines giving a wide range of normally unavailable graphic functions. The book contains many comprehensively analysed routines and photographs to illustrate the effects created.

"... an invaluable guide to graphics on the PET."

*Micro Forecast*

#### Please send me:

..... copy/ies of Library of PET Subroutines  
@ £10.00 each

..... copy/ies of The PET Revealed  
@ £10.00 each

..... copy/ies of PET Graphics @ £12.00 each

I enclose a cheque for £ ..... payable to  
Computabits Ltd., P.O. Box 13, Yeovil, Somerset.

Name .....

Address .....

Postcode .....

✂  
● Circle No. 267



Check our prices against similar lists!!!

Micro Business Centre Ltd,  
Linthouse Lane, Wednesfield,  
Wolverhampton, West Midlands.  
Tel (0902) 725687

**NEW SHOP**

Check our prices against similar lists!!!

A.B.C. Ltd,  
Sutton Computer Centre, 28 High Street,  
Sutton Coldfield, West Midlands.  
Tel 021-354-2684

# MICROCOMPUTERS

AT:

## ABC HARDWARE — JUST LOOK AT THESE PRICES!!!!!!!

- ★ 12" Green Screen Monitor + cable 99.95
- ★ New! Colour Card for Apple — true colours, inc. mod. 49.95
- ★ Box of 10 blank discs 14.95

Add 15% V.A.T. (P&P inc.)

### APPLE

	Cost	V.A.T.	Total
★ Apple 111	2545.00	381.75	2926.75
★ Disk 111	385.00	57.75	442.75
Silentype 111	222.00	33.30	255.30
★ Apple 11 48k. + colour card, modulator	695.00	104.25	799.25
★ Disk Drive + contr.3.3	375.00	56.25	431.25
★ Disk Drive	295.00	44.25	339.25
★ 12" Green Screen Monitor	99.95	14.99	114.94
Programmers Aid	26.00	3.90	29.90
Autostart Rom Pack	33.00	4.95	37.95
★ Versawriter — graphics pad	149.95		
★ Silentype	195.00	29.25	224.25
★ Tantel (Prestel)	170.00	25.50	195.50
B/W Modulator	14.00	2.10	16.10
Pascal Lang. System	245.00	36.75	281.75
Applesoft Firmware Card	95.00	14.25	109.25
Integer card	95.00	14.25	109.25
16k. Ram Card (48k- 64k.)	95.00	14.25	109.25
Apple Pilot	79.00	11.85	90.85
Apple Fortran	105.00	15.75	120.75
Apple Prototype/Hobby Card	12.00	1.80	13.80
Parallel Printer Interface	65.00	9.75	74.75
High Speed Serial Interf	65.00	9.75	74.75
Centronics Card	65.00	9.75	74.75
Communications Card	103.00	15.45	118.45
Colour Card inc. T.V. mod true colours	49.95	7.49	57.44
IEEE-488 Interface	230.00	34.50	264.50
Thermal Paper for Silentype	2.75	.41	3.16
C.P.S. Multifunction Card (Clock/Printer Card)	135.00	20.25	155.25
Supertalker	140.00	21.00	161.00
Romplus + Keyboard Filter	127.00	19.05	146.05
Rom Writer	105.00	15.75	120.75
AD + DA 16 Channel	210.00	31.50	241.50
Numeric Keypad	75.00	11.25	86.25
Videx 80 col card	185.00	27.75	212.75

### JUST AVAILABLE — NEW PRODUCTS TO ENHANCE YOUR APPLE SYSTEM

Apple 5.25" Winchester from: Join up to 127 Apples with "R.O.S."	1872.00	280.80	152.80
Micro Modem	449.00	67.35	516.35
The Mill (6809 board)	169.00	25.35	194.35
Expeditor Basic Compiler	230.00	34.50	264.50
Micro Modeller	79.95	12.00	91.95
Micro Planner	399.00	59.85	458.85
	695.00	104.25	799.25

### EXCLUSIVE ABC SOFTWARE

DISKIO — Disk program and file recovery system — you'll wonder how you managed without it! Send for full details.

49.95 7.50 57.45

INTEGRATED SALES/PURCHASE/NOMINAL LEDGER SYSTEM, WILL SUPPORT 50 — 5000 ACCOUNTS, WRITTEN AND FULLY SUPPORTED BY OUR QUALIFIED STAFF. AVAILABLE INTEGRATED OR STAND ALONE.

Integrated	889.95	133.50	1023.45
Stand Alone	349.00	52.35	401.35

### COMMODORE PETS AT CASH AND CARRY PRICES!!!!!!!

Looking for a Pet computer? — try us last — up to 12.5% off list prices PLUS £50.00 TRADE-IN for your Sinclair ZX80 or 81. Pet 4083 (new screen), Pet 8032, Disk Drives, Printers, etc, all in stock.

VIC PERSONAL COMPUTERS — on continuous demonstration at both showrooms.

### CIFER MICROCOMPUTERS

British Made — Twin Z80 (4MHZ) Microcomputer System + CPM 80 column display — 64k. User Memory + 64k. Screen Memory

#### 2600 RANGE

2683	£1970.00	ex V.A.T.
2684 (400k. integral DD)	£2357.00	ex V.A.T.
1880 RANGE (All integral drives + 1000 x 300 point graphics)		
1886 (2 x 800k. integral DD)	£2700.00	ex V.A.T.
1888 (3 x 800k. integral DD)	£3150.00	ex V.A.T.
1885 (6 to 12 mgb.) from	£4530.00	ex V.A.T.
1887 (1 x 800k. + 1 Winchester)	£4980.00	ex V.A.T.

### PRINTERS

Selection from our vast range:

	Cost	V.A.T.	Total
Epson MX 100	549.95	82.50	632.45
Epson MX 82/F/T	399.95	60.00	449.95
Olympia Scripta K.S.R.	945.00	141.75	1086.75
Olympia Scripta R.O.	775.00	116.25	891.25

### COMPUTER BOOKS + MAGAZINES — GOOD SELECTION IN BOTH SHOWROOMS

Beneath Apple D.O.S.	12.95
Computers for Kids (Apple, Pet, TRS80)	4.95
Introd. to Pascal	11.50
Z80 Assembly	12.80
Basic Applications	7.95
(No VAT — sent by return post — many other titles)	

Note: All goods in stock at time of going to press. We will not be beaten on prices, phone David Anderson for latest prices. Allow 7 days for cheque clearance. Advantageous leasing terms for businesses. Suppliers of Micro Computers to Public Companies — Local Authorities — Educational Establishments etc.

**SPECIAL OFFER!**

48K APPLE II ..... £640 ex VAT  
 APPLE DISK + CTL ..... £335 " "  
 APPLE DISK ..... £270 " "

35L supply a full range of hardware, software and accessories to meet all your needs at highly competitive prices.

Prices include p&p.

**ORDER NOW FOR EARLY DELIVERY!**

**35L**

P.O. BOX 19  
 SANDBACH  
 CHESHIRE

Telephone Nos.  
 09363-6031 or  
 09367-3842

● Circle No. 269

**Convert your PET to a terminal for £180!**

Why spend £4000 on a terminal when you can convert your Commodore PET for only £180 to do exactly the same thing?

Kingston offer you this with NETKIT – a hardware/firmware package which dramatically widens the scope of the PET, and maintains Kingston's reputation as market leaders in computer communications and interfaces.

● Netkit allows the PET to link to any RS232 Device, including another PET, micro, most mini and main frame computers.

● Easy to use, no complicated machine code for input.

● Gives automatic character conversion.

Useful in programming and linking to paper tape punches, instrumentation and control devices.

● Can be used as a normal printer interface.

● High speed transmission via RS232 and not IEEE.

● Detailed manual, cable corrections and supporting software also included.

Hundreds of NETKITS have well documented operational reliability in numerous applications. Find out more for yourself, just send for further information on NETKIT and other Kingston products: Once you've seen our leaflet you may wish to take up our 30 day sale or return offer. We are sure you'll be convinced.

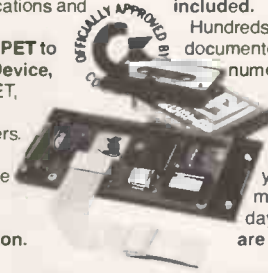

OFFICIALLY APPROVED BY

**KINGSTON**

Kingston Computers Limited, Electricity Buildings, Ffiley, Yorkshire, U.K.  
 Telephone: 0723 514141 Telex: 52163

● Circle No. 270

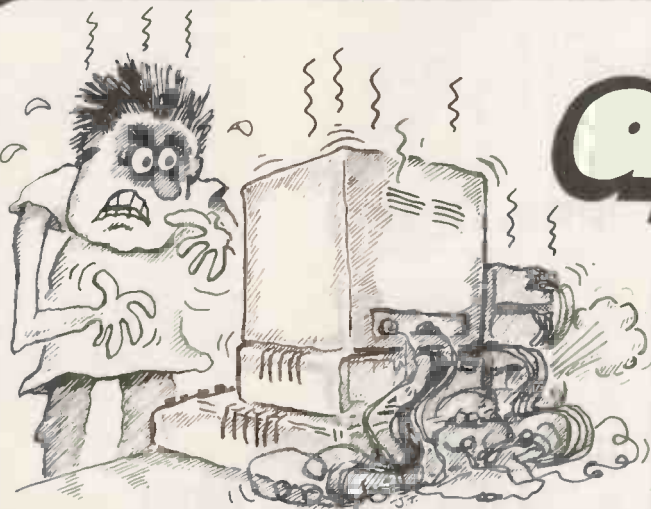

**Are you overheating?**

Cool things down with the APPLEFAN!

Your Apple will not only run more efficiently, with less risk of breakdown, but will be well organised, with easy access to all input/output ports.

Simple to fit, no soldering or drilling – the APPLEFAN still allows access to the lid of your Apple.

APPLEFAN may be removed at any time.

Basic model only £68.60 +VAT.

Ask your Apple dealer for a demonstration, or post the coupon for our brochure!

Hiteck Products 21 Station Rd, Knebworth, Herts. Tel 0438 812137

**applefan**<sup>TM</sup>  
 by hiteck



Please send me your brochure of APPLEFAN!

NAME: \_\_\_\_\_

ADDRESS: \_\_\_\_\_

● Circle No. 271





# Who's Who in Floppy Disk Drives

&  
how much?

# We've done your homework for you.

If you intend to become the fastest growing peripheral supplier to the mini and micro markets, you've got to start with the right product—the best.

So naturally, when it comes to flexible disk drives, we searched, researched and searched again, looking at every product and manufacturer, to make sure Microware customers could depend on exceptional product performance and reliability.

It took a lot of time and we ended up where we started: with Control Data flexible disk drives.

And Control Data obviously

liked our approach to customer service as well. Because we are now officially appointed UK distributors for Control Data flexible disk drives.

So if you want flexible disk drives with built-in reliability and service, you know where to come.

**Control Data flexible disk drive performance, now available through Microware:**

- 5ms track to track
- Head load solenoid
- Band stepper
- 250K, 500K, 1000K
- Door open status
- Industry standard compatibility

**Microware is more than flexible disk drives.**

We're also in complete drive subsystems, offering switch-mode power supply, 110–240 volt selectable, over voltage protection—all enclosed in attractive desk-top cabinets for all popular micros.

**Between us we guarantee the best price/performance ratio.**

## microware

Microware (London) Ltd.,  
5 Western Court,  
Huntley Drive,  
London N.3.  
Tel: 01-346 8452.



**CONTROL  
DATA**

● Circle No. 272

# TRADE AND EXPORT

Definitely the very best deal for

**O.E.M., DISTRIBUTORS AND DEALERS**  
throughout Europe

**THE SINGLE SOURCE FOR MICROCOMPUTER EQUIPMENT,  
PERIPHERALS, SUPPLIES AND SOFTWARE**

EPSON - ANADIX - TEXAS INSTRUMENTS - QUME - DIABLO - NEC -  
RICOH - OKI - CENTRONICS - TEC - OLYMPIA - ADLER - APPLE -  
COMMODORE - HITACHI - SHUGART - CONTROL DATA - BASF -  
FACIT - FUJITSU - PRINTRONIX - DATA PRODUCTS - OLIVETTI - ETC. ETC.

Obtain substantial savings by combining your purchases with  
hundreds of other trade buyers throughout Europe

- No commitment to purchase minimum quantity
- Parts and labour warranty
- Fast delivery

Telephone or write for details of  
**INFORMEX CONSORTIUM PURCHASE SCHEME**

**INFORMEX-LONDON LTD**

8-12 Lee High Road, London SE13 5LQ  
Tel: 01-318 4213 (10 lines) Telex: 892622

**INFORMEX**



AGENTS REQUIRED WORLDWIDE

● Circle No. 273

## Have you bought a ZX81? Now here's a cassette recorder to match it!

The ECR81 Enhanced Certified Recorder from MONOLITH is a major advancement in cassette recorder technology which minimises the problems associated with standard audio recorders. This is a high quality proven cassette mechanism, enhanced to provide just the right signal levels to ensure reliable read and write data transfer between the magnetic tape and your ZX81.

- Each ECR81 comes complete with its own individual certification tape, tested and serial numbered to prove your machine reliability.
- Signal enhancement circuit board with phase - locked - loop control and signal shaping for peak performance.



**£47.50**  
Including VAT.  
complete

- A long life head is fitted, matched to TDK CrO2 high bias, super avilyn cassette tapes.

- Mains & DIN connector leads provided.
- Certification of tape head alignment - height and azimuth.
- Certified tape tension, torque and speed.
- Fast forward and rewind tape search controls.

The ECR81 is also suitable for Sinclair ZX80

- Please allow up to 28 days delivery.
- The ECR81 is backed by our 14 day money-back option.
- The ECR81 is not suitable for audio reproduction.

**MONOLITH**  
electronic products

Telephone: Crewkerne 0460 74321

● Circle No. 274

To: MONOLITH ELECTRONICS CO. LTD., 5/7 CHURCH STREET, CREWKERNE, SOMERSET

Please supply me with:	Price	Total
..... (Qty.) Monolith ECR 81 Enhanced Certified Recorder(s) to be used with my ZX81	£47.50 (Each)	
I also enclose postage & packing per recorder	£2.50	
Please print		Prices include VAT £ <input type="text"/>
Name: Mr/Mrs/Miss. _____		
Address _____		



**NOW IN STOCK**

**THE NEW & EXCITING TRS80 MODEL III**



**48K £599 + VAT**  
EXTENDED GUARANTEE BY COMPUKARE

The Radio Shack TRS-80™ Model III is a ROM-based computer system consisting of:  
 ● A 12-inch screen to display results and other information  
 ● A 65 key console keyboard for inputting programs and data to the Computer  
 ● A Z 80 Microprocessor, the "brains" of the system  
 ● A Real-Time Clock  
 ● Read Only Memory (ROM) containing the Model III BASIC Language (fully compatible with most Model I BASIC programs)  
 ● Random Access Memory (RAM) for storage of programs and data while the Computer is on (amount is expandable from "16K" to "48K", optional extra)  
 ● A Cassette Interface for long-term storage of programs and data (requires a separate cassette recorder, optional extra)  
 ● A Printer Interface for hard-copy output of programs and data (requires a separate line printer, optional/extra)  
 ● Expansion area for upgrading to a disk based system (optional/extra)  
 ● Expansion area for an RS 232-C serial communications interface (optional/extra)  
 All these components are contained in a single moulded case, and all are powered via one power cord.

Disc Drives Kit with 2x40 Track Drives - £599 + VAT  
 Disc Drives Kit with 2x80 Track Drives - £729 + VAT

**HITACHI PROFESSIONAL MONITORS**



9" - £129 £99.95  
 12" - £199 £149 } VAT

● **Reliability** Solid state circuitry using an IC and silicon transistors ensures high reliability. ● **500 lines horizontal resolution** Horizontal resolution in excess of 500 lines is achieved in picture center. ● **Stable picture** Even played back pictures of VTR can be displayed without jittering. ● **Looping video input** Video input can be looped through with built-in termination switch. ● **External sync operation** (available as option for U and C types) ● **Compact construction** Two monitors are mountable side by side in a standard 19-inch rack.

**ACORN ATOM**

**UNIQUE IN CONCEPT - THE HOME COMPUTER THAT GROWS AS YOU DO**



Fully Assembled **£157.50 + VAT** inc. PSU

Special features include ● Full Sized Keyboard ● Assembler and Basic ● Top Quality Moulded Case ● Optional High Resolution Colour Graphics ● 6502 Microprocessor

**THE EPSON MX SERIES**



**MX80T £339 + VAT**  
**MX80F/T £389 + VAT**

- 80/132 Column
- Centronics Parallel
- Bi-directional
- Upper & lower case
- True Descenders
- 9x9 Dot Matrix
- Condensed and Enlarged Characters
- Interfaces and Ribbons available

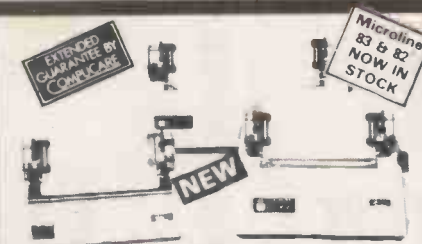

**MICROLINE 80 £289 + VAT**

● 80 cps Uni-directional ● Small size: 342 (W) x 254 (D) x 108 (H) mm. ● 160 Characters, 96 ASCII and 64 graphics ● 3 Character sizes: 40, 80 or 132 chars/line ● Friction and Pin Feed ● Low noise: 65 dB ● Low weight: 6.5 kg

**INTRODUCING THE NEW SHARP MZ-80B**



**£999 + VAT**

● 4 Mhz Z-80 CPU ● Dynamic RAM ● 2K ROM ● BASIC is provided ● High Resolution Graphics ● 9" High Focus Green Display ● Upper and Lower Case ● 80/40 Characters x 25 line display ● Electro Magnetic Cassette Deck included ● ASC11 Keyboard ● Numeric Keypad ● Sound Output ● Built-in Clock and Music

Available Soon-Discs, Printers and other Accessories.

**DUE TO IMMENSE POPULARITY SALE CONTINUED**

**COMPUKIT UK101**

● 6502 based system - best value for money on the market. ● Powerful 8K Basic - Fastest around ● Full Qwerty Keyboard ● 1K RAM Expandable to 8K on board. ● Power supply and RF Modulator on board. ● No Extras needed - Plug-in and go ● Kansas City Tape Interface on board. ● Free Sampler Tape including powerful Disassembler and Monitor with each Kit - If you want to learn about Micros, but didn't know which machine to buy then this is the machine for you.

**KIT ONLY £99.95 + VAT** PLUS £4.60 Post & Packing  
**Fully Assembled - £149 + VAT**

**WE ARE NOW STOCKING THE APPLE II AT REDUCED PRICES**



**AUTOSTART EURO PLUS**

**48K £649 + VAT**

Getting Started APPLE II is faster, smaller, and more powerful than its predecessors. And it's more fun to use too because of built-in features like:  
 ● **BASIC** The Language that Makes Programming Fun.  
 ● **High-Resolution Graphics** (in a 54,000 Point Array) for Finely-Detailed Displays ● **Sound Capability** that Brings Programs to Life. ● **Hand Controls** for Games and Other Human-Input Applications. ● **Internal Memory Capacity** of 48K Bytes of RAM, 12K Bytes of ROM, for Big-System Performance in a Small Package ● **Eight Accessory Expansion Slots** to let the System Grow With Your Needs.  
 You don't need to be an expert to enjoy APPLE II. It is a complete, ready-to-run computer. Just connect it to a video display and start using programs (or writing your own) the first day. You'll find that its tutorial manuals help you make it your own personal problem solver.

**INTRODUCING THE NEW GENIE**

Ideal for small businesses, schools, colleges, homes, etc. Suitable for the experienced, inexperienced, hobbyist, teacher, etc.



**GENIE I**

**STILL ONLY £279 + VAT**

**NOW INCLUDED:** Sound, Upper and lower case, Extended BASIC and Machine Code enabling the Writing and Execution of Machine Codes Programming direct from Keyboard.  
 16K RAM, 12K Microsoft BASIC  
 Extensive Software Range.  
 Self-Contained PSU UHF Modulator Cassette. External Cassette Interface. Simply plugs into TV or Monitor. Complete and Ready to Go. Display is 6 lines by 32 or 64 Characters Switchable. 3 Manuals included, Users Guide, Beginners Programming and BASIC Reference Manual. BASIC Program Tape Supplied. Pixel Graphics.



**GENIE II**

**£299 + VAT**

The **NEW GENIE II** an ideal Business Machine. 13K Microsoft BASIC in ROM. 71 Keyboard, Numeric Keypad, Upper & Lower Case. Standard Flashing Cursor. Cassette Interface 16K RAM Expanded externally to 48K.

**GENIE I & II EXPANSION UNIT WITH 32K RAM £199 + VAT**

**PARALLEL PRINTER INTERFACE CARD £35.00 + VAT**



**TEAC DISK DRIVES**

- TEAC FD-50A has 40 tracks giving 125K Bytes unformatted single density capacity.
- The FD-50A can be used in double density recording mode.
- The FD-50A is Shugart SA400 interface compatible.
- Directly compatible with Tandy TRS80 expansion interface.
- Also interfaces with Video Genie, SWTP, TRS80, North Star Horizon, Superbrain, Nascom, etc, etc.
- Address selection for Daisy chaining up to 4 Disks.
- Disks plus power supply housed in an attractive grey case.

**40 TRACK**  
 Single Disk Drive **£225 + VAT** Double Disk Drive **£389 + VAT**  
**77 TRACK**  
 Single Disk Drive **£299 + VAT** Double Disk Drive **£499 + VAT**

Delivery is added at cost. Please make cheques and postal orders payable to **COMP SHOP LTD.**, or phone your order quoting **BARCLAYCARD, ACCESS, DINERS CLUB** or **AMERICAN EXPRESS** number.

**MAIL ORDER AND SHOP:**

**CREDIT FACILITIES ARRANGED** - send S.A.E. for application form.

14 Station Road, New Barnet, Hertfordshire, EN5 1QW (Close to New Barnet BR Station - Moorgate Line).  
 Telephone: 01-441 2922 (Sales) 01-449 6596 Telex: 298755 TELCOM G  
**OPEN (BARNET) - 10am - 7pm - Monday to Saturday**

**NEW WEST END SHOWROOM:**

311 Edgware Road, London W2. Telephone: 01-262 0387  
**OPEN (LONDON) - 10am - 6pm - Monday to Saturday**  
 \* IRELAND: 19 Herbert Street, Dublin 2. Telephone Dublin 604165

**TELEPHONE SALES**  
**OPEN 24 hrs. 7 days a week**  
**01-449 6596**



**"Europes Largest Discount Personal Computer Stores"**

Buy our  
**£475\***

**Electronic Typewriter  
and you have a  
Daisy Wheel Printer  
for your computer  
absolutely FREE**



The T/Printer 35 is a superb portable typewriter that also doubles as a computer printer. It's the first electronic typewriter that's truly portable (it weighs only 17 pounds and is supplied with an ABS carrying case) and has all the features you'd expect of an electronic office typewriter. Except price.

Features include self-correction, dual function 100 character keyboard, triple pitch (10, 12 and 15 characters per inch), up to 12 in. wide paper—all with excellent print quality. And with Olivetti reliability.

Best of all, when you're finished using it as a typewriter, it's all set to go to work as a word processing quality computer output printer.

That makes the T/Printer 35 about the most versatile and cost effective piece of equipment you can buy. You get all the advantages of having a daisy wheel printer *and* electronic typewriter in a compact unit. And at one low price of £475\*, including carrying case.

*\*The T/Printer 35 costs £475 with Centronics compatible parallel interface. With RS-232C interface it costs £535. Prices listed are exclusive of VAT.*

**DATARITE**

Datarite Terminals Ltd  
Caldare House  
144-146 High Road  
Chadwell Heath, Essex RM6 6NT

Tel: 01-590 1155

Buy our  
**£475\***

**Daisy Wheel Printer  
for your computer  
and you have an  
Electronic Typewriter  
absolutely FREE**



The T/Printer 35 is the lightest weight and lowest cost daisy wheel printer you can buy for your computer. So it will fit within your budget and you can carry it wherever you take your micro. Yet it is tough enough to give years of reliable service. Interchangeable typefaces (standard Olivetti 100 character daisy wheels), variable pitch, multiple copies—all the features you would expect of more expensive word processing printers.

Yet the T/Printer 35 costs only £475 with parallel interface. Operating speed under computer control is approximately 120 words per minute of letter perfect output. What typist can equal that?

Then when you're finished using it as a computer printer, the T/Printer 35 is ready to go right on working as an electronic typewriter.

That's the dual-purpose T/Printer 35—the versatile computer printer that fits your budget.

Orders are shipped within the UK carriage-free. To order or for more information about the T/Printer 35:

**DATARITE**

Datarite Terminals Ltd  
Caldare House  
144-146 High Road  
Chadwell Heath, Essex RM6 6NT

Tel: 01-590 1155



# 3 FANTASTIC OFFERS

## VIDEO-TYPER

Would you like to touch-type effortlessly at 95 words per minute?

Is typing slowing your speed of programming?

Would you like your secretary to be quicker and more accurate?

"Video Typer" is very easy to use.

Learn fast, yet at your own pace. There are many features including:

- Automatic speed rating in w.p.m.
- Automatic accuracy rating (as a percentage).
- Special typing lines.
- Simultaneous graphic display as the keys are pressed.

It has built in to it the latest speed learning techniques to help you develop your typing skills to their highest level.

Contains a series of step-by-step lessons which progress in line with your accuracy and speed.

It is designed by experts to help you and your office staff learn to touch-type fast.

Please specify Screen Control Codes, (44k required). A C/PM programme from Western Digital Systems.

£49.50.

## ENCIPHER-DECIPHER

A worthwhile investment for anyone concerned with data security. You issue a short one line command to make your file totally different. There are hundreds of millions of 8 character passwords for you to invent at will. Within seconds the file has been written back in place on disc but now is completely changed. Using the wrong password to decipher the file can only make matters worse.

- \* Strings of passwords can be used to further encipher files.
- \* Enciphered files can be transmitted by Modem or Data courier.
- \* Disc editors, DDT and disassemblers reveal nothing.

A programme from Western Digital Systems £49.50.

## DISC-MASTER DIRECTORY DATABASE

You can find in seconds any file or group of files according to name, type, disc title, or disc number.

Searches can be according to CP/M wild cards (? in place of a letter; \* in place of word or part).

You choose a disc title and number. The disc's directory tracks are automatically read by the programme into a master data base.

Updates are automatic. It removes from the data base files no longer appearing in the disc's directory and inserts the new ones. The information can go to the screen or printer.

A C/PM programme from Western Digital Systems £49.50.

**PLUS**

Buy any two of these programmes from Western Digital Systems and get one free. Dealer enquiries welcome. Other C/PM software: The Word by Oasis Corporation. £49.50. Rated No.1 spelling corrector by Byte magazine: A spelling proofreader and computer dictionary (32K required)

Disc doctor by Supersoft Associates. £49.99. A programme to Recover Crashed Discs automatically. Does not require knowledge of CP/M file structure. Menu driven and virtually automatic. Specify CP/M formats. Price may increase in line with falls in the pound. Other U.S.A. programmes also available at special prices.

With all orders please state computer model and disc format. Orders with payment (state computer model & disc format) >>DEALER ENQUIRIES WELCOME<< SYSTEMISE LTD., 36 TRINITY Ad., London SW17 7RE TEL 01-672 1132

● Circle No. 277

# ATTENTION!



## Menu du Jour

STYLAFONT DAISYWHEEL PRINTER  
only £549

EPSON MX80 FT/2	£375	VISICALC 3-3	£99
APPLE 48K	£599	TRANSTEC MONITOR	£99
2 DISK DRIVES AND CONTROLLER	£599	PASCAL	£225
Z-80 CARD + CP/M	£120	80 COL CARD + KEYBOARD	£165
WORD STAR	£145	SHIFT	£150
		ZARDAX	£150

Complete word processing package including the Stylafont only £1999.

ADD VAT @ 15% TO ALL PRICES - SERVICE INCLUDED

Drop in for a byte at:

## THE BROMLEY COMPUTER SHOP

49 Beckenham Lane  
Shortlands  
Bromley, Kent

01-460-2580  
01-464-0541

● Circle No. 278

## WORLD CUP 82 ZX81 SOFTWARE (16K)

This programme will simulate the 1982 World Cup action. Set each teams performance rating and kick off.

Other programmes included

ENGLISH LEAGUE ★ PREMIER LEAGUE ★ WORLD LEAGUE ★ ANGLO/SCOTTISH LEAGUE

- set your own weighting
- league positions on request
- relegation/promotion
- 10 year history

FA CUP ★ SCOTTISH CUP ★ EUROPEAN CUP

- set your own weighting
- last 10 years history

UNLIKE MOST GAMES SOFTWARE, THIS PACKAGE WILL HOLD YOUR INTEREST.

SEND **£5.50**

## GLENROTHES COMPUTER SERVICES

81, ARDROSS PLACE,  
GLENROTHES,  
FIFE KY5 2SQ.

● Circle No. 279

# Castle Electronics

## Service - at Supermarket Prices!



### VIC-20 COLOUR COMPUTER

- Graphics character set ●Plug-in programme/memory cartridges
- Colour ●Sound ●Programmable function keys ●5K memory expandable to 32K
- Standard PETBASIC ●Full-size typewriter keyboard ●Low-priced peripherals ●Joystick/paddles/light pen
- Self teaching materials ●Cassette Deck now available £44.95

Only £189-95 INC. VAT

ALL PERSONAL COMPUTER ENQUIRIES  
HASTINGS (0424) 437875

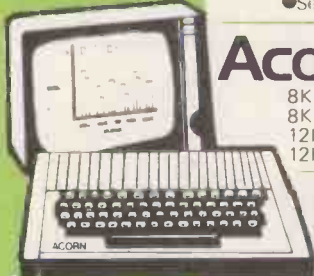

### Acorn Atom BRITISH DESIGNED PERSONAL COMPUTER

8K ROM + 2K RAM kit .....	£140.00	4K Floating Point ROM .....	£ 23.00
8K ROM + 2K RAM Ass. ....	£174.50	Colour Encoder .....	£ 21.85
12K ROM + 12K RAM kit .....	£255.00	Mains Power Supply .....	£ 9.20
12K ROM + 12K RAM Ass. ....	£289.50		

YOU WON'T FIND A BETTER DEAL ANYWHERE IN THE SOUTH



### TANGERINE microtan

Microtan 65 Kit .....	£79.35
Microtan 65 Built .....	£90.85
Tanex Min. Config. Kit .....	£49.45
20 way Keypad .....	£11.50

#### TANTEL PRESTEL ADAPTER - £199.00

We hold a complete stock of all the Tangerine equipment. Send SAE or Phone for details.



COMPUTERS FOR PEOPLE



FROM £345.00 Plus All Accessories Available!

Model 400 16K .....	£345.00
Model 800 16K .....	£645.00
Cassette .....	£ 50.00
Disk Drive .....	£345.00
80 Col. Printer .....	£550.00

ALL PRODUCTS ARE FULLY GUARANTEED BUY WITH CONFIDENCE

ALL PRICES INCLUDE VAT



### COMMODORE PET

16K PET .....	£550.00
32K PET .....	£699.00
Dual Disk Drive .....	£699.00
Printer .....	£454.25
External Cassette .....	£ 44.95

Complete range of PET equipment in Stock

CASSETTE SOFTWARE: Strathclyde Basic Course, Basic Basic Course, Invaders, Treasure Trove of Games 1 to 10 (10 Selections of games), Basic Maths, Algebra, Statistical Packs and lots more!

Special Offer!  
**sinclair ZX81 FOR IMMEDIATE DESPATCH £69.99**



BUILT-IN SOUND—HIGH RES. GRAPHICS'  
Apple II Plus 48K .....

Apple II Plus 48K .....	£790.00
Disk Drive + Controller .....	£383.00
D.D. without Controller .....	£303.00
Pascal Card .....	£264.00
Eurocolour Card .....	£73.00
Hitachi 9" Monitor .....	£146.00

We Stock All the Goodies for Apple!

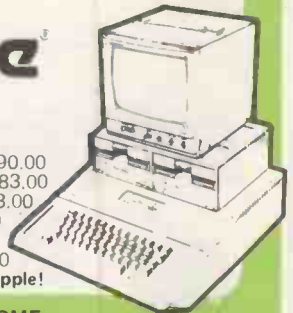

ALL PRICES INCLUDE VAT : ACCESS & BARCLAYCARD WELCOME  
ORDERS NORMALLY DESPATCHED DAY OF RECEIPT

WE SPECIALISE IN COST EFFECTIVE SYSTEMS FOR SMALLER BUSINESSES

## South East Computers MicroComputers for Business

ASK FOR DETAILS OF OUR TOTAL SUPPORT OPTION

From Only £19 per week

### Package A SILICON OFFICE SYSTEM

- 1 x CBM 8096 Computer
  - 1 x CBM 8050 Dual Disk Drive
  - 1 x CBM 8023 Matrix Printer
- Connecting cables, plus Silicon Software

From Only £43 per week

### Package B

- #### ALTOS MULTI-USER HARD DISK SYSTEM
- 1 x ALTOS 8000/10 Computer with 10 Mbyte Hard Disk
  - 208Kbyte Memory (4 users)
  - 500Kbyte Floppy Disk Drive
  - 2 x TVI 912C VDU's
  - 1 x OKI Microline 83A Printer

UNBEATABLE OFFERS FOR EDUCATION & TRAINING CONTACT US NOW!

SEC BUSINESS SYSTEMS SUPPLY A WIDE RANGE OF EASY-TO-OPERATE SYSTEMS AND PROGRAMMES TO MEET ALL OF TODAY'S BUSINESS NEEDS + FULL RANGE OF COMPUTER RELATED PRODUCTS + LEASING AGREEMENTS + FULL AFTER SALES SERVICE



## The Complete Computer Service!

15 CASTLE STREET, HASTINGS, EAST SUSSEX TN34 3DY Dept. PC4

FOR ALL BUSINESS SYSTEMS ENQUIRIES:—  
Phone Nick Rosenberg on Hastings (0424) 426844









# PRINTERS

## SEIKOSHA GP-80

**The Smallest 80 Column Dot Matrix Printer.**



Unique printer principle. 80 col lines. 30 cps. 12 cpl. Plain Paper. Tractor drive. Weight 2.5 kg. Footprint 12.6 sq. ins. Bit addressable graphics. Parallel interface standard. RS 232 Apple Pet TRS 80 options

£199

## OKI MICROLINE 80 & 82A

**Compact 80 Column Printer.**

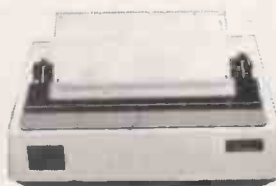

80-120 cps. Uni direction ML 82A bi-direction). Parallel interface. Serial interface option. (ML 82A standard). Pin and friction feed. Tractor option. Condensed and expanded characters. 80, 40, 66 and 132 cpl.

ML 80 £299  
ML 82A £437

## EPSON MX SERIES

**Low Noise, Low Price-High Performance Printer**

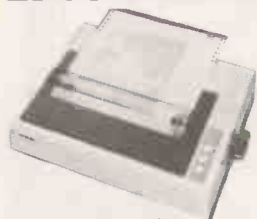

Six models. 80 cps. Bi-directional. Parallel interface. RS232 Pet Apple TRS 80 Video Genie Sharp options. Letter quality. Lower case descenders. Condensed enlarged and bold characters. Models provide tractor roll and sheet feed - bit image graphics - up to 15 ins paper.

MX-80 £353  
MX-80 F/T £399  
MX-80 II £399  
MX 80 F/T-II £447  
MX-82 £447  
MX-100 £569

## OKI MICROLINE 83A

**Medium Speed 15" Printer.**



120 cps. Bi-direction. Pin and friction feed. Tractor option. 132 cpl at 10 cpl. 4 character sizes. Graphic characters. Parallel and serial interface. Fast serial interface option.

£827

## ANADEX DP-9000 RANGE

**Fast, Versatile Printers.**



Seven models. Up to 15 inch paper width. Lower case descenders. 160-220 cps bi-directional printing. RS232 current loop & parallel interface. X on X off. Optional 2K buffer. Multiple print densities. Fast print of high-density bit image graphics.

DP-8000 £541  
DP-9000L £747  
DP-9000 £841  
DP-9001 £888  
DP-9500L £841  
DP-9501 £982  
DP-9500 £935

## TEC STARWRITER

**Best-Buy Daisy Wheel Printer.**



Bi-direction. 25 cps. Low cost supplies. Standard Daisy Wheel. Carbon and fabric ribbons. Parallel or RS232 interface. Sheet feeder options.

Parallel Interface £1020  
Serial Interface £1067

## LEAR SIEGLER 310

**Professional Dot Matrix Printer.**



High throughput. 180 cps. Bi-direction. Fast head travel. Space skip over. Lower case descenders. Enlarged and bold fonts. Parallel RS232 and current loop interfaces. X on X off. Condensed character option. Sound reducing option.

£1386

- Authorised distributor
- Rapid delivery
- Dealer educational & quantity discounts
- Prices exclude VAT

FROM

# RIVA

**RIVA TERMINALS LTD.**

New Head Office: Woking Business Park  
Albert Drive, Woking, Surrey GU21 5JY  
Tel: Woking (04862) 71001 Telex: 859502  
Northern Office: Tel: Harrogate (0423) 503867

• Circle No. 285

# ATTENTION ZX81 Owners!

The April issue of Your Computer is full of good things:

- How to write your own adventure game for the ZX81.
- Review of the growing range of ZX81 boards and control ports
- How to adapt the ZX81 to use Atari joysticks

**Also in this issue:**

- Expanding your VIC20. Tim Hartnell looks at peripherals and add-ons
- BBC graphics. A further look at the colour and graphics facilities of the BBC micro.

**All this, PLUS our regular features and pages of program listings and games for YOUR micro.**

Why not place a regular order to avoid disappointment?  
Or take out a subscription by completing the coupon.

To: Marketing Department, Room 316,  
IPC Electrical Electronic Press,  
Quadrant House, The Quadrant,  
Sutton, Surrey SM2 5AS

Please send me 12 issues of Your Computer  
I enclose cheque/PO for £8 UK/£14 Overseas,  
payable to IPC Business Press Ltd.

Name .....

Address .....

PC09

**At all leading newsagents.  
Price 60p.**

## IMPROVE YOUR PETTING TECHNIQUE!

WITH PROGRAMMING THE PET/CBM by RAY WEST

NEW and COMPREHENSIVE — the only book dealing with all aspects of Commodore's PET and CBM 2000, 3000, 4000 and 8000 ranges of microcomputers and peripherals. Contents include this and much more.

- 1 INTRODUCTION AND OVERVIEW. Plan of the book; sources of information and help; features and chronology of CBM hardware.
  - 2 BASIC AND HOW IT WORKS. Storage of BASIC and its variables; pointers, syntax; modifying and optimising BASIC.
  - 3 PROGRAM AND SYSTEM DESIGN. What the equipment can do; charts, structured design, algorithms; estimating size, timing.
  - 4 EFFECTIVE PROGRAMMING IN BASIC. Subroutines, DATA, Data handling, crashproof INPUT, rounding, sorting, etc.
  - 5 ALPHABETIC REFERENCE TO BASIC KEYBOARDS. Full descriptions, examples, notes for all keywords, plus DEL, DLD, PDP, PRINT USING, etc.
  - 6 DISK DRIVES. Description; six FILE types; CBM disk handling; direct access; machine-code; reliability; bugs.
  - 7 ALPHABETIC REFERENCE TO DISK BASIC. All BASIC 4 disk commands with syntax, examples, and notes.
  - 8 OTHER PERIPHERALS AND HARDWARE. Cassettes; tape handling; storage; ROM routines; printers; modern; keyboard; reset switches.
  - 9 GRAPHICS AND SOUND. Tables of characters; graphics; CRT chip; 6502 animation, bar plots, 80 by 50 etc; user-port sound.
  - 10 TRANSITION TO MACHINE CODE. Introduction to 6502; a BASIC monitor; MLM, Supermon, and Extramon; easy examples.
  - 11 MORE 6502 MACHINE-CODE. 6502 addressing, PC, SP, etc; seventeen typical problems; debugging.
  - 12 ALPHABETIC REFERENCE TO 6502 OPCODES. Examples, notes, full details on all opcodes, ADC to 1YA.
  - 13 USING ROM ROUTINES. IRQ, NMI, RESET; BASIC and the kernel; modifications — LIST, PRINT USING, TRACE; relocating loaders.
  - 14 EFFECTIVE 6502 PROGRAMMING. BASIC CURGET and wedges; assemblers; examples; PIAs, VIA, IEEE; common mistakes.
  - 15 INDEX TO BASIC ROMS AND RAM. Memory map; the first four pages; comparisons and detailed explanations of BASICs 1, 2, and 4.
  - 16 MATHEMATICAL PROGRAMMING. Accuracy; equations; statistics; simulation; finance; matrices; how ROM routines work, etc.
  - 17 BUSINESS AND EDUCATION. Examples, applications, cautions; menus, users, input; packages; documentation; education.
- APPENDICES. 6502 reference charts; tables; SUPERMON listings; pseudo-opcodes; ASCII glossary
- INDEX.

Many programs, diagrams, and charts.  
Paperback, 504 pages, 19 x 26 x 2½ cm.  
ISBN 0 9507650 0 7

U.K. and Europe Price £14.90\* (includes p&p)

**LEVEL LIMITED, PO Box 438,  
Hampstead, London  
NW3 1BH.**

\*5 or more £13.99 each

CUT OUT OR COPY THIS COUPON, OR WRITE TO:

LEVEL LIMITED, PO BOX 438, HAMPSTEAD, LONDON NW3 1BH.

Send ..... copy/ies of 'Programming the PET/CBM' by Ray West.

Cheque/postal order value ..... is enclosed. (£14.90 each).

NAME: .....

ADDRESS: .....

PC4

● Circle No. 286





# COMPUTECH for apple

## Authorised dealer, service centre and system consultancy

### SUCCESS BREEDS SUCCESS!

As authorised dealer and service centre for Apple computers we have acquired extensive experience of users' needs and the most cost effective means of satisfying them from the considerable resources of this popular and reliable machine. Over 1,000 of our financial accounting packages have been installed. In the process we have detected areas of special need and opportunities for enhancing these resources. Our own manufactured hardware and system software have been produced to meet these requirements. As a result we have compatible products for all configurations of Apple II and ITT 2020 installations - and the new Apple III!

<b>Apple III now on demonstration - systems from</b>	<b>£1,645</b>
<b>Pro-File 5 MB mass storage for Apple III</b>	<b>£2,256</b>
<b>Computech mass storage for Apple II and Apple III, up to 12 MB, from</b>	<b>£1,950</b>

### COMPUTECH SOFTWARE AND HARDWARE INCLUDES:

**Payroll** for 350 employees, 100 departments, all pay periods, printed payslips, approved year end documents, very quick and easy to use, **£375**. **Sales, Purchases and General Ledgers** **£295** each, detailed statements. **Job Costing and Group Consolidation** are amongst many and various applications of the **General Ledger** package, which supports values to totals of one thousand million accurate to a penny! Our **Utilities Disk** available like other packages in 13 sector or 16 sector format, is widely used for reliable, error checking, copying, including single drive, and the renowned **DPATCH** program beloved of programmers for **£20**. We have developed a **Terminal Utilities** package which enables Apple to Apple and Apple to mainframe communications with local processing and storage as well as Apple to host communications from the amazingly low price of **£130**. Our **Graphics Utilities** program for use with the **Microline** and **Epson** families of printers enable the plain paper production on low cost printers of high resolution screen pictures, graphs etc. - free with **Microlines** or **£30** separately. **Keyboard Driver** enables the use of our **Lower Case** adaptor with BASIC programs and **Applewriter Patches** supplied. **FREE** with our character generator package (total cost **£50**) is separately available on disk with documents for **£10**. At the same price **CAI** (convert Apple pictures for ITT) makes binary high resolution picture files display properly on the ITT 2020. We sell the famous **Visicalc** for **£111** and have delivered systems using it to do amazing things like production control, shipping accounts and stocks and shares valuations! The versatile **Applewriter** word-processing package at only **£39**, especially employed with our **Lower Case Character Generator** is widely used by people who cannot type to produce word-perfect copy! Experience with Apple systems has led to the design and manufacture of compatible products with enhanced features at very favourable prices to satisfy users' needs. These include the **Diplomat Serial Interface** which has handshaking capability and switchable options (**£80**), the **Diplomat Parallel Interface** which enables the direct use of text and graphics with the **Microline** and **Epson** printers and is a complete 'plug in and go' item with gold-plated edge-connector at **£80** and has optional direct connection for **Centronics 730/737** printers. Our new **Diplomat Communications Card** at **£95** is a sophisticated peripheral especially suitable for Apple to mainframe communications at high speeds in full duplex mode with switch selectable bit rates and other options. The **Lower Case** adaptor is available for Apples (revision 7 and earlier) as well as ITT 2020, complete with diskette software for **£50**. It offers true descenders on screen and the £ sign. We also have an **Optional Character Generator** for the ever popular **Microline M80** at **£15**. This provides £ sign and improved digits and lower case characters with USASCII special symbols. Our price for the **Microline M80**, with graphics, 40, 80 and 132 characters per line, friction, sprocket and teleprinter feed, is only **£295**, amazing for this small, quiet reliable 'look alike' printer. Tractor option is **£40** and **Serial Adaptor** **£80**. The **Microline M82**, bidirectional printer with both parallel and serial input is only **£345**, it can have an optional 2K buffer, while the **Microline M83** full width adjustable tractor 120 cps printer with similar specification is only **£595**. Then for all computer users there is the unique **Micromux** which from **£800** provides up to 16 ports for simultaneous independent serial asynchronous communications! Telephone for data sheets or to arrange a demonstration or for the address of our nearest dealer. Please hurry - the demand for our products has been such that some have been temporarily out of stock. We offer the effective low cost solutions you need. **Prices exclude V.A.T., carriage and packing.**

## COMPUTECH SYSTEMS

168, Finchley Road, London NW3 6HP. Tel: 01-794 0202

AGENTS THROUGHOUT THE UK AND OVERSEAS





# BRAIN~WAVES

by **MicroMods Ltd.**

53 ACTON ROAD, LONG EATON, NOTTINGHAM NG10 1FR  
Telephone (06076) 64264

## SuperBios

Upgrade to Intertec DOS 3.2  
and much more besides

The

**FIRST**

improved SuperBrain™ DOS

The

**BEST**

improved SuperBrain™ DOS

**NOW**

The

**LOWEST PRICE**

## SuperBios 1.7

SOURCE LISTING AVAILABLE

Upgrade for existing SuperBios owners = £20

ONLY

**£45** plus VAT

## SuperVid

MULTIPLE CHARACTER SETS  
BLOCK GRAPHICS  
Dim, Reverse, Underline

**£190** plus VAT

INCLUDES SuperBios, WordStar patchfile, and demonstration programs in source-code

Prices exclude VAT and carriage

SuperBrain™ of Intertec Data Systems

● Circle No. 289

# SUPERBRAIN IN THE SOUTH-WEST



CIS  
COBOL £425

WORDSTAR £230

M BASIC £155

+ OTHERS

MANY MORE

PAYROLL

STOCK

ACCOUNTS

**TOTALLY INTEGRATED MSL ACCOUNTS SYSTEM**

**PROFESSIONAL SERVICE & SUPPORT**

FOR QUOTATIONS OR FURTHER DETAILS CONTACT

## EASTFERN LIMITED

19 ALEXANDRA PARADE WESTON-SUPER-MARE AVON TEL: 0934-418346

● Circle No. 290

# sbd

Software

"THE MAGNIFICENT FIVE!"

£150.00  
ZARDAX



A wonderful writing tool has at last appeared on the market. ZARDAX can be used with a 40 or 80 columns on your Apple II. Enter your text in free-form, then enter your format commands and watch as ZARDAX either prints (or Videoprints, to the screen) your copy. Powerful and versatile, yet easy to use.

£60.00  
THE APPLE SPELLER



Finally the first professional spelling verification programme is available for the Apple II. THE APPLE SPELLER interfaces to all Apple word-processors that write a standard Apple binary or text file to a diskette. There is a 30,000+ word dictionary with space to add another 8,000 words. Proofreading for spelling mistakes is no longer a problem.

£79.95  
MAGIC WINDOW



A revolutionary concept in Apple word processing. No modifications are needed to your standard Apple II system. MAGIC WINDOW formats the text as you enter it. You can type up to 80 characters per line and see your letter or report exactly the way it will be printed. Look into our MAGIC WINDOW and experience a wonderland in word processing.

£49.95  
BASIC MAILER



It is now simple to get mass mailing capability with a personal touch. The 'document' is created with any word processor which can generate a standard Apple II text file. The 'data file' (names etc.) can also date base as long as it is again an Apple DOS 3.3 text file. BASIC MAILER merges them together.

£175.00  
WORDSTAR



For CPM systems WORDSTAR is the finest, most versatile word processing software on the market today. WORDSTAR is the word processing software behind your computer, and it can easily produce quality results. You'll save time and money.

**SBD SOFTWARE (Dept. W1PC)**

15 Jocelyn Road, Richmond TW9 2TJ. Telephone 01-948 0461 Telex 22861  
All prices are plus VAT, postage & packing free.

Please telephone for a full catalogue, or use the coupon provided.  
Dealer enquiries are welcome.

Name .....

Company .....

Address .....



● Circle No. 291

## Screen handling for CBASIC programs



Microscreens provides professional forms-style input to CBASIC programs. It will run on a computer with 48K of store, CP/M and a VDU with an addressable cursor. At last the interactive nature of the Microcomputer can be used with one of the most popular languages. Dumb terminals can be used in page mode. Full control of protected fields, highlighting and cursor controlled editing is provided. Numbers and dates are validated on input.

- Only 7 program fields needed
- Compact (2 1/2K) and fast
- User can 'draw' his own formats
- Automatic configuration supplied

£125 plus VAT. Manual only £6.50. Please add £1.00 post and packing to each order.

Available on 8" s.d. and North Star formats

**McMILLAN COMPUTING SERVICES**  
PO BOX 82  
READING RG3 5XF  
READING 414751

CBASIC is a trade mark of Compiler Systems Ltd. CP/M is a trade mark of Digital Research Ltd



● Circle No. 292



# TCL SOFTWARE

TCL Software supplies and supports an ever increasing range of CP/M based software, as well as producing and supplying packages of our own such as TCL Pascal. We are a British company and our new software catalogue puts major emphasis on British software.

Our central London showroom makes us a convenient port of call. Why not call in and see us, or send an SAE plus 50 pence for our latest catalogue, which gives a full description of our packages.



TCL SOFTWARE

## SOFTWARE AND SUPPORT FOR CP/M

Prices: Software plus Manual/Manual alone

LANGUAGES	£55/£6
TCL DISC BASIC	£75/£10
CBASIC 2	£155
BASIC 80	£195
BASIC COMPILER	£120/£9
TCL PASCAL CP/M	£120/£9
TCL PASCAL PET	£215
FORTRAN 80	£400/£25
CIS COBOL	£450
COS COBOL	£325
COBOL 80	£60/£10
C-COMPILER (BDS)	£325
C-COMPILER (W)	£37.50
C 80	£105
MU LISP	£37.50
LISP 80	P.O.A.
COMAL	
(CB80 (compiles to machine code CBASIC compatible))	£250/£25

OPERATING SYSTEMS	
CP M 2 2 TUSCAN VERSION	£95/£22
COSY CP/M ENHANCEMENT	£200/£15

ELECTRONIC OFFICE	
WORD PROCESSING	£200/£15
MAILING SYSTEM	£200/£15
WORDSTAR	£255/£15
WORDSTAR/MAILMERGE	£315/£15
DATASTORE	£200/£15
DATASTAR	£195/£25
DATAFLOW	£99/£10
DMS	£400/£10
GENERAL DATABASE	£100/£5
DBASE II	£395/£35

COMMUNICATIONS	£180/£1
TTY	£115
BSTMS	£445/£30
BISYNC 80	£95/£20
METTY	£75
BSTAM	

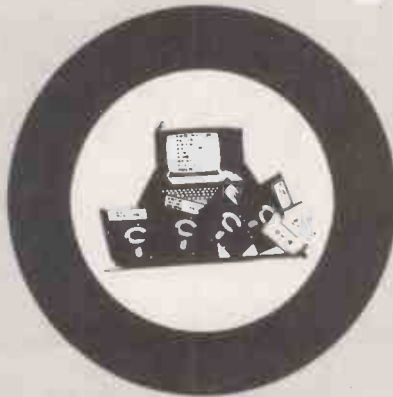

EDITORS	£45
EDIT 80	£75/£15
WORDMASTER	£75/£3
TEXTWRITER III	£45/£10
TEX	

CP/M USER GROUP  
See our catalogue for details

BUSINESS AND ACCOUNTING

PAYROLL	£500/£40
ORDER ENTRY AND INVOICING	£350/£40
NAME AND ADDRESS	£250/£40
STOCK CONTROL	£350/£15
SALES LEDGER	£350/£15
PURCHASE LEDGER	£350/£15
GENERAL LEDGER	£250/£15
INVOICING	£455/£10
BILLFLOW	£350/£1
TIMEREK	£400/£40
TIME RECORDING	

PROFESSIONAL AND SCIENTIFIC	
SURVEY ANALYSIS-SNAP	£1200/£5
T/MAKER	£155/£15
REPORT WRITER	£95/£30
MU SIMP/MU MATH	£135
STATPAK	£270/£20
MICROSTAT	£195

UTILITY PROGRAMS

MACRO 80	£75
MAC	£55/£10
COS ASSEMBLER	£75/£15
SID	£45
ZSID	£50
DISILOG	£35
Z80 DEVELOPMENT PACKAGE	£50
DESPOOL	£30/£1
RECLAIM	£40
ARCHIVE	£100
LYNX	£225
IBM/CPM REFORMATTER	£125
RATFOR	£125
FORMS 2	£37.50
OSORT	£100
SUPERSORT I	£50
PEARL III	£125/£15
	£295/£25

### NEW! NEW! NEW! NEW!

EXCELLENT NEW CP/M UTILITIES

Examine sections of your disks, diagnose and (usually) cure.

DDUMP	£35
DTEST	£35
DIAGNOSTICS II	£65
DISK DOCTOR	£65
RESTORE/SPOOL	
UNSPPOOL/QSUB	£45

Use disk space better

COMPRESS	£20
ARCHIVE	£100

Re-design keyboard

SMARTKEY	£45
----------	-----

Simplify your applications software

SUPERVYZ	£65
----------	-----

### NEW! NEW! NEW! NEW!

NEW OFFICE AND LITERARY AIDS

INDEXER	£100
DOCUMATE	£45
SPELL	£45
TYPING TUTOR	£35

NEW WORDPROCESSOR WITH VISICALC FUNCTIONS

	£270
--	------

NEW APPLICATIONS WORD PROCESSOR

plus calculator plus programming functions	£270
SUPERCALC	£185
ESTATE AGENTS	£800
FILEFORCE (Database with many extras)	£250
GRAPHICS	£30
AUTHORING (helps non-programmers to write computer-aided learning programs)	£30

ALL PRICES EXCLUSIVE OF VAT OR CARRIAGE

#### DISK FORMATS SUPPORTED AS FOLLOWS

- 8" A1: Standard IBM format for 8"
  - 5 1/4" A2: Research Machine 5 1/4"
  - 5 1/4" A3: Tuscan and Superbrain DOS 3 5/4"
- For other formats please enquire.

TCL SOFTWARE is a division of



#### HOW TO ORDER

Please specify clearly when ordering the title of the package and whether you require the complete package or just the manual. Please also specify the machine type, the memory size, size of drives, disk format and any other information you think could be relevant. Telephone/credit card orders accepted. Please make cheques/postal orders payable to Transam. Minimum carriage charge £2.50.

59/61 THEOBALD'S ROAD, LONDON WC1 Tel: 01-405 5240/2113

# SOFTWARE FOR CP/M®

HIGH QUALITY SOFTWARE - WITH HIGH QUALITY SERVICE

★ NEW THE FORMULA £300. Application Builder and Reporter. SPELL STAR £125. Option for Wordstar. SUPER CALC £165. Spread Sheet financial planning.

WORDSTAR - Professional word processing software. On-screen formatting, wordwrap, pagination, line and character count on view. Micro-justification on daisy-wheel printer. Search and replace. Block/paragraph manipulation. External file read/write. Background printing during editing etc.	£250	MICROSOFT FORTRAN COMPILER	£205
MAIL-MERGE - Powerful Wordstar enhancement for file merging and document personalisation.	£65	MICROSOFT COBOL	£310
DATASTAR Screen orientated system for Data Entry, Retrieval and Updating.	£175	MAGSAM - Versatile easy to use Keyed File Management System for Microsoft Basic or CBASIC.	£130
SUPERSORT - Sort, merge and selection program.	£125	CIS - COBOL - ANSI 74 implementation to full level 1 standard. Supports random, indexed and sequential files, features for conversational working, screen control, interactive debugging, program segmentation etc.	£425
CONFIGURABLE BUSINESS SYSTEM (CBS) - Unique information management system with user definable files, powerful report generator, menu-driven for ease of use. No programming experience necessary!	£225	FORMS-2 - Automatic COBOL code generator for screen formats.	£100
ACCOUNTING PACKAGES by Median - Tec: PAYROLL, SALES, PURCHASE, NOMINAL Specially developed by UK software house to exacting specifications. Written in Microsoft Basic each package may be customised by end user, all are widely used. Ledgers are open item. Payroll caters for weekly and monthly pay.	£300	PASCAL-Z	£265
PROJECT COST CONTROL/JOB ACCOUNTING - A comprehensive set of programs to monitor budgets, account for expenditure and project completion etc. Ideally suited for contractors. Written in CBASIC-2.	£150	STRUCTURED BASIC - Relocatable compiler	£160
STATISTICS PACKAGE - Over 25 routines including Regression & ANOVA	£100	CBASIC-2 - Extended Disk Basic pseudo compiler and run-time interpreter.	£75
MATHS PACKAGE - Over 40 easily used routines.	£100	SELECTOR III - C2 - Information management system written in CBASIC-2	£185
IBM - CP/M COMPATIBILITY - Powerful utility to transfer data to/from IBM machines in standard disk format.	£110	SELECTOR IV - Upward compatible version of III with enhanced reporting.	£300
MICROSOFT BASIC INTERPRETER	£155	BSTAM - Telecomms facility for exchanging files between CP/M computers.	£100
MICROSOFT BASIC COMPILER	£205	ASCAM - Facility for communicating with other computers.	£95
		TRANSFER - CP/M to CP/M file exchange - telecomms source code	£125
		MACRO 80 - Macro Assembler	£99
		CP/M 2.2 - Standard Version 8" Single Density.	£99

Please contact us for availability of other products  
All orders must be PREPAID. Add £1 per item P & P (Minimum £2.00) and VAT  
CP/M is trade mark of Digital Research

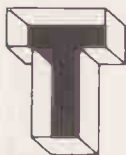

## TELESYSTEMS LTD

P.O. Box 12, GREAT MISSENDEN, BUCKS, HP16 9DD

Telephone (02406) 5314

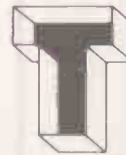

● Circle No. 294

Combine accurate flight characteristics with the best in animation graphics and you'll have SubLOGIC's

# T80-FS1 Flight Simulator

for the TRS-80

SubLOGIC's T80-FS1 is the smooth, realistic simulator that gives you a real-time, 3-D, out-of-the-cockpit view of flight.

Thanks to fast animation and accurate representation of flight, the non-pilot can now learn basic flight control, including take-offs and landings! And experienced pilots will recognize how thoroughly they can explore the aircraft's characteristics.

Once you've acquired flight proficiency, you can engage in the exciting British Ace 3-D Aerial Battle Game included in the package. Destroy the enemy's fuel depot while evading enemy fighters.

Computer and aviation experts call the T80-FS1 a marvel of modern technology. You'll simply call it *fantastic!*

#### Special Features:

- 3 frame-per-second flicker free animation
- Maximum transfer keyboard input
- Constant feedback cassette loader

#### Hardware Requirements:

- Radio Shack TRS-80, Level 1 or 2
- 16K memory
- *Nothing else!*

£17  
Only

INCLUDING VAT POST & PACKING. SEND £1.00 FOR DESCRIPTIVE CATALOGUE OF OVER 200 TRS-80 PROGRAMS.



**MICROCOMPUTER APPLICATIONS**  
42A CHURCH STREET,  
CAVERSHAM, READING,  
RG4 8AU, ENGLAND.  
TEL: (0734) 470425



'IT'S A  
SECRETARY'S  
DREAM!'

'IT'S GOT  
AN A4  
SCREEN!!'

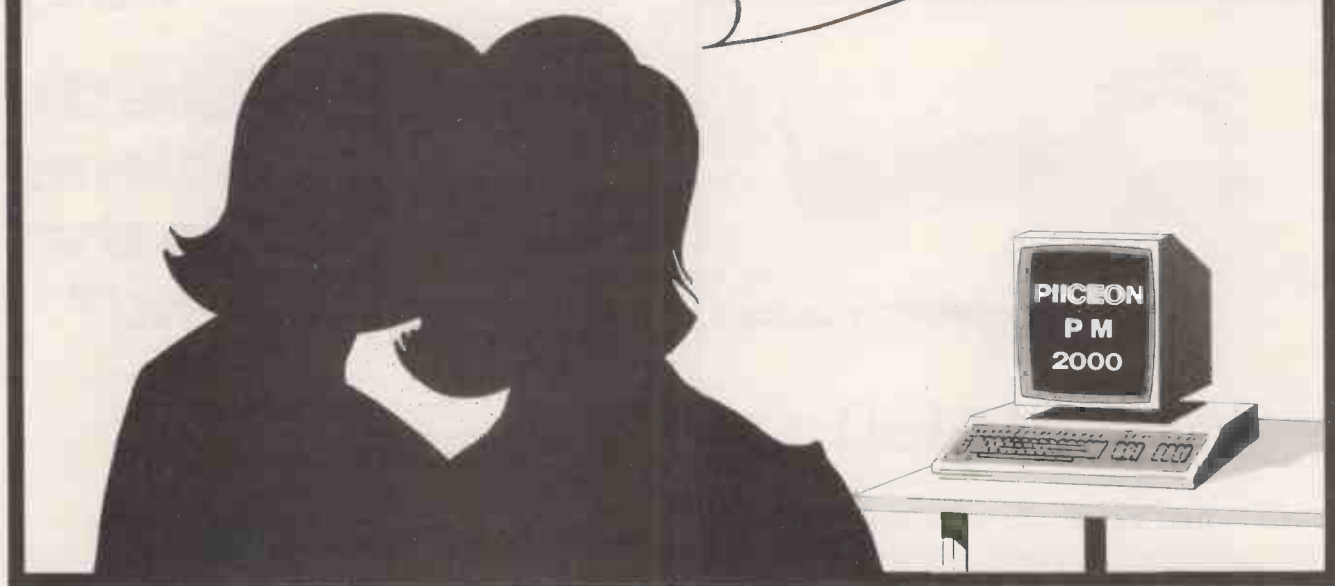

Yes, Piiceon is the one with the full A4 screen — that's 66 lines of 80 characters displayed in green — so you can view a full page before you print without eyestrain. Use it as a unique stand-alone system or as an intelligent peripheral of a mini or mainframe. Its got a 16-bit 8086 processor, disc storage and runs CP/M-86 — so software is no problem. We're the sole UK agents and can offer a Piiceon to suit your application, together with full technical back-up. So if you want the highest performance in micros at a very reasonable price — come and see Piiceon at Pall Mall — you won't be disappointed.

We also have Superbrain, Compustar and ACT Series 1 in stock at very attractive prices, together with a full range of supporting peripherals and software. If there is

not a software package available off-the-shelf to suit your needs — don't worry — our professionals will write it for you.

Standard software in stock includes Wordstar, Mailmerge and Spellstar, BASIC-80, FORTRAN-80, COBOL-80, ALGOL-80, PASCAL M, CIS COBOL, plus many application packages.

If you already have a system — ask us about our service and maintenance schemes — they're the best in the business.

**MICRO NETWORKS**  
60 PALL MALL LONDON 01-839 3701

# 5MB WINCHESTER FOR APPLE II

- LOWEST COST/MBYTE FROM ANY SUPPLIER
- SINGLE APPLE CONTROLLER
- PASCAL COMPATIBLE "DROP IN" BIOS
- LICENSABLE "PROTECTED SOFTWARE" OPERATING SYSTEM (only available to bona-fide software suppliers)
- DEDICATED APPLE II
- FAST DELIVERY

SUBSYSTEM DOES NOT INCLUDE APPLE DRIVE

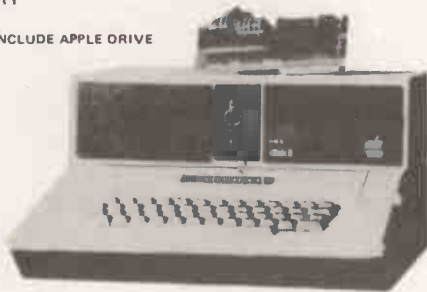

## SYMBFILE

## LOWEST UK PRICES



**apple computer**  
Sales and Service

R.R.P. **£1450**

TO PLACE YOUR ORDER, OR TO MAKE  
FURTHER ENQUIRIES, CONTACT:-

## symbiotic computer systems

85/87 STATION ROAD, WEST CROYDON,  
SURREY CR0 2RD

**01-680 8606**

● Circle No. 296

# APPLE II and ITT2020 PAYROLL £30.43

A program with many outstanding features in spite of its low price!  
Example: If you enter net pay — the program will compute gross pay deductions!

**HEWLETT-PACKARD 9845** Spline: Upwards compatible with HP Spline but: four times faster, more accurate, more versatile. Also available For HP85. £43.48 + Tape cost.

Also: **ZX81** + 16K programs to professional standard: full-featured **PAYROLL** £21.74.\* fast, flexible, big (16 to 48K) **STOCK CONTROL PACKAGE** £21.74.\* Critical Path Analysis £13.04.\* Business or Home **BUDGET** Program £13.04.\* **LOAN, VAT, MORTGAGE** £6.96 for all three **GOLD** — a good adventure game with a chance to win a Memotech £6.96.\* **RELIABLE 16K RAM Pack** £36.52.\* Memotech 48K RAM.

Prices include Postage and Packing, but VAT must be added.

Details from and orders to:

**HILDERBAY LTD**  
8/10 PARKWAY, REGENTS PARK  
LONDON NW1 7AA  
TELEPHONE 01-485 1059 TELEX 22870

● Circle No. 297

## Are your diskette problems all in the head?



A major cause of read errors and downtime is the build up of oxide and foreign bodies on heads.

But it doesn't have to be — not even in environments where diskettes are subject to dust and other airborne debris.

The simple solution is a CompuClean diskette, which will keep your heads clean and prevent the cumulative effects of oxide build-up. It takes just thirty seconds and costs less than fifteen pence a day.

But our ability to solve your problems doesn't end there. Find out how much we have to offer now.

Send for our colour catalogue to:  
Willis Computer Supplies Ltd., FREEPOST,  
PO Box 10, Southmill, Bishops Stortford, Herts.,  
CM23 1BR. Tel: Bishops Stortford (0279) 506491.

Name \_\_\_\_\_  
Company \_\_\_\_\_  
Address \_\_\_\_\_

**WILLIS** Computer  
Supplies  
for people who know better

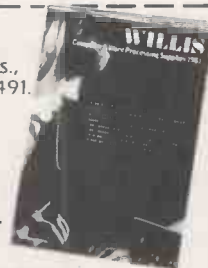

● Circle No. 298



## MIDAS S100 SYSTEMS

MIDAS 1: From £835

MIDAS 2: From £1,790

MIDAS 3: From £2,450

MIDAS 3HD: From £5,495

ITHACA-DPS 1: From £1,494

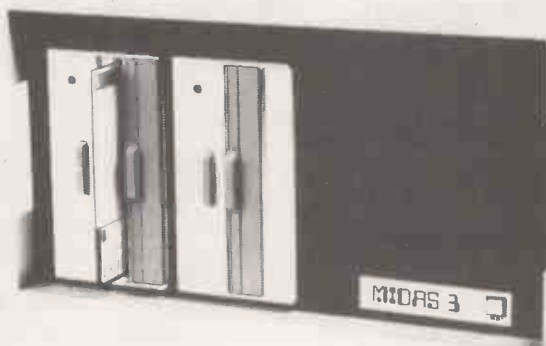

- Our versatile **Z80** Microcomputers are available as standard units or custom configured to your exact specification from a comprehensive range of stocked **S100** boards.
- Disc storage capacity of the **MIDAS 3** can be 2M Bytes, expandable to over 80M Bytes with a Winchester Hard Disc Unit in our **MIDAS 3HD** range.
- **MIDAS** runs **CP/M** and **MP/M**. Other Software includes M-BASIC, C-BASIC, FORTRAN, COBOL, CIS-COBOL, PASCAL and Word Processing.
- A **MIDAS 3D** with 64K RAM and 2M Bytes storage on two 8" drives with two Serial I/O Ports and CP/M only **£2,965**.
- Printers, VDUs and other peripherals stocked to give complete package system at keen prices.

## BOARDS

We stock over 50 different S100 Boards all from quality manufacturers, such as Godbout, SSM, Micromation, Dual, Ithaca, Vector, S.D. Systems, Morrow, Pickles & Trout, etc.

### PROCESSOR

Z80 Starter Kit	£251
SBC 100	£215
8085/88 CPU	£190
Z80A CPU 4MHz (4 Types) 8086	From £157 (tba)

### EPROM

27 16 EPROM (2 x 16K)	£95
2768/2716/2732 Programmer	From £143

### VIDEO BOARDS

24 x 80 I/O Drive	£240
24 x 80 Memory Mapped	£240

### DISK CONTROLLERS

Single Density 5" or 8"	From £150
Disc 1 D/D DMA	£282
Double D/D + Serial I/O	£336

### RAM

Static RAM 16-64K 24 Bit add.	From £175
Dynamic RAM 64K 8/16 Bit Memory Manager	£683 £60

### I/O BOARDS

2s/2p or 4s/2p or 3p/1s etc	From £120
A/D & D/A 8 or 12 Bit	From £220
IEE 488 interface	£360

### MISCELLANEOUS

Real Time Clocks (2 Types)	From £120
Graphics 256 & 512 x 256	£280
Maths Board AMD 9511	£345
Extender Boards/Logic Probe	£45
Mother Boards 8-20 Way	From £32

### MAINFRAMES

We are the sole UK Distributor for Ingrand Mainframes and Disc Enclosures, available in nine models including Desk Top and Rack Mounting, with or without provision for Disc Drives. All units totally enclosed, painted on all external surfaces and complete with power supply etc.

### SOFTWARE

CP/M 1 & 2, MP/M, PL/1, C-BASIC 2, M-BASIC V5, XYBASIC, FORTRAN 80, COBOL 80, CIS-COBOL, PASCAL/Z, PASCAL M/T, Forth, MAC, ZSID, Disassembler, Wordstar, Datastar, Magic Wand, Wordmaster, Supersoft etc etc.

Prices exclusive of VAT.

We are pleased to discuss your requirements and will advise you as to whether your needs can be met with one of our computers.

All of our systems are specials as they are configured to suit your specification, thus ensuring that you get what you want rather than what happens to be available.

Write or phone for a catalogue.

**Unit 14, 29 Willow Lane, Mitcham, Surrey**  
**Telephone: 01-640 6931/2/3**



# L&J COMPUTERS

192 HONEYPOT LANE, QUEENSBURY, STANMORE, MIDDX HA7 1EE. 01-204 7525

## THE "PET" SPECIALISTS



### GET THE BEST OF BOTH WORLDS!

WE CAN SUPPLY ALL YOUR 'PET' NEEDS AT CASH & CARRY PRICES

4032	40 Col. PET.	£585.00*	8050	IM Byte Disk	£755.00*
8032	80 Col. PET	£755.00*	4022	Printer	£357.00*
4040	347K Disk	£585.00*	8024	Printer	£975.00*

OR WE CAN SUPPLY, INSTALL AND TRAIN YOUR STAFF AT THE NORMAL PRICE WITHOUT ANY EXTRAS!!



**TRY US!  
YOU WILL NOT BE  
DISAPPOINTED**

### EXT CASSETTE DECKS (INC COUNTER & SOUNDBOX) £65-£55\*

<b>Printers</b>	<b>Disk Drives</b>	<b>Sundries</b>	
CBM 4022 & 8024	CBM 8050	Interfaces:	C12 Cassettes
Centronic 779	CBM 4040	Disks:	Library Cases
Centronic 737	CBM 3040	Paper	(roll & tractor feed)
Spinwriter 5510		Labels:	Dust covers
CBM 8026 & 8027			

NOW IN STOCK! Single floppy disk drive £350\*

TOOL KITS (BASIC 2 & 4), SUPERCHIPS... AND ALL SORTS OF OTHER CHIPS... UPGRADE YOUR PET EVEN MORE!!

### THE "MUPETS" ARE HERE!

3 TO 8 PETS ONLY NEED 1 DISK DRIVE...  
Daily demonstrations: Ring for details.

\* PRICES DO NOT INCLUDE VAT

PERSONAL SHOPPERS WELCOME  
Phone & Mail Orders accepted.

ALL GOODS SENT SAME DAY WHEREVER POSSIBLE  
LARGE S.A.E. FOR LISTS ETC.



## SOFTWARE

As well as a full range of Petsoft and Commodore Software, we have some highly reliable "Home-Brewed" programs available.

**STOCK CONTROL & INVOICING** £60  
(Handles up to 500 items — 32K) (180 on 16K). Stock depleted on invoicing, search etc. Cassette, disk (& print option).

3000 item; 4040/8050 £125

**CASH BOOK** £90  
Enter daily/weekly amounts — printout and totals, weekly/monthly analysis, totals and balances.

4032 & 8032 versions £110 & £120

**STOCK TAKING** for the licensing trade £240

**OUTSIDE SERVICES** (For Mini-Cabs etc.) £220

See for free software booklet

VISICALC "OZZ" Commodore Business Programs  
COMPSOFT DMSV Bristol Trader, Item & Monitor  
ANAGRAM LEDGERS Superpay Word Processing.

COME AND SEE THE NEW

# VIC-20

at £189 (inc VAT)

FULLY WORKING AND OPERATIONAL  
ASK US ABOUT ALL THE ADD-ON-GOODIES THAT GO WITH THE VIC...!

● Circle No. 300

# MICRO-80

UK Subscription Dept.

24 Woodhill Park Pembury Tunbridge Wells Kent TN2 4NW

GET THIS free software offer when you subscribe to MICRO-80 — The specialist magazine for TRS-80 and VIDEO GENIE.

LOOK AT the programs you get FREE when you subscribe...

★ **Level I in Level II** — Convert your Level II TRS-80 to operate as a Level I machine. Opens a whole new library of software for your use.

★ **Copier** — Copies Level II System tapes, irrespective of where they load in memory. Copes with multiple ORG programs.

★ **Z80 MON** — A low memory, machine language monitor which enables you to insert OP codes, edit memory, punch system tapes etc.

★ **Improved Household Accounts** — Powerful enough to be used by a small business.

★ **80 Composer** — A music generating program which enables you to play music via your cassette cord.

★ **Plus Two Games** — Poker and Cube (a version of the Rubiks cube for Disk users)

and don't forget MICRO-80 is now available in monthly cassette edition as well — all the published programs each month ready to load on cassette.

Please enrol me for an annual subscription and send me my FREE cassette program. I enclose £16.00  (magazine only) or £43.60  (magazine and cassette edition).

(enclose your cheque/P.O. made payable to MICRO-80 and send to the above address)

Software offer, and cassette edition prices applies to U.K. residents only. Overseas subscription rates on application.

Name.....

BLOCK CAPITALS PLEASE

Address.....

PC 4/82

● Circle No. 301



# Tomorrow's memories ... at tomorrow's prices

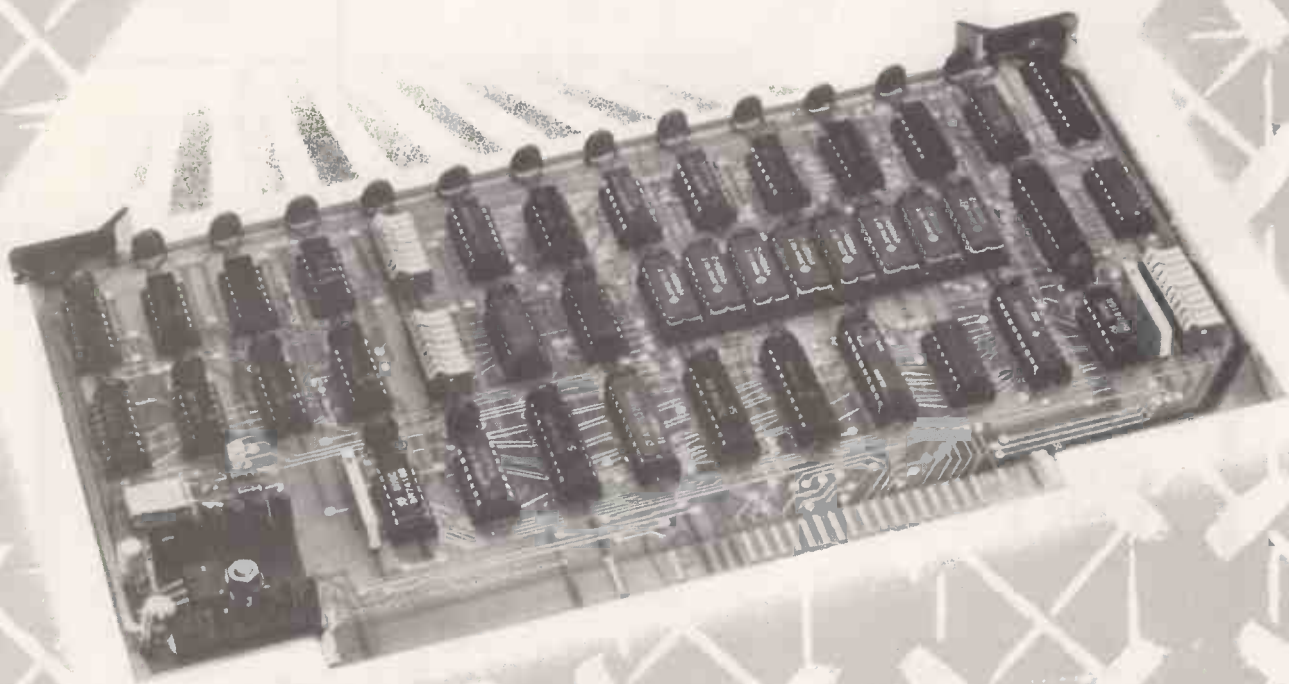

Yet another advanced S100 board from Hi-tech Electronics, SAM (Simply Add Memory) is a full 64 K byte memory board with bank select, designed to IEEE specifications. Features include: switchable reset in or out of bank — bottom 16 K bytes optionally in all banks — upper 48 K bytes in selectable bank — 8 K block disable switch — top 8 K block with 1 K disable — fast 64 K D RAMS for 4 MHz operation with on-board refresh.

High technology means lower prices: Hi-tech Electronics new SAM memory costs just:

**£199** + VAT 

To order your SAM now, phone or write to:

**HI-TECH ELECTRONICS**

54 HIGH ROAD, SWAYTHLING, SOUTHAMPTON SO2 2JF  
TEL 0703 581555 TELEX NO. 47388 HTEL

A Grand Metropolitan Electronics Company

# microware

## MEMOREX FLOPPY DISKS

WHOLESALE PRICES FOR END USERS



5 1/4" Single sided Single density £1.59

5 1/4" Double sided Double density £1.99

8" Single sided Single density £2.39

8" Double sided Double density £3.45

Soft Sektored  
10 Sector  
16 Sector

MAIL ORDER

Tel. 01-346-8452

### DISK STORAGE BOXES

from £14.95



full range of 5 1/4" and 8" models available

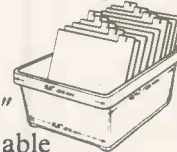

### Dysan Diskettes

104 1D £3.25

104 2D £3.75

full range available



In stock

Dust Covers for Micro's & Printers & VDUs from £6.95

Floppy Saver Kits from £7.95

Indexing Systems from £1.50

● Circle No. 303

## WHY YOU NEED THE INSPECTOR.

If you're serious about programming, you need to set all your utilities together in one place — *inside* your Apple. The Inspector comes on an Eprom that simply plugs into the D8 socket, or on a disk ready to merge with Integer Basic for automatic loading on boot. Either way, it stays at your fingertips, ready to call without disturbing your current program.

The Inspector puts you in total control of both memory and disks. You can search forward and backwards, edit, read nibbles, map disk space, dump the screen to a printer, examine every secret of your Apple. Use The Inspector to repair blown disks, undelete files, input "illegal" commands,

read and alter files, locate strings in memory or on disk. The uses are endless. The manual, alone, is an education. And it's always *there* when you need it.

You need the most powerful disk and memory utility available for your Apple. You need the Inspector.

See your local dealer, or order direct for just £45.00. Access or Visa accepted. Add £1.50 P & P. VAT excluded.



DDP RESEARCH & MARKETING

17 NOBEL SQ., BASILDON  
ESSEX SS13 1LP.  
TEL: (0268) 728484

Apple is a registered trademark of Apple Computer, Inc.

● Circle No. 304



★ Complete Installations

★ Staff Training

# RAIR BLACK BOX MICROCOMPUTER

## EXPANDABLE HARD DISK SYSTEMS - fast delivery ASK FOR DEMONSTRATION AT YOUR PREMISES

RAIR 3/30	5 Mbyte	64K Microcomputer with 1 Hazeltine Workstation	£ 4,280
RAIR 3/30	5 Mbyte	128K Microcomputer with 2 Hazeltine Workstations	£ 5,810
RAIR 3/30	5 Mbyte	256K Microcomputer with 3 Hazeltine Workstations	£ 7,590
RAIR 10 Mbyte	Add on Hard Disk	for extra storage	£ 2,500
Workstations:	IBM, Hazeltine, Tektronik etc.		POA
Printers:	Diablo, Qume, NEC, Oki, Texas, Anadex etc.		POA

Lease Purchase. Rentals available from 3 months.

★ Stop Press: ICL now manufacture Rair Black Box under license ★

## COMPETITIVE QUOTATIONS FOR SOFTWARE DESIGNED TO YOUR REQUIREMENTS

Examples below include software designed to your own specifications on Rair Black Box Microcomputers:

Invoicing. Integrated with Stock, Sales & Accounts	from £750
Stock. Integrated with Invoicing & Accounts	from £650
Sales. Integrated with Invoicing & Accounts	from £750
Payroll. Integrated with Accounts	from £795
Purchases. Integrated with Stock & Accounts	from £750
Name & Address. Integrated as required	from £550
Accounts. Integrated to Balance Sheet P&L	from £750

Estate Agents Client Matchup	from £550
Printers Estimator	from £950
Associations/Hirers etc. Member Tracker	from £500
Surgeries Patient Controller	from £500
Haulage Loads Sorter	from £500
Solicitors Bookkeeper	from £850
Insurance Brokers Paper Eater. Rentals per month	from £ 65

## MAIL ORDER CP/M SOFTWARE

INCLUDING: Black Box. Comart Communicator. Comart Educator. Cromenco. Excidy Sorcerer. Gemini. Nascon. ICL. North Star Horizon. Rair. Research Machines. Sharp MX. Superbrain. SD Systems. Transam Tuscan. Vector MZ. 8" IBM Format and others.

### BYROM SOFTWARE

BSTAM-Utility to link one microcomputer to another also using BSTAM £95 (£6)

BSTMS-Utility to link a micro to a mini or mainframe £95 (£11)

### COMPILER SYSTEMS

CBASIC v 2.08 £65 (£15)

### CREATIVE COMPUTING

CS-9001 BASIC Games 1 £14

CS-9002 BASIC Games 2 £14

CS-9003 ADVENTURE 1.0 £14

CS-9004 BILINGUAL Original Adventure £14

CS-9005 BASIC Games 3 £14

CS-9006 BASIC Games 4 £14

### PR DAILY - INTEGRATED ACCOUNTS

Name & Address £200

Stock £350

Invoicing £200

Sales £350

Purchase £350

General Accounts £500

Payroll £350

Time Reloading £500

### DIGITAL RESEARCH

MPM 1.1 £195 (£20)

MPM 2.0 £250 (£30)

CP/M86 £160 (£27)

CP/M 2.2 £95 (£20)

CP/NET £120 (£14)

SID £50 (£14)

ZSID £55 (£14)

MAC £60 (£14)

TEK £50 (£14)

DESPOOL £55 (£6)

PL/1 £300 (£27)

BT-80 £140 (£20)

### TINY-C ASSOCIATES

Tiny-C language for 8080, 8085, Z80 systems £55 (£39)

### NEW PRODUCTS

MICROPRO INFOSTAR TBA

FOX & GELLER QUICKSCREEN TBA

MICRO AP SELECTOR V TBA

DIGITAL RESEARCH CB-80 TBA

### GRAFFCOM INTEGRATED ACCOUNTS

Payroll £500

Sales £450

Purchases £450

Stock £350

General Accounts £400

Invoicing £350

Time Recording £400

HP/Rental/Lease £400

Name & Address £200

### GRAFFOX ENGINEERING GRAPHICS

2D & 3D POA

### INFORMATION UNLIMITED

WHATSIT (Database Management System) £80

### KLH SYSTEMS

Spooler for CPM systems v3.0 £70 (£6)

### MICROFOCUS

CIS COBOL version 4.4 £400 (£25)

FORMS 2 v11 £100 (£10)

### MICROLOGY

FTNUMB (FORTRAN-80 RENUMBER & REFORMATTER) £50 (£5)

### PEACHTREE

MAGIC WAND WORD PROCESSOR £185 (£20)

PHOENIX SOFTWARE ASSOCIATES (For Z80 only) £72 (£15)

PLINK-Disc to disc link loader £72 (£15)

PASM-Macro Assembler £72 (£15)

PEDIT-Line editor with Macros £72 (£15)

BUG-Very powerful debug £72 (£15)

PDEVELOP Package with all the above £193 (£33)

PLINK-2 Overlay Link Loader £185 (£15)

### MICROPRO INC.

WORD-MASTER 1.7A £75 (£22)

TEX-WRITER 2.6 £37 (£17)

WORDSTAR 3.0 £250 (£38)

MAILMERGE 3.0 (requires Wordstar) £75 (£10)

SPELLSTAR 1.0 (requires Wordstar) £125 (£10)

WORDSTAR TRAINING MANUAL (£18)

WORDSTAR CUSTOMIZATION NOTES £50

SUPER-SORT 1.6: Version 1 £125 (£22)

Version 2 £110 (£22)

DATASTAR V.101 £175 (£25)

CALCSTAR £150 (£25)

### SUPERSOFT INC.

DIAGNOSTICS 1 £45 (£9)

DIAGNOSTICS 2 £55 (£9)

TERM £72 (£7)

### TDL SOFTWARE (Technical Design Labs)

BUSINESS BASIC £80

ZTEL (Text Editing Lang.) £35

### LINKER

£35

### MICROSOFT INC.

BASIC-80 5.2 1 £185

BASIC Compiler 5.3 £205

FORTRAN-80 3.43 £260

COBOL-80 4.01 £380

M/SORT 1.01 £75

EDIT-80 2.02 £65

MACRO-80 3.43 £105

MULISP 2.10 £105

MUMATH 2.10 £130

### MICROTECH EXPORTS

REFORMATTER

CPM-IBM £98 (£17)

CPM-DEC £98 (£17)

### MT MICROSYSTEMS

PASCAL MT-5.25 £150 (£25)

PASCAL MT-5.25 with SPP £265 (£50)

Library Sources £110

Speed Programming Pkge. (Softbus) £125 (£25)

### RAIR

Enhances software for Black Box

MP/M £250

CP/NET £150

BASIC-80 £175

BASCOM-80 £225

FORTRAN-80 £275

COBOL-80 £425

PL/T-80 £325

PASCAL-80 £225

MACRO-80 £100

SUPERSORT £150

MSORT £100

DATASTAR £225

BSTAM £100

BSTMS £125

WORDSTAR £275

MERGEPRINT £100

Prices above are for Software and Manual. Prices in brackets denote Manual only.

MAIL ORDER INFORMATION. Due to price fluctuations please phone for current prices, updates, new releases and Order Information. Payment by Access and Barclaycard welcomed.



**Metcalfs**

111 HIGH HOLBORN LONDON WC1  
TEL. 01-534 3095 TELEX 893959

ALL PRICES SUBJECT TO 15% VAT AND FLUCTUATION.

● Circle No. 305

211



**NEW PRODUCTS**

I.B.S. now manufacture Industrial quality S100 products in Scotland. I.B.S. 1903 and 1906. S100 19" Sub Rack System. These racks were designed originally to the exacting specification of the Electricity Generating Board for use on nuclear power stations.

1903 is a 3U high card cage and 8 amp power supply and will take 6 S100 cards.  
1906 is a 6U high card cage and 16 amp power supply and will take 12 S100 cards.

- ★ IEC mains connector, filter, fuse and tap change switch on rear panel.
- ★ Key operated ON/OFF/RESET for maximum security.
- ★ Heavy duty painted front panel.
- ★ Carrying handles.
- ★ Supplied assembled complete with Power supply, IEEE (696) motherboard, card guides, and cooling fans.

I.B.S. 1903 ..... £299.00  
I.B.S. 1906 ..... £399.00

**I.B.S. 64K CMOS Static RAM/PROM Board for S100**  
This is a superior quality Ram/Prom board for the industrial user, the board will accept either H6116-3 (2K x 8) Ram chips or 2716 EProms in any combination.

- ★ S100 IEEE (696) Compatible. ★ 24 Bit Addressing.
- ★ Can be used with any CPU. ★ Will run at 6Mhz with standard Rams.
- ★ Wait state generation for Proms. ★ Phantomable.
- ★ Prom/Ram selectable on 2K boundary. ★ Low power.
- ★ Prom/Ram can be disabled to suit popular memory mapped devices.

**PRICES:**

<b>BARE BOARD</b>	£65.00				
Assembled/Tested	16K	32K	48K	56K	64K
	£179.00	£239.00	£299.00	£329.00	£359.00

Educational and industrial discounts available.

**SOFTWARE SALE (whilst stocks last)**

Microsoft Basic 80	..... WAS £175	NOW £149.00
Microsoft Basic Compiler	..... WAS £180	NOW £159.00

**Introductory offer**  
MicroPro CALC STAR ..... WAS £175 NOW £149.00  
★ Visit our stand at the Thames Valley Business Show, on 23/24/25th March 82.

- ★ Stand H5051.
- ★ The Fulcrum Centre.
- ★ Slough.

*The above prices exclude V.A.T. at 15%*

IRVINE BUSINESS SYSTEMS LTD

P.O. Box 5, 10 North Vennel, Bourtreehill, Irvine, Ayrshire KA11 1NE.

Tel: 0294-218888. Telex: 777582 Mark: attn. IBS

● Circle No. 306

# We have the technology to make your business more efficient.

Come to a free seminar at The LONDON MICRO CENTRE and find out what a micro processor can do for you.

See what our business programs do – and try them out yourself.

At our seminar, you can ask any question you like and get an answer you can understand.

Seminars are held every Wednesday and Saturday from 10.30 am till noon at

**The LONDON MICRO CENTRE**  
47 Lower Belgrave Street  
LONDON SW1  
Telephone 01-730 8791

Contact us today for further information

Open evenings and weekends.

The LONDON MICRO CENTRE Ltd. – An EMG Company

● Circle No. 307

# The '6809' centre

**Micro-Computer Hardware**

FUJITSU MICRO COMPUTER "JUST ARRIVED FROM JAPAN"	EX VAT	INC VAT
Fujitsu Micro 8 Twin '6809' 64K computer	868.70	999.00
Fujitsu Dual 5" Disc Drive with Adaptor (656 Kb)	1216.52	1399.00
Fujitsu Z-80 Alternative Processor Card	50.00	57.50

**APPLE ALTERNATIVE PROCESSOR CARDS**

Stellation The Mill '6809' With Disk Editor & Assembler	239.13	275.00
Stellation The Mill '6809' With Pascal Speed up kit	239.13	275.00
Microsoft Z-80 Softcard, With CP/M and Basic	191.30	220.00

**SOUTH WEST TECHNICAL PRODUCTS CORP - SS-50c MICRO-COMPUTERS**

SWTPC S/09-64K 64K Computer with 3 ports (2 MHz)	1448.70	1666.00
SWTPC 69/A 8K Computer with 1 port (1 MHz)	634.78	730.00
SWTPC MP-09 6809 Processor board (S-Bug, 1 MHz)	200.00	230.00
SWTPC MP-S2 Dual Serial Interface	110.00	126.50
SWTPC MP-L2 Dual Parallel Interface	110.00	126.50
SWTPC 8209 Intellegent 9" Terminal	860.00	989.00
SWTPC DMF-2 Dual 8" DS/DD disk drive (2.5 Mb)	2347.83	2700.00
SWTPC D-5 Dual 5" DS/SD disk drive (740 Kb)	1216.52	1399.00

**'77-68' MICRO-COMPUTER - SOLE UK DISTRIBUTOR FOR THIS 8" x 8" PCB KIT SYSTEM**

'77-68' '6800' CPU With 256 Bytes Ram & Parallel Port	10.43	12.00
'77-68' MON 1 Software Monitor & 2 Serial Ports	10.43	12.00
'77-68' MON 2 Rom Monitor with Serial Port	10.43	12.00
'77-68' '6809' CPU With 1K Ram, 2K Rom & 2 Ports	10.43	12.00
'77-68' Cassette 300-2400 Baud Cassette Interface	5.22	6.00
'77-68' 4K Ram 4K Static Ram Board	10.43	12.00
'77-68' Dynaram 32K Dynamic Ram Board	10.43	12.00
'77-68' VDU 40 x 24 Memory mapped VDU Board	10.43	12.00
'77-68' PIO 2 Parallel I/O Ports & Timer	10.43	12.00
'77-68' ROM A 8 x 2708 or 2716 Rom Board (8K-16K)	10.43	12.00
'77-68' Prom Prog 2708 Eprom Programmer Board	10.43	12.00
'77-68' Disk CTRL Hard Sectored Disk Controller Board	10.43	12.00
'77-68' System manual - '6800' CPU, MON 1 & 4K Ram Board	4.35	5.00
'77-68' Design notes for other boards (each)	0.87	1.00

**Micro-Computer Software**

<b>'6800' CASSETTE SYSTEMS SOFTWARE</b>		
SWTPC CST-012 Disassembler, with move function	10.00	11.50
SWTPC CST-014L Text Editor with source listing	28.00	32.20
SWTPC CST-015L Two Pass Assembler with source list	28.00	32.20
SWTPC CST-016L Text Processor with source listing	28.00	32.20
SWTPC CST-017L Program Relocator with source list	16.09	18.50
SWTPC CST-003 8K Basic Interpreter V2.3	15.22	17.50

**'6809' CASSETTE SYSTEMS SOFTWARE - DIRECT FROM THE STATES**

TSC '6809' Cassette Text Editor	60.78	69.90
TSC '6809' Cassette Macro Assembler	60.78	69.90
TSC '6809' Cassette Basic	60.78	69.90

**FLEX9 OPERATING SYSTEM SOFTWARE, ON 5" OR 8" DISKS - FORMOST '6809' MACHINES**

TSC Flex Configurable + Editor & Assembler	120.00	138.00
TSC TS-003 Sort/Merge Package	58.26	67.00
TSC TS-004 Debug Package	58.26	67.00
TSC TS-005 Disk Utilities	46.96	54.00
TSC TS-006 Text Processor	58.26	67.00
TSC TS-009 Editor & Macro Assembler	69.57	80.00
TSC TS-017 Disk & Memory Diagnostics	52.17	60.00
TSC TS-007 Basic	52.17	60.00
TSC TS-008 Extended Basic	75.65	87.00
TSC TS-016 XBasic Pre-Compiler	40.87	47.00
TSC TS-019 Pascal	145.22	167.00
Washington R.M.S. Record Management System	145.22	167.00
C.S.C. Tabula Rasa Spreadsheet/Tabulation Program	120.00	138.00
Microware Stylograph Word-Processing System	173.04	199.00

**Books (Please add 1.50 p&p per order)**

Osbourne 4 & 8-Bit Microprocessor Handbook	13.60	13.60
Osbourne 16-Bit Microprocessor Handbook	13.60	13.60
Practical Micro-Computer Programming with the M6800	16.75	16.75
'6800' Assembly Language Programming	11.60	11.60
Scelbi - '6800' Software Gourmet Guide and Cookbook	8.50	8.50
'6801, 68701 & 6803' Micro-Computer Programming & Interfacing	9.95	9.95
'6809' Assembly Language Programming	12.10	12.10
The MC6809 Cookbook	5.60	5.60
'68000' Microprocessor Handbook	5.90	5.90

**Blank Disks & Cassettes (Please add 1.50 p&p per order)**

Accutrack Disk x 10 5" SS/SD Soft Sectored	16.96	19.50
Accutrack Disk x 10 5" DS/DD Soft Sectored	29.48	33.90
Accutrack Disk x 10 8" SS/SD Soft or Hard (32) Sectored	17.83	20.50
Accutrack Disk x 10 8" DS/DD Soft or Hard (32) Sectored	32.17	37.00
Cassettes C-12 x 10 6 minutes per side	4.34	4.99

- Come and try any of our systems or make use of our mail order service.
- All prices include carriage charges within mainland UK, except where stated.
- All prices are correct at time of going to press and subject to availability.
- Send for our latest price list and catalogue covering our vast range.
- Further information is available on all the products listed, send for details.
- Store opening hours - 9.30 to 5.30 - Monday to Saturday - Access and Visa.
- Stirling Microsystems Limited - The '6809' Hardware and Software Store.



241 Baker Street, London NW1 6XE. Telephone: 01-486 7671.

● Circle No. 308



# CUMANA promise you absolutely reliable and compatible

# FLOPPY DISK DRIVES

## 40 and 80 TRACK CASED UNITS

### Dual Disk Units

2 x 40 Track single sided Drives	£399
2 x 80 Track single sided Drives	£539
2 x 80 Track double sided Drives	£799

### Single Disk Units

1 x 40 Track single sided Drive	£219
1 x 80 Track single sided Drive	£285
1 x 80 Track double sided Drive	£429

### Disk Drive Cables

2 Drive Cable	£15.00
4 Drive Cable	£25.00

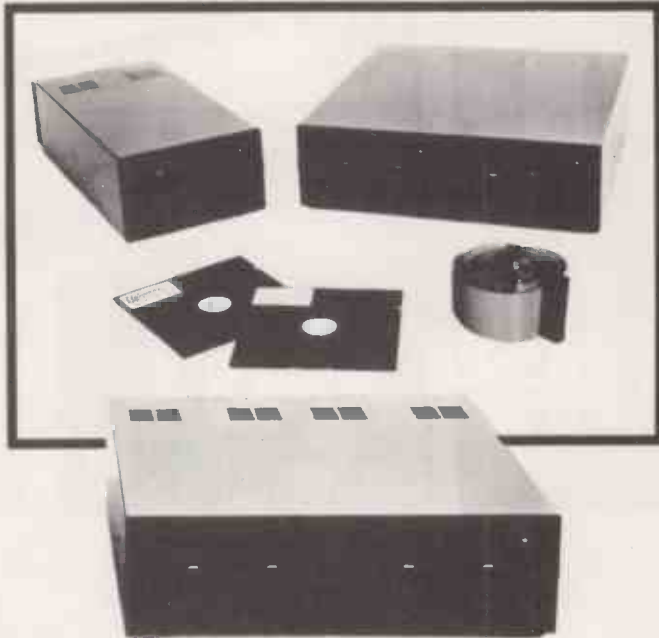

Cumana Ltd., offer you a dependable flow of exceptionally high quality **DISK DRIVES** from **TEAC** of Tokyo featuring high reliability and compatibility. Cumana have an enviable reputation and aim to continue giving you the best service in the business. These main powered Disk Drive units are designed to interface to a wide range of computers such as **Genie I and II, SWTP, Heathkit, Superbrain, Nascom, Atom** and the **BBC Micro**.

Write or 'phone for Data Sheets

## Call your nearest dealer for a demonstration:

**RADIO SHACK LTD.**,  
188, Broadhurst Gardens,  
London NW6  
Tel: 01-624-7174

**COMP SHOP LTD.**,  
14, Station Road,  
New Barnet, Herts  
Tel: 01-441-2922

**COMP SHOP LTD.**,  
311, Edgware Road,  
London W2  
Tel: 01-262-0387

**COMP SHOP LTD.**,  
19, Herbert Street,  
Dublin 2  
Tel: 604165

**LONDON COMPUTER CENTRE**, 43, Grafton Way, London W1.  
Tel: 01-368-5721

**N.I.C.**  
61, Broad Lane,  
London N15.  
Tel: 01-808-0377

**CROYDON COMPUTER CENTRE**, 29a, Brigstock Road, Thornton Heath, Surrey.  
Tel: 01-689-1280

**P J EQUIPMENT LTD.**,  
3, Bridge Street,  
Guildford.  
Tel: 0483-504801

**R.D.S. ELECTRICAL LTD.**, 157-161, Kingston Road, Portsmouth.  
Tel: 0705-812478

**TANDY HASTINGS LTD.**, 48, Queens Road, Hastings.  
Tel: 0424-431849

**MICROWARE COMPUTING SERVICES**, 57, Queen Charlotte Street, Bristol.  
Tel: 0272-279560

**BLANDFORD COMPUTERS**, Higher Shaftsbury Road, Blandford Forum.  
Tel: 0258-53737

**TAPE SHOP**  
321 Viaduct Road,  
Brighton.  
Tel: 0273-609099

**PARWEST LTD.**,  
18, St. Mary Street,  
Chippenham.  
Tel: 0249-2131

**COMPUTER SHACK**  
14, Pittville Street,  
Cheltenham.  
Tel: 0242-584343

**TANDY GLOUCESTER**,  
13, Clarence Street,  
Gloucester.  
Tel: 0452-31323

**COMSERVE**,  
98, Tavistock Street,  
Bedford.  
Tel: 0234-216749

**CLEARTONE COMPUTERS**, Prince of Wales Ind. Estate, Abercarn, Gwent.  
Tel: 0495-244555

**EMPRISE LTD.**,  
58, East Street,  
Colchester.  
Tel: 0206-865926

**MAGNUS MICRO-COMPUTERS**,  
139 The Moors,  
Kidlington, Oxford.  
Tel: 08675-6703

**CAMBRIDGE COMPUTER STORE**,  
1, Emmanuel Street,  
Cambridge.  
Tel: 0223-65334

**I.C. ELECTRONICS**,  
Flagstones,  
Stede Quarter,  
Biddenden, Kent.  
Tel: 0580-291816

**MICRO CHIP SHOP**,  
190, Lord Street,  
Fleethwood, Lancs.  
Tel: 03917-79511

**HARDEN MICRO-SYSTEMS**, 28-30, Back Lord Street, Blackpool.  
Tel: 0253-27590

**AMBASSADOR BUSINESS COMPUTERS LTD.**,  
Ashley Lane Works,  
Shipley, W. Yorks.  
Tel: 0274-595941

**Q-TEK SYSTEMS LTD.**,  
2 Dalry Close, Old Town, Stevenage, Herts.  
Tel: 0438-65385

**COMPUTER & CHIPS**,  
Feddinch Mains House,  
St. Andrews, Fife,  
Scotland.  
Tel: 0334-72569

**HEWART MICRO-ELECTRONICS**,  
95, Blakelaw Road,  
Macclesfield.  
Tel: 0625-22030

**KARADAWN LTD.**,  
2 Forest Way,  
Great Sankley,  
Warrington.  
Tel: 0925-572668

**PHOTO-ELECTRICS**,  
459 London Road,  
Sheffield.  
Tel: 0742 53865

**ARC ELECTRONICS**,  
54 Heron Drive, Sandal,  
Nr. Wakefield,  
W. Yorks WF2 6SL.  
Tel: 0924-253145

**VICTOR MORRIS LTD.**, 340 Argyle Street, Glasgow, G2 8LY.  
Tel: 041-221 8958

**COMPRITE LTD.**,  
Thorite House,  
Laisterdyke,  
Bradford  
Tel: 0274-663471

**GNOMIC LTD.**,  
46, Middle Street,  
Blackhall,  
Hartlepool.  
Tel: 0783-863871

**BRIERS COMPUTER SERVICES**, 1, King Edward Square, Middlesbrough, Cleveland.  
Tel: 0642-242017

**3 LINE COMPUTING**  
36, Clough Road, Hull.  
Tel: 0482-445496

**H.C. COMPUTER SALES LTD.**, 162, Earlsway, Team Valley Trading Estate, Gateshead.  
Tel: 0632-874811

**EWL COMPUTERS LTD.**,  
8, Royal Crescent,  
Glasgow.  
Tel: 041-332-7642

**EVERYMAN COMPUTING**,  
14 Edward Street,  
Westbury, Wilts.  
Tel: 0373-864644

# CUMANA LTD

35 Walnut Tree Close, Guildford, Surrey, GU1 4UN.  
Telephone: (0483) 503121. Telex: 858306

Please add VAT to all prices.  
Delivery at cost will be  
advised at time of order.

# DAISYWHEELS ARE DOWN

.....down to a new low price!  
For less than the price of some dot matrix printers, the Smith-Corona TP-1 brings the benefits of daisywheel printers within the reach of most micro users. Now letters, documents, forms, invoices, reports, price lists etc., can be printed with the quality that until now was not readily affordable. This quiet, reliable machine will produce 120 wpm.



- Simple reliable mechanism
- Serial or Parallel Interface
- IEEE option
- Single sheet and fanfold paper

## £485

+ VAT

Sole Distributors:

# discom

Old Manor Farm, Ashton-under-Hill,  
Evesham, Worcs. Tel (0386) 881962

Please send me details of the TP-1

Name ..... Trade/OEM\*

Address .....

Tel. No ..... Delete as necessary

● Circle No. 309

## PROTECT YOUR SOFTWARE INVESTMENT

# APPLE® COPY II PLUS

— the newest and fastest bit-copier  
version 3.0

Apple Copy II Plus gives you the power to make back-up copies of nearly all the "protected" software packages currently available. Several thousand Apple users have already recouped their investment many times over with Copy II Plus.

### RELAX

With the Apple Copy II Plus in your top drawer you can stop worrying about accidental damage to your valuable diskettes. The Copy II Plus allows you to make back-up copies for normal use, so you can keep your originals safely locked away — away from the dangers of spills or stray magnetic fields, or just the wear and tear of everyday usage.

### EXTREMELY VERSATILE

Version 3.0 of Copy II Plus is an advanced bit-copier which can defeat nearly every protection system now in use. It will copy most DOS 3.2 and 3.3 diskettes including: Visicalc 3.3, Desk Top Plan, Magic Window, DB Master (2.4) Dataplan, the Apple Special Delivery Software range and many, many more.

### UNIQUE

- Copy II Plus is the *only* bit-copier that allows you to make back-up copies of itself — for complete peace of mind.
- Copy II Plus is the fastest bit-copier by far. It copies 5 tracks at a time and makes a complete disk copy in only 35 seconds, while ordinary bit copiers take 5–7 minutes!

### FEATURES

- easy to use menu.
- comprehensive instructions.
- copy with 1 or 2 drives.
- track-by-track copy program report.
- copies half-track and irregular track spacing
- variable search parameters — for non-standard sync or header nibbles
- "display" option shows data being copied
- "examine buffer" option helps identification of protection system used.

### HOW TO GET YOUR COPY II PLUS

Copy II Plus needs 48K DOS 3.3, and at least one disk drive.

Send £45.00 + VAT to:

Apple Orchard Ltd  
7a Church Lane  
Loughton  
Milton Keynes MK8 0AS  
or: Phone 0908 53595 and quote your Access or Diners Club card to our 24-hour answerphone.  
Please allow 7–14 days for delivery — or tell us to rush if that's too long.



Apple is a registered trademark of Apple Computer Inc. Desk Top Plan and Visicalc are registered trademarks of Personal Software Computer Systems. Dataplan is a registered trademark of Responder Ltd. Magic Window is a registered trademark of Bitwise. D.B. Master is a registered trademark of Strawberry Man. Copyright © Apple Orchard Ltd 1985.

● Circle No. 310



# NCC

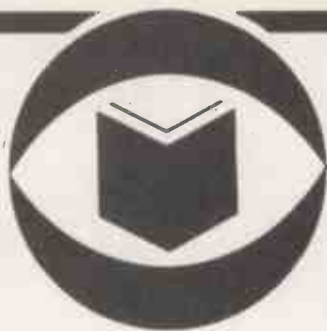

## The National Computing Centre

**Oxford Road, Manchester M1 7ED**

The National Computing Centre, Manchester, and John Wiley & Sons Ltd. are pleased to announce that as from 1st April, 1982, N.C.C. Publications will be marketed and distributed exclusively by Wiley.

N.C.C. publications cover all aspects of computing with particular emphasis on the requirements of the data processing professional. 24 new titles are planned for 1982 and there is an active backlist of 120 titles. Details on the forthcoming publications programme can be obtained from Mr. John Wilson, **John Wiley & Sons Ltd.**, Baffins Lane, Chichester, Sussex PO19 1UD. Tel: (0243) 784531

### *New titles:*

#### **REVIEWING YOUR DATA TRANSMISSION NETWORK**

by P.R.D. Scott, NCC, Manchester

This review is an exercise to 'know your data network', in terms of how users view the system, what is happening on the network, and how much the network is costing. The need for careful management of the network is stressed, so that operation, expenditure, future enhancement, expansion, modification, and ultimately replacement of the network are all properly planned. The aim is to provide a systematic approach to assessing the quality and cost effectiveness of the communications element of a computer network.

April 1982  
085012 326 7

approx. 160pp  
£25.00

#### **DATABASE FOR THE SMALL COMPUTER USER**

by R.A. Elbra, NCC, Manchester

This book looks at the options available to a small user, defined as a business or part of a business with only a limited use for computer facilities. Following a resume of why a database would be useful for such an installation, three alternatives are examined in turn. These are:— using a minicomputer with a DBMS, using a shared data machine and participating in a distributed database (the last being an option available to small users who form part of a large user). The advantages and difficulties of each method are given.

April 1982  
085012 328 3

approx. 150pp  
£12.50

#### **PROGRAMMING EMBEDDED MICROPROCESSORS — A High-Level Language Solution**

by R.L. Foulger, NCC, Manchester

Gives guidance on the use of high-level languages to program embedded systems — an embedded system being regarded as a product which contains a microprocessor but which is not itself a computer. Examines language aspects of special relevance to embedded applications, enabling engineers and designers of embedded microprocessor products to make an informed choice of language from the available options. Languages considered include PL/M, PLZ, MPL, BASIC, Pascal, CORAL 66, RTL/2 and FORTH.

April 1982  
085012 336 4

approx. 200pp  
£15.00

#### **INTRODUCING COMPUTER SECURITY**

by M.B. Wood, Manager, Data Processing Division of N.C.C.

An introductory text for people involved in security of computer systems. Surveys the principles of security as applied to modern business and administration systems. Practical application of these is illustrated in chapters dealing with physical security, fire, access control, software, communications and people. The book also offers guidance on computer crime and abuse. It discusses data security and confidentiality, especially in relation to privacy legislation.

April 1982  
085012 340 2

approx. 160pp  
£7.50



**Distributed by**  
**John Wiley & Sons Limited**  
Baffins Lane · Chichester · Sussex PO19 1UD · England

● Circle No. 311

## Fighting your way through the silicon jungle?

We carry a comprehensive selection of microcomputer software, hardware and peripherals

Apple ][  
Apple III  
Sharp 3201, MZ80B  
Superbrain  
Altos  
Millbank System 10

Accounting  
Stock Control  
Database Management  
Production Control  
Graph Plotting  
Word Processing

We are to you as Jane was to Tarzan!

Well, perhaps not quite, but please 'phone us for a brochure which explains exactly how we can help

THE AVERY  
COMPUTER COMPANY

13, The Mall  
Bar Hill  
CAMBRIDGE  
Tel. Crafts Hill 80991 (24 hours)

● Circle No. 312

## PET EPROM PROGRAMMER ACORN EPROM PROGRAMMERS

SUITABLE FOR ALL PET OR ACORN COMPUTERS

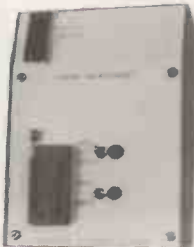

THE  
2716/2532  
MODEL  
PLEASE ADD  
£1.50 P&P

£46.00

The programmer includes the software tape for reading/programming the 2716/2532 Eproms. Plus a FREE programme for making your own Pet graphics on a 2716 Eprom.

## PET SUPERBOARD 32 NEW

ONLY  
INC P&P

£45.50

Only 6" x 4" x 2"

- Pet IEEE Port Connector and Cable
- Acorn Expansion Port Connector and Cable
- Independently Powered
- Mains switch with neon indicator light, anti surge fuse at rear.
- Zero force insertion socket.
- Indicator light for read and programme.
- Switch select for read and programme.
- Switch select for 2716/2532 Eproms.
- The programmer can read and programme 2716 and 2532 Eproms.
- And read any 2716/2532 pin compatible ROMs, ie, any Pet ROM/Eproms.
- Software control programme supplied on tape.
- Instantaneous read of Eprom/ROMs verification of data.
- Total price inc P&P £47.50.
- Remittance with order.

2532 compatible EPROMS  
£10.50  
2716 compatible EPROMS £4.50  
Incl P&P

- This board can be plugged into any ROM socket from \$9000 to \$F000.
- You can plug up to 8 ROM/Eproms into the board in any combination of 2k or 4k, 2716/2532.
- Simply slots onto the expansion port, no soldering or wires required.
- Each chip is programme selectable at a speed of 3y5.
- You can now have viscal, toolkit, etc plugged into one socket.
- It is possible to run a 32k m/c programme from any single ROM location.
- The board plugs onto the expansion port and is compatible with any other add on board.
- Up to 7 boards could be used simultaneously giving a maximum of 224k of on board ROM/Eprom.
- These boards could be used to have several languages residing in the Pet permanently.
- Can also be plugged into the character generator socket to run 8 different character sets.
- SAE for further details.

## COMPUTER INTERFACE DESIGNS

4 Albert Road, Margate, Kent CT9 5AN.

Tel: (0843) 294648.

● Circle No. 313

STCS

S T Commercial Systems Ltd

# Brain Specialists

Simplify all your accounting  
Sales, Purchases, Invoicing,  
Payroll, Stock control  
VAT Reports  
Even Trial balances and  
P & L Accounts

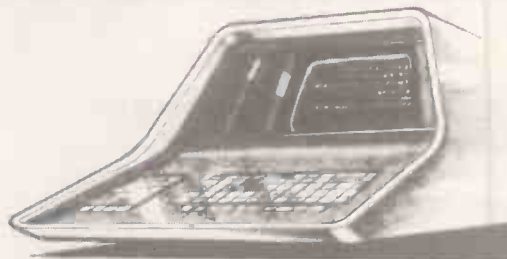

SuperBrain can work as a word processor  
Provide All Tektronix type graphics  
and even emulate a Tektronix terminal.

- Communications to most mainframes and MINIS
- Runs IBM "BISYNC" protocol emulating 3270s or 2780s.
- Programming languages include PASCAL FORTRAN BASIC COBOL!
- Disk capacities from 360K to 10M bytes ● Prices from **£1,695** plus VAT
- Full range of CP/M software and peripherals
- NEC spinwriters. EPSON printer MICROPRO software
- **DEALERS BEST DISCOUNTS**

26 New Broadway, Ealing, London W5

- We also sell CROMEMCO and North Star Hardware. Telephone: 01-840 1926

● Circle No. 314



ASSOCIATION OF LONDON COMPUTER CLUBS

Proudly presents

**THE**  
3rd LONDON  
**COMPUTER**  
**FAIR**

APRIL 15th 16th & 17th 1982 10am - 6pm  
[7pm 16th]

Including: Retail Exhibitors • Hobbyists  
Club Stands • Seminars • Workshops  
Bring and Buy Sale [17th only]

Admission £1.00

POLYTECHNIC OF NORTH LONDON  
THEATRE

⊖ Opposite Holloway Rd. tube station ⊖

SPONSORED BY EDUCATIONAL COMPUTING,  
COMPUTING TODAY and

The Polytechnic  
of North London

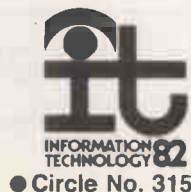

# WHY BUY FROM CAMDEN?

- ★ WE SUPPLY : THE **HARDWARE**
- ★ WE SUPPLY : THE **SOFTWARE**
- ★ WE SUPPLY : THE **BACK-UP**
- ★ WE SUPPLY : THE **EXPERIENCE**
- ★ WE SUPPLY : THE **KNOWLEDGE**

MAIN DISTRIBUTORS FOR ALL THE LEADING MAKES OF MICROCOMPUTERS AND PERIPHERALS.

OFF THE SHELF PROGRAMS TO SUIT MOST APPLICATIONS FROM THE LEADING SOFTWARE HOUSES — WITH PROVEN RELIABILITY.

FROM OUR OWN ENGINEERING WORKSHOPS WITH FULLY QUALIFIED TECHNICIANS OR ON-SITE SERVICE — YOUR CHOICE.

AS ONE OF THE COUNTRY'S LEADING DISTRIBUTORS WITH PROVEN SALES RECORDS — AND ONE OF THE PIONEERS OF THE MICROCHIP.

OUR FULLY TRAINED STAFF WILL ADVISE ON YOUR REQUIREMENTS TO SUIT YOUR NEEDS AND IMPROVE YOUR BUSINESS.



## Superbrain

64K QD MODEL  
PLUS EPSON MX80FT  
PLUS FULLY INTEGRATED  
ACCOUNTS PACKAGE  
**£21** PER WEEK LEASE  
OR PURCHASE



## Apple III

128K MODEL  
INCLUDES MONITOR  
VISICALC III — SOS  
MAIL LIST MANAGER  
AND APPLE BUSINESS BASIC  
PLUS SILENTTYPE PRINTER  
PLUS ADDITIONAL DISK DRIVE  
**£21** PER WEEK LEASE  
OR PURCHASE

## CAMDEN ELECTRONICS LTD (SYSTEMS DIVISION)

462 COVENTRY ROAD, SMALL HEATH, BIRMINGHAM B10 0UG

PHONE: 021-771 3636 (10 lines)

TELEX: 335909 (CAMDEN G)



● Circle No. 316

## For the best PET software...

COMMAND-O.....	For Basic IV CBM/PET, 39 functions with improved "Toolkit" commands	£59.95 + Vat
DISK-O-PRO....	For Basic II PET, adds 25 commands including Basic IV, in one 4K rom	£59.95 + Vat
KRAM.....	For any 32K PET/CBM for retrieving disk data by KEYED Random Access	£86.95 + Vat
SPACEMAKER IV	For any PET/CBM, mounts 1-4 roms in one rom slot, switch selection	£29.95 + Vat
USER I/O	For software selection of up to 8 roms, in any two Spacemaker Quads	£12.95 + Vat
FRONTO-PET....	Soft/hard reset for 40-column PETs	£9.99 + Vat

SUPERKRAM, REQUEST & KRAM PLUS will be available shortly

We are sole UK Distributors for these products, which are available from your local CBM dealer, or direct from us by mail or telephone order. To order by cheque write to: Calco Software, FREEPOST, Kingston-upon-Thames, Surrey KT2 7ER (no stamp required). For same-day Access/Barclaycard service, telephone 01-546-7256. Official orders accepted from educational, government & local authority establishments

## ...at the best prices!

WORDPRO IV PLUS	RRP £395 less £98.75 =	£296.25!
WORDPRO III PLUS	RRP £275 less £68.75 =	£206.25!
WORDPRO II PLUS	RRP £125 less £31.25 =	£93.75!
VISICALC	RRP £125 less £25.00 =	£100.00!
TOOLKIT Basic IV	RRP £34 less £9.50 =	£24.50!
TOOLKIT Basic II	RRP £29 less £7.25 =	£21.75!

The items above are available by mail or telephone order at our Special Offer Price when purchased with any one of our software products. This offer is for a LIMITED PERIOD only. UK - ADD 15% VAT. OVERSEAS airmail postage - add £3.00 (Europe), £5.00 (outside Europe).

# Calco Software

Lakeside House - Kingston Hill - Surrey - KT2 7QT Tel 01-546-7256

● Circle No. 317

## i systems ltd.

### A/D BOARD FOR NASCOM

- 8 input channels
- 30 microsec conversion
- Over voltage protection
- Prototyping area
- 8 bit resolution
- Sample and hold
- Full flat/interrupt control
- NASBUS compatible

Price £135 + 15% VAT (post free)

### GRAPHICS BOARD FOR NASCOM

- 384(H) x 256(V) high resolution graphics display
- Fully bit mapped
- Full software control
- Mixed text and graphics
- NASCOM 2 or 4MHz NASCOM 1

- Graphics software supplied

Price £55 + 15% VAT (post free)

### EPROM PROGRAMMER

- Programs 3 rail: 2708/2716
- Single rail: 2508/2758
- 2516/2716
- 2532/2732

- Software supplied for Read/Program/Verify
- Can be used with other machines with 2 parallel ports

Price £63 + 15% (post free)

### DUNCAN

- Fast real time interpreter/control language for NASCOM 1 or 2 (please specify)

Price £12 + 15% VAT (post free)

### MEMORIES

- 4116-150ns 95p each + 15% VAT (min order 8)
- 64K-200ns £10 each + 15% VAT

### MONITORS

- BMC 12" green phosphor — 18MHz

Price £175 x 15% VAT (carriage paid)

6 Laleham Avenue, Mill Hill,  
London NW7 3HL  
Tel: 01-959 0106

● Circle No. 318



# Mind your Language



**MONEY BACK GUARANTEE!**

... It's essential these days with so much verbiage around. But, there's no misunderstandings with **dBASE II** — absolutely the last word in High Level Language for micro systems.

*"By using dBASE II on all our new software development we have cut development time by 90%"* — Robin Coles of Dataflow B.V.

**dBASE II** is the most powerful, easiest to use micro database management system available. It handles information by relational rather than hierarchical contexts so that users don't get bogged down with system syntax. Data bases can be created and initial data entered in less than a minute. The system can be programmed so that even untrained personnel can accurately run even your most complicated applications.

With **dBASE II** you can extend the power of your micro computer to jobs that were previously reserved for larger mainframes. General ledger, accounts, payroll, stock control, tax accounting, mailing labels and scheduling are just some of the tasks **dBASE II** will handle.

The interactive reports, and prompts, are in plain English for simplicity of use. **dBASE II** requires 8080, or Z80 systems, with 48K of memory running with CP/M, one or more disk drives and an 80 column cursor addressable VDU and an optional printer.

Unlike other systems, you don't have to change the way you operate to use **dBASE II**. Indeed, you'll be amazed just how quickly you can benefit from **dBASE II** and you'll wonder how you managed without it before — at only £435 it's a must.

*If you need further proof then contact: the people who believe in Quality, Reliability and Support.*

ESL Dealers  
 Applied Micros Ltd., 14 Clifton Road, Heaton Moor, Stockport, Cheshire. 061-431 9390.  
 Atlantic Microsystems Ltd., 72 Honor Oak Park, London SE23. Tel: 01-699 2202.  
 Bondbest Ltd., 66 Wells Street, London WC1. Tel: 01-580 7249/6702.  
 Boyd Microsystems Ltd., 59 High Road, Bushey Heath, Herts. Tel: 01-950 0303.  
 The Electronic Office, 33 West Street, Brighton, Sussex. Tel: 0273 505223.  
 ISIS Computer Services Ltd., Millwood House, Middle Assendon, Henley on Thames, Oxford. Tel: 04912 77735.  
 Micro People Ltd., 1 Union Street, Long Eaton, Nottingham NG10 1HH. Tel: 06096 69117.

Encotel Systems Limited,  
 530-539 Purley Way,  
 CROYDON, Surrey.  
 Tel: 01-686 9687/8 Telex: 265605

# YOUR DATA LIFELINE



The **DATALIFE** Series of magnetic media from Verbatim, incorporates many advanced data shielding benefits. These ensure a longer, more trouble-free recording, storage and retrieval life — quite simply Datalife is the best range of media available today.

And now BFI, the UK's major distributor of Verbatim products, has introduced a new service — called the Datalife Line. Call us on the Datalife Line and we can offer you fast deliveries, competitive prices on Verbatim products, excellent back-up and technical advice on flexible disks, mini diskettes, data cartridges, digital cassettes, alignment disks, XE disks and Datalife head cleaning kits.

**CALL THE Datalife<sup>TM</sup> LINE NOW:**  
**01-941-4066**

**BFI**

Scottish Distributor:  
 Computer Supplies Co.,  
 8/18 Union Street, Bo'ness,  
 West Lothian, Scotland.  
 Tel: 050-682-3393

BFI Electronics Ltd.,  
 516 Walton Road,  
 West Molesey,  
 Surrey. KT8 0QF  
 Tel: 01-941 4066  
 Telex: 261395

● Circle No. 319

● Circle No. 320

SOS Missile Command... Multihead Destroyers destroyed city... SOS Missile Command... Cluster Mines sighted...  
 ... SOS Missile Command... Plasma Projectile assault... SOS Missile Command... Satellite Bombs in range... SOS Missile Command... Megon Annihilator destroyed further city... SOS

Kansas £350  
**'COMMAND' CONTEST**  
 Computer Fair—Earls Court  
 April 23—25

# Missile Command

Together, Mike Chalk and Kansas  
 bring you not just another Arcade game

... an EXPERIENCE!

YOU command the ground-to-air missiles to save the cities from total Alien destruction, progressing to TEN levels of difficulty from not-to-easy to bloody impossible! Multiple displays with five types of Aliens and Satellite Bomber. Infinite missile 'sight' control.

Based on the Arcade game of the same name, this is easily the finest computer game of its kind available today. It demands quick responses and no small amount of skill to overcome the Aliens even at the lower levels of play. As the game proceeds, so does the risk of total abillation, giving at last, a very, very competitive game indeed, and one which will satisfy even the very skilled gamesman.

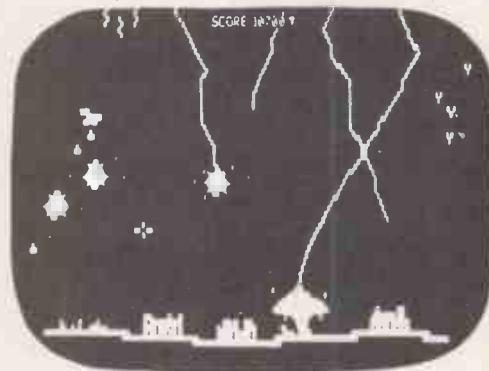

Available only from Kansas—£9.50

## Kansas

Programs for the TRS-80 and Video Genie. All prices are Vat paid and post free. Same-day first class return post service. All software in stock and fully guaranteed as we are the actual publishers. Free catalogue upon request. ACCESS & BARCLAYCARD WELCOME

Kansas City Systems, Unit 3, Sutton Springs Wood, Chesterfield, S44 5XF. Tel. 0246 850357

## THE REVOLUTIONARY TWOSOME

SDM Computer Services are major distributors of the Intertec Superbrain micro computer. This machine has established itself as *the* micro for the serious business user... it is not an upgraded hobby system.

Running, as it does, under the CP/M operating system, there is a wealth of readily available commercial software and SDM have their own tried and tested suite of packages covering:

Invoicing ● Stock ● Sales ledger ●  
 Purchase & Nominal ledgers ● Payroll

All models are available from double density through the 1.5MB system to the (shortly to be announced) Superbrain W6 which includes a 5MB Winchester.

Full software and engineering support when you buy from SDM.

MPI-88G — everything you need

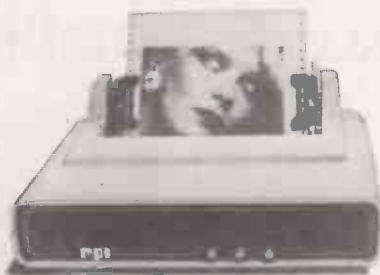

**SUPERBRAIN** — built for commerce

This printer has more standard facilities than any other at a similar price:

- RS232 serial and Centronics type parallel,
- 1K byte buffer
- Upper and lower case 96 character ASCII set,
- 100 cps maximum
- 10, 12, 16.5 cpi and correspondence font
- High resolution graphics (vertical 72 dots/inch, horizontal 82 dots/inch)
- 6 or 8 lines per inch paper feed
- Full forms control

All the above list and others are *standard* at no additional cost.

Whether it is for your Superbrain business system or any other computer with RS232 or Centronics interfaces you cannot find a better printer.

Supplied ex stock for the amazing price of £475 plus VAT and P & P

## S.D.M. COMPUTER SERVICES

BROADWAY, BEBINGTON, WIRRAL,  
 MERSEYSIDE L63 5ND. Tel: 051-608 9365.



● Circle No. 321



# SUPERBRAIN W6

**5 Megabytes**  
**of Winchester Disk Storage with**  
**Data Error Recovery**

**by MicroMods Ltd. for ICARUS**

- ★ Error correcting hardware protects your data
- ★ Fast seek times implemented by controller
- ★ Up to 6 logical disks defined to your choice by utility program
- ★ Disk error utility reports track and sector of last error
- ★ Boot from hard disk
- ★ Easy-to-use format program
- ★ All Intertec utilities rewritten by MicroMods
- ★ System supported by SuperBios with full DOS 3.2 compatibility

**System with 1×80 track floppy drive £3,950.00**  
**Retrofit from £1,450 plus fitting charge**  
**External Boxed System £1,750.00**

Nationwide dealer network



Icarus Computer Systems Ltd. Deane House 27 Greenwood Place London NW5 1NN Tel: 01-485 5574 Telex: 264209

All prices exclude VAT and carriage

SUPERBRAIN is TM of Intertec Data Systems

● Circle No. 322



**FREE EXTRA 16K WITH GENIE I**



**£299**



**£299**

FREE PET INTERFACE  
WITH EPSON PRINTERS

MX80T	£359
MX80F/T	£399
MX100	£570

SEIKOSHA GP80A  
**£179**  
WITH PET INTERFACE  
**£239**



40 TRACK DISK DRIVE TO FIT TANDY,  
GENIE, SUPERBRAIN, ETC.  
**£179 SINGLE**                      **£349 DUAL**

PAPER FOR SEIKOSHA 8" X 11"  
**£12/2000 sheets**  
PAPER FOR EPSON etc 9 1/2" x 11"  
**£12/2000 sheets**

**KRAM ELECTRONICS**  
VICTORIA HOUSE  
17 HIGHCROSS STREET  
LEICESTER  
(0533) 27556

PET — CENTRONICS INTERFACE  
(SUITABLE FOR TAPE & DISK  
MACHINES)

**£69**



Prices exclude VAT and carriage

# THE PRINTER YOU WANT IS HERE



## PERTEC P80

- \* Heavy duty matrix printer at a sensible price. \* 80cps.
- \* 80/120 character lines.
- \* Optional character sets, with true descenders. \* Centronics and RS232 serial interfaces.

**£439 + VAT**



## RICOH RP 1600

- \* Advanced daisywheel printer for word processing, mini and micro applications. \* 60cps.
- \* Intelligent option includes Qume/Diablo compatible commands and auto bidirectional operation.

**£1395 + VAT**

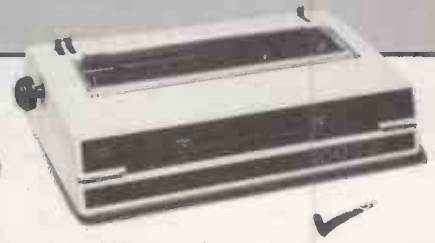

## TRIUMPH-ADLER STYLIST

- \* Low cost daisywheel printer for most popular micros and minis. \* 14.5cps. \* Proportional spacing. \* Bidirectional / logic seeking. \* Range of type styles and languages.

**£695 + VAT**

**Trade and OEM discounts available.**

Write or call for further information  
**Butel-Comco Limited**  
Garrick Industrial Centre,  
Garrick Road, London NW9 6AQ.  
Telephone: 01-202 2277

**BUTEL** ✓  
**Technology for business**

● Circle No. 323





# Pete & Pam Computers

**VISICALC 3.3** Our Price £105.00  
At last - Visicalc on 16 sector DOS 3.3 with 12 additional commands. Enhanced Manual is included.

**VISIDEX** £105.00  
New from Personal Softcard - type in whatever key words, phrase dates or numbers you want the info to be associated with and store away.

**VISITERM** £79.00  
Allows your computer to communicate with larger computers or other personal computers. Link your personal computer with your company's mainframe.

**VISIPLOT** £85.00  
Automatically creates high resolution graphs and charts. Visualise data in six different formats and 6 different colours. Data can be directly entered or data files loaded from VISICALC 3.3.

**VISITREND** £129.00  
Allows you to perform sophisticated math operations on a time series data such as stock prices or production figures. Includes multi-line regress cumulative total percent change lead/lag moving averages, smoothing and various transformations which let you create new time series. This package also includes VISIPLOT.

**VISIPAK** £325.00  
A Visicalc 3.3, Visitrend/Plot and Visifile all in one pack.

**VISICALC UTILITIES VUno3** £39.95  
From Progressive Software - add to Visicalc's capabilities.

**VISIPLUS +** £19.95  
Allows you to consolidate Visicalc models.

**PASCAL JOB CONTROL SYSTEM** - from High Technology £195.00  
A fast sophisticated job control/costing system able to control costs on 400 jobs providing useful reports and maintaining 50 cost centres.

**DB MASTER** £129.95  
The data base with 100 fields operating on multi diskette files for large capacity.

**DB MASTER Utility Pack No.1** £60.00  
Links DB Master with Apple text files and VISICALC 3.3 add/delete or change existing DB Master fields and more.

**DB MASTER for Corvus** - available soon £295.00

**INFORMATION MASTER - Date Base** £79.00  
A dream to use has advanced facilities such as global change and calculator mode of entering figures. A system that a novice can use with ease.

**DATA MASTER** £55.00  
A utility for use with INFORMATION MASTER allows the splitting of data base system selectively change of field types and transfer of print formats.

**TRANSIT** £29.00  
A utility that enables you to link INFORMATION MASTER to many files including those created by VISICALC. With 500 sub cost centres. Worth its weight in gold!

**DATA FACTORY (88 fields)** £99.95

**PFS PERSONAL FILING SYSTEM** £55.00

**PFS REPORT** £55.00

**VISIFILE** £139.00  
New date base from Personal Software.

**WORDSTAR for Apple** £169.00  
If you want the best in word processing for Apple then WORDSTAR is the answer. Very well documented and great to use. Requires the installation of a Z-80 Softcard.

**MALMERGE** £69.00  
Allows you to maintain name and address lists and merge fields into text to form letters etc.

**SUPERSORT** £105.00  
For use with Wordstar and Malmerge.

**DATASTAR now available on Apple** £169.00

**CALCSTAR** - The very latest from Micropro £99.00  
An electronic spreadsheet via Visicalc with the capability of moving information into Wordstar for improved presentation and ease of use. A must for every Wordstar user.

**DATASTAR** £99.00  
The very latest from Micropro, Calcstar, an electronic spreadsheet via Visicalc with the capability of moving information into Wordstar for improved presentation and ease of use. A must for every Wordstar user.

**LETTER PERFECT** £99.00  
A WP system that will work with both 40 and 80 column system configurations.

**APPLE PIE** £99.00  
A separate package is available for use either 40 col, Double Vision, Videx, Smarterm or Suprterm 80 col boards.

**SUPER TEXT II** £85.00  
A WP system that has added arithmetic functions to WP power.

**SUPER TEXT FORM LETTER** £55.95

**SUPER TEXT ADDRESS BOOK** £29.95

All three SUPER TEXT together £150.00

**MAGIC WINDOW** £55.95  
A complete letter writing system - much advertised.

**BASIC MAILER** £39.95

**SOFTKEY** £99.00  
Basic or pascal version available! A 15 key programmable keypad.  
Patch for WORDSTAR and SOFTKEY to permit use of programmable pad with WORDSTAR. £29.95

**SUP-R-TERMINAL WIZARD 80** £195.00  
A new 80 column board with both switchplate and softswitch.

**VIDEX VIDEOTERM** £185.00

40/80 Column switchplate £12.95  
Video softswitch £21.95  
Character Eprints: French, German, Katakana, Spanish, Inverse, Math and Greek symbols, Super and subscript, Line draw graph £17.95  
Videoterm Utilities disk £22.95  
NEW! - **VIDEX KEYBOARD ENHANCER II** £89.00  
The very latest from Videx - uses 6504 microprocessor to provide typewriter like keyboard, adds ability to store macro instructions, remembering words and phrases. Can remember what you typed whilst your Apple was busy talking to disk or doing other things. Can auto-repeat any key held down. Replaces the existing keyboard encoder for easy installation.

**PASCAL TUTOR** £79.00  
If you want to learn Pascal this is the package to use - complete with two disks.

**APPLE MUSIC THEORY** £29.95  
Apple Inc's own program designed to teach the fundamentals of music.

**APPLE HOW TO** £29.95  
Lessons in integer programming.

**APPLE SHELL GAMES** £14.95  
An interesting shell in which to place your children to learn in the best way.

**TYPING TUTOR** £12.95  
Programs from edware  
Algebra 1 - Compumath: Fractions - Compumath: Decimals - Each £20.95  
Spelling Bee £26.95  
Arithmetic skills £12.95  
Compuread £10.95  
Perception £15.95  
Counting Bee £22.95  
Edu pac 1

**CHEMISTRY LAB SIMULATIONS** £55.00  
No. 1 - Acid-base titration, Avogadro's number - No.2 Ideal Gas law and entropy - No.3 Calorimetry experiments, Mass' law - Thermodynamics of an Equilibrium reaction and heat of Vaporisation -

**AIDS TO D'LEVEL COMPUTER STUDIES** £60.00  
5 disks by Pedagogy Aids.

**MOUNTAIN MUSIC SYSTEM** £239.00  
A 16 voice digital synthesizer for Apple, now much reduced price.  
Crae 2.0 - Macat - Applesoft Program Optimiser Each £13.95  
Applesoft Structured BASIC - QOS Plus - Multi-Disk Catalog II - Quickloader - Applesoft Utility Programs Each £15.95  
Disk Organizer II - Disk Recovery - The Directory Manager - Graphic Writer for Tiger 445/460/560 - Higher Graphics II Each £17.95  
Program Line Editor - Higher Text II - Applesoft Command Editor - Macro Screen Editor - Graphic Oump Programs for 445/460/560 Tiger, Anadex 9501, Spinwriter, in both PASCAL and BASIC Each £20.95  
Apple Ooc - Program Line Editor in ROM - Applesoft Extended Editor (AXE) Each £24.95

**DAKIN 5 Programming Aids 3.3 (12 utilities in one pack)** £49.95

**APPLE DOS TOOL KIT** £36.95  
Animation, programming and assembling all in one pack from Apple Inc.

**PASCAL PROGRAMMER** £79.00  
The pascal programmer's dream - all the utilities you wanted to use but never had time to write

**DOS SOURCE 3.3** £24.95  
A disassembled listing of QOS on 4 sides of 2 disks - Limited Edition.

**SENSIBLE SOFTWARE UTILITIES**  
Applesoft Programme Optimiser £12.95  
Multi Disk III £14.95  
Super Disk Copy III £17.95  
DOS Plus £17.95  
Disk Organizer II £17.95  
Disk Recovery £17.95  
Applesoft Plus Structured Basic £14.95

**GRAPHIC UTILITIES**  
Apple World £34.95  
30 Supergraphics £21.95  
Animation Pack £39.95  
Animation Pack Editor £17.95  
Graphic Enhancement £15.95  
Saturn Navigator (needs animat. pack) £15.95  
Micropainter £20.95  
PASCAL Graphics Editor (Sirius) £59.95

**VERSAWRITER** £149.95  
Superb graphics tablet from Versa Computing - you don't have to go to the expense of an Apple Graphics Tablet for graphics capability.

**VERSA EXPANSION SOFTWARE** £20.95  
Auxiliary pack for the VERSAWRITER includes the ability to draw in fine detail using magnification mode.

**BOOKS**  
Beneath Apple DOS £11.95  
HYDE - Assembly Language Programming £11.95  
INMAN - Assembly Language Programming £11.95

**MACHINE COVERS** - only the best material used  
Apple only £5.95  
Single Disk £2.95  
2 stacked disks £4.45  
Apple, 2 disks and 9" monitor or Apple and 12" monitor £8.95  
Apple and 2 disk £7.95  
Epson MX 70/80 £5.45  
Paper Tiger 445 - 460 £5.45  
Apple, 2 disks and 12in monitor £9.95  
12in monitor cover £7.95  
9in monitor cover £5.45

**BASF DISKS (for 10)** £18.50  
**DYSAN DISKS (for 10)** £25.00  
Kassette disk boxes 5.25 in £2.45

**Z80 SOFTCARD** £195.00  
A Z 80 microprocessor for Apple comes with CP/M operating system and Microsoft Basic 5.

**COBOL 80** £299.00  
**FORTRAN 80** £199.95  
**BASIC COMPILER** £199.00  
**ASSEMBLY LANGUAGE DEVELOPMENT (6502, 8080 and Z80)** £79.00  
**MYCHESS** £20.95  
A chess game for Apple with a Z80 Softcard installed - beats Sargon II.

**Z TERM** £59.00  
Software that allows you to emulate the terminal of your choice whilst using Apple with a Z-80 Softcard.

**THE MILL - A 6809 plug in board for Apple** £249.95  
Can run at full speed whilst the 6502 runs at 20%. Comes with either a Pascal speed up kit to increase the speed of execution of Apple's U650 Pascal or a 6809 assembler. Also available a debugging utility. Coming Soon - OS9 Operating System.

**64 RAM CARDS**  
Here at last! Can be used in pairs to emulate a disk drive £499.00  
2 cards and card emulating software £225.00  
Single board

**VISTA 8 INCH CONTROLLER CARD** £349.00  
Works with 8 inch double sided double density drives to give autoboot capability in Applesoft, CP/M, and Pascal on Apple.

**REMOTE OPERATING SYSTEM - RDS** £499.00  
Provides multiple Apple II users with the capability of utilising the disk storage available from one control Apple, up to 127 remote computers may be connected to one central Apple containing up to 8 floppy disk drives starter system (1 central + remote boards) with software and cables.

**APPLE OS9 - STELLATION TWO'S MILL 6809** £399.00  
Now available with OS9 and BASIC 09.  
BASIC 09 allows simultaneous running of separate programs. It has to be seen to be believed. (OS9 is modelled along the lines of UNIX).  
Single board £124.00

**EPSON MX 80 T** £349.00  
9 x 9 matrix printer with friction and tractor feed.

**EPSON MX 80 T** £349.00  
Tractor feed only.

**INTERFACE AND CABLE** £65.00  
For the above (non-graphic).

**GRAPPLER from Orange Micro** £99.00  
An interface for the Epson MX 80 and 100 that obeys Apple protocols and has a graphics dump programme in ROM producing 2 sizes of picture and 360 degrees rotation with positive or negative image.

**AIO Parallel / Serial Interface from SSM** £119.95

**MOUNTAIN CPS - Multi-function Card** £135.00  
A bi-directional serial interface - parallel port and clock/calendar card - all on one board. Can be made to use phantom slots.

**RAMCARD** £99.95  
A 16K Expansion card for your Apple. It will provide additional memory for Visicalc load integer from a System Master and is fully compatible with Apple's Pascal System. The only board with Neon Red Write indicators. The only card with data bus lines for faster data retrieval.

**RAMEX 16** £89.95  
UK entrant to the expansion card market - does not need to be ribboned to the memory area.

**THE MANAGER** £19.95  
A utility that moves DOS onto a 16K expansion card - freeing motherboard Ram space for larger programs.

**TG PRODUCTS**  
JOYSTICK - Self-centering, adjustable pots £34.95  
PADDLES - Top quality controllers £20.95

**VERSA EXPANDER PORT** £12.95  
An expansion cable ZIP socket for the Apple game I/O socket allows zero insertion force of peripherals requiring connection to game socket.

★ SPECIAL OFFER ★★  
**EXPEDITER II** only £49.00  
An Applesoft Compiler from On-Line Systems.

**TASC - THE APPLESOFT COMPILER** £99.00  
A two pass compiler from Microsoft - the Applesoft authors. Comes with extensive documentation and copyable disk. Compiles to disk so can compile any length of programme. From 2 to 20 times improvement in speed.

**NEC GREEN SCREEN MONITOR** £139.00

**ABT NUMERICAL KEYPAD** £74.95

**APPLE HOW TO** £29.95  
Requires Int Basic or 16K Expansion Card - teaches calculating and programming.

**APPLE MUSIC THEORY** £29.95

**ELEMENTRY MY DEAR APPLE** £19.95  
Tuition for children.

**ECHO II SPEECH SYNTHESIZER** £139.95  
Based on TMS 5200 chip from TI - type in speech direct from keyboard.

**EXPANSION CHASSIS** £399.00  
Long awaited - here at last - More slots for your Apple.

**GAMES**  
Apple Galaxian - Galaxy Wars - Head On - Galactic Revolution - Galactic Trader - Galactic Empire - Mystery House - Bridge Partner - Checker King - Gammon Gambler - Roulette - Craps - Apple 21 - Puckman - Global War - Space Warrior - Apple Typhoon - Sneakers - Galactic Attack - Olympic Decathlon - Cribbage - Star Dance - Asteroid Field - Anti Ballistic Missile All at £12.95  
Microsoft Adventure - ABM - Dog Fight - Phantoms Five - Dribtron - Pulsar - Microchess 2 - Odyssey - LA Land Monopoly - Morloc's Tower - Rescue at Rigel - Space Eggs - Trilogy of Games - The Prisoner - Raster Blaster - Autobahn - Space Raiders - Tawala's Last Redoubt - Gamma Gobins - Apple Panic - Red Alert - Firebird - Genetic Drift - Mad Venture - Space Quarks - Castle Wolfenstein - Appledis - Pegasus II - Softporn Adventure - Cross Fire - Jaw-Breaker - Zork II - Crush-Crumble and Chomp - Dragon's Eye - Dark Forest - Star Thief - Bug Attack - Outpost - Borg - Sneakers - Hi Res Soccer All at £14.95  
Cyborg - OO-Topos - David's Midnight Magic - Akalabeth - Pool 1.5 - Beer Run - Epoch - Madron - Russki - Duck - Ulysses - Wizard and the Princess All at £17.95  
Computer Conflict - Computer Quarterback - Carrels and Cutthroats - Space Album - Bill Budge 30 Graphics Tutor - Cyber Strike - 3 Mile Island - Adventure 789 - Temples of Apshar - Hellfire Warrior - Zork - Computer Baseball - President Elect - The Battle of Shloh - Tigers in the Snow - Warp Factor - Computer Conflict - Gorgon - Flight Simulator - Ultima - Trick Shot - Robot War - The Best of Muse - Cops and Robbers - Southern Command All at £20.95  
Computer Air Combat - Computer Ambush - Computer Bismark - Operation Apocalypse - Torpedo Fire - Dragon Fire - Napoleon's Campaigns All at £29.95

### Authorised Apple Sales and Service

LONDON RETAIL, 98 Moysers Road, London SW16 6SH  
Tel: 01 677 2052/7341

MAIL ORDER AND DISTRIBUTION, Waingate Lodge,  
Waingate Close, Rosendale Lane, BB4 750,  
Tel: Rosendale (0706) 227011

Prices do not include VAT  
Please add 15% VAT to your remittance  
Postage and packing FREE

Telex No. 635740 Orders welcome by phone or telex PEP/PAM G





Metal cased 9" PM101  
**CROFTON MONITOR**

10 MHZ Bandwidth  
P4 Standard

Also available with P31

Price on application

Plastic cased 12"  
**NEW-PRINCE MONITOR**

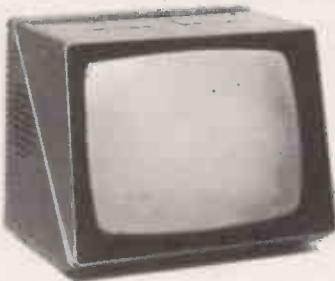

High resolution  
24 MHZ Bandwidth  
P31 (green) Standard  
P4 high resolution standard  
Price on application

DEALER OEM enquiries welcome

**CROFTON ELECTRONICS LTD**

35 Grosvenor Road, Twickenham, Middx TW1 4AD  
01-891 1923/1513  
Telex: 295093

● Circle No. 325

# Don't spend more than £500 on a Local Area Network until you know about Clearway

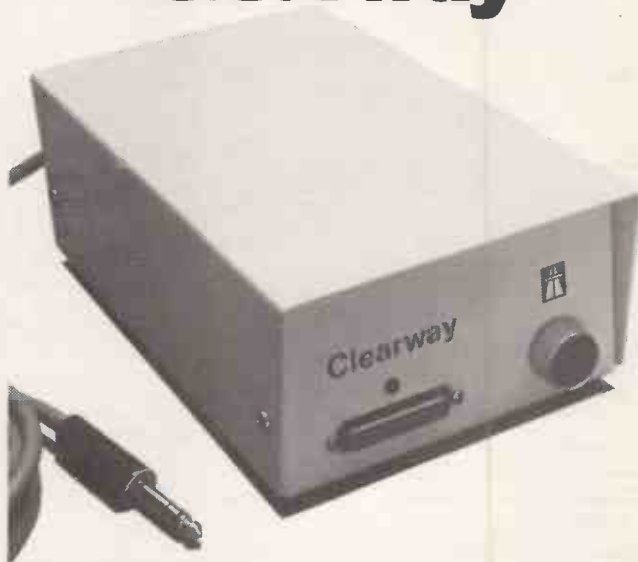

Clearway brings the benefits of Local Area Networking to you at very low cost. So if you're thinking about a networking system be sure to find out more about Clearway.

Mail the coupon now for full information

I'm Interested In Clearway – the low cost Networking System, please send me details.

## REAL TIME

Developments Limited,  
Lynchford House,  
Lynchford Lane,  
Farnborough, Hampshire  
GU14 6JA  
Telephone: Farnborough  
(0252) 546213  
Telex: 858893 Flete! G



PC4.82

Name .....

Position .....

Address .....

Telephone .....

Send to: Real Time Developments Limited,  
Lynchford House, Lynchford Lane,  
Farnborough, Hampshire GU14 6JA

● Circle No. 326

**SINCLAIR ZX81**  
ZX81 built + mains adaptor £60.83 (Post £2.95 extra).  
**PRINTERS**  
Buy any of the below and get a free interface kit and word processor program for UK101 or Superboard. Seikosha GP80A £199. Centronics 737 £335. OKI Microline '80 £295. OKI Microline 82A £399. Epson MX70T £259. Epson MX80T £359. Epson MX80F/T1 £399. Epson MX80F T2 £449.



**SHARP COMPUTERS**  
MZ80K 48K £345. PC1211 £82. 46 sample programs for £15. We can supply any Epson printer to run direct from the MZ80K without I/O box for £39 plus printer price.

**VIC 20 COMPUTER**  
VIC 20 with free kit to allow use of a normal cassette recorder £165. Kit by itself £6. New low cost memory board. No need for a mother-board. Comes with 3K high resolution area + socket for a rom + sockets for 24K of ultra low current Nmos ram (just plug in chips to expand memory) £49. Extra memory chips £39 per BK. Vic printer £199. Joy-stick £6-52.



**5V POWER KITS**  
Fully stabilized 5V computer and TTL power kits. Short circuit and over-voltage protection 1. 5A £7-83, 3A £12-17, 6A £20.

**UK101 AND SUPERBOARD**

UK101 with 1K and free power supply and modulator built £149. The below accessories suit both the UK101 and Superboard: Extra ram £2-10 per K. 16K memory expansion complete kit £50, built £58. 32K memory expansion kit £74, built £82. Cassette recorder £19. Cesmon £22-50 Wemon £19-95. Assembler/Editor tape £25. Word processor program £10. Centronics interface kit £10. 610 expansion board £179. Cased mini-floppy disc drive with DOS £275. Cassette recorder £19. The below suit only Superboard: Colour adaptor board built £45. Guard band kit £10. Series 1 only 30 lines x 50 characters display expansion kit £14. UK101 display expansion kit £14.

**ACORN ATOM**  
8K ram + 2K ram kit £120, built £150. 12K ram + 12K ram kit £168, built £198. 4K expansion rom £25. Power supply £10-20



**NEW GENIE 1 £299**  
EG3014 Expansion box with 16K/32K ram £199/£213. Disk drive £220. Ldos £88. Newdos + £49. Ajedit disk. Colour board £36. Parallel printer interface £36. Monitors: EG100 white £69. OVM9PGR green £99. Colour gene poa. Genie 3 poa.



**SWANLEY ELECTRONICS**

Dept PC, 32 Goldsel Rd, Swanley, Kent BR8 8EZ  
Tel: Swanley (0322) 64851

Postage £3-50 on computers, £4-50 on printers and 45p on other orders.  
Lists 27p post free. Please add VAT to all prices.  
Official credit orders welcome.

● Circle No. 327



# NEW books from Prentice-Hall International

## BASIC Programming on the BBC Microcomputer

Neil Cryer and Pat Cryer

For beginners with no experience of computers, this comprehensive book has been written with particular reference to the BBC Microcomputer, the amazingly versatile home computer which has been causing so much interest and enthusiasm in the computing world. **BASIC Programming on the BBC Microcomputer** provides a step-by-step course on BASIC and teaches you how to write programs using the BBC's enhanced version of BASIC. It shows you how to make the best use of the machine and explains special features for which the BBC Microcomputer is renowned—including colour graphics, animation and sound.

Designed for use while you are sitting at the machine, this book actively involves you through frequent and clearly labelled activities on the computer and by providing points to think about and discussions of the material covered.

Every program has been tested on a production model of the BBC Microcomputer.



£5.95 Paperback 224 pages 13-066407-3 April 1982

### **BASIC Programmer's Notebook**

Earl R. Savage

Techniques and subroutines for efficient, accurate programming in BASIC for games, instruction and record keeping, written in Level II BASIC.

£10.45 Paperback 110 pages 672-21841-0

### **Explore Computing with the TRS-80 (and Common Sense):**

With Programming in BASIC

Richard V. Andree and Josephine P. Andree

£11.95 Hardback 230 pages 13-296145-8

£8.95 Paperback 13-296137-7

### **Starting FORTH: An Introduction to the FORTH Language and Operating System for Beginners and Professionals**

Leo Brodie, FORTH Inc.

£14.95 Hardback 360 pages 13-842930-8

£11.95 Paperback 13-842922-7

### **The UCSD Pascal Handbook: A Reference and Guidebook for Programmers**

Randy Clark and Stephen Koehler

£11.95 Paperback 356 pages 13-935536-7

Prices are correct at the time of going to press but may be subject to change.

### Book Orders

These books can be ordered from your usual bookseller. In case of difficulty contact:

Prentice-Hall International,

66 Wood Lane End, Hemel Hempstead, Hertfordshire HP2 4RG, England.

Telephone: 0442 58531.

PC4

# TWICKENHAM

**COMPUTER CENTRE LTD**

With the best microcomputers available



**SPECIAL OFFER**  
★ WE PAY YOUR VAT ★  
ON MOST ITEMS

1/2 day Wednesday - 'phone for latest Prices

### PRINTERS

Anadex  
Epsom  
Ricoh

### SOFTWARE

Micro Modeller  
Visicalc  
Magic Window

### ACCESSORIES

Z-80 Softcard  
Monitors  
Graphics Tablet

**NEW TO OUR RANGE**

*Prestel with*



£150.00 + VAT.

01 - 892 7896  
01 - 891 1612

**TWICKENHAM COMPUTER CENTRE LIMITED**

72, Heath Road Twickenham Middlesex TW1 4BW

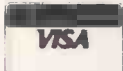

● Circle No. 329

## CITY MICROSYSTEMS LIMITED

65 LONDON WALL, LONDON EC2M 5TU

01-588 7272

### SUPERBRAIN



320K, 680K and 1.5MB Diskdrives.  
Full graphics available.  
Wide range of standard packages.

### TELEVIDEO SYSTEMS



Multi-user, multi-task, multi-processor, televideo reliability with complete expandability.  
One to sixteen users.

### VIDEO GENIE with VISICALC



Complete system £1275, inc. Computer, Monitor, Expander, 1-disk drive printer and Software.  
Vast library of standard software.

**Complete business accounting systems from £2000. Word processors from £1420**

ADVICE, TRAINING AND MAINTENANCE

ALL YOUR COMPUTER REQUIREMENTS READILY AVAILABLE

**IN THE CENTRE OF THE CITY — LONDON EC2**

VISITORS TO OUR OFFICES MOST WELCOME 10.30am-4.30pm

● Circle No. 330



# SEIKOSHA

**NEW  
WIDER VERSION.  
TAKES STANDARD  
PAPER.**

**The Seikosha GP100A**  
Manufactured by the Seiko Company, Japan.

## The micropriced microprinter

**80 col dot graphics for around £215<sup>EX. VAT.</sup>**

**DEALER  
ENQUIRIES  
WELCOME**

Seikosha introduce the GP100A. A wider and updated version of the highly successful GP80. Now able to take standard width paper, the amazingly compact GP100A offers big printer performance at a fraction of the cost.

With a high quality output that includes full graphics capability, the Seikosha's proven reliability and variety of interfaces make the GP100A the ideal choice for hobbyists, educationalists and businessmen. Full service support is provided by DRG Business Machines' nationwide distributor network.

### FEATURES INCLUDE:

- 80 col. 30 cps.
- Dot Matrix unihammer action.
- ASCII standard. 116 characters.
- Full graphics.
- Upper and lower case.
- Double width printing.
- Up to 10" paper width.
- Original + 2 copies.
- Tractor feed.
- Self testing.

### INTERFACING for most systems:

- Standard: Centronics.
- Options: RS232C, Serial TTL, 20mA current loop. IEEE-488. Apple II, Sharp (GP100D).

### DIMENSIONS:

- Depth - 9¼" (234mm)
- Width - 17¼" (420mm)
- Height - 5¼" (136mm)

### OPTIONS:

- Pinch feed.

**DRG  
BUSINESS  
MACHINES**

**Birmingham:** Microcomputers at Laskeys, (021) 6326303. **Bradford:** Eltec Services Ltd., (0274) 491371. **Bristol:** Microcomputers at Laskeys, (0272) 20421. **Chester:** Microcomputers at Laskeys, (0244) 317667. **Edinburgh:** Microcomputers at Laskeys, (031) 5562914. **Frodsham (nr Warrington):** Northern Computers, (0928) 35110. **Glasgow:** Microcomputers at Laskeys, (041) 226 3349. **Leicester:** Kram Electronics, (0533) 27556. **Liverpool:** Microcomputers at Laskeys, (051) 236 2828. **London:** Microcomputers at Laskeys (W1), (01) 636 0845. **London:** C/WP Ltd. (SW1), (01) 828 3127. **London:** Chromasonic Electronics (N19), (01) 263 9493. **Manchester:** Microcomputers at Laskeys, (061) 832 6087. **Preston:** Microcomputers at Laskeys, (0772) 59264. **Sheffield:** Microcomputers at Laskeys, (0742) 750 971. **Watford:** Watford Electronics, (0923) 40588.

● Circle No. 331

DRG (UK) Ltd, Reg No. 22419 England. (Peripherals & Supplies Division)  
13/14 Lynx Crescent, Winterstoke Road, Weston-super-Mare, BS24 9DN. Tel: (0934) 416392.

# Nascom & Gemini USERS NEW 32K C.M.O.S. BATTERY BACKED RAM BOARD

## FEATURES:

### EFFECTIVELY REPLACES EPROMS.

Does away with the inconvenience of EPROM programming and the compromise of assigning valuable address space to ROM.

### ON BOARD RE-CHARGEABLE Ni-Cad BATTERY RETAINS MEMORY FOR OVER 1000 Hrs.

Battery is automatically charged during power-up periods.

### HIGH SPEED OPERATION up to 6 MHz WITHOUT WAIT-STATES.

### FULLY NASBUS<sup>1</sup> and GEMINI-80 BUS<sup>2</sup> COMPATIBLE.

### PAGE MODE SCHEME SUPPORTED.

The board can be configured to provide one 32k byte page or two completely independent 16k byte pages. Complete pages of 64k bytes are simply implemented by adding more boards on to the bus.

### SOFTWARE and/or HARDWARE READ/WRITE PROTECTION.

4K blocks in either page are link selectable to be aligned on any 4K boundary.

### FULLY BUFFERED ADDRESS, DATA AND CONTROL SIGNALS.

### MEMORY I.C. SOCKETS ARE LINK SELECTABLE TO SUPPORT ANY 24 PIN 2k byte MEMORY I.C.s.

Thus the board can support up to 32k bytes of any mixture of cmos, nmos rams or 2716/2516 eeproms.

All options are link selectable using wire links plugged into gold-plated socket pins, avoiding the risk of damage and the inconvenience caused by soldering links directly to the board. The printed circuit board is manufactured to the high quality demanded by industrial users and conforms to B.S.9000.

The board comes assembled and tested and is supplied with a minimum of 2k bytes of low-power cmos ram. Fully documented.

## AVAILABLE NOW!

### PRICES:

Board with 2k bytes	£80.00
Board with 16k bytes	£120.00
Board with 32k bytes	£170.00
Bare Boards (circuit diagram supplied)	£37.50
HM6116-LP/3 Very low power 2k cmos memory I.C.	£6.50

Please add 95p P&P and VAT @ 15%

<sup>1</sup>nasbus is a trademark of nascom microcomputers a division of LUCAS LOGIC  
<sup>2</sup>trademark of GEMINI MICROCOMPUTERS LIMITED

## Processes

cheques and P.O.s to:

41a MOOR LANE, CLITHEROE, LANCS.  
BB7 1BE. For further information Phone (0200) 27890

Please supply me with the following:

Price

Total enclosed £

Address:

POST CODE

● Circle No. 332

## APPLE SOFTWARE

A.C.E. — A program line editor with macro facilities	£19.95 A48K
Akalabeth — An advanced fantasy role playing game	£22.95 M48K
Apple-Doc — Cross reference utility + Variable replacement	£22.95 A48K
Apple Panic — Chase little apples up and down ladders	£16.95 M48K
AppleWorld — Allows you to produce 3-D animated graphics	£38.95 M48K
Ascii Express II — A complete intelligent terminal package	£42.95 A48K
Asteron — The ultimate Asteroids replica game	£19.95 M48K
Autobahn — Road race game with sound and hi-res graphics	£14.95 M48K
Beer Run — Catch the Artesians before the Guzzlers and Bouncers catch you	£16.95 M48K
Both Barrels — 2 hi-res action games on one disk	£12.95 A48K
Castle Wolfenstein — An action adventure in hi-res graphics with speech	£18.95 M48K
Cops & Robbers — An adventure game in the tombs of ancient Egypt!	£19.95 M48K
CPS Multifunction card — Serial, Parallel and Clock on one card	£183.95 Card
Cranston Manor — A new hi-res adventure like Wizard and the Princess	£19.95 M48K
Crossfire — Stop the aliens from taking over the city	£16.95 M48K
Cross-Ref — Cross reference Applesoft programmers utility	£14.95 A32K
Cyber Strike — 3-D hi-res action arcade game in space	£19.95 M48K
Dark Forest — An adventurous game of strategy and conquest for up to 6 players	£16.95 M48K
Dogfight — Hi-res jet combat game for 1 or 2 players	£18.95 M32K
Epoch — Hi-res 3-D shoot-up in space. Our favourite	£19.95 M48K
E-Z Draw 3.3 — The poor man's graphics tablet. Very easy to use	£28.95 M48K
EXPEDITER II — THE APPLESOFT COMPILER AT A LOW, LOW PRICE	£56.95 A48K
Falcons — The best invaders style game for the Apple	£18.95 M48K
Fender Bender — Super car game in hi-res colour graphics	£14.95 M48K
Galaxy Wars — Colour graphics + Sound effects + Hi-res arcade style game	£13.95 M32K
Galactic Attack — A hi-res Star Trek type game	£19.95 M48K
Gamma Goblins — Yet another superb hi-res action game	£16.95 M48K
Genetic Drift — A departure from the normal arcade game. Great fun	£16.95 M48K
Hadron — A 3-D battle in the midst of a meteor field	£19.95 M48K
Higher Graphics — Hi-res picture drawing utility	£23.95 M48K
Hi-Res Cribbage — The title describes it. Even hear the pegs move	£14.95 M48K
Hi-Res Soccer — English football for 1 or 2 players in hi-res	£16.95 M48K
Jawbreaker — Eat up the dots but watch out for the Gobblers	£16.95 M48K
KRAM — Fast and powerful Keyed Random Access Method for quick disk access	£58.95 M32K
LISA — The assembly language development system for professionals	£45.95 M48K
List Master — An excellent companion product to Apple-Doc	£22.95 M48K
Memory Management System — Enables you to put DOS on a RAM card	£29.95 M64K
Microsoft 16K Ram Expansion Card. Includes FREE Memory Management System	£114.95 Card
Missile Defence — Hi-res animation and sound arcade game	£16.95 M48K
Mission: Asteroid — Hi-res adventure in 21 colours. Save the World!!	£10.95 M32K
MultiBoot Upgrade — Upgrade 3.2 disks to boot under 3.2 or 3.3	£23.95 M48K
Mystery House — Hi-res adventure using over 100 pictures	£12.95 M48K
Norad — A hi-res simulation of an I.C.B.M. attack	£19.95 M48K
Olympic Decathlon — Long jump, high jump, hurdles plus much more	£17.95 M48K
Online — A new concept in dial-up software for the Apple	£59.95 A48K
Orbitron — Fight off enemy forces and avoid meteor showers	£14.95 M48K
Outpost — Save your space outpost from attack by enemy fighters	£16.95 M48K
Pascal Graphics Editor — Professional graphics editing package for Pascal	£49.95 M64K
Pegasus II — The latest in pub games now available for the Apple	£16.95 M48K
Phantoms Five — A fighter-bomber mission in 3-D real time graphics	£18.95 M48K
Pool 1.5 — Hi-res colour graphics pool table simulation. 4 games	£19.95 M48K
Pool II — 2 superb hi-res arcade games on one disk	£14.95 M48K
Raster Blaster — A very realistic full colour pinball simulation	£15.95 M48K
Sabotage — Shoot down helicopters and bombers in hi-res	£13.95 M48K
Shooting Gallery — Real-time simulation of a fairground gallery	£15.95 M48K
Shuffleboard — Real time hi-res simulation by the authors of Pool 1.5	£19.95 M48K
Sneakers — Waves of little creatures attack you in hi-res	£16.95 M48K
Softporn Adventure — An adventure for adults only	£16.95 M48K
Space Eggs — Hi-res super-fast arcade style game	£14.95 M48K
Space Quarks — Shoot down the quarks before they get you	£16.95 M48K
Space Warrior — Protect your shields from the dreaded drone RAM ships	£13.95 M48K
Star Avenger — A fast paced game of guerilla warfare in space	£19.95 M48K
Star Cruiser — Save yourself from the swooping aliens	£18.95 M48K
SuperGraphics — A 3-D game development system in colour	£23.95 M48K
SuperKRAM — As KRAM but with multi-key and multi-index	£99.95 M32K
SUPERSCRIBE II — WORD PROCESSOR. TRUE UPPER/LOWER CASE ON SCREEN	£73.95 M48K
TASC — An optimising Applesoft compiler from Microsoft	£129.95 A48K
The Dictionary — Checks spelling of any standard DOS text or binary file	£54.95 M48K
The General Manager — User-friendly hierarchical database package	£54.95 M48K
Threshold — Yet another fast action arcade style game	£21.95 M48K
Time Zone — The largest adventure ever. Hi-res colour graphics. 1,182 rooms	£54.95 M48K
Ulysses & The Golden Fleece — Another adventure like Wizard and the Princess	£19.95 M48K
Visicalc 3.3 — The 16 sector version with enhanced manual	£119.95 M48K
Visidex — Store and retrieve information by key words	£119.95 M48K
Visifile — A database package from the same stable as Visicalc	£149.95 M48K
Visiplot — A hi-res graphics graph plotting package	£94.95 M48K
Visiterm — Use your Apple as an on-line terminal	£89.95 M48K
Visitrend — Performs maths operations on time series data	£149.95 M48K
Wizard and the Princess — Hi-res adventure in 21 colours	£18.95 M48K
Wizardry — 3-D adventure. The best we have seen yet	£28.95 M48K
Z-Term — A full feature terminal package for the CP/M Apple	£65.95 M48K

A: Requires Applesoft in ROM

M: Will run on any Apple

Please specify which DOS you require when ordering. If you don't see what you are looking for please give us a call. WE ALSO OFFER A BESPOKE SOFTWARE SERVICE WHICH IS SECOND-TO-NONE.

PRICES INCLUDE VAT AT 15%. Add 50p P+P for orders under £30 totally.

Please write or telephone for your free copy of our up-to-date software list.

Dealers Inquiries Invited. PERSONAL CALLERS BY APPOINTMENT ONLY PLEASE.

## SPIDER SOFTWARE

98 AVONDALE ROAD,  
SOUTH CROYDON,  
SURREY.



Tel: 01-680 0267 (24 hours a day — 7 days a week)

● Circle No. 333



# SYSTEM 4000 EPROM EMULATOR/PROGRAMMERS

EX-STOCK



## P4000 PRODUCTION EPROM PROGRAMMER

This unit provides 'simple, reliable' programming of up to 8 EPROMs. It has been designed for ease of operator use — a single 'program' key starts the blank check — program — verify sequence. Independent blank check and verify controls are provided along with mode, pass/fail indicators for each copy socket and a sounder to signal a correct key command and the end of a programming run. Any of the 2704/2708/2716 (3 rail) and 2508 / 2758 / 2516 / 2716 / 2532 / 2732 EPROMs may be selected without hardware or personality card changes.

2 year warranty. Price **£545 + VAT: + £12.00 DELIVERY**

## VM10 VIDEO MONITOR

This compact, lightweight Video Monitor gives a clean crisp picture on its 10" screen. Suitable for use with the EP4000, SOFTY and other systems. 12 month warranty. Price **£88 + VAT, carriage paid.**

## MODEL 14 EPROM ERASERS



## MODEL UV140 EPROM ERASER

Similar to model UV141 but with out timer. Low price at **£61.50 + VAT, postage paid.**

## EP4000 EPROM EMULATOR/PROGRAMMER

The microprocessor based EP4000 has been designed as a flexible, low cost, high quality unit for emulating and programming all the popular NMOS EPROMs without the need for personality cards, modules or hardware changes. Its software intensive design permits selection of the 2704 / 2708 / 2716 triple rail EPROMs and the 2508 / 2758 / 2516 / 2716 / 2532 / 2732 single rail EPROMs for both the programming and emulating modes.

The video output (T.V. or monitor) for memory map display in addition to the built-in Hex LED display, for stand alone use, is unique in this type of system. This, with the double function 28 key keypad, powerful editing features, powered down programming socket, buffered tri-state simulator cable and 4k x 8 data RAM gives you the most comprehensive, flexible and compact systems available today.

2 year warranty. Price **£545 + VAT: + £12 DELIVERY**

## MODEL UV141 EPROM ERASER

- 14 EPROM capacity
- Fast erase time
- Built-in 5-50 minute timer
- Safety interlocked to prevent eye and skin damage
- Convenient slide-tray loading of devices
- Available Ex-Stock at **£78 + VAT Postage Paid**

EX-STOCK

**DISTRIBUTORS REQUIRED — EXPORT ENQUIRIES WELCOME**

# GP INDUSTRIAL ELECTRONICS LTD,

UNIT E, HUXLEY CLOSE, NEWNHAM INDUSTRIAL ESTATE,  
PLYMOUTH, DEVON PL7 4JN

TELEPHONE: PLYMOUTH (0752) 332961 (Sales) / 332962 (Technical Service).

# SOFTY SYSTEMS

EX-STOCK



## SOFTY 2 LOW COST 2716 EMULATOR/PROGRAMMER

● Direct output to T.V. ● High speed cassette interface ● On card EPROM Programmer ● Multifunction keypad ● 2K Monitor in 2716 ● 2K RAM ● 128 byte scratchpad RAM ● 2K EPROM Emulation ● Can program 2732/2532 in two halves ● Editing facilities including — Data entry/deletion, Block shift, Block store, Match byte, Displacement calculation ● Supplied with ZIF socket, Simulator cable, comprehensive manual, Antistatic lined EPROM tray and PSU. **SOFTY 2 £169 + VAT (includes p&p)**

## SOFTY 1 LOW COST 2704/2708 EMULATOR/PROGRAMMER

● Direct output to T.V. ● High speed cassette interface — On card EPROM Programmer ● Multifunction keypad ● 1K Monitor in 2708 ● 1K RAM ● 128 byte scratchpad RAM ● 1K EPROM Emulation ● Comprehensive editing facilities ● Supplied with ZIF socket, Simulator cable and comprehensive manual.

SOFTY 1 (Built and tested) **£120 + VAT**

SOFTY 1 Power Supply **£20 + VAT**

## SOFTY 1 CONVERSION CARD

Enables SOFTY to program the single rail EPROMs, 2508 / 2758 / 2516 / 2532. Selection of device type and 1K block are by pcb slide switches. ZIF Programming socket. Supplied built and tested. **£40 + VAT.**

## EX-STOCK EPROMS

	1-24	25-99	100 up
2732	6:50	5:75	4:95
2716	2:80	2:60	2:40
2708	2:80	2:60	2:40

ADD VAT AT 15% - POSTAGE PAID

WRITE OR TELEPHONE FOR DETAILS  
ON ANY OF OUR PRODUCTS



## Apple II      Apple III

Full systems, expansion cards, printers, software, disks, books

**Good service — low prices**

### Full systems

Computer professionals to analyse your requirements, demonstrate your system, deliver, install and train your staff at **no extra cost**.

### Add-ons at discount prices

Just look

Ramex 16K RAM card only £69.

Videx videoterm 80-col card only £179

Z80 softcard only £189

Cash with order only — please add 15% VAT.

Write or 'phone for full details

## ozwise computers

28 CROFTS ROAD, HARROW, MIDDX. HA1 2PH.

**01-863 2309**

24 hour service

● Circle No. 335

# A NEW MICRO TIME MODULE

A REAL TIME BATTERY SUPPORTED CALENDAR CLOCK MODULE FOR YOUR TANDY OR VIDEO GENIE MICROCOMPUTER AT A

## REALISTIC PRICE

**£69.25**

includes delivery and VAT

Place your order now or contact for further information



JOHN BIRKWOOD ASSOCIATES  
WYVERN HOUSE, 49 STATION ROAD, BILLINGSHURST,  
W. SUSSEX. TELEPHONE (040381) 3813

● Circle No. 336



## Reserve these dates now!

**Apple User Convention**  
— June 5-6

**Apple User Exhibition**  
— June 4-6

It's going to be the biggest Apple event ever held — and a MUST for all Apple users.

From Friday, June 4 to Sunday, June 6, the whole of the ultra-modern Fulcrum Centre in Slough will be completely devoted to the Apple.

And it will be an action-packed weekend. Some of Britain's top Apple experts will be revealing their secrets. There will be hands-on demonstrations of Apple programs. Plus a comprehensive exhibition of all the latest Apple hardware and software.

There's bound to be a big demand for Apple '82 — so early booking is advisable.

### DELEGATE APPLICATION FORM

I wish to attend Apple '82, the First National Apple User Convention.

Please reserve ..... delegates places at £12 per delegate      £ .....

I would like you to arrange accommodation for the following nights:

Friday June 4  Saturday June 5

for ..... adults and ..... child(ren). Accommodation costs £17.00 per night for a single bed in a twin room. Single rooms are available for £21.00. Children under 5 years free.

Children over 5 and under 14 years £1.00.

Accommodation includes bed, Continental breakfast; VAT and service charge.

All extras to be paid for separately on departure.      £ .....

Please give preference of hotel in order of choice:

Post House Hotel  Excelsior Hotel

Ariel House  Skyway Hotel

I would like to reserve a car parking space for the duration of the Convention. (£2.00).      £ .....

TOTAL £ .....

I enclose my cheque as payment, or debit my Access/Barclaycard/American Express account No.

Signed .....

Company .....

Name .....

Position .....

Address .....

.....

Tel: .....

Please tick appropriate box if interested in any of the following:

Coach trips to London for shopping

Coach trips to London for theatre

Choice of play or show .....

Coach trip to Windsor Safari Park

Coach trip to Windsor Castle

Coach trip to Oxford

.....

.....

.....

.....

.....

The above will of course depend on sufficient people being interested in particular trips.      PC/4

POST TO: Apple '82, Europa House, 68 Chester Road, Hazel Grove, Stockport SK7 5NY

● Circle No. 337



**PAYROLL ?**



**SUPERBRAIN QD 64K**

**SALES ?**



**APPLE II 48K**

**STOCK ?**



**SUPERPET 134K**

**TRY BEFORE YOU BUY!** If you are considering the acquisition of a microcomputer why not visit our demonstration suite one evening and try our Apples, PETs and Superbrains first. *We can open outside our normal hours to suit you. Even weekends!* Come and see the range of business utilities your competitors are using. We have the full TABS integrated accounting system Nominal, Sales, Purchase Ledgers, Payroll, Stock Control, etc, Video Training films, word-processing, automated filing and financial modelling systems *ready to help you.* We are Authorised Dealers for several micros and are in business to sell you a solution rather than one manufacturer's specific hardware. After all, to a business it's the effort and money you save that's important not the internal machine specifications. We offer our business clients lease/rental terms to bring the benefits sooner, without capital drain.

**FOR EXAMPLE A TYPICAL BUSINESS SYSTEM COMPRISING SAY, AN APPLE II, A DISK DRIVE, MONITOR, PRINTER AND VISICALC CAN BE INSTALLED ON YOUR DESK AND WORKING FOR YOU NEXT WEEK FOR LESS THAN £12.00 PER WEEK EX. VAT AND ALL DEDUCTIBLE!**

Naturally, we provide full support and after-sales service of the highest level.

INTERESTED? CALL NOW FOR DETAILS.

# MASS MICROS **WELWYN GARDEN 31 436**

WELLSON HOUSE, BROWNFIELDS, WELWYN GARDEN CITY, HERTS. Telex 298641.

● Circle No. 338

## You don't need a big computer to run Britain's N°1 payroll program

Don't take a sledge hammer to crack a nut. You can get all your payroll needs from a micro computer and the AUTOPAY program. Autopay, from Micro Management, is fast,

friendly and flexible. It comes complete with comprehensive manual and software support, nationwide. For small or large companies up to 300 employees, AUTOPAY pays.

# AUTOPAY



**£195 +VAT**

**MICRO MANAGEMENT**

Micro Programs that think BIG! 

32 Princes Street, IPSWICH. Tel: (0473) 57871

● Circle No. 339

## "ATTENTION COMPUTER DEALERS"

Let us be your Exporter/Purchasing Agent in the United States for the following products:—

**MICROCOMPUTERS:**— Ohio Scientific, Onyx.

**PRINTERS:**— Okidata, Centronics, NEC, Xerox/Diablo, Anadex, Printerm, Eaton.

**TERMINALS:**— Micro-term, Televideo, Hazeltine, Zintec, Beehive.

**MAG-TAPE:**— Alloy engineering cartridge and reel.

**FURNITURE:**— Printer Stands, CRT Stands, Computer Tables.

**MISC:**— Blank Floppy Disks, Blank Cartridge and reel mag tape, CRT Cables, etc.

### NOTE

IF YOU DON'T SEE YOUR NEEDS, PLEASE CONTACT US WITH YOUR REQUIREMENTS.

**SYSTEMS INTERNATIONAL INC**  
500 CHESHAM HOUSE,  
150 REGENT STREET,  
LONDON W1R 5FA

**SYSTEMS INTERNATIONAL INC**  
15920 LUANNE DRIVE  
GAITHERSBURG, MARYLAND  
20760 U.S.A.

Telephone 301-977-0100. Telex 710-828-9703  
Cable Address SYSINTL. GAITHERSBURG MD

● Circle No. 340

## INFRA COMPUTER COMPONENTS LTD

### EPROMS

2708	£2.40
2716-350ns	£6.00
2716-450ns	£2.90
2532	£4.50
2732	£5.00

### RAMS

2114 2L	£1.00
2114 4L	£0.95
4116 — 150ns	£0.90
4116 — 200ns	£0.79
4118	£4.30
4864	£11.50
6116P3	£8.00

### ZILOG Z80 FAMILY

Z80 CPU	£3.50
Z80 A CPU	£4.60
Z80 CTC	£3.80
Z80 A CTC	£3.95
Z80 DART	£6.00
Z80 A DART	£7.10
Z80 A PIO	£3.50
Z80 A PIO	£3.50

### CPU's

6502	£4.10
6802	£4.50
6809	£9.50
6809 E	£14.00

### 74LS SERIES

74LS 00	.09
74 LS 1-10	.11
74 LS 27	.13
74 LS 85	.65
74 LS 86	.13
74 LS132	.43
74 LS139	.35
74 LS157	.31
74 LS161	.35
74 LS165	1.00

Quantity discounts available on request. All prices exclusive of VAT & Carriage. Government, Education Authorities & Trade welcome.

### INFRA COMPUTER COMPONENTS LTD.

PENDORRIC HOUSE · 7 WESTFIELD ROAD  
GREAT SHELFORD · CAMBRIDGE CB2 5JW

Telephone: (0223) 841728/843953 Telex: 81416 ICC UKG

● Circle No. 341

## CU-GRAPH



## ACORN COMPATIBLE GRAPHICS CARD

### 8 colours in 512 x 256 pixels

- Uses EF9366 graphics processor chip.
- Each plane of colour (red, green, blue) displays 16kB of memory, giving 512 x 256 resolution; each pixel can be red, blue, green, white, yellow, cyan, magenta or black.
- Only 256 bytes of the host computer memory are used, all 48k bytes of screen memory being on the memory map of the EF9366 only.
- Text display can be superimposed on graphics, and can be up to 85 columns by 32 rows, using an on board character generator. Each character can be scaled for height, width, slope and orientation, all independently.
- Driver software for use on Acorn and Cubit systems is available now, and a high resolution graphics extension to Acorn BASIC will follow later.

£190\*, £155† Eurocard monochrome, 16k bytes. £380\* · £275† with piggy-back extension for colour and Centronics Printer Interface.

\*Price for 5V only RAM. †Price for 3-rail RAM.

## CONTROL UNIVERSAL LTD

Unit 2, Andersons Ct, Newnham Rd, Cambridge, Tel 0223 358757.

● Circle No. 342



# Plain talk.

You should be able to talk to your computer in simple, everyday language. It should talk to you in the same language. Yours.

Through Vector Graphic products the right system can be found for you and your company. We can provide a package specifically designed to help your business including solicitors packages, accounts, stock control, payroll, job costing, estimating, planning, printers job costing, manufacturing and a host of scientific and technical systems.

All Vector systems are based on the Industry Standard S-100 Bus Configuration and CP/M operating system. Give Almarc a ring today and we'll arrange a demonstration. It couldn't be simpler than that.

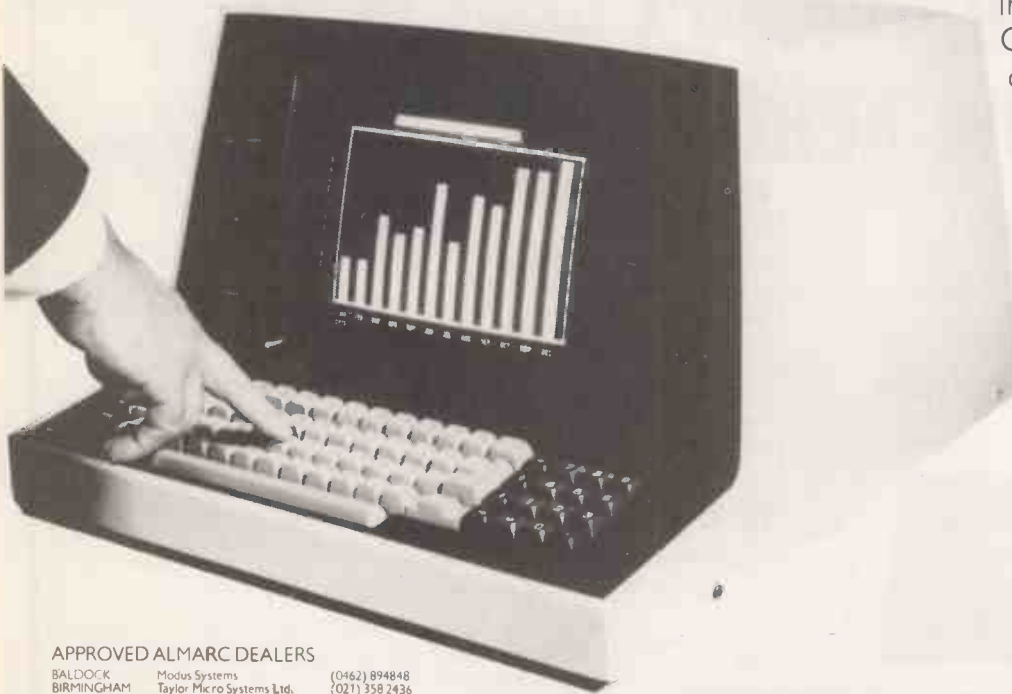

#### APPROVED ALMARC DEALERS

BALDOCK	Modus Systems	(0462) 894848
BIRMINGHAM	Taylor Micro Systems Ltd.	(021) 358 2436
DONCASTER	Reed Computing	(0709) 67087
HIGH WYCOMBE	Common Sense Business Systems	(0494) 40116
HARROGATE	Business Microsystems	(0423) 68229
KETTERING	Shuttleworth Business Systems	(0536) 511357
LEEDS	A. C. Barratts	(0532) 456944
LONDON	Micro Systems Consultants	(01) 979 4098
LOUTH	Compu-Crop	(0507) 604271/2
MACCLESFIELD	Resolux Ltd.	(0625) 28220
NOTTINGHAM	Baymoor Limited	(0602) 415315
SWANSEA	Business Microsystems	(0792) 474082
TYNE & WEAR	H.P. Micros	(0632) 859923
YEovil	Dale Computers	(0935) 72000

Almarc Data Systems Limited,  
Great Freeman Street,  
Nottingham NG3 1FR. Tel: (0602) 52657.  
Telex: 37407 Almarc/G.

Also at: Green Street, High Wycombe,  
Bucks. HP11 2RF. Tel: (0494) 23804.

## Almarc

DATA SYSTEMS

● Circle No. 343

If that Apple  
is just out of Reach....

*Rent One!*

If you have a short term requirement for a microcomputer system for evaluation, training or just hands-on experience — come to Atlanta!

Apart from Apples we have top quality printers, monitors, disk drives and a huge range of software including VisiCalc, Visidex, Wordstar, Format-80, Magic Window, Micromodeller, APM, CIS COBOL and all accounting programs.

A complete system can be working for you within a few days of your enquiry with *no* capital expenditure!

**Rental Hotline**  
01-729 1411/2

*Atlanta* Data Systems

350/356 Old Street, London, EC1V 9DT. 01-739 5889

● Circle No. 344

## ARBOR SUPPLIES

### 5.25" Diskettes — '10 Packs'

DYSAN — UNBEATABLE QUALITY

Single Sided/Single Density	£22.00
Single Sided/Double Density	£25.50
Double Sided/Double Density	£31.00
Double Sided/'Quad' Density	£43.00

**KYBE ACCUTRACK** — With Free Library Box  
Single Sided/Double Density £17.50

**BLANK LABEL** — Economy for APPLE & PET  
Single Sided/Single Density £15.00

(PLEASE SPECIFY IF 10 OR 16 SECTOR DISKS REQUIRED)

### Disk Storage — 10 DISK CAPACITY

Genuine 'EGLY' Plastic Library Boxes £1.90 ea.

### Drive Head Cleaning Kits

26 Weekly Cleans for £16.60

All Prices exclude Postage and VAT  
UK P&P — Diskettes £0.60 per pack; Library Boxes  
£0.50; Head Cleaning Kits £0.60 ea.  
VAT is calculated at 15% of total goods + P&P value

Please make Cheque/P.O. payable to ARBOR SUPPLIES  
or quote your ACCESS Number

11, CHAMBERLAIN GARDENS, ARBORFIELD CROSS,  
NR. READING, BERKS. Tel. (0734) 470174

● Circle No. 345

# The Micro Support Centre

AUTHORISED DEALER FOR

## The new XEROX 820

**£1750**

FOR STANDARD MODEL  
64K RAM/2 x 5 $\frac{1}{4}$ " DISKS

ALTERNATIVE 2 x 8" DISKS £2250



XEROX AND RANK XEROX ARE REG. TRADE MARKS OF RANK XEROX LTD.

FOR PROFESSIONAL  
SUPPORT AND TRAINING  
THROUGHOUT THE  
THAMES VALLEY

TELEPHONE  
0990 23377/23536

### WORDPROCESSING SYSTEMS

complete wordprocessing systems including standard Xerox 820, Xerox Wordprocessing, superb Diablo 630 printer, installation, up to one day's training and hard backed reference manual for only

**£3695** SUPERCALC  
£125 extra

### BUSINESS SYSTEMS

we market and support a wide range of business applications software from highly reputable and experienced software houses including:  
Data Management — DMS  
Purchase Ledger  
Sales Ledger  
Nominal/General Ledger  
Payroll  
Stock Control

### SUPPORT

1600 SERVICE ENGINEERS to service and maintain equipment on your premises through the Rank Xerox national service network.

**The Micro Support Centre**  
Index House  
Ascot, Berks.

PRICES EXCLUDE VAT

● Circle No. 346





## CRYSTAL ELECTRONICS CC ELECTRONICS

### FOR YOUR SHARP MZ80K CP/M 2.21 (XTAL)

BASIC CP/M FACILITIES INCLUDE:

- Dynamic file management Fast assembler
- General purpose editor • Advanced debugging utility

YOUR SHARP CP/M 2.21 (XTAL) PACKAGE INCLUDES:

- Hardware modification (if fitted by a SHARP dealer does NOT break the guarantee) • SHARP CP/M 2.21 (latest version) on disc • XTAL Monitor and Operating system • 7 Digital Research manuals • 12 months guarantee and up-dates (on all our products)

### CP/M 2.21 (XTAL) FROM £150 + VAT

Ask your SHARP dealer for further details or contact CRYSTAL ELECTRONICS

CP/M SOFTWARE HOUSES—XTAL CAN HELP YOU ESTABLISH YOUR SOFTWARE ON THE SHARP.

### XTAL BASIC (SHARP)

Takes 5K less memory, has all the features of SHARP BASIC PLUS Multi dim strings, error trapping, logical operators, machine code monitor, more flexible peripheral handling, improved screen control, increased list control, auto run, If..then..else—and it doesn't stop there—it grows. You can extend the commands and functions at will—10K, 12K, 16K, BASIC?. SHARP to XTAL BASIC conversion program is included. £40 plus VAT.

Bi-directional serial board for your SHARP RS232 compatible 150 Baud to 2400 Baud adjustable. <5.6.7.8 Bit words, plugs into MZ80I/O £99.50 plus VAT. Includes software for bi-directional use in XTAL BASIC, software for using SHARP BASIC with serial printer and self-diagnostic software for testing Baud rate etc.

Members of Computer Retailers Association & Apple Dealers Association  
Shop open 0930—1730 except Saturday & Sunday  
40 Magdalene Road, Torquay, Devon, England. Tel: 0803 22699

Access and Barclaycard welcome



● Circle No. 347

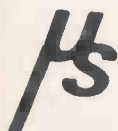

## MicroSec

DEC

IBM

CP/M

CP/M

CP/M

CP/M

## File Star

MicroSec's  
Filestar package will  
enable your CP/M® system

to read, write, list directories  
and initialise 3740 compatible disks for:

- IBM 3740 Basic Exchange Data-sets
- DEC RT/II ASCII Files
- INTEL ISIS II ASCII Files
- MOTOROLA MDOS ASCII Files

All this for only £195 + VAT!!!

Phone or write to MicroSec for further information or guidance on machine suitability.

MicroSec, 49b Market Parade, Havant, Hants PO9 1PY.  
Telephone (0705) 450055

® CP/M is the registered trade mark of Digital Research

● Circle No. 348

# VIDEOTEX SYSTEMS '82 CONFERENCE

Cunard International Hotel  
Hammersmith, London W6

May 5,6,7, 1982

This important two day conference will cover in depth, both technical and marketing aspects of videotex technology.

Presentations will be made by experts, drawn from the industry's leading equipment manufacturers, system operators and users.

Subjects include: Day One— The politics • Gateway • Direct transfer • Hardware and Software compatibility • International networks. Day Two— Marketing the product • Economics • Umbrella services • The Canadian experience • Private systems • The next ten years.

Speakers include: John Wakeham, MP, John Durham, Alan Haines, David Gilbert, Ken Knight, Ted Sedman, J Döring, Murray Cook, Tony Book, Jenny Clayton, Tim Chapman, Colin Tipping, Geoff Hutt, Andrew Lighting, Anthony Harris, James Smith, John Marsh, Chris Singer, Mike Aston and Malcolm Smith.

Conference organised on behalf of AVIP The Association of Viewdata Information Providers Limited.

Run in parallel with  
**VIDEOTEX SYSTEMS '82 EXHIBITION**  
Cunard International Hotel May 5-7

Full details from: Sue Bonnell,  
IPC Conferences Ltd, Surrey House,  
Throwley Way, Sutton, Surrey SM1 4QQ.  
Tel: 643 8040 Ext. 4889 and 4891

Please send details about Videotex Systems '82  
conference/exhibition to:

Name \_\_\_\_\_

Company \_\_\_\_\_

Address \_\_\_\_\_

Tel: \_\_\_\_\_

PC

● Circle No. 349

# Knights T.V. & COMPUTERS

## SHARP DEALS — MZ-80B £899

Deal A — Sharp MZ-80K with full 48K, BASIC, PASCAL + 10 programs. . . . .£345  
 Deal C — as deal A plus FORTRAN, FORTH + 16 programs. . . . .£379  
 Deal F — as deal ? plus MACHINE CODE, KNIGHT COMMANDER + 100 programs. . . . .£425  
 Deal ? — Sharp MZ-80B with 64K, RAM, 8K VRAM, 4K ROM, and BASIC. . . . .£899  
 Deal 1B — as deal 1 plus our MZ-80B easy Assembler + 70 programs. . . . .£979

## NEW PRODUCTS FOR SHARP

MZ-80P4 160 column/150cps £645, MZ-80 single floppy disk, the PC1511 hand held computer and colour printer, MZ-80DU colour terminal.

## NEW SOFTWARE FOR SHARP

KNIGHT COMMANDER for the MZ-80B giving RENUMBER, TRACE, SINGLE STEP, DUMP VARIABLES, etc. — as supplied to Sharp. Our latest B programs include Jumbo Flight Simulator, Dis-assembler and Circuit Of Doom. For the MZ-80K we introduce Machine Code Trace, KNIGHTS POWER MONITOR, Russian Gold Divers, Fighter Cockpit, etc. We are just back from Japan for the second time in six months and have hundreds of exclusive Sharp items. Write, phone or telex for our latest prices and newsletters. All prices exclude VAT but inclusive delivery. ACCESS and VISA welcomed.

## KNIGHTS TV AND COMPUTERS

108 Rosemount Place, Aberdeen.  
 Telephone: (0224) 630526. Telex: 739169 KNIGHT

● Circle No. 350

## CAN YOUR COMPUTER READ THIS?



Light-pen and signal conditioning unit enable your computer to read all types of bar code. Typical applications include data collection, ticket identification systems, security checkpoint verification, stock control, identifying assemblies in service, repair or manufacturing environments, programming computers and intelligent instruments, matching of patient and transfusion blood, retail product price information at checkouts etc. Various interface options available for all computers.

Hardware from £149 + VAT . . . . . Further details on request

Professional quality light pens for use with VDUs, graphics terminals etc. Stainless steel construction, glass lens optics, built in buffer amp and touch sense switch.

£50 + VAT . . . . . Data sheet available

'FAST DATA' light pen system (complete hardware/software package) for Commodore PETs. This is a quality product designed for serious use. Typical applications include Computer Aided Design (CAD), wordprocessing, data selection etc. When the pen is pointed at the screen its high resolution coordinates are automatically returned as BASIC variables. Compatible with Supersoft & MTU hires boards.

Complete system £149 + VAT . . . Full literature available.

**ALTEK** (PC) 1 Green Lane  
 Walton-on-Thames, Surrey

Phone (093 22) 44110 — 24 hours  
 Access . . . Visa . . . Callers by appointment

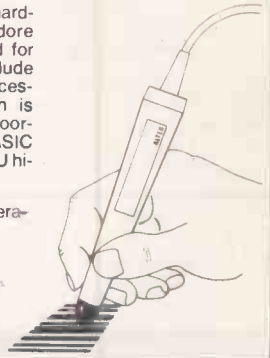

● Circle No. 351

## PETS



CBM 4016 — 16K 12" Screen 40 Col. Computer.  
 CBM 4032 — 32K 12" Screen 40 Col. Computer.  
 CBM 2031 — 170K Single Drive Floppy Disk.  
 CBM 4040 — 340K Twin Floppy Disk Drive.  
 CBM 4022 — 80 Col. 65cps Tractor Printer.  
 CBM 8032 — 32K 80 Col. 12" Screen Computer.  
 CBM 8096 — 96K 80 Col. 12" Screen Computer.  
 CBM 8050 — 1 Meg. Twin Floppy Disk Drive.  
 CBM 8422 — 22 Meg. Winchester Disk Drive.  
 Please phone for latest prices.  
 We offer some of the best deals around!

## APPLES

Apple II — 48K Computer.  
 Apple III — 128K Computer.  
 Video Monitors — Colour and Black & White.  
 Disk Drives.  
 Silentype Printer.  
 All Apple related products available. Please call for prices.

## PRINTERS

Epson MX80FT — 80/132 Col. Friction/Tractor.  
 Auto Bi-Directional. 9x9 Head True Descenders.  
 Ricoh RP1600 — 164 Col. 60cps Daisy Printer.  
 Scripta — 17cps Daisy Printer at low prices.  
 We will quote for any type or make of printer available.

## DEMONSTRATIONS AT YOUR PLACE

We are able to demonstrate complete business systems at your site in our mobile demonstration unit (up to 4 people at a time). Just phone for an appointment anytime.

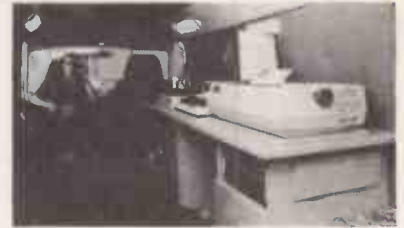

## VIC

VIC20 — Computer. Works with your colour TV.  
 VIC1530 — Cassette Unit.  
 VIC1540 — Single Floppy Disk Drive.  
 VIC1515 — Printer.  
 Expansion Memory, Games Cartridges, Programmers' Aids & Tutorials.  
 Low price computer. New accessories coming in all the time. Call for latest news and prices.

## SOFTWARE

Word-processing  
 Payroll  
 Incomplete Records  
 Book-keeping  
 Invoicing  
 Stock Control  
 Sales Ledger  
 Purchase Ledger  
 Record Keeping  
 Financial Packages  
 Time Recording  
 Silicon Office

## INTELLIVISION

Superb TV Game for your TV. Cartridges Include: Space Battle, Skiing, Boxing, Poker, Golf, Tennis, Roulette, Horse Racing, Basketball, Backgammon & many others.  
 Free soccer game with unit.

## BOOKS

Full range of computer books available from Beginners Guides to Advanced Machine Code Programming.

## ACCESSORIES

All types of accessories and stationery supplied.

## 2'ND HAND

We have a constant changing range of 2'nd hand and ex-demo equipment at considerable savings.

Floppy Disks  
 Storage Boxes  
 Printer Ribbons  
 Tractor Feeds  
 Cassettes  
 Maintenance

Stationery  
 Continuous Labels  
 Daisy Wheels  
 Auto Sheet Feeders  
 Dust Covers  
 Installation & Training



## DAVINCI COMPUTER SHOP

65 High Street,  
 Edgware, Middx.  
 HA8 7DD.

Open Mon-Fri 9.00-5.30  
 Sat 9.30-5.00  
 Telephone: 01-952 0526



● Circle No. 352



# INDEPENDENT COMPUTER ENGINEERING LTD

## A BRITISH 5¼" WINCHESTER DISK DRIVE

INTERFACE-COMPATIBLE WITH YOUR MICROCOMPUTER

- ★ 3.14, 6.28, 9.42, 12.56 MEGABYTE CAPACITIES
- ★ FAST ACCESS TIMES
- ★ OPTIMISED SEEK TIMES
- ★ ON-BOARD MICROPROCESSOR CONTROLS DRIVE OPERATION AND PROVIDES DRIVE DIAGNOSTICS

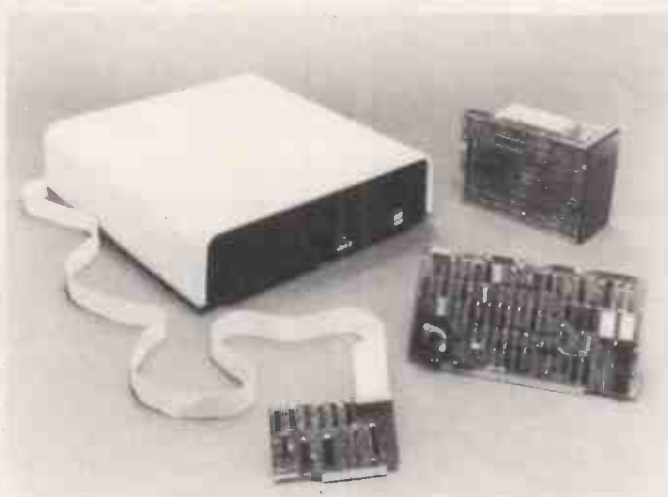

### THE ICE WINCHESTER SUBSYSTEM COMPRISES:

- ★ Winchester Drive/s (**RODIME**), Controller, Cables, cabinet and Software to support your system.
  - ★ Subsystem can be enhanced to provide 2 Winchester drives, or Winchester plus floppy disk drive.
  - ★ Your BACK-UP problem solved with 20 Megabyte Streamer Tape Subsystem.
  - ★ Whisper Quiet Operation.
- ★ **APPLE, S100 BUS, IBM PERSONAL COMPUTER, XEROX 820, SUPERBRAIN, DIRECT 280 CONNECTION.** Call us with **YOUR** Interface problems.

ALL SALES ENQUIRIES TO: Ashford (STD 07842) 47271 or 47171  
**ICE - INDEPENDENT COMPUTER ENGINEERING LIMITED.**  
16/18 LITTLETON ROAD, ASHFORD, MIDDLESEX TW15 1UQ. TELEX 8952042

# UK101 - UK101 - UK101 SPACE GAMES



**SPACE INVADERS (8k) . . . £5.50**  
Written entirely in fast 6502 machine code, 'Space Invaders' needs no introduction. Excellent use of graphics make this a superb version of a classic game.

**FIGHTER PILOT (8k) . . . . £5.50**  
You're at the controls of a deep space Starfighter with a mission to destroy alien rockets and fuel dumps. Using 6 keys you can swoop and straffe or climb and bomb all over the moving landscape. Machine code subroutines enhance the excellent graphics.

**ASTEROIDS (8k) . . . . . £5.50**  
This is the real, completely machine code 'Asteroids'. 9 levels of speed, 3 levels of difficulty, 6 key control (including a Hyperpace button) and very fast, very smooth graphics. Need we say more!!!

**SPACE WARS (8k) . . . . . £4.50**  
Your Solar System is littered with debris from an Intergalactic Space War. Your task is to collect debris and to do this you must steer in and out of alien spacecraft. A real test of reflexes.

**THE SET OF FOUR . . . . . £15**

send 95p (redeemable against first order) for full catalogue and FREE listing. Please state 'UK 101' on order

All prices include VAT and P&P available from

Oasis Software, Lower North Street, Cheddar, Somerset.

Tel: Cheddar 743409

Dealer enquiries welcome

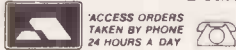

● Circle No. 354

# Save your time on paperwork and calculations

Visit The LONDON MICRO CENTRE to see word processing and business programs in action.

The Centre stocks a full range of software packages, but experience has shown that programs should normally be tailored to meet the client's particular needs.

We are main SUPERBRAIN, SORCERER and APPLE dealers. We can provide any printer to fit these computers.

You can rent a word processor and a micro system from £12.90 per week.

Contact us today for further information

**The LONDON MICRO CENTRE**

47 Lower Belgrave Street

LONDON SW1

Telephone: 01-730 8791

Open evenings and weekends

The LONDON MICRO CENTRE Ltd - An EMG Company

● Circle No. 355

S.B.D. Software is proud to announce their distribution agreement with the most up to date APPLE-only magazine in America.

## CALL A.P.P.L.E. MAGAZINE

In today's fast changing world of the APPLE you just can't afford to stay behind, so don't settle for anything less than the best APPLE-only magazine in America.

Now you can purchase this outstanding magazine for the low price of £1.75 per issue.

Your subscription for 12 or 24 magazines may start from any month in 1981.

Single back issues are available at £2.25 per issue including postage and packing.

A bound volume of the issues in 1980, 1979, 1978 are available for £20.00, £15.00 and £10.00 respectively, including postage and packaging. (Please note that in 1980 & 1981 there were only 9 issues published but in 1982 there will be 12 issues.)

12 issues @ £21.00     24 issues @ £40.00

Europe Air Mail postage, add £6 per 12 issues

NAME .....

ADDRESS .....

TOWN ..... POSTCODE .....

Please start my subscription ..... Month ..... Year .....

Barclaycard/Access Number ..... Expiry Date .....

Please make cheques payable to CALL APPLE (UK)

Send to:- CALL APPLE (UK), c/o SBD Software,  
FREEPOST, RICHMOND, SURREY TW9 1BR  
(No postage stamp required)  
Telephone: 01-940 5194

The Famous Book  
**"ALL ABOUT APPLESOFT"**  
Now available @ £9.50 incl. P. & P.

## PHOTO ACOUSTICS LTD

THE ONE STOP COMPUTER SHOP—

VIC 20 computer	£189.95	CBM 8032	£875.00
Expansion box	£97.95	CBM 8050	£875.00
3K RAM packs	£29.95	CBM 8026	£1,006.00
8K RAM pack	£44.95	CBM 4032	£690.00
16K RAM pack	£74.95	CBM 4040	£690.00
Joysticks	£10.00	CBM 4022	£399.00
C2N cassette deck	£44.95		

These prices are Cash and Carry. Ring Dick at Watford for quote.

★★ Software Available ★★

Apple II computer	£784.00	Genie I computer	(Ring for quote)
Disc drive + cont.	£384.00	EG3014 Expansion	£228.00
Disc drive without	£301.00	EG3013 Expansion	£234.00
Eurocolor card	£70.00	EG3013/WExpansion	£264.00
9" Hi-res B/W monitor	£99.00	EG400 disk drive	£243.00
9" Hi-res green monitor	£110.00	12" B/W monitor	£79.00
12" B/W monitor	£79.00	12" green monitor	£87.00
12" green monitor	£87.00		

★★ Games software avail. ★★

★★ Software avail. ★★

58, High Street  
Newport Pagnell  
Bucks.  
Tel: 0908 610625

255a St. Albans Road,  
Watford, Herts.  
(entrance in Judge Street)  
Tel: 0923 32006



ALL PRICES INCLUDE VAT  
CREDIT CHARGE MAIL ORDER



● Circle No. 357



# ORCHID COMPUTERS LTD.

**EARLS COURT**  
24-25 APRIL

Dealer enquiries welcome

**THE ORCHID SM1Z80 B.** A CPM business computer.  
**THE ORCHID TABLET.** A sophisticated digitising tablet with Z80A computer board.

**THE ORCHID SM2Z80 B.** A high resolution colour graphics computer with frame grabbing facility.

**STAND No. 456 — SEE YOU THERE!**

**ORCHID COMPUTERS LTD.**

3, Collins Street, Oxford OX4 1XL, England. Telephone Oxford (0865) 722102/3/4/5



**MEMOTECH**

**STAND NO. 357**

**64K-£79**

**EARLS COURT**  
24-25 APRIL

The growth of interest in computer use caused by the introduction of the Sinclair ZX81 has made new and exciting demands on the ingenuity of electronic engineers. At Memotech we have focused our attention on the design of an inexpensive, reliable memory extension.

The Memopak is a 64K RAM pack which extends the memory of the ZX81 by a further 56K. Following the success of our 48K memory board the new memory extension is designed to be within the price range expected by Sinclair users. It plugs directly into the back of the ZX81 and does not inhibit the use of the printer or other add-on boards. There is no need for an additional power supply or for leads.

The Memopak together with the ZX81 gives a full 64K, which is neither switched nor paged, and is directly addressable. The unit is user transparent and accepts such basic commands as: 10DIM A(9000) 0-8K ...Sinclair ROM

8-16K...Memopak memory which can switch in or out in 4K blocks to leave space for memory mapping.

12-16K...Memopak memory which holds its contents during cassette loads and allows communication between programmes.

16-32K...This area can be used for basic programmes and assembly language routines.

32-64K...32K of RAM memory for basic variables and large arrays.

With the Memopak extension the ZX81 is transformed into a powerful computer, suitable for business, leisure and educational use, at a fraction of the cost of comparable systems.

Memotech Ltd · 3 Collins Street · Oxford · OX4 1XL · Telephone 722102/3/4/5

# Superior Systems Ltd. Sheffield

178 West Street, S1 4ET. Tel. (0742) 755005.

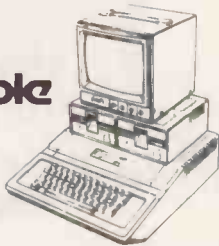

APPLE II 48K.....£670.00  
 DISK DRIVE  
 WITH CONTROLLER.....£370.00  
 DISK DRIVE  
 WITHOUT CONTROLLER...£290.00  
 BMC 12" GREEN MONITOR  
 12" GREEN MONITOR....£145.00



## SHARP

PC 1211 POCKET COMPUTER. 69.50 c  
 MZ 80K (48K) COMPUTER. PHONE FOR  
 MZ 80B (64K) COMPUTER. CHEAPEST  
 PRICE  
 DUAL DISK DRIVE.....550.00  
 P3 PRINTER.....360.00  
 P4 PRINTER.....745.00  
 P6 PRINTER.....420.00  
 SPEED BASIC.....10.00  
 MACHINE CODE.....17.40 b  
 EDITOR/ASSEMBLER.....35.00 b  
 PASCAL INTERPRETER.....40.00 b  
 MZ 80K DUST COVER.....5.00 a  
 APOLLO WORD PROCESSOR...24.95 b  
 CALC II.....34.50 b  
 DATA BASE.....29.50 b  
 ZEN EDITOR ASSEMBLER...19.50 a  
 MACHINE LANGUAGE.....17.74 b  
 MZ 80K DUST COVER.....5.00 a  
 POSIEDON.....5.00 a  
 ADDRESS BOOK.....5.00 a  
 MOONLANDER.....5.00 a  
 COMBAT.....5.00 a

## Mail Order Accessories

### Postage Rates

a.75p b.1.00 c.1.50 d.2.50 e.5.00

### BOOKS

(SEND SAE FOR FULL LIST)

BASIC HANDBOOK.....13.95 c  
 SOFTWARE SECRETS(MZ80K)...7.95 b  
 APPLE II USER GUIDE.....11.10 c  
 BASIC BASIC.....8.95 b  
 PROGRAMMING Z80.....11.95 c  
 PROGRAMMING 6502.....10.75 c  
 PROGRAMMING VIDEO GENIE...5.00 b  
 ZX 81 COMPANION.....7.95 b  
 ZX 81 POCKET BOOK.....5.95 b  
 GETTING AQUAINTED ZX81...4.95 b  
 GETTING AQUAINTED ACORN...7.95 b  
 HINTS & TIPS ZX81.....4.25 b  
 CP/M HANDBOOK.....11.50 c  
 6502 GAMES.....10.25 c  
 MICROSOFT BASIC.....8.75 b  
 ATOM BUSINESS.....6.95 a  
 APPLE PASCAL GAMES.....11.45 b  
 WORD STAR MADE EASY.....7.60 b

### APPLE

VISICALC.....97.50 b  
 VISIPILOT.....95.00 b  
 VISITREND/VISIPILOT.....135.00 b  
 VISIDEX.....105.00 b  
 CIS COBOL.....475.00 b  
 MICROMODELLER.....420.00 b  
 APM.....119.00 b  
 APPLEWRITER.....39.00 b  
 MAGIC WINDOW.....79.00 b

### VIDEO GENIE

SOUND MOD.....7.50 a  
 COLOUR MOD.....39.46 b  
 SYNTHESISER.....45.00 b  
 DUST COVER.....5.00 a

ALL PRICES EXCLUDE VAT

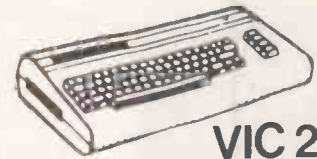

## VIC 20

VIC 20 COMPUTER.....173.90 e  
 VIC CASSETTE DECK....39.09 d  
 VIC PRINTER.....200.00  
 3K RAM CARTRIDGE.....26.04 b  
 8K RAM CARTRIDGE.....39.09 b  
 16K RAM CARTRIDGE...65.17 b  
 JOYSTICK.....6.52 b  
 PADDLES.....11.74 b  
 INTRODUCTION TO BASIC  
 PART I.....13.00 b  
 VIC GAMES ROM CARTRIDGES  
 VARIOUS FROM.....17.35 b



## VIDEO GENIE

MKI with sound &  
 lower case.....309.00  
 MKII  
 BUSINESS COMPUTER.....309.00  
 EXPANSION UNIT  
 WITH 16K ROM.....199.00

## ACORN ATOM

ACORN ATOM 8+5  
 with colour+PSU.....199.00 d  
 ACORN DISK PACK.....299.00 d  
 FLOATING POINT ROM...20.00 a  
 GAMES PACKS 1-10....10.00 each  
 WORD PACK ROM.....26.00 a  
 COLOUR ENCODER.....39.00 b  
 B.B.C. ROM PACK.....PHONE b  
 MAGIC BOOK.....5.50 c  
 MATHS PACK.....10.00 a  
 ATOM CHESS.....10.00 a  
 ATOM ADVENTURES.....10.00 a

### MAIL ORDER FORM

PLEASE SUPPLY..... £.....  
 ..... £.....  
 ..... £.....  
 ..... £.....

ACCESS/BARCLAYCARD/CHEQUE

P&P+V.A.T. £.....



CARD No.....

TOTAL ENCL.£.....

NAME.....

ADDRESS.....

POST CODE.....TEL.....

● Circle No. 359





# WHAT'S the CATCH?

HOW COME THESE PRICES ARE SO LOW?  
There is no catch except you always catch a good DEAL  
at DEANS



Apple II + 48K £649.00  
Disk drive + controller £349.00  
Disk drive £289.00  
16K Ram card £60.00  
Pascal system £239.95

## ● APPLE SOFTWARE

Visicalc (3.3) £99.00  
Visiplot £95.00  
Visidex £99.00  
Visitrend/plot £135.00  
Apple word £29.95  
Apple writer I £35.00  
Apple writer II £74.00  
Desk top plan II £105.00  
DOS plus £19.95  
Aplus £19.95  
Appleguard £19.95

## ● WORD PROCESSING

Apple Writer (I) £39.00  
Apple writer II (80 col) p.o.a.  
Magic window £59.95  
Mailmerge (80 col) £60.95  
Wordstar p.o.a.

## ● MONITORS

12" green screen £129.95  
9" b/w Hi-Risul £127.95

## ● COLOUR MONITOR

14" JVC-PAL/SECAM/NTSC £299.95  
Euro colour card £69.00  
Integer card £95.00  
Language card £97.50  
Parallel interface card £87.00  
Communication card £99.00  
Centesonic card £99.00  
High speed serial card £94.95

## ● PRINTERS

Silentype £190.00  
Centesonic 737 £345.00  
Paper Tiger £545.00  
Epson p.o.a.  
MX80 T2 £399.00  
MX80 FT/1 £395.00  
Epson/Sharp cassette £65.00  
Epson/Sharp disk p.o.a.

## ● GAMES

Space Warrior, Alien Rain, All Snoggle, Galaxy Wars, Gobbler, Star Cruiser, Alien, Typhoon, Cribbage, Galactic Empire all at £12.95  
Star Mines, Apple Panic, Tartusian, Tawala's Creature, Venture. all at £14.95  
Star Thief, Missile Defence, Epoch, Soft Porn Adventure, The Wizard and the Princess, Threshold, Sneakers, Oldof Revenge, Peagus II all at £17.95



## ● PC 1211

PC1211 Pocket computer £69.95  
CE121 Cassette interface £10.95  
CE122 Printer £59.95  
CSR700 Paper roll (40) p.o.a.

## ● MZ80K

MZ80K computer 48K £345.00  
MZ80FD Dual disk £550.00  
MZ80P3 Dot printer £360.00  
MZ80F I/O Disk interface £49.95  
MZ80F 15 Disk cable £8.00  
MZ80 I/O Expansion box £94.00  
MZ80T 20C Machine language £18.00  
MZ80TU Assembler £35.00

400 16K computer £295.00  
800 16K computer £549.00  
16K Ram upgrade £49.95  
Disk drive £295.00

## ● VIDEO RECORDERS

Sony SLC5 £390.95  
Sony SLC7 £548.10  
JVC HR7200 £451.53  
JVC HR7300 £477.95  
Akai VS5

## ● FLOPPY DISC

5 1/4" Verbatim SS/DO £2.30  
5 1/4" Verbatim SS/DDX10 £19.95  
5 1/4" Verbatim DS/DD £2.60

## ● BOOKS

APPLE  
Apple II Ref. Manual £11.00  
6502 Assembly language £12.10  
DOS 3.2 Manual £6.00  
Apple II Basic tutorial Pascal Reference Manual £8.50

## ● ZX81

Getting Acquainted with your ZX81 £5.95  
Mastering Machine code on your ZX81 or 80 £5.95  
The Gateway Guide to the ZX81 and ZX80 £5.95  
49 Explosive Games for the ZX81 £5.25

MOST of our prices are heavily discounted therefore please send cheques payable to DEANS. Credit-card sales add 3%. Add 15% VAT. Postage and packing free on books & software.

## DEANS

191, KENSINGTON HIGH STREET, LONDON W.8.  
Tel. 01-937 7896 Ext. 3.

● Circle No. 360

## Advertisement Index

A		Datarite	192	Kingston	188	P	
A & G Computerware	34	Davinci	236	Knights	236	Pearcom	65
Access	34	DDP	210	Kontron	138	Penbie International	234
ACT	66, 67	Deans	241	Kram	222	Pete & Pam	223
Adler	23	Digital Devices	181	L		Photo Acoustics	238
Almarc	233	Digitek	145	Laskys	85, 86, 87, 88, 96	P.R. Daly	180
Altek	236	Discom	214	Level	198	Prentice Hall	225
Anglia	12, 13	Disking	177	Lifeboat Assoc.	109	Protech	176
Apple Orchard	214	DRG	227	Lislar	116	Ram	61
Atlanta	234	Duplex Communications	142	Little Genius	29	Real Time Developments	224
Atlantic Computer Shop	44	E		L & J Computers	208	Riva	197
Avalon	196	East Fern	201	London Computer Centre	179	S	
Avery	216	Electronic Brokers	29	Lowe	24, 130	SBD	202, 238
Avon	196	EMG	131, 212, 238	LSI	74, 75	SDM	220
B		Encotel	219	Lucas Logic	20, 21	S.E.C.	194
BFI	219	Engineering Computer Services	64	M		Sharp	51
Beeline	73	Equinox	42, 112, 113	Macmillan, J.	202	Sinclair Research	121, 122, 123, 124, 146
Black Box/Rair	211	G		Maplin	185	Sirton	207
Blyth Computers	147	Gate	81	Mass Micros	231	Soft Option	39
Bromley Computer Shop	193	Glenrothes	193	Melbourne House	144	Spider Software	228
Butel	222	G.P. Industrial	229	Memotech	239	STCS	216
C		Gram	30	Mercator	102	Stirling	212
Calco	218	Gram (Winter)	6, 7	Metrotech	14, 15	Superior Systems	240
Cambridge Micro Computers	30	Gt. Northern Computer Services	26	Micro Business Centre	187	Swan	144
Camden	218	Guestel	Inside Back Cover	Microcentre	Inside Front Cover	Swanley	224
Centronics	69	H		Microcode	228	Symbiotics	206
Chromasonic	114	Hal	30, 196	Micro Computer Applications	204	Systemise	193
City Microsystems	226	Hilderbay	206	Micro Computer Land	132	System Logic	39
Clenlo	110	Hitec	242	Micro Computer Products International	25	Systems International	232
Commodore	16, 17, 52	Hitec	209	Microcosm	26	T	
Commodore Machines	104, 105	Hiteck	288	Micromanagement	231	3rd London Computer Fair	217
Compshop	191	Hobby Electronics	174	Micromods	201	3SL	188
Computabits	186	I		Micronetworks	205	Tabz	82
Computace	28	IBR	140	Micropute	76, 137	Technomatic	199
Computech	200	Icarus	36, 221	Microsec	235	Telesystems	204
Computer Aided Printing Services	22	I.C.E.	237	Microsource	17	Transam	203
Computer Facts	139	Informex Centralex	190	Micro Support Centre	234	Transdata	48
Computer Fair	182, 183	Infra	232	Microvalve Dealers	10, 11	Transec	195
Computer Interface	182, 183	Inta Corporation	18, 19	Microware	31, 183, 210	Twickenham Computer Store	226
Computers for All	178	Interam	115	Micro 80	208	V	
Comshare	37	10 Systems	218	Millbank	6, 9	Videotex	235
Control Universal	232	Irvine	212	Monolith	190	Visconti	40
Crofton	224	Ithaca	Outside Back Cover	N		Vlasak	38
Crystal	235	J		Northern Amateur Radio Sch.	180	W	
CTEC	103	John Birkwood Assoc.	230	Northamber	27	Watford	4
Cumana	33, 213	John Wiley & Sons	215	O		Wida	34
CWP	184	K		Oasis	238	Willis	206
D		Kai	180	Overseas Computer Systems	61	Windfall	230
Data Applications	68	Kansas	220	Oxford Computers	35	Y	
Data Efficiency	129	Keele	99	Ozwise	230	Your Computer	198
Datalect	32	KGB	91			Z	
						Zenith	5



Mail Order Software

# THE MORE YOU TAKE THE MORE YOU GAIN FROM COMPUTING

### MILESTONE: £210.- Manual alone: £20.-

"Critical path" network analysis program for scheduling manpower, dollars and time to maximise productivity. NEW IMPROVED. Interactive project management program that runs under CP/M. MILESTONE can be used to track paper flow, build a computer, check a department's performance, or build a bridge. MILESTONE can be used by executives, engineers, managers, and small businessmen.

- Produce PERT chart in minutes.
- Find critical tasks that can't be delayed.
- Investigate tradeoffs between manpower, dollars and time.
- Give plans to others using a printed project schedule.
- Change details and immediately see the results on screen.
- Balance time, manpower and costs.

Requires 56K RAM and CP/M. Specify Z80 or 8080. Also available for Apple Pascal, UCSD Pascal or CP/M-86 operating systems. (Milestone-86 version 290 1) Formats: 8, NS, MP, SB, TRS2, OB-1, XX, IPC, IDW.

### ACCESS/80

A report generator and cross-tabulator. Virtually any report that can be described on paper can be generated by using your existing ASCII data files. Produces reports in minutes that would take hours to program in BASIC.

#### — Level I — Report Generator and Cross-Tabulator — £210.-

Read ASCII files and create sorted reports with subtotaling capability. Provides multi-dimensional cross tabulation and computation. Includes operating system commands.

#### — Level II — Output and Logic Processor — £354.-

Everything in Level I plus, write out new files in any sorted order (including subtotaling). Load arrays from files. Performs binary search on sorted arrays in memory. Includes control language extensions for complex applications. Requires CP/M and 48K RAM. Formats: 8, NS, MP, CDOS, SB, TRS2, APPL.

### DATEBOOK II: £210.-

#### Manual alone £18.-

- Schedules appointments for up to 27 different doctors, lawyers, rooms, etc.
- File structure allows for appointments up to one year in advance.
- Searches for openings that fit time of day, day of week and/or day of year constraints.
- Appointments made, modified or cancelled easily.
- Copies of day's appointments can be printed quickly.

Requires 56K RAM and CP/M. Specify Z80 or 8080. Also available for Apple Pascal, UCSD Pascal or CP/M-86 operating systems.

Formats: 8, NS, MP, SB, APPL, TRS2, OB-1, XX, 1-5, IPC, IDW.

### PERSONAL DATEBOOK — 110. Manual alone 20

Time management and appointment scheduling calendar for an individual or small office with up to nine staff members. Displays one appointment schedule on screen at a time. Cancellations can be put into hold file for easy rescheduling at your convenience. Menu driven commands do not require referral to manual.

Requires CP/M 2.x and 56k RAM. Specify Z80 or 8080. Also available for Apple Pascal, UCSD Pascal or CP/M-86 operating systems. Formats: 8, NS, MP, SB, APPL, TRS2, XX, IPC, IDW.

### WHATSIT?

A data base/query/retrieval system that communicates conversationally, accepting questions and updates in simple sentences. Store, index and retrieve information about one or more aspects of related or unrelated subjects. Information is stored under your designated "subject" and "tag" headings, which can be added to, changed

or deleted at any time. 116 page manual assumes no programming knowledge. Requires CP/M, CBASIC2 AND 24k RAM. Formats: 8, NS, MP, SB, APPL, OB-1, XX.

### THE FIELD COMPANION £210.-

#### Manual alone £20.-

Created for the needs of the travelling Salesman or Professional. Allows you to track the time spent with your clients, each client having up to four user-defined sub-fields. Expense accounting is provided and is itemised in a detailed journal for budgeting and tax reporting purposes. Maintains appointments and current customer list including shipping and billing addresses, year-to-date sales and person to contact for follow-up. Invoicing features retrieves required data from both customer and product lists. Special instructions and discounts are supported. Invoice copies may be output to a printer or sent to the home office via modem, permitting electronic transfer of the content of any report. Requires 56k RAM and CP/M or CP/M-86 and 128k RAM. Formats: 8, NS, MP, APPL, SB, XX, IPC, IDW.

### FOOTNOTE £125.-

Automatically numbers and formats footnote calls, footnotes and text, placing footnotes on the bottom of the correct page. At the user's option, the footnotes can also be removed from the text file to a separate note file. Footnotes can be entered singly or in groups, in the middle or at the end of paragraphs. After running FOOTNOTE the user can re-edit the text, add or delete notes, and run FOOTNOTE again to re-number and re-format. Price includes PAIR, a companion program that checks that underline and BOLDFACE commands are properly terminated. Requires CP/M, WordStar, 48k RAM. Formats: 8, NS, MP, SB, APPL, OB-1, XX.

### CBASIC/86: £230.-

#### Manual alone £20.-

Industry standard intermediate code basic compiler with runtime interpreter for CB/M-86. Features include chaining, integer and external precision arithmetic, random and sequential records of any length (not limited to 256 bytes). Requires CP/M-86. Formats: 8, 1-5.

### Personal PEARL: £210.-

— User friendly application software generator. A fourth generation language, automatically creates completely new programs in CBASIC. Excellent documentation makes it easy to create "personal" software such as checking and financial programs, name, address and telephone lists, etc. Requires CP/M, CBASIC2 and 48K RAM. Formats: 8, NS, SB, TRS2, APPL, OB-1, MP.

### SPELLBINDER: £354.-

#### Manual alone £35.-

Full feature word processing system with Office Management capabilities. Its special features include ease-of-use by office personnel, flexible print formatting & output, and powerful macro capability which allows features to be added for the unique requirements of each user. Mail list macro is included for mail merge with form letters. Requires CP/M & 32K RAM. Formats: 8, NS, MP, CDOS, SB, APPL, XX.

### ACT:

#### New text and prices:

CP/M compatible macro assembler family supporting all major 8 bit micros. ACT features include full macro capabilities, comprehensive pseudo ops, link file structures, cross reference map and algebraic expression processor. Requires 32k RAM and CP/M.

ACT I - 6502 £130ACT-86/88 £130

ACT I - 6800 £130ACT-6809 £130

ACT I - 8080/Z 80 £130Manuals £18

### COPYRIGHT:

Access/80 Friends Software; Pearl Relational Systems; Pascal/M, ACT, Trans 86, Supercalc Sorcim, CBASIC 2, CBASIC/86 Compiler Systems; Datebook II, Milestone, Textwriter III Organic Software; Spellguard ISA; CP/M, CP/M-86 Digital Research; Superbrain Interlec Data Systems; S-Basic Topaz Programming; Spellbinder Lexisoft; Selector IV; Selector/86, Glector Micro Ap.

Prices quoted do not include dealer installation and training. Prices and availability subject to change without notice.

### PASCAL/M: £280.-

#### Manual alone £15.-

CP/M compatible language for 8080/Z80 CPUs, supports full Jensen & Wirth plus 45 extensions to Standard Pascal including Random access files, 40 segment procedures & 16 bit BCD real type. Also includes symbolic debugger which features trapping on stores, examining and changing variables and tracing of program execution. Requires CP/M 2.2 & 56K RAM. Formats: 8, NS, APPL, TRS2.

### PASCAL/M for 8086/88: £350.-

#### Manual alone £15.-

All the features of PASCAL/M for the 8086 and 8088 processors running under CP/M-86. Requires CP/M-86 and K RAM. Formats: 8, 1-5.

### PASCAL: Sort - £140.-

#### Manual alone £14.-

Fully commented source code into which the user simply places the particular file description and sequence requirements to obtain the desired sort. Can run stand-alone or as a overlaid segment of larger program. Uses indirect Shell-Metzner in RAM, interleaved polyphase (Fibonacci) merge on disk, full sector buffering and shortest seek logic. Can match machine language sorts even under Pcode interpretation. Requires CP/M 2.x and 56k RAM and CP/M-86 and 128k RAM. Pascal/M,UCSD Pascal or Pascal /MT. Formats: 8, NS, APPL, XX, MP, TRS2, IPC IDW.

### SUPERCALC: £210.-

Allows a layman to manipulate business data in a variety of forecasting and accounting applications. Combines the interactive nature of an electronic spreadsheet with the power and convenience of a simple simulation language. Video display can be scrolled over entire worksheet using cursor controls. Symbolic vector reverences eliminate repetitive low level data manipulation commands. Easy to use menu driven "Help" commands. Requires CP/M and 48K RAM. Formats: 8, NS, MP, SB, APPL, TRS2. Call for terminal formats.

### SUPERDOS: £100.-

Upgrade of CP/M2.2 for Superbrain. Includes ADM/31 Hazeltine, or Superbrain Terminal emulation mode. Other new features include 132 character keyboard buffer, repeat on all keys, key click, user programmable numeric keypad, 30% disk read/write improvement, real time clock, baud rates to 19,2K on RS232 ports, printer handshake modes, 4 new utilities, and 4 fixes. Requires Superbrain 3.0. Format: SB.

### TRANS 86 — £104.-

#### Manual alone £15.-

8086/88 Translator for existing 8080/Z80 programs. New source code is easily edited and assembled using ACT II to produce hex code which is executed by 8086/88 CPU. Emphasizes the extensions and features available in the 8086/88.

Requires CP/M & 32K Ram. Formats: 8, NS, APPL, OB 1, XX.

### MAILER — £75.-

A fast and easy to use mailing list program. Address labels can get printed in any desired order including alphabetically. Data can be selected. APPL.

### IMP — £310.-

Instant mathematical programming for complex engineering design as well as allocation problems, statistics, transport and many other applications. It allows a user to enter difficult mathematical problems (simultaneous non-linear equations, linear programming constructs and multivariate analysis problems) in simple algebraic form. APPL.



Datenverarbeitungs- und Betriebsberatungs GmbH

London  
5 to 9  
17 WIGMORE STREET  
LONDON, W1H 9LA.

**ORDERS** must specify disk type and format. Add 15% VAT to orders. Add £1 per item postage and packing. All orders must be prepaid. Make cheques, POs etc payable to HITEC Company, 5 to 9, 17 Wigmore Street, London W1H 9LA. Manual costs are deductible from subsequent software purchase. Dealer Inquiries welcome.



# FOUR GOOD REASONS FOR CHOOSING GUESTEL

**1. The Systems** – Whatever your micro computer hardware or software requirements, Apple systems can meet them and we can supply them to rent or buy. Visit our showrooms in London, Brighton and Bristol or use our nationwide mail order service – one of the largest and most efficient in the country.

Guestel provide sales, service and an in depth knowledge of Apple systems. We buy bigger so you can buy cheaper.



**2. The Consultancy** – Micro computer systems are simple to use once you know how. But how do you learn when so much of the so-called advice is in confusing computer jargon? Come to

us. We talk plain English. Quite simply, we will help you to identify your particular needs for hardware, software and support services – then we'll match them with Apple systems.



**3. The Service** – Immediately you come to us with your needs you'll get a personal service. Whatever your requirements, we respond right away. And once your equipment is installed our reliable back up service ensures that help is always on hand



when you need it. We operate a two tier maintenance agreement, with a 24 hour call out service. We also have an in house engineering facility and a telephone enquiry service to cope with emergencies. Our fast, efficient mail order service will take care of your additional requirements and our offices are within easy reach.

**4. The Know How** – Some of Britain's leading companies have come to us for help in developing major custom built micro computer linked systems – your guarantee that we have the depth of technical knowledge and the experience to help with your needs, large or small.



**GUESTEL**

EXPANSION THROUGH EFFICIENCY

8-12 NEW BRIDGE STREET LONDON EC4V 6AL TELEPHONE 01 583 2255

41/43 BALDWIN STREET BRISTOL O272 27461

15 GRAND PARADE BRIGHTON EAST SUSSEX BN2 2QB TELEPHONE 0273 695264

AUTHORISED APPLE DEALER AND LEVEL ONE SERVICE CENTRE

 **apple**® APPLE III NOW AVAILABLE

243

Apple is a trademark of Apple Computer Inc., Cupertino, CA, USA.

“MAKING MICROCOMPUTERS FOR THE '80S”



Pictured is the SuperFAST™ CACHE BIOS System. For further information and a catalogue of our IEEE S100 products contact us today

Coleridge Lane, Coleridge Road,  
London N8 8ED England  
Telephone: 01-341 2447  
Telex: 295568

ITHACA **Ithaca Systems**™ (UK) Ltd

● Circle No. 363