

PRESENTS FOR OUR READERS

Popular Wireless

Every Thursday
PRICE
3d.

No. 281. Vol. XII.

INCORPORATING "WIRELESS"

October 22nd, 1927.

ANOTHER FOUR 6d Blue Prints

Free!

Special Features

How to Check Your Valves
This Year's Battery Eliminators
THE
"UNIVERSAL" THREE
The Best Broadcasting Voice
THE
"BP 34" TWO-VALVER
A Series for the New Amateur
A Visit to 2BE



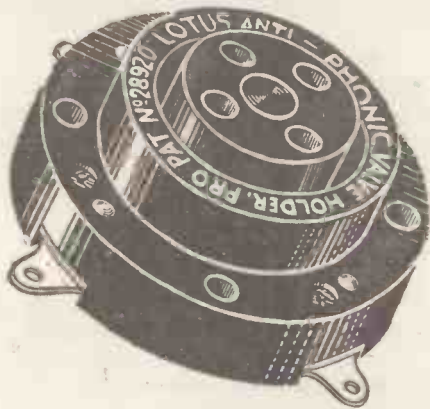
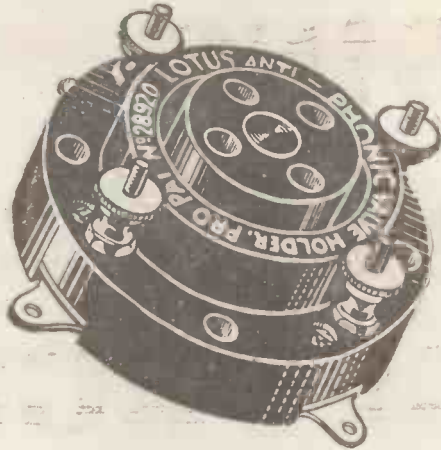

Prices :

- Without Terminals 2/3
- With Terminals 2/6
- Combined Grid Leak and Terminal Valve Holder 3/9

Look to your Valve Holders !

IF your reception is unsatisfactory or weak, if it is spoiled by constant irritating noises, look to your Valve Holders.

See that they are guaranteed to absorb shock and eliminate all microphonic noises, because that IS where the fault lies.

The Lotus Valve Holder is constructed to give immediate and lasting connection when the valve pins enter the valve sockets. The leg sockets expand and automatically lock, and the floating platform in which they are fixed is suspended by four phosphor bronze springs, which have great mechanical strength and at the same time are sufficiently resilient to absorb any external shock that would cause damage to the valve.

Carefully made from the finest bakelite mouldings, with phosphor bronze leg sockets, every Lotus Valve Holder undergoes strict tests before leaving the factory, and can be relied on to withstand a great deal of rough usage.



Made by the makers of the famous Lotus Remote Control, Vernier Coil Holders, Jacks, Switches and Plugs.

GARNETT, WHITELEY & CO., LTD.
"Lotus Works" - Broadgreen Road, Liverpool

ABSORBS SHOCK—ELIMINATES MICROPHONIC NOISES



HANGING UNCLE GEORGE

Users of 6-volt accumulators are assured of superlative results by employing the following new 6-volt Marconi Economy Valves.

FOR GENERAL PURPOSE.

Marconi Valve—
Type D.E.H. 610 (10/6) or
" D.E.L. 610 (10/6).

FOR THE LAST STAGE.

Marconi Valve—
Type D.E.P. 610 (12/6)—a
power valve.

An amusing but informative booklet entitled "Back Chat" may be obtained by posting the coupon below.

Talking about Marconi Valves we might claim that the filament was strong enough to hang Uncle George's portrait.

But who cares?

We might claim that it was long enough to dry the week's washing on. But surely you've got a clothes-line?

No. We prefer to talk about what the Marconi Valve does. To tell you that very little juice goes in at the input end for what comes out at the output. We prefer to state that, operated from Marconi Valves, the loud-speaker suffers neither from loss of voice nor nasal catarrh.

And, what's more, that Marconi Valves keep on working for a very long time indeed. They're built for power, they're built for truth and they're built for time.

MARCONI VALVES
-do everything that a valve should do

.....
The Marconiphone Company Ltd. (and reduced)
210-212, Tottenham Court Road, London, W.1.
Please send me copy of "Back Chat." Thank you.
Name.....
Address.....
County.....
P.W.6.....
..... 3d stamp if unsealed

Condensers and Resistances

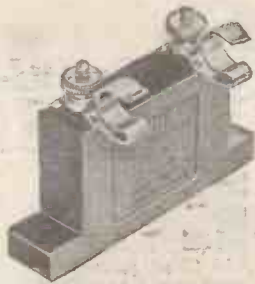

Type 620 Mica Receiving Condenser. 21 standard capacities from 0.00005 to 0.015 mfd.



Dubilier Resistors, made in 21 standard values up to 50 ohms. to fit Dumetohm holders.



The Duwirohm wire-wound Anode Resistance, made in 14 standard values.

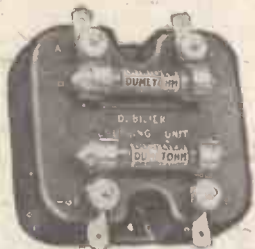

The Dubilier R.C. Coupling Unit, for use with high-amplification factor valves.

DUBILIER Condensers and Resistances are the outcome of a highly-specialised experience. They are designed with a thorough understanding of the functions which each is expected to perform, and their unfailing accuracy and reliability have made them famous wherever the science of radio is known.

Use Dubilier Condensers and Resistances in every radio set you build, and be assured of the satisfactory results which only carefully chosen components can give.

TYPE 620. This is the famous fixed mica condenser which is the vertical counterpart of the Type 610. It is suitable for use as a grid condenser, by-pass condenser, etc., etc. Both Types 610 and 620 are made in 21 different standard capacities between 0.00005 and 0.015 mfd., and are supplied with the necessary clips for series and parallel mounting of the Dumetohm between 0.00005 and 0.0005 mfd. capacities. Prices from 2/6 to 4/6, according to capacity.

DUBILIER FILAMENT RESISTORS. We supply a complete range of accurate Filament Resistors which clip into the Dumetohm holder as shown. By employing the correct value of resistor you are enabled to obtain the drop in voltage necessary when using, say, 2-volt valves with a 6-volt accumulator. We shall be pleased to forward a Chart enabling you to determine the correct resistor to use in any given case. Dubilier Resistors, 1/- each. Dumetohm Holders, 1/- each.

The **DUWIROHM**, a Dubilier wire-wound Resistance, is constructed with a special form of non-inductive winding enabling the Resistance to carry a potential of several hundred volts in safety. Graded to a close degree of accuracy, it is guaranteed to remain constant indefinitely. Standard Resistances are 10, 20, 30, 40, 50, 60, 70, 80, 90, and 100 thousand ohms, at 5/- each, 150 and 200 thousand ohms at 8/- each, 250 thousand ohms at 9/9 each, and 300 thousand ohms at 11/6 each. Holder, as shown, 1/6 extra.

The **DUBILIER R.C. COUPLING UNIT.** In this unit is combined our unique experience in the manufacture of Condensers and Resistances. The condenser element contains dielectric of the best India Ruby Mica, the resistances being the famous Dumetohms which, it will be noticed, can be interchanged for values to suit your own requirements. Many thousands of these units are giving excellent reproduction all over the country. Price 7/- each.

Your Dealer
stocks



Products
ask him.

Adv. of The Dubilier Condenser Co. (1925) Ltd., Ducon Works, North Acton, W.3.

T.C.51

The Best of the 2 volt Batch



THE B.T.H. Co. have always made good valves—valves you can *rely on*—but the new 2-volt Valves are the best they have ever made. These valves are unsurpassed for efficiency, long life and economy in up-keep. They were not put on the market in a hurry, but only when it was felt that a **PERFECT 2-volt Valve** had been evolved.

B.T.H. 2-Volt Valves are perfect in EVERY part. The filament has emissive properties second to none, and it has an unusually long life—*no filament lasts longer*. The anode and grid too, are so perfectly constructed and placed relatively to one another and to the filament that maximum working efficiency is assured.

If you want the *best possible* results—and who does not?—you would be well advised to compare the results obtained with these the up-to-date 2-Volt Valves, and those you are using now. Comparison is invited—for it will be in your interest as well as our own.

ASK YOUR DEALER FOR THE NEW B.T.H. 2-VOLT VALVES

Type	Purpose	Fil. Volts	Fil. Amps.	H.T. Batt. Volts	Ampl. Factor	Impedance	Price s. d.
B 21	H.F.	2	0.1	40 to 150	16.0	32,000 ohms	10 6
B 22	G.P.	2	0.1	40 to 100	7.5	14,000 ohms	10 6
B 23	Power Amp	2	0.2	40 to 100	6.0	8,000 ohms	12 6
B 8	Res. Coupl.	2	0.1	100 to 150	50.0	180,000 ohms	10 6

The above prices are applicable in Gr. at Britain and Northern Ireland only.



2803

A COMPLETE RANGE OF VALVES—

2 VOLT VALVES

FOR ALL SETS AND CIRCUITS

B21	{ H.F. & DET }
B22	{ General Purpose }
B23	{ Loud Speaker }
B8	{ R.C. }

If you are interested in R.C. Coupling, write for a copy of the "RESISTOR" Booklet to Publication Dept., The British Thomson-Houston Co., Ltd., Rugby

£50 OFFER.

Please forward to me booklets on the following subjects I am an old student of your College and am anxious for my sons to become students also. I am constantly recommending your College and am glad to do so.—Yours faithfully, WM. JAMES.

20, Maesteg Road, Cwmfelin, Maesteg, Glam.



W. Bennett

F.R.S.A., M.I.Mar.E.,
A.I.Struct.E., M.B.I.P.S.,
etc. (GOVERNOR) THE
BENNETT COLLEGE,
SHEFFIELD.

We have recently received the above letter, but we are prepared to produce on demand thousands more of its kind, or hand over to any applicant the sum of £50 in cash.

We give a written signed guarantee to every student that we will give tuition until he has passed the examination for which he enrolls. We prepare and print our own textbooks specially for the examinations, and we give all the necessary books Free. If a student can get through the Examination on only a few lessons, then all the better for the student, and the College, but if a student is backward more patience and more lessons are required. There is no limit either of time or number of lessons. We guarantee success.

Send for the booklet of the subject in which you are interested.

Most Moderate
Charges, Pay-
able Monthly.

**EXPERT TUTORS
FOR EVERY
DEPARTMENT.**

Have You
**ANY
Ambition?**

WE TEACH ALL THE FOLLOWING SUBJECTS:

COMMERCIAL.

Accountancy
Advert. Writing
Salesmanship
Army Certific. Courses
Auctioneering and Estate
Auditing [Agency]
Banking
Book-keeping
Civil Service
College of Preceptors
Commercial Arithmetic
Commercial Law
Company Law
Costing
Economics
English and French
Executorship Law
Foreign Exchange
General Education
Modern Business Methods
Police Entrance and
Promotion Courses

COMMERCIAL—Con.

Secretaryship
Workshop Organisation

TECHNICAL.

Applied Mechanics
Architectural Drawing
Building Construction
Clerk of Works' Duties
Boiler Engineering
Boiler Making
Chemistry
Civil Engineering
Concrete and Steel
Draughtsmanship
Electrical Engineering
Practical Mechanical
Engineering
Engineering Costing,
Quantities and Specifi-
cations
Foundry Work
Heat Engines

TECHNICAL—Con.

Internal Combustion
Engines
Marine Eng. B.O.T.
Mathematics
Matriculation
Metallurgy. Mining
Mine Surveying
Motor Engineering
Naval Architecture
Pattern Making
Post Office Examinations
Quantity Surveying
Road Making
and Maintenance
Sanitation. Shipbuilding
Structural Engineering
Surveying and Levelling
Surveyors of Works, R.E.
Telegraphy and Telephony
Town Planning
Wireless Telegraphy
Works Managers' Course

WE SPECIALISE IN
PREPARATION FOR
ALL EXAMINATIONS.

WE TEACH BY POST
IN ALL PARTS OF
THE WORLD.

Note THE BENNETT COLLEGE,
Address: Dept. 106, SHEFFIELD.



Delivery of LEWCOS (Regd. Trade Mark) Radio Products

DIFFICULTY may have been experienced in obtaining some of our products from your local Radio Dealer.

The truth is that the demand for LEWCOS Radio Products has been so enormous that it has quite outstripped our ambitious manufacturing programme, with the result that we are somewhat behind on delivery.

We are increasing production daily, installing additional manufacturing and testing plant and training new labour, and expect shortly to be in a position to supply the trade promptly with all their requirements.

Meanwhile we ask your kind indulgence.

The
**LONDON ELECTRIC
WIRE CO. & SMITHS, LTD.,**

Playhouse Yard, Golden Lane, London, E.C.1.



ILLUMINATED DIAL 9/6

Complete with Bulb.

An elegant and perfectly made Dial for mounting behind the Panel. A Push-Pull Switch controls lighting. Easy to mount, and can be fitted to any standard condenser.

THE FORMO COMPANY,
Crown Works, Cricklewood Lane,
Phone: 1787 Hampstead, N.W.2
Full Catalogue free on request.



ONLY 90! now is all you need pay for a handsome Hornless Loud Speaker

THERE'S no need now to pay a high price for your Loud Speaker. Only ninety shillings will buy an instrument which will satisfy the most discriminating ear and the most fastidious eye. The BROWN Mascot Loud-Speaker is unrivalled at its price both in performance and appearance. It will give you—now and always—a reproduction that is so true that it can only be compared with the original. That is

unmatched, in its class, in the purity of its tone, and unequalled in the majesty of its volume.

The reproduction you hear when first you listen to the Mascot is the reproduction you will hear after years of use. That is a guarantee upon which the world-famous BROWN reputation is staked. Hear the Mascot at your Dealer's, or, better still, get him to demonstrate it in your own home. Price 90/-.

Hear also the new **BROWN UNIVERSAL Loud Speaker** Price £6

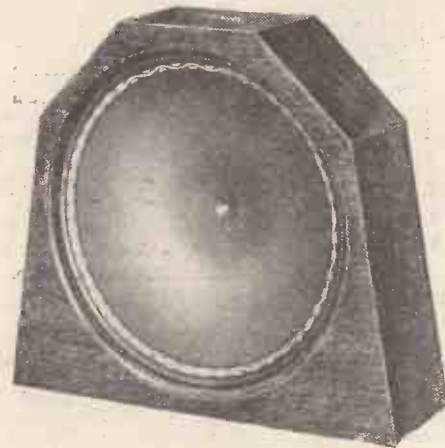

Unrivalled, at its price, for Performance and Appearance

Brown Mascot Loud Speaker

S. G. Brown, Ltd., 11 Est-ryn Avenue, North Acton, London, W.3.

Forging ahead

Cossor introduces
2 Volt
 Screened Grid Valves



Cossor 2-volt Screened
 Grid. Consumption
 1 amp.

22/6

Also 6-volt type.
 Consumption 1 amp.

22/6

A GAIN Cossor leads the way. Hitherto only 6-volt Screened Grid valves have been available. Now the exceptional efficiency and the enormous emission given off by the Kalenised filament has made possible the production of a 2-volt Cossor Screened Grid valve giving a far higher standard of performance. Current consumption has been reduced to one tenth of an ampere.

Use this wonderful new Cossor Valve in any Set where screened grid valves are specified—you'll get better results, increased amplification, improved stability with a considerable economy in maintenance. All Cossor Screened Grid Valves are fitted with standard double-ended caps. Build up a Receiver to utilise these new Cossor Valves now—you'll be thrilled at the ease in which you'll be able to pick up distant Stations at tremendous volume. The new Cossor Screened Grid Valve is Radio's latest—and greatest—development.

Cossor

the melody maker

Advt. of A. C. Cossor Ltd., Highbury Grove, N.5

Popular Wireless



Scientific Adviser :
 Sir OLIVER LODGE, F.R.S.
 Editor :
 NORMAN EDWARDS, M.Inst.R.E., M.R.S.L., F.R.G.S.
 Technical Editor : G. V. DOWDING, Grad.I.E.E.
 Assistant Technical Editors : K. D. ROGERS, P. R. BIRD,
 G. P. KENDALL, B.Sc., A. JOHNSON RANDALL.

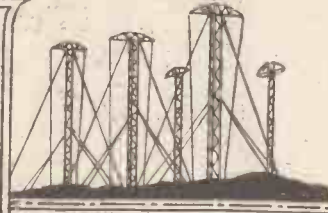

RADIO NOTES AND NEWS.

The Fight Broadcast—The Noise To Come—Germany's Troubles—B.B.C. and Receivers—Radio At School—The Promenade Concerts.

The Fight Broadcast.

I THOUGHT the "running commentary" on the Baldock-Smith massacre stood fairly still most of the time. Whenever there was something really exciting the commentator was too absorbed in it to comment. They do this sort of thing much better in the U.S.A. By the way, did you notice that whenever Smith landed on on Baldock the sound *via* radio was that of an empty box kicked by a mule?

The Noise to Come.

PEOPLE are beginning to express fear that the big electrification schemes of the Government are going to provide a great deal of troublesome noise for radio sets. I do not think much difference will be noticed by the majority of listeners, though it is, of course, true that increased electrification must tend to increase stray pick-ups.

Sunday Times.

ONE feels inclined to say to the B.B.C. "Thanks for nothing" for their plan to begin the Sunday evening concert at 9.5 p.m. instead of at 9.15 p.m. What is a shift of ten minutes, anyway? Now, if the B.B.C. would start on Sunday afternoon at 2.30 p.m., or even 3.0 p.m. and so enable us to have our tea without missing—sometimes—a good item they would probably win general approval.

The Spanish Lessons.

THESE were extraordinarily well done and very popular, but now they are discontinued; the French continues and German has been introduced. This is more than a pity; it is bad management. Hundreds of people are now probably left high and dry through the cessation of the lessons, with a tantalising half-proficiency. A friend of mine who wrote to the B.B.C. in protest was informed that they had done all they thought necessary in that direction—or words to that effect. If the B.B.C. pretends to be an educative body all language lessons should be continuous every year from September till May.

Those Angel Voices.

I BELIEVE that most of us agree that I men's voices come over the ether better than women's. At any rate, in spoken items. Baltimore Station (W B A L) has done some "figgering,"

and finds that during the past two years 82 sopranos and contraltos have appeared before its microphone, and only 60 male singers. But—a big "but"—the regular broadcasting staff of the station contains more men than women, which proves our case. Incidentally, W B A L finds that of "outside" pianists, 59 were women and 39 were men. Men are made for sterner stuff.

stated that up to the middle of this year some 500 "wireless pirates" were convicted every three months. In some instances the penalty is prison, and in all instances the offending set is confiscated. Now we know why radio sets are cheap there. However, in spite of this legal "frightfulness" the number of convicted "pirates" rose in the third quarter of this year to 1,003.



Mr. Ivor Goddard, the first visitor to the Radio Exhibition, being presented with a wireless set.

To Report Progress.

THE gloomy prophets are again confounded. August, the holiday month, showed an increase in licences of 9,437, say 300 per day. The rain was responsible, naturally. Since January 1st an increase of 137,463 has been achieved. In addition to the total number of licences in force at the end of August, namely, 2,315,722, there were 8117 free licences such as are issued to the blind. Altogether, very healthy and, I suppose, a testimonial to the B.B.C.

Germany's Troubles.

THE annual licence fee in Germany is 24 marks, which seems to us to be on the high side. Evidently it appears so also to numerous Germans, for it is

Mr. Heaviside, Forward!

A WRITER to "The Scotsman" has just awoken with wonder in his eyes. He cannot for the life of him think why wireless waves do not go clean off the earth at a tangent, unless the cause is gravitation. What a pity! And they say education is cheap in Scotland! But isn't it enough to make the Heaviside Layer refuse to lay another "atmospheric"?

B.B.C. and Receivers.

SOME time ago I expressed concern about the current rumour that the B.B.C. intended to lay down the law on the subject of receiver design and enter the market, as I feared that it would injure the interests of manufacturers. The

(Continued on next page.)

NOTES AND NEWS.

(Continued from previous page.)

B.B.C. now confesses that such a policy would probably paralyse a great industry, and might be argued as unfair competition. I am flattered by this authoritative confirmation of my judgment. All the same, I do not agree with the B.B.C. when it refers to "the inadequate standard of receiving apparatus." Except for the "junk merchants," the standard this season is fairly high.

First Socialist Station.

WEVD, the result of the Debs Memorial Radio Fund, which begins to operate this month, is the first station to be devoted to Socialist interests, outside, I suppose, those of Russia. It is to be devoted to "the building up of that sympathetic understanding which is so necessary to International peace, and that knowledge of our social and economic organisation which is basic to the creation of domestic tranquillity." Tranquillity? Yes, I think so! What-ho, the strikes!

The "P.W." All-Wave Two.

ANOTHER "bull" scored for a "P.W." set! C. W. H. B. (Purley) writes to say that with this set he has heard a two-way conversation between PCJJ and Radio Malabar (Java), and also between the last-mentioned station and New Amsterdam, an island in the Pacific. He has also picked up 2FC (Sydney, Australia) at strength R8. His aerial is a 50 ft. vertical, a type he recommends for short-wave reception. If that is not good work I should like to know what is.

"Ariel's" Reminders.

TONIGHT at Aberdeen; "The Eve of Trafalgar"; 5GB, Symphony Concert. October 21st, Manchester, "Memories of Trafalgar." London and 5XX, Queen's Hall concert, conducted by Sir Landon Ronald. November 5th, Firework night (all stations). November 11th, Armistice Anniversary. December 31st ends another Christmas holiday for pieceworkers in various industries.

"Wired Wireless" Scores.

"WIRED wireless" is, briefly described, the art of guiding radio waves along wires, the wires generally being used at the same time for telephone or telegraph line transmission. On September 14th there was a bad breakdown in the trunk telephone between Bombay and Poona, but the Bombay Beam station, which was using the same lines for transmitting messages to the wireless station at Kirkee, experienced no trouble whatever as a result of the breakdown, as the "wired wireless" waves jumped the gap. Radio to the rescue, again!

The Second Link.

WE can now telephone to Canada, at the attractive price of £15 for three minutes plus £5 for each extra minute, between 12.30 p.m. and 11.0 p.m. (British time). This service, with the Beam telegraph, ought to assist business enormously, though the price will have to be reduced, and probably will be when the Beam is used instead of Rugby.

Television.

SO Mr. Baird has succeeded in getting a moustache sound across the Atlantic! Come! This is excellent progress. George Robey's eyebrows ought to get over well and look like black rainbows on the television screen. Still, I think that Mr. Baird would impress us more were he to give us a satisfactory television service, and receivers, on this side of the water first. He must walk before he will be able to run.

Telepathy.

DESPITE the poor results of the telepathy tests here and in Australia; and the distinctly dubious views of professional psychologists all over the world, M. Rene Waccolier is reported to have predicted the era of universal telepathic communication, wherein cables and wireless stations will be scrapped. If he really did so I beg leave to doubt that he was serious or even sane. Suppose your man were asleep or under "gas" or playing chess, when you "called" him! The butler could not take the message for him!

Radio at School.

JUST as I have predicted! This absurd B.B.C.-ism, the confusion of schoolkids' minds and the wasting of their time by so-called radio lessons is beginning to show symptoms of collapse. It is, by all I hear, pronounced a washout in Nottingham, where the young 'uns have exhibited bore-

SHORT WAVES.

Visitor: "I suppose your wife listened in when you were broadcasting, Professor?"
Professor: "She did, madam. And for the first time in nearly thirty years I had the pleasure of addressing her without interruption."—"London Opinion."

SHAKESPEARE UP TO DATE.

"When shall we three meet again—in thunder, lightning or in rain?" (Macbeth).
No, for there is too much static then.

"One reason why the habit of attending church by radio is not apt to become popular with certain people," says a keen observer, "is that other people will not be able to see their new hats."—"Radio News."

"Hit by Wireless," runs a headline in the "Nottingham Journal and Express."
This must have been one of the new "super-hit" sets.

First Schoolboy: "My brother has a two-valve set, a five-valve set, and a super-het., as well as several crystal sets."

Second Schoolboy: "Gee, he must be awfully keen on wireless!"
First Schoolboy: "Oh no, he's not; he's got a pawnshop."

Thanks to the deferred terms, they call it radi-owe now.—"Daily Mirror."

AS EASY AS B.B.C.

Middle-aged Listener: "It's wonderful the strides they are making in wireless. Every year they are making the sets simpler and more easy to switch off!"—"Yorkshire Evening Post."

"Moving coil cone type of loud speaker," runs a headline in the "Liverpool Evening Express."

The one next door doesn't show any signs of moving, worse luck!

QUITE AT HOME.

"I like to feel in sympathy with my listeners," declared Professor Borem, in a radio talk. "I like to feel that I am at home, so to speak."
Most listeners heartily wished that he was.

Jim: "Do you know how to eliminate static?"
Bill: "No."

Jim: "Turn off your radio."

dom, the sets have gone "phut," and the acoustics have proved to be fiddlesticks. In my opinion the intrusion of radio into schools is unfair to the scholars, the teachers, and the parents. If the teachers were really keen on their job and had sufficient spirit, they would cut out the radio instanter, or know the reason why not,

The Dempsey Fight.

USING a "Simmonds 10-metre Panel" C. I. (East Finchley) got 2 X A E perfectly. That Simmonds hook-up is a stayer and no mistake! S. T. (Wotton-under-Edge) got it from W G Y on a "P. W." set not described; W. J. B. (London) also heard this show, using Ediswan valves throughout. And J. S. (Bamford) has several good words for the "P. W. Every Purpose Two," on which he gets an inexhaustible number of amateur stations far and near, and received the fight broadcast so excellently that he says he might have been by the ring. These kindly references to "P. W." circuits set all our technical hounds barking, and we have to throw insulators at them.

Our Blue Prints.

HAVING bought for threepence two shillings-worth of blue prints with this week's "P. W.," you may be excited to learn, if you don't know it already, that with last week's number also you get the same, though the prints are different. With these eight prints in hand you have your work cut out for a long time, and some good times with the jolly old dials are in store for you.

Counsels of Perfection.

I WAS interested in Mr. Posner's letter headed "H. F. Leakage" (see p. 298, "P. W.," October 8th), because he has found out the truth of what I have preached and always practised. There is always a "best way" of doing a thing, but very often the difference in the results are scarcely appreciable. It is right to advise people to have clean surfaces and soldered joints for radio work, but the idea need not be carried out too religiously unless you are dealing with weak signals, when every little counts. For DX work reduce your losses as much as possible, but for ordinary broadcast reception on a loud speaker, don't worry.

The Promenade Concerts.

ORDINARY well-balanced people—the salt of the earth—thought the B.B.C. Promenade Concerts at the Queen's Hall pretty good. But if a certain writer in "The Outlook" counts at all, his remarks must cause the B.B.C. to despair. Hark! "the concerts were most unsatisfactory and . . . the critical standard of the listeners had deteriorated."

B-hosh!

THE orchestral playing was ragged and unbalanced, and the tone of the violins . . . was thinner than ever." Also, "The B.B.C. took over the 'promenades' with many high-sounding declarations of its sense of musical duty. That duty has not been fulfilled." I don't agree. That's putting it mildly.

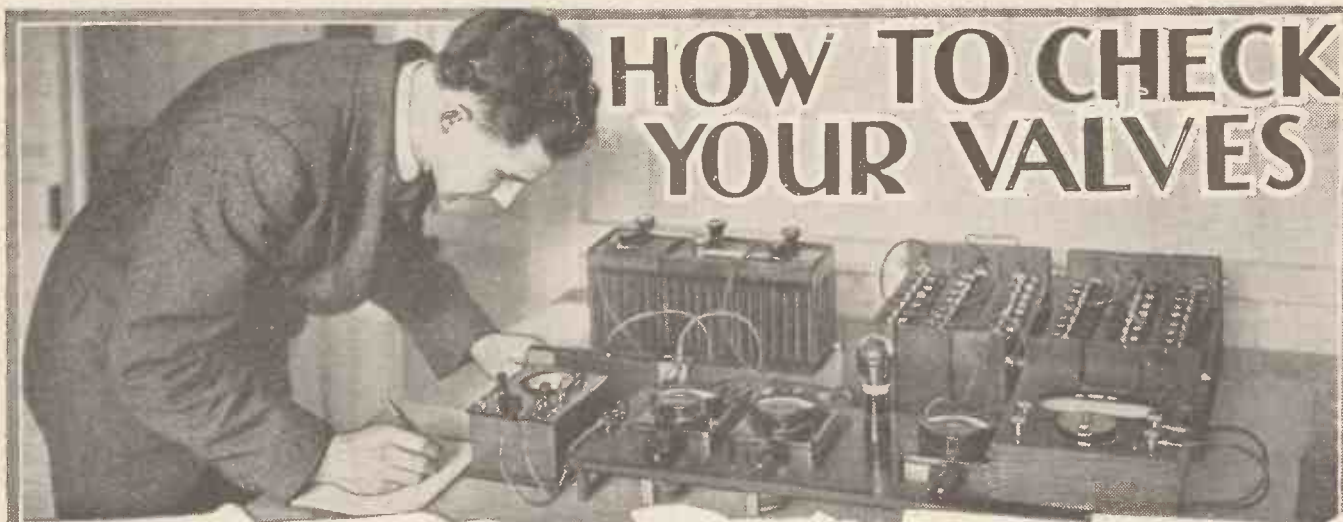

HOW TO CHECK YOUR VALVES

THE operation of a valve receiver depends very largely on the characteristics of the individual valves used. Particularly is this true with modern receivers which are often designed to use valves having definite characteristics in each stage. Even the simplest of sets usually has two or more different types for the best results; while a four or five-valve set employing high-frequency amplification is almost bound to need specially selected types of

"Valves of a type vary a good deal amongst themselves, and in course of time their characteristics tend to change. . . ." This may be a truism, but many readers will find that there are several truisms in connection with their valves which they have overlooked, but which are clearly indicated in this important article

By W. JAMES.

through the filament of the valve. If the current is much below normal the impedance will be high; in fact, a very convenient way of varying the impedance of the valve is by altering the filament current, using a rheostat for the purpose.

We can measure these things very easily and at no great expense. The apparatus illustrated here is a valve-testing board, and is the one used by the writer for many of his measurements. It has more instruments perhaps than the average user will find really necessary. For instance, an ammeter is included to measure the filament current, a voltmeter for the grid bias, a second voltmeter for the anode voltage, a milliammeter for the anode current, and a microammeter to indicate grid current; but it really is a most valuable piece of apparatus.

Apparatus Required.

The connections of the valve-testing board are given in Fig. 1, which also shows the batteries connected. In series with the filament is the filament ammeter A_1 and a rheostat R_1 ; we therefore have complete control of the filament current. In the anode circuit is the anode battery and a potentiometer for providing a fine adjustment of anode voltage as measured by voltmeter V_1 , while milliammeter A_2 measures the anode current.

The grid circuit is also provided with a voltmeter V_2 and a microammeter A_3 , means

(Continued on next page.)

to the maker's specification. He knows that variations affect performance.

In this respect it has to be admitted that very few valves have characteristics identical with those quoted by the makers. Further, the makers are usually rather optimistic as to the performance of their products, for we find that they almost invariably give us the characteristics under the most favourable conditions, as distinct from normal operating conditions. For if we measure the amplification factor and impedance with an anode voltage of say 120 at zero grid bias, we are bound to get a much lower impedance than when we take the characteristics with a grid bias of negative six or nine which may be the usual operating voltage.

A Simple Tester.

Another factor which decides to a large extent its properties is the current passing

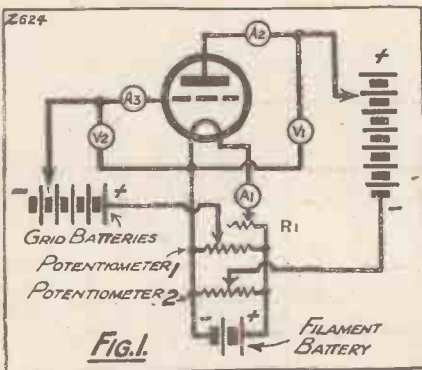

valves, for the characteristics of those used in the high-frequency stages very materially affects selectivity and magnification.

Valves of a type vary a good deal amongst themselves, and in the course of time their characteristics tend to change. Too much or too little grid bias, or anode voltage, or insufficient filament current, all have effect on the valve's characteristics.

Valve Characteristics.

You will understand what is meant by the term characteristic, for in every valve box is a slip giving details of the more important of the valve's characteristics. We are usually told its amplification factor, its impedance, the maximum anode voltage which can be used, and sometimes approximate grid bias values; and a set of curves for an average specimen is usually given. The information provided is usually tolerably complete as regards the average user, who merely purchases a valve and plugs it into his receiver, but the user with an inquiring mind wishes to know how nearly the valve which he has purchased comes up

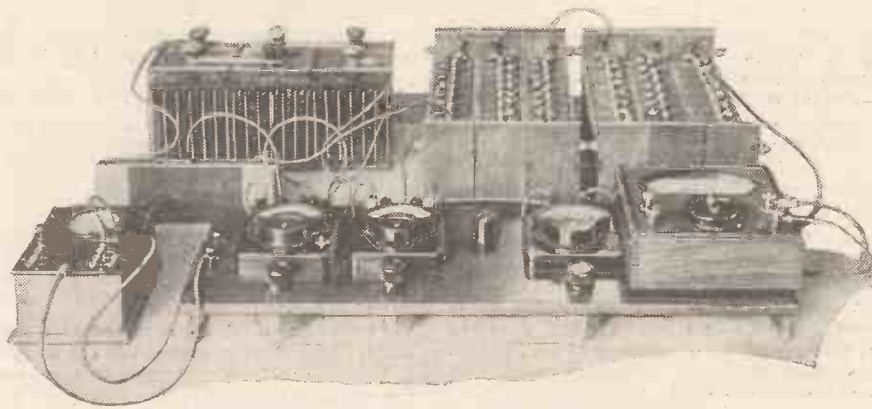

The apparatus used by Mr. James in the tests described in this article.

HOW TO CHECK YOUR VALVES.

(Continued from previous page.)

for critically adjusting the grid bias being provided by a second potentiometer joined across the filament battery.

The parts are conveniently arranged as shown in the photographs and the diagram

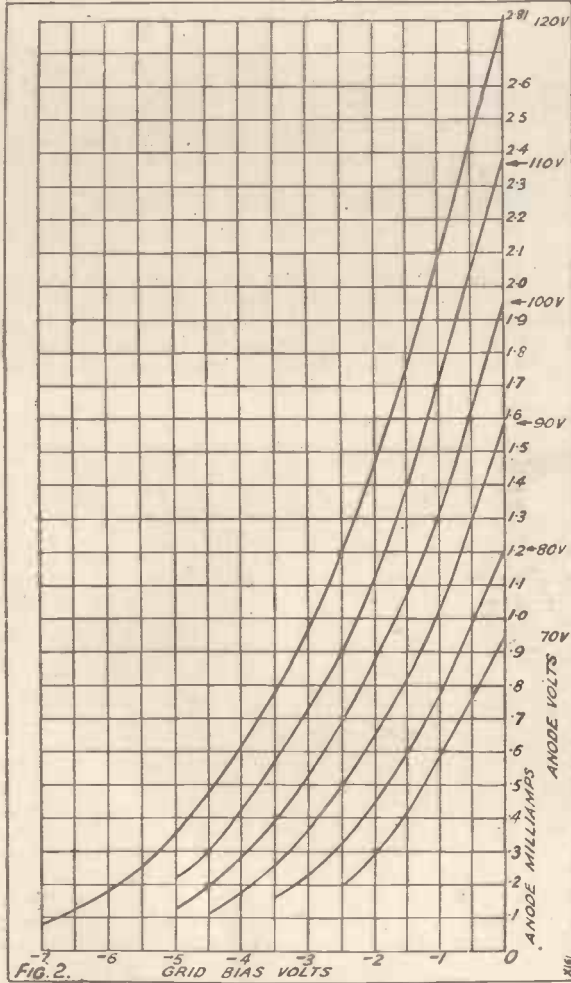

Fig. 4. None of the measuring instruments is fastened to the baseboard, but the wires which connect the instruments are brought from below through holes in the instrument board and finished off with spade ends.

There is nothing elaborate or difficult in the construction. The board measures 28 in. by 9 in. by 1/2 in., and is fitted with two American Hard Rubber Co.'s brackets—one at each end. The terminals, valve holder, 30-ohms rheostat, and two 300-ohms potentiometers (Igranic Electric Co.), are fastened to the baseboard in the manner shown, special care being taken with the grid terminals for the grid microammeter, which are insulated.

Under-Baseboard Wiring.

Connections are made below the baseboard, lengths of rubber-covered stranded wire being used for the battery and instrument connections.

We now come to the instruments. Those actually used by the writer are rather ex-

pensive, the two voltmeters and filament ammeter, made by the Weston Electrical Co., costing £5 5s. each. The milliammeter is by Cambridge & Paul (pattern L), and costs about £9 10s.; while the microammeter used is a cheaper instrument, costing about £5. The reader can, however, purchase quite reliable meters for much less than this, and he need not use a microammeter or a filament ammeter.

Not Expensive.

It is naturally essential to use a good anode circuit milliammeter, but no doubt in cases of necessity one reliable two-range voltmeter could be employed to measure filament, grid, and anode volts. It is therefore essential to have two instruments which, however, with all the other parts, need not cost more than £5. The writer is of course obliged to use high-class instruments in his laboratory work. A word of warning is necessary here, though, and it is this—that it is dangerous to measure the grid bias when small, dry cells are used and then to remove the voltmeter and connect it, say, to the anode circuit, for the removal of the load provided by the voltmeter is almost bound to cause the grid bias to increase slowly.

Let us now proceed to check the figures and curves given by the makers. The first thing you will see on the valve data slip included with the valve in its box is its filament voltage and current. This can be checked if thought necessary, but it is not of much importance. The next thing you will notice is a statement as to the valve's amplification factor and impedance, with details of anode voltage and usually of grid bias. You will also notice the nice characteristic curves labelled with the appropriate anode voltages.

What shall we do next then? Is it necessary to obtain data for the check curves or can we measure the other factors without going to this trouble? We can do either. Drawing curves is quite a nice pastime, and is remarkably easy.

Put a valve in the holder, adjust the filament current to the specified value, connect the grid battery and set the anode voltage to, say, 120. All you have to do now is to measure the anode current for grid voltages of from zero to such a negative voltage that the

anode current is reduced practically to zero.

Readings can be taken for every half volt grid bias, the grid potentiometer being carefully adjusted. A set of readings such as these will be obtainable:

Anode Voltage	Grid Bias Volts	Anode Current, ma.	Anode Voltage	Grid Bias Volts	Anode Current, ma.
120	-0.0	2.81	110	-0.0	2.36
"	-0.5	2.44	"	-0.5	2.1
"	-1.0	2.1	"	-1.0	1.69
"	-1.5	1.75	"	-1.5	1.4
"	-2.0	1.49	"	-2.0	1.12
"	-2.5	1.2	"	-2.5	0.9
"	-3.0	0.96	"	-3.0	0.74
"	-3.5	0.78	"	-3.5	0.58
"	-4.0	0.62	"	-4.0	0.42
"	-4.5	0.48	"	-4.5	0.3
"	-5.0	0.34	"	-5.0	0.22
"	-5.5	0.26			
"	-6.0	0.18			
"	-7.0	0.08			

Alter the anode voltage to 110 and take a further set of readings as before. Now take a sheet of squared paper, mark it off as indicated in Fig. 2, to show the anode current and grid bias; then mark off the points as shown, and draw curves through

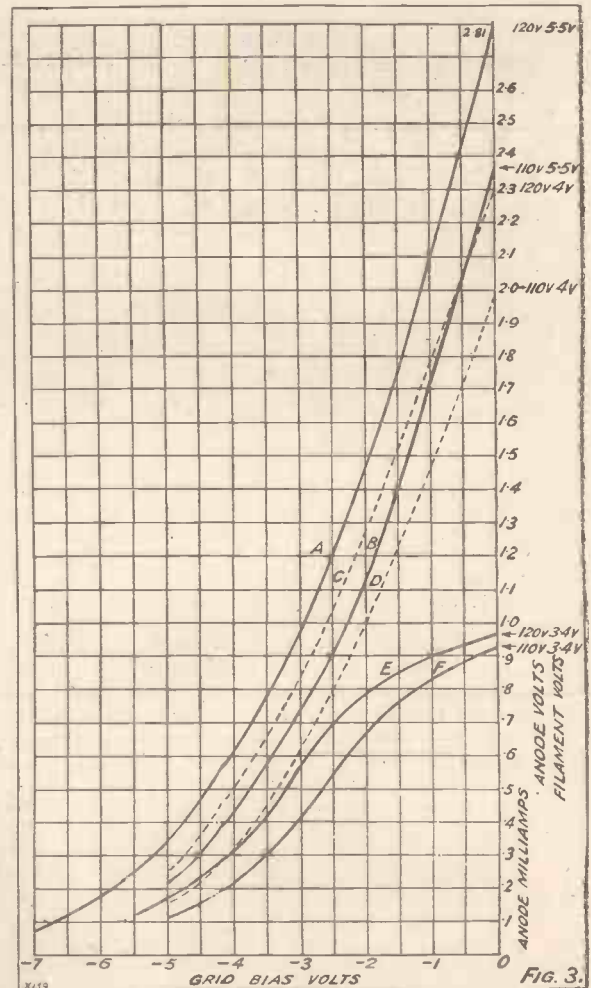

Fig. 3.

these points. In Fig. 2 the points are marked for the guidance of the reader.

The writer actually took further sets of figures and drew curves as shown.

(Continued on next page.)

HOW TO CHECK YOUR VALVES.

(Continued from previous page.)

You will now want to find the valve's amplification factor and impedance. This seems a mysterious operation to some people but really it is quite an easy matter. Let us find the impedance when the anode voltage is 110 to 120 and the grid bias is about -1.5.

Impedance and Amplification.

At 120 volts and -1.5 volts the current is 1.75 milliamperes, while at 110 volts and -1.5 volts the current is 1.4. We see from these figures that by changing the anode voltage by 10 the anode current has changed 0.35 milliampere. Therefore, the valve's impedance is

$$\left(\frac{\text{Volts}}{\text{Amperes}} \right) \frac{10 \times 1,000}{0.35} = 28,500 \text{ ohms.}$$

To find the amplification factor we leave the anode voltage as it is at 110 volts, and merely alter the grid bias to bring the anode current back to 1.75 milliamperes. In the example we have an anode current of 1.4 milliamperes, 110 anode volts and

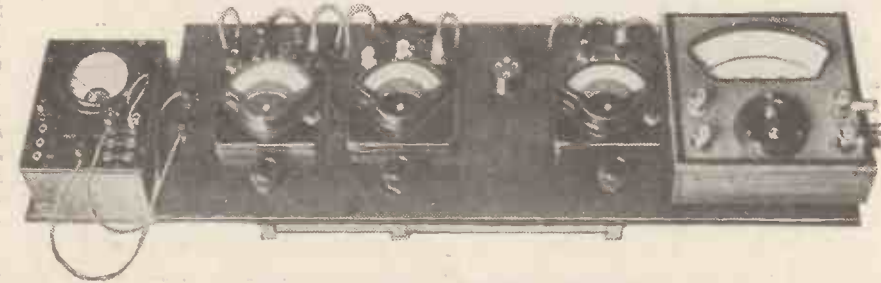

The special valve-testing panel employed by the author.

-1.5 volts grid bias. We, therefore, have to shift the grid bias from -1.5 to 0.95 volts, whence the amplification factor is $\frac{10}{0.55} = 18.2$.

Further figures were taken by the writer at -3 grid volts and the impedance found to be 45,500 ohms for an amplification factor of 16.7. You will be able to check these results from the curves.

These figures are really by way of explanation. What everybody would like to know is what happens when we alter the valve's operating conditions. If we reduce the anode voltage, increase the grid bias or lower the filament current, how do these things affect the impedance and amplification factor and shape of the curves? Suppose we find out one thing at a time. Let us increase the grid bias to -4.5. You will see by working it out as described above that the impedance has increased to 55,600 ohms, while the amplification factor has fallen to 14.3. Tabulating the figures we have:

Anode Voltage	Grid bias volts.	Impedance ohms.	Amplification factor.
120	-1.5	28,500	18.2
120	-3.0	45,500	16.7
120	-4.5	55,600	14.3

Thus, if for a given anode voltage we make the grid more negative, we increase the

valve's impedance by quite a large amount, and reduce the amplification factor.

This is quite likely to happen if you adjust the grid bias haphazardly, and you see what the result will be. You lose amplification, and in the case of a low-frequency amplifier, you will undoubtedly lose some of the high

other hand the selectivity will be better. Variation of grid bias can therefore be used as a volume control, making the grid more negative, increasing the valve's impedance, and lowering the amplification.

Our next question concerns the anode voltage used. What happens to the im-

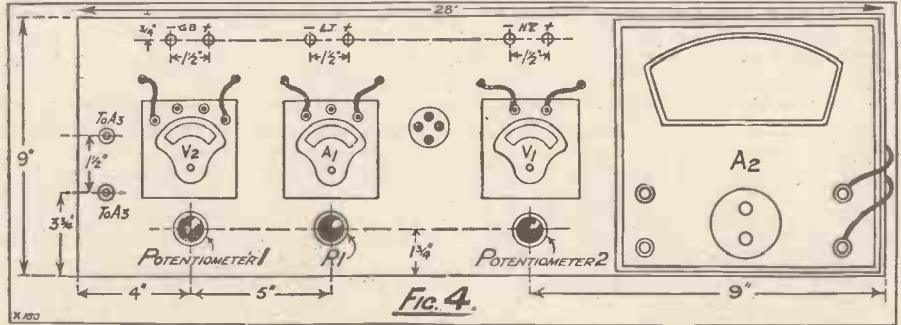

and low notes if transformer coupling is used.

The figures show conclusively that it is far better to work with a grid bias of -1.5—which, in the majority of instances, is all that is required, as the valve is an amplifying valve, and not a power valve.

This brings us to a further point. In which position can a valve be used? We

pedance and amplification factor when we reduce the anode voltage, it being understood of course that the grid bias is fixed at, say, -1.5 volts and the filament heating current is at a normal value? You can obtain the values for the different anode voltages by the methods given above, which come out as follows:

Anode voltage.	Grid Bias.	Impedance.	Amplification Factor.
120	-1.5	28,500	18.2
110	-1.5	31,300	15.4
100	-1.5	38,500	16.7
90	-1.5	45,500	16.7
80	-1.5	50,000	18.2
70	-1.5	55,600	18.2

The results show quite conclusively that for a fixed grid bias the effect of reducing the anode voltage is to increase the impedance.

Effect of Anode Voltage.

Many experimenters "try" different anode voltages—how many know what they are really doing? They are altering the impedance of the valve, and here a further practical point emerges. Your high-frequency stage oscillates. You stop it oscillating by cutting down its anode voltage. Why? Because this increases the valve's impedance, which in turn reduces the amount of high-frequency amplification to a point which the circuit will stand without oscillating. Then, someone asks, why not control oscillation by a variable resistance connected in series with the H.T. supply to the high-frequency amplifying valve, so as to vary the voltage applied to the anode. It has been done, and in fact the method is used in certain commercial receivers, but as the scheme works

(Continued on page 428.)

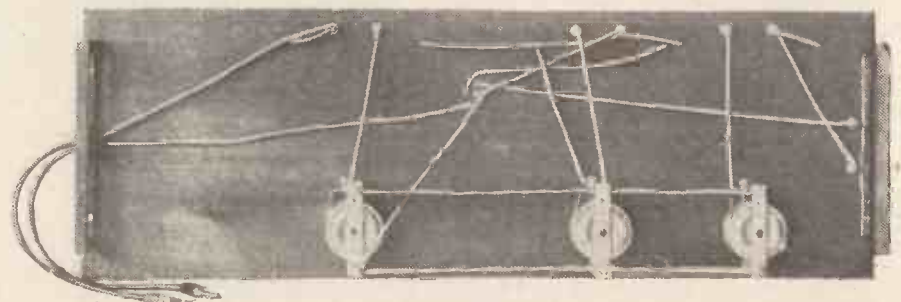

The wiring of the valve-testing panel.

THE WASHINGTON CONFERENCE.

How some outstanding radio problems are being dealt with by representatives of all nations at Washington, D.C.

By THE EDITOR.

THE International Radiotelegraph Conference, which was opened by President Coolidge at Washington on October 4th, is dealing (as these words are written) with a variety of radio problems, some of which may have far-reaching effects on the conduct of broadcasting in Great Britain

the work has indeed been multiplied many times since 1912.

A good deal of the work handled by the Conference is not of any immediate interest to amateurs, but there are items on the agenda which do most emphatically concern the amateur, and also the many

hundreds and thousands of people who are now generally termed "listeners."

The question of regulations with regard to the use of short waves will, for example, have a wide interest for the amateur.

At the last Conference, in 1912, waves below 200 metres were not regarded with any seriousness: to-day they are extremely important. Beam stations, amateur stations, and, we hope, an increasing number of short-wave broadcasting stations, have

loomed up large on the horizon since 1912.

It is proposed at Washington to confine the use of short waves almost entirely to long-distance work between fixed points. Great Britain proposes, also, that the rule "One wave-length only" shall not be regarded as definite in view of the variable force of strength of signals on the short waves when used over great distances.

Great Britain suggests the use of two alternative waves as a limit for each short-wave transmitting station, in order to allow for the use of one or the other under different working conditions.

Great Britain also proposes, in addition to a general provision limiting the use of damped waves by ships to those of 600 and 800 metres, and other provisions limiting the power to be used in connection with these waves, that all ships which are compulsorily equipped shall fit apparatus enabling them to receive continuous waves of any length between 500 and 20,000 metres. Britain also proposes certain provisions in connection with the automatic alarm signal which has recently been developed.

The Amateur's Status.

This alarm signal is intended to be used in conjunction with the SOS signal, and is intended to dispense with the heavy expense which is incurred in keeping continuous wireless watch on board cargo ships.

Amateurs will be glad to hear that the scope of the experimenter and the amateur transmitter is not likely to be restricted. The American Radio Relay League will certainly hold up its end in that quarter!

The amateur, in fact, has improved in status very considerably since 1912, and the authorities now realise that the radio amateur is by no means the unimportant dabbler, as he decidedly was once regarded. It is early yet to forecast the full results of this Conference at Washington, but we hope its labours will be successful, and that its decisions will be acted upon by the governments concerned with greater celerity and conscientiousness than has been the case in connection with some of the broadcasting wave-length conferences of the Union de Radiotelephonie of Geneva.



Transmitting and receiving apparatus fixed to the dashboard of a motor car during recent transmitting and D.F. tests carried out in France.

and Europe, and upon the status and scope of the amateur experimenter.

It is a conference, in fact, fraught with great responsibilities and important decisions. Little has been said about it in the daily Press, and beyond the fact that Captain Eckersley has gone to Washington to represent the B.B.C. and the Union de Radiophonie at the International Radiotelegraph Conference, the average amateur is not much the wiser.

Although this article is being penned only a few days after the official opening of the Conference, it is more than likely that the delegates at Washington will still be hard at it when this issue is on sale. Is on sale!—at least six weeks work lies before the delegates as I write, for they have no less than 1,800 items included in the agenda!

Multitude of New Problems.

The Conference last met in London—in 1912—and the regulations then agreed upon were almost completely confined to wireless telegraphy as employed for communication between ship and shore stations.

But this year's Washington Conference will not only have to deal with new problems in connection with ship and shore communication, but with the multitude of new problems which have arisen since the inception of broadcasting and the rapid growth of the amateur transmitting movement.

Problems in connection with regulations governing radio communication between ships, land stations, aircraft, trains, amateurs, broadcasting stations, short-wave stations for commerce and broadcasting—

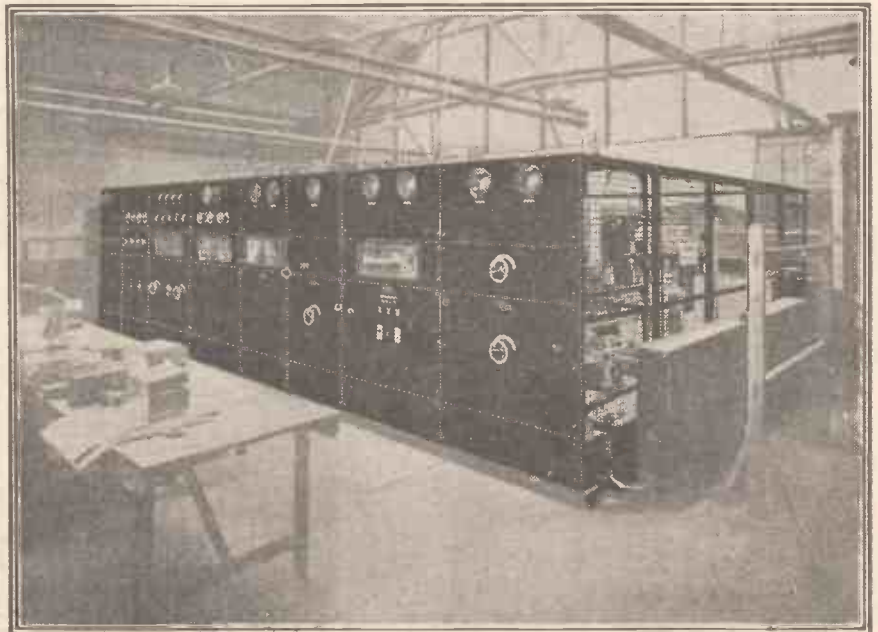

A Standard broadcasting equipment (15 kilowatts) undergoing preliminary tests.

Have you bought your copy of
MODERN WIRELESS?

October No. On Sale Everywhere, Price 1/-



Designed and Built in the "P.W." Research Department.

ONE of the most difficult problems which must be overcome in getting out a design for a set which is likely to be built by a large number of people is that of making it reasonably universal in its applications. Such a set will be used in all sorts of conditions, with wide differences in the quality of the accessories, and the problem is so to arrange the receiver that adjustments can be made to enable it to give good results notwithstanding.

Great pains have been taken in producing the "Universal" Three to make it as adaptable as possible. We shall see how this has been done when we come to examine the details of the receiver, but first it may be as well to give a general idea of the purpose of the set, and the results to be expected. The "Universal" Three is intended for the man who has outgrown the stage at which he demanded the biggest possible noise from his loud speaker, caring little for quality, and who has come to realize that to continue to get pleasure from broadcasting he must be able to obtain signals of moderate volume but of the greatest possible quality of reproduction.

Quality Reproduction.

The set is definitely a "local" one, since most of its special features are designed simply and solely to enable the most pleasing kind of reproduction to be obtained, and no attempt has been made to make it capable of picking up large numbers of distant stations on the loud speaker, since to do this without H.F. stages usually involves some sacrifice of quality. The main purpose of the "Universal" Three, then, is to give very good quality within the radius of 20 miles or so which is usually taken as being the boundary of the "local" area round each station, and naturally up to much greater distances from Daventry. The set is also capable, as a matter of fact, of picking up quite a number of Continental stations, and even putting them on the loud speaker when conditions are favourable, but this is not a feature of the instrument, for which no claims are made for wonderful "DX" results.

The circuit is a very straightforward

A three-stage local receiver with provision for the use of two valves in parallel in the last stage. It is specially designed to give high quality of reproduction with a great variety of valves, and to suit all sorts of aerials. A fine blue print of this set is given free with this issue.

arrangement of a detector with reaction and two L.F.

Starting at the beginning, it will be noted that the circuits of the detector valve have been carefully arranged to permit a wide variety of values to be used, and also to allow for the effects of different sizes of aerial. The circuit actually used is a version of the popular Reinartz scheme, arranged for plug-in coils, the "aperiodic aerial" circuit being planned to accommodate all sorts and sizes of aerials. The main adjustment here is of the size of the primary coil, which will be about a No. 25 or 35 for a fairly large aerial, and a No. 40 or even 50 for a small one. This adjustment also affects the selectivity of the set, smaller primary sizes making it easier to cut out the local and get 5 G B.

The secondary coil (the middle one of the three) forms the tuned circuit and will be a No. 60 (unless your local station works on a wave over 400 metres, when slightly better results may be got with a No. 75). The reaction coil can be varied in size to suit the particular detector valve in use. The usual size will be 50 or 75, but it is best to try various coils here until you find one which gives a smooth control of reaction.

Long-distance Reception.

You will then be able to get just the necessary small amount of reaction which strengthens signals without spoiling their quality. This is chiefly of importance at the longer distances; close up to the local station no reaction will be needed to get adequate strength, and the reaction coil can be left out of its socket altogether. Before leaving the detector circuits, it should be pointed out that if the aerial lead is connected to terminal A₁ instead of A₂ it will give slightly greater selectivity, which will be in favour of 5 G B. A size larger coil will usually be desirable in the

(Continued on next page.)

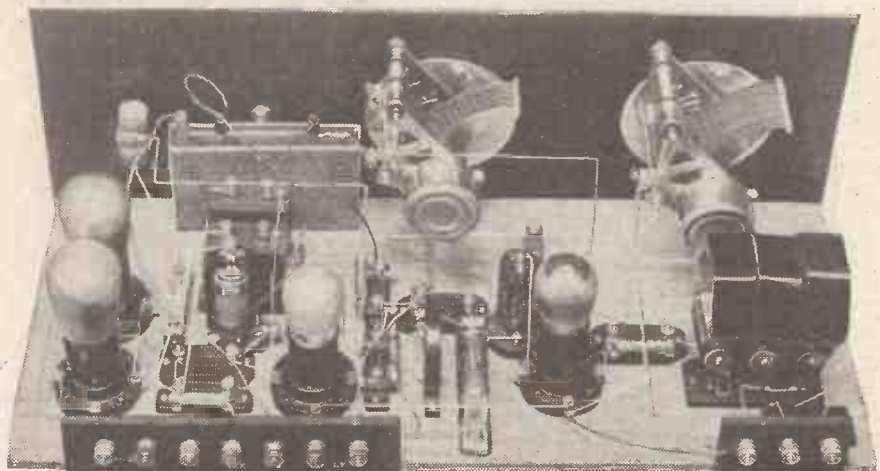

The grid-bias battery stands behind the panel. The flex lead between the filament circuit and earth was used for test purposes. A permanent connection is shown on the wiring diagram, and this should be followed.

THE P.W. BLUE PRINT No. 35-6d.

The "Universal Three."

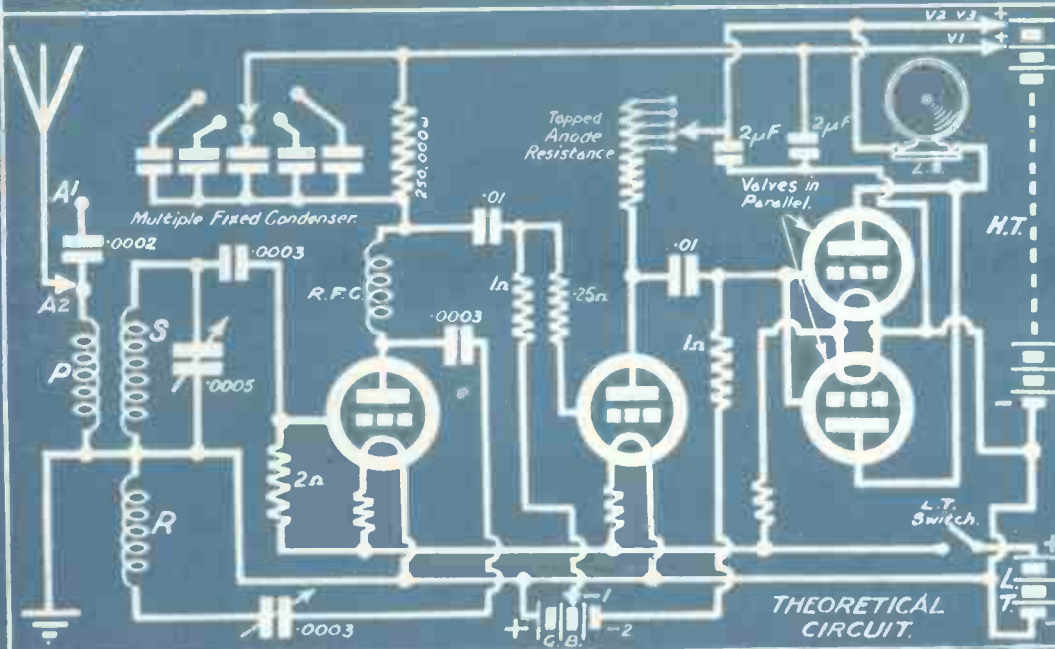
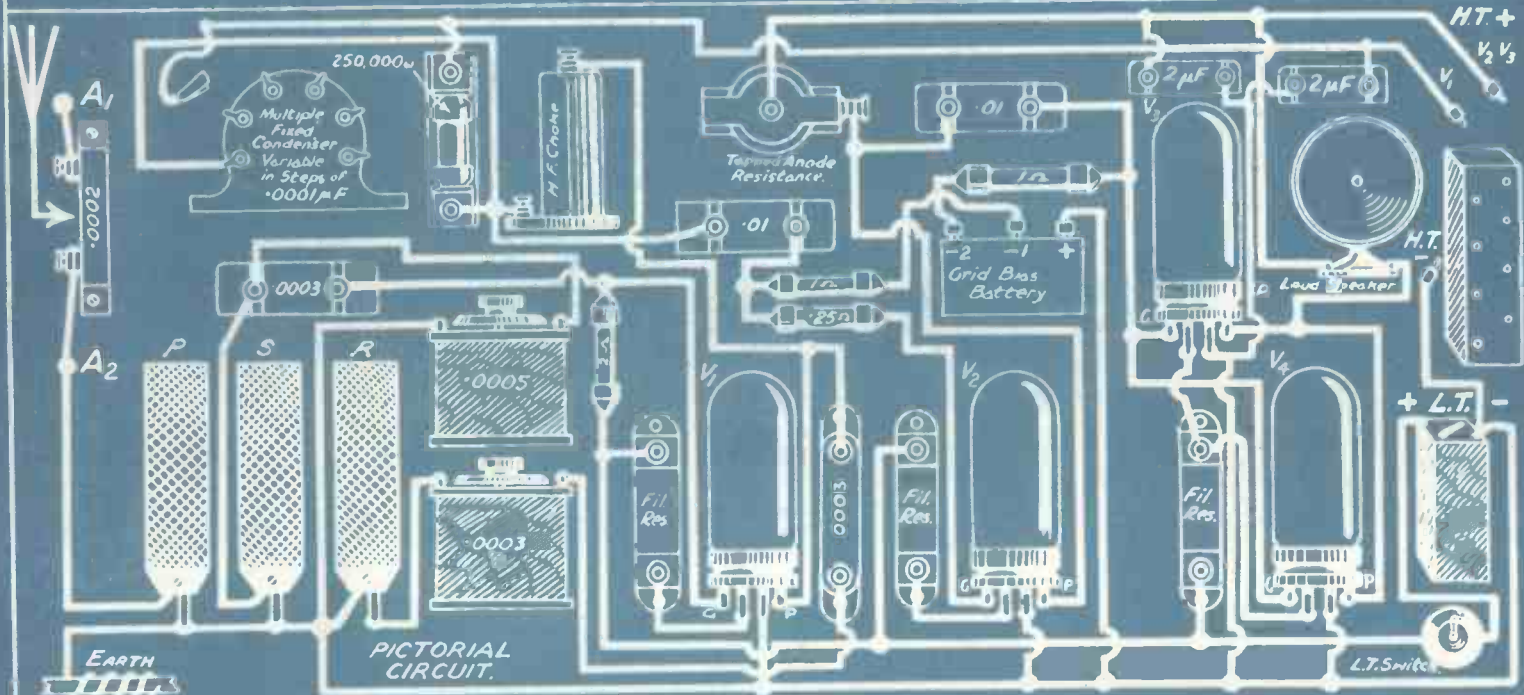

LIST OF COMPONENTS.

- 1 Panel, 21 in. x 7 in. x 1/4 in.
- 1 American type cabinet, baseboard 9 in. deep.
- 1 .0005 mfd. variable condenser, with slow-motion or vernier dial.
- 1 .0003 mfd. ditto.
- 1 On-off switch.
- 3 Baseboard-mounting single coil sockets.
- 4 Spring valve sockets.
- 3 Baseboard filament resistances.
- 1 Anode resistance, 250,000 ohms, and base.
- 1 Multiple fixed condenser, .0001-.0015 mfd.
- 1 Tapped anode resistance, maximum 480,000 ohms, with holder. (R.I. Varley).
- 1 .25 meg. grid leak and holder.
- 2 1 meg. grid leaks and holders.
- 2 2 meg. grid leak.
- 1 .0003 mfd. fixed condenser with clips for grid leak. (One clip to be of the insulating type; alternatively a separate grid-leak holder could be used.)
- 2 .01 mfd. fixed condensers.
- 1 .0003 mfd. fixed condenser.
- 1 .0002 ditto.
- 2 2 mfd. Mansbridge condensers.
- 1 H.F. choke.
- 10 Terminals.
- 2 Terminal strips, (1 3 x 2 in. and 1 8 x 2 in.)
- 1 Tapping clip, flex, 3 plugs for G.B. battery.
- Wire, screws, etc.

ACCESSORIES.

- 2 H.F. or R.C. type valves.
- 1 or 2 L.F. or power valves.
- H.T., L.T. and G.B. batteries to suit valves.
- Loud speaker.
- Coils Nos. 25, 35, 50, 60 or 75, 100, 150, 250.

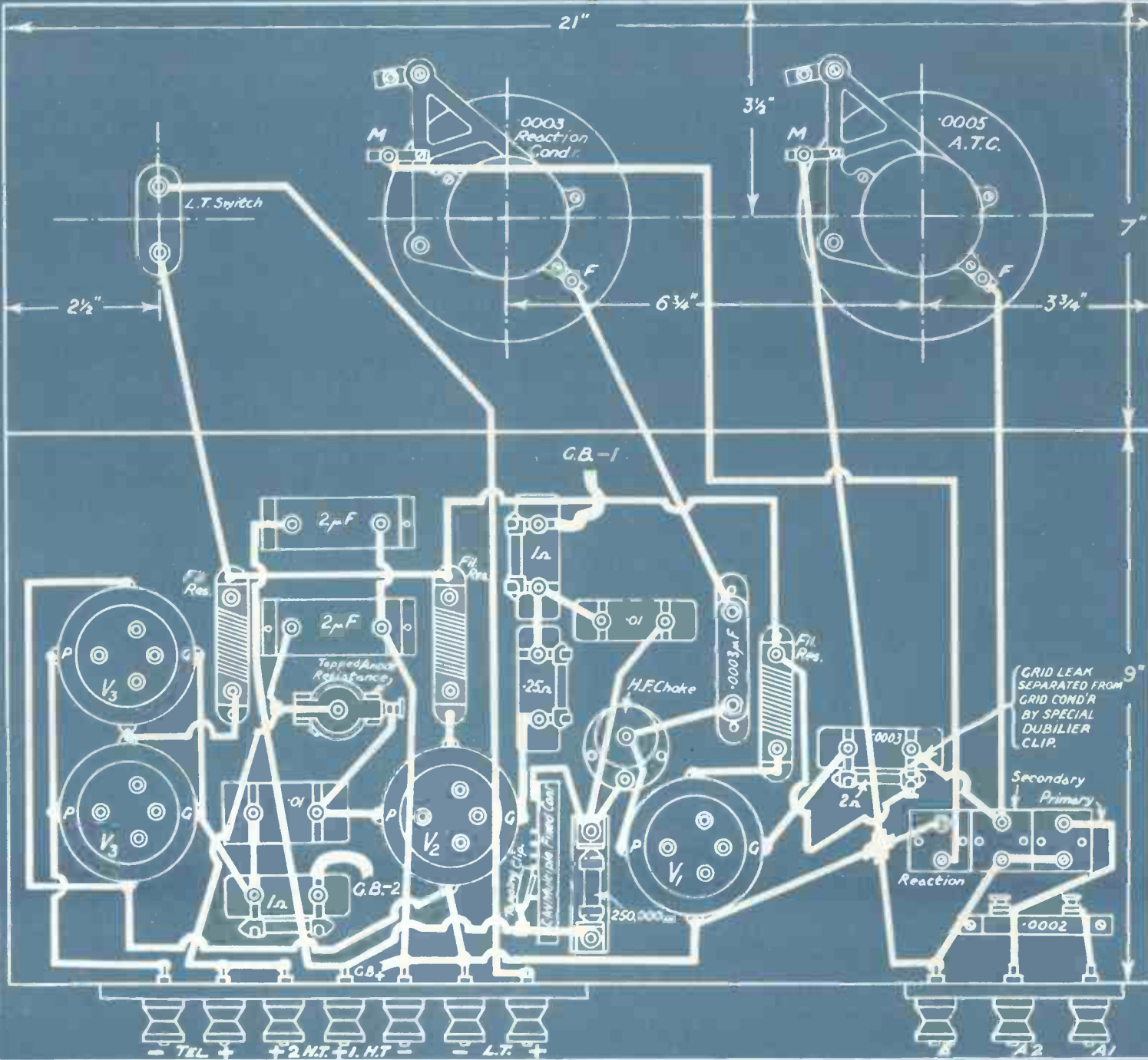

DRAWN BY *W.D.*
 CHKD BY *R.K.B.*
 SER. NO *BP14*

The "P.W." Blue Print No. 35.—Detector and two resistance-coupled L.F. stages, with provision for the use of 2 valves in parallel in the last stage. A great variety of valve types can thus be used, even when signals are strong. Tone of reproduction can be altered by varying tapping clip on multiple condenser. Different valves can be suited by varying the tapped anode resistance. Usual coil sizes: Primary, No. 25 or 35; secondary, 60 or 75; reaction, 50 or 75 (B.B.C. waves), and primary, 100 or 150; secondary, 250; reaction, 100 or 150 (Daventry range). Reverse reaction leads if set will not oscillate.

THE "UNIVERSAL" THREE.

(Continued from previous page.)

primary socket when the series condenser is in use in this way, otherwise the increase in selectivity will be at the expense of too serious a loss of strength. The coil sizes given are those for the ordinary B.B.C. waves; for the Daventry range, see the sizes given on the blue print accompanying this issue.

Turning now to the L.F. side of the set the first point to be noted is that there is a fixed condenser giving a range of capacities from .0001 mfd. upwards (the higher values will not be used) which can be shunted across the first anode resistance; a clip being provided to enable different values to be brought into use. This device is intended to provide a means of controlling the tone of the reproduction to compensate to some extent for one of the defects common in certain types of loud speaker. The effect of the condenser is to reduce the amplification of the higher notes, the larger the capacity the greater being the effect. This adjustment is quite useful when the only loud speaker available tends to give a high-pitched and even "tinny" sound. The capacity required to modify the tone will not usually exceed .0005 mfd., but larger values can be obtained by joining two terminals together on the condenser as per the instructions which will be found in the packing (this component is of C.A.V. make).

L.F. Refinements.

In series with the lead to the grid of the first L.F. valve (V_2) there is a quarter megohm leak, and this serves the important purpose of helping to keep H.F. currents from getting into the L.F. circuits. Coupling the second valve to the next stage is a tapped anode resistance, the intention being to vary this to suit the particular valve in use in the second socket (V_3). This component is one of the R.L. Varley tapped type, which gives a variation of resistance by simply turning it in its mounting.

In the last stage provision is made for the use of two valves in parallel, this

arrangement being intended to permit the use of a much greater variety of valves. By using two in parallel, of course, it is possible to obtain an output strength which could only be handled properly by a super-power type if a single valve were used in the last stage. This feature is specially useful when 2-volt valves are employed, because the average 2-volt power valve will not as a rule handle strong signals without

amount permitted by the valve maker's instructions. A little care here is very essential if you want the best results, and values of about $1\frac{1}{2}$ to $4\frac{1}{2}$ volts on G.B.-1, and from about 6 volts upwards (according to the valves) on G.B.-2, are given as a general guide.

At this point it should be pointed out that in order to allow as much of the H.T. voltage as possible to get through to the



The panel lay-out is pleasingly simple. The small object between the right hand condenser and the on-off switch is a bushed "window" intended to enable the operator to see whether the valves light. Since so many modern valves give little glow this is to be regarded as an optional fitting, and is therefore not marked on the diagrams.

overloading. Of course, if a good super-power valve is available it can be placed in either socket and the other left empty. On the other hand, if your H.T. supply will deliver sufficient current to feed two super-power valves, by all means use them, but this is scarcely a proposition for either dry batteries or the smaller sizes of H.T. accumulators, and really calls for a supply from the mains.

As regards valves for the other sockets, two of the special R.C. type will give the loudest signals, but at a pinch H.F. types can be used, with slightly reduced amplification. It will be seen that a very wide choice of valves is available for this set, special pains having been taken to achieve this end.

The H.T. voltages should naturally be high for good quality, as they should be in any set for loud-speaker work. One hundred volts is really the minimum, and even more is desirable. Grid bias will, naturally, depend on the H.T. and the valves used, but a point should be made of using the full

valve or valves in the last stage, it is desirable to use an output filter for the loud speaker, with a really good low-resistance choke (say, not more than 300 ohms). This is specially desirable when two valves are worked in parallel.

The Components.

A few final points about components: in a set of this type it is very important to use anode resistances, leaks and fixed condensers of good make in order that dependable insulation and reasonably accurate values may be assured. In the original set these components were partly Mullard, Lissen, Dubilier, and T.C.C., as may be gathered from the photos.

The variable condensers can naturally be of any good make (the original set used Ediswan), but the slow-motion type, or the plain variety with the addition of vernier dials, are strongly advised, if the set is to be used more than about ten miles from the local station. At greater distances the tuning of any set which does not incorporate an H.F. stage becomes fairly sharp when a modern moderately-selective circuit is used, and hence slow-motion controls are a great convenience.

During some of the tests on this set valves were used giving a fair amount of light when working, which explains why a small valve window was fitted on the panel between the on-off switch and the reaction condenser. This was simply a small brass bushing, which was originally the centre bearing of a switch, and came from the junk-box. Most modern valves, of course, give very little light when working, and a window is useless, consequently the position for this is not shown on the panel diagram; most constructors will probably prefer to omit it.

The placing of the three coil sockets calls for a little attention when the various components are being screwed in place on the baseboard: the object at which to aim is to place these at such a distance apart that the particular coils to be used

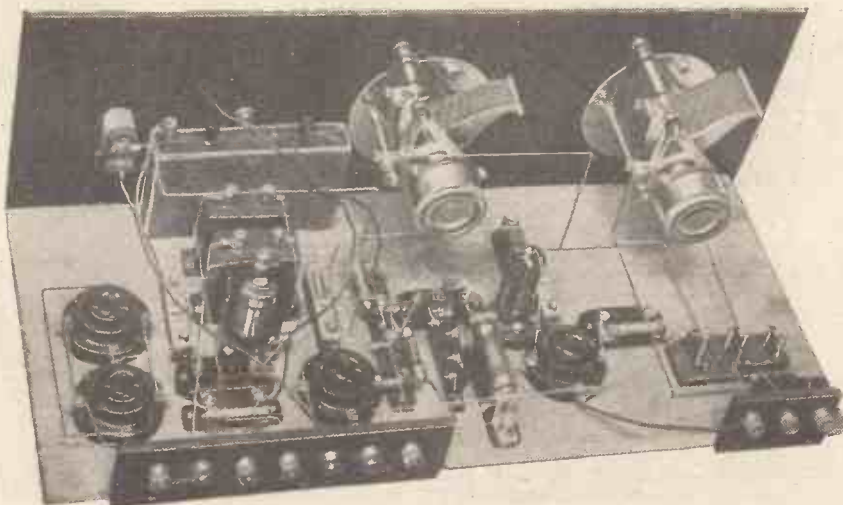

The lay-out lends itself to neat direct wiring, and no difficulty should be experienced in making a workmanlike job.

(Continued on next page.)

THE "UNIVERSAL" THREE.

(Continued from previous page.)

shall be placed closely side by side when they are inserted in the sockets. A suitable spacing is shown on the wiring diagram for the majority of coils, but if the coils you intend to use are wider than the average it may be as well to experiment

a little to find the correct spacing. Take the three sockets, place a coil in each, and stand them upright and side by side, almost touching. A ruler will then enable you to measure off the correct separation. This is a small point, but it is well to pay due attention to it, since close coupling is very desirable here.

Finally, a few practical hints: don't expect good quality if you have to use a great deal of reaction. Plenty of H.T. is necessary for quality and volume. Care in adjusting grid bias is always well repaid.

POINT-TO-POINT CONNECTIONS.

One filament socket of each of the valve holders, V_1 and V_2 , to one side of each of their respective rheostats.

One filament socket of each of the valve holders marked V_3 joined together and to one side of the third rheostat.

L.T. + terminal to one side of the L.T. switch.

Other side of this switch to the remaining sides of the rheostats.

H.T. — to the L.T. — terminal, to G.B. + via a flexible lead, to one tag of each of the 2 mfd. Mansbridge condensers, to the remaining filament sockets of the valve holders, to the socket of the reaction coil holder, to the earth terminal, to the plugs of both the primary and secondary aerial coil holders and to the moving vanes of the .0005 mfd. A.T.C.

Fixed vanes of same condenser to the socket of the secondary aerial coil holder and to the "free" end of the .0003 fixed grid condenser.

Side of grid condenser common to grid leak to the grid of V_1 .

"Free" end of grid-leak holder to the L.T. + side of the first rheostat.

A_1 terminal to one side of the .0002 mfd. fixed condenser.

Other side of this condenser to the A_2 terminal and to the socket of primary aerial coil holder.

Plug of the reaction coil holder to the moving vanes of the .0003 mfd. reaction condenser.

Fixed vanes of reaction condenser to one side of the .0003 mfd. blocking condenser.

Other side of the .0003 fixed condenser to the top contact on the H.F. choke and to the plate of V_1 .

Bottom contact on H.F. choke to one side of the 250,000 ohm anode-resistance holder, to the common terminal on the multiple fixed condenser unit and to one side of the first .01 mfd. mica condenser.

Remaining side of the anode-resistance holder (250,000 ohms) to the tapping clip for the multiple fixed condenser unit, to H.T. + 1 terminal and to the remaining tag of the 2 mfd. Mansbridge condenser nearest the back of panel.

Remaining side of the first .01 mfd. mica condenser to one side of the first 1 meg. grid-leak holder and to one side of the .25 meg. grid-leak holder.

Other side of the first 1 meg. grid-leak holder to the G.B. — 1 plug, via a flexible lead.

Plate of V_2 to one side of the second .01 mfd. mica condenser and to the bottom contact on the upright tapped anode-resistance holder.

Top contact on this anode-resistance holder to the remaining tag of the second 2 mfd. Mansbridge condenser (one nearest back of baseboard), to the telephone + terminal and to the H.T. + 2 terminal.

Remaining side of the second .01 mfd. mica condenser to grids of the valve holders V_3 , and to one side of the second 1 meg. grid-leak holders.

Other side of the grid-leak holder to the G.B. — 2 plug via a flexible lead.

Plates of the valve holders V_3 joined together and to the telephone — terminal. This completes the wiring.

A WORKING "SCALE" ON DIAGRAMS.

ARRANGEMENTS have been made for the inclusion of a small 3-inch "scale" on all diagrams appearing in POPULAR WIRELESS" which refer to panel or baseboard layouts, or apparatus for which scale drawings have been prepared.

It is hoped that this scale will be of assistance to readers constructing apparatus detailed in our pages, and serve as a ready guide for finding any particular drilling point, etc., the position of which may not be indicated in the illustrations.

Use can be made of a pair of draughtsman's "dividers" to obtain the smaller dimensions, but if such an instrument is not readily available, it is quite easy to make use of the scale without damaging the paper by cutting it out. Take a piece of white cardboard or very stiff paper about 12 in. long and an inch or so wide, and place one edge against the scale reproduced in the paper.

Hold the paper firmly in position and mark carefully on its edge the dimensions

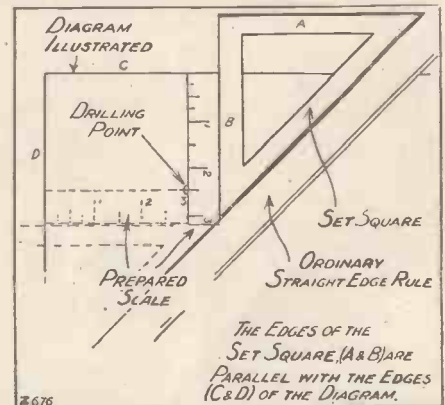

as indicated by the scale, lengthening the stroke where necessary to show $\frac{1}{4}$ in., $\frac{1}{2}$ in., etc. Reference to the illustration will make the method clear. By moving the paper or cardboard 3 in. to the left, a further 3 in. can be marked on the scale being prepared, until we have a scale rule applicable to the diagram.

Another method is to cover the scale on the diagram with a piece of tracing or semi-transparent paper and tracing the scale through. This method, however, has its disadvantages, as any form of tracing paper is necessarily thin, and the resulting scale will not be firm enough to be used with accuracy.

Having made the scale, it is used as follows:

Assume that a diagram indicates a drilling point for, say, a variable condenser, but that no dimensions are shown. By applying the scale across the drawing of the panel, as shown in the illustration, we find that the point is 3 in. in from the side edge of the panel, and by "dropping" the scale from the top edge of the panel we find it is $2\frac{1}{2}$ in. down.

Having obtained the necessary dimensions, an ordinary rule is substituted for the scale, and these dimensions, in inches, are then marked on the actual panel.

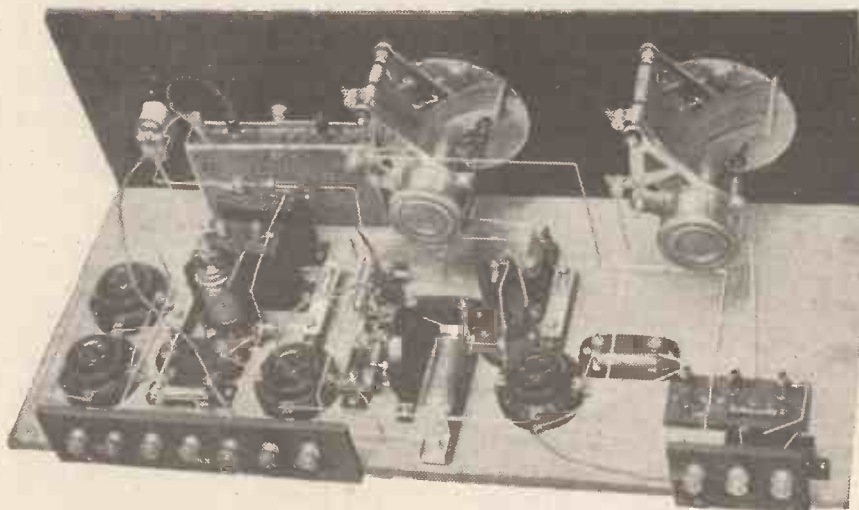

Three separate coil mounts are screwed down on the baseboard to carry the aerial, secondary, and reaction coils.

TECHNICAL NOTES

By Dr. J. H. T. ROBERTS, F.Inst.P.

L.F. TRANSFORMER IMPEDANCES

BURNT-OUT TRANSFORMERS—FREQUENCY DISTORTION—A VOLUME INDICATOR.

L.F. Transformer Impedances.

THE voltage transfer from a valve to the primary of an L.F. transformer depends upon the relation between the transformer impedance and the total impedance of the plate circuit.

According to an article by a well-known radio engineer, "if the impedance of the transformer at the lowest frequency is equal to three times the output impedance of the valve, 75 per cent of the available voltage will be delivered to the transformer primary. With such an arrangement the frequency-response curve of the valve and transformer combination cannot vary more than 25 per cent over the usual range of frequencies. It should be remembered that the output impedance of the valve remains constant, whilst one impedance of the transformer primary varies with the frequency.

"To calculate the approximate voltage transfer from the valve to the transformer primary, this formula is used: $R_t / (R_p + R_t)$, R_p being the impedance of the plate circuit, R_t the transformer impedance of any particular frequency."

The influence of the valve and transformer impedance upon the operating conditions is a matter on which opinions differ considerably, and probably many of my readers will not entirely subscribe to the views put forward in the foregoing extract.

Burnt-out Transformers.

Talking about transformers, a low-frequency transformer which has one winding burnt out (or otherwise damaged) may often be turned to useful account in various ways. Usually it is the primary which is burnt out, and the transformer may be used quite satisfactorily by connecting a 100,000-ohm resistance across the primary terminals and a condenser of .005 to .01 mfd. between the "grid" and "plate" terminals. This connection gives resistance-capacity coupling with an impedance leak and, according to a writer in "Radio News Magazine," will often be found to produce good quality even with an inferior transformer.

Radio Cures.

Specialists in diseases of the ear state that, quite apart from the fact that ordinarily deaf persons may often hear radio programmes quite well (using ear-phones), it has in many cases been shown that the condition of deafness has actually been improved by practice in this way. Usually a two- or three-valve set is prescribed, so that a considerable loudness is obtained in the ear-phones.

Distortion.

Distortion, which it is the aim of every experimenter and set designer to reduce or eliminate, but which is, nevertheless, always present to a greater or less degree, arises

from a variety of causes. If the music received in the loud speaker differs in any way from that which is rendered at the studio, we say it has suffered distortion in the process of transmission—by transmission we here mean, of course, the whole process of carrying the sound from the studio to the listener's ear.



One reader of "P.W." grows hops on his aerial mast, forming a picturesque method of camouflage.

The most common type of distortion is that which may be described as amplitude distortion. It means that sounds are not reproduced with the same relative volume as they had in the original. For example, we may hear the flute or cornet in a band sound twice as loud as the 'cello. We may even fail to hear the bass instruments altogether, and yet it may be that at the studio each of the instruments was producing the same volume of sound.

Frequency Distortion.

A second type is called frequency distortion, and applies to the case where frequencies are introduced in the process of transmission which did not exist in the

original music. These extra frequencies are often brought in by the processes associated with modulation. It is possible to reduce frequency distortion by the proper means and, incidentally, the frequencies which are introduced in this way may not always be objectionable from a musical standpoint, although even then they tend to rob music and speech, especially the latter, of some degree of naturalness.

A third type of distortion which is, however, appreciable only to the highly-trained musical ear (unless it is very pronounced) is sometimes called "phase-angle" distortion. If we divide a complex sound into its components we find a series of simple tones which may vary widely in frequency; if the transmission process introduces unequal lag in different frequencies, it is evident that a phase difference will be introduced and give rise to phase angle distortion.

A Volume Indicator.

A simple arrangement which is interesting for experimental purposes, although not of great practical value otherwise, may be set up to indicate upon a meter the signal strength supplied to the 'phones or loud speaker at any instant. The components required in the extra circuit (which circuit is connected across the loud-speaker terminals) include a valve, with rheostat, a potentiometer, a high-resistance volume control, a low-frequency transformer and a milliammeter. The latter instrument should have an open scale and should preferably have a full-scale reading of not more than 5 milliamps. The necessary H.T. and L.T. voltages for the valve may be obtained from the H.T. and L.T. battery of the set, but in addition a separate 4½-volt grid-bias battery will be required. The primary of the L.F. transformer is connected across the loud-speaker terminals as mentioned above. The secondary of the transformer has a variable resistance of about ½ megohm connected across its terminals. One terminal of the transformer secondary then goes to the grid of the valve, the other terminal to the negative end of the grid-bias battery, the positive end of the latter being connected to the slider of the potentiometer. The potentiometer is connected across the filament terminals of the valve, the rheostat being, of course, in series with the filament. A 1 mfd. fixed condenser is connected between plate and filament of the valve, the milliammeter being connected in the positive H.T. supply to the plate. The bias applied to the grid has the effect of making the valve act as a rectifier instead of as an amplifier. The high resistance across the transformer secondary is a means of accommodating the indicator to the receiver.

Using the Indicator.

In order to use the arrangement, switch on the filament of the valve and adjust the potentiometer until the milliammeter reads zero: if zero cannot be reached with 45 volts on the plate, reduce the plate voltage. Now start the receiver and you will notice that the needle of the milliammeter will be deflected, the deflection varying with the volume of the sound. The motion of the needle provides an interesting study and it is useful to compare the volume variations as shown by the milliammeter with the variations as they seem to the ear.

(Continued on page 424.)

A SERIES FOR THE NEW AMATEUR

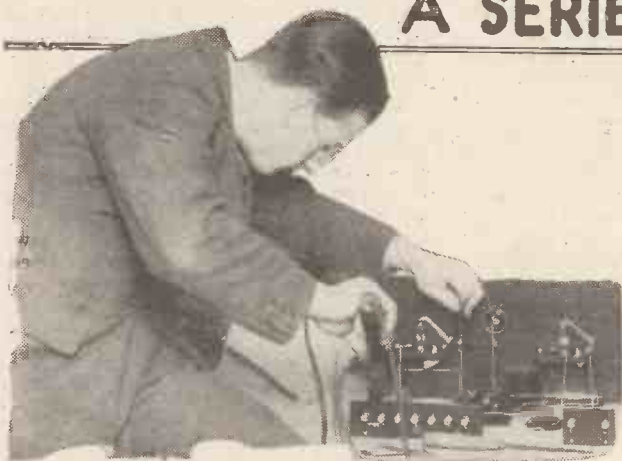

No. 2. COILS AND CONDENSERS.

This is the second article of a short series in which both the theory of radio and its practical application to wireless-set construction are simultaneously dealt with. You will find that a superficial knowledge of the theory will make your interest in receiver assembly much keener, and will enable you to choose your components and your circuits with the discrimination necessary to enjoy the home-construction of sets to the full and in the most economical manner.

By G. V. DOWDING, Grad.I.E.E.
(Technical Editor.)

LAST week I dealt with the actual reception of wireless energy on an aerial, and gave you some idea as to how the transmissions of any one particular broadcasting station can be picked out from all the others by shortening or lengthening the aerial.

You will remember that this variation in the length of the aerial wire altered it to receive ether waves of particular lengths. It will probably prove interesting to you to learn that the aerial would have to be about 240 ft. long to be suitable by itself to receive the 361-metre wave of the London station. Actually, the wave-length a straight-forward aerial will tune to is approximately one and a half times its length in feet, the wave-length being expressed in metres. I hope this will give you the idea that this wave-length business is quite a tape-measure sort of affair and not a mysterious scientific wangle.

Explaining Capacity.

Anyway, you will see that if we had to erect our aerials so that they themselves had to do the tuning, the majority of listeners would find it a difficult task. Few would have room for a 240-ft. aerial, for instance, let alone an aerial of about 1,100 feet, as would be required for the Daventry 5 X X station!

The length of the aerial decides to a very great extent both its capacity and its

inductance. You will, no doubt, have grasped the meaning of capacity, for this word is self-explanatory and really does mean the capacity to hold a certain amount of electricity. Something with a small electrical capacity can be compared with a small water-tank, for both will hold but a

or rather the more intense the area, the longer it will take to develop. It forms an opposition to the current reaching its maximum, and it also forms an opposition to any

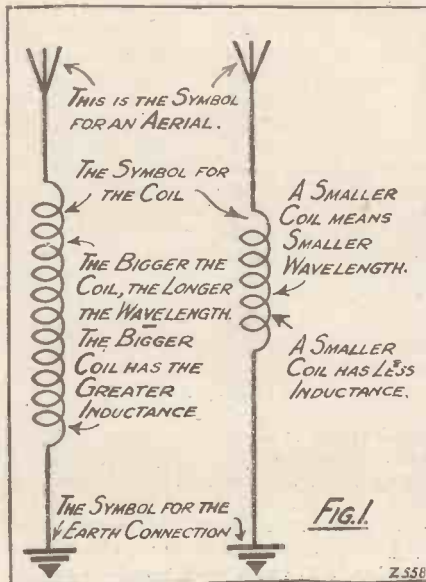

This coil is a "solenoid" or "cylindrical" coil, the wire being evenly wound round a tubular former.

change in the intensity of the current. You can compare inductance to mechanical inertia. Before you can start a heavy vehicle in motion, you have to overcome its inertia. An average man can push a railway truck along—once it has had its inertia overcome, and has been set in motion by a large number of men.

The practical unit of inductance is the microhenry (mh.). An aerial wire having an inductance of 10 mhs. would tend to retard the development of an electrical current in it more than one having an inductance of only 5 mhs.

If you know the capacity and inductance of an aerial wire you can work out the wave-

small measure of their respective fluids and both will fill up more quickly than objects having larger capacities, given a similar degree of current flow in both cases. The electrical unit of capacity is the microfarad, and you can think of this as a sort of electrical gallon. The microfarad is generally abbreviated to "mfd."

When you see two condensers referred to as having .0005 mfd. and .001 mfd. capacities you will know now that the latter has double the capacity. Now let us leave the subject of capacity for a moment and turn to inductance.

Unit of Inductance.

When a current of electricity flows along a metal wire it has to do a certain amount of work by pushing out an area of magnetic influence all around the wire. And until this magnetic condition is at its maximum the current of electricity cannot complete its journey. It takes a certain amount of time to do this and the greater this area,

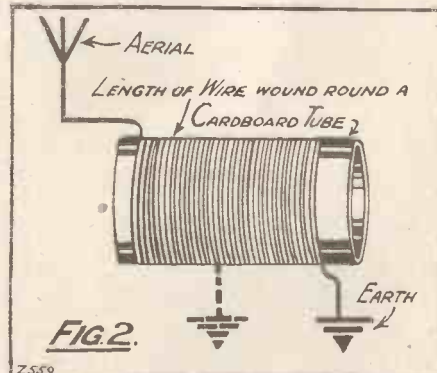

length to which it will tune by this simple formula:

$$\text{Wave-length} = 1885 \sqrt{\text{Capacity (in microfarads)} \times \text{Inductance (in microhenries)}}$$

(Continued on next page.)

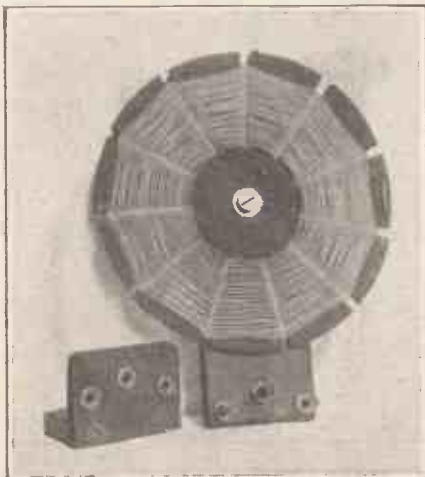

This is a coil wound in what is known as the "spider-web" fashion. The wire is wound in and out of slots cut in a circular piece of fibre or well-waxed cardboard.

A SERIES FOR THE NEW AMATEUR.

(Continued from previous page.)

If you increase either or both the capacity and the inductance you will increase the wave-length, as you will see. And if you reduce either or both you will reduce the wave-length.

In an ordinary wireless receiving system the aerial does not have to be altered in actual

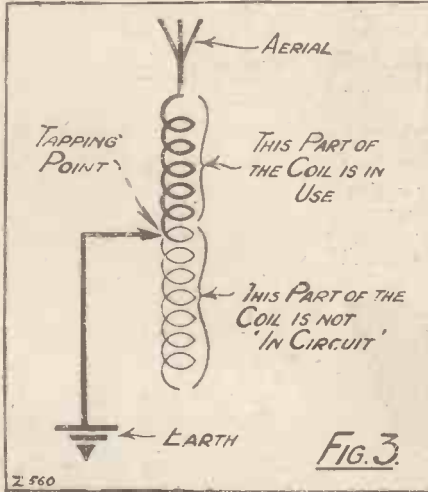

length to tune to different wave-lengths, but its capacity and its inductance are varied in another way. The aerial is joined inside the receiving set to a coil and variable condenser, and these things do the tuning.

It was found that if a length of wire was coiled up the electrical field of magnetic force pushed out from it was considerably intensified, and therefore its inductance was increased. A wireless coil is nothing but a length of wire coiled up. Coils are wound in various patterns, but you should never think of them as being anything else other than lengths of wire wound up so that they are compact, and so that their inductances are increased.

Practical Aerial Hints.

A coil is joined to an aerial to increase its electrical length as it were—to make it tune to a longer wave-length. The bigger the coil, the longer the wave-length. Now have a look at some of the photographs of coils and the first diagram accompanying this article. This latter will explain itself, but I must just say a few more words about the aerial and earth.



A variable condenser with its moving plates partially intermeshing with the fixed vanes or plates.

From the aerial through the coil to the earth constitutes a complete circuit for the current generated by the wireless waves. And this current rushes backwards and forwards along this path at an extremely high speed—anything up to a million or so times per second in the case of the reception of broadcasting. Such a rapid traveller naturally requires an easy path, so that all the joints between wires in this circuit must be very good, and the connection to the earth cannot be too good. The usual way of making this connection with the earth is to bury a large metal object such as a big metal plate or an old pail in the ground, but quite a good earth connection can be made by joining a wire to a water-pipe. The joint must be a good one and should, if possible, be soldered.

“Tapping” a Coil.

Now, I have mentioned the word circuit, and I want you to regard this as a complete journey for an electrical current. We have a complete aerial circuit in our suspended aerial wire, our coil and our earth, as per Fig. 1. But we could join either our aerial or earth to an intermediate part of our coil. Supposing the coil consisted of a length of wire wound round a cardboard cylinder, as shown in Fig. 2. The wire coming from the earth connection could be twisted round one of the centre turns of the coil, as indicated by the dotted lines. This condition is shown diagrammatically at Fig. 3 and you will see that only half the coil is in circuit. The result is the same as having in use a coil of about half the size, and only half the inductance or electrical length of the coil would be added to the aerial. This “shortened” aerial system would tune to a shorter wave-length. And so you will see that one coil could, by being “tapped” at various points, make the aerial system suitable for the reception of various wave-lengths. The arrow head shown in Fig. 3, by the way, is the symbol for a variable tapping—one not definitely fixed at any one point.

In most modern wireless receivers the actual tuning is done by means of varying the capacity in the circuit. A coil is chosen which will enable a certain band of wave-lengths to be covered, say, for instance, anything between 250 and 500 metres, and the variations between these are carried out solely by means of a condenser which adds capacity. A variable condenser specified as having a capacity of say .0005 mfd. capacity is capable of producing a capacity variation between practically zero and the .0005 mfd.

Variable Condensers.

Now, a condenser consists of two metal plates or two sets of metal plates placed closely together, but not touching. And these plates or sets of plates are separated by means of air or some substance, such as mica, which will not conduct electricity. The size of its plates, the distance separating them and the substance separating them decide the capacity of a condenser. The larger the plates and the closer they are together, the greater the capacity (its capacity to hold electricity like a tank holds water). You need not worry yourself about the separating substance at present. The capacity of an ordinary variable condenser is varied by varying the overlap of the two sets of plates, and this is the same as varying its size of plates or the distance between them, whichever way

you like to look at it. A fixed condenser is a condenser which is not provided with any such means of adjustment. Its capacity will always be just that value marked on it, .0005 mfd., .001 mfd., etc., etc.

You have probably looked at Fig. 4 and wondered why the electrical current passes through a condenser, as it looks just like a gap in the circuit. Well, this, in brief, is what happens. The electrical current we are dealing with dashes backwards and forwards (up and down our aerial system in the present case). It is known as an

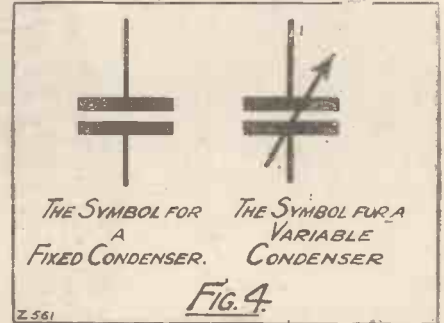

oscillating current for this reason. Place a condenser in its path and this is what it does. It reaches the first set of plates in its way and then stops and induces a charge of electricity in the opposite set of plates, and this current charge careers on through the rest of the circuit. And the same sort of thing happens on the return journey. (Experienced amateurs who may be glancing through these articles will note that I am not troubling about the finer points at present in my various explanations.)

Increasing the Wave-length.

Now, if we join a variable condenser across our coil as shown in Fig. 5, we have a means of varying the capacity of the whole aerial-earth circuit from a point representing the existing capacity of the system up to a value of this plus the maximum capacity the condenser will provide. We can now tune our system to any wave-length within certain limits. But it will be noticed that, although we could go on increasing the maximum wave-

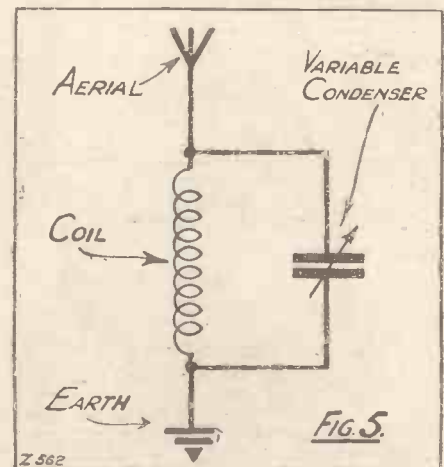

length by increasing the size of our coil, and by increasing the capacity it does not seem possible to reduce our minimum except by reducing the coil to a negligible size.

NEW LISSEN LINES

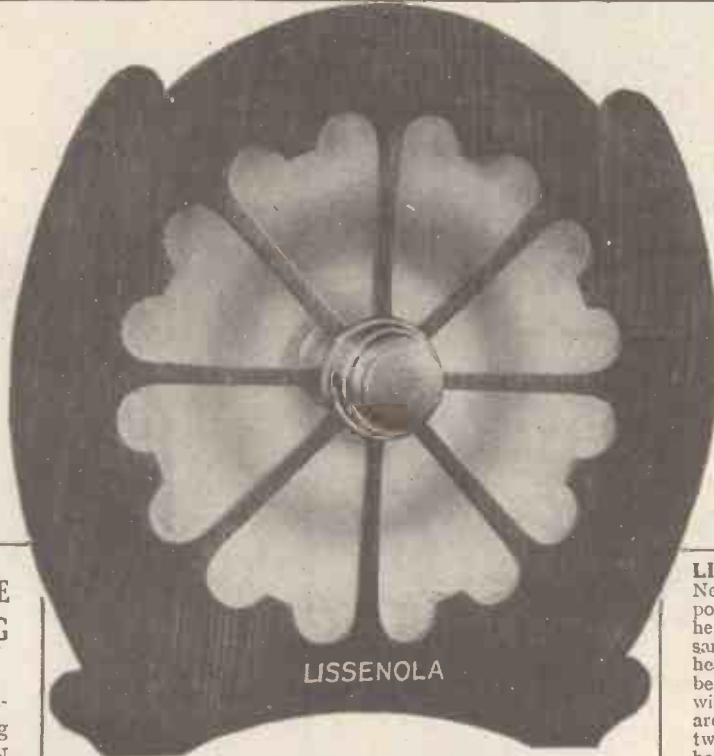

LISSENOLA

LISSEN REVOLUTIONISING CONE

A combination of horn and cone in the same loud speaker.

29/6

Fills in the missing note.

LISSEN COILHOLDER

Fine degree of control to permit of extremely selective tuning. Gear ratio selected as the best for all practical purposes. Big knob for comfortable finger grip and wide range of movement with one turn. No slip or backlash, coils will not move as the result of their own weight. No flexible connections to break. Moving block on the right-hand side, but may easily be changed over to left-hand side by following the simple instructions enclosed with each coil holder.

Model A. With 2 in. spindle (2 way) .. **4/6** Model B. With 5 in. spindle (2 way) .. **5/6**

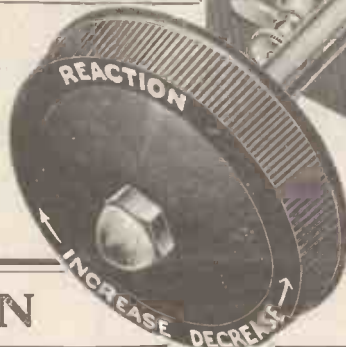
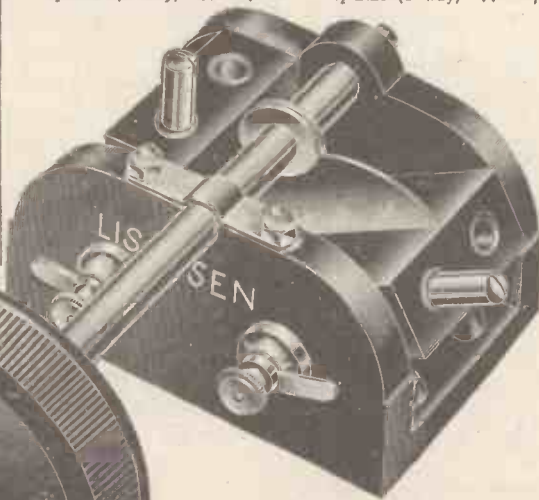

LISSEN RESISTANCE CAPACITY COUPLING UNIT

Provides a complete Resistance Capacity Coupling Unit. Includes two LISSEN Fixed Resistances and one LISSEN Mica Condenser. Values incorporated have been selected as the most suitable for general use, but the resistances are easily interchangeable. May be mounted upright or flat.

4/-



LISSEN HEADPHONES

Never before was it thought possible commercially to make headphones so light and at the same time so sensitive. These headphones are so light they may be worn throughout an evening without the wearer realising they are on the head. Cords will not twist or tangle but will always hang straight down no matter how the head may be turned, moved or twisted. The two earpieces are extremely sensitive and both are exactly matched in impedance. They settle at once into comfortable positions and may be secured there by the single movement of a special ball joint .. **8/6**



LISSEN LIMITED,
8-16, FRIARS LANE,
RICHMOND,
SURREY.

Managing Director : Thos. N. Cole.

L: 417

LISSEN

LEADS IN RADIO PARTS



A.C.9.
£7:0:0



A.C.1. 52/6



A.C.3. 75/-



A.C.4. £4:0:0



A.C.5. £6:0:0



A.C.7. £6:10:0

What do you hear?

You need not—should not—suffer poor quality from a loud-speaker. With a reasonably good set, the right valves, sufficient H.T. and—above all—an **AMPLION** you will enjoy reception such as you never imagined possible.

The Natural Tone

AMPLION
CONE
SPEAKER



Advertisement of Graham Amplion Limited, 25, Savile Row, London, W.1.

EVERYTHING

The **G. E. C.**
your guarantee

ELECTRICAL



L.F. TRANSFORMER FACTS
Performance

GECOPHONE L. F. TRANSFORMERS give results as near perfect as it is possible to obtain. With a good loud-speaker such as the GECOPHONE CONE, the purity and natural tone is amazing, and sets using them have been given unstinted praise by such famous artistes and musicians as Dame Clara Butt, Miss Edith Day, Albert Sammons, De Groot and many others.

Reduced Prices
Ratio 2-1 ... 17/6 Ratio 4-1 ... 20/-
MADE IN ENGLAND

GECOPHONE
L.F. TRANSFORMERS
for volume and purity.

Sold by all Wireless Dealers and Stores.

Adt. of The General Electric Co., Ltd., Magnet House, Kingsway, London, W.C.2.

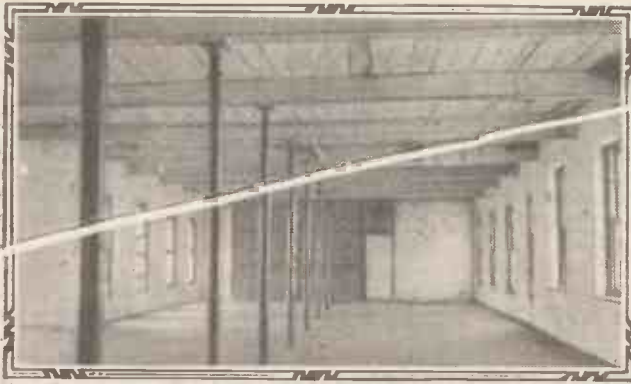

One of the floors in the Linen Hall Street building, which is to be reconstructed to form large studios and comfortable offices. The pillars are to be removed. Note the section of flooring removed at far end to improve acoustics of studio beneath.

2 B E

All about the Belfast Broadcasting Station.
By G. V. DOWDING,
Grad.I.E.E.
(Technical Editor.)

ORIGINALLY, I had the idea that the Belfast Station was quite a small affair; a sort of senior relay station, in fact. Probably this was because we do not hear much of 2 B E because the population of Belfast city is something less than that of either Leeds or Sheffield. Nevertheless, I suppose I should have known better, for 2 B E serves the whole of Northern Ireland, and this is a very respectable slice of our country. Perhaps, if 2 B E were to figure more prominently in our S.B.'s we would be able to appreciate its activities more, but, although it transmits dozens of programmes in the course of the year which are fully worthy of the honour of "S.B.'ing," it is cursed with an unsatisfactory "link." The twenty-five mile submarine cable to England has always been a nuisance, and even the new one which has been laid is by no means perfect.

Unsatisfactory S B "Link."

And, from 2 B E's point of view, it is an exasperating fact that while the Belfast Station can and does take programmes from other stations and relay these in quite a passable fashion, it cannot work over the cable in the reverse direction with equal efficiency. For when 2 B E's radio fare is led from the cable at the England end it has to be magnified for a further journey across miles and miles of landline and the ratio of music to cable noises assumes such a lopsided inversion that B.B.C. engineers tear their hair in despair!

Now, I promised the 2 B E folk that I wouldn't say much about their premises because extensive rebuilding is going on, in fact, a studio is to be built which will rival that of any other provincial station or, indeed, any of those at Savoy Hill. And I cannot blame the Belfast broadcasters if they are just a little ashamed of their present home, for it is a pretty shabby outfit. Curiously, or rather appropriately enough, it is situated in Linen Hall Street in a building that was originally a linen warehouse. It should be unnecessary for me to remind readers that Belfast is the world's centre of the linen industry!

Ambitious Rebuilding Scheme.

The building is flat-fronted, obviously fairly ancient but with none of the redeeming features of age, although if it were painted and polished up it might look positively hideous. However, I understand that the present ugly front may eventually become a side of the building as the rebuilding scheme includes the addition of a more presentable entrance at the one end. On

the occasion of my visit, I had to enter a very ordinary door and mount a narrow, grimy stairway. And when eventually I landed in a poky little artistes' waiting-room, my first ideas regarding 2 B E were considerably strengthened. "What a hole," I thought. "Erin hasn't much to be proud of here." However, when in due course Mr. G. C. Beadle, the Station Director, led me to his private office and seated me comfortably therein, I soon had my murky misgivings removed. Right away he told me something of the ambitious development schemes in progress, and sketched a brief summary of the station's activities which put a very different aspect on the subject of 2 B E.

Surprising Facts.

Mr. Beadle is a young, handsome, well-groomed fellow, and the whole time I was with him he smiled—not, let me add, with superiority or automatically like a Persian cat, but with right good humour. The sort of smile that proclaims *joie de vivre*. He must find it a great asset in his work.

First of all, he gave me some details concerning the personnel of 2 B E, and I learnt with something approaching amazement that the station has a permanent station orchestra numbering twenty, that this orchestra is engaged on a six-day basis, that 2 B E is the only provincial station having its own dance band, and that this dance band is of the respectable size of eleven, including no less than three saxophonists.

And, as Mr. Beadle pointed out, good use is made of these musicians. For instance,

as much attention is paid to the afternoon concerts as to those given during the evenings, and the full orchestra figures in them and not merely octettes, as at many of the stations. And, by the way, I think this is a real feather in the cap of 2 B E; it is a pity that some of its afternoon concerts cannot be widely S.B.'d, for they are admirably schemed and produced and would be appreciated by those English listeners who have at present little else but hotch-potches of "mike tryouts," scrappy talks, and skeleton bands to entertain them during afternoons.

The Value of "O.B.'s"

"Do you do much O.B. work?" I asked Mr. Beadle. I must explain that O.B. is the technical abbreviation for "outside broadcasting," and that this covers practically everything where a microphone is in use away from the studio such as in concert halls, restaurants, cinemas, churches, and in running commentaries.

"Yes, we do a great deal of 'O.B.'," replied the Station Director. "I am a great believer in 'O.B.'s' for they widen the scope of broadcasting and provide many interesting programme variations."

"And it must inevitably create greater local interest in broadcasting," I added, "for when you bring radio right into a man's own home town by broadcasting a local affair you are making your radio truly domestic."

Strangely enough, at that very moment the telephone bell rang and Mr. Beadle was soon busily engaged in a conversation with the caller regarding a projected O.B. of a very ambitious nature. After replacing the earpiece he gave me some details of this particular O.B., which happened to be the broadcasting of a "running commentary" on the "T.T." motor-cycle race of Northern Ireland.

An Interesting Broadcast.

"Do you ever broadcast launching scenes at Messrs. Harland and Wolff's Belfast ship-building yard?" I enquired.

"Yes, quite recently we did this," said the Station Director. "And we were able to include the 'noises' of a ship actually in construction in the adjoining yard." He then went on to give me some very interesting information concerning the event and I

(Continued on next page.)

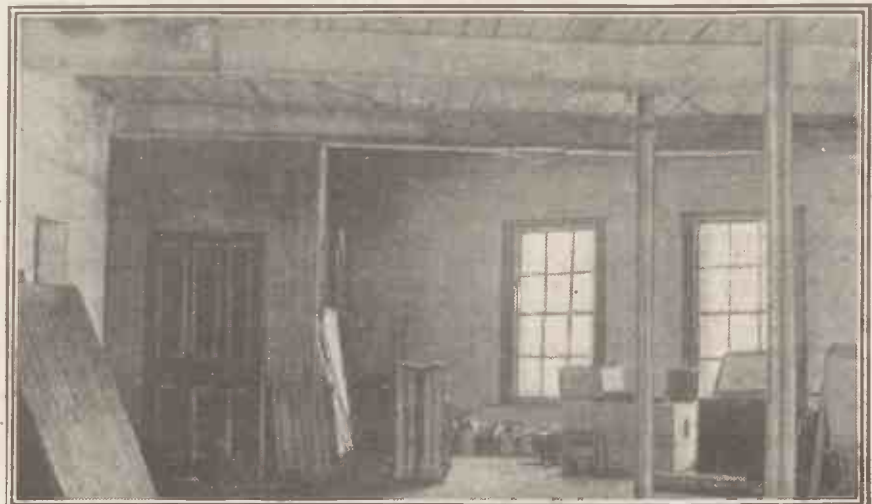

There will be offices at this end of the floor when it is reconstructed. At present it is used for storing "effects" properties, the portable commentator's hut (extreme left), and miscellaneous stores.

2 B E.

(Continued from previous page.)

learnt for the first time that Messrs. Harland and Wolf's do not make the launching of their vessels social events, and that contrary to an almost universal custom new ships are not attended with the cracking of bottles either on behalf of the ships themselves or of speechmakers!

Among other of 2 B E's more prominent O.B.'s are transmissions from the Belfast



Junction and switch-board boxes where hundreds of telephone lines terminate in 2 B E's control room. All this wiring was carried out by the station engineers, and is remarkably neat.

Cathedral and from the Roman Catholic Cathedral at Armagh, and the concerts of the Belfast Philharmonic Society, artistes at which include such well-known names as those of Miss Gwladys Naish, Mr. Dale Smith, Pouishnoff, etc.

"More O.B.'s!"

In the studio at 2 B E some noteworthy performances have been given, including Elgar's "Dream of Gerontius," in which no less than one hundred and twenty performers took part. And three of Belfast's largest male voice choirs have appeared before the microphone. Of course, flute bands have been broadcast from 2 B E for Belfast is a great flute city, and has some two hundred amateur flute bands in it and its immediate surrounding districts.

We had chatted about all these and other of 2 B E's multifarious achievements and activities, when Mr. Beadle announced that he had to visit some people in order to arrange certain O.B.'s. More O.B.'s! He therefore handed me on to his Musical Director, Mr. Godfrey Brown, a gentleman of some fame as a conductor and as an adjudicator at musical festivals not only in Ireland but all over the country. And I found him to be most interesting. He forms a distinct contrast to Mr. Beadle,

being elderly and of rather serious mien. I judged him to be something of a martinet, but I may be nearer the mark if I say he radiates driving force. Is this a distinction without a difference? Anyway, he was most enthusiastic about his work at 2 B E and told me a great deal about his endeavours to create and maintain a high musical standard. The stories of the gathering together of an orchestra recruited from all over the country and the development of dance bands, symphony quartettes and what not, and the building up and continual increasing of repertoires made most fascinating hearing, and I could not but express my admiration of the results of these and the hope that they were duly appreciated by 2 B E listeners. Mr. Brown also told me that the standard of the local talent of Belfast is very high and that the auditions result in the discovery of many first-class soloists and violinists. He showed me a list of artistes marked down for engagements and it was both long and of a very varied character. I found Mr. Brown also to be keen on "O.B.'s."

Pillars in the Studio.

My next visit was to Mr. E. A. Wheeler, the Engineer-in-Charge, and it was he who showed me around the station. There was not much to be seen. The studio is of moderate size, but its ceiling is low and is supported by a number of pillars which the 2 B E people find very awkward at times, more especially when accommodating augmented orchestras. I think if I were a conductor and had men with distended cheeks and goggling eyes peering at me from behind pillars, I too would be somewhat disconcerted, not to say annoyed!

By the way, one of the other engineers later told me that for some time they were troubled by a peculiar resonance effect in the studio and subsequently, after much worry and research, discovered that one of these pillars was vibrating!

Mr. Wheeler took me upstairs and showed me one of the two floors which are being reconstructed to form a large double-height studio and a series of new offices. In the large room he sketched the probable arrangements and showed me where the new artistes' waiting-room and entrance are to be situated.

At the far end I noticed a screen and the engineer led me over to this and showed me that a large section of the flooring had been removed. Through the aperture I could see the ceiling draperies of the present studio beneath and through chinks in these the studio itself. He explained that the removal of this flooring had considerably improved the acoustics of the studio.

The Control Room.

Against one wall in the empty room stood the sections of the portable "O.B." hut. This, it appears, is erected in the football ground or other "O.B." scene of action, in order to provide the necessary isolation for the commentator.

Downstairs again, we went into the control room, and in here I must have spent at least an hour chatting with Mr. Wheeler and others of the staff who were on duty there, and with those who drifted in and out. 2 B E's control room is somewhat like a conservatory, as it has a glass roof. It is very light, but must get very hot in the summertime. The various instruments are arranged on three benches, these forming

three sides of a square, the other side being occupied by a switchboard which stands back to allow free access to the instrument "enclosure." There is an electric clock, and a window looking into the studio.

There are also the usual "A" and "B" amplifiers. By the way, "A" amplifiers are those which are connected directly to microphones in order to magnify the energy passed on from them, and "B" amplifiers are used for amplifying energy brought in from land-lines, cables, etc. 2 B E's radio link with Daventry is most interesting. The private house of one of the engineers, some four miles or so from the station, is connected by means of landlines and in this house there is a multi-valve receiver which permanently is tuned-in to Daventry. This set can be switched on or off from the control room at 2 B E, and its output passed back for amplification and relaying.

An Enthusiastic Announcer.

Although the engineer was away and his house empty, I was shown how the set could be switched on despite this, and I listened to its reception for some time. It was the most perfect example of the useful application of distant control I have ever had brought to my notice. But this radio link is seldom used during the summertime, owing to the static, although it is always available and forms a most valuable standby in case of emergencies.

It was while I was in the control room at 2 B E that I met Mr. Thompson, one of the announcers, a stout-hearted broadcaster whose enthusiasm can be judged by the fact that he writes no less than thirteen chatty articles about 2 B E's programmes every week for thirteen local newspapers free of all charge, and hopes to be able to extend his invaluable publicity still further. These are the sort of fellows that the B.B.C. has gathered under its flag. Not much of that so-called "bureaucracy" about it, is there?

(Continued on page 401.)

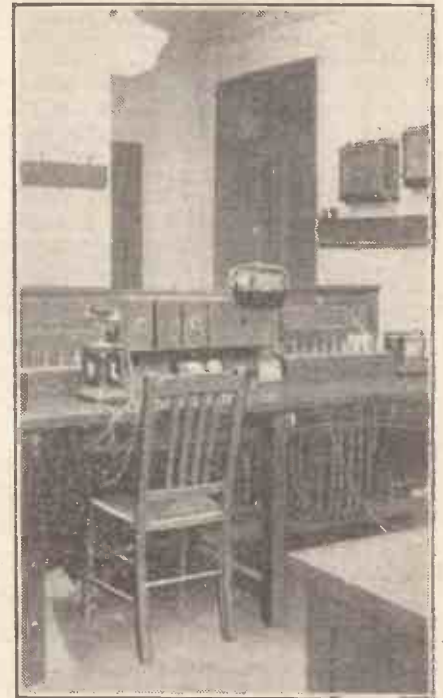

The control room at 2 B E. The door leads into the studio.

WHEREVER RADIO PARTS ARE WANTED—USE LISSEN—

No matter what may be mentioned or used in any circuit of any booklet or periodical you may be building from . . . remember that you can replace the parts mentioned and use the corresponding LISSEN parts instead, with a gain in clarity and volume of reproduction.

USE ANY CIRCUIT BUT ONLY LISSEN PARTS, NO MATTER WHAT MAY BE NAMED

Facts of importance about LISSEN parts—

LISSEN FIXED CONDENSERS



Fixed condensers should be leak-proof, and if they are LISSEN, which DELIVER ALL THEIR STORED-UP ENERGY ALL THE TIME, nothing is lost. Note the case in the LISSEN condenser, how it can be clipped into the LISSEN COMBINATOR in resistance circuits, how it can easily be used upright or flat. Then the price of LISSEN FIXED CONDENSERS is half what it was a year ago. The plates are properly laid in a LISSEN—they are homogeneous with each other, and cannot move or come apart. Capacities .002 to .006, 1/- each (much reduced).

DEMAND LISSEN FIXED CONDENSERS.

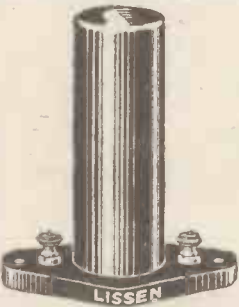

LISSEN H.F. CHOKE

Previously

10/-

NOW

5/6

LISSEN FIXED GRID LEAKS



They do not alter—they are perfectly silent. You can put a LISSEN half-megohm leak in circuit direct on to a 220-volt supply and leave it on indefinitely—it will not alter. It can then be put straight into a critical radio circuit—it will be absolutely silent. LISSEN grid leaks have been further tested by exposure to rain and sun on the roof of the LISSEN factory. They never altered, never varied. Patented.

All resistances—Previously, 1/8, NOW 1/- each.



LISSEN VALVE HOLDER

Has both low losses and also low capacity, twin virtues found in few valve holders. Sent out ready for baseboard mounting, but can also be used for panel mounting by bending springs straight. Patented, previously 1/8, NOW 1/- each.

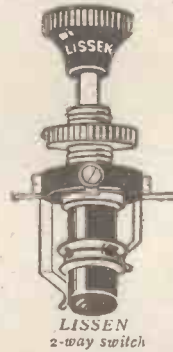

LISSEN SWITCHES

There is one for every switching need in radio. Designed for radio work where currents are small—they will not waste current. They fit easily—take up little room. LISSEN ONE-HOLE FIXING, OF COURSE.

	Pre-viously.	NOW
LISSEN 2-way	2/9	1/6
LISSEN Series-parallel ..	3/9	2/6
LISSEN Double Pole ..		
Double Throw	4/-	2/6
LISSEN Key Switch	2/6	1/6

HOW TO MAKE H.T. BATTERIES LAST LONGER



Every ordinary H.T. battery can be made to yield more energy if a LISSEN 2 mfd. (or 1 mfd. but the larger capacity is the better) is put across it. It will absorb all the noises when the battery gets old. Your dealer will be pleased to show you how to connect it easily.

LISSEN (Mansbridge type) Condenser

2 mfd. 4/8;	1 mfd., 3/10	
*01	2/4	2/6
*025	2/4	3/-
*05	2/4	3/4

Specially moulded case makes it impossible for the condenser to short circuit on to case—a feature exclusive to LISSEN.

BASEBOARD RHEOSTATS Reduced from 2/6 to 1/6

To popularise baseboard mounting resistors, LISSEN has now just reduced the price. Baseboard type are without knob, dial, and pointer, which are not needed for baseboard.

Prices	Previously.	From Jan. 24.
7 ohms	2/6	1/6
35 ohms	2/6	1/6
400 Potentiometer	2/6	1/6

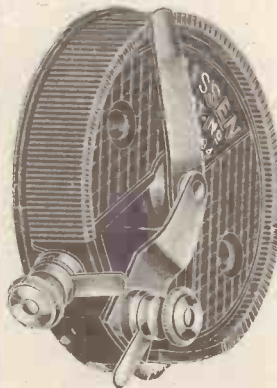

Quality Rheostats for Panel Mounting previously 4/- NOW 2/6

LISSEN quality—look how they are made, and note the irresistible appeal of price.

	Pre-viously.	NOW
LISSEN 7 ohms, patented	4/-	2/6
LISSEN 35 ohms, patented	4/-	2/6
LISSEN DUAL, patented	6/-	4/6
LISSEN Potentiometer, patented	4/6	2/6
LISSEN ONE-HOLE FIXING, OF COURSE		

USE ANY CIRCUIT BUT ONLY LISSEN PARTS, NO MATTER WHAT ELSE MAY BE NAMED, and you will gain in volume and eliminate distortion. LISSEN PARTS—WELL THOUGHT OUT, THEN WELL MADE.

LISSEN LIMITED, 8-16, FRIARS LANE, RICHMOND, SURREY

Managing Director: THOMAS N. COLE.

Tungstone High Tension 96 Volt De Luxe

Special Ebonite and Rubber Insulation. No Current Leakages. 3 Amp. Hour Actual Capacity. Patented 12-16 Volt Low Tension Removable Charging shown on the Front of Illustration removed.

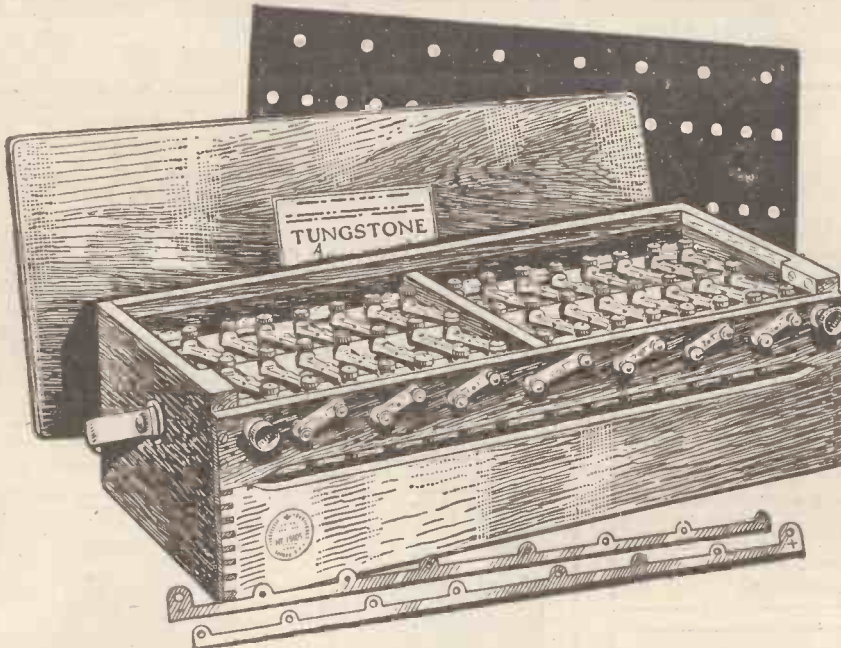

Showing Low Tension Charging Equipment removed.

Thick ebonite panel is fixed between each 48 volt section. All terminal bridge pieces are firmly mounted on an ebonite panel which forms the front of the cabinet. Rubber bands round each 2 volt unit separate independent separation and perfect insulation. Additional insulation is provided as all units stand on Rubber mat, and cabinet is fitted with rubber feet. The Cabinet is solid teak highly polished, with the new enamel, giving a glass hard surface that cannot be soiled or scratched. Twelve volt Sections can be taken out separately.

Price :

60 Volt - £5 15s. 0d.

96 Volt - £10 10s. 0d.

Sold U.K. on Extended Monthly Payments.

Apply for Details.

TUNGSTONE DE LUXE HIGH TENSION Fitted with Patented Equipment for Charging on 12-16 Volt Low Tension Plant.

First Charge completed in the Short Period of 12 Continuous Hours. Re-Charges in Seven Hours.

The practical advantage of Tungstone's exclusive feature of **BALANCED PLATES**, in combination with Low Tension Charging Equipment, guarantees that the First Charge and all Re-charges are fully completed, consistently and reliably, which the present-day long period charging cannot guarantee and never secures, the basic fault necessitating heavy costs for repeated re-charges at short intervals.

HIGH TENSION PLATES. EXCLUSIVE FEATURES Never Before Achieved by any other Maker.

All Tungstone High Tension Plates are **SCIENTIFICALLY BALANCED** in correct weight proportions of the Grid and Pure Lead Paste, so that the Ampere Hour Capacity is evenly used up by an automatic proportional discharge of current from Positive and Negative Plates securing steady voltage. No abrupt changes in the potential. The drop slow and imperceptible. No Wood Separators prevent Voltage fluctuations due to polarization and internal resistance which is negligible. No frothing or foaming. No Sulphation. No Parasitical Noises in Phones or Loud Speaker. No sudden Plate failure at a critical moment demanding Voltage adjustments. The respective Plates are Certain to get their required proportionate charge of current. If correctly First Charged is a guarantee against uneven strain and irregular drain on Plates on Charge and Discharge, and there is no chance of a separate Cell discharging and reversing long before the others. The loss of charge on standing is low and the local action small.

The open Circuit Voltage will give due warning of the approach of the Battery to a discharged state. As H.T. Cells are small it is difficult to test the Specific Gravity. Balanced Plates allow greater dependability to be placed on voltage readings. Cells are not permanently ruined by being left standing for months.

For Post Free Copy of Free Booklet on **MODERN BATTERY FAILURES** containing Special Illustrated Articles, send name on Postcard to:—

TUNGSTONE ACCUMULATOR CO., LTD., The Independent Battery of the British Empire,
3, St. Bride's House, Salisbury Square, Fleet Street, London, E.C.4.

2 B E.

(Continued from page 398.)

The main topic of conversation among the engineers in the control room was a forthcoming "O.B." of a very ambitious nature. And I could not but appreciate the friendly compliment paid me by my inclusion in the discussion. Not that my remarks could have been particularly helpful, although, perhaps, they had some little value coming as they did from an "outsider." But I must add that I felt more "at home" in 2 B E's control room than anywhere else during my B.B.C. wanderings. Seldom have I met such a cheery crowd. Every now and then people would wander in from the adjoining studio, but there was none of that "chilliness" one could have reasonably expected. Nevertheless, do not let it be thought that broadcasting is treated lightly in the control

people residing in Belfast. These sets were stored away in the band room, a room which figures in all B.B.C. establishments, and wherein members of the various orchestras seek seclusion and rest during the intervals between their periods of work in the studio.

And as, in the company of one of the engineers, I turned to leave the building in order to sojourn to the transmitter, I heard Mr. Godfrey Brown's voice crying, "Band! Take your places, please," followed by a shuffling and scuffling and finally the click of the studio door shutting. I glanced at my watch and saw that it was exactly half-past three and knew that 2 B E was "on air" to the second, pouring into the ether of Northern Ireland an afternoon programme schemed and produced by broadcasters whose only desire seems to be to please their listeners.

A Typical Transmitter.

2 B E's transmitter is situated at the Corporation Power Station in East-Brige Street. I was transported thereto by an engineer in his private two-seater, a vehicle



The transmitter at 2 B E. It is a standard outfit and is installed at the Corporation Power Station in East Brige Street.

room at 2 B E; on the contrary, one could sense an underlying atmosphere of tense-ness and endeavour.

In due course, I regretfully noted that the time for my departure was drawing near, so I had to pay a rather hurried visit to the office of Miss Shaw, the lady who arranges 2 B E's women's features and children's hours. She was hard at work planning the details of a bazaar and exhibition kiddies' broadcast which were to have been held in conjunction with the Ulster Wireless Traders Show. About these she was most enthusiastic, as indeed, I found her concerning the whole of her work at 2 B E.

2 B E Goes "On Air."

"Our Children's Radio League has a membership of nearly four thousand," she explained, "and it is still growing." She then described the charitable work that is being carried out at 2 B E, under the auspices and by this league of junior listeners.

And as I was leaving the station, Mr. Wheeler, the Engineer-in-Charge, showed me a large number of crystal sets which were, in due course, to be presented to blind

which will long remain in my memory. It is fourteen years old, but has the liveliness of a "last year's model," and in the hands of its owner displayed the energy of an earthbound comet.

However, we arrived safely, and I was soon gazing with little interest at a typical B.B.C. aerial suspended between typical power-station chimneys and threading down into a typical power-station outbuilding on to a typical "Q" type B.B.C. transmitter!

I had a look at the ubiquitous Brussels Wavemeter, and noted that the "pea-lamp" was glowing, and thus indicating that 2 B E was tuned-in sharply. I also examined a rectifier valve that had burnt out that very morning. The bulb had cracked under the heat generated. Finally, I was whisked back to the centre of the town again, and said good-bye to my genial companion, the engineer charioteer.

But before I left Belfast I purchased a packet of "2 B E" cigarettes at one of the local tobacconists and was puzzled all the way over the water as to whether the title of these indicated an active local interest in broadcasting in Belfast or merely that Belfast has tradesmen of abnormally enterprising natures!

AN L.T. ACCUMULATOR FUSE.

THE little device described and illustrated below has proved very satisfactory as a protection against accumulator short circuits. Procure an ebonite tube about 1½ in. to 1¾ in. long and ¾ in. outside diameter, and tap each end with a screw thread of the same pitch as the screw end of a Clix spade tag. In my own case, I found an old McMichael grid leak tube was of suitable size and had threads cut already in each end of the



The parts used in the fuse device.

correct pitch. Obtain a Clix spade tag and a Clix pin tag, and discard the insulating sleeveings, since the tags must be screwed in the ebonite holder. Now cut off the screw shank from an Eastick T.2L.C. terminal engraved with L.T.—, and file a slot across the flat base so that the pin tag will just lay along it, as shown in Fig. 1 and the photograph. Solder the pin tag and terminal together, and the fuse holder is

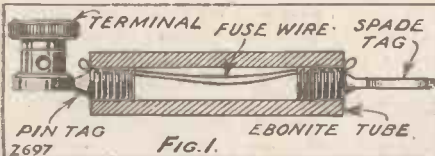

now ready for the fuse wire. The Clix spade and pin tags have small slots cut in their screwed ends, and these will allow a piece of ordinary fuse wire to be held in place, each end of the length of wire passing through the slot and being gripped inside the tube by screwing in the spade tag and pin tag with its terminal.

Insert the spade tag under the L.T.— terminal of the accumulator, and the

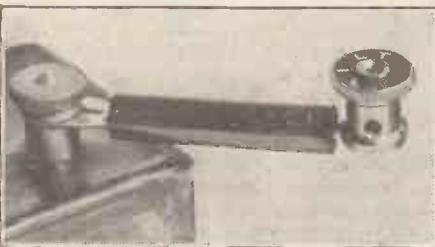

The complete fuse. A piece of 2-amp. fuse wire should connect the two end pieces inside the small tube.

terminal end of the fuse holder can now be used for joining to the battery lead. This simple device is remarkably efficient, and the replacement of the fuse wire, should an accidental short circuit take place, is quickly carried out, while, of course, complete protection is given to the battery, a vital feature which too frequently is overlooked.

BROADCAST NOTES.

FROM OUR BROADCASTING CORRESPONDENTS.

Coming Broadcasters—Cabinet Doubts a Controversy—Better Times for Scotland—Doubts about Bournemouth—Discourtesy at Savoy Hill—The Local News War—Sir Thomas Beecham and Opera—Hallé Concert—News Bulletins in 1928.

Coming Broadcasters.

OF the younger element at Savoy Hill perhaps the most promising is Mr. Wellington, now assistant to the London Station Director. He is hotly pursued by Mr. Victor Hely Hutchinson, the composer pianist. On the other sides of the work, Mr. Eric Machwitz and Mr. Ashbridge carry the biggest guns for rapid and continuous promotion.

Cabinet Doubts a Controversy.

It is an open secret that Lord Birkenhead's open advocacy of more controversy on the wireless has disturbed some of his Cabinet colleagues, and there is bound to be heart-searching when the question comes up at an early meeting of the Government. The Government would rather leave the question alone, to settle itself through a process of gradual evolution. But now that there has been all this discussion in public, it looks as if some Cabinet decision will have to be taken. It will not err on the side of rashness.

Better Times for Scotland.

Apart from minor troubles such as the recent row between the B.B.C. and the International Bible Students' Movement, there is remarkable calm spreading over Scottish broadcasting circles. Mr. Cleghorn Thomson has decided to come out more into the public eye, and to take the public into his confidence. The result is steady improvement, and an appreciable decline of devastating criticism. The problem of Scottish broadcasting may not be insoluble, after all.

Doubts About Bournemouth.

The fate of Bournemouth hangs in the balance. Some months ago its orchestra was replaced by an octette. In common with Newcastle and Aberdeen, Bournemouth became something less than a main station, and yet something more than a relay station. Under the full regional scheme as planned at Savoy Hill there is no place for Bournemouth. It is too near London.

The problem now is, what to do in the two years or so which must elapse before the regional scheme is in operation? Some local listeners and a good number of others along the coast stick to Bournemouth, and would be very sorry to see it go. On the other hand, many listeners within the zone of Bournemouth would rather have relays of the London programmes than the somewhat curtailed local efforts which are now provided. The B.B.C. will have to face up to a decision before long. The most economical and efficient solution would appear to be to make Bournemouth a relay station at once on its present power.

Discourtesy at Savoy Hill.

There is an alarming increase in the number of complaints of discourtesy and rudeness to visitors at Savoy Hill. It is

alleged that if a speaker is very eminent he receives every attention: if he is not so eminent, but yet an authority on his subject, he runs the risk of being very roughly handled. The managing editor of an important London newspaper was described as having been subjected to abject humiliation on the occasion of a recent talk which he had been invited to broadcast. It is understood that efforts are being made to put these matters right and to restore the previous good name of the B.B.C. in matters of courtesy and hospitality. It is hoped that one result will be a more liberal dispensa-

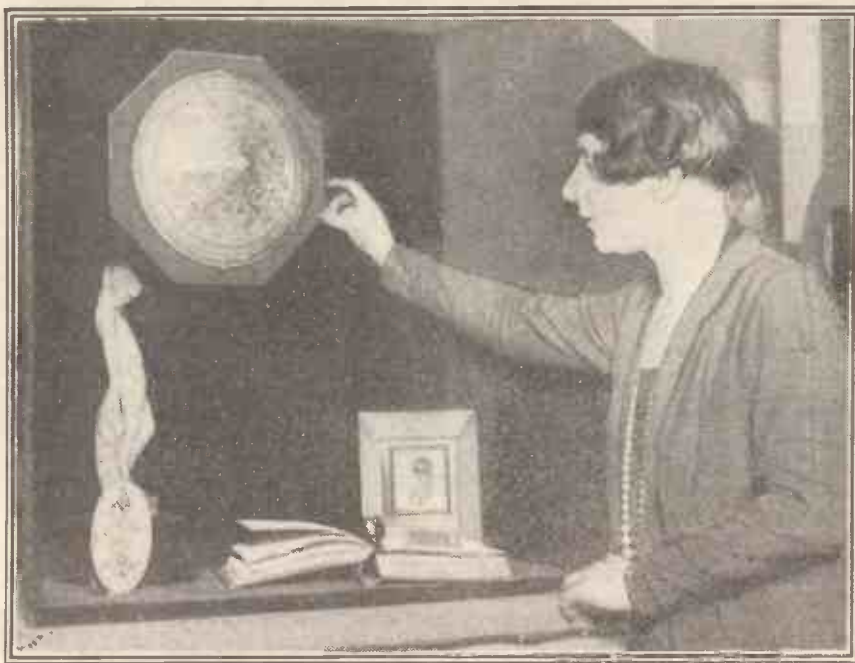

A loud speaker of unusual design, which created considerable interest at the recent Radio Exhibition.

tion of refreshments for those who have to wait a long time for their engagements! There is more than a suggestion of "prohibition" at Savoy Hill.

The Local News War.

Local news is again the subject of violent controversy. The B.B.C., yielding to public opinion some nine months ago, did away with the wearisome mass of trivialities which had gone by the name of "local news." They decided that for the future they would not put out local news or pay for it, except when the occasion clearly called for it. The result is that there is practically no local news given. And now the public is again complaining, particularly in Glasgow. What listeners want is brief accounts of fatal accidents, floods, and crimes.

So strong is the agitation that it is likely

the B.B.C. will introduce a new system of local news adapted to local requirements and not standardised for the country.

Sir Thomas Beecham and Opera.

In working out his great scheme for the salvation of opera in Britain, Sir Thomas Beecham has so far ignored organised broadcasting. It is noteworthy, however, that his recent public utterances have not contained any repetition of his violent attacks on the B.B.C. Enquiries at Savoy Hill on the possibility of *rapprochement* have produced no answer, but here again there is not the same feeling of hostility as there was a few months ago. Thus, there is some reason for deducing that Sir Thomas Beecham and the B.B.C. are perhaps unconsciously drawing closer together. Anyway, it is a fact that, whether or not there is official co-operation, any measure of success which may attend Sir Thomas Beecham's scheme will be due mainly to the preliminary educative influence of wireless.

Hallé Concert.

Next Thursday (October 27th) the first of the series of Hallé Concerts will be broadcast

from London and other stations, with Sir Hamilton Harty conducting. The concert will run from 7.45 to 10.10 p.m., the second news bulletin being given at 8.45.

News Bulletins in 1928.

There is so far no definite indication of B.B.C. intentions with regard to its service of news after the end of this year, when the agreement with the press automatically expires. The first question which arises is whether there will be peace or war between the spoken and the printed word. While the chances of war should not be wholly neglected, the balance of probability is with the pacifists. There will probably be a new temporary agreement under which a few concessions will be granted to the B.B.C. in return for more adequate pecuniary compensation.



The "B.P. 34" TWO VALVER

IN designing this receiver I had in mind the requirements of the ordinary constructor with but little experience in the art of radio reception. At the same time the set had to be of an efficient up-to-date type. It is easy to simplify a receiver at the expense of efficiency, but it is another matter to retain maximum efficiency with a simple lay-out of a type that practically anyone can attempt with a hundred per cent chance of success.

This little two-valver is not only simple in construction, but it is cheap. It isn't necessary to purchase very special components.

The Circuit.

In many instances the reader will be able to make use of a number of his stock parts. The plug-in coils, valve holders, fixed condensers, variable condensers might easily be already available in a less up-to-date set. The cabinet and panel are the well-known "All Concert" sizes, probably the most popular of the standard types. An examination of the theoretical circuit (Blue Print No. 34) will show that a standard well-tried arrangement has been chosen. A semi-a-periodic plug-in coil forms the aerial-earth circuit. This coil is placed close to a tuned secondary circuit, consisting of another plug-in coil and a .0005 variable condenser. The H.F. voltages across this tuned circuit are applied between grid and filament of the H.F. valve, V_1 . In the anode circuit of the H.F. valve is the split-primary winding of an ordinary standard split-primary H.F. transformer. "Reinartz" reaction can be applied to the secondary winding of the transformer with the aid of a small .00025 variable condenser. The valve V_2 is a leaky grid condenser rectifier, the rectified signals being passed through a pair of telephones connected in the anode circuit of the valve, or through the primary winding of an L.F. transformer if the receiver is required for use with an amplifier for loud-speaker work. The .0003 fixed condenser between the anode of V_2 and the .00025 reaction condenser is to prevent the H.T. battery from being damaged should the plates of the reaction condenser accidentally touch. Since the receiver employs a neutralised H.F. valve it is possible to use maximum reaction with but little chance of radiation.

An efficient long-distance receiver which enables many alternatives to the local programme to be obtained. It is a set well within the province of the unskilled constructor and a magnificent blue print of it is given free with this issue. The receiver was built in the "P.W." Research and Set Construction Department.

Designed and described by
A. JOHNSON-RANDALL.

Readers will observe that the filament rheostat for the H.F. valve is connected in the negative L.T. lead, whilst that for the detector is in the positive lead. This was done deliberately with a view to obtaining a small negative bias on the grid of the first valve, and with the object of ensuring maximum selectivity.

The set is intended for use on long-distant stations when employing telephones, or for

attachment to an L.F. amplifier when loud speaking is required. As a simple H.F. and detector the receiver will not work a loud speaker, and constructors should bear this in mind. So many listeners choose sets quite unsuited to their requirements that it is just as well to point out what results may be expected under average conditions. With a standard 100 ft. single wire aerial, approximately 30 ft. high, and in conjunction with a good earth, loud telephone results may be expected from a number of British and Continental stations. With the addition of a single stage of L.F. amplification loud-speaking would be possible from ten or twelve stations on the ordinary B.B.C. band.

Constructional Details.

On the longer waves, using the set as described, consistent telephone reception ought to be possible from 5 X X at distances up to 200 miles. In addition, Hilversum and Radio-Paris ought to come

(Continued on next page.)

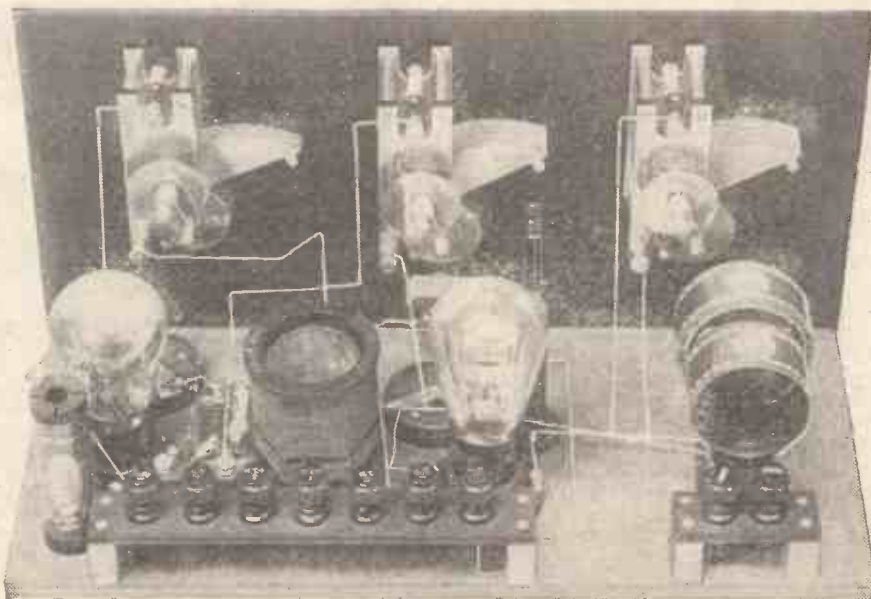

This is a back-of-panel photograph of the completed receiver with the coils and valves in position. As will be seen, the terminals are arranged on small horizontal panels. This enables the wiring, which is very simple, to be kept well down and protected.

THE P.W. BLUE PRINT No. 34—6d.

An H.F. & Detector Two-Valver (Tuned Transformer, Neutralised).

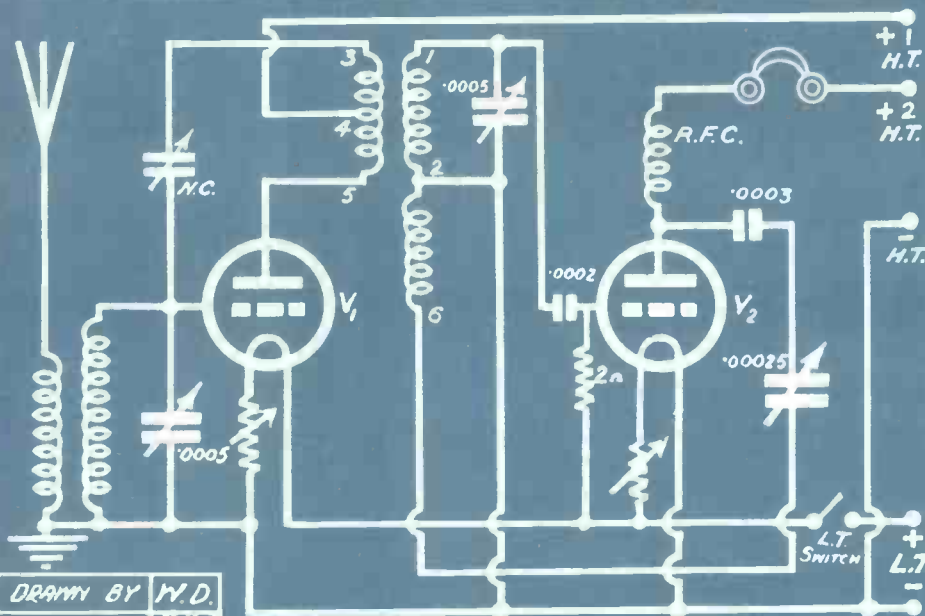
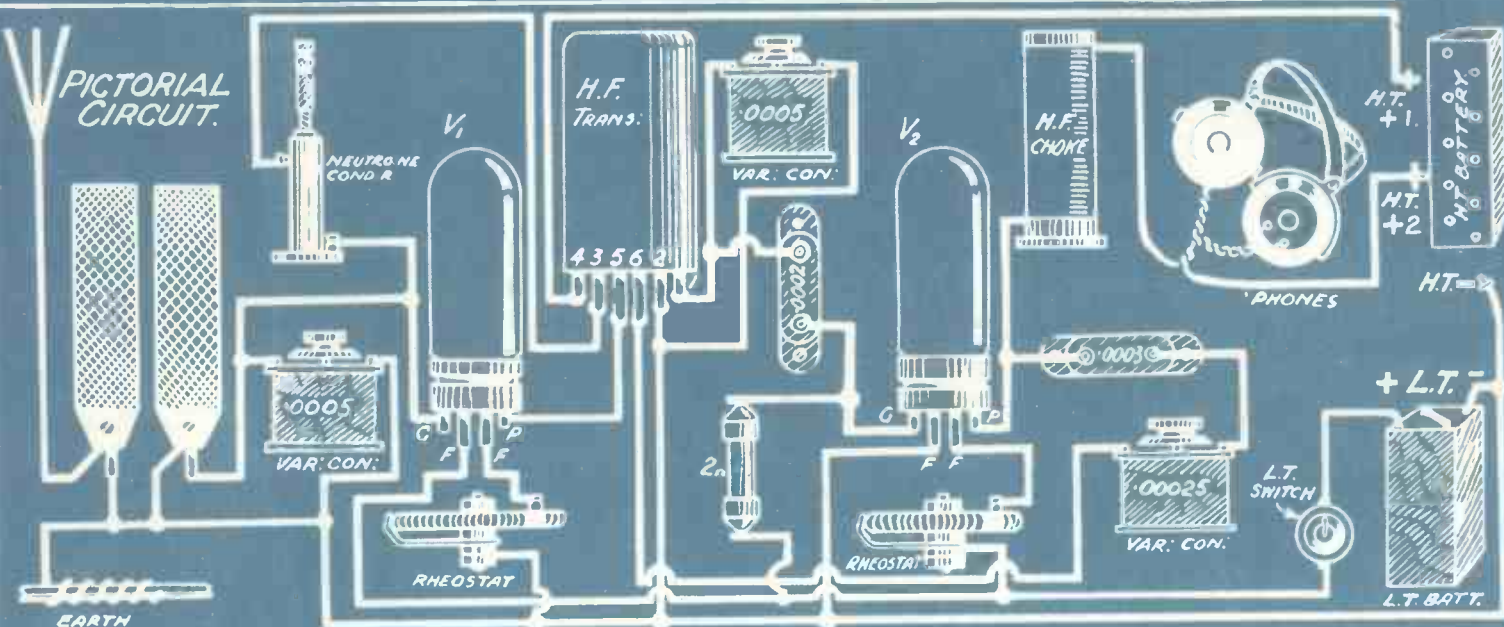

COMPONENTS AND MATERIALS.

- 1 Ebonite panel, 16 in. × 8 in. × ¼ in.
 - 1 Vertical front cabinet to fit, with baseboard 7 in deep.
 - 2 ·0005 mfd. variable condensers, with slow-motion or vernier dials, square law or S.L.F.
 - 1 ·00025 or ·0003 mfd. ditto.
 - 1 Neutrodyne condenser, baseboard mounting.
 - 2 Sprung valve holders.
 - 1 H.F. choke.
 - 2 Baseboard-mounting filament rheostats.
 - 1 ·0002 mfd. fixed condenser.
 - 1 ·0003 mfd. ditto.
 - 1 2 megohm grid leak and holder.
 - 2 Baseboard-mounting single coil sockets.
 - 9 Terminals and 2 terminal strips.
 - 1 On-off switch.
 - 2 split primary H.F. transformers and 1 6-pin base, unscreened. (1 short-wave transformer and 1 Daventry.)
- Wire, screws, etc.

ACCESSORIES.

- 2 Valves.
H.T. and L.T. batteries to suit valves.
Nos. 25, 35, 60, 100, 150 and 250 coils.
'Phones.

DRAWN BY	W.D.
CHKD BY	R.K.G.
SER. NO.	BPB

THE "B.P.34" TWO-VALVER.

(Continued from previous page.)

in at good strength in districts favourably situated.

The construction of the receiver is quite simple. Considering the panel first, the constructor should note that only four main holes need to be drilled, provided single-hole fixing condensers are chosen. These four holes may all be drilled with a $\frac{3}{8}$ -in. twist drill and a carpenter's brace.



This is the complete set. The three dials from left to right, are the two tuning condensers and the reaction control. A switch for switching the set on and off is the only other panel-mounted component.

In addition, three or four small holes will be necessary along the bottom edge of the panel in order to secure it to the baseboard.

On the back of the baseboard are two terminal strips. These are mounted horizontally on $1\frac{1}{2}$ in. or 2 in. wooden supports, the height of these supports being sufficient to permit easy connection to the underside of the terminals. The main terminal strip will need to be about 7 in. in length by 1 in. wide, while the short strip for the aerial and earth terminals can have a length of about 2 in. The general lay-out can be seen from the photographs and the back-of-panel diagram.

The location of the six-pin coil socket is worthy of note, since this has been placed in a convenient position for easy wiring. At the same time it is important to place the H.F. transformer as far away from the aerial and secondary coils as possible.

Next we come to the operation of the receiver.

Operating the Set.

For the ordinary B.B.C. band place a No. 35 or 40 coil in the primary or aerial socket and a No. 60 in the secondary socket. In the six-pin socket insert a standard split-primary H.F. transformer (250-550 metres), preferably with a Litz wire secondary, although this is not essential. It is possible to make an H.F. transformer for oneself by winding 50-55 turns of No. 24 D.C.C. or $\frac{3}{8}$ silk-covered Litz wire on a 3-in. diameter Collinson former, unspaced. This forms the secondary winding, the upper end being joined to pin No. 1 and the lower end to pin No. 2. The reaction winding consists of 20 turns of No. 28 or 30 gauge D.S.C. wound as a continuation of the secondary winding and in the same direction. The beginning is joined to pin No. 2 and the end to pin No. 6.

The primary and neutralising windings can be wound on a detachable former placed inside and at approximately the centre of the secondary. The neutralising winding can be wound on first and this may consist of 25 turns of, say, No. 30 D.S.C. The beginning of this winding goes to pin No. 3. Over the top of the neutralising winding place a layer of Empire tape and then wind on another 20 turns for the primary winding. This should be in the same direction as, and on top of the neutralising winding.

Valves to Use.

The beginning of the primary is joined to the end of the neutralising winding and taken to pin No. 4. The end of the primary goes to pin No. 5. All windings should be in the same direction whether primary, secondary, neutralising or reaction.

The constructor may vary the size of the primary winding to suit his own particular valve and requirements as to selectivity.

In a receiver of this type I strongly recommend the use of 6-volt valves, since I have found that with the standard H.F. transformers poor results are frequently obtained with other types. Suitable valves would be the Marconi or Osram D.E.5b, D.E.L.610, Cossor 610 H.F., Mullard P.M.5X, etc. The H.F. and detector valves may be similar types, but the H.F. valve is the most important. Connect up the aerial and earth and H.T., L.T. and telephones. On the H.F. valve (H.T. + 1) you will need about 72-90 volts and on the detector about 60. With the reaction condenser at zero tune in the nearest station. You will probably find that the H.F. valve oscillates. There are two methods of neutralising,

one is by obtaining the "silent point," and the other is called the reaction demand method.

Neutralising.

If you are fairly close to the local station you can try the first-named method. Turn out the valve filament by means of the filament rheostat and you will find that signals can still be heard, although perhaps weakly.

Then adjust the neutralising condenser very slowly until signals die away and become inaudible. If you are very close to a powerful station you will have to take the position of minimum signal strength as the "silent point." This point is fairly critical and a minute adjustment of the neutralising condenser is necessary. Having found this point the valve may be switched on and the receiver is ready for use.

The second method is as follows. Set the reaction control at minimum, and likewise the neutralising condenser. Now, on setting the tuning condensers so that the two tuned circuits are in step with each other it will probably be found that the set is oscillating. To test for oscillation, touch one or other of the sets of plates of the tuning condensers (this may be either the fixed or moving, according to the particular set). You will probably find that the set will only oscillate under the above conditions when the two circuits are in tune with each other, and this can be used as an indication. It is convenient to perform the operation at some point near the middle of the tuning range. Now, increase the capacity of the neutralising condenser. (In the case of such condensers as the Gambrell "Neutrovernia" this means screwing downwards.)

Final Adjustments.

Test at intervals for oscillation as this is done, and you will presently find that the set has ceased to oscillate, and will not recommence even when the tuning dials are slightly readjusted. Now increase the reaction a little, until the set once more

(Continued on page 407.)

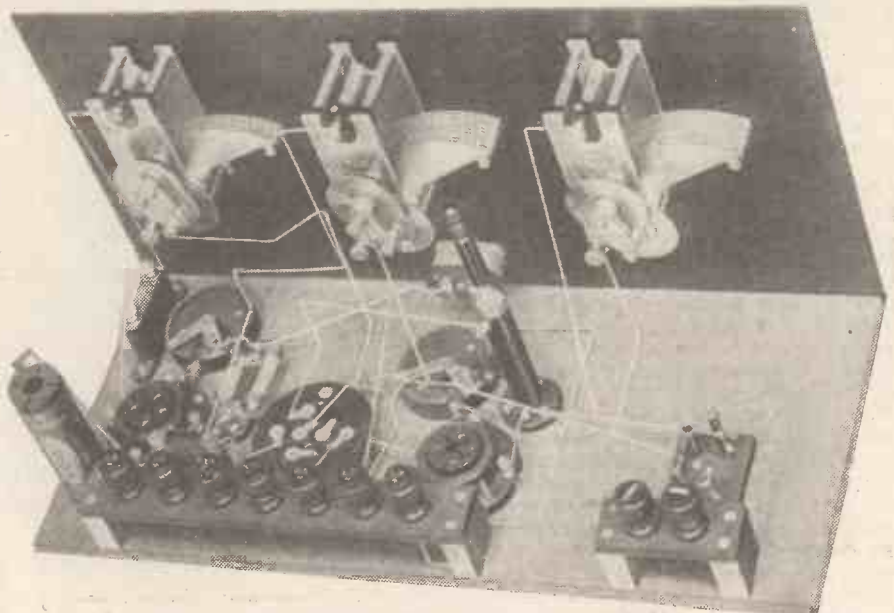

You should be able to see most of the simple wiring connections in this photograph. The terminals from left to right are: Two for the telephones, H.T. plus 2, H.T. minus 1, H.T. minus, L.T. minus, L.T. plus, and, on the small panel, Earth, Aerial.

FERRANTI

RADIO METERS

SINGLE RANGE INSTRUMENTS
FOR PANEL MOUNTING



PROJECTING PATTERN
TYPE R1Pa.

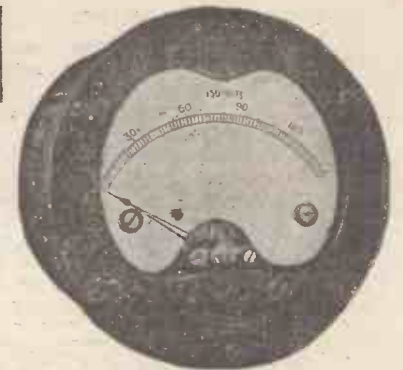

FLUSH PATTERN
TYPE R1Fa.

No.	MILLIAMMETERS.	Price.	No.	VOLTMETERS 200 ohms per volt.	Price.	No.	VOLTMETERS 1000 ohms per volt.	Price.
		£ s. d.			£ s. d.			£ s. d.
1	0-5	1 10 0	9	0-75	1 10 0	—	—	—
2	0-15		10	0-25		—	—	—
3	0-50		11	0-150		13	150	2 2 6
4	0-150		12	0-250		14	250	2 7 6
	AMMETERS							
5	.75		—	—		—	—	—
6	0-1.5		—	—		—	—	—
7	0-10		—	—		—	—	—
8	0-20		—	—		—	—	—



PORTABLE PATTERN
TYPE PR3a.

THREE RANGE INSTRUMENTS

Front Connected { Portable Pattern,
without switch.
Portable Pattern,
with switch.

Back Connected — Flush Pattern,
with switch.



FLUSH PATTERN
TYPE R3Fa.

No.	COMBINED INSTRUMENTS: Ranges.	Portable Type, PR3a. 200 ohms per volt.		No.	Flush Type, R3Fa. 200 ohms per volt. With switch.	No.	Portable Type, PR3a. 1000 ohms per volt. Without switch.
		Without switch.	With switch.				
15	7.5, 15 and 30 milliamps.	£ 1 17 6	£ — —	—	£ — —	—	£ — —
16	7.5, 30 and 150 volts	1 17 6	— —	—	— —	25	2 10 0
17	10, 50 and 250 volts	2 2 6	— —	—	— —	26	2 15 0
18	5 milliamps., 15 volts and 150 volts	1 17 6	— —	—	— —	—	— —
19	15 milliamps., 7.5 volts and 150 volts	— —	2 7 6	22	2 7 6	—	— —
20	30 milliamps., 7.5 volts and 150 volts	— —	2 7 6	23	2 7 6	—	— —
21	100 milliamps., 10 volts and 250 volts	— —	2 12 6	24	2 12 6	—	— —

Every Instrument is fitted with a fuse, and a spare fuse is included in the price of each Instrument.
Additional spare fuses, 6d. each.

For Non-Standard Ranges the price will be increased by 5/- per non-standard range.

MANCHESTER RADIO EXHIBITION, STANDS Nos. 59 and 60.

FERRANTI ELECTRIC
LIMITED,
Toronto, Canada.

FERRANTI LTD.,
Hollinwood, Lancashire.

FERRANTI INC.,
130, West 42nd Street,
New York, U.S.A.



**MAINS
POWER
AT A
TOUCH**
FROM THE NEW
EKCO
ONLY 17'6

**M.1 H.T. ADAPTOR FOR D.C.
MAINS - 17/6 COMPLETE**

The cheapest, most compact and handiest—although thoroughly reliable—form of H.T. supply. Provides one tapping of 60 or 90 or 120 volts at 10 milliamps. In the form of an enlarged adaptor, 3" x 2" diameter, fitting direct into the lamp-socket. Suitable for 1 to 3 valve sets only.



**M.2 H.T. MODEL
FOR D.C. MAINS
29/6 COMPLETE**

Provides two tapplings of 60 and 120 volts at 10 milliamps. Suitable for 1 to 3 valve sets only.

Write for full details of the ten new 1927-28 "EKCO" Units!

See them at Stand U4, Manchester!

"FOR EFFICIENCY-EKCONOMISE!"

E.K. COLE LTD DEPT. A., "EKCO" WORKS,
LONDON RD., LEIGH-ON-SEA



Components of Distinction & Quality

Constructor's Kit containing principal components for building a Seven Valve Set, £10. Three Transformers, one Filter, and fixed Condenser, £4. Interchangeable Oscillator Couplers: 250-500 metres, £1. 550-2000, £1. Base for same, 4/-

Pioneers in Super-Het Components

The world-wide success of BOWYER-LOWE Super-Het Components and Receivers has not been due to chance. BOWYER-LOWE were Super-Het pioneers. Long before other manufacturers had begun to think of Super-het production, BOWYER-LOWE designers were at work. Laboratory research was followed by elaborate and exhaustive testing and no component was introduced until it had satisfied the high standards of BOWYER-LOWE performance.



THE WHITE LINE VALVE HOLDER, 2/3.

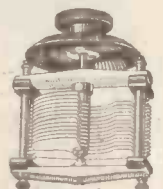

"POPULAR" CONDENSER
"0003 .. 10/-
"0005 .. 10/6

WRITE TO-DAY FOR A COMPLETE LIST OF OUR PRODUCTIONS



BOWYER-LOWE CO. LTD., LETCHWORTH

A BOOK THAT EVERY EXPERIMENTER SHOULD HAVE:
"The Bowyer-Lowe Standard 7 and 8-valve Super-Heterodyne"
How to Build and Operate By A. E. BOWYER-LOWE.
PRICE - - 2/-

Send your remittance for a copy to-day.

THE "B.P.34" TWO-VALVER.

(Continued from page 404.)

oscillates, and again increase the neutralising condenser setting until oscillation ceases. Slightly readjust the tuning condensers again to make sure that the set is completely stable once more. Proceed in this way until it is found that the correct adjustment of the neutrodyne condenser has been overshot. Once this point has been passed it will be observed that further increases of the neutrodyne condenser setting no longer stop oscillation but cause it to become stronger

Reaction Control.

The object is to find such an adjustment of the neutralising condenser as will permit the greatest setting of the reaction condenser to be used without producing oscillation. It will then be observed that when the two tuned circuits are in step and the set is brought to the verge of oscillation a slight movement in either direction of the neutrodyne condenser will cause the receiver to break into oscillation.

With a given station tuned in, increasing the capacity of the reaction condenser should increase signal strength, until a point is reached where the detector valve oscillates. Be sure to use a good H.F. choke, since a poor choke will prevent proper reaction being obtained on the longer waves. The chief requirement of a good choke is plenty of wire and only those which have a very large number of turns should be considered.

Long-Wave Coils.

For 5 X X the aerial coil should be a No. 100 or 150 and the secondary a No. 250 (Lissen or Lewco Coils). The H.F. transformer will need to be changed to one suitable for the 1,000-2,000 metre band.

If greater selectivity is required reduce the size of the aerial coil. For instance, a

No. 25 may be tried on the shorter waves and a No. 75 for 5 X X.

If an L.F. amplifier is connected up to the receiver make sure that the L.T. —

POINT-TO-POINT WIRING.

Join aerial to pin of primary coil holder and earth to socket of same coil holder.

Join pin of secondary coil holder to fixed vanes on first tuning condenser, to bottom of neutralising condenser, and to grid of V_1 .

Join socket of primary coil holder to socket of secondary coil holder, to moving vanes of first variable condenser, to arm of first filament rheostat, to L.T. —, to one filament terminal of V_2 , to moving vanes of second .0005 variable condenser, and to pin No. 2 on six-pin base. Join L.T. — to H.T. —. Join remaining side of first filament rheostat to nearer filament terminal on V_1 .

Join L.T. + to one side of L.T. switch. Take other side of L.T. switch to remaining filament terminal of V_2 , valve holder, to one side of grid leak mounting, and to arm of second filament rheostat. Take other side of filament rheostat to remaining filament terminal on V_2 .

Join remaining side of grid leak holder to grid of V_2 and to one side of .0002 grid condenser. Other side of grid condenser goes to pin No. 1 on six-pin base, and to fixed vanes of second variable condenser. Pin No. 3 on six-pin base goes to top of neutralising condenser, Pin No. 4 to H.T.+1, Pin No. 5 to plate of V_1 , and Pin No. 6 to moving vanes of reaction condenser. Fixed vanes of reaction condenser go to one terminal on .0003 fixed condenser. The remaining terminal on .0003 condenser goes to plate of V_2 and bottom of H.F. choke.

Top of H.F. choke goes to 'phones — terminal. 'Phones + terminal is joined to H.T. + 2.

This completes the wiring.

terminal in the amplifier is joined to H.T. — or you will short circuit your L.T. battery.

AN EXPERIMENTAL CABINET.

The Editor, POPULAR WIRELESS.

Dear Sir,—You have from time to time published in your paper, POPULAR WIRELESS, various types of Experimental Baseboards evolved by readers, and in the hope that the following will be of interest I send details of one I have evolved and which I claim to be the most simple and yet at the same time the neatest, as it can be used as the "finished article," if required, and one's handiwork can be displayed to visitors without fear of awkward criticism.

I enclose rough sketch herewith, by which it will be seen that a framework of polished oak 3-ply (or thicker wood, if required), is mounted on a fairly large baseboard. The cross pieces of the frame consist of battens of 3-ply fixed to form a slot $\frac{1}{2}$ in. apart at both top and bottom. The actual size

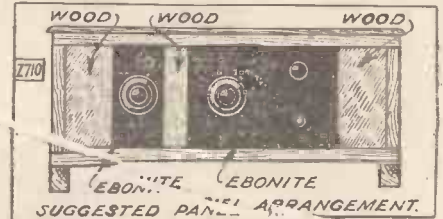

allowed for "panel space" is 26 in. by 8 in., a size large enough to take the biggest of sets. The baseboard is dowelled at each end to take what will be the sides of the cabinet which is also holed to take dowels, and which, when in position, is screwed to sides of frame to give full support. The top side of sides is again dowelled to receive the top of cabinet, which is made $\frac{1}{4}$ in. larger all round to overlap front and sides when in position. The back consists of one stretcher piece in any convenient position to give rigidity when all is assembled.

The whole arrangement can be taken to pieces in about five minutes. When assembled the whole looks even better than a commercial cabinet in view of the neat frame holding the panels.

For experimental purposes, such things as condensers, etc., which should be of one-hole fixing type, can be mounted on small ebonite panels or rather narrow panels just wide enough to take the component. Each panel should be of an even width (mine are 2, 4 and 6 in. wide). When the ebonite panels have been slipped into the slots the remainder of the space is filled in symmetrically with the polished wood panels. The result is an extremely pleasing appearance and a great saving

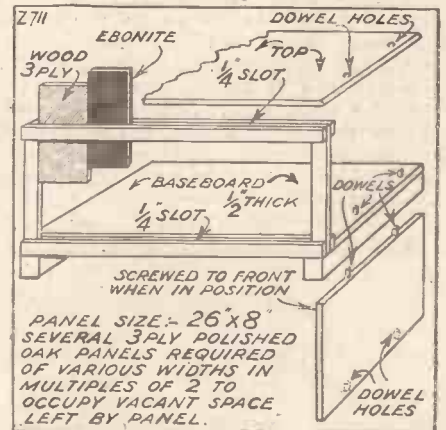

in ebonite. The arrangement also allows for an extremely flexible juggling of the various panels and components.

The baseboard is raised from the bench by means of battens to allow for under-wiring, but as these are screwed the battens can be dispensed with, if required.

My drawing is not quite correct, but as the idea more or less speaks for itself and you think this worth publication you will no doubt make necessary alterations. I had my panels, etc., made up by a carpenter, and the resultant job is more than pleasing.

Yours faithfully,

B. GLADSTONE.

Kensington, W.14.

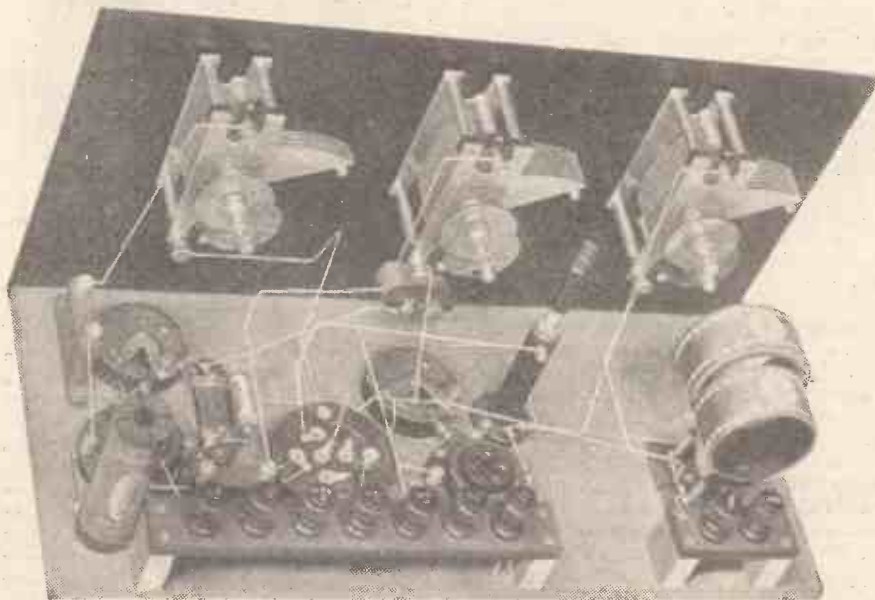

The neutrodyne condenser, which can be seen just behind a valve holder to the left of the coils, requires to be adjusted properly before the set can be efficiently operated. This adjustment is quite a simple one, and it is fully described in the accompanying article.

THIS YEAR'S BATTERY ELIMINATORS.

A Review of the From-the-Mains apparatus displayed at the recent National Radio Exhibition.

By J. R. WHEATLEY.

AT the recent Radio Exhibition held at Olympia it was remarkable to note the keenness of the visitors and manufacturers in H.T. and L.T. eliminators. Until this last year the possibility of efficiently working sets from lighting mains has been looked upon with a good deal of suspicion and doubt. During the latter part of 1926 and through 1927 rapid strides have been made both in the design of super-power valves and in the construction of larger loud speakers to handle the

output from these valves. Whereas in the early days of wireless the actual H.T. voltage required rarely exceeded 100 volts and the current a few milliamps, today all this is changed. We think nothing of using two or even three hundred volts H.T., and our last valve may take 30 milliamps.

The units shown at the Exhibition are really the outcome of months of research work. They are not perfect but the majority are certainly worth every penny asked. Possibly you have considered buying a unit, but have hesitated to do so as you were not sure just whether this or that one would be most suitable. A general description of some of the principal makes is therefore given in the following columns. If you think that a unit will suit your purpose, then write to the manufacturer, giving him the following information: Types of mains available, whether D.C. or A.C.; number of valves and types; and also type of circuit in general use.

One of the K.L.1 type A.C. valves with indirectly-heated cathode.

Special Valves.

Foremost amongst the Marconiphone products was to be seen the new Rice-Kellogg L.S., complete with equipment for use with either D.C. or A.C. mains. The R.-K. would long ago have come to the fore but for the difficulty in obtaining a suitable power supply.

A complete unit for adapting any number of valves up to 5-6 for use with D.C. mains was also extremely interesting. The filament control covers a wide range, and a meter is fitted (which, by the way, is carefully hand-calibrated) so that an exact setting is possible, avoiding any possibility of inadvertent over-running. A similar unit is also obtainable for use with A.C. mains, but in this case the special indirectly heated cathode valves, i.e. K.L.1 and K.H.I,

must be employed. Several interesting H.T. units, ranging from £1 5s. to £3 13s., for use with small sets, are also available.

It is now possible to obtain a special filament current smoothing choke for use with D.C. mains, and also a baseboard-mounting filament rheostat capable of handling several amps. The power drive resistance unit also allows for the use of practically any voltage D.C. mains for filament lighting without the need for any intricate calculations.

New Mains Sets.

Several excellent transformers for use with mains from 100-240 volts, and any frequency above 40 cycles for supplying L.T. and H.T., are likely to prove very useful for the home-constructor.

Amongst the many exhibits by Messrs. Metro-Vick Supplies, Ltd., probably the most interesting were the two new valves. The A.C./G. green spot and the A.C./R. red spot. These valves are intended for use with A.C. mains, and can be directly incorporated in any set by means of a simple adaptor supplied with the valve, price 23s. complete.

The eliminators for use with these valves may be obtained in two types, one which may be regarded as a substitute for the accumulator used with the ordinary type of valve, and the other eliminates both H.T., L.T., and G.B. A selective five-valve set which entirely eliminates batteries by employing the new A.C. valves, and which is capable of giving a wide choice of programmes, is obtainable for the moderate sum of £48 (plus royalties).

Messrs. Igranit Ltd.'s combined auto-charger and H.T. supply units should have found many a purchaser. By means of a very elaborate system of wiring, very simple operating details have been arranged. In fact, it should be possible for even the merest amateur, who has not the slightest idea when an accumulator is fully charged or not, to use one of these units; an automatic cut-out is fitted which entirely removes the human element in this connection.

A simple H.T. battery eliminator is also available giving an output of 30 milliamps at 200 volts, and is fitted with a small ruby indicating lamp which is one of the many excellent points in the design of the unit.

In the past, commercial eliminators have been looked upon in a rather doubtful sort of way, partly because of their size, but Messrs. Climax have settled this point by producing a D.C. unit with one fixed voltage output and two variable H.T. + tapplings in a small box, 4½ in. by 3½ in. by 2½ in., and with a voltage output only a few volts below that of the mains. It is not limited to a few milliamps, but can give up to 50 m/a. at the fixed voltage, and 20 m/a. at each of the tapplings.

Simple Units.

"Atlas" eliminators are of a variety of types, from a simple unit with four fixed

output voltages to the super-model D.C.14 with three-variable tapplings and a variable grid bias supply from 0-40 volts. In the A.C. class six types are obtainable, with outputs varying from a few milliamps up to 60 or 70 m/a. and are thus suitable for use in a multi-stage set employing several super-power valves. This abnormal output is obtained by employing two super half-wave rectifying valves in the unit and arranging the circuit so that full wave is available.

Greater Current Output.

At the radio exhibition in 1925 I greatly doubt whether it would have been possible to find a dozen eliminators in the whole exhibition. In 1927 one manufacturer alone is showing fourteen different types and several sets working direct from the mains.

The Ekeo units have long been known for their sturdy construction and silent working and the 1928 range is even "one better" than 1927.

A written guarantee is also given which guarantees the units for 12 months against it breaking down under fair wear and tear. The range covers a unit suitable for a simple single-valve set, up to such sets as the multi-valvers for use with A.C. or D.C. mains. The combined H.T., L.T. and G.B. unit for use with D.C. mains is certainly an economical proposition, with running costs of only 3d. per hour.

The name Gecophone has always been associated with the elite of radio apparatus, and the eliminators bearing this name are again an excellent example of the G.E.C. products. They are sturdily constructed, and totally enclosed in metal cases, finished in black crystalline enamel. An extremely efficient arrangement is included in both the D.C. and A.C. units whereby the volt-



A Low-Tension Battery Eliminator, displayed by Metro-Vick Supplies, Ltd.

age is kept absolutely constant up to a load of 20/25 m/a. A point which other manufacturers would do well to study. The eliminator will give a greater supply than that stated, but the output voltages will then decrease as the load increases.

An ingenious little battery charger for use with A.C. mains, is the Fellows charger, at £2 5s., which charges at a cost of about 10 hours for a 1d. The charger is simplicity itself and cannot harm either you or your electric light. An excellent A.C. H.T. eliminator with an output of 100 volts, 10 m/a. at £3 10s. is well worth consideration—as also is the D.C. model at £2 10s.



WHO has the best broadcasting voice? The majority of our readers will probably, offhand, give the winning vote to their favourite B.B.C. announcer, or, ignoring the professional element, to Sir Oliver Lodge. Sir Oliver Lodge, although



Lady Askwith.

his talks are of a scientific nature, has undoubtedly that power of arousing interest and close attention, when he speaks from 2 L O, by the very attraction of his voice. Sir Oliver Lodge, indeed, has that essential quality for broadcasting which may be concisely summed up in the word "Personality."

His voice is clear, melodious, and, in short, charming; his articulation is undoubtedly a lesson to all would-be broadcasters, and the evenness and rhythm of his diction incomparably superior to any other male broadcasting lecturer. It is, indeed, primarily the quality of his voice which always makes Sir Oliver Lodge's talks so very welcome, for a beautiful speaking voice is such a rare thing these days that when one does hear one the effect is pronounced.

Famous Broadcasters.

When we turn to consider the question of who has the most attractive and most suitable broadcasting voice from the feminine point of view, the range of choice is wider, for, curiously enough, more eminent women have broadcast than eminent men. At any rate, more eminent women from the artistic point of view.

Listeners have heard the voices of such famous women as Mrs. Patrick Campbell, Miss Sybil Thorndyke, Lady Askwith, Miss Madge Titheradge, and many others too numerous to mention; but judging from the correspondence we have received from readers it would undoubtedly appear that the verdict of the majority of listeners is in favour of a lady who will be recognised by the majority of the readers of this article when I remind them that, when

A postcard to "Ariel," of this journal, giving your answer to the question in the above title will be welcome. Meanwhile, "Ariel" gives a few opinions of his own.

making certain announcements regarding the revues Mr. Archibald de Bear has occasionally arranged for broadcasting purposes, she has usually concluded with the simple words: "Thank you."

The words "Thank you," in cold print, convey nothing out of the ordinary, and if any reader of this article has not heard Miss Enid Stamp-Taylor broadcast he will find it difficult to appreciate the wealth of artistry which can be conveyed in those two very ordinary words.

Miss Stamp-Taylor, however, although comparatively unknown by name to many listeners, has often participated in various broadcasting revues, and everyone who has heard her voice on the radio—quite apart



Miss Enid Stamp-Taylor.

from the subject matter of her remarks—has remarked on the extraordinarily suitable quality of her voice for the microphone.

Now, the microphone is an extremely tricky and capricious instrument. People who have good natural speaking voices, let us say on the stage, often find that when they broadcast the microphone is not too sympathetic to their voices. The ordinary telephone is a very good example of what can only be termed "electro-magnetic cussedness." For example, Mr. Henry Ainley, whose stage voice is reputed to be first-class, does not broadcast very well; but in the case of Miss Enid Stamp-Taylor there is some peculiar quality in her voice and in her method of delivery which, like Sir Oliver Lodge's, makes it distinguished both for charm and clarity far above the ordinary, and which when one has heard it prompts one to say, "What a perfectly delightful voice!"

We are not discussing the singing voice, but the speaking voice. Possibly if Sir Oliver Lodge were to sing "Abide with Me" in front of the microphone the result at the receiving end would not be very attractive; but it is a peculiar fact that although the B.B.C. have many artistes on their books whose singing voices are most attractive, they have scarcely half a dozen people whose broadcast speaking voices can be regarded as interesting, musical, and wholly delightful.

Lady Announcers.

It is another peculiar fact that although the B.B.C. has been in existence for very nearly five years it has never had a regular woman announcer. The only station, indeed, which seems to have invested in this luxury is Rome—the distinguishing feature of that station being the pleasant voice of its lady announcer.

Undoubtedly, Miss Enid Stamp-Taylor has a voice eminently suitable for the rôle of lady announcer. There is an old quotation

(Continued on next page.)



Sir Oliver Lodge.

COFFEE TIN COMPONENTS.

Two Useful Ideas by "AMEC."

SURPRISING as it might seem, there are quite a number of useful radio articles which are capable of being made out of old coffee and cocoa tins, and similar articles of sheet metal.

Such tins generally comprise thin sheet iron of good quality and conductivity, the surface of which has been more or less heavily tinned in order to prevent rusting. A tinned article has a good electrically conducting surface, and, what is more, it readily admits of easy soldering operations being performed on it.

Thus it is that small articles of a radio nature, such as terminal tags, connectors, and so on, which are made out of old tins will serve their purpose quite efficiently.

Two of these articles, are illustrated in the accompanying photographs, Figs. 1

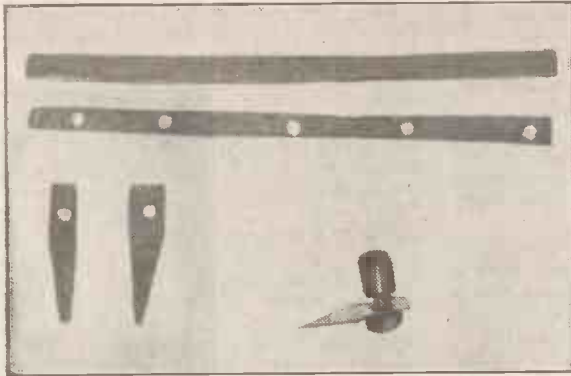

Fig. 1, showing stages in the construction of terminal tags.

and 2. Fig. 1 illustrates a very useful form of terminal connector which can be made in dozens within the space of a few moments. The tin can is first of all cleaned, and then rolled out as flat as possible. After that it is cut up into strips of a convenient length and width. Holes of a size sufficiently large enough to admit the terminal shank passing through them are bored in the strips of metal at distances of, approximately, $1\frac{1}{2}$ in. from one another. A metal strip of this nature, before and after drilling, is shown in the upper portion of the photograph, Fig. 1.

Making Terminal Tags.

The strips are then cut up and tapered in the manner illustrated on the left of Fig. 1. These articles then constitute the final terminal connectors. Finally, on the right of the photograph will be seen a metal terminal connector, made as above, which has been fitted to the under side of a panel contact stud. The connecting wire from the stud is soldered on to the end of the metal connector, and in this way an efficient connection can be secured with the minimum of trouble.

Terminal tags for 'phone or loud-speaker use can also be made from tin-can strips, as the photograph, Fig. 2, will show.

A piece of metal strip, about $1\frac{1}{2}$ in. by $\frac{1}{2}$ in. in size, is cut out, after which it is roughly shaped in the manner shown on the upper right-hand corner of Fig. 2. Finally, the terminal tag illustrated in the lower portion of the photograph is formed. This, after a little final trimming makes the completed tag, an article which in every possible re-

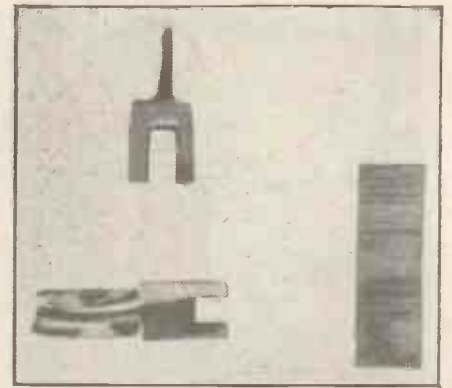

Fig. 2, illustrating the making of 'phone tags.

spect, save perhaps that of appearance, will be fully as efficient as the commercially manufactured product. At any rate, such articles can be conveniently turned out in quantities of a dozen or so for experimental use, and for providing temporary connecting tags for hook-up purposes.

A little consideration will show that many other articles of a like and an equally useful nature can be turned out from a few tin cans, and therefore the amateur who has a bent for experimental radio, but whose purse is not unlimited, will find considerable economy effected by the exercise of a little ingenuity in respects such as the above.

Don't forget your copy of

**"THE WIRELESS
CONSTRUCTOR."**

November Issue Now On Sale. Price 6d.

THE BEST BROADCASTING VOICE.

(Continued from previous page.)

about music having charms wherewith to soothe the savage beast. Perhaps it would be exaggeration to say that the average listener is a savage beast, but it is pretty clear that when the average listener has to listen to the dull voice of a male announcer reading Professor So-and-so's talk on "How Postage Stamp Gum is Made" for a period of twenty minutes, his feelings may at least be described as savage, and his criticism of the monotonous drone of the broadcast talker and of the subject of the talk may be summed up, to say the least of it, as beastly.

Famous Authors.

But think of the difference in such talks if a twenty minute talk of this kind were read to listeners by somebody with a voice which, in itself, gave real aesthetic pleasure. I, for one, am quite prepared to listen to any sort of a talk so long as the talker has a nice, pleasant, musical, and generally charming voice.

It is a curious thing that many of the most famous people in the world have unattractive speaking voices. If my

memory serves me right, Mr. Arnold Bennett has never broadcast. But Mr. Bennett, as everybody knows, is a very famous author, whose works have placed him in the front rank of the world's novelists. Consequently, if it were announced that Mr. Bennett was going to broadcast a talk, most listeners would be prepared to listen to him with considerable interest and attention. But, whatever the subject of Mr. Bennett's talk, I guarantee they would be very disappointed, just as they would be very disappointed to listen to Mr. H. G. Wells. Both these gentlemen, literary gods in the literary cosmos, have unattractive speaking voices. Mr.



Miss Sybil Thorndyke.

Bennett's voice, in particular, is very high-pitched. Mr. Winston Churchill, whose name needs no explanation, has a voice marred by a slight lisp, and although probably 99 per cent of my readers would sooner hear Mr. Churchill speak than Mr. Baldwin, they would find that Mr. Baldwin would make a much better broadcaster than Mr. Churchill.

And so it is with Miss Enid Stamp-Taylor. By some lucky chance the Fates have given her the best broadcasting voice of any woman who has yet appeared before the microphone. Why does not the B.B.C. take advantage of this unique opportunity of securing more frequently the services of someone who, by the charm of her voice, can clothe the most dull and most uninteresting subject with beauty and interest? Voices suitable for the microphone are very few and, indeed, rare. Personality, if it can be got over the microphone, is 99 per cent in the battle of holding the interest of the listener.

An Essential Quality.

Sir Oliver Lodge can talk about astronomy in a highly technical way, and yet can hold the interest of hundreds of thousands of people. And his voice is universally praised by listeners as one of the best and the pleasantest to listen to. The same with Miss Stamp-Taylor. I happen to know that she would be willing to undertake special announcing work for the B.B.C. And when next Mrs. So-and-so has to give a dull talk on the formation of a Dorcas Society, the B.B.C., instead of letting Mrs. So-and-so read the talk, had much better secure the services of Miss Stamp-Taylor and so clothe a futile and idiotic talk with at least the semblance of attractiveness in delivery which is so essential in every phase of broadcasting.

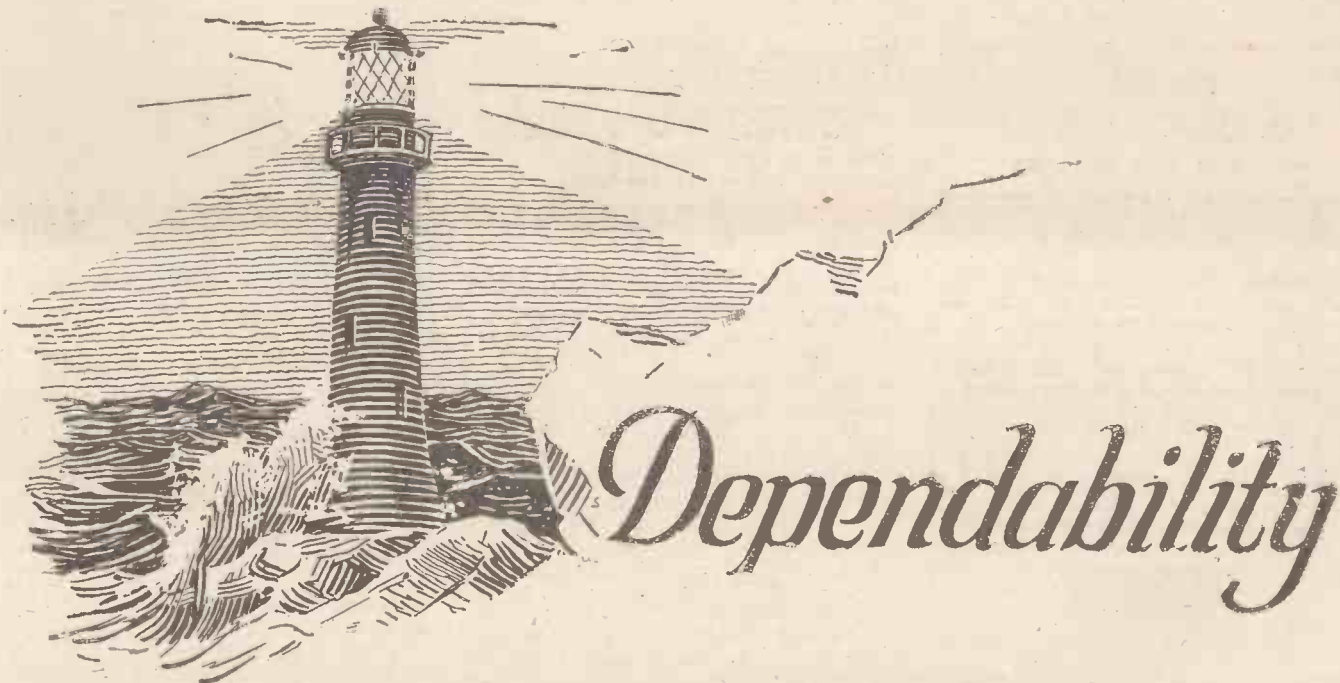

ON BOARD SHIP! A roaring gale, the darkest night; dangerous rocks and shallow water ahead. But your fears subside; for there, clear-cut through the blackness, flashes the lighthouse's ever-present warning. Your faith in the watchdog of the seas never wavers.

And so with ADICO! This outstanding battery will never let you down. Its long life, exceptional recuperative powers, and low price will astound you. If your dealer cannot supply you, write to us now for full particulars, post free.

The ADICO range of batteries includes H.T., Grid Bias, Flashlamp, Dry Cell and batteries made to specification.

Positively the finest value in the world

ADICO

BATTERIES

ADIE & CO., LTD., 2, Aldermanbury Avenue, E.C.2.
Telephone: London Wall 2474.

PRICES:

- H.T., 100 v. - 12/6
- H.T., 60 v. - 7/6
- H.T., 30 v. - 3/6
- Grid Bias, 9 v. - 1/3
- Flashlamp, 4.5 v. 4½d.

PRICES:
DRY CELLS.

- Spring Terminals 1/10
- Screw Terminals
- Large capacity - 2/3
- Torch, 4.5 v. - 1/1
- " 3 v. - 9d.
- " 1.5 v. - 4½d.



CHARGING FROM THE MAINS.

The Editor, POPULAR WIRELESS.

Dear Sir,—The following details of my arrangements for charging accumulators from house mains (and the conveying of current to set) will, perhaps, be of sufficient interest to your readers to warrant publication.

My set is housed on the ground floor and I have a cellar directly underneath where the house meter is fixed.

This has enabled me to install my accumulators on a bench near the meter and is both convenient for charging and feeding to set without moving accumulators.

I have two accumulators, one of which is on charge and the other supplying current to set.

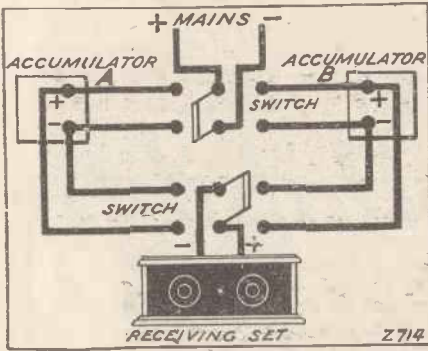

By the switching arrangements shown in sketch on attached sheet I am able to change one accumulator from set to charge and the other from charge to set.

Accumulators, are, of course, charged through house lighting and cost is nil.

My current is 230 volts D.C. and normally the lights on at one time are:

1 x 100 and 1 x 60 and 1 x 40, which gives a charging rate of approximately 0.87 amps, a moderate rate of charge which comfortably keeps pace with my consumption of current.

Yours faithfully,
F. ARMSTRONG.

Seven Kings, Essex.

AN INTERESTING CIRCUIT.

The Editor, POPULAR WIRELESS.

Dear Sir,—I am sending a circuit I came across while doing a little experimenting, thinking it may be of interest to "P.W." readers. I have found it very good.

Yours faithfully,
J. E. S.

Hereford.

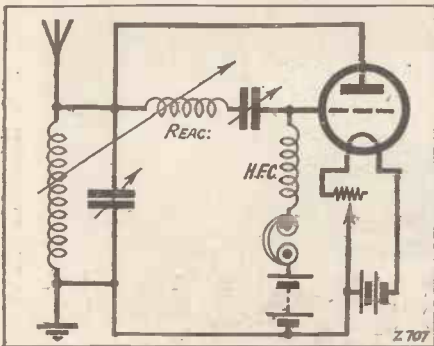

FILADYNE PORTABLE ONE-VALVER.

The-Editor, POPULAR WIRELESS.

Dear Sir,—I feel it my duty to write and thank you for that really excellent little set, the "P.W." Filadyne Portable One-Valver. I had intended to make use of an H.F. valve, and make a larger set altogether, but about that time the Filadyne portable was published and I decided to give it a trial. The results quite exceeded my expectations and never yet has it failed to give good 'phone signals from several stations even during daytime. I have used all kinds of freak aeriels, including a wire mattress indoors at 30 miles from 2 L O, and a short length of flex carelessly hooked over a bush or fence in the open. At Guildford, 2 L O is audible several feet from the 'phones using a piece of flex strung across the room for an aerial and an ancient disused gas-pipe for earth. At Dorking, 25 miles from 2 L O, on my outdoor aerial—which is rather a good one—the one-valver works the L.S. quite audibly.

CORRESPONDENCE.

CHARGING FROM THE MAINS.

AN INTERESTING CIRCUIT—MR. BAGGS REPLIES.

Letters from readers discussing interesting and topical wireless events, or recording unusual experiences, are always welcomed; but it must be clearly understood that the publication of such does in no way indicate that we associate ourselves with the views expressed by our correspondents, and we cannot accept any responsibility for information given.—EDITOR.

Thanking you once again for your excellent paper, POPULAR WIRELESS, and also the "Wireless Constructor."

Yours faithfully,
D. G. H.

Dorking.

ANOTHER FILADYNE SUCCESS.

The Editor, POPULAR WIRELESS.

Dear Sir,—I have roughly "hooked-up" the one-valve Filadyne described by Mr. J. English in an April issue of POPULAR WIRELESS, and can honestly say I am astounded with the results obtained. I am about 65 miles from the "local" 2 L O, which comes through extremely well. The other evening I invited an old wireless "fan" to hear this set, and the first remark he made was: "What splendid reproduction you are getting. It reminds me of a crystal set I once heard working 2 miles from the London station." Last Sunday evening I tuned in about ten stations at really good strength. Another dozen or so came through a little weaker. I am using a nine-months old 60-volts H.T. battery, and a twenty-months old B3 valve. Coil details: Aerial, 75; Filament, 30; and grid, 45.

By the way, has any reader tried this Filadyne on the short waves?

Wishing "P.W." every success.
Yours faithfully,
W. J.

Suffolk.

MR. BAGGS REPLIES.

The Editor, POPULAR WIRELESS.

Dear Sir,—I hope you will excuse my trespassing again on your space but I feel I cannot allow the letter by "Maltese Cross" in your issue for the 17th, to pass without comment.

I have at no time endeavoured to hide my interest in the AF3 transformer, and as the views expressed have been my own I have felt it sufficient to sign my name rather than cover my identity with a non-deplume, and I wish your correspondent would be equally frank, and by giving his name indicate his interest in R.C. coupling, although it seems obvious.

What the B.B.C. do is beside the point as, although it may be presumptuous to suggest that there is anyone fallible in that great institution, there are limits to the expense to which the ordinary individual can go and one should weigh carefully the pros and cons of the suggestions of those who are apt to recommend the user who wants the best results to employ not less than 300 volts H.T., obtained from accumulators of large capacity, charged by means of a motor generator.

A straight-line characteristic is certainly desirable in a good transmitter, but whether this applies to a good receiver is another matter, seeing that the output of all the B.B.C. stations does not comply with the ideal, and even if it did an amplification curve with a rising characteristic at the higher frequencies, such as may be obtained by good transformer coupling, results in better reproduction than if the amplifier has a perfectly straight characteristic owing to the frequencies above 2,000 cycles usually being cut off to an appreciable extent by the combined effects of high-frequency tuning, the small unavoidable inter-wiring capacities on the L.F. side of the set, and if the detector stage comprises an anode rectifier with resistance coupling the higher frequencies are always cut off somewhat by the necessity for shunting the anode resistance with a condenser if proper rectification is required.

As I am out for the best reproduction possible, I shall be very interested to know the names, in confidence if necessary, of any transformers, either British or American, at present on the market, superior to the AF3. As most competent engineers recognise the qualities of that article, and the fact that "Maltese Cross" claims to know one or two better ones, indicates that he has knowledge not generally available or that he does not agree with expert opinion.

Yours faithfully,
J. BAGGS.

New Moston, Manchester.

RAIN RUINS RECEPTION.

The Editor, POPULAR WIRELESS.

Dear Sir,—With regard to the trouble with the rain, I think Mr. Hudson must be using series aerial tuning or has a small fixed condenser connected in series with his aerial tuning inductance.

This will cause the charge induced on the aerial by the rain to build up to such a value that it will leap the gap between the condenser vanes, each spark causing a distinct crack in the earphones or loud speaker.

That the crackle can be more or less tuned-in but never out, is probably due to the lessened resistance of the gap; when the condenser is at its all-in position, the sparking is then very rapid, causing a loud crackle.

I have experienced this trouble, and once during a thunderstorm (not quite the best time to experiment) I was able to obtain sparks over one-eighth of an inch in length. A sharp shock can be experienced by touching the aerial terminal when the aerial is charged.

Reverting to parallel aerial tuning cured the trouble—barring, of course, atmospherics.

Wishing your paper every success.
Yours faithfully,
R. P. W.

Cheltenham, Glos.

"P.W." IS IMPARTIAL.

The Editor, POPULAR WIRELESS.

Dear Sir,—It is refreshing to find a journal devoted to the interests of radio, and not only to those of the B.B.C., as so many daily and weekly publications so slavishly are.

What a treat to find the pages of a wireless periodical free from the adulatory slush and bunkum which abound when the sacrosanct B.B.C. and its "works and pumps" are referred to in the average paper. Your outspoken criticism of the autocratic methods of the Savoy Hill mandarins strikes an echo in the thoughts of the vast majority of radio enthusiasts.

Yours faithfully,
GEORGE MACARDIE.

W. 14.

A 4-ELECTRODE ONE-VALVER.

The Editor, POPULAR WIRELESS.

Dear Sir,—On a separate sheet I give particulars of my small portable one-valve set. It was made in a small wooden box from "junk," and designed to receive the local station on the headphones. Batteries take up very little space, and the total cost is very small.

It is rather late to write to you of it, but perhaps it may be of use to you, for those who spend their holidays in a town with a radio station, and who

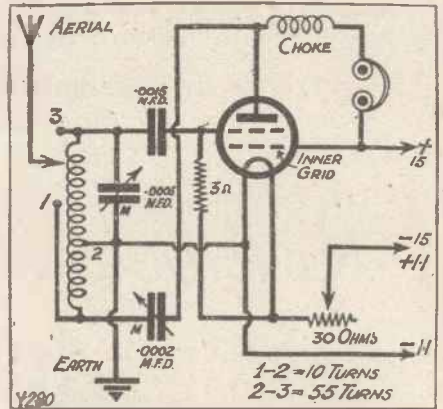

Coil: An old spider-web coil of 65 turns tapped at the 10th turn. H.T. 10-20 volts.

wish to spend but little on a set, mine is, I think, "just what they want"! Properly made-up it can receive half a dozen stations easily; by leaving the inner grid lead loose, an ordinary triode can be used, the set then being an ordinary Reinartz. (In saying that the set can "get" half a dozen stations easily, I imply use of an outside aerial.)

May I thank you for "Modern Wireless" and Co.? They are just sure splendid and full of interest.
Yours very sincerely,
D. M. MACKENZIE.

NEXT WEEK—

How to build The "CUBE-SCREEN" FOUR.

A magnificent long range loud-speaker set.
ORDER YOUR COPY NOW!

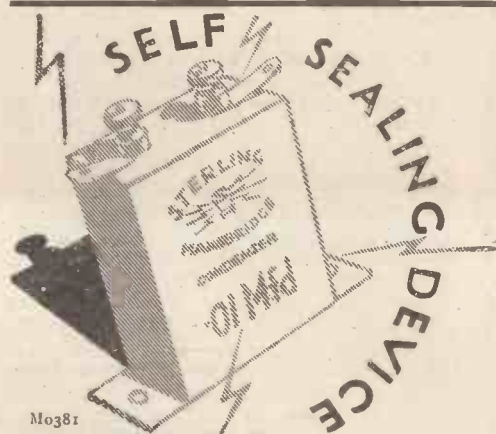

QUALITY FIRST AND SAFETY ALL THE TIME

Not only is a Sterling the best Mansbridge Type Condenser you can buy—but it is protected against dielectric breakdown by the patent self-sealing device. Should the dielectric be punctured, you only need to let the condenser stand idle for a few hours and it is automatically sealed.

Prices from 2/6 for '01 mfd. to £1 for 10 mfd. From your dealer, or full particulars on request.

THE MARCONIPHONE COMPANY LIMITED, (AND REDUCED).
Head Office: 210-212, Tottenham Court Road, W. Regd. Office: Marconi House, Strand, W.C.2

STERLING MANSBRIDGE CONDENSER

Have you had your FREE circuit yet?

6 from which to choose

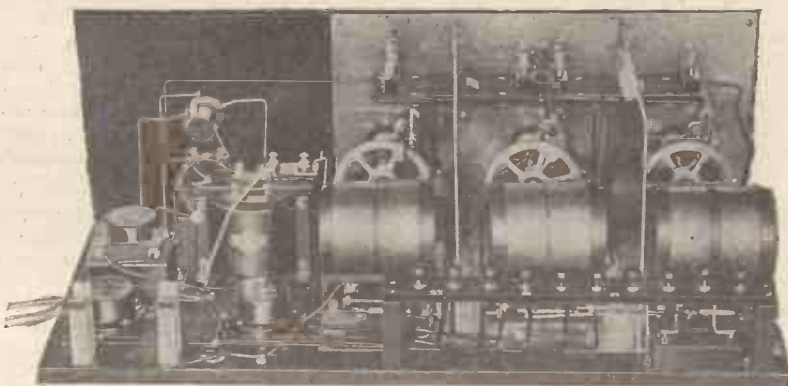

You can easily build a receiver like this from the clear instructions given in the FREE booklet. The set illustrated is the T.2, a 5-valve receiver, incorporating two Marconi S.625 Shielded Valves. It is a revelation in H.F. efficiency.

SIX SPECIAL CIRCUITS by the Marconiphone engineers are offered to the home constructor. Each one designed for a particular purpose, incorporates the very latest developments in radio. Four circuits are for receivers to operate direct from the mains; two show how to get the best results from the Marconi S.625 Shielded Valve.

Here are the circuits for operation ENTIRELY FROM THE MAINS.

- K.1 (for A.C. Mains). 3-valve receiver employing the famous K.L.1 valves.
- K.2 (for A.C. Mains). Similar to K.1, but in addition incorporates an H.F. stage.
- D.P.1 (for D.C. Mains). 3-valve receiver—simple to construct.
- D.P.2 (for D.C. Mains). Similar to D.P.1, but gives greater range and selectivity by means of a neutralised H.F. Stage.

FREE CONSTRUCTIONAL BOOKLET, including blue print and full details will be supplied for any one of these receivers. Booklets (including blue print) of the other receivers, 6d. each.

DISTANCE WITH THE MARCONI S.625 SHIELDED VALVE is achieved to perfection with these two circuits.

- T.1. 4-valve receiver, including 1 H.F. stage, with S.625 valve.
- T.2. 5-valve. Two H.F. stages, with S.625 valves. Stations hundreds of miles away can be tuned in with complete stability.

MARCONIPHONE

SEND THE COUPON NOW

To the MARCONIPHONE CO., LTD. (AND REDUCED), 210-212, Tottenham Court Road, London, W.1.

Please send me free constructional booklet, including blue print for circuit.....

I am also enclosing..... for the following booklets.....

NAME..... TOWN

ADDRESS..... COUNTY..... P.W.



Traders and manufacturers are invited to submit wireless sets and components to the "P.W." Technical Department for test. All tests are carried out with strict impartiality in the "P.W." test-room, under the supervision of the Technical Editor, and the general reader is asked to note that this weekly article is also intended to provide a reliable and unbiassed guide as to what to buy and what to avoid.—EDITOR.

EDISWAN H.F. 210 VALVE.

THIS valve was designed solely for H.F. amplification and it takes 1 amp. at 2 volts. It has an impedance of 30,000 ohms and an amplification factor of 20—very useful characteristics indeed.

The samples sent us by Messrs. Ediswan were tested in various receivers and were found to be most efficient little tubes. Used in conjunction with D.R.2's of the same make very good results could be obtained, results in respect of DX which were well up to those judged as standard for six-volters. And the economy of using such valves as this H.F.210 will be apparent, for the filament consumption is of a very low order. A four-valve set using one H.F. 210, two D.R.2's, and a P.V.2 could be run off a very small 2-volt accumulator cell, for the total current consumption would not be as much as half an ampere.

Messrs. Ediswan's range of valves is

being kept well up to date, and is becoming both important and comprehensive. And in producing this new H.F.210 they will increase their popularity, for there is a great demand for 2-volters these days.

A USEFUL BOOK

We recently received from Messrs. D.A.R. a leather-covered book entitled "How to Understand a Storage Battery." It is illustrated with some very clear photographs and contains some most interesting and useful information about accumulators.

"BECOL" EBONITE.

We have received the latest price list issued by the British Ebonite Co., whose "Becol" panels, low-loss coil formers and other products will be well known to "P.W." readers. And knowing the high standard maintained by the "Becol" people the prices appear to us to be distinctly attractive.

A CARBORUNDUM R.C.C. UNIT.

The Carborundum Co., Ltd., of Trafford Park, Manchester, will be well known to "P.W." readers as the makers of a very useful and efficient carborundum crystal detector unit. This firm has recently turned its attention to the making of anode resistances and grid leaks, and is using carborundum for these purposes. Each grid leak and each grid resistance made by them consists of a solid rod of carborundum, a product of the electric furnace which is nearly as hard as a diamond. This substance would appear to be ideal for the purpose, and we can only imagine that the reason why at least, to our knowledge, it hasn't been used before is because it requires very special plant for its production.

Carborundum is quite unaffected by atmospheric variations and it can stand anything in the way of current within radio receiver limits without affecting its electrical characteristics.

Carborundum Anode Resistances are available in the following values. 80, 100, 150, 250 and 500,000 ohms, and 1, 2, 3 and 5 megohms, at the price of 2s. 6d. each, and they are decidedly attractive



Major Ozanna, formerly manager of the Radio Communication Co.'s Broadcasting Dept., is now London Manager of Wingrove and Rogers, Ltd., who will in future handle the famous "Polar" radio products.

(Continued on page 416.)

MET-VICK (COSMOS) WIRELESS COMPONENTS

Amongst the new and most interesting features in wireless components, seen for the first time at the recent Wireless Exhibition, were the new Met-Vick A.N.P. Coils, Units and Valve Sockets. Intense interest has been roused by the advantages to be had from their use in constructing sets—but for full details ask your dealer for the various literature mentioned below.

A.N.P. (Astatic-Non-Parasitic) COILS

These new "Met-Vick" products provide a clever solution of a difficult problem. They overcome, simply and efficiently, the three difficulties associated with H.F. amplification, namely, Magnetic coupling between coils, Stabilisation, and Parasitic Oscillation. List 4117/8.

RESISTANCE COUPLING UNITS

"Cosmos" ("Met-Vic") Resistance Coupling Units are well known to all wireless enthusiasts. The "V" type can now be obtained fitted with new "Met-Vick" A.C. Valve-holder. The latter is also supplied separately. List 7117/8. Have you seen the new Met-Vick A.C. Valves? Obtain Lists 4117/8 and 7117/8.

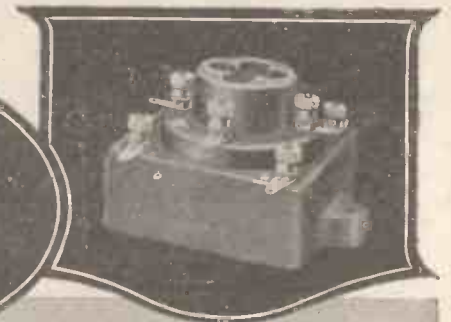
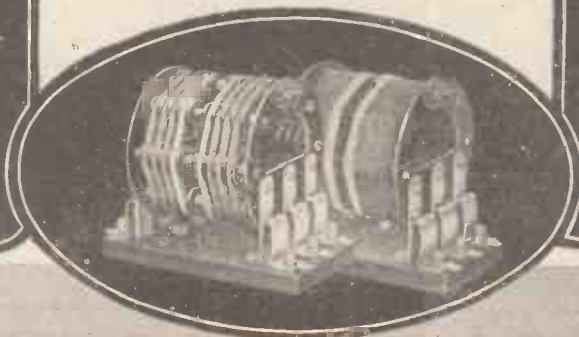

METRO-VICK SUPPLIES, LTD.

(Proprietors: Metropolitan-Vickers Elec. Co., Ltd.)

155, Charing Cross Road, LONDON, W.C.2

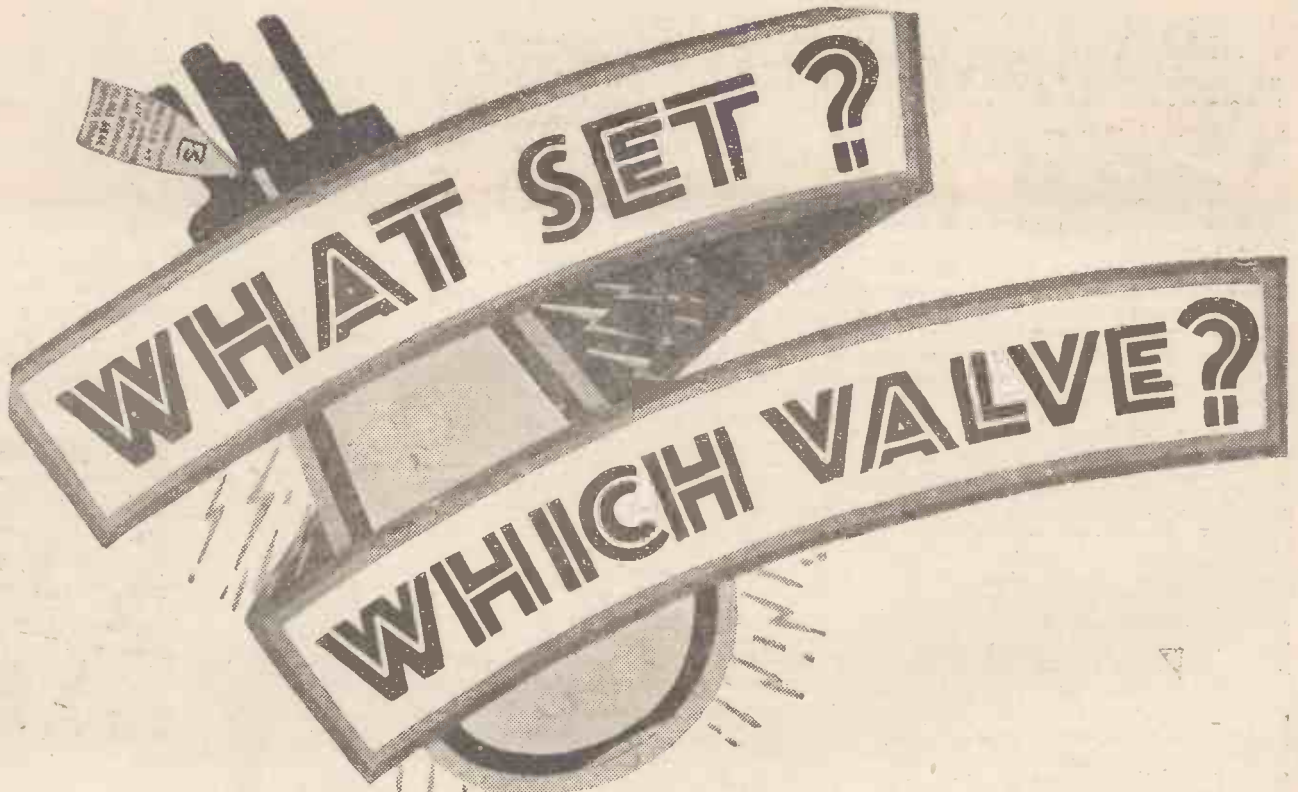

SAY WHAT SET YOU HAVE-AND WE'LL TELL YOU WHAT VALVE TO USE

There are over twenty Ediswan valves — each different — each specifically designed to do a certain thing and do it well.

Choosing valves for your set is like choosing instruments for a band. Each must perform in harmony with the other.

Let us help you to get the best out of your set. Describe the set you have (or the set you're going to build) and post it to us with the coupon below. We will send you a copy of the Ediswan Range booklet with the valves you require specially marked. *Just post coupon.*

See that little window in the Ediswan Valve?

Here's the reason.

The low-current consumption of Ediswan valves (and especially the Quarter-Watt, Point One Economy types) is so low, and the glow is so dull that a window is necessary to tell you if the valve is really operating! Ediswan valves will bring immediate improvement in a set which is already good. Ediswan valves in many sets will bring enchantment out of chaos. Prove for yourself how true is the famous Ediswan Slogan:—

"Clearest, strongest, last the longest!"

EDISWAN



To The Edison Swan Electric Co., Ltd.,
(Publicity) 123/5 Queen Victoria Street, LONDON, E.C.4.

P.W.22/10/27

Particulars of my set are attached. Send your valve booklet marked up with the valves you recommend.

NOTE.—If you would like a copy of the "R.C. Threesome" Book and Blue Print also, place a cross here.....)

Name.....

Address.....



APPARATUS TESTED.

(Continued from page 414.)

propositions if they maintain reasonable standards of consistency in values.

We recently received from the makers of these an R.C. coupling unit embodying two of these carborundum resistances and a mica condenser. The resistances are of the sizes of average dimensioned grid leaks, and they are held in two simple sets of clips on the insulating moulding in which is embedded the condenser. The anode resistance is marked ".5 meg." and we found that it very closely approximates this value. The unit retails at 8s. 6d.

A SPLENDID CABINET.

The tendency these days seems to be to endeavour to make radio sets as much articles of furniture as pianos or cabinet gramophones. The days of weird-looking "hook-ups" are passing, and even experimenting amateurs appear to build their numerous sets on panels and baseboards the cabinets of which are always available, if necessary.

A radio set can be just as tidy and attractive an outfit as a gramophone, and can be built into a cabinet which will also accommodate all the accompanying batteries or eliminators. And some really high-class radio-set cabinets are now available—cabinets as much in advance of the earlier designs as are modern receivers themselves over the sets of a few years ago. We were reminded of all this by the arrival of a "Radiola" Wireless Bureau from Messrs. Pickett Brothers of Bexley Heath. It is a

magnificent production. Messrs. Pickett make all kinds of cabinets, in all kinds of woods, from "flat panel" cases at 1s. 6d. to beautiful pieces of radio furniture at prices reaching £25, and they will also make cabinets to individual specifications. Therefore, the "Radiola" they sent us and which costs £7 15s., is a very happy medium, although it has made us wonder what £25 would buy! But we must hasten to add that we have seen many of their cheaper cabinets and these all seem to represent excellent value for money.

Anyway, this particular "Radiola" Wireless Bureau is modelled on Queen Anne lines, a dignified and graceful style which appeals strongly to us. It is made of solid oak and the doors are framed to prevent warping. The top compartment, which would easily take a five- or six-valve set, is fitted with a baseboard, and the front lets down, bureau fashion. The top of the cabinet can be raised. The bottom compartment is provided with two doors and will take anything in the way of batteries. In fact, its roominess is a feature of the cabinet, and should appeal to those who have had experience of cabinets badly designed in this respect.

The finish of the "Radiola" is worthy of the term "de luxe." The fittings are of the highest grade and the doors open smoothly and fit snugly. The cabinet is brilliantly polished.

We were, as readers may judge by the foregoing, considerably impressed by this "Radiola" Wireless Bureau, and, indeed, it appears to us to be a first-class piece of British craftsmanship. In general assembly it is excellent but it is the attention to detail

that specially appeals to us and provides the hall-mark of quality. £7 15s. might appear to be a lot of money—it is a lot of money to all but millionaires, but spent in buying such a cabinet one gets a good return for one's cash.



The "Radiola" Wireless Bureau which is dealt with on this page.

Build a Loudspeaker worth 5 guineas FROM 27/6

It is much cheaper, and if you use GOODMAN'S Components results and appearance will equal in every way those of the most expensive instruments. Do not be afraid of unforeseen difficulties—without any previous knowledge or skill, if GOODMAN'S Components are used, it is a simple matter to build a highly efficient and attractive Reproducer. Essential parts are the Vibratory Movement and the Diaphragm. For the best results use our Seamless Moulded Conical Diaphragm with either of our Units.

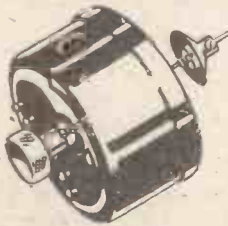

Write for Illustrated Lists (L3) for full particulars. Original unsolicited testimonials can be seen at our Office:

From Cardiff: "I must write and tell you how pleased I am with the instrument (27/6 Unit and Seamless Cone). The tone is excellent, and superior to most and equal to any other, irrespective of price."

Our New Unit (the Junior) is a Reed Unit actually designed for the sole purpose of driving large Diaphragms of the Cone, Pleated disc, or similar type. It is not a converted Earpiece or Gramophone Attachment. Housed in a strong brass case, finished bronze by electrolysis, every part interchangeable, with six screws provided at back, for fitting either to GOODMAN'S Backstays and Frames, or to those made by the Constructor. Adjustable by heavily-plated knob at back. Cone Bushes and strong leads (for Set connections) are supplied with each Unit. Noteworthy features are the specially designed pole piece and bridge, built up from quantities of laminations—not solid. Three heavy magnets are incorporated in each Unit. The ample proportions of all parts render this Unit capable of handling considerable volume, without overloading or distortion. Its general appearance and finish is equal to that of the most expensive instruments. Price 14/6.

The Original GOODMAN Double-Acting Reed Unit, 27/6. The Total cost of the parts shown in the illustration—i.e. Diaphragm, complete with Frames, Backstays, and Vibratory Movement, is only 27/6 for the 12" Cone, or 32/6 for the 15" Cone. Stands 6/6 extra. Complete Sets of parts also stocked for BROWN'S or LISSENOLAS.

If you have any difficulty in obtaining locally, send direct to us, enclosing your Dealer's name and address.

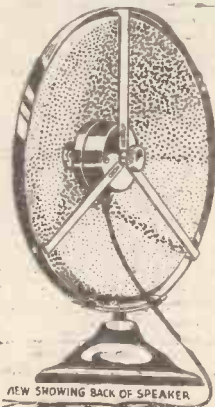

NEW SHOWING BACK OF SPEAKER

GOODMAN'S, 27, FARRINGDON STREET, E.C. 4.

Two Shillings buy what two-and-ninepence did

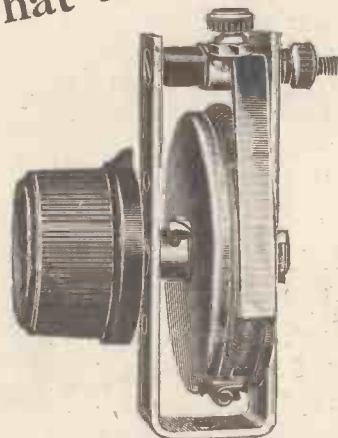

IGRANIC FILAMENT RHEOSTAT

now only

2/-



Now you save ninepence when you buy this IGRANIC FILAMENT RHEOSTAT for it is reduced that much in price.

No reduction in material or its efficiency has been made—it is the same efficient smooth valve control that only Igranic radio engineers can make. Take advantage of this substantial price cut—ask your dealer to show you this IGRANIC RHEOSTAT.

The range also includes the Universal type, Igranic-Patent Porcelain and Bakelite model and Pre-set Resistors.

Write for Publication R.63 which describes them all.

IGRANIC ELECTRIC CO., LTD., 149, Queen Victoria St., London, E.C. 4

Works: BEDFORD. Branches: BIRMINGHAM, BRISTOL, CARDIFF, GLASGOW, LEEDS, MANCHESTER, NEWCASTLE.

EVERYTHING **The G.E.C. ELECTRICAL** your guarantee

Perfect at Every Point

New

Osram Valves

with the New Filament

The Perfect Anode

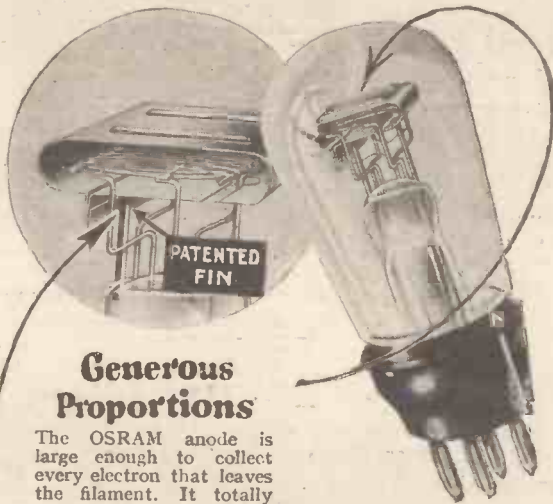

Generous Proportions

The OSRAM anode is large enough to collect every electron that leaves the filament. It totally encloses the active portion of the filament, reducing valve resistance and increasing the undistorted volume of output given to your loud speaker

Firm & Rigid

The anode is ribbed to increase its strength. A new and patented design incorporating a projecting fin increases the area of the weld between the anode and its support wire. This makes for a much firmer contact, and for greater rigidity than if the round edge of the anode were used.

MADE IN ENGLAND

VALVES TO IMPROVE YOUR LOUD-SPEAKER REPRODUCTION

OSRAM	2-volt	4-volt	6-volt	
	D.E.P.215	D.E.P.410	D.E.P.610	Price 12/6 each
	D.E.P.240		D.E.5A	Price 20/- each

Made at the factory with the greatest experience in valve manufacture in the British Empire. Manufactured from raw material to finished product by the same British organisation.



HIGH TENSION BATTERY ELIMINATORS

The convenience of obtaining HIGH TENSION SUPPLY STRAIGHT OFF THE MAINS, where electric light is available, has created a wide demand for High Tension Battery Eliminators.

The Efesca Junior (illustrated), for direct current, incorporates a feature not usually found in low-priced instruments in the provision of Grid Bias, which not only clarifies reception, but suppresses the commutator noises from the generating station usually experienced. It is guaranteed to give satisfactory results when used with sets employing up to 35/- three valves. Price 35/-

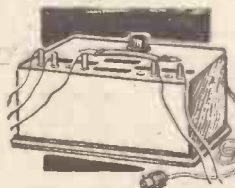

MODEL No. 1

Dimensions, 12 by 7 by 4 1/2 in. Direct Current, suitable for up to five valves.

Contained in polished oak case, with three positive tapplings—one variable 40 to 75 volts, for H.F. and detector valves, and

two fixed at 90 and 120 volts, for L.F. and power valves, incorporating negative grid bias tapplings at 2, 4, 6, and 8 volts. Price £4 10s.



EFESCA
ALL WAVE
REGENERATIVE
AERIAL
TUNER
25/- EACH

EFESCA
VARIFORM L.F.
TRANSFORMER
WITH FOUR
INTERCHANGEABLE
PRIMARY
BOBBINS—
25/- EACH



Write for complete Catalogue of Efesca Components.

FALK, STADELMANN & CO., LTD.,

Efesca Electrical Works,

83/83, Farringdon Road, London, E.C.1.

And at Glasgow, Manchester, Birmingham, Dublin, Newcastle, Cardiff.

RADIOTORIAL

All Editorial Communications to be addressed to The Editor, POPULAR WIRELESS, The Fleetway House, Farringdon Street, London, E.C.4.

Editor:
NORMAN EDWARDS, M.Inst.R.E., M.R.S.L., F.R.G.S.

Technical Editor:
G. V. DOWDING, Grad.I.E.E.

Assistant Technical Editors:
K. D. ROGERS, P. R. BIRD.
G. P. KENDALL, B.Sc.
A. JOHNSON RANDALL.

Scientific Adviser:
Sir OLIVER LODGE, F.R.S.

Foreign Correspondents:
F. M. DELANO, Paris; Dr. ALFRED GRADENWITZ, Berlin; L. W. CORBETT, New York; P. F. MARTIN, Italy; W. PEETERS, Holland.

The Editor will be pleased to consider articles and photographs dealing with all subjects appertaining to wireless work. The Editor cannot accept responsibility for manuscripts and photos. Every care will be taken to return MSS. not accepted for publication. A stamped and addressed envelope must be sent with every article. All enquiries concerning advertising rates, etc., to be addressed to the Sole Agents, Messrs. John H. Lile, Ltd., 4, Ludgate Circus, London, E.C.4.

The constructional articles which appear from time to time in this journal are the outcome of research and experimental work, carried out with a view to improving the technique of wireless receivers. As much of the information given in the columns of this paper concerns the most recent developments in the radio world, some of the arrangements and specialities described may be the subject of Letters Patent, and the amateur and the trader would be well advised to obtain permission of the patentees to use the patents before doing so.

Questions and Answers

VALVES FOR THE FILADYNE.

O. B. (Aldershot, Hants).—"Reference the one-valve Filadyne which appeared in "P.W." dated April 30th, 1927, and which has given me loud-speaker reception from

2 L O (35 miles) since that date. Can you inform me of any modern valves which will work well in this circuit?

"I am using a Marconi D.E.R. 2-volt 4 amp. which has been in constant use for nearly four years. I have tried numerous modern valves, such as P.M.I.H.F., P.M.I.L.F. Osram 1 amp., etc., with very poor results. It would appear from this that the amperage flowing through the circuit has a lot to do with the powerful reception which I obtain from the Marconi 4 amp. This valve only requires 1.5 v. anode bias, which I obtain from the L.T. accumulator.

"I may add that I have made most of the smaller sets that have been published in "P.W." since its inception, and up till now, the 1 v. Filadyne is the pick of the bunch; 29 stations at good phone strength on one valve is, I think, sufficient testimonial to this circuit."

Your results with the old D.E.R. 4 amp. are certainly very good indeed. We have found that the Marconi or the Osram D.E. 2 L.F., which operate on a 2-volt accumulator, and take but 1 amp. work very well indeed in the Filadyne circuit, as also does the Ediswan D.R.2.

In addition there is the B.T.H. B.5, which only takes .06 amp. filament current at 2.8 volts. This valve can be used with 4-volt accumulator or with two large dry cells in series, giving 3 volts.

However, we doubt whether any of these newer types will give quite as good results as can be obtained from one of the earlier D.E.R.'s, such as you possess, as for some reason these older valves seem to be exactly suited to the peculiar properties of the Filadyne circuit. Nevertheless, the two D.E. 2 L.F.'s and the D.R.2 have given almost equal results, both as regards volume and easily controlled reaction with clarity of reception.

ACCURACY IN DRILLING EBONITE.

P. S. (Erdington, Birmingham).—"Although always centre-punching the holes when drilling ebonite, I often find that where several holes have to be in exact alignment, such as in a

(Continued on page 420.)

You must have a precision instrument



for sharp tuning

Modern radio circuits call for critical tuning—critical tuning demands precision condensers—precision condensers means Pye condensers for accuracy and reliability. Pye precision condensers are scientific instruments made one at a time with great care. You need them to get the best from your set.

PRICES—'0001, '0002, '0003 Mid. 17/6 each.
 '0005 Mid. 18/6 "
 '00075 Mid. 22/6 "



W. G. PYE & Co.,
 "Granta Works," Montague Rd.,
CAMBRIDGE.

WATES UNIVERSAL TEST METER

Milliammeter 0-36 milliamps.
 Voltmeter 0-6 volts.
 do. 1-20 volts.

Accuracy guaranteed.
 Dependable.

The voltmeter is High Resistance 3600 ohms.
 Think of the advantage of this instrument.
 You can test your receiver for distortion.
 You can find the drain in milliamps from H.T.

Test voltage of H.T. supply.

Test L.T. Battery.

8/6

Post free 8/9.

Send for our 28-page booklet of the Standard Sac Leclanche Wet Batteries.

THE WET H.T. BATTERY CO.,
 12-13, Brownlow Street,
 High Holborn, London, W.C.

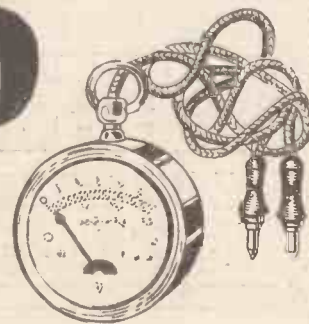

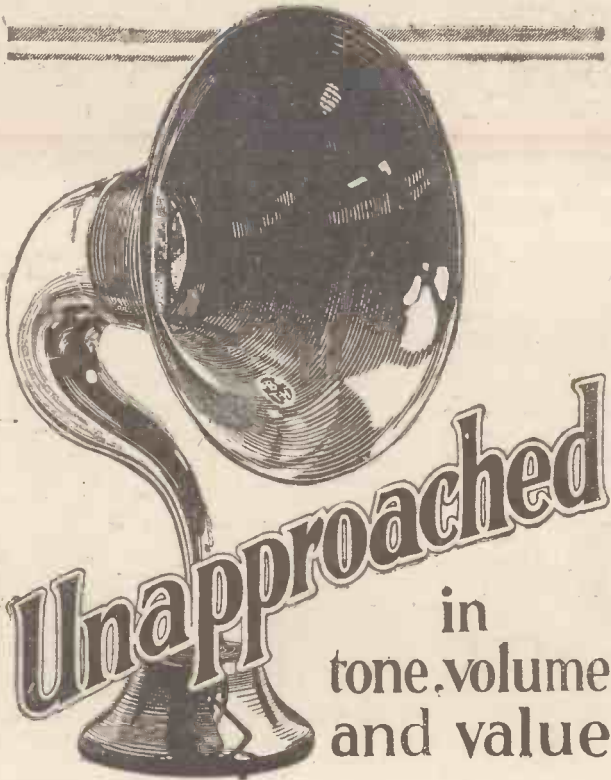

ASK your dealer to let you compare the C2 Loud Speaker for tone, volume and value with any other instrument at anywhere near the same price. Such a test will convince you that in all these qualities it is unapproached by any other maker. It will convince you of the all-round merits of the C2—a full-sized, full-toned instrument of superlative appearance and workmanship for £3.

Full-sized
Full-toned
£3



LOUD SPEAKER
TYPE C2

2809

The British Thomson-Houston Co., Ltd.



RECUPERATING AGENT
IN THE
HELLESEN
DRY BATTERIES.

THE proof of a Dry Battery is the number of hours of efficient service you can get out of it for the money you spend. We are confident of the result if you rely on a Helleesen Dry Battery for your H.T. Supply.

Get a smooth uniform H.T. Supply at the minimum cost per hour from a sealed genuine Helleesen H.T. Battery with the quadruple insulation and the No. 7 Recuperating Agent.

60-volt "WIRIN" 12/6
99-volt "WIRUP" 21/-
(Postage Extra.)

All types, voltages, etc., in Double and Treble capacities for H.T. and L.T. Supply. Ask your dealer for the type to suit your set and get the maximum service, or write us for full particulars. Obtainable at all Radio, Electrical and General Stores, Harrods, Selfridges, etc., or direct from

A. H. HUNT, Ltd. (Dept. 12), CROYDON, SURREY.



MADE FOR THEIR JOB

THESE HOLES

Patent No. 246977



Enable the Rapid Building-up, with Tappings each 4.5 volts, of any size H.T. Unit. No connection to solder, no danger of a weak connection and no container required.



THESE POINTS

Patent No. 240314.

Protect every "Cordesia" Battery against usage before sale thereby securing you "100% value of your purchase." Protecting a Battery containing "the Maximum of Capacity" they enable a guarantee of complete satisfaction.



Specify "CORDESIA" but always see the seals are unbroken.

MAINTAINED PRICES.

4.5 Pocket Lamp Battery—
5d. each, 4/6 dozen.

HIGH TENSION.

Grid Bias	1/3	each
S.T. 60 volt	7/3	"
S.T. 100 volt	12/-	"
T.C. 60 volt	7/6	"
C.S. 60 volt	8/6	"
C.S. 90 volt	12/-	"
C.S. 100 volt	13/6	"
S.C. 60 volt	14/6	"
S.C. 72 volt	17/-	"

BUY BEST BATTERIES CORDESIA



RADIOTORIAL QUESTIONS AND ANSWERS

(Continued from page 418.)

six-pin fitting, little errors creep in through the drill wandering. How can this be prevented?"

The best way is not to rely on the drill starting itself accurately in the hole left by the centre punch, but to first cut this hole deeper with a multi-bladed countersinker. This is a small rose-bit with many cutting edges, and with it the hole started by the centre-punch can be deepened without any tendency to get out of alignment.

If, however, the actual working drill is used and has to start from a centre-punch hole, there is nearly always a slight but appreciable "side-slip," due to the unequal cutting edges which the end of the ordinary drill presents to the chonite. The proper multi-bladed bit will, however, cut straight down without wandering.

THIS SCREENING BUSINESS.

G. H. H. (Haywards Heath, Sussex).—"Is all this screening business really necessary? Two or three years ago we made up sets without thinking of putting copper plates here, and biscuit tins there, and moreover

THE TECHNICAL QUERY DEPARTMENT

Is Your Set "Going Good"?

Perhaps some mysterious noise has appeared and is spoiling your radio reception?—Or one of the batteries seems to run down much faster than formerly?—Or you want a Blue Print?

Whatever your radio problem may be, remember that the Technical Query Department is thoroughly equipped to assist our readers, and offers an unrivalled service.

Full details, including a revised scale of charges, can be obtained direct from the Technical Query Dept., "Popular Wireless," Fleetway House, Farringdon Street, London, E.C.4.

A postcard will do: On receipt of this an Application Form will be sent to you, free and post free, immediately. This application will place you under no obligation whatever, but having the form you will know exactly what information we require to have before us in order to solve your problems.

those sets used to give good, reliable results. But now all the latest H.F. designs seem to want screening here and there, and everywhere—even screens between condensers—and what I should like to know is aren't we slavishly following a fashion? Why are these screens so necessary nowadays?"

Three or four years ago there were few screens in use because they were unnecessary in most cases. The valves used for H.F. work then had a magnification factor of only about eight. But now we have valves in common use which have magnification factors of from 16 to double or treble that figure, and we are starting to use valves which have a "mu" of 100 and more. Consequently, couplings which at one time gave no noticeable ill effects now have to be screened against—unless, of course, you want to continue to use the old valves with no H.F. kick in them worth mentioning.

NEUTRALISING AN H.F. STAGE.

H. T. W. (Merton Park, London, S.W.).—"What is the method of neutralising an H.F. stage by means of the 'silent point'?"

This method is only applicable where the set is being used near enough to a transmitting station for the signals from this to be really strong, but it gives good results up to distances of fifteen miles or so. To neutralise the H.F. valve, turn off the filament, but leave the valve in its socket. (If there is no rheostat which can be turned off, its filament circuit must be broken. In cases where a fixed resistor is used this may be removed from its holder.

In other cases, it is generally best to wrap thin paper or other insulator round one of the valve's filament pins, so that its filament circuit is broken even when it is in position in its holder.)

When the tuning controls are set as usual, it will be found that signals from the local station still come through, even though the H.F. valve is not alight. Listen carefully to these signals whilst varying the setting of the neutralising condenser, and it will be noticed that at one point adjustment of the neutralising condenser has the effect of weakening the signals. So carefully adjust the neutralising condenser with the object of getting signals to fade away altogether.

This may not be easy, because sometimes a slight readjustment of the tuning control will bring in signals again.

But providing there is not much stray capacity owing to insufficiently spaced wiring, it should be possible to find a fairly sharply defined setting of the neutralising condenser at which the local station's signals are inaudible, or nearly so. It is in this position that the neutralising condenser should be set, so if a "lock" is provided, the plates may be fixed at this point, and will not need readjustment unless another valve is used.

WET CELLS FOR H.T. BATTERIES.

J. V. C. (Windsor, Berks).—"I have been trying the wet type of H.T. instead of using

WHAT IS WRONG?

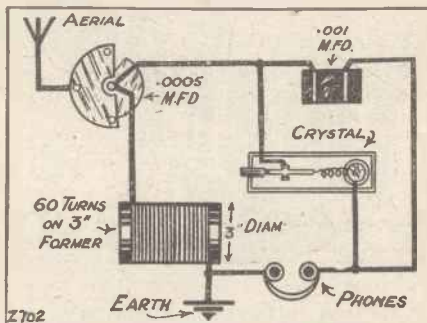

The above diagram is supposed to represent a series-tuned crystal set, of the type shown last week, under this heading. But it is wrong, and the set would not work efficiently. Can you see why?

Next week the correct diagram will be given, and to test your skill we shall continue to publish every week a diagram in which a mistake, (or mistakes), has been inserted. The correction will be published the following week, and the series will work up from a simple crystal set to multi-valvers.

No prizes are offered, but by following this series and trying to solve the problems week by week the reader cannot fail to learn a lot about correct connections.

dry-cells, and although it seems pretty good, I get a lot of trouble with the acid creeping. The cells were bought separately and made up at home, and I move the battery about as little as possible, but I find that the great disadvantage of this creeping acid always crops up sooner or later. How can this be cured?"

Creeping of the acid can hardly be cured, but it can be prevented if the sides of the container, etc., are kept perfectly dry. To allow the acid to splash or to spill about is fatal, so great care must be taken that each cell is perfectly dry before the acid is put in, and then this must be done very gently, with a filler such as a glass nasal douche, or glass fountain-pen filler—the great necessity being to let the acid flow in gently without splashing. If the cells are perfectly dry to start, and the acid is run in gently in a small stream, with no splashing, the creeping should not again give trouble.

BEST POSITION FOR A CRYSTAL SET.

P. T. (High Wycombe, Bucks).—"I am putting in a crystal set, and as this is a fair distance from 2 L.O. and from Daventry, I want to get the set in the best possible position to pick up the programmes. There are two places where it can go—upstairs, with a lead-in

(Continued on page 422.)

QUALITY CONDENSERS

INCORPORATING THE FINEST POSITIVE SLOW MOTION DEVICE YET PRODUCED.

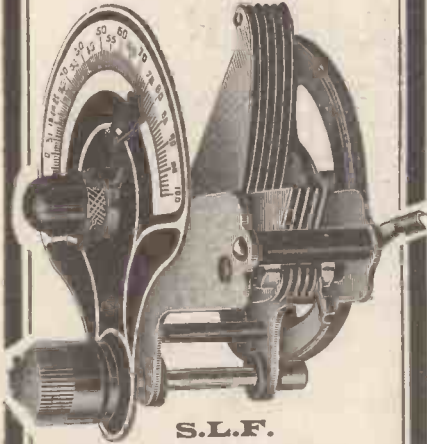

S.L.F.

SLOW MOTION STRAIGHT LINE FREQUENCY. Beautifully designed, this Condenser is an ideal instrument for use in any type of Receiver which calls for precision. Supplied with an attractive bronze scale richly engraved, adding to the appearance of your set. A masterly piece of workmanship.

PRICES:
 .0005 .. 17/-
 .0003 .. 16/-
 .0002 .. 15/6

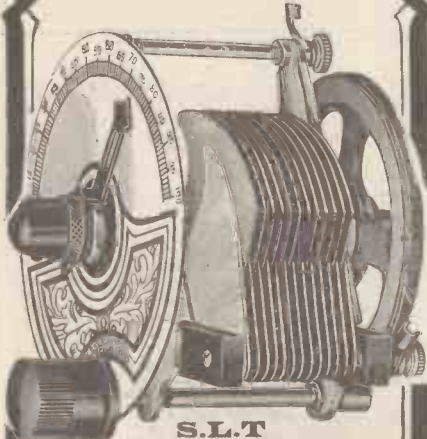

S.L.T.

SLOW MOTION STRAIGHT LINE TUNING. Experts are unanimous in their opinion that this is the best S.L.T. Condenser yet offered the public. The Slow Motion device (as on the S.L.F. Condenser shown above) is highly efficient. Special cone and floating ball race bearings carry the Rotor, ideal for Broadcast short-wave work. One-hole fixing.

PRICES:
 Single. .0005, 13/-; .0003, 12/6;
 .0002, 12/-;
 Triple (rotors electrically separated):
 .0005, 50/-; .0003, 48/6.

LAMPLUGH BEST RADIO

"LAMP-LOO"
S. A. LAMPLUGH, LTD.
 King's Road, Tysley
 BIRMINGHAM.

Distributors for London and Southern Counties—G. O. Shore & Co., 28, Newman St., Oxford St., London, W.1.
SEND FOR LISTS.

RADIOTORIAL QUESTIONS AND ANSWERS

(Continued from page 420.)

near the aerial, and an earth straight down to a flower-bed under the bedroom window. Or downstairs with lead-in running along the wall and an earth on to the scullery water tap. (See sketch I am enclosing). Which would be the better position from an efficiency point of view?"

The results would be much better with the set upstairs, as this needs very short leads indoors, and you should be able to get a good earth by burying a large metal "plate" underneath the window. The long alternative route for the lead-in would certainly not be compensated for by the fact that you would then be getting a water-pipe earth, for if the buried plate is large and in really moist soil, it should be quite as efficient in itself as the water-tap method, and you would have the advantage of not having to bring the lead-in from the front of the house to the back.

THE CAUSES OF DISTORTION.

"SANDY" (Silloth, Cumberland).—"What are the faults which give rise to distorted reception? (The set is a three-valver.)"

CRYSTAL SET, WITH "SERIES" TUNING.

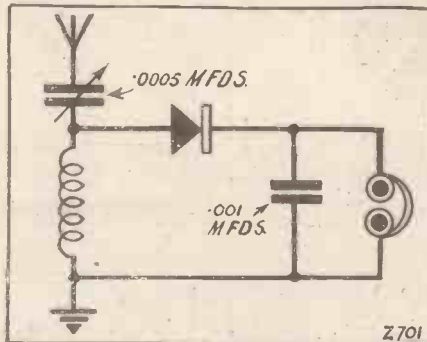

The correct connections for an ordinary crystal set, with "series" tuning, are shown above. (See also last week's "P.W.")

Instead of an '01 tuning condenser (which is about twenty times too big for good results), a tuning condenser of .0005 mfd. should be used.

Similarly the "shunting" condenser across the 'phones should be about .001 mfd. The 2 mfd. condenser, shown in the "What is Wrong?" diagram last week, was about 2,000 times too big, and would have prevented anything from being heard in the 'phones.

It will be noted, too, that the crystal 'phones circuit must be connected across both ends of the tuning coil, and not only to one end, as was shown in the test diagram.

There are, alas! a large number of faults which either alone or in conjunction with each other, will produce distortion. To decide which is the likeliest in your case, it will be necessary to know what circuit the set employs, together with details of the valves, L.T. and H.T. supply, etc. (See the Query Department's Application Form.)

The commonest causes of distortion are:
 (a) The use of too much reaction, generally due to a reaction coil having too many turns, or to a reaction condenser of too large a capacity. (In some sets the reaction-condenser effect is obtained via the neutralising condenser.)

(b) Incorrect voltage. Generally the H.T. voltage or the grid-bias voltage are to blame, but it is possible that the L.T. voltage, if not correct for the valves in use, will cause distortion.

(c) The use of a grid-leak of an unsuitable value.
 (d) Deterioration of one or more of the batteries.
 (e) Insufficient smoothing or by-passing in apparatus for taking current from the electric-light mains.

(f) The use of unsuitable or deteriorating valves. This latter is the likeliest cause of all. Much information as to cause can be gleaned from when and how the trouble developed, so the more details of this that can be furnished the better.

The DIX-ONEMETER

is a precision instrument of universal use, with an ingenious system of Multipliers which enable full scale readings of any value to be made over as wide range. 1 millivolt to 2,000 v., or 50 ohms to 50 megohms. Mirror Scale, jewelled knife-edge, a £10 De-Luxe Model for 55/-.



The VIOLINA Loud Speaker is constructed on cabinet lines, and gives wonderful reproduction over the complete tonal range. The loud speaker De-Luxe is of beautifully polished mahogany. Price, complete with Reed producer and Cord, 25/-.

Distant Control Switch Relay. This is the most efficient method of Distant Control for all who use valve receivers. Simple to connect up and easy to operate; only two connections to L.T. Battery, and two to control circuit. Can be used in all L.T. Circuits of 2 to 8 volts up to 5 amps. Indoor type, which is enclosed in a fine polished oak case, 15/-; Outdoor type, in watertight brass case, 17/6.

Our New 72-Page Catalogue is now ready! Over 1,000 bargains are listed and hundreds illustrated. Send 4d. in stamps to—

ELECTRADIX RADIOS,
 218, UPPER THAMES STREET, E.C.4.

WIRELESS CABINETS

TABLE PEDESTAL PORTABLE
 Made to your own special requirements. Send particulars and we will quote prices.
W. R. NURSE, Union St. Cabinet Works, KING'S LYNN

GAMBRELL CENTRE-TAPPED COILS

not only give the best results, but are unlimited in use, as they can be employed in any circuit, centre-tapped or otherwise.

SIZE.	APPROX. No.	PRICE.	OF Turns.
a2	4/10	18	
a	4/10	25	
A	5/1	30	
B1	5/3	40	
B	5/6	50	
O	5/9	75	
D	6/3	100	
E1	6/9	150	
E	7/9	200	
F	8/6	300	
G	10/-	500	



There is a Gambrell Coil Holder specially designed for use with above coils which does away with all flexible leads. Price Quoted 1/9 each. Centre-Tapped Coils. 6d. Extra.

GAMBRELL BROS., Ltd.,
 76, VICTORIA STREET, London, S.W.1.

RADIO REGISTERED PANELS

7x 5, 1/-		6x 6, 1/-
7x 6, 1/3		8x 5, 1/2
8x 6, 1/4		9x 6, 1/7
10x 8, 2/1		11x 8, 2/3
10x 9, 2/4		12x 8, 2/6
12x 10, 3/-		12x 9, 2/10
14x 12, 4/-		14x 10, 3/5
14x 7, 2/7		16x 9, 3/6
16x 8, 3/2		1 in. thick. Post Free.

Money back guarantee that each and all Panels are free from surface leakage. Megger test Infinity.
CROXSONIA CO., 10, South St., Moorgate, E.C.2.

Phone: Clerkenwell 7853
 Agents: John Henry Smith, 139, Anlaby Rd., Hull
 L. H. Helyar, 82, Chamberlin Rd., Norwich.
 A. Stredwick & Co., 27, The Market, Chatham.
 Boynton & Co., Ltd., 34, Bradford St., Birmingham

EASY PAYMENTS

LOUD-SPEAKERS, HEADPHONES, H.T. ACCUMULATORS. Anything Wireless. Send a list of the parts you are requiring, and we will send you a quotation on monthly payments.
H. W. HOLMES, 29, FOLEY STREET,
 Phone Museum 1414. Gt. Portland St., W.1.

EBONITE BUSHES

FOR MOUNTING ON METAL OR WOOD PERFECT INSULATION
 Orders under 1/- send 1d. Postage. Two required for each hole.
NUMBER 0 1 2 3 4 5 6
 Hole in Bush 6BA, 4BA, 2BA, 1", 5/16", 3/8", 7/16"
 Price each: 1d. 1d. 1d. 1d. 2d. 2d. 2d.
 (Complete List of sizes free on application.)
DAREX RADIO CO.,
 Waldram Rd., Forest Hill, London, S.E.
 TRADE SUPPLIED.

NO CRYSTAL SET USER SHOULD BE WITHOUT

The NON-VALVE MAGNETIC MICROPHONE BAR AMPLIFIER (Patent No. 248581-25)



which operates any LOUD SPEAKER direct from any CRYSTAL SET up to 6 miles or more from main Broadcasting Stations; or makes WEAK RECEPTION LOUD AND CLEAR in HEADPHONES under any conditions. Enables even VERY DEAF PERSONS to hear from Crystal Sets. Works perfectly on one or two dry cells, no other accessories being needed. May be used on small valve sets.

EVERY AMPLIFIER GUARANTEED.

NO Valves, Accumulators : : : **NO FRAGILE PARTS.**
or H.T. Batteries.

EASY TO ADJUST. NOTHING TO GET OUT OF ORDER.

Price **34/-** Post free. **2 DRY CELLS,**
(Without Battery) lasting 3 months **4/-**

ILLUSTRATED LITERATURE SENT FREE ON REQUEST.

Obtainable from your Dealer or from Sole Manufacturers and Patentees:

NEW WILSON ELECTRICAL MANUFACTURING Co., Ltd.,
18, FITZROY ST., LONDON, W.1. Telephone: Museum 8974

"MAXALDING" BROADCASTS HEALTH AND STRENGTH!! WON'T YOU LISTEN IN?



THIS WONDERFUL METHOD OF DRUGLESS HEALING is fully described in a 14,000 word illustrated treatise, which deals lucidly with the following subjects:—

Constipation, Indigestion, Headache, Neurasthenia, Lung-weakness, Flat Chest, Distended Abdomen, Obesity, etc.
Muscle-Control, Abdominal-Control, Direct Exercise to the Internal Organs, Full-Tidal-Breathing, Energy-Conservation, Suppleness, Speed, Great Strength and Heavy Muscular Development.

NO APPARATUS!! NO DRUGS!!

The illustration shows the superb physique of Maxick, the discoverer of the Abdominal-Control Feats. Muscle-Control and Abdominal-Control are taught to all Maxalding Students.

THE TREATISE IS ENTITLED:— NATURE'S WAY TO HEALTH

One copy of this valuable treatise will be sent Free of Charge, Postage or Liability, to any applicant (Lady or Gentleman), residing in any part of the world.

If you include a letter dealing with any functional disorders of which you wish to be relieved, any sport at which you wish to excel or any particular degree of physical condition you wish to acquire, Mr. Saldo will include a diagnosis of your case, and send it with the Treatise under sealed cover.

Please send your name and address to:—

Mr. A. M. SALDO (Dept. 91), MAXALDING 14, CURSITOR STREET, LONDON, E.C.4

THE FINISHING TOUCH

Belling-Lee Terminals are the finishing touch to every good receiver. Belling-Lee Terminals are a perfect combination of Beautiful Finish and First class Workmanship. Bakelite insulated and made in 30 different engravings.



Patented.

Type 'B' illustrated, sold in attractive carton carrying a year's guarantee.

Price 9d. each.

Type 'M' as type 'B' but non-insulated.

Price 6d. each.

Illustrated catalogue free on request.

BELLING-LEE TERMINALS

Belling & Lee, Ltd., Queensway Works, Ponders End, Middlesex.

TECHNICAL NOTES.

(Continued from page 392.)

Power Consumption.

Have you ever calculated the amount of power which is consumed in the different parts of a wireless set? The calculation is very simple and the figures are rather interesting.

Probably nine people out of ten would say at once that the power consumed in the filament circuit was much greater than that in the plate circuit. This, however, is not necessarily the case, particularly when modern dull-emitter valves are used. Suppose the filament current to a valve is $\frac{1}{4}$ of an ampere at 4 volts—the power is 1 watt. If the plate circuit carries 10 milli-amperes at 100 volts the power is again 1 watt, so that in such a case the power in the plate circuit would actually be equal to that in the filament circuit. Of course, it is unlikely that the plate current with a single valve would be so much as 10 milliamps, although the total plate current in a multi-valve set might well be considerably more than 10 milliamps. On the other hand, the valve filaments may consume only .1 or even so little as .06 amp., at 3 volts, the power consumed in the filament circuit of each valve being in the first case .3 watt and in the second case .18 watt.

Rectifier Valves.

When we come to gas-filled rectifier valves, the relation of plate current to filament current may be much upset, owing to the fact that the plate current is not carried entirely, or even principally, by the emission from the filament.

Considerations such as the foregoing are interesting when we apply them to the other parts of the circuit. For example, what power ultimately goes into the loud speaker, considering the latter as an electric motor or machine? Again, how much power is converted into sound-waves in the air? How does this power compare with that actually emitted by the various musical instruments, the sound from which is being produced? It has been said that the maximum sound output of a piano, struck with all the fingers of both hands, is less than 3 watts. This, of course, means the power actually converted into sound-waves.

Valves from the Mains.

Now that valves designed to work direct from the electric-light supply are coming to the fore, it is interesting to note that there are three chief methods of construction employed in valves of this type. There are (1) the heating coil enclosed in an oxide-coated tube or "thimble," which latter acts as the electron emitter or cathode; (2) the valve of more or less ordinary construction, but with a heavy filament or a heavily-coated filament (sometimes referred to as a "fat" filament) designed to retain its heat throughout the current fluctuation of a complete cycle; and (3) the valve in which the heat from a subsidiary heater, drawing current from the mains, is focussed upon the cathode, after the fashion of the concave or bowl electric radiators used for domestic purposes.

In type (1) the plate and grid returns are wired back to the thimble, but do not connect with the heating coil; in type (2) the plate and filament connections are

(Continued on page 426.)

-even the Critics are enthusiastic

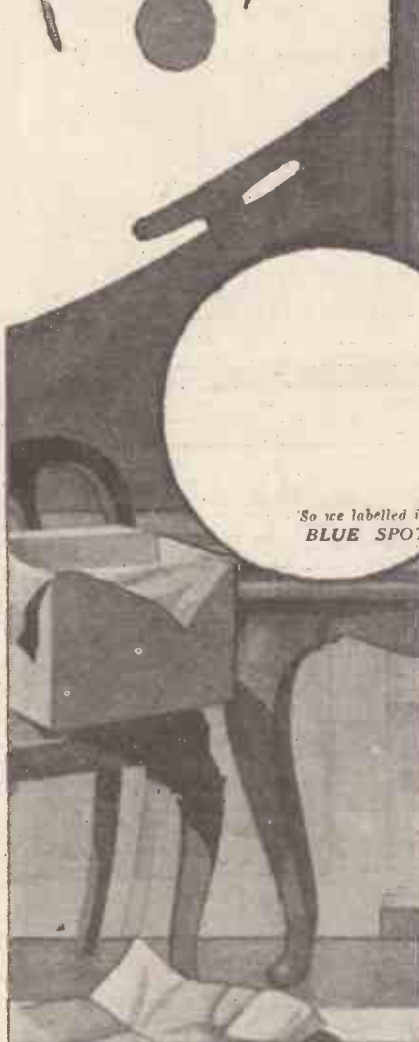

So see labelled it BLUE SPOT

F. A. HUGHES & Co., Ltd.,
 204-206, Great Portland Street, W.1.
 Telephone: Museum 8630 (3 lines).
 Telegrams: Distancing, Wesdo, London.
Manchester Office:
 6, Booth St. East, C. on M., Manchester.
 Telephone: Ardwick 3709.

TRADE MARK "RED DIAMOND"
 THE RECOGNISED DETECTOR FOR ALL CIRCUITS USING CRYSTAL RECTIFICATION.



RD40 2/-

Shield for same, 6d.

By Insured Post 2/3 or 2/9 with shield. Can be mounted on brackets or through panel. Once set always ready. Not affected by vibration. Each one is tested on broadcast before despatch, and is perfect. Of all high-class Radio Dealers or Sole Makers:—

JEWEL PEN CO., LTD.,
 (Radio Dept. 46), 21-22, Gt. Sutton St., LONDON, E.C.1.

MAHOGANY CABINETS
 Hand polished, moulded top and bottom, hinged lid, 8" baseboard, 1/2" polished ebonite panel and back strips. 12" x 8" x 9", 22/6; 16" x 8" x 9", 27/6; 20" x 8" x 9", 32/-; 21" x 7" x 9", 32/-. Also two-compartment model. Many testimonials. Carr. paid.
J. H. TOOMEY 137, Riversdale Road, BISHOPSTOWN, N.5.

DAREX
Safety First
 SAVE VALVES and Batteries. Accidental Damage avoided. Descriptive List free on request.
TERMINALS
DAREX RADIO CO.,
 Waldram Rd., Forest Hill, London, S.E.23.
 TRADE SUPPLIED

"THE WIRELESS COMPETITOR,"
 The most competitive and comprehensive list of Wireless Components yet published. Wholesale prices to traders only.—Dept. P.W., **THE PERSEUS RADIO, Burton-on-Trent.**

CABINETS
 for
COSSOR "MELODY MAKER"
 Cabinet in Jacobean Oak 30/-
 Baseboard 2/-
 Resistor Panel 21" x 7" 9/3
 Resistor Terminal Strip 2/-
 (If drilled, 2/- extra for the pair)
TRADE SUPPLIED—
 Write for Terms
UNICA CABINET CO.,
 73, Camden St., London, N.W.1.
 9759

HEADPHONES REPAIRED
 Rewound and re-magnetised 4/- per pair. Loud Speakers repaired 4/-. Transformers rewound 5/- each. All work guaranteed and tested before delivery. Write for Trade Prices. Phone: Clerk 1795
MASON & CO., 44, East Rd., City Rd., N.1.

EVERYTHING RADIO ON
EASY TERMS
WOOLDRIDGE
RADIO CO. LIMITED,
 16 LISLE STREET,
 LEICESTER SQ. LONDON, W.C.

Dependable Mains Units
REGENTONE
 For A.C. & D.C.
BEHIND EACH REGENTONE INSTRUMENT THERE LIES 4 YEARS' SPECIALISED EXPERIENCE.
MAINS UNITS, MAINS RECEIVERS, COMPONENTS
 SEND FOR ILLUSTRATED CATALOGUE.
REGENT RADIO SUPPLY CO.
 Offices and Demonstration Rooms:
 21, BARTLETT'S BDGS., HOLBORN CIRCUS, E.C.4
 CENT. 9661.

CARBORUNDUM IN RADIO

Perfection in R.C. Coupling

THE CARBORUNDUM RESISTANCE CAPACITY COUPLING UNIT

is quite different from any other at present on the market, presenting as it does many distinct advantages over Units employing ordinary Grid Leaks and Anode Resistances. The Resistances used in the Carborundum Resistance Capacity Coupling Unit are solid rods of unbreakable Carborundum, which is created in the largest electric furnaces in the world, at the terrific temperature of 4060° F. They cannot burn out, present no capacity effects, and are absolutely non-microphonic. The Unit takes up far less room than the smallest L.F. transformer, and the complete absence of background noises enhances the already great possibilities of R.C. Coupling. Not being dependent on a metallic film, the resistances will not disintegrate and are unaffected by atmospheric changes.

No. 73. Price 8/6.



CARBORUNDUM ANODE RESISTANCES AND GRID LEAKS in all standard values. Price - each 2/6.

CARBORUNDUM STABILISING DETECTOR UNIT: The most satisfactory method of crystal detection.

Price 12/6 (Dry Cell 5d. extra).

Send for new 24-page Book containing circuits and much useful information. All Carborundum Radio Products are sold under our complete guarantee that they will operate satisfactorily in properly designed circuits.

THE CARBORUNDUM CO., LTD.,
TRAFFORD PARK :: :: MANCHESTER.

IN NO OTHER CONDENSERS!

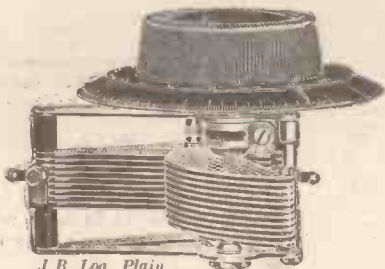

J. B. Log. Plain.

A study of all J.B. Condensers reveals a wonderful compactness in design. This permits of the reduction of the amount of metal and insulating material to an absolute minimum. In no other condensers can such economy of material be found. The dielectric thickness is minutely adjusted to ensure maximum efficiency.

Attention to such important details as this has placed J.B. Condensers among the finest manufactured.

J.B. is the Trade Mark you will find on all really good Logarithmic S.L.F. or Neutralising Condensers.

- Prices. Logarithmic Models.
J.B. Log. Plain. Complete with 4 in. Bakelite Dial. '0005 mfd. 11/6; '0003 mfd. 10/6; '00025 mfd. 10/-; '00015 mfd. 10/-.

J.B. Log. Slow Motion. Double Reduction Friction Drive, Ratio 80-1. Complete with 2 in. Bakelite knob for vernier control and 4 in. Bakelite Dial for main control. '0005 mfd. 16/6; '0003 mfd. 15/6; '00025 mfd. 15/-; '00015 mfd. 15/-.

Full particulars of J.B. S.L.F. and Neutralising Models on application.

JACKSON BROS.
8, POLAND ST- OXFORD ST Telephone:-
LONDON - W.1. GERRARD 7414

WAS ~~1/6~~ NOW

12/6



The famous Ericsson Super Sensitive Telephones are reduced to 12/6 a pair!

Adopted by the B.B.C. for use in their studios. Used by all the D.X. experimenters. Adopted as standard in 1909 by the Admiralty and in 1917 by the Air Board. Three resistances, 120, 2000 and 4000 ohms - one price, 12/6. Get your pair to-day!

Even if you have a multivalve set now and again you'll need a good crystal set. Buy an Ericsson Crystal Set to-day. Sturdily and handsomely made. A really sensitive instrument. Tunes up to 5 G.B. and has a loading coil plug for 5 X.X. A real snip at 15/-.

At all our agents or direct from the Company.

ERICSSON TELEPHONES LTD., 67/73, Kingsway, London, W.C.2.

Ericsson
SUPER SENSITIVE
TELEPHONES.

Kits for the COSSOR Melody-Maker

Red Triangle Panel, Polished and Mat back, 21 x 7 x 1/2, Drilled Free	s. d.
Red Triangle Terminal Strip, 21 x 1 1/2 x 1/2, Drilled Free	9 6
Engraved 2/1 extra.	2 3
4in. x 7in. Pertinax Tube	2 9
2 Reels wire for winding Green Silk	3 6
Complete Coils ready wound	7 6
Polished Oak Cabinet as specified	30 0
Base-board	2 0

We supply all the parts from stock.

INSIST ON

KEYSTONE COMPONENTS

"Copied by many—equalled by none."

Keystone Neutralising Condenser

Used in all the popular circuits this season. These condensers have been designed by experts, and they are suitable for neutralising the electrode capacities for all types of valves. Very low minimum capacity.

The wide spacing of the vanes renders accidental "shorting" impossible. Very well made from best quality material and beautifully finished.

Board mounting 5/-
Panel mounting 6/3



COPEX 6-PIN BASE

Standard spacing with terminals arranged for easy accessibility. For use where the standard 6-pin coils are utilised without the actual screen. Price 2/9



Keystone "Midget" Reaction Condenser

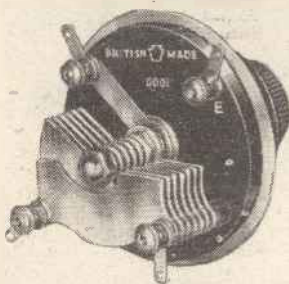

Ideal for the many positions where a small capacity condenser is required. An aluminium shield prevents hand-capacity effects, and a special taper bearing gives a beautifully smooth movement. Accurately designed and rigidly

constructed, this Keystone condenser is backed by the usual Keystone guarantee of efficiency. Capacities: .00005 (7 plate) and .0001 (17 plates). Price 5/6

Send for Illustrated Catalogue "P," describing these and many other components.

PETO-SCOTT Co., Ltd.,
77, City Road, E.C.1.

Branches:—62, High Holborn, London, W.C.1.
4, Manchester St., Liverpool.

TECHNICAL NOTES.

(Continued from page 424.)

brought back to the electrical centre of the filament, or more accurately to the centre of a high resistance or potentiometer which is connected to the terminals of the filament; in type (3) the conditions are as in type (1).

In the types (1) and (3) the set needs no rewiring, so far as the radio circuits are concerned, but, of course, the heating element leads must come out to the mains' connection or to a transformer. In the type (2) the wiring of the set has to be somewhat adjusted.

In view of the inconveniences arising with direct-from-the-mains valves, it is fairly certain that the various forms of electric-supply device for operating valves of the more conventional types are far from ever becoming a "back number."

Loud-Speaker Reproduction.

If you have been accustomed to use your loud speaker always in the same room with very little alteration in the furnishing or draping of the room, you will be surprised to find what a difference will be made in the reproduction when the loud speaker and set are transferred to another room in which the draping or furnishing is very much different. The fact is that the sound reflections from the various parts of the room and the various objects in it play an important part in the reproduction as eventually perceived by the ear. Everyone knows the great difference between the sound of the speaker's voice in a large hall or church when the latter is empty and when it is filled by an audience. In the former case the sound is much more easily carried, but is less intelligible than in the latter case. The audience has the effect of breaking up the sound reflection which would otherwise take place from the floor of the hall, whilst, of course, the temperature variations in the air due to the heat from the audience as well as the varying conditions in the air arising from the exhalations, all have their bearing on the acoustical conditions. If your set is used in a room which is heavily curtained, you may find it worth while to remove the set to another room which gives more sound reflection, as the volume and quality of the reproduction may be considerably improved.

ALL
communications
concerning
advertising in

**POPULAR
WIRELESS**

**MODERN
WIRELESS**

**WIRELESS
CONSTRUCTOR**

must be made to

**JOHN H. LILE,
LIMITED,**

4, Ludgate Circus,
LONDON, E.C.4.

(Phone: City 7261.)

Proof of its excellence



and

Terminal Strip

are used

in the

Cossor Melody Maker Receiver

Panel: (in black) - - - 9/3
" mahogany grained 11/6
Terminal Strip - 2/-

Get them from your Dealer

American Hard Rubber Co. (Brit.) Ltd.,
13a, Fore Street, London, E.C.2.  9748

**A
FREE
Booklet
for
YOU**

Here is a free offer to all Battery users which shouldn't be missed. Just send a 1/4d. stamp to the address below and receive by return a valuable 20pp. booklet dealing with the wonderful ETON primary H.T. Battery. This offer is only for a limited period so write off for it TO-DAY to the

ETON GLASS BATTERY CO.,
46, St. Mary's Road, Leyton, E.10.

**BUY WET H.T. BATTERIES
DIRECT
AND SAVE 30%**

Complete Leclanche cells with treble-capacity sacs designed for a discharge of 15 milliamps. per dozen. **4/3**

Samples, lists and instructions, 8d.

DIRECT BATTERY CO., Low Valley,
BARNLEY.

AMAZING WIRELESS OFFER.

Pair of powerful headphones given free to every purchaser of a W.C.R.S. Crystal Set. (Limited number) ORDER NOW.

.0005 square law Condensers	each	2/11
.0003 square law Condensers	"	2/9
2-way Coil Holders for Baseboard or- Panel Mounting	"	1/11
4 v. W.C.R.S. Dull Emitter Valves	"	3/11
2 v. W.C.R.S. Dull Emitter Valves	"	3/11
4 v. Bright Emitter Valves, Low Consumption	"	1/11
Habana L.F. Transformers, Ratio 5:1	"	3/6
W.C.R.S. Crystal Set—Powerful Receiver	"	10/6

SEND FOR BARGAIN LIST AT ONCE.

NOTICE.—Any of above goods will be sent POST FREE.

WEST CENTRAL RADIO SUPPLIES,
259, GRAY'S INN ROAD, KING'S CROSS, LONDON, W.C.1.

SHORT-WAVE NOTES.

By W. L. S.

SHORT-WAVE work has always tended to become more easy with the advance of winter, but this year seems to be the proverbial exception. A few weeks back conditions were extremely good for transatlantic work on 23 metres, and for fairly long-distance work on 45 metres, but at present it is apparently much more difficult than it was then to establish reliable communication with the American stations on either of these wave-lengths. However, short-wave conditions change so quickly that by the time this appears in print it may be "all wrong."

The British amateur transmitters are more active this autumn than they were at the corresponding time last year as regards numbers, but on the whole they are using considerably less power, and this winter should see some remarkably low-power records set up by the "QRP" stations. The favourite power in use at the present time seems to be about 7 or 8 watts; the great majority of "EG" stations very seldom exceed this.

A Message for "P.W."

This may be because dry battery plate supply has not yet become unpopular on account of the difficulty in securing mains in certain parts. It is rather peculiar to listen on 40 metres at a time when the United States stations are coming in well, and to hear the number of British stations being called by them, when one reflects that most of the Americans use 100 watts as a minimum, and the British stations 10 watts as a maximum.

One exception on the other side is a station that has recently started up in North-west Labrador. He is the second Grenfell Expedition station, NE-8 WG, and is using only 7 watts from an M.L. converter. 6 QB worked him on October 6th, using exactly the same power, also from an M.L. converter!

He was at once given a message for POPULAR WIRELESS, of which more will probably be heard later. 8 WG's signals with this 7-watt input are generally as strong as any of the United States stations, which shows what can be done with careful adjustment and "low-loss" construction. 8 WG particularly wants reports from over here, but all that can be done at present is to log his call-sign and "sit tight," for he is in a region where there are no mails.

Antipodes Difficult to Work.

The West Coast amateurs (the American 6th district) have always been elusive people to receive, but they now seem to be coming in occasionally during the afternoons (G.M.T.). The writer logged one at 3.30 one afternoon, and 6 HP reports that he logged NU-6 BJX and NU-6 HW at about the same time on another afternoon.

The Antipodes seem for some reason or other much more difficult to receive nowadays (except on the 20-metre wave-band) than they ever used to be in the days of 80 metres (a wave-length, by the way, which is now quite deserted). It is only on fairly rare occasions that one logs an "OZ" or "OA" station during the evenings at 6 p.m. or so, as one always used to do.



The Benjamin Standard

The Benjamin Standard is known throughout the Radio trade. It stands for a greater efficiency, a far higher degree of excellence and an unequalled value. Every component that is stamped with the name of "Benjamin" is the very best of its class.

THE BENJAMIN RHEOSTAT
has its windings protected inside the dial. Three windings—6, 15 and 30 ohms. Price 2/9.

THE BENJAMIN IMPROVED EARTHING DEVICE.

Twelve feet of one inch copper in $1\frac{1}{2}'' \times 1\frac{1}{2}''$ giving 288 sq. in. of surface area. The inclined plane of the plates ensures perfect contact. Price 5/9.

THE BENJAMIN BATTERY SWITCH.

Simplest and most efficient switch. It's OFF when it's IN. Single contact, one hole fixing. Price 1/-.

THE BENJAMIN BATTERY ELIMINATOR

for Alternating Current 200-240 v. 50 cycles. Delivers current for loads up to twelve valves, giving 180 volts for power valve. A really dry eliminator. No acids, no liquids, no hum. £7 15 0.

THE BENJAMIN VALVE-HOLDER.

No other valve-holder so efficiently disperses microphonic noises and absorbs shocks so thoroughly. Valves free to float in any direction. Price 2/-.

BENJAMIN

THE BENJAMIN ELECTRIC LTD.

Brantwood Works, Tariff Road, Tottenham, N.17.



Benjamin Rheostat.



Benjamin Improved Earthing Device.

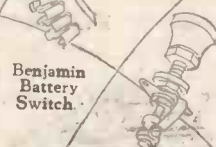

Benjamin Battery Switch.

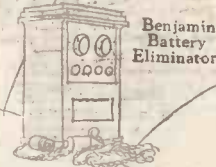

Benjamin Battery Eliminator.

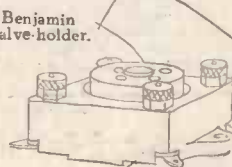

Benjamin Valve-holder.

The HOME for your WIRELESS SET

OUR STANDARD CABINETS
are DUSTPROOF and house the whole apparatus, leaving no parts to be interfered with. All you do is **UNLOCK & TUNE IN.** Made on mass production lines, hence the low price. Provision is made to take panel, from 16 by 7 up to 30 by 18 in. Carriage paid and packed free England and Wales. Thousands supplied with full satisfaction.



From £4 15 0.
Write to-day for descriptive pamphlet and suggestions for adapting your receiver or panel in our Standard Cabinets. Immediate Delivery.

MAKERIMPORT CO.
Dept. 5, Melville Chambers,
50a, Lord St. LIVERPOOL.

TRANSFORMERS REPAIRED
All L.F. Transformers 4/-, Headphones 4/-, Loud-speakers 4/-, post free. Maximum efficiency attained. Every repair is accompanied with a three months' guarantee. Don't discard if burnt out. Trade invited. **REPAIRS, 115, LINKS RD., Tooting, London, S.W.11.**

The "MONOTUNE 3"

is the master stroke of that genius in receiver design, Mr. A. P. Allinson, A.M.I.R.E. It has but one tuning dial, great selectivity and volume and has received over forty stations on the loud speaker. It is the set for the vast majority. Descriptive Circular Free. Our full Catalogue, 2d. The "Monotune" Envelope with the fullest and most lucid description, illustrations, diagrams, template, etc., 2/8, including our Catalogue post free.

RADIAX, LTD. PALMER PLACE, HOLLOWAY, LONDON, N.T.

CATWHISKERS & CRYSTALS ABOLISHED



Everlasting **FIXED DETECTOR**. Guaranteed Indefinitely. Pat. No. 265,469.
Fixed Permanent Detector and Stabilising Unit. No Batteries required with Crystal Circuits. Indispensable for Redex Circuits. From all dealers, 2/6, or post free from Patentees, 2/8.

A. W. GRIFFIN & CO., Manufacturers, REDDITCH.

COMPLETE SETS, LOUD SPEAKERS, COMPONENTS, Etc.
Send list of requirements, and best monthly terms will be quoted by return.

EVERYTHING WIRELESS ON EASY PAYMENT TERMS

Best British Batteries
60-v. 8/-, 108-v. 15/-, Free Post

THE P.D.P. COMPANY,
41, GREAT TOWER STREET, LONDON, E.C.3.

DIGBY'S CABINETS

WRITE FOR NEW 16 PAGE CATALOGUE
F. DIGBY, 9, BANBURY ROAD, SOUTH HACKNEY, LONDON, E.9.
PHONE: CLISSOLD 5458.

AMPLIFIERS: 1-VALVE, 19/-; 2-VALVE, 30/-
2-Valve All-Station Set, £4. Approval willingly. Wet H.T. Batteries—Jars, Zincs and Sacs complete, 3/6 per doz. (18 volts). Post 9d. extra. Sample 6d. 5 doz. upwards in divided cartons. Bargain List Free.

P. Taylor, 57, Studley Rd., Stockwell, London.

THE PERFECT WET H.T.

Assured with our new Insulating Liner, Jars, 1/3 doz. plain; 1/6 doz. waxed; Special Zincs, 1/- doz.; High-Capacity Sacs, 1/6 doz.; Perforated Liners, 4d. doz. Post Free on three dozen Units and over, including special divided carton suitable as a container. Send 6d. for sample complete unit, particulars and instructions. We stock Seamless Moulded Cone Parts, Telephones and Loud Speakers re-wound.

SPENCERS STORES LTD.
4-5, MASON'S AVENUE, COLEMAN ST. LONDON, E.C.2.
'Phone: London Wall 2292. (Nr. Bank.)

HOW TO CHECK YOUR VALVES.

(Continued from page 387.)

merely by lessening the amplification it is not an efficient one, although it has to be admitted that it is effective. However, we prefer saner methods whereby we retain the amplification.

Let us pass to another point of interest. We have a receiver, and our valves are supplied with normal values of anode voltage and grid bias. We connect a freshly charged filament accumulator. By and by we notice something is wrong—the quality seems to have gone all to pieces and the sounds are getting weaker and weaker. Experience tells us what is the matter. We change the accumulator, and with the fresh one connected once again we hear the broadcast as it should be heard. But why?

Effect of L.T. Drop.

Let us put a valve to the test board and find out. Take figures for curves at 120 and 110 anode volts with the filament fully heated, and then with smaller and smaller filament voltages, just as though our heating battery were running down.

This has been done for the same 6-volt valve as tested above, and the results are given in Fig 3. The two curves marked A and B are for 120 and 110 anode volts with 5.5 volts applied to the filament. The next two curves marked C and D, shown by broken lines, are for the same anode voltages, but with a filament voltage of 4. Lower down are the two curves taken when the filament voltage was 3.4—they are marked E.F.

Finding the amplification factors and impedance values as before, we have:

Filament volts.	Impedance ohms.	Amplification factor.
5.5	32,100	16.7
4.0	47,500	16.7
3.4	100,000	13.3

Thus the impedance rises a little as the filament voltage falls from 5.5 to 4, but not by a very large amount, and many people would not notice a great difference in the quality or volume if the receiver is used for local station work only.

Alteration of Curve.

The shape of the curve is not changed by a large amount either (there is plenty of emission even if the filament voltage is only 4 instead of 5.5) so that no distortion will be produced through lack of emission.

But when the filament voltage has fallen to 3.4 volts you will see that the quality will be very bad. In the first place there is not sufficient emission shown by the bending over of the tops of the curves E.F. Secondly, the impedance has gone up to 100,000 ohms, while the amplification factor is down to 13.3. This condition will surely result in the most distressing quality with a big loss in amplification.

The "LINDLEY" "5" PORTABLE

This efficient British-made Portable Receiver has a wonderful range of reception and great excellent volume from the self-contained Ampion loud speaker, over a distance of 300 miles from Daventry, 100 miles from the local and several Continental stations. Wholly self-contained, requires no aerial or earth, and is enclosed in handsome cabinet. All-in Price (including Royalties) **£30**

The "LINDLEY" H.F. CHOKE

Used with great success in many Receivers described in Radio publications. No surface leakage. D.C. Res. 450 Ohms Induct. 55,000 MH. Self Cap. 5.5 m/mfds. Absolutely Low Loss. Length 3 inches.

PRICE with Clips **7/-**



British made.
FROM ALL DEALERS OR

LINDLEY & CO

Telephone: Holborn 3052
14, Great Queen St., Kingsway, LONDON, W.C.2.

its amazing

SCRAP your old crystal now and put new life, new power, and new tone into your set. Results will astonish you. From your dealer or direct, post free, from **DEPT. P. RUSSELL LABS. 138, Suffolk St., Birmingham.** World Distributors.

how any ordinary crystal set can be made into the high-power valveless receiver

at the cost of only **16/-**

STUTZBERG

THE SUPER NATURAL CRYSTAL

D-XELLENT!

DX IN PLUG-IN COILS

From 1/- D X COILS, LTD., London, E.8.

CASTLE RADIO CABINETS.



Send for our illustrated List No. 36P, post free.
E. Farnell & Sons, Birkenshaw, nr. Bradford.

THE RELIABILITY GUIDE No. 99A

RELIABILITY S.L.F. CONDENSER
With ebonite ends and 4" Trolite Dial.
"0005 5/9 "0003 5/6
Vernier Dial 1/6 extra. Post Free.

J. H. TAYLOR & CO
4, RADIO HOUSE - MACAULAY ST. - HUDDERSFIELD.

Send for Free Guide Now. Trade Enquiries Solicited.

ADVERTISEMENTS

As far as possible all advertisements appearing in "P.W." are subjected to careful scrutiny before publication, but should any reader experience delay or difficulty in getting orders fulfilled, or should the goods supplied not be as advertised, information should be sent to the Advertisement Manager, "Popular Wireless," 4, Ludgate Circus, London, E.C.4.

Don't Save up —

PUT a small sum down and buy one of our Sets. We have a wonderful range of instruments. All accessories sold on instalment system, too. A Postcard to Desk "P." will bring you our brochure.



New Times, Sales Co., 77, City Rd., London, E.C.1.

SPECIALISTS IN LOW FREQUENCY AMPLIFICATION

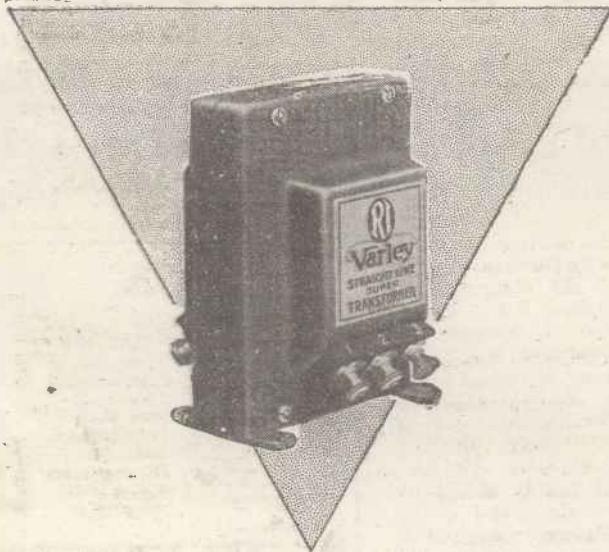

Every problem has at least two different sides. The firm that has studied both sides of a question has obviously a big advantage. This is the fortunate position in which R. I. & Varley, Ltd., find themselves. Prior to the amalgamation which has already done so much for Radio Science—vide all the leading Wireless Journals of the day—R. I. Ltd. had spent years in perfecting L.F. Transformers, and the success achieved by the famous Varley Bi-duplex Wire-wound Anode Resistances had made itself known in almost every corner of the world. The pooling of the resources of these two firms, both from a technical and manufacturing standpoint, has resulted in the production of two of the finest Radio components ever known, and there is now no excuse for the existence of distortion in your reproduction.

The New Straight Line Super Transformer.

This transformer proved to be one of the biggest achievements at the National Radio Exhibition, Olympia. The National Physical Laboratory curve shows that its amplification is practically constant from 100 to 6,000 cycles, and that exceptionally good results can be obtained even at 20 cycles. The iron content of this transformer is considerably greater than in other models, and, further, the iron is of a special grade considerably higher in permeability and lower in core losses than was hitherto obtainable; in fact, some idea of what has been achieved can be gauged from the fact that at 50 cycles the inductance is 122 henries, and at 500 cycles 123 henries.

Price 25/-

The New Bi-duplex Wire-wound Resistance Capacity Couplers.

The National Physical Laboratory Curve of these remarkable components, shown for the first time at the Wireless Exhibition, proved beyond doubt the extraordinary efficiency of resistance capacity coupling when the high resistances are wound on the Bi-duplex system with the special alloy wire used only by this company. **Perfect Straight Line Amplification** at all frequencies from 20 to 6,000 is assured, and for the first time it is now possible to get tremendous amplification and volume consistent with almost unbelievable faithfulness of reproduction.

Type A. Suitable for use after Valves with A.C. Resistance (Impedance) of 15,000 - 40,000 ohms 20/-

Type B. Suitable for use after Valves with A.C. Resistance (Impedance) of 30,000 - 100,000 ohms 22/6

If you are seriously interested in L.F. amplification and in getting the best results from your loud speaker, our new Booklet "Low Frequency Amplification" (Price 1/-) contains in simple language

THE MARK OF

Kingsway House, 103, Kingsway, W.C.2.



the fullest details of Transformer, Resistance Capacity and Choke Coupling. The information is absolutely reliable, and confirmed by independent tests made by the National Physical Laboratory.

BETTER RADIO

Telephone: HOLBORN 5503.

THE P.W. BLUE PRINT No. 33—6d.

The "Knife Edge" Crystal Set.

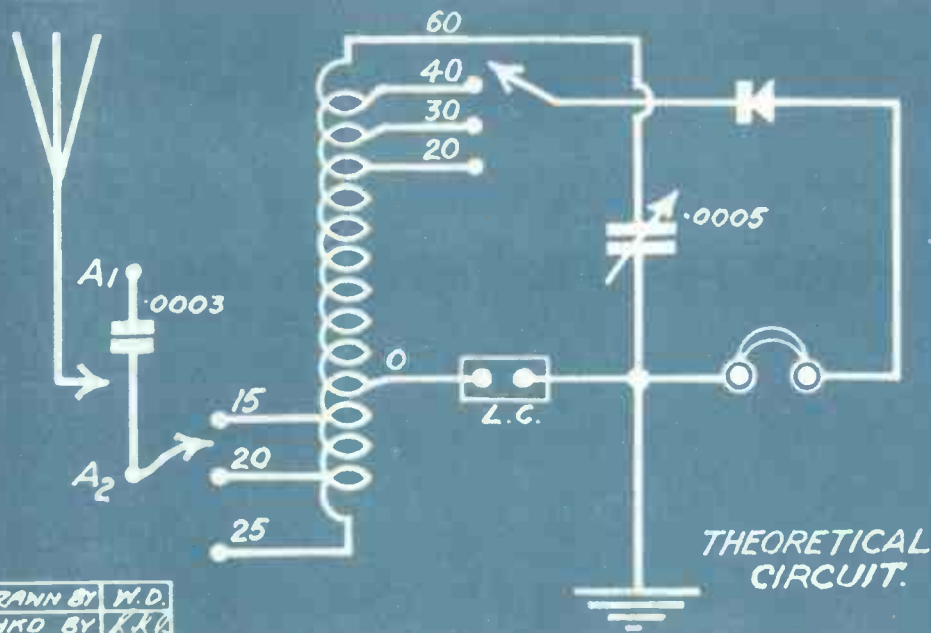
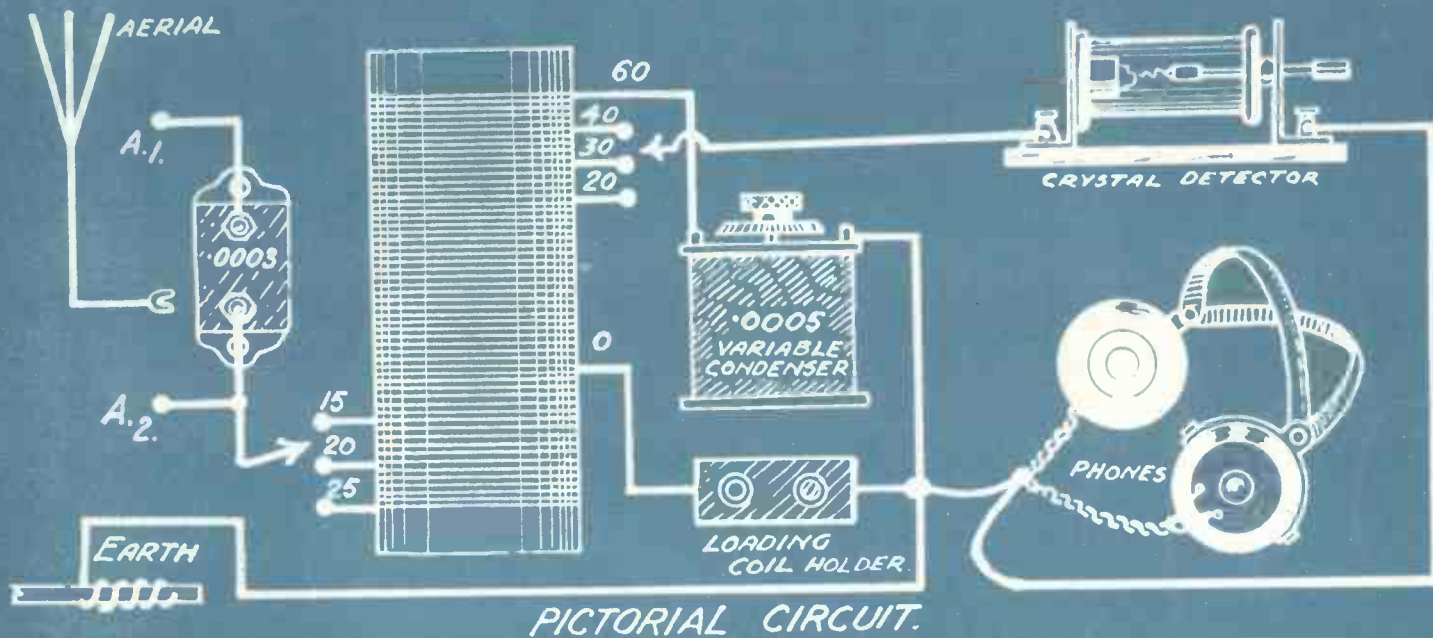

COMPONENTS AND MATERIALS.

- 1 Ebonite panel, 7 in. × 7 in. × ¼ in.
- 1 Vertical front cabinet and baseboard, 9 in. deep.
- 1 Semi-permanent crystal detector.
- 1 Piece of "Pirtoid" tubing, 3 in. diameter, 4 in. long.
- 1 .0003 mfd. fixed condenser.
- 1 .0005 mfd. variable condenser.
- 6 Terminals.
- 6 Sockets and 2 plugs.
- 4 oz. No. 22 D.C.C. wire.
- 1 Board-mounting single coil socket.
- Strip of ebonite to carry sockets for crystal tappings.
- Wire, screws, etc.

ACCESSORIES.

- Pair of 'phones, Nos. 100 and 150 coils.

DRAWN BY	W.D.
CHECKED BY	K.K.K.
SER: NO	BP5

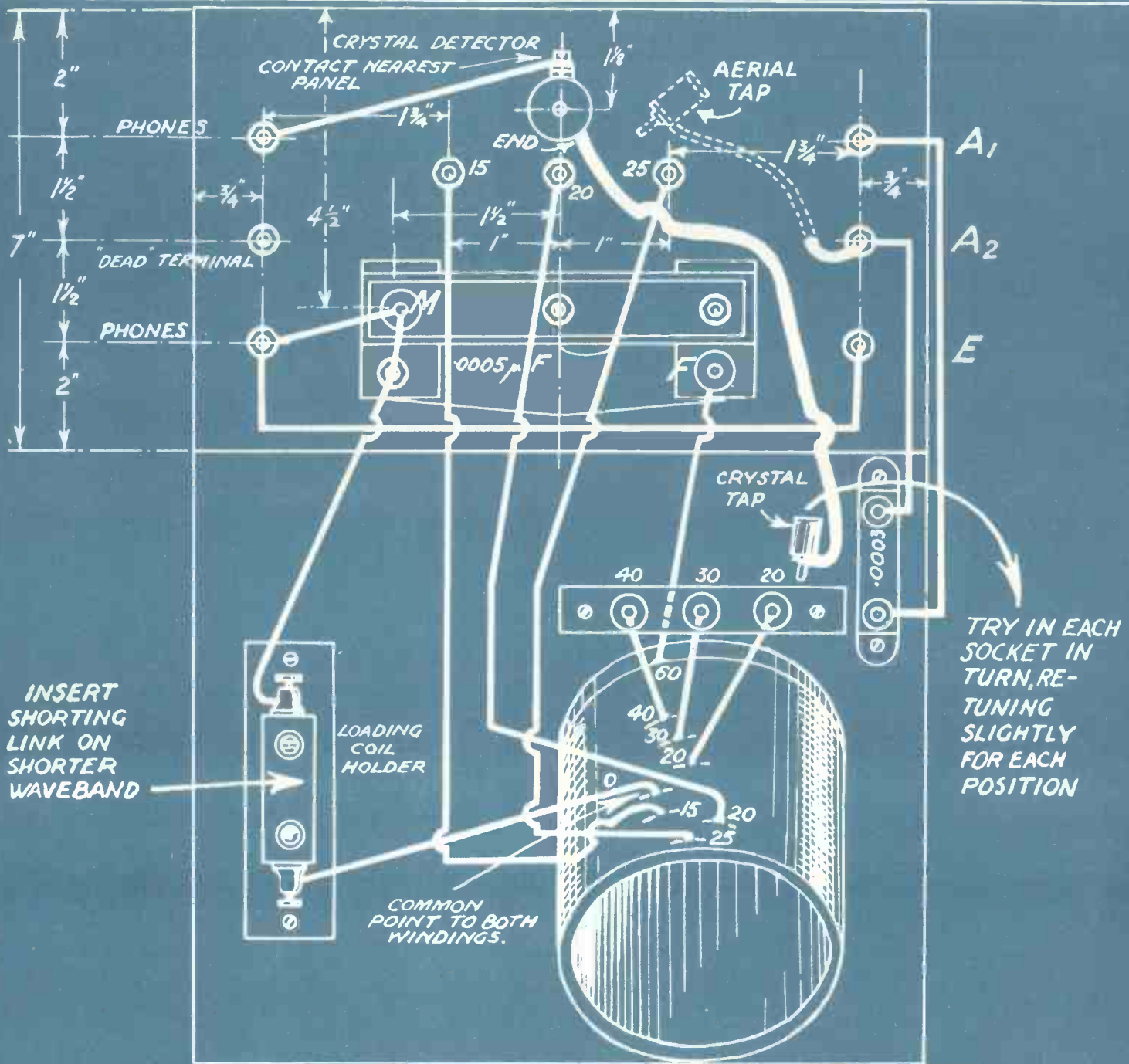

DRAWN BY *W.D.*
 CHKD BY *M.C.*
 SER: N^o *BP6*

The "P.W." Blue Print No. 33.—The "Knife Edge" crystal set. A very sharply-tuned crystal receiver.
 NOTE.—The coil consists of two single-layer windings in the same direction. Both start at "common point to both windings," where they are joined together. One consists of 25 turns with tappings at 15 and 20, and the other of 60 turns, tapped as shown. The sockets for these last taps are carried in an ebonite strip mounted on two little blocks of wood.

**IT COSTS YOU LESS
TO USE MULLARD
0.075 VALVES**



Mullard P.M. '075 Valves make 1/10 ampere valves extravagant. They give the ample power you want from your receiver; last long and stand hard service . . . provide pure tone and true reproduction, all with reduced running cost.

These are some advantages of valves with the wonderful Mullard P.M. Filament, the filament that is robust and tough, the filament with great emission surface.

Depend on Mullard to improve your radio reception.

Mullard
THE MASTER VALVE

Advt. The Mullard Wireless Service Co., Ltd., Mullard House, Denmark Street, London, W.C.2.