

SPLENDID FREE GIFT WITH THIS ISSUE.

Popular Wireless

Every Thursday
PRICE
3d.

No. 228. Vol. X.

and *Wireless Review*
Scientific Adviser ; SIR OLIVER LODGE, F.R.S., D.Sc.

October 16th, 1926.

**£200 in Prizes
for Constructors**

**The "P.W."
Constructors'
Guide**

64 Price
3d.
PAGES As usual

Fine Free Supplement With This Issue

Mr. Percy W. Harris

(See Important Announcement on page 343)

Special and Exclusive Features.

THE "SPIDER."

A Three-Valver of Unsurpassed Merit.

How to Work the "N" Receiver.

By Sir Oliver Lodge, F.R.S.

Progressive Broadcasting.

By Captain Eckersley.

And many other exclusive Articles.

ANOTHER FREE GIFT NEXT WEEK.

THE VALVE IN THE PURPLE BOX.



EXPERTS ACKNOWLEDGE MARCONI SUPREMACY.

THIS is conclusively proved by the fact that the principle broadcasting stations of the world are equipped with Marconi Valves. Surely nothing can approach the efficiency of a valve which has attained this high distinction.

A popular valve is the
MARCONI TYPE D.E.2 L.F.
 Dull Emitter for 2-Volt Accumulator.

Takes only about one-third the current of Type D.E.R. for early stages of L.F. Amplifier. Can also be used as a rectifier with anode voltage 20-40. For final stage of L.F. Amplifier a D.E. 6 is recommended. Fil. Volts, 1.8. Fil. Current Amps., 0.12. Anode Volts, 20-30. Impedance (ohms) 22,000. Amplification Factor 7.

TYPE D.E. 2 H.F. DULL EMITTER. Designed for H.F. amplification and rectification. Has similar filament characteristics to D.E. 2 L.F. Filament Volts, 1.8. Fil. Current Amps. 0.12. Anode Volts, 40-120. Impedance (ohms) 45,000. Amplification Factor, 12.

14'

14'

Some recommended combinations for 2- 3- and 4-valve sets.

Type	Position	Fil. Volts	Grid Bias Volts	H.T. Volts
2-Valve Set.				
D.E.2 H.F.	Det.	1.8	+2	60
D.E.2 L.F.	L.F.	1.8	-4.5	80
3-Valve Set.				
D.E.2 H.F.	H.F.	1.8	0	60
D.E.2 H.F.	Det.	1.8	+2	60
D.E.2 L.F.	L.F.	1.8	-4.5	80
4-Valve Set.				
D.E.2 H.F.	H.F.	1.8	0	60
D.E.2 H.F.	Det.	1.8	+2	60
D.E.2 L.F.	1 L.F.	1.8	-4.5	80
D.E.6	2 L.F.	1.8	-9	120

Copies of interesting valve literature forwarded free on request.

THE MARCONIPHONE COMPANY, Ltd., MARCONIHOUSE, STRAND, LONDON, W.C.2

THE GREATEST NAME IN RADIO

The

NATURAL TONE

Loud Speaker



THE
RADIOLUX AMPLION
Prices £4: 15: 0 — £13: 13: 0
Other Amplion Models from 38/-

Write for Latest
Illustrated List.

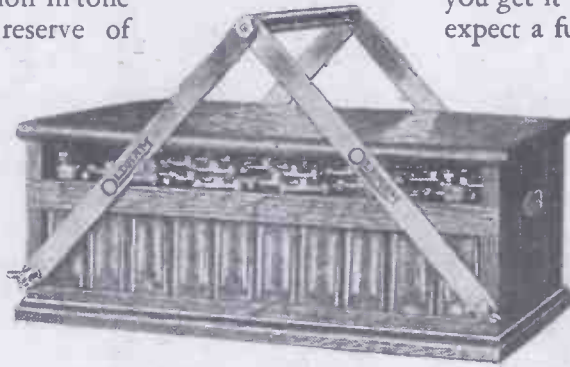
There is no substitute for a genuine AMPLION

An adequate H. T. supply is more vital than you may think —

NO one would expect a railway engine handicapped by a leaky boiler to keep to its scheduled time table. You ought not to expect perfect results from any Set using a partly run-down H.T. Dry Battery. A falling off in sensitivity and a degradation in tone is inevitable. A good reserve of electricity is just as vital as a good head of steam. Many of the pitfalls in wireless are directly traceable to faulty H.T. supply. Everyone knows the noises and cracklings due to weak cells, but many of the troubles are much more subtle and not so easily traced. Such defects as a mysterious loss of 'pep' and failure to pick up distant

stations—distortion—lack of volume—and so on are frequently due to a faulty H.T. battery. An H.T. dry battery starts working the day it is made—it can't be controlled. If it has been on the Dealer's shelf for a month or two before you get it then naturally you cannot expect a full voltage. Even a volt-

meter isn't a safe guide because an idle H.T. Battery will always produce enough current to flick over the needle. It is on the long sustained discharge where it fails so miserably. And here is where the new Oldham H.T. Accumulator comes into its own. Use it for hours on end and the current flow won't vary a trifle.



60 Volts 50/- as above

Complete with lid and handles. Base 3/6 extra if required

40 volts £1 - 13 - 4 100 volts £4 - 3 - 4

80 volts £3 - 6 - 8 120 volts £5 - 0 - 0

A tapping point is available on each 2-volt cell.

Charge this Oldham four times a year—and forget it!

LOOK at the cleverly designed Oldham H.T. Accumulator shown above. Note that it is assembled on the unit system. Each unit consists of 20 volts. Build them up just like an expanding bookcase. 60, 80, 120 volts—just what you will. The Accumulator is always neat and tidy—fit to take its place in any

room. Acid can't be spilt and when it needs re-charging a convenient carrying handle is available. Each of its big capacity cells is a miniature Oldham accumulator capable of holding its charge for months on end. Each plate is made under the same Special Activation Process which has made the name Old-

ham famous throughout the country. Ask your Dealer to show you one of these handsome H.T. Accumulators—don't be put off with a substitute. Nothing can take its place for none other can give you the same steady flow of power—the same freedom from sulphation and the same generous length of service.

Oldham & Son Ltd., Denton, Manchester

[London Office and Service Depot—6, Eccleston Place, S.W.1

Phone: Sloane 2701

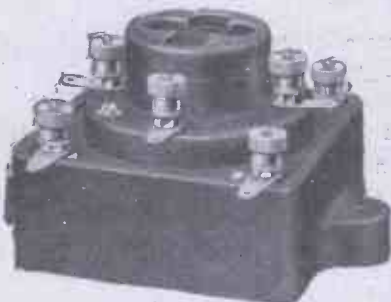
Special Activation Process
OLDHAM

Accumulators

The Cosmos Resistance Coupling Unit



Type "O" The Unit alone.
Price 8/6



Type "V" a similar unit incorporating
the "Cosmos" Spring Valve Holder.
Price 10/6



Illustration
shows a
Type "V"
Unit with
a valve
inserted.

Suitable Valves are :
for 2-volt, "Cosmos" S.P.18/B at 14/-
for 6-volt, "Cosmos" S.P.55/B at 18/6

Real purity of reproduction

Even the advertisements of the best Transformers plead guilty to imperfect amplification over the whole musical range. Real purity of reproduction can only be obtained with resistance capacity coupling. The Cosmos coupling unit with a suitable valve can be as effective as a transformer-coupled stage. Avoids all distortion and effects considerable economies in first and operating cost.

Designed primarily for use with the "Cosmos" S.P. Blue Spot Valves, it can be used successfully with any valve having an amplification factor of 30 or more.

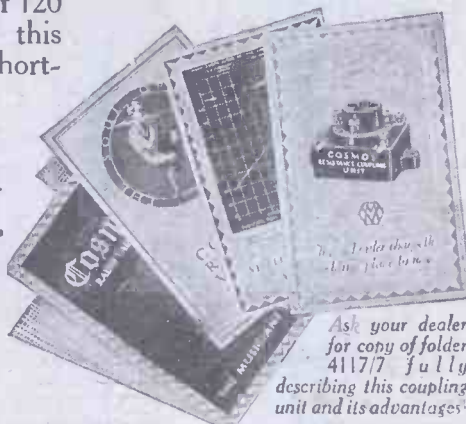
Additional Advantages :-

1. Maximum possible amplification per stage.
2. Economy in filament consumption. Cosmos S.P. Blue Spot Valves consume 0.09 amps.
3. Economy in H.T. battery consumption. Less than 1/20th of normal.
4. Immunity from breakdown caused by complete or partial failure of the windings of transformers or chokes.
5. Small space and light weight.

A high-tension battery of 120 volts is adequate with this unit and "Cosmos" Short-path Blue Spot Valves.

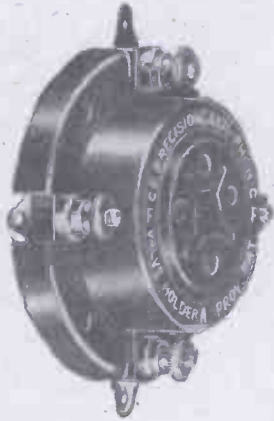
**METRO-VICK
SUPPLIES LTD.**

Metro-Vick House,
155, Charing Cross
Rd., London, W.C.2



Ask your dealer
for copy of folder
41177 fully
describing this coupling
unit and its advantages.

R
P51



OUR latest production, the C.E. PRECISION FLOATING VALVE HOLDER, shows great improvements upon others. By its use, the distortion due to vibrations transmitted to valve filaments is entirely eliminated and a receiver fitted with it acquires a perfectly clear background which facilitates the reception of distant stations. Of very low capacity and entirely non-microphonic, the C.E. PRECISION FLOATING VALVE HOLDER is ideal for its purpose. Made from Bakelite and fitted with soldering tags and terminals.

2/3 each.

C.E. PRECISION RHEOSTATS AND POTENTIOMETERS have so frequently been specified by the Wireless Press that they need little description. The special care taken in their production ensures a perfectly smooth and silent action. Bakelite formers; silvered dials; fitted with soldering tags and terminals.

- 7 and 15 ohms - 2/9 each
- 30 and 50 ohms - 3/- each
- Dual Rheostats & Potentiometers - 3/9 each

**FOR UTMOST
C.E. PRECISION
EFFICIENCY**



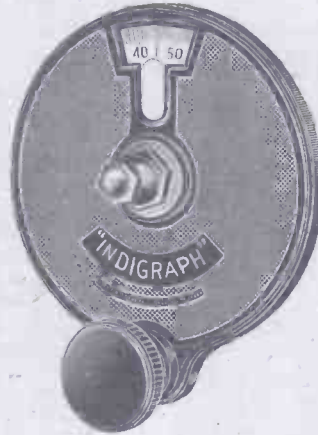
C. EDE & CO., LTD., BYFLEET, SURREY

Telephone: Byfleet 226X

Telegrams: "Ceprecise, Byfleet."

Log it on the

**IGRANIC
INDIGRAPH
Vernier Knob
and Dial**



Pat. No. 240983.
Other patents pending.

The Indigraph Vernier Knob & Dial helps you to tune in stations. The smooth silky movement and the reduction ratio of approximately 8:1 makes tuning delightfully easy. And every station can be logged on the dial opposite the dial setting. No searching through your pockets for records made on odd scraps of paper. With the Indigraph the records are always where you want them—on the dial. If you want to alter them they can be erased with a damp cloth or soft rubber.

The Indigraph Vernier Knob and Dial is 7/6
Send for new Igranice Catalogue No. R.29.

IGRANIC ELECTRIC CO., Ltd.,
149, QUEEN VICTORIA STREET, LONDON.
Works: Elstow Road, Bedford.

"BEST WAY"

GUIDES FOR WIRELESS CONSTRUCTORS

The Two Latest Numbers Now On Sale Everywhere.

**MODERN
LOUDSPEAKER SETS**

This book contains straightforward, amply illustrated directions for constructing three of the latest valve sets. The first is a two-valve household loudspeaker set. The second is a sensitive three-valver incorporating a novel reflex principle which will receive European stations with ease. The third set described is a four-valver including every possible modern refinement.

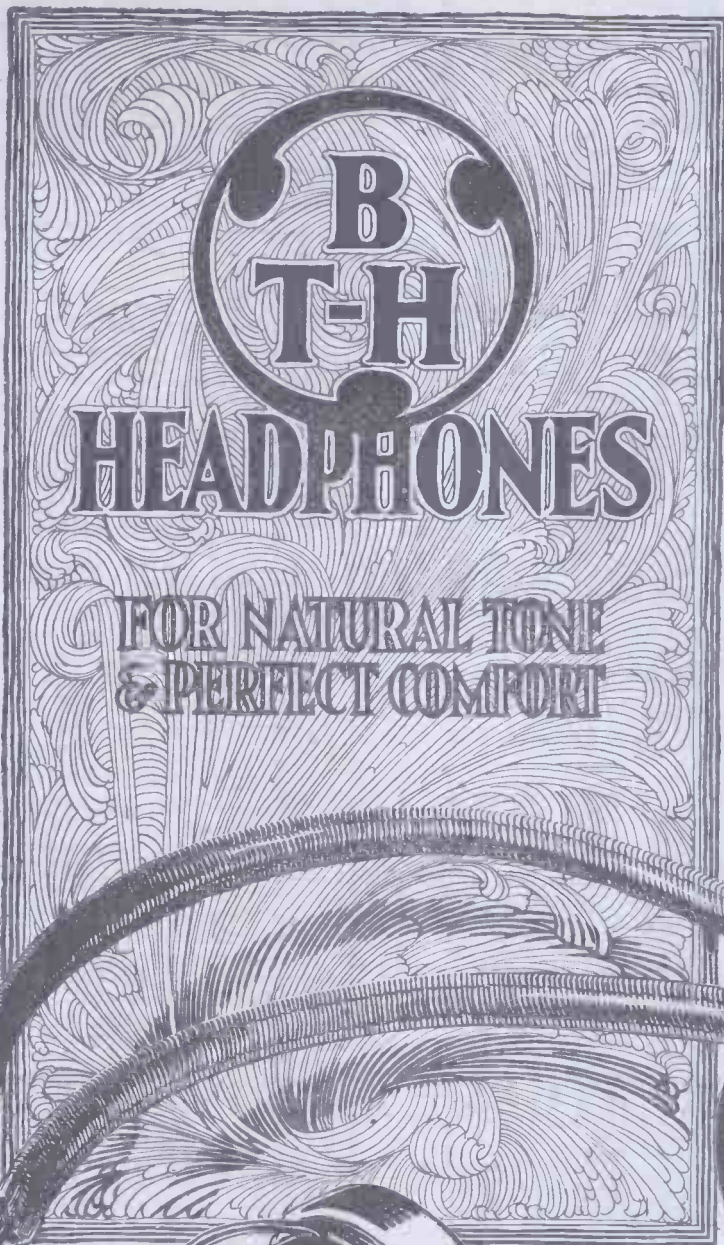
**CONSTRUCTORS USING THESE
BOOKS CANNOT GO WRONG.**

**PICTORIAL
BLUE PRINTS**

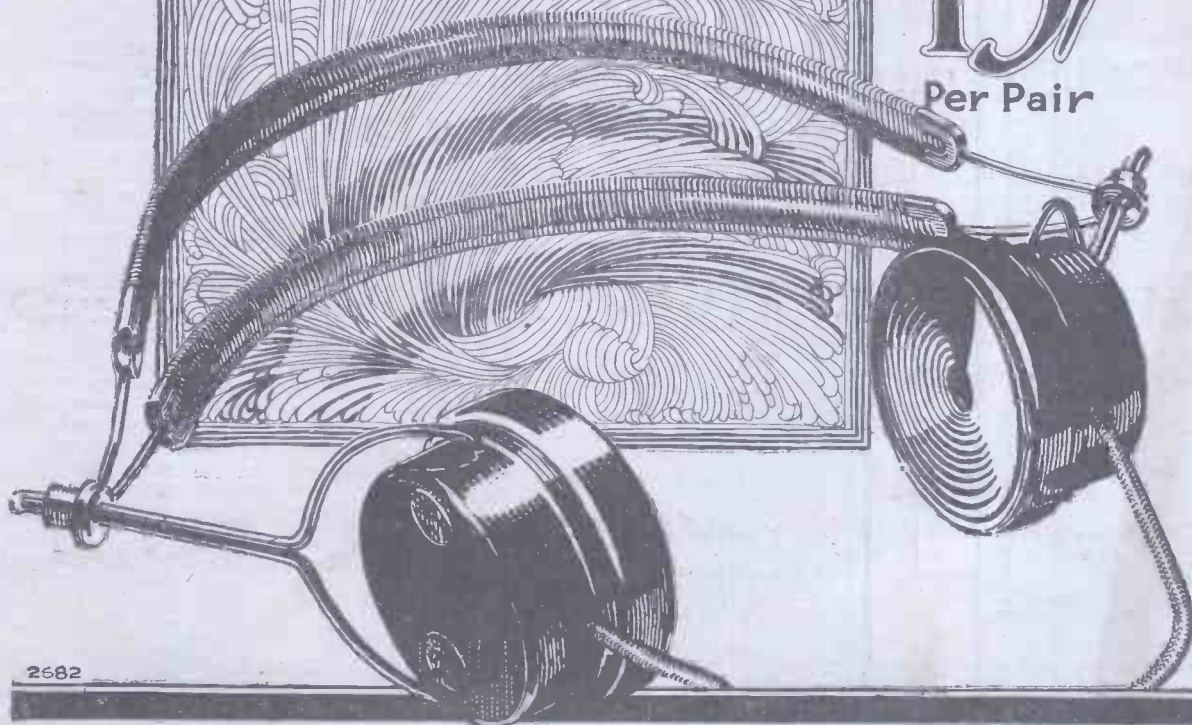
This book consists of an up-to-date and comprehensive range of blue print diagrams drawn in a simplified pictorial style so that the amateur constructor cannot possibly go wrong when building up a set on the lines of any of the circuits with which the book deals. There are 11 circuits in all.

**AT ALL NEWSAGENTS AND
BOOKSTALLS EVERYWHERE.**

**6^d.
EACH**



Price
15/-
Per Pair



2682

Sold by all good Radio Dealers

BUY BRITISH HEADPHONES

The British Thomson-Houston Co., Ltd.

H. WOOLLCOTT

The Building they could not destroy

BEHIND a mighty Skyscraper towering high above San Francisco lies a dramatic story. It was built just before the disastrous earthquake which laid low so many proud buildings. After the calamity the city authorities decided that this skyscraper could not possibly be safe. It must inevitably have suffered some hidden damage which would render it a danger to the community. The edict went forth that it must be abolished. After several ineffectual attempts to destroy it, the building was surveyed, floor by floor, from top to bottom. It was found to be in perfect condition. The fabric, being of ferro-concrete, had survived the earthquake with never so much as a crack. Ferro-concrete is concrete with a core of steel. It is a homogenous mass combining the pliability of steel with the durability of stone. It is man's triumph over nature.

What has this to do with valves, you ask?

Just this—the new Kalenised filament now being used in every Cossor Dull Emitter is manufactured under principles strikingly akin to ferro-concrete. It, too, has a pliable metal core surrounded by an electron-emitting substance astonishingly tough and durable. The metal core, strong in itself, is made immeasurably more so by its thick outer covering. This perfect combination of metal and incrustation produces a solid homogenous mass capable of withstanding the hardest shocks with ease. Remembering also that the Kalenised filament is utilised in conjunction with Co-axial Mounting—one of the greatest improvements in valve construction yet evolved—it is not difficult to understand why such enthusiasm has been aroused among users. Not only does the Cossor system of Co-axial Mounting permit practically the whole of the immense emission given off by the Kalenised filament being usefully employed, but life-long uniformity between valves of the same class is positively assured. It is quite impossible for the filament to sag—or for the grid to become displaced. Both elements are securely fixed in permanent alignment with the anode by means of a seonite insulator. See these remarkable valves at your Dealer's to-day.

Cossor Point One

THREE TYPES:
Black Band Detector
Valve. Also Red Band
for H.F. use. Consumption
1 amp. Voltage 1'8.

14/-

Stentor Two Power
Valve. Consumption
1'5 amp. Voltage 1'8.

18/6

Gilbert Ad. 5996

Popular Wireless

Scientific Adviser :
 Sir OLIVER LODGE, F.R.S.
 Technical Editor :
 G. V. DOWDING,
 Grad. I.E.E.
 Assistant Technical
 Editors :
 K. D. ROGERS,
 P. R. BIRD.



Editor : NORMAN EDWARDS, M.Inst.R.E., F.R.S.A., F.R.G.S.

Consultants :
 Dr. J. H. T. ROBERTS,
 F.Inst.P.
 J. F. CORRIGAN, M.Sc.,
 A.I.C.
 C. E. FIELD, B.Sc.
 E. J. SIMMONDS,
 M.I.R.E., F.R.S.A.

RADIO NOTES AND NEWS.

Is Daventry Weakening?—The Albert Hall Venture—Sir Alan Cobham—B.B.C.'s Birthday—A Knockout—New Broadcasting Chief—A Radio University?

The New Disease—

WHAT is this terrible new disease that is spreading amongst wireless listeners? This awful, uncontrollable impulse? This contagious, tickling, twitching, tingling feeling? This malady that attacks the worthiest citizens without warning? That makes them bolt their food, lose their sleep, tear their hair, and babble strange words about neutrodyne, heterodyne, and the like?

Listen! I will tell you; I will be frank. I know what it is because I've got it myself. It is the Distance Itch.

—And Its Cure.

THAT, my masters, is the whole trouble. The Distance Itch. The Feel of the Far-off. The Rapture of Reaching Out.

And once you've got it in your bones, there's no peace, no rest, no pleasure in local programmes, no patience with Britain, this favoured Isle, set in the silver sea. What you desire is *distance*. And the only thing that will cure the itch is to scratch together the necessary parts for a "P.W." set, and then tune in to all creation! So that's that!

"N" Circuit Demonstration.

A DEMONSTRATION of the Lodge "N" Circuit is amongst the attractions at a free Wireless Exhibition, to be held in the Lansdowne Hall, High Road, Tottenham, on October 21st, at 7.30 p.m.

The general public is invited to the demonstration, which has been arranged by the Tottenham Wireless Society.

"Is Daventry Weakening?"

IT is, without a doubt, according to the mass of correspondence I have received since I raised the query a couple of weeks ago. Almost without exception readers' replies show that there has been a falling off in the strength of 5 X X lately.

The trouble first appeared about the time the new aerial was fixed at 5 X X, and in my opinion the old temporary aerial was a far better radiator than the one now in use.

MR. PERCY W. HARRIS



I am pleased to announce to readers of "P.W." that Mr. Percy W. Harris, late Editor of "Conquest" and late Editor of "The Wireless Constructor," has accepted an invitation to associate himself with this journal. Mr. Harris will act as Editor of a special constructional supplement, consisting of eight pages, which will be published for the first time in "Popular Wireless" on sale the week after next. The title of this supplement will be "The Radio Constructor," and in it "Popular Wireless" readers will find exclusive constructional articles and other matter by Mr. Percy Harris. No other wireless magazine in the country will be so favoured, and "Popular Wireless" readers will receive the benefit of the researches and discoveries of the foremost constructional expert in the country.

Other references to Mr. Harris's association with "Popular Wireless" will be found in this issue.

THE EDITOR.

Radio Evangelist Sensation.

AMERICA has been provided with a first-class broadcasting sensation in connection with the charge of criminal conspiracy levelled against Mrs.

Aimee McPherson, the popular radio evangelist.

Her "parishioners," who have been thrilled by her wonderful wireless sermons, still believe the evangelist's story that she was kidnapped and taken to Mexico by bandits. But the prosecution sought to identify her with the woman who at the time named occupied a cottage in California with a wireless operator, who is now missing.

B.B.C.'s Albert Hall Venture.

THE Albert Hall was about half-filled for the first National Concert, organised by the B.B.C., on October 31st. Everything went off very nicely, apart from the mis-timing which made the broadcast news bulletin about half an hour late, but I think that the audience that enjoyed the concert most was the one that stayed at home and heard it by air-line.

Those echoes that bothered listeners in parts of the Albert Hall itself did not affect the pick-up microphones that were suspended from the roof, 20 feet or so above Sir Hamilton Harty, as he conducted the orchestra.

Sir Alan Cobham.

THANKS to wireless, the whole nation was able to welcome Alan Cobham home, at the conclusion of his magnificent flight to Australia and back. In his account of this historic flight, the intrepid airman says he has proved that a regular service to Australia could be maintained "if sufficient ground organisation were employed, the stopping places were in short jumps, and wireless equipment were installed on the aircraft and at all the various landing-places."

B.B.C.'s Birthday.

A WEEK of special programmes will be simultaneously broadcast to all B.B.C. stations to mark the fourth birthday of the British Broadcasting Company, which falls on Sunday, November 14th. This special week precedes the birthday, and during this period another National Concert falls due. On this occasion the world-famous composer, Dr. Richard Strauss, will conduct at the Albert Hall.

(Continued on next page.)

NOTES AND NEWS.

(Continued from previous page.)

An Oscillating Crystal Set.

THE great interest that is now being taken in oscillating crystal sets prompts me to refer new readers who are looking for a good how-to-make article on the subject to the one that appeared in "P.W." No. 223.

By the way, the author's name was spelt incorrectly, and actually it is A. F. Fergus not A. F. Fingus, as stated.

The W G Y Family.

THE famous American broadcasting station, W G Y, is one of a family of fifteen stations, all living together at Shenectady. The group belongs to the General Electric Co., and frequently half a dozen of the stations, are on the ether at the same time, on different wave-lengths.

Station 2 X A F, one of W G Y's young brothers, who works on 32 metres, was recently heard direct in Australia during the same evening that it was being re-broadcast by Johannesburg, South Africa—a feat that constituted a world's record.

Trafalgar Day Broadcast.

NEXT Thursday, October 21st, the B.B.C. will broadcast a programme from the decks of the world's most famous warship. This is H.M.S. "Victory," Lord Nelson's old flagship, now lying at Portsmouth. The glorious old vessel did her first broadcasting over a century ago, and the world will never forget that message, "England expects" for it has now passed into history.

A Knock-out.

RECENTLY I suggested that the B.B.C. might do worse than arrange for a description of a Cup-tie to be broadcast, kick by kick, from the field of play. Such sporting events are a great attraction of the American programmes, as witness the fight for the world's championship. On that occasion, Tex Rickard—writes Lawrence W. Corbett, our New York correspondent—asked fifty thousand dollars for the right to broadcast the Tunney-Dempsey fight from the ringside at Philadelphia.

A Record for 2 N M.

THAT famous experimenter, Mr. Gerald Marcuse, of Caterham, Surrey (2 N M), has broken another record! Searching down on 23 metres recently he got into touch with the Straits Settlements, and tuned in a message of hearty congratulations upon being the first British amateur to make contact with Malaya.

After an hour's conversation they had to close down because although it was only 10.30 p.m. at Caterham, the next day was breaking in Singapore!

The Severn King.

HOW many more kings are going to be fitted with wireless? An Aberystwyth reader tells me he saw my remarks upon the "Southern King," but about the same time he had heard the "Severn King" testing his wireless telephony. The signals in this case were very powerful at Aberystwyth, upon a wave-length of 400 metres.

The Imperial Conference.

NEXT Wednesday (Oct. 20th) is the date fixed for the Empire Press Union dinner, when speeches will be given by members of the Imperial Conference, including the Prime Minister of New Zealand and the Prime Minister of Australia. It is hoped to broadcast these, and I suggest to some of our short-wave wizards that it would be a good stunt to pick up the speeches, and re-broadcast them on the low wave-lengths (if the hour of day is suitable) in the hope that they will be picked up at the Antipodes.

Those Poison Pills.

NOTHING that the B.B.C. has broadcast in the way of drama has touched the imagination of the public so deeply as the announcement of the mistake of the Birmingham chemist, who made up some poison pills in error.

Millions of people speculated about that box of pills, and rejoiced when it became known that the broadcast message was in time to prevent the pills being taken! A good many plays and "thrillers" have been written for the microphone, but this bit of real life was more dramatic than any of them!

Baby's Threat.

NOT all the broadcasting concerns have been able to handle the problems of the S.O.S. as effectively as the B.B.C.

SHORT WAVES.

The chief trouble in connection with most broadcast receivers is the provision of currants for their operation. (Provincial paper.)
Doesn't that take the bun?

Taps and hose-pipes are being installed for water effects in the new studio at Savoy Hill, and a large door will be built in a solid brick frame for slamming purposes. We suggest a good scheme for supplementing the B.B.C.'s income would be to hire this out to irate husbands!

It is reported that Mme. Galli-Curci says she objects to having her voice sandwiched between a bed-time story and a jazz orchestra.
A sort of lark sandwich!

An attempt is being made, we understand, to popularise the saw as a musical instrument for broadcasting. Why return to the original when so many life-like substitutes have been devised?

A writer in one of the leading daily papers says that he has heard better reception on a crystal set from a station three hundred miles away than could be received on a familiar set from a station that was about six miles away only.

A case of "familiarity breeds oscillation"!

Mr. John Goss, at this broadcast concert, sang groups of songs with strings. (London paper.)

Including "Blue Bonnet," "In your little muslin apron," etc., etc.

"Augustus in Search of a Lather" is the title of a play, in one act, which is to be broadcast from 2 L O shortly. (Provincial paper.)

He should try the B.B.C.; there's quite a lot of soft soap there!

"I hate broadcasting," declared Mr. Jacob Epstein, the sculptor. "I hate it worse than journalism, of which it is only a debased form." ("Daily Herald.")

Our special correspondent has definitely refused to interview Mr. Epstein.

An official wireless service will be opened in a few days between Belgium and the Congo and Vice Versa. ("Daily News.")

Vice Versa is, we understand, a small town in Verse Vica.

Some of the American stations now refuse to handle such messages, because of the abuse to which they have been put in the past.

This is the kind of thing that has been broadcast: "Will Joe Brown, who deserted his wife and baby 25 years ago, leaving them at such-and-such an address, return there as soon as possible, when said baby will proceed to knock stuffing out of him!"

B.B.C.'s New Chief.

THE EARL OF CLARENDON has been appointed by the Government to the post of Chairman of the new British Broadcasting Corporation, as forecast in "P.W." three weeks ago. He will take up his new duties on Jan. 1st, 1927, the date upon which broadcasting will be taken over from the present B.B.C. and administered by the State.

Coming Chamber Concerts.

THE B.B.C. has arranged an international series of chamber concerts to take place on the first Tuesday in each month. November will be devoted to Italy, December to Germany, January to France, February to Czecho-Slovakia, and March to Holland. These chamber-music concerts are quite distinct from the B.B.C. National Concerts.

Radio University for Britain?

THE time is coming when University courses will be sent out by radio, and British students, listening on a special wave-length, will be able to qualify for degrees, granted by the Radio University. So says Mr. J. C. Stobart, of the B.B.C. And so say I.

For they are doing this kind of thing in the U.S.A., and in the University of Sorbonne, and this country simply can't afford to go on wasting its share of the ether, as we are now. Just because we can't all go to Oxford (even if we cared to risk meeting all those Morris-Cowleys on the road), there's no earthly reason why Oxford and the other big-hat centres shouldn't come to us.

Victoria Monks.

MISS VICTORIA MONKS, the popular music-hall star, will make her microphone debut on Tuesday next, October 19th. Her broadcasting turn commences at 10.15 p.m., and Grand-dad ought to sit up and listen in, for I hear that "Won't You Come Home, Bill Bailey?" will probably be amongst the items!

Favourite Announcer Leaves B.B.C.

THE B.B.C. is to lose its favourite announcer. This is Mr. Eric Dunston, whose deep, pleasant voice had made him a great favourite with listeners all over the country.

It was quite by accident that Mr. Dunston took up broadcasting. Happening to hear that the B.B.C. were testing out voices at a Strand hotel, he went in for fun—and was immediately appointed an announcer!

India's New Stations.

NOW Mr. Dunston—who is thirty-two—has been appointed General Manager of the Indian Broadcasting Co. He will leave this country for India in December, to take charge of powerful new stations at Calcutta and Bombay.

ARIEL.

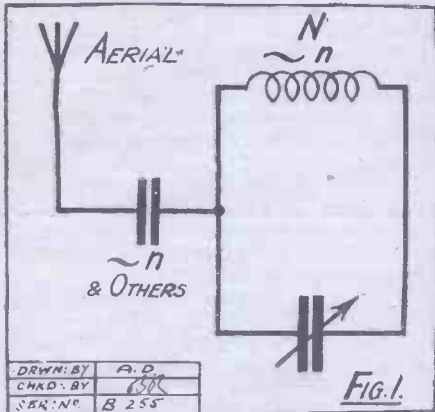
MORE ABOUT the "N" CIRCUIT

In this special article our Scientific Adviser deals in detail with the theory and operation of this latest invention—the "N" circuit.

By SIR OLIVER LODGE, F.R.S.

AN "N" circuit is an isolated closed resonator composed of a special inductance coil and a small capacity, which is stimulated without coupling by impulses conveyed to it through a single wire, and which builds up by syntony only those oscillations to which it is itself in tune. It is stimulated by exceedingly small amounts of energy, and these it can receive either from an antenna or from the earthed anode of a valve, or from both in combination. The following figures illustrate this.

Fig 1.—The antenna collects energy of any frequency, but the N circuit accepts



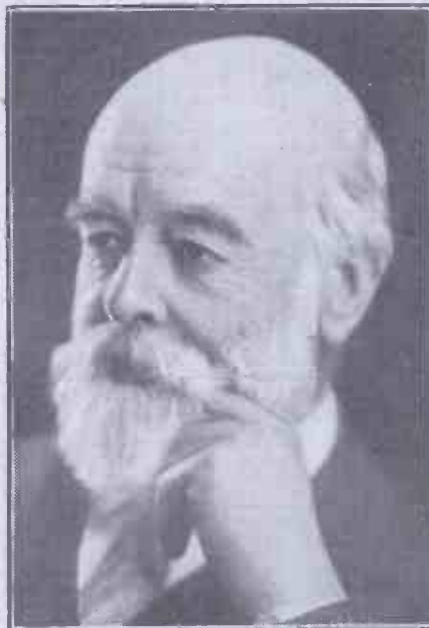
only that to which it is attuned, and that it builds up by syntony.

Fig. 2.—If a suitable choke is placed in the anode circuit of a valve and if the grid has alternating potentials of a frequency "n" imposed on it, then the earthed plate will pulse gently at that frequency.

Fig. 3.—If these two circuits are now combined by connecting the N circuit to the grid of the valve, the N circuit will build up energy of frequency n both from the antenna by collection and from the antenna by capacity effect between earth and antenna.

In practice these feeble regenerative impulses are needed to overcome the damping of the N circuit due to resistance of wire, etc.; and they may be very feeble, because it is so easy to build up the regenerative energy by syntony. What is wanted is to leave just sufficient damping to give free play to the necessary variations in frequency, due to modulation, so that there is no undue curtailing of the side bands.

Now, suppose this limit is overstepped, so as to give over-regeneration, and suppose the frequency to which N is tuned differs from that of the incoming signals. If the difference is great, the circuit can "oscillate" only at the natural frequency of the N circuit, and therefore will not respond;

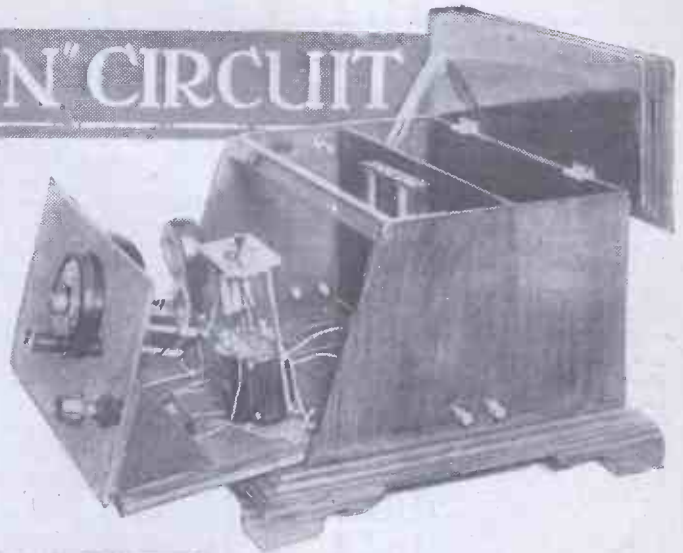


Sir Oliver Lodge, F.R.S.

but if the difference is very slight the incoming signals will build up to an amount in accordance with the energy curve, and heterodyning will take place in the N circuit. The antenna being a collector only, and out of tune with the incoming signals, cannot respond, and therefore cannot re-radiate.

IMPORTANT NOTICE

We wish to make it quite clear to our readers that N circuits are covered by letters patent, and that all N circuit patents are owned by the inventor and Messrs. Cleartron Radio, Ltd., the firm now owning the exclusive N circuit commercial rights. Bona-fide experimenters are privileged, and in pursuance of their work may "hook up" and experiment with N sets; but royalties are payable by ordinary listeners who make N sets for general use. This article is expressly intended for bona-fide experimenters only. The general constructor desiring to make an N circuit set for home use should obtain particulars and the necessary permission from Messrs. Cleartron Radio, Ltd., 1 Charing Cross, London, W.C.

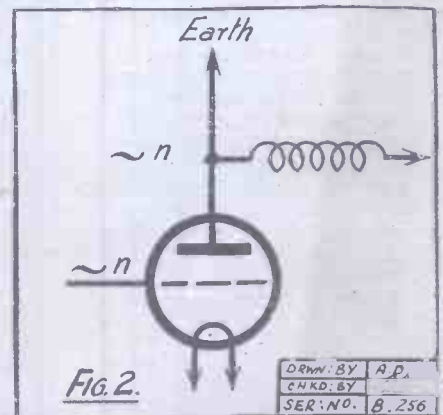


The circuit indicated by Fig. 3 has one disadvantage. Strong signals of frequencies differing from that of the N circuit may force their way on to the grid and so otherwise mar excellent results. This is remedied in Fig. 4.

Fig. 4.—To overcome this disadvantage, a choke is placed between antenna and earth, as in Fig. 4, so that the unwanted signals may have as free a path as possible to earth. This choke is preferably inductive. It will be seen later that the introduction of this choke has certain other advantages, even apart from the "choke aerial" theory, which add to the novelty of the circuit.

The Preferred Circuit.

The antenna-choke-earth (A.C.E.), Fig. 5, system is an isolated open circuit, and it can, therefore, receive energy from its "A" capacity area or its "E" capacity area, and can build up energy of that frequency to which it is attuned. But the frequency at which the plate, and therefore the earth, will pulse is dominated by the N circuit. Now, as the amount of regenerative energy



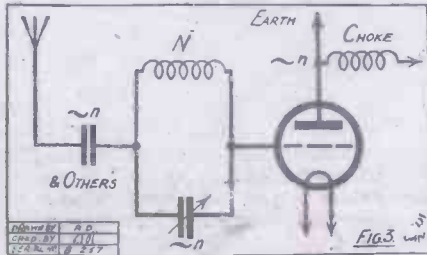
available is extremely small, there will not be enough to overcome the damping of both the A.C.E. and N circuits in this case. The tuning, therefore, will be flat, and there will be no tendency for either circuit to oscillate. (By a circuit "oscillating" in the deleterious sense, we mean that the energy in the circuit is more than that

(Continued on next page.)

MORE ABOUT THE "N" CIRCUIT.

(Continued from previous page.)

required to overcome its damping, so that it becomes self-exciting.) So soon, however, as the A.C.E. circuit is out of tune with the N circuit, the regenerative energy is short-circuited through the A.C.E. circuit, and wave motion is introduced through the fixed condenser into the N circuit, which will build up the energy by sympathy until the damping factor is overcome. There should be only sufficient regenerative energy just to overcome this damping of the N circuit, so that the latter can be



brought near to the point of self-excitation, at which point the circuit is most sensitive. This is where the value of the anode choke comes in. The true explanation of regeneration in N circuits is a most important point, for it appears to occur, in this system, in a novel way, such as would not readily have been anticipated. It must be of just the right value to give the necessary amount of high-frequency oscillating potential on the plate when the valve is functioning at about its specified conditions. If there is much too much anode choke, regeneration will be uncontrollable; if decidedly too little, there will not be sufficient regeneration to actuate the circuit efficiently.

The Transformer.

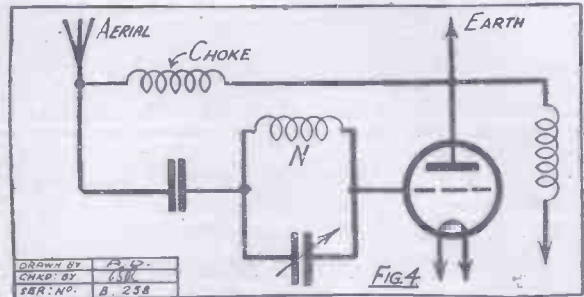
In actual practice the correct state of affairs is obtained easily by using the right component. If 'phones are used, the choke in the anode circuit should be equivalent to 8,000 ohms resistance. If a transformer is used, it should be similar to the Silvertown type, an ordinary straightforward transformer. For choke coupling the choke should have the characteristics of the primary of the Silvertown transformer. The actual impedance value could easily be obtained by measuring the actual impedance of the primary of the transformer. Its self-capacity must also be measured, as this seems to be an important practical feature. If this self-capacity is eliminated there will be too much regenerative energy available at the plate.

It is advisable to supply this capacity as a self- or distributed capacity, and not as an added capacity across a low self-capacity choke or primary. The choke with correct self-capacity is more easily obtained in practice, so it is not necessary to eliminate the self-capacity, and then add an extra unit of capacity to replace it.

In these and other directions, constructive experience has proved essential.

The value of the anode choke depends to a certain extent on the valve used. With the Silvertown transformer or Stevens choke a valve of an impedance of some 18,000 ohms is preferable. The majority of dull-emitter valves of this type function well, providing they give the advertised electron emission. Similar types of bright emitters should be quite satisfactory providing the electron emission is still adequate. If the electron emission is faulty, in any valve, then the circuit cannot be brought up to the point of oscillation. (This naturally holds with any circuit.) If the electron emission is above that of the average valve (e.g. Phillips-Mullard P.M. 3), tuning will be more critical, and perhaps rather too sharp for loud-speaker work on broadcast wave-lengths. This type of valve will tend to oscillate at higher frequencies than the average valve mentioned above. Characteristics of valve and anode choke bear some relation, and naturally there will be one combination which is better than others.

It is not desirable to have the A.C.E. circuit in tune with incoming signals, for the signals and the regenerative energy should build up together in the N circuit. It is interesting to note, however, that the circuit does not tend to "oscillate" even when both the A.C.E. and N circuits, as here arranged and earthed, are in tune, and, consequently, the possibilities of re-radiation are remote, for it is only when both the A.C.E. and N circuits are in tune and the whole circuit is "oscillating" that re-radiation from the antenna can take place.



having the A.C.E. too much out of tune tends to give a little too much regeneration, so making tuning a little too sharp. The happy medium for the value of the choke is a figure that will make the wave-length of the A.C.E. circuit, say, 10 per cent. above that of the signals to be received. When interference is present, it may sometimes be of great service to make the wave-length of the A.C.E. circuit below that of the signals to be received. The energy from strong signals, not wanted, would then tend to go straight to earth, while there is still sufficient choke to deflect some energy of the wave-length required into the N circuit.

Collection of Energy.

The efficient working of a receiving set depends in the first place, in making the most of the initial energy collected. The preferred circuit conforms with this principle and so can be classed as efficient. In practice it is being proved the most efficient "straight" circuit at present known.

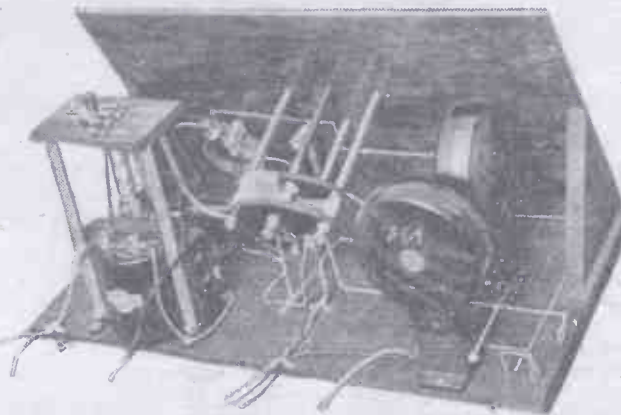
Weakness of collected energy can be overcome by a better aerial rather than by increase in the number of valves used, for it is useless to strain the overall efficiency of the receiver if more initial energy were available for the asking.

Maximum overall efficiency, limited by certain practical considerations only, cannot be stressed too strongly, and, for this reason the consideration of frame aerial reception can be excluded for the present. The majority of persons can supply a suitable earth for working conditions, and they can also find room for an antenna. They can thus start off with a good supply of energy that requires no maintenance from their point of view. Stress need not be laid specially on outdoor aerials as a good many people think them unsightly. Nevertheless, the use of as long and as high an antenna as is convenient to the user of a receiving set is very desirable. An antenna can generally be hidden from view

if a little thought is used. From actual results obtained we find that such a concealed antenna, although technically inefficient, gives good results on an N set.

So far, consideration has been given to present broadcasting conditions when the length of the antenna is such that its natural wave-length is smaller than that of the waves to be received. What are the conditions to be observed in the A.C.E. circuit when the natural wave-length of the antenna is greater than that of the waves to be received? It is not desirable to shorten

(Continued on next page.)



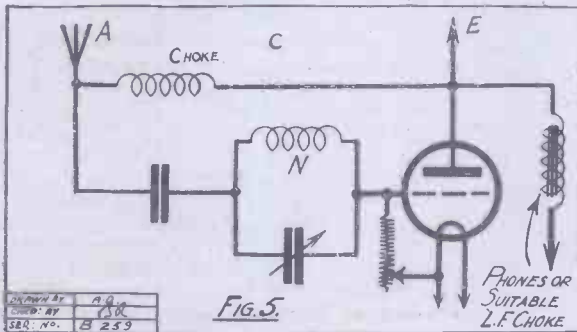
A rear view of the two-valve "N" set, now exclusively manufactured, under patent rights, by Messrs. Cleartron.

It is necessary, on the other hand, to get the A.C.E. circuit not too far out of tune when a Post Office antenna (i.e. one whose natural wave-length is smaller than that of the ether waves to be received) is used, otherwise strong signals in tune with the A.C.E. circuit might force their way by sheer brutal strength through the N circuit on to the grid. Also a high value choke may prevent the antenna picking up the maximum amount of energy (e.g. Daventry with the same P.O. aerial). If the choke is too small, the energy will tend to go too easily to earth. Again,

MORE ABOUT THE "N" CIRCUIT.

(Continued from previous page.)

the effective length of the antenna, as it is desirable to pick up as much energy as possible. Experiment will indicate the best value for the choke coil to obtain maximum efficiency of pick-up without altering the main principles of the circuit. For low wave-lengths—say below 100 metres—the detector valve must be given consideration. It must be so designed that it will "oscillate" at these wave-lengths. This factor is common to most receivers.



P.M.3 valves will oscillate down to about 50 metres without alteration of the set in any way. Below this value there are no doubt suitable valves on the market already for efficient working, but in any case, the problem will solve itself as and when the emergency arises.

In practice there appears to be some threshold value of energy collected that can build up by syntony. It may be very small, probably smaller in the preferred circuit than in any other, but, nevertheless, it is finite.

Earth.

The "Earth" does not introduce anything different from present practice. As short a lead as is convenient is advised.

Choke Coil for A.C.E.

This may be of any type of inductance.

Coupling Condenser (Fixed).

Experience up to the present time fixes the value of this at '0001 for Post Office aerial of 100 feet or thereabouts.

"N" Circuit.

Inductance Coil.—The essential theoretical factor is that this coil must be able to build up energy. Not every type of coil will do this. The pure "basket"

type seems to be the most efficient, while certain modified types work well (e.g. Stevens). The construction of the basket type of coil is very simple and inexpensive in practice. In the case of a coil for long wave-lengths (e.g. for Daventry) the Stevens type oscillates too easily with the same anode choke as for 2 L.O. Keeping the latter choke (i.e. the primary of the transformer in 2-valve set) constant it is feasible to damp down the 500 Stevens coil by placing a piece of metal about the

size of a penny in the core. A similar effect can be obtained without damping the coil by placing a fixed condenser of '0005 mfd. across the primary of the transformer. In practice there is no doubt that the damped coil is the more simple method when a change is required from 365 to 1,600 metres or vice-versa.

The fact that not every type of coil will function in no way interferes with the theory of the circuit, nor does it prove that the circuit is tricky. It merely indicates that the method of winding an inductance

coil introduces a factor—perhaps quite new—which does not allow the energy to build up by syntony. It seems that this factor is not a function of inductance, capacity, or resistance. A keen analysis of the construction of the types of coils which do not function in the N circuit, although otherwise perfect, will, no doubt, explain the anomaly.

Variable Condenser.

The maximum value of this condenser should not be more than '00095 mfd.



The "All-in" Cleartron "N" circuit set. Complete with loud speaker, batteries, etc., for £1 down and easy monthly payments.

If convenient, half this value would be better, but, in practice, the three plate condenser seems to be most convenient and will cover a reasonable range of wave-lengths for one coil.

Ebonite in the mechanical construction is advised.

Detector Valve.

A valve that has an impedance of some 18,000 ohms seems to function best for the normal amount of received energy.

An independent observer who has tried many valves has come to the conclusion that any valve of the correct construction should function efficiently. In a certain instance an old valve that gave very poor results on an ordinary reaction circuit gave quite good results on the preferred circuit.

Most 3 volt '06 valves are known to be suitable and can be recommended.

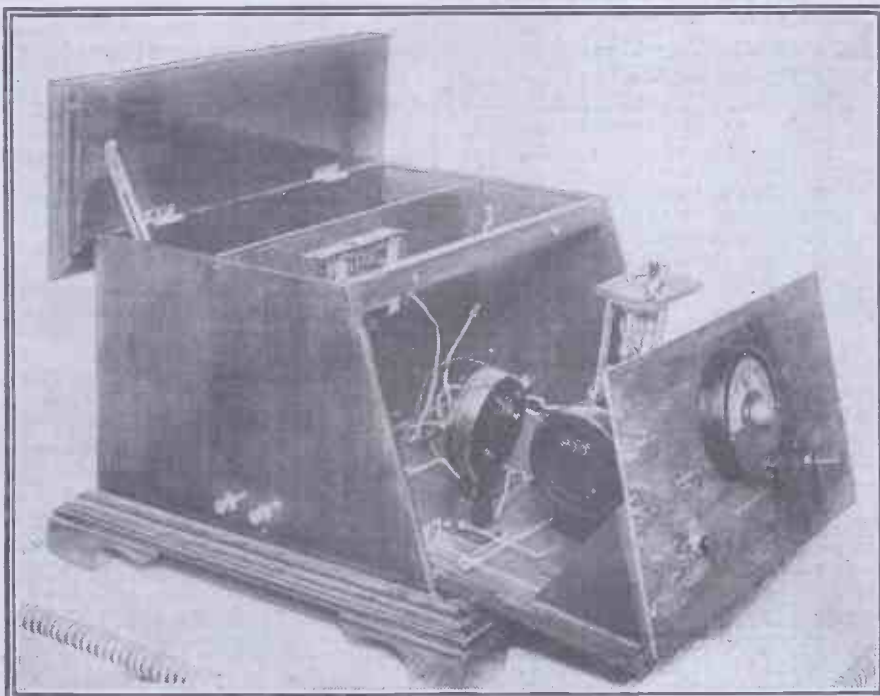
Low-Frequency Valves.

These valves follow common procedure.

Grid Leak.

The value of this depends on the valve to a certain extent, but it is certainly of no greater importance in the preferred circuit than in any other circuit.

The use of the Watmel Variable Grid Leak is recommended. Once set it need never be touched again unless other alterations are made. The value lies between '5 and 1 megohm approximately for most purposes.



Another view of the commercialised Cleartron Lodge "N" Receiver.

(Continued on page 390)

THIS week's issue of POPULAR WIRELESS is a special one in more than one sense.

To begin with, publication of this number marks the opening of our winter campaign, and to celebrate that event we are giving away a large four-page supplement entitled: "The 'P.W.' Constructors' Guide." Two more supplements will be given away with succeeding issues, making three in all, and these three supplements together will, we feel sure, make a valuable addition to the library of the wireless constructor.

We are also offering £200 in prizes for amateur constructors; full details about this competition will be found on page 353. But perhaps the announcement regarding Mr. Percy Harris, which we publish on page one of "Radio Notes and News," will attract the widest attention in the world of amateur radio.

Mr. Harris and "P.W."

Mr. Harris is undoubtedly one of the leading constructional experts in the country. In the old days, when Mr. Harris was Editor of "Conquest," his constructional articles were widely read and appreciated. Later, he joined the "Radio Press" as Editor of "The Wireless Constructor," and until a few weeks ago filled that position with remarkable distinction. Why Mr. Harris left the "Radio Press" and decided to link up his fortunes with this journal he will explain himself in a special article which will appear in next week's issue. Mr. Harris has been invited to take charge of a special constructor's supplement. This supplement, which will consist of eight pages in the centre of POPULAR WIRELESS, will commence in the issue on sale the week after next. It will be edited by Mr. Percy Harris.

We have made special arrangements with Mr. Harris for the exclusive publication of his wireless articles, both constructional and otherwise, and we wish to take this opportunity of expressing our pleasure at having him associated with POPULAR WIRELESS, a pleasure which we feel sure will be shared by every one of our readers.

Mr. Harris's reputation as a radio engineer needs no words of praise in these pages. It would be superfluous, for his reputation is indeed world wide, as an inventor and designer of wireless receivers *par excellence*, and we count it singularly fortunate that we have been able to make successful arrangements with Mr. Harris in connection with the editing of the new constructor's supplement.

The Radio Constructor.

This supplement (which will be entitled "The Radio Constructor") will provide an avenue for Mr. Harris to place before constructors his latest receivers and the latest results of his researches. These results will appear in no other wireless journal. At this stage we cannot explain in detail Mr. Harris's programme, but he himself will deal with this matter in the special article which he has written for POPULAR WIRELESS, and which will be published in next week's issue.

In the next issue but one the first instalment of this supplement will be included in POPULAR WIRELESS, and we advise every reader to take the earliest opportunity of placing an order, for there is bound to be an extraordinarily heavy demand.

A few words will not be out of place with

MR. PERCY W. HARRIS AND "P.W."

Our Gift Supplements—£200 for
Constructors—The Lodge "N"
Circuit.

By THE EDITOR.

regard to the £200 we are offering in cash prizes to POPULAR WIRELESS readers in connection with our amateur constructor's competition. The full rules governing the competition will be found on page 353, and on one of the back pages in this issue a column of labels will be found, which should enable the amateur to indicate clearly which particular class he is entering, when sending in his set for adjudication.

It should be clearly understood that no apparatus should be sent to the Editorial offices of this journal. Special accommodation has been acquired for receiving these sets, as there would be no room in the editorial offices to deal with the many entries, which we shall undoubtedly receive. All apparatus is sent at the reader's own risk and it cannot be returned unless adequate cost in the shape of a postal order or stamps is sent with the receiver to cover its return. Every possible care will be taken of apparatus, but we cannot be responsible for any damage which may occur to it.

Sending Your Apparatus

It would particularly assist the adjudicators if the parcel containing your apparatus was labelled with one of the labels we publish in this issue, as this will greatly facilitate the work of handling the entries. It is extremely important that amateurs should note that their apparatus should be sent to the following address:

Amateurs Radio Competition,

"Popular Wireless,"

c/o 7-9, Pilgrim Street,

Ludgate Hill,

E.C.4 (Comp.).

The competition is open until November 16th. Any apparatus received after November 16th will not be admitted for adjudication. As soon as possible after November 16th apparatus will be returned to the owners.

Our younger readers will note that we have included a special class for constructors under sixteen years of age. The apparatus to be submitted consists of a one-valve B.B.C. wave-length (not 5 X X) receiver, and the size limit for the panel of the receiver is 10 by 7 inches. By limiting this size we feel that we can gauge the constructor's ability to greater advantage.

In all, there are ten prizes offered; five first-class prizes of £25 each, and five second-class prizes of £15 each, and the apparatus we have set as a test for constructors is of such a nature that no great outlay and no great expense need be incurred in purchasing the materials necessary for the construction of the various units mentioned in the list of classes.

We feel sure that this competition will attract very wide attention and interest

among our readers, and we hope that they will enter one or more classes and test their skill as amateur constructors.

In this week's issue we also publish an exclusive article by our Scientific Adviser, Sir Oliver Lodge, the inventor of the now famous "N" Circuit Receiver. In a previous article we published a description of an experimental form of "N" Circuit receiver, and as there seems to be some slight misunderstanding in connection with this article we should like to point out that the circuit given in the article referred to was not the "N" Circuit in its refined and improved form, as now adopted for commercial purposes by Messrs. Cleartron Radio, Ltd., the firm which, by arrangement with Sir Oliver Lodge, has now the exclusive manufacturing license of Lodge "N" Circuit Receivers.

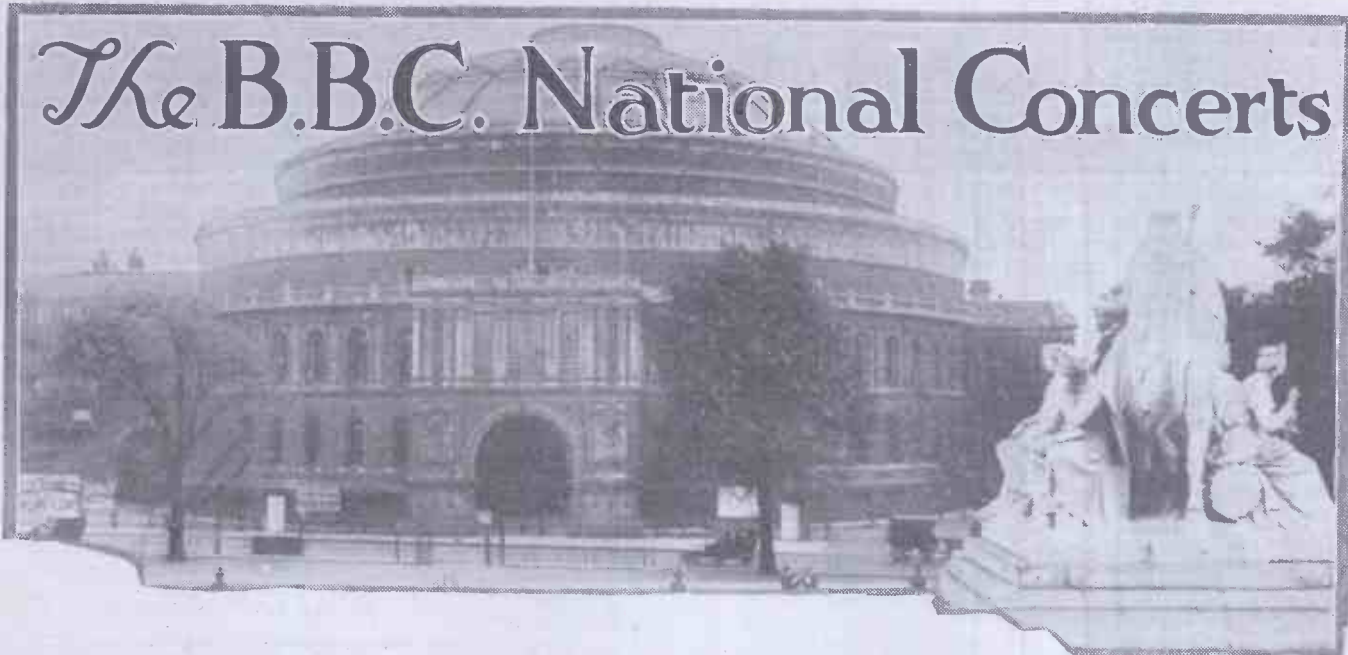
"N" Circuit Receivers.

The article we published was intended for experimenters only, and the information given was in regard to the early "N" Circuit upon which Sir Oliver Lodge has been working for some time and from which has now been evolved the more versatile circuit adopted by Messrs. Cleartron. As our readers know, bona-fide experimenters have the privilege of hooking up various circuits even when covered by patent rights, on the clear understanding that they do so as bona-fide experimenters. The Lodge "N" Circuit is covered by British patents and it must not be constructed, nor must any article in POPULAR WIRELESS connected with it be considered as an incitement for amateurs to construct "N" Circuit receivers purely for general use, and certainly not with the intention of passing them on to friends or selling them. Readers who do so render themselves liable to serious consequences.

The "N" Circuit may, however, be experimented with, and if a reader wishes to build himself an "N" Circuit receiver for ordinary B.B.C. reception and not with any intention of conducting research work, then he should first of all obtain the written permission of the license holders, Messrs. Cleartron Radio, Ltd., of 1, Charing Cross, S.W. Sir Oliver Lodge himself appreciates the value of the experimental work done by many amateurs in this country, and he would be the last man to issue an edict against the experimenter from personal investigation of his receiver. But inventors must be protected, and so must businesses which conduct commercial undertakings on the strength of such inventions, and we hope that all readers will thoroughly appreciate these remarks.

Messrs. Cleartron have informed us that they will be only too pleased to supply all possible information regarding the "N" Circuit to any of our readers who communicate with them. In referring to Messrs. Cleartron, we do so with every appreciation of the work they have done in connection with Lodge "N" Circuit receivers, and we should like to take this opportunity of congratulating them on the way in which they have launched the "N" Circuit receiver on to the market, and the novel way in which they sell these receivers at £1 down and with easy monthly payments.

The B.B.C. National Concerts



IT was a very calm, unassuming little Irishman I discovered sitting deep down in a plush armchair in the only dressing-room the Royal Albert Hall possesses. Sir Hamilton Harty, with his keen, boyish face, in smiling contrast to his grey hair, is as great a personality in the intimacy of his own surroundings, or in a simple dressing-room, as when he is waving the baton above the heads of his one hundred and fifty musicians.

"This evening will be one of the most memorable in the history of the B.B.C.," Sir Hamilton said to me, as he sipped at a cup of black coffee. "The London station has often been harshly criticised on its policy, but there is none to-day who can really sincerely say that the B.B.C. is not well on the road to progress."

Sir Hamilton Harty is by no means a wireless enthusiast. As a hobby wireless broadcasting means absolutely nothing to him, and he has never in his life had a set which he could call his own. Notwithstanding his refusal to accept radio as a necessity to his home, the eminent musician has often listened-in, and the more he listens the more he is convinced that broadcasting is one of the greatest things that has ever happened.

The Average Programme.

"What do you think of the average broadcasting programme?" I asked him.

"I have often thought about it. Taken on the whole, I think it is an almost perfect concoction of what the public requires, but the items taken individually are not always worthy of the big brains behind Savoy Hill."

Sir Hamilton Harty is one of jazz's biggest enemies. His attitude towards syncopated music is not one of violent hatred, but rather one of silent contempt. His broadmindedness, how-

By **SIR HAMILTON HARTY**
The famous conductor of the **Hallé Orchestra**, and the first conductor chosen to lead the **150 musicians** at the first **National Concert** organised by the **B.B.C.** at the **Albert Hall**. (In an exclusive interview with "Ariel.")

ever, allows him to say that it is a most necessary item in any broadcasting programme.

"A Welcome Change."

"Jazz is a very curious thing," said Sir Hamilton Harty, with a smile. "I am sure that few people understand it. I like beautiful music. Jazz is not beautiful. In fact, it is very ugly. It means absolutely nothing. It is only good music presented with terrible, grotesque distortion. Everyone knows I am no lover of jazz. The beauty of music is in its quietness. The blare and blast that is in every piece of dance music is an insult to every musical mind."

Sir Hamilton Harty thinks that there is too much modern dance music in the B.B.C. programmes.

"I know there is a great demand for it," he told me,

"but in anything, as you know, there is nothing more disastrous to its popularity than having too much of it. And that is exactly the case with dance music. Too much of a good thing is always ruinous, however good that thing may be.

"Lately, however, at Savoy Hill, there have been more requests for better music; and it comes as a welcome change after the fifty per cent of dance music. Now one can say there is just as much straight symphony as there is jazz in any broadcasting programme, and this is just as it should be."

The greatest brainwave the B.B.C. has ever had, according to Sir Hamilton, is to be found in the scheme of the National Concerts.

"The London Station," he said, "has often been accused of lack of artistic foresight. I think this is very unfair. The organisation of the National Concerts has shown that the B.B.C. takes a very great interest in its artistic future. It will be some time before it is realised how greatly it has helped music in England.

"England requires better music, and music has always been a great and much-loved Art in England, and it has been left to the B.B.C. to cater to the great public demand for the works of the great masters performed in the right manner. Not only have we shown that a B.B.C. programme can attract thousands to witness it, but we have also shown there is still a large section of the British public who would much rather hear Handel than Whiteman."

A Curious Happening.

Now, with regard to the first National Concert at the Albert Hall, which consisted of the works of Handel, Beethoven, and other great masters performed by the wonderful orchestra conducted by Sir Hamilton Harty, and which also included the beautiful rendering of a few German songs by the famous singer, Madame Maria Olczewska, a very curious thing happened. By unanimous public opinion it was agreed that the concert sounded better by wireless than in the Albert Hall.

(Continued on next page.)



Sir Hamilton Harty, the eminent Hallé Orchestra conductor, wielding the baton on the occasion of the first B.B.C. National Concert.

LEAD-IN EFFICIENCY.

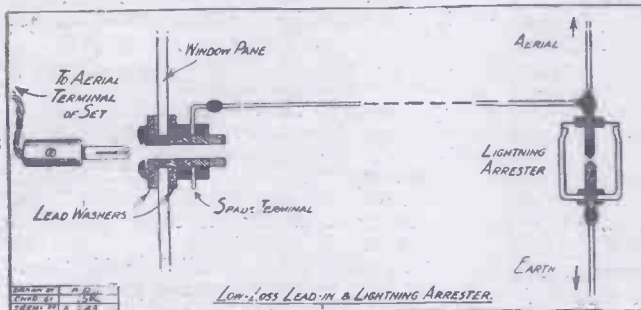
By H. JACKSON.

"EFFICIENCY" is the slogan of the radio enthusiast nowadays more than ever it was in the past; with so many "fans" taking up DX work seriously, the cry for low-loss components is increasing daily in volume and earnestness.

An Important Item.

Now, the endeavour to change one's radio outfit from a state of comparative mediocrity to one of ultra-efficiency is a very admirable one, since it shows the true engineering spirit, but there is always the danger of beginning in the wrong place. So many amateurs of my acquaintance seem to imagine that when one speaks of one's radio outfit one means the apparatus that comes after the aerial terminal—the aerial itself being looked upon as an extremely unattractive but unfortunately (in most cases) necessary adjunct to the set proper.

So what they do is to go out one dark night when nobody is looking, throw some kind of a mast up in the back garden, sling



a bit of wire from the top of it and from a convenient chimney, and then sink shamefacedly indoors in order to pull the lead-in through a narrow hole drilled in the framework of the window in the wireless room.

Now, of course, this is all very simple, but it is decidedly not good engineering practice.

The Logical Beginning.

What is the use of losing half the strength of the aerial current because of an inefficient lead-in, and then attempting to remedy matters by an assembly of low-loss coils, low-loss condensers, and low-loss everything else? Surely it is far better to start at the logical beginning of a wireless installation, and to carefully shepherd those tiny oscillations from the aerial to the set. It is natural to assume that, in almost all cases of well-constructed aerial systems, the largest proportion of losses are due to capacity effects just where the lead-in enters the house. Even the very popular lead-in tube is not guiltless in this respect; true, capacity losses in this case are small, but the following method of bringing in the lead-in, which is used by the writer, is not likely to be improved upon for absolute efficiency, and, as such, should make a strong appeal to the discriminating amateur.

It consists in taking the lead-in through the glass of the window-pane itself, and the writer accomplished it as follows.

Obviously, the first job is to remove the glass pane from the window frame (it is not much use trying to drill it in its usual position!); This was accomplished by chipping off the putty all round the edge of the pane with a sharp knife and carefully slipping out the glass. This latter was then placed on a perfectly flat surface (this is important, and must be followed, or failure is certain). Having purchased an ordinary plug and socket (the plug having an insulated arm), and selected a size of twist-drill $\frac{1}{2}$ inch of an inch larger than the outside diameter of the shank of the socket, the exact centre of the glass pane was found and marked, and drilling commenced with an ordinary hand-drill.

Drilling a Window Pane.

Very little pressure was used, and as a result the drilling took rather a long time, but the results obtained have amply repaid the care taken at this stage. When half-

way through, the glass was turned over, and drilling commenced from the other side, as this helps to prevent cracking. When the drilling had been successfully accomplished the socket was inserted, along with two home-made, fairly large, lead washers (one on each side of the glass), and the whole screwed up tight. The lead washers, being com-

paratively soft, helped to take up the strain of tightening, and so saved the glass from any undue stress which might have caused cracking. The pane was then replaced in the frame, and refixed with putty in the usual way.

A piece of 18 S.W.G. D.C.C. wire, about a yard long, was then used to connect

ANOTHER SPLENDID FREE GIFT

NEXT WEEK

Order Your Copy Now.

the socket to the lead-in, or rather the "lead-down," from the aerial proper, as this wire, being fairly stiff, could be made to stand straight out from the window in a horizontal position, so assuring that the vertical wire from the aerial well cleared the roof-guttering.

The whole is shown in section in the accompanying diagram, which also illustrates a simple but effective home-made lightning-arrester which the writer has fitted. The description of this, however, is not for this article.

The reader may think that the whole matter is too much of a detail to bother about, but the results obtained will show that it is well worth the trouble.

Previous to using this attachment, the writer was taking his lead-in through an ebonite tube in the wooden framework of the window; and, situated twenty-five miles from Manchester, this station was comfortably audible on the 'phones, using 60 volts H.T., on a Chitos one-valve set, but since completing the new lead-in attachment, Manchester can be heard all over the room with the 'phones on the table with only 24 volts H.T.! In addition, tuning is vastly sharper, and many more foreign stations can be heard than formerly.

The writer considers the improvement effected to be equivalent to the addition of another valve.

THE B.B.C. NATIONAL CONCERTS.

(Continued from previous page.)

As the manager, Mr. Charles B. Cochran, might tell you, the Royal Albert Hall is notorious for its terrible acoustics. Half the audience on the first evening will tell you that it seemed that two orchestras were playing, whereas the other half might tell you that it was disappointing how small seemed the sound from such a huge combination.

Several of my listener friends have written to me saying what a really wonderful programme it was. The B.B.C. engineers (Captain Eckersley at their head) are to be congratulated on the great performance of arranging such a perfect broadcast from the Albert Hall.

Not at any moment was the programme of unequal quality. Madame Olczewska's voice turned out to be one of the most beautiful that has ever been "sent out into the ether." Not a note, not a fleeting second of Sir Hamilton Harty's beautiful harmony was lost or distorted, and the B.B.C. is to be complimented on one of its greatest achievements.

"Where Broadcasting Scores."

"In reality," continued Sir Hamilton, "the B.B.C. has done a great deal for music in England. I think that the more one hears programmes of good music broadcast, the more popular they become.

"Broadcasting is like the hors d'œuvres at lunch. It gives one an added appetite for the rest of the courses. It is the same with a novel. A good cover is often responsible for bigger sales. I certainly think that the broadcasting of really good music makes one want to hear more of it."

Sir Hamilton Harty told me afterwards that he was very pleased with the success of the first National Concert.

"Everything was so well organised. From beginning to end it ran with perfect smoothness. I am one of those people who really think that music loses nothing by being broadcast.

"Where broadcasting scores is that it augments day by day its already huge popularity for special items, and I am convinced that the broadcasting of straight symphony will prove in the end to be the most popular of all items."

PROGRESSIVE BROADCASTING

ANOTHER season begins; to commemorate the event POPULAR WIRELESS is publishing a special number. It is a good time "to look back on the way we have come, and forward to the summit whither our way lies."

What problems are there yet to overcome? What signs are there that they will be overcome? Where have we failed, and what are we going to do to improve the service for the public?

Such questions as these form subjects for several articles, but I have set myself the task of attempting to answer a few, confining myself naturally to technical aspects.

Broadcasting concerns itself with two sets of apparatus, the transmitter and the receiver. The transmitter problem divides itself, naturally, under two further heads: "Quantity" (or "Distribution") and "Quality."

Taking, then, first, distribution, where are we now, and what changes do we contemplate making? No new stations have been erected, and the distribution system stands as it did a year ago. This is not, however, indicative of stagnation. I am told that if one decides to build a big block of offices or a new theatre, it takes the architects and designers a full year or more to get out the drawings. So with us; it is important carefully to consider the whole problem of distribution before embarking upon hastily considered schemes.

The Broadcasting Service.

The deliberations of the International Committee on the technical problems endemic to all European systems are wholeheartedly agreed that a limitation in the number of wave-lengths used is essential if progress is to be maintained. Fewer wave-lengths available means at present fewer stations, and fewer stations to give the same service means that they must be of higher power. Further, it has become obvious that we must consider broadcasting for the general public in terms of an interest in what is received, not in the means of its reception, and no station can be considered as giving a good service to a listener if that listener is continually interrupted by extraneous noises. The service area of a station is increased in proportion to its power, but in any direction in proportion to the square root of its power. Thus, if the London station may be said only just to give a service to St. Albans at 20 miles, then its power will have to be quadrupled to give a service to Colchester at 40 miles (my figures may not be accurate; they serve to illustrate my point). Thus, again, high power is essential for any new system of distribution where a multiplicity of stations is replaced by a few.

Giving further alternative programmes would seem to be an important step in advance; the public should have two things to grouch about instead of one! With only a few available wave-lengths we halve the number of stations, and so still greater must be the power. The experiments done this year to show that the best method of giving

STARTING A NEW SEASON



A Specially Contributed Article by the
Chief Engineer of the B.B.C.,
CAPTAIN P. P. ECKERSLEY, M.I.E.E.

alternative programmes will be to radiate the two programmes from one point at equal power, make us visualise the future of distribution in terms of a very few stations with twin wave-lengths but of very high power. It remains for experiment to prove the feasibility of such a plan. Existing



Captain P. P. Eckersley, Chief Engineer of the B.B.C.

stations might well be kept on if they worked upon exactly the same wave-length, it being realised that in such a case the programmes would only be received locally, the stations being designed for local significance only. The year 1927 should see finality in the framing of the future scheme of distribution.

Turning now to the problem of quality, we have a problem on the transmitting side which is as easy as possible to state and as difficult as possible to solve. Sound waves can be quantitatively expressed in terms of the pressure above and below normal atmospheric pressure they exert at maximum upon the microphone. A good way of expressing the performance of a microphone is to say that its quality approaches perfection as it nears the ideal of converting equal sound wave pressure into equal electrical impulse over the audible gamut. Thus, if we create sound waves of equal pressure over the audible range from, say, 30 up to 10,000 a second, our microphone should be able to turn these sound impulses into equal electrical impulse over that range of frequency.

We have microphones capable of doing this. The next important point is to see that no part of the circuits which handle these electrical impulses from microphone to transmitting aerial and from receiving aerial to loud speaker diminishes their quantity differently at any of these frequencies.

Take, for instance, the transformer. There are five of these between microphone and transmitter; there have to be. If they each cut off 20 per cent of the impulses at, say, 100 cycles compared with 1,000, then the net result is to diminish the true ratio of this impulse by more than 50 per cent by the time it reaches the transmitter. The electrical circuits in the transmitter are again responsible for more "cut-off" and the receiver and the loud speaker especially add their quota of differential imitation.

Some years of research have enabled us to design amplifiers with a remarkable performance. In designing the new transmitters we have learned how to overcome any cut-off; the London station has now a curve approaching perfection. I think I may state with fair confidence that in a year's time the electrical system will be practically perfect if only awaiting the time and money for its final adoption at all British stations.

The Perfect Loud Speaker.

"What," however, is often asked, "is the use of designing a perfect electrical circuit between microphone and transmitting aerial if the receiver cannot deal with what is given them?" In effect, I would reply to this: "It is our job in the B.B.C. to make the electrical performance perfect while waiting for the perfect receiver—or, since the perfect receiver (from the point of view of electrical performance up to the loud speaker) can be designed, the only problem that remains is the 'perfect' loud speaker, and we do not want to be found waiting when someone produces it."

Truly it is more blessed to send than to receive, and the problem of the receiver designer and the loud speaker designer is beset with pitfalls. Take the loud speaker itself. To reproduce in full bass notes

(Continued on next page.)

SAFETY IN TRANSFORMER WINDINGS.

By "AMEC."

QUITE a number of practical amateurs carry out the rewinding of old transformers, telephone magnets, and the construction of high-resistance choke coils, and similar operations which necessitate the employment of very thin insulated wire.

The unfortunate part about such operations is that if an undetected break occurs in the wire, the whole instrument under construction is thereby rendered useless and much valuable time may have to be spent in locating the fault.

Automatic Warning.

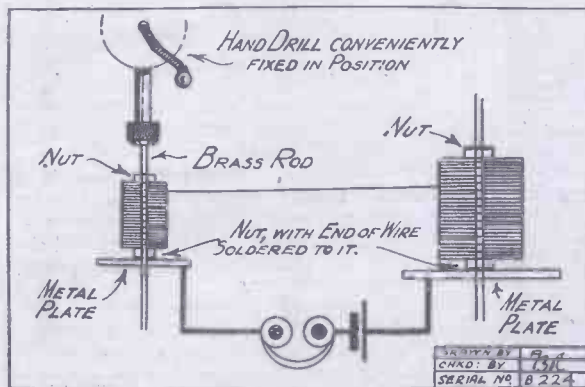
By the use of the following method, however, such troubles may be completely eliminated. The bobbin containing the wire to be wound and the bobbin or core on which the wire is being wound are both mounted on small, perfectly flat circular

Under these conditions, a complete electrical circuit is made, and, owing to the loose rubbing contacts between the nuts under the bobbins and the metal plates, a clicking noise will be heard in the phones while the winding operation is in progress, and, provided that the wire itself is intact.

If a break occurs in the wire, the circuit will be broken, and thus the constructor will immediately have his attention drawn to this fact.

If preferred a galvanometer can be arranged in place of the phones. In this event, a battery of two or three cells will be required, especially if the wire on the bobbins is very long.

For carrying out the actual winding operation, a clockwork motor may be used, but in most cases it is sufficient to mount an ordinary hand-drill in a fixed position and to fasten the screwed rod in the chuck of the drill, in the manner illustrated.



metal plates. Under each bobbin is placed a nut which, although free to revolve with the bobbin on its axis makes an effective rubbing contact with the metal plate. The

NEXT WEEK

ANOTHER FREE SUPPLEMENT

in which will be described the construction of a One-Valve-Set and a One-Valve-Reflex.

Articles by Percy Harris, M.I.R.E., Capt. H. J. Round, M.C., J. C. W. Reith, (Managing Director of the B.B.C.), etc., etc., etc.

ORDER YOUR COPY NOW!

pressure of this contact is maintained by a nut placed on top of each bobbin, the vertical axis of both bobbins comprising a length of screwed rod. The free ends of the wire are soldered on to the bottom nuts.

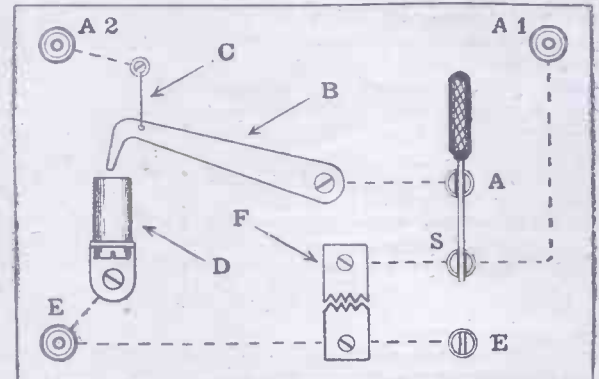
Connected in series with the metal plates is a pair of headphones and an old single cell, the whole arrangement being similar to that illustrated in the accompanying diagram.

is cut off from the set and discharges to earth via two paths.

All fittings are mounted on the face of a vertical panel which is attached to the wall, the wiring being carried out on the back of the panel as shown by the dotted lines. The aerial lead-in is joined to the terminal A 1, and the A and E terminals of the set to the terminals marked A 2 and E.

Ingenious Idea.

This little piece of apparatus is certainly very ingenious, though it is doubtful whether



A NOVEL LIGHTNING ARRESTER.

THE sketch depicts a little idea recently introduced by a French amateur who maintains that the usual gap arrester is, contrary to the belief of many, anything but a safety device when using the set in stormy weather, for when the earthing switch, S, is in the working position (as shown) there are two open paths for the discharge of atmospheric electricity from aerial to earth: (1) across the gap, F, and (2) through the receiver. The gap arrester forms a perfect protecting device for the aerial, but leaves the set quite unprotected, and it is pointed out that usually a goodly portion of the discharge will take the path of least resistance through the set rather than expend energy in jumping across the gap.

How it Operates.

In order to bring matters a little nearer to perfection the current from the "on" switch stud, A, is made to pass to the receiver via a hinged brass lever, B, which is suspended by means of a very fine fuse wire, C, directly over a metal cup, D, filled with mercury, the ordinary gap arrester being also employed and connected in the usual manner. A heavy atmospheric discharge "blows" the fuse and allows the lever to fall and make instantaneous contact with the mercury; thus the charged aerial

the atmospherics that we encounter in this country warrant such a complicated arrangement. In tropical countries and the south of France where atmospheric discharges are more heavy, the idea might prove of considerable advantage, as it certainly would afford a greater measure of protection against heavy discharges than would the more usual micrometer gap. The latter is, of course also incorporated, so that the fuse-lever idea is an added safeguard and does not merely replace the other.

PROGRESSIVE BROADCASTING.

(Continued from previous page.)

requires horns theoretically some 30 ft. long, or movements that are capable of motions up to inches in extent. Where is the space to accommodate such desiderata? Where is the power to work them coming from? True it is that never in this world can we have perfect reproduction of an orchestra, for instance, unless the room in which we receive it is a concert hall, and what, then, of two echoes in series? We must always consider the loud speaker as giving a "picture," not reality, but at present the Rima requires less imagination to give the beholder a feeling of reality than the listener a feeling of pleasure when he hears some loud speakers.

With the increase of house mains adaption, as gradually the public is induced to saner views with regard to reception, as the problems of loud-speaker design are overcome (as they have been, vide modern types versus those of three years ago), I feel that we shall approach nearer the perfect picture.

Olympia revealed, if not the actual set, still a tendency to get away from the mysteries, and the reaching out to get noises from far away; to produce, in fact, a nice-looking instrument making a nice hearing noise with one handle, or should I say simple adjustment? Let us hope for a bumper year and progress in the future, as in the past, in all phases of the art.

£200

IN CASH PRIZES FOR "P.W." READERS

A

GREAT CHANCE FOR AMATEUR CONSTRUCTORS

WHAT YOU HAVE TO DO—

The Editor of POPULAR WIRELESS is offering 5 prizes of £25 each and 5 of £15 each to readers of POPULAR WIRELESS who enter the "P.W." Constructors' Competition by filling up the coupon on this page. There is no entrance fee.

The prizes will be awarded under the following categories:

- A. A prize of £25 for the best home-made L.F. amplifier unit. Second Prize £15.
- B. A prize of £25 for the best home-made Variable Condenser, approx. capacity .001 mfd. Second Prize £15.
- C. A prize of £25 for the best original wireless receiving set component. Second Prize £15.
- D. A prize of £25 for the best home-made Variometer for B.B.C. wave-lengths. Second Prize £15.
- E. Special prize for readers under 16 years of age. A One Valve B.B.C. wave-length (not 5XX) receiver, size limit for panel 10 in. by 7 in. First Prize £25. Second Prize £15.

READ THESE RULES CAREFULLY.

The First Prize of £25 in each class will be awarded by the Editor of POPULAR WIRELESS for what he considers the best constructive effort within the terms laid down for the respective classes. In all cases workmanship and design and the amount of actual "home made" apparatus will be primarily considered in the judging. The second prizes will follow according to merit.

The Editor may divide any of the prizes, at his discretion. The Editor's decision will be absolutely final and binding in all respects.

Any number of entries may be sent but each entry must be separate and distinct in itself and must be accompanied by a separate signed coupon (as given below). Thus, if you want to enter two of the classes, just buy another copy of "P.W." which will give you the necessary coupon.

All apparatus must be addressed to:

"Amateurs' Radio" Competition,
The POPULAR WIRELESS
7/9, Pilgrim Street, Ludgate Hill,
London, E.C.4 (Comp.)

and it must reach that address not later than TUESDAY, November 16th. Nothing arriving thereafter will be admitted for adjudication. When packing your apparatus, pack carefully and make sure that you enclose stamps to cover the cost of its being sent back to you, otherwise its return cannot be guaranteed. And when sending up your apparatus please use on the parcel a label (according to the class you are entering), see page 396. This will greatly facilitate the work of handling entries. Every care will be taken of entries, but no responsibility can be undertaken in this respect. This contest is only open to *bona fide* wireless amateurs.

Any apparatus of professional make (other than the smaller component parts and accessories) will be disqualified.

No one connected in any way with POPULAR WIRELESS is eligible to compete.

Apparatus will be returned as soon as possible after the adjudication.

ENTRANCE FORM.

I (Signature).....
of (Address).....

.....
an amateur in wireless construction, wish to enter the "P.W." Constructors' Competition Class. . . . (write "A," "B," "C," "D" or "E," as the case may be) and hereby agree to abide by the Editor's decision. I declare that the entry herewith submitted, is of my own construction. (If under 16 years, please state age.)

To the Editor ("Amateurs' Radio" Competition Dept.), POPULAR WIRELESS, 7/9, Pilgrim St., Ludgate Hill, London, E.C.4 (Comp.)

IT is not uncommon for the amateur, when erecting an aerial, to enter into some friendly arrangement with a neighbour whereby he saves himself the trouble of erecting a mast by hitching his aerial wire on to his neighbour's mast. It might at first be thought that, provided suitable insulators were used, there would be no disadvantage in this arrangement. As a matter of fact, however, it frequently leads to disappointment when both parties wish to tune their sets at the same time.

Two aerials erected close together, and especially if parallel or nearly parallel to one another, will often affect each other in such a way that an alteration in the tuning of one of them will upset the tuning of the other. In the case of a very selective set, with stations crowded close together on the tuning dial, a variation in your neighbour's tuning may then be sufficient to throw you over from one station to another.

This effect will be understood by comparing it with that which is observed when a closely-coupled H.F. transformer is used with a variable condenser across one of the windings only. It is well known that in such a case, owing to the closeness of the coupling, this variable condenser serves to tune both windings. The effect which takes place with aerials which are in too close proximity is precisely similar to that obtained with the coils.

Consequently, it is important when erecting an aerial to keep this as far away from other aerials as possible and in a direction more or less at right angles to them. It is particularly inadvisable to have two aerials more or less in the same straight line attached to a mast in the centre. This is an arrangement which is sometimes adopted between neighbouring amateurs whose gardens are placed back to back, and although mechanically very convenient it is electrically very bad.

Accumulator Frothing.

A correspondent has asked the reason for the frothing of his accumulator when charging, which trouble apparently in his case has reached serious proportions.

Any accumulator will "gas" when reaching a full charge. The amount of the gassing after the cell is fully charged depending on the charging rate.

With some cells, however, it is noticeable that frothing occurs long before the cell is fully charged, and the froth produced is of quite a different character from the ordinary gassing due to the electrolysis of the water in the acid. It may be taken as a general rule that frothing is due to impurities in the cell which pass into solution in the acid. These impurities are commonly introduced by inferior celluloid used for the battery case, and they may also arise from inferior acid or from the use of dirty water in diluting the acid.

The trouble due to the celluloid is very difficult to cure, unless the plates be transferred to another case; but it is always worth while to try emptying out the cell and washing out thoroughly with distilled water, afterwards filling with the best acid diluted to the right strength with distilled water. If this does not overcome the trouble, a partial cure can often be effected by introducing a small quantity of ordinary soap into the acid.

In this connection, I am often asked by readers of these Notes whether it is really essential to use distilled water for making

TECHNICAL NOTES.

A Weekly Feature
Conducted by

Dr. J. H. T. ROBERTS, F.Inst.P.
(Staff Consultant.)

up the evaporation in accumulators, or whether ordinary soft water will not serve the purpose?

The answer to this is that the harmful result of not carrying out the instructions is a matter of degree. If ordinary tap water be used it will certainly, sooner or later, cause trouble in the accumulator if it contains much lime salts in solution. In the absence of distilled water, rain water may be used, and again, if this is not available, it is preferable to take some tap water which should be thoroughly boiled and then allowed to stand until quite cold. Water which has been boiled and allowed to cool is a fair substitute for distilled water.



A recent photograph of our staff consultant, Dr. J. H. T. Roberts, F.Inst.P.

It is, however, a comparatively simple matter to produce genuine distilled water by arranging some device for condensing the steam from a kettle. For example, if a jug of cold water be placed in the centre of a clean basin or bowl, and the whole be put alongside a kettle boiling on a gas-stove, the kettle being in such a position that the steam jet from the nozzle is directed against the outside of the jug of cold water, the steam will be rapidly condensed and distilled water will drip down the outside of the jug and will be collected in the larger basin.

Distilled Water.

After a time the water inside the jug will become warmed: it should then be thrown away and the jug refilled with fresh cold tap water. In this way it is only a matter of half an hour or so to collect sufficient real distilled water to "top up" your accumulators. The little trouble involved in manufacturing your own distilled water is well spent.

Interest has recently been directed afresh upon the photo-electric cell owing to important developments in the De Forst photofilm. As readers will no doubt be aware, this is a combined pictorial and sound reproducing film developed by Dr. Led de Forest, the inventor of the 3-electrode valve. In the making of the film, whilst the photographic representations are impressed upon the film in the ordinary way, another light-record is also made on the film, the intensity of the light being controlled by means of a microphone apparatus, which in turn is influenced by the spoken or other sounds which accompany the actions.

Photo-electric Cell Used.

The photo-electric cell is used, not in the making, but in the reproduction of the film. When the film is placed in the projector apparatus, whilst the light through the pictures is projected upon the screen in the usual way, the light beam which has passed through what we may call the "sound-record" on the film is caused to fall upon a suitable photo-electric cell, which is thus stimulated in a way corresponding to that in which the microphone was originally stimulated when the film was being made.

The photo-electric cell generates varying electric currents, corresponding again to

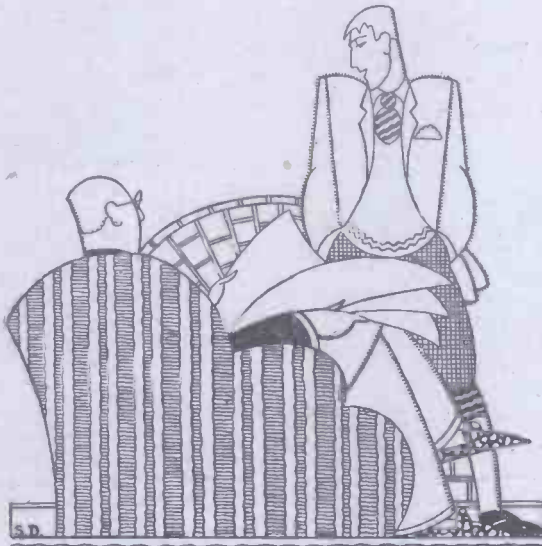
those which were generated in the original microphone.

These currents are exceedingly small in strength, but so long as they have the necessary speech and musical characteristics they may readily be amplified by valve amplifiers in the usual way. The amplified current is then passed into a loud speaker and the sound reproduced.

One of the fundamental features of this system is that, as the sound record and the pictorial or photographic record are impressed upon the same film, there is, in the ordinary way (apart from breakages or manipulations of the film), no possibility of the sound record and the photographic record getting "out of step," so to speak.

It is interesting to note that the idea of impressing the two records upon one film for synchronisation purposes is by no means new, but hitherto attempts in this direction have not met with any great success.

EXPERTS IN RADIO ACOUSTICS SINCE 1908



'I say, Guv'nor! —
'Let's be economically extravagant!

GUV'NOR, I propose to be gallantly Gungselfish! You're always paying for valves, I know—jolly decent of you. But I simply monopolise the telephones and then, we can't all listen at once. But I know the Mater would enjoy sitting-back to listen to one of the new Brandes Cones. So would you! And, dear old grown-up sister likes to dance. Yes, I know she takes it out of the carpet but I've spotted you indulging. Fact is, can you spring one or two from the jolly old note-case. *Pro bono* family, you know. It's a luxury but it's cheap at the price. Guv'nor, old man, you're a sport!

Brandes

From any reputable Dealer.

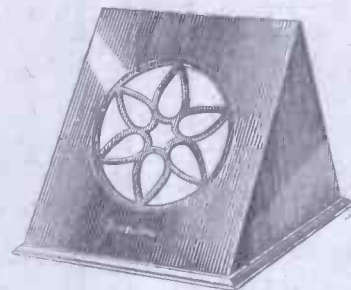


THE ELLIPTICON

(Registered Trade Mark)

The new Brandes Cone. Undoubtedly the best loudspeaker produced, it brings tone of great depth and sweetness. The cone has a large vibrating area and a driving unit of special design. The magnets in the unit are unusually large. There is no diaphragm but a small armature which, actuated on the "push-pull" principle, reacts to the faintest impulse. The specially designed cabinet "reflects" the sound in rich and mellow tones. Height 13½ ins., depth 7½ ins., width 10½ ins.

£5 - 10 - 0



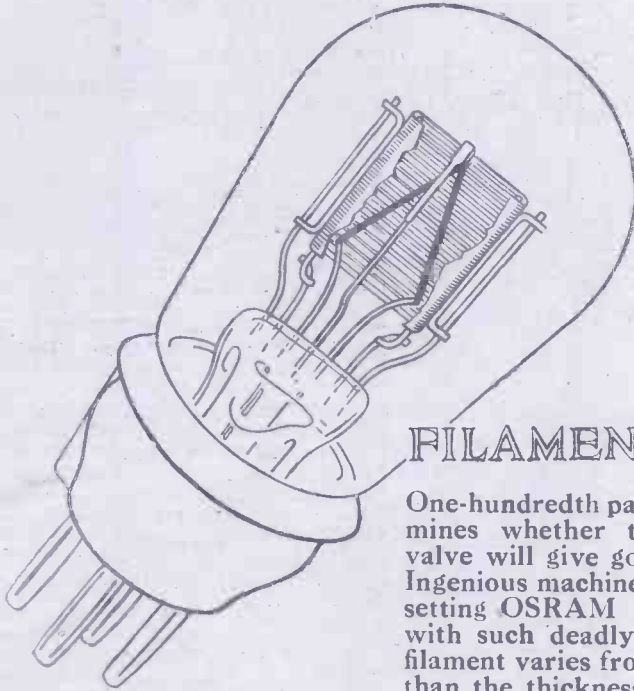
THE TABLECONE

Attractive cabinet of unique design, finished in dark walnut. The cone unit is fitted with a large magnet and the circular diaphragm has an extremely sensitive driving unit which provides plenty of volume with unblemished tone. Supplied complete with cord connection. It has a genuine claim to be superior to any similarly priced cone speaker. Height 10 ins., depth (at base) 11½ ins., breadth 9½ ins.

£2 - 15 - 0



Depending on 1/100th of an Inch



FILAMENT LENGTH

One-hundredth part of an inch determines whether the filament of a valve will give good or poor results. Ingenious machinery is employed for setting OSRAM VALVE filaments with such deadly accuracy that no filament varies from another by more than the thickness of a human hair. Long life and consistency of performance are, therefore, positive certainties.

Osram Valves

None know better than users of OSRAM VALVES how reliable and consistent is the performance of every single type, due to the soundest methods of construction and to the unrivalled excellence of the OSRAM Dull-Emitter filament.

for Broadcasting

The G.E.C. - your guarantee

Use

GECOPHONE

Britain's Best Broadcasting Sets
Components and Accessories.

LONG DISTANCE RECEPTION



It is well known that with the coming of autumn long-distance reception begins to improve rapidly, reaching a maximum during the long dark winter evenings. This fact probably accounts for the annual attack of DX fever, and most of us begin to exhibit symptoms of it about this time of the year. The receiver is overhauled, possibly new components and batteries are purchased, and everything is boosted up to the highest degree of efficiency. Then we settle down to business.

These preparations alone, however, will not guarantee good DX reception, for although the receiver may be the last word

 A Special Article for "P.W."
 DX Amateurs.
 By J. ENGLISH.

keep on practicing until tuning becomes almost second nature. When you can do this, then your DX records will go up by leaps and bounds.

Capacity Reaction.

Now, we have seen how essential is skill in tuning, but the most expert of us will not be able to do great things with a receiver that bristles with knobs and switches. In other words, the simpler the set and the fewer the controls the better.

Another point, the importance of which cannot be over-emphasised, is the control of reaction. If this is smooth and even, so that the set can be brought gradually right up to the very threshold of oscillation, then tuning will be much

easier, and those very weak signals received which would otherwise be lost. Just prior to oscillation the detector valve, and the H.F. valve, too, are most sensitive to weak signals. Therefore, it will be realised how important it is to have some form of reaction control that makes it easy to maintain the valve in this sensitive state.

Of the two most used methods of reaction coupling, magnetic and capacity, the latter, as in the Reinartz circuit, gives by far the smoothest control. With magnetic coupling it is difficult to get a critical adjustment of reaction, as even a very slight movement of the reaction coil makes a great difference when approaching oscillation. The condenser method, however, does give very critical control as a relatively considerable variation in capacity is necessary in passing over the threshold stage into oscillation.

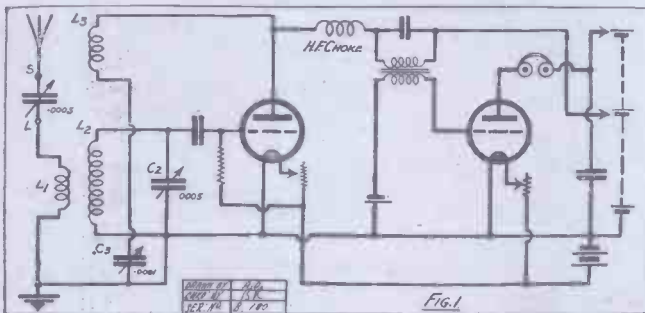
Now, we have all experienced that condition of things where, on increasing reaction, the signal gets louder, but suddenly the circuit falls into oscillation with a pop!

This spells "backlash," which is absolutely fatal. However, the smooth building up of reaction, so that the set slides almost imperceptibly into oscillation, can be obtained by careful adjustment of anode voltage, filament brilliancy, and grid leak resistance. Quite a low anode voltage, a leak of high value, and fairly liberal filament current are the main essentials for getting the best out of your detector valve. One thing needs watching, and that is the grid leak. A bad component will set up faint hissing noises that spoil the reception of weak signals. Variable leaks are notorious offenders, and perhaps the best combination is a fixed leak of, say, 3 to 5 megohms, with potentiometer control of the working grid potential.

We come now to a subject of a highly controversial nature—that is, the best type of circuit to use for DX reception. Most amateurs have their favourite circuits, and what one man finds most satisfactory is not necessarily satisfactory for all. However, it is possible to generalise by considering the pros and cons of definite types of circuits, of which the many possible variations in lay-out and wiring do not alter the main principles of operation.

L.F. Amplification.

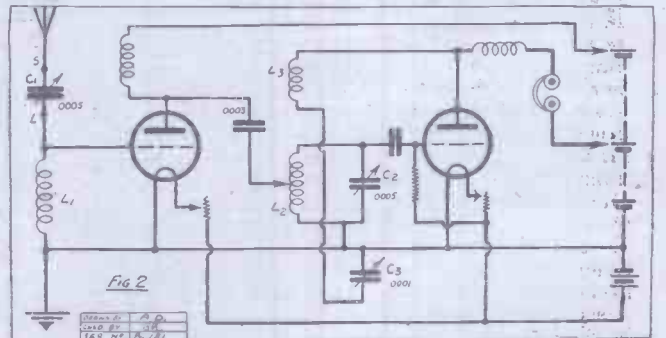
I do not propose to consider as a DX receiver the superhet. which, by the turning of two knobs, brings in almost anything on the loud-speaker. That takes all the fun out of DX work, for it is the bringing in of distant stations with the minimum of apparatus that is so fascinating. For the man who is commencing long-distance work the best type of circuit is undoubtedly a straight detector valve with capacity



in mechanical and electrical efficiency, the human element is of vital importance in getting the best out of the set. Thus Jones may have an expensive ultra low-loss receiver, but he can never get the results that Brown does with a set that looks like a Heath Robinson drawing. The explanation of this paradox is quite simple. Brown knows his set, and has learnt all there is to know about the tuning of it. Jones, however, has not the patience to sit down and master the working of his receiver, relying too much upon the super excellence of its entrails.

Knowing Your Set.

The secret of good DX reception is, then, not so much a perfect receiver as skill in tuning, which means knowing your set. This knowledge may take weeks or even months to acquire, but it is well worth being patient as, in the end, remarkable results can be obtained with even the worst pile of junk. Let not the DX hunter be discouraged because his tuning condensers are not of the latest low-loss type, nor because his valves are just ordinary ones. Provided commonsense precautions have been taken in the lay-out and the wiring-up, the thing that matters most is the way in which the controls are handled. Skill in tuning is not a gift from the gods, but something to be acquired by practice. Moreover, it is much better to stick to one receiver and



reaction control. Such a circuit has only two controls, one for each hand, so that skill in tuning is more easily acquired. By practising on the reception of nearby stations, the knowledge of tuning so gained

(Continued on next page.)

LONG-DISTANCE RECEPTION.

(Continued from previous page.)

will make easier the reception of more distant ones.

Now, L.F. amplification can be added to this detector valve circuit without adding any more tuning controls. This addition, however, should not be made until the operator is thoroughly accustomed to working the single-valve circuit. For clear 'phone signals one L.F. valve will usually be sufficient. More than one L.F. stage is apt to mask any inefficiency in the detector circuit, while that desirable soundless background is often lost.

From time to time fierce arguments have raged over the respective merits of L.F. and H.F. amplification for DX work. The L.F. men maintain that since the detector valve is so extraordinarily sensitive, adding sufficient L.F. valves will make even very distant stations audible, while retaining the simple tuning controls of the detector valve circuit which makes quick searching so easy. The H.F. men, on the other hand, argue that L.F. amplification magnifies hum and other noises so much that weak signals are drowned out, and that, since the response of the detector valve is proportional to the strength of the H.F. input, H.F. amplification must give a greater range. Also they maintain that H.F. amplification is more selective and quieter.

A Suitable Circuit.

There is a lot to be said for both sides, and as far as my experience goes, the L.F. men have it where a simple set is required, but the L.F. stages must be well designed and preferably fresh batteries used to get a quiet background. Under these conditions it is surprising how far one can reach out with a detector valve and two L.F. stages.

While L.F. amplification almost looks after itself, it is by no means an easy matter to build and operate an H.F. amplifier giving as much magnification per valve as the L.F. This fact probably accounts for the wide popularity of L.F. amplification. What is wanted is a simple and stable H.F. circuit giving ease in searching and the ability to change the wave-length range by the use of plug-in coils. When we can build such an amplifier then H.F. will achieve the wide popularity it undoubtedly deserves. At present one H.F. valve is about the maximum that can be successfully used in DX work, but even this single stage is well worth the trouble of putting up.

Now, it is fairly easy for a skilful operator to get clear 'phone reception of a broadcasting station perhaps a 1,000 miles away, but it is quite a different matter receiving the same station on the loud speaker so that the transmission is worth listening to. That requires a really well-designed multi-valve set, the superhet. being of all receivers, the ideal. When this Rolls Royce of the ether receives the improvements and the simplification which are bound to come with time, it will undoubtedly be very widely used for this class of reception. At present not many of us can afford the high initial outlay and cost of upkeep.

However, the real DX man is not concerned with loud-speaker reception and

rather scorns broadcasting, tolerating it as a sometimes useful aid in experimental work. All that he is concerned with is the clear 'phone reception of distant signals on the smallest number of valves. Two valves will give nearly all that is wanted and, as mentioned above, the beginner will do best with a 0-V-1 circuit similar to that of Fig. 1, which incorporates the desired simplicity, smooth reaction control, and ability to change the wave-length range by using plug-in coils or their equivalent. By using interchangeable coils the receiver can easily be designed to work successfully on practically any wave-length up to 3,000 metres.

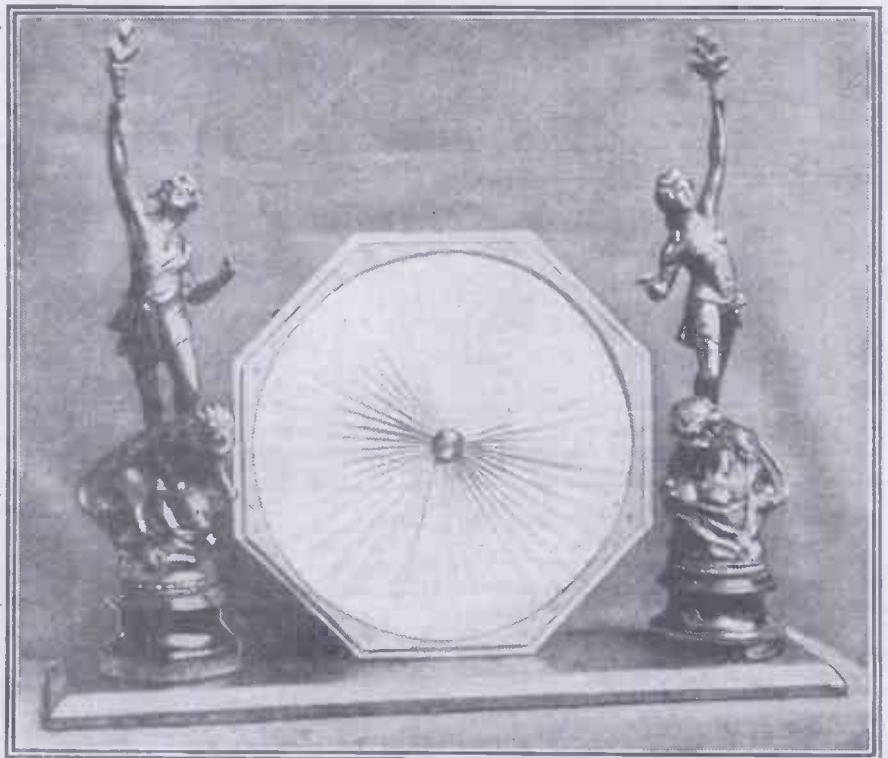
Reinartz Arrangement.

This circuit is very similar, both in design and operation, to the well-known Reinartz receiver, C_2 being the reaction control condenser. The aerial system may be tightly coupled by winding a few turns over the coil L_2 or loosely coupled to the latter, using an untuned coil, L_1 , as shown. Below 600 metres the aerial is connected in series with the condenser; C_1 , which serves to

proportionately. The degree of selectivity, however, will not be so great as that obtainable with a loosely coupled aerial circuit.

Valves to Use.

Regarding the valves to be used in this circuit, quite good results are obtainable with all the general purpose types for both detector and amplifier. If you have several of these, a little experiment will decide which is the more efficient as detector. Often the use of a D.E.8 H.F. or similar type as detector will give a more freely oscillating circuit especially on the shorter waves. Where available, the D.E.2 H.F., D.E.3B or similar types will generally give better results as a detector than the general purpose valves. As for the L.F. valve, where the maximum amplification of weak signals is required, a fairly low impedance valve with a bigger amplification factor similar to the D.E.2 L.F. or D.E.8 L.F. can be used. Rather more than the normal value of negative grid bias will reduce the anode current and the drain upon the H.T.



A handsome loud speaker built by Mr. D. Draper, of 57, Breschan Road, Rotton Park, Birmingham.

remove any dead spots in tuning and will be found especially useful on short waves.

Dead spots in the reaction control, if present on any wave-length, can also be eliminated by substituting a non-inductive resistance of 20,000 to 50,000 ohms for the H.F. choke. It should be noted that L_3 is fixed in relation to L_2 and may be wound on the same former. L_1 may be arranged to give various degrees of coupling with L_2 , thus improving selectivity and affording an additional critical control of reaction on short wave-lengths. Above 200 metres louder signals are obtained by auto-coupling the aerial, that is, connecting the aerial lead to a tapping point some way down the coil L_2 . The nearer this tapping is to the filament end of L_2 , the greater the selectivity, although signal strength diminishes

battery, without affecting greatly the quality or magnification of weak signals.

DX hunters who have previously worked with a detector valve circuit should certainly try a stage of H.F. this season, as it will pay for the trouble of putting up, while the greater skill in tuning for best results is not difficult to acquire.

Now as regards the circuit incorporating this H.F. valve, this amounts in effect to the choice of the H.F. coupling device. The necessary requirements from the DX point of view are simple tuning with quick searching and the ability to cover different wave bands by using interchangeable coils. The tuned anode coupling gives the greatest amplification per stage, but unless a well-designed neutrodyne circuit is used the

(Continued on page 390.)



Patent Nos. 238003.

223625 and pending.

IMPORTANT NOTICE



Photo of Sir Oliver Lodge.
by LAFAYETTE.

Having acquired the World Rights for Sir Oliver Lodge's famous "N" Circuit we desire to state that we assume all responsibility under the CLEARTRON "Ironclad Guarantee" for the performance of all sets *made by us or in accordance with the diagrams furnished with CLEARTRON-Lodge "N" Constructor Kits* containing the components selected and approved by the inventor—and *royalty paid*. Any sets made up otherwise than in accordance with the foregoing carry no guarantee by us, and unless the "Lodge" royalty is paid the manufacture of these Circuits without our authority constitutes an infringement of the Lodge Patents owned by "CLEARTRON."

LODGE 'N' CIRCUIT

CHIEF FEATURES:

- Non-radiating,
- Non-interfering,
- Great volume,
- Extreme purity,
- Keenly selective,
- Highly sensitive.



Send for
Lodge "N"
Booklet post
free.

SINGLE
DIAL
CONTROL

2-Valve Model complete with all accessories
£15 15 0
(including all royalties)

3-Valve Model complete with all accessories
£19 19 0
(including all royalties)

or with
CLEARTRON'S NOVEL SERVICE PLAN
on Easy Monthly Payments.

Also
Home Constructor Kits
complete

2-Valve - £6.6.0

3-Valve - £8.8.0

plus Royalties and Valves.

All LODGE "N" CIRCUITS are fitted with
CLEARTRON ^{1926/27} NEW MODEL VALVES
and backed by
CLEARTRON'S NOVEL SERVICE PLAN

CLEARTRON RADIO LIMITED

1, CHARING CROSS, LONDON, S.W.1.
Telephone: Regent 2231-2.

Works: BIRMINGHAM.
Telegrams: Cleartron, Westrand, London.

C.T. 63a



Distortion—visible or audible ?

WHEN little Willie takes photographs you must have noticed how the buildings often look as if they are falling down. Frequently this is due to the distortion caused by the use of an inferior and uncorrected lens. It is distortion made visible to the eye. But every wireless enthusiast knows the distortion which comes from the use of uncorrected L.F. Transformers. Just as an anastigmatic lens is scientifically corrected against distortion of every kind and is guaranteed to give a faithful

image, so a Eureka Transformer is scientifically corrected and guaranteed to give faithful reproduction. It is a matter of precise mathematics and expert knowledge. The Eureka stands in a class by itself. It has no laminated core and its improved method of "stratum-winding" ensures greater volume with an even amplification of all frequencies. Again and again has it been proved to be the one L.F. Transformer which really "re-creates the living Artiste."



Eureka Concert Grand

A superb L.F. Transformer hermetically enclosed in a coppered steel case proof against atmospheric influences. For second stage use there is the No. 2 which is designed for work in perfect partnership with the Concert Grand. Designed under identical principles.

Concert Grand 25/- No. 2 21/-

Eureka Reflex

For reflex work a special Eureka is available. Gives an exceptional volume of mellow clear tone. Fully guaranteed 15/-

Eureka Baby Grand

For those who cannot afford the necessary higher price of the larger Concert Grand we have introduced the Baby Grand. Fully up to the same high standards of workmanship and carrying the same generous guarantee. Chosen by many manufacturers of Broadcast Receivers.

No. 1 15/- No. 2 15/-

Eureka L.F. Choke Unit

The L.F. Choke method of amplification is gaining in popular favour among seasoned experimenters. The Eureka Choke Unit, incorporating grid leak and condenser is the finest instrument of its type.

Fully guaranteed 25/-



Portable Utilities Co., Ltd., Fisher St., W.C.1.

Sole Manufacturers of Eureka Radio Products

Re-creates the **EUREKA** Living Artiste

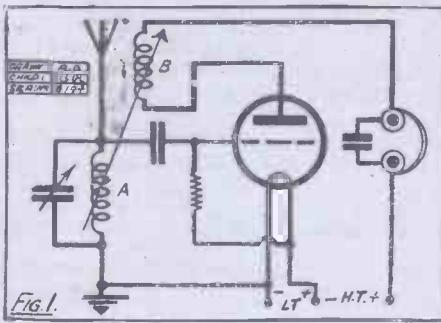


Reaction Control

It would probably come as somewhat of an eye-opener to many readers to learn from the article on "How Valve Circuits Have Grown Up," in a recent issue of POPULAR WIRELESS (April 3rd), to what an extent many unusual circuits differ from standard practice only in

 * Ease of control is a very real asset. *
 * This article will help you *
 * achieve this desirable result. *
 * By C. E. FIELD, B.Sc. *
 * (Staff Consultant.) *

of energy fed back from output to input, so that the valve may be operated at the point just short of oscillation (for that is the condition under which loudest signals are obtained).
 The most usual method of introducing and controlling reaction, with which every



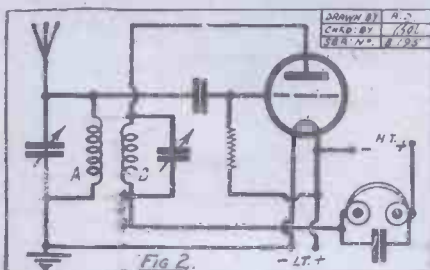
method employed for applying and controlling reaction.

No doubt many of us have owned circuits which we have fondly imagined to be "supers," and now realise that the virtue of the circuit lay in the fact that reaction was introduced in such a way that we could control it as we desired, and the only wonderful feature was that we were able to get the best out of it with a minimum of skill and patience.

What Reaction Means.

Nevertheless, ease of control is a very real asset, and many a simple circuit which can be operated to its best advantage will give better results than will a reflex or complicated multi-valve circuit, even though the latter may be very skilfully handled.

As every reader is aware, reaction means



the handing back of a portion of the output of a valve into its own input circuit, or that of a preceding valve, the result being that the input is augmented, and, by the amplifying action of the valve, the output is correspondingly strengthened. The increased output causes more energy to be passed back into the grid circuit, this additional input being still further amplified by the valve.

The Most Usual Method.

This process continues until a certain signal strength is obtained, when the losses in the grid circuit, chiefly brought about by resistance and aerial radiation, absorb all the energy fed back from the

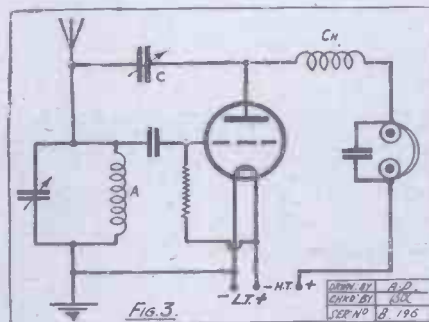
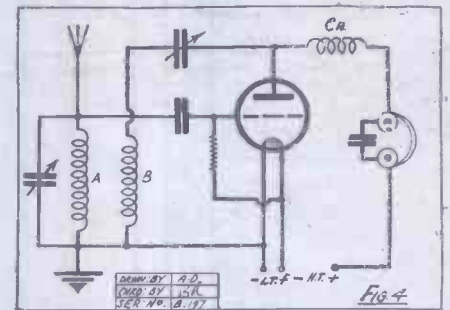


plate. If a very great deal is handed back, however, the limit is reached when the whole of the electron stream in the valve is fully utilised in giving output current, all impulses received on the grid being amplified to the full carrying capacity of the valve, which emits simply a continuous train of waves.

When this occurs the valve is said to be oscillating, a state of affairs usually accompanied by a howl in the headphones, or by hopelessly distorted signals.

In order to make use of reaction for strengthening signals, we require some means of continuously varying the amount



reader will be familiar, is by means of a reaction coil, the simplest and fundamental circuit being shown in Fig. 1.

Here a portion of the energy in the telephone circuit passes by means of electro-magnetic coupling from the reaction coil B back into the aerial coil A, and thence once more into the valve. In order to vary the amount of feed-back, the reaction coil is usually mounted in a movable holder, so that it may be moved nearer to or farther away from the coil to which it is coupled.

This method is by far the most popular at the present time, but it suffers under many disadvantages, chief among which may be mentioned the following:

Disadvantages of "Overlap."

Firstly, suddenness of oscillation. As the coils are brought closer together, signals become louder and louder, and, just as we are getting really good results—*plop!* and the set is howling.

A smaller reaction coil which will only just make the valve oscillate when the two coils are together, will be found easier to control in this respect, and should be mounted in a coil holder capable of fine adjustment.

Secondly, *backlash* or *overlap*. If we have inadvertently over-stepped the mark and caused the valve to oscillate, it is necessary sometimes to separate the coils

(Continued on next page.)

REACTION CONTROL.

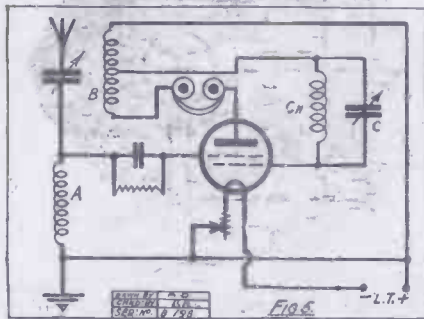
(Continued from previous page.)

by a considerable distance before oscillation ceases. Signals are then weak, and we have very gingerly to increase our reaction coupling once more. This is a trouble which is very serious in the reception of weak signals.

Overlap may be reduced by employing a larger reaction coil, which needs to be separated widely from the other, but the larger coil introduces the first trouble mentioned above. The only real remedy lies in a very careful adjustment of filament current and plate voltage, a reduction of the latter generally being necessary. This is in order to bring the average potential of the grid, when the valve is oscillating, to a value which will tend to check the oscillation as soon as the feed-back is reduced.

An Alternative Method.

A third serious drawback to this method of reaction control is the fact that every alteration in the position of the moving coil necessitates a re-tuning of the circuit to which it is coupled.



Other disadvantages are the necessity for a range of coils to cover different wave-lengths and the unsightliness and space taken up by the arrangement. There are other methods of controlling magnetically introduced reaction.

A large reaction coil may be mounted with a constant, fairly tight coupling to the valve grid circuit, and the degree of reaction controlled by means of a variable condenser of about .0003 mfd., joined in parallel, as shown in Fig. 2.

This condenser is *not* for the purpose of tuning the coil, but of by-passing some of the current from it, and thus lessening the amount of energy fed back.

Much More Satisfactory.

Backlash is largely eliminated by this means, and tuning is not affected to the same extent as when a moving coil is employed. There is a danger, however, when the size of the coil is similar to that of the aerial or anode coils in the circuit, that the condenser will tune it, which renders oscillation very difficult to control and considerably affects the tuning.

Instead of a condenser, a variable resistance may be employed for shunting the reaction coil. This method gives good control and does not seriously affect the tuning, but a suitable resistance, which should be continuously variable from zero up to several thousand ohms, is very

difficult to procure, and an inferior product will give rise to noises and instability.

A more unusual, but in many ways more satisfactory, method of obtaining reaction consists in feeding back impulses through a variable condenser joined between the plate and grid of the valve. A typical circuit is shown in Fig. 3, where it will be seen that the output of the valve can take two paths, one through the headphones *via* the H.F. choke coil Ch., and the other through the variable reaction condenser C.

Grid Circuit Tuning Affected.

The purpose of the choke coil is to divert the requisite amount of H.F. energy through the coupling condenser. If it were not there, nearly all the current would pass through the capacity of the telephones and their parallel condenser.

It is sometimes possible to omit the choke coil, if no telephone condenser is employed, but the latter is always an advantage, as it keeps high-frequency currents away from the 'phone leads and reduces body-capacity effects.

An ordinary 100-200-turn honeycomb coil is suitable for the choke, the condenser being a .0002 mfd. variable for broadcast reception. These values will require increasing for higher wave-lengths, the best sizes being determined by experiment. The larger the choke, the smaller the condenser capacity for a given wave-length, and vice versa.

Except for the initial expense and small amount of trouble involved in adjusting the relative values of the coil and condenser, the capacity method of feed-back scores over the moving-coil method from almost all points of view, particularly with regard to the ease of control on the verge of oscillation. There is still a slight amount of overlap, however, and the grid circuit tuning is affected, though only slightly, by adjustment of the reaction condenser.

The Most Efficient System.

A system which possesses few of the drawbacks and most of the advantages of both the coil and condenser methods of introducing reaction consists in using a coil and condenser connected in series between the plate of the valve and the

bottom end of the aerial coil, a high-frequency choke being inserted before the headphones, as shown in Fig. 4.

The reaction coil B is coupled permanently to the aerial or grid coil A, the coupling being fairly tight. The coil should be a 150-turn basket or 200-turn honeycomb, and the condenser should have a capacity of .0005 mfd. for broadcast reception. This condenser will then give all the reaction control necessary, either for short-wave work or for the reception of Daventry, without either backlash or detuning of the grid circuit.

This is probably the most efficient, yet most easy to control, of all methods of applying reaction, and is the means employed in the excellent "Simplicimus" circuit, which was fully described in the issue of POPULAR WIRELESS dated April 10th.

In conclusion, mention should be made of the very ingenious and efficient method employed for controlling oscillation in the 1926 Unidyne circuit, which was described first in the issue of October 31st, 1925.

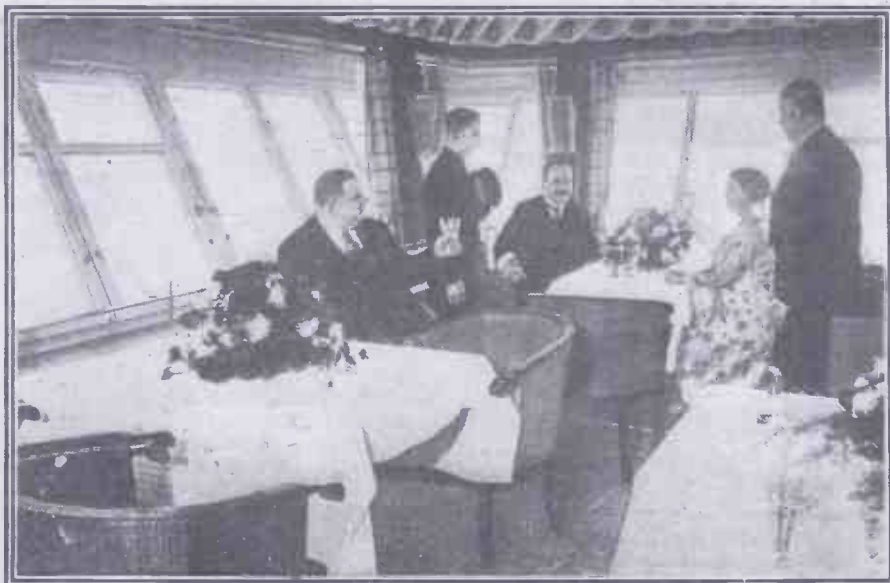
The 1926 Unidyne Control.

The circuit is reproduced in Fig. 5, from which it will be seen that a reaction coil B is introduced into the plate circuit and tightly coupled to the aerial inductance A, the headphones being inserted between the plate and the reaction coil. A tapping from this coil is taken *via* an H.F. choke Ch., shunted by a variable condenser C to the inner grid of the valve.

The upper portion of this coil behaves as an auto-coupled reversed reaction coil, and quenches oscillations set up by the ordinary reaction coupling, the feed-back being controlled by varying this quenching effect.

The high-frequency choke coil normally prevents the reversed reaction, and thus stimulates oscillation, while the parallel condenser by-passes energy from the choke and reduces its effect.

Signals are therefore strengthened by decreasing the condenser capacity, and at the same time the tuning of the valve input circuit is unaffected. Hand-capacity effects are absent, and, altogether, the circuit is a delightful one to operate.



A corner of the restaurant, which is situated 200 feet above the ground in Berlin's new radio tower.

Build your own loud speaker

GONE ARE the days of troublesome 'phones. The LISSENOLA brings loud speaker convenience to every home at a record in low price. For 13/6—less than the cost of headphones—you can buy this wonderful loud speaking unit, needing only the addition of a horn to make it a powerful, full-sized instrument yielding results equal to an expensive speaker. And you can build a horn yourself—with each LISSENOLA we give you full size exact patterns and clear instructions how, for a few pence, you can build a big horn of proved efficiency. In addition, the LISSENOLA will fit the tone arm of any gramophone. The secret of this efficiency rests in the remarkably effective manner in which the electro-magnetic sound-reproducing system is concentrated.

Compare the price last

—before you buy go to your dealer and make this test: Ask him to put on the best loud speaker he has in stock—then use the same horn on the LISSENOLA, and see if you can notice any difference.

THE LISSENOLA

Now no home need lack a loud speaker.

Full directions for making this horn are given with every "Lissenola."

A cone diaphragm loud speaker can easily be constructed. The illustration shows one method of mounting.



PRICE
13/6
EACH

The illustration shows the effective horn you will build yourself—it can be covered with fancy paper, or wallpaper, and painted so as to resemble a factory article. Get a LISSENOLA for your home.

By using the Lissen Reed (sold separately for 1/-) the Lissenola will carry a cone or any other diaphragm working on the reed principle.

Your dealer will gladly demonstrate and supply, or the "Lissenola" can be obtained post free by return from the makers.

LISSEN LIMITED,

8-16, Friars Lane, Richmond, Surrey.

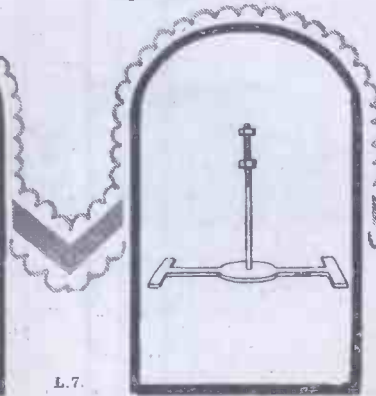
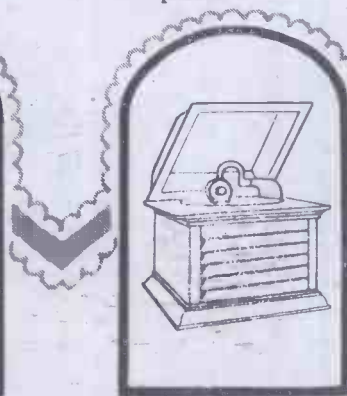
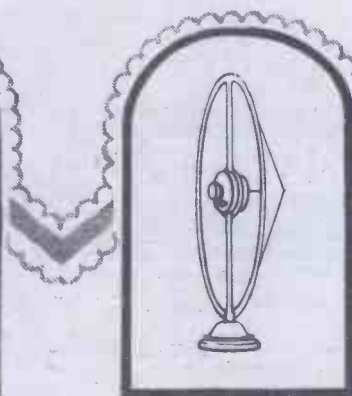
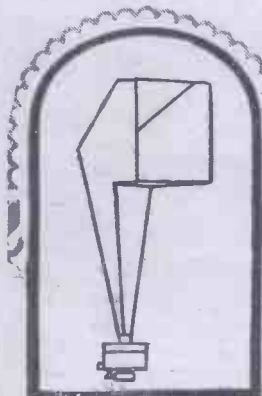
Phone: Richmond 2285 (4 lines).

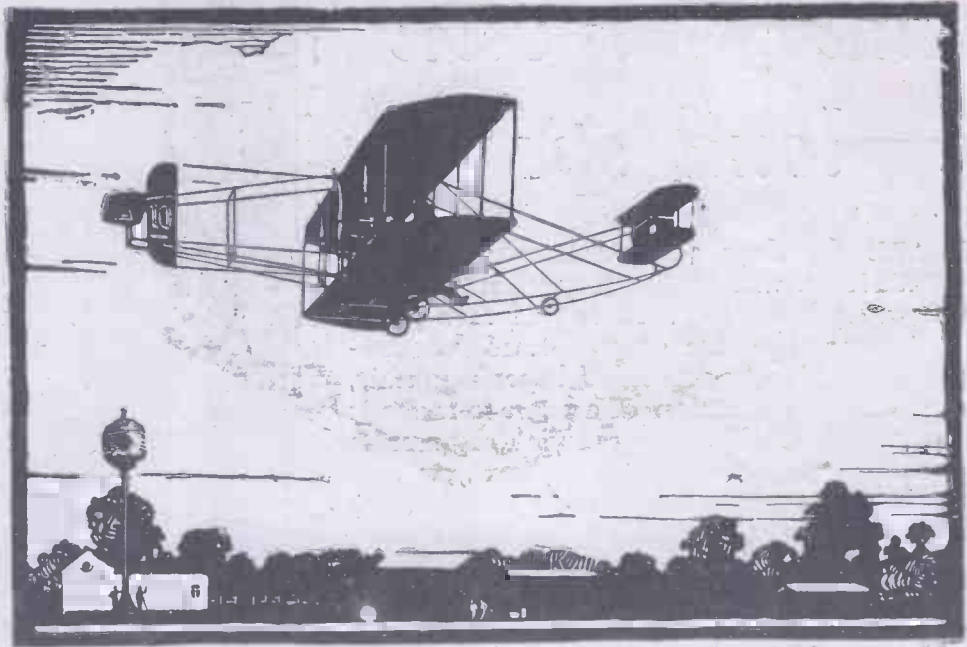
Grams: "Lissenium," Phone, London."

Managing Director: T. N. COLE.

The "Lissenola" instantly converts any gramophone into a loud speaker.

The "Lissen" Reed Attachment (pat. pending) for use with cone diaphragm loud speaker. Price 1/-.





In 1910

In 1910 arose the problem of designing condensers for aircraft wireless sets.

The glass Leyden jars of those days were too bulky and too fragile, and there was no other suitable condenser made.

Thus it was that William Dubilier turned his attention to the subject and commenced his pioneer experiments. He immediately realised that to design a condenser which should be compact, unbreakable, and at the same time efficient under the high frequencies and voltages of wireless circuits would call for much specialised research.

He was successful in that same year in producing the first con-

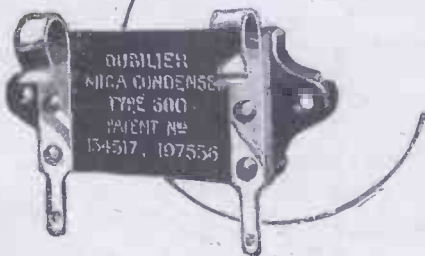
denser to meet these requirements. Its dielectric was Mica.

Three years later, encouraged by the War Office, he commenced upon the manufacture of condensers on a large scale, and the Dubilier Condenser Company at once assumed the leadership which it holds to this day.

For sixteen years we have specialized in the manufacture of wireless condensers, and for all products bearing our name we have continuously insisted upon that high standard of efficiency which we as Radio Engineers know to be so essential!

Naturally this high standard implies a slightly increased selling price, but it undoubtedly results in the production of condensers in which you *can* have complete confidence.

And the possession of such condensers is essential to good results whether you build a crystal set or conduct laboratory research.



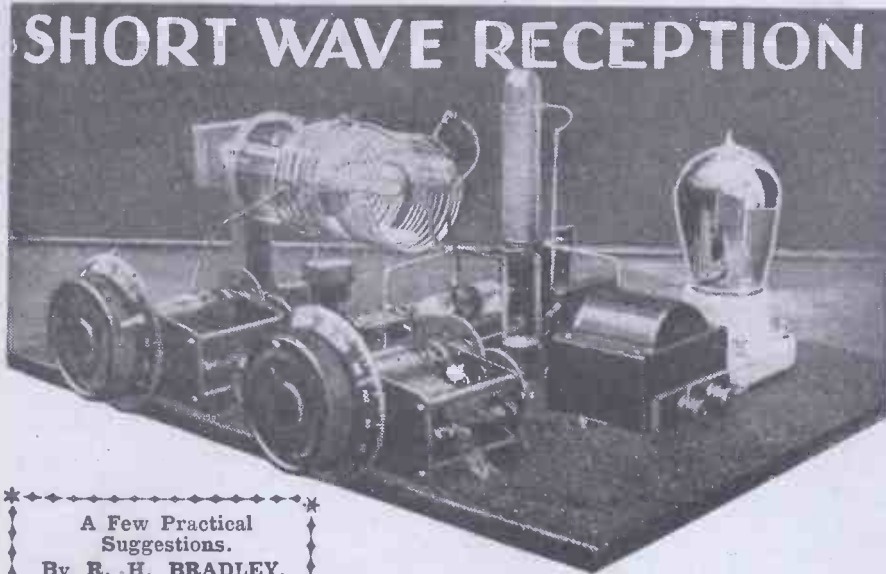
Specify—

DUBILIER

ADVERT. OF THE DUBILIER CONDENSER CO. (1925) LTD.
 DUCON WORKS, VICTORIA ROAD, NORTH ACTON, W.5.
 TELEPHONE: CHISWICK 2241-2-3.

E.P.S. 449

SHORT WAVE RECEPTION



A Few Practical Suggestions.
By R. H. BRADLEY.

THERE appears to be a fairly general belief that a special type of receiver is necessary for the reception of short wave-lengths—i.e. those below 100 metres. But articles and correspondence which have appeared in this journal must have made it evident that many of the receivers

very efficient for the reception of broadcast wave-lengths. This is rather a significant fact and it suggests that the design and general efficiency of many receivers in use are not all that they might be.

This statement is supported by some experiments which the writer has been

Schnell, as shown in Fig. 1, thus introducing the loose-coupled aerial circuit so essential for successful short-wave reception.

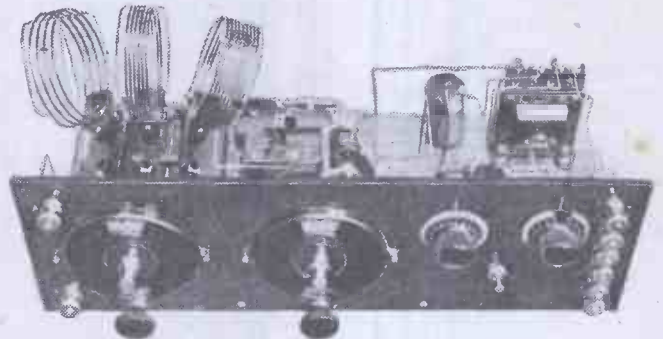
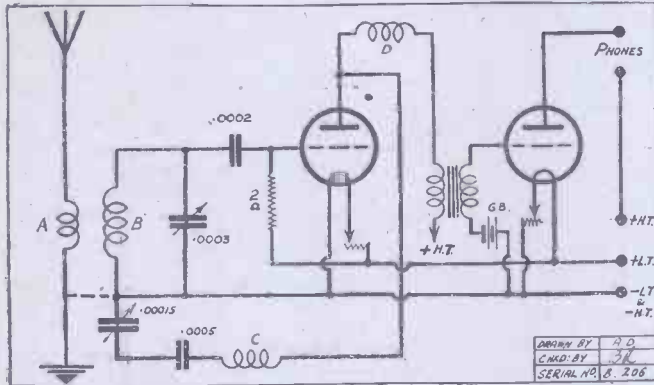
The coil "A" is the aerial coil, "B" the closed circuit and "C" the reaction coil. The latter's coupling to "B" is fixed, and reaction is controlled very smoothly with the .00015 variable condenser.

The coil "D" is an H.F. choke, and in the actual receiver illustrated was a small solenoid coil. The successful operation of the receiver depends to quite a large extent upon this choke having low self-capacity and losses and a sufficiently high inductance value. If these characteristics are not obtained there may be patches in the wave-length range when the detector will go out of oscillation. A No. L200 plug-in coil, such as a triple honeycomb coil, proves very suitable. The choke should, of course, be arranged so as to prevent interaction with the fields of the other coils.

On Very High Frequencies.

The short-wave coils used were selected from the new range of four now made by the Igranic Electric Co. The coils are made with 2, 4, 6 and 9 turns, and cover wave-lengths of approximately 10 to 100 metres.

When wishing to tune through a certain band of wave-lengths, coil "B" is first selected and then "A" is the same size or a size smaller, and "C" also the same size as or the size larger, the best combination being found by experiment.



This photograph shows the three Igranic short-wave Coils which gave good results.

used for successful short-wave reception have not differed materially from those often used for reception of the broadcast wave-lengths.

Useful for all Waves.

Although it cannot be said that all broadcast receivers are suitable for reception of the short waves, yet it is safe to say that most short-wave receivers prove

making with the receiver illustrated herewith. This was built primarily for short-wave reception and has proved very successful. As there is nothing unusual about the circuit it is naturally quite a simple matter to adapt it for broadcast reception by changing the coils, and, as such, it is easily the most efficient two-valver the writer has ever operated.

The circuit is a modified Reinartz, or

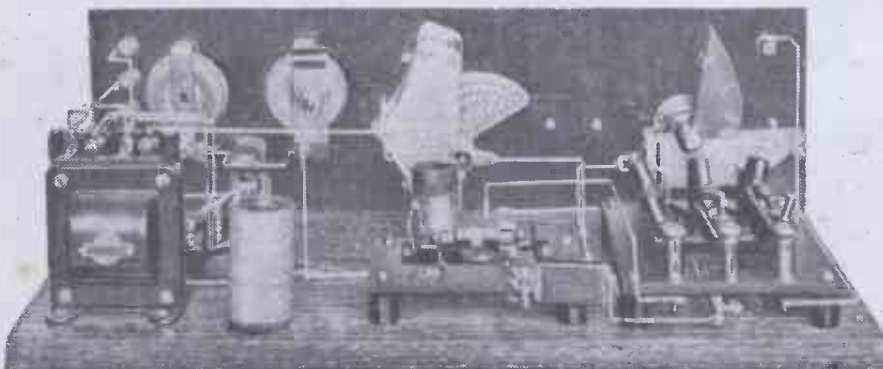
A 3-way coil holder is used, and adjustment of the aerial coupling provides a vernier adjustment of reaction control.

As the receiver was required for very short-wave reception the detector valve used was of the V24 or D.E.V. type, but it was found that when a low capacity 4-pin holder was connected in place of the valve holder shown, it was possible to obtain successful reception above about 20 metres with a standard 4-pin valve. A power

Setting a Standard.

valve, such as a D.E.5, B.4, or S.P.18 Red Spot, proved more satisfactory than a general purpose valve.

The wiring was well spaced, but it will be seen from the photographs that the receiver is quite "ordinary," and any reader who has built a receiver for broadcast reception could build one similar to the one shown. Which brings the writer back to his original contention—viz. that by choosing a suitable circuit and building a receiver carefully so that it is suitable for short-wave reception, the constructor is at the same time building for himself a receiver which will give him very efficient reception of the higher wave-lengths.



A behind-panel view of the short-wave receiver, the circuit of which is shown in the above diagram.

THE "SPIDER."

(Continued from previous page.)

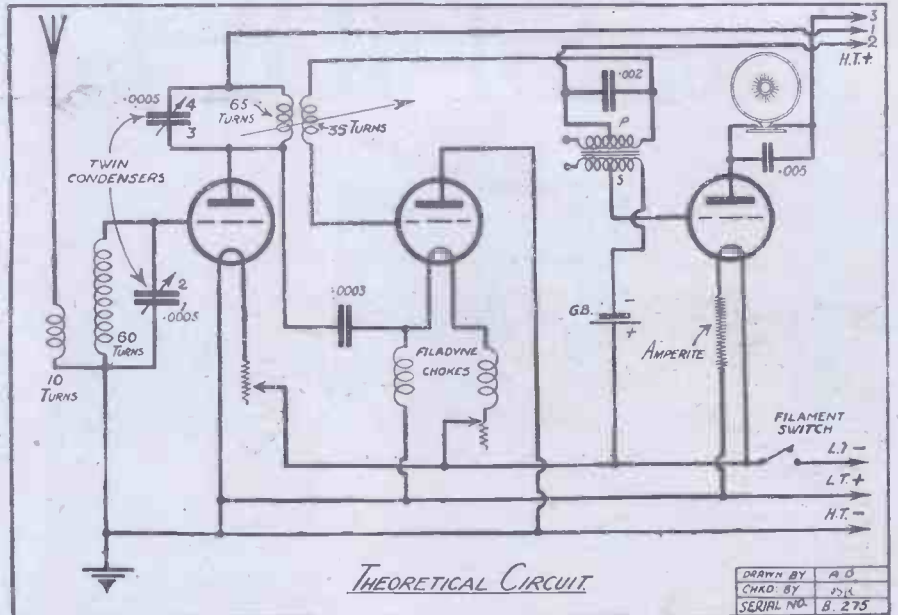
product makes it a simple matter to arrive at the most satisfactory point without trouble.

Obviously if every "Spider" constructor uses exactly similar parts and components to those which figure in the original set and assembles them in a similar way the risk of failures occurring is reduced to a minimum. But in any case, there are not very many what we call "live" components in the "Spider." Actually, there are only two items that fall in this category, the "gang" condenser and the L.F. transformer. The "gang" condenser differs from a "dual" condenser in that, from an electrical point of view, it consists of two entirely separated variables which are, however, controlled by the one dial.

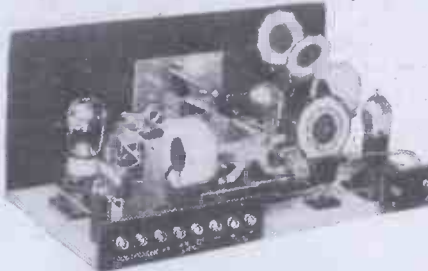
An "on-off" switch is provided so that the receiver can be left "set" on any particular station and music turned on and off at will. The only H.F. chokes which figure in the circuit are two standard Filadyne low resistance filament chokes.

Regeneration Smoothly Controlled.

As befits a "Spider" set "home-made" spider-web tuning coils are used throughout. Details of the construction of these will be given later. The H.F. valve and the Filadyne valve are each provided with a filament resistance, but the L.F. valve has an "Amperite" filament "bar-reter." The two-coil holder does not provide quite an ordinary reaction control, at least it is not absolutely normal in operation. The coupling between the detector anode and grid coils can be more or less fixed, regeneration being smoothly controlled by the high resistance detector filament rheostat somewhat similarly to the "N." The "Spider," although being an exceedingly "lively" receiver, does not radiate to any appreciable extent.



There is little more we need say at this juncture in connection with the circuit arrangements, as these are sufficiently straightforward to allow the theoretical diagram to be quite clear to any reader



A general view of the interior of the set with valves and coils in position.

capable of reading ordinary hook-up diagrams. The point to be stressed is that while the detector stage is a Filadyne and quite unconventional with its filament

and not grid input, the H.F. stage and L.F. stage are quite straightforward. The former is, of course, tuned anode coupled and the latter transformer coupled.

Having obtained all the necessary parts and components, a list of which is given separately, a commencement on the actual construction of this interesting receiver can be made. In order to make everything as clear as possible, we have supplemented our usual photographs and diagrams with a scale drawing of the baseboard lay-out. It should be noted that a nine-inch baseboard is essential, as the gang condenser has a depth slightly exceeding eight inches.

The fact that the Cyldon condenser is screwed both to the baseboard and to the panel obviates the necessity of using panel supporting brackets, and the panel need only be screwed to the baseboard by five screws along the latter's front edge.

As will be seen in the panel-drilling diagram, four of the components are of the single-hole-fixing type. These are the two filament resistances, the coil holder, and the "on-off" switch. The metal shielding-plate of the Cyldon variable can be used as a template.

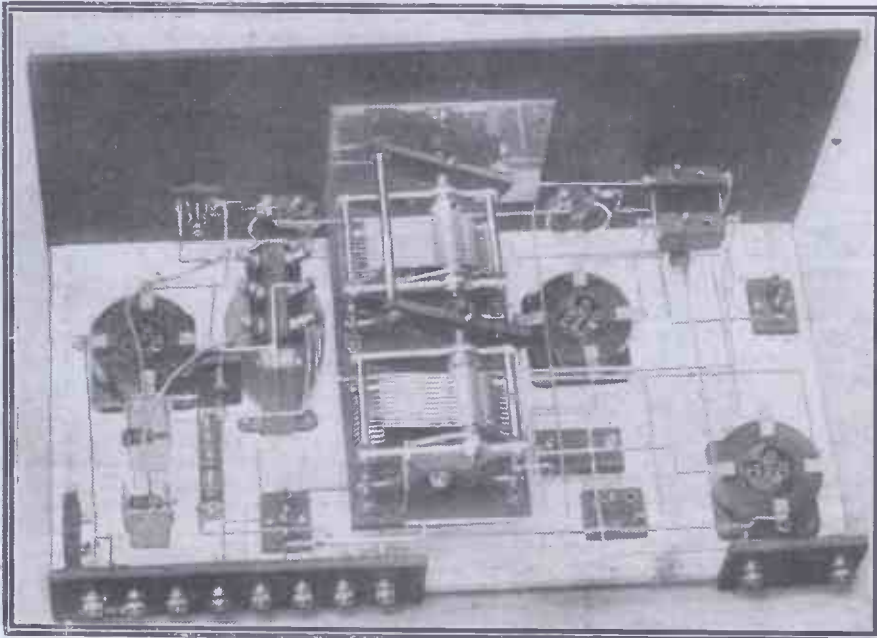
The Baseboard Components.

When the panel is drilled it can be mounted on the baseboard and the Cyldon variable fixed securely in position.

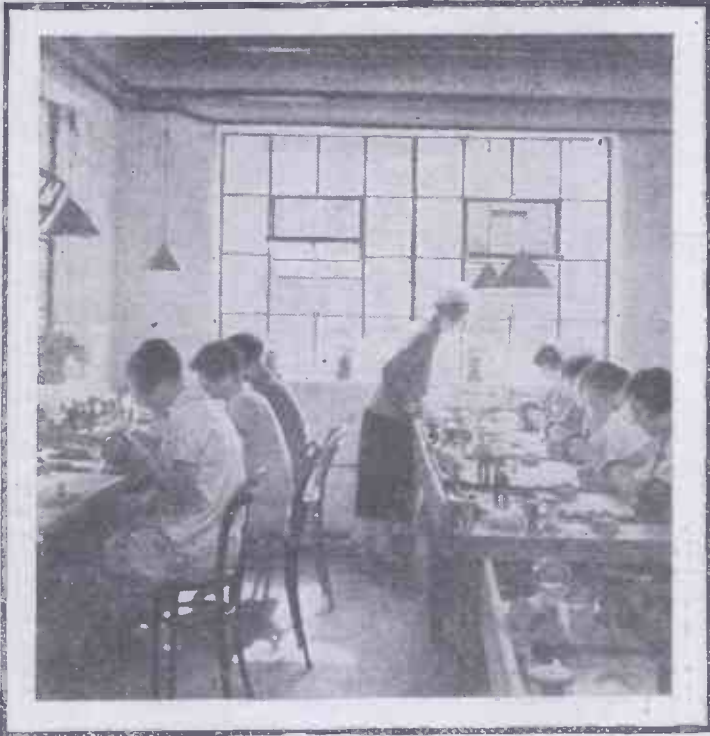
Two terminal strips are required, one measuring 8 by 2 in. and carrying 8 terminals (spaced $\frac{1}{2}$ in. from centre to centre), and another measuring 3 by 2 in. carrying 2 terminals. These strips can be cut from $\frac{1}{4}$ -in. ebonite, or can be obtained with terminals mounted and drilled and engraved from Messrs. Peto-Scott. These strips should be screwed to the back of the baseboard in the position indicated in the photographs. The coil holder, filament resistances and on-off switch can then be mounted.

The baseboard components, which really are quite few in number, should be collected together and laid out in position as indicated in the baseboard diagram and in the photographs. These positions should be carefully checked before any one component is screwed down. There is ample space for

(Continued on page 371.)



How the components are arranged will be seen from the above and the photograph on page 372.



Type A2
Headphones

Brown A2 Headphones are famous for their astonishing sensitiveness, astounding responsiveness and superior tone. Many crystal users have obtained a large increase in volume by their use, while valve users in many countries prefer them for long distance reception. In resistance of 2000 ohms. Price 30/-

The World's Ears in the making

LONG before Broadcasting was ever thought of in England, the name Brown was indubitably bound up with Wireless Headphones. On the high seas, ships' operators relied upon them to receive vital messages; on the fields of war, when thousands of precious lives depended upon messages going through, the army put their faith in Brown A type phones; the Navy, many other Government services, and the World's Cable Companies—all have for long chosen the Brown as the supremely sensitive and utterly dependable Headphone.

What better recommendation could you desire than the faith so many vital Services have placed in the Brown? Whether you buy the famous original A-type, the new A2 (unequalled anywhere at thirty shillings) or the popular Featherweights, you know you are getting a headphone constructed on the same unique Brown principals, with the same Brown high standard of manufacture, and which, you can be sure, will give the same Brown incomparable service. Don't ask for Headphones—follow the experts' choice and say: "Brown."



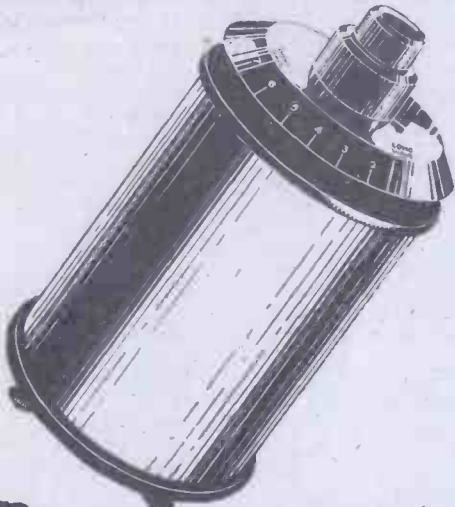
Brown H.Q. Loud Speaker
—one of the range of nine,
from 30/- to £15 15s.

Brown

S. G. BROWN. LTD., Western Avenue, North Acton, W. 3.

Retail Showrooms: 19, Mortimer Street, W. 1.; 15, Moorfields, Liverpool; 67, High Street Southampton.
Wholesale Depots:—2, Lansdowne Place, West Bath; 120, Wellington Street, Glasgow; 5-7, Godwin St., Bradford;
Cross House, Westgate Road, Newcastle; Howard S. Cooke & Co., 59, Caroline St., Birmingham;
N. Ireland: Robert Garmany, Union Chambers, Union St., Belfast.

EFESCA



Regenerative AERIAL TUNER

THE Efesca Regenerative Aerial Tuning Coil has an inductance equal to a whole range of plug-in type coils, from No. 30 to No. 300; thus by using a .0005 Variable Condenser in parallel, all wave lengths are covered from 200 metres to 2,600 metres.

The Coil is tapped at calculated points so that the inductance, with reference to the capacity in use, may be varied by a simple turn of the switch, enabling the desideratum of maximum inductance with minimum capacity to be far more easily secured than is possible with fixed coils.

Reaction is effected by employing a rotor, rotating within a separately wound section of the aerial coil, so that efficient and easily controlled regenerative effect is obtained over the whole wave band. Price 35/- complete.

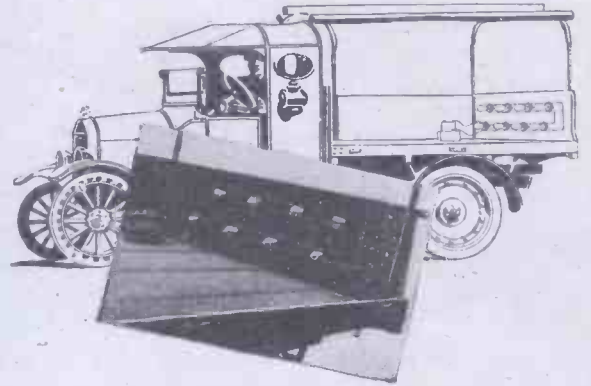
The advantages of the Efesca Regenerative Aerial Tuner: Possesses the tuning range of a whole set of coils in a single self-contained unit; a turn of the switch covers both low and high wave-lengths; obviates the bother of choosing coil combinations; losses eliminated; reaction under perfect control; convenient to mount and simple to operate.

Ask your wireless dealer, or write for complete catalogue No. 573/6 of all Efesca Components and circuits employing them.

FALK, STADELMANN & Co., Ltd.,
83-93, Farringdon Road, London, E.C.1
And at Glasgow, Manchester, Birmingham, Newcastle and Dublin.



Tune-in with
Efesca Headphones!



Here's Proof that
the 'LOTUS' Survives
Shock and is
anti-microphonic!

EIGHT Lotus Valve Holders fitted with large power valves and fixed to tailboard of a Ford motor lorry, driven over rough roads for 30 miles survived the test.

At the finish each spring was as it started—perfect. No damage or looseness at the connection of leg socket and spring—no valve became loose from the holder. Both were electrically perfect all the way.

That is why we guarantee the security of Lotus Valve Holders against shocks and vibration.

Fit the Lotus to *your* set and protect your valves

From all Radio Dealers



Pat. No. 256833.

Made from best bakelite moulding with springs of nickel silver and phosphor bronze valve sockets.

GARNETT, WHITELEY & CO., LTD.,
Lotus Works, Broadgreen Rd., Liverpool.
Makers of the famous "Lotus" Vernier Coil Holder.

- Prices :
- Combination GRID LEAK and VALVE HOLDER 3/9
 - VALVE HOLDER With Terminals 2/6
 - VALVE HOLDER Without Terminals 2/3

THE "SPIDER."

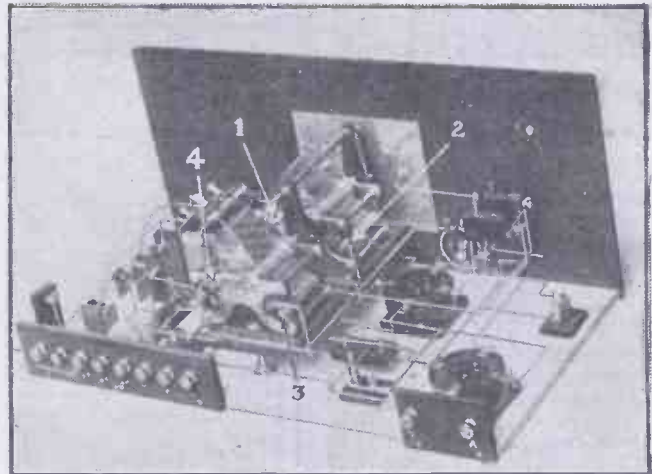
(Continued from page 368.)

everything, and plenty of clearance for valves and coils is possible without cramping in any one direction. Not that the "Spider" requires any very special "low-loss" treatment—it doesn't, and it is capable of giving almost as good results when hooked up roughly as when it is skilfully assembled in the approved "professional" style.

As we are going to advocate the use of square section busbar for the wiring, none of the fixed condensers needs to be screwed down on the baseboard, but each can be held in position by its own connections, and this also can apply to the Amperite. Therefore, the three single coil holders, three valve holders, and the L.F. transformer can be permanently screwed down after the constructor has satisfied himself that their positions have been correctly located. Clips

for the 4½-volt grid-bias battery can be fashioned from thin brass or aluminium sheet, and can be mounted as shown in the photographs. Of course, these clips are not essential, more especially if the set is not to be moved about much, but they are well worth making if only from the point of view of back-of-panel appearances.

Now great care must be taken with the wiring, for a reversed L.F. transformer connection can play havoc with results. Particular attention will have to be paid to the four connections to the gang condenser, and to



A view of the set showing the four connection points on the variable condenser.

facilitate the making of them they have been numbered on our photograph and in the wiring diagram. This should prevent any mistakes.

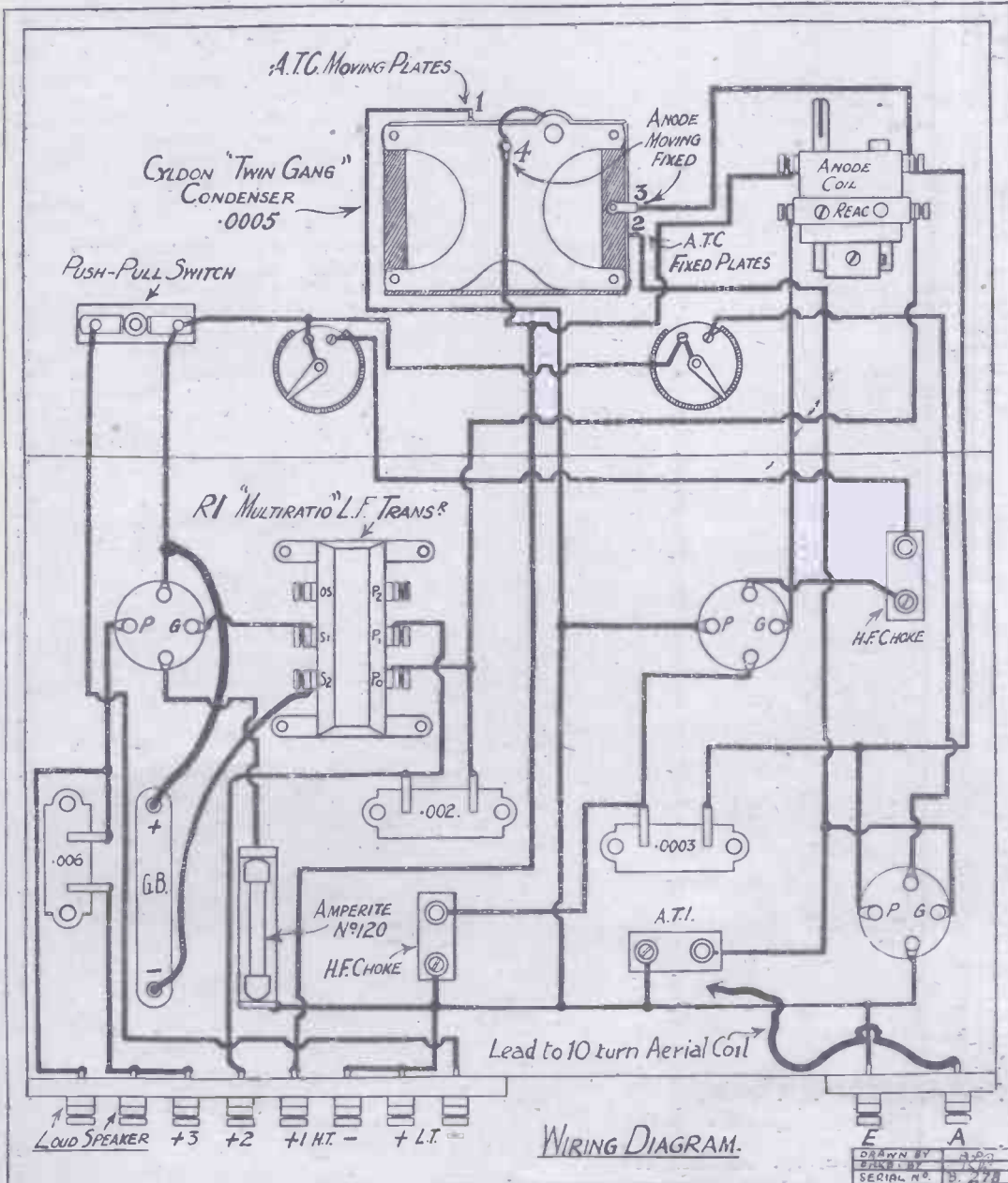
Soldering throughout wherever possible must be the rule for by no other means can such permanent and efficient connections be made. "Dry joints"—the result of unclean work and cold iron—must be avoided like the very dickens, for these are difficult to trace and can cause endless trouble

Wiring

Constructors will not need to be reminded that leads must be well spaced to obviate the risk of accidental short circuits occurring. There are one or two fairly difficult leads to run owing to the space occupied by the gang condenser. The lead from O.P. of the L.F. transformer which runs right across the set to the coil holder is an example. This lead passes right through the gang, and it must be kept clear of the moving parts of this component. Better still, perhaps, it could be taken right underneath the variable. It could be engineered through then with a little ingenuity and would be well out of harm's way.

Taken all round, the wiring is no more difficult than that of most three valvers, and should take no longer to carry out.

As usual, a point-to-point check list is provided for the "Spider," and the careful use of this in conjunction with



WIRING DIAGRAM.

THE "SPIDER."
(Continued from previous page.)

that of the photographs and wiring diagram should make every point clear. One photograph, in fact, has been reproduced at a more than usually large size in order that readers may be able to follow the majority of the leads throughout the whole of their routes.

Now we come to the coils and chokes. These latter are standard Filadync filament chokes, and can be purchased from the Reflex Radio Co. For ranges up to 600 or so metres they consist of 250 turns, and are, in fact, ordinary plug-in coils of low ohmic resistance. They need only be changed for a long-wave station, such as 5 X X, and as this station's programmes are so often duplicated from 2 L O, and as there are hundreds of other stations available on the lower band, it is problematical whether it is worth the constructor's while to obtain chokes for 5 X X as well.

The Tuning Coils.

Some constructors may wish to wind their own chokes and it is quite a simple matter to do so; 22 gauge wire should be used, and it can be wound in any normal manner. These chokes, we repeat, are ordinary plug-in coils wound to a certain number of turns (a few turns more or less one way or the other will not matter), using a heavy

gauge wire, such as 22 S.W.G., to keep their ohmic resistance down as they have to carry filament current.

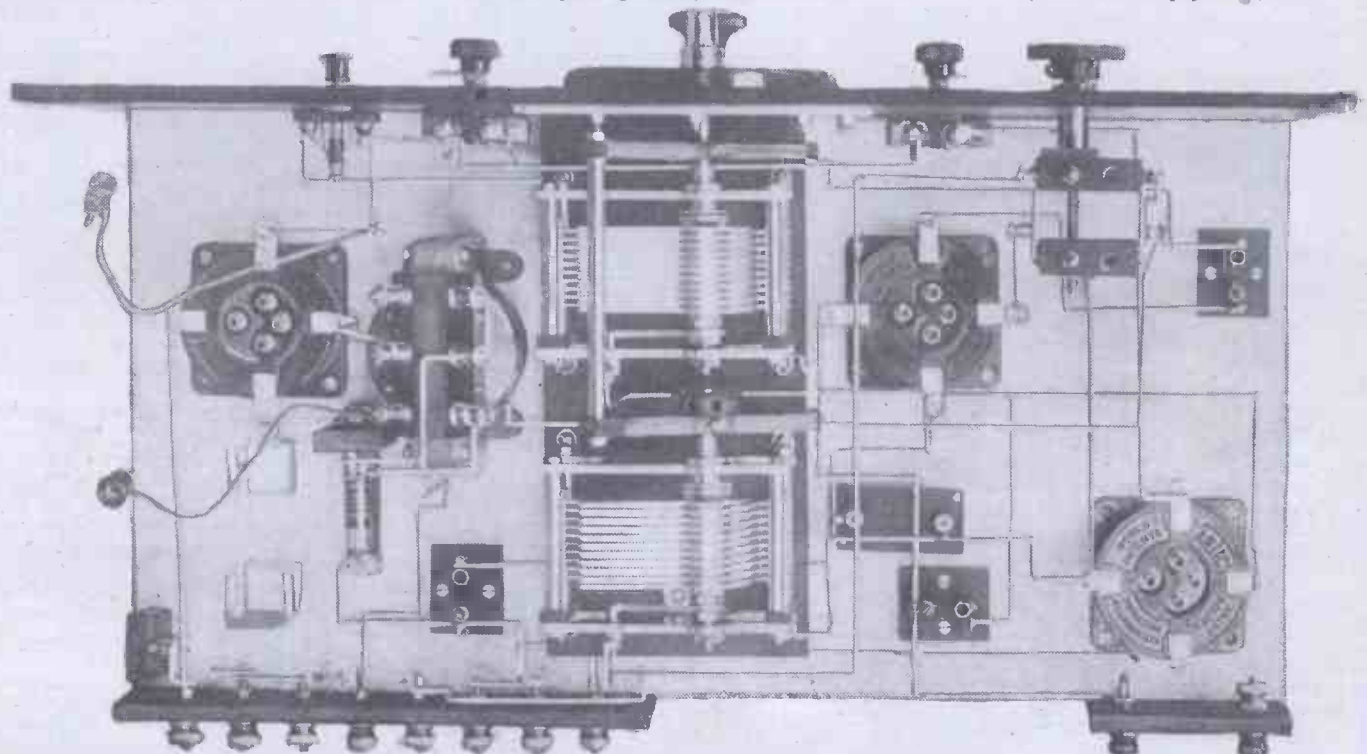
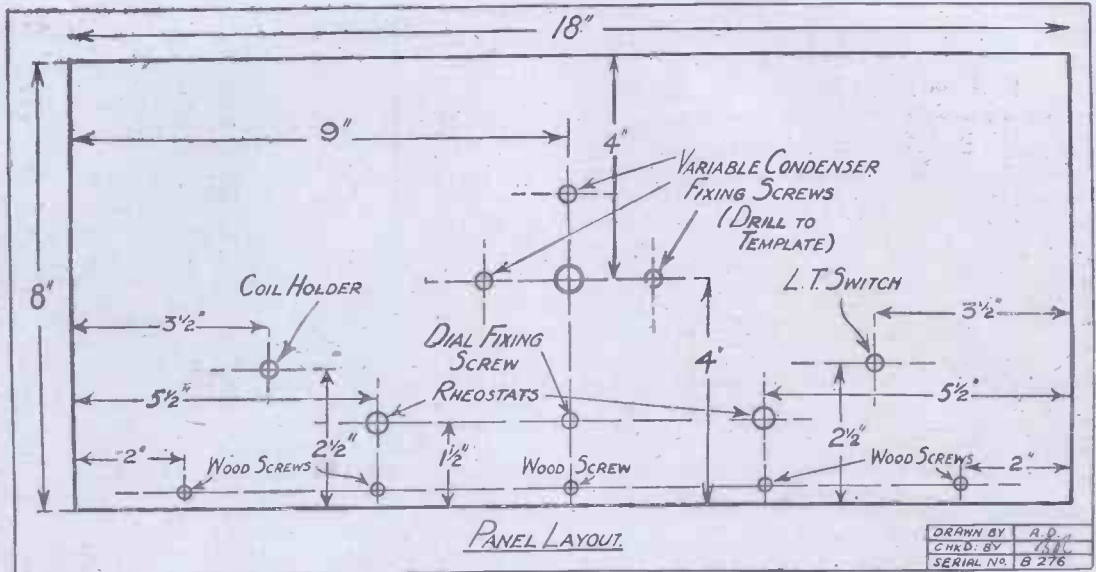
The tuning coils are quite ordinary "Spiderwebs" wound on 11-slot former (1½ inch centre) with No. 26 D.C.C. They should be wound missing every other turn; that is to say, instead of the wire passing in and out of each successive slot it passes over one slot and carries through the second, and over the next and through the fourth. The object of this is to obtain compactness. The anode coil (fixed block of two-way coil holder) should consist of 65 turns (sixty-five). The reaction requires 35 turns (thirty-five). Now two coils are required for the aerial wound in opposite directions, and clamped together on the one holder by means of a small nut and bolt passing through their centres.

One coil consists of 10 (ten) turns and the other of 60 (sixty) turns.

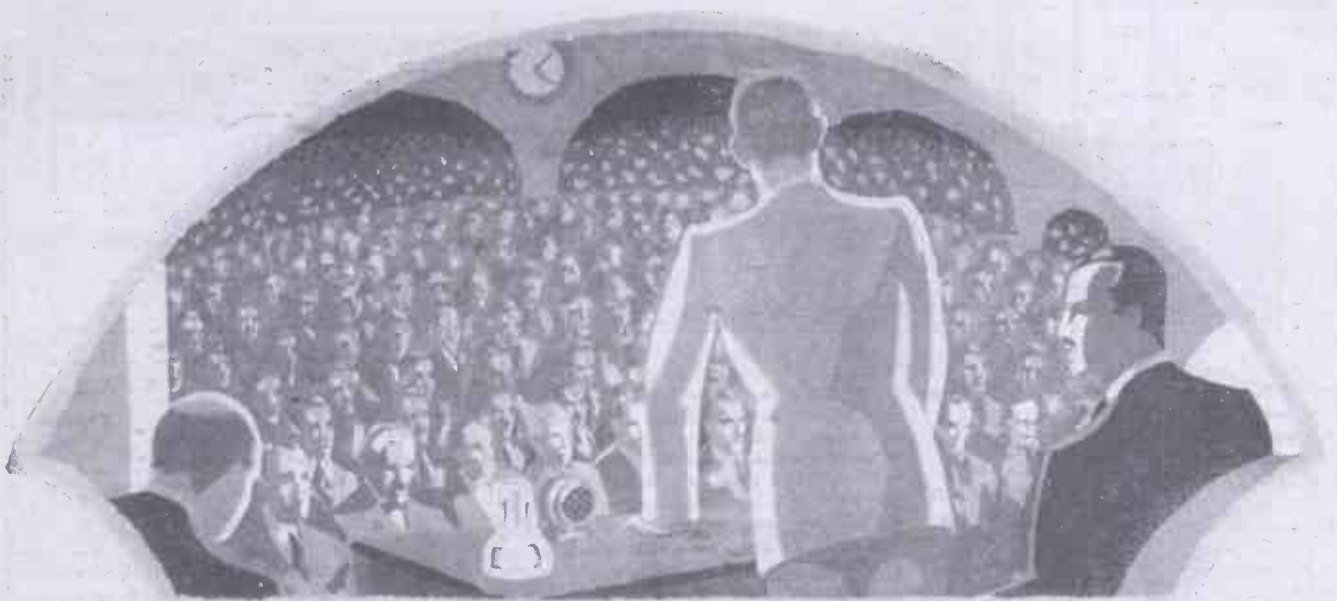
The outside end of the small coil (ten turns) should be joined to the inside end of the large coil (sixty turns), both these ends being taken to the plug of the coil holder. The outside end of the large coil should be taken to the socket of the coil holder. This leaves one end free (the inside end of the small coil), so this should be soldered to a piece of flex with a spade terminal on its other end. This flex can then be joined by this terminal to the receiver's aerial terminal on the small terminal strip when the coil is plugged in position.

Suitable Valves.

The spider formers can be mounted on the coil plugs by cutting slots in these
(Continued on page 375.)



An extremely clear illustration of the "works" of the "Spider" showing exactly how the components are laid out and connected up. The terminals on the strip on the left hand side are, from left to right, Phones, HT+3, HT+2, HT+1, HT-, LT+, LT-,



GENTLEMEN, THE EDISWAN POLICY

IS THIS—

THE AVOIDANCE OF ECCENTRIC CONSTRUCTION, and concentration upon the perfection of every part.

It is a policy justified by results. Ediswan Valves are famous everywhere for their trustworthiness and their long life—they last—and last—and last!

Ask your Dealer for the booklet—
"The Ediswan Range."

RECOMMENDED EDISWAN COMBINATIONS				
Receiving	Accumulator or Battery Volts	Prices	P.w'r	Prices
*A.R.D.E.	1.8-2	14/-	P.V.6	18/6
†R.C. 2	1.8-2	14/-	P.V.6	18/6
†R.C. 2	1.8-2	14/-	P.V.2	18/6
G.P. 2	1.8-2	14/-	P.V.2	18/6
D.R. 2	1.8-2	14/-	P.V.2	18/6
*A.R. .06	3	14/-	P.V.8	18/6
G.P. 4	4	14/-	P.V.4	18/6
*A.R. R.	4	8/-	P.V.4	18/6
*A.R. R.	4	8/-	P.V.4	18/6
*A.R. R.	6	8/-	P.V.5	18/6
*A.R. R.	6	8/-	P.V.5	18/6

*Made in L.F. and H.F. Types.
†When R.C. 2 is used as detector, anode bead rectification should be employed.
All DULL EMITTERS except A.R. and R.

EDISWAN 1/4 - WATT VALVES				
Ediswan 2-Volt Range				
H.F.	Detector	1st L.F.	2nd L.F.	
G.P. 2	D.R. 2	G.P. 2	P.V. 2	
	G.P. 2	P.V. 2	P.V. 6 (1-Watt)	
Resistance Coupling				
	*R.C. 2	P.V. 6 (1-Watt)		

*The anode resistance used should not be less than 1-5 megohms.
PRICES: G.P. 2, D.R. 2, and R.C. 2, 14/- each; P.V. 2 and P.V. 6, 18/6 each.
Fully described in the Booklet "The Ediswan Range." Ask your Dealer for a copy, or write direct.

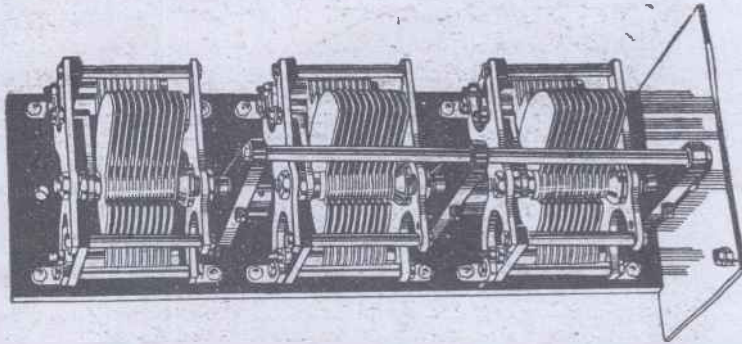
FIT

EDISWAN VALVES

AND NURSE YOUR SET

THE EDISWAN ELECTRIC CO., LTD., 123-5, QUEEN VICTORIA STREET, LONDON, E.C.4.

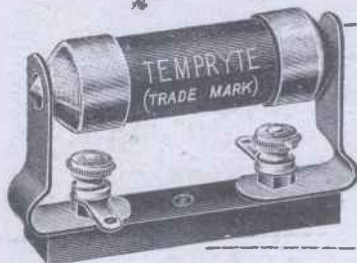




CONSTRUCTORS are giving this handsome new model a most enthusiastic welcome because of (1) Its absolute freedom from whip. (2) Independent adjustment of each Condenser by novel means, completely eliminating hand capacity.

OTHER attractive features are:—Each Condenser electrically separated; anti-capacity plate supplied; operation of all three Condensers as "silky" as if only one was used; whole instrument perfectly rigid; supplied ready for immediate fitting; construction and finish are well up to the fine Cyldon standard.

Send for particulars of the Cyldon WAVEMETER—it identifies unknown stations, and makes searching and testing out simplicity itself.



Cyldon TEMPRYTES

The best means of valve control. British made and delivered from stock immediately. Can be supplied in correct resistance for any Valve. State resistance (ohms) required when buying, or be sure to give name of Valve and voltage of Accumulator supplying current to the Valve.

Cyldon Temprytes - 2/6 each.
Holder Mountings - 1/6 "

The CYLDON

(pronounced SIL-DON).

TRIPLE GANG CONDENSER

(as specified for the "SPIDER" THREE VALVE SET)

Price **£3 - 10 - 0**

2 Gang Condenser **£2-10-0**

4 Gang Condenser **£4-10-0**

Prices without Dial

Get full particulars of all Cyldon Products from your dealer or write direct to the makers. Other Cyldon Condensers comprise Square Law, Square Law Dual Pattern, and the S.L.F. 4 in. Knob Dial supplied free with Square Law and Dual Models, and 2/- extra with S.L.F. or Triple Gang.

SYDNEY S. BIRD & SONS

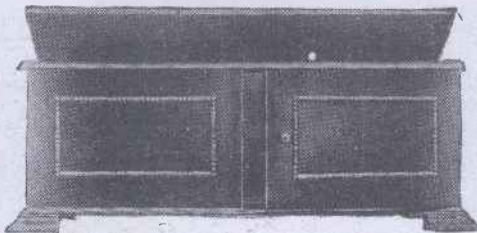
"Cyldon" Works, Sarnesfield Road, Enfield Town, Middlesex.

Telephone - ENFIELD 0672.

CAXTON 4-VALVE CABINET

Made for Sets "All Concert Receiver," "Fieldless Coil Three Valve Set." "Any Valve Low Frequency Amplifier."

Special Cabinets made to customer's measurements. Prices Quoted.



Cash with Order. Fumed Oak ... **£1 5 0**

Dark or Jacobean Oak ... **£1 10 0**

Real Mahogany ... **£1 14 0**

Detachable 7" deep Base Board to mount 16" by 8" panel to slide out of Cabinet front.

The two beaded front doors as illustrated, placed 2 ins. in front of the enclosed panel at 10/- extra.

Ebonite or Radion Panels Supplied and perfectly Fitted at low extra-cost.

All Polished with the new enamel that gives a glass hard surface that cannot be soiled or scratched. SENT FREE.—Catalogue of standard Wireless Cabinets in various sizes and woods.

Packed and delivered free in U.K.

NO. C2

CAXTON WOOD TURNERY CO., Market Harborough



Results!

The proof of any wireless component is in the quality of results it gives. Performance is everything. Fit an Ormsby Transformer into your set—first or second stage, it doesn't matter. Then listen with a critical ear.

Amplification in abundance, but no distortion—one long flow of pure mellow music is what the Ormsby Transformer gives.

Experience the joy of filtered tone, and absence of "Throatiness" in speech. And the Ormsby Transformer costs no more than you would expect to pay for fine quality and workmanship.

The Ormsby Transformer is made in 3 ratios. 1st and 2nd stages for all ordinary receivers and special No. 1 for Ormsby 4-valve model. Post 6d. Price **15/-**

Catalogue on Request.

Trade enquiries invited.

ORMSBY & Co., Ltd.,
1, Ormsby Works, Lower Richmond Rd.,
Richmond, Surrey.

London Showrooms: 10, New Oxford Street, W.C.1

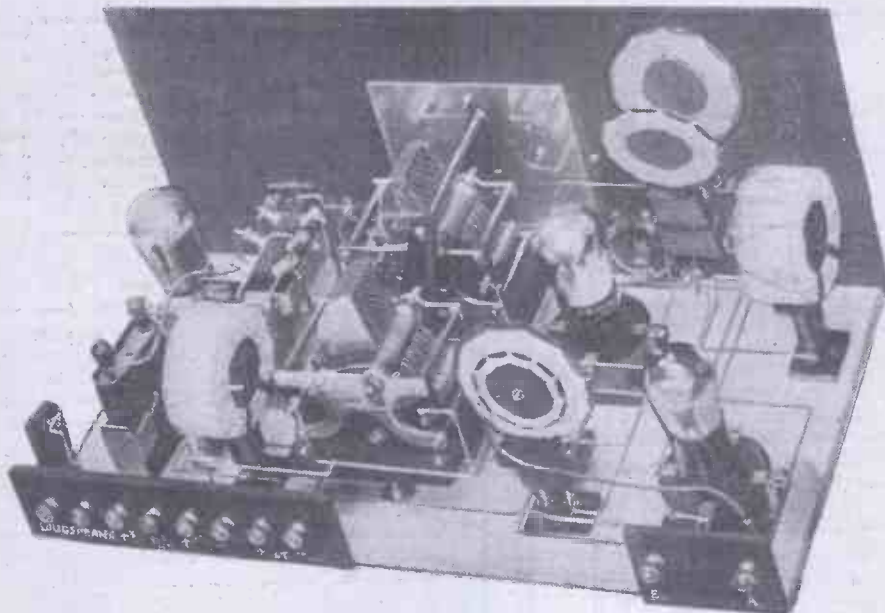
"THE SPIDER,"

(Continued from page 372.)

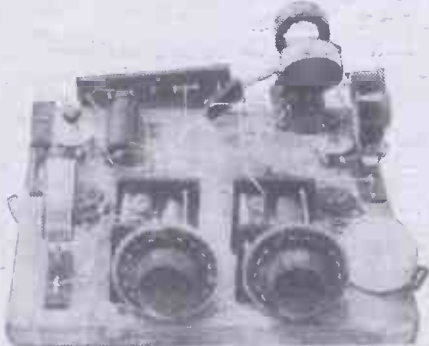
latter with a hacksaw and bringing some Chatterton's compound into service. The spider formers can be trimmed down neatly with scissors.

For Daventry and Radio-Paris the following coil sizes are recommended. Anode 250, reaction 70, aerial 250 and 70.

When the coils have been wound, everything is ready for that simple but important task of "lining up" the "gang" condenser. But, first of all, we must deal with the valves. In the detector position a Marconi or Osram D.E.R. should be used. Failing this a B.5 is quite good. For the H.F. an Ediswan G.P.4, or a Cossor "Point One" (Red Top), can be used (we like this latter), and for the L.F. a P.M.4. The Amperite is specially chosen for this last, although any other four-volt L.F. valve can be catered for. A four-volt accumulator is required. It should be remembered that the Filadyne section has filament chokes in series with its



A back of panel view showing the valves and coils in position. Note the flux lead from the 10 turn coil to the aerial terminal.



The experimental "Spider" from which was developed the receiver described here.

filament circuit. Now the small resistance of these will hardly affect a high-resistance valve such as the B.5, but will a D.E.R., and this is why the D.E.R., which is a two-

volt, can as safely be used as the B.5 on a four-volt accumulator. The Cossor "Point One" can only be used in the H.F. position by carefully allowing ample resistance in reserve when adjusting the rheostat.

Final Details.

The H.F. and L.F. positions are quite normal from an L.T. point of view. High resistance filament rheostats are, of course, employed.

Three H.T. pluses are provided, although this is quite a refinement and not a necessity. Anyway, 35 to 45 volts will suit the H.F., 60 or so the detector, and 66 upwards the L.F., as in standard practice. Care must be taken that the L.T. accumulator is joined up the right way round.

With the chokes, coils and valves in position, and all the batteries connected,

(Continued on page 391.)

POINT-TO-POINT CONNECTIONS OF THE "SPIDER."

Aerial terminal (by flex) to tap on duo-coupled aerial coil. Socket of aerial coil holder to fixed plates (No. 2) of A.T.C. section of condenser unit, and to grid socket of 1st valve holder.

Earth terminal to plug of aerial coil holder, to moving plates of A.T.C., (No. 1) to H.T. negative, and to L.T. positive; also to plate socket of 2nd valve holder. L.T. positive also goes to one filament socket of 1st valve holder, to one side of H.F. choke nearest terminal strip, and to one side of Amperite. Other side of H.F. choke to one filament socket of 2nd valve holder. Other side of Amperite to one filament socket of 3rd valve holder.

L.T. negative to one side of switch. Other side of switch to one side of each rheostat; also to remaining filament socket of 3rd valve holder.

Other side of 1st rheostat to other filament socket of 1st valve holder.

Other side of 2nd rheostat to one side of H.F. choke nearest panel. Other side of H.F. choke to remaining filament socket of 2nd valve holder.

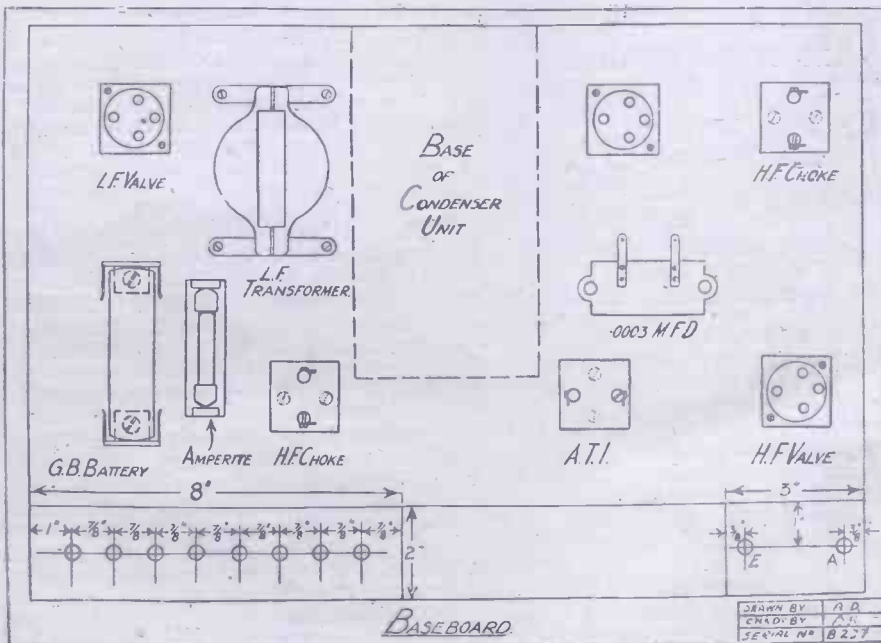
Plate socket of 1st valve holder to socket of anode coil holder, to fixed plates of rear section of condenser unit (No. 3); also to one side of .0003 fixed condenser.

Plug of anode coil holder to moving plates of condenser (No. 4) and to H.T. positive 1.

Other side of .0003 fixed condenser to positive (nearest) filament socket lead of 2nd valve holder.

Grid socket of 2nd valve holder to plug of reaction (moving) coil holder. Socket of reaction coil holder to P.O. terminal of L.F. transformer, and to one side of .002 fixed condenser. P.1. terminal and other side of fixed condenser to H.T. positive 2. S.1. terminal to grid socket of 3rd valve holder. S.2 terminal to G.B. negative. G.B. positive to rheostat switch L.T. lead.

Plate socket of 3rd valve holder to one loud-speaker terminal; other loud-speaker terminal to H.T. positive 3, A .006 fixed condenser is connected across the loud-speaker terminals.



BROADCAST NOTES.

A Celtic Week—Stale Criticism—De Groot—The Old Scots Sabbath—Glasgow Concerts—Drama at Newcastle—That News Agreement—Mr. Sheppard's Future—Reduced Announcing—Miss Mignon Nevada as Marguerite—A Musical Surprise—Hoffman to Broadcast—National Wireless Week.

BY OUR BROADCASTING CORRESPONDENTS

A Celtic Week.

THE broadcasters of Wales, Scotland, and the Irish Free State have decided to put on a special series of Celtic programmes, probably in the third week of November. Music, talk, and drama will all be distinctly Celtic, and the various branches of the Celtic race represented by the stations concerned will contribute to each programme.

Stale Criticism.

Both the dramatic and the film critics of the B.B.C. have recently referred rather over-generously to newspapers for which they write. They are also showing a tendency to give through the microphone a re-hash of what has already appeared in print over their signatures. It would be a pity if abuses of this kind made it necessary for the B.B.C. to change their critics; but no other course will be open unless there is more rigid censorship on the points complained of by competitive newspapers.

De Groot.

The B.B.C. contract with De Groot and his orchestra at the Piccadilly Hotel is about to expire, and there is some doubt of its renewal. There are known to be strong influences at work at Savoy Hill to kill any renewal. Apparently De Groot is anathema to a certain section of musical highbrow opinion that is now rather strongly entrenched at B.B.C. headquarters. So far as listeners generally are concerned, there is no doubt whatever that De Groot has lost none of his old popularity. There would be a tremendous outcry if his name disappeared from the programmes.

The Old Scots Sabbath.

On Sunday, October 17th, the Dundee Station will give a revival of the procedure and atmosphere of the traditional Scots Sabbath service. The Dundee Select Choir, under their blind leader, Mr. H. S. Marshall, will render hymns in the old style, and, in addition, the service will include Bach's Chorale and Montague Phillips' Evensong.

Glasgow Concerts.

The programmes of the Glasgow Station are attracting much more notice now than ever before. The station's regular following now includes listeners many miles south of the Tweed. The feature of Glasgow's future arrangements is the series of six special orchestral concerts to be held in St. Andrew's Hall, Glasgow, and relayed, throughout Scotland during the coming season. Mr. Percy Pitt will conduct the first concert, at which Miss Katherine Goodson will play the pianoforte. The station orchestra will be considerably augmented for the occasion. This will be given on Thursday, October 28th, Mr. Carruthers, the musical director of the Glasgow station, is building up an enviable reputation for his good work for the B.B.C.

Drama at Newcastle.

Radio drama is always to the fore at Newcastle. This is only natural in view of the fact that Mr. Rule, the station director there, has specialised in the subject, and is second only to Mr. R. E. Jeffreys in his practical and theoretical knowledge of radio drama. Unusual interest, therefore, attaches to the broadcast from Newcastle on October 18th, of Walter Pearce's short play entitled "The Greater Love." Gordon Lea is the pen name of Mr. Rule. George Allen and Unwin have a book in the press by him on the subject of radio drama.

That News Agreement.

Neither the Newspaper Society nor the Newspaper Proprietors' Association has made a move for a conference with the B.B.C. on the news agreement for the period after the end of this year. Meanwhile there is considerable comment in Fleet Street about an expedient tried by the B.B.C. on the occasion of the broadcast of the arrival ceremony of Alan Cobham.

NEXT WEEK.

ANOTHER FREE SUPPLEMENT.

"WHY I LINKED UP WITH P.W."

By PERCY W. HARRIS, M.I.R.E.

NOTES ON RECEIVERS.

By CAPTAIN H. J. ROUND, M.C.

THE FUTURE OF THE B.B.C.

By J. C. W. REITH,
Managing Director of the B.B.C.

The actual narrative of the events immediately preceding the landing were given in the reported style, reference being made to the morning and noonday press. Fleet Street is undoubtedly puzzled by this ingenious expedient, and there is some alarm at its possibilities. This new factor may bring about a meeting sooner than was expected.

Mr. Sheppard's Future.

Those in the confidence of Mr. Sheppard declare that, as soon as his health is restored he would be quite prepared to take on a

job at Savoy Hill in connection with religious broadcasting. Such an appointment would meet with the universal approval of listeners, and would certainly do much to strengthen and popularise the Sunday broadcasts.

Reduced Announcing.

The new system under which the announcing is reduced by fully 50 per cent., seems to be well received by listeners. The official programme organ of the B.B.C. has now become almost indispensable to intelligent listening. This is a logical result of the policy of withholding licence money from the Broadcasting Authority.

Miss Mignon Nevada as Marguerite.

In the B.B.C. special production of the Opera "Faust" from London on October 15th, Miss Nevada will take the part of Marguerite, Mr. Robert Radford will be Mephistopheles; Mr. Parry Jones, Faust; Mr. Harold Williams, Valentine; Mr. Raymond Baylis, Wagner; and Miss Gladys Palmer, both Siebel and Martha. Mr. Percy Pitt will conduct the Wireless Symphony Orchestra for the occasion.

A Musical Surprise.

Listeners will be relieved and surprised to hear that there is to be an all-British programme of music on Saturday afternoon, October 16th, at 4.30, when the String Band of the Air Force will play for listeners from the Motor Industries Exhibition. The international side of music has been somewhat overdone lately. In order to observe the dictum that art has no boundaries, it is not necessary to ignore all British art.

Hoffman to Broadcast.

The B.B.C. has scored again in securing a famous artiste hitherto barred to listeners. This time it is Hoffman, the great pianist, who will play in the London studio at 10.15 on October 22nd. Miss Peggy Collins, the eminent violinist, will be associated with this broadcast.

National Wireless Week.

The central committee controlling the plans for National Wireless Week is meeting weekly at the B.B.C. and excellent progress is reported. This is the first occasion on which all the groups and societies interested in wireless and broadcasting have got together for a common purpose. The central committee includes representatives of the wireless popular press, the wireless technical press, the wireless trade, the Radio Association, the Wireless Association, the Wireless League, the Radio Society of Great Britain, the Wireless Retailer's Association (Messrs. Clifford and Clifford), and the British Broadcasting Company, Ltd. (Special programmes are being arranged by the B.B.C. which will "spread" itself for the whole week. The trade are undertaking to exploit the selling possibilities of the week by additional advertising both in the press and by posters. The various societies are stimulating the interest of their members. The main psychological idea behind the movement this year is to induce listeners to hold wireless parties, so that the enjoyment of radio may be worthily communicated to all those who are still unaware of it, November 7th to 13th is the week.

SIEMENS

RADIO BATTERIES

are

**AN IDEAL SOURCE OF
CURRENT SUPPLY BOTH
FOR H.T. & L.T. PURPOSES**

*Clean—safe—simple to install
and simple to operate—
unsurpassed for convenience—
perfectly reliable.*



REG. TRADE MARK.

**SEE THAT THEY BEAR
THIS TRADE MARK!**

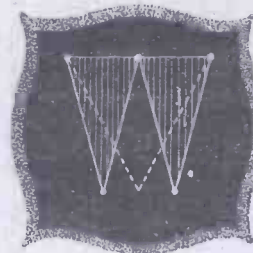
Our new catalogue of "Siemens" Radio Batteries will assist in the selection of the most suitable size of battery for any radio purpose. It also shows how to obtain the most efficient service from "Siemens" Radio Batteries at the lowest operating cost. A copy will be sent post free on request.

**SIEMENS BROTHERS & CO., LTD.,
WOOLWICH, LONDON, S.E.18.**

For 2, 4, or 6-volt Accumulators



The New Six-Sixty POINT-ONE VALVES



**Duo-triangular
filament
suspension**



S.S. 2A, H.F. and L.F.
D.E., 1.8 volts, .1 amp.,
H.F., L.F. & Detector
14/-

S.S. 10.
D.E., 2 volts, .15 amp.,
Power Amplifier 18/6

S.S. 7.
D.E., 3.7 volts, .1 amp.,
Power Amplifier 18/6

S.S. 8.
D.E., 3.4 volts, .1 amp.,
General Purpose 14/-

*These Prices do not
apply in the Irish
Free State.*

Descriptive leaflet S.S.9-26, giving full particulars of complete range, free on application.

WIRELESS enthusiasts can now secure the advantages made possible by Duo-Triangular Filament Suspension whether their L.T. supply be 2, 4 or 6 volts.

It has been the aim of Six-Sixty right from the beginning to produce not just one type of specialised valve with unique characteristics for use with, say, a 4-volt accumulator, but a complete range of valves designed to meet all existing requirements.

After extensive research, Six-Sixty produced a special filament which, when operating at its rated voltage, showed absolutely no sign of "glow," and required barely .1 amp. to give perfect results. The success achieved with this filament led to further research, resulting in the famous Six-Sixty Duo-Triangular system of Suspension. The combination of these two developments ensured increased electronic emission, consistently perfect reception, longer life and lower running costs. Six-Sixty, not content to rest on their laurels, worked incessantly until these advantages were made generally possible to the wireless enthusiast, irrespective of whether his L.T. supply was 2, 4, or 6 volts.

Briefly, this is the story of the new Six-Sixty Point One Valves—valves which bring hitherto undreamed of advantages within the reach of the General Radio Public.

It is interesting to note that Messrs. A. J. Stevens & Co. (1914), Ltd., have decided, after exacting and exhaustive tests, to standardise Six-Sixty Valves in their famous "Symphony" Range of Receivers.

SIX-SIXTY VALVES
Better by Six Times Sixty



Time Tells

USE "HART" Wireless Accumulators in preference to dry batteries—always. You will quickly note the difference, and the longer you use them the greater will be your appreciation of their undoubted merits. There are models for all low and high tension wireless circuits.

HART

THE BATTERY OF QUALITY

Write Dept. P.W. to-day for full particulars of all "Hart" Batteries. We are exhibiting at the Manchester Wireless Exhibition, Oct. 26th to Nov. 6th, Stand No. 42.

HART ACCUMULATOR CO. LTD.
MARSHGATE LANE, STRATFORD, LONDON, E. 15

Telephone - Maryland 1361, 1362, 1363 and 1364
Branch Offices in - STURNEBURG, BELFAST, BIRMINGHAM, BRISTOL, CARDIFF, DUBLIN, GLASGOW, MANCHESTER, WESTMINSTER & YORK

Banish 'Ringing' noises



At last you can run your receiving set without the intrusion of those "ringing" noises, caused by shocks and vibration, which spoil perfect reception, and which are increased by the use of dull emitter valves.

Fit the NEW

Fit the new NELSON-NON-PHONIC VALVE, made so that the greatest shocks or vibrations do not reach the delicate internal construction; the efficiency of the valve being in no way impaired.

Perfect reception is assured by the "floating" of the glass envelope on a rubber cushion; a method far superior to the combination of valve and so-called anti-microphonic valve-holder.

NELSON NON-PHONIC VALVE

THREE TYPES NOW AVAILABLE:—

For 2 Volt Accumulators

TYPE G220.
2 Volts, '2 amps.
Impedance 20,000 ohms.
Amplification Factor 7.
11/-

For 3-4 1/2 Volt Dry Cells (or 4 Volt Accumulators)

TYPE G306.
3 Volts, '06 amps.
Impedance 25,000 ohms.
Amplification Factor 7.
11/-

For 4 Volt Accumulators

TYPE G410.
3'8 Volts, 0'10 amps.
Impedance 20,000 ohms.
Amplification Factor 7.
11/-

If unable to obtain from your dealer, apply direct to actual manufacturers

NELSON ELECTRIC CO. LTD.
138, Kingston Rd., London, S.W.19

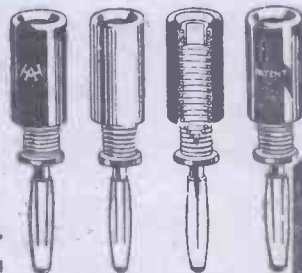
All rights reserved

"YOU'LL CONVERT YOUR RIGID HOLDERS NOW"

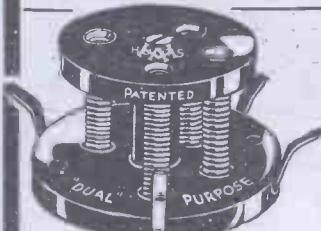


Fig. 975.
Code Word

JUST PLUG THEM IN! Per 1'6 Set of 4 (3 black, 1 red)



Full Size Illustration.



Full Size Illustration.

Fig. 976.
Code "DUAL" Word. **PURPOSE**

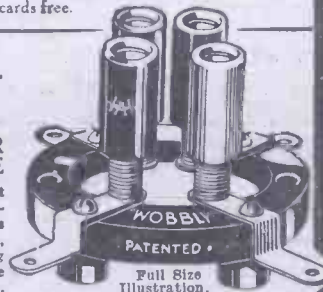
DOUBLE ENDED. Price 1/9 each. THE FOOL-PROOF HOLDER FOR BASE OR PANEL FITTING OR IN ANY OTHER POSITION.

The smallest and neatest combined holder on the market. No joints because the soldering tag is the same piece of wire as the spring. Show cards and display cards free.

Fig. 974.
Code "WOBBLY" Word. **PRICE .. 2/3 each.**

THE IDEAL EXPERIMENTER'S HOLDER TOO SIMPLE TO IMPROVE

For the genuine experimenter who must have a holder without capacity, and perfectly sprung, Hunt's "WOBBLY" is ideal. It is impossible to have fewer parts, or to better insulate, separate or spring them. Separately sprung legs are far more effective than a closed-in solid spring top.



Full Size Illustration.

Made under Patent 242057/24, Prov. Pats. 30670/25 and 40/26, by:—
A. H. HUNT, Ltd. (Dept. 12), Croydon, Surrey.

CORRESPONDENCE

Letters from readers discussing interesting and topical wireless events, or recording unusual experiences, are always welcomed; but it must be clearly understood that the publication of such does in no way indicate that we associate ourselves with the views expressed by our correspondents, and we cannot accept any responsibility for information given.—Editor.

ADDING L.F. TO REFLEX.

The Editor, POPULAR WIRELESS.

Dear Sir,—Since publishing my one valve and crystal circuit in "P.W." November 28th last, I have succeeded in adding an amplifying valve in the circuit, which has improved things very much. Loud-speaker reception from 5 I.T. and Daventry is everything that may be desired, and I can also get 2 L.O., 2 Z.Y., and Hamburg on the loud speaker fairly audibly.

The circuit is very selective, and tuning very sharp, a vernier being necessary across the .001 variable condenser.

Using a 35 aerial and 50 anode coil I can get about

that the practice of placing a single-pole switch in the common lead of the batteries is unsound, but to prevent users of this arrangement, as far as possible, from being careless with loose wires, etc., being under the impression that no damage can be done since both batteries are switched off.

Incidentally, the circuit of Fig. 3 is incorrect, as it stands, because a so-called "series" grid-leak is necessary after a tuned-anode H.F. amplifier.

Best wishes to "P.W."

Yours faithfully,
S. R. KENWORTHY-BROWNE.

Dryden House,
Oundle, Northants.

MINERAL DEPOSITS AND WIRELESS.

The Editor, POPULAR WIRELESS.

Dear Sir,—Some time ago there appeared an article in POPULAR WIRELESS about the effects of tin deposits on radio broadcast reception. It stated that the tin areas of Cornwall had a decidedly bad effect on reception.

My experience, however, has been to the contrary (a usual peculiarity where radio science is concerned).

I am resident in what is probably the largest tinfield in the world—the Kinta Valley. Screened on the immediate west by a range of mountains running north and south, and on the east by another distant range running in the same direction.

On the 40-30 metre band, within a period of four hours I have logged Java, Borneo, Celebes, Philippines, China, Japan, Honolulu, Australia, New Zealand, California, Utah, Kansas, Oregon, New Jersey, Quebec, Texas, Rio de Janeiro, South Africa, Rhodesia, Holland, Italy, Russia, Siberia, India, Singapore. Telephony from Japan, Australia, and U.S.A.

The telephony was unsatisfactory, being unsteady, with considerable fading and distortion. The receiver used was a three-circuit regenerative detector, and one stage audio amplification, the panel being made with locally grown rubber.

The aerial system was one vertical 3/20 wire 50 ft., and the Cps. one horizontal 3/20 wire 3 ft. from the ground. Except for the use of only good quality components in the receiver, no precautions against the much-used term "low-loss" were taken, either in the receiver wiring, or aerial system.

When trying various aerial systems I picked up Californian amateurs on a 2-ft. frame aerial, using the same receiver! Considering the above were heard through the ever-present Equatorial static, I cannot say that the presence of tin deposits has any bad effect on reception.

Yours faithfully,
F. J. BARNETT.
F.M.S. Railways,
Ipoh, Perak, F.M.S.

(The article referred to dealt exclusively with signals on the usual broadcast wave-lengths, short waves not being taken into consideration.)

THE FILADYNE CIRCUIT.

The Editor, POPULAR WIRELESS.

Dear Sir,—I should like to congratulate you on the success of the Filadyne Circuit. I have tried this out thoroughly and consider that it should have a great future.

Next to the D.E.R. I find the Loudon P.E.R. (4 volt) quite good. It is interesting to note that the

latter valve, notwithstanding it being a 4-volt, requires more of the 30-ohm rheostat in than the D.E.R., both working off 4-volt battery. It is necessary, however, to use closer reaction. I find the best on my indoor aerial to be 75 turns for both aerial and reaction.

Another interesting point is that with a vertical filament D.E.R. I obtained very poor results.

Yours faithfully,
H. HERON SMITH,
Tower House, Belvedere, Kent.

AERIAL TENSION.

The Editor, POPULAR WIRELESS.

Dear Sir,—I have been reading "An Aerial Hunt," by F. G. Finn, in a recent "P.W." and I cannot fancy myself fiddling about with a bit of string and renewing it at every change of the weather, at least, not in England. He should try my trick. I tie a weight, just heavy enough to keep the aerial taut on to the rope and pass the spare end of the rope loosely round the pole and rope to prevent the weight swinging out. When the rope contracts the weight rises, and when it stretches, the weight lowers. Obviously, the tension on the aerial for all practical purposes remains the same in all weathers. It is, of course, only necessary at one end of the aerial. I trust this hint will be of assistance to others.

Yours sincerely,
A. G. J. BEKEM.

41, Butler Rd., Becontree, Essex.

INTERESTING TESTS.

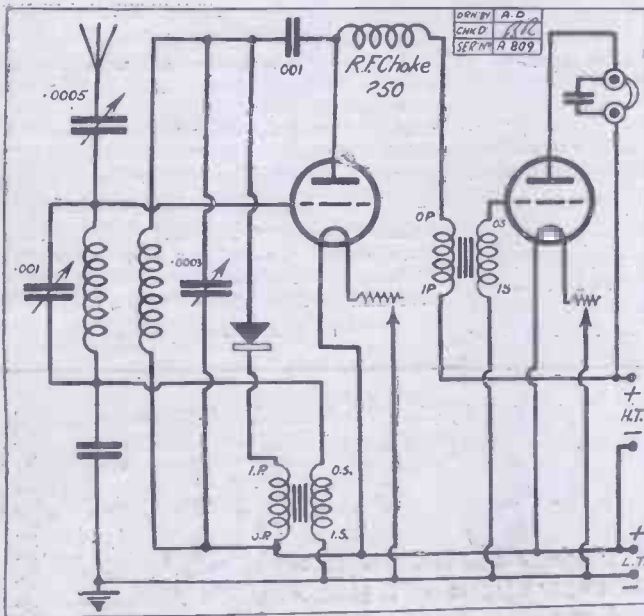
The Editor, POPULAR WIRELESS.

Dear Sir,—With reference to the comparative insulating properties of ebonite and wood, the following tests may be of interest to those who think the latter "good enough" for panel use.

Connect up a properly insulated single valve with H.T. and L.T. batteries as usual, but without aerial or earth, and with a milliamperemeter or other current indicator, in the anode circuit—without any telephone. Let the whole of the appliances, including the batteries, stand on something that really insulates them. In the trials about to be described they were on a newspaper, spread on a living-room table, covered with a plush cloth. The table had the usual porcelain-roller feet, and the floor was laid with linoleum.

With the valve connected as stated, the grid, being isolated, will become negative, and the current in the anode circuit will be low. It was actually only one-fifth of a milliampere, with the 30-volt H.T. battery employed. To increase this current, the grid must be made positive. To do this connect it to the plus pole of the H.T. battery with the three-ply wood, ebonite, etc., as a resistance between the two. The diagram shows the arrangement.

The advantage of using ebonite now becomes clear. With really good ebonite, the needle of the instrument does not even quiver when a contact is made on it, even a few inches away from the H.T. plus, provided its surface is not breathed upon. The longest piece of three-ply wood available was about two feet long, but a touch even with a wire, at the far end, caused a jump forward of the needle of the meter of a degree or two. Then a trial was made of a thin wooden rod, half an inch in diameter and four feet long. This conducted quite freely, so a mop handle was tied to it with bare wire, making eight feet in all. A contact to the end of this gave a marked jump forward, to four or five-tenths of a milliampere. It was too inconvenient to test a still longer pole, otherwise the leakage could easily have been shown, even with the comparatively crude means described, so a return was made to other insulating materials. Among these it was surprising to find a tube of what appeared to be some kind of celluloid which insulated so well that it was thenceforth used as a handle for



eight or nine different stations in about half a turn of condenser dial, and all audible for comfortable 'phone reception.

The crowning achievement being able to hear Rugby communicating with New York, and also their replies, I've had both these stations simultaneously two Sundays running, using a 300 aerial and 350 anode. Very interesting cross-talk is heard, especially when Rugby on Sunday—22nd ult.—was asking for a Mr. King in New York, and he spoke to them. This was 3.20 p.m., and when asked if he had had his breakfast, stated he had only just done so.

I am enclosing a wiring diagram for any readers who may like to try same.

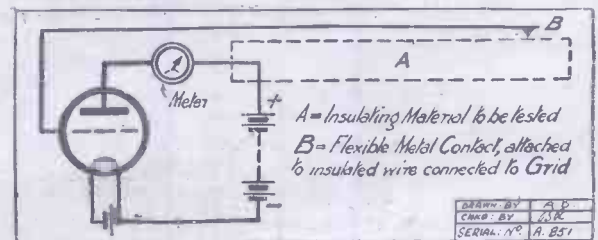
Wishing you every success,
Yours faithfully,
W. T. KING,
32, Gt. Road,
Handsworth,
Birmingham.

USEFUL SWITCHING ARRANGEMENTS.

The Editor, POPULAR WIRELESS.

Dear Sir,—I am very sorry to see that your correspondent, Mr. T. Douglas Baker, in his article entitled "Useful Switching Arrangements" ("P.W." No. 224, page 158), has fallen into the old trap of thinking that a single-pole switch in the common lead will disconnect both the L.T. and the H.T. batteries. The fact that the latter is by no means disconnected may be verified, for example, by laying down the 'phones of either Fig. 1 or Fig. 3 in such a way that their positive terminal touches the earth terminal or wire. The entire voltage of the H.T. battery, less that of the L.T. battery, will then be applied across the filaments of the valves. In cases where the switch is not used for earthing the aerial, but is connected, together with H.T. minus, in the non-earthed lead of the L.T. supply, the above procedure will result in the H.T. battery being simply shorted through the L.T. battery.

This letter is not intended to convey the impression



shifting about the wire used for touching purposes: The sensitiveness of a valve, used as an electrometer in the way described, is simply amazing. Owing to static charges generated by friction between dress materials, especially wool, and the tablecloth or chair every movement of a person seated at the far end of the large table used in the experiment sends the needle lying about, and when the aerial is loosed up, static charges on it are shown when there are lightning clouds overhead.

LESLIE MILLER,
"Avonhurst," Rural Way,
Strattham, S.W.16;



ings after the knob had been rapidly twisted to and fro several times.

ACME PLUG-IN COILS.

Messrs. M. Matthews, of 542a, Stockport Road, Longsight, Manchester, recently sent us a complete range of their Acme plug-in inductance coils for test. They are neat little coils, and are of practically a standard size throughout. They are wound in a multi-layer solenoid fashion, each layer being well separated from the other. The self-capacities of these coils are not particularly low as self-capacities go in these days of "low loss," but the Acmes couple well and provide moderately sharp tuning.

As many amateurs will have discovered, there is very little gain in the use of ultra-low-loss components in an ordinary aerial circuit on "ordinary" wave-lengths.

However, the Acmes are well made coils, and are rigidly assembled. Their prices are attractive, as the following shows: No. 25, 1/4; 35, 1/6; 50, 1/9; 75, 2/-; 100, 2/3; 150, 2/6; 200, 2/10; 250, 3/2; 300, 3/6; these prices are inclusive of postage throughout, and are, in the circumstances, distinctly competitive, and should ensure a good sale for these coils among discriminating amateurs.

CONCERNING RADIO BATTERIES.

Messrs. Siemens Brothers & Co., Ltd., have recently issued a most interesting little catalogue in which some very informative and interesting data concerning their

(Continued on page 382.)

Traders and manufacturers are invited to submit wireless sets and components to the "P.W." Technical Dept. for test. All tests are carried out with strict impartiality in the "P.W." Test room under the supervision of the Technical Editor, and the general reader is asked to note that this weekly article is also intended to provide a reliable and unbiassed guide as to what to buy and what to avoid.—EDITOR.

MESSRS. WRIGHT AND WEAIRE, LTD.

WILL readers please note that the address of this firm is 740, High Road, Tottenham, London, N.17, and not 240 as stated in our issue of October 2nd.

LAMPLUGH VARIABLE GRID LEAK.

In some circuits a variable grid leak is an absolute necessity, and there are few receivers in which such a component could not be incorporated with considerable advantage. But a variable grid-leak must be reliable if it is to be anything else but a nuisance. And really reliable variable grid leaks are, unfortunately, few in number. Of course, the majority of the well-known makes are trustworthy, and the Lamplugh should be able to give good service for an indefinite period. We recently had one sent us for test. In appearance the Lamplugh product is not

unlike an American all-enclosed filament rheostat, and has a largish milled knob, a solid brass pointer, and a black and gold dial. It is a one-hole fixing panel mounting component and is provided with two stout terminals and two sensibly-sized soldering tags in its base.

We found that this variable grid leak gave a very smooth variation between 1/2 and 7 megohms, taking nine-tenths of its scale to cover this range. Above 7 there was a fairly rapid increase towards "infinity," and below the 1/2 there was a sharp drop towards a reasonable minimum. Therefore, it will be seen that its action is sensibly spread out, and that it is capable of giving comparatively fine graduations of resistance between the most frequently employed limits. It proved to be constant in operation and re-calibrated settings deviated but little from the original read-



Prov. Pat. No. 13126.

Another Worry Ended!

of 200 to 250 volts any voltage from 20 to 150 can be obtained by simply plugging in to the nearest electric light socket. Four stages of Grid Bias are provided for: 4, 8, 12 and 16 volts. No more H.T. trouble! A lifetime's worryless wear.

For DIRECT and ALTERNATING Current

	£	s.	d.
Ordinary Model, D.C. 3 (for 200/250 volt-mains)	4	10	0
Special Model, D.C. 3 M (for Marconi Straight 8)	5	5	0
Ordinary Model, A.C. 1 (for 100/125 Volt-mains)	6	15	0
Special Model, A.C. 1 M (for Marconi Straight 8)	7	10	0
Ordinary Model, A.C. 2 (for 200/250 Volt-mains)	6	15	0
Special Model, A.C. 2 M (for Marconi Straight 8)	7	10	0

Royalty 12/6 per instrument extra, irrespective of number of valves.
Extras: 2 Special Valves—15/- each.

Sole Manufacturers:—

H. CLARKE & CO. LTD., (M'cr.) Radio Engineers, Atlas Works, Old Trafford, MANCHESTER

CLARKE'S

"ATLAS"

RADIO COMPONENTS

Clarke's "ATLAS" High Tension Battery ELIMINATOR makes the old H.T. Battery an unnecessary evil for all who have electric light in the home. It completely solves the problem once and for all. With a supply of 200 to 250 volts any voltage from 20 to 150 can be obtained by simply plugging in to the nearest electric light socket. Four stages of Grid Bias are provided for: 4, 8, 12 and 16 volts. No more H.T. trouble! A lifetime's worryless wear.

It completely solves the problem once and for all. With a supply of 200 to 250 volts any voltage from 20 to 150 can be obtained by simply plugging in to the nearest electric light socket. Four stages of Grid Bias are provided for: 4, 8, 12 and 16 volts. No more H.T. trouble! A lifetime's worryless wear.



Pat. No. 215053

Clarke's "ATLAS" Low-Loss Coils

After a careful study of thick-wire coils, bare-wire coils, big coils, long coils, fat, narrow, square, skeleton and other coils, one fact stands out with startling clearness. It is this: The twin wire, specially spaced windings of Clarke's "ATLAS" Low-Loss Coils have all the advantages of the super-low-loss ultra-modern coil, yet are light, neat and compact. They are a revelation in tuning efficiency—and look at the prices!

RETAIL PRICES:

Nos. 25-50	2/6 each	No. 490	5/6 each	No. 1000	12/6 each
" 65	3/- "	" 500	7/6 "	" 1250	14/- "
" 75-150	3/6 "	" 600	9/6 "	" 1500	15/6 "
" 175-300	4/6 "	" 750	10/6 "		

THE LISSEN H.T. BATTERY

10/6

—and British Made!

Your Loud Speaker needs
this Better Battery

The LISSEN NEW PROCESS BLOCK TYPE 60 volt H.T. Battery is unlike all previous H.T. batteries—it is both highly efficient and inexpensive.

Its discharge curve shows a stubborn resistance to volt drop—it excels in efficiency because we have discovered a new combination of chemicals not hitherto used in battery making. The unique new process—which naturally is a closely guarded secret—yields far clearer loud speaker reproduction and volume than any previous H.T. Battery and the success of the new process is now a definitely established fact.

Its price would have been 13/-: we could not have sold this new process block type battery at its present price but for our putting into operation a new direct-from-factory-to-dealer policy of distribution which CUTS OUT ALL WHOLESALE PROFITS. The price of this LISSEN Battery includes very little trade profit, because our dealer friends have all agreed to take a smaller profit than they get on any other battery, while it is only large quantities that will justify our own narrow margin per battery.

These LISSEN Batteries have another supreme advantage—every battery is absolutely fresh—they are actually on sale less than three days after being made—you cannot get a stale LISSEN Battery because dealers are only supplied at regular short intervals of some days—every LISSEN NEW PROCESS BATTERY is therefore brimful of new energy when you put it into your set.

We are making this new process battery only in the popular block type with socket tappings—an additional advantage are the four one volt tappings provided for grid bias at one end of the battery, while the other usual tappings give any voltage required.

LISSEN NEW PROCESS BATTERY IS DEFINITELY GUARANTEED—PLOT ITS CURVE AND RECORD ITS SERVICE.

No block type battery of this size and quality could be sold at the above price but for our new policy.

You can obtain this battery at any dealer's—but if any difficulty send direct to factory. Include nothing for postage but please mention your dealer's name and address.

LISSEN NEW PROCESS BATTERY is rated at 60 volts, but goes considerably over.

10/6

(Price would have been 13/- but for new policy.)



L62

LISSEN LIMITED,
Lissenium Works, 8-16, Friars Lane,
Richmond, Surrey.
Managing Director: Thomas N. Cole.

Heat your LISSENOLA working of this battery to know what a good loud speaker and a good battery can do together.



THE GLORY CORNER

This is the Glory Corner at The Bennett College. We give it that name because it contains in bundles about One Hundredweight of letters which we have received from Grateful and Successful Students. We keep all these thousands of unsolicited testimonials as a fountain of inspiration and because we are really proud of them. Having helped thousands of others to achieve success and advancement, it may be possible that we can help YOU.

I am assisted by a large and expert staff and the advice we give is sound. If we cannot help you we will say so; if we can we will tell you how.

We have FREE booklets setting out the possibilities in connection with each of the subjects shown in the lists; send for the one in which you are interested, or ask for MY PRIVATE ADVICE, which also is free. You incur no obligation.

COMMERCIAL
Accountancy
Advert. Writing
Salesmanship
Army Certif. Courses
Auctioneering, and
Estate Agency
Auditing
Banking
Book-keeping
Commercial Arithmetic
Company Law
Costing
Economics
English and French
Executorship Law
Foreign Exchange
General Education
Modern Business
Methods
Police Entrance and
Promotion Courses
Secretaryship
Workshop Organisation

TECHNICAL
Applied Mechanics
Architectural Drawing
Building Construction
Clerk of Works' Duties
Boiler Engineering
Boiler Making
Chemistry
Civil Engineering
Concrete and Steel
Draftsmanship
Electricity
Engineering
Engineering Costing,
Quantities and Specifications
Foundry Work

GOOD REASONS
why you should join The Bennett College.

1. We give a written guarantee of success.

2. We supply all the necessary books FREE.

3. We have expert tutors for every department.

4. We teach by post—you study in your spare time.



Yours sincerely,
The Bennett

Have You ANY Ambition? Most moderate charges, payable monthly. No extra fees.

TECHNICAL (contd.)

Heat Engines
Internal Combustion Engines
Marine Eng. B.O.T.
Mathematics
Matriculation
Metalurgy
Mining
Mine Surveying
Motor Engineering
Naval Architecture
Pattern Making
Quantity Surveying
Sanitation

TECHNICAL (contd.)

Shipbuilding
Structural Engineering
Surveying and Levelling
Telegraphy & Telephony
Town Planning
Wireless Telegraphy
Works Managers Course

WE SPECIALISE IN PREPARATION FOR ALL EXAMINATIONS IN CONNECTION WITH THE ABOVE SUBJECTS.

Note Address: The Bennett College, Dent 106, Sheffield.

TEACH BY POST IN ALL PART OF THE WORLD.



FORMO
CALCULATED TO LAST

A MONUMENT IN THE MARCH OF PROGRESS
The Formo Shrouded Transformer is the universal favourite.
Made in Ratios 1-1, 1-2, 1-3, 1-4 and 1-5
10/6 1-3 and 1-5 for 1st and 2nd stages
Send for Catalogue and Descriptive Literature of Complete Formo Range
THE FORMO COMPANY
Crown Works, Cricklewood, N.W.2
Phone: Hampstead 1787.
Manchester: Mr. J. B. Levee, 23, Hartley St., Levenshulme.
Phone: Heaton Moor 475.
(See page 385 for Formo S F Condenser.)

APPARATUS TESTED.

(Continued from page 380.)

H.T. batteries is given. We are particularly interested to note that Messrs. Siemens are now supplying high-class small sack Leclanché cells to meet the requirements of those who prefer the wet type for H.T. purposes. A notable feature of these cells is the provision of an enclosing cork cover to prevent the undue evaporation of the electrolyte and to keep the sack element rigidly in position. Complete cells are obtainable from 1/- each, and also complete batteries in boxes are available. L.T. and grid bias batteries are dealt with in this catalogue (No. 650) and readers are invited to write for a copy.

A FOUR-ELECTRODE DULL EMITTER VALVE.

For some time we have had a four-electrode dull-emitter valve on test, one that was sent us for this purpose by Messrs. Aneloy Products, of Eton Works, East Dulwich, London, S.E.22. Known as the "Two Grid," it consumes 34 amps. at 2 volts, and is retailed at 14/- with either a four-pin or five-pin base, as desired.

In various Unidyne receivers it gave very good results, although in most cases it requires a potential of 4 volts on the filament and care had to be taken not to over-run it.

We also discovered that it could be used with considerable advantage in ordinary

circuits. In many instances an increase of sensitivity was obtainable with decreased H.T. voltages. The four-pin base type has normally spaced legs and has a small terminal mounted in its base. It can, therefore, be plugged into any ordinary receiver, an extra H.T. positive lead being taken from the small terminal.

In a detector position this extra plus H.T. connection, which, of course, goes to the additional grid of the valve, requires some 4 to 10 volts, 15 to 30 being necessary for the anode. The one H.T. battery can still be used, and it is surprising what "low maximums" will still give normal results.

In a first L.F. stage volume can be increased and H.T. voltage conserved. We hold the opinion that the four-electrode valve has by no means reached the height of its usefulness and popularity, and firms such as Messrs. Aneloy Products are doing good work in bringing such valves to the notice of the public.

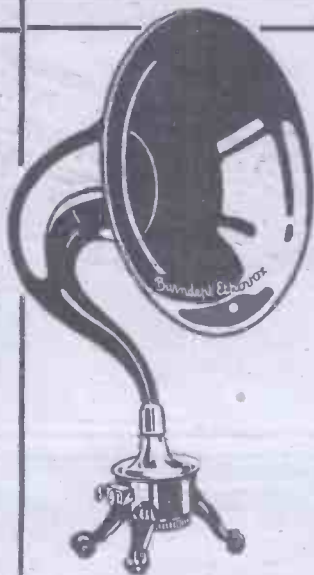
T.C.C. MANSBRIDGE CONDENSERS.

We publish on this page a photograph showing a 2 mfd. T.C.C. Mansbridge condenser tested to 300 volts, and a condenser of similar make and capacity tested to 600 volts. We have been asked to point out that although there are circumstances in which the former can be used in battery eliminators with perfect

safety, the B.E.S.A., of which the T.C.C. people are members, have just decided that condensers used on mains should be tested at voltages at least double that at which they will be permanently used.

Readers will appreciate the necessity of a "margin of safety" where house lighting electric mains are concerned, and will, no doubt, join with us in commending the action of the T.C.C. people in marking their special product so plainly with figures that will be clear to the least technical of constructors.

(Left) a T.C.C. Mansbridge condenser which has been tested to 300 volts, and (right) one that has been tested to 600.



No. 963. "ETHOVOX" (Type 750) with Metal Horn: for use direct in the plate circuit.

PRICE - £4 10 0

No. 966. "ETHOVOX" (Type 750) with Mahogany Horn: for use direct in the plate circuit.

PRICE - £5 5 0

"... the best we have tried, and we shall always use it in future." — THE WIRELESS TRADER, after testing the Burndept L.L. 525 Super Valve.

THE "Ethovox" and the new Burndept Super Valve type L.L. 525 go together, one is the complement of the other. The "Ethovox" is a remarkable reproducer, but its tones are enhanced still more when the correct Super Valve is used. The "Ethovox" is justly famed as the best horn type loud speaker made. It is finished in the exclusive Burndept rich mahogany colour, with polished smooth surface that does not collect the dust.

Type L.L. 525 is a super Power Valve designed for the last stage of an amplifier where great volume is required. Its high emission and good characteristics ensure perfect reproduction.

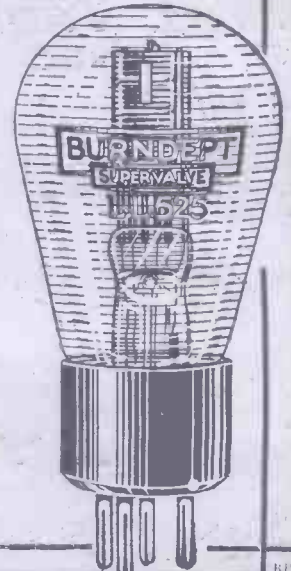
Type L.L. 525. Super Power Valve, 5 volts, 0.25 amp. Emission 35 ma., amplification factor 3.3. Impedance 3,000 ohms. 22/6
H.T. :—120 v. (grid—15 v.); 150 v. (grid—20 v.)



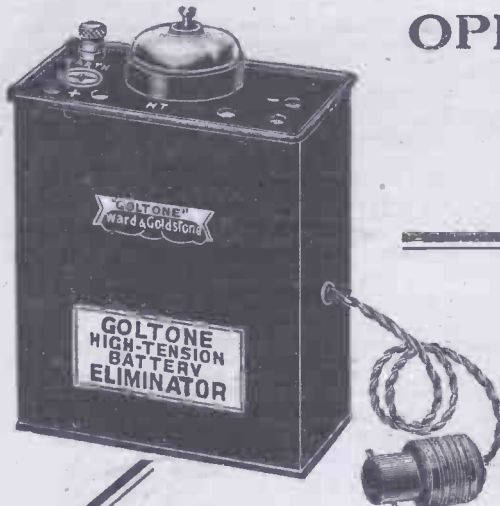
Head Office & Factory: Blackheath, London, S.E.3. Telephone: Lee Green 2100. Telegrams: Burnacoil, Phone, London.

London Office & Showrooms: 15, Bedford St., Strand, W.C.2. Telephone: Gerrard 9072. Telegrams: Burndept, Westrand, London.

AGENTS AND BRANCHES EVERYWHERE



OPERATE YOUR WIRELESS SET from the LIGHTING MAINS instead of using WASTEFUL and EXPENSIVE HIGH TENSION BATTERIES.



"GOLSTONE" (Regd.)

HIGH TENSION BATTERY ELIMINATORS

First cost saved in a short time. Give Increased Volume and Purity of Tone. A refinement and convenience beyond praise. Simply plug into any convenient lampholder.

COMPLETE WITH ADAPTOR, SWITCH AND CONNECTING CORDS.

DIRECT CURRENT MODEL

Approx. Voltage Tappings, 30, 50, 75, 90 and 120 Volts. Five separate tappings ready for immediate use. **£3:0:0**

"CONSTRUCTIONAL KIT."

Complete with full wiring instructions. **£2:5:8**

ALTERNATING CURRENT MODEL

Approx. Voltage Tappings, 30, 60, 90 and 130 Volts. Dual tappings are taken from each voltage thus providing Eight separate tappings. Ready for immediate use. (Including Valve) **£5:10:0**

"CONSTRUCTIONAL KIT." Complete with full wiring instructions. **£4:3:8**
Valve extra.

What Users Say!

E. J. G., Hillside, Moulscombe, Brighton:—"I find it very satisfactory, and have recommended it to several friends."

Mr. B., Littleborough:—"Have installed the 'Golstone' A. C. H. T. Battery Eliminator, and must say that it has exceeded expectations. It has not the slightest suggestion of hum or distortion of any kind, and is very satisfactory."

L. A. D., Colinton Road, Edinburgh:—"The Eliminator is working in a highly satisfactory manner."

J. W. G., Atkinson Road, Fulwell, Sunderland:—"I am delighted with the results; I did not think my set could do what it does with the Eliminator instead of dry cells. The increase of volume is great and no trace of hum whatever."

S. & Co., London:—"I should like to say I find the Eliminator excellent, no hum whatever, and giving wonderful volume."



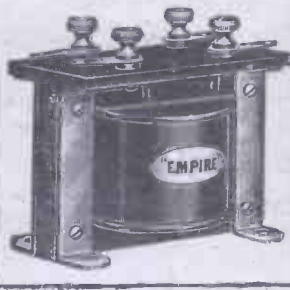
Stocked by the
Leading Radio
Stores.
Refuse Substitutes.



When ordering please state voltage & frequency of Lighting Mains

Large fully illustrated 48-page Catalogue free on request. Traders should enclose Business Card for Trade Terms.

CONSTRUCTIONAL KIT
DIRECT CURRENT MODEL.



7/6 A RELIABLE 7/6 BRITISH TRANSFORMER

A Prominent Wireless Paper said recently: "On test the two samples sent in gave surprisingly good results. They evinced an efficiency out of all proportion to their size and price."

SHROUDED? Why shroud a good Transformer? It is unnecessary. The Empire Transformer is not shrouded. Shrouding often lowers the efficiency of a Transformer by introducing a condenser effect and sometimes only covers inferior workmanship. 75% of the Empire Transformer's total weight is effective iron core and copper wire and is open to inspection.

7/6 STANDARD RATIOS 7/6
12 months' written guarantee

EMPIRE TRANSFORMER

THE H.T.C. ELECTRICAL CO., LTD.,
1, Bondaries Road, Balham, London,
S.W.12. Phone: Battersea 0374

Weak Joints need Strong Treatment

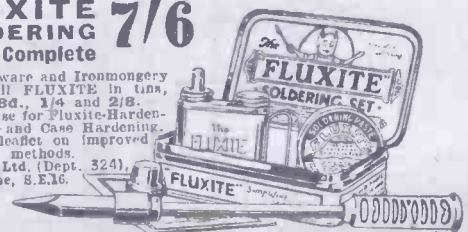
An imperfect joint . . . a tiny leakage . . . gone are the chances of good, long-distance reception.

The Fluxite Soldering Set will fix all joints quickly, and for ever. No trouble . . . no mess . . . and so simple.

FLUXITE SOLDERING 7/6 SET—Complete

All Hardware and Ironmongery Stores sell FLUXITE in tins, price 8d., 1/4 and 2/6. Another use for Fluxite—Hardening Tools and Case Hardening. Ask for leaflet on improved methods.

FLUXITE, Ltd. (Dept. 324),
Rotherhithe, S.E.16.



FLUXITE

RADIO TORIAL

All Editorial Communications to be addressed to The Editor, POPULAR WIRELESS, The Fleetway House, Farringdon Street, London, E.C.4.

Editor:
NORMAN EDWARDS, M.Inst.R.E., F.R.S.A.,
F.R.G.S.

Technical Editor:
G. V. DOWDING, Grad.I.E.E.

Assistant Technical Editors:
K. D. ROGERS. P. R. BIRD.

Scientific Adviser:
Sir OLIVER LODGE, F.R.S.

Staff Consultants:
Dr. J. H. T. ROBERTS, F.Inst.P.; J. F. CORRIGAN, M.Sc. A.I.C.; C.E. FIELD, B.Sc.;
E. J. SIMMONDS, M.I.R.E., F.R.S.A.

Foreign Correspondents:
F. M. DELANO, Paris; Dr. ALFRED GRADENWITZ, Berlin; L. W. CORBETT, New York; P. F. MARTIN, Italy; W. PEETERS, HOLLAND.

The Editor will be pleased to consider articles and photographs dealing with all subjects appertaining to wireless work. The Editor cannot accept responsibility for manuscripts and photos. Every care will be taken to return MSS. not accepted for publication. A stamped and addressed envelope must be sent with every article. All inquiries concerning advertising rates, etc., to be addressed to the Sole Agents, Messrs. John H. Lill, Ltd., 4, Ludgate Circus, London, E.C.4.

As much of the information given in the columns of this paper concerns the most recent developments in the Radio world, some of the arrangements and specialities described may be the subject of Letters Patent, and the amateur and the trader would be well advised to obtain permission of the patentees to use the patents before doing so.

Readers' letters dealing with patent questions, if sent to the Editor, will be forwarded to their own patent advisers, where every facility and help will be afforded to readers. The envelope should be clearly marked "Patent Advice."

TECHNICAL QUERIES.

Letters should be addressed to: Technical Query Dept., "Popular Wireless," The Fleetway House, Farringdon Street, London, E.C.4.

They should be written on one side of the paper only, and **MUST** be accompanied by a stamped addressed envelope.

Queries should be asked in the form of the numbered questions: (1), (2), (3), etc., but may be accompanied by a short letter giving any necessary additional particulars as briefly as possible.

For every question asked a fee of 6d. should be enclosed. A copy of the numbered questions should be kept, so that the replies may be given under the numbers. (It is not possible to reproduce the question in the answer.)

BLUE PRINTS. A series of 20 Blue Prints can be obtained from the Query Dept. price 6d. per Blue Print.

Only a limited number of circuits are covered in this series, and full details of the circuit arrangements available in Blue-Print form are published fortnightly in the advertisement columns of this journal.

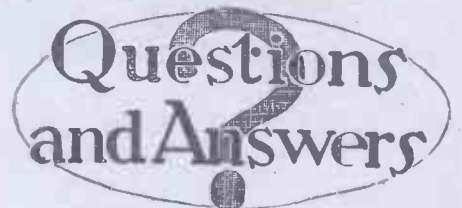
All other back-of-panel diagrams are specially drawn up to suit the requirements of individual readers at the following rates: Crystal Sets, 6d.; One-Valve Sets, 6d.; One-Valve and Crystal (Reflex), 1s.; Two-Valve and Crystal (Reflex), 1s.; Two-Valve Sets, 1s.; Three-Valve Sets, 1s.; Three-Valve and Crystal (Reflex), 1s. 6d.; Four-Valve Sets, 1s. 6d.; Multi-Valve Sets (straight circuits), 1s. 6d. Except SUPER-HETERODYNE DIAGRAMS, all of which, irrespective of number of Valves used, are 2s. 6d.

If a panel lay-out or list of point-to-point connections is required an additional fee of 1s. must be enclosed.

Wiring diagrams of commercial apparatus, such as sets of any particular manufacture, etc., cannot be supplied. (Such particulars can only be obtained from the makers.)

Readers may submit their own diagrams, etc., for correction or for criticism. The fee is 1s. per diagram, and these should be large, and as clear as possible.

No questions can be answered by 'phone. Remittances should be in the form of Postal Orders.



POLARITY OF D.C. MAINS.

L. M. (Southend).—Please inform me of a reliable method of finding the polarity of my D.C. mains, as I wish to use them for my H.T. unit and also for charging accumulators.

There are several good methods of finding the polarity of D.C. mains, the water test being perhaps the best and simplest. This consists of inserting the two leads from the mains in a cup of water. If the two wires are kept well apart in the water bubbles of gas will be given off the negative pole in a greater

(Continued on page 386.)



hear this new T.M.C. GRAMO-SPEAKER

THE pure rich tone and ample volume of the new T.M.C. "Gramo-speaker." will astonish you.

It can, in a moment, transform your gramophone into a splendid Loud Speaker. By the addition of a home-made horn you can have as good a Loud Speaker as many a one sold at five times its price.

It is not an adapted "earpiece," with a diaphragm held in place by a screw-on cap, ready to loosen through its own vibration. It is a real Loud Speaker Unit with an adjustable magnetic system (Loud Speaker size) fitted with permanent magnets of cobalt steel and a diaphragm firmly clamped between ground metal surfaces.

Go to your local wireless dealer. Ask him to put a horn on the GRAMO-SPEAKER—hear why it is the most perfect of its kind. Price **13/6**

THE T.M.C. "JUNIOR" LOUD SPEAKER

This popular little fellow is better than ever. Its copper horn is responsible for its rich mellow tone. No "throatiness"—no blasting—pure liquid music and speech. You'll like the T.M.C. Junior—but it's not made to look at—hear it—then you'll know why it's so popular. Price **£1-17-6**

There is a T.M.C. Loud Speaker to suit every pocket. Ask for the new T.M.C. Catalogue at your local wireless shop—or we will send a copy free on request. Please mention the name of your usual dealer. Prices do not apply to Irish Free State.

OTHER T.M.C. RADIO SPECIALITIES:

LOUD SPEAKERS

"Concert Grand" ..	2	5	10	0
"Standard" ..	4	5	0	0
"Minor" ..	0	17	6	

CRYSTAL SETS
From 12s. 6d. to 2 7 6

HEADPHONES

No. 3 (Lightweight) in cardboard box ..	0	17	6
No. 2A, Heavier Model ..	0	15	0

LOW CAPACITY KEYS

No. 1, 12 point, 3 position ..	7	0	0
No. 2, 6 point, 2 position ..	6	0	0
No. 3, 24 point, 3 position ..	15	6	

Telephone Manufacturing Co. Ltd.
HOLLINGSWORTH WORKS, WEST DULWICH, S.E. 21
Phone: Sydenham 2460/1. Telegrams: "Bubastis, Dulerox, London."

ALL THE LATEST "P.W." SETS

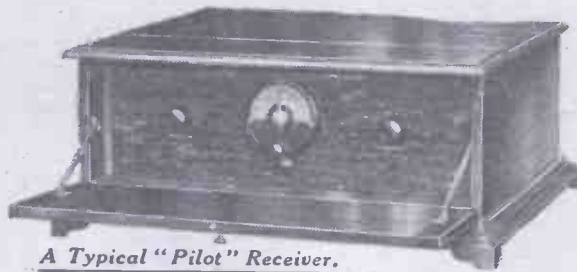
supplied as finished instruments or in parts for home construction

NOW is your opportunity to acquire a really good set at a very reasonable price. Under the famous PILOT service, you can obtain from us all the parts for any set published in the various wireless papers, and you may rely upon receiving free advice and help from our Technical and Service Department. On the other hand, if you prefer to have your set ready built, we can supply it at a small extra cost. In either case, you are assured of first-class results.

"P.W." Supplement Sets

Plug in Crystal Set	
1 Square Law Condenser, '0005 mfd.	£ s. d. 8 6
1 Mic-Met Crystal Detector and Crystal	6 0
1 Single Coil Holder	1 2
Ebonite Panel, matted and drilled	3 6
Polished Mahogany Box	3 6
FINISHED INSTRUMENT, aerial tested, less coil	1 7 6
One Valve Amplifier	
1 Max.-Amp. Transformer	19 6
1 30-ohm Rheostat	3 0
15 Terminals and 4 Valve Sockets	3 0
Ebonite Panel, matted and drilled	3 6
Polished Mahogany Box	4 6
FINISHED INSTRUMENT	2 2 0
Marconi Royalty	12 6

The PILOT MANUAL contains illustrated details of a number of up-to-date sets which we thoroughly recommend. Much useful information on soldering, assembling, testing, etc. is also included. Post free, 3d.



A Typical "Pilot" Receiver.

This week's attraction The "P.W." SPIDER SET

(Described in this issue).

"Pilot" Kit of Components

These are the components required:

1 Cylidon Twin Gang Condenser '0005 mfd. (each section)	£ s. d. 2 10 0
1 Back of Panel Worm Drive Coil-holder	9 6
2 30-ohms Rheostats	6 0
1 Keystone Fixed Resistor and Base	2 6
1 R. I. Multi-ratio Transformer	1 7 6
3 Anti-microphonic Valve-holders	8 9
4 Single Coil-holders, B. M.	5 0
1 ON and OFF Switch	2 0
2 Terminal Strips complete with Terminals	5 0
1 "Pilot" Dial	5 0
2 Special Chokes	9 0
3 Dubilier Fixed Condensers, '0003, '002 and '006 mfd.	8 6
	£6 16 9
"Red Triangle" Ebonite Panel 18 x 8 x 1/2 ins. matted and drilled	12 0
Engraving extra (if required)	2 6
Polished mahogany Cabinet and Baseboard	1 10 0
Finished Instrument, Aerial Tested and Guaranteed.	
Less Coils and Valves, etc.	£12 0 0
Marconi Royalty	1 17 6

PETO-SCOTT CO., LTD., 77, City Road, E.C.1, also at 62, High Holborn, W.C.1; Walthamstow, Liverpool and Plymouth P.S. 7022.

THIS is our price for assembling, wiring, testing and guaranteeing any "P.W." or "Bestway" Set up to three valves.
(Four-valve Set, £4; Five-valve Set, £5)

Every finished set we sell is tested under the supervision of Capt. Tingey, A.M.I.R.E. [Late of Radio Press Laboratories]

H.T. Eliminators

PROVIDED you have electric light in your house, you need no longer buy expensive H.T. Batteries. Full instructions for building H.T. units to work from D.C. or A.C. mains were described in "Popular Wireless" of September 11th and October 9th, respectively.

For A.C. Mains

Complete set of parts, including Panel and Cabinet .. £5 9 6
FINISHED INSTRUMENT, tested and guaranteed .. £8 5 0

For D.C. Mains

Complete set of parts, including Panel and Cabinet .. £ 2 2 9
G.E.C. 2-way Adaptor with Switch, if required .. 5 9
FINISHED INSTRUMENT .. 3 10 0

When complete set of parts and panels are purchased together a Marconi Royalty of 12/6 per valve must be remitted.

N.B.—We can only advertise a few instruments here. Let us know the type of set you want and we will quote you by return.

STEEL PLATE ACCUMULATORS

FOR HIGH TENSION

only 1/- per Volt.

Absolutely Noiseless. No Acid.
No Fumes. Last a Lifetime.

BATTERIES LTD., REDDITCH

LONDON SHOWROOM: 220, Shaftesbury Avenue, W.C.2.

ULTRA LOW-LOSS

Straight Line Frequency Condenser

Cone Bearings. Braced Vanes. Positive Collector. A real precision job. 9/- Condenser only, '0003uF., '0005uF. .. 9/- Condenser with plain Dial, Standard 10/6 1/2" dial shaft .. 10/6

Send for Catalogue and Descriptive Literature of complete Formo Range

THE FORMO COMPANY,
Crown Works, Cricklewood, N.W.2
Phone: Hampstead 1787.

Manchester: Mr. J. B. Levee, 23, Hartley St., Levenshulme.
Phone: Heaton Moor 475.
(See page 387 for Formo Transformer.)

"Silvertown"

WIRELESS ACCESSORIES

Quality guaranteed by over 50 year's electrical manufacturing experience.

SILVERTOWN WIRELESS ACCESSORIES include:

CONDENSERS (All Types)

CRYSTAL HOLDERS

DIALS AND KNOBS

EARTH PLATES

INDUCTANCE SWITCHES (10-way, etc.)

INSULATORS, ("Ever-dry," "Featherweight," Cone lead-in, Window Pane, etc.)

POTENTIOMETERS

RHEOSTATS, FILAMENT (One-hole fixing, etc.)

"SILVERVOX" LOUD-SPEAKERS

TESTING BUZZERS

TRANSFORMERS (All Types)

VALVE HOLDERS, ANTI-MICROPHONIC

VERNIOMETERS, Etc., Etc.

B 500.

INTERVAL TRANSFORMER.
Guaranteed for 12 months.
Price 21/- each.

This Transformer has been adopted by leading manufacturers of Wireless Receiving Sets and discriminating amateurs in all parts of the world. Excellent results have been obtained on tests carried out by the National Physical Laboratory. Copy of the curve can be had on application.

THE SILVERTOWN COMPANY
106, Cannon Street, London, E.C.4.
Works: Silvertown, E.16.

BELFAST, BIRMINGHAM, BRISTOL, CARDIFF, DUBLIN, GLASGOW, LEEDS, LIVERPOOL, LONDON, MANCHESTER, NEWCASTLE-ON-TYNE, PORTSMOUTH, SHEFFIELD.

RADIOTORIAL QUESTIONS AND ANSWERS.

(Continued from page 384.)

quantity than at the positive. This gas will be hydrogen, and may be tested by holding a lighted match just above the water at the point where the gas is coming off, when each bubble should ignite.

Another well-known test is to rest the leads on a freshly-cut surface of a potato. The positive lead in this case leaves a greenish blue mark. Polarity can also be found by means of paper impregnated with potassium iodide and starch. If the paper is moistened and the wires held in contact with it about an inch apart the positive will leave a brown stain.

LOADING FOR DAVENTRY.

W. J. S. (Cambridge).—I have recently constructed an ordinary single-valve receiver employing reaction.

Although working quite satisfactorily on the usual B.B.C. band of wave-lengths, I find it impossible to tune in 5 X X, except for a barely audible murmur when the coils are tightly coupled and the set oscillating. I have tried several "Daventry" coils and altered winding of reaction. How can this be remedied?

Apparently your tuning condenser is at present connected "in series," whilst the average "Daventry coil" for loading to 1,600 metres is intended for use with a tuning condenser that is placed "in parallel."

You can either alter the connections of the condenser or use a larger 5X X coil (of approximately 300 turns).

ACCUMULATOR TROUBLES.

A. H. B. (Glasgow).—My accumulator does not seem to be lasting as long as it should after each charge now, although it looks quite all right. The dealer to whom I take it does not seem to know much about it. What is likely to be the fault?

This may be due to careless charging. Take the battery to an electrician, explaining the circumstances, and asking him to give it a long, slow charge. Sulphation may have commenced, although yet barely noticeable, but the above will put matters right. We should also ask him to test the acid solution.

P.W. COIL TABLES.

No. 1.—BASKET OR SPIDER-WEB COILS.
(A) AERIAL COILS WITH PARALLEL TUNING CONDENSER.

No. of Turns.	Gauge of Wire S.W.G.	Wavelength, in Metres.				Suitable No. of turns in reaction coil.
		Capacity of the Parallel Condenser. = .0003		Capacity of the Parallel Condenser. = .0005.		
		Max.	Min.	Max.	Min.	
20	24	285	190	335	195	20-40
30	24	380	255	450	260	20-40
40	24	500	335	590	345	30-60
50	26	620	415	735	425	30-60
60	26	750	500	885	515	60-80
70	26	895	595	1050	610	60-80
80	28	1025	685	1210	700	60-100
90	28	1170	780	1380	800	60-100
100	28	1320	885	1560	905	60-100
125	30	1675	1125	1975	1145	60-100
150	30	2100	1405	2470	1430	60-100

A NEW ONE-VALVE FILAMENT CIRCUIT.

Constructors should note that results with the above receiver (described in "P.W." 227, October 9th issue) are often improved by a modification of the H.T. connection to L.T.

Instead of H.T. negative being joined (through the H.F. choke) to the L.T. negative lead, one end of the choke remains connected to H.T. negative and its other end is joined direct to L.T. positive.

NEGATIVE AND POSITIVE.

"STUDENT" (Bishop's Stortford).—In electrical text-books it is often assumed (for the purpose of illustrating a point) that current flows from positive to negative. The terms "positive" and "negative" also suggest that

the current goes from the former to the latter, and yet we are told elsewhere that current electricity is a flow of electrons from negative to positive. If this is so, the terms appear to mean exactly the reverse of what is intended. Would it not be better if the "positive" of all batteries, etc., were marked "negative," and the "negative" "positive"?

The present system of marking negative and positive was in use before the discovery of the electron, and it is this later knowledge that makes the marking appear contradictory.

Actually it would be advantageous if all the "negatives" were "positives," and vice versa, but obviously this would be a very difficult change to make now. In a few years' time all the text-books in use will be written in the light of the electron theory, and the confusion will not then arise.

RESULTS WITH A REFLEX.

"FLAT-DWELLER" (Hammersmith, London, W.).—I am unable to erect an outdoor aerial, so I wish to use a frame aerial. Would a one-valve dual circuit give good strong broadcasting in the 'phones at this address?

At your distance a set of this kind will generally work quite satisfactorily with a frame aerial. The frame should take the place of the A.T.I., the tuning condenser being in parallel. You will not get loud speaker strength of course, but on 'phones the signals should be quite loud.

Before trying a frame aerial, however, we would advise you to see what results can be obtained with three or four wires hung across the room and joined to the set in the usual manner. This aerial, if placed so that it is directional for 2 L O, should give better results than the frame, while the usual tuning apparatus of the set will need no modification. If the frame aerial is used, the variable condenser tuning the aerial must be in parallel. The P.W. Blueprint No. 7 gives details of a suitable set.

RESTORING A DULL EMITTER.

R. S. A. (Goring-on-Thames).—Having allowed a dull-emitter valve to have too much voltage across the filament, is there any chance of restoring its properties, as they have been destroyed?

(Continued on page 388.)



5/-
SECURES

5/- down and
12 monthly
payments of
five shillings

"BULLPHONE NIGHTINGALE" LOUD SPEAKER

CLEAR
TONE

POST your deposit of 5/- now and get by return the famous "Bullphone Nightingale" Loud Speaker.

Individually tested and guaranteed to be superior to any other Loud Speaker regardless of price, for finish, purity and strength of tone and value. Cash Price 60/-, post free United Kingdom.

GREAT
VOLUME

Specification. Height 21", Bell Mouth 14". Nickel Arm and Stand. Black crystal bell head, as photo. Also de luxe model, mahogany finish bell, same size, 65/- cash or 10/- deposit. List free

W. BULLEN (Dept. P.W.2), 38, Holywell Lane, London, E.C.2

A Wonderful evening with the Latest Circuit

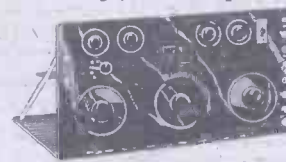
The remarkable achievements of Receivers Constructed from the Home Constructors' Model of the Ormsby 4-Valve Extra Selective Long Range Receiver become more evident every day. One enthusiast writes to say he has tuned in 72 stations, others tell of 50 and 60. At our Showrooms, less than a mile from 2 L O, we cut the London Station out dead and tune in 18 others easily... all at Loud Speaker Strength and most of them on 3-valves.

SIMPLE TO CONSTRUCT

Our Constructional Model does away with complicated charts. It is a full size replica of the set illustrating all components and wires. Coloured strings show different wires. Every connection is clear and you cannot fail to build it successfully. All you have to do is just copy the model.

WONDERFUL SELECTIVITY

The selectivity of this Circuit is wonderful. It cuts the Local Station absolutely out and brings in Station after Station all over Europe, on Loud Speaker.



The ORMSBY CONSTRUCTIONAL MODEL is a full-size Cardboard Model of Receiver, complete with instructions and advice on building. Packed in a box. 3/- Post 5d.

Demonstrations every evening in London.

Catalogue on Request.

Trade enquiries invited.

ORMSBY & Co., Ltd.,
1, Ormsby Works, Lower Richmond Rd.,
Richmond, Surrey.

London Showrooms: 10, New Oxford Street, W.C.1



No. 1

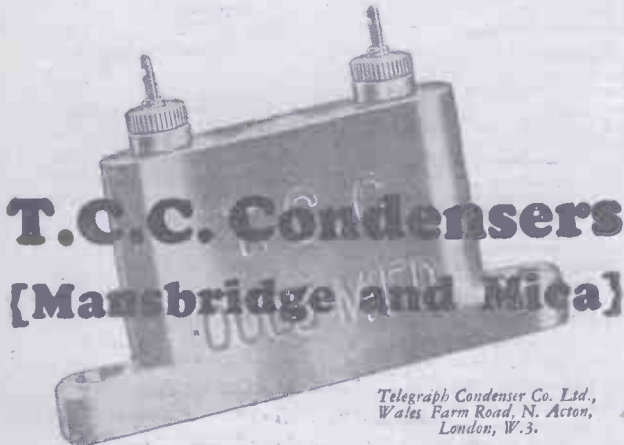
Things are not always what they seem.

"The Cowl does not make the Monk"

"THINGS are not always what they seem," says the old adage. A man may wear cloak and cowl, yet who can tell he is of the Monastery—until he probes beneath. Who knows but that the sacred cowl may be but the shield of an impostor? Is there a "Judas" in your Wireless Set? Those constant cracklings and that worrying weakening of your signals—where do you suspect lies the culprit? You examine the components, check over the wiring—everything seems correct. Are you sure of the fixed Condenser? Of all the faults in a Receiver more are traceable to the fixed condenser than to any other component. Yet you buy it on faith: you may have the choice of two Condensers—alike in outward appearance, except that one bears the name "T.C.C." stamped upon its case. The unnamed condenser may be nothing but a case shielding inferior materials and bad workmanship—an impostor. To buy such is false economy.

Although to buy T.C.C. may cost a few pence more in the first place, it will assuredly save you time, money and temper, for when you buy a T.C.C. Mica or Mansbridge Condenser you obtain a product behind which is the experience of England's Condenser pioneers. Because only the finest materials available are used, by men with more-than-a-score years' experience in Condenser manufacturing, you know you are buying a Component whose capacity is guaranteed to be within an ace of accuracy, and that your set will be entirely free from leakage and all other condenser-troubles.

Q T. C. C. Mansbridge Condensers are priced from 2s. 0d. upwards; Mica are from 2s. 4d.



T.C.C. Condensers
[Mansbridge and Mica]

Telegraph Condenser Co. Ltd.,
Wales Farm Road, N. Acton,
London, W.3.

G.A. 6035.

"I don't know much about R/L values but these LEWCOS Coils certainly give better results"



Lewcos Coil users do not need National Physical Laboratory figures, although these are being published, to prove that they are the most efficient coils produced. They know, from practical experience, that LEWCOS Coils give them greater selectivity and signal strength than any other coil.

Try LEWCOS Coils on your set—they make all the difference! Any dealer stocks or can obtain them for you. Write for descriptive leaflet.

No.	25	35	40	50	60	75	100	150	200	250	300
Price	4/6	4/6	4/6	5/-	5/6	5/6	6/9	7/6	8/6	9/-	10/-

The
LONDON ELECTRIC WIRE
COMPANY & SMITHS, LTD.
Playhouse Yard, Golden Lane, London, E.C.1

LEWCOS
Inductance Coils



JUDN

Rheostat



Inside

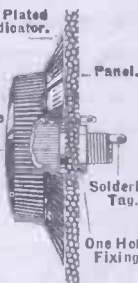
A RHEOSTAT is ingeniously built inside this dial. Only a space of $2\frac{1}{2}$ " diameter is required in front of the panel and $7/16$ " at the back. Thus valuable space is saved, wiring is made easier and the appearance of the panel improved.

The movement is extremely smooth and a very fine variation is possible. The dial (made of genuine Bakelite) is marked 0 to 100 and a nickel-plated pointer guides the adjustment. Fixing is by the one-hole method.

Nickel Plated
Dial Indicator.

Resistor
in Dial.

Patent
246435



Made in three types, 6, 15 and 30 ohms resistances respectively. Each sold at the very moderate price of

2/9

Obtainable from all up-to-date dealers.

BENJAMIN Self-contained RHEOSTAT

Out of sight, out of mind.

THE BENJAMIN ELECTRIC LTD.
Brantwood Works, Tottenham, N.17.

The Benjamin Battery Switch gives perfect current control and costs only 1/3.

RADIOTORIAL QUESTIONS & ANSWERS.

(Continued from page 386.)

This depends upon the type of valve, and fortunately many '06 amp., and similar types, are curable after this sort of mishap. In any case, the procedure is to burn the valve at the correct voltage for about half an hour or more *without any H.T.* on the plate. This will bring some of the special chemicals to the surface of the filament, and normal electron emission will result.

Another way is known as "flashing," but it is decidedly risky. It consists in connecting one filament leg of the valve to one side of the H.T. battery, and just brushing the other H.T. connection on the other filament leg. This should have the same effect as the above.

One method of ensuring that too much current does not pass when "flashing" a valve in this way is to do the flashing from a fixed condenser.

All that is necessary is to connect a very large fixed condenser—(say 1 mfd. or more)—across a high-tension battery of 100 volts or so. Disconnect the H.T. battery, and then connect the filament legs across the fixed condenser.

This latter will, of course, discharge itself via the filament, and as the current is limited by the capacity of the condenser there is no danger of applying the current for too long a period.

HUM ON D.C. H.T. UNIT.

E. L. T. (no address given).—I have constructed a D.C. unit (similar to the one described in POPULAR WIRELESS No. 223), and while it allows me to obtain a good volume from my new set, yet a considerable "hum" accompanies its use. Any suggestions for overcoming this will be appreciated.

Below are outlined probable causes that would account for the "hum" experienced.

(a). A "rough" D.C. supply.

(b). Mains interference, generally via aerial or earth lead.

Referring to (a), even the best H.T. battery eliminators will not give a steady output if the supply from the main is not good.

We have found that in some small towns in England the dynamos used at the power stations are of an inefficient type, and are inclined to fairly large voltage fluctuations, as well as being erratic in other ways.

In such cases it is usually necessary to provide an auxiliary smoothing arrangement with the eliminator. (In the case of the one described in "P.W." No. 223, further L.F. chokes of about 100 henries inductance placed in series with each +H.T. lead taken from the eliminator will effect a noticeable improvement. If these chokes are used, it will be necessary to raise the voltage tapplings on the eliminator one higher in each case, so that if, say, a tapping is arranged in the 8th socket it must be raised to the 9th, owing to the loss in the choke).

Fixed condensers of about 2 mfd. capacity can be placed across each +H.T. tapping and -H.T.; the number required will, of course, depend upon the number of H.T. tapplings taken from the eliminator.

In the case of (b) it sometimes happens that a hum is heard in the loud speaker or 'phones, and this hum would be present, whether an H.T. eliminator, or an H.T. battery, were used.

Interference of this type comes from the electric light or power system, but it is not brought to the set by the eliminator. Generally it is induced into one of the leads (aerial or earth) from the house wiring.

In addition, as most H.T. eliminators have a certain hum or ripple in use—however small this may be—there is a risk that this will combine with any hum in the set and aggravate the trouble.

You should therefore endeavour to reduce to a minimum the "hum" in the set itself, and this can only be accomplished by carefully arranging the aerial lead away from walls, ceilings, etc., and keeping it as short as possible.

Finally, care must be taken to arrange the H.T. voltages to the set as near as possible to those ordinarily used. Tables indicating near approximation of the voltages given by the eliminator were given in "P.W." No. 225.

Blue Prints and Diagrams.

J. H. R. (Astley Abbots).—I am a regular user of your blue prints, but recently there has been a demand for sets built in the American way, and although I have built a few 3-valve sets (D. and 2 L.F.) from your blue print (No. 20) they have been in the English way, (Flat Panel).

(Continued on page 392.)



Columbia

DRY BATTERIES FOR CONTINUOUS AND EVEN DISCHARGE

USE Columbia for every radio battery purpose. Unlike your ordinary batteries, their current drains evenly and eliminates hum and distortion. Then again the voltage drops gradually which prevents a sudden fall in reception volume. Columbia Radio "A" Cells are designed to discharge the greater part of their useful energy before their voltage drops to approximately .8 volts.



Send for our free instruction books "How to get the most out of your radio batteries" and "Choosing and using the right radio batteries." It is astonishing what will result in economy of operation and improved quality of reception when you have definite knowledge as to the correct use of your radio batteries.

J. R. MORRIS,
15-19, KINGSWAY, LONDON, W.C.

Telegrams: Colcarprod, London. Telephone: Gerrard 3033.

Scottish Representative:
John T. Cartwright, 3, Cadogan Street,
GLASGOW.

FELLOWS WIRELESS



THE FINEST H.T. BATTERY IN THE WORLD!

4 good reasons why it will pay you to order your H.T. Batteries from us.

1. Your battery will reach you as "fresh as a crisp roll," because we send out such large numbers DAILY—no lost voltage through standing about on shelves.
2. You get your full money's worth of battery by ordering from us—there are no middlemen's profits for you to pay.
3. You get an H.T. Battery that is made in London, and everything about it, Capital, Materials, Labour, is British—with a capital "B."
4. You get a Battery that will give the longest possible life of perfect reception, because it has been scientifically designed, and the "elements" are so generously proportioned—nothing is skimped.

Get your Fellophone Battery either from one of our six branches (see below) or direct from us. Just send Postal Order, Money Order, Cheque, or (registered) Cash. But do it now.

54 Volt (with 3-volt tap for grid bias) **6/6**
Postage and Packing 9d.

60 Volt (tapped every 3 volts and complete with 2 wander plugs) **8/9**
Postage and Packing 9d.

108 Volt (tapped every 6 volts and complete with 2 wander plugs) **13/-**
Postage and Packing 1/3.

FELLOWS, PARK ROYAL, N.W.10

Branches:

- LONDON: 20, Store Street, Tottenham Court Road, W.C. (Museum 9200).
- BIRMINGHAM: 248, Corporation Street.
- BRIGHTON: 31, Queen's Road. (Brighton 899).
- CARDIFF: Dominions Arcade, Queen Street. (Cardiff 7685).
- NOTTINGHAM: 30, Bridlesmith Gate. (Nottingham 5551).
- TONBRIDGE: 34, Quarry Hill. (Tonbridge 172).

Send for 48-page Catalogue No. 33, FREE

BUY DIRECT AND SAVE MONEY

R.P.S. 260.

CLIMAX for "P.W."

HIGH TENSION SUPPLY UNITS

The technical designers of "Popular Wireless"

A.C. and D.C. UNITS

used, specified and recommended CLIMAX Components.

You can be certain of success when you construct your H.T. Supply Unit by following the lead of "P.W." experts in their issues of September 11 and October 10.



CLIMAX AUTO-BAT TRANSFORMER

Ref. No. CN 257.	200-250 volts	} Double-wave Model	Price 39/6
" " CN 258.	100-125 volts		
Ref. No. CN 259.	200-250 volts	} Single-wave Model	Price 27/6
" " CN 260.	100-125 volts		



CLIMAX SPECIAL CHOKE

Ref. No. CN 200... Price **5/-**

CLIMAX POTENTIAL DIVIDER

Ref. No. CN 256... Price **10/6**

CLIMAX

Showrooms,
257, High Holborn,
London, W.C.1.
Telephone,
Holborn 2538.

CLIMAX RADIO ELECTRIC, LTD.,
Quill Works, Putney, London, S.W.15.
Telephone: Putney 2599.

THE ONLY ADHESIVE FOR EBONITE

BULLDOG

CHATTERTON'S COMPOUND

For mounting small components, labels, etc., on panel; covering screw heads; filling up unwanted holes.



6d. PER STICK FROM ALL RETAILERS

THE POMONA RUBBER COMPANY,

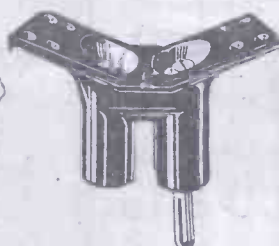
MEDLOCK WORKS, LONDON ROAD,

Manchester "GRAMS" Pom-Rub, Manchester

REFLEX Radio Co. 102, HIGH STREET STOKE NEWINGTON, N.16



UNMOUNTED COILS entirely self supporting. losses negligible. Accuracy guaranteed. Prices 25-30-35 at 8d., to 1500 at 10/-.



REFLEX "LOWLOSS" COIL PLUG Genuine "Bakelite" skeleton design, minimum losses. Highest efficiency. Price 10d.



REFLEX MOUNTED COIL a combination of our Coil and plug. Result—a thoroughly scientific and a workmanlike job. Prices 25-30-35 at 2/5 to 1500 at 11/9.



SILENT CONSTANT ROBUST

It is personal experience that counts; special sets and other people's experience are certainly of interest, but your own experience on the set that you have built, are building, or intend building is the one satisfactory test for a wire-wound resistance.

Uniformity in value, silence in operation, mechanical strength and purity of tone. Surely you are the best judge of their characteristics.

The Mullard standard of production allows one result and one only. Complete satisfaction, however severe the test.

Mullard **EVER-REST** Wire Wound Anode Resistance (80,000 and 100,000 ohms) - - - - - 5/-

Complete with Holder 6/6

Other Values to Specification.

Mullard Grid Leaks and Condensers, Type Grid B 0.5 to 5.0 megohms - - - - - 2/6

Type Grid B combined with .0003 mfd. Condenser Type MA - - - - - 5/-

Type MA Condenser .0001 to .0009 mfd. 2/6

Type MB Condenser .001 to .01 mfd. - - - - - 3/-

Leaflet P.W. free on request.



WIRE WOUND ANODE RESISTANCE

The MULLARD WIRELESS SERVICE Co., Ltd.
Mullard House, Denmark St., London, W.C.2.

LONG-DISTANCE RECEPTION.

(Continued from page 358.)

H.F. amplifier will be unstable. If a choke coupling is used the H.F. valve will be quite stable and searching easier, but the amplification obtained not so great as with the tuned anode coupling.

However, the choke coupling lends itself more readily to the design of a simple and stable circuit, one form being shown in Fig. 2. This is quite selective and has given a good overall amplification as low as 100 metres. Possibly it would give good results even lower but it is increasingly difficult to get good amplification as the wave-length is reduced, with any type of H.F. amplifier. At the present time the detector valve circuit, similar to that of Fig. 1, is the only one that can be used successfully on wave-lengths below about 50 metres.

The H.F. Choke.

With the circuit of Fig. 2, when L_1, C_1 is in tune with L_2, C_2 there is a modified reaction effect in the H.F. valve resulting in better amplification and selectivity, C_1 should be connected in parallel with L_1 above, say, 500 metres. An auto-coupled or loose-coupled aerial can be used as in the circuit of Fig. 1. A loose coupling is an advantage on the shorter wave-lengths as it is often difficult to get full reaction effects with a direct-coupled aerial.

The most important point about the circuit is the design of the H.F. coupling choke which must have a large inductance and a small self capacity. A disc former $2\frac{1}{2}$ in. in diameter, having a slot $\frac{1}{8}$ -in. wide and 1 in. deep, wound full of No. 40 enamelled wire, makes an efficient choke for a wave-band of approx. 100 to 3,000 metres. The detector part of the circuit is similar to that of Fig. 1.

MORE ABOUT THE "N" CIRCUIT.

(Continued from page 347.)

High-Tension Battery.

A good type of H.T. battery is strongly recommended.

Low-Tension Battery.

This should have a fairly high capacity for loud-speaker reproduction. *The terminals and contacts should always be kept clean.*

Variable Rheostat.

Any reasonable type of wire wound rheostat should be used. The use of the carbon type should be avoided.

As the regenerative effect can be controlled in practice by the amount of electron emission, for the detection of very weak signals a variable rheostat of small maximum value (say 4 ohms) is advised, any additional resistance required being of the fixed type. Where more than one valve is used, a fixed resistance only need be used for all low-frequency valves of a value depending on the functioning voltage of the valve and the voltage of the low-tension battery.

Layout.

There is nothing unreasonable in the layout of a preferred set. A special layout is recommended as it is simple and does not introduce unnecessary complications.

ORDERS BY POST MUST BE ACCOMPANIED BY SUFFICIENT TO PAY PORTAL CHARGES.

2-VALVE SETS

Sets complete with following accessories:
Long distance 2-valve L.F. and Detector Receiver in handsome polished cabinet. Includes set as shown: 1 power, 1 .06 D.E. valves, tuning coils, H.T. 60-v. L.T., Aerial Equipment, H.T. & L.T. Leads, 2 pairs of 4,000 ohms phones, or LOUD SPEAKER (Marconi Tax Paid) £4:19:6 The Lot. Carr and Pack. 5/-

HEADPHONES, all 4,000 ohms, N. & K. Standard Eastern Phones, Superb Tone, 4,000 ohms. Special Price, 7/11 pair. N. & K. Genuine, new light-weights, 11/6. Extra quality do. 13/6. Dr. Nessler, unapproachable value, adjustable, 12/11. Telefunken, adjustable, genuine (20" model), limited number at 14/11. Brunet, stood the test of years, needs no boosting, 11/9. 12/11. 14/6. 3 models.

BRITISH HEADPHONES: Brown's Featherweight, 20/-; Brown's A Type (Head), 30/-; B.T.E., 20/-; Sterling, 20/-; Western Electric, 20/-. All makes stocked.

THORPE K4 VALVES (5-pin) 9/6. Limited number.

BURNE-JONES (Magnum) Screened Coils, delivered, Baseboard, N. Condensers, 5/-; Twin Sq. La w. Variable, 22/6. "Magnum" West End Depot.

PARTS IN STOCK FOR ALL SUBJECT TO MANUFACTURE'S DELIVERY.

H.T. BATTERIES: Eveready, 66-v., 12/6; 108-v., 21/-; L.T.3 for D.E. Valves, 7/6; Siemens, 60-v., 12/6; Hellesset's, 60-v., 14/6; Various 1.5 D.E. Batteries, 1/6 to 2/6.

EBONITE, "Grade A" cut while you wait, 3/16 at 3d. per sq. inch; 1 in. at 3d.

CHOKES—Cosmos H.F. 6/6; Lissen H.F. or L.F. 10/- each; Success L.F. or H.F. 10/- each; A.J.S., 15/-, with unit 20/-; R.I. Multi Ratio, L.F. 27/6 (Standard Model, 25/-).

BARGAIN DEPT.
Huge quantities of window-sold and goods which have been taken in exchange for sale at ridiculous prices. Bargains not sent by post.

LOW LOSS SQUARE LAW
This variable Condenser is simply marvellous value. It cannot be equalled in price or quality.
.0005 or 4/11
Post 6d. set. .0003 4/11
VERNER 1/- each extra.

WARNING!
SEE K. RAYMOND'S NAME ON PREMISES THIS WILL ASSURE YOU GETTING THE GOODS I ADVERTISE. PLEASE ASK "IS THIS RAYMOND'S?"

RECOGNISED WEST END DISTRIBUTOR
of the manufacturers of Edison, Bell, Jackson's (JB) Polar, Igranic, Peerless, Eureka, Ferranti-Amplion, Magnum, Euradep, Lotus, Dubiller, Marconi, Dorwood, Sterling, Success, B.T.H., St. Michael, Lissen, Utility, R.I., Bowyer-Lowe, Formo, Brunet, Ormond, Newey, P. and M., etc., etc.

CALLERS
EVERYTHING in demand stocked for Wireless
Send for full POST LIST

LISSEN
ALL PARTS STOCKED
West-End Distributor.
Postage extra.

LISSENOLA 13/6
L.F. TRANSFORMER 8/6
35 OHM RESISTAT 2/6
H.F. or L.F. CHOKE 10/-
FIELDLESS COILS 10/-
GRID LEAKS F. 1/-
Do. VARIABLE 2/6

VALVES—Cosmos S.P. 18, Bed or Green, 14/-
New Blue Spot, 14/-
All Mullard, Ediswan, Osram, Marconi, Cossor stocked. Bright, D.E. and Power, 8/6, 14/-, 13/6, 22/6, 24/6, 30/-, £2.
Mullard P.M.4, 18/6. Do P.M.3, 16/6.

See the circuits in recent issues of all Wireless Books.
All specify RAYMOND VARIABLE CONDENSERS

DON'T FORGET TO READ THIS
From E. Barker Esq., Ivy Bridge, Stanley, near Wakefield, Yorks:—
24th September, 1926.
"I would like to congratulate you on your Establishment. I have seen many Northern Wireless Shops, but none such as yours, none with such stock, bargains, or service. I can assure you that all our further orders will go to Raymonds."
(Signed) E. BARKER."

KAYRAY
S.L.F. CONDENSERS
LATEST MODEL NOW READY
With knob and dial.

.0005 or .0003 Alumina Vans 7/11
Sakelite Ends
Please note Test Report F.D. 27/26. "Amateur Wireless."
Brass Vans 9/11
Metal Ends POST 6d. SET.

Wonderful Low-Loss Sakelite Vans. Frequency All Stations Condenser (No. 4), including knob and dial. This Model HAS BRASS Vans and Central ROTOR .0003. 6/11 .0005. 7/11 With VERNER 1/- each. EXTRA. POST 6d. per set.

OUR NOTED 1-VALVE and CRYSTAL SET, in solid polished cabinet, complete with valves, 'phones, H.T. and L.T. Units, Aerial Equipment, Daventry Coil. Extraordinary value. 45/11. Carriage, 2/-.

ASTOUNDING 2 Valve Amplifier in L.F. tube, 25/11. Amplifiers in or COMPLETE handsome with valves, polished box, H.T. and L.T. valve, 18/11. Units, 45/6. Carriage 1/6. Carriage, 7/-.

Ormond Products.
SQUARE LAW LOW-LOSS .0005, 9/6; .0003, 8/6
Values in L.F. tube, 25/11
Friction Geared .0005, 15/-; .0003, 14/6; .00025, 13/6. Straight Line Frequency Friction Geared. .0005, 20/-; .00035, 19/6. S.L.F. .0005, 12/-; .00025, 11/-.

SO. LAW LOW-LOSS DUAL, .0005, for Elstrée Six, 11 each. Ormond Friction Dial, 10/6. Filament Rheostats Dual, 2/6; 6 ohms or 30 ohms, 2/-; Potentiometer, 400 ohms, 2/6. L.F. Shrouded, latest model, 17/6.

IGRANIC TRIPLE-HONEY-COMB INDUCTANCE COILS. 30, 2/9; 40, 2/9; 50, 2/9; 60, 3/-; 75, 3/3; 100, 3/6; 150, 3/9; 200, 4/0; 250, 4/6; 300, 4/9; 400, 5/6; 500, 7/-; 750, 9/6; 1,250, 14/-; 1,500, 16/-.

ALL PARTS STOCKED.

K. RAYMOND

27 & 28a, LISLE ST., LEICESTER SQ., W.C.2

Hours 9.15-7.45 Back of Daly's Theatre.
Sat. 9-8.45 Nearest Tube, Leicester Square.
Sun. 11-1 Phone: Gerard 4637.

THE "SPIDER."

(Continued from page 375.)

and the aerial and earth leads joined to their respective terminals, the receiver can be "lined up." Naturally enough, with a selective, sensitive set like the "Spider" the few adjustments will be critical—or sharp is perhaps a better word. If this were not the case how could one expect to crowd dozens of stations on one dial?

Anyway, the two main controls are the wave-length tuning on the variable condenser and the filament rheostat of the detector valve. The coupling between the reaction coil and the anode coil can nearly always be left at minimum (coils widest apart) until the final polishing up of a station is carried out. Constructors should not be alarmed at a loud howl or two; these are easily subdued and are not indicative of radiation.

"Lining Up" the Variable.

The nearest station should quickly be found, and then the filament rheostat of the H.F. valve can be "set." This will require but very little attention in the future. A touch or two on the detector rheostat and the coupling and the local should be heard at good strength. Finding the best position on the variable dial the screw in the centre ebonite crossbar of the variable should be loosened. The control knob should be tightly held in one hand and the vanes of the back section of the "gang" moved by inserting the "tommy bar" (which is supplied with each Cyldon sold) in one of the holes drilled in the edge of the ebonite disc until loudest signals are obtained.

A light movement independently one way and another of the vanes of the back and front sections will soon determine the correct position. Then the screw can be tightened up again and the set is ready for a distance test. If the set is to give really good DX results it will be as well to re-set the "gang" condenser on some distant and comparatively weak station. The re-setting can be carried out quite well with a carrier. The procedure is to tune the carrier in, bring its strength up by means of filament rheostat adjustment and then set the dial at the silent point that is in the valley, as it were, of the rising note. When on this point, moving the dial in either direction will cause a squeal, rising in pitch. Then the moving vanes of the back section of the condenser should be very, very carefully adjusted together with very fine re-adjustments of the main dial until the two sections are well and truly in line.

Detector Filament Control.

It should be remembered that this adjustment is a keenly critical one. The two sets of vanes should be but a few degrees out of line, if they are more then something must have gone wrong in the matter of coil winding.

The "Spider" will be extremely lively if it is working properly; if it functions like a stolidly conventional three-valver with an ordinary reaction control and won't give much else but very loud local station results, then it is not working properly. The filament control of the detector valve is critical and requires re-adjustment for

(Continued on next page.)

Tungstone ^{Registered Trade Mark} the First Accumulator in the World

to VOLUNTARILY make this Impartial and Independent Test for Battery Users Security now announces the

British Government's Test Actual Amp & Watt Hour

made at the Teddington

NATIONAL PHYSICAL LABORATORY

Tungstone's Patented, Exclusive, Original and Revolutionary Claims for exceptional Capacity, Reliability, Durability, giving Users the longest Working Life of any Accumulator in the World, are by this British Government Independent and Impartial Test

Amplly Substantiated Conclusively Proved beyond Question

Sent post free, Copy of the Original British Government's Test Certificate with "Unique Booklet of the Battery Trade" Inaugurating Revolutionary Methods favourable to Users. For the first time in the World's History of Accumulator Manufacture Tungstone as the result of its Original Design and manufacture on Standardised, Interchangeable and Accessible principles can issue a definite Priced Parts List of all its component parts and Plates for fitting in any Tungstone Battery by unskilled labour. No other Accumulator maker in the World has ever issued a complete Parts List for Battery Owners.

T.A.71

TUNGSTONE ACCUMULATOR CO., LTD., St. Bride's House, Salisbury Square, London, E.C.4

EASY PAYMENTS

Finest 2-valve amplifier set, including loud speaker, 120 H.T. D.E. valves, £7 10s.; or 18/9 down and 11 instalments of 15/-.
CASH BARGAINS.

Good Crystal Sets, 8/3 and 9/3. Amplifiers, 17/6 and 21/-. Phones, Telefunken type, 7/9; Fr. T. Houston, 11/-; U.S. Baldwins, 17/9. Valves, Radio Micro, 5/6; or power, 8/9. Good H.T., 60-v., 5/9; or 4-v. (laboratory test), 3/9 doz. Accumulators, with 12 months' guarantee, 2-v. 40 ignition, 8/3; 4-v. 40, 15/-; 6-v. 60, 29/-. Polished Cabinets, Ebonite, Voltmeters, Condensers, Coil Holders, and everything in Wireless, reliable and cheap. Satisfaction or cash refunded.

MUSIC ROLL EXCHANGE, 29, High Street, Clapham, London, S.W.4.

'PHONE REPAIR SERVICE

Phones rewound and remagnetised, 4/6 per pair. Remagnetised only, 2/-. Loud Speakers and Transformers rewound. Glass Jars for making up wet H.T. units, waxed, 1/3 doz.; plain, 1/-. Post extra. The H.E.P. Co., 1, Cottrill Road, nr. Hackney Downs Station, E.8.

VALVES - BATTERIES

Radio Micro 3-v. '06, each 7/3	Fama 2-v. '06, each 6/3
Radio Micro Power, 3-v. '1, each 10/9	2-v. '2, each 4/-
Fama 4-v. '08, each 5/9	Power 4-v. '2, each 8/6
	60-v. Batteries, guaranteed.
	3-v. tappings, each 7/6

TRADE ENQUIRIES INVITED. WRITE FOR LISTS.
ALL goods sent post free.
BISHOPSGATE ELECTRIC SUPPLY CO., 180, Bishopsgate, London, E.C.2.

LITTLE WIRELESS CACKETS

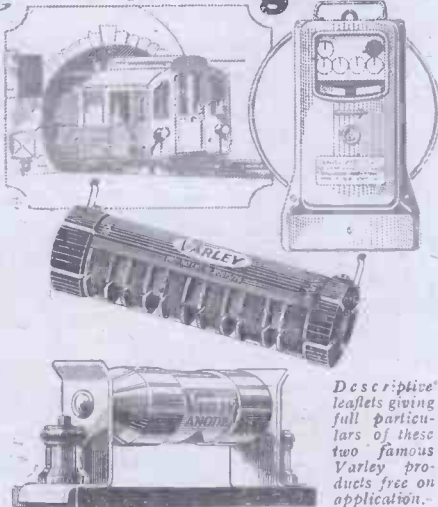


THE VERNI-NOB, 6d. Postage 1ld. each.

MAP Co., 24 Gt. Lister St., Birmingham.

ALL APPLICATIONS FOR ADVERTISING SPACE IN "POPULAR WIRELESS" MUST BE MADE TO THE SOLE ADVERTISING AGENTS JOHN H. LILE, LTD., 4, LUDGATE CIRCUS, LONDON, E.C.4.

Before Broadcasting was thought of



Descriptive leaflets giving full particulars of these two famous Varley products free on application.

The Varley Magnet Company

were specialising in the design and construction of every form of intricate Coil winding. In scores of the biggest electrical undertakings in the country—among them the Electric Railway Systems of Great Britain—the Varley winding has enabled automatic electrical devices of every kind to be brought to their present state of perfection.

With the growth of Broadcasting, the Varley Magnet Company, realising that their long and successful experience in coil winding design and construction gave them advantages possessed by no other firm in the country, produced first the Varley Anode Resistance, and secondly, the Varley Multi-cellular H.F. Choke, both wire-wound on the famous Bi-Duplex system, and both infinitely superior to any similar products on the market to-day.

What has happened in the Electrical world is now taking place in the Radio world proper. Varley components are used by the biggest institutions in the country to ensure that the public shall get the benefit of real purity of tone and constancy of perfect reception.

Such indeed is the remarkable efficiency of these Varley Radio products that they have been chosen for all the "Star" Sets of 1926.



The VARLEY MAGNET CO.

(Proprietors: Oliver Pell Control, Ltd.),

Granville House, Arundel St., London, W.C.2

Telephone: CITY 3393.

THE "SPIDER."

(Continued from previous page.)

every station tuned in. Each filament adjustment is good for only a few degrees on the condenser, and all sorts of curious things may happen if this control is not handled carefully. Admittedly, it takes a little practice before the "Spider" will give its best, but once the knack is acquired its single dial will run through the stations quite rapidly. The procedure is as follows. Following the dial round with delicate adjustments of the filament control of the detector, carrier after carrier will be heard. Taking any one of these it can be resolved in a few seconds by a touch on the reaction coupling and a delicate movement of the rheostat, together with the lightest of readjustments of the condenser control.

Some Final Hints.

There are other valves than the D.E.R. which will give pretty good results in the detector position, but few that will allow carriers to be resolved as quickly. The H.F. valve is as important in its way as the detector, but once one is operating well it requires no attention during tuning.

A faulty L.T. or H.T. battery will cause trouble as with any sensitive receiver, and, by the way, constructors should not forget to adjust this H.T. voltage, although this is by no means a critical task.

The aerial and earth requirements of the "Spider" are perfectly normal and it will operate successfully on any good outdoor or indoor antenna system.

In conclusion, we trust that every constructor who builds a "Spider" will be able to duplicate the results given by the original set. Having made himself thoroughly acquainted with the simple controls there is no reason at all why he should not be able to bring stations in straight on to the loud speaker.

RADIOTORIAL QUESTIONS AND ANSWERS.

(Continued from page 388.)

Have you got any blue print or wiring diagram of this very popular instrument in the "enclosed" or "American" style?

No "P.W." blue prints of "American-type" enclosed sets have been published, but if the dimensions of the case and baseboard are stated, a back of panel diagram can be drawn up specially for you by the Query Department. (Details of this service are given under the heading "Radiotorial.")

Such diagrams are not actually "blue prints," but are done with pen and ink, and even an inexperienced constructor can wire up the back of panel and baseboard from a sketch of this kind.

TESTING H.T. BATTERIES.

P. J. F. (Farnborough, Hants).—What is the best method of testing H.T. batteries?

The following extract (from a handbook issued by Siemens Brothers & Co., Ltd.) deals with the various points that arise in testing:

"Considerable misapprehension appears to exist regarding the correct method of testing an H.T. dry battery. To be of any value such a test should only be made with a high resistance moving coil voltmeter having a resistance of at least 100 ohms per volt scale. The internal resistance of the battery increases with use and age, but its internal resistance is relatively not of much importance in view of the high internal resistance of a thermionic valve—i.e. from about 8,000 to 30,000 ohms.

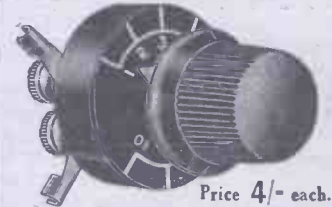
"A battery having a high internal resistance may still be capable of supplying the maximum current required to operate the receiving apparatus, providing its overall voltage is sufficiently high. Even a high.

(Continued on page 394.)

Britain's Best in Radio

LAMPLUGH GRID LEAK

Variable, 5 to 15 MEG.-OHMS. One-hole fixing. An efficient and well-made component, the resistance element is guaranteed constant and is impervious to moisture.



Price 4/- each.

S. A. LAMPLUGH LTD.
King's Road, Tyseley, BIRMINGHAM.

Sole distributors for London and the Southern Counties:—
The Empire Electric Co., 303, Euston Road, London, N.W.

Scottish Depot:—
38, Montrose Street, GLASGOW.

Send for **RADIO** Lists.



This mark is our Guarantee.

Obtainable from all the leading Wireless Dealers.

REPAIRS SETS, PHONES, TRANSFORMERS

Officially Approved by Radio Association.
ALL WORK GUARANTEED LOWEST RATES 24 HOUR SERVICE
Cash on Delivery if Desired.
JOHN W. MILLER, 68, Farringdon St., E.C.4.
Phone: Central 1950

1/19 DON'T PAY MORE

AERMONIC

VALVE HOLDER. ANTI-PHONIC.

The price is only 1/9.
If hard to get, drop us a line.

James Christie & Sons, Ltd.,
246, West Street, Sheffield,
London Agents: A.P. BULGIN & Co.,
10, Cursitor St., London, E.C.4.

2-VALVE AMPLIFIER, 35/-

1-Valve Amplifier, 20/-, as new; Valves, D.E. .06, 7/-; Headphones, 8/6 pair; new 4-Volt Accumulator, 13/-; new 60-Volt H.T., guaranteed, 7/-; 2-Valve All-Station Set, £4. Approval willingly.

Write for free bargain list.

P. Taylor, 57, Studley Rd., Stockwell, London.

Valves Repaired AS GOOD AS NEW!!

HALF PRICE

(Except Weco, S.P.'s, and low capacity types). Minimum D.E. Current 0.15 amps when repaired.

ALL BRIGT & DILL EMITTERS

Listed at less than 10/-.
Minimum charge - - 5/-

VALCO LTD., Dept. P.W., Tabor Grove, Wimbledon, S.W.

TRANSFORMERS REWOUND

Transformers, Phones, Loudspeakers, Rewound and Repaired to Maximum Efficiency. All One Price 4/- each. Don't discard if burnt out. All work guaranteed for 12 months. Write for trade terms.

TRANSFORM CO., 115, LINKS RD., TOOTING LONDON, S.W.17

SAVE YOUR VALVES

PRICE complete 2/-

New Bulbs 6d. each

HUNTS "SAVE IT"

SAFETY FUSE WANDER PLUG COSTS PENCE SAVES POUNDS

A. H. HUNT, LTD., (Dept. 12), Croydon, Surrey

— electric
light in your
home — ?

IF SO WHY NOT
GET YOUR
H.T. SUPPLY
FROM THE MAINS?

You can make sure of a perfect and constant High Tension supply, entirely free from crackling, hum or ripple.

TUDORADIO MAINS UNITS

can be connected to the nearest lamp socket. Current consumption is negligible and expensive and troublesome batteries can be done away with once and for all. There are two types: D.C. for direct current and A.C. for alternating currents. There is no risk to your valves or set with either of them. Ask your dealer for details or apply direct to:



TUDORADIO JUNIOR D.C. MAINS UNIT

Output volts 100
Price **35/-** complete

THE TUDORADIO COMPANY, LIMITED.
Tudor Works, Park Royal,
London, N.W.10.
Telephone: Wembley 41.

USE TUDORADIO MAINS UNITS

SPECIFY
Watmel
PRODUCTS

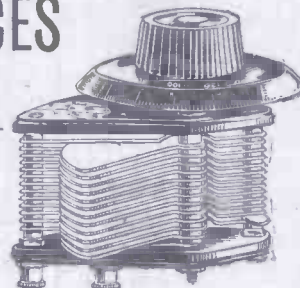
THE WATMEL WIRELESS CO. LTD.
332a, GOSWELL ROAD, LONDON, E.C.1. Telephone: Clerkenwell 7590
Representative for Lancs, Yorks, and Cheshire:
Mr. J. B. LEVEE, 23, Hartley Street, Levenshulme, Manchester.

A LEADING valve manufacturer reports that "exceptionally good loud speaker results" were obtained with the Watmel Auto - Choke. "Speech was clear and sharp and music free from distortion." Get full particulars of Watmel Auto-Choke, Grid Leak, and Combined Fixed Grid Leak and Fixed Condenser from your dealer, or write direct to manufacturers.

REDUCED PRICES FOR 1927.

001	7/-
00075	6/-
0005	5/3
0003	4/3
0002	4/-

Bakelite End Plates. Positive Contact. Carriage Paid if Cash with Order, or C.O.D. 6d. extra. Delv. Ex-Stock.



H. E. ASHDOWN (BIRMINGHAM) LTD.,
PERRY BARR, BIRMINGHAM.

"POPULAR WIRELESS" ADVERTISEMENT RATES

WHOLE PAGE £40:0:0 QUARTER PAGE £10:0:0
HALF PAGE £20:0:0 EIGHTH PAGE £5:0:0

Narrow Column Advts. (3 cols. to page) per inch 30/-
Minimum Space accepted - - - half inch 15/-

SPECIAL POSITIONS BY ARRANGEMENT. **NO SERIES DISCOUNTS.** ALL ADVERTISEMENT COPY SUBJECT TO EDITORIAL APPROVAL

Cover pages close for press 11 days prior to day of issue.
Inside pages close for press 9 days prior to day of issue.

COPY AND BLOCKS MUST BE IN HAND AT LEAST 3 DAYS EARLIER TO ENSURE PROOFS

ALL communications respecting advertising must be made to the

SOLE ADVERTISEMENT AGENTS—

JOHN H. LILE LTD.
4, Ludgate Circus
London, E.C.4.

Phone No.:
CITY 7261

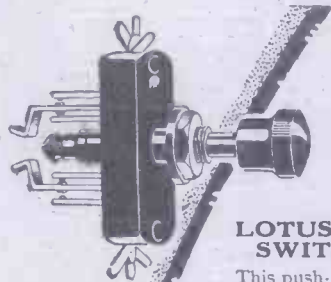
ALL communications respecting advertising must be made to the

SOLE ADVERTISEMENT AGENTS—

JOHN H. LILE LTD.
4, Ludgate Circus
London, E.C.4.

Phone No.:
CITY 7261

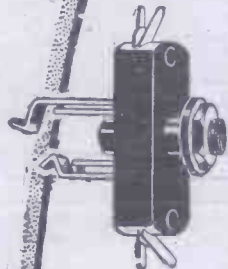
The latest in Jacks & Plugs



LOTUS JACK SWITCHES

This push-pull switch is designed to occupy the minimum space, being only 1 1/4 in. deep. Of the finest Bakelite, it has nickel silver springs and contacts of pure silver. Soldering contacts can be made to suit any wiring.

PRICES:
No. 9, as illustrated .. 4/-
Others from .. 2/9



LOTUS JACK

Designed to take up the least space, the depth of panel being 1 1/4 in. Made from best Bakelite mouldings with nickel silver springs and pure silver contacts. One-hole fixing. Soldering contacts can be brought into any position.

PRICES:
No. 3, as illustrated .. 2/6
Others from 2/- to 3/-

LOTUS JACK PLUGS

Designed for use with Lotus Jacks. Made from best Bakelite mouldings and nickel-plated brass. To fix, the wires are placed in slots and gripped in position by a turn of the screw cams.

PRICE 2/-



LOTUS

JACKS · SWITCHES · PLUGS

Garnett, Whiteley & Co., Ltd.,
LOTUS Works, Broadgreen Road, Liverpool.

RADIOTORIAL QUESTIONS & ANSWERS.

(Continued from page 392.)

grade moving coil voltmeter having a resistance of 100 ohms per volt of scale will take a current of 10 milliamperes at its full scale reading, and it can be assumed, therefore, that if a battery shows a good voltage on such an instrument it will give at least the same voltage when delivering current to the receiving apparatus.

Testing sections of an H.T. battery by means of a flash-light bulb is not recommended. It will certainly indicate the ability or otherwise of a battery to light such a lamp, but is an extremely unreliable method of determining whether the battery is still capable of being used for H.T. purposes. The usual flash-light bulb takes a current of from 200 to 300 milliamperes, and although a battery which has seen considerable service may not be able to give this discharge, it may still be perfectly capable of supplying the very much smaller current required for H.T. purposes.

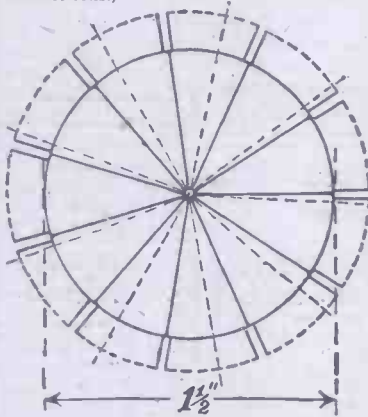
Incidentally, the practice of connecting a wire across an apparently "dead" section is usually a certain method of damaging the entire battery and is strongly deprecated.

For the Constructor

NO. 4—TEMPLATE FOR SPIDER-WEB COILS.

Spider-web coil formers having a centre diameter of 1 1/2 inches can be made from this sketch.

The heavy lines show how eleven segments should be marked out, and how the slots are cut down towards the centre. The dotted lines show the arrangement for nine slots. (Note:—The angles are the same for Basket coils.)



Failure on Long Waves.

K. W. (Hull).—I have constructed the 1-valve set, entitled "A Detector Valve Set with Reaction," as depicted in "P.W." Blue Print No. 1. I am satisfied with the results to the utmost, and have been able to "log" the following stations:—

British: Hull (local, very loud), Newcastle, Manchester, Aberdeen, Cardiff, Bournemouth and Leeds (all at good earphone strength). Foreign: Brussels, Prague, Toulouse, Breslau, Frankfort, Leipzig, and Münster (all at good strength).

There is only one fault, and that is, I am unable to get Daventry or any of the "high" stations, although I have the coils that were recommended. Can you please tell me how to obtain these?

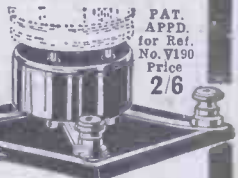
Probably there is a fault in one or both of your larger coils, and we should carefully examine the connections of these; also test for contact inside the coils, and between the different plugs and sockets.

Another possible cause of failure is the use of a coil for the long waves that is wound in a direction different from the lower wave-length coils. In this case you would not be getting reaction effects, which would account for the insensitiveness; but the likeliest cause of the trouble is a break in one of the circuits when the long-wave coils are in use.

TRIUMPH

CUSHION ANTI-MICROPHONIC VALVE-HOLDER TEST

this new holder alongside any other and you will agree with experts in pronouncing it best!



PAT. APPD. for Ref. No. V190 Price 2/6

NO METAL SPRINGS, VIBRATIONS QUICKLY DAMPED

Ask your Dealer for free list of TRIUMPH GUARANTEED COMPONENTS AND SETS, or send P.C. mentioning "Popular Wireless" to: A. H. CLACKSON LTD., WHITE HART WORKS, LONDON, N. 22

Private Greeting Cards. Largest manufacturers want Agents. Free Sample Book. Delightful novelties in Velvet with real Glass Eyes. Celluloid Calendars for Pocket or Handbag. Bicycles, Newspapers, Greeting Cards for all tastes. Highest Commission and Prizes for all. Write: ALL-BRITISH CHRISTMAS CARD CO., Dept. 382, Blackburn.



MEANS DOUBLE POWER

For use in both H.T. and ordinary circuits. B.E., D.E., and O.S.

Send card for Radio press reports and booklet. This valve can be used in any set without alteration and will give 50% to 150% increase in power.

ANELOY PRODUCTS, Fton Works, East Dulwich, London, S.E. 22. GALLERS: 36a, Forest Hill Road, East Dulwich.

WIRELESS.—Capable, trustworthy men with spare time who wish to substantially increase income required where we are not fully represented. Applicants must have practical knowledge of installation of Set and Aerial, be a householder or live with parents, and be able to give references; state age and experience. Address: Dept. 32, General Radio Company, Limited, Radio House, Regent Street, London, W. 1.

HEADPHONES REPAIRED

Re-wound & re-magnetised 5/- per pair. Loud Speakers repaired 5/-. Transformers re-wound 5/- each. All work guaranteed and tested before delivery. Write for Trade Prices. Phone Clerks. 1795. MASON & CO., 44, East Road, City Road, N. 1.

PHONES

We still have a number of good wireless Headphones for disposal at the very low price of (Post free) 3/9

These are in every way suitable for broadcast reception, and were, in fact, manufactured by a leading British maker for this purpose.

Also a few 7 ft. cords at 1/2, from C. L. WILDE, Willesborough, Ashford, Kent.

SPLENDID VALUE Bargain Clearance


of famous A.F. Marconi R.B. 10 Crystal Detector and 1-valve L.F. Amplifier Receivers with two new Osram Valves.

Straight from the factory of leading wireless makers. Closed cabinet contains Engraved Panel, nickel fittings, 2 Spade Variable Verniers, T.C.C. and M.S.I. Fixed Condenser, 2 H.F. Chokes, Detector Valve-holder, Terminal Plug Sockets, Long and Short Wave Switch, Wiring Diagram, etc. All new and nearly completely wired. New valve fitted and one spare.

Great Bargain, 12/6. Post, 1/3

Guaranteed exactly as above. Valves alone worth the money.

ELECTRADIX RADIOS
218, Upper Thames St., London, E.C. 4



MÉTAL RADIO VALVES

Why pay more for valves when you can obtain "Métal" Radio Valves at the prices quoted. It isn't as if higher priced valves are better than "Métal." They are not, for with "Métal" Valves—one of the oldest makes—you can get results unobtainable with most valves. That is why they are used by the French Government and in countless Continental and U.S.A. sets.

Type.	Fil. Vols.	Amps.	Price.
C.L.62	2	0'06	10/6
C.L.202	2	0'2	8/-
6/100	4	0'06	9/6
Power.			
C.L.502	2	0'5	12/-
C.L.104	4	0'10	15/-

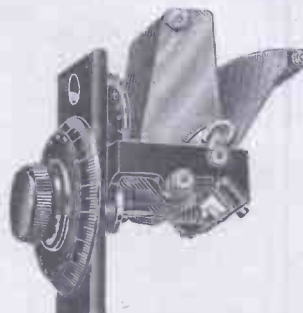
Your dealer stocks them. Write for list showing all types

Sole Distributors:
JOHN RAE, LTD., 60, BLACKFRIARS RD., LONDON, S.E.1

This New Bretwood Component

(STRAIGHT LINE FREQUENCY CONDENSER)

has ALL the essentials of a REAL Low Loss, Slow Motion, Straight Line Frequency Condenser.



LOW LOSS. Losses minimized, the supports being two only and with very small area surface.

STRAIGHT LINE FREQUENCY. Fixed and moving plates specially designed to give this.

VERNIER. Noiseless adjustment with a reduction of 40 to 1. Dial giving 360 degrees registering in all 3,600 degrees.

CONSTANT. Constancy is obtained by rigid construction. All wear is automatically taken up through conical and ball thrust bearings.

HAND and Body Capacities. These are completely eliminated by insulation and the special setting of vanes.

CALIBRATION of Vernier. Calibration over the whole vernier is given by the automatic indicator of numbers and degrees.

High Class Workmanship and Finish. All parts guaranteed dead true to within one-thousandth of an inch.

Easy to Mount and Connect.

Price 17/6 **GRID LEAK de LUXE**

The Syphon Container now embodied in our new de Luxe Model Grid Leak is a vast improvement which makes the readings on a par with a straight line frequency condenser.

It guarantees constant supply and even distribution of the resistance element.

Accurate readings from 50,000 ohms to 10 megohms.

Grid Leak de Luxe	PRICE 3/6
Grid Leak with Condenser	" 4/8
Anode Resistance	" 3/6

*British Throughout and carry the "Bretwood Guarantee."
Obtainable from most Dealers or from Sole Manufacturers.*

BRETWOOD LTD., 14, London Mews, Maple St., London, W.1

Parrs Ad.

"EKCO" H.T. UNITS

SCRAP DRY BATTERIES!



by obtaining H.T. current from electric supply mains (D.C. and A.C.) by just attaching adaptor to electric light lampholder.

SAFE! SILENT! SOUND!

Illustrated Catalogue **FREE!** Trade Inquiries Invited.

Model	Voltage Tappings	D.C. Price	A.C.
1A	One	£2 2 6	—
2A	Two	£2 15 0	£6 10 0
3	Three	£3 7 6	£7 5 0
V2A	1 Variable, 1 Fixed	£4 5 0	£7 15 0
V3	2 Variable, 1 Fixed	£5 10 0	£9 0 0
V3A	3 Variable	£6 2 6	—
3A	Special "Marconi Straight 8" Model	£6 6 0	£9 10 0

E. K. COLE,

(Dept. A),
513, LONDON ROAD,
WESTCLIFF-ON-SEA.

The BECOL FORMER

Ask your Dealer for the 'BECOL' LOW-LOSS FORMER—the Former of the Future.

Specially designed for low loss. Has large air space between wings. Easy windings. British made from the famous "BECOL" genuine ebonite. Size 3" diameter to outside of wings. Prices: 6" lengths 3/- (postage 6d.), 4" lengths 2/- (postage 6d.), 3" lengths 1/6 (postage 6d.).



THE BRITISH EBONITE CO., Ltd., Hanwell, London, W.7.

SAXON GUIDE TO WIRELESS

This book enables any beginner to construct Wireless Sets which are unequalled in price, quality or efficiency, and the cost is only one-fourth the price charged for a ready-made instrument not half so good. The exact cost of each set is clearly stated.

FULL INSTRUCTIONS WITH CLEAR WIRING DIAGRAMS

are given for making Super Efficient Crystal Sets, Dual Amplification Receivers, Single Valve Sets, One and Two Valve Amplifiers; Two, Three and Four-Valve Tuned Anode All-Wave Receivers, and the Very Latest Type of Five-Valve Resistance Capacity Receiver.

NO SOLDERING. NO SPECIAL TOOLS. NO KNOWLEDGE REQUIRED.

The chapter on testing wireless components is alone worth the price charged. **178 PAGES.** **PRICE 1/3 POST FREE**

SPECIAL OFFER.

This book will be sent on approval on receipt of your promise to return same post paid or to remit 1/3 within seven days.

SAXON RADIO CO. (Dept. 14), Henry St. Works, BLACKPOOL

The Highest Magazine Value in the World!

The PREMIER MAGAZINE
The ALL-STORY MAGAZINE
The RED MAGAZINE
The MERRY MAG.
The VIOLET MAGAZINE

ONLY 6d. EACH.

Ask for them at your Newsagent or Bookstall.

TANGENT
H.T. BATTERY ELIMINATOR

**ELIMINATE RADIO H.T. BATTERIES!
USE THE A.C. MAINS**



Absolutely silent in operation. Ample anode voltage and current. All component parts can be supplied separately if desired. The output is ample for even a large receiving set—20 milliamps with a variable detector voltage and amplifier voltage of 160.

Price, complete in metal case with connecting plug:

£7 : 15 : 0

ASK FOR LEAFLET 123A.

London:
25 Victoria
St., S.W.1.



Newcastle-on-Tyne:
TANGENT
House,
Blackett St.

GENT & CO., LTD., Faraday Works, LEICESTER.

CLASS A

"Amateurs' Radio" Competition,
"POPULAR WIRELESS,"
7/9, Pilgrim Street,
Ludgate Hill,
London, E.C.4.
(Comp.)

CLASS B

"Amateurs' Radio" Competition,
"POPULAR WIRELESS,"
7/9, Pilgrim Street,
Ludgate Hill,
London, E.C.4.
(Comp.)

CLASS C

"Amateurs' Radio" Competition,
"POPULAR WIRELESS,"
7/9, Pilgrim Street,
Ludgate Hill,
London, E.C.4.
(Comp.)

CLASS D

"Amateurs' Radio" Competition,
"POPULAR WIRELESS,"
7/9, Pilgrim Street,
Ludgate Hill,
London, E.C.4.
(Comp.)

CLASS E

"Amateurs' Radio" Competition,
"POPULAR WIRELESS,"
7/9, Pilgrim Street,
Ludgate Hill,
London, E.C.4.
(Comp.)

Cut out these labels and attach them to the apparatus you send in for the "P.W." Constructors Competition, according to the class you enter.

TRUMP ELECTRIC
Soldering Iron

BRITISH MADE.

ITS NEATNESS GETS IT ANYWHERE.



Fitted 2 yds. flex and lamp adapter **22/6**
Bit projects 3". Diam. only 1". Loading 240 watts

UNIQUE FEATURES:—(1) Barrel gets red hot. Result, very lively bit. (2) Element is porcelain insulated. Result, reliability. Easily replaceable cartridge.

ARDEA VULCANIZER SYNDICATE LTD.,
316, King Street, Hammersmith, W.6.

H.T. ACCUMULATORS

60 volts—Price 32/6

DO YOU REALISE

(that light weight and low cost may be linked up to high efficiency? The inexpensive 60-volt 5-amp. hour ELITE High Tension Accumulator, which actually costs under a 1d. to recharge, will do all that the more expensive types will do and are never done. Therefore, look before you leap at our Descriptive Folders, which will be forwarded per return on application.



Type .02 Semi-Oil Submerged.
60 volts, complete as illustrated, 32/6. or 5/- per 10-volt Unit.

Obtainable only from—
ACCUMULATORS ELITE, 32, King Cross Street, H.M.Fax.
Tele.: 1304. Trade Supplied. Telegrams: Elite, H.M.Fax.
London Distributor: Cecil Pohlman, 77, Great Portland Street, London, W.1.

Want a better Set?

YOU can have one and listen while you pay! We supply any Radio press set on a system of easy payments. Our technical advice is yours for the asking. Send for Catalogue "P" to:

New Times SALES CO., 77, CITY ROAD, E.C.1

A HOME FOR YOUR WIRELESS SET

OUR STANDARD CABINETS

are **DUSTPROOF** and house the whole apparatus, leaving no parts to be interfered with. All you do is **UNLOCK & TUNE IN.** Made on mass production lines, hence the low price. Provision is made to take panels from 10 x 7 up to 30 x 18 in.



Carriage paid and packed free England and Wales. Thousand supplied with full satisfaction.

From £4 15 0
Write to-day for descriptive pamphlet and suggestions for adapting your receiver or panel in our Standard Cabinets. Immediate Delivery.

MAKERIMPORT Co. Dept. 5, Melville Chambers 60a, Lord St., LIVERPOOL.

REPAIRS

By specialists skilled in every form of accurate and intricate coil winding.

Headphones, Loud Speakers & Transformers rewound, remagnetised and reconditioned **EQUAL TO NEW.**

Owing to the rapid growth of business in our REPAIRS Department, we regret that we find it temporarily impossible to maintain our 24-hours' service. Pending extension and re-organisation, a delay of a few days may be unavoidable.

VARLEY Magnet Co.
Repairs Dept.,
Woolwich,
S.E.18



Proprietors:
Oliver Pell
Control Ltd.

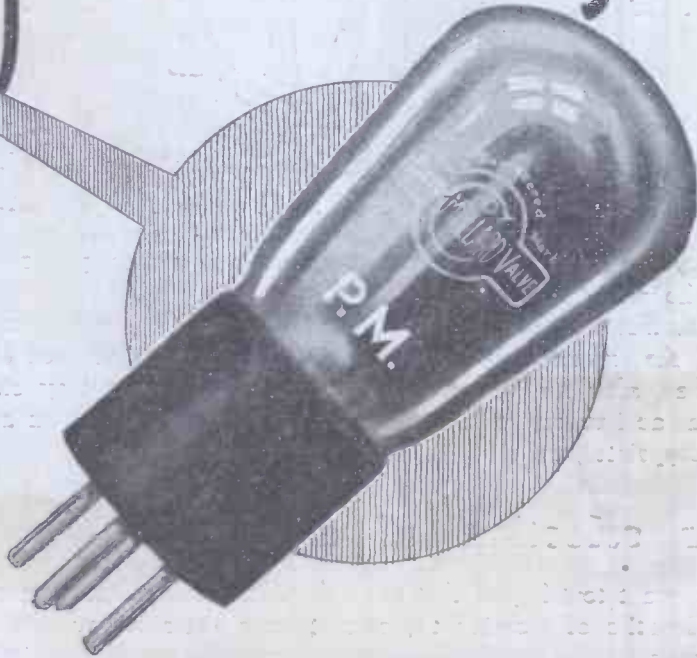
Study these figures



The higher the filament figure of merit the more you get for your money. Note the high values (between 45 and 74) given by the wonderful Mullard P.M. Filament in the Mullard P.M. Series of Valves.

Even the best ordinary dull filaments have a figure of merit from 14 up to 45 that barely approaches the minimum figure of the P.M. Series.

The extravagant and low figures between 2 and 5 of bright filaments are strikingly obvious.



The filament figure of merit

is an accurate indication of what any filament gives in exchange for the correct applied input.

A comparison of figures of merit taken from a wide range of filaments shows the marked superiority of Mullard design. A study of the accompanying scale will indicate the vastly increased "output for input" possessed by Mullard P.M. Valves. This is due without question to the excellence of the Mullard P.M. Filament. Its generous emission of up to 5½ times that of an ordinary filament with its low current consumption of only one tenth ampere give it a remarkable performance of high efficiency.

To feel the rich reserve of power that is placed behind your rheostats when you fit Mullard P.M. Valves and to know that your accumulator charges can last up to 7 times as long as before is a pleasure and certainty for satisfaction that every radio amateur should lose no time in securing. Thousands have proved for themselves the manifold advantages of these valves with the wonderful Mullard P.M. Filament.

Make your radio a real success this season with Mullard P.M. Valves.

OBTAINABLE FROM ALL RADIO DEALERS

Mullard

THE MASTER VALVE

For 4-volt accumulator
or 3 dry cells
THE P.M. 3 (General Purpose) 0.1 amp. 14/-
THE P.M. 4 (Power) 0.1 amp. 18/6

For 6-volt accumulator
or 4 dry cells
THE P.M. 5 (General Purpose) 0.1 amp. 18/6
THE P.M. 6 (Power) 0.1 amp. 18/6

For 2-volt accumulator
THE P.M. 1 H.F. 0.1 amp. 14/-
THE P.M. 1 L.F. 0.1 amp. 14/-
THE P.M. 2 (Power) 0.15 amp. 18/6

These prices do not apply in Irish Free State.

British Made
in a
British Factory

MULTI RATIO

There must be a reason

why many amateur constructors do not secure perfect results from their radio receivers from the very start. Thousands have been disappointed with their first reception and have questioned the efficiency of modern broadcasting till the expense they have been put to demands renewed efforts on their part when, after further loss of time, money and temper, they stumble upon rather than achieve, something resembling perfect reception. You may be one who is disappointed, and since you have reasons of your own

for your selection of a circuit

we want to tell you that until the Multi-Ratio Transformer was available, the difficulties of securing the correct transformer for every circuit was one that even set manufacturers had to face through exhaustive experiments and expense.

You will realise that perfection in the individual parts of a circuit tends to give perfection in the final result, but your choice of components

and your choice of valves

play a tremendous part in securing the perfect functioning in the final stage. The wide range of valves and components on the market is beyond the comprehension of the man in the street. You cannot afford to purchase better reception by the process of elimination.

So be right first time!

Choose transformers that can collaborate with any valve in any circuit. With the R.I. Multi-Ratio Transformer the first cost is the last and only cost because there are 7 ratios and 4 values of impedance to secure correct operation and perfect radio reception.

Ask for the R.I. Multi - Ratio Transformer

NOW 25/-

Advt. R.I. Ltd., 12, Hyde St., New Oxford St., London, W.C.1.