

No. 27. FREE ADVICE FOR THE BEGINNER (SEE PAGE 1).

# POPULAR WIRELESS

3d

Weekly

No. 27, Vol. 2.  
Dec 2, 1922.



**A RADIO TEA.**

SPECIAL FEATURE IN THIS ISSUE:

## THE ORIGIN OF THE FLEMING VALVE

By Dr. J. A. Fleming, F.R.S.

THE FASCINATING STORY OF THE INVENTION OF THE THERMIONIC VALVE, SPECIALLY WRITTEN FOR "POPULAR WIRELESS" BY THE GREAT INVENTOR.



# HULLO!!! C.Q. WILL DAY CALLING

TO ANNOUNCE SOME RARE BARGAINS.

- BEST FRENCH HEAD PHONES  
4,000 ohms .. 22/6 per pair
- BEST FRENCH HEAD PHONES,  
8,000 ohms .. 27/6 per pair
- SPLENDID QUALITY BRITISH  
HEAD PHONES, 4,000 ohms .. 26/- per pair
- Single Head Phones, with Cord, 150  
ohms .. 6/- each
- 100 feet Stranded Copper Aerial Wire .. 2/6
- Trench Buzzer Sets, complete with  
Single Head Phone .. 10/6
- Best Quality Filament Resistances .. 2/9 each, Postage 3d.
- Switch Arms with Laminated Blades .. 1/- each, Postage 3d.
- 3-Way Coil Stand for Panel Mounting .. 15/- each, Postage 6d.
- Best Ebonite Knobs with Brass Nut  
inserted 2 B.A. .. 5d. each, Postage extra
- Insulated Sleeving, all colours .. 5d. yard, Postage extra
- Brass Terminals with Nut and Washer .. 1/- doz., Postage 3d. doz
- Complete Set of Parts, including two Ebonite Plates, 4" x 4"  
for making Best Quality Variable Condensers, .001, 9/- set ;  
.005, 7/- set ; .0003, 5/- set. Set of Vernier Condenser Parts  
without Ebonite, 1/9.

These are only a few of our bargains. Do not fail to send for our Price List giving the lowest prices for the best quality goods. Postage on all goods extra.

We always Stock the Famous **HERTZITE CRYSTAL** at 2/6 each, or mounted in Brass Cup 2/10, postage 3d. extra.

## WILL DAY, LTD.,

19, Lisle St., Leicester Sq., London, W.C.2.

Phone : Regent 4577. Telegrams : Titles, Westrand, London



## Listen in with the Fellows

Handphone which has been specially designed for ladies. It has no head band to catch or tear the hair. Beautifully finished, very comfortable to use and wound to 4,000 ohms, 15/- each.

Postage, 1/-.

He will use Fellows *Headphones* with two earpieces in light die cast non-ringing metal and wound to 4,000 ohms. 21/- per pair.

Postage 1/-.

*All Fellows radio instruments are British Made throughout and guaranteed.*

### FELLOWS MAGNETO Co., Ltd.

LONDON, N.W. 10.

Telephone : WILLESDEN 1560-1. Telegrams : "QUIXMAG," PHONE, LONDON

*For they are jolly  
good Fellows*

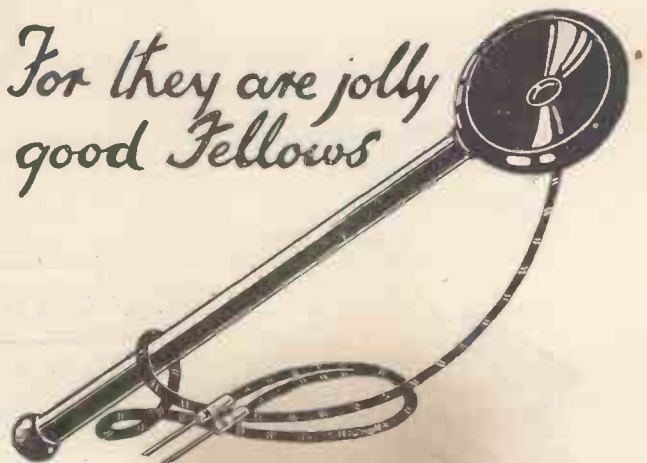

32/- per pair  
4,000 ohms)  
All resistances  
in stock.

## CQ Std bi for ERICSSON PHONES

WHEN you instal your wireless set—crystal or valve—you'll get maximum results if you fit ERICSSON PHONES—clarity, sensitivity, strength of signals and absence of "click." Specially suited to telephony. ERICSSON PHONES embody the accumulated experience of telephone manufacture for a generation.

Easy to the head, light and comfortable. The magnets never lose their strength and "shorts" are non-existent.

Write for Particulars

The BRITISH L.M. ERICSSON MANUFACTURING Co., Ltd.

Head Office :  
67/73, International Buildings,  
Kingsway, W.C.



# Ericsson Telephones

**NEXT WEEK.**

**ANOTHER VALVE ARTICLE.**

By

**JOHN SCOTT-TAGGART, F.Inst.P.**

The Chief Technical Adviser to **POPULAR WIRELESS.**

# Popular Wireless

TOPICAL NEWS AND NOTES.

**NEXT WEEK.**

**SUCCESS WITH DRY CELLS.**

**A CHAT ABOUT CRYSTAL DETECTORS.**

**COUPLED TUNERS.**

**TREE AERIALS.**

**HINTS TO AMATEURS**  
And other excellent articles.

**For the Beginner.**

**T**HE Editor asks me to point out to readers of **POPULAR WIRELESS WEEKLY** that if they have any friends who are anxious to take up Radio as a hobby now that Broadcasting has begun, the Questions and Answers Department have made special arrangements to reply to all "beginner's" queries very fully, and to offer all possible help to those who wish to instal a set.

So if you know of any one who is anxious to know "what to do and how to do it," tell him to write in to **POPULAR WIRELESS WEEKLY**. His questions will be answered both carefully and sympathetically. We all have to make a start at one time or another.



Mr. F. Hicks Arnold and his experimental portable set.

**The Beginner's Supplement.**

**S**PECIALY prepared for the new amateur, the **Beginner's Supplement** will start in **POPULAR WIRELESS WEEKLY** very shortly. Naturally, the Editor wants as many people to know about it as possible, hence these preliminary announcements.

**Authors and Radio.**

**A**T the Authors' Club, recently, "Wireless Research" was the subject of discussion. Mr. C. J. Cutcliffe Hyne presided. Owing to indisposition Senatore Marconi was prevented from being present and giving an address. His place was taken by Captain M. H. P. Riall-Sankey. A listening-in apparatus was installed at the instance of Senatore Marconi.

Captain Riall-Sankey said that there was very little to tell in regard to new discoveries in wireless. What was happening was that experiments were constantly proceeding, and there were developments that would go on until free and easy communication between this country and the most distant parts of the Empire would be a matter of daily use.

**FL and Armistice Day.**

**F**OR the first time there was an Armistice Day wireless service. It was sent out from the Eiffel Tower, Paris, at nine o'clock. The programme was: Chopin's Funeral March, the "Last Post" on a bugle, a minute's silence, the Reveille, followed by the "Marseillaise."

**The Latest Story.**

**I**F you are a wireless enthusiast you will have heard this anecdote. It is the latest radiophone story and formed part of the miscellaneous programme broadcasted from Birmingham's first station the other night.

It is quite a simple one and concerns the young son of a wireless amateur who was called upon to say grace. This is what he said: "Hallo, hallo, good Lord, stand by and listen-in for thanks for what we are about to receive."

**Duke of York and "Wired Wireless."**

**T**HE Marine and Small Craft Exhibition and Congress, held at the Agricultural Hall, was formally opened by the Duke of York, in what he described as a somewhat unusual way. He employed the method of speech transmission known as "wired wireless," in conjunction with the new loud-speaking invention embodied in the "Public Address System."

Speaking in ordinary conversational tones into a transmitter at Buckingham Palace, the Duke's voice was carried to the wireless stand directed by Autoveyors, Limited. Thence it was retransmitted by wire to the special loud speaker erected by this firm near the roof, through which it was heard distinctly in every part of the vast hall.

**Radio in Brazil.**

**T**HE President of Brazil has signed a decree sanctioning the installation and use by the Agencia Americana of high-power wireless stations and the establishment of a wireless telephone service on Brazilian territory.

**Well Under Way.**

**I** THINK the most hypercritical will agree that 2 L O's provisional broadcasting is all that can be desired. First-class items and first-class transmission is essential to the success of "wireless for the masses," and Marconi House has set the ball rolling in the right direction. Mr. Burrows, who is the master of ceremonies; has been gifted with a "radio voice," and is provided with an excellent microphone. The result is that all the "-achs," "-steins" and "-ofskis" of the items are understandable. Truly a remarkable achievement. I wonder what lead that is that keeps breaking? 2 L O should use armoured cable!

**That "Three Minutes."**

**W**E still have our grumblers, although they are decreasing in number. I have heard quite a few commenting disagreeably on the "2 L O closing down for three minutes," which occurs at ten-minute intervals. I point out to them that apart from the fact that it is "Government regulations," it is rather necessary that the "stage manager" should have a moment or two to smooth out his arrangements. Theatres and music-halls have their "curtains," don't they? Anyway, I am told it is good for the accumulators of a receiving set—frequent rests—so don't forget to take advantage of the "three-minute silences."



The "leading-in" tubes at the Radio Station at Hong Kong.



NOTES AND NEWS.

(Continued from previous page.)

Dance and Social.

ON Friday evening, November 24th, a dance and concert was given by the Mullard Radio Valve Company to the staff and employees of their works at Hammersmith and Balham. A most enjoyable evening was spent, among those present being the directors and their friends.

A concert was arranged and carried out entirely by members of the firm, and the evening terminated with a very enjoyable dance, to which friends of the employees were invited.

Dr. Fleming.

THE Council of the Institution of Electrical Engineers of London have elected Dr. J. A. Fleming, F.R.S., an honorary member of the Institution.

At the introductory meeting of the Royal Society of Arts of London on November 8th, a silver medal was presented to Dr. Fleming by Lord Askwith in recognition of the Trueman Wood Lecture he gave before the Society on November 23rd, 1921, "On the Coming of Age of Long Distance Wireless Telegraphy and Some of its Scientific Problems."

Radio Association Meeting.

A SPECIAL meeting for the trade was held by the Radio Association at the Hotel Cecil on November 10th. Some two hundred manufacturers and traders were present.

Professor A. M. Low was in the chair. The result of the meeting was that the trade section of the Radio Association and the trade section of the Wireless Manufacturers' and Traders' Association amalgamated. A trade section committee of fifteen was formed, and it is hoped that the committee will show some interesting results very shortly.

Frayed Tempers.

THE meeting was marked by some excitement, and frayed tempers were much in evidence. Thanks to the chairman, however, those present with the aforementioned frayed tempers were kept reasonably well behaved, though to my mind it seemed that the manufacturers and traders present were rather bewildered at the acid retorts of the various speakers.

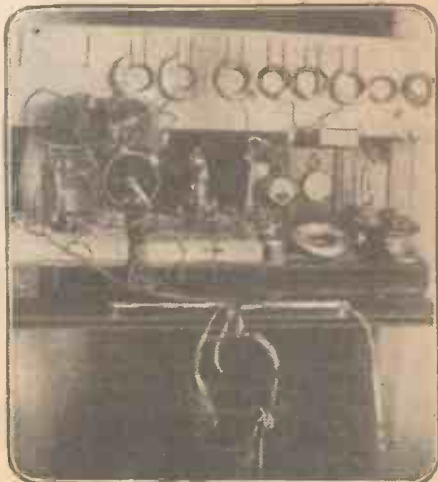

Mr. Cecil Winstoner's set, 11, The Ridgway, Wimbledon.

Transatlantic Tests.

DESCRIBING the Transatlantic wireless tests made by six members of the Manchester Wireless Society recently, Mr. Y. W. P. Evans, secretary of the society, told a "Daily Mail" reporter that this was the first attempt by amateurs in this country to communicate with American amateurs by wireless.

The attempt was made from the society's station at Baguley, Cheshire. The following message was sent to two amateur wireless stations in America, one kilowatt of power being used:

"Here test message from Manchester Wireless Society to American amateurs. Please cable results."

The message was sent at 1 a.m. Sunday and repeated each hour until 6 p.m. No replies were received.

The members heard, however, as many as 23 other American amateur stations communicating among themselves, one of them in California. This station used only 500 watts, and its distance from Manchester is estimated at about 6,000 miles. In the opinion of Mr. Evans this creates a record.

L.C.C. and Radio.

MEMBERS of the London County Council had a pleasant interlude in their duties recently in the form of a wireless demonstration, which took place in the large committee-room at the new County Hall. The Council was in session



Mr. E. Bathurst's set, 94, Oakfield Road, West Croydon.

when the wireless recital began, but member came in to listen as opportunity offered.

The transmission was from the London Broadcasting Station, and took the form mainly of vocal and instrumental music. The demonstration was given under the auspices of the L.C.C. Radio Society, and was eminently satisfactory.

Another Radio Ball.

THE organisers of the Three Arts Club costume ball to be held on December 7th propose to set up a broadcasting apparatus in the ballroom so that the new dance tunes to be played will be broadcast all over the country.

ARIEL.



# Broadcasting Programmes

What you can hear every evening of the week on your set.

**TELEPHONY AND MUSIC TRANSMISSIONS.**

Station.	Call sign.	Wave-length in metres.	Remarks.
Croydon	GED	900	Throughout day to aeroplanes.
Marconi House, London, Broadcasting Station	2LO	360	Every evening, 6 p.m., 8 to 9 p.m., 9.30 to 10 p.m. Continuous service to be given shortly.
Writtle, Essex	2M1	400	Tuesdays, 8 p.m. (Concert.)
Paris	FL	2,600	7.20 a.m., 11.15 a.m., 5.10 p.m. Also occasional telephony at 10.10 a.m. and 9.20 p.m.
Königswusterhausen	LP	2,800	Between 6 and 7 a.m., between 11 and 12.30, and between 4 and 5.30 p.m.
The Hague	PCGG	1,085	Sundays, 3 to 5 p.m. (Concert.)
Haren	OPVH	900	Practically every 20 minutes past each hour from 11.20 to 4.20, giving messages to aeroplanes on the Brussels - Paris, Brussels - London, and Brussels-Amsterdam lines.
Radio-Electrique, Paris	—	1,565	Concerts at 8.45 p.m.
Brussels Meteorological Institute	OPO	1,500	Slow C.W. and Morse. Easy reading for amateurs.
Messrs. Burnham* (Blackheath)	2FQ	440	About 9 o'clock in the evening.
Newcastle*	5BA	440	Between 6 and 7.30 p.m.
Manchester Broadcasting Station	2ZY	385	Every evening.
Birmingham (Witton) Broadcasting Station	2WP	425	Every evening.

NOTE.—The Bar Lightship, Liverpool, sends telephony at 7 a.m., 9 a.m., 11 a.m., 12 noon, 1 p.m., and every two hours until 9 p.m. Calls "Dock Office." Liverpool answers "Bar Ship."

In addition to the regular transmissions carried on between the British amateur stations, much telephonic conversation may be heard from St. Inglevert (A M), Le Bourget (Z M), and Brussels (B A V). These stations are quite powerful, but they call for a little extra care in tuning. Wave-length, 900 metres.

All times given are G.M.T.  
An asterisk denotes transmissions made purely for experimental purposes.



# THE ORIGIN OF THE FLEMING VALVE.

NOTE.—Dr. J. A. Fleming is one of the most brilliant scientists of our age, and his researches have conferred a boon on the whole world. As Senatore Marconi said in November, 1921, before the Royal Society of Arts, London: "Not only is wireless telegraphy indebted to Dr. Fleming for his numerous and valuable contributions on the theoretical side of the subject, but personally I wish to put on record once more Dr. Fleming's most valuable co-operation in the early design of long-distance transmission plants at Poldhu and other stations. And with regard to the practical side of radio-telegraphy in general, much gratitude is due to Dr. Fleming for his invention of the FLEMING THERMIONIC VALVE, WHICH IS PERHAPS ONE OF THE MOST IMPORTANT CONTRIBUTIONS TO THE PRACTICE OF LONG-DISTANCE COMMUNICATION." We are privileged to publish Dr. Fleming's own account of the origin of the valve which has worked such wonders in wireless telegraphy and made broadcasting possible.—THE EDITOR.

By DR. J. A. FLEMING, F.R.S.

AN aeroplane is speeding along at a hundred miles an hour, two miles up in the sky above the English Channel. A slender wire trails out behind the machine. From time to time the pilot glances at the compass on the instrument board.

Suddenly a voice speaks to him; the voice of a man sitting many miles away in his office in the city of London, a voice that, fast as the aeroplane has been travelling, has flown on invisible wings and overtaken it in an instant.

The pilot listens, turns a switch, and answers. He is detached from earth, hurtling through space, but it is as though he were standing in that city office talking to his director.

This is one of the miracles of to-day brought to pass by a lamp. Another aeroplane speeds like a blind thing in a fog. The pilot can see nothing. He is quite lost, everything is blotted out, yet he has no fear. A tiny lamp has the aeroplane on an invisible leash, and leads it safely to the aerodrome.

The story of how I came to invent the Fleming thermionic valve, which played so important a part in bringing these things to pass, began long ago when Edison was devoting his genius to lighting the homes of the people with electricity. After countless experiments the labours of Edison in the United States and of the late Sir Joseph Swan in England, aided by Mr. C. H. Stearn, turned a scientific theory into an accomplished fact, and produced the electric incandescent lamp which was destined to work such wonders in the world.

## Early Discoveries.

Forty years ago, early in 1882, after the Edison Electric Light Company of London was formed, I was appointed electrical adviser to the company. I was therefore brought into close touch with the many problems of incandescent lamps, and I began to study the physical phenomena with all the scientific means at my disposal. Like everyone else, I noticed that the filaments broke easily at the slightest shock, and when the lamps burned out the glass bulbs became discoloured.

This discoloration of the glass was generally accepted as a matter of course. It seemed too trifling to notice. But in science it is the trifles that count. The little

things of to-day may develop into the great things of to-morrow.

I wondered why the glass bulb grew dark, and I started to investigate the matter. I discovered that in many burned-out lamps there was a line of glass that was not discoloured in any way. It was as though someone took a smoked glass, drew a finger quickly down it, and left a perfectly clean line behind.

## Edison Effect.

I found that the lamps with these strange, sharply-defined clean spaces, were covered elsewhere with a deposit of carbon or metal, and that the clean line was immediately in the plane of the carbon horseshoe filament and on the side of the loop opposite to the burnt out point of the filament.

It was obvious to me that the unbroken part of the filament acted as a screen to that

obtained from Edison some of these electric lamps with metal plates sealed inside them, and he turned his attention to the investigation of the phenomena of the Edison effect. He decided the Edison effect was connected with the projection of carbon molecules from the filament in straight lines, thus confirming my original discovery. There Sir William Preece let the matter rest, just as Edison had done. He did not satisfactorily explain the phenomenon, nor did he seek to apply it in any way. The Edison effect remained just a peculiar property, a mystery, of the incandescent lamp, and nothing more.

Other work claimed my attention for a long time, but I was certain in my own mind that there was still a great deal to discover about this peculiarity of the incandescent lamp, and directly the opportunity occurred I started to investigate the subject once

more. In 1888 I had some special lamps made at the Edison and Swan lamp works. Some were strangely shaped, with long glass tubes springing from the sides: others had tubes shaped like the capital "L." The filaments were of carbon, bent round like a horseshoe, and within the bulbs or in the side tubes metal plates were fixed.

With these lamps, I conducted many tests of a highly technical nature which I fully described in various scientific papers to the Royal Society

and Physical Society. I was keenly interested, although the average man would have found little in my laboratory to appeal to him. I fully confirmed Sir William Preece's observations that the molecules discharged from the incandescent filament could not pass round a right-angle bend, and doubly confirmed my original discovery that the molecules travelled in straight lines.

## Further Experiments.

Then I enclosed the negative leg of the carbon filament in a glass tube, and found that the bombardment of electrified particles was completely stopped. By altering the position of the metal plates, I learned that I could vary the intensity of the bombardment. At last I tried placing a metal cylinder right round the negative leg of the filament, without touching it, and the mirror galvanometer that I was using to



A new and unpublished photo of Dr. Fleming, taken in his study by his niece, Miss Dorothy Fleming. The famous inventor kindly consented to the publication of this photo, which was only taken recently, in "Popular Wireless."

particular line of clear glass, and that the discharge from the overheated point on the filament bombarded the remainder of the bulb with molecules of carbon or vaporised metal shot out in straight lines.

My experiments at the end of 1882 and early in 1883 proved that I was right, and I published the result of my researches in a paper on "Molecular Radiation in Incandescent Lamps" in 1883, followed by another paper with further researches "On Molecular Shadows" in 1885.

Edison was at work in his laboratory in 1883 when he noticed that if he fitted a tiny metal plate inside the bulb of an electric lamp and connected it outside the bulb with the positive end of the filament, he obtained a slight current. The phenomenon was called the Edison effect; but Edison could not explain it, nor did he use it in any way.

In October, 1884, Sir William Preece



## THE ORIGIN OF THE FLEMING VALVE.

(Continued from previous page.)

detect the currents indicated a strongest current. It was plain that the metal cylinder enclosing the negative filament caught all the electric particles that were shot out from the filament.

What I discovered led me to experiment with electric arcs in the open air, and I found that the same phenomenon existed. I published the result of these experiments in a paper in 1889 "On Electrical Discharge between Electrodes at Different Temperatures in Air and High Vacua."

Thereafter, whenever the opportunity occurred, I continued my experiments with a view to further discoveries. I need not enter into technical details here, but all my researches indicated that the molecules of my original discovery were composed of particles charged with negative electricity. Since the brilliant discoveries of Sir J. J. Thomson in 1897 we have called them electrons. By surrounding the negative filament with a metal cylinder and bringing the filament to a high state of incandescence, a current of negative electricity was induced to flow from the filament to the plate, but it could not be induced to flow in the opposite direction from the plate to the filament.



One of the first valves with which the rectification of high-frequency currents was first achieved in 1904.

Early Wireless Attempts.

I have often been asked to explain why the current could flow one way and not the other, and I think a rough analogy is to liken the glowing filament to a battery of guns always firing shells at a certain target. The shells must travel away from the guns. The impulse is behind them, so they must go forward. It is physically impossible for them to travel towards the guns from which they have been fired. In hitting the target, the shells burst and expend their energy, just as the electrons give up their energy, or negative electricity, when they hit the cylinder surrounding the filament.

It is thus easy to understand why the current can only flow one way from the filament to the cylinder. The electrons are like porters all hurrying in one direction with a tiny load of negative electricity. As there are no porters travelling in the opposite direction, it is impossible to get any current carried back again.

In 1899 I was asked to act as electrical adviser to Marconi's Wireless Telegraph Company and to assist in solving the technical problem of equipping the first Trans-Atlantic wireless station at Poldhu with electrical apparatus that would send a wireless impulse across the Atlantic. At that time a wireless signal had not been sent

much over 100 miles, so it was a tremendous jump to send a signal for 2,000 miles.

We realised that high power would be necessary, and that the old methods of supplying power would be useless. Accordingly we ordered certain machinery, which was installed in due course, and in November, 1901, Senatore Marconi, with two assistants, went to St. John's, Newfoundland, to see if it was possible to obtain messages from Poldhu.

The weather was bad. High winds enveloped them as they stood on Signal Hill trying to induce their kites to rise in the air. They had barely coaxed one balloon to rise when it broke from its moorings and fell into the sea. They tried again until at last the long-looked-for signal was detected. On December 12th, they heard three distinct taps signalling the letter "S," and wireless telegraphy across the Atlantic was an accomplished fact, needing only more perfect instruments to make it commercially possible.

### Rectifiers.

In those early days the coherer was used to detect signals. All wireless students know how it works. The metal filings in the coherer leap together at the touch of an electrical impulse and form a bridge for the current to pass over, and they have to be tapped apart before they can detect another electrical impulse. Senatore Marconi improved on the coherer as a receiver, by inventing the magnetic detector. Yet there was room for still further improvement.

Wireless waves from spark sets arrive as a series of impulses, or gushes, and they set up an alternating current in the aerial wire, that is, a current that swings backward and forward. I realised that if this alternating current could be rectified or converted into direct current, it would be possible to use the mirror galvanometer of Kelvin to register oscillations that were

possibly too weak for the known receivers to detect. I aimed, like many other men, to stop the current swinging back and to make it always flow forward.

It was a difficult problem. I experimented with many of the rectifiers then in use in my efforts to solve it. One rectifier can be made of plates of aluminium and graphite immersed in a solution of certain salts. The current was able to pass freely from the graphite to the aluminium, but when the current was reversed and attempts made to make it flow from the aluminium to the graphite, a deposit formed on the aluminium, which effectually stopped the current from flowing.

While this acted well enough for certain purposes when the frequency of the currents was low, it was quite useless for wireless purposes. With a low frequency current the electric impulses, coming slowly, gave time for the deposits to form on the alu-



A valve with metal plate and metal cylinder in the bulb.

minium plates. But wireless oscillations, coming at the rate of hundreds of thousands or millions per second, were so rapid that they gave no time to create the deposits.

Finding that these chemical rectifiers were not suitable for use with high frequency currents, I sought something that would operate more rapidly as a rectifier. I was pondering on the difficulties of the problem when my thoughts recurred to my experiments in connection with the Edison effect.

### A Great Moment.

"Why not try the lamps?" I thought. Then and there I determined to see if they would serve the purpose. I went to a cabinet and brought out the same lamps that I had used in my previous investigations. My assistant helped me to construct an oscillatory circuit with two Leyden jars, a wired wooden frame, and an induction coil. We then made another circuit, in which was inserted one of the lamps and a galvanometer, afterwards tuning it to the same frequency as the first circuit.

It was about five o'clock in the evening when the apparatus was completed. I was, of course, most anxious to try the experiment without further loss of time. We set the two circuits some distance apart in the laboratory, and I started the oscillations in the primary circuit. To my delight I saw that the needle of the galvanometer indicated a steady direct current passing through and found that we had in this peculiar kind of electric lamp a solution of the problem of rectifying high-frequency wireless currents. The missing link in wireless was found—and it was an electric lamp.

I saw at once that the metal plate should be replaced by a metal cylinder enclosing the whole filament, so as to collect all the electrons projected from it. I accordingly had many carbon filament lamps made with such metal cylinders, and used them for rectifying the high frequency currents of wireless telegraphy.

This instrument I named an oscillation valve, and it was at once found to be of value in wireless telegraphy, the mirror galvanometer that I used being replaced by an ordinary telephone, a replacement that could be made with



Valve used in 1904 by Dr. J. A. Fleming, having on it a metal grid and filament.



A modern three electrode thermionic valve.



## CORRESPONDENCE.

To the Editor, POPULAR WIRELESS.

Dear Sir,—Regarding your recent appeal for assistance in erecting the aerials for blinded soldiers, the undermentioned members of our Association would be pleased to do all in their power :

Mr A. W. Knight, 26, Stanbury Road, Peckham, S.E.15; G. Horwood, "Buckland," 557, Lordship Lane, S.E.22; H. Kendall, 66, Dunstan's Road, S.E.22; H. G. Hersey, 241, New Cross Road, S.E.; H. Corbett, 378, Rotherhithe Street, S.E.16; F. McNair, 1, Bredon Road, Loughborough Junction, S.E.5; L. A. Chapman, 40, Teddington Park Road, Middlesex; P. Voigt, 41, Honor Oak Park, S.E.23; C. Taylor, 5, Upland Road, East Dulwich, S.E.22; H. Yerik, 29, Hindman's Road, Dulwich, S.E.22; H. Simmonds, 19, Hillsboro Road, Dulwich; A. C. Musselbrook, 48, Tennyson Road, Penge; W. Jull, 14, Melford Road, S.E.22; L. F. Hunter, 18, Tannsfeld Road, Sydenham; E. White, 16, Cliff Terrace, St. John's, S.E.8.

Yours faithfully,

GEORGE STUTTON, A.M.I.E.E.  
Hon. sec., Wireless and Experimental Association, London.

## THE ORIGIN OF THE FLEMING VALVE.

(Continued from previous page.)

advantage in those days when the spark system of wireless telegraphy was employed. In this form my valve was somewhat extensively used by Marconi's Telegraph Company as a detector of wireless waves. I applied for a patent in Great Britain on November 16th, 1904.

In 1907 de Forcet, who had been following closely the published accounts of my work, added the grid, consisting of zig-zag wire placed between the filament and the plate. This was born into the world the valuable thermionic valve, consisting of an incandescent filament enclosed in a highly exhausted glass bulb, the filament being surrounded by a metal cylinder, with a wire grid or cylinder of metal gauze placed between the cylinder and the filament.

It may be truly said that a little thing like a burned-out lamp led up in the course of years, and after countless experiments by many scientists, to the modern miracle of wireless telephony.

Since the date of my experiments in 1904 a countless multitude of eminent scientists have turned their attention to the study of the thermionic valve.

In its three-electrode form, that is with the spiral wire grid in addition to my metal cylinder, it has given us the solution of a long-considered problem, viz. that of making a perfect telephone relay.

It has enabled us to transmit speech by ordinary wires thousands of miles overland, as well as made possible the achievement of wireless telephony.

It has become the master weapon of the telephonic engineer. We are even now not nearly at the end of the services it may render to electrical science and to mankind.

## IN LIGHTER VEIN.

I HAD been listening to a radio concert(?) perpetrated by an heroic but impecunious amateur.

*The wave was long, the "hum" was bold,  
The records were both bad and old;  
I murmured as I dropped a tear,  
"Where are the sigs of yesteryear?"*

*Here's to 'em—the assiduous, hard-working,  
resourceful amateurs, with their battered  
gramophones and overworked records; they  
kept the flag flying and the ether working, and  
gave us some sort of pie what time we were  
otherwise fed on promises.*

A caterwauling tenor mangling an aria from *Il Something-or-Other-o* reft consciousness from me-ward, and I slept. Noisily, I fear—and with horrid grunts and gurgling noises. Then they came, the wireless martyrs, the grids who could not leak, the noble army of ripples who refused for conscience' sake to be smoothed out, vagrant electrons fettered to molecules of gas, men who once madly conceived the perfect X-stopper, and carrier-waves worn out with toil.

"Tell me, brother," I said to one, "what is thy sorrow?" He replied: "Lo! Behold in me one of that unnumbered company of half-waves, rejected by detectors. We came forth from the aerial, slick and ready, every ampere correct aloft and aloft, and fell foul of carborundum. I hear they're trying to organise us—sort of Barnardo's Home, I suppose—so that we can help to make sigs and not be wasted. But it's no good. A toy-shop's bought us all up to shove us into cheap dry-cells to work their seven-and-sixpenny sets."

### A Precious Plaything.

Another wraith flickered up: "I am the wretch who used to make the squeaks and howls for 'broadcasting' sets. But now the P.M.G. has stopped the business, and all my stock is on my hands. Listen to this. (He squeaked and howled a bit.) That is what we used to supply in our ten guinea set. Good, isn't it? Bah, there's no room in the world for an artist!"

"What about me?" boomed a muffled spectre.

"I'm the man who invented the word 'broadcasting.' It was not done wilfully. Anyone is liable to make a bad break once in a lifetime. Besides, I've been hanged for it, isn't that enough? They short-circuited me with best 7/22 silicon-bronze wire. But they reprieved the chap who invented loud-speakers. Is that quite fair, sir?"

Then my attention was drawn to the tragic figure of an intellectual-looking man who sat cross-legged, apart; he moaned aloud, cutting his flesh with broken valves and sprinkling grid-leaks upon his head.

"Who are you?" I asked. "A priest of Baal or Mr. Job?" He glared at me balefully.

"Come, now," I went on, "I can guess your trouble. You had all your neighbours in to hear Writtle and forgot that British Summer Time had ceased. They jeered while you applied all known tests to the receiver. It broke your heart. Am I right?" He gave himself an awful gash with a ruined

plio-dynatron, and bit pieces out of a 2-stage note mag.

"Nay!" he howled. "Such an one were lucky. Consider me. I am Heaven's own precious plaything—in other words, an inventor and patentee."

"An honour, surely?" I murmured: "Are you not one of a glorious company? Do you not rank with Beecham of the Pill, Marcel of the Permanent Wave, Mr. Hinde, the great curler, Madam Seigel, Professor Seidlitz and Dr. Klaxon?"

### Good Advice.

"Nay, I am anybody's dog! When I did not invent things, they said I was unoriginal, and when I did they called me a crank. When I did not patent my discoveries they called me a fool and said also that I hindered progress. When I took out patents they claimed anticipation; when that failed they said the inventions were useless, and when I disproved that they used 'em right and left without a 'by your leave.' Young Man, do not invent; but if you do, forget it."

I threw the fellow a copper, which set him howling louder than ever, waking me up just in time to hear my heroic amateur say "Hello, 6 PP. I hope you got that quite O.K.? 3 TT OVER and standing by." (Howl, Pop, Sizzle!)



Mr. R. J. Cottis' (2LD) set, 4, Crondale Road, Fulham, S.W.

## CATALOGUES.

We have received a new catalogue from Messrs. George Adams, Engineer, Tool Dealer, etc., of 255-256, High Holborn, London. The radio experimenter will find much of interest in this catalogue—the prices are moderate; the contents attractive and useful.

Radio Instruments, Ltd., of 12, Hyde Street, Oxford Street, London, W.1, have sent along their new catalogue and a book of working diagrams they have just brought out.

The latter is very interesting, and in it the amateur will find many useful "hook-ups." The diagrams are clearly drawn on art paper and represent an excellent shillingsworth.



# HOW TO MAKE A D.F. STATION.

By MICHAEL EGAN.

## PART 2.

NOW in practice the maximum point on a frame aerial is not nearly so "sensitive" as the minimum point. That is to say, when searching for loudest signals from a particular station, one can usually turn the aerial about  $15^\circ$  or  $20^\circ$  to either side around the maximum point without being able to appreciate any difference in the strength of signals.

This means that it is practically impossible to locate an exact maximum point. The minimum point, however, is extremely sensitive, and can frequently be appreciated to an accuracy of  $1^\circ$ . In practice, therefore, it is always best to work on the minimum point for direction-finding purposes. When it is desired to receive the substance of a message, the aerial can, of course, be swung back again to a position that will give good readable signals.

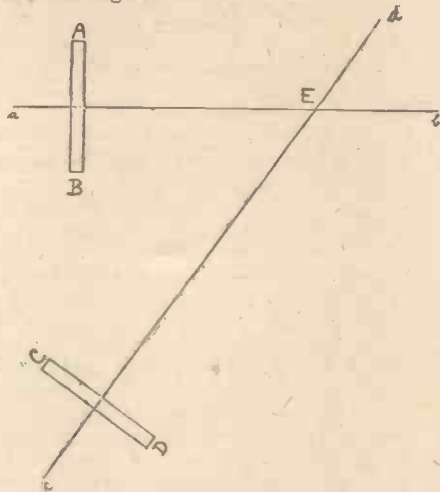

Fig. 1

The minimum point must first be found; the line of direction is then at right angles to the plane of the aerial in that position.

Since the position of a station can only be found by means of two direction-finding stations at some distance apart (as will be explained presently), it is necessary that each of these stations should have some common point of reference. This is usually "true north," as that is a fixed geographical point which is independent of the changes that are always taking place in the earth's magnetic field.

### True North.

An ordinary compass indicates "magnetic north" (and south). This is due to the attraction exerted on it by large magnetic areas on the earth which lie close to, but do not coincide with, true north and south. From any particular point on the earth, therefore, one line will run to true north and another (a little to the left or right of it) to magnetic north. The angle between these two lines is called the "angle of variation."

It is necessary, for accurate work, to make use of true north and south, which are at the extremities of the earth's axis of revolution.

Observations made at different parts of the earth have enabled tables to be compiled which give the different angles of variation for different localities. Thus, by first finding the magnetic north (with an

ordinary compass needle) and then marking off the angle of variation (as given in these tables) the true north can be found. For Greenwich the angle of variation is approximately  $14^\circ$  W.; that is, true north lies  $14^\circ$  to the east of magnetic north, since the variation is a westerly one.

Let us imagine that AB and CD (see Fig. 1) are two frame aerials at a distance of 30 miles from each other, and also that they are both in their minimum positions with respect to the transmitting station at E. Now since E. must lie somewhere along the line ab (i.e., at right angles to the plane of AB) and also somewhere along the line cd (i.e., at right angles to the plane of CD), it will be obvious that it must lie at the exact point where these two lines cut one another.

With one frame aerial, it must be remembered, only the line of direction of a transmitting station can be found, and there is no means of ascertaining whether it lies to the right or left of the frame. By introducing a second aerial, however, the actual position of the transmitting station can be found.

Also, the farther apart these two directional aerials are the smaller the error that is likely to occur. Still greater accuracy will be obtained by three stations working together, the third station serving to corroborate the results of the other two.

### "Team" Working.

Of course, for "team" working of this kind it is necessary for the operators of the different directional stations to have some means of communicating their results to one another. The ideal way would be by means of wireless transmission; failing that, by land line telephony. If both these methods are out of the question, the ordinary postal service can serve the purpose quite well. A list of "bearings" can be dispatched each night by postcard.

Now, how is the bearing of an unknown transmitting station found? The answer to this question calls for an explanation of how a compass card is fitted to a frame aerial. And it should be noted here that the degree of accuracy subsequently attained will be largely dependent upon the care taken in performing this preliminary operation.

In the last article the construction of a simple form of frame aerial was described. It consisted of a square wooden frame, which rested on a vertical spindle about which it was capable of being revolved. Also, the frame could be lifted off the spindle, thus facilitating the adjustment of the compass card. This adjustment of the compass card is the first essential.

A compass card is merely a round piece of pasteboard whose circumference is marked off into 360 degrees. At its centre a hole is cut away to enable it to be slipped down over the spindle. It also has the four cardinal points of the compass marked on it.

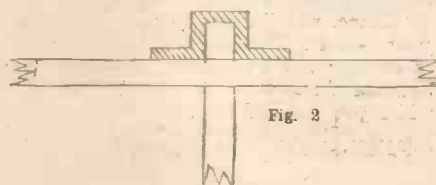

Fig. 2

Now the north point of the compass card has to be set to true north. It is advisable to mark the true north line on the table before placing the compass card.

### Fixing Up.

The magnetic north must first be found. Having determined the position which the spindle will take up on the table it is an easy matter to ascertain the direction of magnetic north from it, by means of a compass. Draw this line on the table. The next thing is to erect the spindle, which should be set perfectly rigid in a vertical position. (Having drawn the line of magnetic north-south the spindle can, of course, be erected at any point along it.)

Perhaps the most satisfactory way of doing this is as shown in section in Fig. 2. A metal or strong wooden cup is fixed underneath the table. A hole is cut in the table to allow the spindle to sit in the cup, in which it is held rigidly by means of screws. As the table itself should also be rigid it is advisable to screw it to the floor, or at any rate to mark its exact position by some means or other, so that it can be readjusted should the occasion arise.

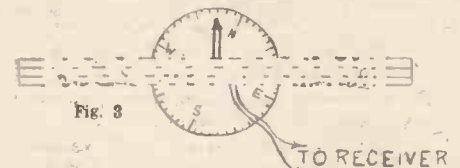

Fig. 3

Having erected the spindle, the compass card is now slipped down over it. This is set so that the magnetic north-south line (running from beneath it along the table) coincides with the point  $14^\circ$  W. of North, as indicated on its circumference. In this way the angle of variation (for Greenwich) is allowed for. The North point of the compass card therefore points to true north. In this position the card should be fixed to the table with drawing-pins, or by gluing.

The next step is to provide some means of indicating the direction of the aerial minimum line. This is done by fixing a small pointer on the lower horizontal piece of the frame, at right angles to its plane. When the aerial is fitted on the spindle this pointer moves over the face of the compass card as the aerial is revolved.

The direction-finder is now complete. When the aerial is placed in minimum position with reference to any transmitting station, the bearing of that station will be indicated by the reading of the pointer on the compass card, e.g.,  $23^\circ$  W. of true north. Fig. 3 shows a plan of the equipment, the aerial wire being indicated by dotted lines.

If two or more frame aerials are being used in collaboration by different operators for position-finding, each must know the other's correct positions on the map. Thus when they exchange direction results each operator can work out positions by drawing the bearing lines on the map from the points at which their respective aerials are located.

The next article will explain why wireless waves produce these directional results with frame aerials.

(To be continued.)



# FREAK SETS.

By G. V. DOWDING, A.C.G.I.

THE other day I had shown to me a beautiful but rather peculiar ring.

It was fashioned from some black substance in the form of a small snake, and the stone was of a lustrous golden yellow, set in platinum. I admired this ornament, but was puzzled by the presence on the underside of four small holes.

I was informed by the proud owner that this delicate piece of jewellery constituted a "complete" wireless set, and the small holes were for the introduction of "plugs" in the shape of 22-gauge copper wire for aerial and earth and 'phone connections.

## Limitations.

The "stone" was the crystal, probably copper pyrites, and floating on a film of mercury was believed to form a very efficient self-adjusting detector. The circuit was merely of the "plain aerial" type, with the 'phones and detector directly in series with the aerial and earth. Therefore, "complete" seemed rather a broad term to apply—complete crystal detector might have been more correct. The owner was quite a clever jeweller, but his knowledge of his own particular trade evidently far exceeded that of wireless. He asked my opinion as to the efficiency of "the set"; I gave it him, and told him that while I greatly admired the workmanship of the delightful little "freak," I did not consider it good for a range of more than a few yards under the best of conditions.

Pocket wireless sets seem to exercise a very considerable fascination for the younger amateurs, and quite a number of the older amateurs, too, but while diminutive apparatus will give the doubtful advantage of extreme portability it will, unfortunately, lack to a considerable degree that of efficiency. In the first case, crystal sets—these "freaks" must perforce employ crystal detectors—require, owing to their comparative insensitivity, sharply tuned

circuits and efficient aerial systems, so, therefore, it is hardly fair to expect results from a finger ring "plain aerial" set, on an aerial arranged on one's person. Then, again, it is extremely difficult to carry out even the fundamental essentials of efficient wireless apparatus construction on a very small scale.

If it is desired to approach somewhere within the realms of "obtaining results" tuning devices are essential, and how can an



A Freak Radio Set.

inductance with a minimum of self-capacity and a maximum of conductivity be wound to tune to even 400 metres within sufficiently small overall dimensions to allow it to go into a brazil nut and leave room for at least a detector as well?

## A Matchbox Receiver.

The small receiver shown in the accompanying photograph falls within the category of "freak sets," but, curiously enough, can claim "results" owing to the fact that in its construction "there is a limit to everything" has been observed. It consists of a fixed inductance wound round the outside of a match-box, a variable condenser which is nothing more than the drawer and case of the box. The former covered on the outside and the latter on the inside with tinfoil, having a covering for both dielectric and protective purposes of stout, well-waxed paper.

The value of the inductance was obtained by first a mathematical approximation, and then "turn by turn" in conjunction with a wave-meter and artificial aerial. Tuning is accomplished by means of sliding the drawer in and out. The small crystal detector which may be removed from the box to facilitate adjustment, has a small screw to regulate the pressure of the "cat's whisker."

This diminutive wireless set has received 2 LO on a good, outdoor, fairly directional aerial, from a distance of 5 miles, but the result, although decidedly interesting, is of little scientific value. It was many hundreds of years ago that Shakespeare said, "How far that little candle throws its beam," but it is only fair to expect a larger candle to throw its beams still farther.

## HINTS TO AMATEURS.

Grid leaks may be made by pencilling a line on a good non-conductor and making contact at the ends of the line. This gives an easy method of varying the resistance of the leak, for a portion of the line may be quickly altered to increase, or decrease, the resistance according to the valve in operation.

Many amateurs who have large inductance coils experience difficulty in tuning down to the smaller wave-lengths. This may be largely due to what is known as "dead end" effect. This can be reduced by having the coils split up into sections; so that the parts not in use can be switched off and entirely disconnected from the rest of the coil.

For those who have a grid leak but no grid condenser, a useful point to know, when adding the condenser, is that the resistance of the leak in ohms, multiplied by the capacity of the condenser in microfarads, should equal 200.

A good hint for those who experience "jamming" is to tune their aerial circuit to a slightly different wave-length from that of the secondary, which should be tuned as near as possible to the length it is required to receive. The insulation of the aerial should always have plenty of attention, especially in smoky districts. The insulators are liable to become coated with soot, and, unless attention is paid to them, a great loss of energy will result.

It is always safer to secure your crystal by means of screws than to solder it into the holder. Heat very often reduces the sensitivity of the mineral, if it does not destroy its rectifying properties altogether.

Several times it has been stated that the electric wiring system could be utilised as an aerial for reception purposes. This is usually a risky experiment, but if attempted, a condenser should be inserted in series with the set, and only the un-earthed side of the circuit should be connected to the receiver. If the condenser is omitted, there is danger of blowing the fuses and damaging the set.

Always make sure that your aerial circuit is well "earthed." Otherwise a flash of lightning in the neighbourhood may induce such a large current into the aerial that it will spark across any gap there may be in the circuit. Thus, instead of the charge going safely to earth, it is likely to damage the set. It is just as well to arrange a switch to "short" your aerial to earth before leaving the set for any length of time, and thus secure it from danger of this sort.

Those desirous of making a portable crystal set will do well to see that they always have their connections tightly screwed up, or soldered. A perikon detector is best for this kind of set, as it retains its adjustment very well, in spite of knocks and jars. You will have to use a battery and potentiometer in order to obtain the best results.



Miss Dorothy Dickson, the famous Revue Star, and her Radio set.



# NEW USE FOR EXHAUSTED DRY CELLS.

By G. E. BALDWIN, B.A., A.I.C.

**T**HE dry cell used in the manufacture of batteries for pocket electric torches and similar apparatus is in principle the same as the Leclanché cell. The outside of the dry cell—the pocket torch battery usually contains three joined in series—is made of zinc which acts in the same way as the zinc rod, while in the centre is a carbon rod packed round with powdered coke and manganese dioxide, the whole contained in a "sack" likened to the porous pot. Between the two is packed some moist sal-ammoniac or sawdust soaked in a strong solution of the same.

Now, just as the Leclanché cell can be re-charged with fresh sal-ammoniac—or the zinc renewed if necessary—so can the dry cell. The following is a good method which allows of easy and repeated re-charging of "exhausted" H.T. or flash-lamp batteries for use again as a source of H.T. or other supply.

## Cell Construction.

Remove the packing and pitch around the cells, taking care not to break or damage the carbon rods which protrude from the sacks, and separate them by cutting the wires joining them in series. With a sharp knife, cut down the zinc container from top to bottom, not damaging the inner sack by pushing the knife lip in too far. Open out the zinc and carefully remove the sack carbon element as a whole, and wash it free from adhering matter. Then wash and clean the zinc so that its surface is purely metallic. Cut the latter into two round the centre, and solder wire leads to each and also to the brass cap on the carbon rod.

With one piece of zinc—keep the other as a spare for renewal—the sack carbon element, and a small container of non-conducting material, a miniature Leclanché cell can now be constructed.

For the container, short test-tubes, not less than 1 inch wide, may be used, or glass or porcelain ointment or shaving-stick jars are quite suitable. Put the carbon sack into the container and fit the circular zinc around it, packing fine sawdust, or cotton or glass wool, in between the two and around the zinc to a height not above the top of the sack.

## Re-charging.

Pour in a saturated solution of sal-ammoniac until the packing is soaked and will absorb no more. The liquid can be added without the packing, but the contents are then liable to be spilt in moving. After standing for a short time, the cell will give practically the same voltage as in the "dry" state, and, if found to be in order, a tightly fitting cork cover should be added to prevent evaporation of the liquid.

A number of such cells can be made and joined in series, i.e., carbon to zinc, to give any required voltage, and packed into a varnished box fitted with outside terminals and handles.

For H.T. supply in W/T reception the current used is small, and recovery is more than sufficient to enable these cells to be used in this work for long spells at a time. They are not suitable, however, for filament current, though two or three cells in series will provide for flash lamps, bell circuits, etc., where only occasional use is required.

## WIRELESS SOCIETY PUBLICITY.

By GEORGE SUTTON, A.M.I.E.E.

**O**NE of the main difficulties of the existence of the secretary of a wireless society is the publicity part of his duties. Even if he has been able to find a man with a genius for journalistic work, the matter put forward for publication is not quite the same as the secretary might have turned out, had he been his own press agent.

First of all, for club reports in one or other of our excellent technical journals. These must be bright, interesting, and terse, else you might as well not write them. The name of Mr. Smith might conjure up all sorts of delightful memories for those who know his happy and informative style in addressing your meetings, but to the vast majority of the readers of the paper the name of Smith does not scintillate.

If you can infuse Mr. Smith's breezy style into a few words you have shared your club's delight with other clubs' members, and the Editor will bless you. Think what a lot of other people's stuff he has to wade through, poor man (Hear, hear!—Ed.), and make your effort short. It is quite another thing when dealing with what Mr. Smith said, for if a few remarks remained in your mind at the close of the lecture, it will probably be that those remarks are most worth remembering and recording for the benefit of others.

## Be Concise.

Terse they must be, as other clubs are only too anxious that they should get a share in the notice of the paper, and the concise, clear report in your own words is much better than a report that has had to be copiously blue-pencilled.

It is quite another matter, however, when you are writing for the local papers, and the secretary who neglects this avenue of bringing the doings of his society before the British public is depriving the club of some of its rights. If you can spare the time to write a column of the right sort of stuff the local Editor will be delighted with it, and surely our science will provide matter which will put to shame most paper-backed novels.

Mind, the public do not care anything for your views unless they are very brilliantly expressed, and we are not all George Bernard Shaws; but they will read for hours if you recount the possibilities and probabilities of the wireless telephone and how it will be a feature in every household for education, information, and amusement, while the older forms of wired telephone will still be reserved for individual communication purposes. The advent of the broadcast wireless is on us, and the public is anxious to learn all about this new science, which its votaries are so enthusiastic about.

Address your note to the Editor of the "Weekly Informer": "Dear Sir,—I beg to submit the following report." Then make your first paragraph practically a synopsis of the whole, and if the report has to be curtailed for reasons of space, the intelligence conveyed by the head of it will still carry its message.

Remember, Editors adore brevity.



M. Edouard Belin, who recently claimed to have perfected a system of "secret wireless."



# COMMAND a higher Salary

£5 per week + {The New Harmsworth Self Educator} = £500 a year

**G**AIN the knowledge these books offer. Knowledge brings Power—the power to choose your work—to succeed in your work—to realise your ambition.

**T**HE finest opportunities, the biggest incomes, go to the men and women “who know their job”—and more than their job. Do you? The

## NEW HARMSWORTH SELF EDUCATOR

contains just that practical knowledge which you need to progress in your vocation, and it will also make you well-read, well-informed and quick to seize the chances that are lost by the man who is mentally ill-equipped. The New Harmsworth Self Educator may be likened to a Home University, the twenty-five departments of which convey practical instruction in different spheres of the knowledge that brings success.

### Here is a list of the 25 Departments :

Success  
Geography  
Arts and Crafts  
Physiology and Health  
Agriculture and Gardening  
Chemistry  
History  
Dress and Housekeeping  
Metals and Minerals

Civil Engineering and Transport  
Literature and Journalism  
Civil Service and Professions  
Life and Mind  
Business  
Physics and Power  
Astronomy, Geology and Archæology

Building Trades  
Natural History  
Electricity  
Music  
Manufactures  
Mathematics  
Clerkship

Mechanical Engineering  
Languages

For a first payment of 5/- only you have the ten volumes of this great, inspiring, educative and success-bringing Work sent to your home, and while you profit by its possession you complete your purchase by small monthly subscriptions.

“Get in front of the Crowd!”

This is the message of the free Prospectus you are invited to accept. Please fill in this coupon now, post it at once, and it will bring you a booklet that is a mental tonic to the ambitious man. It takes you through the 25 departments of this great Home University, shows you exactly the appearance of the Work and enables you to judge its value to you personally.

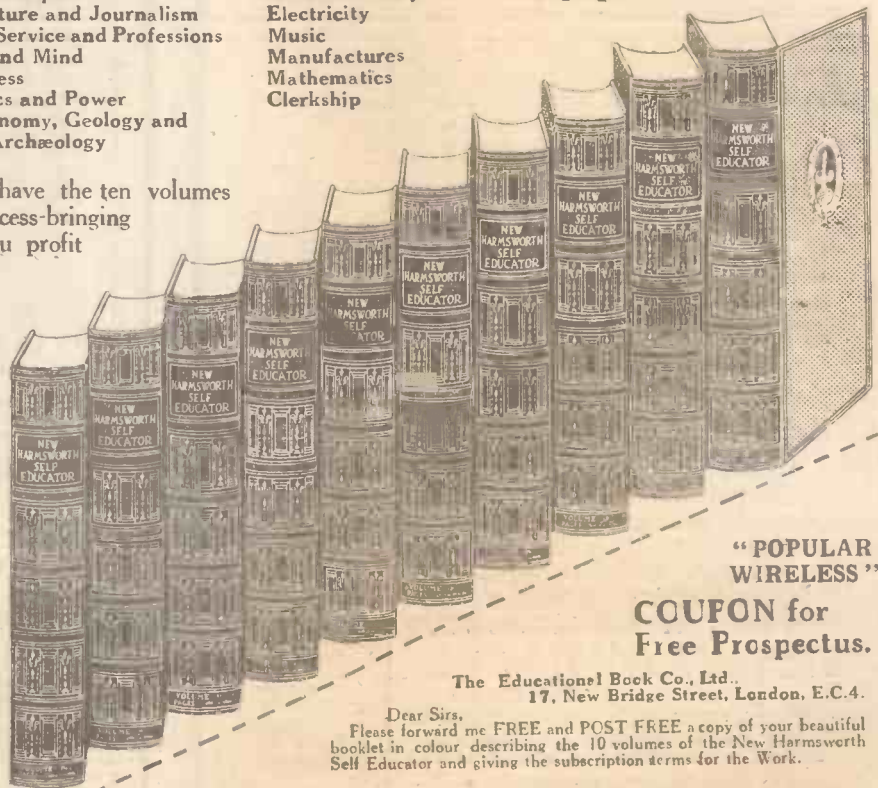

“POPULAR WIRELESS”

**COUPON for Free Prospectus.**

The Educational Book Co., Ltd.,  
17, New Bridge Street, London, E.C.4.

Dear Sirs,  
Please forward me FREE and POST FREE a copy of your beautiful booklet in colour describing the 10 volumes of the New Harmsworth Self Educator and giving the subscription terms for the Work.

*SOUTH AFRICAN Readers should post the coupon to the Central News Agency, Ltd., P.O. Box 1033, Johannesburg.*

*AUSTRALIAN Readers should apply to Gordon & Gotch (Australasia), Ltd.*

**Post this Coupon NOW!**

NAME.....

ADDRESS.....

OCCUPATION.....

P. Wireless



# WIRELESS WORTH WHILE

COMPLETE INSTALLATIONS ERECTED, LEFT WORKING SATISFACTORILY, AND PERIODICALLY INSPECTED.



## T.M.C. Crystal Set No. 1.

A CAREFULLY designed and perfectly efficient instrument. Variable type Tuner, designed to receive up to 1,200 metres. The whole enclosed in a well polished Walnut Case. Complete with 4,000 ohms.

"De Luxe" Headphones  
Size 9 in. by 5 in. by 5½ in. high.

PRICE £4 12 6



## T.M.C. Crystal Set No. 2.

THIS SET embodies all the principles of No. 1 Set. Wave length 500 metres. Is fitted, with our permanent "Everset" Patent Crystal Detector, which needs no adjustment whatever, and is always in position. The

whole mounted in polished Walnut Case. Complete with 4,000 ohms. "De Luxe" Headphones.  
Size 5½ in. by 5 in. by 5½ in. PRICE £5 17 6

**THE NEW SYSTEM PRIVATE TELEPHONE CO., LTD.,**  
212-214, Great Portland Street, London, W.1.

Telephone No.: MAYFAIR 3779

All Sets Approved by P.M.G. and Stamped B.B.C.

## AN AUCTION OF INTEREST TO AMATEURS

Included in this important sale of

### EX-GOVERNMENT WIRELESS APPARATUS

there will be a large number of SMALL LOTS eminently suited for purchase by WIRELESS EXPERIMENTERS

THE TRADE will also have an excellent opportunity of securing :

New Mark III. Tuners. Mark III. C.W. Transmitters and Receivers. B. Mark II. 2-Valve Detector Amplifiers. 50 Watt Spark Trench Sets for Receiving and Transmitting. C. Mark III. 3-Valve Amplifiers (low frequency) in new condition. Brown's Head Telephones, Reed Type, 120 and 8,000 ohms, in new condition. Valve Boxes, Teak Instrument Cases, a quantity of 13 ft. masts and a large quantity of Miscellaneous Wireless Gear.

### STEVEN'S AUCTION ROOMS, LTD.

(ESTABLISHED 1760)

will sell the above by Auction at their Great Rooms,  
38, KING STREET, COVENT GARDEN, W.C.2,

WEDNESDAY, 6th DECEMBER, 1922,  
at 12.30 o'clock precisely.

On view Monday, 4th Dec., from 12.30 to 5.30, Tuesday from 9.30 to 5.30, and on morning of Sale from 9.30 till 12 o'clock.

Catalogues free on application.

Telephone: 1824 GERRARD

Telegrams: "AUKS, RAND, LONDON."

## RELIANCE RADIO SERVICE CO.

THE "RELIANCE"

### CRYSTAL RECEIVING CABINET.

Consisting of Ebonite Panel mounted in Oak Cabinet with lid; Tuning Coil and condenser. Patent Crystal Detector, totally enclosed in glass; 4,000 Ohms. Double Headphones; 100 feet of Stranded Copper Wire; 2 Shell Insulators.

No further outlay, no batteries required. Each set has been tested and carries our guarantee, and we confidently assert that for the price it is the most compact and reliable that is obtainable.

PRICE COMPLETE

£3-5-0

INSTRUMENT ONLY

£1-12-6

We have also a complete range of Valve Sets in stock from £7 to £20. Call and inspect the famous FELLOPHONE 2-Valve and 4 Valve Receiving Sets, prices complete, £10 10s. to £17 10s. respectively. Also the FELLO-CRYST SUPER Crystal Receiving Set, price £4 7s. 6d. complete. All our sets are passed by the P.M.G. for reception of broadcasting. All sets open to inspection at our London address. Demonstrations given daily, Hours 10 a.m. to 6-30 p.m.

ILLUSTRATED CATALOGUE  
POST FREE.



RELIANCE RADIO SERVICE CO.,  
283, St. John Street, Clerkenwell, London, E.C.1.

'PHONE: CLERKENWELL 4290.



# FRAME AERIALS.

By H. A. D.

**I**N order to receive wireless signals on any desired wave-length, it is essential that the receiving apparatus be so constructed that it is possible to vary either the value of inductance or capacity. Modern receiving apparatus invariably permits of the variation of either.

This, of course, is to enable the operator to "tune" to a required wave-length, which would be impossible if neither of the above factors could be altered, because wave-length depends directly upon the values of capacity and inductance.

## Many Advantages.

We have, therefore, in considering the reception of any given wave-length, to consider both capacity and inductance, and in this respect we must not exclude the aerial, which possesses both.

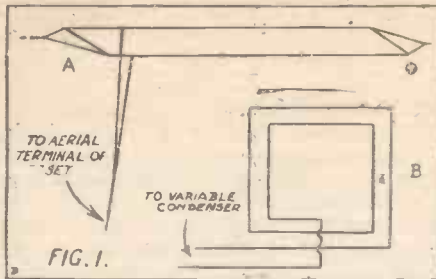

Different aeriels, used in conjunction with a calibrated receiving set, show that certain types have more inductance but less capacity than others; and, generally speaking, aeriels can be brought under two heads, viz., the type that possesses a relatively large amount of capacity and the type in which the value of the inductance predominates.

The former is the ordinary "line" or "flat-top" aerial—sometimes called an inverted "L" or "T" aerial, according to the point of attachment of the down-lead—and is shown at A in Fig. 1. The wires act as one side of a condenser, and the ground beneath as the other. We thus have a large amount of "capacity" attached, as it were, to the receiving circuits of the apparatus. It must be understood, however, that the aerial also possesses a certain amount of inductance.

The second type of antennæ is the "frame" or "loop" aerial, which is gradually becoming more popular with

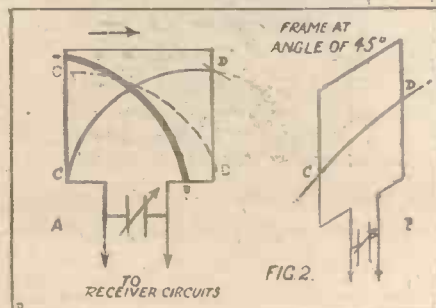

the owner of the amplifying valve set. This type is shown diagrammatically at B. Each type has its advantages.

The predominance of the flat-top or line aerial, and its popularity with both professional and amateur, has no doubt been largely due to the fact that over a given distance, with a given power, this type of aerial has proved the more efficient. A frame aerial, in the past, would have to have been almost as large as the line type to give the same results, and would then have offered no advantages.

With the advent and improvement of valves, however, and the development of "amplifiers" and super-sensitive regenerative sets, satisfactory results can be obtained with a comparatively small frame aerial; and the additional advantages to be derived from the use of the "loop" type, such as its directive properties, compactness, and partial freedom from "jamming" or atmospheric interference, offer attractive inducements to the experimenter.

## Ideal for Telephony.

The fact that it is possible to eliminate many, if not all, of the stations not required to be heard is, perhaps, the most important advantage which a frame aerial possesses over the "flat-top" type. Another point in favour of the frame aerial is that the amount of space necessary for its installation is very small when compared with the area required to instal one of the "open" variety.

Its low resistance also compensates, in a measure, for any reduction in signal

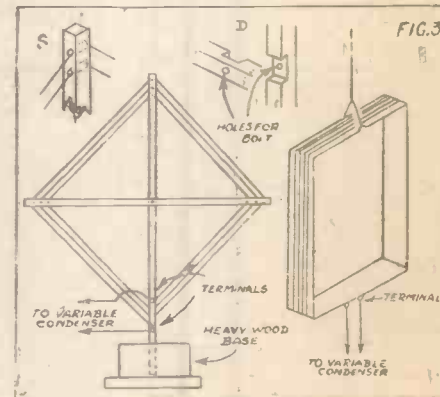

strength due to its comparatively small size. Finally, it has been stated that the frame aerial is more efficient on short wave-lengths than long, and in this respect is particularly useful when used for the reception of wireless telephony. Any attempt to use a frame aerial with a crystal detector is bound to result in disappointment, unless valve amplification is employed.

A brief outline of the principles governing the operation of a frame aerial will not only show why it is more efficient on shorter wave-lengths, but will also explain why it possesses directive properties.

It is well known that, before a current can flow in a wire, a difference of potential must exist between the two ends of the wire. It is, therefore, easy to see that

before a current can flow in a frame aerial, a difference of potential must exist between two given points in the wire composing such an aerial.

If voltages of equal value are generated on opposite sides of the frame windings, no current will flow. In Fig. 2 a frame aerial is shown with its edge or side pointed towards the radiating station. If we now imagine a wave travelling in the direction indicated by the arrow, it is apparent that the edge of the frame nearest to the transmitting station will be cut by the radiated wave before the far edge is affected.

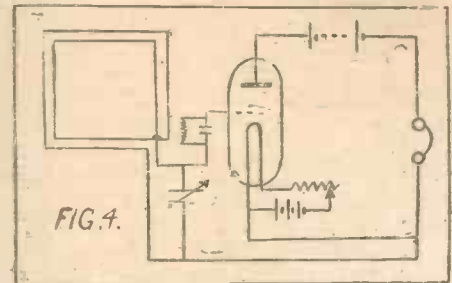

A difference of potential is thus created in the aerial, and a current dependent for its value upon the resistance of the circuit will be caused to flow. The difference of potential in the aerial at any moment is represented graphically by the difference in the heights of the two points C and D:

## Directional Effects.

These values, of course, are constantly varying as the wave proceeds on its way across the aerial, until eventually C is higher than D, as represented by the dotted line, when the current will reverse and flow in the opposite direction.

In this manner alternating currents are set up in the frame aerial which will oscillate at a frequency depending upon the length of the received wave. It is now easy to see why better results are obtainable on a frame aerial from a short wave station than from a station employing a long wave-length.

From the formula for wave-length  $\lambda = \frac{V}{F}$ , where  $\lambda$ =wave-length,  $V$ =velocity, and  $F$ =frequency, it will be seen that the shorter the wave-length, the greater the resultant frequency. The "curve" representing the shorter wave-length will therefore be the steeper curve, shown in Fig. 2, A, as a thick black line.

From the illustration it will be seen that a greater part of each cycle is thus embraced between the sides of the frame, and the difference in height between the two points on the frame cut by the wave is greater, showing a stronger potential difference, which means stronger signals.

This serves to explain the increased efficiency manifested by frame aeriels when receiving short wave-lengths. So far we have considered the frame as having its two sides in alignment with the transmitting station.

In order to understand the directional properties possessed by a frame aerial.

(Continued on next page.)



## FRAME AERIALS.

(Continued from previous page.)

let us now imagine the frame as being rotated through one-eighth of a revolution, as shown at B, Fig. 2.

This shows that a smaller portion of the wave cycle is enclosed by the frame, with a corresponding diminution of potential. This can be seen from the drawing, where the difference in the relative heights of C and D is considerably less than that shown in A. If we turn the frame still

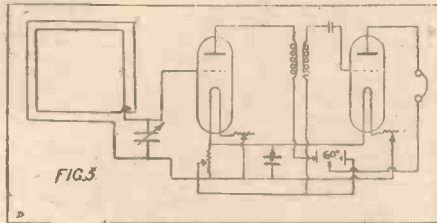

farther, until its plane is at right-angles to the wave-front, the currents in both sides of the frame will be of equal value, and thus nullify each other. No signals will be heard under these conditions.

It is not intended here to give a detailed account of the manner in which various directional finding stations have been designed for the purpose of assisting aircraft or ships at sea. It is hoped, however, that the foregoing will convey something of the principle governing the operation of this type of receiving station.

### Spacing the Turns.

From what has already been written, it should not be presumed that any and every size of frame aerial will work more efficiently as the received wave-length decreases. To obtain the best results, the fundamental wave-length of the frame aerial and that of the received signal should bear some relationship one to the other.

A general rule which is worth remembering is that which states that the wave-length of the loop should never be greater than one-third of the wave-length of the received signals. If this rule be departed from, inferior reception will result, unless the transmitting station is very powerful and situated in the vicinity.

The square type of loop, sometimes loosely referred to as the "diamond," is perhaps the most efficient of all small frame aerials for receiving purposes. The frame is erected with one corner of the square towards the ground, in order to reduce capacity effects between the aerial and the earth.

The spacing of the wire as it is wound round the frame is worth consideration, and it has been found that for a frame 2 ft. square the wires should be about one-tenth of an inch apart; for a 4 ft. square frame, about three-tenths of an inch; and for a 6 ft. square frame, about half an inch.

If the wires are placed a greater distance apart considerable reduction in the inductance of the aerial will result, and more turns will be necessary.

The addition of extra wire will, of course, mean additional resistance which

is undesirable. The wave-length it is required to receive should, as previously stated, be at least three times as long as the natural wave-length of the aerial.

To those amateurs who wish to construct a frame aerial for reception from the broadcasting stations, the writer would recommend that a 6-ft. frame, wound with four turns of wire and spaced as above, be used. The wire employed should be of the stranded variety; gauge 22 will answer for small frames.

### Construction.

In giving the above approximate dimensions, it is presumed that the broadcasting wave-length is to be 350 metres. To give accurate measurements for a frame aerial would be extremely difficult, but the above will be found a useful basis on which to work. The type of frame aerial under consideration, and shown in Fig. 3 A, is by no means difficult to construct.

Two lengths of wood, one to form the vertical shaft and the other the horizontal cross-piece, will be required, together with a heavy wooden base. If the base is heavy enough, and the vertical shaft is sunk into it for a few inches, the whole frame may be rotated without trouble.

Two terminals to take the two ends of the frame windings should be fitted on the shaft as shown, in order to receive the ends of the aerial winding, and also to supply connections for the condenser leads. One method of supporting the aerial wire is to drill equidistant holes in the wooden shafts through which the wire is passed, as shown in the section S, Fig. 3.

If the wire is bare and the wood not properly seasoned, it is possible that a certain amount of leakage will result from employing this method. This difficulty may be overcome by using insulated wire.

The two shafts may be bolted together

where they cross, and in some cases are cut as shown in section D. The aerial support is then collapsible, when unwired.

Another method of winding a frame aerial is that shown at B in Fig. 3. If this type of frame is employed, and bare wire is used, the wood should be prepared before the wire is wound on it, and it should be inspected periodically to see that no short-circuiting is taking place between the turns.

### Aerial Tuning Condenser

This design of aerial may be conveniently hung from the ceiling in the manner shown, although it is difficult to keep it in any one position—a serious drawback to any type of directional aerial.

Fig. 4 shows the wiring diagram of a simple circuit with which results can be obtained if used in conjunction with a frame aerial. The capacity of the aerial tuning condenser is .0005 microfarad. Fig. 5 shows the frame aerial connected to a two-valve set.

This set has high-frequency amplification, although note magnification or low-frequency amplification can easily be added to the circuit if desired by connecting the primary of the audio frequency transformer to the telephone terminals.

### Connecting the Set.

It may be found advantageous, under certain circumstances, to earth one end of the frame windings in order to obtain the maximum amount of signal strength, but this practice is not to be recommended unless all other efforts to make the aerial function satisfactorily have resulted in failure.

Remember that frame aerials will not give results if used with an ordinary crystal detector set. To construct an aerial of this type for simple crystal reception is a waste of time and money and can only prove a disappointment.



Boy Scouts all over the country are taking a keen interest in Wireless. Many Scouts H.Q.'s have Radio Sets fitted up, and instructional classes are regularly held. Our photo shows some scouts at Morse practice.



# FROM OUR NEW YORK CORRESPONDENT.

It is only a few years since Alexanderson, the designer of the high-frequency alternator that bears his name, was quoted as saying that the then newly discovered audion tube would never be of much use for generating currents of more than one kilowatt.

To-day, it is predicted that before the last Alexanderson alternator shall have been installed in the great Radio Central station now under construction, they will all be out of date, and it will be advisable at least, to take them out and substitute tubes!

The tube has been successfully developed by Dr. Irving Langmuir to the point where it can be made to give 20 kilowatts successfully. It is stated on reliable authority, that the General Electric Company has a 100 KW tube under way, and that greater ones still are planned. Of course, in comparing the alternator and the triode tube, it must be remembered that, just as the alternator requires a motor to drive it, so the triode tube must be provided with a machine to furnish it with high-voltage current.

Moreover, though this is a condition which it seems certain will be removed in course of time, the cost of upkeep, or rather replacement of the triode tubes is high. The filaments have a comparatively short life as at present constituted, but already experiments are being successfully carried on in the direction of evolving a more robust material, and with water cooling, combined with improved manufacturing methods, the best opinion of American engineers is that there is, in theory at least, no limit to the possible size of triode tubes.

And the latter will have always the advantage over the alternator that they deliver a frequency which is practically constant within the finest limits. In addition, they can be made to deliver to the antenna at least 80 per cent. of the energy supplied to them, which is far superior to the alternator or the arc.

American radio enthusiasts are half amused and half worried by the plight of the English amateur, who, so far as can be gathered at this distance, has but two or three concerts a week, and must possess apparatus sufficiently costly to enable him to hear over a distance of several hundred miles. If, as appears from the newspapers to be the case, it is impossible to get any action out of the radio manufacturers in the way of providing broadcasting stations, why not do as is being done in the United States, put up at little expense, one or two stations near the centres of population which will pick-up and relay the programmes from the distant station rendering them available to the man of moderate means with his 50 or 100 mile set?

The American manufacturer simply cannot understand the attitude of the British radio firms, which apparently want to have the cost of erecting broadcasting stations in their pockets before they build them. In America it was realised that the best way to sell sets was to give the public something to listen to when they had got them. The legal restrictions on broadcasting stations are no greater in England than they are in the United States, and yet the inhabitants of New York have at least ten stations to choose from every night, and two of these

are Government stations, one run by the navy, the other by the army!

As for the British Government restrictions on amateur receivers, some of these strike Americans as at least humorous, as indeed they must impress the English radio men. How on earth, they ask, are you going to produce a set limited to receiving up to a certain wave-length to which the owner can't attach and detach a loading coil at will, to receive any wave-length he likes?

Seen at a distance, the whole situation in England seems rather ridiculous; at all events—and it is an Englishman writing these words—it makes England look ridiculous.

New York is to have a radio theatre. There will be a great auditorium, where concerts will be reproduced, equipped with a kinema screen, and adjoining, a ball-room, where dancing will be carried on to radio music.

The United Fruit Company, which operates one of the largest radio systems in the world, has announced that in future the services of its doctors in the company's ships and hospitals will be available for radio consultation free of charge. Any captain of a ship which has no doctor can get medical advice in case of emergency, and any ship's surgeon who wishes to discuss an obscure case with another medico will be able to call in a second or third opinion by wireless. The United Fruit vessels, "The Great White Fleet," as they are called, run between New York and all parts of South America.

The question of wireless power transmission, which has of course excited the imagination of wireless engineers from the very beginning, is again raised by Dr. Steinmetz, chief engineer of the General

Electric Company, who is quite convinced that the day will come when power will be transmitted over long distances without the aid of wires. As he points out, the great problem to overcome is the dissipation of energy which takes place when it is sent out from an aerial under present conditions, only a small fraction of the energy sent out from the transmitting station arriving at the receiving station. But it is impossible to believe he considers that developments in the art of wireless will not find a way to overcome this difficulty.

A five-stage amplifier operating without any storage batteries has been evolved by the United States Bureau of Standards. This set is another arrangement for the use of electric lighting circuits as a source of current supply. There are on the market at the present time a number of "plugs," designed, usually in haste, for this purpose, but in actual practice, few if any of them are of much use. The peculiar thing about the Bureau's set, which is the work of Mr. P. G. Lowell, its associate physicist, is that it discards the vacuum tube detector and returns to the crystal.

It was found that when the audion detector was used an appreciable amount of the 60 cycle a.c. lighting current came through the step-down transformer used to reduce it to six volts, and the hum of the 60 cycle generators was very apparent. Curiously enough, this current made no effect on the crystal detector. There are three stages of radio-frequency amplification in this set and it was found that there was no difficulty in finding a sufficiently sensitive spot on the crystal, because the signals had been so much strengthened before reaching the detector. The current from the lighting mains is used, of course, on the filaments of the radio-amplifying tubes. The plate current is supplied from a battery.



The Lady Mayoress of Birmingham listening-in to a broadcast speech.



# THE DERIVATION OF UNITS.

By E. BLAKE, A.M.I.E.E.

SOME wise man has said, "Science is measurement," an aphorism which is noteworthy on account of its truth and wide applicability rather than for its brilliancy. Mathematics is the mistress of science. Qualitative science is the beginning of knowledge; quantitative science is both knowledge and power. Qualitative science, in general, can never be other than academic; applied science is always quantitative.

It is not enough to know that two points do not coincide; the important thing is to know how far they are apart. Similarly it is necessary to know how long is the duration of an action, how heavy a thing is, how hot a thing is, how often something happens, and at what rate something increases or decreases. In short, mere qualitative knowledge is like the knowledge you have of a man by travelling to the City with him once a day, and quantitative knowledge is like that you have of him by living with him. When you can measure a thing you really know something about it.

## A Standard Essential.

Now we cannot measure anything without a standard of reference, a unit, something to measure it against. Without a unit of length, for example, it would only be possible to say that one thing is longer or shorter than another. If we say that something is, like the cloud in the Bible, no bigger than a man's hand, we express only an approximation. Even for the base purposes of trade it is necessary to have standards of weights and measures, as the ancients discovered so soon as the principle of barter succeeded that of clubbing the other fellow first and hardest.

The normal adult pace, the length from a man's finger-tips to the centre of his breast, a span between thumb and little finger, the width of a man's hand, these were, no doubt, the early units of length and sufficed the needs of primitive dealings. Sunrise to sunset, from new moon to new moon, or from tide to tide, served to measure time, for in olden days seconds and minutes—in fact, time itself—was not greatly considered. Long distances were so many days' marches; protracted duration was measured in moons, harvests, or the number of times certain annuals flowered. Speeds were but sketchily expressed, the flight of the hawk or swallow being the usual terms of reference. Weights were expressed in multiples of certain masses of metal or stone.

## Some Examples.

None of these units, true natural units as they might be, were satisfactory. They varied with the size of the man or the time of the year, and the units of weight were not so inviolable as are ours, being liable to "manipulation" by any king, chief or priest who preferred to amass wealth by the aid of his wits rather than by straight dealing and work. But, as science became more exact measurement became more reliable, or vice versa; the two matters are inseparable.

A measurement of any physical quantity must be expressed by the name of a unit (or

a symbol for a unit) preceded by a number (or something representing a number). Here are a few examples:

1 pound.  
2 metres.  
8 seconds.  
20 degrees (Fahrenheit).  
3 amperes.  
9 ohms.

$nV$  ( $n$  being any number, and  $V$  the symbol for the volt or unit of electromotive force).

$\pi \omega$  ( $\pi$  being 3.1416, and  $\omega$  the symbol for the ohm, or unit of resistance).

0.6 dyne.

12 cubic centimetres.

There being no known natural units on which it is convenient to base a system of physics, scientists have had recourse to three fundamental conceptions—Length, Mass and Time—and starting from agreed units of these have derived units for most physical quantities, heat being a notable exception.

## Planck's Theory.

The electron is sometimes referred to as the natural unit of electricity, but the kilogramme is a practicable unit of mass, and the electron would not be such.

Similarly, there is reason for arguing that there exists a natural unit of energy; this is the "quantum" hypothesized by Planck. Planck's theory of quanta is, in brief, that radiated energy is emitted not so much in a continuous stream, but, as it were, in bundles or packets, so that the radiating body will deliver up so many complete bundles but will not split any bundles—it will deliver no quantity less than one complete bundle. The quantum or amount of energy delivered per bundle varies with the frequency of radiation, and is expressed as  $hn$  ergs,  $n$  being the frequency and  $h$  being called "Planck's Constant." The value of  $h$  has been determined as  $6.56 \times 10^{-27}$ , and this multiplied by the frequency gives the quantum in ergs, the erg being the unit of energy now employed by physicists.

The English unit of length is the yard, that of the French being the metre, and we can represent two of each by the expression  $2L$ ,  $L$  being either yards or metres, according to which system we are using. Hence  $L$  represents only the size of the unit (i.e., if the yard, the size is 36 inches; if the metre, 39.37 inches), and is referred to as the dimensional unit of length. When a dimensional unit is intended, it is placed in brackets, thus— $[L]$ . The dimensional units of Mass and Time are  $[M]$  and  $[T]$ . Obviously the dimensional unit of Area is  $[L^2]$ , and that of volume  $[L^3]$ .

In physics and science generally the

C.G.S. or centimetre-gramme-second system is used, because calculations by the metric system are so simple.

The C.G.S. unit of length is the centimetre or one-hundredth part of a metre. The metre is the fundamental unit of length under the metric system, originally taken as one ten-millionth part of the distance from the Poles to the Equator, but now the standard metre is the length of a bar of iridium-platinum alloy deposited in Paris.

The C.G.S. unit of Mass (or weight) is the gramme, which is one-thousandth of a kilogramme, the metrical unit of mass.

The C.G.S. unit of Time is the mean solar second, or  $\frac{1}{86400}$  part of the mean solar day.

## Origin of Units.

From these three fundamental units we build up the important unit of Force, called the Dyne, which is that force which will give a mass of 1 gramme a velocity of 1 centimetre per second if applied to it for 1 second.

Having defined a unit of force, we can go further. For instance, the electrostatic unit of electricity is defined as that quantity of electricity which, if placed 1 centimetre in air from an equal and similar quantity, repels it with a force of 1 dyne.

Units which are derived from the three fundamental ones are called absolute units, and from these are derived the practical units with which we are more familiar, i.e., the volt, ampere, ohm, etc.

When we take the trouble to examine the origins of some of the units from which the formulae of the physicist are constructed we are brought sharply up against the fact that the wonderful picture of science is painted upon a canvas woven very largely of three kinds of material. One strand is a measurement of a portion of an [imaginary] meridian of longitude; another is a fraction of the time taken by the earth to revolve once on its axis—a time which the astronomers tell us is not constant but gradually increasing, so that the second is really growing longer; the other strand is the weight of a piece of metal carefully preserved at Paris—at Paris it weighs a kilogramme, but at either of the Poles it would weigh more and at the Equator less. It would almost seem that our world is unreal, a fairy-tale, or a structure of cards liable to collapse at a breath. Were it not for the fact that abstract reasoning so often confirms or is confirmed by our experiments, we might well be compared to a monkey trying to pull itself along by its own tail and calling the result progress.

In another article we shall make closer acquaintance with the units of current, resistance and electromotive force, and thus achieve a fuller understanding of Ohm's law.



Some apparatus shown at a recent exhibition held by the Iramax Wireless Club



# An Ideal Xmas Gift—Order Now

The Best Value in Single Valve Panel Sets on the market  
No Finer Set could be built if 20 times the price were paid

**30/-**  
 COMPLETE



**30/-**  
 COMPLETE

**Comprising:** Handsome polished mahogany cabinet, panel of best quality Ebonite, well finished and bevelled edges, valve holder, filament resistance, 2 Mullard's Condensers, '0003 and '0002 mfd., Mullard's Grid Leak, 10 Terminals, 10 engraved terminal tablets, coloured systoflex and copper wire, blue print with full instructions.

**Hundreds of these sets have already been sold. As will be observed, ONLY THE VERY BEST COMPONENTS ARE SUPPLIED. This is the secret of the success and popularity of this panel.**

## EVERY WIRELESS ACCESSORY IN STOCK

Coil Holders, 25/-; "Ora" Valves, 15/-; Marconi "R" Valves, 17/6;  
 Valve Holders, 1/9; Variable Condensers '0005 mfd. £1; '001 mfd. 26/6;  
 Filament Resistances, 4/-; Mullard Condensers '0002 and '0003 mfd., 2/6;  
 '001 mfd. 3/-; Mullard Grid Leaks, 5/-; Transformers, intervalve, 25/-;  
 High Tension Batteries complete with Wander Plugs 36 volts, 8/6, 60 volts, 14/-.

### FREE GIFT

A useful Case containing  
 3 padded compartments  
 free to every purchaser of  
 3 valves.



**BROWN HEADPHONES, "A" Type, 120 ohms. £2 2 6**

" " " " 8000 " £2 9 6

**SULLIVAN HEADPHONES (Complete with 25/-  
 Transformer) 120 ohms - - - £1 10 0**

" **HEADPHONES 8000 ohms - - - £1 16 6**

All brand new and unused, and sold under our express guarantee that we will refund full amount paid if not absolutely satisfied and goods are returned within 7 days

## THE CITY ACCUMULATOR CO., 79, Mark Lane, London, E.C.3.

### AGENTS—

LONDON: A. W. GAMAGE, LTD., Holborn, E.C. SELFRIDGE & Co., LTD.,  
 Oxford Street, W. RICHFORD & Co., 153, Fleet Street, E.C.4.  
 H. V. ALBROW, 56, George Street, Portman Square, W.1.  
 YORKS: BARNESLEY BRITISH CO-OPERATIVE SOCIETY, LTD.,  
 Barnsley.

GLOS: BRISTOL WIRELESS Co., 52, Cotham Hill, Bristol.  
 S. WALES: SOUTH WALES WIRELESS INSTALLATION Co., LTD.,  
 18, West Bude Street, Cardiff.  
 N. WALES, LANC., ORES. & F.O.M.: THE "ALL-BRITISH" WIRELESS  
 MANUFACTURERS Co., LTD., 18, Vauxhall Road, Liverpool.

**IMPORTANT NOTICE:** We beg to announce that most of our goods can now be obtained from H. V. ALBROW, 56, George St., Portman Square, W.1, who has been added to our list of London Agents.

# CONTROLLING MODELS BY WIRELESS.

By MAJOR RAYMOND PHILLIPS, I.O.M., Late Member of the Inter-Allied Commission of Control.

## PART 11 (Conclusion).

WHEN the coherer, with de-cohering device, relay, selector, etc., are mounted upon a baseboard as shown in Fig. 1 (last week), the various instruments can be connected up, as shown in Fig. 1 (this article).

The connections can be made with No. 18 gauge double-cotton covered copper instrument wire.

It will be apparent that where junctions of wires are shown, these may be effected by twisting such wires together, and securing them by the terminal involved. On referring to Fig. 1 (this article), it will be observed that terminals A and B are for connecting to the terminals of a 4-volt accumulator.

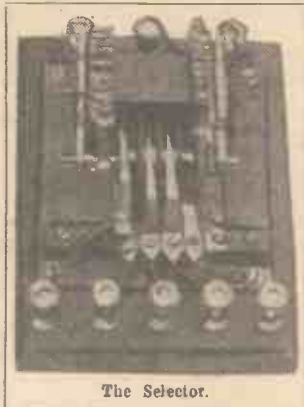

The Selector.

Terminals C and D are for connecting to the conductor, and outer rails of a model electric railway.

Terminals E and F are supports for metallic tubes (the antenna), as shown in Fig. 1 (last week).

Terminals G and H shown in Fig. 1 (this article), are connected with the contacts of the relay whilst terminals I and J are connected with the windings of the electromagnet of such relay as described in No. 20 of POPULAR WIRELESS.

The selector terminals are marked 1 to 8 respectively, which correspond to those described in No. 23 of POPULAR WIRELESS. The coherer M (with base), as shown in Fig. 1 (this article), is mounted in such a manner that when the de-cohering device N and N' functions, the hammer P strikes the coherer, thus shaking up the nickel filings contained therein.

It will be observed that the de-cohering device is somewhat similar to the movement of an ordinary trembling type of electric bell. In my last article (Fig. 3), I showed the device connected up similar to a single stroke type of electric bell.

I have shown the two types in case any amateurs may wish to try experiments. I am of opinion that the trembling type of de-cohering device will be found more reliable for apparatus controlling models by wireless. The coherer circuit switch R as shown in Fig. 1 (this article) is an inexpensive one-way type such as is used in connection with electric-bell circuits.

### Final Adjustments.

The 3½-volt dry battery is simply one of a type used for pocket lamps. It will be advisable to fit small terminals to the brass strips attached respectively to the Positive and Negative poles of the battery in question, so that the terminal wires of the coherer circuit can be connected to, or disconnected from the battery terminals as desired.

A miniature 4-volt electric lamp should be fitted to the miniature lamp-holder L shown in Fig. 1 (this article).

Assuming the complete wireless receiver has been connected up as shown in Fig. 1 (this article) it will now be ready for testing.

The terminals A and B (Fig. 1) can be connected by means of a short length of insulator copper-wire (No. 16, or 18 gauge

double cotton covered copper-wire will do) to the terminals of a 4-volt (40 ampere-hour capacity) accumulator; and the terminals C and D connected respectively to the conductor and outer rails of a model electric railway as previously described.

On closing the coherer circuit switch R (Fig. 1), the selector will probably function. There is nothing to be alarmed at if such a thing happens; but, if the functioning continues, it indicates that the coherer M (Fig. 1) is too sensitive. To reduce its sensitiveness, it will only be necessary to remove some of the nickel filings contained therein.

It may also be necessary to increase the tension of the balance spring H of the relay as shown in Fig. 2 No. 20 of POPULAR WIRELESS.

### Testing.

When the complete receiver is properly adjusted, it will be found that by functioning the transmitter described in No. 19 of POPULAR WIRELESS the selector and other component parts of the "receiver" will also function, and the miniature electric lamp fitted to the lamp-holder as shown in Fig. 1 (this article) will light up each time the contact-pins fitted in the selector drum make contact with the spring brass contacts as shown in Fig. 1 No. 21 of POPULAR WIRELESS.

If the model locomotive attached to the electric train (which it is desired to control)



The Relay.

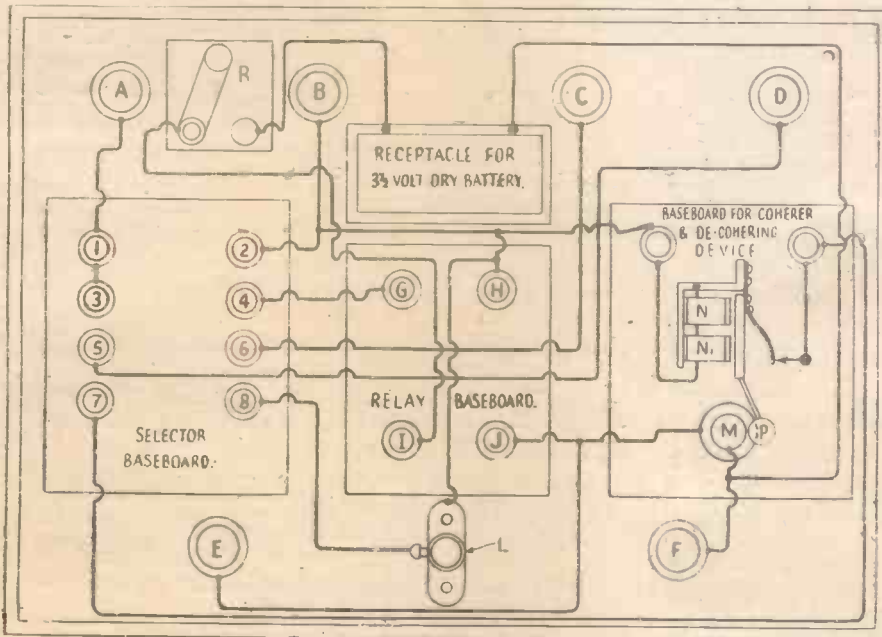

Completed Receiver.

is fitted with a permanent magnet type of motor, it will be noticed that the model train can be caused to run backwards, or forwards, and stopped as desired.

Best results are obtained with the transmitter and receiver in question when the metallic rods (i.e., those forming an antenna) are parallel to each other. For that reason the metallic rods fitted to the transmitter should not be placed at right angles to those fitted to the receiving apparatus.





# Place An Order For Your BROADCASTING INSTRUMENTS NOW!

If you are Expecting Perfect Reception You MUST Use R.F.H. RECEIVING INSTRUMENTS, R.F.H. 'PHONES, THE MAGNAVOX LOUD SPEAKER  
*(For which we are factors and retail agents.)*

WE manufacture our own Components, Coils, Condensers, Resistances, Switches, Cabinets, etc., which not only enables us to ensure perfect Workmanship and Materials, but enables us to give quick delivery, and to offer guaranteed high quality Radio Goods at the lowest possible price.

ALL R.F.H. Receiving Instruments are made to fulfil the conditions laid down, and are accepted and passed by the Postmaster General for Broadcasting Reception, and are made under licence. Prices range from 5 gns. to 100 gns. Exceptionally fine sets are purchasable from us or our agents at prices varying from 12 gns. to 35 gns., according to number of valves, etc., etc.

FOR super-excellence in reception and simplicity in operation, you must get an R.F.H. 2, 3, or 4 Valve Radio Set.

**IMMEDIATE DELIVERY.**

Write to us for particulars.  
LISTS FREE.

**BUYING AGENTS WANTED IN ALL TOWNS**  
**ROGERS, FOSTER & HOWELL**  
LTD.  
Edward Rd., Balsall Heath,  
BIRMINGHAM.

**R. F. H.**  
**RADIO**  
**SETS**



## HANG IT!

IF you hang this Directory of land, ship and experimental call signs from your table, you will have at your disposal a most useful list of the World's station calls.

Suppose, for example, you heard the call:

**POZ POZ POZ de WSO WSO WSO**

you would simply look up the Directory for WSO and immediately find out who was working.



Thousands of other call-signs are given and you will be using this handy Directory, which is absolutely up-to-date, every time you listen-in. Every genuine experimenter, whether interested in Morse or Telephony, is buying a copy.

**HAVE YOU BOUGHT YOURS YET?**

**ORDER YOUR COPY TO-DAY!**

From all Booksellers  
2/6 NET  
or direct (post free 2/8)

**Radio Press**  
LIMITED,

Publishers of Authoritative  
Wireless Literature,  
DEVEREUX COURT,  
TEMPLE, LONDON,  
W.C. 2

- DON'T LIMIT YOUR ORDER TO ONE BOOK.**  
RADIO PRESS LIMITED, Devereux Court, London, W.C. 2.  
PLEASE SUPPLY:
- .....copies "Wireless Valves Simply Explained" ... 2/8
  - .....copies "Wireless for All" ... 7½d.
  - .....copies "Simplified Wireless" ... 1/1½
  - .....copies "Construction of Wireless Receiving Apparatus" 1/7½
  - .....copies "Radio Press Wireless Directory" (call signs) 2/8
  - .....copies "Practical Wireless Valve Circuits" ... 2/8

I enclose remittance of .....

Name .....

Address .....

# WIRELESS FOR THE HOME

By **NORMAN P. HINTON, B.Sc.**

**Price**  
**2/-**  
**NET**  
**OF ALL**  
**BOOKSELLERS.**

WRITTEN BY AN EXPERT FOR THE AMATEUR, this book is intended as a guide for all who have installed or who contemplate installing wireless apparatus. It tells the amateur how to install the apparatus, and gives the best advice on its selection and purchase. The style is simple, technicalities are avoided, and everything that will smooth the way for the amateur and help him to grasp the main principles of wireless, so as to be able, after perusal, to receive messages, etc., has been included.

"An excellent guide for the amateur, and will have a wide appeal among the latest recruits to the hobby of wireless."—*Popular Wireless.*

**Price**  
**2/-**  
**NET**  
**OF ALL**  
**BOOKSELLERS.**

**PITMAN'S, Parker Street, Kingsway, London, W.C.2.**



**An Unprecedented Offer!**

4,000 ohms  
in series.

Every Set Tested  
and Guaranteed.

**27/6**

COMPLETE  
WITH  
FLEXIBLE  
CORDS.

TRADE AGENTS REQUIRED.

The extreme sensitivity of the

**"SENSIFONE"**

is due to the fact that the very powerful magnets are so arranged that the pull on the diaphragm is in exactly the correct spot.

A really first class instrument.

## Seven Days' Free Trial

THE "SENSIFONE" is the finest value-for-money Headphone on the market to-day—and you can prove it in your own home at no risk to yourself! If your dealer does not stock, simply remit the purchase price (27/6), and the "SENSIFONE" will be sent you by return. Test it at home, and if you do not find it all we claim, return it within 7 days and we will refund your money without question.

This is a genuine offer that only supreme confidence in the efficiency of the "SENSIFONE" would enable us to make. Write to-day.

## The "SENSIFONE"

Free descriptive leaflet on application to sole makers—

**TOWNSHEND'S, LTD., 50, ERNEST STREET, BIRMINGHAM.**

Agents and Showrooms  
LONDON: COWARD & Co., 81 Charlotte Street, W.1.  
MANCHESTER: COLISTON & Co., 5, Cross Street.  
NEWCASTLE: R. F. SUNDERLAND, Milburn House.  
GLASGOW: CLARKSON HOOD & Co., 45, Hope Street.

## BROADCASTING HAS NOW BEGUN!

### HAVE YOU OBTAINED YOUR SET YET?

Our No. 1 CRYSTAL RECEIVING SET is suitable for reception of all broadcast matter for a range of 20-30 miles.

TYPE APPROVED BY P.M.G. Reg. No. 126.

Price **35s.**

Plus 7s. 6d. broadcasting royalty.

PHONES. British made, wound to 4,000 ohms.  
Price **25s.**

AERIAL EQUIPMENT, comprising 100 ft. 7/22 SWG. Stranded Aerial Wire and Insulators, 4/- extra.

COMPLETE EQUIPMENT, ready to "Listen-in."

Price **£3 3 0**

Plus 7s. 6d. broadcasting royalty.

"Excellent Results."

"Costs Nothing."

West Kensington, 18th Nov., 1922.

"You might like to know that in spite of the fact that I have a 3-Valve Set, I prefer listening-in on the Broadcasting Co.'s Transmission of your No. 1 Crystal receiver, which gives excellent results, and unlike Valves costs nothing to run."

Write for Illustrated Catalogue of all RADIO ACCESSORIES.

## BOWER ELECTRIC LTD.,

15, GRAPE STREET,  
SHAFESBURY AVENUE, London, W.C.2.

## HERE'S REAL RADIO SERVICE

AERIAL WIRE, 7/22 bare copper, stranded, 100 ft. coils ...	3/3
ENAMELLED AERIAL WIRE, 7/22 copper, 100 ft. coils ...	4/6
AERIAL WIRE SILICON or Phosphor Bronze, 1/18, 100 ft. coils ...	2/0
LEADING-IN CABLE, heavily rubber-covered, per yard ...	6d.
LEADING-IN TUBES, Ebonite, heavy terminal ends, each ...	1/6
INSULATORS: Shell, 6d. and 9d.; Egg, 4d. and 6d.; Keel ...	2d.
THE FOLLOWING DETECTORS ARE OF OUR OWN MANUFACTURE, AND ARE A PERFECT MECHANICAL JOB BOTH IN CONSTRUCTION AND FINISH:	
BALL & SOCKET JOINT mounted on Ebonite base, 3 screw cup with hard copper contact at joint ...	2/6
PERIKON, with 3-screw cup top and bottom ...	3/6
.. with 1 cup top and 2 on base ...	4/6
.. with 1 cup top and 3 on base ...	5/3
HERTZITE CRYSTALS (Needs no comment) ...	6/-
BLOCKING CONDENSERS, any capacity ...	1/6 & 2/-
RHEOSTATS, silent action ...	2/-
INTERVALVE TRANSFORMERS ...	4/6, 3/6 & 2/6
TELEPHONES, 2,000 ohms, single earpiece, with cords ...	20/- & 15/-
.. 4,000 ohms, double-steel headbands ...	12/-
.. 8,000 ohms, ...	£1-2-3
..	£1-5-0

**Waterloo Electric Co.,** Electrical and Wireless Engineers,  
129, WATERLOO RD., LONDON, S.E.1  
Telephone: Hop 5649. 1 min. Waterloo Station.  
Please enclose sufficient postage; balance returned. Send for our Free List.



## CRYSTAL RECEIVING SET.

(British throughout.)  
One of many items from our catalogue, complete as illustrated.

**£3 : 7 : 6**

Subject to B.B.C. surcharge.  
Guaranteed to receive  
**BROADCASTING.**

Illustrated Catalogue, P., including List of Stations, etc., 3d. post free.

**EONS WIRELESS SUPPLY COMPANY,**  
115, FLEET STREET, E.C.4.





**HEAD 'PHONES**  
Fitted light steel Bands  
4,000 ohms 14/- pair.  
300 ohms 8/6 "

**SINGLE RECEIVER**  
2,000 ohms 8/6 each.  
150 ohms 3/6 each.

**SINGLE RECEIVER**  
Fitted Canvas Band and Strap  
2,000 ohms 7/6 each.  
150 ohms 5/- each.

'PHONE CORDS, single 1/3; Double 2/6.  
'PHONE PLUG & JACK, 1/6 pair.  
MAHOGANY BASEBOARD, suitable Crystal Set, 3/3.  
STEEL HEAD-BANDS, 2 3 pair.  
ALL POST FREE.  
**ROBERTS, 2, Midmoor Rd., BALHAM.**

**TO THE TRADE.**

**Ebonite—Copper Wire, Bare & Covered—Aerials—Sleeving, &c.**

Wireless Supplies: Prompt Delivery.

Cables & Electrical Supplies, Mica House, Offord St., Caledonian Rd., London, N.1. Telephone: North 805

**AGENCY WANTED.**

Birmingham firm, with extensive connection, offices, show rooms, and shop, is open to accept Agency for known and reliable Radio Sets.  
Apply—Box C6, TOON & HEATH, Ltd., Advertising Contractors, Holborn Chambers, Broad St. Corner, Birmingham.

**WIRELESS POLES ; GOV. SURPLUS.**

PRIME QUALITY PAINTED WOOD.

13 ft. 1/11; 16 ft. 3/6; Sectional 27 ft. 42/-; Iron Taper and Parallel Poles 32 ft., 30/-; 40 ft., 35/-; also Stays, Insulators, Anchors, Aerials, Buzzers, Jacks, Switches, etc. Approval Terms; Trade Enquiries Solicited. Send Stamp for List.

JENNINGS, LTD. WIRELESS, 305, BRISTOL

**IF YOU REQUIRE A FULL EXPERIMENTAL RECEIVING AND TRANSMITTING LICENSE**

you must satisfy the G.P.O. that you have a sufficient knowledge of W/T science to warrant the issue of such a license. THE LONDON TELEGRAPH TRAINING COLLEGE, LTD., will give you the necessary qualifications in 12 Lessons.

Write for full particulars of Evening Lectures to Secretary (Dept. P.W.), 262, Earl's Court Road, London, S.W.5.

**PORTLAND'S Parts by Post. "EBONITE"**

4 x 4 . . . . .	s. d.	12 x 7 . . . . .	s. d.
7 x 5 1/2 . . . . .	1 3	12 x 8 1/2 . . . . .	5 2
8 x 6 . . . . .	2 8	12 x 10 . . . . .	6 5
9 x 6 . . . . .	3 0	15 x 8 1/2 . . . . .	7 6
10 x 6 . . . . .	3 5	15 x 10 . . . . .	8 0
12 x 6 . . . . .	3 9	12 x 12 . . . . .	9 0
12 x 5 1/2 . . . . .	4 2	17 1/2 x 8 1/2 . . . . .	9 6
9 x 8 1/2 . . . . .	4 10	14 x 12 . . . . .	10 5
17 x 5 . . . . .	5 3	18 x 18 (halfsheet) . . . . .	12 10
		36 x 18 . . . . .	£1 3 0

7 lbs. . . . . £1 3s. 0d. 28 lbs. . . . . £4.

No charge for cutting, waste, or postage.

Delivery by return of post.

Quality A 1. DRILLING, manufacture—BRITISH. Thickness One Quarter; Surface Mat.

JAMES PORTLAND, 39, Sinclair Road, Olympia, W.14.

N.B. Mr. Portland stocks 200 Wireless Parts.

**WIRELESS CLUB REPORTS.**

The Editor will be pleased to publish concise reports of meetings of Wireless clubs and associations, reserving the right to curtail the reports if necessary. Hon. secretaries are reminded that reports should be sent in as soon after a meeting as possible. Reports sent in cannot appear in this paper in less than ten days after receipt of same. An asterisk denotes affiliation with the Wireless Society of London.

**Ramsgate, Broadstairs and District Wireless Society.\***

The second weekly meeting of this society was held at the society's headquarters, No. 22, Princes Street, Ramsgate, on Thursday, October 5th, when the society's first lecture was given by Mr. P. F. Cotton, a member of the committee, on "The Aerial and its Construction." A most pleasing feature of the lecture was the absence of technical expressions that are so puzzling to the beginner, and the interest of all those present was apparent by the number of the questions that were asked by the members present. The lecturer traced the construction step by step, and the whole lecture was most enjoyable.

The third weekly meeting was held on October 12th, when Mr. C. E. Hume gave a very instructive lecture on "Electric and Magnetic Fields," which was followed with keen interest, and the subject was discussed by the members and many questions were put to the lecturer, who was accorded a hearty vote of thanks. At the general request of members, the weekly meetings of the society are now held on Tuesday evenings, at 7.30 p.m.

Joint hon. secs.: Mr. F. Harrison, "Rochester Cottage," High Street, Lawrence (Ramsgate); Mr. F. C. Marshall, 6, Ramsgate Road, Broadstairs (Broadstairs and District).

**The Fulham and Putney Radio Society.\***

At a meeting held at headquarters on Friday, October 13th, there was a large gathering and several new members were enrolled, including two ladies. After the preliminary business was disposed of, Mr. Houston opened a discussion on the various forms of amplification and the screening of transformers, and promised to have a set at the next meeting with a new type of screening arrangements. Another discussion was started on accumulators, and Mr. Calver gave a short explanation of the various ways the plates are now made.

On Saturday evening, October 7th, Mr. E. Barker, at our headquarters, produced the Prince's speech on a loud speaker to a bevy of interested Boy Scouts.

Major K. Field, of West Kensington, also entertained a large number of Scouts with the speech, and the Marconi concert after.

The society being now affiliated to the Wireless Society of London, it is to be hoped that those interested in wireless in the district will join and participate in the additional advantages gained by the affiliation.

Hon. sec., J. Wright Dewhurst, 52, North End Road, West Kensington, London, W.14.

**The Portsmouth and District Amateur Wireless Society.**

The weekly meeting of this society was held on the 11th ult., with a good attendance of members. After the usual buzzer class, a talk was given by Mr. R. G. H. Cole, the secretary of the society, with regard to accumulator charging on the Noden valve system. Following upon this talk and discussion, Mr. Cole gave a further interesting talk with regard to his transmitting apparatus, and also upon the various receiving sets he had experimented with at various times.

The society was very pleased to receive Mr. Simpson, of Radiophones, Ltd., at their meeting, and this gentleman gave a very interesting talk upon broadcasting plans, and very kindly offered to demonstrate his three-valve set to the club.

The society is still anxious to increase its membership, and all amateurs who would care to join will be certain of a hearty welcome. Prospective members should address communications to Mr. R. G. H. Cole, of 34, Bradford Road, Southsea.

**AMATEURS**

**DO BUY QUALITY GOODS.**

"GRIFPHONES," 4,000 ohms per pair 22/6  
The Best Value on the market.

Quality British Phones, 4,000 ohms . . . per pair 30/-  
"Brown's" A Type, 8,000 ohms (Ex-Government stock) . . . . . per pair 40/-  
Very Limited Quantity. (Postage 1/-)

**TRENCH BUZZER SETS** . . . . . 8/6  
Complete with Ear-piece, etc. (Postage 1/3)

**INTERVAL TRANSFORMERS**  
Guaranteed THE BEST, being Distortionless, Noiseless. These are HEDGEHOG pattern. Ratio 5-1. Wound with D.S.C. Wire . . . . . PRICE 20/-  
(Postage 9d.)

**TELEPHONE TRANSFORMERS**  
As specification of above. . . . . PRICE 17/6  
But Ratio 10-1 (Postage 9d.)

**QUALITY FILAMENT RESISTANCES** . . . 2/9  
"GRIFFIN" Fixed CONDENSERS, .001 . . . 1/6  
"DUBILIER," .001 to .0009 . . . . . 2/6  
.001 to .005 . . . . . 3/-  
Grid Leaks, 2 Megs. . . . . 2/6

**SWITCH ARMS** . . . . . 2/6  
Ebonite Dials, 1 to 180° . . . . . 1/6  
Siemens H.T. Batteries, 30V. . . . . 7/6  
" " " 66V. . . . . 45/-  
Ebonite Panels, all sizes . . . . . per lb. 4/6

" Knobs . . . . . 6d.  
" Sliders . . . . . 9d. and 1/8  
Aerial Wire, 7/22 Copper, 100 ft. . . . . 3/9  
" " " Enamelled " . . . . . 4/6

Resistance Wire, 12 yds . . . . . 10d.  
Rubber-Covered 20 g. Copper, 12 yds. . . . . 1/4  
1/2 oz. Bobbins, 47 g. D.S.C. (for rewinding Phones) . . . . . 1/-  
Pkts. of asstd. Crystal (Real Value) . . . 2/6

**QUALITY CRYSTAL DETECTORS** . . . 2/6  
" " " Super. Qual. 6/-  
Wound Ind. Tubes, 3 x 12, 3/3; 4 x 12, 4/7  
Valve Holders, Mld., 1/-; "A" 1/2; Eb. 1/6  
**BASKET COILS**, special line, shellacked, not waxed. Wound with 3-stranded wire, set of 8 . . . . . 7/6

Complete List of all Parts sent Free.

**GRIFFIN**

WIRELESS SUPPLIES CO.

82, NEWINGTON CAUSEWAY,

Hop 1806. LONDON, S.E.1.

(2 Minutes from Elephant & Castle Stations.)

**WIRELESS AMATEURS AND RETAILERS PARTS SUPPLIED FROM STOCK**

List free. Condenser Plates, 1/6 doz. pairs (post 3d.). FRASER, SENTINEL HO., SOUTHAMPTON ROW, LONDON

**SELECT YOUR SET WHEN YOU HEAR A VELOPHONE**

A high-class set, simple to operate, remarkable for clearness and reliability.

A DEMONSTRATION WILL CONVINCE.

You are welcome to a wireless concert without obligation.

PRICES FROM £4 4s.

H. C. DALY,

95 GREAT PORTLAND St., London, W.1. (Next Philharmonic Hall.)



# RADIOTORIAL

All Editorial Communications to be addressed The Editor, POPULAR WIRELESS, The Fleetway House, Farringdon Street, London, E.C.4.

The story of the origin of the Fleming Valve, published in this issue of POPULAR WIRELESS, cannot fail to grip the interest and imagination of the reader.

When we think of the astounding new possibilities opened up by the discovery of the thermionic valve, its invention can be clearly seen in a perspective which indicates the accomplishment of a feat of world-wide importance.

That POPULAR WIRELESS should have the honour of publishing this historical article, is extremely gratifying to me, and I am sure all my readers will find it an article of extraordinary fascination.

At the time of writing, three broadcasting stations are now working every night—London, Manchester, and Birmingham. Very soon the other stations will commence regular transmissions.

If any of my readers have friends who are thinking of putting up a set, but feel in need of a little advice on such matters as aerials, crystal and valve sets, they have only to write to the Queries Department, and their questions will be answered promptly by post. No trouble is too great, providing POPULAR WIRELESS can assist.

THE EDITOR.

## Questions Answered

Owing to the enormous number of queries received daily from readers of POPULAR WIRELESS, I have decided to reply individually by post. A weekly selection of questions will, however, be printed on this page, together with the answers, for the benefit of readers of POPULAR WIRELESS in general. Questions should be clearly and explicitly written, and should be numbered and written on one side of the paper only.

All questions to be addressed to: POPULAR WIRELESS, Queries Dept., Room 132, The Fleetway House, Farringdon Street, London, E.C.4. Readers are requested to send necessary postage for reply.

M. V. B. (Hackney).—I have a low-resistance loud speaker, a pair of 4,000-ohm and a pair of 120-ohm 'phones. Can I use all these together, and if so, how?

If signals are very strong you should be able to do so; but we can hardly see the necessity. If a loud

speaker is used, surely 'phones are unnecessary, and also, if the 'phones are used for weaker signals, then the loud speaker can be disconnected. However, for the low-resistance 'phones and loud speaker a telephone transformer will be required. The loud speaker and L.R. 'phones can be placed in series across the secondary, while the 4,000-ohm 'phones can be placed in series with the primary of the transformer and the plate circuit of the set.

"MISLED" (Birmingham).—I have purchased a licence at the post-office, and find that the apparatus it mentions the use of must have the stamp "B.B.C." on it. If I made a set myself, could I have it stamped by paying a royalty to the British Broadcasting Co.?

No. The idea is that if you desire to enjoy the programmes broadcasted by the B.B.C., you must buy a set from a firm who is a member. Should you desire to experiment and build your own set, experimental licences are still issued to bona-fide applicants on application to the Secretary, G.P.O., London.

"RADIOPLANE" (Newcastle).—Does an aeroplane gain anything in the case of transmitting wireless owing to height? Is it a fact that the higher it flies the farther it can send?

Yes. An aeroplane can transmit with a 12-watt spark set signals that are readable on a crystal set up to twelve miles, and at times even greater distances, while two ground stations would be limited to a range of but a mile or two with similar sets. The altitude of the machine does, as you suggest, very considerably affect the range.

D. F. E. (Oxford).—If I am correct in supposing that a piano string would vibrate in sympathy with a frequency similar to that of its natural frequency, would the following idea be of any practical use: a series of small telephone magnets arranged in series inside an ordinary piano in order to reproduce broadcasted piano solos on the actual piano?

Hardly, because the reproduction, if reliable apparatus and careful adjustments are employed, on a loud speaker that does not distort, is so faithful that to all intents and purposes the actual piano at the broadcasting station might actually be in the room. If you can play the piano, however, we commend the following, which we have heard several times to our enjoyment. A loud speaker is placed on a bracket

at the side of the piano, and the vocal solos softly accompanied.

"BROADCAST" (London).—When listening-in to the Marconi concerts in the evening, I always hear a faint singing noise accompanying the music. It is more pronounced between the items. Can I cut that out?

Afraid not. It is a very slight fault at the transmitting station. It is practically impossible to cut out that generator noise. It will not be audible to those listening-in from more distant points. In your case you are so near that all noises in the transmitting station will be more or less faithfully reproduced.

J. B. (Cromer).—Should it be possible for me to hear the Hague on one valve? I have heard that wireless waves travel with much greater strength and for a greater distance over sea than land, and it is mostly all sea between Cromer and the Hague.

It should be quite possible with a good aerial and fine adjustments. You are quite correct; greater ranges have been registered on small power at sea than on land.

C. I. (Norwich).—When charging my accumulator, how can I prevent the danger of overcharging, and how can I tell when it is nearing the end of the charge?

You need not fear any danger from overcharging—that is in respect of the duration of the charge. It is more harmful to undercharge. No trouble will be caused by an overcharge providing the current is of, or slightly below, the marked charging rate. Towards the completion of a charge the cells will "gas." That is very easily discernible by the numerous small bubbles rising from both plates. Keep the cells on charge for half an hour or so after the commencement of "gassing" is noticed.

How can I tell the capacity and charging rate of an accumulator which has no directions on it?

The capacity can be taken as 65 ampere hours per square inch of positive plate, and the rate for charging as 14 ampères per square inch maximum. An accumulator will, however, have a longer life if the charging current is kept well below the maximum.

G. R. P. (Turnham Green).—I have a small 4-volt 20-amp. accumulator, but I find it runs down very rapidly. Could I add another cell of the same size and increase the capacity of the cells? If so, what would be the best way of connecting up? I am using one valve without a filament resistance.

Yes, you can add another cell of the same voltage, though it need not be of the same capacity. Connect them in parallel; this will give you the same voltage as before, but will increase the capacity of your battery.

(Continued on page 610.)

## THE LIGHT THAT DIDN'T FAIL.

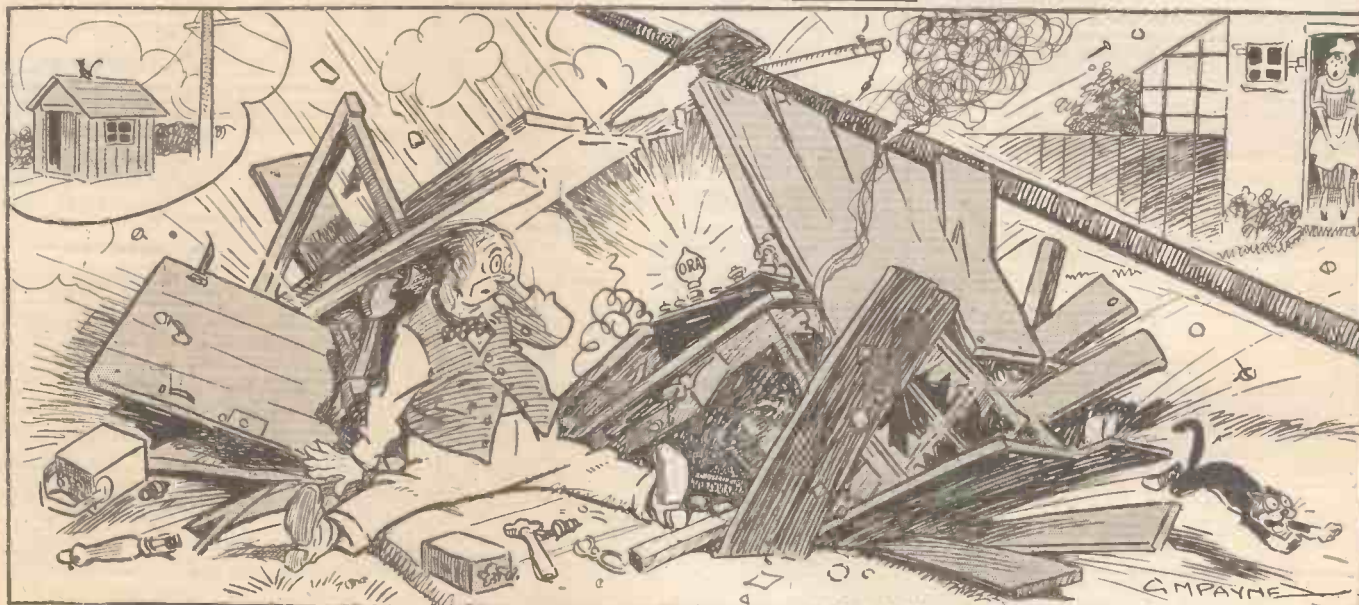



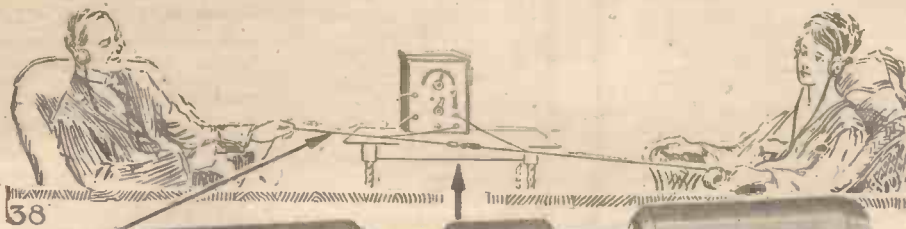

38

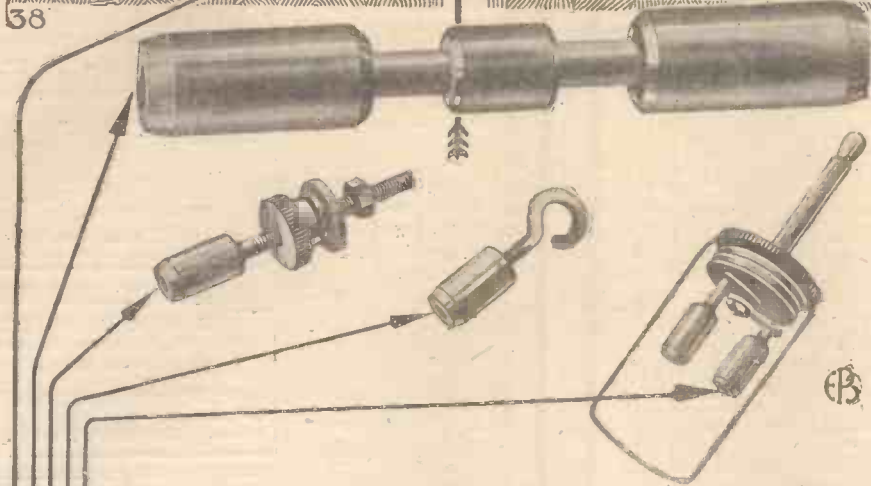

- (1) The self-tightening bull-dog grip fitted to the Elwell plug enables telephones or loud speaker connections to be changed in a moment.
- (2) By the terminal adaptor, the bull-dog grip connector can be added to any existing terminals.
- (3) For fitting to the face of a panel this pattern is recommended. It combines a standard terminal for fixed connections with a bull-dog fitting for connections which you require to change.
- (4) A series connector with a bull-dog grip at each end. Invaluable for connecting telephones in series.
- (5) The series connector in use. Telephones can be connected in series in an instant. No amount of pulling can break the connection. It thus avoids those annoying interruptions caused by involuntary movements.

## BULL-DOG GRIP CONNECTORS

Elwell patented self-tightening grip fittings are a big convenience. Without soldering, tightening of nuts or screws or the use of any tools whatever, electrical connections can be made, broken or changed in a moment.

Moreover, the connections when made are electrically perfect and self-tightening. The more you pull them the tighter they grip. But they can be released in a moment when desired.

Ask to see them at your wireless dealer or write for descriptive leaflet.

**C. F. ELWELL, LTD.,** Radio Engineers,  
**CRAVEN HOUSE, KINGSWAY, LONDON, W.C.2.**

Telephone: REGENT 421.



## RADIOTORIAL QUESTIONS AND ANSWERS.

(Continued from page 608.)

H. A. C. (Doncaster).—Can I use an ordinary house telephone ear-piece for my crystal set, and if not, why?

No; you require telephones of high resistance—4,000 ohms or higher—as the instrument that you mention will not be sufficiently sensitive for wireless purposes.

"AMATEUR" (London, N.).—I have only 20 feet available for the length of my aerial, in so order to obtain 60 feet in length can I run it up and down or zigzag?

No; the aerial must consist of straight parallel wires without bends or angles, and where two wires are employed they must be insulated from each other, run parallel 4 feet or so apart, and connected together only at the down-lead end. Otherwise currents will be induced in the wires in opposite directions. Two wires as high as possible will be quite O.K.

W. R. (Birmingham).—Is a battery required with a wireless receiving set?

Only in the case of receiving sets employing valves either for detecting or amplifying. A crystal set does not require a battery unless it employs a carburettum crystal and potentiometer. These latter are not employed on the broadcasting sets generally sold.

T. J. K. (Edinburgh).—Would it matter much if I connected my aerial to the earth terminal of the set and the earth to the aerial terminal, because by so doing I can avoid crossing the leads?

Generally speaking, it does not matter with the simple single-circuit crystal set, although you should note whether there is a difference in signal strength when you change them over.

G. J. C. (Leytonstone).—I am about 6 miles from Marconi House. Would you advise me to have a crystal receiving set?

You should hear Marconi House quite well with such a set on a good outdoor aerial, but signals will not be so loud that exterior noises will not interrupt reception slightly. If possible, we would advise you to employ a single valve.

B. N. L. (Chadwell Heath).—These sets that they are selling all over the place for broadcasting seem to have very large inductance coils. Why is that? I thought that the P.M.G. had placed a limit on wave-length; and in any case, what use are they?

There is no limit now on wave-length, and many people like a set that will tune up to 2,600 metres, in order that they can listen to Eiffel Tower's time and weather signals on 2,600 metres, which is quite within the scope of a crystal set.

"PENSIVE" (Croydon).—I have read that an indoor aerial is not much good for a crystal set. Why should that be when I am also told that wireless waves will travel through anything?

In certain circumstances wireless waves will pass through, as far as we know, all substances, but even so it has been proved that they are capable of reflection in a similar way to light. Light will pass through clear glass, but can also be reflected by the same material; therefore, while wireless waves can, and will, pass through the walls of a building, there will be a certain amount of reflection, much more so than in the case of light and the glass. The reflection is more in the form of diversion.

W. P. L. (Southend-on-Sea).—I am, roughly, 38 miles from the nearest broadcasting station. What set would you advise for receiving on telephones and on a loud speaker?

A single-valve set employing a good outdoor aerial will give quite fair signals for 'phones, but two—one being a stage of L.F. amplification—will render reception more comfortable. A second L.F. stage of amplification at least would be necessary for a loud

speaker—possibly four valves in all will be required. It depends to a great extent upon the efficiency of your aerial and earth system.

A. W. Q. (Stoke-on-Trent).—Are basket coils suitable for a crystal set?

Fairly, but the single layer cylindrical type are preferable for crystal sets. Basket coils are more suitable in the case of valve sets.

A. L. (Hollingworth).—What is the wave-length range of a coil consisting of 542 turns of 26 S.W.G. on a 5½-in. former?

450—3,400 metres approx.

What capacity fixed condenser would be advisable to use with the above coil?

.001 mfd. across the telephone receiver terminals, to improve the quality and tone of the signals. This value, however, has no connection with the value of the coil.

J. H. (Seaton Burn).—Many thanks. Your tip as to the soldering of leads to the metal foil of small fixed condensers by using "Wood's Metal" instead of ordinary solder, which would, of course, melt the foil, is extremely useful.

(Continued on page 612.)

### GLASGOW WIRELESS SUPPLY CENTRE.

W. & J. JAMIESON, LTD.,  
68, Shamrock Street,  
St. George's Cross,  
GLASGOW.

SOLICIT your enquiries and specifications of accessories and parts for making complete  
RECEIVING SETS

### A PERFECT LOUD SPEAKER

AT A PRICE WITHIN THE MEANS OF EVERYONE.

Suitable for two or more valves.  
PURE TONE, CLEAR ARTICULATION,  
GOOD VOLUME OF SOUND.

Low resistance, 150 Ohms. . . . . 2/6  
High resistance, . . . . . 3/6

STANLEY WYMAN, 110, Ladbroke Grove, London, W. 10.

# BROADCASTING RECEPTION SETS.

## One-Valve Set Complete for Working, £7:10:0

Including All Accessories

Send for  
Catalogue

AGENTS  
WANTED

G.P.O.  
Prov.  
No. 1027.



### DESCRIPTION:

Single Valve, mounted on polished ¼-in. Ebonite Panel with Variable Condenser, smooth acting resistance, grid leak and condenser and all terminals clearly engraved in white, in a Mahogany Polished Cabinet, 9 in. by 5 in. by 5 in. **£3:15:0**

A TAPPED COIL for wave-lengths up to 900 metres with 2 terminals for coils for any higher wave-lengths.

The coil is enclosed and the tappings are brought out to an 8-way switch mounted in the front of the cabinet.

### ACCESSORIES INCLUDED:

Siemen's 54 volt high-tension Battery with plugs for altering the voltage **£0:15:0**  
4. volt 50 amp. hour low tension Accumulator in case with carrying strap **1:4:0**  
One pair of Sensitive Head Phones of 4,000 ohms resistance **1:1:0**  
One Mullard "Ora" Detecting Valve **0:15:0**

**Total £7:10:0**

## WIRELESS INSTALLATIONS Limited, 15, ALDERSGATE STREET, LONDON, E.C.



# Indoor Aerials will give splendid results



If you cannot erect an Aerial out of doors, don't worry. Fasten duplicate Wires (stranded copper or insulated Pertinax) across the room, three inches below the ceiling, insulate them from the walls, and connect to your Set. You will get results which will surprise you. If you have an upstairs landing or passage, four wires stretched 12 inches apart, and connected in pairs—each about 30 feet long—will give you practically a P.M.G. Aerial.

Use a Peto Scott No. 4 Unit, and you will receive excellent speech and music without atmospheric disturbances.

The usual earth lead to water-pipe is required.

Adding a No. 3 H.F. Unit will enable you to pick up long-distance Broadcasting stations with ease.

All Peto Scott Apparatus is manufactured under license from Marconi Co.

Offices and Showrooms:  
Featherstone House,  
64, HIGH HOLBORN,  
W.C.1.

Our new Booklet explains the whole system

POST 6<sup>d</sup> FREE

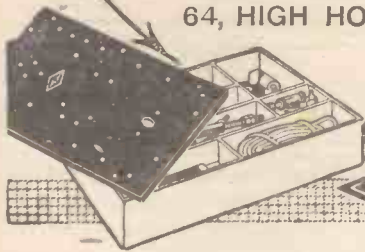

# How did YOU receive the Election Results?

It can be confidently said that all who were listening in with a Wates Set were very pleased with the reception when the Election results were broadcasted.

The reception was good—not only because Wates Sets are perfect in manufacture, but also because purchasers can avail themselves of the free advice of our technical experts, who can help them to get the best possible results under varying circumstances.

Not only do we manufacture complete receiving sets of the best quality, but also all component parts.

The illustration is that of the PYRAMID H.T. Battery, which we can confidently recommend to help you to get better results. It is priced as follows:—

15-Volt - - - 3/6  
With variable plug connection.  
30-Volt - - - 7/6

Send 3d. stamps for our Illustrated Catalogue. List of H.T. Batteries or Accumulators free.



## BROADCAST RECEIVING SET.

Price complete with British made head phones, aerial and everything ready for fixing—

£5 0 0

Plus 7/6 Broadcasting Fee: Low Frequency Amplifiers for use in conjunction with this set having special transformers—Price

£5 0 0

Two of these amplifiers are capable of working a loud speaker with excellent results within a distance of 20 miles from London.

Filament Resistances ... 3/9  
"Ideal" Valve Accumulator in case.

4-Volt 50 amp. 25/- (Carriage 2/-.)

6-Volt 50 amp. 35/- (Carriage 3/-.)

Variable Condensers (of various capacities) ... From 6/-

Fixed Condensers ... From 2/6

3-Coil Holder, complete Unit for use with Standard Coils ... 20/-

Call at our Showrooms—they will interest you.

**Wates Bros.** 13/14, Great Queen Street, KINGSWAY, LONDON, W.C.2

## BROADCASTING HAS COMMENCED.

Hear, in the comfort of your own home, our most talented musical artistes and lecturers, bedtime stories for the kiddies, political speeches, etc., with the aid of an

# APOLLO RECEIVING SET.

Type OO

Passed by P.M.G. Marked "E.B.C."



The chief feature of the "Apollo" is its simplicity and its absolute perfection whether used by the technical enthusiast or the novice. The "Apollo" is complete down to the minutest detail. Tuning—the bugbear of the novice—is ridiculously easy—so easy that a child could do it. The "Pericon" Crystal—acknowledged to be the finest crystal in the world—is carefully enclosed in a glass cylinder, thus making it impervious to dust. The "Apollo" is an extremely sensitive set, yet will withstand a good amount of misuse without getting out of order.

### DESCRIPTION:

Receiving Set in handsome Solid Mahogany Case, comprising specially sensitive "Pericon" Detector, Variometer Tuner and Terminals for earth, Aerial and Telephones, 100 feet Aerial Wire, Four Insulators, and one pair Sensitive Double Headgear Phones I.E.C. (4,000 ohms). Up to 5 extra headphones may be used. (Range 20 miles).

COMPLETE  
£4 19 6

Catalogue of APOLLO Wireless Sets and Accessories and address of nearest dealer sent on application.

**CRAIES & STAVRIDIS, 4, Bunhill Row, LONDON, E.C.1.**

## THE "HESTAVOX" II.

Licensed under MARCONI PATENTS

(G.P.O. Regd. No. 2005)

Fully Approved by P.M.G.

## BROADCAST RECEIVER. (TWO VALVE SET.)

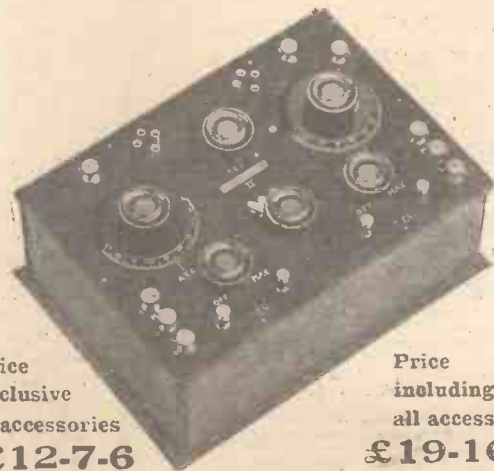

Price exclusive of accessories  
£12-7-6

Price including all accessories  
£19-16-0

This is an ideal instrument for general home use. It is fitted with variable reaction, and will accurately tune in Broadcast Telephony from distances within 150 miles radius. "Hestia" L.F. Amplifying Units can be added as required in order to increase the Signal Strength.

### ASK YOUR DEALER FOR A DEMONSTRATION

Our Loose Leaf Catalogue of above, also other types of Crystal and Valve Apparatus, post free 6d.

The "HESTIA" ENGINEERING COMPANY, Showrooms open 9 a.m. — 6 p.m.  
32, PALMERSTON ROAD, ACTON, LONDON, W.3. Telephone: Chiswick 536.  
1 min. South Acton Stn. (N.L. and District Rlys.)

## VALVE AMPLIFIERS FOR CRYSTAL SETS

The easiest, most economical and efficient method of increasing the range of any good crystal receiver is to add a single-valve H.F. Amplifier, built from our set of parts. The combination is extremely sensitive, and quite equal to many two-valve outfits. Everything necessary is supplied (excepting valve and batteries), including panel drilled and engraved, variable condenser, polished walnut cabinet, etc., etc. Nothing to make; only assembling and wiring to be done. Sent post free, with full instructions and diagrams.

Price 45/-

Send for full particulars and list P.  
Post free.

THE OMNIPHONE WIRELESS Co.,  
24, WARWICK STREET,  
REGENT ST., LONDON, W.1.  
20 yards from Regent Street, between Maison  
Lewis and Robinson & Cleaver's.  
Phone: Regent 3335.

## That book you want

On Wireless, or any Technical subject.  
Foyles have it, or will quickly obtain it.  
1,000,000 vols. (Second-hand and New)  
in every conceivable subject in stock.  
Write for Catalogue 120 (free) mentioning  
requirements.

FOYLES, 121, Charing Cross Rd., London.

## LUNCH HOUR RAMBLE

STROLL ROUND TO  
**SPENCER'S STORES,**

4 5, MASON'S AVENUE,  
BASINGHALL STREET,  
LONDON, E.C. :

CHEAPEST HOUSE IN CITY  
FOR WIRELESS PARTS & SETS

**ACCUMULATORS, etc.** New and Guaranteed  
4-Volt, 25-Amp. Celluloid, 11/3. Postage 1/-.  
4-Volt, 40-Amp. 17/6      6-Volt, 40-Amp. 25/6  
4 " 60 " 21/3      6 " 60 " 31/-  
4 " 80 " 27/-      6 " 80 " 36/-  
Packing, 1/6 extra.      Packing, 2/- extra.  
7/22 Aerial, 5/6 100 ft.; Mullard Ora Valves, 15/-;  
15-V. Siemens H.T. Batteries, 4/-; Marconi R.  
Valves, 17/6; Accumulator Charging Board, 37/6;  
Voltmeters, Watch pattern, 0/12 Volts, 6/-.  
Cash with order. Goods despatched per return.  
LOWKE & SONS, Ltd., Northampton.

## 24-HOUR SERVICE

We make it our boast that every  
letter received has attention within  
twenty-four hours. Send your  
enquiry along and test our service  
for yourself.

## ELECTRICAL SUPPLY STORES

Wireless Specialists.

5, Albert Terrace, King Cross,  
HALIFAX, ENG.

New Lists Now Ready:

## 24-HOUR SERVICE

## CUT THIS OUT

"Popular Wireless" PEN COUPON Value 2d.  
Send 7 of these coupons with only 2/9 direct to the  
Fleet Pen Co., 119 Fleet St., E.O.4. You will  
receive by return a splendid British-Made 14ct. Gold-  
Nibbed Fleet Fountain Pen, value 10/6 (fine, medium,  
or broad nib). If only 1 coupon is sent the price is  
8/9, 2d. being allowed for each extra coupon up to 6.  
(Pocket Clip, 4d.) Satisfaction guaranteed or cash  
returned. Special New Offer.—Your own name in  
cut letters on either pen for 1/- extra. Lever Self-  
Filling Model with Safety Cap, 2/- extra.

## RADIOTORIAL QUESTIONS AND ANSWERS.

(Continued from page 610.)

"PHOTOPHONE" (Ebbw Vale) asks for an opinion on an idea of his for the transmission of photographs and pictures by wireless, using a selenium cell.

Your idea would be quite O.K. if it were not for the theory you state for the inductances of different values connected to the same aerial. Unfortunately this arrangement as you show it would not give you a varied wave-length—that is, a series of wave-lengths all during the same transmission, so that several stations listening-in on either of these wave-lengths would receive the messages—but would only result in providing a single wave-length in accordance with the total effect of these inductances. Thus, two inductances in parallel will not give you two distinct wave-lengths at one and the same time, but will furnish a wave-length decided by the values of the inductances concerned. We suggest that you further your experiments, taking this fact into account.

J. W. (Bickley).—Does the natural wave-length of an aerial affect transmission? If so, how do stations with large aerials transmit on low wave-lengths? Does the carrier wave of Marconi House reinforce Morse, as I find it comes in very loudly sometimes?

(1) The method employed is to connect a condenser in series with the aerial, thus lowering its wave-length. (2) Yes, the carrier wave certainly has this effect upon spark signals.

J. O. N. (Glasgow).—Can you please tell me the wave-length I could tune to with a coil 12 inch by 4 inch with 520 turns of 26 SWG enamelled. My aerial is 40 ft. long, and has a 20 ft. lead in.

Approximately 375-3,000 metres.

"BEGINNER" (Hampstead).—I have bought a crystal set and have been told that it will only receive up to 2,600 metres. This works out at about 1½ miles. I live about three miles from Marconi House, what can I do to increase the range so that I can receive their concerts?

The range mentioned in reference to your set is not the distance it will receive, but the range of wave-lengths which will affect it. You should be able to hear 2LO quite well.

"PUZZLED" (S. London).—Why can I not hear CW on a crystal set?

Because CW is unlike "spark" transmissions, which are received in impulses, each impulse making a click in the 'phones. CW, however, is continuous, and requires breaking up by some interrupter so that it may be changed into impulses, and thus affect the phones. Telephony must not be confused with either, however, as this is a modified form of CW impulses being superimposed on it.

W. R. (N.W. 8).—What can I expect to hear with a crystal set, 8,000 ohm 'phones, PMG aerial, and an inductance 7½ in. by 1½ in.?

You should be able to hear Marconi House broadcasting, and other telephony up to about 15 miles or so. A few spark stations should also be audible.

"TADPOLE" (Clapton, E.).—On Sunday morning I heard very faintly the station NZP call KIE at 3.30 a.m. Can you please tell me whose these call signs are?

NZP is the land station of Bolinas, California. KIE is situated on the island of Oahu, Hawaiian Islands. Are you sure the letters of the call sign you heard are correct?

E. S. P. (Laindon).—I am using a five valve set, and employing "Ora" valves. These, I understand, only require 30 volts on the plate. My signals are very weak, however, and if I switch off two valves they become stronger. Why is this?

You are making a mistake that many often make regarding the plate voltage. If you increase the number of valves the voltage should be increased somewhat. Instead of 30 volts HT, try about 75 volts. The low voltage would account for the weakness of reception.

## ACCESSORIES FOR WIRELESS



Fuse.

**FUSES** for protecting the filament accumulators and batteries in the event of a short circuit.

**TELEPHONE HEAD SETS** specially designed for wireless work. Terminals enclosed to prevent receiving circuit being interfered with.

**VACUUM PROTECTORS** (for protecting the aerial). They secure protection against risk of fire or damage by lightning.

**SWITCHES** for series—parallel switching of condensers, adding to or reducing the number of valves in simultaneous use.

**AERIAL WIRE & INSULATORS, EARTHING DEVICES, JACKS & PLUGS, H.T. BATTERIES, etc., etc.**

Also manufacturers of

**BROADCASTING RECEIVING SETS.**

Descriptive pamphlet and prices on application to

**SIEMENS BROTHERS & Co., LTD.,**  
WOOLWICH, LONDON, S.E.18.

Telegrams:  
Siemens, Woolwich.

Telephone:  
City 6400

AND AT

Belfast, Birmingham, Bristol, Cardiff, Glasgow, Leeds,  
Manchester, Newcastle, Sheffield, Southampton.

## Beginners Guide to Wireless

Explains, in plain everyday language, everything beginners wish to know about wireless telegraphy.  
**HOW TO ERECT, CONNECT, AND MAKE** all the apparatus required for reception of telephony or morse, and full instructions and diagrams for making coils, tuners, and complete valve and crystal sets. 112 pages, price 1/-, post free.—**SAXON RADIO CO.** (Dept. 14), South Shore, Blackpool. 32-page cat. of wireless apparatus, 3d., post free.

## CRYSTAL RECEIVING SETS AND ALL COMPONENT PARTS.

Send for Catalogue, printed on art paper and profusely illustrated.

Price 3d., returnable on first order of 5s. Valve Sets, or Panels on the unit system, also in Stock.

Valve Catalogue will be ready shortly.

**P. H. BOYS and CO.,**  
ELECTRICAL AND WIRELESS ENGINEERS,  
187, Goswell Road, London, E.C.1.  
Phone: Clerkenwell 4454.



# "ORA"

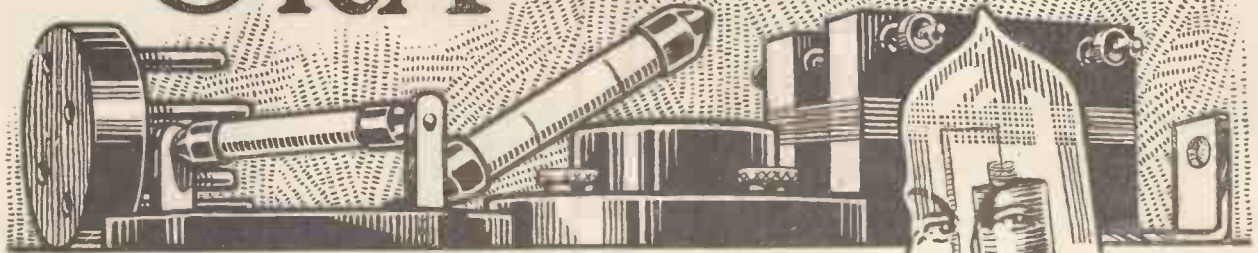

## for Perfect Reception

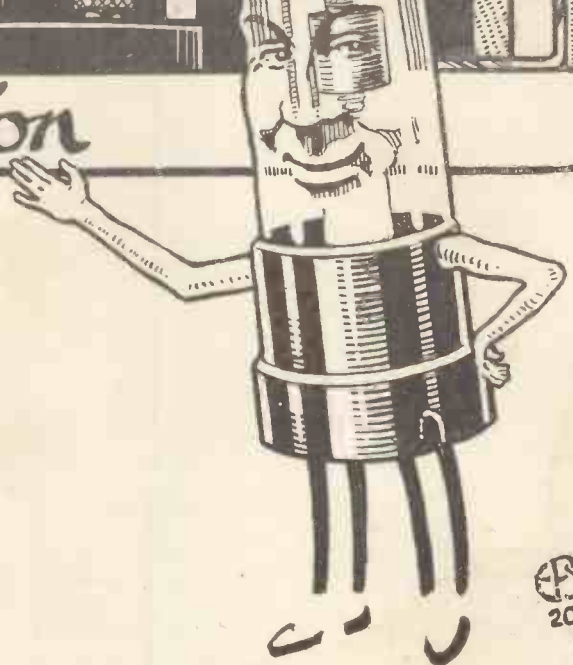

For receiving vocal and instrumental items you must have

### MULLARD "ORA" Valves

to get the best results.

**O**scillates **R**ectifies **A**mplifies

Specially recommended where good amplification is required.

The "Ora" Valve requires about 3.8 volts on the filament and 30 volts or over between the anode and filament for efficient results.

## 15/- EACH.

### IMPORTANT NOTICE

The great demand for Mullard "ORA" Valves and other accessories has compelled us to open much larger works. A greatly increased output is now available.

The MULLARD "R" Valve is now reduced in price from 22/6 to 17/6.

# Mullard Radio Valve Co. Ltd.

45, Nightingale Lane, Balham, S.W.12.

.....

Contractors to H.M. Admiralty,

War Office, Royal Air Force & Post Office.

Telephone: Battersea 1068    Codes: ABC(5Ed)    Telegrams: Radiovalve Hammer Lond.  
Bentley's



Name and Address.....  
To the  
**MULLARD RADIO VALVE CO., LTD.**  
45, Nightingale Lane,  
Balham, S.W.12.

Please send me post free

Quantity	Description	Price
.....	Telephone Head Sets	39/- per set
.....	"ORA" Valves	15/- each
.....	Grid A Resistances	5/- each
.....	Anode A or B Resistances	5/- each
.....	BA Condensers, mfd. 0008	2/6 each
.....	Combined Condensers and Valve Bases with Terminals	7/6 each
.....	Valve Sockets	5/- each
.....	Terminal Clips	1/6 each
.....		80/- per pair

I enclose (Cheque Money Order, P.O.) value

to cover the cost.

Name of usual Wireless Dealer

**SEND THIS TO-DAY.**

# STERLING - - - No. 1 CRYSTAL - - - RECEIVING SET.



The Sterling No. 1 Crystal Receiver has been specially designed for use in connection with the Wireless Telephony Broadcasting Scheme, and is suitable for a range of about 25 miles.

Contained in polished walnut case, with fittings mounted on ebonite panel, and comprises:

**TUNER.**—This consists of an inductance which can be varied by means of tappings taken to two stud switches, one giving coarse and the other fine adjustment.

A separate coil is provided for reception of time signals, etc., from Eiffel Tower.

Detector of the crystal type, requiring no battery. Sensitive and easily adjusted.

The equipment includes one pair of **DOUBLE HEAD TELEPHONES**, No. R 1258, wound to a total resistance of 2,000 ohms the pair.

**PRICE £7 - 12 - 6**

**IMMEDIATE DELIVERY.**

To be obtained from all dealers or direct from:

**Sterling Telephone & Electric**

TELEPHONE HOUSE, Co., Ltd.,

210/212, Tottenham Court Road, London, W.1.

Telephone No. 4144 Museum (7 lines). Telegrams: 'Cucumis, Wesdo, London'

Works: **DAGENHAM, ESSEX.**

**BRANCHES:** NEWCASTLE-ON-TYNE: 9, Clavering Place.

CARDIFF: 8, Park Place.

# THE *Crystophone* REGISTERED BROADCAST RECEIVERS

(to Postmaster-General's Specification)

TYPE.	PRICE Inclusive of all Royalties.		
	£	s.	d.
"The Scout" Crystal Receiver	3	10	0
Royalties included—7s. 6d. ...			
21. Crystal Receiver	4	15	0
Royalties included—7s. 6d. ...			
20. Crystal Receiver	5	10	0
Royalties included—7s. 6d. ...			
30. Crystal and Single Valve L.F.A.	12	10	0
Royalties included—£2 0s. 0d. ...			
33. Crystal and 2 Valves (1 Detector)	15	0	0
Royalties included—£3 7s. 6d. ...			
34. Crystal and 3 Valves (1 Detector)	23	0	0
Royalties included—£4 10s. 0d. ...			

The **PROVED BEST** for  
Maximum Power, Purity of Tone  
and Simplicity in Operation

INSIST on a practical demonstration before you purchase—is all we ask. IT IS SUFFICIENT TO PROVE THE SUPERIORITY OF

THE *Crystophone* REGISTERED

*Crystor* REGISTERED

## COWL INSULATORS

(PROV. PATENT)

THE **ABSOLUTE ESSENTIAL**  
OF A PERFECT AERIAL



**AERIAL INSULATORS**

Price 1/9 each.

**Crystor Aerial Outfit**

**SINGLE WIRE AERIAL**, containing 2 Crystor Cowl Aerial Insulators, 1 Crystor Cowl Lead-In (vertical or horizontal), 100 ft. Best Quality stranded copper Aerial Wire, 100 ft. Best Hemp Rope, and one pulley block, packed in box. Price complete, **18/6** Postage 1/6 extra.

Horizontal Wall or Window  
**LEAD-IN**  
6/6

**WIRELESS SUPPLIES CO.**  
64, MORTIMER ST. LONDON, W.1.  
Phone: Museum 2672 Grams: Adragonax, Wesdo, London.

Vertical Roof  
**LEAD-IN**  
6/-

All Applications for Advertisement Space in POPULAR WIRELESS to be made to JOHN H. LILE, Ltd. (Sole Agents), 4, Ludgate Circus, London, E.C.4. Phone: 10806 Central.



No. 28. BRITAIN'S FIRST RADIO CHRISTMAS.

# POPULAR WIRELESS

3d  
Weekly

No. 28. Vol. 2.  
Dec. 9, 1922.



**LISTENING-IN  
TO 2 LO.**

**SPECIAL FEATURES IN THIS ISSUE:**

Radio Presents for Christmas.  
A Chat About Crystal Detectors.  
A Simple Automatic Transmitter.

Coupled Tuners.  
The Marconi Museum.  
Some Remarks on Broadcasting.

Another Valve Article by John Scott-Taggart, F.Inst.P.



**B.B.C.**  
BRITAIN'S BEST COMPANY

# WHAT IS YOUR OPINION NOW!!

You who purchased No. 1 Home Sets at our recommendation, does it not do all we claim?— is it not the best of its kind? You have proved it covers comfortably the 35 miles radius from a Broadcasting Station, and we thank you for the many recommendations made to others.

## THE INSTRUMENT SHOWN HERE

Is the original Home Wireless No. 1 Outfit, which was described in the Press back in April last, and sold since 1913. The instrument does justice to the manufacturers, and is admired by purchasers. The outfit is supplied complete as illustrated, and there are no extras to be bought, and the illustrated booklet supplied enables a layman to erect without any assistance or experience.

**Price £4 10s. Complete.**

Tuning range 200 to 1,200 Meters. Dimensions 12 ins. x 8 ins. x 6 ins. We invite you to call at any of our branches and hear reception made through this set. If you purchase through a dealer, insist on seeing our trade-mark, and label No. 1 Home Wireless Set. None are genuine without. Unconditionally Guaranteed. Supplied for use against "B.B.C." or experimental licences.

### High Grade Triple Valve Set De Luxe.

Mounted in highest grade Cabinet, similar to pedestal Gramophone, supplied in various finishes, to harmonise with existing furniture. The ideal set for the reception of Broadcasting, being complete in itself. Price £45 to £60.

CALL AND INSPECT.

## MITCHELL'S ELECTRICAL & WIRELESS, LTD.,

McDermott Road, Peckham, London, S.E.15.

RETAIL BRANCH: 188, Rye Lane, Peckham, S.E.15.



G.P.O. Regd. No. 151.

### NEW WEST-END BRANCH.

For the convenience of our customers, we are opening a branch at

**No. 2, GERRARD PLACE**  
(Next to Shaftesbury Theatre)

where commodious accommodation will enable us to carry large stocks and save you that journey to Peckham.

**B.B.C.**  
AND EXPERIMENTAL APPARATUS

## "RESULTS EXCELLENT"

The above remark is contained in a repeat order telegraphed to us by a trade customer at FELIXSTOWE, who obtained perfect reception of the London Broadcasting Station on our

G.P.O. Reg. **"HESTAVOX" II.** No. 2005

2-VALVE BROADCAST RECEIVER



This beautifully finished instrument, fitted with High Frequency Amplification and Variable Reaction, is the last word in efficient Broadcast Receivers. It is licensed under Marconi Patents and bears the B.B.C. Trade Mark.

**PRICE (less accessories) £12 : 7 : 6**

**ASK YOUR DEALER FOR A DEMONSTRATION**  
Illustrated Loose Leaf Catalogue, Post Free, 6d.

The **"HESTIA" ENGINEERING COMPANY,**  
32, PALMERSTON ROAD,  
1 min. South Acton Stn. ACTON, LONDON, W.3.  
(N.L. and District Elys.)

Showrooms open  
9 a.m. — 6 p.m.  
Telephone :  
Chiswick 586.

## AMATEURS!

### Don't Work in the Dark.

You can acquire a thorough knowledge of the Scientific Principles which govern the working of your apparatus quickly and easily by our system.

**PLEASANT LESSONS BY POST AT YOUR LEISURE.**  
Our Course of individual tuition is certain to appeal to you, whatever previous knowledge you may have, or if you have none. Among our students we number highly trained scientists with University Degrees, as well as those with no scientific knowledge whatever.

Special fee for the Course—30/- cash, or 6/- upon enrolment and five monthly payments of 5/-.

**THIS IS JUST THE THING YOU NEED—BEGIN TO-DAY.**

Write for full particulars to—  
**THE NATIONAL INSTITUTE OF APPLIED SCIENCE,**  
3, 5 & 7, OLD QUEEN STREET, LONDON, S.W.1.

## No Waiting. Delivery from Stock

### Perry Head Phones

4,000 Ohms **21/-** per pair



Specially designed for Wireless Telephony. Receivers arranged in series, Aluminium Cases and fitted with extremely light and efficient Head Bands, and Twin Connecting Cords.

Illustrated Wireless Catalogue now ready. Post Free 3d.

**The JEARY Electrical Co<sup>LD</sup>**

8, LAMBETH HILL, & 97, Queen Victoria St., London, E.C.4



**NEXT WEEK.**

Special Articles

By

P. J. Risdon,  
F.R.S.A.

E. Blake,  
A.M.I.E.E.

Sir J. Kenneth D.  
Mackenzie Bt.

John Hill.

# Popular Wireless

TOPICAL NEWS AND NOTES.

**NEXT WEEK.**

Balanced Crystal  
Circuits.

Success with Dry  
Cells.

Notes on the  
London Ether.

Wireless and the  
Seasons.

And many useful  
"Tips" sent in by  
readers.

**A P.W. CHRISTMAS DISH.**

TAKE half-a-dozen leaks, one pound of high frequency currents and a pint of ether. Remove the cores from the leaks, and carefully stone and insulate the high frequency currents. Strain the ether through a finely meshed grid to remove electrons. Beat well in a heterodyne receiver, and ionise for half an hour. Place in a transformer until done to an ampere turn, and serve with a garnishing of statics on a hot plate.

**Christmas Arrangements.**

I WAS surprised to learn from the Broadcasting Company that so far no special arrangements have been made for any extra features in the Christmas broadcasting programmes. Maybe it is a little early, and it is to be hoped that before the advent of the festive season enlarged programmes will be announced. I trust that the B. B. C. will realise the immense possibilities that such a season holds for the furtherance of the popularity of wireless in the home.

**Empire Greetings.**

I AM informed from an authoritative source that the authorities have now been approached in connection with the broadcasting from the home country of a Christmas greeting to all the outlying islands of the Empire.

I understand, however, that a difficulty arises inasmuch as the only station available for the transmission over the necessarily very great radius is Leafield, and that the instruments possessed by the smaller stations by whom the greeting would be more appreciated are not (in most cases) suitable for the reception of the long wave sent out by that station.

**THE LURE.**

LONG into the night she sat watching  
The fire that but feebly burned;  
The hour of midnight solemnly tolled,  
But yet he had not returned.  
What could she do to keep him at home,  
Keep him away from that club?  
While love springs eternal hope will not die,  
Traps must be set for that "hub."  
But now you'll find him always at home,  
And proudly to you he'll own,  
That he's never been out since the day  
She bought him a Radiophone.

**RADIO RAMBLINGS.**

Radio greetings—"Hallo, Old Grid!"  
\* \* \* \* \*  
Seen at the Wireless Revue—Valve legs.  
\* \* \* \* \*  
Song of the lost signal—"Come Back to Erin."  
\* \* \* \* \*  
"Every little helps," said the H.T., as it jumped across the filament.  
\* \* \* \* \*  
Why did the valve "howl?" Because an electron passed round the plate, and found it 2 M T.  
\* \* \* \* \*

Why did the valve oscillate? Because it had got the "ague."  
\* \* \* \* \*

To the "I O watter" (more particularly 2 G M). Full many a wave is born to rush unseen, and waste its sweetness on the desert air.  
\* \* \* \* \*

He who oscillates is "cussed."  
\* \* \* \* \*

Waves of a feather jam together.  
\* \* \* \* \*

Generally the "sun" sets in the West, but not when the set's in the East—part of the room.  
\* \* \* \* \*

Song of the Hague.  
—It is better to have heard and lost, than never to have heard at all.  
\* \* \* \* \*

**Provincialities.**

Wireless sets tuned by an efficient staff of trained blackbirds. Concert pitch and "howling" (if desired) guaranteed. Terns moderate. Lettit Leak & Co., 17, Rapid Path, E.C.

Lost, somewhere between 2 L O and a private crystal set, a dear little electron answering to the name of Tiger. Finder, returning same to the nearest wireless station will be rewarded.

Leaky condensers and all other earth-seeking apparatus effectively and permanently repaired. Grid leaks a speciality. N. Sulation & Co., Poole.

**YOU** who have a wireless set are aware of the pleasures it gives—of the fascination to be experienced by listening-in to the voices and musical items sent out by the broadcasting stations by Radio.

This will be Britain's first Radio Christmas and you can help others to enjoy to the full the true spirit of the season by inviting them to "listen-in" on your set and so, perhaps for the first time, appreciate the pleasures of a Wireless Concert.

In this number of "Popular Wireless Weekly" many well-known firms of established repute are offering attractive presents in the shape of Broadcasting Receivers.

You can give no better present than one of these instruments, which will provide endless entertainment for your friends and their friends too.

Urge your friends to buy a set now, for remember

**"This is Britain's First Radio Christmas."**

**The Radio Association.**

A SERIES of lectures have been arranged under the auspices of the Radio Association.

On the afternoon of December 14th, Professor P. M. Baker, M.B.E., B.Sc., A.M.I.Mech. E., A.M.I.E.E., will lecture on Wireless to six hundred scholars at the Central Foundation School, Cowper Street, London, E.C.2.

Professor Baker will be assisted by Major Raymond Phillips, I.O.M., the well-known expert on wireless control, whose articles have been appearing in POPULAR WIRELESS.

Application for lecture fixtures should be made to the organising secretary, the Radio Association, 44, Great Russell Street, London, W.C., when full particulars will be given.

## NOTES AND NEWS.

(Continued from previous page.)

## "Drum Wireless."

**CAPTAIN R. S. RATTRAY**, of the Gold Coast Political Service, as a result of close observation and intimate inquiries in Ashanti, has found that these wireless messages are tonic: That is, they are based and depend on tone.

Travellers, explorers, and scientists have usually ascribed these drum messages to a code, but Captain Rattray has brought home to England the complete tone system, and will embody the result of his researches in a book.

## A Christmas Greeting.

**CHRISTMAS** greetings from England will be sent by wireless to within 600 miles of the North Pole this year.

A remote colony of workers in the marble and coal mines of the Northern Exploration Company, at King's Bay, Spitzbergen, will wait expectantly on December 25th for a wireless message from home. King's Bay is in latitude 79 degrees N., 1,500 miles away, and there are about 170 men and women in the two camps at this part of Spitzbergen Island.

## American Concert Heard.

**THE** following is extracted from the "Daily Mail."

For the first time on record a wireless concert broadcast from the United States has been heard in England. Mr. Frank Phillips, chief engineer of Messrs. Burndept, Ltd., wireless engineers, of Blackheath, S.E., told a "Daily Mail" reporter the other day:

"About 1.15 a.m. on November 27th our chief test-room operator, Mr. J. H. Ridley, was tuning up an apparatus at his house in Croydon, hoping to pick up test Morse signals sent out by amateurs in the United States.

"He was surprised to hear strains of distant music, together with the call No. W J Z repeated several times. W J Z is the call number of the Newark, New Jersey, U.S.A., wireless station. (Newark is 3,750 miles from London.)

"For more than an hour," Mr. Ridley says, "the concert continued and he was able to hear every item of it. A prelude by Chopin was among the things played. The wave-length used was 325 metres, which we know is the wave-length used by the Newark station."

While listening in Mr. Ridley heard no fewer than nine American amateur stations calling to one another. The most distant station he heard was Chicago (4,652 miles from London).

## Absurd!

**A BAN** on wireless for flat-dwellers is recommended by the St. Pancras Estates Committee, who suggest that "applications from tenants of flats in the Council's dwellings to fix wireless installations be not acceded to." The committee report that the insurance company with whom the property is insured for fire consider that it would be advisable to refuse permission if the sets are being installed and fitted by amateurs.

The recommendation of the committee will cause considerable surprise among



Miss Gloria Swanson, the Cinema Star, listens-in.

wireless circles. A more absurd ban was, in my opinion, never suggested before.

## Various Items.

**AT** a special general meeting, held on November 22nd, the Wireless Society of London altered its title, and will in future be known as the Radio Society of Great Britain.

**POPULAR WIRELESS** has received from Marconi's Wireless Telegraph Co. a copy of a special souvenir prepared as a memento of the Prince of Wales' speech by wireless. The souvenir contains the names and comments of all those who reported on H.R.H.'s speech.

The Rt. Hon. F. G. Kellaway, P.C., has been appointed a director of Marconi's Wireless Telegraph Company, Limited.

## Radio Association.

**THE** Radio Association is progressing well judging by the enterprise of the Brockley branch members.

Since broadcasting commenced crowds may be seen nightly outside their headquarters at 111, Upper Brockley Road, listening to excellent musical programmes and all the latest news of the world.

Further remarks of the Radio Association appear on the Radiotorial page. **ARIEL.**



# Broadcasting Programmes

What you can hear every evening of the week on your set.

**TELEPHONY AND MUSIC TRANSMISSIONS.**

Station.	Call sign.	Wave-length in metres.	Remarks.
Croydon .. ..	<b>GED</b> ..	900 ..	Throughout day to aeroplanes.
Marconi House, London, Broadcasting Station	<b>2LO</b> ..	360 ..	Every evening, 6 to 6.30 p.m. (News Bulletin); 8 to 9 (Concert); 9 to 9.30 (Late News); 9.30 to 10 (Concert and Dance Music. Continuous service to be given shortly.
Writtle, Essex .. ..	<b>2MT</b> ..	400 ..	Tuesdays, 8 p.m. (Concert.)
Paris .. ..	<b>FL</b> ..	2,600 ..	7.20 a.m., 11.15 a.m., 5.10 p.m. Also occasional telephony at 10.10 a.m. and 9.20 p.m.
Königswusterhausen ..	<b>LP</b> ..	2,800 ..	Between 6 and 7 a.m., between 11 and 12.30, and between 4 and 5.30 p.m.
The Hague .. ..	<b>PCGG</b> ..	1,085 ..	Sundays, 3 to 5 p.m. (Concert.)
Haren .. ..	<b>OPVH</b> ..	900 ..	Practically every 20 minutes past each hour from 11.20 to 4.20, giving messages to aeroplanes on the Brussels - Paris, Brussels - London, and Brussels - Amsterdam lines.
Radio-Électrique, Paris	— ..	1,565 ..	Concerts at 8.45 p.m.
Brussels Meteorological Institute .. ..	<b>OPO</b> ..	1,500 ..	Slow C.W. and Morse. Easy reading for amateurs.
Messrs. Burnham* (Blackheath) .. ..	<b>2FQ</b> ..	440 ..	Irregularly any evening.
Newcastle* .. ..	<b>5BA</b> ..	440 ..	Between 6 and 7.30 p.m.
Manchester Broadcasting Station .. ..	<b>2ZY</b> ..	385 ..	Every evening, 6 to 10 p.m. (News, vocal and instrumental music).
Birmingham (Witton) Broadcasting Station	<b>2WP</b> ..	425 ..	Every evening, except Sunday, 6 to 10 p.m. (News, Concerts, etc.).

NOTE.—The Bar Lightship, Liverpool, sends telephony at 7 a.m., 9 a.m., 11 a.m., 12 noon, 1 p.m., and every two hours until 9 p.m. Calls "Dock Office." Liverpool answers "Bar Ship."

In addition to the regular transmissions carried on between the British amateur stations, much telephonic conversation may be heard from St. Ingelvert (AM), Le Bourget (ZM), and Brussels (BAV). These stations are quite powerful, but they call for a little extra care in tuning. Wave-length, 900 metres.

All times given are G.M.T. An asterisk denotes transmissions made purely for experimental purposes.



# A FEW THOUGHTS ABOUT BROADCASTING.

By HIGHAM BURLAC.

I BELIEVE that wireless broadcasting will be a powerful force in the evolution of society. The development of a highly sensitive organism is controlled to an enormous degree by its environment, and if broadcasting enters deeply into the life of the community, as I think it will, it will produce a well-marked effect as the result of an intensified environment.

Those who select the material which is to be conveyed into tens of thousands of homes by wireless means will undertake a grave responsibility; they will be not entertainers only, but educators and moulders of the plastic mentality of the country's youth. They will utilise a mighty force for good or ill.

There is a striking parallel between the cinema and the broadcasting station, which is so obvious that I will not describe it. Although I enjoy fifty per cent. of the average cinema programme, I believe the "films" have missed the mark and that one day we shall use them properly. Broadcasting is just beginning; it has its career before it. Let it not be a by-word, and the hall-mark of the unsophisticated.

## Educative Value.

We who are wireless men do not want our art to be stigmatised as something equivalent to the art of cheap but purple melodrama of the "Curse you, how I hate you" type. I have no doubt whatever, but that clearly seen as the ideal may be, the accomplishment will be attended by those difficulties which invariably beset the path of men whose job it is to please everybody. Luckily public taste in this country is, in the main, sound and healthy if not cultured; I would back it against that of any other country outside the Empire.

Therefore, I think that "broadcasting," though it must minister to many varieties of mind and taste, may well aim at the high levels without fear of failure. I go further and assert that to succeed it must "hitch its wagon to a star." The quality of the broadcast matter which the public will stand will stamp us just as surely as we are known by our national sports or by the books which we cause to be "best sellers."

The effect of broadcasting upon the rising generation should be well worth watching. The kiddies of two and three years old just taking a full grip on consciousness, and those who will be born hereafter, will take possession of homes into which, through peculiar trumpet-like instruments and other noisy little contrivances, there will pour the amazing influence of the world outside; but these amazing influences will be part of their normal environment and will be accepted as casually as the moon and patent foods.

What kind of school-child will be produced by a home in which, by the operation of a few switches and the kind permission of a Cabinet Minister, the voices of men and women, stringed instruments, trumpets and the loud-sounding cymbals, nay, even the lute, the harp and the oboe, may be rendered audible for hours at a stretch? We shall learn in due time, but I fancy the result will be that we shall prepare an excellent

foundation for school education somewhat at the expense of that sweet simplicity, that Victorian virginity of mind which we like to associate with those of tender age.

I am not sure that I want my boy and girl to discuss Grieg or Brahms—just yet. I prefer to hear Wonder (aged four) speculating under the table as to why the black kitten resents attempts to poke it into a jam-pot, and Wisdom (aged eight) reading about the immortal Beanstalk.

Yes, there will be bed-time stories for such as these, but those who would remind me of this are not parents of human kiddies or they would know that anything with "bed-time" tied to it is regarded by the victims with instinctive, incurable suspicion.

So for the infant and adolescent, eighty per cent. of whose environment is, normally, the home and the school, we shall make sensible the pulse of the great outside world of thought and music, in a manner more real and convincing, more intimate and personal, than does the newspaper, the book or the gramophone.

## A Useful Habit.

Tempted by the fascination of wireless, many people will be content to listen to broadcast matter which, if in print, they would not consider to be interesting. They will assimilate pills of knowledge embedded in the jam of curiosity. There are persons who will not read books or stir out-of-doors to attend lectures or concerts, who will experience a revelation when their telephones begin to speak to them—a revelation accompanied by regret for the lost past, and anticipation of the future.

Incidentally, what a blessing the Radio-phoné will be to the hostess when the guests are shy, and what a fund-of-table-topics it will provide.

Words, phrases, and facts picked up by wireless will stimulate or, should I say, augment the intermittent flow of questions propounded by the receptive mind of youth,

and thus the elders will (by stealth in many instances) explore the dictionary and encyclopædia—a wholesome activity, which may well be transformed under the influence of broadcasting from a series of spasms into a habit.

## Beating the Gramophone.

This will be all to the good, for the average man of forty and over does not use his books of reference half enough. Meanwhile the youngsters will sit through lectures or "talks" by notabilia, by authorities, and even by men who know their subjects—and a little of it will assuredly stick, because of the personal touch.

Technical wireless is forbidding stuff in a book, but where is the man, woman, or boy, who would turn off the valves if Senatore Marconi or Sir Oliver Lodge were billed to address the ether, as I sincerely hope they may be ere long. No longer shall the immortals confine their utterances to exclusive gatherings at 4 p.m. of a working day; they belong to mankind, and thanks to broadcasting, mankind shall have them, through a microphone.

Ten years of successful broadcasting will leave a mark on society. Age will be more informed, less bored and sharper of hearing. The switch which lights up the valves will be where the porcelain bell-pull of the Victorian house had its place, by the side of the mantelpiece—"between the wall and the fire." The loud-speaker will hang from the ceiling, with the electric light bulb hanging from its centre like the stamen of a flower. Youth and Innocence will also be more informed and sharper of hearing, and will turn on "gaiety" chorus when Age desires its post-dinner nap.

Grandma will regard the Sunday radio sermon with suspicion, just as her father regarded Professor Huxley, but the dear old lady will eventually surrender and thereafter will be the proud possessor of a special pair of L.R. telephones, which will dwell beside her spectacle-case in great honour.

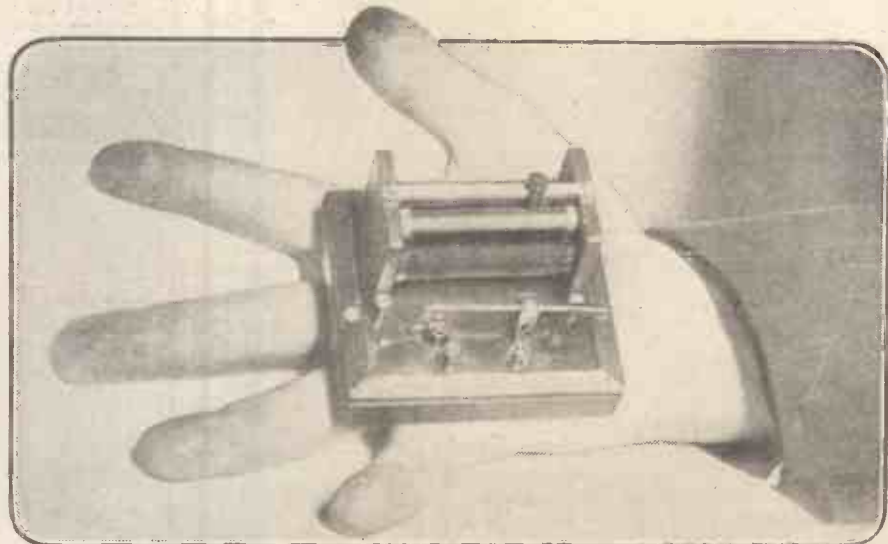

A neat, compact and efficient little crystal set made by Autoveyors Ltd.



# THE MARCONI MUSEUM.

RECENTLY I spent a very enjoyable afternoon inspecting the numerous treasures contained in the museum at Marconi House, London.

From the earliest type of miniature coherer and clumsy oscillating transmitter circuit, there are a wonderful variety of instruments. So numerous and so interesting are they, in fact, that I find it by no means an easy task to select a limited number of items for treatment in this article. To describe even briefly the interesting characteristics of each instrument in the museum would fill a complete issue of POPULAR WIRELESS. I will, therefore, confine myself to those items with which the amateur is most likely to be already familiar in some connection or other.



The Magnetic Detector.

One of the first things to catch my attention was a huge induction coil which stood on the floor under one of the benches. I was informed by the Marconi representative who courteously enlightened me on the origin of the various objects in the museum that this coil functioned as the transmitting equipment of the first commercial station in the world, which operated from "The Needles," Isle of Wight. It certainly looked as if it deserved that distinction, if size and sturdiness are any criterion of efficiency!

## Primitive Apparatus.

No less burly and efficient-looking was the primitive transmitting equipment that looked hopelessly out of place under a glass case in one corner. So far as one could see, it comprised merely a coil of wire and a spark gap. Ten turns of heavily insulated wire were wound horizontally on a wooden frame, the result being rather like a miniature fence. Inside this fence were two electrodes, mounted on ebonite supports. This arrangement was used with some of the earliest experiments with tuned circuits.

Close by, in the depths of another glass case, an early form of Poulsen's telephone transmitter hobbled with a thing that looked like a toy Catherine wheel! This latter turned out to be one of the first rotary disc dischargers. This form of transmitter has always been a great favourite with amateurs, because of the high penetrating quality of the note resulting from it.

I must not forget transmitting keys. One of the most interesting features in the museum was the "Grasshopper" key, which worked more like a pump-handle than anything else. The "dip" was about three inches, and the handle was a knob of ebonite about three inches high!

There were also one or two good, solid transmitting keys, each of which possessed a "telephone short-circuiting device." This took the form of two strips of brass, one of which was fitted to the key base, the other being attached to the end of the lever arm farthest from the handle. When the key was depressed for transmission these two strips of brass made contact before the key itself made contact for transmission.

## Valve History.

As the brass strips were connected across the telephones, the effect of this was to short-circuit the latter whilst transmission was taking place, and thus save the telephones (and the operator) from the effects of the heavy transmitting currents. As the brass strips were very springy, this did not tend to make the process of transmitting as laborious as one might expect.

In the course of my wanderings among these relics of bygone days I suddenly caught sight of something that looked exactly like one of the modern patterns of loud speaker! At first I thought it must have got in among the collection by mistake; then, feeling that I might be on the verge of a wonderful discovery "all by myself," I approached it gingerly. I had only to touch it, of course, to realise that it was one of the first types of aerial down-lead insulators! Its funnel shape was to prevent the rain from leaking through the roof of the receiving-room at the point at which the aerial lead was brought in.

Now for the receiving instruments. By far the most important of these was the original two-electrode Fleming valve. There were, in fact, several of the valves used by this famous scientist in his very earliest experiments. I noticed one valve that had a small flat metal plate, instead of the cylindrical plate which characterised the others.

The flat plate at once recalled the "Edison effect" to my mind. It was Edison who first noted the fact that a glowing wire in a bulb from which the air had been extracted shot off electrons. He discovered this after studying a number of the "blackened" bulbs which were fairly common in the early days of electric lighting.

Instead of throwing them away as useless, Edison examined these bulbs, and found that in each case there was a thin streak on the surface of each bulb which was not black. On further examination he discovered that this was due to the shielding effect of one leg of the filament, the particles of carbon that caused the blackening being shot off from the other

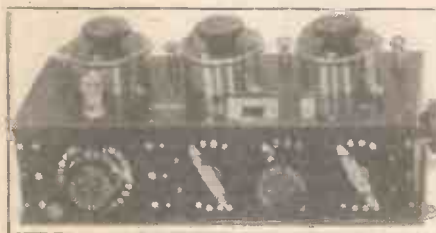

The Multiple Tuner.

leg of the filament. Still closer analysis revealed the fact that it was not carbon particles that were shot off in the first place. Electrons were shot off, carrying the carbon particles with them.

Edison, however, did not realise the important application of his discovery to wireless. It was left to Fleming to make use of this electronic flow for the purpose of detecting wireless signals. In his first attempts, therefore, he used a flat plate, as Edison had done when demonstrating his discovery.

Apparently, Fleming did not content himself with the ordinary open cylindrical plate, however. The museum collection showed a variety of experimental types. In one small valve the plate was a closed metal cylinder; in another it took the form of a fine mesh.

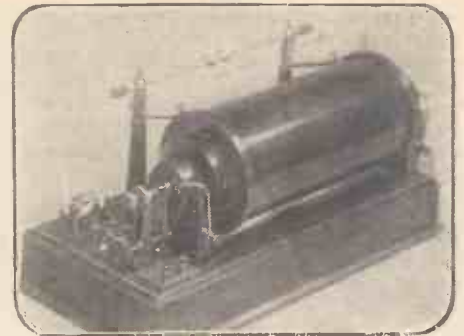

Emergency 10 in. Spark Coil.

Another Fleming invention was a cymometer. The simpler modern term for an instrument performing the same function is wavemeter. This particular wavemeter was approximately four feet long! It contained a variable inductance and capacity that could be adjusted by a sliding handle. It occurred to me that it would make a very effective hat-rack!

## An Interesting Relic.

I had no sooner noted this fact than I found myself confronted by a very well-made bird-cage. At least, it looked like a bird-cage. On inquiry, I found that it was a perfectly harmless "radiogoniometer." In other words, it was one of the first instruments made in this country for use with the Bellini-Tosi system of direction-finding. It looked quite capable of doing its job thoroughly.

I must not forget the famous magnetic detector. This instrument was designed by Marconi specially for use on board ship. In the early days of maritime wireless crystals were not considered sufficiently reliable for working on board ship, on account of the vibration, etc.

As a final item, I would mention a multiple tuner, the type of instrument on which so many S O S calls have been received in all parts of the world. There were two or three of these well-known ships' instruments in the museum. One of them looked rather pale and battered. It was the tuner of the SS. Falaba, which was sunk during the war and afterwards salvaged—an interesting and valuable item in an interesting and valuable museum.



# THE THREE-ELECTRODE VALVE AS A PRACTICAL AMPLIFIER.

By JOHN SCOTT-TAGGART, F.Inst.P., M.I.R.E.

Author of "Wireless Valves Simply Explained," "Simplified Wireless," etc.

HAVING discussed the general theory of the action of the three-electrode valve, we may now consider simple circuits in which the valve will act as an amplifier. Fig. 1 shows, diagrammatically, a thermionic valve V containing a filament F, a grid G, and a plate or anode P. In the plate circuit we have the telephones and the high-tension battery. The filament is heated by an accumulator. The terminals W X have supplied to them varying potentials or voltages which make the grid G control the flow of the electrons from the filament F to the plate P, and round through the telephone receivers.

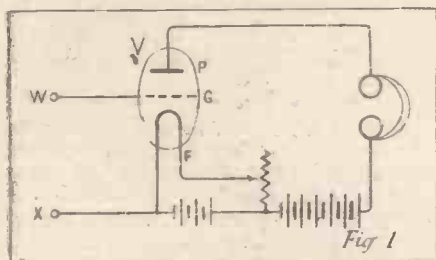

A steady current through a pair of telephone receivers will produce no effect, but if we vary the current through the telephones a note will be heard. The telephone receivers will operate if the plate or anode current flowing through them varies at a low frequency. In the diagram, R represents a variable resistance or rheostat, and its purpose is to vary the current flowing through the filament F.

**Note Magnifiers.**

As we have pointed out that the valve V will act as an amplifier, it will be seen that if we apply weak potential variations to the grid, we will get much stronger variations in current in the anode or plate circuit of the valve. These stronger variations of current will cause the telephones to give out a signal which is much stronger than the original signal received without the aid of a valve. Such an arrangement is called a "low-frequency amplifier," or sometimes a "note amplifier" or "magnifier." We can improve the simple arrangement of Fig. 1 by passing the signals through a step-up transformer instead of directly on to the grid.

Fig. 2 shows the use of a transformer T1 T2, the terminals W X being those to

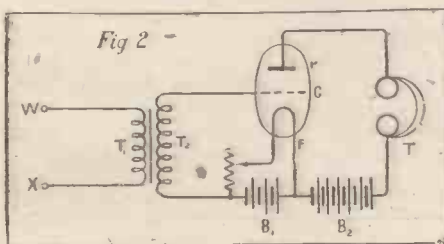

which the signals to be amplified are applied. The transformer T1 T2 really consists of an iron core on to which is wound two sets of windings, T1 and T2, the connections to the winding being kept separate. If such an arrangement is used, any varying currents through the winding T1, which is called the "primary winding," will produce similar varying currents in T2, which is called the "secondary winding." If there are more turns on the secondary winding than on the primary, the transformer is called a step-up transformer, and it has the effect of increasing the voltage of the signals.

**Crystal Sets and Amplifiers.**

These signals are now applied to the grid G of the three-electrode valve V, and produce large variations in the current through the telephones T. We have now a very simple and efficient one stage low-frequency amplifier which may be used for strengthening the signals from a crystal detector, or from a valve receiver. All we do is to connect the terminals W X to the telephone terminals on the receiver apparatus. The rectified currents will now pass through T1 instead of through the telephone receivers.

A crystal detector receiver is only suitable for receiving comparatively short distances. If, however, it is desired to strengthen the signals several times or to receive a further distance, valve amplifiers may be employed, and it will be found that a single valve will give greatly enhanced signals. Such an arrangement is often termed a single valve amplifier or one stage amplifier. It is sometimes also termed a note magnifier or note amplifier. Another name is audio-frequency amplifier.

In Fig. 3 we have the usual kind of crystal receiver with the exception that the telephones are not connected across the telephone condenser C2. In place of the telephones, however, we connect the primary T1 of the step-up transformer T1 T2, the secondary of which is connected across the grid G and filament F of the valve V. The remainder of the apparatus is the same as that of Fig. 2.

The action of this circuit is briefly as follows: The incoming oscillations are rectified by the crystal detector D, and produces a varying current through the primary T1 of the step-up transformer T1 T2. This varying current produces similar varying currents of greater voltage in T2, and these greater voltages are applied to the grid G.

The varying volt-

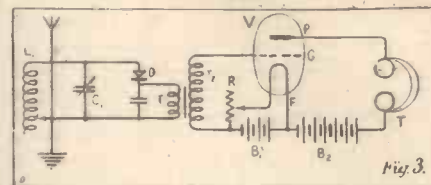

ages on the grid G vary the number of electrons which pass between the filament F and the plate P, and therefore control the current flowing through the telephones T. The greatly magnified variations of current through T produce a loud signal which may be three or four times that which would have been obtained if the telephones T had been connected across the condenser C2. In these circuits, it is to be noted, high-resistance telephones should be employed, the type of telephone used in the ordinary crystal receiver serving excellently.

**A Complete Receiver.**

Fig. 3 is shown in a perspective manner in Fig. 4. In this figure the aerial is shown by the letter A, the variable inductance by the letter L, and the earth by the letter E. A switch S is shown for tapping off the inductance L. A variable condenser C1 is connected across the aerial and earth. This variable condenser is omitted if, instead of using a variable inductance of the kind shown in the figure, a variometer or slider arrangement is employed. The aerial is also connected by a wire to one terminal of a crystal detector D.

The other terminal of the detector is taken to a fixed condenser C2, generally enclosed in a box. The other terminal of the condenser C2 is connected to the earth. So far, we have the ordinary crystal receiver with the exception that the telephones are omitted.

We now propose to take a connection from the top terminal of the condenser C2 to the primary winding of a step-up transformer T1 T2. A similar connection is made between the other end of T2 and the bottom terminal of C2.

The primary winding consists of a relatively few number of turns wound on a bunch of iron wire, this bunch being called

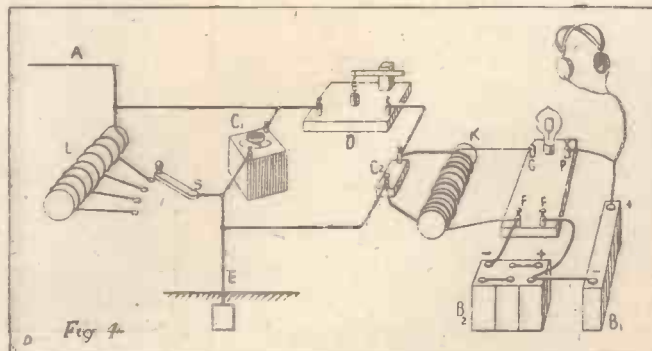

# TESTING VALVE SETS.

By J. MELLANBY.

IT is of the utmost importance for the experimenter to know whether a certain valve circuit is functioning properly, and whether he is using the most efficient combination of filament current, plate potential grid leak, etc. It is also of interest to determine the "amplification factor" of the valve. The "amplification factor" is the ratio of the plate current to the grid current, so that it is obvious that to obtain the best results, this factor should be as large as possible.

The only apparatus required is a small induction coil with tapping key and battery, a pair of telephones (resistance immaterial) and two flat coils of wire, the construction of which will be subsequently described.

## THE THREE ELECTRODE VALVE.

(Continued from previous page.)

the core and being labelled K. Over the winding T1 is wound the secondary winding T2, consisting of a greater number of turns than T1. The whole step-up transformer is generally mounted in a box, and four terminals are provided, two for the primary and two for the secondary. The letters P and S are commonly employed to designate the primary and secondary terminals.

Sometimes one primary terminal is lettered I P, meaning "in primary," and the other terminal being lettered O P, "out primary." Similarly the secondary terminals are sometimes lettered I S and O S. The secondary winding T2 has one end connected to the grid terminal of the valve panel M.

This has four terminals on it marked F, indicating the filament terminals, one marked G indicating the grid terminal and one marked P indicating the plate or anode. A filament rheostat, R, enables us, by turning the knob round, to vary the amount of current flowing through the filament of the valve.

It is generally found that by turning the filament rheostat to the right the filament gets brighter. All valve panels of this kind should be so designed that when the rheostat is turned round to one side the filament circuit is broken, and no current flows through the filament. This is a simple way of switching off the valve when the apparatus is not in use.

The left-hand terminal F of the valve panel M is connected to the negative terminal of a six-volt accumulator B2. The positive terminal of this accumulator is connected to the right-hand terminal F of the valve panel. The terminal P is connected to one lead of a pair of telephone receivers T, the other lead from the telephones being taken to the positive terminal of a high-tension battery B1, giving about 30 volts.

A larger high-tension battery of 45 or 60 volts will generally result in louder signals being obtained. The negative terminal of the high-tension battery B2 is connected to the positive terminal of the filament accumulator B1.

The principle of the method is that when two coils of wire, through one of which an alternating current is passing, are placed parallel to one another and fairly close together, an alternating current will be induced in the second, the magnitude of which is inversely proportional to the square of the distance between the coils. An example will serve to make this clear. Suppose that in two different instances the coils are at distances of 4 and 5 feet apart, then the current induced in the second case will be  $\frac{4^2}{5^2} = \frac{16}{25}$  of that in the first.

The form of the coils should be similar to that of a frame aerial, and not less than 4 ft. square; in fact, one of these may be used for the purpose. 40 turns or more of 24 or similar gauge wire is required. Two pieces of wood, 2 in. x 1 in. x 5 ft. 6 in., are dovetailed together at their centres so as to form a rectangular cross. Down the centre of each arm, commencing from the extremity, small nails, 40 in number, are driven in at distances of  $\frac{1}{2}$  in. apart.

The wire, No. 30 D.C.C. copper, is then led round from one nail to the corresponding one on the adjacent arm, so that when all the nails have been used it takes the form of a flat, square, open spiral. Two of these coils are required and should be mounted in a vertical position in any manner found convenient.

Connect the battery and key in series with the primary of the induction coil, and the ends of one of the coils to its secondary terminals. The ends of the other coil are connected to the telephones.

Place the coils so that their faces are parallel and about six feet apart. On depressing the key, an alternating current will flow in the first coil, while by induction, a similar current will produce a note in the receivers in the second.

If the induction coil is at all rowdy and is causing interference, it must be placed in a box and packed round with cotton-wool. Increase the distance between the coils until the buzz in the telephones is just easily audible; measure this distance, and for convenience let it equal "A" feet.

Disconnect the telephones, and substitute the grid circuit of the valve which is to be

## HINTS TO AMATEURS.

ONE of the greatest enemies to insulation and to batteries—especially dry cells—is damp. Never keep your set in a place where it is likely to be at all wet. Damp sheds or leaky windows may cause no end of trouble if the wet gets at the apparatus.

The drawback of using dry cells for wireless purposes is their high internal resistance. Where, however, a potential only is required, and only a small amount of current will be drawn from the cells, such as when used for grid biasing, the small pocket lamp type of cell will be found to be suitable. It should last quite a long time.

A tip which has been found useful in the Armstrong Super-regenerative circuit, is to connect a small piece of bare heavy copper wire—No. 16—to the grid leg of the regenerative tube. This wire should be about four or five inches long and project like a small aerial straight up from quite a considerable amount of energy, increasing the efficiency of the set.

If you are troubled by telegraph or telephone wires in your garden, erect your aerial as nearly at right angles to them as possible, and as far above them as is consistent with the P.M.G. regulations regarding height and length of aerial.

tested, the telephones being inserted in the plate circuit. The note heard will now be much louder, and the coils must be further separated until it is again just easily audible. Let this distance equal "B" feet. The amplification factor is then equal to  $\frac{B^2}{A^2}$ . An average value for this factor is 6, but with careful adjustments it may be made as high as 10, and has been known to reach higher values.

It will be found much easier to adjust the anode resistance and other fittings to their most efficient values when using this method, than by listening-in to a station, as in the former case the "transmitting" is completely under control, and no tuning is necessary.

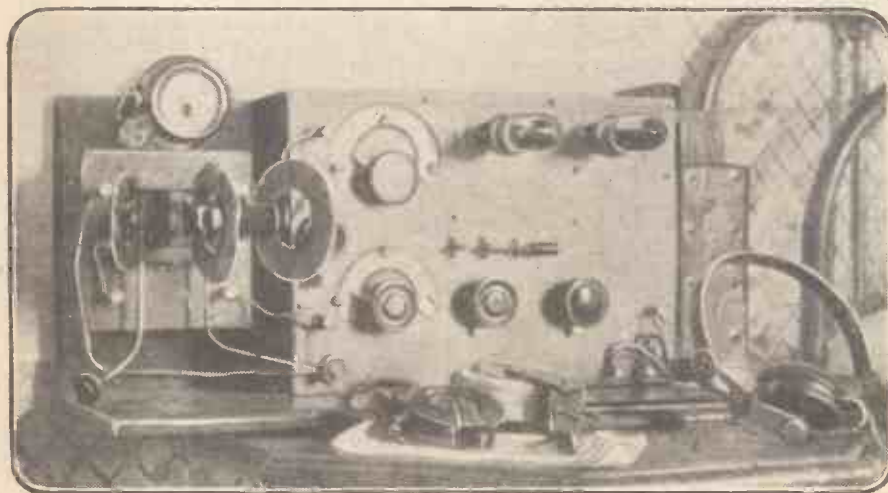

Mr. A. E. Jackson's home-made set, 106, Londonderry Road, Stockton-on-Tees.



# GET IT at GAMAGES

**WHY** Because you are dealing with the PIONEERS OF BETTER APPARATUS FOR AMATEURS—a Firm with too high a reputation to supply Wireless Goods below the high standard of efficiency the Amateur must have to make his experiments successful—his hobby worth while.

**CALL** AT HOLBORN and see any set demonstrated. Look over the large and varied stock of WIRELESS SUNDRIES. Avail yourself of the Expert Knowledge of our staff. That costs NOTHING. And Gamage Prices are the keenest in the Trade for Reliable Apparatus.

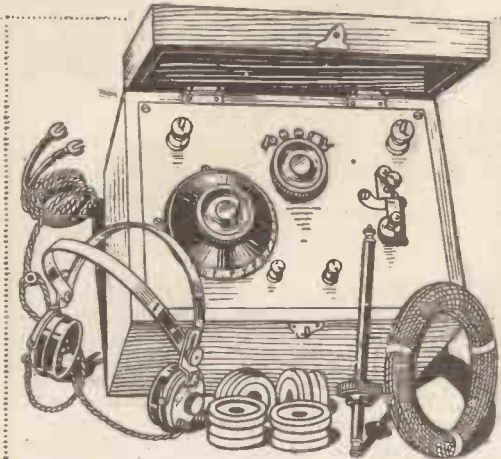

## Fully Licensed CRYSTAL RECEIVER

Fully Licensed and passed by Postmaster-General. The neatest, most efficient and most compact receiver to-day. The Crystal combination is the "Perikon," being Zincite and Copper Pyrites. The wave-length covered is 170 to 800 metres. Beautifully finished and mounted in polished mahogany box, and certainly makes a suitable and desirable present. The total cost of this instrument with high-resistance phones, 100 ft. Aerial wire, Aerial insulators and lead-in tube is **6 Gns.**

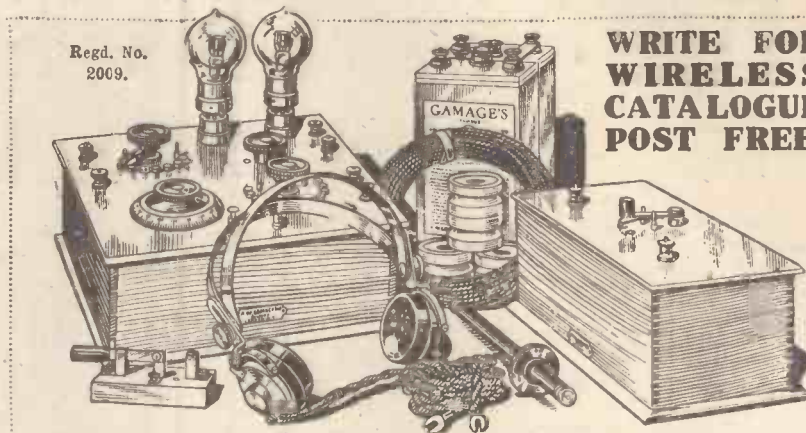

Regd. No. 2009.

**WRITE FOR WIRELESS CATALOGUE POST FREE.**

## The "SONUS" Two-Valve BROADCAST RECEIVER

Consisting of one High Frequency and Detecting Valve. Telephony from Broadcasting Stations up to 60 miles distant can be satisfactorily received on telephones and Low Frequency Amplifying Valves can be added, to increase the volume of music for purposes of operating a loud speaker or several pairs of 'phones. The number of Low Frequency Valves required depends upon the distance from the Transmitting Station. Music and speech are exceptionally clear on this Broadcast Receiver. The Set has been designed to work on the average aerial, and has a wave range of 300 to 3,000 metres, which enables the owner to receive the well-known Time Signals from Paris. The range of reception of Speak Signals is approximately 150 to 2,000 miles. This set is in accordance with the requirements of Postmaster-General, and has been passed by him. Price, complete as shown, **£22 10s.**

## LARGEST STOCKS OF WIRELESS SUNDRIES IN THE WORLD

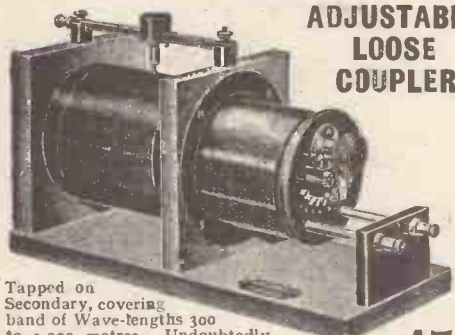

### ADJUSTABLE LOOSE COUPLER

Tapped on Secondary, covering band of Wave-lengths 300 to 1,000 metres. Undoubtedly the most efficient for shorter wave-lengths, especially with crystal receivers. Price **47/6**  
Superior type with long and short wave switch, **£3:17:6**

### VARIABLE CONDENSERS

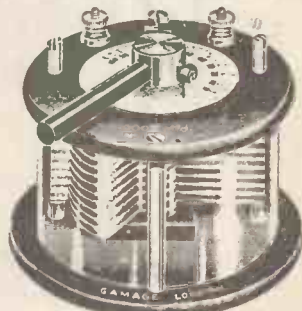

### AIR DIELECTRIC TYPE

Paraday House Calibration. These condensers are the best obtainable. Of the finest workmanship, electrically and mechanically perfect.

- No. 1.—As illustrated. Circular, with 10 fixed and 9 moving vanes and a maximum capacity of .0003 mfd. Fitted with matt ebonite top and base, and engraved ivory scale. Price **25/-**
- No. 2.—As above, with .00045 mfd. capacity. Price **33/6**
- No. 3.—.0005 mfd. Circular, with ebonite top, bottom and sides, and engraved ebonite scale. Price **40/-**
- Ditto in Square Mahogany Case **33/6**
- No. 4.—.0006 mfd. Circular with ebonite top and base. Encased in celluloid. Price **40/-**
- No. 5.—.0007 mfd, otherwise as No. 4. Price **50/-**
- No. 6.—.0015 mfd. Square; ebonite top, mahogany container, engraved ebonite scale. Price **39/6**
- No. 7.—.0015 mfd. Square, with sloping panel. Engraved ebonite scale. Price **70/-**

### PERMANITE DETECTOR

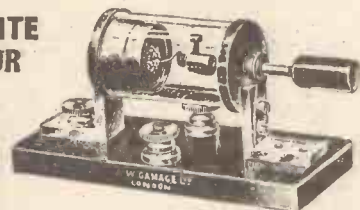

Designed particularly for use with crystals requiring a fine wire contact, such as "Permanite," Silicon, Galena, etc. and as such is unequalled by any other detector. The crystal is enclosed in an air-tight celluloid vessel which keeps it free from dust—the enemy of all crystals. Ball-joint action with variable pressure. Mounted on ebonite base, 4 1/2 by 1 3/4 by 1 1/2 in. Price (without crystals) **15/6**

Amazing Wireless Catalogue—First Edition Exhausted. Second Edition nearly ready. Mention "Popular Wireless."

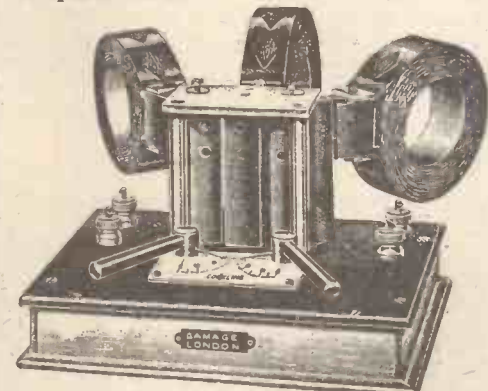

### HONEYCOMB COIL HOLDER

Three-coil holder, geared to enable fine adjustment. Finished in beautifully polished mahogany and lacquered brass fittings; ebonite base and pillars. Price **32/6**

Smaller type, 20/-

### HIGH-TENSION BATTERY BOX

Improved design with base board and green baize bottom. Finished in polished mahogany with ebonite top. Designed to give total output of 105 volts varied in seven steps of 15 volts. Price, container only **29/6**  
Complete with Batteries, ready for use, 55/-  
Small size to take 60 volts, 4 tappings, container only **15/6**  
Complete with Batteries, ready for use, 31/-  
Batteries, 3/9 per unit of 15 volts.

# It Speaks for Itself—

and in no uncertain voice.

## THE WORLD'S STANDARD LOUD SPEAKER.

# AMPLION

WIRELESS LOUD-  
SOUNDING RECEIV-  
ERS are supplied in a  
series of TEN MODELS  
suitable for every service:  
THE HOME, LAB-  
ORATORY and the  
CONCERT HALL.



AT PRICES ranging from  
£2 : 10 : 0 to  
£15 : 15 : 0

DAILY DEMONSTRATIONS  
at the GRAHAM  
SHOWROOMS, The  
ALGRAPHONE  
SALON, 25-26, Savile  
Row, Regent Street, W.1  
*'Phone : Regent 1075.*

### "MUSIC MASTER" HORN.

Type AR 13, 120 ohms .. .. .	£6 : 0 : 0
Type AR 15, 2,000 ohms .. .. .	£6 : 2 : 6

"GRAHAM" WIRELESS  
PRODUCTIONS INCLUDE  
"HIGH EFFICIENCY"  
TELEPHONE HEADSETS  
OF IMPROVED DESIGN  
AND CONSTRUCTION.  
THE "GRAHAM" IS THE  
BEST HEAD GEAR MONEY  
CAN BUY.

Full Particulars forwarded upon  
request.  
Ask for Folder P.W.

Patentees and Manufacturers:

## ALFRED GRAHAM AND COMPANY,

St. Andrew's Works,

Crofton Park, London, S.E.4

SCOTLAND—

Mr. F. M. Milligan,  
25, Renfrew Street,  
GLASGOW.

IRELAND—

Mr. Alex. R. Munday,  
41, Chichester Street,  
BELFAST.



# HOW GEORGE AND I BUILT A SET.

By JOHN CASH.

GEORGE is rather tall, and if you saw him in the street, you'd say at once, "Wouldn't he make a fine aerial!" But I would advise you not to make the remark aloud if you value your health, because George, like most good aerials, is very sensitive.

Well, one day he was struck with a wave and vibrated with energy to the soles of his shoes. He bounced into our little parlour, in which we used to sit during the evenings listening to the gramophone, and when a man over forty "bounces into a room," you may be sure there's something the matter with him. He produced a book with a blue and yellow cover, and began turning from page to page and picture to picture, rambling incoherently of valves and crystals and music. When he'd calmed down so that I could get a word in, I said:

"George, aren't we too old for that sort of thing; and, what's it going to cost?"

"Going to cost nothing hardly. If other fellows can we can."

## A "Friendly" Neighbour.

Well, the end of it was George got his way, and we went out in the street to see where we could fix our aerial. We owned half of a chimney stack and a short back garden, and we both realised for the first time what a little bit of the country was ours. George thought a wire from the chimney stack to a pole in the garden would be too shut off by the surrounding houses, and that if we could arrange a wire from our stack to the next stack, it would be a lot better. Then we remembered who owned it, and we looked at each other. It was Jones.

Jones is a man we always got on well with as a neighbour. That is, we always said "Good morning" and commented on the weather, but there it ended. We weren't what you might call friends, and hadn't realised it until it came to asking him a favour. Then we saw the gulf between us. And only last week George had thrown a piece of coal at his dog for chasing a cat,

and Jones happened to turn the corner at the psychological moment. We didn't think anything about it at the time, but, oh! how serious it was now.

"You go and ask him," said George. "You can talk so well."

By this time we had gathered round us a noisy crowd of young people, who had left their playing in the street to gaze roofwards with us. Farther off, and more covertly, grown-ups surveyed the skyline. George said we had better go in before the police came, and we worked our way past the wondering children, who begged us to tell them whether it was a fire or an aeroplane.

I put on my coat, and George wished me good luck as I set off to interview Jones. He was standing in the doorway, and as I saw him blocking the entrance to his castle, I perceived in him an air of majesty and importance that I had never credited him with before. He took the pipe out of his mouth and stared at me when I said I wanted to see him. His dog came to the door, and I called it and stroked it affectionately; but, unluckily, Jones wasn't looking, and just as I was going down the lobby behind him, the ugly little brute got under my feet and I trod on it. The yelp it gave went to Jones's heart, and I knew all was over. He shook his head when I told him what we wanted, and said "he couldn't do with fellows climbing over his roof and setting his house on fire with lightning."

## Great Progress.

Next evening saw George and me with our coats off digging steadily at the bottom of the garden, both secretly wishing it was for Jones's dog, and in less than a week our whole aerial was up. It gave a distinguished appearance to our house. Hitherto all the houses on the row had been of a drab sameness, but now the difference between ours and the rest was most marked. George gave a grunt of satisfaction.

Next night George and I could be seen wandering from shop to shop, staring in the windows at those wireless accessories which were so many mysteries to me, but of which George professed the most intimate knowledge. At times I caught him tripping, and then he would get angry and ask me which of us did I think was building this set. But that's just like George. However, after many of these excursions we at last began to bring things home.

"You should never rush things in a job of this sort," George advised; "this is a science that needs delicate care and accuracy."

Some say it's difficult to build a set on your own when you're not an expert. Well, George and I wish it to be put on record how we built ours.

We fastened one of those round things to a wire, and then we screwed one of those "what-is-its" to another thing. George could tell you the names. We only fastened—I think George says "plugged"—a few more things together, and it was ready. Really, it was quite simple. And don't make any mistake about it—it worked splendidly. The joy of hearing the first sound was worth all our days of toil. We tried it on 2 L O for a start. Brown connected up . . .

Brown? Oh, he's only a friend of George's, and often comes down to see how we're getting on. But George and I built most of it, anyhow.

## FORD CAR TRANSFORMERS.

IT is now claimed in America that the purchasing of a Ford coil will place in the hands of the wireless enthusiast a transformer which is not only distortionless, but also free from any tendency to create "howling" when in operation.

Having bought the coil, take out the secondaries, and find both leads to one of them. Now decide what ratio the transformer is to be, always bearing in mind that, to be effective, the ratio should be 4 to 1, or lower. Then count off the layers on the coil, until you have a proportionate number to act as the primary on the centre of the coil.

The winding should then be exposed at this point by forcing back the coil with a pocket-knife, or any suitable implement, and the last turn of the winding broken.

Stouter wires are then soldered firmly to the ends thus obtained, and the joints carefully insulated, with rubber tubing. The primary coil should be pushed back, and the whole device coated with hot paraffin wax.

The iron core consists of a bundle of iron wires, which are bent round the coil in such a manner that the ends meet, the amount of wire used being equivalent to the quantity contained in the original coil. Four or five turns of thick bare wire are taken around the outside of the transformer to complete the instrument, and to hold the core tightly in place.

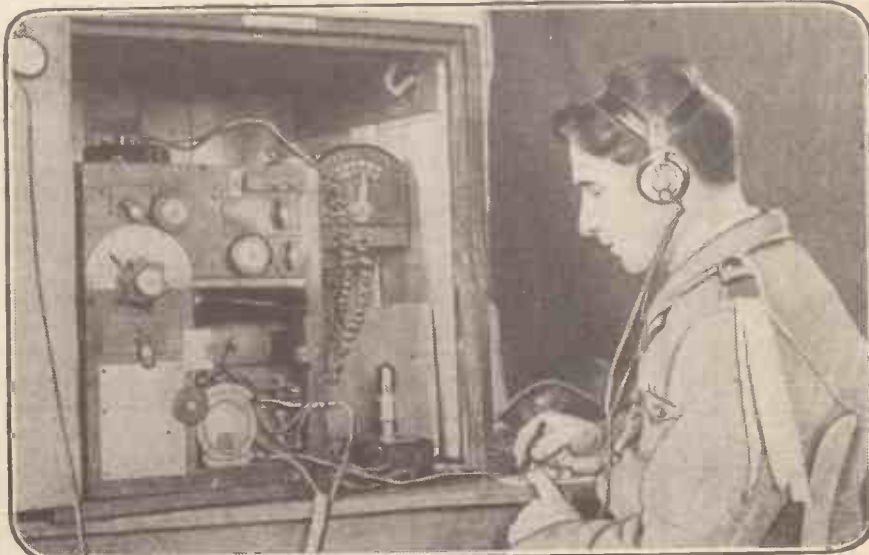

Operator of the 1st Leighton Buzzard Boy Scouts Troop receiving messages on an ex-Naval Receiving Set.

# A SIMPLE AUTOMATIC TRANSMITTER.

By C. R. PALMER.

UNHAPPY is the lot of the wireless enthusiast who, through the lack of a suitable companion, is unable to master the reading of Morse signals. It is more or less futile and extremely monotonous to sit for hours and hours tapping a key; as obviously one knows what letter is to follow. Now, the whole secret of Morse reading is the recognition of the code, not by their respective dots and dashes, but by their sound, or "song" of each letter or symbol. The following apparatus, in effect a simple Wheatstone transmitter, will provide a fascinating solution to this problem.

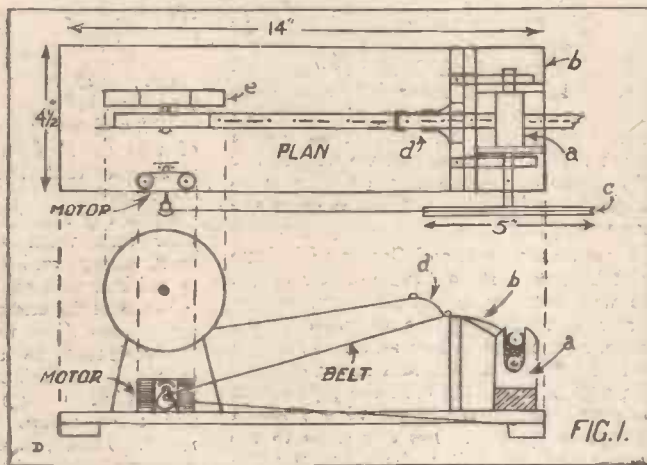

### Baseboard and Rollers.

Firstly, let us consider the baseboard. Any fairly hard wood 1/2 in. in thickness should be cut to the size as shown in Fig. 1. Screw a piece 1 1/2 by 1 1/2 by 1 1/2 in. to one end of this on which to mount the bearings for rollers A. Half an inch behind A secure another piece the same width as baseboard, 3 1/2 in. high, 3/4 in. thick. The construction of the rollers is obvious by referring to Fig. 2.

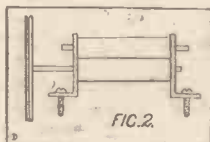

The rollers should be made of brass tube, of such size that they will fit tightly into rubber gas tubing; two springs rest lightly on the extending ends of the top roller as in Fig. 1B, partly to make the rollers grip, and partly to overcome the slight weight of the large grooved pulley that must be affixed to the long end of the bottom roller, as in Fig. 1C.

### "Punching" the Tape.

In the top centre of the piece of 3/4-in. wood should be secured a brass contact strip cut and bent as in Fig. 3D, the small hugs being bent up at right angles to form guides for a paper tape, which is unwound from a reel made of sheet tinplate so as to revolve freely on an axle, which should be mounted on a suitable support 6 in. high—Fig. 1E.

Our next item is the paper tape. I find the paper streamers, as thrown at dances and such places, to be ideal for the purpose, and can be obtained at most stationers'. This tape should be perforated with dots and dashes of the code. A small blade of a penknife can be used for this. The whole length of the tape should be

marked off into lengths of about 1/8 in. A good method of doing so is to run a small cogwheel from a clock or other mechanism along the centre, thereby leaving impressions on the paper at even distances. Fig. 4 shows clearly how this should be done. For one dot use the space between two consecutive impressions, then a space of the same length, and a dash the space between six impressions, leaving the same number between each letter. It will be helpful to repeat those letters which prove an obstacle to the learner.

### How it Works.

The mode of operation is as follows: The tape is pulled over the brass contact strip D by means of the rollers A, the latter being turned slowly by a 4-volt motor with a suitable resistance to decrease or increase the speed of the tape at will. Rest-

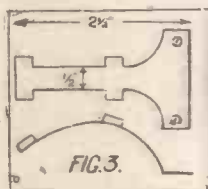

ing on the brass contact strip D is a small brush of flexible copper wire, which may be fixed in many ways so as to complete a circuit in which a buzzer is in series, every time the perforations arrive between brush and contact strip.

The connections are as follows: One pole of battery to flexible brush; brass contact strip to one terminal of buzzer; the other terminal of buzzer to the remaining pole of

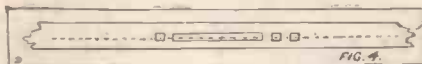

battery. Of course, one can employ other methods for supplying the power to operate the rollers. The tape should be allowed to run unobstructedly to the floor, and will be quite easily rewound if not disturbed.

## TO FIND THE NUMBER OF PLATES REQUIRED IN A CONDENSER.

ONCE the method of determining the capacities of condensers has been grasped, it is easy to twist the formula round in order to find the number of plates required for a given capacity, and of any given diameter.

Suppose we have a quantity of plates 2 1/2 in. diameter, and we wish to build a condenser whose capacity is to be .0005 mfd. This method applies equally for all types of parallel plate condensers. In this case we have taken the variable type as being a good illustration.

$K = \frac{Ak}{11.31 \times 10^6 \times d}$  is the formula for finding the capacity, and we can use it in this case to find the number of plates required.

$K$  = capacity in mfd.,  $A$  = effective area of plates belonging to one terminal in sq. cms., and  $d$  = distance in cms. between the + and -ve plates.  $k$  = dielectric constant.

Twisting the formula about, we know  $K$ , and we want  $A$ .

$$\frac{Ak}{11.31 \times 10^6 \times d} = K$$

As before in the case of capacities, we had to calculate  $d$  from the size of spacing washer used between the fixed plates.

Suppose we decide to use the usual 1/8-in. washers.

$$\begin{aligned} \therefore d &= (\frac{1}{8} \text{ in.} - \text{thickness of plates}) \div 2 \\ &= (\frac{1}{8} \text{ in.} - \frac{1}{32} \text{ in., say}) \div 2 = \frac{3}{64} \\ &= \frac{3}{64} \times 2.5 = .117 \text{ cms.} \end{aligned}$$

$$\text{Thus we have } \frac{A \times 1}{11,310,000 \times .117} = .0005.$$

$$\begin{aligned} k &= 1 \text{ (using air).} \\ \therefore A &= .0005 \times 11,310,000 \times .117 \text{ sq. cms.} \\ &= .0005 \times 1,323,270 = 661,6350 \text{ sq. cms.} \end{aligned}$$

This is our total effective area, and if we divide the area of each plate surface into it, we have the number of surfaces required for the condenser.

In other words,  $A$  = area of total number of plates minus one.

$$\text{Total number of plates} = \frac{\text{total area}}{\text{area of each plate}} + 1 \text{ plate.}$$

$$\begin{aligned} \text{Now the diameter of the plates is } 2\frac{1}{2} \text{ in.} \\ \text{area} &= \frac{4.9}{2} = 2.5 \text{ sq. ins. approx.} \\ &= 2.5 \times 6.25 \text{ sq. cms.} = 15.625 \text{ sq. cms.} \\ \text{From this we have the number of plates} \\ &= \frac{661,6350}{15.625} + 1 \\ &= 42 + 1 = 43 \text{ plates.} \end{aligned}$$

Of course, as the decimals all through the calculations have been merely taken to two or three significant figures, the answer will only be approximately correct. Correct enough, however, for practical purposes.

## AMATEURS, NOTE!

If at any time you are in doubt about a calculation, send along your problem to POPULAR WIRELESS. We will solve it for you and post you the answer without delay.



# The Broadcast Set with a broadcast sale



The "Cosmos" Crystal Type Radiophone shown in illustration sells at  
**£5 0 0**  
complete with aerial, insulators, "leading-in" tube, earthing materials and one set of head telephones.

## THE "COSMOS" RADIOPHONE makes an ideal CHRISTMAS PRESENT.

The "Cosmos" Radiophone illustrated above is a thoroughly efficient Crystal Type Radio Receiving Set. It is made by the firm with a vast experience in every branch of the Electrical Industry, and can be thoroughly depended upon to give satisfactory results within its range.

We are also manufacturing a series of valve type "Cosmos" Radiophones, Note Amplifiers and Loud Speakers. All these types are designed to give perfect results and no technical knowledge is necessary. **IT SHOULD BE NOTED THAT WE GIVE FULL PATENT INDEMNITY TO ALL PURCHASERS OF THESE SETS.**

**Important Note**  
All types of "COSMOS" RADIO-  
PHONES conform with the  
Postmaster-General's Regulations

- Belfast
- Birmingham
- Bristol
- Cardiff
- Dundee
- Edinburgh
- Glasgow



**METROPOLITAN  
Vickers**  
ELECTRICAL CO. LTD.  
TRAFFORD PARK WORKS,  
MANCHESTER.

Send  
for  
Lists.

- Leeds
- London
- Manchester
- Newcastle-on-Tyne
- Sheffield
- Southampton
- Swansea
- 1 R  
202



# WIRELESS BROADCASTING



*Which Set  
Shall I buy?*

IF you want to obtain the best possible reception from Wireless Broadcasting, "listen in" on a

## GECOPHONE

(REGISTERED TRADE MARK)

"GECOPHONE" Receiving Sets are of perfect design and construction, and represent the accumulated knowledge and experience of their makers in many years of telephone and wireless development.

**Simplicity** is the keynote of all "GECOPHONE" Receiving Sets. They are noticeably devoid of all technical complications and can be installed and operated with the utmost ease.

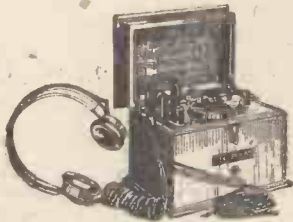

**CRYSTAL SET No. 1.**  
Approx. range (with standard P.O. Aerial) 25 miles.

*Fully approved by H.M. Postmaster-General and comply in all respects with the Regulations affecting Wireless Broadcasting.*

**Obtainable from all  
Principal Electricians  
Stores and Ironmongers.**

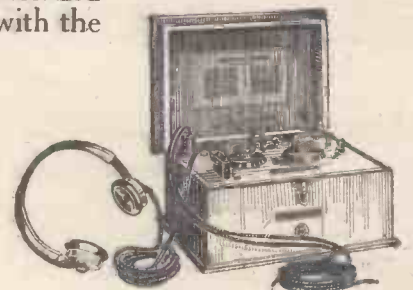

**CRYSTAL SET No. 2.**  
Approx. range (with standard P.O. Aerial) 30 miles.

# GECOPHONE

(REGISTERED TRADE MARK)

Manufacturers (Wholesale only) **THE GENERAL ELECTRIC CO., LTD.**, Magnet House, Kingsway, London, W.C.2.



# COUPLED TUNERS.

By BERNARD LAX.

**M**ANY amateurs will have to convert their receivers from directly connected to inductively coupled now that the Postmaster-General does not permit the use of a directly connected oscillating valve. For this reason an outline of the principles of coupling tuned circuits will be acceptable to the average experimenter.

Valves are virtually potential operated, that is to say, maximum potential effects must be obtained from the tuning circuits in order to get best results.

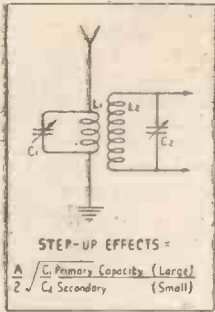

In the case of a directly connected valve this potential effect is obtained by making the capacity as small as possible for a given wave-length. The decrease in capacity is compensated for by a larger inductance being placed in the circuit.

Two-circuit tuners have to be designed to give step-up potential effects. This means that the potential effects of the aerial circuit are increased in the secondary circuit.

### Stronger Signals.

The potential step-up in the secondary circuit is not dependent upon the ratio of primary turns to secondary turns on the tuning coils but is governed by the capacities of both circuits. The secondary volts induced is governed approximately by  $\frac{A}{2} \sqrt{\frac{T}{C_2}}$ : the resultant potential effects in the secondary circuit are proportional to the square root of the primary capacity divided by the secondary capacity, multiplied by a factor depending upon the type of transmission.

The factor A is roughly .8 for spark transmission and is unity for continuous waves. This only applies, however, when the two circuits are very loosely coupled and when both are tuned to the same wave-length.

Nevertheless, in order to obtain maxi-

mum potentials to affect the grid of the valve, the aerial circuit requires large capacity and the secondary circuit small capacity for a given wave-length. This necessitates the use of small coils in the aerial circuit and larger coils for the secondary.

The increase in aerial capacity is limited, however, by the fact that a few turns of inductance is required in order to have sufficient magnetic relationship or coupling between the circuits.

Some of the advantages of utilizing coupled tuning circuits are as follows: In spark reception, effective tuning to accommodate a double-humped wave can be obtained by varying the degree of coupling between the two circuits until the coupling at the receiver equals that at the transmitter. As reception is now being effected from both radiated waves, maximum strength of signal will be obtained.

### Prevents "Jamming."

The system is more selective, that is to say, the secondary circuit responds only to incoming waves on or near the wave-length of the circuit. By use of a loose coupling then, signals on other nearby wave-lengths are considerably weakened and sometimes rendered inaudible.

In the reception of continuous waves, interference from spark stations can be cut down considerably by using a very loose coupling. The continuous waves can transfer energy across a looser coupling than damped waves, and the step-up effects, it will be noticed, are also higher due to the fact that the factor A is unity in the formula  $\frac{A}{2} \sqrt{\frac{C_1}{C_2}}$  for continuous waves.

Where duo-lateral coils are used, the practice of placing coils of the same inductance in both circuits is the means of loss in signal strength. Smaller coils should be used in the aerial circuit, the wave-length being brought up by capacity and the aerial itself.

Reference to Fig. 1 will serve to simplify the explanation. By obtaining a maximum step-up potential effect, only then will the tuning circuits be working efficiently.

## TREE AERIALS.

By G. H. DALY.

**I**N the wars of the future it will be unnecessary for scouts of an advancing army to carry any form of aerial for picking up wireless messages—all they will have to do is to connect up their receiving instruments to some available tree. This discovery is the result of some years of research work on the part of the United States Signal Corps, in which they have found that the interior of a tree is a good electrical conductor, and makes quite an efficient aerial when used in the proper manner.

In the first place, a suitable tree is selected, and somewhere near the top a metal peg is driven deep enough to ensure that it has penetrated into the soft part of the tree,



Will the owner of this photo please communicate with the Editor.

which is normally two or three inches from the bark. This peg is then connected, by means of a flexible lead, to the aerial terminal on the receiver.

A wire mat, consisting of several square feet of copper gauze, is next laid upon the ground near the foot of the tree, and when this mat is connected to the earth terminal on the receiver, wireless signals can be picked up in the usual way.

Now, wireless waves on striking the tree will have the choice of two paths to earth. The first is through the roots of the tree and the second is via the metal peg, receiver, and earth mat. So it will be seen that this arrangement is different from the usual aerial system, for in the latter the receiver is invariably placed in series with the aerial, and the received waves must first pass through the receiver before passing to earth. In the case of the tree aerial, however, the receiver is in parallel or shunt with the aerial, for this arrangement is found to give the best results when the trees are used as antennae.

It might appear at first sight that the wire joining the receiver to the metal peg in the tree-top would act as the aerial—and this is correct to a certain extent—but in actual practice it will be found that if the lead to the receiver is insulated from the nail, signals will fall right off, thus showing that the tree is the actual aerial, and not the down lead.

Although this type of aerial has been primarily introduced for military purposes—where the erection of an ordinary overhead aerial would naturally be fraught with dire consequences—interesting experiments can be carried out by any amateur who takes his wireless set with him on a day's outing in the country. It should be added, however, that valve amplification is necessary in order to obtain satisfactory results.



Mr. C. H. Smith and his experimental set, Market Tavern, Coppergate, York.

# HOW TO MAKE A MILLIAMMETER

By A. G. WOOD.

THE ammeter which I am 'bout to describe is quite easy to construct, only costs a shilling or so, and is so sensitive that it will register variations in plate current—when put in the H.T. lead—caused by incoming signals.

The materials required are as follows: About quarter of an ounce of No. 44 S.W.G. S.S.C. copper wire, a magnetised gramophone needle, a short length of fine unspun silk thread, scraps of wire, ebonite, etc., and a little sealing-wax—sundry odds and ends always to be found in the experimenter's scrap-box.

Cut two lengths off a French nail, each a little more than  $\frac{1}{2}$ " long. File up the ends so that they do not present a jagged edge. Heat them to dull red heat and allow to cool slowly, thus annealing them. Coat these several times with shellac, and attach little pasteboard discs of about  $\frac{1}{4}$ " diameter at each end to form a bobbin. Wind on half of the No. 44 wire on to each bobbin, taking care that the wire is put on evenly and does not "short" anywhere. Thus one obtains two little electro-magnets.

The best way to magnetise the gramophone needle is to pass it through one of the coils of an electric bell with the iron core

removed. After this, tie the fine silk thread to the middle of the needle, and fix it with a touch of shellac or sealing-wax. At the same time a piece of No. 36 bare copper wire about 3" long should be attached to the needle so as to act as a pointer. The wire should have a small blob of wax at the other end to act as a balance (shown in diagram).

The magnets should be arranged in series with the iron cores about  $\frac{1}{4}$ " apart. Attach one end of the silk thread to the end of the wire support, which should be directly over the middle point between the iron cores of the magnets. The other end is fixed with a little wax exactly below in such a manner that the needle is suspended between the magnets.

Vary the angle between the needle and the wire pointer until the needle remains at right angles to the magnets when there is no "juice" passing. The paper scale is fixed as shown, and the instrument is then ready for action. Mount it in the position indicated in the diagram. This little outfit is extremely sensitive and therefore very delicate, and should be shielded from any draughts which will affect the readings.

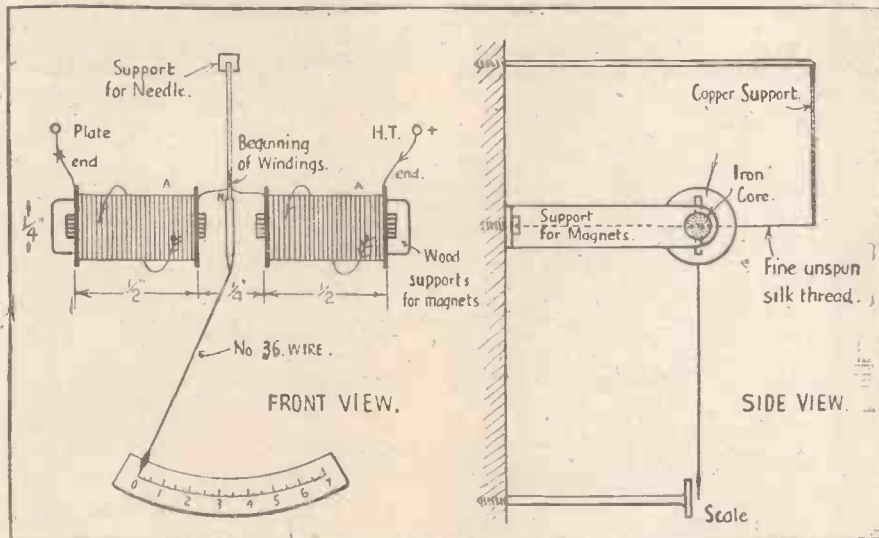

## "THE VOICE FROM THE VOID."

Mr. William Le Queux has added yet another to the long list of thrilling novels of mystery, love, and adventure, with which he has delighted the present generation of readers for many years. The novel, "The Voice from the Void" (The House of Cassell), is of particular interest to readers of POPULAR WIRELESS owing to the fact that wireless telephony is used to thread up the details of the plot, taking the much more or less of the old time and much overdone method of the coded telegram.

In the story in question it is interesting to note the uses of wireless made by the hero of the story, who is the fortunate possessor of a pocket receiving set, but whose efforts at circumventing the plans of his enemies are again and again frustrated by the fact that they possess transmitting apparatus, which they take with them from one scene of the story to the other. True, the hero himself has also a transmitter, but for the main part of the story he, in true conformity to the ethics of exciting fiction, is the hunted as well as the hunter.



Mr. C. Lewis and his set, Tranby House, Hesse, E. Yorks.

Mr. William Le Queux's knowledge of wireless is, as our readers know, very extensive. He has always been well to the forefront in experimental matters, and students of wireless may rely upon the correctness of his use of this modern adjunct to imaginative writing. As an illustration of Mr. William Le Queux's thoroughness of detail may be quoted the paragraphs dealing with the construction of a transmitting set, which the hero of the story erects. The precautions necessary, but so often neglected by amateurs, when constructing that most important part of a set—the earth lead—is fully and carefully dealt with, and should be of use to those about to take up wireless.

The book is one that can be recommended to all who love a spirited story, and especially to those who are interested in wireless advancement.



Before and after 2 L O's evening call.

### Britain's First Radio Christmas.

TELL your friends about Broadcasting, and when buying presents bear in mind the excellent Sets offered by advertisers in this issue of "Popular Wireless."





# For the first time a wireless Xmas

Xmas 1922 is the first time you will be able to give a really novel Present :—

## A WIRELESS SET.

A present in which the fascination and enjoyment never fails.  
We offer a complete range of wireless receivers from simple crystal sets to cabinets de luxe.  
All T.M.C. wireless receivers are fully approved by the P.M.C. and give maximum results from the British Broadcasting.  
The illustration shows the T.M.C. Crystal Set No. 2, with Patent Everset Crystal, which needs no adjusting

**£5 : 17 : 6 each.**

COME AND CHOOSE YOUR PRESENT TO-DAY:  
If you cannot call, full particulars will be sent on request.

**The Telephone Manufacturing Co., Ltd.**  
68, Newman Street, W 1.

Phone—Museum 5581. Branches in every large town.  
LONDON, MANCHESTER & BIRMINGHAM are Broadcasting NOW!

# T.M.C.

makes Wireless worth while.

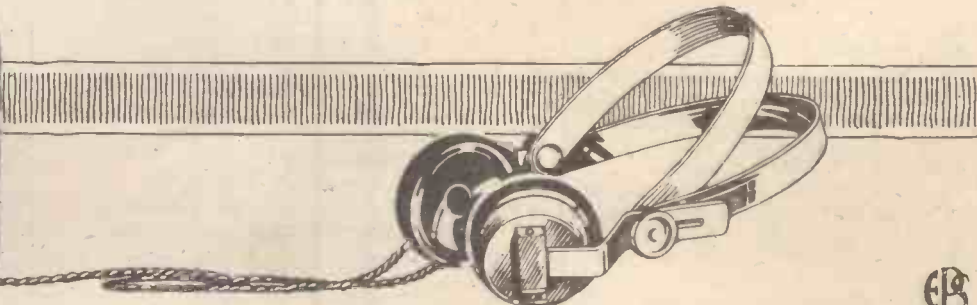
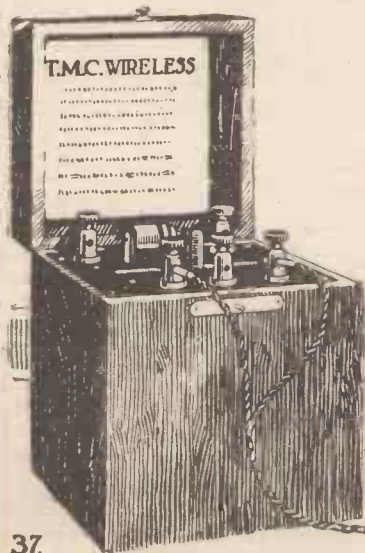

# A RADIO GUIDE CABLE.

By G. H. DALY.

**F**OG is the great enemy of efficient transport, especially where the steamship and aeroplane are concerned, and although numerous inventions have been tried for circumventing this evil, no satisfactory results were obtained until the radio guide cable appeared on the scene. With this cable, however, ships can enter harbours, and aeroplanes fly from place to place without danger even in the thickest fog. In addition to this the motorist can find his way in the dark or in unknown country without the aid of map or signpost.

The radio guide cable depends upon the fact that if a high frequency alternating current is passed through a wire, a magnetic field is set up for some distance around the wire. And further, should there be any coil of wire within the radius of this magnetic field, an electric current will be induced in the coil. By placing a telephone receiver in circuit with this coil, the induced current can be heard in the form of buzzer similar to the ordinary wireless signal.

## Defeating Fog.

Along the bottom of the channel leading into the New Harbour of New York, an insulated electric cable has been laid. In foggy weather this cable is supplied continuously with a high frequency alternating current—with the result that a magnetic field is set up for about 130 feet around the cable. Thus it is possible for ships passing up and down the channel to pick up and follow this magnetic field.

The apparatus on the ship consists of a coil of wire slung from each side of the ship connected to a pair of telephone receivers which are worn by the pilot. When the ship enters the channel and picks up the magnetic field from the coil, the pilot hears a humming noise in the receivers. If he hears a loud hum from the coil slung on the starboard side of the vessel, and a faint noise from the coil on the port side, he knows that the ship is too much to the left of the cable, and steers accordingly. If it is the reverse, and he hears the louder sound from the port coil, the ship is too much to the right. When, however, the sound from both coils is of equal strength, the ship is directly over the cable, and can proceed into the harbour in perfect safety.

## The Guiding Hand.

The cable used for aircraft is very similar to that used for ships; except that the cable is carried on wooden poles over the ground and the apparatus on the aeroplane consists of three coils instead of two. These coils are connected through switches to the telephone receivers worn by the pilot. Two of the aeroplane coils enable the aero pilot to tell whether he is to the right, left, or directly over the cable, functioning in the same way as the ship's coils. The third enables him to ascertain whether the cable is running over level ground. This is a very valuable coil, for it enables the pilot to check the undulations of the country over which he is flying with his map, even although the ground is invisible. Should, therefore, a forced landing be necessary, due to engine failure or other cause, he can pick out level ground on which to alight.

The other application of the guide cable is that invented by an American, Mr. Hansome, for enabling motorists to know if they are on the right road. The cable in this case is either carried along the side of the road on wooden poles which carry the ordinary telegraph wires, or is buried under the bed of the road. A 500-cycle generator situated at one end of the cable generates a current along the wire. This current is not continuous, but is broken up by a mechanical interrupter into long and short bursts of current at regular intervals. A short burst of current represents a dot, and a long burst a dash of the Morse code. The idea is that different roads will be allotted cables carrying different combinations of bursts of current. For instance, we will imagine that the generator supplies the cable running along the London-Brighton road with two long bursts and one short burst of current, i.e., dash dash dot at intervals of ten seconds. Whereas the cable running along the Great North Road would be supplied with an entirely different combination, such as three loud bursts every thirty seconds.

## The "Directometer."

Each time a burst of current passes along the cable a magnetic field will be set up over the road, and if a coil of wire is mounted on any car passing along the road, a current will be induced into this coil. Each burst

of current on being received in the motor-car coil passes into a two-stage amplifier, and then passes through a special relay, which operates an instrument called the directometer.

This directometer, which is mounted on the dashboard of the car, contains a number of small electric bulbs, similar to the bulb-shaped lamps used for electric pocket torches. These lamps are for registering the dots—or short bursts of current emanating from the cable.

## No Maps Required.

A number of rectangular shaped lamps denote the dashes or long bursts of current from the cable. To refer back to our previous example, if the motor is travelling along the London-Brighton road, which is denoted by two long bursts and one short burst of current (dash dash dot), two of the small round bulbs and one rectangular lamp will glow every ten seconds. By this the motorist will know which road he is on. As mentioned above, for other roads the directometer registers a different combination.

In addition to the dot and dash lamps the directometer also contains two electric lamps shaped like arrows—one arrow points to the right, the other to the left. When the motorist comes to cross roads the correct direction to turn is denoted by either arrow lighting up. This is caused by an automatic transmitting apparatus situated at the cross roads. So in future there will be no need for the motorist to pore over guide books and road maps, for the directometer will guide the way.

## A LOUD SPEAKER TIP.

**T**HE instrument about to be described is a very inexpensive and at the same time a very efficient piece of apparatus. It can be constructed by the most inexperienced amateur with a minimum expenditure of patience and time.

The following items are necessary: A large-size petrol funnel, a 5-amp. switch cap of the flat variety, soldering materials, and a small quantity of suitable enamel. The first item can be obtained from the local ironmonger at a cost of about three shillings, and has the advantage of presenting a good soldering surface in that it is clean.

The switch cap should not present any great difficulty. If the experimenter is lucky a few coppers will purchase one from the inevitable junk box of the average electrical dealer. Otherwise a new switch can be obtained at a cost of about two shillings.

The switch cap should be soldered to the small end of the funnel, so that a perfectly airtight joint is presented, and the whole enamelled and left in some dust-free place to become thoroughly dry.

It will be found that a "Brown" ear-piece will make a tight fit with the switch cap, and the apparatus can be mounted in any convenient manner.

Such a loud speaker has been found to give very excellent results with little or no distortion.

## BOOK REVIEW.

**"RADIO 'Phone Receiving,"** edited by Erich Hausmann, Sc.D. (9s. net, Constable, London). This book consists of seven chapters, each of which is contributed by an eminent authority on the particular phase of wireless with which the chapter deals. This seems to have the happy effect of breaking that tedium that is invariably consequential to the reading of a full outline by the one author. There are numerous diagrams and photographs, and the text is very readable. This latter, combined with the fact that the book covers extraordinary ground within its 180 pages, renders it in our opinion one of the most valuable of works on the market for the practical instruction of the intending "listener-in."

## RADIO ASSOCIATION.

To Professor A. M. LOIV, D.Sc., A.C.G.I.,  
M.I.A.E., F.C.S., Hon. Treasurer.  
RADIO ASSOCIATION,  
44, Great Russell Street, W.C.1.

Dear Sir,  
Please enrol me as a Member of the  
Radio Association, for which I enclose annual  
subscription of 2s. 6d.

Name in full.....  
(with Titles)  
Address .....



**JUST PUBLISHED!**

Radio Press

# WIRELESS HANDBOOK & DIARY

1923

**THE IDEAL PRESENT FOR CHRISTMAS. PRICE 2s. 6d. NET**

(2s. 8d. POST FREE)



THE GREAT NEW MONTHLY WIRELESS MAGAZINE

Handsomely bound in *real leather*, it will form a gift useful throughout the year. It contains a complete Letts' Diary with 20 pages of general, useful information, and nearly 40 pages of valuable wireless information, circuits, call signs, etc. Show this advertisement to your friend who *was* going to buy you an ordinary sort of diary! This diary costs no more, but is invaluable to the wireless enthusiast.

## JANUARY 15th.

On this date, Radio Press, the well-known publishers of thoroughly sound and useful wireless literature, will publish a new wireless monthly magazine entitled "Modern Wireless," and costing **1s. Net**.

It will be edited by John Scott-Taggart, F.Inst.P., M.I.R.E., assisted by Paul D. Tyers and E. Redpath, and will be full of interesting articles. On no account miss the first number.

A book which POPULAR WIRELESS has recommended with unstinted praise. Thousands of readers have purchased a copy and found in it just what they wanted. It will be found indispensable to all who hope to build or use a Valve Set. If you have ambitions above a Crystal Receiver, you will find this book will give you the information you require. **Price 2s. 6d. Net.** (post free 2s. 8d.).

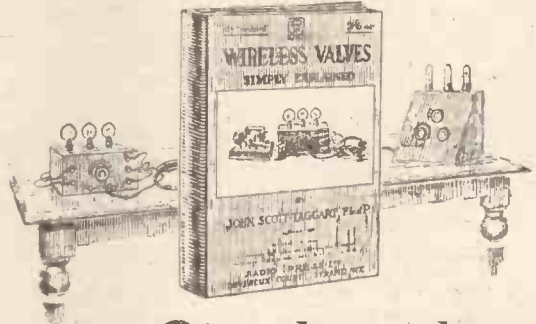

## Standing alone

**HANG IT** from your table. It contains

thousands of the world's call signs; those of amateur telephone transmitters, ships, land stations, and in fact every call-sign at present in use. It has been brought up-to-date, and everyone who listens-in needs this directory as much as a person having a telephone needs a telephone directory.



## NEW EDITION JUST OUT!

The Construction of Wireless Receiving Apparatus.—By PAUL D. TYERS. A very successful book on making your own parts, whether for Crystal or Valve-Sets. **Price 1s. 6d. Net** (post free 1s. 7½d.).

## PRACTICAL WIRELESS VALVE CIRCUITS

By JOHN SCOTT-TAGGART, F. Inst.P.

A book of the latest and most successful wireless circuits.

**Price 2s. 6d. Net.** (post free 2s. 8d.).

## FOR THE ABSOLUTE BEGINNER

"Wireless For All" and "Simplified Wireless" are the ideal books.

All our books may be obtained from the trade or direct from—

DON'T LIMIT YOUR ORDER TO ONE BOOK. RADIO PRESS LTD., Devereux Court, PLEASE SUPPLY: [London, W.C.2.]

- ...copies "Wireless Handbook and Diary" ... 2/8
- ...copies "Wireless Valves Simply Explained" ... 2/8
- ...copies "Wireless for All" ... 7½d.
- ...copies "Simplified Wireless" ... 1/1½
- ...copies "Construction of Wireless Receiving Apparatus" ... 1/7½
- ...copies "Radio Press Wireless Directory" (call signs) ... 2/8
- ...copies "Practical Wireless Valve Circuits" ... 2/8

Enclose remittance of .....

Name .....  
Address .....

**Radio Press Ltd. Devereux Court, London, W.C.2** OPPOSITE THE LAW COURTS

# HULLO!!! C.Q. WILL DAY CALLING TO ANNOUNCE SOME RARE BARGAINS.

- BROWN'S RE-CONDITIONED HEAD PHONES, 8,000 ohms . . . . 50/- per pair
  - BEST FRENCH HEAD PHONES 8,000 ohms . . . . . 27/6 per pair
  - SPLENDID QUALITY BRITISH HEAD PHONES, 4,000 ohms . . . . 26/- per pair
  - Single Head Phones, with Cord, 150 Ohms . . . . . 6/- each
  - 100 feet Stranded Copper Aerial Wire . . . . . 2/6
  - Trench Buzzer Sets, complete with Single Head Phone . . . . . 10/6
  - Best Quality Filament Resistances . . 2/9 each, Postage 3d.
  - Switch Arms with Laminated Blades 1/- each, Postage 3d.
  - 3-Way Coil Stand for Panel Mounting 15/- each, Postage 6d.
  - Best Ebonite Knobs with Brass Nut inserted 2 B.A. . . . . 5d. each, Postage extra
  - Insulated Sleeving, all colours . . . . 5d. yard, Postage extra
  - Brass Terminals with Nut and Washer 1/- doz., Postage 3d. doz.
  - Complete Set of Parts, including two Ebonite Plates, 4" x 4" for making Best Quality Variable Condensers, '001, 9/- set; '005, 7/- set; '0003, 5/- set. Set of Vernier Condenser Parts without Ebonite, 1/9.
- These are only a few of our bargains. Do not fail to send for our Price List giving the lowest prices for the best quality goods. Postage on all goods extra.*

We always Stock the Famous **HERTZITE CRYSTAL** at 2/6 each, or mounted in Brass Cup 2/10, Postage 3d. extra

# DO YOU WISH TO GIVE A REALLY USEFUL AND PLEASING XMAS GIFT?

If so, why not

## A WIRELESS OUTFIT?

**No. 1 Set.**—Crystal Receiving Outfit, fitted with Genuine Hertzite Crystal Detector, 12-inch Coil, pair of British-made Head Phones, 4,000 ohms, Aerial Wire, Insulators, Lead-in Wire, &c.

Price, **£3 10s.** the Complete Outfit.  
Postage, 1/6 extra.

**No. 2 Set.**—A Complete Receiving Set, fitted with Genuine Hertzite Crystal, Variable Condenser, mounted on Ebonite Panel, suitably engraved and enclosed in Hand Polished Mahogany Case, with pair of British-made 4,000-ohm Head Phones, Aerial Wire, Insulators, Lead-in Wire, &c.

Price, **£5** the Complete Outfit.  
Postage, 2/- extra.

*All our sets are passed by the P.M.G., and include the cost of Fee for Licensing the set.*

# WILL DAY, Ltd., 19, Lisle St., Leicester Sq., LONDON, W.C. 2

Phone: Regent 4577.

Telegrams: Titles, Westrand, London.

## CQ Do you get PCGG?



**Y**OUR crystal or valve may be the best of their kind—your aerial high as Snowdon, your tuner beautifully selective, but unless your 'phones are O.K. you won't get maximum "sigs."

Signals come "thumping in" through **ERICSSON 'PHONES**—they're built that way—for never-failing clarity and sensitivity. The magnets never lose their strength and "shorts" don't exist. And they're easy and comfortable to the head.

Back of **ERICSSON 'PHONES** is the accumulated experience of a generation in telephone manufacture.

*Write for Particulars*

The **BRITISH L. M. ERICSSON MANUFACTURING Co., Ltd.**

Head Office: International Buildings, 67/73, Kingsway, W.C.

# Ericsson Telephones

## BROADCASTING HAS COMMENCED.

Hear, in the comfort of your own home, our most talented musical artistes and lecturers, bedtime stories for the kiddies, etc., with the aid of an

## APOLLO RECEIVING SET.

Passed by P.M.G. Marked "B.B.C."

Type OO

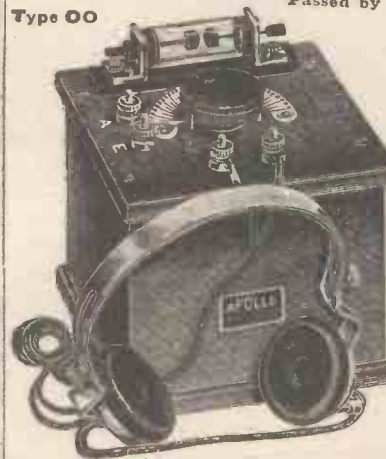

The chief feature of the "Apollo" is its simplicity and its absolute perfection whether used by the technical enthusiast or the novice. The "Apollo" is complete down to the minutest detail. Tuning—the bugbear of the novice—is ridiculously easy—so easy that a child could do it. The "Pericon" Crystal—acknowledged to be the finest crystal in the world—is carefully enclosed in a glass cylinder, thus making it impervious to dust. The "Apollo" is an extremely sensitive set, yet will withstand a good amount of misuse without getting out of order.

### DESCRIPTION:

Receiving Set in handsome Solid Mahogany Case, comprising specially sensitive "Pericon" Detector, Variometer Tuner and Terminals for earth, Aerial and Telephones, 100 feet Aerial Wire, Four Insulators, and one pair Sensitive Double Headgear Phones I.E.C. (4,000 ohms). Up to 5 extra head-phones may be used. (Range 20 miles).

**COMPLETE  
£4 19 6**

*Including Royalty.*

*Catalogue of APOLLO Wireless Sets and Accessories and address of nearest dealer sent on application.*

**CRAIES & STAVRIDIS, 4, Bunhill Row, LONDON, E.C. 1**



# CONSTRUCTION OF SMALL FIXED CONDENSERS.

By S. Burman.

SMALL fixed condensers are extensively employed in wireless circuits, as a glance at almost any diagram will show. They are used in various ways, such as grid condensers, blocking condensers, by-pass condensers, etc. Where a high impedance is inserted in an oscillatory circuit (or in a circuit traversed by high-frequency currents, such as may be set up by telephones, primary windings of low-frequency transformers, etc.), the impedance is invariably bridged by a small fixed condenser, which allows high-frequency currents to pass freely through it. It is intended to describe a simple way of making up these condensers cheaply and efficiently.

### Method of Building.

Procure some scrap  $\frac{1}{4}$ -in. ebonite, two 1-in. by 4 B.A. or  $\frac{1}{8}$ -in. set-screws, two small flat brass washers, and four nuts to fit. Cut out one piece of ebonite 2 in. by  $\frac{3}{8}$  in., and one piece  $1\frac{1}{2}$  in. by  $\frac{7}{8}$  in. Drill the ebonite as shown in Fig. 1, recessing the holes on the underside of the longer piece to allow the heads of the screws to drop in slightly below the surface.

Cut out some tinfoil to size and shape as in Fig. 2. The dielectric is thin waxed paper. To prepare the waxed paper, procure some good quality bank writing paper, free from holes or other defects, and soak a piece of the size required in hot paraffin wax for, say, 15 minutes. Withdraw it and place between two sheets of blotting paper, pressing it with a hot flat iron so as to remove all superfluous wax. Cut the paper into a sufficient number of pieces measuring  $\frac{7}{8}$  in. by  $\frac{7}{8}$  in.

To build up the condenser, place the two screws in position in the longer piece of ebonite, and lay a piece of waxed paper on the ebonite between the projecting screws.

On the top of this place one of the pieces of tinfoil, the screw coming through the slot cut away in the foil. The bottom of the foil should be about  $\frac{1}{8}$  in. away from the opposite screw. Then lay another paper and another foil in the opposite way so that the other screw comes through the slot. Continue in this way with alternate papers and foils until the required number are put on, taking care that the foils and papers do not shift during the building up process. Slip the second piece of ebonite on top so that the two screws come through the holes provided, and bend the projecting ends of the foils up over the edges of the ebonite, clamping them under a washer as in Fig. 3.

### Complete Condenser.

The condenser is now complete, and if well made will present a neat, compact appearance. Two holes may be drilled in the bottom piece of ebonite so that the condenser may be fastened to a panel by means of two screws.

The following are some actually measured values of capacity, of condensers made in this way, with various numbers of foils.

- 1 foil between 2 .00018 micro-farads
- 2 foils between 3 .00032 " "
- Suitable for grid condensers.
- 6 foils between 7 .001 micro-farads
- 12 " " 13 .0018 " "
- Suitable for blocking, by-pass, telephone condensers, etc.

## NEXT WEEK!

Articles by—  
 P. J. Risdon, F.R.S.A.  
 E. Blake, A.M.I.E.E.  
 Sir J. Kenneth D. Mackenzie, Bt.  
**ORDER YOUR COPY NOW!**

## POINTS ON CRYSTAL RECEIVERS.

By K. D. Rogers.

THOSE amateurs who are building crystal receiving sets will probably find that a few small details carefully considered now will save them quite a considerable amount of trouble later on.

Perhaps the most important part of the apparatus is the crystal itself, because it is here that a great deal of the trouble experienced with this method of rectification is located.

All crystals do not have the same sensitivity, even though they are of the same type. Several crystals should be tested, as this is the only satisfactory method of finding a really good crystal.

Another point that is very often passed over as of no very great importance is the crystal holder. This should always be firm, and grip the crystal tightly. If galena is used the crystal should not be soldered into its holder, as heat destroys the rectifying properties of the substance. It should be clamped tightly by means of three or four screws. Carborundum is usually soldered.

### The Sensitive Point.

Remember that sensitivity is not the only thing to be aimed at, as a very sensitive crystal often needs adjustment, and atmospheric are liable to upset its action. A good all-round type, such as galena or carborundum, is usually preferable to many of the specially sensitive kinds.

Having fixed the crystal, the wire or plate to be used as contact must be carefully mounted. This should be arranged so that it will be firm, but yet be capable of being easily adjusted. One that has a variable pressure is advisable, and it is also more convenient if it can be swivelled from side to side.

Do not forget your buzzer, as it is the best way of determining the sensitive point on the crystal. This point is often difficult to find, but, once found, you will be spared a great deal of trouble if your contact wire is well and firmly fixed. Different crystals require various pressures, hence the advantage of being able to regulate the pressure of your contact wire.

If at any time the crystal seems to have lost its sensitivity, and defies all your efforts to find a "spot," do not discard the crystal, but break it up into small pieces and use these as rectifiers. It is often discovered that such pieces have several sensitive points, and they not infrequently prove even better than the whole crystal. If the pieces are very small and are difficult to fix, wrap them in tinfoil, when it will be found that they can be easily gripped in the holder.

When galena is used, it is often found that deeply scraping the surface of the crystal with a knife will uncover several more sensitive spots.

## HAVE YOU IDEAS?

Send them along to 'Popular Wireless.' Short articles containing bright and original ideas are welcomed.

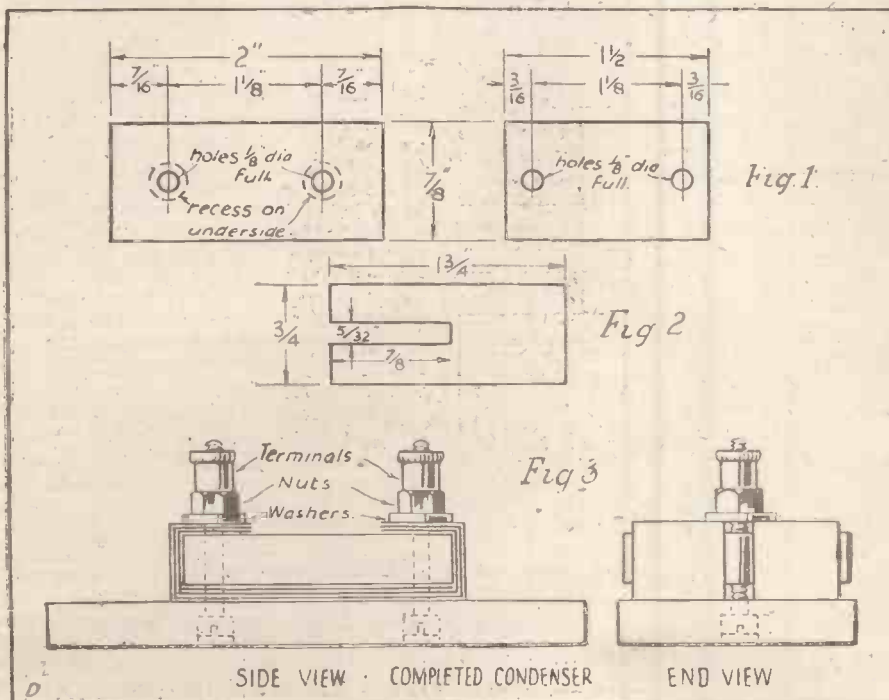

# HOW TO MAKE A D.F. STATION.

By MICHAEL EGAN.

## PART 3.

IN order to get any idea of how and why a frame aerial can be used to find the direction of transmitting stations, it is necessary to know something of the manner in which wireless waves are radiated from a transmitting aerial. Needless to say, the whole question of wave propagation from aerials is one which demands an amount of technical knowledge for its full comprehension. In the following article, however, technicalities are reduced to a minimum, and the subject of wave propagation is treated in its simplest aspect.

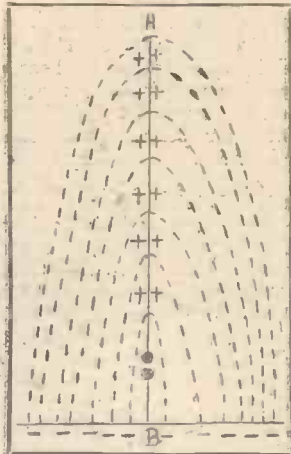

Fig. 1

Referring to Fig. 1, the line AB represents an upright aerial wire, connected to earth through a small air gap. When the aerial is charged in one direction by an alternating current, electrostatic strain lines stretch down from the aerial to the earth as illustrated. Thus, if the charge is positive the earth will be negative with respect to the aerial, and vice versa.

### Wave Propagation.

As the aerial discharges, the current rushes down it and across the gap to earth. The flowing of this current may be regarded as the flowing of all the little individual charges that gave rise to the strain lines. As it flows, therefore, the charges rush down to the foot of the aerial. Similarly, the negative charges in the earth, being of opposite polarity, flow towards the positive charges as the latter arrive at the foot of the aerial.

But, as the aerial may be regarded as offering a better conducting path than the earth, the positive charges reach the earth before the negative charges reach the aerial. The result of this is that a high loop of strain lines is set up at some little distance from the aerial. This is illustrated in Fig. 2.

Looking first at the loop of strain lines nearest the aerial, it will be seen that at one extremity they are positive, and at the other negative. In other words, the earth is positive at one place and negative at another. The effect of this difference of potential is to make a current flow along the

earth, and as it flows the strain lines collapse.

Now, this collapsing of the strain lines sets up other strain lines (magnetic lines of force) at right angles to the former. And these in turn collapse, and, in doing so, create a second loop of electrostatic strain lines at some distance away from the first. This process is carried on, each loop of electrostatic strain lines being created at some distance away from the preceding one. In this way the wave is propagated outwards, as the original charge given to the aerial oscillates up and down between aerial and earth.

It must not be forgotten, of course, that the wave is not sent out in one direction only. It is radiated in all directions at once; although, depending on the shape of the aerial and the nature of the earth in the neighbourhood of the transmitting station, it may be radiated with more energy in some directions than in others.

### Vertical Conductors.

Also, as there is a certain amount of energy lost in overcoming the resistance of the earth each time a current flows along it from the extremities of the loops, the energy of the wave diminishes as it recedes further and further from its original source—the aerial. In practice, this is manifested by the weakness of signals received from transmitting stations that are a long way off.

Now comes the question: how does the shape of receiving aerials affect the amount of energy induced from such a wave? In the first place, if we put a single wire in the path of these strain lines (which may be regarded as passing over it, or round it), a small current of electricity will be induced in that wire. Moreover, as the strain lines change their direction and strength, the induced current will likewise change its direction and strength.

Therefore, just as it was an oscillating current in the transmitting aerial that gave rise to the strain lines originally, so they, in turn, set up an oscillating current of similar frequency in the wire placed in their path.

Fig. 3 represents a lateral view of the "legs" or lower portion of a set of vertical

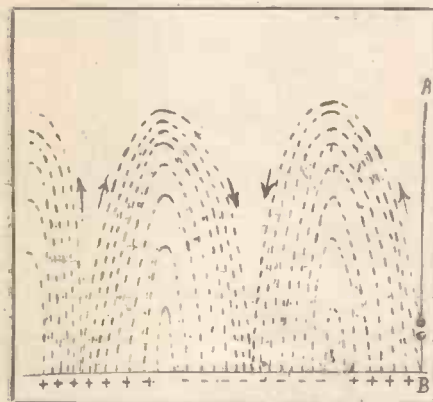

Fig. 2

strain lines. That is, the reader is supposed to be in the position of watching the wave move past him over the surface of the earth, and the illustration shows the position of the strain lines in his locality at a particular instant in time. It will be seen that the lines are more closely packed together at certain points than at others. This represents their varying intensity, or strength, which, of course, corresponds to the varying intensity of the current in the transmitting aerial. Also, their direction of flow is indicated by arrows.

Suppose now that we insert the single wire AB in the path of the wave at this precise moment. It will have a current induced in it in a certain direction, as shown by the small arrow. Suppose, also, that we

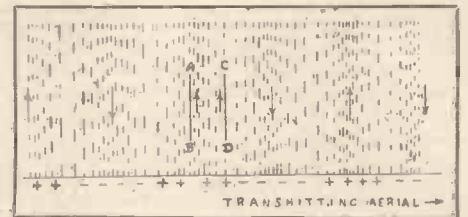

Fig. 3

had inserted a second wire CD in the path of the wave at the same instant, and that we had placed this second wire about a yard or so nearer to the transmitting aerial, and in line with it and the receiving wire AB. What would be the effect?

Obviously, this second wire will also have a current induced in it. And now two important points must be observed. In the first place, the current in the second wire will be smaller than that in the first wire AB, because the strain lines at that point are not so dense as at AB. Secondly the current in CD will flow in the same direction as the current in AB.

### Importance of Size.

Bearing these two points in mind, let us assume now that we join the two wires at top and bottom; that is, we join A to C, and B to D. We would then have a closed loop of wire, in two sides of which there is a current flowing upwards. This means that these two currents would oppose each other inside the loop. The effect of this would be that the smaller current (in CD) would nullify the effect of an equal amount of the larger current (in AB). And the remaining portion of the current in AB would flow round the loop.

It will be observed also that the closer CD is brought to AB, the greater will be the current induced in it, and hence the smaller the resultant current that will flow in the loop. In other words, the longer the connecting wires AC and BD, the greater the energy that will be available to operate the telephones. But, also, the bigger the aerial wires AB and CD, the better. That is, the bigger the area of the loop, the better.

What happens when such a loop is rotated in the path of a wave? This aspect of the subject will be considered in the next article.

(To be continued.)



# ORA

## The Valve for perfect reception

For receiving vocal and instrumental items you must have

### MULLARD "ORA" Valves

to get the best results.

**O**scillates **R**ectifies **A**mplifies

Specially recommended where good amplification is required.

The "Ora" Valve requires about 3.8 volts on the filament and 30 volts or over between the anode and filament for efficient results.

**15/-** EACH.

### IMPORTANT NOTICE

The great demand for Mullard "ORA" Valves and other accessories has compelled us to open much larger works. A greatly increased output is now available.

The MULLARD "R" Valve is now reduced in price from 22/6 to 17/6.

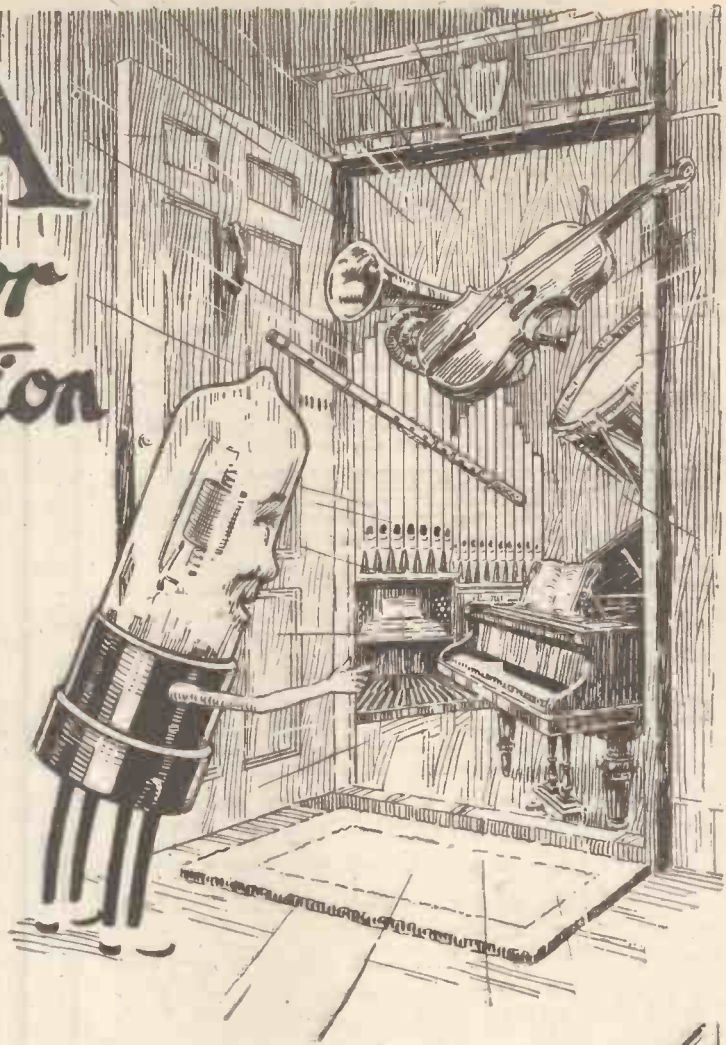

## Mullard Radio Valve Co. Ltd.

45, Nightingale Lane, Balham, S.W.12.

Contractors to H.M. Admiralty

War Office, Royal Air Force & Post Office.

Telephone: Battersea 1068    Codes: ABC(5Ed) Bentley's    Telegrams: Radiovalve Hammer Lond.



Name and Address.....

To the **MULLARD RADIO VALVE CO., LTD.**,  
45, Nightingale Lane,  
Balham, S.W.12.

Please send me post free

Quantity	Description	Price
.....	Telephone Head Sets	30/- per set
.....	"ORA" Valves	15/- each
.....	Grid A Resistances	6/- each
.....	Anode A or B Resistances	5/- each
.....	BA Condensers	2/6 each
.....	Combined 1000 mfd. and Condensance	7/6 each
.....	Valve Bases with Terminals	5/- each
.....	Valve Sockets	1/8 each
.....	Terminal Clips	od. per pair

I enclose (Cheque Money Order, P.O. value) to cover the cost.

Name of usual Wireless Dealer.....

**SEND THIS TO-DAY.**

## BOOKS YOU NEED

### WIRELESS APPARATUS MAKING. By A. V. Ballhatchet.

The aim of the book is to help beginners on the constructional side of the work, and the author, being a practical man, speaks from experience. 184 pages, and 138 illustrations. Price 3/6, post free, 3/10.

### WIRELESS TELEGRAPHY SIMPLY EXPLAINED. By H. T. Davidge.

One of the useful "Model Engineer" Series. A guide to Wireless. 64 pages, 35 illustrations. Price 9d., post free, 10½d.

### WIRELESS AT HOME. By H. de A. Donisthorpe

A guide to receiving Wireless News, Concerts, and Messages. Tells you how to obtain the best results. 50 pages, 16 illustrations. Price 6d., post free, 7½d.

### WIRELESS CIRCUITS. By A. V. Ballhatchet.

Contains illustrations of 90 different circuits. A useful help to experimenters. Price 6d., post free, 7½d.

### HOW TO MAKE A SIMPLE WIRELESS SET. By A. V. Ballhatchet.

Gives complete instructions for making a successful Crystal Receiving Set with all accessories. 48 pages, 22 illustrations. Price 6d., post free, 7½d.

### "THE MODEL ENGINEER" RADIO CALL BOOK.

A Directory and Reference Book specially adapted for Private Wireless Stations. You can identify most stations you may hear, and also a good many amateur radio stations. Have a copy by your apparatus for easy reference. Punched ready for the hanging material. Price 6d., post free, 7½d.

### THE MODEL ENGINEER AND ELECTRICIAN.

Published every Thursday. Always contains some useful information on Wireless matters, and has been in touch with Wireless for over twenty-four years. Price 4d., post free, 5½d.

From all booksellers, as above, or post free from

**PERCIVAL MARSHALL & CO.,**  
66, FARRINGTON STREET, LONDON, E.C. 4.

## L. McMICHAEL Ltd.,

Have pleasure in announcing to their Customers, both TRADE and RETAIL, that they have taken

### SHOWROOMS at

179, STRAND, W.C.

(Corner of Norfolk Street),  
AND

### OFFICES at

HASTINGS HOUSE,  
NORFOLK STREET,  
STRAND, W.C.

(ALL COMMUNICATIONS SHOULD BE SENT  
TO HASTINGS HOUSE ADDRESS.)

All goods will be received at, and delivered from our warehouse, Providence Place, Kilburn.

Send for Illustrated Price Lists and particulars of our Crystal—2 valve  
:: and 3 valve—Broadcasting Sets. ::

## LOW PRICES ! ! !

Purely for the purpose of bringing to your notice our New Showrooms & Demonstration Lounge, all our small parts are marked at practically Cost Price. Below are a few samples of our prices.

<b>Moulded Valve Holders,</b> Polished, with Flange and 3 screw holes ..	6d	<b>Aluminium Condenser Plates,</b> fixed or moving, per doz. ..	5d
<b>Moulded Polished Slider</b> with Spring and Plunger	3d	<b>Ebonite Condenser Ends</b> ..	1/-
<b>Moulded Polished Knobs</b> 1½ in. Blind nut inlaid	3½d	<b>Bright Valve Sockets.</b> Best Quality ..	2d
<b>Moulded Condenser Ends</b> drilled ..	5d & 8d	<b>Sensitive French Phones</b> with Leads, 4,000 ohm, pair ..	18/-
<b>Egg Insulators</b> ..	3d	British Made Ditto ..	21/-
<b>Switch Arms</b> with Knob complete ..	1/-	<b>Heavy Teak Base Boards</b> 9½×9½×½ ..	1/-
<b>Mahogany Boxes, High Class</b> Polished, 9½×6½×5 ..	7/-	Ditto, 4½×7×½ ..	4d
<b>Ebonite Panels, Best Matt</b> finished, 9×6×½, fit neatly into above boxes ..	2/-	<b>Crystal Receivers</b> (Two kinds) ..	25/-
Ditto Panels, 5×7×½ ..	1/6	<b>New (ex-Govt. Stores) Brown Phone</b> (type A) H.R. ..	49/6
Ditto, ditto 4½×4½×1½ ..	8d	Ditto, L.R. ..	42/6
		<b>Telephone Cords,</b> Best Make, pair ..	3/6

All kinds of Valves, Phones, Valve and Crystal Sets. Amplifiers, and Hundreds of other Wireless Lines.

These absurd Prices are merely to induce you to give us a call. Terms net cash with order, include sufficient for postage. Orders of £1 and over post free.

AT THE  
BACK OF  
SELFRIDGE'S

**H. V. ALBROW**  
56, GEORGE STREET,  
BAKER STREET, W.1

PHONE NO.  
MAYFAIR  
5842



ESTABLISHED 1905

## DOUBLE HEAD PHONES

(4,000 Ohms).

Double Plate Magnets,  
Duralium Headbands,  
Replaceable Coils,

**£1-0-0**

(Postage 9d.)



## SINGLE EAR PHONES

(2,000 Ohms).

Special Christmas Offer.

**6/- EACH.**

(Postage 4d.)

MADE BY—  
**TURNOCK'S TELEPHONE WORKS,**  
41, High St., Aston, Birmingham.



# WIRELESS CLUB REPORTS.

The Editor will be pleased to publish concise reports of meetings of Wireless clubs and associations, reserving the right to curtail the reports if necessary. Hon. secretaries are reminded that reports should be sent in as soon after a meeting as possible. Reports sent in cannot appear in this paper in less than ten days after receipt of same. An asterisk denotes affiliation with the Wireless Society of London.

## Barnsley and District Amateur Wireless Association.

At the official opening night of the above association, held on Wednesday, October 11th, the president, Major E. A. Barker, M.C., delivered his inaugural address at the new headquarters, Y.M.C.A. Buildings.

In his remarks upon heterodyning the president emphasised the necessity for eliminating interference with other people's reception, and pointed out the great assistance which could be rendered by the association, by instructing its members in the theory of wireless, so that they may be real "bona-fide" experimenters and not merely "dabblers." To this end the president stated his intention of presenting to the association a "Heterodyno" wave-meter.

The lecture on directional wireless was based upon his extensive experience during the war. This was clearly elucidated by means of a large map, and appliances for tracing both land and air transmitting stations.

## Tottenham Wireless Society.

The third meeting of this society was held on Thursday, October 5th, and was opened with a half-hour's buzzer practice. The chairman then gave a lecture on "Retroactive Amplification," which was of great interest to everybody present. Business was then discussed, and it was proposed by the chairman that the future place of meeting should be the Bruce Grove Schools, Sperling Road, and that the evening should be changed to the Wednesday of every week. This was carried unanimously.

A general committee was formed, three more members being elected, namely, Messrs. Winter, Hall, and Glyde.

It was also decided that the society should have a library, and Mr. F. Allard was elected as librarian.

An interesting programme has been formed for the next four meetings, and intending members should join immediately.

Full particulars for membership on application to the hon. sec., R. A. Barker, 22, Broadwater Road, Bruce Grove, N. 17.

## Leeds and District Amateur Wireless Society.\*

The first instructional meeting of the session 1922-23 was held on October 6th at the society's new headquarters, the Grammar School, Leeds, at 8 p.m. Mr. G. P. Kendall, B.Sc. (vice-president), commenced a lecture entitled "The Elementary Principles of Tuning," which (as all subsequent lectures at instructional meetings) was specially arranged to meet the needs of the section of the membership having only elementary knowledge of radio matters. Mr. Kendall thoroughly examined his subject, his very clear and concise remarks being greatly appreciated by a large audience.

The first general meeting of the new session was held at the headquarters on October 13th, proceedings commencing at 8 p.m., being the occasion of the presidential address.

The president announced that as a result of a committee and sub-committee meeting it was proposed to impose a levy on the membership, in order to be enabled to commence the installation of an experimental wireless station. This proposal was put to the vote, and was almost unanimously accepted. Preliminary announcements of the annual social were given, it being resolved by a show of hands to hold a dinner, etc., on December 22nd, 1922. The president then called upon Mr. J. O'Donohoe to make the presentation to the hon. sec. of a pair of Brown's phones, suitably inscribed, in recognition of greatly appreciated services during the last session. The hon. sec. expressed great pleasure in accepting the gift, heartily thanking the society for their splendid and most acceptable mark of appreciation.

The president then delivered the presidential address, entitled "The Reinartz Tuner." The

tuner was demonstrated on an aerial, and many practical details explained.

Hon. sec., Mr. D. E. Pettigrew, 37, Mexborough Avenue, Chapelton Road, Leeds.

## Beckenham and District Radio Society.

The president, Mr. Graves, brought his new four-valve set, and tuned in for the tail end of the Hague concert and also for the Marconi House concert. Amateur transmitters were afterwards tuned in, music being received from Brentford, Blackheath, and Forest Hill. A loud-speaker was used, so that all could hear.

Further, it was requested from Marconi House that those in possession of valve sets should not allow their valves to oscillate. Signals are less clear when valves oscillate, and other people are unable to receive signals and music.

Hon. sec., Mr. J. Butterfield, 10, The Close, Elmers End, Beckenham.

## Knightsbridge Radio Club.

Meetings of the above club are being held every Wednesday evening at 8 p.m. at our headquarters, St. Paul's Men's Club, Wilton Crescent Mews, and are well attended. On two previous meetings Mr. Walker, a member of the club, gave lectures on the elementary theory of waves, their production and detection, after which he explained the method of winding basket coils, showing a winding former and coils, wound in two ways.

Hon. sec., Mr. R. Davis, 1, Kinnerton Place South, Knightsbridge, S.W.

## The Ealing and District Radio Society.

Meetings will, in future, be held on Friday evenings, from 7.30 to 10 p.m., in order to meet the wishes of the majority of our members. The acquisition of the new premises has already given a considerable fillip to our membership numbers.

We extend a welcome to all beginners who may feel disposed to join us, yet feel their lack of knowledge may prove somewhat detrimental to live membership. We make a point of catering specially for their needs. Prospective members have the option of attending one meeting without obligation to join. Application forms may be obtained from the secretary, W. F. Clark, 52, Uxbridge Road, Ealing, W.5, or at any ordinary meeting of the society at the college.

## Aberdeen and District Wireless Society.\*

The Aberdeen and District Wireless Society met in their new quarters, Aberdeen Grammar School, on Friday, October 20th, at 7.45 p.m.

Dr. Fyvie, the chairman, intimated that the society had now been affiliated with the Wireless Society of London.

The meeting terminated with an inspection and demonstration of the society's five valve set.

The society is in a very flourishing condition, and has a membership of sixty.





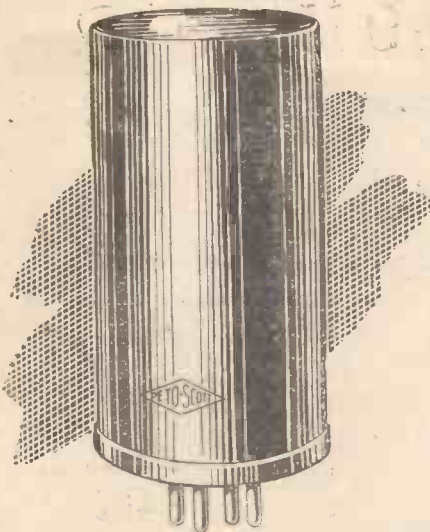

## For all wave lengths over 1000 MULTI-WAVE AMPLIFIER

(Made throughout by Peto Scott Co.)

HERE is a new plug-in Amplifier being sold with absolute confidence after the most exacting tests. For use on all wave-lengths over 1,000 metres. No condenser or other critical tuning is required—merely plug-in and be assured of the best possible results. Made in two styles in solid ebonite throughout, No. 1 for use with one H.F. Valve, and No. 2 for more than one stage of H.F. amplification (in this case No. 2 is used as coupling between first and second H.F. Valves and No. 1 between second H.F. Valve and Detector).

No. 1—  
for use with  
one H.F. Valve **8/6**

No. 2—  
for more than  
one stage of  
H.F. amplification **12/6**

### THINKING OF BUILDING YOUR OWN SET?

Then don't worry about drawing up a design—start with a proved system. The Peto Scott Unit method of home constructed Sets, enables you to add further Valves whenever you wish. Our new Book (6d. post free) describes the System and gives full descriptions of Radio principles involved. Many illustrations, 32 page Catalogue free.



Offices and Showrooms:

**64, HIGH HOLBORN, W.C.1.**

WHEN REPLYING TO  
ADVERTISEMENTS  
PLEASE MENTION  
"POPULAR WIRELESS."

### WIRELESS CABINETS

PROMPT DELIVERIES  
COMPETITIVE PRICES

PICKETT BROS., Albion Rd., Bexley Heath, S.E.

### CUT THIS OUT

"Popular Wireless" PEN COUPON Value 2d.  
Send 7 of these coupons with only 2/9 direct to the Fleet Pen Co., 119 Fleet St., E.C.4. You will receive by return a splendid British-Made 14ct. Gold-Nibbed Fleet Fountain Pen, value 10/6 (fine, medium, or broad nib). If only 1 coupon is sent the price is 8/9, 2d. being allowed for each extra coupon up to 6. (Pocket Clip, 4d.) Satisfaction guaranteed or cash returned. *Special New Offer.*—Your own name in gilt letters on either pen for 1/- extra. *Lever Self-Filling Model with Safety Cap, 2/- extra.*

# RADIO T O R I A L

All Editorial Communications to be addressed The Editor, POPULAR WIRELESS, The Fleetway House, Farringdon Street, London, E.C.4.

### THE RADIO ASSOCIATION.

The following is an extract from a report on the last meeting of the Radio Association, held at the Hotel Cecil, on November 20th, which appeared in the "Wireless World" for December 2nd:

"After a lively discussion the Secretary of the Traders Association virtually took the meeting out of the hands of the Radio Association, and an entirely new association was formed in less than ten minutes. Members of both the other organisations were recommended to join it at once.

"The name of the new association is The British Radio Manufacturers' and Traders' Association, and the address of the Organisation is Dundee House, 15, Eastcheap, E.C.3."

The Radio Association strongly protest against the misleading construction of this report, and a letter has been addressed to the journal in question.

The Radio Association Trade Section has amalgamated with the Trade Section of the Wireless Manufacturers' and Traders' Association, and will work in co-operation with them. The amateur section of the Radio Association is still in existence, and is in a flourishing condition. Many wireless clubs have sought affiliation with it, and members are daily being enrolled.

In fact, so successful has the Radio Association been that it is now in a position to organise a series of popular lectures, details of which appear on another page.

The name of the combined Traders sections of the two organisations is now known as The British Radio Manufacturers' and Traders' Association.

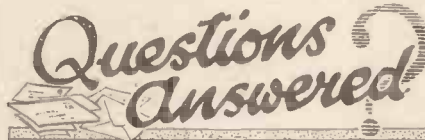

Owing to the enormous number of queries received daily from readers of POPULAR WIRELESS, I have decided to reply individually by post. A weekly selection of questions will, however, be printed on this page, together with the answers, for the benefit of readers of POPULAR WIRELESS in general. Questions should be clearly and explicitly written, and should be numbered and written on one side of the paper only.

All questions to be addressed to: POPULAR WIRELESS, Queries Dept., Room 132, The Fleetway House, Farringdon Street, London, E.C.4.

Readers are requested to send necessary postage for reply.

"ELECTRO-MAGNET" (Norwich).—What is the nearest broadcasting station to Norwich?

Marconi House, London.

Could I receive the signals on a crystal set?

No; you would require a three-valve set of the orthodox broadcasting pattern.

"QUERY" (Wolverhampton).—I have been told that the electric light mains are direct current, and also that I can use them for charging accumulators. Can they be used for this? I was further informed that I could find the positive pole of the main by placing the wires in water to which has been added a little vinegar. Can you explain how this works and why, if I am correct?

Provided you have sufficient resistance in series between your main supply and the accumulators, you can use D.C. mains for charging. The resistance should bring the current value down to the charging rate stamped on the cells. Thus, if you have a 200-volt main and your charging rate is one amp., you need 200 ohms resistance between the mains and your cells.

The other test—of polarity—that you refer to is quite practicable, and will easily distinguish which pole is which. To explain fully all that occurs would take too long, but briefly it is as follows: The current passes through the water—vinegar is added to make the liquid conductive—from positive pole to negative pole. Now, when a current passes through a liquid it decomposes, or changes the state of, that liquid. In this case the water is decomposed into hydrogen and oxygen (the substances that compose water), and these being gases are liberated in the

form of bubbles. The bubbles appear at the two electrodes or wires. This would not help us if the two gases came off together, but one travels along without the current—or actually acts as a carrier of the current itself—to the negative pole. This gas is the hydrogen and is known as the hydrogen or negative ion. Arrived at the electrode it gives up its charge and rises in the form of bubbles of gas. The oxygen ion has meanwhile gone in the opposite direction and has come off at the positive pole. Thus we have oxygen gas coming off at the negative terminal of the mains and the other at the positive. As water is composed of twice as much hydrogen as oxygen (H<sub>2</sub>O) the gas bubbles at the negative pole will be twice as many as at the positive electrode. This, then, gives a sure way of determining which pole is which.

"OSCILLATIONS" (South Mimms).—I have a three-valve set, and the other evening was listening-in to a station sending music on about 1,570 metres. My friend told me the next day that I was oscillating badly and that it completely jammed his reception of Birmingham on 400 metres. Would that be the case?

If you live very near one another it might have disturbed him slightly if you were oscillating very violently, but otherwise the interference would be confined to stations who were listening-in on the same wave-length as you. But there should be no doubt as to when your valves are radiating. The oscillations start with a decided click in the 'phone, followed by a rushing sound or possibly a deafening roar or howling. In any case, the music and speech would be distorted or lost altogether as soon as your valves commence oscillating.

L. C. M. (Croydon).—I can clearly hear Writtle on my crystal set; is that a good result? How far is Writtle from here?

Yes, your results are very good indeed. Writtle is about 40 miles from Croydon.

A. C. N. (No address).—How can I tell when my valve is oscillating? Also, can I use 150 ohm 'phones on a one-valve set?

(1) You will hear a loud click and a rushing sound, possibly deafening in its intensity, when your valve commences to oscillate. Besides this, the speech and music and all signals will be distorted. (2) The 'phones you mention can be used if a telephone transformer is used.

K. D. (Montrose).—I have a three-valve resistance coupled set and a 100-ft. aerial 50 ft. in height. I cannot hear Manchester or Birmingham telephony. Should I be able to do so, or do I require more valves?

Generally speaking, resistance coupled sets are not suitable for the shorter wave-lengths such as these stations employ. With three valves, transformer (one stage, at least, of high frequency) or tuned-circuit coupled, and such an aerial, you should hear excellent telephony from the stations you mention.

P. B. L. (Loughborough).—Why are some telephone receivers known as "watch" type?

Merely because of a similarity in shape to that article.

"DISCHARGED" (Exeter).—What exactly is this sulphating of accumulators that you mention in connection with cells that are allowed to over-discharge?

It is that state of an accumulator caused by neglect signified by the lead sulphate working out of the plates and forming on the surface in the form of whitish crystals. These are almost insoluble, are very poor conductors, and extremely difficult to remove. If not too bad, they can, however, be removed, as has been stated before in these columns, by prolonged charging.

"OHMLESS" (Stockport).—You refer in one of your articles to surface resistance. What is this, and why should it be different to the inside resistance? Does it mean "skin

(Continued on page 638).



**Making you think!!**

**“POLAR”**

**VARIABLE CONDENSERS**

**ONLY  
14/9**

**EACH  
POST FREE**

WIDE RANGE—·0001 to ·001 M.F.D.  
SMALL SIZE—3 IN. x 3½ IN. x 1 IN. ONLY  
SPECIAL EARTH SCREENING.  
GUARANTEE—*Replace within 12 months.*  
*Invaluable for tuning, H.F. amplifiers, etc.*

**ONLY  
14/9**

**EACH  
POST FREE**

CHEQUES—POSTAL ORDERS—MONEY ORDERS—ETC. TO

**THE RADIO COMMUNICATION CO. LTD.**

**35 NORFOLK STREET - LONDON - W.C.2**

or Branches at

**NEWCASTLE**  
17 Sandhill

**CARDIFF**  
Atlas Chambers  
James Street

**LIVERPOOL**  
67 Dale Street

**SOUTHAMPTON**  
19 Queen's Terrace

**GLASGOW**  
10 Blythswood Sq.

(E.P.S.) 19



**The  
MECCANO  
Radio  
Receiving Set**

*For Broadcasting and Morse Reception*

**T**HE Meccano Crystal Receiving Set will receive telephony (i.e. music and speech) from distances of 20 to 30 miles. It is a piece of scientific apparatus with which anyone may spend hours of delight and enjoyment "listening in" to broadcasting stations and other telephony transmissions. It has been thoroughly tested, and has received with great clearness broadcast music and speech in London, Paris, New York, and elsewhere.

The Meccano Receiving Set is low in cost and is complete in itself, ready to be connected to any aerial. A complete Aerial Set is sold separately.

The Meccano Radio Receiving Set makes an ideal present for Christmas. Give one to your boy and make him happy.

**Send for this Book**

Our new booklet, "The Meccano Crystal Receiving Set," explains Radio so that everyone is able to understand how simple is the reception of broadcasting, telephony, and Morse messages. This booklet will be mailed free on request.

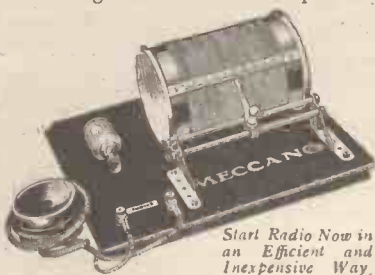

*Start Radio Now in an Efficient and Inexpensive Way.*

**PRICES**

Meccano Crystal Receiving Set complete . . . . . **55/-**  
Meccano Aerial Set (including antenna, lead-in and aerial wires, and insulators) . . . . . **12/6**

**MECCANO LTD Binns Road LIVERPOOL**

**RELIANCE RADIO SERVICE CO.**

**THE "RELIANCE"  
CRYSTAL RECEIVING CABINET.**

Consisting of Ebonite Panel mounted in Oak Cabinet with lid; Tuning Coil and condenser, Patent Crystal Detector, totally enclosed in glass; 4,000 Ohms. Double Headphones; 100 feet of Stranded Copper Wire; 2 Shell Insulators.

No further outlay, no batteries required. Each set has been tested and carries our guarantee, and we confidently assert that for the price it is the most compact and reliable that is obtainable.

**PRICE COMPLETE  
£3-5-0**  
**INSTRUMENT ONLY  
£1-12-6**

We have also a complete range of Valve Sets in stock from £7 to £20. Call and inspect the famous FELLOPHONE 2-Valve and 4 Valve Receiving Sets, prices complete, £10 10s. to £17 10s. respectively. Also the FELLO-CRYST SUPER Crystal Receiving Set, price £4 7s. 6d. complete. All our sets are passed by the P.M.G. for reception of broadcasting. All sets open to inspection at our London address. Demonstrations given daily. Hours 10 a.m. to 6-30 p.m.

**ILLUSTRATED CATALOGUE  
POST FREE.**



**RELIANCE RADIO SERVICE CO.,  
283, St. John Street, Clerkenwell, London, E.C.1.**

PHONE: CLERKENWELL 4290.

# EXTRACTS FROM OUR CATALOGUE

(3d. Post Free).

Aerial Wire (7/22's encl. Hard drawn Copper).....per 100 ft. coil	6/-
Aerial Insulators, Shell Type, 2 1/2 in. by 2 1/2 in. approx., best glaze finish.....each	1/3
Aerial Insulators, Reel Type, 2 1/2 ins. dia. approx.....each	3d.
Aerial Insulator, strainer, 2 1/2 ins. by 1 1/2 ins. approx.....each	8d.
Aerial Leading-in Tubes, Sturdy Ebonite 6-in. overall, 1/8 each; 12-in. overall, each	2/-
Aerial Pulleys (large), 5 1/2 ins., with tackle hook and bucket.....each	2/6
Aerial Pulleys (small), 2 1/2 ins.....each	1/-
Accumulators (Oldham's Special Process) 4 volt 40 amp. I.C.....each	20/-
4 volt 60 amp. I.C.....each	22/6
6 volt 40 amp. I.C.....each	27/6
6 volt 60 amp. I.C.....each	32/6
Bamboo Canes for Spreaders, 6 feet long.....each	1/6
Brass Rod (screwed).....each	5d.
3 B.A., in 12-in. lengths.....each	4 1/2d.
4 B.A., in 12-in. lengths.....each	4d.
5 B.A., in 12-in. lengths.....each	3 1/2d.
Brass Washers, 2, 3, 4 or 5 B.A.....dozen	2d.
Nuts, 2, 3, 4 or 5 B.A.....dozen	4d.
Batteries, Flash Lamp.....dozen	5/-
Terminals to fit Contacts of these.....dozen	2/-
Condenser Vanes, 2 1/2 ins. diam., in 0.22 in. hard drawn aluminium.....dozen	9d.
Condenser Vanes (Other sizes see list).	
Condenser Spacing Washers, accurate. Large, 6d. doz.; small, 4d. doz.	
Condenser Centre Spindles.....from	4d. ea.
Condensers Variable (See catalogue)	2/-
Condensers fixed .0001 to .0005.....each	2/3
.001 to .002.....each	2/6
.003 to .004.....each	2/6
Cabinets, beautifully polished Mahogany (See Catalogue)	
Crystal Cups (with screw to fix crystal), ea.	3d.
Crystal Detectors (the neatest design and best finish on market).....each	5/-
Contact Stands (Superior finish, 4 in. by 1 in., with nut and washer).....dozen	1/-
Contact Stops.....dozen	1/8
Copper Foil Sheets (Uniform thickness, 12 ins. by 3 ins.).....each	3d.
Core Wire, soft iron in straight lengths.....lb.	2/4
Coil Mounting Flags, with screw connections.....each	1/3
3-Coil Holders, for panel mounting.....each	12/6
Ebonite Engraved Dials.....each	1/6
Ebonite Sheet, best quality; light, not headed.....lb.	5/-
Filament Rheostats, for panel mounting. The best offered.....each	3/6
Grid Leaks and Condensers (tested with proper instruments).....each	5/6
High Frequency Transformers (improved type, double grooved).....set	£2-10-0
Instrument Wires. Thousands of miles in stock. Competitive prices.	
Insulated Sleeving, 1/4 in. m.m. (Insulation of all kinds, see catalogue).....yard	6d.
Inductance Sliders, with spring and plunger.....each	6d.
Inductance Sliders Rod, in 13-inch lengths.....each	4d.
Ivoryine Scales, engraved, with nuts.....each	10d.
Ivoryine Tablets (Aerial, Earth, Primary, On, Off, Reactance, Phones, H.T., H.T., L.T., L.T., A.T.I., and others).....each	2d.
Knobs, ebonite, 1 1/2 ins. diam.....each	5d.
Loud Speakers and Phones (see catalogue)	
Low Frequency Transformers, 24/- each. For description see catalogue.	
Paraffin Wax.....lb.	1/-
Publications (see catalogue)	
Resistance Wires, 22 & 24 S.W.G. and Enamelled 28 S.W.G.....yard	1d.
Screws (Brass).....from	2d. doz.
Spring Washers (2 B.A.).....each	1d.
Terminals.....from	1/6-2 doz.
Telephone Transformers.....each	17/6
(For description, see catalogue)	
Tin Foil, free from lead, Sheets 26 ins. by 13 ins.....each	4d.
Valve Pins, complete with nut and washer.....dozen	1/3
Valve Sockets, complete with nuts and washer.....dozen	1/3
Valve Holders, complete with nuts and washer.....each	1/-
Valves—Huge stocks B.T.H., 15/-; Mullard Ora, 15/-; Marconi Osram, 17/6.	

Please include ample postage.  
.. Balance will be returned ..

**J. L. CARTWRIGHT & CO.,**  
Dept. P., 24, London Road,  
MANCHESTER.

Phone: CENTRAL 4209      Works: Berry Street.  
Grams: "PLADURAM," Manchester.

Sole Distributing Agents for Scotland: **J. GORSTON SINCLAIR & Co.,** 47 Waterloo St., Glasgow.  
Retail Agent for Blackburn: **THOS. BARTON & Co.,** The Electric Works, Blackburn.

## RADIOTORIAL QUESTIONS & ANSWERS.

(Continued from page 636)

resistance" to high-frequency currents which travel on the surface of conductors?

No, it does not refer to high-frequency resistance, but to the resistance between two points on the surface of a material through a film deposited thereon. For instance, the resistance of a good ebonite insulator may be enormous, but should a film of moisture collect on its surface there will obviously be a surface resistance of much less a value than that through the ebonite itself.

"EXPERIMENTER" (Sheffield).—If I placed two plates of pure lead in a solution of sulphuric acid, would that constitute an accumulator, or is "paste" essential?

That is all that is necessary, but such a cell would require constantly charging and discharging until the plates became "formed" to the condition that is necessary for a secondary cell. That was the original method devised by Planté in 1860. Nowadays the plates are chemically prepared by "pasting" them with red-lead. After a few charges the plates become "formed," the positive to lead peroxide and the negative spongy lead.

S. E. D. (Thorpe Bay).—Until recently my three-valve set was working perfectly, but last week I fixed it up on a better aerial and earth in a different house, and can obtain but poor results. The reaction does not seem to function, and I can hardly hear 2 L.O. Can you tell me why this should be?

Possibly you have wrongly connected up the set. If the leads to the A.T.I. or reaction happen to have become crossed, that would cause the failure. Without further particulars, that is all that we can suggest.

A. L. O. (Ilford).—Can ordinary "R" valves be used for transmitting?

Yes, quite well up to a radiation maximum of 4 or so amperes.

"WAVEMETER" (Dublin).—Referring to your article, the "Amateur Wavemeter," how can one measure C.W. wave-lengths when harmonics can be heard on several adjustments?

That is quite simple by means of a little algebra. Harmonics are invariably exact multiples of the fundamental wave-lengths. Thus, the first harmonic of 1,000 metres would be 500 metres, and the second 250, and so on. If you tune in a signal on a certain coil, and you know that to be, say, 500 metres, and then find the "silent point" of the same station also at 600 metres, then you will know that the fundamental wave-length will be some number times 600, and the same number plus one times 500. Call the unknown number  $x$ , and the fundamental wave-length  $y$ ; then both  $600 \times x$  and  $500(x+1) = y$ . Therefore, eliminating  $y$ ,  $600 \times x = 500x + 500$ , that is  $100x = 500$ ;  $x$  then is 5, and reverting back,  $600 \times 5$  and  $500 \times 6$  is the fundamental wave-length, i.e., 3,000 metres. So you see the "amateur wavemeter" will cover a very useful range, and both high and low value coils can be calibrated by means of harmonics.

A. W. R. (Algeiras, Spain).—What distance can I receive with a crystal set? Would a steel or copper point be suitable with galena or silicon, or is it best to use the two crystals together?

Provided you have a good aerial, you should hear signals over a distance of about 200—300 miles. Large power stations will, of course, be heard further away than that. Paris should be quite easily audible. A copper "cat's whisker" wire is used for galena, and a gold point is best for silicon. No; the crystals should be used separately.

"REGULAR READER" (Pirbright) gives a detailed description of his set—three valves—and complains that speech is very "jumbled up and shaky." He further adds that he has 4 volts on the filaments and 22 volts on the plates. He takes his H.T. from his lighting plant.

Your trouble appears to be the H.T. battery. One valve requires 30 volts, or often more, and three

(Continued on page 640).

## PORTLAND'S Parts by Post. "EBONITE"

4 x 4 . . . . .	1 3	12 x 7 . . . . .	5 2
7 x 5 1/2 . . . . .	2 8	12 x 8 1/2 . . . . .	6 5
8 x 6 . . . . .	3 0	12 x 10 . . . . .	7 6
9 x 6 . . . . .	3 5	15 x 8 1/2 . . . . .	8 0
10 x 6 . . . . .	3 9	12 x 12 . . . . .	9 0
12 x 5 1/2 . . . . .	4 2	17 1/2 x 8 1/2 . . . . .	9 6
9 x 8 1/2 . . . . .	4 10	14 x 12 . . . . .	10 5
17 x 5 . . . . .	5 3	18 x 18 (halfsheet) 12 10	
		36 x 18 . . . . .	£1 3 0

7 lbs. . . . . £1 3s. 0d.      28 lbs. . . . . £4.

No charge for cutting, waste, or postage.  
Delivery by return of post.

Quality A 1. DRILLING, manufacture—BRITISH.  
Thickness One Quarter; Surface Mat.

**JAMES PORTLAND, 39, Sinclair Road, Olympia, W.14.**  
N.B. Mr. Portland stocks 200 Wireless Parts.

### LUNCH HOUR RAMBLE

STROLL ROUND TO  
**SPENCER'S STORES,**  
4-5, MASON'S AVENUE,  
BASINGHALL STREET,  
LONDON, E.C. 4.

CHEAPEST HOUSE IN CITY FOR WIRELESS PARTS & SETS

### THE "SILVER BELL."

A LOUD SPEAKER AT A PRICE WITHIN THE MEANS OF EVERYONE.

Suitable for two or more valves.  
PURE TONE, CLEAR ARTICULATION, GOOD VOLUME OF SOUND.

Low resistance, 150 Ohms . . . . . 29/6  
High resistance, 2,000 Ohms . . . . . 32/6

STANLEY WYMAN, 110, Ladbroke Grove, London, W. 10.

### Beginners Guide to Wireless

Explains, in plain everyday language, everything beginners wish to know about wireless telegraphy.

**HOW TO ERECT, CONNECT, AND MAKE** all the apparatus required for reception of telephony or morse, and full instructions and diagrams for making coils, tuners, and complete valve and crystal sets. 112 pages, price 1/6, post free.—**SAXON RADIO CO.** (Dept. J4), South Shore, Blackpool. 32-page cat. of wireless apparatus, 3d., post free.

## WOODWORKING TOOLS.

Our 1923 Illustrated List  
- - is Now Ready - -

Send for your Copy, Post Free

### GEORGE ADAMS

(Dept. P/W),  
255-6, HIGH HOLBORN, LONDON, W.C.1.

**ALL** Applications for rates for Advertisements in "Popular Wireless" must be made to the Sole Agents: **JOHN H. LILE, Ltd.,** 4, Ludgate Circus, London, E.C.4.



# ROMANCE

Romance did not pass with the Crinoline and the Stage Coach. It is still with us—for which we may be thankful. Could anything be more romantic than the fact that one can sit in one's own drawing-room and hear the great Artistes of the World performing hundreds of miles away? We hardly think so. Get a Wireless Receiving Set now—it is the Gateway to Romance.

The Deskophone Single Valve Set, made in our own workshops to our own design, is the last word in wireless apparatus. It comprises—Accumulator, H.T. Battery, Headphones, Aerial, Lead-in-Wire, Insulators, and Coil. It has been passed by H.M.'s Postmaster General (No. 1019). Made under licence from the Marconi Coy., approved by the B.B.C., and fully stamped.

## THE DESKOPHONE SINGLE VALVE SET

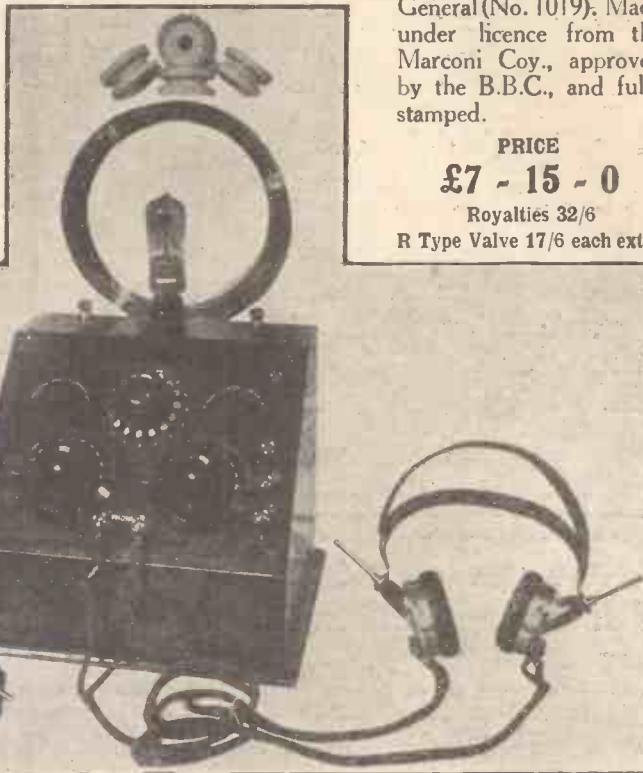

PRICE  
**£7 - 15 - 0**  
Royalties 32/6  
R Type Valve 17/6 each extra

CATALOGUE—

Post Free

TRADE SUPPLIED.

## AMPLIFIER

PRICE

**£3 - 17 - 6**

Royalties 22/6

R Type Valve 17/6 each extra.

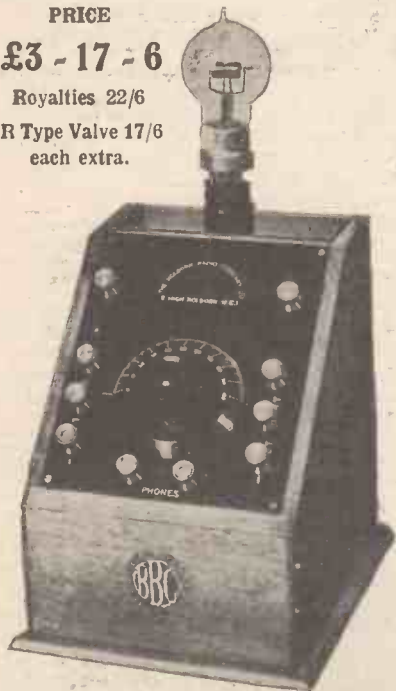

This Low Frequency Amplifier can be used in conjunction with the single or two valve set. It considerably increases the volume of sound. Strongly recommended. Made under licence, etc., as above (P.O.No. 3042).

## THE DESKOPHONE TWO-VALVE SET

(See illustration on right)

The Deskophone two-valve, high frequency amplifier, detector, and tuner. Complete with accessories as shown in illustration above of single valve set. Made under licence, etc., as above (P.O.No. 2020.)

PRICE

**£12 - 17 - 6**

Royalties £3 - 0 - 0

R Type Valve 17/6 each extra.

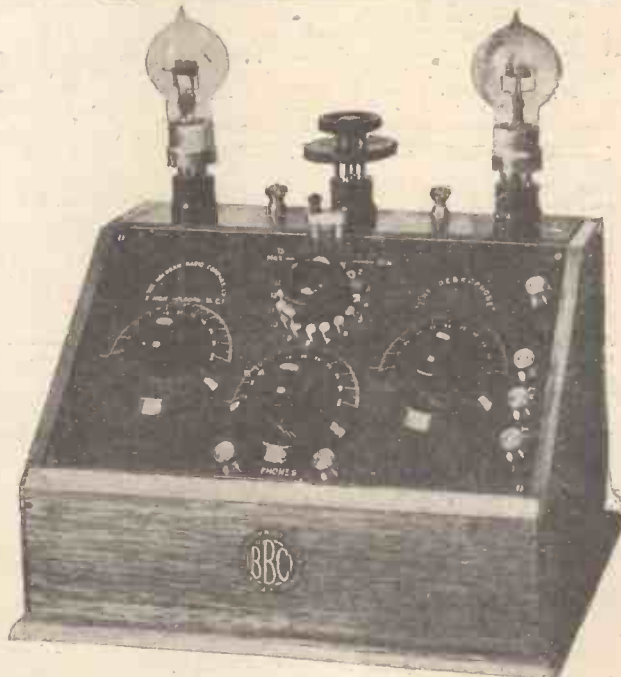

Phone No. : CHANCERY 8'83

# THE HOLBORN RADIO CO., LTD.,

8, HIGH HOLBORN, LONDON, W.C.1

(5 doors from Gray's Inn Road.)

# OMNIPHONE Wireless Service

We not only supply sets and components of the highest grade at the lowest prices, but offer a really helpful free service of technical assistance and advice.

Our thirteen years' experience of wireless places us in an unrivalled position, and we never fail to solve the problems submitted to us, either by correspondence or personally. Your satisfaction is absolutely assured whether you buy a complete set or assemble your own from our components. Lists free.

## OMNIPHONE WIRELESS CO.,

24, WARWICK STREET,  
REGENT ST., LONDON, W.1.

20 yards from Regent St., between Maison Lewis  
and Robinson & Cleaver's.  
Phone: Regent 3335.

OPEN UNTIL 4 P.M. SATURDAYS.

**ACCUMULATORS, etc.** New and Guaranteed  
4-Volt, 25-Amp. Celluloid, 11/3. Postage 1/-.  
4-Volt, 40-Amp. 17/6 | 6-Volt, 40-Amp. 25/6  
4 " 60 " 21/3 | 6 " 60 " 31/-  
4 " 80 " 27/- | 6 " 80 " 36/-  
Packing, 1/6 extra. Packing, 2/- extra.  
7/22 Aerial, 5/6 100 ft.; Mullard Ora Valves, 15/-;  
15-V. Siemens H.T. Batteries, 4/-; Marconi R.  
Valves, 17/6; Accumulator Charging Board, 37/6;  
Voltmeters, Watch pattern, 0/12 Volts, 6/-.  
Cash with order. Goods despatched per return.  
**LOWKE & SONS, Ltd., Northampton.**

Have you seen them?  
Have you HEARD them?

**L. F. TRANSFORMERS.**  
The last word in efficiency.  
Price 21/- each.

**H. F. PLUG-IN TRANSFORMERS.**  
350-450 metres - Price 6/6 each  
900-1100 " - Price 7/6 each  
Manufactured at our Works.  
Liberal discounts to the trade.

**P. H. BOYS & CO.,**  
Electrical & Wireless Engineers,  
167, GOSWELL ROAD, LONDON, E.C. 1.  
Phone: Clerkenwell 4454.

## THE BEST BOOK ON WIRELESS FOR AMATEURS

How to make and use a Wireless Valve Receiver Set. By E. K. Spiegelhalter. This book has been specially written for Amateurs in Wireless. Clear Constructional details accompanied by 24 very practical Illustrations are given, which will enable the operator to build his own set economically and to work it successfully when made.

Price 2/- net. Send P.O. for a copy.

E. & F. N. SPON, Ltd., 57, Haymarket, London, S. W. 1

## RADIOTORIAL QUESTIONS AND ANSWERS.

(Continued from page 638.)

valves will therefore need far more than you are giving them. Try about 60 volts on the plate. This should cure your trouble. The method you are using for your H.T. source is far from satisfactory. This method only gives uncertain and unsteady supply. Use a dry battery of well-known make.

\* \* \*  
"BEGINNER" (Jersey).—I am thinking of making the crystal receiving set described in your issue of November 11th. (1) What range can I have with this set? I suppose telephony is out of the question? (2) If I use an indoor aerial, must I have a licence? (3) What condensers do I need?

(1) Your range will be about 250 to 300 miles for telegraphy reception. (2) An indoor aerial is unsuitable for a crystal set. (3) Use a .0005 mfd. variable condenser across the inductance, and a .001 mfd. fixed condenser across the 'phones. Your description of lead-in will be all right insulated by glass, though it should go as direct as possible to the instruments.

\* \* \*  
T. S. R. (East Sheen).—Would you kindly answer the following questions: (1) What is ebonite composed of? (2) How can the waves touch earth when a condenser is in between?

(1) Ebonite is a compound composed of sulphur and rubber. (2) You have a somewhat mistaken idea of the theory of wireless. It is not the actual ether waves which go up and down the aerial, but it is a potential or pressure, varying from point to point and from moment to moment, which causes the oscillations to take place in the aerial. This rapidly changing potential is caused by the ether waves as they come into contact with the aerial. Thus you will see that the condenser does not act as you suggest, but merely has a varying potential across, it with which, of course, it does not interfere.

\* \* \*  
"NO NAME" (Colchester).—(1) How long should a four-volt ten-amp. accumulator last, using three valves? (2) How often should the acid be changed? (3) Is the Armstrong super-regenerative set allowed by the P.M.G.? (4) What valves are necessary for this set?

(1) If the accumulator is stamped 10 amp. hours, it probably means 10 hours' ignition—that is, 5 hours actual. This is too small for three valves, and would only last a couple of hours or so. (2) When the specific gravity is too low, or the level of acid is too far below the top of the plates. (3) As far as we know, it is not likely to be allowed, as it oscillates violently. (4) The valves should be the Q type.

\* \* \*  
"LOKAP" (Liverpool).—Would a 36 feet twin aerial, 46 feet and 34 feet high, be O.K. for a crystal set? (2) How many sets am I allowed to have? (3) Would a variable condenser help?

(1) Yes, the aerial is quite O.K. (2) The regulations allow for only one "station." You can, therefore, only use one aerial, though you can use two crystal sets, if required, alternately on the same aerial. (3) A variable condenser of about .0005 mfd. is always a help for fine tuning. Your diagram is quite suitable.

"DOUBTFUL" (Tufnell Park).—Which would be the best condenser to use across an inductance of 12" by 4" wound with 24 S.W.G. enamelled wire? I have several condensers, .001, .0005, .0003 mfd. respectively. The .0005 mfd. condenser would probably be most suitable.

\* \* \*  
"AERIAL" (no address).—I wish to erect an aerial of as few joints as possible. Can I take it as a continuous wire right round and down at the lead-in end? It would be a double aerial.

We presume you mean that the two leads would be joined at both ends. This arrangement is not suitable. At one end of the aerial both the wires must be insulated from one another. It is only at the lead-in that they should have any electrical connection.

\* \* \*  
"OIDAR TREBOR" (Tufnell Park).—Can you tell me the wave-length of a loose-coupled inductance? Primary is 4½" diam. with 270 turns of 28 enamelled wire. Secondary is 3" diam. with 300 turns of 28 cotton-covered wire.

Your wave-length approximately is 350 metres to 3,300 metres. This will vary, however, according to the degree of coupling used.

\* \* \*  
R. P. D. (Totnes).—I have a condenser consisting of 29 plates. Fixed plates are 3¼" diam., moving plates are 2½" diam. The washers appear to be about ⅜". Please let me know the capacity.

Capacity is approximately .0005 mfd.

\* \* \*  
"RADIO" (Liverpool).—What stations am I likely to hear on a crystal set, being only about a mile from the river Mersey?

You may possibly hear the Manchester broadcasting station. You should hear the Liverpool station working with the Bar Lightship; also ships and several coast stations will be within range for telegraphy reception. The wave-length of the set in our issue of November 11th is about 200 to 700 metres.

\* \* \*  
W. L. T. (Balham).—I am thinking of using one of those aerial attachments that plug into the electric light, as I have no facilities for an outdoor aerial. Will I be able to use a crystal set with it, and will it make any difference if the light is switched on? (2) Is the usual earth attachment required?

(1) Possibly you may hear 2 L O fairly well, but we prefer valve sets with such attachments to give comfortable signals. It will be noticed that it is necessary to switch the electric light current on to obtain good results. (2) Yes.

\* \* \*  
"AMATEUR" (Norwich) gives full particulars of his tuner, and asks what capacity would be suitable for the telephone-condenser.

The function of the telephone condenser is not to vary or affect the tuning of the set in regard to wave-length, but to smooth out the irregularities of the H.F. impulses and, by doing so, improve the quality and tone of the music or speech. The value of this condenser is by no means critical; .001 mfd. or so would be quite suitable.

## CRYSTAL RECEIVING SETS

Complete set of parts, including Cabinet 12 x 4½ x 4 inches deep, Crystal Detector (Ball and Socket type), Tested Crystal, Ebonite Panel Drilled, making a strong, good-looking instrument, needing pliers and screw-driver only to assemble. With complete instructions, and drilling, etc., done - - - 17/6 post free.

100 ft. Aerial Wire Insulators, earth clip and wire, - - - 8/6 post free.

4000 Ohm Double Headphones - 25/6 post free.

(Five Years' Wireless Instrument Experience.)

**THE SOUTH WESTERN  
WIRELESS MANUFACTURING CO.,  
PENZANCE.**



## CRYSTAL RECEIVING SET.

(British throughout.)  
One of many items from our catalogue, complete as illustrated.

£3 : 7 : 6

Subject to B.B.C. surcharge.

Guaranteed to receive  
**BROADCASTING.**

Illustrated Catalogue, P., including List of Stations, etc., 3d. post free.

**EONS WIRELESS SUPPLY COMPANY,  
115, FLEET STREET, E.C. 4.**



What "POPULAR WIRELESS" says of these  
TWO NEW WIRELESS PRESS BOOKS:

IN order to be able to enjoy to the full the usefulness of a crystal or any other receiver, a knowledge of the Morse code is essential, and the first-named little brochure (The Perry Auto-Time Morse System) details concisely and convincingly (with an original method) how rapid progress may be made in that direction.

PHOTOS of actual apparatus, sketches in perspective of practical "hook-ups," and an abundance of useful analogies render Mr. Coursey's outline of Wireless Telephony both informative and readable, and for the non-technical reader forms a complete introduction to the mysteries of both transmission and reception.

"The Perry Auto-Time Morse System."

Cr. 8vo. 16 Pages.

Price 6d. net. Post free 7d.

"The Wireless Telephone What It Is and How It Works,"

Cr. 8vo. 128 Pages.

Price 2/6 net. Post free 2/10

Read the Oldest Wireless Weekly,

"THE WIRELESS WORLD & RADIO REVIEW"

Price 6d. Nett.

The Wireless Press, Ltd. (Dept. P.W.),  
(THE PIONEER HOUSE FOR WIRELESS PUBLICATIONS),  
12-13, Henrietta Street, Strand, London, W.C.2.

Chelsea Steel Masts

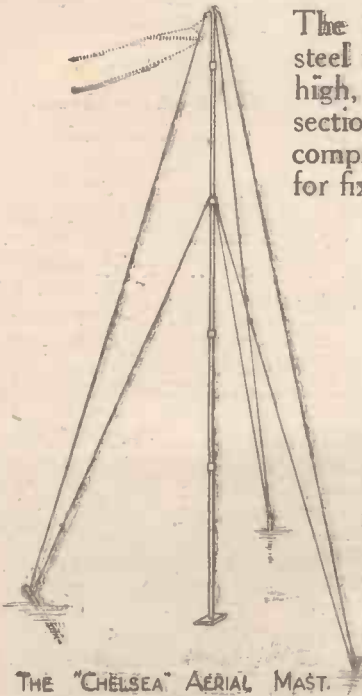

The Chelsea hollow steel mast stands 30 ft. high, is built in four sections, and is sold completely equipped for fixing.

The equipment includes—30 ft. mast, painted battleship grey, sole plate, intermediate and top stay plates, 6 steel wire guy ropes, 3 2-ft. long iron earth pegs, 6 strainers, 12 S hooks, and 1 galvanised pulley block.

PRICE F.O.R.

£5:10:0

40 ft. Mast with extra set of guys

£9:0:0

Prompt Deliveries from Stock.

TRADE SUPPLIED.

THE "CHELSEA" AERIAL MAST.

CHELSEA MOTOR BUILDING CO., LTD.,  
164, King's Road, Chelsea, S.W.3.

BROADCASTING



The FELLOCRYST SUPER

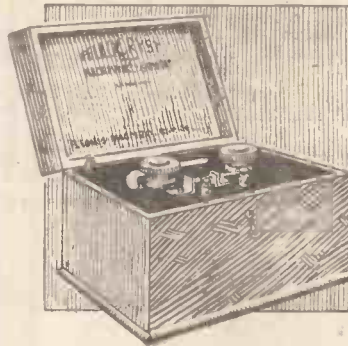

THIS is a high-grade Crystal Detector especially designed for receiving broadcasting, and complies with all regulations. Beautifully pure clear speech and music are received, and as many as three pairs of Fellows 4,000 ohms double headphones can be simultaneously used.

The "FELLOCRYST SUPER" is mounted in a highly polished oak cabinet and is sent out complete with 100 ft. coil of 7/22 stranded copper aerial wire, two shell insulators, and one pair 4,000 ohms double headphones, and is

British Made Throughout

PRICE COMPLETE - - £4:7:6 (Postage 2s. each)

Extra 4,000 ohms double headphones 2/1- (Postage 1s.)

FELLOWS MAGNETO Co., Ltd.  
LONDON, N.W.10.

Telephone: WILLESDEN 1560-1

Telegrams: "QUIX MAG," PHONE, LONDON.

For they are jolly good Fellows





# Where there's Electric Light there's Wireless

Your electric light catches the wireless exactly as an aerial does. Plug a "Ducon" into any lamp holder or wall socket, connect it to your wireless receiver and you will receive the broadcasting perfectly. Use a "Ducon" and you don't need an aerial. "Ducons" are perfectly safe—each one is tested to 1,000 volts, *they consume no current* and do not affect the electric light in any way.

## The DUCON 10/-

is obtainable from leading wireless dealers, electrical contractors and stores, or direct from the makers.

*Dealers not yet stocking are invited to write for trade terms.*

**Over 50,000 in use.**

**The Dubilier Condenser Co. (1921) Ltd.,**  
Ducon Works, Goldhawk Road, Shepherd's Bush, London.  
Telephone: Hammersmith 1084. Telegrams: Hivoltcon, Phone, London.



## C.T.C. MULTUM-IN-PARVO CRYSTAL RECEIVERS

No technical knowledge is necessary to listen-in at once on the MULTUM-IN-PARVO. Full instructions are given with every set.

*These Sets as Illustrated comprise:—*

**TUNER.**—Inductance which can be varied by means of tappings taken to switch giving correct wavelengths, 200/1,000 metres.

**MICROMETER DETECTOR.**

**FIXED CAPACITY CONDENSER.**—Fitted with best ruby mica.

**VARIABLE CONDENSER** for selective tuning.

**RANGE.**—30 miles. Telephony Morse up to 600 miles.

**AERIAL.**—Complete equipment—120 ft. Wire Earthing Wire, Lead-in Tube, and Two Insulators.

**EVERY SET IS FITTED WITH BROWN'S 'PHONES (4,000 OHMS.)**



"MULTUM-IN-PARVO."

*Complete as Illustrated*

**BLACK LEATHERETTE... £5 15 0**

**MAHOGANY ... £5 15 0**

**COW-HIDE ... £6 15 0**

**All Prices PLUS TAX, 7/0.**

**JUNIOR ASSEMBLY SET, range 10 miles £1 12 6**  
Post Free.



ASSOCIATED WITH  
**CONSOLIDATED TRADING & MANUFACTURING CO., LTD.,**  
FULWOOD HOUSE, FULWOOD PLACE, HIGH HOLBORN, W.C.1.  
*Call or Write for List, Threepence!*

# Exide BATTERIES

**H.T.  
Batteries  
for  
Valve Sets**

24v. 28v. 32v.  
Type B.K.



Owing to the demand for these batteries, all orders will be dealt with in strict rotation. Prices approximately one shilling a volt.  
:: Ask for Leaflet 4030 ::

## THE Chloride ELECTRICAL STORAGE COMPANY LIMITED.

CLIFTON JUNCTION, | 219, 229, SHAFTESBURY AVENUE, W.C.2.  
NR. MANCHESTER. | 58, DALE END, BIRMINGHAM.

# BROADCASTING RECEPTION SETS.

One-Valve Set Complete for Working, £7:10:0

Including All Accessories

Send for  
Catalogue

Passed for  
Broadcasting  
Licence G.P.O.  
No. 1038.

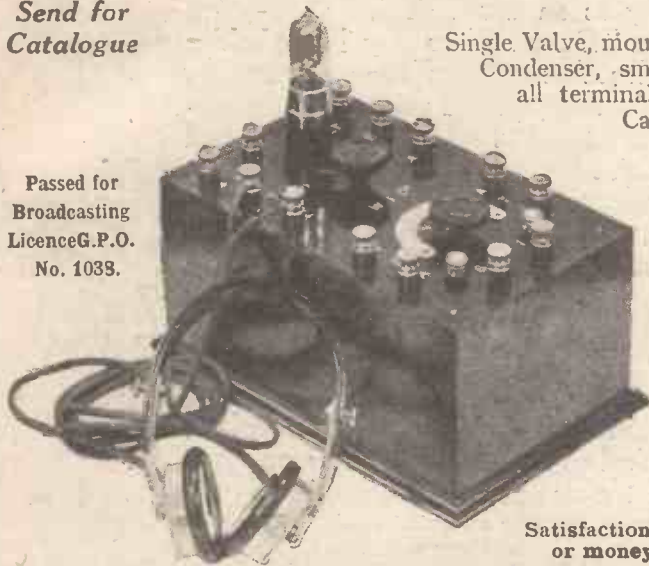

## DESCRIPTION:

Single Valve, mounted on polished 1/4-in. Ebonite Panel with Variable Condenser, smooth acting resistance, grid leak and condenser and all terminals clearly engraved in white, in a Mahogany Polished Cabinet, 9 in. by 5 in. by 5 in. **£3:15:0**

A TAPPED COIL for wave-lengths up to 900 metres with 2 terminals for coils for any higher wave-lengths.

The coil is enclosed and the tappings are brought out to an 8-way switch mounted in the front of the cabinet.

## ACCESSORIES INCLUDED:

Siemen's 54 volt high-tension Battery with plugs for altering the voltage **£0:15:0**  
 4 volt 50 amp. hour low tension Accumulator in case with carrying strap **1:4:0**  
 One pair of Sensitive Head Phones of 4,000 ohms resistance **1:1:0**  
 One Detecting Valve **0:15:0**

Satisfaction Guaranteed  
or money refunded.

**Total £7:10:0**

**WIRELESS INSTALLATIONS Limited,**  
15, ALDERSGATE STREET, LONDON, E.C.

## Wireless Headphones

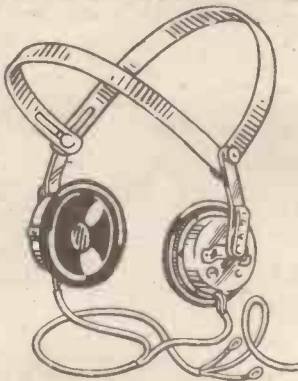

2,000 OHMS  
**45/-** POST  
FREE.

THIS High Grade Instrument, fitted with Aluminium Adjustable Diaphragms, is acknowledged by leading experts to be the finest yet placed before the Public. Wound to a total resistance of 2,000 ohms, their sensitivity is equal to most others on the market of 4,000 ohms. Specially Shaped Ear Pieces are designed so that all outside noises are excluded. Headbands are extremely light and covered with the finest quality Ebonite.

Special Terms to Trade.

**THE BRITISH DOMINIONS TRUST, LTD.**  
161, NEW BOND STREET,  
LONDON, W.1. 'Phone - GERRARD 3438.  
B.P.S.

## HERE'S REAL RADIO SERVICE!

### A SPECIAL OFFER FOR TWO WEEKS

To those who are expecting Xmas visitors who will also want to "LISTEN IN."

TELEPHONES 4,000 ohms, Guaranteed, per pair	1 0 0
8,000 " " " " "	1 2 6
Single Earpiece 2,000 " with cords,	10 6
DETECTOR PANEL, mounted in cabinet	1 0 0
INTERVALVE TRANSFORMERS, remarkable value	15 0
COIL-HOLDERS, three-way	14 0
BASKET COILS, set of seven	5 0
SLAB COILS, set of eight	7 6
LECLANCHE CELLS, miniature for H.T., each	1 0
(1 1/2 oz. Sal Ammoniac changes, 12), per doz.	10 6
AERIAL WIRE, 7/22 bare copper, per 100 ft.	3 3
AERIAL WIRE, 7/22 enamelled, per 100 ft.	4 6
INSULATORS, reel, 2, Shell, 9d. and	6 6
RHEOSTATS, Best Quality, 3/9 and	2 6
HERTZITE CRYSTALS, 2/- and	1 6

These are but a few of our many bargains taken from our Price List. Post free on application.

**WATERLOO ELECTRIC Co.,**  
Electrical and Wireless Engineers,  
129, Waterloo Road, London, S.E.1.  
(1 min. Waterloo Station.) Tel.: Hlop 5619.





# An Ideal Xmas Gift—Order Now

The Best Value in Single Valve Panel Sets on the market  
 No Finer Set could be built if 20 times the price were paid

**30/-**  
 COMPLETE

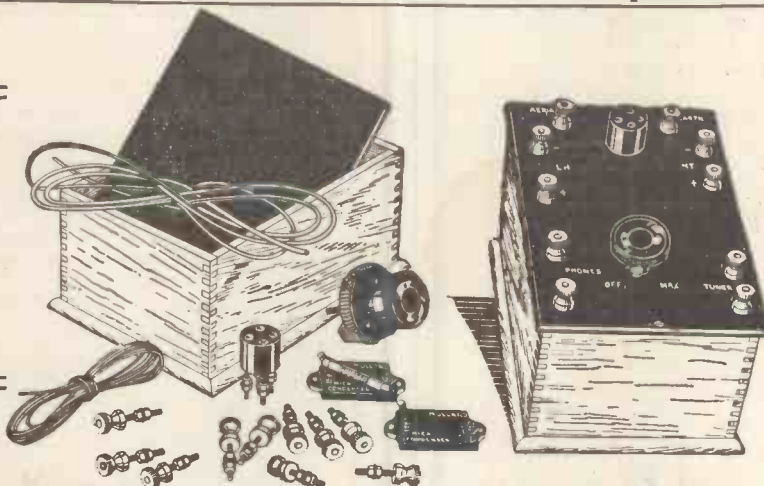

**30/-**  
 COMPLETE

**Comprising:** Handsome polished mahogany cabinet, panel of best quality Ebonite, well finished and bevelled edges valve holder, filament resistance, 2 Mullard's Condensers, '0003 and '0002 mfd. Mullard's Grid Leak, 10 Terminals, 10 engraved terminal tablets, coloured systoflex and copper wire, blue print with full instructions. **Hundreds of these sets have already been sold. As will be observed, ONLY THE VERY BEST COMPONENTS ARE SUPPLIED. This is the secret of the success and popularity of this panel.**

## EVERY WIRELESS ACCESSORY IN STOCK

Coil Holders, 25/-; "Ora" Valves, 15/-; Marconi "R" Valves, 17/6; Valve Holders, 1/9; Variable Condensers '0005 mfd. £1; '001 mfd. 26/6; Filament Resistances, 4/-; Mullard Condensers '0002 and '0003 mfd., 2/6; '001 mfd. 3/-; Mullard Grid Leaks, 5/-; Transformers, intervalve, 25/-; High Tension Batteries complete with Wander Plugs 36 volts, 8/6, 60 volts, 14/-.

### FREE GIFT

A useful Case containing 3 padded compartments free to every purchaser of 3 valves.



**BROWN HEADPHONES, "A" Type, 120 ohms. £2 2 6**  
 " " " " 8000 " £2 9 6  
**SULLIVAN HEADPHONES (Complete with 25/- Transformer) 120 ohms - - - £1 10 0**  
 " HEADPHONES 8000 ohms - - - £1 16 6

All brand new and unused, and sold under our express guarantee that we will refund full amount paid if not absolutely satisfied and goods are returned within 7 days.

**AGENTS.**  
 LONDON: A. W. GAMAGE, LTD., HOLBORN, E.C.  
 SELFRIDGE & Co., LTD., Oxford Street, W.  
 RICH. FORD & Co., 153, Fleet Street E.C.4.  
 H. V. ALBROW, 56, George Street, Portman Square, W.1.  
 YORKS: BARNESLEY BRITISH CO-OPERATIVE SOCIETY, LTD., Barnsley.

# The City Accumulator Co,

**79 MARK LANE — LONDON, E.C. 3.**

**IMPORTANT NOTICE.** We beg to announce that most of our goods can now be obtained from Mr. W. E. BIRKHEAD, Church Street, WALTON-ON-THAMES, who has been added to our list of Agents.

**AGENTS.**  
 GLOS.: BRISTOL WIRELESS Co., 52, Cotham Hill,  
 S. WALES: SOUTH WALES WIRELESS INSTALLATION Co., LTD., 13, West Bude Street Cardiff.  
 N. WALES, LANCs., CHES. & I.O.M.: THE "ALL-BRITISH" WIRELESS MFRS. Co., LTD., 18, Vauxhall Road, Liverpool.



*An ideal and economical  
Xmas gift for your  
Broadcasting friends.*



# Radio Head Phones.

(Manufactured under Brown's  
Patent No. 134353/18 by Sole  
Licence.

No. R1238.  
MARCONI STANDARD

To those who possess a Broadcast Receiving Set a pair of Head Phones as a Xmas gift strikes a novel idea, and will be greatly appreciated.

Many will be spending a real radio Xmas this year, and an extra pair of Head Phones enables another to listen to the high class musical programmes transmitted from the Broadcasting Stations.

*The instrument above illustrated is of the highest efficiency and constructed to give a comfortable fit to the ear of the user.*

## Immediate Delivery.

WRITE FOR—Leaflet 321 & 325 dealing with Radio Headphones.  
Leaflet 324 re Sterling No. 1 Crystal Receiving Set.  
Leaflet 331 re Marconiphones.  
Booklet 332 re "Magnavox" Loud-Speakers.

To be obtained from all dealers or direct from:  
**Sterling Telephone & Electric Co., Ltd.**

TELEPHONE HOUSE,  
210/212, Tottenham Court Road, London, W.1.

Telephone No.: 4144 Museum (7 lines). Telegrams: "Cucumis, Wesdo, London"

Works: DAGENHAM, ESSEX.

BRANCHES: NEWCASTLE-ON-TYNE: 9, Clavering Place.  
CARDIFF: 8, Park Place.

# THE Crystophone

## BROADCAST RECEIVERS

(to Postmaster-General's Specification)

TYPE.	PRICE	
	Inclusive of all Royalties.	
	£	s. d.
"The Scout" Crystal Receiver	3	10 0
Royalties included—7s. 6d. ...		
21. Crystal Receiver	4	15 0
Royalties included—7s. 6d. ...		
20. Crystal Receiver	5	10 0
Royalties included—7s. 6d. ...		
30. Crystal and Single Valve L.F.A.	12	10 0
Royalties included—£2 0s. 0d. ...		
33. Crystal and 2 Valves (1 Detector)	15	0 0
Royalties included—£3 7s. 6d. ...		
34. Crystal and 3 Valves (1 Detector)	23	0 0
Royalties included—£4 10s. 0d. ...		

The **PROVED BEST** for  
Maximum Power, Purity of Tone  
and Simplicity in Operation

INSIST on a practical demonstration before you purchase—is all we ask. IT IS SUFFICIENT TO PROVE THE SUPERIORITY of

# THE Crystophone

## Crystor

### COWL INSULATORS

(PROV. PATENT)

THE **ABSOLUTE ESSENTIAL**  
OF A PERFECT AERIAL



Horizontal Wall or Window  
**LEAD-IN**  
6/6

## WIRELESS SUPPLIES CO.

64, MORTIMER ST  
LONDON, W.1.  
Phone: Museum 2672  
'Grabs':  
'Adragonax, Wesdo, London.

Vertical Roof  
**LEAD-IN**  
6/-

All Applications for Advertisement Space in POPULAR WIRELESS to be made to JOHN H. LILE, Ltd. (Sole Agents), 4, Ludgate Circus, London, E.C.4. Phone: 10806 Central.



No. 29. ETHER VIBRATIONS: BY P. J. RISDON, F.R.S.A.

# POPULAR WIRELESS

3d

Weekly

No. 29, Vol. 2.  
Dec. 16, 1922.



SEEN ON TOP  
OF A 'BUS.

FEATURES IN THIS ISSUE:

Success with Dry Cells.  
Action at a Distance.  
Wireless and the Weather.

Balanced Crystal Circuits.  
Notes on the London Ether.  
Useful Tips for Amateurs.



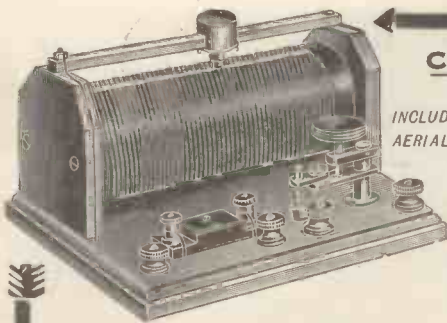

**COMPLETE**  
FOR **50/-**  
INCLUDING  
AERIAL AND  
ONE  
PAIR  
OF  
"MITCHELLPHONES."

*Tested and  
Guaranteed.*

**Get It In Time For Xmas Concerts.**

A Handsome Receiving Set, tuning up to 1,000 Metres, at a very sensible price that will appeal to intending purchasers.

Without doubt the finest value for the money, and is sold under our usual unconditional guarantee.

The price covers one pair of the famous Mitchellphones and aerial material for 100 feet, postage paid to your door. Immediate delivery can be effected, and you can easily instal the whole outfit by following the book, which is included, in time for your Christmas Holiday.

Dimensions :

9 ins. x 6 ins. x 5½ ins. high.

**MITCHELLS** ELECTRICAL AND WIRELESS Ltd., 188, Rye Lane, Peckham, S.E.15

POSTAL ADDRESS: McDermott Road, Peckham, London, S.E.15.  
WEST END BRANCH: 2, Gerrard Place, London, W.1.

*Read This:—*  
Unsolicited, original can be inspected.  
Surrey, Oct. 22, 1922.  
Dear Sirs, I am writing this to assure you of the efficiency of your Wireless Outfit. On Tuesday last I heard the Writtle Concert, although it is advertised to have only a 25 mile radius for speech.  
I am yours truly,  
R. \_\_\_\_\_

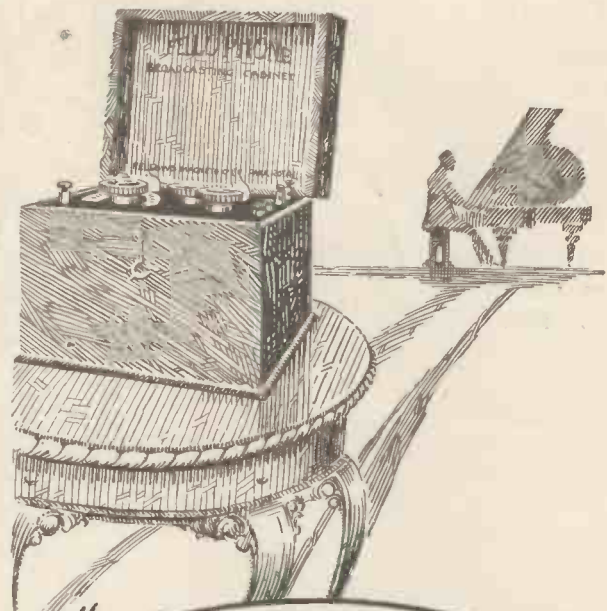

*The* **FELLOPHONE**

**2-Valve Receiving Cabinet.**

A high-grade instrument at a very low price. This set has been especially designed for receiving broadcasting, and complies with all the Postmaster-General's regulations. It can be used either for listening-in with headphones or with a loud speaker.

Additional interest and use is secured because it will receive all amateur transmitting stations within a range of 20 miles. The "Fellophone" is mounted in a handsome oak cabinet, and is sent out complete with H.T. battery, 6 volt accumulator, 100 ft. aerial, 2 shell insulators, and one pair of Fellows 4000 ohms double headphones, but without valves.

*British Made Throughout.*

PRICE COMPLETE (without valves),

**£9 0. 0.** (Carriage 2/-)

EXTRA FOR 2 MULLARD "ORA" VALVES, 30/-

EXTRA FOR ADDITIONAL FELLOWS DOUBLE HEADPHONES, 21/- (Postage, 1/-)

**FELLOWS MAGNETO Co., Ltd.**  
LONDON, N.W.10.

Telephone: WILLESDEN 1560-1.

Telegrams: "QUIXMAG," "PHONE, LONDON.

**HAVE YOU HEARD THE**

**? "HESTAVOX" ?**

**BROADCAST RECEIVERS**

(as illustrated in recent numbers of this paper).

**IF NOT, YOU MUST HAVE HEARD OF THEM.**

They are all licensed under Marconi Patents, bear the G.P.O. approved number, and the B.B.C. trade mark.



OUR  
GUARANTEE

YOUR  
PROTECTION

**TRADE MARK.**

Your dealer, when showing them to you, will confirm our assertion that they represent the last word in Efficiency, Value and Finish. If he is out of stock WRITE AT ONCE for our loose leaf catalogue, containing full particulars of Receivers ranging in price from £3 7 6 to £45 0 0

This will be sent post free for 6d.

The "HESTIA" ENGINEERING COMPANY,  
32, PALMERSTON ROAD,  
1 mln. South Acton Sta. ACTON, LONDON, W.3.  
(N.L. and District Elys.)

Showrooms open  
9 a.m. — 6 p.m.  
Telephone:  
Chiswick 583

EB

8A

*For they are  
jolly good Fellows*



**NEXT WEEK**

Radio in the next Great War.



By

P. J. RISDON, F.R.S.A.

# Popular Wireless

TOPICAL NEWS AND NOTES.

**NEXT WEEK**

A two-slide inductance coil.

A home-made telephone transformer.

Two-valve L.F. amplifier.

And many useful "tips" sent in by readers.

**The Ever Ready Co., Ltd.**

THE directors have declared an interim dividend at the rate of 7 per cent. per annum on both the preference and ordinary shares for the half-year ended September 30th, 1922, payable on December 1st. The transfer books will be closed from November 27th to December 1st inclusive.

**The Largest Broadcaster.**

DESCRIBED as the largest and most powerful radio station of its kind, a wireless transmitter has been erected on the roof of the Æolian Hall, in New York. It is claimed that this will permit of the creation of an entirely new standard of broadcasting music. Two 100-ft. skeleton towers have been erected. The programmes will be carried out in studios in the building, and will be relayed to the roof.

**A Record.**

A NEW record in wireless telephony from an air express in flight to a ground station was established recently, when Captain W. G. R. Hinchliffe, flying from London to Amsterdam, was in communication, despite the roar of his engine, with the Air Ministry wireless station at Croydon when he was circling over the aerodrome at Amsterdam.

**A Radio Lighthouse.**

DETAILS of a wireless lighthouse which has been installed on Inchkeith Island in the Firth of Forth are given in "Lloyd's List."

By means of reflectors wireless waves are concentrated into a beam with a radiation of about 100 miles, which revolves, and in passing each point of the compass assumes a distinctive signal. For ships possessing direction-finding instruments it will be a simple matter to determine precisely their position, while other craft with wireless sets will be able to deduce their whereabouts approximately.

The Inchkeith installation is a development of the experiments to secure privacy of conversations. An apparatus 20 ft. high

is employed, and with the reflector the diffusion of the waves is prevented. The broadcasting wave is 360 metres, and it is held that the shorter the wave-length the freer it is from interference.

The wireless lighthouse is considered an advance on the system established by the American authorities of setting up a series of radio beacons on the Atlantic seaboard by which, with directional apparatus, craft could work out their position in a fog.

**Licence Figures.**

SINCE broadcasting actually began there has been a steady and growing demand for licences, but the actual figures will not be available till the end of the year.

Messages must reach the company's offices at Radio House, Wilson Street, E.C.2, before midnight on Saturdays. The time limit at Marconi House is 7 p.m., and at Fenchurch Street and the Baltic Offices 4 p.m.

There are at present possibilities of delay up to 48 hours in the service.

**Broadcasting in Sweden.**

THE Allgemeine Elektrische Gesellschaft, Svenska Radio Aktiebolaget, and Tidningarnas Telegrambyrås Aktiebolaget have applied to the Swedish Government for a joint concession for a monopoly of broadcasting in Sweden.

**"Government Regulations" Relaxed.**

I WONDER what those few remaining "hard to satisfy" people who frequently alluded to 2 L O as the "interrupted C.W. station" will find to grumble at now that "Government regulations" have been relaxed in regard to the "three minute silences." Nearly an hour's musical programme with but one five-minute interval will not, however, appeal to that Government station that agreed to confine its spark-gap activities to the periods of 2 L O's silences.

**HAVE** you bought your Christmas present yet? If you have not, glance through the many attractive offers made by advertisers in this and last week's number of "Popular Wireless." You will see that this is to be undoubtedly a Radio Christmas, for, with the commencement of the broadcasting service at London, Manchester, and Birmingham, and the certainty of an early commencement of a service in other parts of the country, thousands of people are anxious to acquire a set and enjoy for themselves the broadcast concerts.

If you have friends who would like to buy a wireless receiver, but fear to do so because they do not know exactly how to fix it up, tell them to write to "Popular Wireless," where every question is answered in detail by post.

You can give your friend no better present than a broadcast receiver, which will provide amusement in the home as well as a medium of true educational value. Do this and help to make the pleasures of broadcasting known both far and wide, and

**A Radio Christmas to You.**

A striking increase is shown in the number of experimental licences, which are granted only to those who hope and are competent to make a useful contribution to wireless research. Up to the end of last March 8,000 such licences had been issued, but by October 31st the number had increased to over 18,000, showing an increase of more than 10,000 in seven months.

**Cheaper Wireless.**

A WIRELESS letter service at 3d. per word has been introduced by Marconi's Wireless Telegraph, Co., Ltd. At present it will be limited to week-end messages between London and New York. Letters after being wirelessly across the Atlantic will be forwarded to any destination in the ordinary way.

**Misleading.**

I NOTICED the other day an advertisement in a certain journal above the name of a very well-known firm stating that its most wonderful crystal receiver was able to receive music broadcasted "in London, Paris, and New York." Such advertisements should state that the receiver in order to repeat such a performance should be taken to London, Paris, and New York respectively.

**Wireless to the Rescue.**

Recently a serious accident occurred on board the steamer *Editor*, but fortunately medical help was immediately forthcoming from another ship in answer to a wireless message.

## NOTES AND NEWS.

(Continued from previous page)

## Newcastle's Broadcaster.

THE site selected for the Newcastle broadcasting station is in West Blandford Street, a large chimney recently erected having been acquired to support the aerial. It is believed that Newcastle will be in full broadcasting swing by Christmas, although that would appear to be rather an optimistic view.

Professor Fleming, lecturing in Glasgow, stated that it had been decided that Glasgow was to be the first Scottish city to be provided with a broadcasting station.

## Sir Oliver Lodge.

SIR OLIVER LODGE is to give a Silvanus Thompson Memorial Lecture at the Technical College, Leonard Street, London, E.C.2, at 7.30 p.m. on Friday, January 26th, 1923. The subject will be: "The Basis of Wireless Communication."



A photograph of Senatore Marconi, who is now in Rome

## Concert Notes.

ON Saturday, December 9th, 2 L O's evening concert programme contained two items of more than average interest. Songs by Mr. George Elliot, the well-known music-hall entertainer, came out excellently on my loud speaker, and cello solos by that fine musician, Mr. John Snowden, were a joy to listen to. I hope that in the near future we shall all have the pleasure of listening to Mr. John Snowden again—with his talented sister, Miss Marion Snowden, at the piano. Such a combination would be a treat indeed.

## Another Wireless Lighthouse.

A WIRELESS fog signalling station has been set up on one of the small islands at the mouth of the Firth of Forth.

It possesses a working radius of ten miles, and the wireless waves indicate to warships, etc., making for Rosyth base the exact position in which they are during fog.

## French Journalistic Enterprise.

A PUBLIC wireless concert in the street has provided a new sensation for Parisians.

The "Matin" has had arranged four-

teen loud speakers, which are fixed in one of the windows of its offices facing the boulevard. The crowds strolling along the boulevard are now able to stop and listen to the concerts broadcasted from Eiffel Tower.

## Don't Oscillate!

2 L O has had to descend to C.W. Morse in its endeavours to quieten the howling of heterodyning caused by the misuse of reaction. Wimbledon, Caterham, Kentish Town, Highgate and Ilford seem to be the chief London offenders. These people should be satisfied with quieter but clearer signals, and the knowledge that they are allowing their neighbours to enjoy the music rather than employ reaction in such a way that the slightest thing will cause their sets to oscillate.

## Wireless Chain.

SOUTH AFRICA has given the Marconi Co. a concession, and a station will be erected in that country very shortly. Australia has, as has been previously reported, entered into agreement with the Amalgamated Wireless, Ltd., for a high power station, and Canada has given the Canadian

Marconi Co. a licence to erect a station in Montreal. Altogether two million pounds' worth of work is contemplated to complete the first important stages in the direct linking of all parts of the British Empire by wireless.

## Broadcasting in Sweden.

THREE Swedish firms have applied to the Swedish Government for a joint concession for a monopoly of broadcasting in that country. These radio firms intend, if the concession is granted, to form a special company for the purpose with a minimum share capital of kr. 1,000,000.

## AND in Ireland.

THE Irish Postmaster-General has sent an expert abroad for the purpose of studying the question of broadcasting, but it is not probable that the system will be introduced into Ireland for at least some little time.

## Waves and Shaves.

A LINCOLN barber has installed a wireless receiver in his saloon in order that customers may "listen-in" while being shaved. **ARIEL.**



# Broadcasting Programmes

What you can hear

every evening of the week on your set.

## TELEPHONY AND MUSIC TRANSMISSIONS.

Station.	Call sign.	Wave-length in metres.	Remarks.
Marconi House, London, Broadcasting Station	2 L O	360	.. Every evening, 6 to 6.30 p.m. (News Bulletin); 8 to 9 (Concert); 9 to 9.30 (Late News); 9.30 to 10 (Concert and Dance Music.) Continuous service to be given shortly.
Manchester Broadcasting Station	2 Z Y	385	.. Every evening, 6 to 10 p.m. (News, vocal and instrumental music).
Birmingham (Witton) Broadcasting Station	2 W P	425	.. Every evening, except Sunday, 6 to 10 p.m. (News, Concerts, etc.).
Croydon	GED	900	.. Throughout day to aeroplanes.
Writtle, Essex	2 M T	400	.. Tuesdays, 8 p.m. (Concert.)
Paris	FL	2,600	.. 7.20 a.m., 11.15 a.m., 5.10 p.m. Also occasional telephony at 10.10 a.m. and 9.20 p.m.
Königswusterhausen	LP	2,800	.. Between 6 and 7 a.m., between 11 and 12.30, and between 4 and 5.30 p.m.
The Hague	PCGG	1,085	.. Sundays, 3 to 5 p.m. (Concert.)
Haren	OPVH	900	.. Practically every 20 minutes past each hour from 11.20 to 4.20, giving messages to aeroplanes on the Brussels-Paris, Brussels-London, and Brussels-Amsterdam lines.
Radio-Electrique, Paris	—	1,565	.. Concerts at 8.45 p.m.
Brussels Meteorological Institute	O P O	1,500	.. Slow C.W. and Morse. Easy reading for amateurs.
Newcastle*	5 B A	440	.. Tuesdays, Thursdays, and Saturday evenings.

NOTE.—The Bar Lightship, Liverpool, sends telephony at 7 a.m., 9 a.m., 11 a.m., 12 noon, 1 p.m., and every two hours until 9 p.m. Calls "Dock Office." Liverpool answers "Bar Ship."

In addition to the regular transmissions carried on between the British amateur stations, much telephonic conversation may

be heard from St. Inglevert (A M), Le Bourget (Z M), and Brussels (B A V). These stations are quite powerful, but they call for a little extra care in tuning. Wave-length, 900 metres.

All times given are G.M.T.

An asterisk denotes transmissions made purely for experimental purposes.



# ETHER VIBRATIONS.

By P. J. RISDON, F.R.S.A.

**W**HAT are ether vibrations? It is surprising how many persons speak of the ether and of ether waves who, if they were asked this question, would be quite unable to answer it properly. Yet the reply is really very simple, although it cannot be given in half a dozen words. To make it comprehensible involves some little consideration of the spectrum. No, dear reader, please do not turn over the page yet—a little patience, and it is our hope and belief that you will never again fear that awe-inspiring expression.

Nothing is more trying than to pick up a paper and to find that, in an article professing to explain something, it is assumed that the reader already knows a good deal about it, or that he is referred to some other article in an unavailable back number for certain necessary explanations. Therefore, and especially for the benefit of new readers, we shall begin at the beginning, even at the risk of repeating certain facts that have previously appeared in these pages.

Failing proof to the contrary, it is assumed by the majority of scientists that space is not empty, but that it is filled with a medium called the ether. That assumption is made because, without it, it is difficult to understand or explain the passage of light from the stars or from the sun through space. A medium simply means something by means of which something else is enabled to take place.

Thus the press is the medium for circulating news. Steam is a medium by means of which heat can be converted into useful work. Water is the medium by means of which the waves travel that expend their energy by flinging a mass of water on the shore. Air is the medium for circulating sound, and the ether is the medium by means of which light waves and many other kinds of vibrations travel through space.

## Wave Motion.

Now it is important to remember that the medium itself does not travel. If, like air and water, it consists of material particles, there is only a local movement or oscillation of the particles through which the wave travels. In the case of a sheet of water or the ocean, the water only moves up and down—that is to say, *transversely to the direction in which the wave travels*. If a disturbance, such as ringing a bell, be made, when the gong is hit by the striker it quivers, and with every quiver strikes the air, setting up waves of energy, much as touching water sets up ripples.

The difference, however, is that sound-waves do not only move up and down like waves in water; they expand in every direction, like so many invisible, expanding globes, and it is much the same with ether waves.

We have to assume, however, that these globular waves do not proceed smoothly and evenly, but that they travel in jerks, or rather pulsations, that vary according to the kind of wave. Thus, waves of light proceed in exceedingly minute pulsations, whilst electro-magnetic waves proceed in much longer ones.

Let us take the case of a star and think of a vast, spherical plane all-round it at the same distance from it as we are. Then, from

whatever point in that spherical plane we gaze at the star, our eye will only catch an infinitesimal portion of the complete waves as they radiate outwards in every direction. In other words, we only catch the portion of a wave that vibrates along a line.

Now, contrary to what might be expected, the denser a medium, the more rapidly waves travel through it. Thus, sound waves travel through air at a speed of about 1,100 feet a second, but through water they travel more than four times as fast, and through iron at 16 times their speed through air.

From the sun there proceeds a great variety of waves of different kinds through the ether of space, and neither air or even a heavy metal such as platinum would be

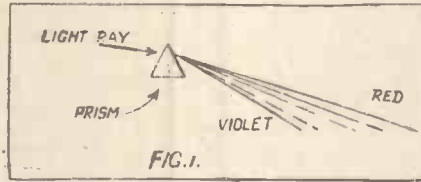

sufficiently dense to permit of their passage. They require a medium more than a million times as dense as steel, and it is therefore assumed that the ether possesses such a density.

A very natural question that then arises is—if the ether is so dense, how can solid masses like worlds and suns move through it?

## The Spectrum.

Well, let us consider that wonderful metal mercury (quicksilver). Mercury is nearly twice as heavy as iron, which floats on it as cork floats on water. More than

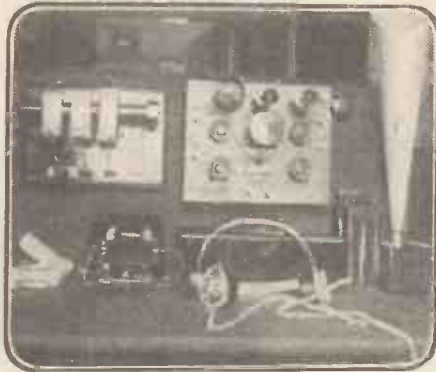

Mr. F. W. Knight's set, Lyndhurst, Rothley House Lane, Rothley, near Leicester.

that: Iron moves through mercury almost without friction, use being made of that fact in supporting great, heavy, revolving lanterns of lighthouses weighing several tons, which float in mercury contained in a circular channel, with less friction than that of ball bearings.

However, it is not our purpose to endeavour to prove what has never yet been definitely proved, namely, the possibility of such a phenomena as the ether; we must take that for granted. Its density, at any rate, explains how energy from the sun is conveyed in the form of waves through space.

We will now consider the spectrum. Spectrum is only a harmless Latin word meaning an appearance. In the sense in

which we are now dealing with it, it means the appearance of light rays, after passing through a transparent prism. But it implies more than that, because it is only the visible portions of the spectrum that appears in the ordinary way. The accompanying diagrams, with the following description, will make this clear. Fig. 1 illustrates how light waves, in passing through a transparent prism, are split up so as to appear in the different colours of which light consists. Each colour is an effect of sensation produced in the brain by a different wave-length of light.

According to its length, so each wave is affected by the prism to a different extent from that in which waves of other lengths are affected. The consequence is that the different waves are refracted or bent, and emerge from the prism at different angles so that the various colours appear merging into each other, from red at one end to violet at the other. But, as will be seen on reference to Fig. 2, this visible section is only a very small proportion of the whole spectrum of ether vibrations. At one end, the red waves merge imperceptibly into the infra-red or invisible heat waves. At the other end, the violet merge into the invisible ultra-violet rays that can be detected by their chemical effects, or by their lighting up a fluorescent substance.

From the ultra-violet we pass on through an unknown portion of the spectrum into a region where X-rays occur, and the realm of radium emanations, the waves constantly decreasing in length and increasing in frequency.

## Waves of Energy.

On the other hand, at the other end of the spectrum, the waves constantly increase in length and decrease in frequency. Thus heat rays range from about 1/25,000th inch to 1/50th of an inch in length where they join up with another unknown portion of the spectrum, beyond which we find the Hertzian or electro-magnetic waves of wireless, which range from about an inch or less up to many miles.

It may be useful and of interest to give a few figures showing the relation between wave-length, velocity and frequency. Assuming that wave velocity and wave-length are both given in the same unit of length—i.e., either in inches, feet, yards, metres or miles—the following simple equations hold good.

$$\text{Frequency equals } \frac{\text{Velocity}}{\text{Wave-length}}$$

$$\text{Wave-length equals } \frac{\text{Velocity}}{\text{Frequency}}$$

Velocity equals Frequency  $\times$  Wave-length. The velocity of all ether waves being (it is believed) the same, namely 186,000 miles a second, knowing either the frequency or wave length, we can always find the unknown one of the two. Thus, given a wave-length of 9.3 miles,  $186,000 \div 9.3$  equals 20,000, which is the frequency for a wave-length of 9.3 miles, whilst a wireless wave-length of 1 mile would have a frequency of 186,000.

(Continued on next page.)



## ETHER VIBRATIONS.

(Continued from previous page.)

Although we know much that is intensely interesting about the spectrum, there is still an enormous amount to learn. At each end—if one may presume to speak of an end to it—we find waves which may be described as waves of energy, although it is energy of different kinds. In the visible portion the light waves can scarcely be described as waves of energy in the same sense, although energy of some kind they must of course possess in order to traverse almost countless millions of miles of space; indeed, they can produce chemical changes and even movement, but only under conditions of delicate balance.

X-rays, near one end of the spectrum, possess the power to penetrate metal; I believe the latest Coolidge tubes render it possible to penetrate 6 inches of solid steel. On the other side, immediately adjoining the visible portion, are heat rays which possess life-giving and other properties, and which can be converted into useful work. And, further down the scale, electro-magnetic waves are certainly power waves.

In the following table the figures are given approximately in round numbers, and it must be remembered that there are no hard and fast dividing lines between the different portions of the spectrum.

Portion of Spectrum.	Frequency. (Vibrations per Second.)	Wave-Length.
Unknown Electro magnetic.	From 8,000 to 11,785 million . . . .	From 23 miles to say 1 inch
Unknown . . . .	From 11,785 million to 550,000 million	From say 1 inch to 1/50th inch.
Heat . . . . .	From 550,000 million to 281½ billion	From 1/50th inch to 1/25,000th inch
Visible light . . . .	563 billion	1/50,000th inch
Ultra-violet light . .	From 844 billion to 36,000 billion . .	From 1/70,000th inch to 1/3,200,000th inch
Unknown . . . .	From 36,000 billion to 288,000 billion	From 1/3,200,000th inch to 1/25,600,000th inch
Gamma rays, X-rays	From 288,000 billion . . . . .	From 1/25,600,000th inch
Radium emanations	To 18½ million billion . . . . .	To 1/1,664,000,000th inch
Unknown		

We know, or believe we know, that from end to end of the spectrum, all those waves are in some mysterious way co-related; it is even said that indications of X-rays have been found in ultra violet light. Let us run up the scale of vibrations and ascertain their effect. For this purpose we may imagine a source of energy, capable of setting up ether waves of varying frequency, sending forth vibrations of lowest frequency.

### Unknown Regions.

These would belong to the unknown portion at one end of the spectrum. With our present knowledge, we should neither detect anything nor experience any sensation as the result. But now suppose the frequency of the waves to increase, and to go on increasing.

First, by means of receivers tuned to varying wave-lengths, the vibrations would be detected as long electro-magnetic waves, which would become shorter and shorter until they could no longer be detected. Then there would be a pause during which the waves, at an ever-increasing speed of vibration ran up through another unknown portion of the spectrum.

Then gradually we should experience the sensation of heat, which would rise to a maximum and die down again, as a dull red light appeared, growing brighter and followed by the whole range of colour in the visible portion of the spectrum, ending in violet, and finally disappearing as the frequency of the waves speed up into the ultra-violet region. Here photographic plates would indicate chemical effects.

Later on, and in another unknown region, we should be unconscious of whatever effects are produced by waves vibrating hundreds of millions of times a second.

### Possibilities.

Emerging into the last known field, fluorescent screens would show us X-rays vibrating at thousands of millions of times a second, and we should finally be plunged into the unexplored portion of the spectrum at the other end, where no sensation would be experienced, the speed of vibration of the waves ultimately becoming infinitely fast, just as, at the other end, they would become infinitely slow.

Fortunately for us, we do not receive these blessings thus in succession, but in a more broadcast sense, so that we are able to experience and enjoy the effects of all of them at the same time. And now, what of the unexplored portions of the spectrum? Surely we have here enormous fields for research.

In view of the limitations of human experience, it is not surprising that the

“known” spectrum should emerge from and disappear into the unknown, and it may be that further investigation and discovery in those directions may take a long time, although one may hope that it will not be long before more is known about the intermediate unexplored zones sandwiched in, as they are, between known sections.

That those unexplored zones represent vibrations that serve a definite and wonderful purpose in Nature's vast scheme, there can be not the faintest shadow of doubt. And that, when discovered, we shall be able to turn them to purposes hitherto dreamt of by but few, there is every possibility.

### Mysteries to be Revealed.

It would appear that to the wireless research worker the two unknown zones, one at either end of the electro-magnetic wave zone, offer fields for the most fascinating research. It is possible that in those regions may be found the key to the secrets of true wave transmission of pictures and of television and telepathy.

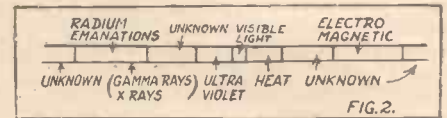

There may be wonders awaiting us never dreamed of—sources from which we may derive means that may revolutionise all our present ideas and methods of wireless.

It must be remembered, too, that it is not only wireless experts for whom these unknown regions of the spectrum hold an enthralling interest: it may be that their discovery will disclose other things of greater import—things that may enlighten us as to the mystery of life itself.

Although the professional scientist has the best chance of discovering them, whether by accident or design, it may easily fall to the lot of some amateur to make a name and become famous in the realm of science as the result of experimental research.

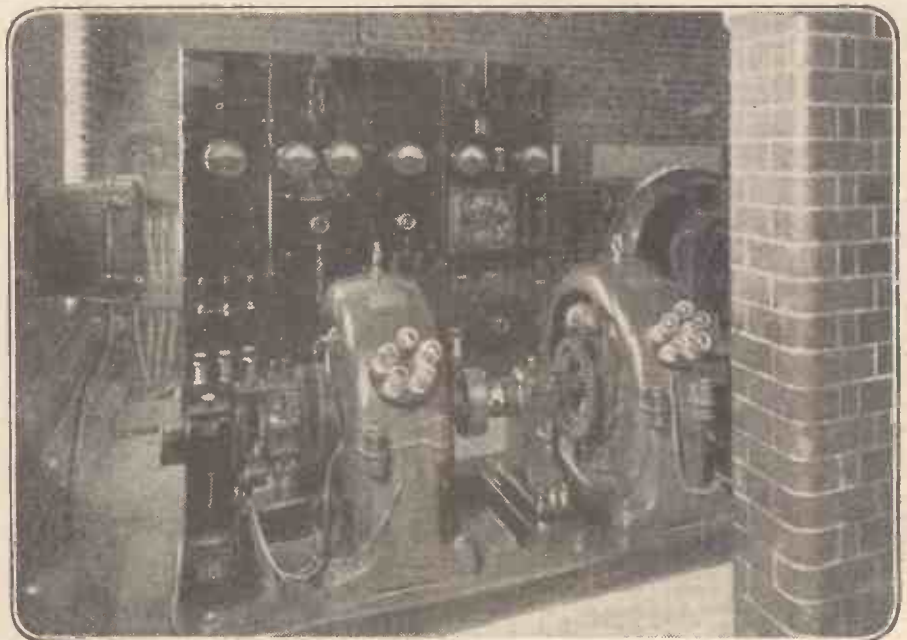

One of the smaller generators at the Carnarvon Wireless Station.



# THE SECRET OF SUCCESS WITH DRY CELLS.

By S. F. WALKER, M.I.E.E.

TO obtain the best results, to have as little trouble as possible in the matter of attention, have the individual cells as large as possible, take as small a current as possible from the cells, and rest them as often and for as long as possible.

The dry cell is a development of the old wet Leclanché cell, and the working may be considered to consist of two distinct operations: the oxidation of the zinc, or its chlorination if it be preferred; and the absorption of the hydrogen gas and the ammonia gas that is delivered at the carbon plate.

It is the oxidation of the zinc that furnishes the energy which the battery delivers in the form of an electric current; but after the zinc has been consumed there is the hydrogen gas and the ammonia gas to be reckoned with. When the zinc combines with the oxygen of the water in which the sal-ammoniac of the battery solution is dissolved, and with the chlorine of the sal-ammoniac itself, it sets free a certain quantity of hydrogen gas and ammonia (this also is a gas), and these gases are delivered at the carbon plate of the cell, the plate from which the current flows when the cell is in operation.

### Leclanche Principle.

The hydrogen gas and the ammonia gas, acting upon the carbon plate, would set up an opposing electrical pressure, which would break down the cell, cause it to cease furnishing a current, in a very short time, unless something was done to absorb them.

In the wet Leclanché cell, the hydrogen gas is absorbed by a substance that is placed around the carbon plate for the purpose: oxide of manganese, which is very rich in oxygen, and gives it up very readily. The hydrogen gas seizes upon that oxygen the oxide of manganese is ready to give up, and forms water, which assists the working of the cell. The ammonia comes away freely in the form of gas; and may be smelt when a Leclanché battery is working very hard. If the battery is overworked, however, the hydrogen gas cannot be absorbed quickly enough, the oxide of manganese cannot give up its oxygen quickly enough, and the ammonia gas cannot get away freely enough, and hence the battery breaks down.

### Limiting Current.

The larger the individual cells the larger is the quantity of oxide of manganese prepared to give up its oxygen, and the larger the quantity of pellets of carbon packed in with the oxide of manganese, and ready to absorb the ammonia gas that is delivered to it. With every size of cell there is a definite current strength which it will deliver continuously, without breaking down. On the other hand, with every size of cell, if the battery is allowed to rest for a certain time, after current has been taken from it, the ammonia gas is able to get away freely, the hydrogen gas is able to get hold of the oxygen it wants, and the cell picks up; hence the more frequently the cell is allowed to rest, the more steadily will it keep up to its work when required to.

The dry cell differs from the wet Leclanché only in point of solution, which in the former is naturally limited and cannot be renewed. With a wet cell water can be added to the solution from time to time, also sal-ammoniac can be added, and this is the practice with wet Leclanché cells.

### How they Recuperate.

With dry cells, either a certain quantity of water has to be enclosed in the completed cell, or certain chemicals must be added to the sal-ammoniac, that will form water under the operation of the electric current flowing through the cell.

In the modern dry cell a certain amount of water is enclosed in the cell when it is sealed up; and in addition chemicals are added to the sal-ammoniac. These chemicals perform the office of the solution in the wet Leclanché; they dissolve, or absorb the salts of zinc that are formed in the working of the battery, and so keep it going. If the salts of zinc formed are not dissolved, electrical resistance is set up, and the pressure furnished by the battery steadily decreases. In the wet cell the liquid dissolves the salts of zinc, or should do; in the dry cell they are absorbed by the chemicals mentioned above placed there for that purpose.

It will easily be understood that the larger the cell, the larger the quantity of liquid in the case of the wet cell, and of the special absorbing salts in the case of the dry cell, the larger will be the current the cell can furnish, or the longer the time it can furnish a small current. As mentioned above, with every size there is a limit to the strength and duration of the current the cell will furnish, but if it is allowed to rest, the hydrogen and other gases will be allowed to clear away, and the zinc salts to be absorbed, and the better it will stand up to its work.

## A WIRELESS PROPOSAL.

A love lorn amateur recently sent the following to the lady of his affections:

Resonance,  
Etherland.

Darling Cath. (CATHODE),

I am writing this in the hope that you will TRANSFORMER portion of the EARTH into AERIAL realms for me. Since you SWITCHED on the BATTERY of your charms, and TUNED-IN to my WAVE-LENGTH, I have thought of you with increasing FREQUENCY. The CON-

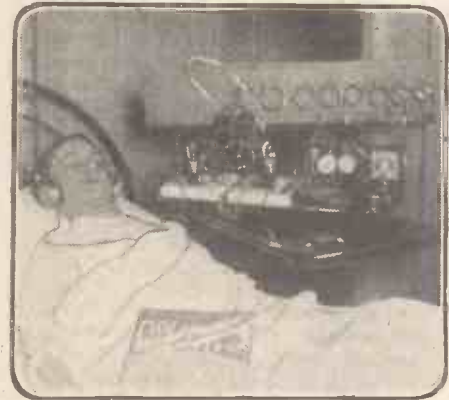

Mr. Cecil Winston; 11, The Ridgway, Wimbledon, enjoys 2LO in Bed.

TINUOUS WAVES of your personality are like LINES OF FORCE from a MAGNETIC FIELD, the ATTRACTION KEEPING me at HIGH-TENSION.

If there is any POTENTIAL DIFFERENCE in our natures, I am POSITIVE that in our own OHM we should run well in SERIES. The power of your personality would act as a RECTIFIER, and I should make no RESISTANCE. My soul is like A QUENCHED SPARK, and I would VOLT over any QUANTITY of obstacles. WATT your answer will be I know not, and I LISTEN-IN hoping that it will not be in the NEGATIVE. I hope you will decide without RELUCTANCE to change this PHASE, and we will let the parson make a TIGHT COUPLING.

Your HENRY.

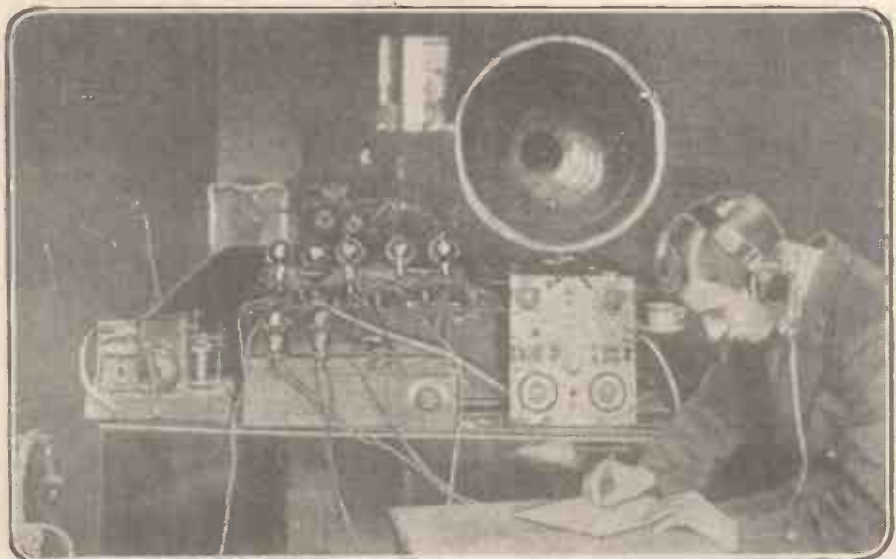

A fine home-assembled amateur set owned by Mr. A. Thorne, Greylake, Beaconsfield Road, Blackheath.

## WIRELESS AND THE WEATHER.

PERHAPS one of the most recurring and evaded questions in connection with wireless is whether and to what extent reception is affected by the weather. As a matter of fact the question involves so many factors that it is not to be wondered at that the expert endeavours to escape an explanation.

The "not so expert" will more easily deal with the subject in a few words that could be condensed to "Not at all because wireless waves are not air waves, but ether waves, and ether waves and ether exists in everything—in rain, fog, and snow, with exactly the same density and elasticity as in a calm summer day's air or even a vacuum." Then comes the inevitable question, "And what exactly is ether?"

This may elicit an accurate version of the electron theory in quite an understandable and colloquial manner, or perhaps that mysterious all-knowing "Ah! that's what we cannot say," the "we" presumably including all the scientists of the day, and, or including (according to the degree of egotism of the speaker) the propounder of the words of "wisdom."

### Where Winter Scores.

As a matter of fact, communication by means of wireless is very considerably affected both directly and indirectly by weather, not always adverse weather, relative to seasonal conditions. The fine summer afternoon with its beautiful warm, still air (when we do have the good luck to enjoy such) will invariably be much less kind to the "ether shakers" than the cold, drizzly, foggy November evening.

This fact will no doubt be received with acclamation by those who will regard (and their number will be legion) the reception of broadcasted entertainments by wireless as the only possible and economical solution to the "what shall we do and where shall we go?" problem.

Winter has been proved by means of prolonged experiments to be the season most conducive to uninterrupted radio communication. Atmospherics, those funny noises reminiscent of the morning's bacon frying, and not a welcomed accompaniment to Beethoven's "Moonlight Sonata," etc., are less, and signals three times as strong as in the summer. Two theories have been propounded in regard to this latter, and there is not the slightest reason why both should not collectively contribute to the phenomenon.

### Concerning X's.

The first and perhaps most probable is that the increased foliage, leaves and general vegetation, tends to absorb the energy of the ether waves, and the second that the ionisation of the atmosphere by the more intense solar light and heat causes the absorption, but of course in rather a different way. The effects of the latter can also very well be regarded as the cause of that better known fact that wireless signals are much stronger during the night than during the daytime. This, by the way, is another feather in the cap of the much maligned season with its before-mentioned dark, etc., etc., evenings.

"Why are atmospherics stronger in the summer than in the months of inclement weather?" will be the next question, and it can be dealt with in a very few words. The majority of statics, strays, and X's (signifying the unknown) as they are variously termed, are caused by discharges and leakages to earth through the aerial of "stray currents" caused in the atmosphere by the existence of uneven potential to a greater intensity than exists in winter owing to the drier atmosphere. In atmospherics also are received the signals of nature transmitted by her operator, "Jove of the Heavens," by means of lightning.

### What About Rain?

Were I addressing a meeting I should judge this to be the point where the following question would arise: "Doesn't rain weaken wireless signals as rain will provide a path to earth for electricity?"

The answer to that is that there possibly may be a leakage to earth caused by the coagulation of moisture on the insulators of the aerial system at either the receiving or transmitting station, but that is purely a mechanical and easily remedied fault. That little ripple in the ether, our wireless wave, must not be regarded as a current of electricity ready to slide down to that universal

reservoir, the earth, through any convenient conductor.

A current of electricity is employed to cause this ripple in that mysterious medium which is presumed to permeate all matter between the electrons, as it were, and fill all space, which in its turn, by cutting a conductor, the aerial, at the receiving station induces another current of electricity which is employed to actuate the receiver in accordance with the peculiarities given to the wave by any particular transmitting station.

### A Slight Difference.

It may be taken for granted that a very minute fraction of the energy of the ether disturbance is absorbed by that process, but no more, perhaps infinitely less, than that of an ocean tidal wave by the interposition of a fine fishing line. "What about that absorption caused by vegetation?" might well be asked, and the answer discloses a very interesting fact.

A tree or tall plant can be employed as a wireless aerial, although with relative inefficiency, connections being taken from top and the base. The presence of so many "aerials" both large and small will obviously tend to have considerable effect even although the individual absorption is infinitesimal. Next please!

"What about high winds?" Why should wind affect our ether ripple? In the first case, as has been stated before, wireless waves are ether waves, not air waves. Then again, ether waves travel at the rate of 186,000 miles per second against the "high wind's" paltry one or so.

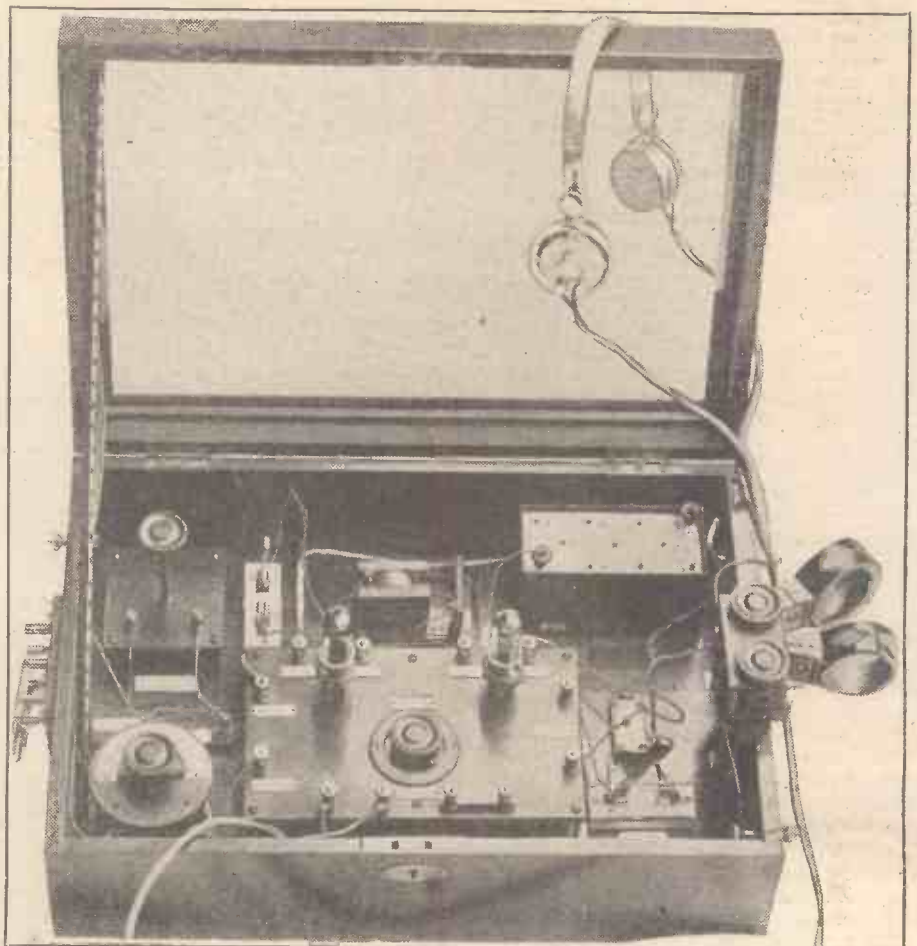

Portable set designed by an amateur for the Worthing Wireless Society.



# T.M.C. Wireless.



*“My Xmas present”*

MAKE it a T.M.C. Wireless Receiver and strike a new note. T.M.C. offer you a wide selection of fully approved, British Broadcasting Receivers, from simple crystal sets to cabinets de luxe. The illustration shows the

**T.M.C. Crystal Set No. 2**  
with  
**Patent “Everset” Crystal**  
which needs no adjusting.

Call and choose your Present to-day.

If you cannot call, full particulars will be sent on request.

**The Telephone Manufacturing Co.,**  
LIMITED,  
**68, Newman Street, London, W.1.**  
Tel: Museum 5581.

*We have engineers in every large town, who install the wireless to your satisfaction.*

**London, Manchester and Birmingham are Broadcasting Now.**

**T.M.C.**  
makes Wireless worth while

# Making you think!!

## “POLAR”

### VARIABLE CONDENSERS

ONLY  
**14/9**

EACH  
POST FREE

WIDE RANGE—0001 to 001 M.F.D.  
SMALL SIZE—3 IN. x 3½ IN. x 1 IN. ONLY  
SPECIAL EARTH SCREENING.  
GUARANTEE—Replace within 12 months.  
Invaluable for tuning, H.F. amplifiers, etc.

ONLY  
**14/9**

EACH  
POST FREE

CHEQUES—POSTAL ORDERS—MONEY ORDERS—ETC. TO

## THE RADIO COMMUNICATION CO. LTD.

35 NORFOLK STREET - LONDON - W.C.2

or Branches at

NEWCASTLE  
17 Sandhill

CARDIFF  
Atlas Chambers  
James Street

LIVERPOOL  
67 Dale Street

SOUTHAMPTON  
19 Queen's Terrace

GLASGOW  
116 Hope Street

(E.P.S.) 10

C.T.C.

## MULTUM-IN-PARVO CRYSTAL RECEIVERS

No technical knowledge is necessary to listen-in at once on the MULTUM-IN-PARVO. Full instructions are given with every set.

These Sets as Illustrated comprise:—

**TUNER.**—Inductance which can be varied by means of tappings taken to switch giving correct wavelengths, 200/1,000 metres.

**MICROMETER DETECTOR.**

**FIXED CAPACITY CONDENSER.**—Fitted with best ruby mica.

**VARIABLE CONDENSER** for selective tuning.

**RANGE.**—30 miles Telephony Morse up to 600 miles.

**AERIAL.**—Complete equipment—120 ft. Wire Earthing Wire, Lead-in Tube, and Two Insulators.

EVERY SET IS FITTED WITH BROWN'S PHONES (4,000 OHMS.)

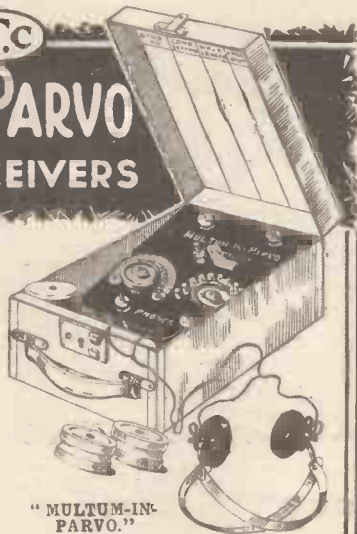

“MULTUM-IN-PARVO.”

Complete as Illustrated

BLACK LEATHERETTE... £5 15 0

MAHOGANY ... £5 15 0

COW-HIDE ... £6 15 0

All Prices PLUS TAX, 7/6.

JUNIOR ASSEMBLY

SET, range 10 miles £1 12 6

Post Free.



ASSOCIATED WITH  
**CONSOLIDATED TRADING  
& MANUFACTURING CO., LTD.,**  
FULWOOD HOUSE, FULWOOD  
PLACE, HIGH HOLBORN, W.C.1.

Call or Write for List, Threepence!

## RELIANCE RADIO SERVICE CO.

THE “RELIANCE”  
CRYSTAL RECEIVING CABINET.

Consisting of Ebonite Panel mounted in Oak Cabinet with lid; Tuning Coil and condenser. Patent Crystal Detector, totally enclosed in glass; 4,000 Ohms Double Headphones; 100 feet of Stranded Copper Wire; 2 Shell Insulators.

No further outlay, no batteries required. Each set has been tested and carries our guarantee, and we confidently assert that for the price it is the most compact and reliable that is obtainable.

PRICE COMPLETE

£3-5-0

INSTRUMENT ONLY

£1-12-6

We have also a complete range of Valve Sets in stock from £7 to £20. Call and inspect the famous FELLOPHONE 2-Valve and 4-Valve Receiving Sets, prices complete, £10 10s. to £17 10s. respectively. Also the FELLO-CRYST SUPER Crystal Receiving Set, price £4 7s. 6d. complete. All our sets are passed by the P.M.G. for reception of broadcasting. All sets open to inspection at our London address. Demonstrations given daily. Hours 10 a.m. to 6-30 p.m.

ILLUSTRATED CATALOGUE  
POST FREE.

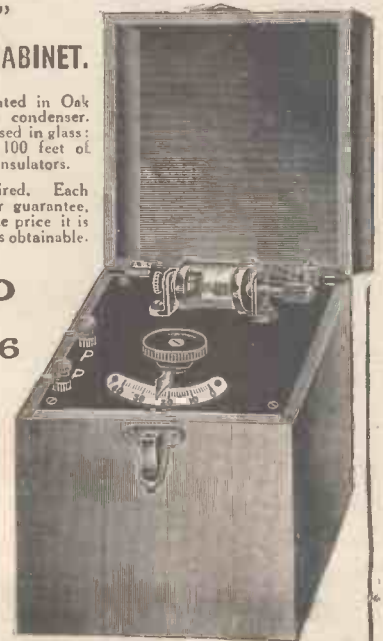

**RELIANCE RADIO SERVICE CO.,**  
283, St. John Street, Clerkenwell, London, E.C.1.

PHONE: CLERKENWELL 4290.



# NOTES ON THE LONDON ETHER.

By 2.G.M.

THE microphone possessed by 2LO will, when occasion demands, bark like a dog, squeak like a mouse, laugh and cry, scale up to A, and sink down to bottom C, but it will not sibilate properly. In other words, it possesses a delicate lisp. Also, it won't whistle, and until very recently, "Whistling Friars," or whatever they are, more resembled tin whistles than anything else.

Then 2LO began to whistle beautifully, and we are informed apologetically that it was due to "an interaction originating through a refractory heterodyning of a parasitic harmonic"—or words to that effect; but really 2LO should be proud of its latest accomplishment as a "siffleur."

## Chestnuts from 2LO.

We would respectfully suggest that 2LO should very carefully censor the "chestnuts" with which their entertainers bend the helpless ether. One in particular, which surely must have been handed down from the 10 to the minus power umpteenth generation, was actually inflicted in the form of 2LO's special harmonic dodging 369 metre wave, twice in the same week—we could hear every aerial in the world os-

cillating with impotent rage. Curiously enough, it seemed as though they were calling unto Caesar.

2ON was always an "early closer," and his diminution of ether shaking comes as but little surprise, but we wonder to what extent 2KT has reverted to his alternative diversions of well-hung game and fiddle scraping. Perhaps he is relegating his electron pushing to even smaller hours than ever.

## Hark, the Lark!

The little "ten watters" are evidently feeling the pinch of classical competition, but will never emulate the shocking example of the ten diminutive youths of negroid extraction, whilst there remain such stalwarts as 2FQ, 2OM, 2SX, 2YH, 2YQ, and others to tickle etheric space.

Morse seems very popular of late among the amateurs. A few days ago we were endeavouring to carry out a test with 2SX, when our set began to jazz to the song of an artificial canary. 2YY must have replaced the carbon granules in his microphone for birdseed. His remark to 2AU to the effect that he hoped to "dodge the jamming" would have seemed to indicate that

his intention was to apply a counter-irritant, or "charm" with his "music" all other producers of amateur lightning into prostration.

If 2YY is using mains for his H.T., he should employ a choke—several chokes in fact. His rendering of the Morse code, however, was excellent, and we were nearly (but not quite) rude enough to laugh when, after the canary had gone to roost, we heard the delicate quaver of 5BV's doubtful signalling. The latter, however, propagated a nice unobtrusive little wave, and can be forgiven.

Surely that wasn't 2JX we heard a few days ago, with the stern, compelling voice of at least 200 volts H.T. Truly if it were so he must feel in a "volts to the left of me, volts to the right of me, how shall I stop 'em shorting" condition?

His earlier experiments with "60" volts H.T. will be remembered as a very commendable effort. It will be "Hallo the Azores!" for 2JX if he ever commands a battalion of 1,500 volts.

The other night 2LO announced an item—Tosti's "Parted," and no explanation was forthcoming to the subsequently undisturbed ether. We are still wondering whether that refractory lead obeyed the word of command and—"parted."

## A NEAT COIL ADJUSTMENT.

WHEN "tuning in" very weak telephony or CW signals on a set which employs reactance, the proper adjustment of the coils is an important factor, and any method which will enable the operator to adjust the coils swiftly and correctly for the reception of signals from a desired station is worthy of consideration.

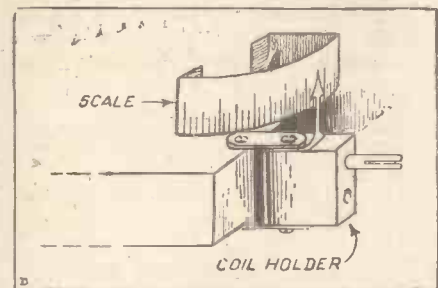

The diagram shows a useful addition to the amateur receiving circuit, and is more or less self-explanatory. The scale indicated might consist of an ordinary metal rule bent to the shape required, or, if preferred, a blank mounting could be affixed and the correct coupling position for any station marked upon it.

The calibrating pointer may be fashioned from any spare piece of brass and attached to the coil-holder as shown. Once the most satisfactory coupling point has been found by actual test, the position of the pointer can be marked upon the chart, together with the call letters of the particular station to which the adjustment applies. It is then only a matter of moments for the operator to "tune" in the station in question—so far as coupling is concerned—at any time.

## "600 METRES."

THE following remarks, whilst intended to encourage the amateur still mastering the Morse Code, may also add interest to the "watch" of the more skilful operator. In addition to the pleasure of hearing our largest liners entering and leaving port, and tracing the course of P. & O. and similar vessels up and down channel, the possessor of a list of call signs, and an old copy of Lloyd's Weekly List of ships, can gather a store of interesting observations by comparing nationalities in conjunction with the note heard, and the actual rendering of the Morse Code.

Perhaps it is little known that national characteristics can be heard in the various styles of dots and dashes—even the temperaments (and often temper)—of the individual can be guessed at behind what may seem to the beginner a collection of stereotyped and expressionless sounds.

## A Little Imagination.

Compare, for example, the slow and ponderous morse of a German trader with the erratic squeaks of a French trawler, the latter so typically gesticulating as to be often humorous. Listen to the rush of dots and dashes, the abbreviations and short, sharp morse of our hustling cousins from over the Atlantic, and you may turn—with perhaps a suspicion of relief—to listen to the code as interpreted by a British operator on a first-class liner, neither halting nor rushing, but both clear-cut and balanced.

If the work of a coast-station is followed it is easy to sympathise with the operator as he persists—obviously with patience or

resignation—to extract information from a small vessel on which the duties of wireless operator may be combined with master, or even cook.

Soon after the listener may be treated to an exhibition of polished morse as a huge liner literally pumps forty or fifty messages on to the land without a false note or a single query.

An intelligent summary of ships' morse in a certain district will sometimes show the state of the sea, the apology "Sri O.M. (sorry old man) rough," after a gallant but unsuccessful medley of dots and dashes may, even save this task. A knowledge of commercial geography will help the listener to conjure visions of stacks of pit-props as he hears "O.R.F. Aalborg Q.R.D. Blyth" or of shining ores to make way for coal when S.S. — arrives "Cardiff from Bilbao."

Technical knowledge will assist the "600" enthusiast to judge the make of the set in use—he can compare his judgment with the data in the "Year Book." The possessor of a long range-set who can hear French, Italian, Dutch, German and Scandinavian land-stations chattering round our Islands to their sea-going brothers (strangely enough he will generally hear his own tongue) will be able to check the variations in strength of signals due to the relative positions of the sun—a standard of signal strengths, say A-G, is useful for these observations.

The thrill of hearing a land-station arranging for the safety of a vessel in distress, and the checking of routes, and the recording of the friendly notes of familiar vessels are still others amongst endless interests presented to the listener on "600."

## A NOVEL CRYSTAL DETECTOR.

A SIMPLE, but satisfactory, crystal detector can be constructed from an ordinary clothes peg, a few odd pieces of wood, a "butterfly" or "wing" nut, together with a suitable screw, two small

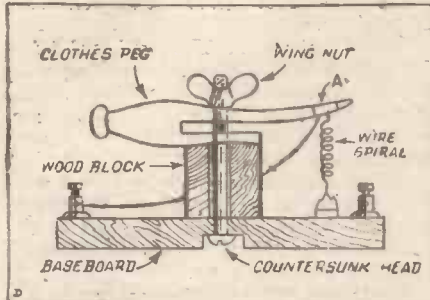

terminals, and a piece of wire, about gauge 28.

Take a good, sound clothes-peg, and saw or cut one prong off, as shown in the illustration; then drill a hole through both legs at the point indicated, to allow the adjusting screw to be placed in position. A small block of wood about one cubic inch in size

should be procured, and a hole bored through the centre. The shortened prong of the peg is then glued firmly to the block in such a position that the holes in the peg and the block coincide.

### Universal Adjustments.

A baseboard, about  $\frac{1}{2}$  in. thick and of fairly large area to give the detector stability, should be obtained, and a machine screw countersunk through the centre of it, so that the head does not protrude below the level of the wood. The block and peg should then be placed in position over the screw and the wing nut screwed on the top. A small piece of wire is wound into the form of a spiral, and the end which is to make contact with the crystal filed to a fine point. The other end of the wire is soldered to a small metal band or "sleeve," fixed as shown at A on the longer prong of the clothes-peg. A wire is also taken from this band to one of the two terminals, which are let into the baseboard in the usual manner.

The crystal, which may be purchased already soldered into a "cup," can easily be fixed into the baseboard, and connected

by a short length of wire to the remaining terminal. The detector is then complete, and while the pressure of the wire spiral on the crystal can be suitably regulated by means of the wing nut, it is also an easy matter to move the contact wire in a horizontal direction when searching for the "sensitive point" of the crystal.

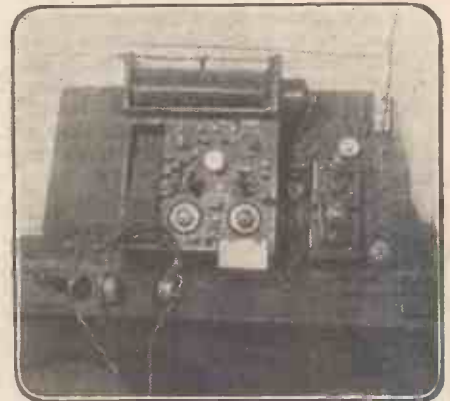

Mr. H. C. Smith's set, 62, Chisendale Road, Victoria Park.

Send along your Ideas to Popular Wireless and let other Amateurs share them.

## EXPERIMENTAL LICENCES

THE following copies of letters have been sent to POPULAR WIRELESS WEEKLY by Messrs. Peto Scott, for publication:

### Applicant's Letter to the Postmaster-General.

Dear Sir,—I beg to apply for an experimental licence to enable me to use a home-constructed Peto Scott installation for receiving at my private residence.

I have already a broadcasting licence, but realise that this will be useless for the apparatus I desire to use and the field I wish to cover.

Yours faithfully,

### Secretary to the P.M.G.'s Reply.

Dear Sir,—With reference to previous correspondence, I am directed by the Postmaster-General to forward a licence for the reception of broadcast messages, and to say that, as it is understood that you have already purchased your apparatus, no objection will be raised to its use provided that it was purchased from a British manufacturer and that it complies with the technical conditions of the licence.

The requirement in regard to the apparatus bearing the registered trade-mark of the British Broadcasting Company will not, in the circumstances, be enforced as far as the set in question is concerned.

I am to add that when this licence is renewable an account will be rendered by the local postmaster.

I am, Sir,

Your obedient servant,

## A PAPER LOUD-SPEAKER HORN.

A LOUD-SPEAKER horn can be constructed of paper for a very small sum, and will prove extremely efficient, inasmuch as the material and design will obviate distortion.

Procure two or three sheets of cartridge or drawing paper, which will cost 3d. or 4d. per sheet, and threepennyworth of glue.

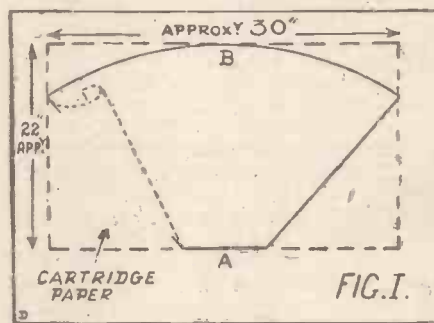

Take a sheet of the cartridge paper and cut it with scissors something to the shape and dimensions shown in Fig. 1. The length from A to B will be the length of the horn. Melt the glue in a gluepot, to a thin consistency, by adding sufficient water. (If you haven't a gluepot, a saucepan with a tin surrounded with water inside will serve.)

Now take the shaped cartridge paper and commence rolling it from the top corner, as shown by the dotted lines in the sketch (Fig. 1), and it will assume a conical shape of any diameter you may desire. Unroll it and give one side a coat of the thin glue. When it has had time to soak and stretch a

bit, roll it up again, rubbing it well down with a pointed stick—a lead pencil will do—to make each layer adhere thoroughly. When completed you will have a conical tube similar to Fig. 2, running almost to a point at one end, and irregular at the top. The outside joint should be a straight line right down the cone. The paper can be cut to ensure this, just before you finish rolling it up. Allow this to dry, not in front of the fire, and then sandpaper the outside joint until smooth with the rest.

Take another sheet of cartridge paper and repeat the process on the top of the cone already made, and if greater strength is required apply a third piece, after the second is dry. Trim off the top and bottom with a pair of small pointed scissors, where dotted lines are shown in Fig. 2. The tube should then be coated inside and out with a hard, black varnish.

Although it may seem a difficult job to reach the inside of the small end, it can easily be accomplished by tying a piece of sponge to the end of a thin cane or wire.

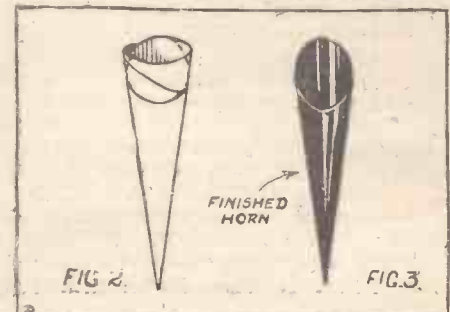



# Your Wireless Needs Cost You Less at GAMAGES

Considering everything—design, quality, workmanship, and low price, there is no Apparatus to equal Gamages. Prove this for yourself by a trial order; by calling and inspecting our Extensive Wireless Department; or by obtaining a copy of our New Wireless Catalogue, post free on request.

## LARGEST SELECTION : LOWEST PRICES

### DOUBLE SLIDE TUNING INDUCTANCE



With this type of receiving inductance much better selectivity can be obtained than with the single slide tuner. Stations other than that it is desired to pick up can be satisfactorily tuned out.

The end supports are polished mahogany, panelled with ebonite. Metal parts are burnished, lacquered brass, and the coils are wound with the best enamelled copper wire.  
Size of coil (Former only) 12 ins. x 4 1/2 ins. Price **37/6**  
Smaller instrument (Former only) 9 ins. x 3 1/2 ins. 26/6

### SINGLE SLIDE TUNING INDUCTANCE



Similar in design and construction to double slide tuner already detailed, but with one slide. These instruments can be suitably employed as loading coils also.  
Large Tuner. Size of coil (Former only) 12 ins. x 4 1/2 ins. Price **29/6**  
Small Tuner. Ditto. 9 ins. x 3 1/2 ins. Price 21/-

### COMBINED GRID CONDENSER & LEAK



Polished mahogany and ebonite (as illustrated). Suitable for use with the various valves on the market. The efficiency of reception and the freedom from extraneous noises in the telephones are largely dependent on a good "leaky grid condenser," and our type will be found to give the best results obtainable.  
"0003 mfd. 2 meg. ohms. Price **8/6**  
Post 6d.



### VOLT-AMMETER

Watch type, dead beat. In Nickel-plated Brass Case. Reading 0-10 volts, 0-35 amps. Price **7/6**



### EXPERIMENTAL CHANGE-OVER PANEL

A specially-designed panel for changing over from one set of receiving apparatus to another in one operation. The advantages of a panel of this description will be readily appreciated by those experimenters who are often testing the merits of one set or circuit against another during the reception of actual signals.  
One high-tension battery, one accumulator and one pair of telephones will suffice for both sets of apparatus under test. Highly finished in polished mahogany, ebonite (matt, with polished bevelled edge) and burnished lacquered brass.  
Size 12 ins. x 7 ins. x 3 1/2 ins. Price **30/-**

### SPECIAL OFFER OF ACCUMULATORS.

We have an extremely good Job Line in Glass Case Accumulators which we are offering at the following low prices to clear:  
2 volt 20 amp. Price **4/-**    2 volt 40 amp. Price **5/-**    2 volt 80 amp. Price **6/-**

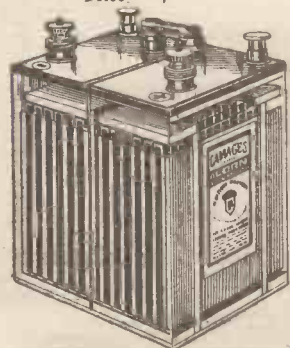

### "ACORN" ACCUMULATORS

Famous for efficiency, power and long-life. British made with first grade plates and stout celluloid cases.  
4 volts 20 amps. **22/6**  
2 1/2 x 3 1/2 x 6 1/2 ins.  
4 volts 40 amps. **27/6**  
2 1/2 x 5 1/2 x 6 1/2 ins.  
4 volts 60 amps. **37/6**  
4 1/2 x 4 1/2 x 7 ins.  
4 volts 80 amps. **42/-**  
4 1/2 x 5 1/2 x 7 ins.  
6 volts 60 amps. **53/6**  
6 1/2 x 6 1/2 x 7 ins.  
6 volts 80 amps. **63/-**  
3 1/2 x 6 1/2 x 7 ins.



### ROTARY POTENTIOMETER

An exceedingly neat and efficient instrument with the windings completely enclosed to ensure good insulation. It is fitted with an engraved ivory scale enabling comparative readings to be taken, and has a very smooth contact point.  
Resistance:—Zero to 800 ohms. Size 3 1/2 ins. x 3 1/2 ins. x 2 1/2 ins. Price **21/-**



Regd. No. 176.

### THE GAMAGE CRYSTAL BROADCASTER No. 1

This set constitutes a complete receiving station, comprising tuning coil with ratchet slider, Crystal Detector, Phones, Aerial and Earth Terminals, Insulators, Aerial wire, etc., as illustrated. Well finished and proved satisfactory under tests. Ideal set for beginner, and can be used for telephony (Concerts, etc.) up to 15 miles, and also for telegraphy up to 200 miles.  
Price, complete as shown, ready for use. Post free **75/-**

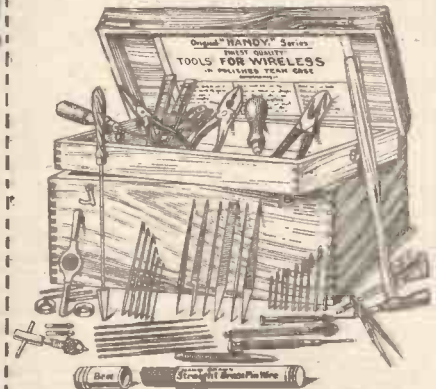

### SPECIAL SET OF WIRELESS TOOLS

In polished Teak box. Comprising 1 set B.A. Steel Dies Taps; 1 set of Twist Drills; 1 set of 6 Engineer's Needle Files; 1 set of 3 1/2-in. Files; 1 combination Drill Chuck, Tap Wrench and Tool Hold r.; Lancashire Brooch, Solder Iron; 2-ft. Rule; Electrician's Turnscrows; Pliers; Long Nose Pliers; Bradawl; 1 box of 70 lengths hard Brass Wire; Pattern-maker's Hammer; Pin Tong; Pin Vice; Jeweller's Turnscrow, with 3 blades; Fixed Turnscrow; and Tweezers, etc.  
Price complete **52/6**  
Smaller set, 30/- Carriage paid.

### THE "PARLIPHONE" LOUD SPEAKER

(Prov. Patent No. 21067)

NO METAL USED IN ITS CONSTRUCTION. EQUAL IN EFFICIENCY TO THOSE THREE TIMES THE PRICE.

Horn and stand moulded in one solid piece of Ebonite. Contains no receiver, but the interior is screwed and made to receive a Brown's Patent Standard Receiver. Thus by simply unscrewing one ear-piece from Headphones and inserting in the "Parliphone" an efficient Loud Speaker is obtained at a small cost. The remaining ear-piece can still be utilised for tuning in the ordinary way. As no metal is used in its construction, the objectionable metallic "ring" so common to most Loud Speakers is entirely obviated, the result being a rich mellow note without the slightest distortion.

Price **32/6**  
Packing and Postage, 1s. 3d. extra.



GAMAGES, HOLBORN, LONDON, E.C.1.

Tels. :—  
HOP 124

# IMPORTANT

We have opened very commodious premises at  
**54, GRACECHURCH STREET, LONDON, E.C.3**  
for the demonstration and sale of all types of  
**WIRELESS RECEIVING SETS** and **"CLARITONE" LOUD SPEAKERS.**

*Amateurs and Experimenters will be able to obtain every part required for any type of Set*

INCLUDING—

Transformers, L.F. and H.F.  
Headphones (all types, all resistances).  
Condensers, variable and fixed (all capacities).  
Vario-Couplers and Variometers.  
Coil-Holders and Coils.  
Anti-Capacity Switches (all types).  
Rheostats (all types).  
Radial Switches (5, 10, and 15-way).  
Valves (M.O. and Mullard's).  
Ebonite Valve Holders, Dials, Scales, other parts and in Sheet.

Brass W.O. and Telephone Type Terminals,  
Nuts, Washers, Contact Studs, and all other parts.  
Accumulators.  
Dry Batteries.  
Aerial Wire.  
Insulators.  
Hertzite and Gaena Crystals.  
Cotton and other Tubings (all colours).  
Etc., etc.

**PRICE LIST ON APPLICATION**

**PETTIGREW & MERRIMAN, LTD., 122-124, TOOLEY, STREET, LONDON, S.E.1.**

**NOTE**—54, Gracechurch Street, is a few yards from Monument, Eastcheap, Bank, Cannon Street, and London Bridge.



## The MECCANO Radio Receiving Set

*For Broadcasting and Morse Reception*

**T**HE Meccano Crystal Receiving Set has been thoroughly tested and has received with great clearness broadcast music and speech up to 30 miles of London, Birmingham and Manchester.

*EACH SET IS TESTED AND GUARANTEED EFFICIENT ON A P.M.G. AERIAL.*

An ideal present for Christmas. Give one to your boy and make him happy. It is low in cost and complete in itself, ready to be connected to any aerial.

**Send for this Book**

Our new booklet, "The Meccano Crystal Receiving Set," explains Radio so that everyone is able to understand how simple is the reception of broadcasting, telephony, and Morse messages. This booklet will be mailed free on request.



*Start Radio Now in an Efficient and Inexpensive Way.*

### PRICES

Meccano Crystal Receiving Set complete .. . . .	55/-
Meccano Aerial Set (including antenna, lead-in and aerial wires, and insulators) .. . . .	12/6

**MECCANO LTD., Binns Road, LIVERPOOL**

## An Ideal Xmas Gift

JUST OUT  
**WIRELESS HANDBOOK  
AND DIARY  
1923**

Price **2/6** net

A complete Letts' Diary with 40 pages of valuable wireless information and the usual pages of useful general information. Beautifully bound in leather, it will form an ideal Xmas gift. Get someone to buy you one.

Obtainable through all Booksellers or direct post free 2/8 from

**RADIO PRESS Ltd.,  
Devereux Court, Strand, London,  
W.C.2.**



# A CHAT ABOUT OHM'S LAW.

By E. BLAKE, A.M.I.E.E.

IT is very interesting and instructive, not to say soothing, to drop coils and condensers sometimes, and make a quiet study of some of the laws and theories which are applied by electricians in their many designs and contrivances. For general practical purposes, if the theory seems practicable, we may as well take it for granted and get on with the job in hand. It is generally when some well-meaning but tactless relative says: "Yes, I understand all that—but what is an ampere?" that we wish we knew more about the derivation of some of the terms we rattle off so glibly.

A resistance of 2 megohms, a current of 3.64 amperes, a potential difference of 5 volts! Do we ever seriously ask ourselves the meaning of this jargon? A megohm is a solemn thing, especially if it gets into the aerial, and amperes cost money. One Henry—well, think of one putting one Henry into a basket-coil! I suppose you know that the reciprocal of one ohm is one mho—and that convinces me it is high time for us to be serious.

## Direct Relation.

The relation of electromotive force, resistance, and current to each other in a direct-current circuit, or in an alternating-current circuit of negligible inductance and capacity, may be expressed by the simple formula,  $C = \frac{E}{R}$  which means that the current (C) is directly proportional to the electromotive force (E), and inversely proportional to the resistance (R). In other words, if the E.M.F. remains constant, whatever factor operates on R to vary its value, operates on C in an inverse manner. If we double, treble, or quadruple the resistance, and so on, the effect is to reduce the current to a half, third, or quarter its first value. On the other hand, any alteration in the value of the E.M.F. results in a similar alteration of the current; by doubling E we double C, always provided the resistance remains constant. It appears, therefore, that if we have a metallic circuit of 2 ohms resistance, with a potential difference of 10 volts applied to its terminals, we may expect a current of  $10 \div 2 = 5$  amperes to flow in the circuit, as indeed there would, if the resistance continued to be 2 ohms; but does the resistance remain at that value?

## Effect of Heat.

Let us consider what happens. When a current flows along a wire it does work against the resistance of the wire, and whenever work is done some energy is transformed from one kind into another. In this case some of the electrical energy is changed into the energy of heat—that is to say, the temperature of the wire increases. Now the resistance of any substance depends, *inter alia*, upon its temperature, and in the case of a metal increase in temperature means increase in resistance; so that directly the current flows in our wire the resistance increases and the current accordingly drops.

The increase of resistance due to the rise in temperature of the wire does not seriously affect our calculations for ordinary work-

aday purposes, but it shows that in order to state Ohm's law accurately we should take temperature into account, and thus say that if the temperature of a conductor be constant, the ratio of the steady, direct potential difference at its terminals to the current flowing in it is also constant.

## Unit of Potential.

Now for a closer look at the units of the three physical quantities which are connected by Ohm's law. The volt is defined as that electromotive force which will cause a current of 1 ampere to flow through a resistance of 1 ohm, a correct definition, but not very helpful, inasmuch as it includes two other terms, ampere and ohm, each of which is defined by a phrase which includes the word "volt"—a sort of vicious circle. In fact, that definition of a volt is something like the definition of a shilling, as "that sum which will purchase one ounce of tobacco when the duty on the tobacco is ninepence."

In order to understand what the volt represents we must hark back to the fundamental conception of Length, Mass, and Time. In the article published in No. 27 P.W. we saw how from the centimetre, gramme, and second, was evolved the absolute unit of force, the *dyne*, and from that the electrostatic unit of electricity. Now, when a force of 1 dyne acts through a distance of

From the C.G.S. unit of potential is derived the practical unit, the volt, which is equivalent to 100,000,000 C.G.S. units.

## About the Ampere.

Next let us attack the ampere. The basis of the unit of P.D. was a consideration of the amount of energy transformed per unit quantity, but the idea embodied in the unit of current is that of the intensity of the magnetic field produced by an electric current under certain specific conditions. First a word or two about magnetism. Unit quantity of magnetism is defined in the C.G.S. system as that quantity which repels an equal quantity, in air, with a force of 1 dyne; such a quantity is called a *unit pole*. If a piece of wire 1 centimetre long be bent into an arc of a circle of 1 centimetre radius, and a current flowing in the wire exerts a force of 1 dyne on a unit pole at the centre, then that current is 1 C.G.S. absolute unit of current. This is quite simple to follow if you do not fall into the error of supposing the wire bent into a circle of 1 cm. radius, for that is a physical impossibility. It is an arc of a circle which is assumed, with a unit pole situated at what would be the centre if the circle were complete.

## Defining Resistance.

The practical unit of current, the ampere, is equivalent to one-tenth of a C.G.S. unit, and when 1 ampere flows for 1 second it conveys 1 coulomb of electricity—that is, 1 (practical) unit of quantity. The Board of Trade Standards Committee has adopted a working definition of the ampere, which may be of interest to experimenters, namely, that steady current which, flowing through a solution of silver nitrate (in water), deposits silver at the rate of 0.001118 gramme per second.

When a current flows through a wire it experiences a certain resistance, the value of which is dependent upon the dimensions of the wire and the material of which the latter is composed. The result is that a certain amount of heat is generated, which is thus a measure of the resistance of the wire. Therefore the resistance of a conductor may be taken numerically as the value of the heat (expressed in units of energy) which is generated in 1 second when 1 unit of current passes through it. This definition should be understood to refer to a circuit in which the process by which the heat is developed is not reversible, as it is in certain primary cells.

## Heat and the Ohm.

Hence 1 C.G.S. electro-magnetic unit of resistance is that by which 1 erg of heat energy is produced per second when 1 C.G.S. electro-magnetic unit of current passes. From this is derived the ohm, which is equivalent to 1,000,000,000 electro-magnetic units of resistance. When 1 ampere passes and 1 joule (heat) is produced, the resistance is 1 ohm.

The interesting thing about the foregoing explanations of our old friends, volt, ampere, and ohm, is that they are all derived from the fundamental conceptions of Length, Mass, and Time.



Putting up the Aerial.

1 centimetre, 1 C.G.S. absolute unit of work is done, or, as it is equally correct to say, 1 absolute unit of energy is transformed. This unit of energy is called the *erg*.

Considering now a potential difference (P.D.) between two points A and B of a circuit, that P.D. (or "voltage") is 1 C.G.S. electro-magnetic unit if 1 erg is transformed when 1 electro-magnetic unit of quantity passes between A and B. It may be explained here that the unit quantity of electricity passes when 1 absolute unit of current flows for one second.

# It Speaks for Itself—

and in no uncertain voice.

## THE WORLD'S STANDARD LOUD SPEAKER.

# AMPLION

WIRELESS  
LOUD  
SOUNDING  
RECEIVERS  
are supplied in  
a series of  
**Ten Models**  
Suitable for  
every service:  
**The Home,  
Laboratory  
and the  
Concert Hall**



At Prices  
ranging from  
**£2 : 10 : 0**  
to  
**£15 : 15 : 0**

**DAILY  
DEMONSTRATIONS**  
at the  
**GRAHAM  
SHOWROOMS**  
The  
**ALGRAPHONE  
SALON**  
25-26 Savile Row,  
Regent Street, W.1  
Phone : Regent 1075.

### "MUSIC MASTER" HORN.

- Type AR 13, 120 ohms .. .. . £6 : 0 : 0
- Type AR 15, 2,000 ohms .. .. . £6 : 2 : 6

"GRAHAM" WIRELESS  
PRODUCTIONS INCLUDE  
"HIGH EFFICIENCY"  
TELEPHONE HEADSETS  
OF IMPROVED DESIGN  
AND CONSTRUCTION.  
THE "GRAHAM" IS THE  
BEST HEAD GEAR MONEY  
CAN BUY.

Full Particulars forwarded  
upon request.  
Ask for Folder P.W.

Patentees and Manufacturers:

## ALFRED GRAHAM AND COMPANY

St. Andrew's Works, Crofton Park  
LONDON S.E. 4

Phone : Sydenham 952. Grams : Navalhada, Brock, London

### SCOTLAND—

Mr. F. M. Milligan,  
25, Renfrew Street,  
GLASGOW.

### IRELAND—

Mr. Alex. R. Munday,  
41, Chichester Street,  
BELFAST.



# BALANCED CRYSTAL CIRCUITS.

By SEXTON O'CONNOR.

THE difficulty of minimising the effect of strong jamming by some local station when one is ardently striving to follow a distant signal is well known to every amateur. Similar trouble is frequently experienced as the result of what are generally termed "strays," i.e., casual or vagrant disturbances of the electric equilibrium of the atmosphere, which give rise every now and then to loud, harsh

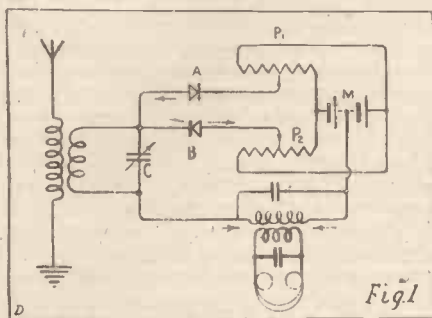

notes on the 'phones. The reason is the same in both cases. Abnormally strong disturbances affect the aerial by shock-impulse, and set it vibrating by sheer force, no matter to what wave-length it may be tuned.

### Elimination of Jamming.

When the disturbance is not sufficiently strong to shock-excite the aerial, it may be excluded by the ordinary method of selective tuning, and by loosening the coupling between the open and closed circuits, provided there is a sufficient difference between the wave-lengths of the clashing signals. With very strong jamming, or with atmospheric strays, this remedy is practically useless. The aerial circuit is affected so powerfully that any attempt to eliminate the disturbance must result in completely losing the desired signals.

One of the simplest ways to minimise trouble of this kind is to employ the balanced-crystal circuit shown in Fig. 1. As will be seen, the arrangement is quite simple, and is well within the experimental capacity of any amateur.

A certain amount of care is necessary in adjusting the crystals, but when this has been attained the relief from interference is most marked, and there is but very little loss in sensitiveness. Incidentally it affords a useful insight into the general behaviour and operation of crystal detectors as a class. Any form of asymmetrical detector may be utilised for the purpose, but in the example shown the carborundum crystal has been chosen.

It will be noticed that the only addition made to the standard circuit is an extra crystal. A double potentiometer, serving for both crystals, may be arranged across a single dry-cell battery of 4 volts. Each potentiometer wire should be about 400 ohms resistance. Care should be taken to see that the crystals are in opposition, i.e., the condenser lead is joined to the metal point in one case, and to the crystal terminal in the other. Two tapping points are taken from the crystals to the potentiometer resistance, as shown.

In order to explain the principle underlying the circuit arrangement, it will be necessary to refer for a moment to the characteristic curve of the carborundum crystal shown in Fig. 2. If the steady E.M.F. applied to the crystal B in Fig. 1 is in the neighbourhood of 1 volt, that crystal will work at the rectification "bend" marked B in Fig. 2. That is to say, an imposed signal-impulse of  $\frac{1}{2}$  volt in the positive direction will increase the average current much more than the ensuing impulse on the negative direction will diminish the current. In other words, the crystal B is set for efficient detection.

On the other hand, if the potentiometer voltage applied to the other crystal is such as to correspond with the point marked A in Fig. 2, applied signal-impulses in either direction will have practically no result at all upon the already very small current traversing that crystal. In other words, the crystal A has no appreciable effect upon the receiving circuit as a whole so long as signals of normal strength are being received.

### How it Works.

Now consider the effect upon the system of a very strong high-frequency impulse from a jamming signal, representing, for example, an applied voltage variation amounting to several volts. The result will

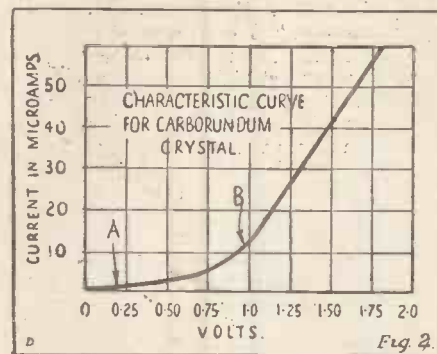

be to shift both crystals to the right along the characteristic curve until they are both on the steep part of the curve, and are therefore capable of passing fairly large currents.

The first (say, positive) impulse of the disturbing signal will accordingly result in the passage of a strong pulse of current through the crystal B in the direction of the arrow, but will have no effect upon the crystal A (which is set in opposition) owing to its unidirectional conductivity.

Immediately afterwards, however, the voltage impressed by the disturbing signal is reversed, and that side of the crystal-metal combination nearest the upper plate of the condenser C is thrown negative. Accordingly a large potential drop is created across the point contact of the crystal A in a direction which allows of the passage of a considerable current-pulse. This, however, is in opposition to the first current-pulse through B, as is shown by the second arrow. Owing to its unidirectional character, no current passes, this time, through the crystal B.

The upshot, then, is that each half-cycle of the applied disturbance causes a high-frequency current-pulse to pass through the detector circuit in opposite directions.

At the same time the crystal B is always working at a somewhat higher point along the characteristic curve in Fig. 2 than the crystal A, and so there remains a small net difference in the value of the opposed current-pulses, corresponding to the initial adjustment of the potentiometer voltage. This difference is sufficient to give a resultant telephone note, much lessened in intensity, however, from that which would normally be caused by the jamming energy or atmospheric disturbances, as the case may be.

Owing to the differences in crystal characteristics (no two of which are alike), the best results can only be obtained by actual trial and experiment in each case. The time spent in this manner will, however, be well repaid by the intimate knowledge of the behaviour of crystal detectors so gained.

Fig. 3 shows an alternative arrangement in which two crystals are inserted in opposition across an intermediate circuit coupled, on the one hand, to the open aerial, and on the other, to a detecting circuit. The crystal potentiometers are omitted from the drawing for the sake of clearness.

### Atmospherics.

In this system both the crystals A and B are initially set on the lower part of the characteristic curve shown in Fig. 2. For signals of normal strength the crystals, therefore, exert no appreciable effect on the circuit.

However, should atmospheric strays or any other powerful discharge set the aerial circuit into forced vibration, the voltage variations transferred across the aerial coupling will be sufficient to cause both crystals A and B to pass currents in opposite

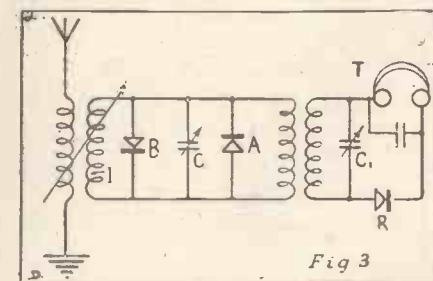

directions. It will be observed that they are both in shunt to the closed circuit inductance, and the effect is therefore to open up two conducting paths, each of which, to a large extent, short-circuits the inductance, and so by-passes the excess voltage.

The consequence is that high-frequency impulses flow in rapid succession, but in opposite directions, through the intermediate circuit, so long as the disturbing energy persists in the aerial. These mutually annul each other, leaving only a small fraction of the applied energy available for transfer to the detector circuit, thus giving rise to a greatly diminished note in the 'phones.



# ACTION AT A DISTANCE.

By JOHN HILL.

Note : This article is intended for the advanced amateur and student.—EDITOR.

THE conception of the ether is magnificent. By its means we can claim continuity between physical processes. It foreshadows, while it does not establish, the truth that at bottom mind and matter are one. Let the logic of our very being bear witness. When men dwelt on our relations with the sun they were unable to believe solar energy could reach us across a stupendous gap. They were compelled to view that gap, and other presumed gaps, as bridged by an etheric medium. They builded better than they knew. In being so compelled lies the philosophic basis of a continuous process involving co-relationship, rather than relationship, not only between earth and sun but also between human-experience and everything else. To follow on, if the ether hypothesis has been, or is, a necessary factor in the evolution of science, the foreshadowed truth will derive substance through an absorption, in itself, of all that is useful in the parent conception. That is evolution, a carrying forward of elements invariable in themselves yet ever varying in their presentation.

## Space Motion.

The weakness of the ether hypothesis is that it fails to bridge the gap between the supreme instrument of investigation—the mind—and the object of investigation—the world viewed as external to the mind. To that extent present scientific interpretation is supposititious. It but foreshadows complete continuity. But, supposing we find grounds for establishing that the ether is not the genesis of motion and unrelatable to experience, but lies under our very noses as the motional element itself? What must be the result of establishing such an identity? The answer is—a greatly amplified coordination of fact in which “action at a distance” and wireless will cease to rest on an enigma.

You may say, we have already a satisfactory science of wireless based on that enigma. Satisfactory indeed, *so far as it goes*. Understand this, you put in the ether what is necessary to your theory of propagation, thus explaining the ether but not the propagation. You bring your fundamental knowledge to a full stop. Instead, identify the ether with the motional element of experience—which you are logically entitled to do and your knowledge will no longer be based on an enigma; with the consequence that your understanding of “action at a distance” and your interest in wireless will be enlarged. Let us, at least, proceed in that direction.

I contemplate an object. Ideas arise. Huxley said: “Every word uttered by a speaker costs him some physical loss; and, in the strictest sense, he burns that others may have light.” This is untrue unless it relates to every act of consciousness. My ideas, beginning, on a surface view, in the external world, re-enter that world by way of my bodily tissue. Here is action; re-action; action at a distance. Where is the line of demarcation between the spacial

and motional elements here? There is none. “Action at a distance” loses meaning unless we conceive “action” and “distance” as co-existent. If this were not so, my perception of the object would depend on the object entering my bodily tissue. Yet this last is implied in the statement that a carrier of energy is needed before light and heat can enter our sphere from the sun.

A space-motion process is the only solution. I say “enter the earth sphere” because our actual limit is not the solid surface. The earth system probably extends 27 or 28 miles above us, as stated in my previous article. From the centre of the earth upwards there is an increasing velocity relative to axial motion, with a correlated fining away of the physical aspect until extreme tenuity is attained. Nevertheless, the elements of our experience, unshaped, persist there. The shaping occurs within the sphere. We transmute into sound certain vibrations reaching us from other things. *Perception is in no wise different in kind*. As to light, Olmsted says, “If the light which comes from a star were bent into fifty different directions before it reached the eye, the star would nevertheless appear in a line described by the ray nearest the eye.” I drop a weight within a uniformly moving railway carriage and see it fall along a straight line. During the fall the train travels twenty yards. The weight's path then terminates twenty yards from where we assume it to end. A curve is described. The process is in strict analogy with that in which the light curve is straightened in perception. We cannot detach the personal side from the general. The shaping of the phenomena of experience cannot be different in kind from the shaping of all other phenomena.

## A Mental Necessity.

An extremely important point follows. Mr. Blake rightly says, in “P.W.”: “ether-waves do not travel, but are propagated”—along a path, of course. Why, then, do we perceive other things as travelling in space? The result of immediate perception is figurative; all language is figurative. Whatever movement we perform is seen in other things, as when we walk along a road; we see our movement spacially. When we see another person walking, or the weight dropping in the moving carriage, we perceive it more in ourselves; that is, primarily through the motional side of consciousness. But since the process is a space-motion one there is no illusion, except in inadequate interpretation. Perception is co-real with the external world. And one thing is certain. The propagation of ether-waves is as stated because we do not directly perceive the propagation. Otherwise our view of the propagation would be more of a spacial character—a traversing of space, as it is of the weight dropping in the moving train, or of a flame travelling along a strip of paper; also, as in the case of the curved ray nearest the eye, along a straight line path.

In fact, you believe in the ether because you have transferred your figurative sense to the sun-earth process and thus comprehend solar energy as traversing space by means of an etheric bridge. This is how the hypothesis of the ether became a mental necessity. Are we to limit the space-motion process either to ourselves or to the world? To do that would be to deny the law of continuity, even as based on the hypothesis of ether. What we find within the sphere cannot differ in principle from what is outside. Apply, in conjunction with what I have stated, the scientific description of “wirelessing” to the sun-earth process. Take, if you like, the earth as the receiving station. Do not forget that the earth is as important as the sun in the process; just as our “wirelessing” is in reciprocity with the earth. Is not your knowledge of, and your interest in, wireless beginning to be enlarged?

So that if we take the 93,000,000 miles between the sun and the earth as having spacial significance only, we require the hypothetical ether for the working of the sun-earth system. But if we take the 93,000,000 miles in its true meaning, the correlative one, we substitute an “action-distance” process for “distance,” a process in common between the earth and the sun, with the actual sun limits—not millions of miles away—but reaching our own.

Here is revealed the fact, the whole fact, and nothing but the fact. On a working basis with the earth, the sun is next door.

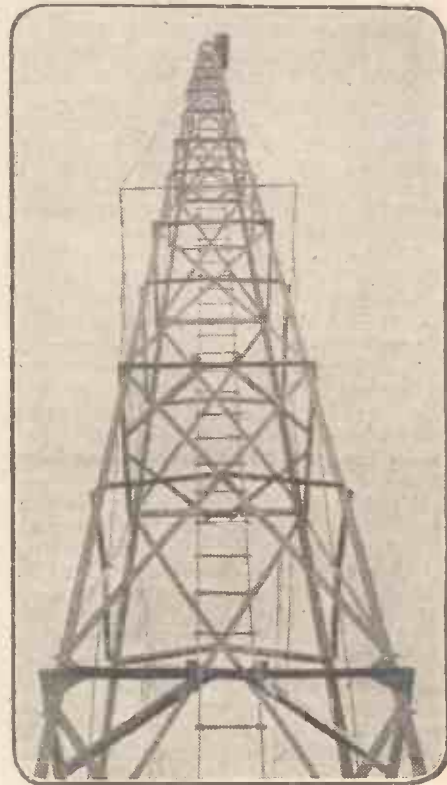

A mast at Croydon Radio Station.



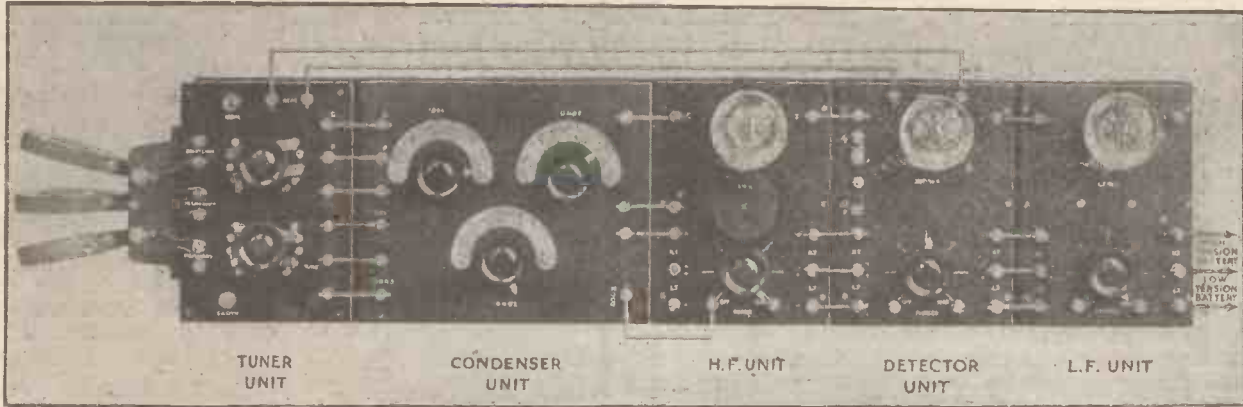

# A sensible Xmas Gift

—one all the family can enjoy 365 days in the year



Facsimile reproduction of a page taken from the Folder issued free with every set of Parts for a No. 4 (Detector) Unit. Note how—step by step—each operation is clearly explained. Absolutely no Radio knowledge is required to build up a Peto-Scott Unit.

All Peto-Scott Standardised Radio Units sold under licence from the Marconi Co.

If you can use a screwdriver and a pair of pliers you can build up a Peto-Scott standardised Radio Unit.

Look at the 3-Valve Set illustrated above. Isn't it an instrument you would be proud to own? Such a Set supplied ready for home construction, complete with full instructions, would cost you but a fraction of the price you would have to pay for a ready-built 3-Valve Set.

With this Set and the necessary Batteries, you can not only make

this Xmas memorable, but give pleasure to the whole family every evening in the year.

Why not treat yourself to a Radio Set—there's just time, if you order right away, for you to have it working in time for the holidays.

Our Booklet "Radio" shows how easy it is for a novice, with absolutely no previous experience, to build up a Multi-Valve Set. Fully illustrated. 6d. post free. 32-page Catalogue sent free with every Booklet.

SETS OF PARTS.	
Tuner Unit - - - -	27/6
No. 4, Detector Unit - -	17 6
No. 5, L.F. Amp. Unit - -	33 6
No. 3, H.F. Amp. Unit - -	13 6
Mahogany Cabinets to fit - -	3/6

Postage 9d. per unit extra, but paid on all orders over £2.  
Full instructions—either in a fully Illustrated Folder or a set of Blue prints—are supplied in every case.  
All sets of parts supplied neatly boxed in special containers.

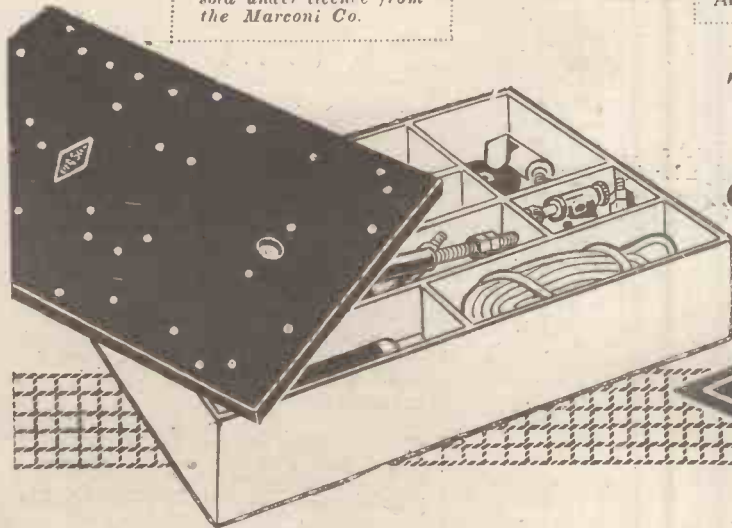

**THE PETO-SCOTT CO.**  
Featherstone House,  
64, HIGH HOLBORN, W.C. 1.



# HOW TO MAKE A D.F. STATION

By MICHAEL EGAN

## PART 4

WE have already seen how wireless waves are propagated from a transmitting aerial, and in a previous article some simple methods of erecting an indoor frame aerial were described. We have now to consider how such an aerial comes to possess its distinctive power.

Fig. 1 shows two vertical wires placed in the path of a wireless wave. As the strain lines are continually rising and collapsing round these wires, the current that is thereby induced in each of them is constantly

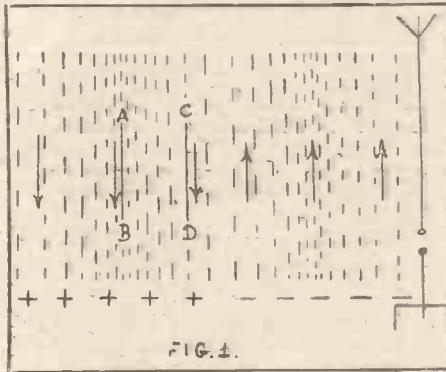

changing in strength and direction. Moreover, as has already been explained, the strain-lines are always moving out radially from the aerial. This means that currents of equal magnitude and direction will be induced in any two vertical wires placed at equal distances from the source of transmission.

It is important to grasp this point clearly. The main thing to remember is that the wave is radiated simultaneously in all directions. Therefore, any two wires placed at equal distances from the transmitter will pick up equal amounts of energy. Even at unequal distances, if the wires are fairly near each other, the induced currents will flow in the same direction in each wire, so that, when the wires are joined top and bottom to form a closed loop, the currents will oppose each other. If the currents are equal in strength, it is obvious that they will mutually nullify each other, and no energy will be available to operate the telephones. In other words, the loop will be in a minimum position with respect to the transmitter.

### Waves in Perspective.

It has already been pointed out that under certain circumstances an aerial radiates more energy in one direction than in another. The effect of this difference, however, is quite imperceptible over the small distance between the sides of an ordinary frame aerial, and may be neglected entirely in considering the amount of energy picked up by the two sides of a frame aerial.

We must now consider the effect of rotating the loop ABDC in the path of the wave. For this purpose the reader must imagine himself to be hoisted to the top of a transmitting mast, from which he commands a perfect view of the circles of electrostatic strain lines that radiate from

the aerial when the transmitting key is pressed. (In order to allow his imagination full scope, we will assume further that he is carefully insulated from the aerial.)

Referring to Fig. 2, the letter M denotes the position of the observer, and the circles represent the strain lines which he beholds at a particular instant. In considering what follows, we must imagine that the ceaseless rising and falling of the strain lines have been temporarily suspended for our special benefit.

### The Minimum Position.

It will be noticed that the circles are closely and loosely bunched together alternately at regular distances from the transmitter. This signifies the varying intensity of the strain lines, which also change their direction alternately at the points of minimum (zero) intensity. To the gifted observer at the mast-top, therefore, they would appear to be rising up from, and dying down into, the earth at a terrific rate.

During this particular moment of suspension, however, we take advantage of the reigning tranquility to erect a single vertical wire aerial A at the point shown, and another similar aerial B at some little distance away, though at the same distance from the transmitting station at M. These aeriels are now in position to receive equal amounts of energy in the same direction (i.e., either up or down) in each of them. And if we join them horizontally at top and bottom to form a loop aerial, there will be no resultant energy.

In other words, if we connect a receiver and a pair of telephones to our loop, no signals will be heard. In this position, then, we have a loop aerial whose plane is at right angles to the direction of the transmitting station. The same effect, of course, will be experienced if we increase the area of our loop by moving the second vertical aerial to C, or if we transfer both aeriels to the points E and F.

So much for the minimum position. If, now, we swing our loop aerial on a pivot, so that it takes up the position denoted by AK, an important change takes place. At K a smaller amount of energy will be picked up than at either A or B. Hence, in this new position there will be a resultant current available to operate the telephones. And as the side K is swung closer to the transmitter at M, this difference in the amounts of energy picked up by A and K will steadily increase. That is, signals will get gradually louder.

### Actual Direction.

When, finally, the side K has been brought into line with the side A and the transmitter at M, the difference will be greatest and the loudest signals will be heard in the telephones. In this latter position, AK is a loop aerial whose plane is in line with the direction of the transmitting station. This is known as the "maximum position."

It will also be seen from Fig. 2 that the same effect (working in a reverse manner) would have been experienced if the side K had been swung in the opposite direction,

i.e., away from the transmitter at M. It is this fact that makes it impossible to tell from which side of such a frame aerial signals are being received—for instance, whether they are coming in from the north or south. In order to find the actual direction (and position) of a transmitter, two frame aeriels are therefore necessary.

### Obtaining Sensitivity.

From what has been said so far, a little reflection will enable the reader to arrive at a fairly clear idea of why a frame aerial functions as it does. The more thoroughly this is understood, the more efficient one may hope to become in the operation of such an aerial, by understanding and dealing intelligently with the "snags" that occasionally arise with the best of equipments.

We have now seen how the directions and

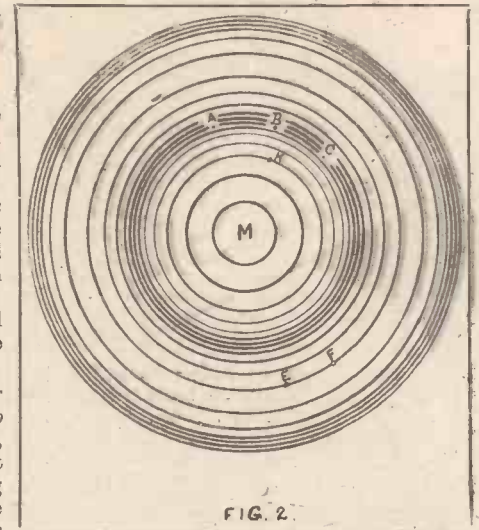

positions of transmitting stations can be found by means of a single frame aerial. With such an aerial good sensitivity can only be obtained by working on "minimum" signals. There is, however, a novel method of getting equally good sensitivity whilst working on "maximum" signals. This will be explained in the next article.

(To be continued.)

## TO READERS OF "POPULAR WIRELESS."

What particular article have you been wanting to read in "Popular Wireless"?

If there is any special Radio Brain subject you would like to see an article about in this paper, send in your suggestions to the Editor.

Better still, write a short article yourself on your latest Radio Brain subject. New ideas are welcomed, and if published in "Popular Wireless," are paid for at our usual rates.

Amateur Photographs, if published in "Popular Wireless," are paid for at the rate of 10/6 each. If used as a cover plate, the fee is 25/-. Photos must be clear and sharp.



# ORA

## The Valve for perfect reception

For receiving vocal and instrumental items you must have

### MULLARD "ORA" Valves

to get the best results.

**O**scillates **R**ectifies **A**mplifies

Specially recommended where good amplification is required.

The "Ora" Valve requires about 3.8 volts on the filament and 30 volts or over between the anode and filament for efficient results.

**15/- EACH.**

### IMPORTANT NOTICE

The great demand for Mullard "Ora" Valves and other accessories has compelled us to open much larger works. A greatly increased output is now available.

The MULLARD "R" Valve is now reduced in price from 22/6 to 17/6

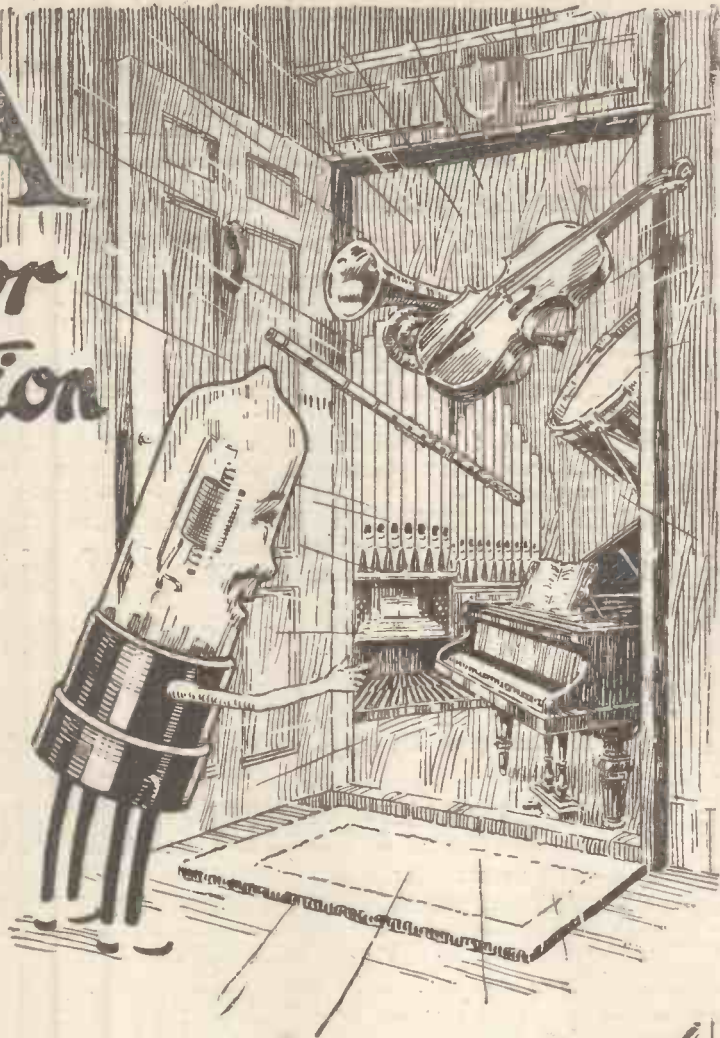

## Mullard Radio Valve Co. Ltd.

45, Nightingale Lane, Balham, S.W.12.

Contractors to H.M. Admiralty

War Office, Royal Air Force & Post Office,

Telephone: Battersea 1068  
 Codes: ABC(5Ed) Bentley's  
 Telegrams: Radiovalve Hammer Lond<sup>n</sup>



*Please send me post free*

Quantity	Description	Price
.....	Telephone Head Sets	Type A—2/1.
.....	"ORA" Valves	Type B—2/1.
.....	Grid A Resistances	15/- each
.....	Anode A or B	5/- each
.....	BA Condensers	6/- each
.....	Combined Resistances and Condensers	2/6 each
.....	Valve Bases with Terminals	7/6 each
.....	Valve Sockets	5/- each
.....	Terminal Clips	1/6 each
.....		9d. per pair

Name and Address.....

To the MULLARD RADIO VALVE CO., LTD., 45, Nightingale Lane, Balham, S.W.12.

Name of usual Wireless Dealer.....

I enclose (Cheque Money Order, P.O.) value.....

to cover the cost.....

**SEND THIS TO-DAY.**

USEFUL PRESENTS WHICH CAN BE USED FOR XMAS

# BROADCASTING

Having purchased a large stock of apparatus from a company in liquidation we offer the following at **SPECIAL PRICES.**

- |   |                          |                    |
|---|--------------------------|--------------------|
| <b>30</b> BROADCASTING 2-VALVE SETS, RANGE 350/500 METRES, B.B.C., P.M.G., No. 2015. Manufactured under MARCONI'S PATENT, complete with high-tension battery, approx. 50-mile range for telephony | Usual price £16 : 16 : 0 | <b>£10 : 0 : 0</b> |
| <b>97</b> BROADCASTING CRYSTAL SETS, RANGE 350/500 METRES, B.B.C., P.M.G., No. 116. Fitted with variable condenser, 'phone condenser, approx. 20-mile range for telephony.                        | Usual price £2 : 12 : 0  | <b>£1 : 15 : 0</b> |
| <b>161</b> SPECIAL 2-VALVE SETS, RANGE 300/1,200 METRES. Fitted with variable condenser, O.C. condenser, 'phone condenser requires minor adjustments. Experimental licence only required          | Usual price £12 : 12 : 0 | <b>£5 : 0 : 0</b>  |
| <b>88</b> CRYSTAL SETS IN PARTS, with full instructions and diagram for making up. Useful and interesting present for boys  | Usual price £1 : 15 : 0  | <b>£1 : 0 : 0</b>  |
| <b>114</b> Telephones, English and French, 4,000 ohms   | <b>22/6</b> each         |                    |
| <b>99</b> Batteries, H.T. 15v.  | <b>2/6</b> "             |                    |
| <b>19</b> " " 36v.  | <b>5/6</b> "             |                    |
| <b>194</b> Crystal Detectors, with crystal  | <b>3/9</b> "             |                    |
| <b>250</b> Fixed Condensers, '0003  | <b>2/3</b> "             |                    |
| <b>700</b> Walnut Insulators  | - - -                    | <b>5/-</b> doz.    |
| <b>900</b> Composition Knobs  | - - -                    | <b>2/-</b> "       |
| <b>50</b> Switches, S.P.D.T.  | - - -                    | <b>2/6</b> each    |
| <b>45</b> " D.P.D.T.  | - - -                    | <b>3/9</b> "       |
| <b>36</b> " S.P.S.T.  | - - -                    | <b>2/-</b> "       |
- (These switches are mounted on ebonite.)

**TERMS :** These goods are offered subject to their being unsold. **CASH** with order. **POSTAGE AND CARRIAGE EXTRA.**

**THE LIGHTING SUPPLIES CO.,** :: 2, FINSBURY AVENUE, ::  
ELDON STREET, LONDON, E.C. 2.

Telephone : LONDON WALL 2475.

Telegrams : "MODELECSUP."

**CQ** Do you get **PCGG?**

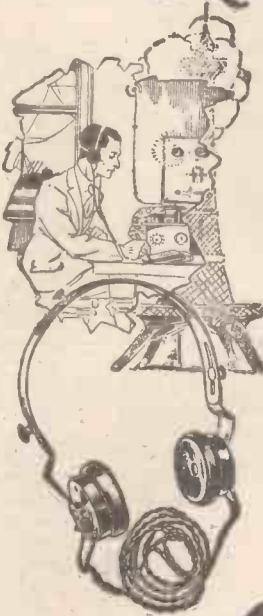

**Y**OUR crystal or valve may be the best of their kind—your aerial high as Snowdon, your tuner beautifully selective, but unless your 'phones are O.K. you won't get maximum "sigs."

Signals come "thumping in" through ERICSSON 'PHONES—they're built that way—for never-failing clarity and sensitivity. The magnets never lose their strength and "shorts" don't exist. And they're easy and comfortable to the head.

Back of ERICSSON 'PHONES is the accumulated experience of a generation in telephone manufacture.

Write for Particulars

The **BRITISH L.M. ERICSSON MANUFACTURING Co., Ltd.**

Head Office : International Buildings, 67/73, Kingsway, W.C.

**Ericsson**  
**Telephones**



39

ESTABLISHED 1905

## DOUBLE HEAD PHONES

(4,000 Ohms).

Double Plate Magnets, Duralium Headbands, Replaceable Coils,

**£1-0-0**

(Postage 9d.)



## SINGLE EAR PHONES

(2,000 Ohms).

Special Christmas Offer.

**7/6** EACH.

(Postage 4d.)

MADE BY—

**TURNOCK'S TELEPHONE WORKS,**  
41, High St., Aston, Birmingham.



# WIRELESS CLUB REPORTS.

The Editor will be pleased to publish concise reports of meetings of Wireless clubs and associations, reserving the right to curtail the report if necessary. Hon. secretaries are reminded that reports should be sent in as soon after a meeting as possible. Reports sent in cannot appear in this paper in less than ten days after receipt of same. An Asterisk denotes affiliation with the Radio Society of Great Britain.

## Hackney and District Radio Society.\*

A meeting of the above society took place on the 16th November, at the society's headquarters, Y.M.C.A., Maro Street, Hackney.

Two home-made sets of three valves each were on exhibition, and with the aid of a loud speaker, the latest news of the day broadcasted by the London Broadcasting Station was heard loudly and clearly to all present.

A spirited discussion took place on the subject of valves v. crystals. Mr. Valins opened the attack on behalf of valves and Mr. Bell most ably defended for the crystals. The general opinion, however, was that each had its own proper functions.

The society meets every Thursday at 7.30 p.m. and visitors are always welcome, especially ladies.

COMING EVENTS.—21st December: lecture and demonstration, "Spark Coils and High Frequency Currents (Tesla)." Mr. A. Valins.

28th December. Informal.

4th January, 1923. Annual general meeting. Sec., E. R. Walker, Esq., 48, Dagmar Road, E. 9.

## The Wireless Society of Hull and District.\*

A meeting of the above society was held on Monday, November 13th, when Mr. G. H. Strong read a paper for his son, Mr. Henry Strong, entitled, "The Calculation of Capacity," in which the lecturer described the way to calculate the capacities of many different types of condensers, and gave many useful formula. Meetings are now held on the second Monday and fourth Friday of the month in the Signal Barracks, Park Street, at 7.30 p.m., the Monday meetings being devoted to lectures and those on Friday to discussions. There will be a half-hour buzzer practice at 7 o'clock before each meeting.

Hon. sec., H. Nightscals, 79, Balfour Street, Holderness Road, Hull.

## Hoylake, West Kirby and District Wireless Association.

A general meeting of the above association was held on October 23rd, at the Green Lodge Hotel, Hoylake. In the unavoidable absence of Mr. Welding the chair was taken by Mr. S. Evans, technical adviser to the association, who, announced in the course of his opening address that a stage of H.F. amplification—designed by Mr. Brattan—was being added by the committee to the 3-valve set then in use. And it was hoped that this would be in action by the next meeting.

Mr. Roper Brattan, with the aid of black-board diagrams, then gave a very helpful list of various symbols used in wireless work, together with a particularly clear explanation of the variometer type of tuning, and of crystal and single valve sets. Specimens of the latest Marconi valves were very kindly loaned by a member for the inspection of those present.

A vote of thanks to the lecturer was seconded and applauded in a manner that showed the keenness and appreciation of the audience. Individual difficulties were then dealt with: a member's inductance coil being discussed and valuable improvements suggested by Mr. Brattan.

The chairman, in closing the meeting, strongly advised members to learn Morse. The signals sent by many shipping stations and the Eiffel Tower were at quite a moderate speed. Actually a receiving set was never silent. To one who knows Morse, the whole ethereal hemisphere teems with interesting signals, which will provide a never-ending source of entertainment when the novelty of broadcasted telephony wanes.

Hon. sec., Mr. Roper Brattan, 14, Kirby Park, West Kirby.

## North London Wireless Association.

On the 23rd of October an interesting lecture was delivered by Mr. Power on the subject of microphones.

Commencing with a description of the early instruments, such as the Bell type, and those making use of loose contacts between metal rods or carbon pencils, he proceeded to describe the various improvements which had led up to the instruments of to-day.

Mr. Power had brought with him several kinds of modern microphones, including inset and solid back types, which he took to pieces and passed round for inspection, at the same time explaining their construction and action. Several questions were asked by members and answered by the lecturer.

At the conclusion, a vote of thanks was accorded to Mr. Power for his most interesting lecture.

All interested in wireless—from the absolute novice to the seasoned experimenter—are invited to join the association. Particulars as to fees, etc., may be obtained at any of the association's weekly meetings, which are held on Mondays, at the Northern Polytechnic, Holloway Road, N., commencing at 8 p.m., or by writing to the secretary at the same address.

## The Portsmouth and District Amateur Wireless Society.

An interesting evening was spent on Wednesday, the 25th of October, when Mr. Gull gave a lecture on "Broadcasting." Mr. Gull dealt with the present regulations, and various diagrams were drawn to demonstrate the requirements of the P.M.G. Mr. Gull further explained a number of diagrams to illustrate how a first-class set could be made, although keeping within the regulations. A discussion arose with regard to licences, and it was gratifying to note the number of members who preferred experimenting licences, and were not merely taking up the cult of wireless for the sake of the long-delayed broadcasting concerts.

Hon. sec., Mr. R. G. H. Cole, 34, Bradford Road, Southsea.

## Stoke-on-Trent Wireless and Experimental Society.\*

At a meeting held at the Y.M.C.A., Hanley, on Thursday, October 26th, details of an interesting competition were announced.

It is proposed to form a buzzer class from 7 p.m. to 7.30 p.m. on Thursdays, if a sufficient number of members care to avail themselves of the opportunity.

Hon. sec., F. T. Jones, 360, Cobridge Road, Hanley.

## Newport and District Radio Association.\*

On the 26th of October, Mr. H. W. Winslow (Newport) gave illustrations of the various methods of jointing. Although "soldering" and "jointing" seem somewhat elementary, it is surprising how different they appear after being carried out by a practical hand, and how easy it is to throw out of gear your whole instrument by the lack of knowledge or care upon some very small matter in this respect.

It has clearly indicated to our members that other evenings could be well spent by similar demonstrations.

Hon. sec., E. R. Brown, 92, Corporation Road, Newport.

## Wireless and Experimental Association.\*

At the Central Hall, Peckham, on Wednesday, November 22nd, there was a crowded and enthusiastic meeting, commencing with the normal half-hour's buzzer practice.

Messrs. Hersey and Voigt discoursed very helpfully on the subject of heterodyne and reaction circuits. Mr. Knight, the chairman, discovered several very simple mechanical analogies, which he described with the aid of the blackboard. And Mr. Hunter exhibited and explained a very comprehensive wave-meter which he had constructed.

# AMATEURS

## DO BUY QUALITY GOODS.

"GRIFPHONES," 4,000 ohms, per pair 22/6  
The Best Value on the market.

Quality British Phones, 4,000 ohms... per pair 30/-

"Brown's" A Type, 8,000 ohms (Ex-Government stock)... per pair 40/-  
Very Limited Quantity. (Postage 1/-)

TRENCH BUZZER SETS... 7/6  
Complete with Ear-piece, etc. (Postage 1/3)

## INTERVALVE TRANSFORMERS

Guaranteed THE BEST, being Distortionless, Noiseless. These are HEDGEHOG pattern. Ratio 5—1. Wound with D.S.C. Wire... PRICE 20/-  
(Postage 9d.)

## TELEPHONE TRANSFORMERS

As specification of above... PRICE 17/6.  
But Ratio 10-1 (Postage 9d.)

QUALITY FILAMENT RESISTANCES... 2/9

"GRIFFIN" Fixed CONDENSERS, .001... 1/6

"DUBILIER," .0001 to .0009... 2/6

" " .001 to .005... 3/-

" " Grid Leaks, 2 Megs... 2/6

SWITCH ARMS... 2/6

Ebonite Dials, 1 to 18<sup>o</sup>... 1/6

Siemens H.T. Batteries, 30V... 7/6

" " 60V... 15/-

Ebonite Panels, all sizes... per lb. 4/6

" Knobs... 6d.

" Sliders... 9d. and 1/8

Aerial Wire, 7/22 Copper, 100 ft... 3/9

" " Enamelled... 4/6

Resistance Wire, 12 yds... 10d.

Rubber-Covered 20 g. Copper, 12 yds... 1/4

1/2 oz. Bobbins, 47 g. D.S.C. (for rewinding Phones)... 1/-

Pkts. of asstd. Crystal (Real Value)... 2/6

QUALITY CRYSTAL DETECTORS... 2/6

" " Super. Qual. 6/-

Wound Ind. Tubes, 3 x 12, 3/3; 4 x 12, 4/-

Valve Holders, Mld., 1/-; "A" 1/2; Eb. 1/6

BASKET COILS, special line, shellacked, not waxed. Wound with 3-stranded wire, set of 8... 7/6

EAR PIECES (ex-Govt.)... each 3/6

Complets List of all Parts sent Free.

# GRIFFIN

WIRELESS SUPPLIES CO.

82, NEWINGTON CAUSEWAY,

Hop 1806. LONDON, S.E.1

(2 Minutes from Elephant & Castle Stations.)

ACCUMULATORS, etc. New and Guaranteed

4-Volt, 25-Amp. Celluloid, 11/3. Postage 1/-.

4-Volt, 40-Amp. 17/6 | 6-Volt, 40-Amp. 25/6

4 " 60 " 21/3 | 6 " 60 " 31/-

4 " 80 " 27/- | 6 " 80 " 36/-

Packing, 1/6 extra. Packing, 2/- extra.

7/22 Aerial, 5/6 100 ft.; Mullard Ora Valve, 15/-.

15-V. Siemens H.T. Batteries, 4/-; Marconi H.

Valves, 17/8; Accumulator Charging Board, 37/6;

Voltmeters, Watch pattern, 0/12 Volts, 6/-.

Cash with order. Goods despatched per return.

LOWKE & SONS, Ltd., Northampton.

## DON'T WASTE MONEY!

### BUY DIRECT.

Complete Crystal Set in polished case, 6 x 6, ebonite top, Hertzite crystal with double phones 2/6. Nothing to add. The most wonderful value ever offered. Valve sets, panels, phones and parts. Everything at less than wholesale. Extracts from recent letters:—

"With your single valve panel (17/6), I get speech from Paris and Hague, besides the English stations."

"Goods arrived safely. They are remarkable value. I shall recommend."

"I have compared your prices, which are by far the cheapest."

Send for quotation to:—HARLEY'S, 115, Shacklewell Lane, Dalston, London, E.8.

# BROADCASTING RECEPTION SETS.

One-Valve Set Complete for Working, £7:10:0

Including All Accessories

Send for  
Catalogue

Agents  
Wanted

Passed for  
Broadcasting  
Licence G.P.O.  
No. 1039.

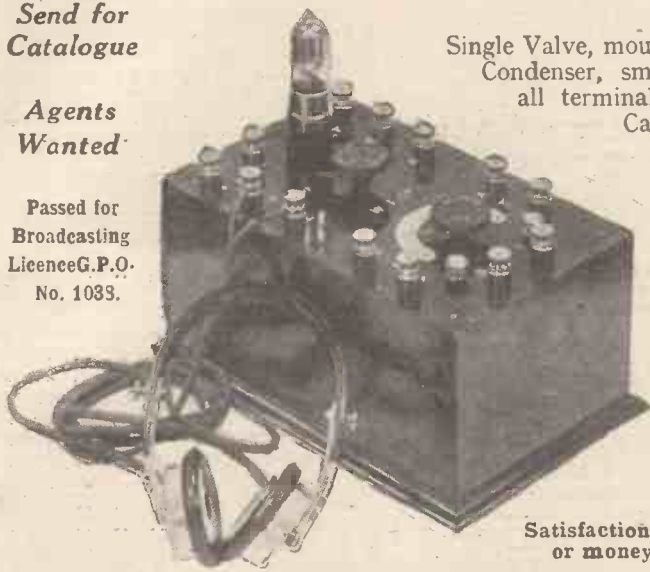

## DESCRIPTION:

Single Valve, mounted on polished 1/4-in. Ebonite Panel with Variable Condenser, smooth acting resistance, grid leak and condenser and all terminals clearly engraved in white, in a Mahogany Polished Cabinet, 9 in. by 5 in. by 5 in. **£3:15:0**

A TAPPED COIL for wave-lengths up to 900 metres with 2 terminals for coils for any higher wave-lengths.

The coil is enclosed and the tappings are brought out to an 8-way switch mounted in the front of the cabinet.

## ACCESSORIES INCLUDED:

Siemen's 54 volt high-tension Battery with plugs for altering the voltage **£0:15:0**  
 4 volt 50 amp. hour low tension Accumulator in case with carrying strap **1:4:0**  
 One pair of Sensitive Head Phones of 4,000 ohms resistance **1:1:0**  
 One Detecting Valve **0:15:0**

Satisfaction Guaranteed  
or money refunded.

**Total £7:10:0**

**WIRELESS INSTALLATIONS Limited,**  
15, ALDERSGATE STREET, LONDON, E.C.

## ENSIGN RADIO

### RECEIVING SETS & COMPONENTS

CRYSTAL SET for broadcast reception. Approved  
 by Postmaster-General and stamped BBC. **£5 5 0**  
 Complete with H.R. 'Phones and Aerial equipment  
 Without accessories **3 17 6**

TWO-VALVE SET for broadcast reception. Approved  
 by Postmaster-General and stamped BBC. **£13 16 6**  
 Complete with Brown's H.R. Featherweight 'Phones,  
 Batteries, and Aerial equipment (valves extra)  
 Without accessories **9 12 6**

AUDIO FREQUENCY TRANSFORMERS (Plate type) **0 19 6**  
 Do. Do. Do. (Hedgehog type) **0 19 6**

TELEPHONE TRANSFORMERS (mounted) **0 15 6**

FILAMENT RHEOSTATS, fitted with brass bush and  
 pointer **0 4 0**

FIXED CONDENSERS, .001 and .0003 mf. **0 1 6**  
 COMPLETE AERIAL EQUIPMENT **0 6 6**

Postage extra on orders under 20/-

**THE ENSIGN RADIO CO.,**  
15, STRAND, LONDON, W.C.2. ('Phone: Gerr. 6703.)



Telephone: Hammersmith 443.

## VARIABLE H.T. BATTERIES

AGENTS WANTED.

THE W.A.S. VARIABLE H.T. BATTERIES will increase the efficiency of your set, and give you undistorted speech and music. These batteries being made from a special formula, have a longer life than any that are on the market, and are perfectly SILENT in working.

PRICES.  
 30-VOLT, tapped every 3 volts **7/-**  
 60-VOLT, " " " " **13/6**

The above prices include insulated Wander Plugs.  
 To be obtained from most Radio Dealers, or Post Free from Sole Manufacturers:—  
**W. A. SAXBY & CO.,**  
 3, GAYFORD ROAD, SHEPHERD'S BUSH, LONDON, W.12

**NOTICE!**

**Please Refer to  
Last Week's Issue.**

**No. 28. Dec. 9th. Page 639.**



# RADIOTORIAL

All Editorial Communications to be addressed The Editor, POPULAR WIRELESS, The Fleetway House, Farringdon Street, London, E.C.4.

Judging by the reports I am receiving from readers, the difficulty in obtaining an experimental licence is not so very great, after all.

The correspondence we publish in this issue, by courtesy of Messrs. Peto-Scott, seems to indicate that the authorities at the G.P.O. are beginning to realise that a ban on home-made sets and harmless experiments will not have much effect.

If amateurs want to make their own sets, it seems to me that it will be an almost impossible job to try to stop them.

I should be glad to hear from readers who have applied for experimental licences, as it is always interesting to note the various phases in the development of the attitude of the G.P.O. towards the amateur.

THE EDITOR.

## Questions Answered

Owing to the enormous number of queries received daily from readers of POPULAR WIRELESS, I have decided to reply individually by post. A weekly selection of questions will, however, be printed on this page, together with the answers, for the benefit of readers of POPULAR WIRELESS in general. Questions should be clearly and explicitly written, and should be numbered and written on one side of the paper only.

All questions to be addressed to: POPULAR WIRELESS, Queries Dept., Room 132, The Fleetway House, Farringdon Street, London, E.C.4.

Readers are requested to send necessary postage for reply.

"CRYSTAL" (Birkenhead).—I have a crystal set, but am at a loss how to test for the sensitive point on the crystal. I understand it is done by means of a buzzer; how is this connected to the set?

The buzzer is not connected to the crystal set at all. It is used as a small transmitter apart from the set altogether, and at some little distance from it. The buzzer is connected to a battery and, if possible, to a tapping key. Failing this, it should be connected to the battery and set "buzzing" during the whole time adjustments are being made on the crystal set.

It is advisable to erect a tiny aerial (24 S.W.G. insulated wire will do) about 3 ft. long, and hung on to a lamp bracket or some handy place. This increases the distance of radiation of the tiny waves from the buzzer. To listen in, the crystal set is used in the ordinary way, except no tuning need be done on the coil. The crystal and contact should be moved about until a spot is reached at which the buzzer signals are loudest in the telephones. The crystal is then correctly adjusted. It is advisable to have the buzzer in another room, or at any rate far enough away to prevent its mechanical sounds being heard while listening in.

A. T. P. (Walthamstow).—I have a choice between two positions for my set, using the same aerial in each case. One gives me a lead-in of 12 ft. and an earth lead to a water pipe of about 20 ft. The other gives a lead-in of 20 ft. and an earth lead of only 5 ft. Which should you advise?

It is better to have the longer lead-in with the shorter earth. The earth lead resistance should always be cut down as much as possible, as it is in this lead that maximum current flows. If a long earth lead is necessary at any time, use several strands of fairly heavy wire.

"BEGINNER" (Lewisham).—I have only room in my garden for a 30-ft. aerial about 25 ft. high. Could I have an insulated aerial round the eaves of the house? This would give about 70 ft. or more at about 25 ft. high.

No, this would not be suitable. An aerial (other than indoor frame aerial) should be as straight as possible, and also it is preferable to have it as far away from buildings, etc., as is practicable.

P. M. B. (Ilford).—I have decided to scrap my present coil, which is too large to let me get down to 2 L.O. As this is the only station from which I will desire to receive signals, would one small basket coil with a .0005 mfd. variable condenser for tuning be sufficient, using a crystal set?

We would advise you to wind a small cylindrical coil of the usual single-layer type, as being preferable to basket coils for crystal work. Wind 60 turns of

22 S.W.G. on a small former 4 by 3 ins., and employ a .0003 mfd. variable condenser.

W. M. C. (Southampton).—Would it be possible to arrange some relaying device so that I could be warned when 2 L.O commenced to transmit? A loud buzzer would be something like the thing I should require.

Not without considerable amplification. Also it would necessitate the valves being in operation throughout the whole time you were "standing by." We must also add that much trouble would be experienced in preventing static or loud signals on the same wave-length, or jamming actuating the apparatus.

"LISTENING" (Brighton).—I have purchased a crystal set that I was informed, when buying, would receive broadcasting up to 50 miles, and although I have a very good aerial nearly 45 ft. high, and everything appears to be in good order, I have not yet heard any signals. Do you think the range of the set was overstated?

Yes, very considerably. Generally speaking, the range of a crystal set for the reception of telephone under the best of conditions will not exceed 20 or so miles. Even then signals at the limit of this range would be very weak, and would require considerable tuning and crystal adjustment. For comfortable reception of the London broadcasting we would recommend you to instal at least a two-valve set.

Y. P. (Martock).—I have a one-valve set, but results are very poor. I wish to add more valves. Would H.F. or L.F. amplifiers be best?

As you are some considerable distance away from the broadcasting stations at least one stage of H.F. would be advisable. Should you desire to employ a loud speaker two or three stages of L.F. in addition will be required.

"NOVICE" (Edinburgh).—Would it be advisable to use a small battery with a "Perikon" detector consisting of copper pyrites pressing against zincite, as signals seem rather weak? If so, where should I place it?

No local potential is required with a "Perikon" detector. We are afraid you will always experience that "could be better" feeling with a crystal set. The best plan is to have two detectors in order that comparison may be made.

B. S. B. (Streatham Hill).—I cannot erect an outdoor aerial—at least, not longer than 17 or so feet. Would a frame aerial or an indoor

(Continued on next page.)

## A "SHOCKING" WAY OF ERECTING AERIALS.





THE MARK OF RELIABILITY

Filament Resistances  
2-/each.  
with Pointer & Knob Panel Type

Potentiometer  
390 Ohms  
4/6 each.  
Panel Type on Ebonite.

1 to 12 volts.  
**VOLT & AMMETER**  
1 to 35 amps.

Combined Dead Beat Pocket Type. New and not German. Splendid Instrument in Nickel-Plated Case. Ideal for Testing Cells and Filament Current

POST PAID **5/6** NUMBER LIMITED OTHER EXCEPTIONAL VALUES.

Aerial Wire, Bright Hard Drawn, 7/22 Copper, 3/8 per 100 ft.; same enamelled, 5/-.  
Aerial Insulators, 2 x 2 1/2 ins., Shell type, 9d. each; 2 in. Reel Type, 2d. each.  
Telephone Transformers, (Army type), 5/- each; L.F. Transformers, 15/- each.  
Vernier Condenser, 5 Plate for Panel mounting, 4/- each; .001, 16/-; .0005, 12/-.  
Wireless Jacks, with Plugs, 1/- the pair.  
High Note Buzzer, (Army type.) Worth treble. 3/- each; Tapping Keys, 5/6 each.  
Dewar Switches, D.P. Change over, panel type, 2/- each; Small Switch Arms, 6d. each.

Write for "Complete Supplementary Price List of Exceptional Values," sent Post Free.  
All goods sent CARRIAGE PAID, but with orders under 5s. 6d. add 6d. for postage.

**J. H. TAYLOR & CO.,**  
ELECTRICAL AND RADIO ENGINEERS,  
Macauley St., HUDDERSFIELD.  
Telephone, 341. Telegrams: "Thorough," Huddersfield

The "OMNIPHONE"  
Crystal Receiver

For broadcast wave-lengths. While a complete highly sensitive receiver in itself, may form the nucleus of a most elaborate set, as provision is made for the attachment of a valve amplifier, Fully guaranteed. Approved by G.P.O. Call for demonstration, or write for full particulars. Price, complete with full equipment

**£4 - 17 - 6** Carriage Paid.

All Accessories. List Free.

OMNIPHONE WIRELESS CO.,  
24, Warwick St., Regent St., London, W.1.

THE "SILVER BELL."  
A LOUD SPEAKER AT A PRICE WITHIN THE MEANS OF EVERYONE.

Suitable for two or more valves.  
PURE TONE, CLEAR ARTICULATION, GOOD VOLUME OF SOUND.

Low resistance, 150 Ohms - - - - - 29/6  
High resistance, 2,000 Ohms - - - - - 32/6

STANLEY WYMAN, 110, Ladbroke Grove, London, W.10.

STEEL TUBULAR MASTS.  
LIGHT, STRONG, & EASILY ERECTED BY ONE MAN. Complete, ready for erection, with flexible steel guy lines, insulators, Base plate, 4 ground anchors, Halyard and Pulley, 10 ft., 15/-; 20 ft., 25/-; 30 ft., 35/-; 40 ft., 50/-; 50 ft., 70/-.

Abbey Engineering Works, Watton, Norfolk.

WIRELESS BARGAINS

Loud Speakers, 10/6; Crystal Detectors, 3/-; Phones, All British, 4,000 ohms, 21/- All Post Free. Trade Supplied.

Illustrated Catalogue P, including list of stations, 6d. post free.

**EONS WIRELESS SUPPLY CO.**  
115, FLEET ST., E.C.4.

CUT THIS OUT

"Popular Wireless" PEN COUPON Value 2d.  
Send 7 of these coupons with only 2/9 direct to the Fleet Pen Co., 119 Fleet St., E.C.4. You will receive by return a splendid British-Made 1ct. Gold-Nibbed Fleet Fountain Pen, value 10/6 (fine, medium, or broad nib). If only 1 coupon is sent the price is 9/9, 2d. being allowed for each extra coupon up to 6. (Pocket Clip, 4d.) Satisfaction guaranteed or cash returned. Special New Offer.—Your own name in gilt letters on either pen for 1/- extra. Lever Self-Filling Model with Safety Cap, 2/- extra.

RADIOTORIAL  
QUESTIONS AND ANSWERS.

(Continued from page 667.)

aerial slung round the walls of an upper room be all right for a single-valve set?

We would prefer an outdoor aerial, even although its length was restricted to 17 ft. Make it a four-wire aerial, spacing the wires by at least 1 ft. each, and obtain as much height as possible. You should have no difficulty in hearing very good signals from the London broadcasting station.

H. W. (Leeds).—I have a three-valve set and employ reaction coupled to the high-frequency transformer between the first and second valve. I am able to tune in 2 L O very easily, but adjustments are critical. During reception the set will intermittently oscillate so that I get bursts of the carrier wave interrupting the reception. How can I remedy that?

As your adjustments are critical it is quite possible that it is caused by the swaying of the aerial or lead-in, or even the movement of telephone or other leads. The slight variation of capacity so caused would be quite sufficient to cause the trouble. The only remedy, apart from ascertaining and removing the possibility of such capacity effects, is to work with looser reaction and less critical adjustments.

N. B. E. (Loughborough).—I am using four valves, two of which are H.F. It is extremely difficult to tune in, as the slightest movement either way with the H.F. condensers will lose the signal. It sometimes takes me 15 minutes to tune in to a station satisfactorily. Should this be the case?

H.F. circuits are always tricky, and some considerable experience is required to handle more than one successfully. A good scheme is to rewind the H.F. transformers with finer wire, say 44 S.W.G., or even resistance wire of similar gauge. This has the effect of rendering the transformers more aperiodic, and of course renders the tuning less sharp. When experience has been acquired it will be found that the sharp tuning of H.F. circuits acts as a very efficient "filter" to unwanted stations and L.F. interruptions such as statics, etc.

D. L. C. (Chislehurst).—My aerial is a 25-ft. twin. How many turns would I want on a basket coil to tune in Marconi House with a .001 mfd. variable condenser?  
40 turns of 26 S.W.G. on a 1 1/2-in. former.

B. A. M. (Aldershot).—I am advised to use a certain valve for rectifying and two other types for amplifying. The two different types are marked with different H.T. voltages, so should I use separate H.T. batteries?

That is not essential, because a valve will always function moderately well with an H.T. pressure above that for which it is marked as being most suitable. However, if possible, and if there is a very great difference between them, it will be advisable to employ separate H.T. batteries.

"INTERESTED" (Blackheath).—With regard to the correspondence regarding valves and their evacuation a short time ago, is it not possible to cause a vacuum by burning phosphorus in them? The phosphorus oxide would settle down at the base of the valve and could be fixed by having some shellac varnish there.

Your idea is good, though we are afraid it is not practicable. Firstly, what would happen to the filament while the phosphorus was burning? Secondly, shellac varnish is inflammable, especially when wet; and lastly, the presence of phosphorus oxide would be very undesirable, even if it would settle as a solid. This latter is doubtful considering the partial vacuum caused.

S. J. Y. (Maldon).—I have just fixed up a one-valve receiving set, using reactance, but I find the set is almost dead, even with the reactance coil coupled tight with the A.T.I. Can you please suggest some remedy?

Probably you have the reactance connected so that it is nullifying the field of the A.T.I. Try changing the leads over.

"FADE AWAY" (St. Albans).—I am using a one-valve set, but though it works quite well the signals keep on fading away. Please put me right.

The diagram you enclose is quite O.K., but you are not using a grid leak. This is probably your trouble. See that the H.T. is O.K., about 30 volts or a little more, and that the accumulators are not run down. You will find a grid leak will cure the trouble, as at present the grid is being choked.

M. P. S. (Stansted).—I am using two valves—one L.F.—but find that lately the signals fade right away. They are quite strong at first, but after a while they become weak, and eventually disappear altogether. If I switch off and then try again they are no better, though if I leave the set until the next day the set works perfectly for a time and then the same trouble occurs.

Your experience points strongly to the fact that the accumulators are the trouble. In all probability they are sulphated, and need careful attention. Have them recharged very slowly, taking several days for the operation. This will get rid of the sulphate unless the plates are badly coated.

"CRYSTAL" (N.W.7).—I have just finished building a crystal set, and would like your advice with regard to the crystal to be employed. I have been advised to use carbondum. Is that O.K.?

Carborundum is a very good and steady detector, but requires a little knowledge in its manipulation. It also needs a battery and potentiometer. We advise the use of galena or silicon—preferably the latter, as galena needs constant adjustment. Hertzite and permatite are also very good minerals to use. Silicon works best with a gold point contact.

J. F. E. H. (Blackburn).—I have a single layer tuning coil wound from 11 in. with 24 S.W.G. enamelled. Former is 4-in. diameter. What is my wave length? What condensers should I use?

(1) 350-2,800 metres approx; (2) Use a .0005 m.f.d. variable condenser, and a .001 m.f.d. fixed condenser across the 'phones.

E. E. J. (Leeds).—(1) What is meant by the following Letters: B.S.T., S.W.G., P.M.G., G.M.T., D.C.C., D.S.C., A.T.I., L.F., H.F., A.T.C., and D.W.S.? What is a megger?

(1) British summer time, standard wire gauge, Postmaster-General, Greenwich mean time, double cotton covered, double silk covered, aerial tuning inductance, low frequency, high frequency, aerial tuning condenser, and double-wound silk. (2) A megger is an instrument for measuring very high resistances, such as megohms, etc. Hence the name "megger."

"No Name" (Belmont, Mill Hill).—I enclose a diagram of a two-valve set. Is it all right, please? Where does the reservoir condenser go? Using an electric light aerial and this set, is it possible to hear Marconi House from Brighton? What H.T. should I use?

(1) The diagram is not quite O.K. You need a transformer or other tuned coupling between the valves. (2) The reservoir condenser goes across the H.T. and the 'phones. (3) Hardly, with an outdoor aerial you should be able to hear 2 L O. Use about 45-60 volts according to the type of valves employed.

(Continued on page 670.)

Have you seen them?  
Have you HEARD them?

L. F. TRANSFORMERS.  
The last word in efficiency.  
Price 21/- each.

H. F. PLUG-IN TRANSFORMERS.  
350-450 metres - Price 6/6 each  
900-1100 .. - Price 7/6 each  
Manufactured at our Works.  
Liberal discounts to the trade.

**P. H. BOYS & CO.,**  
Electrical & Wireless Engineers,  
187, GOSWELL ROAD, LONDON, E.C.1.  
Phone: Jerkenwell 4454.



# How did YOU receive the Election Results ?

It can be confidently said that all who were listening in with a Wates Set were very pleased with the reception when the Election results were broadcasted.

The reception was good—not only because Wates Sets are perfect in manufacture, but also because purchasers can avail themselves of the free advice of our technical experts, who can help them to get the best possible results under varying circumstances.

Not only do we manufacture complete receiving sets of the best quality, but also all component parts.

The illustration is that of the PYRAMID H.T. Battery, which we can confidently recommend to help you to get better results. It is priced as follows:—

15-Volt - - 3/6

With variable plug connection.

30-Volt - - 7/6

Send 3d. stamps for our Illustrated Catalogue.

List of H.T. Batteries or Accumulators free.



## BROADCAST RECEIVING SET.

Price complete with British made head phones, aerial and everything ready for fixing—

£5 0 0

Plus 7/6 Broadcasting Fee. Low Frequency Amplifiers for use in conjunction with this set having special transformers—Price

£5 0 0

Two of these amplifiers are capable of working a loud speaker with excellent results within a distance of 20 miles from London.

Filament Resistances .3/9 "Ideal" Valve Accumulator in case.

4-Volt 50 amp. 25/- (Carriage 2/-)

6-Volt 50 amp. 35/- (Carriage 3/-)

Variable Condensers (of various capacities) From 6/-

Fixed Condensers From 2/6

3-Coil Holder, complete Unit for use with Standard Coils ... 20/-



THE GREAT NEW MONTHLY WIRELESS MAGAZINE

1923	JANUARY				1923
Sun	-	7	14	21	28
Mon	1	8	15	22	29
Tue	2	9	16	23	30
Wed	3	10	17	24	31
Thu	4	11	18	25	.
Fri	5	12	19	26	.
Sat	6	13	20	27	.

## JAN. 15th !

On this day will be published "MODERN WIRELESS," the new monthly wireless magazine for all interested in wireless, but especially for the genuine experimenter and would-be experimenter.

It will be something new in wireless literature.

It will specialise in the study of valves and valve apparatus. The Editor is John Scott-Taggart, F.Inst.P., Member I.R.E. (recently Chief Technical Adviser to "Popular Wireless"), Author of "Thermionic Tubes in Radio Telegraphy and Telephony," "Elementary Text-Book on Wireless Vacuum Tubes," "Wireless Valves Simply Explained," "Practical Wireless Valve Circuits," etc., etc., assisted by Paul D. Tyers, Author of "Construction of Wireless Receiving Apparatus," and by E. Redpath, Author of "Wireless Telegraphy and Telephony" (Cassell's "Work" Handbook).

We cannot, for obvious reasons, give a list of the contents yet. We simply ask you to give your news-agent an *immediate* order to reserve you a copy. It will be on sale everywhere, and delay in receiving a copy may result unless an order is given. Obtainable also direct from us, post free, 1s. 3d.

## Radio Press, Limited

(Publishers of Authoritative Wireless Literature),

DEVEREUX COURT, STRAND, LONDON, W.C.2.

Call at our Showrooms—they will interest you.  
**Wates Bros.** 13/14, Great Queen Street, KINGSWAY, LONDON, W.C.2

## DO YOU WISH TO GIVE A REALLY USEFUL AND PLEASING XMAS GIFT?

If so, why not

## A WIRELESS OUTFIT?

**No. 1 Set.**—Crystal Receiving Outfit, fitted with Genuine Hertzite Crystal Detector, 12-inch Coil, pair of British-made Head Phones, 4,000 ohms, Aerial Wire, Insulators, Lead-in Wire, &c.

Price, £3 10s. the Complete Outfit.  
 Postage, 1/6 extra.

**No. 2 Set.**—A Complete Receiving Set, fitted with Genuine Hertzite Crystal, Variable Condenser, mounted on Ebonite Panel, suitably engraved and enclosed in Hand Polished Mahogany Case, with pair of British-made 4,000-ohm Head Phones, Aerial Wire, Insulators, Lead-in Wire, &c.

Price, £5 the Complete Outfit.  
 Postage, 2/- extra.

All our sets are passed by the P.M.G., and include the cost of Fee for Licensing the set.

## WILL DAY, LTD.,

19, Lisle St., Leicester Sq., London, W.C.2.

Phone: Regent 4577. Telegrams: Titles, Westrand, London.

## ACCESSORIES FOR WIRELESS



Vacuum Protector

**VACUUM PROTECTORS** (for protecting the aerial). They secure protection against risk of fire or damage by lightning.

**TELEPHONE HEAD SETS** specially designed for wireless work. Terminals enclosed to prevent receiving circuit being interfered with

**SWITCHES** for series-parallel switching of condensers, adding to or reducing the number of valves in simultaneous use.

**FUSES** for protecting the filament accumulators and batteries in the event of a short circuit.

**AERIAL WIRE & INSULATORS, EARTHING DEVICES, JACKS & PLUGS, H.T. BATTERIES, etc., etc.**

Also manufacturers of

**BROADCASTING RECEIVING SETS.**

Descriptive pamphlet and prices on application to  
**SIEMENS BROTHERS & Co., LTD.,**  
WOOLWICH, LONDON, S.E.18.

Telegrams:  
Siemens, Woolwich.

Telephones:  
City 6400

AND AT

Belfast, Birmingham, Bristol, Cardiff, Glasgow, Leeds, Manchester, Newcastle, Sheffield, Southampton

### TO THE TRADE.

**Ebonite—Copper Wire, Bare & Covered—Aerials—Sleeving, &c.**

Wireless Supplies: Prompt Delivery.

Cables & Electrical Supplies, Mica House, Offord St., Caledonian Rd., London, N.1. Telephone: North 805

**ALL**

applications for advertisements rates for "POPULAR WIRELESS" must be made to the sole agents:  
**JOHN H. LILE, Ltd., 4, Ludgate Circus, London, E.C.4.**

**GLASGOW WIRELESS SUPPLY CENTRE.**

**W. & J. JAMIESON, LTD.,**  
68, Shamrock Street,  
St. George's Cross,  
GLASGOW,

SOLICIT your enquiries and specifications or accessories and parts for making complete  
**RECEIVING SETS**

## RADIOTORIAL QUESTIONS AND ANSWERS.

(Continued from page 668.)

**T. A. (Farnborough).**—Are water-pipe earths satisfactory in the case of transmission?

No; direct earth to metal plates buried in the ground, or well-balanced capacity earths are more efficient in the case of transmission.

**"ENTHUSIAST" (Birmingham).**—Is it looking from a manufacturer's point of view to say that valves are necessary for loud speakers? If a signal will actuate telephone receivers, surely they will actuate a loud speaker?

That by no means follows. At least "telephone" signals will actuate loud speakers, and as a matter of fact the majority of loud speakers are nothing more than telephone receivers with a horn attached, but not with sufficient strength to fill a room with music. Picture to yourself the amount of sound you must introduce into a horn by means of ordinary speech to make it easily discernible throughout a room; then you will have some idea as to the strength of signals required.

**F. S. L. (Dundee).**—Why is it that should the H.F. become accidentally connected to the L.F. terminals, I burn out my valves, and yet it is said that dry cells are of no use for lighting valve filaments?

Because, although a low resistance conductor, such as a valve filament, can be placed across a dry cell and for a few moments a current proportional to the voltage will pass, the construction of the battery is such that it would not deliver such a current for any useful length of time owing to the internal action of polarisation. Refer to the article on "The Secret of Success with Dry Cells." That will make the matter clear.

**"AMATEUR" (Nottingham).**—In the case of electric light plug-in aerials, is it necessary that the system into which the aerial is plugged in should be the same as that of the transmitting station? What I mean is, must the receiver and transmitter be on the same generating station lines and actually connected in a roundabout way together?

No, that is not at all necessary. As a matter of fact, such attachments can be used in conjunction with barbed-wire fencing in such cases where the barbed wire being on wooden posts is not earthed.

**F. T. Y. (Birmingham).**—I have a crystal set, but cannot get the Eiffel Tower time signals; how big should my coil be so that I could hear Paris?

Your coil should be about 11 in. by 5 in. wound with 24 S.W.G. This will give you about 2,700 metres.

**"QUERY" (London).**—I am just setting up a one-valve set and should like to ask a few questions. (1) Is the length of the lead-in included in the 100 ft. aerial allowed by the P.M.G.? (2) What should be the size of the copper ground plate? (3) I have been told that the filament can be lighted from the ordinary electric light main. Is this so?

(1) The P.M.G. aerial includes the lead-in in the 100 feet combined height and length allowed: There is no stipulation, however, as to the number of wires the aerial contains. (2) About 3 ft. by 3 ft., or more if possible. Bury it 3 or 4 feet down in moist earth. (3) No; the electric light main is far too unsteady for this purpose.

**D. B. (Surrey).**—I hope to be able to listen in for the American Broadcast concerts. Can you tell me: (1) A few I am most likely to hear?

(Continued on page 672).

### Beginners Guide to Wireless

Explains in plain everyday language, everything beginners wish to know about wireless telegraphy.  
**HOW TO ERECT, CONNECT, AND MAKE** all the apparatus required for reception of telephony or morse, and full instructions and diagrams for making coils, tuners, and complete valve and crystal sets. 112 pages, price 1/-, post free.—**SAXON RADIO CO.** (Dept. 14), South Shore, Blackpool. 32-page cat. of wireless apparatus, 3d., post free.



## HANG IT!

Hang this up-to-date and very complete directory of wireless telephone and telegraph call-signs, from your table. Over 12,000 call-signs of amateurs, ships and land stations. As indispensable as an ordinary telephone directory is to a subscriber, to a listener-in.

Price 2/6 net.

Obtainable through the usual channels or direct (post free 2/8) from

**Radio Press Ltd.** DEVEREUX COURT,  
Publishers of Authoritative Strand, LONDON, W.C.2.  
Wireless Literature

## ELECTRADIX RADIOS.

Immediate Delivery  
from our Huge Stocks.

Everything from a Recorder to an Earth Clip.

The best-equipped City depot.  
COME AND SEE US.

9, Colonial Avenue is first opening on left in the Minorities, near Aldgate Station, Metropolitan Railway.

**LESLIE DIXON & CO.** Tel. 4100  
9, Colonial Avenue, London, E.1.

## SINGLE RECEIVERS

2,000 ohms Complete with Cord, best quality. Note the Price. 8s., post 5d. A Sensible XMAS Present—order at once. If not satisfied—Cash returned.

**W. JOANES (Dept. X), 42, Jenner Road, Stoke Newington, LONDON, N. 16.**

**'PHONES! 'PHONES! 'PHONES!**  
Single Receivers, complete with Handle and Cords, 2,000 ohm, 8/6; 4,000 ohm, 12/6. Double Head Sets, 4,000 ohms, 19/6. Send stamp for List. Demonstrations daily. **AUSTEN RADIO SERVICE, 1, Lynd Rd., Leytonstone.**

**WIRELESS POLES; GOV. SURPLUS**  
PRIME QUALITY PAINTED WOOD.

13 ft., 1/11; 10 ft., 3/6; Sectional 27 ft., 12/-; Iron Taper and Parallel Poles 32 ft., 30/-; 40 ft., 35/-; also Stays, Insulators, Anchors, Aerials, Buzzers, Jacks, Switches, etc. Approval Terms; Trade Enquiries Solicited. Send Stamp for List.

**JENNINGS, LTD. WIRELESS, 305, BRISTOL**

## Cabinet Crystal Sets

Variometer Tuning, Complete with Head-Phones, Aerial Wire, Insulators, Pulley, Lead-in Tube, and Wire. Set approved by P.O.

Post Free, **£3-17-6**

**WARREN & CLARK,**  
11a, SIDNEY AVENUE, LONDON, N.13.



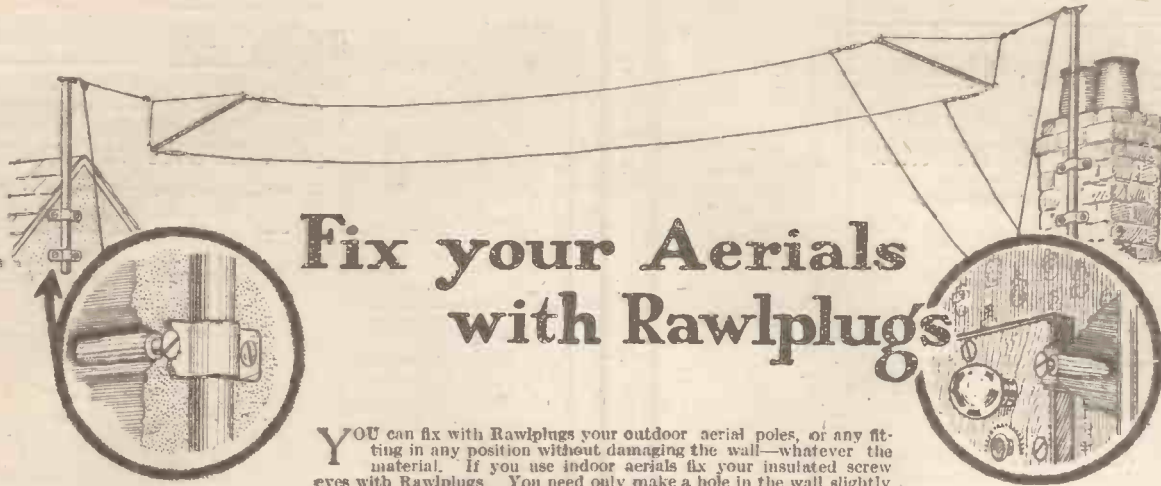

# Fix your Aerials with Rawlplugs

**YOU** can fix with Rawlplugs your outdoor aerial poles, or any fitting in any position without damaging the wall—whatever the material. If you use indoor aerials fix your insulated screw eyes with Rawlplugs. You need only make a hole in the wall slightly larger than the diameter of the screw to be used, but the grip of Rawlplugs ensures a satisfactory job without any damage to the material.

Obtainable of all Ironmongers, Electricians, or Stores.

For any job connected with Wireless where you use a screw in brick, plaster, stone, marble, ebonite, tile, etc., always use Rawlplugs.

Rawlplugs are made in all sizes to suit any standard size screw. (Nos. 7-20.)

## RAWLPLUGS



**HOUSEHOLD OUTFIT**  
50 Rawlplugs No. 8 assorted lengths, a Rawlplug Toolholder and one Bit. A supply of round head and countersunk screws and screw eyes, screw hooks, cup hooks, square hooks, etc., and full instructions. **3/6**

**MECHANICS' OUTFIT**  
100 Rawlplugs No. 8 assorted lengths. A special Rawlplug Toolholder and two Bits. A supply of round head and countersunk screws and screw eyes, screw hooks, cup hooks, square hooks, etc., and full instructions. **5/6**

**THE RAWLPLUG CO., LTD.,**  
GLOUCESTER HOUSE, CROMWELL RD., LONDON, S.W. 7

### LARGE PURCHASE OF EX-GOVERNMENT CRYSTALS

# 100,000

ZINCITE, CHALCOPYRITES AND COPPER PYRITES CRYSTALS FOR SALE

We are making a special offer of the above, all mounted in brass cups with Wood's metal. Sensitive and reliable.

**12 ASSORTED FOR 2/-**

Take advantage of this offer and send P.O. for sample dozen.

DEALERS SEND FOR TRADE TERMS

**ELECTRIC SUPPLY STORES,**  
118a, London Wall, E.C.2.

### HERE'S REAL RADIO SERVICE

QUALITY GOOD. — PRICE LISTS FREE.  
PRICES RIGHT. DELIVERY PROMPT.

TELEPHONES, best French, double headbands, 4,000 ohms. ...	£1-0-0
TELEPHONES, best French, double headbands, 8,000 ohms. ...	£1-2-6
SINGLE EARPIECE, Laminated Poles, 2,000 ohms. ...	10/6
INTERVALVE TRANSFORMERS, Remarkable quality ...	14/0
BASKET COILS, Set of seven "Oajah" ...	5/0
SLAB COILS, Set of eight "Oajah" ...	7/6
AERIAL WIRE, bare copper, 7/22 stranded, per 100 ft. ...	3/3
AERIAL WIRE, enamelled copper, 7/22 stranded, per 100 ft. ...	4/6
AERIAL WIRE, Phosphor Bronze, 1/18 stranded, per 100 ft. ...	2/0
INSULATORS: Reel, 2d.; Shell, 6d. and 9d. ...	3/6
CRYSTAL DETECTORS, mounted on Ebonite, fine adjustment ...	4/6
PERIKON DETECTORS, 1 cup top and bottom ...	5/3
PERIKON DETECTORS, 1 cup top and 2 on base ...	6/0
PERIKON DETECTORS, 1 cup top and 3 on base ...	3/6
WOUND INDUCTANCE, 12" by 4", with 24 Enamel wire ...	2/- and 1/6
HERTZITE CRYSTAL, genuine specimens ...	1/3
SWITCH ARMS, Phosphor Bronze Laminations ...	5/0
POCKET-LAMP BATTERIES, 4½-volt, suitable for H.T. ... per doz.	10/8
LECLANCHE CELLS, 1½-volt, suitable for H.T. ... per doz.	10/8

**Waterloo Electric Co.,** 129, WATERLOO RD., LONDON, S.E.1  
Telephone: Hop 5649. 1 min. Waterloo Station.

### BROADCASTING HAS COMMENCED.

Hear, in the comfort of your own home, our most talented musical artistes and lecturers, bedtime stories for the kiddies, etc., with the aid of an

## APOLLO RECEIVING SET.

Passed by P.M.G. Marked "B.B.C."

Type OO



The chief feature of the "Apollo" is its simplicity and its absolute perfection whether used by the technical enthusiast or the novice. The "Apollo" is complete down to the minutest detail. Tuning is effected by means of a variometer, which has proved to be the best system. The "Pericon" Crystal—acknowledged to be the finest crystal in the world—is carefully enclosed in a glass cylinder, thus making it impervious to dust. The "Apollo" is an extremely sensitive set, yet will withstand a good amount of misuse without getting out of order.

**COMPLETE**  
**£4 19 6**

Including Royalty.

**DESCRIPTION:**

Receiving Set in handsome Solid Mahogany Case, comprising specially sensitive "Pericon" Detector, Variometer Tuner and Terminals for earth, Aerial and Telephones, 100 feet Aerial Wire, Four Insulators, and one pair Sensitive Double Headgear Phones I.E.C. (4,000 ohms). Up to 5 extra headgear phones may be used. (Range 20 miles).

Catalogue of APOLLO Wireless Sets and Accessories and address of nearest dealer sent on application.

**CRAIES & STAVRIDIS, 4, Bunhill Row, LONDON, E.C.1**  
AGENTS WANTED.

Dec. 16 to 24 **SALE!** Dec. 16 to 24  
— ONLY — — ONLY —

Great Clearance Xmas Sale  
of Wireless Instruments and Accessories

# HALL'S

A perusal of a few of the items below will show that unapproachable value and prices are listed. Purchasers are advised to secure while stocks exist, as a rush will undoubtedly be experienced and replacements at the figures shown will not be possible. Another opportunity like this will never again be presented.

## BRITISH HEADPHONES

4,000 ohms. Very Light. Beautifully Finished. Stalloy Diaphragms. Complete with Cords. Adjustable Earpieces.

(Sold elsewhere almost exclusively at 35/-)

**19/6** Postage 9d.

Only 530 left

Every type of instrument and accessory from Mercury Condensers to Double Slider Tuners at ridiculously low prices can be seen at our showroom. Space naturally precludes complete list.

### VARIABLE CONDENSERS:

Capacity	Complete Parts	Assembled for Panel Mounting
.001	6/9	11/9
.0075	5/-	11/-
.0005	4/9	9/9
.0003	3/3	7/-
.0002	2/3	5/9
.0001	2/-	4/-
Top and Bottom Circular Drilled Ebonite Plates, 1/3 extra. Vernier, 3/-		
Interval Transformers, Ratio 5 to 1, finest manufacture		11/9
Crystal Sets		from 15/- to 23
"Royal Phone" Loud Speakers, 4,000 ohms resistance, ebonite horn giving clarity of tone and freedom from distortion. Stock of 72 only each		
Aluminium Condenser Vanes, fixed and moving, 22/24 gauge		28/9
Spacers, true to .001. Small, doz. 1d; large, doz.		2d
Ebonite Knobs, tapped 2 B.A. with brass nut—1st quality, 4d; 2nd quality		2d
Aerial Wire, 7/22 hard drawn copper, in 100 ft. lengths		2/6
Valve Legs, with nuts and washers, 1d each; doz.		9d
Two Coil Holders, solid ebonite mounted on mahogany		4/6
Three Coil Holders, solid ebonite, with long arms to avoid capacity effects		8/9
Crystal Detectors, adjustable in every way turned brass on ebonite		2/6
Slider Rods, 12-in. or 13-in. 1/2-in. square brass drilled both ends		4d
Engraved Ivorine Scales, 0-180°, round or square ends		3/6
Filament Resistances, extraordinary value, velvet action		2/4
Switch Arms, complete with knob, collar, washers, bush nuts, etc. 1st quality, 1/3; 2nd quality		9d
Valve Holders, turned ebonite, complete with nuts, 1/-; 2nd quality		8d
Crystal Cups. Plain 1d; one, two, or three screw		2d
Large Terminals, complete with nut and washer each		1d
Contact Studs, 1/2 in. by 1/2 in., or 3/8 in. by 1/2 in., complete with nut and washer. doz.		4d
Insulators, 2-in. reels—1d each; white egg, 3d; green egg, 4d; green shell, each		3d
Brass Nuts, 2, 3, 4, 5, 6, B.A., 2 1/2 doz. Washers, doz.		1/6
Ebonite Sheets, 1/2, 1, 1 1/2 lb.		3/3
Fixed Condensers, any capacity		each 1/3
Grid Leak and Condensers combined		each 2/9
Slider Plunger complete		each 4d
Hertzite, 1/6. Bornite. Carborundum Galena, etc.		each 4d
Screwed Brass Lengths, 12-in. 2 or 4 B.A. each		3d
Inductances, wound 22/24 enamelled wire, each		3/-

Orders under 30/- kindly remit ample postage. Balance refunded if excess sent. Send for FREE Catalogue.

TRADE SUPPLIED **HALL'S** DISPATCH BY RETURN

'PHONE: REGENT 1282  
71, Beak St., Regent St., London, W.1  
Between Piccadilly Circus and Oxford Circus  
'Buses 3, 6, 12, 13, 15, 32, 51, 53, 59 and 88 pass

## RADIOTORIAL QUESTIONS AND ANSWERS.

(Continued from page 670.)

(2) Their call signs and wave-lengths? (3) What time they transmit?

The one you are most likely to hear is Newark, New Jersey, WJZ on 360 metres—range of 1,500 miles. This station has already been heard in England recently. Others are New York, KDOW, 360, 1,000 miles; WRW, 360, 1,500 miles. These stations transmit at different times from 7 p.m. onwards (American time). Our time is about 5 hours fast of American, so that you will have to listen in from about 12 midnight.

"AMPLIFIER" (Cricklewood).—I have at present a crystal set which is working quite well. I can hear 2 L.O., but should like to make the signals louder. Can I add a valve? If so, which is best to add, H.F. or L.F.?

In all probability the H.F. amplification will give you best results, though L.F. amplification is very good. See the circuit described by "Crystal" in our issue No. 26. This should give you quite good results, and in your case is better than L.F. amplification, as you are some little distance away from Marconi House.

T. P. L. (King's Langley).—I have a two-valve set, one L.F., one detector, and contemplate adding another valve. Which is best to add, L.F. or H.F.?

This depends upon the work you want the valve to do. If you want increased signal strength of stations you can already hear, use L.F. If, however, you want to increase your range, for example, to bring The Hague in well, use H.F. H.F. amplification needs careful tuning, and is only used when long-distance reception is required. For distances up to about 100 miles L.F. amplifiers are to be preferred if stronger signals are required.

F. B. (Leeds).—One of the earpieces of my Brown's adjustable 'phones has gone absolutely "dead." When I screw the knob at the back either way nothing at all happens. Is it possible that it has burnt out on my re-valve set?

That is possible, also the leads may have shorted, but in that case, even if it had happened inside the actual earpiece, the familiar click as the reed pulls away from the magnet should be heard when turning the adjusting screw clockwise, so that it is more probable that the reed requires adjustment. Make sure, first of all, that the adjusting screw at the back is firmly attached to the spindle and the small locking screw tightly screwed up. You will find after carefully removing the diaphragm (don't forget to take out the small screw in the centre of this, otherwise you will destroy the paper ring) that the reed rests on a small capstan-headed pillar with small holes in which a pin can be inserted to adjust height. Adjust this pillar until the reed can be seen to leave the magnet after half a turn of the adjusting screw at the back, and then carefully replace the diaphragm and ebonite cap.

S. R. (Barcelona).—I should like to ask you to explain the difference between valve and crystal reception, both with outdoor and indoor aerials.

For telephony reception valve receivers are undoubtedly the best, unless the transmitting station is near the receiving station. Up to a few miles, 9 or 10, and very often more, the crystal will receive telephony very well indeed. It has the advantage over the valve in that there are no "carrier" wave noises, and the speech comes out very clearly indeed. For long distances—in most cases distances over 15 or 20 miles—the valve must be used for satisfactory results. Crystal receivers are unsuitable for frame aerial reception, as this limits the range very considerably—by about 75 per cent. in fact. A crystal and frame aerial will only receive telephony up to about one mile or less usually, while the range of a valve, using that aerial, is brought down from 50 to about 6 miles or so, and very often less than that.

We reply by return

# CRYSTAL DETECTOR

Lacquered Brass on Ebonite,  
Ball and Socket Movement.  
Suitable for Silicon, Galena,  
etc.

PRICE **3/-** POST FREE

TWO-CUP PATTERN, for  
Zincite, Bornite, etc. **3/6**  
Lacquered Brass on Ebonite - - - - - POST FREE

Complete Wireless Lists Post Free.

ELECTRICAL SUPPLY STORES,  
5, Albert Terrace, King Cross, HALIFAX.

Our Money-Back Guarantee  
Accompanies ALL our goods.

## LUNCH HOUR RAMBLE

STROLL ROUND TO  
**SPENCER'S STORES,**  
4-5, MASON'S AVENUE,  
BASINGHALL STREET,  
LONDON, E.O.  
CHEAPEST HOUSE IN CITY  
FOR WIRELESS PARTS & SETS

## PORTLAND'S Parts by Post. "EBONITE"

	s. d.		s. d.
4 x 4	1 3	12 x 7	5 2
7 x 5 1/2	2 8	12 x 8 1/2	6 5
8 x 6	3 0	12 x 10	7 6
9 x 6	3 5	15 x 8 1/2	8 0
10 x 6	3 9	12 x 12	9 0
12 x 5 1/2	4 2	17 1/2 x 8 1/2	9 6
9 x 8 1/2	4 10	14 x 12	10 5
17 x 5	5 3	18 x 18 (hallsheet)	12 10
		30 x 18	£1 3 0
		28 lbs.	£4.

No charge for cutting, waste, or postage.

Delivery by return of post.

Quality A 1. DRILLING, manufacture—BRITISH.  
Thickness One Quarter; Surface Mat.

JAMES PORTLAND, 39, Sinclair Road,  
Olympia, W.14.

N.B. Mr. Portland stocks 200  
Wireless Parts.

## MATERIALS, TOOLS, & WORKSHOP SUNDRIES

OUR 1923 LIST of above (64 pages) is now ready. Wireless experimenters cannot afford to be without a copy. SENT POST FREE on receipt of Post Card.

**GEORGE ADAMS** (DEPT. P.W.), 255-6, HIGH HOLBORN,  
LONDON, W.C.1.





Unprecedented Offer of—

# Ex-Govt. WIRELESS MATERIAL

## AN APOLOGY.

Owing to the overwhelming number of orders received by us for this Ex-Government apparatus, we have been unable to cope with the tremendous number of enquiries as expeditiously as we would wish.

We respectfully ask the indulgence of readers, and assure them that we will reply to their queries at the earliest possible moment.

In the meantime we are despatching all orders in strict rotation, and guarantee delivery within 48 hours of receipt.

### RECEIVERS, C.W. MARK III

This set comprises a complete 2-valve Receiving Set, with a wave-length range of 350—1,800 metres. The addition of High and Low Tension Batteries, valves, and 'phones completes the entire receiving station. For the reception of Broadcast concerts this set is ideal, the strength and clarity of the signals being absolutely wonderful. London readers should take the opportunity of hearing this set working at our Showrooms. **Only 100 left**

Complete with 4-volt 40-amp. Fuller Block Accumulator, 60-volt H.T. Battery, 2 Mullard "ORA" Valves, and pair of Brown "A" Type Headphones, complete with cords

**£9 9 0**

**£15 10 0**

### AMPLIFIERS, C. MARK IV

This instrument is a complete 3-valve low-frequency amplifier, and can be used in many ways without modification.

The C. Mark IV. Amplifier is an improvement on the C. Mark III. (the latter being sold by other dealers at £6 5s. od. each without cases), inasmuch as the C. Mark IV. contains terminals and change-over switch, allowing the use of the instrument for either High- or Low-Frequency amplification.

The price at which we are offering these Amplifiers is less than the actual value of the transformers contained in the instrument. Limited number only left subject to being unsold.

Complete in Mahogany Case

**£4 5 0**

### INSULATED AERIALS

40-feet **£0 1 0**

60-feet **£0 1 6**

### C.W. TRANSMITTERS, MARK III, 30 WATT

For two valves. Complete, with aerial ammeter, platinum-pointed Morse Key, in Mahogany case. Wave-length range 300—1,800 metres.

Note.—This set can be conveniently converted into a 2-valve Detector-Amplifying Receiver

**£3 5 0**

### B MARK II RECEIVERS

Vertical pattern. Can be easily converted to any wave-length

**£3 15 0**

Above, fitted with Variable Air Condenser, .0005 mfd., in place of change-over switch

**£4 15 0**

### HETERODYNE WAVEMETERS. 500—3,000 Metres

For Receiving—without Galvanometer

**£2 0 0**

### AERIAL MASTS AND EQUIPMENT

15-feet Steel Masts in Sections, each 2 ft. 8½ in., complete with Halyard, Pulley and Stays. Can be erected by one man, and are portable. The height can be increased up to 30 feet by the use of extra stays

**£0 15 0**

30-feet DITTO, in SECTIONS, each 4 ft. 3 in. (mast only)

**£0 17 6**

### SULLIVAN HEADPHONES

120 ohms

**£0 12 6**

### SULLIVAN HEADPHONES

120 ohms complete with new Telephone Transformer (value 25s.) in iron case

**£1 10 0**

Kindly note that the above prices do not include Packing and Carriage. Please add, therefore, an appropriate amount to cover this. Any surplus will be refunded.

# The City Accumulator Co.

79 MARK LANE — LONDON, E.C. 3.

Phone: Avenue 1316

Wholesale and Retail Distributors for Messrs. BURNDEPT, Ltd. Same Trade Discount Allowed as by Manufacturers.

#### AGENTS.

London: H. V. ALBROW, 56, George Street, Baker Street, W.1.

Glos.: BRISTOL WIRELESS Co., 52, Cotham Hill, Bristol.

Leicester: WALTER ROWE, LTD., 96, Granby Street, Leicester.

S. Wales: SOUTH WALES WIRELESS INSTALLATION Co., LTD., 18, West Budg Street, Cardiff.

N. Wales, Lancs. Ches. & I.O.M.: THE "ALL-BRITISH" WIRELESS MANUFACTURES Co., LTD., 18, Vauxhall Road, Liverpool.



# Radio Head Phones.

(Manufactured under Brown's Patent No. 134353/18 by Sole Licence.)



No. R1238.  
MARCONI STANDARD

*An ideal and economical Xmas gift for your Broadcasting friends.*

*Enjoy a Radio Xmas.*

To those who possess a Broadcast Receiving Set a pair of Head Phones as a Xmas gift strikes a novel idea, and will be greatly appreciated.

*The instrument above illustrated is of the highest efficiency and constructed to give a comfortable fit to the ear of the user.*

## Immediate Delivery.

WRITE FOR—Leaflet 321 & 325 dealing with Radio Headphones.  
Leaflet 324 re Sterling No. 1 Crystal Receiving Set.  
Leaflet 331 re Marconiphones.  
Booklet 332 re "Magnavox" Loud-Speakers.

To be obtained from all dealers or direct from:

**Sterling Telephone & Electric Co., Ltd.**

TELEPHONE HOUSE,

210/212, Tottenham Court Road, London, W.1.

Telephone No.: 4144 Museum (7 lines). Telegrams: Cucumis, Wesdo, London

Works: DAGENHAM, ESSEX.

BRANCHES: NEWCASTLE-ON-TYNE: 9, Clavering Place.

CARDIFF: 8, Park Place.

*We guarantee that all Broadcast Radio Apparatus sold by us conforms with the conditions of the Broadcaster's Licence issued by the Postmaster-General.*

FOR YOUR PROTECTION  
INSIST ON A COMPARATIVE  
DEMONSTRATION BEFORE  
YOU PURCHASE, AND PROVE  
THE SUPERIORITY OF

THE  
**Crystophone**  
REGISTERED

## BROADCAST RECEIVERS

"I feel that you would be interested to know that the Wireless Crystophone Set 20TT (Crystal Set), that I purchased from you some time back is producing excellent results, and giving every satisfaction. Reception from "2 L O (Broadcast Station), also from Blackheath and Southall (Amateurs), is very powerful in spite of using 3 sets of 'phones. My instrument is installed at my home in Richmond, Surrey. A.H.C."

"I get the Paris concerts splendidly on my Crystophone (Type 34—3 Valves), using eight pairs of 'phones, while 2 L O. is deafening on the Amplion, if not well tuned down.  
... (The Crystophone) is a truly wonderful instrument, and you have my congratulations.  
J.I.S.—Ewell."

## THE LATTIKONE TUNER

exclusively fitted to all Crystophone Receivers, is the ONLY Tuning Coil which actually builds up the input current and thus enables us to claim

**50 % increase in signal strength.**

DEMONSTRATIONS DAILY 6-10 P.M.

## Crustor COWL INSULATORS

(PROV. PATENT)

GUARANTEE.—100 PER CENT. EFFICIENCY FROM AERIAL TO RECEIVER IN ALL WEATHER.



AERIAL INSULATORS  
Price 1/9 each.

### Crustor Aerial Outfit

SINGLE WIRE AERIAL, containing 2 Crustor Cowl Aerial Insulators, 1 Crustor Cowl Lead-In (vertical or horizontal), 100 ft. Best Quality stranded copper Aerial Wire, 100 ft. Best Hemp Rope, and one pulley block, packed in box. Price complete, 18/6 Postage 1/6 extra.

Horizontal Wall or Window  
**LEAD-IN**  
6/6

**WIRELESS SUPPLIES CO.**  
64, MORTIMER ST.  
LONDON, W.1.  
Phone: Museum 2672  
Grams:  
Adragonax, Wesdo, London.

Vertical Root  
**LEAD-IN**  
6/-



No. 30. RADIO IN THE NEXT GREAT WAR. By P. J. RISDON, F.R.S.A.

# POPULAR WIRELESS Weekly

3d

No. 30, Vol. 2.  
Dec. 23, 1922



RECEIVING THE TIME SIGNAL FROM PARIS.

### FEATURES IN THIS ISSUE:

A Two Valve L.F. Amplifier.  
How to Make a D.F. Station.  
Hints to Amateurs.

A Page of Useful Tips.  
A Home-made 'Phone Transformer.  
More About Units.

How to Make a Two Slide Inductance Coil.

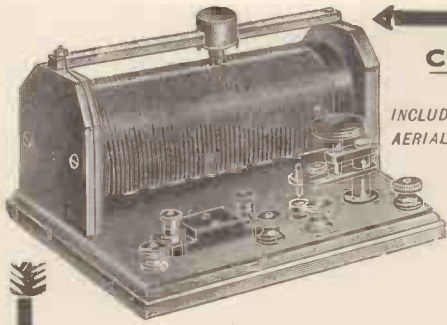

**COMPLETE**  
FOR  
INCLUDING  
AERIAL AND  
**50/-**  
ONE  
PAIR  
OF  
"MITCHELLPHONES."

**Tested and  
Guaranteed.**

**Get It In Time For Xmas Concerts.**

A Handsome Receiving Set, tuning up to 1,000 Metres, at a very sensible price that will appeal to intending purchasers.

Without doubt the finest value for the money, and is sold under our usual unconditional guarantee.

The price covers one pair of the famous Mitchellphones and aerial material for 100 feet, postage paid to your door. Immediate delivery can be effected, and you can easily instal the whole outfit by following the book, which is included, in time for your Christmas Holiday.

Dimensions :

9 ins. x 6 ins. x 5½ ins. high.

**MITCHELLS** ELECTRICAL AND WIRELESS Ltd., 188, Rye Lane, Peckham, S.E.15

POSTAL ADDRESS: McDermott Road, Peckham, London, S.E.15.  
WEST END BRANCH: 2, Gerrard Place, London, W.1.

Read This—  
Unsolicited original can be inspected.  
Surrey, Oct. 22, 1922.  
Dear Sirs, I am writing this to assure you of the efficiency of your Wireless Outfit. On Tuesday last I heard the Writtle Concert, although it is advertised to have only a 25 mile radius for speech.  
I am yours truly,  
R. —

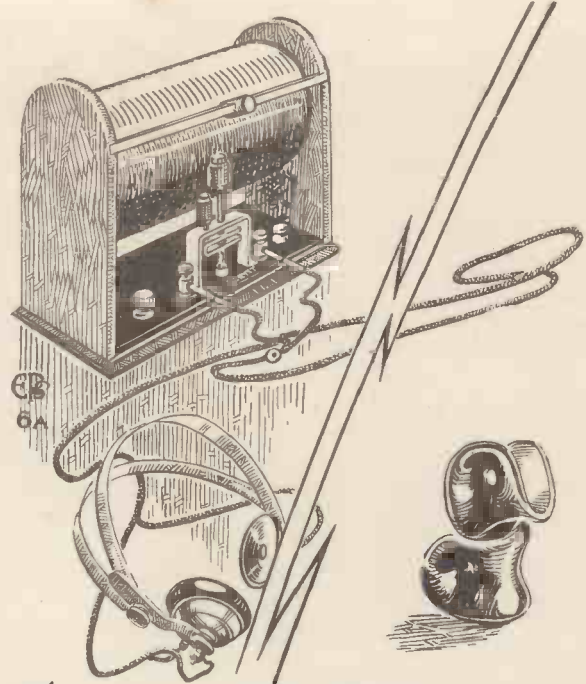

*The*  
**FELLOCRYST**

This is an excellent crystal receiving set, which gives very good results on all wave lengths from 300 to 1,500 metres, and is suitable for receiving broadcasting from ships and long distance stations.

The adjustments are simple and easily made, and the silicon crystal detector well maintains its sensitive state.

No batteries are required.

The set is sent out complete and includes 100 ft. coil of 7/22 stranded copper aerial wire, 2 shell insulators and one pair 4,000 ohms double headphones.

Every set is tested and guaranteed to receiving broadcasting up to 15 to 20 miles, and Morse signals from much greater distance.

The "FELLOCRYST" is British Made throughout.

**PRICE COMPLETE £3 : 7 : 6**

(Postage 1/6 extra.)

Extra 4,000 ohms double headphones 21/-

(Postage 1/-)

**FELLOWS MAGNETO Co., Ltd.**  
LONDON, N.W.10.

Telephone : WILLESDEN 1580-1. Telegrams: "QUIXMAG," PHONE, LONDON

*For they are  
jolly good Fellows*

**YOU MUST HAVE A**

Broadcast "HESTAVOX" I. Receiver

(Type G.P.O. Reg. No. 1007)



Price for Receiver, as illustrated,  
**£7 17s. 6d.**

This is a well designed and beautifully finished instrument, fully approved by H.M. Postmaster-General and licensed under Marconi Patents. It has the full range of wave-lengths from 180-30,000 metres and is fitted with Reaction directly coupled to the Aerial Tuning Inductance. "Hestia" Amplifying Units can be added as required, thus making up a multi-valve set by easy stages.

**ASK YOUR DEALER FOR FURTHER PARTICULARS**  
If he cannot furnish them write for our Illustrated Loose Leaf Catalogue, Post Free 6d. (returnable with first order).

The "HESTIA" ENGINEERING COMPANY, Showrooms open  
32, PALMERSTON ROAD, Dept. PX 9 a.m. — 6 p.m.  
1 min. South Acton Stn. Telephone :  
(W.L. or District Bly.) ACTON, LONDON, W.3. Chiswick 586.



**IN THIS ISSUE.**

**SEEING BY WIRELESS.**

**HELLO EVERYBODY!  
2 LO SPEAKING.**

**A CHAT ABOUT  
CRYSTAL DIRECTORS.**

**AND SO IT GOES ON.  
By HIGHAM BURLAC.**

# Popular Wireless

TOPICAL NEWS AND NOTES.

**NEXT WEEK.**

**FOREIGN LISTENERS  
TO BRITISH  
AMATEURS.**  
By William Le Queux,  
M.I.R.E.

**NOTES ON THE  
SCOTTISH ETHER.**

Look out for a Special Article by Dr. Lee De Forest which will appear shortly.

**Heard at a Bazaar.**

I ATTENDED a fairly rural bazaar the other day, attracted by the announcement of "Wireless Concerts." I must say that I sincerely hope that the people who listened in will not accept the faint, distorted sounds heard as a fair example of broadcast reception. Much satisfaction, however, was expressed by the "multitude" when they "actually heard Big Ben strike." In the circumstances I had not the heart to disillusion them, and link 2 LO with tubular bells, so disconsolately wandered away to the vicarage stall to purchase tea-cosies and such-like.

**Wireless in Mines.**

FURTHER experiments have been conducted in America by the U.S.A. Bureau of Mines in conjunction with the Westinghouse Co. in order to gauge the suitability of wireless communication for rescue work. 200 metres C.W. was used, and signals were distinctly heard through 50 feet of coal strata. Single turn loop aerials were found to be the most efficient, and the results were considered to justify further experiments.

**"Cherchez la Femme."**

WHO was that lady that announced one item from 2 LO the other night? I think I could make a very good guess. With all respect to Mr. Burrows and his confrères, I must add that the reproduction was distinct and pleasant—decidedly pleasant.

**Wireless Control.**

WILL all readers of POPULAR WIRELESS who have followed Major Raymond Phillips' articles on wireless control, and who have any questions to ask him about them, please address their queries direct to him at 6, Knaresborough Place, Cromwell Road, London? Major Phillips will be pleased to advise and help any reader who is anxious to experiment with the wireless-controlled models described in recent issues of POPULAR WIRELESS.

**Newspaper Wireless**

THE Leicester "Daily Mercury" claims to be the only daily paper in this country with a transmitting licence. It also has a five-valve receiver, built on the Marconi unit principle, and has just

carried out a number of interesting experiments in automatic reception. Using a relay which has been made out of a converted magneto bell part, good speeds have been recorded. The magneto bell part was armature mounted on a steel spindle. A contact was fitted to the steel spindle, and the contacts arranged to operate against two contact pillars. The bobbins were, of course, wound to high resistance. A condenser (1 mfd. capacity) is connected across the windings. A second-hand G.P.O. pattern (light armature system) Morse inker is used with this relay.

**Valves Approved for Broadcasting.**

I HEAR that there is a rumour current that only a certain make of valves may be used for broadcast reception, and I think it desirable that this position should be made quite clear to all.

Valves do not have to be approved by the Postmaster-General, but for use with broadcasting they must bear the stamp of the British Broadcasting Company.

**The Right Spirit.**

A FANCY-DRESS dance is being given by Messrs. Peto-Scott Co. at the Holborn Hall on Friday, January 5th, 1923, from 7 p.m. until 12 p.m.

Though originally arranged for members of the staff, it has been decided to extend a hearty welcome to all their patrons.

A special feature will be a descriptive dance on the unit system, and wireless items will be transmitted at intervals.

I feel sure that the evening's entertainment will tune one up to the highest point without fear of subsequent reaction!

Further particulars and tickets can be obtained at the Peto-Scott showrooms, 64, High Holborn, W.C.

**Esperanto Song Broadcasted by Radio.**

I N the words of the announcer of the London Broadcasting Station, "an item of rather unusual interest" was included in its Radio Concert on Friday evening, the 8th December. Miss Gladys Cosmetto sang "Until" in the International language, Esperanto.

Although speeches in Esperanto have already been broadcasted in the United States, this is believed to be the first occasion on which a song has been rendered in the international language.

This was in connection with a lecture and demonstration of radio reception by Mr. H. K. Epton, Chairman of the Hackney and District Radio Society, at the London Esperanto Club, St. Bride's Institute, Ludgate Circus, E.C.

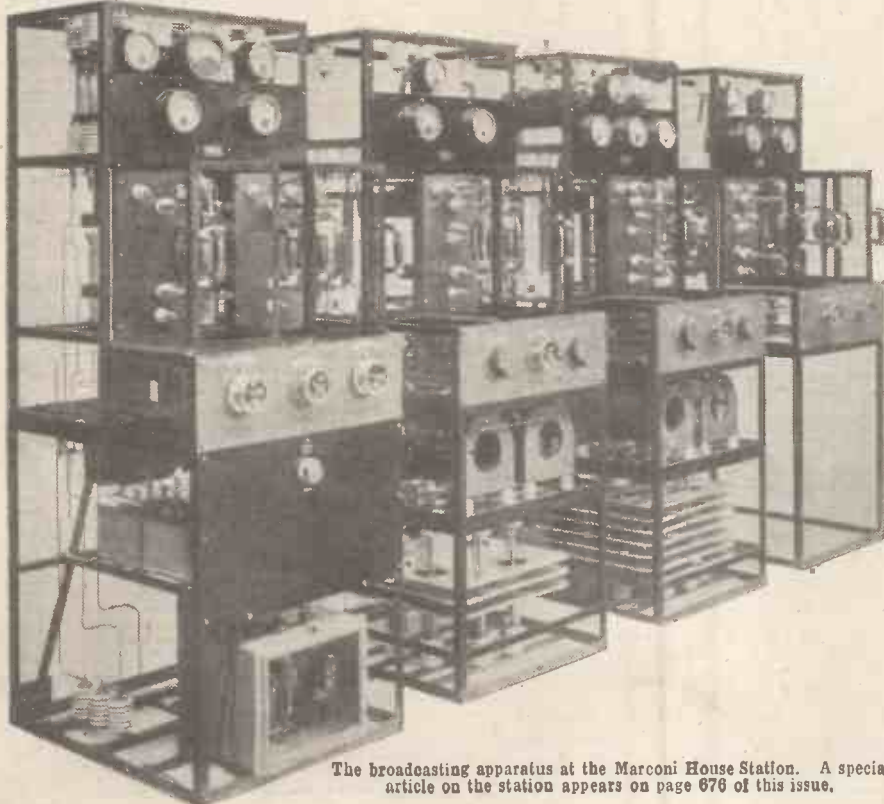

The broadcasting apparatus at the Marconi House Station. A special article on the station appears on page 676 of this issue.

**NOTES AND NEWS.**

(Continued from previous page)

**British Radio Association.**

THE British Radio Manufacturers and Traders Association, Ltd., the new name of the amalgamated trade sections of the Radio Association and the Wireless Traders and Manufacturers Association, was registered on November 29th as a company limited by guarantee. The objects are to promote and protect in the United Kingdom and abroad the various trades concerned in the supply of materials for use by manufacturers of wireless instruments and companies engaged in the wireless industries. The management is vested in a council, upon which no persons had consented to act to November 28th. None but trade members may be councillors. No notice of situation of registered office was filed at time of incorporation.

**The Imperial Chain.**

MR. E. T. FISK, the managing director of Amalgamated Wireless (Australasia), Ltd., said recently in a Press interview that Australia is most anxious to have direct wireless communication with England. "We could have had it three years ago," he told a "Daily Mail" reporter, "had it not been for the report of the Norman Committee set up by the Home Government, which insisted on a State-owned chain of stations. Australian opinion was resolutely opposed to this."

**The Birmingham Programmes.**

THE Beethoven Sonata Pathetique broadcasted the other night from Birmingham was one of the best pianoforte solos I have yet heard by Radio. The violin solos were also very good, particularly that item from the pen of the great Kubelik. The chimes from 2 L O are extremely popular, but did I not hear a clock strike at Birmingham the other night?

Birmingham broadcasting station is certainly providing very decent fare, and, technically, the transmission is excellent.

**A New Record.**

THE Editor has received a letter from Mr. Charles A. Jones, of Holland Cottages, Bradwell, Great Yarmouth, who, I think, has knocked up another record. Mr. Jones writes: "On the morning of December 10th, between the hours of 1 and 4 o'clock, I heard W.J.Z. (Newark, New Jersey, U.S.A.). I was using three valves—one H.F., one Decting, and one L.F. My set is of home construction. The aerial is 100 ft. long and only 20 ft. high."

The programme, which Mr. Jones gives in full, has been checked and found to correspond exactly with the programme sent out by W.J.Z. Mr. Jones's letter was received by the Editor on December 12th. Mr. Jones asks if this constitutes a new record. Signals, he declares, were bad at times, and "X's" caused considerable trouble, but on the whole the telephony was loud and distinct.

The reception of W.J.Z. on an aerial only 20 ft. high, and as far east as Great Yarmouth, is certainly startling, and it seems more than probable that Mr. Jones has set up a new record in this country.

ARIEL.

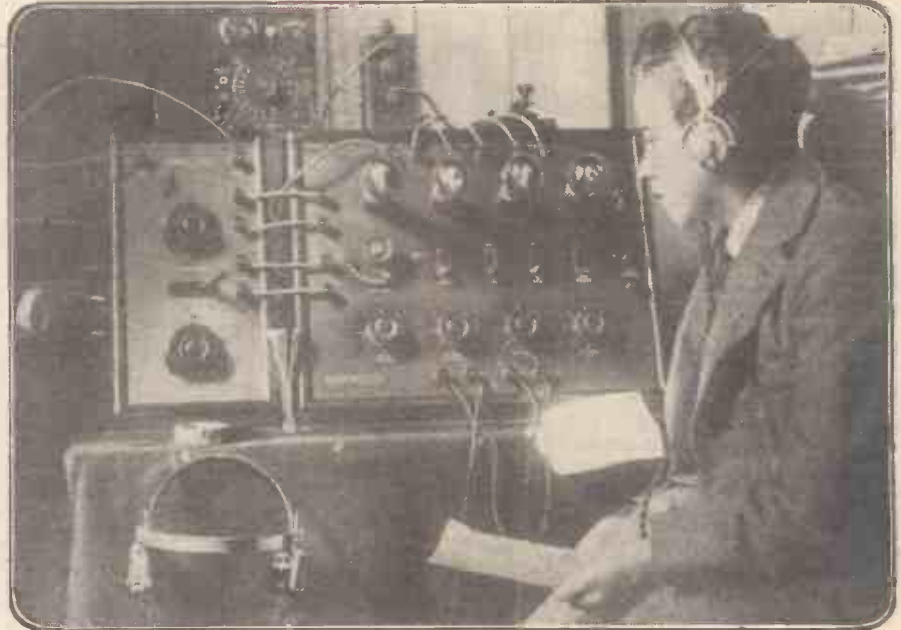

Mr. G. Goodfellow, "Willaston," near Birkenhead, and his four valve set.



# Broadcasting Programmes

What you can hear every evening of the week on your set.

**TELEPHONY AND MUSIC TRANSMISSIONS.**

Station.	Call sign.	Wave-length, in metres.	Remarks.
Marconi House, London, Broadcasting Station	2 L O	360	Every evening, 6 to 6.30 p.m. (News Bulletin); 8 to 9 (Concert); 9 to 9.30 (Late News); 9.30 to 10 (Concert and Dance Music.) Continuous service to be given shortly.
Manchester Broadcasting Station	2 Z Y	385	Every evening, 6 to 10 p.m. (News, vocal and instrumental music).
Birmingham (Witton) Broadcasting Station	2 W P	425	Every evening, except Sunday, 6 to 10 p.m. (News, Concerts, etc.).
Croydon	GED	900	Throughout day to aeroplanes.
Whittle, Essex	2 M T	400	Tuesdays, 8 p.m. (Concert.)
Paris	FL	2,600	7.20 a.m., 11.15 a.m., 5.10 p.m. Also occasional telephony at 10.10 a.m. and 9.20 p.m.
Königswusterhausen	LP	2,800	Between 6 and 7 a.m., between 11 and 12.30, and between 4 and 5.30 p.m.
The Hague	PCGG	1,085	Sundays, 3 to 5 p.m. (Concert.)
Haren	OPVH	900	Practically every 20 minutes past each hour from 11.20 to 1.20, giving messages to aeroplanes on the Brussels-Paris, Brussels-London, and Brussels-Amsterdam lines.
Radio-Électrique, Paris	—	1,565	Concerts at 8.45 p.m.
Brussels Meteorological Institute	O P O	1,500	Slow C.W. and Morse. Easy reading for amateurs.
Newcastle*	5 B A	440	Tuesdays, Thursdays, and Saturday evenings.

NOTE.—The Bar Lightship, Liverpool, sends telephony at 7 a.m., 9 a.m., 11 a.m., 12 noon, 1 p.m., and every two hours until 9 p.m. Calls "Dock Office." Liverpool answers "Bar Ship."

In addition to the regular transmissions carried on between the British amateur stations, much telephonic conversation may be heard from St. Ingelvert (A M), Le Bourget (Z M), and Brussels (B A V). These stations are quite powerful, but they call for a little extra care in tuning. Wave-length, 900 metres.

All times given are G.M.T.  
An asterisk denotes transmissions made purely for experimental purposes.



# RADIO IN THE NEXT GREAT WAR.

By P. J. RISDON, F.R.S.A.

BEFORE the close of the War of 1914-18, we were assured by a then eminent statesman that it was the war that was to end war, once and for all—that its termination would mark the commencement of a new and beautiful world. In other words, that it was Armageddon, and that its close would usher in the Millennium, when the lion would be compelled to associate with the lamb.

It was a beautiful thought—sponsored, perhaps, by a genuine and heartfelt wish—but, unfortunately, even further removed from the bounds of possibility than the relegation of the Jews to Palestine.

Our American cousins liked the idea immensely and, by way of expressing their determination to carry it into effect, announced a naval programme, after the armistice, the scope of which simply staggered and dismayed the exhausted combatants. We, too, have scarcely helped matters in the desired direction by becoming a protected country—by imposing tariffs which are the sole cause of war between civilised nations.

## Spirit of War.

It is true that the original lion was so maimed that he now has no choice but to lie down with the lambs, and insufficient strength even to prevent their frolicking over him, but, unfortunately, other lions have since appeared who stupidly refuse to believe that the Millennium has commenced.

In other words, human nature apparently remains much the same as ever, if, indeed, it has not become much worse, in the sense we are discussing. And, meantime, the incentives to war appear to have increased in number rather than diminished.

That being so, we may, perhaps, be permitted to discuss some possible applications of wireless in the next great trial of arms, without laying ourselves open to the suspicion of advocating war as a means of adjusting international disagreements.

We do not propose, however, to discuss the obvious uses of wireless for warlike purposes, such as directional and secret transmission, and its hundred and one other applications, but to confine the present article to suggestions as to how it may be effectively applied in controlling the movements and action of weapons of war, and it is therefore, perhaps, as well first to consider what has already been accomplished in this direction.

## Crewless Battleships.

The transmission and reception of wireless by submarines is *un fait accompli*, as, also, is the manoeuvring of a crewless warship at sea. In fact, the complete control of any mechanism by wireless from a distant point is a proved and practicable proposition whether it be ships or aircraft, and the loading and firing of guns and explosion of mines by the same means will no doubt soon be effected as readily as by the orthodox methods.

All this, however, important as it is, merely overcomes the initial difficulty, and there still remains the problem of how to follow what would take place beyond the range of vision, for when the next great war is sprung upon us it will not be sufficient to

control by wireless crewless aircraft and ships within sight; we shall have to steer them, to drop their bombs, fire their guns, and sink their depth charges at much greater distances.

It is well within the bounds of possibility that, some day, great naval battles will be fought by crewless men-of-war, directed and controlled by admirals and officers many miles away on shore.

## True Control.

How are these things to be done?

Clearly, if a crewless ship or aeroplane be despatched on an errand of destruction, in order to ensure that it will fulfil its mission means must be devised for receiving messages from it—despite the fact that there is no human being on board—so that its course may be traced, and its whereabouts and the conditions surrounding it may be ascertained at any moment.

Let us suppose that an unmanned bombing plane is despatched to drop its bombs on a distant city. The distance of that city from the point of departure, and the speed of the machine being known, the time required for the aeroplane to reach it can be calculated to a nicety, due allowance being made for wind and weather conditions. Fog would be no deterrent, and would no longer constitute a protection to the inhabitants; it would, in fact, be of assistance to the attacking party.

Wireless control of the engine and steering gear would enable the course to be set and changed in order to avoid a possible intervening danger zone, and the bombing plane might be made to approach its object from the opposite direction.

To ascertain whether it is pursuing the correct course, a compass on board could be made to indicate the direction, wireless-controlled mechanism being provided so that, upon operating it, a transmitter would automatically flash forth the information at any moment required.

Altitude could be ascertained in a similar manner, and with the assistance of a method proposed by Professor Bryan a year or two ago.

This consists of exploding a detonator immediately beneath the machine; from the time taken for the sound to reach the earth and rebound to a receiver on the aeroplane, the height would be automatically recorded, and transmitted by wireless to the controlling station.

Supposing the aeroplane to be under—or rather over—shell-fire, the sound of the bursting shells would be transmitted without difficulty, and the course of the machine could be altered without any fear of losing its bearings in relation to its objective.

## Counter Methods.

The bombs carried would be released by wireless at the psychological moment, and a camera, with a shutter operated by wireless, would record results of the explosions, time being allowed for the bombs to drop and explode, the height of the aeroplane being known. By the same means pictures could be taken at intervals of the country traversed; indeed, there is no apparent reason why a wireless-controlled cinema camera should not be employed.

Its mission of destruction accomplished, the aeroplane would be made to return by any route and at any altitude desired.

Obviously, in certain respects, such a crewless machine might not prove quite so effective as one manned by a pilot, a gunner and an observer, but on the other hand much greater chances could be taken with it, and in circumstances such as fog and bad flying weather it would prove much more effective, whilst its possible destruction would not entail the loss of a crew.

The employment of such aeroplanes would naturally call forth schemes for defence against them, and methods for their destruction, so that, literally, it would not be quite such plain sailing as described.

In clear weather they would be subject not only to anti-aircraft gunfire, but to attack by enemy aircraft fully manned. Again, the secret tuning of receivers carried might be discovered so that such an aeroplane might find itself endeavouring to obey two different sets of instructions.

## Germ Bombs.

Corresponding possibilities apply to crewless warships and submarines which could be employed to raid enemy coast towns and defences, and to block the entrances to ports, the control of mine-layers and mine-sweepers, guns and "tanks" being other probable applications of wireless. Possibly, by the time, the transmission of pictures by wireless will be *un fait accompli*; in that case one can conceive of a wireless-controlled cruiser, carrying a cinematograph machine taking pictures of enemy craft and fortifications with the aid of a telescope, and transmitting them instantly and continuously to the controlling station.

The contravention—the utter disregard—of international rules of warfare, during the Great War, proved conclusively that any means, fair or foul, will in future be employed by combatants, and an appalling prospect is opened up.

Instead of explosive bombs, aeroplanes of the future may carry enormous quantities of frightful disease germs. Imagine a fleet of unmanned wireless-controlled aeroplanes, loaded with such deadly cargo, rising noiselessly at intervals and disappearing one after another into the night on their merciless errand—compared with which the dropping of ordinary bombs on a clear night appears a humane proposition—flying silently through thick fog, and dropping over a city and its unsuspecting inhabitants enough plague, cholera, diphtheria and other disease germs to decimate its population in a week!

## RADIO BRAIN WAVES.

All real amateurs get them sooner or later, and when you get yours don't let it waste energy. Tune it carefully, and send it along to "Popular Wireless" on a 500 words or so wave-length. If accepted for publication it will be paid for at our usual rates.



# “HALLO, EVERYBODY! 2 L O SPEAKING”

Readers of “Popular Wireless” will be interested in this description of 2 L O's Broadcasting Studio. It is an exciting privilege to go behind the scenes at a theatre, but it is far more fascinating to go behind the scenes at Marconi House and see “exactly how it's done.”

By MICHAEL EGAN.

THE other evening, at the invitation of Mr. Arthur Burrows, who controls the operation of the big London Broadcasting Station, I made my way to the seventh floor of Marconi House, Strand, and spent a most interesting couple of hours “behind the scenes” at 2 L O.

In a thickly carpeted room, the walls, windows, doors, and ceiling of which were heavily draped with white muslin, I took a seat among the half-dozen artists who were present, and listened to the first song—a tenor solo—being delivered into the microphone.

## On the Seventh Floor.

It was a unique experience. As I listened to the opening bars of the piano accompaniment, I could not help letting my imagination wander for a second or two. In my mind's eye I saw the effect that was being produced simultaneously by these opening notes in thousands of homes throughout the country. I saw thousands of premonitory forefingers being raised, and heard thousands of excited voices whisper, “Hush! Keep quiet. He's off!” And then, as the first notes of the singer's voice poured into the microphone, I thought of the tuning and readjustment that must be going on.

The singer stood beside the grand piano, and, at a distance of about a foot in front of him, the transmitting microphone was fitted on a tall pedestal. By sliding the microphone up or down a vertical arm, the necessary adjustment could be made to suit the height of each artist. A small switch, fitted to the top of the pedestal, enabled the transmitting power to be switched on or off as required.

The transmitting apparatus is, of course, installed in a separate room, and, during one of the three-minute intervals in the concert programme, I had an opportunity of visiting it. This room is on the same floor of the building, and the first thing I noticed on entering it was the powerful illumination provided by the lighted filaments of the transmitting valves. The room was, literally, a blaze of light.

This, of course, is not so surprising as it might first seem, when it is remembered that the filament of the largest valve in the installation takes a current of 10 amperes! Incidentally, the high tension applied to the plate is in the neighbourhood of 10,000 volts, from which a thermionic current of between 200 and 300 milli-amperes flows within the valve itself!

Returning to the concert-hall before the three-minute interval was over, I found that a window and door in opposite walls had been opened in order to allow the members of the concert party to get a “breath of fresh air.” Owing to the extreme sensitivity of the transmitting microphones it is necessary to keep all sound avenues closed whilst the concert is in progress.

Moreover, for the same reason it is impossible to use electric fans for ventilation purposes, as the whirring sound of the vanes is able to affect the microphones appreciably.

In fact, the microphones seem particularly sensitive to any kind of rustling noise.

I should have mentioned that two microphones are used—connected in parallel. The second microphone is suspended from the raised lid of the grand piano in such a position that it catches the maximum volume of sound from that instrument. The efforts of each artist, vocalist and instrumentalist, are thus directed towards a separate microphone.

In the course of a chat during one of the three-minute intervals with Mr. Jeffries, who directs the musical part of the programme and does all the pianoforte accompanying, I learned that the most encouraging reports on the quality of the transmitted music had been received from all over the country. Mr. Jeffries was full of enthusiasm for his work, and expressed the conviction that “broadcasting” had come to stay in this country.

As the various items on the programme were performed, the *modus operandi* was as follows: At the close of each interval, the transmitting switch was closed and a preliminary “Hallo!” addressed to the microphone by Mr. Burrows, who controlled operations. This preliminary “Hallo!” advised the engineer in charge of the transmitting gear in the distant room that the next item was about to commence, and the appearance of a small glowing light in one corner of the concert-room signalled that the power had been switched on to the microphone circuit.

## “Hot” News.

The item was first announced, and the transmitting switch in the concert-room was then opened again for a few seconds whilst the microphone was adjusted and the artists made their final preparations for their “turn.” Then, in answer to a warning signal, silence was observed amongst those present and, as the transmitting switch was again closed, the opening chords of the accompaniment were struck.

At the termination of the first portion of the concert, I waited to hear Mr. Burrows read the nine o'clock news bulletin, and I can vouch for the “freshness” of the information that it contained. Whilst he was reading some of the first items, a number of the later items were actually received over the 'phone and handed to him as he spoke into the broadcast microphone. There is no doubt about the Broadcasting Company intending to let the public have its news “hot”!

Incidentally, whilst broadcasting the news bulletin, a number of other messages were received, which Mr. Burrows read out to me afterwards. These were reports from various London districts on the quality of the received signals, and they were to the effect that “bad” and “very bad” interference was being caused in different localities by the use of reaction coils in neighbouring receivers.

I asked Mr. Burrows if there was much of that kind of thing going on, and his reply was to the effect that he was receiving reports of a similar character every day.

This, of course, is a very serious affair, and one which is likely to cause a considerable delay in the development of broadcasting in this country if it is not speedily checked. The regrettable thing is that certain amateurs don't appear to realise that if they won't take measures to check it themselves their carelessness is bound to lead to some form of restrictive legislation sooner or later.

## The Temporary Station.

This is to be avoided at all costs. The interference, apparently, must emanate from the receivers of amateur experimenters, since broadcast receivers are guarded against such an occurrence. It behoves all amateur experimenters, therefore, to observe the strictest care in the operation of their instruments, in the general interests of the community.

Before coming away, Mr. Burrows informed me that the London Broadcasting Station is only temporarily erected at Marconi House. All the arrangements, in fact, are of a temporary nature, and negotiations are at present on foot for the choosing of a more suitable site in London. Also, the broadcast programme of the near future will be a much more varied and elaborate one than present circumstances allow.

The concert-room at present in use at Marconi House was originally designed for cinematograph purposes. In adapting it to its present use the thick draperies, to which I have already referred, were introduced as a means of damping down the echoes which would otherwise be thrown back into the microphone, resulting in distortion of the transmitted speech.

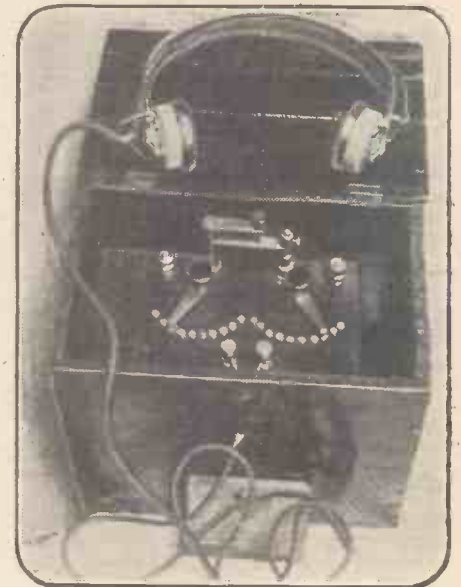

Mr. W. Wilson's portable crystal set, 35, Holmfield Road, Stoke, Coventry.



# HOW TO MAKE A TWO-SLIDE INDUCTANCE COIL.

The construction of a Two-Slide Inductance Coil is comparatively easy work for the average amateur, and the full instructions given in this article should enable readers to make for themselves a useful piece of Radio apparatus

By W. S. SHOLL, A.M.I.E.E.

**H**OWEVER elaborate the enthusiast's outfit may eventually become, the possession of a well-made and really efficient tuning inductance will never be regretted, and the worker is strongly advised to undertake the construction of this piece of apparatus, as the experience thus gained will add considerably to his store of practical knowledge.

An inductance is a good straightforward job, and will prove a good starting point from which to develop that constructive ability which is latent in most of us. The operations are in themselves simple and not tedious, but this must not be any excuse for scamping the work at any point.

Oscillatory currents are fickle things to deal with, and have a way of "getting their own back" if they are not treated with the utmost respect.

Let the worker, therefore, see to it that no care is neglected at the outset, or at any time during the process of construction for that matter, as nothing is more conducive to waste of time and material than having to do the job over again.

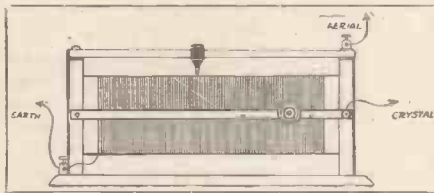

Moreover, the appearance of the job is apt to be quite spoiled if the finish is impaired by taking the finished work down in the trying business of unearthing some hidden fault.

Nothing in these remarks should deter the worker from taking the job on, but it is simply courting failure to take any chances or to trust to luck to the exclusion of definite principles.

The comparative beginner will do well to read all articles of a constructional nature right through from beginning to end before committing himself, and his pocket, to any steps of a practical nature.

He will be well advised to get a clear picture in his mind's eye of the whole process, as this will carry him through the job with almost certain prospects of success.

## Choice of Material.

High finish, such as is attained by professionally built apparatus, is hardly to be expected, but plainly turned out work in which the details bear the stamp of care and accuracy is within the capacity of the worker of modest attainments.

Don't doubt yourself unduly; don't be in a hurry to get through with the job, and don't purchase any materials haphazardly.

While on the subject of materials, let the worker bear in mind that the difference in cost between poor and first-class material is so slight as to make the apparent saving not worth considering.

This does not imply that the dearest firm is the best to go to for our materials; some firms charge fifty to a hundred per cent. more than others; but, as an instance of the wise selection

of materials, do not be tempted to use cardboard tubes as "formers" when it is possible to obtain impregnated fibre for a few pence more.

The capacity of the inductance we are about to build will cover a very wide range of wavelengths, and will suffice for everything but the most advanced work.

Another reason for employing a thoroughly good tube for the former of coil arises from the necessity of having a truly cylindrical base upon which to wind our wire, as unless we have a perfectly even layer we shall have endless trouble with the slider contacts, and poor results, or no results at all, when tuning in. Examine the wire before accepting it, and purchase it on a reel and not in a hank, as every turn in the hank will make a kink which is exceedingly difficult to remove without damaging the insulation.

Here are the sizes and quantities of materials required:

1 lb. No. 22 S.W.G. copper enamel insulated wire.

1 fibre tube 4" external diameter by 10 1/2" long.

2 discs well-seasoned mahogany, 3 3/8" diam., 3/8" thick.

2 square mahogany ends, or "cheeks," on which to mount the tube, each 5 3/8" square by 3/8" thick.

2 brass rods, 1/4" square, each 12" long.

2 ebonite sliders for 1/4" rods.

2 "Hole and screw" pattern terminals with wood screw shanks 1/4" long.

2 milled nut pattern terminals with machine screw shanks and double brass washers.

1 doz. brass wood screws with counter-sunk heads, 5 gauge, 7/8" long.

First strike out the two 3 3/8" circles in the 3" mahogany. I should like to recommend a lathe here, but we will use a pair of compasses and a fret-saw, taking care not to force the saw through such thick wood. Next ease these ends down till they are a snug fit in the ends of the tube. If the tube has been purchased in the stock foot length, mark off 10 1/2" and cut to length, touching up the end, if necessary, with a piece of fine sandpaper, and be sure to get the end true. Bore a 3/8" hole in the centre of the two discs.

## Position of Sliders.

Next cut out the two square end pieces, centre them, and strike out two circles each 3 3/8" diameter, to enable the tube to be accurately located when assembling later on. Lay the discs on the circles of end pieces, and pass a fine bradawl clean through the discs to the outer sides of the squares, thus making four holes spaced equidistant; enlarge the holes on the outer sides of the square ends to take the wood screws and countersink them.

Mark the discs and the end cheeks to ensure accuracy in assembling.

Next take a piece of iron rod 3/8" thick and about 16" long, and bend up into a crank handle; ease the 3/8" holes in the discs until they are a driving fit on the rod, space them apart, and slip the fibre tube over them with a touch of shellac varnish to hold the tube in position; one or two fine brass pins may be used in addition, but if the work is accurate

they are better left out; allow the shellac to set overnight. Now screw the two square ends together, using the holes already bored, and trim them up in one operation, thus ensuring accuracy and saving time in addition.

To those who rather dread planing "end grain," the use of a file or wood rasp will serve equally well, the four edges being finished off with sandpaper wrapped round a flat piece of wood.

While the ends are still screwed together, mark off a line in the centre of top edge from thickness to thickness, and do the same to one vertical edge also.

We now have to decide whether we will arrange our sliders both to work from the top of coil, or one in the centre of top and one at the centre of vertical edge. Either arrangement will give the same results electrically, the latter being the easier method from the constructional point of view, while the former is more "professional" looking, and generally more convenient. Figure 1 in the accompanying illustration shows the sliders located at 90 deg., i.e., each at an angle of 45 deg. to the vertical.

## Winding the Coil.

To get the necessary angle, mark off 1 1/4" from each end of top, and the same distance from the ends as shown, and saw through the two thicknesses while still screwed together. Take the ends apart and clean up nicely, and, presuming that the shellac on the tube ends has set, proceed to wind the wire on the tube.

To do this rig up two temporary wooden uprights on a box, to form bearings in which to rotate the tube by means of the handles; a staple at each end will serve very well. At this juncture the assistance of a friend will be welcome, as it is difficult, if not impossible, to make a good job of it single-handed.

First pierce the tube about an inch from the end with a bradawl, and pass six inches of the enamelled wire through into the interior of the tube, making it secure with a little wooden peg dipped in shellac. Rig up the bobbin of wire on a thin rod so that it can unwind easily; provide yourself with a little block of wood, hold the wire with a piece of clean rag between the finger and thumb of the left hand, and

(Continued on next page).

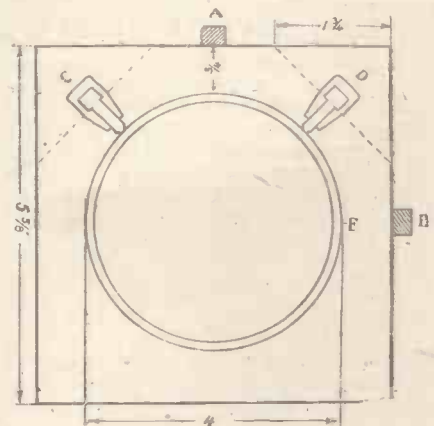

## HOW TO MAKE A 2-SLIDE INDUCTANCE COIL.

(Continued from previous page.)

while the tube is rotated from you, feed the wire on evenly and tightly, keeping the adjacent turns well up to each other by gently "following up" with the little wooden block applied sideways as required.

The operation of winding should be continued without interruption until within an inch or so of the opposite end, the wire being passed through a hole in the tube and finished off as at the beginning.

We should now have a closely wound, nice-looking coil on which the sliders will ride with ease and make efficient contact. Now file the ends of the 12" brass rods up true and square and drill a hole, a nice "clearance" fit,  $\frac{1}{16}$ " from the end of each bar, i.e., two holes in each bar.

Next "fish" for the two ends of the winding and draw them out through the holes, having driven out the temporary handle, clean the ends and "tin" them with the soldering bit, also two of the brass washers, and solder fast by laying the ends, turned into neat circles, on the washers and applying the soldering bit until the metal runs.

A short length of insulating tubing may be slipped over the wire before soldering if desired, but it is hardly necessary unless we run to the refinement of "bushing" the terminal holes with a little piece of ebonite tube. Whether this is done or no, thread the soldered washer on the screw shank of the terminal—the "milled nut" pattern—pass the screw through a hole in the centre of square end of coil, put the other washer on, and screw down the body of the terminal square and tight; treat the other end similarly.

Now we shall see the value of the four holes already drilled accurately to receive the wood screws, as by placing the latter in their proper positions they will find the corresponding holes in the tube ends, and will pull the whole assembly into true and firm shape without trouble.

We next find the centres of the angular surfaces, which should be  $1\frac{1}{4}$ " from ends, and, laying the bars with their sliders in position, mark off and bore the holes for terminals and fixing screws.

### A Suitable Baseboard.

Before screwing down the sliders permanently, slip them on the bars, hold down firmly, and try them up and down for contact. If they work at all slack, and the plungers threaten to work sideways, a little of the wood end will have to come off; if, on the other hand, the action is unduly tight or harsh, slip a very little packing, say a piece of copper foil, or even a piece of thin card, under the bar. Having got everything to our satisfaction, screw down, using the wood screw terminals at one end and two of the brass screws at the other.

Now run the sliders up and down until a bright line is scored in the enamel insulation, take off the bars, mark off a line  $\frac{1}{8}$ " on either side of the "scored" line, and, with the aid of a straight-edge, scrape the enamel off with the tip of a knife. This may seem a bit tedious, but it makes by far the best job, and if carefully done gives a nice finish to the "business side" of the coil. The enamel chips away very readily from a sharp knife and leaves the copper nice and clean.

When this is complete, take a small stiff toothbrush and clear out every bit of enamel or metal that may have lodged between the windings; neglect at this juncture may "short circuit" the greater part of the

windings, and then good-bye to satisfactory results.

The ends of the instrument are best french polished, an art which is well worth acquiring, failing which shellac varnish may be applied, but under no circumstances should any paint with a metallic base, such as white lead, be used, or "surface leakage" may occur with disastrous results. Any permanent finish should be left to the end of practical operations to avoid the effects of the inevitable handling during assembling.

The completed instrument may now be attached to a baseboard if desired, and at this point the maker can decide whether he desires to retain it as a separate unit or to allow room on the board for a crystal or other detector, a condenser, and the necessary terminals for aerial, earth, and 'phones.

An excellent baseboard may be obtained ready-made and highly finished in the shape of a recessed switch block of the type used for main switches and fuses in house wiring.

Any electrical stores will supply one at a couple of shillings or so, according to size.

### Slight Corrections.

If this method is adopted there will be no need to fit brass feet to lower ends of end pieces, as the complete instrument may be conveniently attached by wood screws from the under side of the board. If, however, the experimenter desires to retain the inductance as a "loose" unit, a pair of brass plates may be cut out of sheet metal and attached so as to facilitate screwing down to any board on which are attached such other units as are in use at the time.

It may be mentioned that the tops of the switch blocks are a little on the thin side, so due care should be exercised in forcing wood screw terminals into it, otherwise there is a risk of splitting and thereby disfiguring the completed job.

It should be borne in mind that some of the components, particularly sliders, vary somewhat in dimensions; it is advisable, therefore, before commencing operations to verify the sizes, to prevent errors creeping in at a later stage and causing a good deal of trouble and annoyance in getting a satisfactory fit.

Most sliders require their bars to be  $\frac{3}{8}$ " from the windings, so if this amount is allowed from the actual tube itself the added thickness of the windings will result in a good fit with efficient contact.

Should the sliders be a rather loose fit on the bars, a little strip of brass foil may be slipped under the lower side of the ebonite knob and bent down at both ends to make secure.

In the making of this instrument, as in all electrical work, the utmost care should be

taken to keep materials, tools, and hands as clean and dry as possible. That is the reason for passing the wire, when winding, through a clean piece of rag and not the bare fingers.

When soldering the connections use a good paste flux, such as fluxite, and on no account fluids or "killed spirits."

These latter preparations are of a corrosive nature, and unless washed away are apt to give trouble later on, generally at a most inopportune moment.

### Final Hints.

In screwing the two square end pieces together it will be found that the holes of one will naturally be too large to take the points of the screws which attach it to its fellow. In case any worker should be nonplussed over this it may be suggested that the holes be plugged temporarily with soft wood driven in and cut off level, or, better still, the holes in this end left on the small side until the two ends have been taken apart for good. They may then be bored out full size and counter-sunk for the permanent reception of the screws which hold the end cheek on to the disc fixed to the tube.

Enamelled wire has the advantage of revealing any break in the wire, which is often not the case where the insulation consists of double silk or cotton; where this wire is used, particularly in the finer gauges, it is possible for a discontinuity fault to develop and cause a lot of trouble in testing and subsequent unwinding. Assuming that we have surmounted our difficulties, we may now give the finished instrument a final polish up, and if due care has been expended upon its production we may be justly proud of the result.

Keep the inductance covered when not in use; dust is, next to damp, the worst enemy of electrical efficiency.

The cost of the completed instrument should not greatly exceed ten shillings as against 30s. to 40s. for the purchased article.

### RADIO ASSOCIATION.

To Professor A. M. LOW, D.Sc., A.C.G.I.,  
M.I.A.E., F.C.S., Hon. Treasurer.  
RADIO ASSOCIATION,  
44, Great Russell Street, W.C.1.

Dear Sir,

Please enrol me as a Member of the  
Radio Association, for which I enclose annual  
subscription of 2s. 6d.

Name in full.....  
(with Titles)

Address .....



The Z O A R Radio Society, Wales. A recent photograph of the club members.



# USEFUL TIPS FOR AMATEURS.

## "GEAR CONTROLLED" FRAME AERIAL.

MUCH of the satisfaction obtained from using a frame aerial is often marred by the difficulties which arise in connection with the wiring of the actual frame to the set. Tangled leads, with the inevitable dislocation of the circuit, are common, and it is often a case of "swinging" the aerial and then looking to see where the damage has been done.

The device suggested in the illustration shows a panel mounting for a frame aerial which will not only allow the experimenter to turn his frame without fear of accidents, but will also enable him to calibrate the exact position of the frame for any required station.

### Simple Gearing.

The frame is controlled by a simple gear arrangement, the turning of the knob A revolving the gear B, which in turn engages the gear C, connected to the upright rod, to which the actual frame is connected. The two leads from the frame windings are brought to the two switch arms D and E, which rotate with the frame.

These two arms make contact with two circular brass strips fixed to the top of the cabinet, and shown in the diagram at V. Leads are taken from these two strips as indicated to the two terminals K and L, which are shown for the sake of clarity one above the other.

The circular disc O might be included to enable the operator to mark any required gearing adjustment or to compile a calibration chart of desired stations.

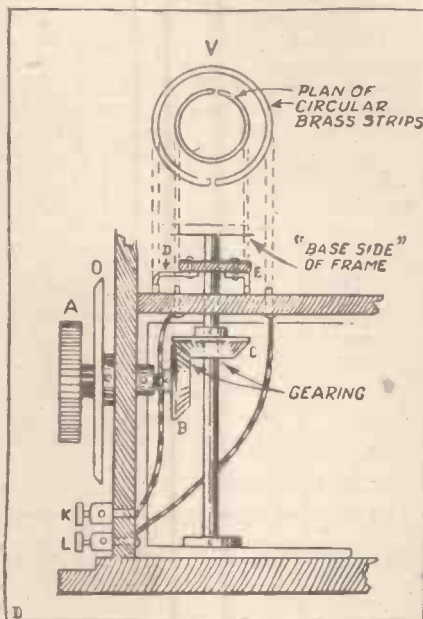

drilled into the mounting and the coil former, the screws being firmly driven to make the connection secure.

It may be found advisable to join the brass strips to the coil former by screws smaller than those used to connect the strips to the mounting, and if very small screws are used it might be possible to use two at the end of each strip instead of one as shown in the diagram.

## COMPASS MOUNTING FOR COILS.

IN the drawing accompanying this article is shown an ingenious device for use in connection with honeycomb coils. By means of a drawing compass, a few machine screws, and one or two other accessories, a very useful mounting for honeycomb or duolateral coils can be constructed.

### Construction.

This arrangement has much to recommend it. No actual contact between the hand and the coil is necessary, and finer degrees of coupling can be obtained by turning the knob B than would be possible by the comparatively clumsy method of adjusting the coils with the finger or hand.

The principal disadvantage of such a coupler is that only one set of coils can be used, and in this respect it is perhaps not so serviceable as the ordinary "plug in" types. The drawback is not insurmountable, however, and might be overcome by taking tappings from the coils in the usual manner.

Having obtained a suitable compass, drill and countersink it at the four points

shown at A in the diagram, to take  $\frac{3}{16}$  flat-headed machine screws. It is advisable, before drilling the holes, to have at hand the remainder of the material to be used in the construction of the device, so that the correct positions can be properly gauged.

Two brass strips shown at D and H in the illustration are then procured and bent into the desired shapes. The strip D is firmly secured to the "fixed" coil F and to one of the compass arms by two of the machine screws referred to above. "D" is also securely screwed to the back of the panel. The movable coil G is then attached to the other arm of the compass by two screws in a similar manner.

### Fine Adjustment.

A fairly large hole, to allow free movement of the compass shaft, is drilled through the panel, and the controlling knob B fastened to the adjusting nut C. If the construction is carefully carried out, and the complete device mounted on the back of the panel, complete control of the coupling is assured. The adoption of this method of coupling would probably do much to eliminate the undesirable "local oscillations" which one sometimes hears, especially round about "concert time." The operator of coils so mounted would have very little excuse to offer for being guilty of "howling."

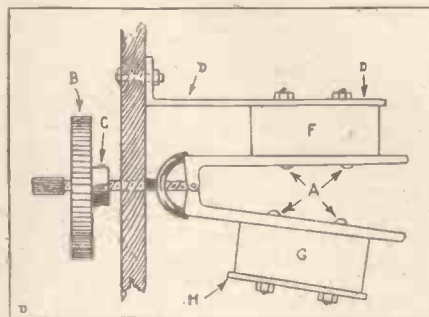

## RACING AND RADIO.

THE radio experiments on racing cars carried out at Brooklands recently were entirely successful.

A grid control set was used with a Marconi Osram R. valve. The high-tension supply was obtained from Pyramid dry batteries giving 250 volts. The input power was approximately 10 watts and the radiation 28 amperes.

The aerial consisted of three wires spaced 1 ft. apart and about 14 ft. in length, held by masts about 2 ft. 6 in. above the body of the car, which, of course, acted as earth.

No very high speeds were attempted, but speech was quite successfully received whilst the car was doing 45 miles an hour and about a mile away, as the crow flies, from the receiving station. The wavelength utilised was 200 metres.

## "PLUG IN" SPIDER-WEB COILS.

A SIMPLE idea for utilising honeycomb coil mountings and spider web coils is given in the illustration to this paragraph.

The method of connecting the coil to the mounting is better seen than described. Two small pieces of brass are cut, as illustrated, and drilled to take screws of any size desired. Corresponding holes are

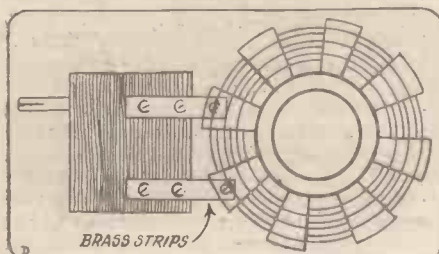

# MORE ABOUT CRYSTAL DETECTORS.

By G. V. Dowding, Grad.I.E.E.

WITH the increase in the number of broadcasting stations, the cheaper crystal set will come into its own. For people residing within, say, 10 miles of one of these stations this type of instrument will be found to reproduce the music more faithfully than the multi-valve set with its loud speaker.

A further considerable advantage is that the cost of upkeep is practically nil. With a crystal set employing a fixed inductance to cover the broadcasting wave-lengths the only necessary adjustments are the slight variation of capacity by means of a variable condenser, and that of the crystal detector.

This latter, however, is not quite the simple and "foolproof" little operation that the confident and polite salesman would endeavour to lead one to believe, and skill in the delicate "wangling" required to ensure results or best results, can only be acquired with a little practice and experience.

## Local Batteries.

To ensure that the two elements are in contact does not render it certain that the detector will function, and due attention must be paid to the fact that with the majority of crystals sensitivity is confined to very small points, and that the degree of this all-important quality depends to a very great extent upon the pressure applied by means of the insulated screw adjustments.

This pressure will be found to vary with various types of crystal, the more sensitive but less stable requiring an infinitely lighter and finer contact. It is thought by many that a sensitive crystal should offer a very easy electrical path in at least the one direction; should, in fact, allow the completion of a local bell or small lamp and battery circuit with sufficient conductivity to allow the required current to flow, but, as a matter of fact, even at its most sensitive adjustment a crystal may have a resistance of 10,000 ohms and 40 times that in its reverse direction.

Another common error is to suppose that no wireless apparatus can function without the inclusion somewhere in the circuit of a battery. This may be quite true with regard to transmitting sets, but not in the case of the simple crystal detector receiver. All the necessary "juice" is drawn via the aerial from the ether, is rectified by the detector, and passes through and actuates the 'phones.

Then comes the question with regard to applied potential, and the answer is—forget it. A carborundum and steel or copper combination must have this, but the handling of the necessary potentiometer in conjunction with the pressure adjustment is, to say the least of it, tricky, and the new amateur would be well advised not to introduce it into his circuit.

Practically any mineral crystal can be employed in combination with some other crystal or metal to perform the functions of a detector, but specimens will vary considerably in their adaptability to efficient rectification, and should be obtained only from reliable wireless firms.

## A Few Combinations.

"All that glitters is not gold" will be heartily endorsed by those amateurs who have at some time been misled by the iron

pyrites to be found occasionally with the household coal, but nevertheless it is interesting to note that small pieces of this deceiving mineral can be employed with a fine wire contact of practically any metal to form a crystal detector. So for that matter can the coal itself, but there are, it is needless to add, many far more sensitive crystals to be obtained.

A point worthy of note is that the majority of the better-known "crystals" contain some kind of metal; for instance, that popular greyish metallic substance, fused silicon, is a fusion of glass, cryolite and aluminium. It is fairly cheap, quite sensitive, and is best employed in contact with a "catwhisker" of gold, steel or copper. (A "catwhisker" is a fine wire of about 36 gauge.)

Then again galena or, more correctly, galenite, is a compound of sulphur and lead. It is very cheap, one of the cheapest of all the crystals, very sensitive, but not at all stable in adjustment, requiring constant

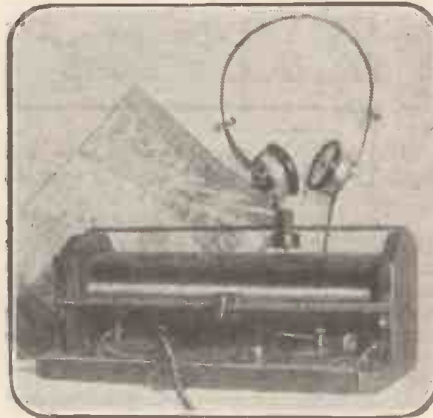

A Typical Crystal Receiver.

attention, and rapidly loses its "live surface." It will not even stand the moderate heat of molten "Wood's Metal" (merely 60 deg. C.), and therefore necessitates in its setting small set screws.

It has quite a distinctive colour (metallic lead-grey), and can be used in combination with almost any metal or the crystal form of tellurium. This latter is nearly as rare as galena is common, and consisting of tellurium, the element, and gold, is only to be found in the proximity of gold mines. It is silver-white in colour, very brittle, and is used with copper, galena or zincite.

A very well-known and extremely useful combination is the "perikon" or zincite and copper pyrites. The latter, a form of chalcopyrites, is a sulphide containing copper, iron and sulphur. It is a brilliant brass yellow in colour, only the brightest specimens being of any use for wireless purposes. It can also be used with a "catwhisker" of gold or phosphor bronze, or with bornite or tellurium. Zincite, the other perikon element and one of the most used of crystals, is red in colour, very rare, and composed of zinc and oxygen. It can be used with bornite, which is a copper ore consisting of copper, sulphur and iron, of rare occurrence, and because of its peculiar bronze tint styled by the miners "horse-flesh ore."

There are on the market quite a number of artificial "crystals," mostly "some-ites." These are nearly without exception fusions in which galena holds no small percentage. They seem to be very sensitive, have very equal surfaces, and are very stable in adjustment, but are apt to deteriorate in sensitivity with exposure to the atmosphere. They are invariably brilliant bluish or blackish grey in colour, and employ "catwhisker" feelers of German silver.

## Practical Hints.

Carborundum, the crystal that requires the applied potential, is used with a small blade or needle of steel, and sometimes copper. It ranges in colour from deep grey to violet purple, although for wireless purposes silver-grey specimens are the most suitable.

It is a fusion of carbon and silica, and is extremely hard. As a matter of fact, that taken from the middle of the furnace is next in hardness to the diamond, but for the aforementioned wireless purposes just beneath the outer incrustation provides the "crystal." Carborundum, as sold in "honingstone" form, grinding wheels, etc., is powdered carborundum that has been moulded under great pressure and is not suitable for rectifying. For many purposes, such as the elimination of atmospheric by the balanced crystal method, certain valve crystal combinations, etc., carborundum is essential, but for purely amateur or broadcast purposes, a silicon or "perikon" detector is the most advisable.

"Per specimen" in a catalogue sometimes results in the possession of a fine lump of crystal the size of a walnut, but while within limits the actual size of the piece used is of little consequence, it is well in point of economy to limit it to about the size of a pea. Therefore the lump should be fractured, and bright suitably sized pieces chosen for mounting.

On no account should ordinary solder be used for this latter purpose, "Wood's Metal," which is a composition of lead, tin, bismuth, and cadmium, and thus obviously an extremely easily melted alloy, should be used. The interior of the cup should be well cleaned but no flux employed. As an alternative to the use of "Wood's Metal," which is rather expensive, tinfoil can be tightly packed into the cup in such a way as to hold the crystal firmly.

Owing to the extremely small working point of a crystal, which may be less than the area of the point of a needle, it is obvious that dust or any extraneous substances should be rigidly excluded, therefore, some sort of protective covering at least while the set is not in use is strongly recommended. Crystals should be cleaned with carbon disulphide applied by means of a perfectly clean toothbrush.

After some considerable period of usage, it will be found that a crystal appears to lose its sensitivity. Generally speaking, this is not due to a chemical change or even electrical deterioration, but because the surface has worn smooth and thus lost the sharpness of points and facets essential to efficient rectification. The specimen should be removed from the cup and fractured, and the new surfaces presented will be found to contain many new sensitive points.





Mr. "ORA" wishes his many friends and supporters a Happy Xmas and a Very Prosperous New Year.

He looks forward to spending many delightful hours in their company during the festive season.

For receiving vocal and instrumental items you must have

### MULLARD "ORA" Valves

to get the best results.

**O**scillates **R**ectifies **A**mplifies

Specially recommended where good amplification is required.

The "Ora" Valve requires about 3.8 volts on the filament and 30 volts or over between the anode and filament for efficient results.

**15/-** EACH.

The MULLARD "R" Valve is now reduced in price from 22/6 to 17/6.

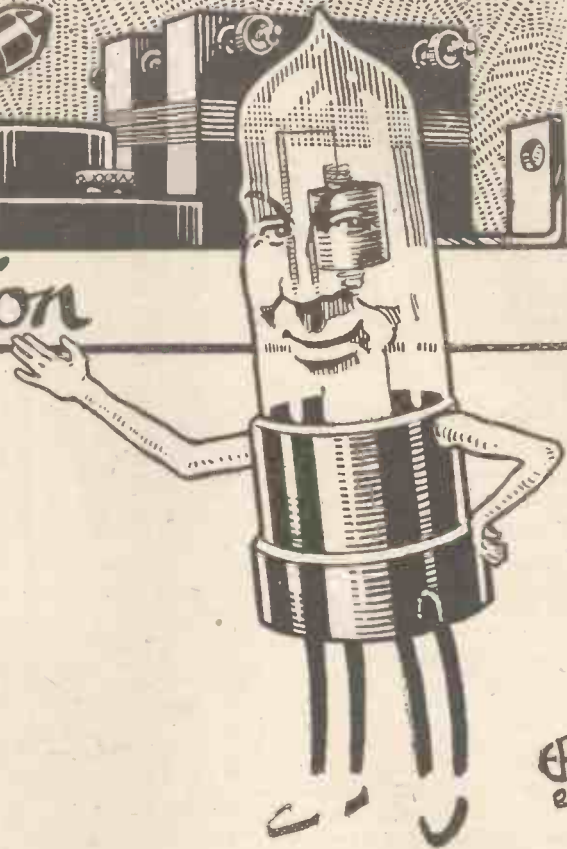

## Mullard Radio Valve Co. Ltd.

45, Nightingale Lane, Balham, S.W.12.

Contractors to H.M. Admiralty,

War Office, Royal Air Force & Post Office.

Telephone: Battersea 1068  
 Codes: ABC(5Ed) Bentley's  
 Telegrams: Radiovalve Wandsworth Lon



Name and Address.....

To the MULLARD RADIO VALVE CO., LTD., 45, Nightingale Lane, Balham, S.W.12.

Please send me post free

Quantity	Description	Price
.....	Telephone Head Set	{ Type A—21/- Type B—25/-
.....	"ORA" Valves	15/- each
.....	Grid A Resistances	6/- each
.....	Anode A or B Resistances	5/- each
.....	BA Condensers	2/6 each
.....	Combined Resistances and Condensers	7/6 each
.....	Valve Bases with Terminals	5/- each
.....	Valve Sockets	1/3 each
.....	Terminal Clips	9d. per pair

I enclose (Cheque or Money Order, P.O. value

to cover the cost.

Name of usual Wireless Dealer

**SEND THIS TO-DAY.**

# It Speaks for Itself—

and in no uncertain voice.

## THE WORLD'S STANDARD LOUD SPEAKER.

# AMPLION

WIRELESS  
LOUD  
SOUNDING  
RECEIVERS  
are supplied in  
a series of

### Ten Models

Suitable for  
every service:

**The Home,  
Laboratory  
and the  
Concert Hall**



At Prices

ranging from

£2 : 10 : 0

to

£15 : 15 : 0

### DAILY DEMONSTRATIONS

at the

**GRAHAM  
SHOWROOMS**

The ALGRAPHONE SALON

25-26 Savile Row,  
Regent Street, W.1

'Phone : Regent 1075.

### "MUSIC MASTER" HORN.

Type AR 13, 120 ohms .. .. £6 : 0 : 0

Type AR 15, 2,000 ohms .. .. £6 : 2 : 6

"GRAHAM" WIRELESS  
PRODUCTIONS INCLUDE  
"HIGH EFFICIENCY"  
TELEPHONE HEADSETS  
OF IMPROVED DESIGN  
AND CONSTRUCTION.  
THE "GRAHAM" IS THE  
BEST HEAD GEAR MONEY  
CAN BUY.

Full Particulars forwarded  
upon request.  
Ask for Folder P.W.

Patentees and Manufacturers:

## ALFRED GRAHAM AND COMPANY

St. Andrew's Works, Crofton Park  
LONDON - - - S.E. 4

'Phone : Sydenham 952. 'Grams : Navalhada, Brock, London

### SCOTLAND—

Mr. F. M. Milligan,  
25, Renfrew Street,  
GLASGOW.

### IRELAND—

Mr. Alex. R. Munday,  
41, Chichester Street,  
BELFAST.



# MORE ABOUT UNITS.

By E. BLAKE, A.M.I.E.E.

IN my last article I gave a simple explanation of how the practical unit of resistance, the ohm, was derived, and the following is a further elementary study of resistance.

For practical purposes the resistance of a conductor depends on its dimensions, and the difference caused by change of temperature may be disregarded. For different conductors of equal dimensions the resistance varies only by virtue of the nature of the material of which they are composed; a rod of copper one foot long and  $\frac{1}{8}$  in. diameter has less resistance than a rod of the same size and shape made of iron, and more than another similar rod made of silver.

### The Moral.

The dimensions upon which the resistance of a conductor depends are its length and the area of its cross or transverse section. The resistance varies, in fact, directly as the length and inversely as the cross-sectional area. This means, of course, that the lengthening of a wire tends to increase the resistance of the circuit, whereas the greater its cross-sectional area the less its resistance.

The moral, which applies with special force to the wireless set, is that no wire should be longer than absolutely necessary, and, wherever convenient, the wires should be as stout as possible. Do not, for example, have seven feet of wire between your accumulators and your valve, or a very long lead to earth.

This rule in simple symbolism is expressed  $R \propto \frac{l}{a}$ .  $R$  stands for Resistance,  $l$  for the length of the conductor, and  $a$  for the conductor's cross-sectional area. As this expression is not an equation, and does not permit us to substitute figures for its symbols, and thus find numerical values of various resistances, we must turn it into an equation. Please do not stop reading now, under the impression that I am going to annoy you with algebra. "Stick it" a little longer, and I think you will find it worth your while.

### "Stick it."

To turn  $R \propto \frac{l}{a}$  into a useful working tool, we have to complete the expression by introducing a factor which will account for the peculiar difference in the resistance of conductors of different materials. It is done like this:—

The ratio of  $R$  to  $\frac{l}{a}$  is constant; it is exactly the same whatever the value of  $R$  and of  $\frac{l}{a}$ , for the same kind of material, of course. It is  $\frac{R}{\frac{l}{a}}$ . Let us take a simpler case—our old friends  $x$  and  $y$ . In my school-days  $x$  was always walking to a place the examiner called A, and  $y$  invariably walked to B, and we were asked perplexing questions about their relative speeds. Generally  $x$  walked at the rate of something decimal something else (to five figures of decimals) per hour—an energetic, altogether loathsome athlete—and  $y$  nearly always walked slower.

Suppose  $x$  varies as  $y$ . This is usually written as  $x \propto y$ . Now, if  $x^a y^a$ ,  $x^b y^b$ , and

so on, are corresponding values of  $x$  and  $y$ , then the ratio of  $x$  to  $y$  is  $\frac{x^a}{y^a} = \frac{x}{y} = \frac{x^b}{y^b}$ , etc., to the end of the alphabet. Now, of all these expressions,  $\frac{x}{y}$  is the basis. It is a constant. It is common to all.

Similarly, whatever the value of  $\frac{R}{\frac{l}{a}}$ , be it  $\frac{R^a}{\left(\frac{l}{a}\right)^a}$  or  $\frac{R^b}{\left(\frac{l}{a}\right)^b}$ , etc., the constant is  $\frac{R}{\frac{l}{a}}$ .

Very good. Now, instead of "the constant is  $\frac{R}{\frac{l}{a}}$ ," we can write  $c = \frac{R}{\frac{l}{a}}$ . Why can we write that? Because "constant" is spelt with a "c," and that is good enough for algebra.

We have got as far as  $c = \frac{R}{\frac{l}{a}}$ , because  $\frac{R}{\frac{l}{a}}$  is a (c)onstant. If you remember any of your algebra—or if not, if you will take my word for it—the expression  $c = \frac{R}{\frac{l}{a}}$  can be transposed into  $R = c \times \frac{l}{a}$ . Try it in figures. Just put 4 instead of  $c$ , 8 for  $R$ , 4 for  $l$ , and 2 for  $a$ . You get  $4 = \frac{8}{\frac{4}{2}}$ . That is correct, is it not?

Then, if  $4 = \frac{8}{\frac{4}{2}}$ , it is equally true that  $8 = 4 \times \frac{4}{2}$ . Similarly, if  $c = \frac{R}{\frac{l}{a}}$ , it is equally true that  $R = c \times \frac{l}{a}$ . In words, this means that the resistance ( $R$ ) of a conductor is equal to the length of the conductor (or  $l$ ) divided by the area of the conductor's cross-section ( $a$ ) and multiplied by  $c$ . What is  $c$ ?

### Simple Figures.

Let us have recourse to simple figures. The simplest figure is 1. So, taking the equation we have made,  $R = c \times \frac{l}{a}$ , let us make  $l$  equal to 1, and  $a$  equal to 1. The result is  $R = c \times \frac{1}{1}$ . Thus,  $R = c$ . We

took  $l$  as 1, and  $a$  as 1, and if we call 1 one centimetre, and  $a$  (the area of the cross-section) one square centimetre, we find that the value of  $R$  is  $c$ .

Now a conductor which is 1 centimetre long and which is 1 square centimetre in cross-sectional area has unit dimensions under the C.G.S. system, which I explained in earlier articles, and its resistance  $c$  is called the specific resistance of that particular material of which it is composed.

### What it all means.

The summary of all the foregoing is to the effect that the resistance of any conductor to direct current is its length multiplied by the specific resistance of its material, and divided by the area of its cross-section. That is,  $R = c \times \frac{l}{a}$ . The specific resistance of various materials may be found in any electrical text-book, and is generally expressed as  $k$ , not as  $c$ , as I have done.

You will find  $k$  given as microhms per cm.<sup>2</sup> at 0° Centigrade. The spec. res. of copper is 1.5 as against 45.0 for iron and 4,000.0 for carbon; that of aluminium is 2.6 and of brass 6.2.

The resistance offered by a given conductor to direct current is less than its resistance to high-frequency oscillating currents such as those which flow in wireless receiving circuits. I hope to expand that statement in a future article, and to explain in a simple manner what is meant by "radiation resistance."

Send along your ideas to "Popular Wireless" and let other amateurs share them. If used they will be paid for at our usual rates.



A typical family party listening to an evening Radio Concert.



# GAMAGES

## INTRODUCE A NEW AND IMPROVED TWO-VALVE BROADCAST RECEIVING SET

A long series of experiments in the Gamage Wireless Station, which is equipped for Transmission and Reception, have resulted in the production of a new Two-Valve Receiving Set as illustrated and described on this page. Not only in complete sets is Gamage Enterprise manifest, but also in Apparatus, etc.

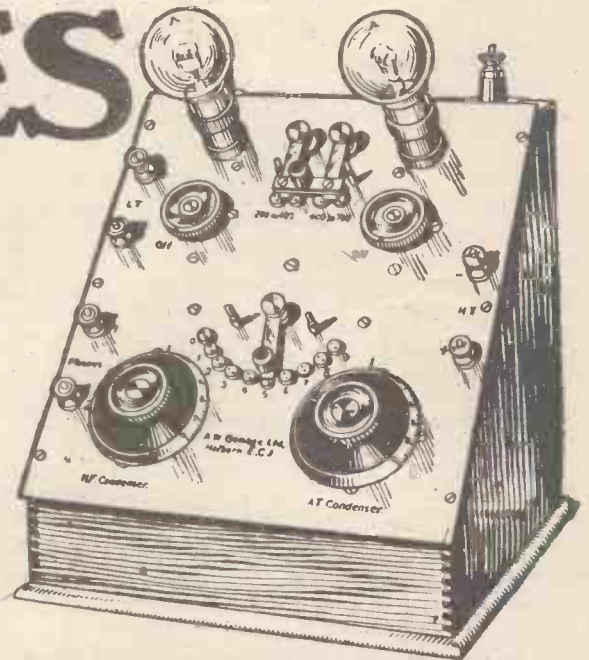

**GAMAGES TWO-VALVE BROADCAST RECEIVING SET**  
 Fully licensed and passed by the Postmaster-General. Regd. No. 2022. Designed to meet the requirements of the more advanced enthusiast. The combination is one H.F. and one Detecting Valve with an adjustable H.F. Transformer in two stages. The tuning inductances are contained in the cabinet and are varied by means of a nine-stud switch. The whole is mounted in sloping panel cabinet of polished mahogany. The complete set comprises Panel as above, Accumulator, H.T. Batteries, Phones, Aerial Wire, Insulators, Lead-in Tube, Switch—everything necessary to erect a high-grade and most efficient apparatus. Price £20 Carriage paid.

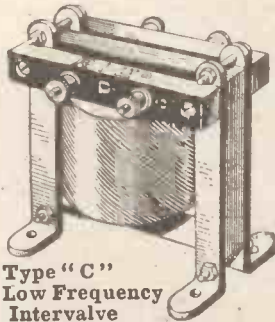

**Type "C" Low Frequency Interval TRANSFORMERS**  
 Type "C." Vertically constructed with laminations kept in place by means of an iron frame. Terminals mounted on ebonite bridges. A very efficient instrument for panel mounting. Small and compact. Ratio 5 to 1. Price 25/- Post free.

### MOVING COIL RELAY

A delicate instrument movement of extreme sensitivity. Of the moving coil type and provided with a platinum circuit closer in place of pointer. The contact screws are adjustable, and so arranged that the circuit closer can be set to move through an arc ranging from  $\frac{1}{2}$  to less than  $\frac{1}{10}$  in. Can be used as an ordinary or polarised relay where the greatest degree of responsiveness is required

42/-



### THE "PARLIPHONE" LOUD SPEAKER

(Prov. Patent No. 21967)  
 NO METAL USED IN ITS CONSTRUCTION. EQUAL IN EFFICIENCY TO THOSE THREE TIMES THE PRICE.

Horn and stand moulded in one solid piece of Ebonite. Contains no receiver, but the interior is screwed and made to receive a Brown's Patent Standard Receiver. Thus by simply unscrewing one car-piece from Head-phones and inserting in the "Parliphone" an efficient Loud Speaker is obtained at a small cost. The remaining car-piece can still be utilised for tuning in the ordinary way: As no metal is used in its construction, the objectionable metallic "ring" so common to most Loud Speakers is entirely obviated, the result being a rich mellow note without the slightest distortion.

Price 32/6 Packing and Postage, 1s. 3d. extra.

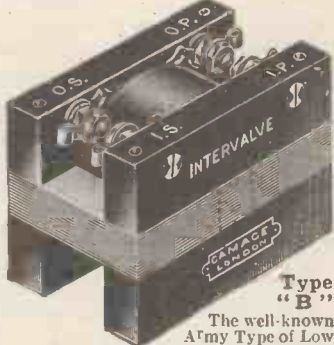

**Type "B"**  
 The well-known Army Type of Low Frequency Transformer. Small, compact, and in ratio of 5 to 1. A most suitable type for panel mounting, as size and weight have been carefully considered in construction. As illustration. Price 21/- Ditto, mounted in polished mahogany box, Price 25/- Post free.

21/-

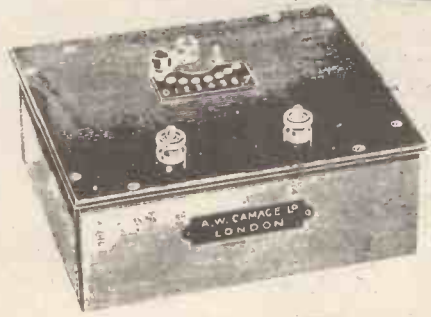

### HIGH-TENSION BATTERY BOX

Improved design with base board and green baize bottom. Finished in polished mahogany with ebonite top. Designed to give total output of 105 volts varied in seven steps of 15 volts. Price, container only 29/6 Complete with Batteries, ready for use, 55/- Small size to take 60 volts, 15/6 4 tappings, container only Complete with Batteries, ready for use, 31/- Batteries, 3/9 per unit of 15 volts.

29/6

**SPECIAL OFFER OF ACCUMULATORS.**  
 We have an extremely good Job Line in Glass Case Accumulators, which we are offering at the following low prices to clear:  
 2 volt 20 amp. Price 4/- 2 volt 40 amp. Price 5/- 2 volt 80 amp. Price 6/-

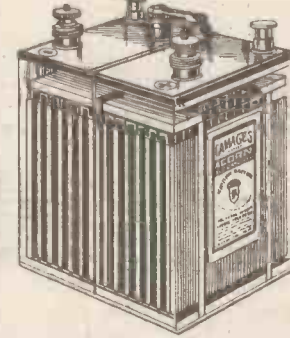

### GAMAGES "ACORN" ACCUMULATORS.

Famous for efficiency, power, and long life. British made with first-grade plates and stout celluloid cases.

4 volts 20 amps.	20/-
2 1/2 x 3 1/2 x 6 1/2 ins.	
4 volts 40 amps.	25/6
2 1/2 x 5 1/2 x 6 1/2 ins.	
4 volts 60 amps.	31/6
4 1/2 x 4 1/2 x 7 ins.	
4 volts 80 amps.	37/6
4 1/2 x 5 1/2 x 7 ins.	
6 volts 60 amps.	47/6
6 1/2 x 6 1/2 x 7 ins.	
6 volts 80 amps.	5/-
8 1/2 x 6 1/2 x 7 ins.	

### SPECIAL HIGH-TENSION BATTERIES

These batteries (as illustration) have been made especially for us, and are well known for their great efficiency, long life, and general adaptability. They can be easily connected together to form a suitable H.T. Battery for valve work, or we can supply them ready mounted in our special battery boxes. We are now able to offer these batteries at the low price of 3/9 of Size 9 in. x 3 in. x 2 in. Post extra.

3/9



### Pure Copper SWITCHES.

Mounted on Porcelain bases. Single pole, double-throw switch 4/6 Double pole, ditto, 6/6 Double Pole, single-throw, 5/6 Similar Type on Ebonite Bases, giving better insulation. Single Pole, double-throw, 6/6 Double Pole, ditto, 9/- Post 6d.

Send for Wireless Catalogue To-day  
 A copy of the New Edition sent post free on request

**A. W. GAMAGE, Ltd., HOLBORN, LONDON, E.C.1.**



# SEEING BY WIRELESS.

By SEXTON O'CONNOR.

FOR the successful transmission of visual effects, either by ordinary line-telegraphy or by wireless, the first essential is to provide an efficient "light-sensitive" device, i.e., one which will respond rapidly and accurately in its electrical qualities to the stimulus of light-rays of varying intensity. In the ordinary process of photography the completed negative represents the result of the impact of light-rays of varying strength upon a chemically sensitive surface. Given the assistance of an equally responsive electric equivalent of the chemically sensitive photographic plate, the problem of picture-transmission becomes a comparatively simple matter.

### Early Experiments.

Up to the present, fairly successful results have been attained in photo-transmission over telegraph lines by the use of light-sensitive cells made of selenium, tellurium,

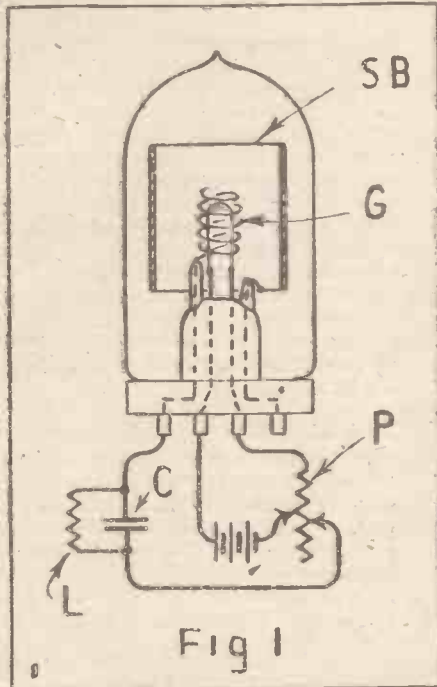

Fig 1

stibnite, and certain similar substances. Such bodies are characterised by the fact that their electrical resistance changes in accordance with the degree of light intensity to which they are exposed. Accordingly, when inserted in an electric circuit, the value of the current flowing in that circuit will reflect the varying strength of a beam of light focused upon the cell.

By interposing a completed photographic negative between the source of light and the selenium element, and gradually moving the negative in such a way that successive small sections of the plate or film intercept the ray in an ordered sequence, a series of current changes will be created corresponding to the varying gradations in light and shade which constitute the picture.

These current fluctuations will, of course, be repeated at the distant end of the electric circuit, and can be synthesised so as to

build up the original picture in several ways. One method, for example, consists in passing the varying current through a specially sensitive electric glow-lamp which is carefully adjusted to emit a certain degree of light. Every increase in the current will then raise the light-intensity of the glow-lamp, whilst a fall in current will lower it. The light from the lamp is focused upon a specially prepared photographic surface which is moved at a rate corresponding with the movement of the picture at the transmitting end.

The drawback to all such methods employing selenium and like sensitive cells lies in the fact that such cells do not react the varying light-intensities with that accuracy and constancy which is essential to produce satisfactory results. After a certain time their light-sensitivity diminishes and becomes unsteady. Further certain other "lag" and inertia effects arise which practically render it impossible to secure clear-cut transmission.

Another class of "electric light-sensitive" device was discovered by Wilhelm Hallwachs in 1888. He found that certain alkaline metals, such as sodium, potassium, and rubidium, as well as their hydrides and amalgams, emit streams of electrons upon being exposed to light, more particularly ultra-violet light. Many attempts have been made to utilise photo-electric cells of this kind to secure telegraphic transmission of pictures, but without any considerable success owing to the fact that they, too, rapidly lose their sensitivity after they have been exposed to light for a certain time, unless the active surface can be kept constantly renewed in some way or other. This either means a constant scraping of the surface or a recoating with fresh amalgam, a process which, up to the present, has proved neither very practical nor feasible.

### A Practical Solution.

Recently, however, a remarkable solution of the problem has been suggested by an American named Hendrick Nakken. His invention, broadly speaking, consists in combining the actino-electric properties of the alkaline metals with the well-known action of the ordinary thermionic valve. Suppose, for example, the usual nickel anode of an ordinary two-electrode Fleming valve is replaced by a plate of sodium-potassium amalgam, or by rubidium, or by any other metal showing the Hallwachs effect to light. Then after the filament has been lit for a certain time there will exist within the tube a condition of equilibrium. The plate (if insulated) will acquire a certain steady potential and as many electrons will return to the filament per second as are emitted from it.

If now a beam of light strikes upon the sensitive plate, it will respond by the immediate emission of a stream of electrons, the number of electrons so emitted varying with the intensity of the directed ray of light. This action is of course accompanied by a corresponding drop in the potential value of the plate, which in turn is reflected in the current value in the external plate circuit.

When the source of light is removed, the

original conditions are instantaneously restored; the plate resumes its normal potential and the plate current reverts to its steady value.

Owing to the constant supply within the bulb of free electrons emitted from the glowing filament, the "actino-electric" plate is not subject to the "fatigue" defects which frustrated the former attempts made to utilise the Hallwachs effect. As previously pointed out, after a certain period of use under ordinary circumstances, the metals seem to exhaust their stock of available electrons and to require either the exposure of a fresh sensitive surface to the ray of light, or else a period of recuperation before the light-sensitive action could again be relied upon.

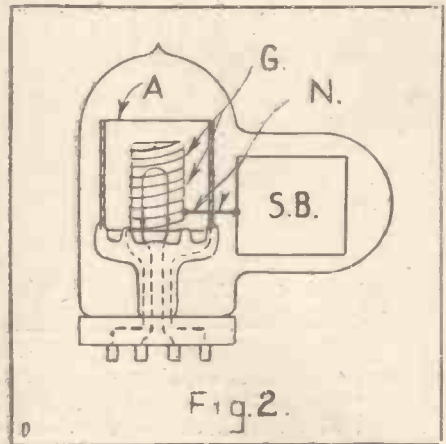

Fig. 2.

Under the conditions existing within the evacuated valve, there is a constant supply of free electrons always available and the impact of the light-rays is responded to instantaneously and quantitatively. Fig. 1 shows a three-electrode valve provided with a photo-electric plate or anode S.B. A grid G of the ordinary type is provided with a condenser and leak C L is maintained by means of a potentiometer P at a slightly positive potential relatively to the filament.

The grid G serves to augment the normal potential drop on the plate caused by the impact of a ray of light. Actually it secures this result by providing a source of attraction (owing to its positive potential) to the electrons shot off from the plate under the effect of the ray of light. The current effect so created in the plate circuit is in this way increased by the action of the grid, just as in the normal type of valve.

In the form of construction shown in Fig. 2, the sensitive body S.B. takes the place of the grid. In order to keep the sensitive material as far away as possible from the heat of the filament it is located to one side as shown, and is connected by a wire N with a wire-mesh grid G, so that both S.B. and G always have the same potential. The plate A, or anode proper, is supplied with a high-tension of 40 or 70 volts.

Under normal conditions the sensitive body S.B. functions either to clog or accelerate the electron stream from filament

(Continued on next page).

# A HOME-MADE TELEPHONE TRANSFORMER.

By J. B. PHILLIPS.

THERE must be quite a number of wireless amateurs who, like myself, have purchased ex-Government or other low-resistance 'phones and who doubt their ability to make an efficient transformer, and yet wish to make as much of their apparatus as possible. I therefore propose to describe the construction of a transformer on the lines of one that has given, on either crystal or valve reception, complete personal satisfaction.

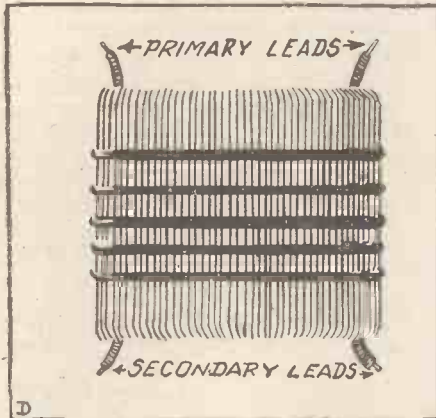

The first item to be constructed is the former or bobbin upon which the wire is wound. This is made from a thin ebonite tube, 3½ in. long, and of ½ in. internal diameter, with 2 blocks of ¼ in. ebonite drilled to fit snugly over the ends. Before fitting together, the ends of this tube should be given a coat of thick shellac in order to stick firmly to the ebonite cheeks.

Some sort of winding machine is now necessary. The author constructed one from "Meccano" gearing and spindles giving a ratio of 8 to 1. Of course, a lathe is the best machine to use, but only the more fortunate are in the happy possession of such a luxury.

Whatever winding machine is employed, the bobbin must be gripped firmly and must not revolve eccentrically.

The secondary or thicker wire, 1200 turns of 38 gauge S.W.G. which (slightly over ¼ oz.) is wound on first. Before commencing to wind, and when each winding is finished, solder a short length of flex (rubber-covered) to the end of the wire. If a break occurs it should be carefully soldered and then enamelled. Three or four thicknesses of well-shellacked cartridge paper, wound carefully round the secondary, form the inter-winding insulation.

The primary, 3½ ozs. of 42 enam., is then wound on, beginning and ending as before with a flexible lead. Winding can run from the one side to the other and then back again.

Four holes, for terminals, should now be drilled in the cheeks and the leads connected.

The transformer is of the hedgehog type with a core formed of 10 in. lengths of 22 gauge iron wire. This is pushed through the ebonite tube and bent round in the form of the lines of magnetic flux or in the form of two capital O's back to back. If the wire tends to spring outwards it may be bound with linen tape, which should subsequently be shellacked.

The total cost of this transformer should not exceed 8s.

# AN UNDERGROUND AERIAL.

By A. H. DALY.

BETWEEN Great Britain and America there is a wall of earth and water nearly 100 miles high, caused by the curvature of the earth. In order to get from one country to another wireless waves must either travel over this wall or through it. The majority of scientists are of the opinion that wireless waves travel over this wall via the atmosphere, but others—notably Dr. Rogers—maintain that the waves are propagated through the earth as well as through the atmosphere. To prove his theory Dr. Rogers has demonstrated that with an underground aerial 400 feet long and upwards wireless reception is quite possible for practically all ranges.

## Scope for Experiment.

Now another American, Mr. E. Jones, has added further proof to Dr. Rogers' contention that wireless waves travel through the earth by producing successfully an entirely new type of underground aerial which can be made by practically anyone without the digging necessary with Dr. Rogers' 400 feet arrangement.

This new aerial consists of two coils of insulated wire, each coil having a diameter of about 2 feet and containing from 200 to 1,000 turns of wire, dependent upon the wave-length required. These coils are dropped on to the bed of a river or lake, or buried under the ground in moist earth, and connected up to an ordinary wireless receiver with a two-step amplifier. The end of one coil is connected to the aerial terminal on the receiver, and the end of the other coil is connected to the receiver's earth terminal. The remaining two ends of both coils are left free.

## Total Elimination.

In the actual experiments stations over 500 miles away came in quite as strong as with the normal overhead aerial. The great point about the underground aerial, however, is with regard to atmospherics; for, whereas with the overhead aerial reception from distant stations was almost impossible owing to atmospheric disturbances, the same stations could be read quite easily when the underground aerial was used, for atmospherics were practically nil.

According to the inventor, total elimination of static can be accomplished by screening the receiver and leads joining the latter to the coils, and, in addition to this, screening the operator. This new type of aerial provides ample scope for experiment on the part of the amateur who has a back garden available or who is near a lake or river. The coils must be placed 30 feet apart, and the holes in the ground must be dug deep enough to ensure fairly moist earth.

# SEEING BY WIRELESS.

(Continued from previous page.)

to anode in the ordinary way, just as though it were not made of light-sensitive material.

But when the grid SB or input current is subjected to light-rays of different intensities, characteristic potential variations arise due to the Hallwach's effect, and are reflected in corresponding but greatly amplified current variations in the plate or output circuit of the valve.

By retroactively coupling the grid or input circuit of the valve shown in Fig. 2 with the plate or output circuit, high-frequency oscillations will be generated and can be fed to a transmitting aerial in the ordinary manner. These continuous oscillations, when modulated in accordance with the visual effects applied to the grid, will then radiate through the ether the necessary electrical effects to enable a suitable receiver to reconstitute the picture at the receiving end.

Along these lines it may soon be possible to broadcast the latest cinema film.

# 2 M T ON ONE VALVE.

A GLASGOW amateur has received 2 M T on his one-valve set.

He managed to tune in after considerable difficulty, for naturally the signals were not very strong. Clear reception was at last obtained, however; but unfortunately only to hear the announcement that 2 M T was "now closing down."

Writtle is about 350 miles as the crow flies from Glasgow, and, while the power at the former may recently have been increased, it is certain that only a few weeks ago reception on one valve of 2 M T music at Glasgow would have been regarded as the merest freak.

Writing of the transmission from Writtle on August 15th, Captain Eckersley remarked that he had had reports of single valve reception at St. Austell in Cornwall (250 miles), and that a few words had been heard on a single valve at the Forth Bridge.

But this is very different from hearing 2 M T satisfactorily at 350 miles.

# AMATEUR PHOTOS.

If you have built your own set, send a photograph of it along to "Popular Wireless." A fee of 10s. 6d. is paid for every Amateur's Photo used, and 25s. if printed as a Cover Plate.



# A TWO VALVE L.F. AMPLIFIER.

By A. ASHBY.

**T**HERE are a large number of amateurs who possess crystal and single-valve sets who are just capable of receiving the concerts now being broadcast, but cannot get them sufficiently loud to hear them distinctly or to use a loud speaker. Now, the volume of sound can be materially increased by audio or low frequency amplification. Each valve will amplify about five times, so with two valves we shall get signals approximately 25 times the strength they were at the input terminals of the amplifier.

### The Transformer.

The method used to couple valves together for low-frequency amplification is by means of iron core step-up transformers. It will pay the amateur in the long run to buy these transformers, and there are a large number of reliable makes on the market. The reader is advised to obtain them from a reliable firm, as badly designed and inefficient low-frequency transformers tend to produce noises in the phones which completely spoil any telephony or signals received.

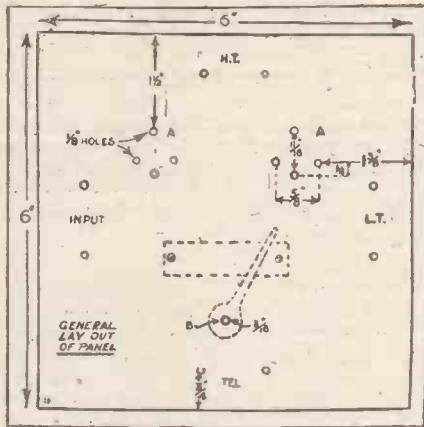

Fig. 1.

The amplifier described below can be coupled to any receiver, and any amateur with a slight genius for constructing his own instruments (which most radio enthusiasts possess) will find this quite within his power, and a valuable adjunct to his gear.

A piece of ebonite will be required 6 inches square by 1/4 inch thick. The edges of this should be nicely rounded and the top given a smooth matt or polished surface, according to type of finish preferred. A good matt surface may be obtained by rubbing the ebonite with pumice powder and linseed oil, or, if the polished surface be preferred, the matt surface should be rubbed with "rottenstone" and finished with metal polish, when quite a high gloss will be obtained.

The ebonite should be marked out according to Fig. 1, and the holes drilled to the respective sizes as marked.

The next item will be the filament resistance. For this procure a piece of 1/2-inch

ebonite rod about 2 inches long. Two 1/8-inch holes should be drilled through the ends, as shown in Fig. 2 (a). Lay the rod on the back of the panel about 1/4 inch above the 1/8-inch hole drilled for the resistance arm, clamp the end of the rod in position, and mark through the two holes already drilled in the rod.

This will give the position on the panel of the holes for fixing the rod in position. Now unclamp the rod from the panel and drill two 3/32-inch holes almost through the panel and tap them 1/4th. The ebonite rod should then be wound with No. 24 gauge enamelled resistance wire.

Procure a piece of 1/8-inch brass rod and thread it 2 B.A., or 1/8-inch Whitworth, as shown in Fig. 2 (b), and from a piece of 22 gauge sheet spring brass cut out the arm to the measurements shown in Fig. 2 (c). On the end of the brass rod, which is threaded down for 1/2-inch, screw a brass collar about 3/8 inch thick.

If a brass collar cannot be obtained or made, two B.A. or 1/8-inch Whitworth (according to the type of thread to which the spindle was screwed) brass nuts to make up the distance piece will do.

### Filament Resistance.

Now place the spring brass arm on the spindle and screw a nut on to lock the arm in position. The ebonite rod wound with the resistance wire should now be permanently fixed by means of two 1/8-inch cheeseheaded screws to the panel. One end of the resistance wire should be soldered to the head of one of the screws, the other end being left free, which can be held down under the ebonite rod.

Now place the spindle and arm through the hole drilled in the panel marked "B" in Fig. 1, and drop a washer over the spindle on the front side of the panel. Screw an ebonite knob tightly on the spindle, making sure that it does not lock the spindle but enables it to turn easily.

The enamel should be carefully removed from the resistance wire. This can be done by turning the knob a few times and so moving the arm along. The cheeseheaded screws should act as stops and so prevent the spring brass arm from going too far and coming off the ebonite rod.

Eight valve legs will be required, and it will be best to buy these as they can be obtained quite cheaply. These are fixed in the holes marked "A" in Fig. 1. Eight terminals should be fixed to the panel. The size of the holes to be drilled in the panel for these can, of course, be determined by the amateur when he has finally decided upon the type and size terminals he thinks best to use.

The box can now be constructed from 1/2-inch mahogany, the inside measurements being 5 1/8 inches by 5 1/8 inches. The depth will be determined by the height of the transformers decided upon by the amateur. About 3 1/2 inches will be found ample in most cases. Brass screws should be used for holding the box together.

Small triangular pieces of wood the depth of the box glued into each of the corners will be found to greatly increase the strength of the cabinet. The bottom of the box should be left 1/8 inch wider all round than the outside measurements. The four edges should be rounded off before fixing to the sides. To give the box a finished appearance it should, after having been nicely sand-papered, be french polished or stained and varnished.

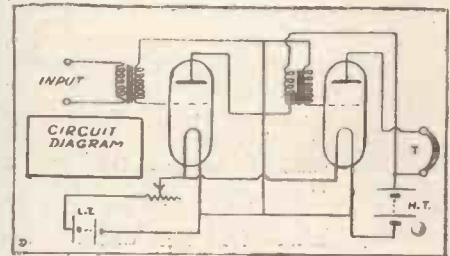

Fig. 3.

It is now necessary to wire up the panel, which should be done according to Diagram 3; 22 gauge bare copper wire threaded through systoflex covering will be found best, and make the neatest job.

### The Complete Instrument.

The panel can now be screwed with small brass screws on to the top of the mahogany box. A semi-circular ivorine scale can be glued or fixed by means of two small brass screws round the filament resistance knob, a small arrow being scratched and filled in with Chinese white to give the readings on the scale. Or of course a better job can be made of it by fixing a small brass pointer to the under side of the ebonite knob.

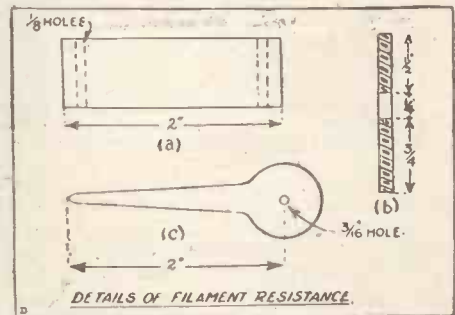

Fig. 2.

The terminals should be marked by any means which the amateur thinks best, so that no mistake should be made as to the correct terminals. Small ivorine plates can be procured from most wireless firms which can be fixed to the panel. Of course, the neatest appearance would be obtained by sending the panel to one of the wireless firms which do engraving work and have it engraved. The instrument is now complete, and may be connected in place of the phones in almost any receiver circuit.

Tele. :—  
HOP 134

# IMPORTANT

We have opened very commodious premises at  
**54, GRACECHURCH STREET, LONDON, E.C.3**  
for the demonstration and sale of all types of  
**WIRELESS RECEIVING SETS** and **"CLARITONE" LOUD SPEAKERS.**

*Amateurs and Experimenters will be able to obtain every part required for any type of Set*

INCLUDING—

Transformers, L.F. and H.F.  
Headphones (all types, all resistances).  
Condensers, variable and fixed (all capacities).  
Vario-Couplers and Variometers.  
Coil-Holders and Coils.  
Anti-Capacity Switches (all types).  
Rheostats (all types).  
Radial Switches (5, 10, and 15-way).  
Valves (M.O. and Mullard's).  
Ebony Valve Holders, Dials, Scales, other parts and in Sheet.

Brass W.O. and Telephone Type Terminals,  
Nuts, Washers, Contact Studs, and all other parts.  
Accumulators.  
Dry Batteries.  
Aerial Wire.  
Insulators.  
Hertzite, and Galena Crystals.  
Cotton and other Tubings (all colours).  
Etc., etc.

PRICE LIST ON APPLICATION

**PETTIGREW & MERRIMAN, LTD., 122-124, TOOLEY STREET, LONDON, S.E.1.**

NOTE—54, Gracechurch Street is a few yards from Monument, Eastcheap, Bank, Cannon Street, and London Bridge.

## Poor 'Phones mar the Programme



RECEIVING broadcast music through bad 'phones is like trying to read F L telephony on a crystal—the results are the same—very poor.

Fit Ericsson 'Phones—and listen. Hear the sigs. come through like a flute. No metallic sounds or distortion. Mark how the natural tone of voice and instrument is preserved.

A user writes: "I am fortunate enough to possess a pair of your 'phones."

Light and comfortable, well-balanced and delicately accurate withal, robust in construction, Ericsson 'Phones connect up as the ideal 'phones for your receiver.

Write to-night for free illustrated list.

BRITISH L.M. ERICSSON  
MANUFACTURING Co., Ltd.  
International Buildings,  
67/73, Kingsway, W.C.2.

**Ericsson**

"The Services use them."

**Telephones**

## RELIANCE RADIO SERVICE CO.

### THE "RELIANCE" CRYSTAL RECEIVING CABINET.

Consisting of Ebonite Panel mounted in Oak Cabinet with lid; Tuning Coil and condenser, Patent Crystal Detector, totally enclosed in glass; 4,000 Ohms Double Headphones; 100 feet of Stranded Copper Wire; 2 Shell Insulators.

No further outlay, no batteries required. Each set has been tested and carries our guarantee, and we confidently assert that for the price it is the most compact and reliable that is obtainable.

PRICE COMPLETE

£3-5-0

INSTRUMENT ONLY

£1-12-6

We have also a complete range of Valve Sets in stock from £7 to £20. Call and inspect the famous FELLOPHONE 2-Valve and 4-Valve Receiving Sets, prices complete, £10 10s. to £17 10s. respectively. Also the FELLO-CRYST SUPER Crystal Receiving Set, price £4 7s. 6d. complete. All our sets are passed by the P.M.G. for reception of broadcasting. All sets open to inspection at our London address. Demonstrations given daily. Hours 10 a.m. to 6-30 p.m.

ILLUSTRATED CATALOGUE  
POST FREE.



(P.O. Registered No. 277.)

**RELIANCE RADIO SERVICE CO.,**  
283, St. John Street, Clerkenwell, London, E.C.1.

PHONE: CLERKENWELL 4290.



# AND SO IT GOES ON.

By HIGHAM BURLAC.

GEARY, my next-door neighbour, chose to be sarcastic about my wireless set, and when I put up my mast he was shaken so much with merriment by his own jokes that he dropped his pipe into a bucket of creosote. He erected a weathercock on his summer-house and christened it "Marconi's Crow." Geary is a third-rate wit, the sort of humorist who shines brilliantly over dominoes in a teashop.

One summer evening I brought some apparatus, including a loud speaker, on to the lawn, and secured good and uninterrupted results from — Station. My friends enjoyed the music immensely, and some of the flappers footed a one-step-footed it right into the cucumber-frame, as a matter of fact. Geary prowled about on his side of the fence, pretending to weed, while Mrs. Geary found it necessary to do something to the trellis.

After the show, whilst I was disconnecting the set, Geary lounged across. Said he: "Did you hire that gramophone?"

"No, sir," I replied.

"Well, how many soap wrappers did you collect for it?"

"You know we never use soap, Geary. The idea!"

"Well, why do you do it? You can't like it. Did you spot the Crow—she whirled like a mad thing. And I don't wonder at it. Couldn't have been worse if it had been your wireless doo-hickey."

"So it was, Geary, so it was!"

Letting it "Rip."

He stopped and stiffened all over for just a fraction of a second, incredulity stamped on his face as plainly as the date on an income tax demand note. Then he crawled out, as follows:

"Ah! I thought there was a catch somewhere. I knew no gramophone could scare a tin crow."

A week later I noticed a wire hanging out of Geary's bathroom window. Geary did very little in his garden after that. Then young Bill Geary waylaid me and asked me what time — Station gave its weekly concert, and what I thought of carborundum. After that his father admitted to me that the boy was "fooling around with some wireless toy or other."

In a month the Gearys had discovered the inefficiency of a crystal set used with an aerial hidden in the creeper on the wall, and "Marconi's Crow" helped to support one end of 35 feet twin-wire aerial. Geary loudly declared that the garden was lowered in tone, and that he might as well keep ferrets and a goat or two. But I noticed the red marks on his ears where the telephones had pressed.

By the time the new broadcasting station got to work, Geary had introduced a valve, and was trying to bury a huge bath for an earthplate. Then he scrapped his set, bought four of the famous Thunder Units, and began to charge accumulators in the coal-cellar. Our loud speakers roared in dreadful unison, and when Geary took Eiffel Tower time-signals on five valves the critical "dot" used to shake the bottles in the "Coach and Horses" at the corner of the street.

When I returned from my holidays I noticed that "Marconi's Crow" was missing, and made anxious inquiries.

"Yes," said Geary, "the old fowl has fallen! I blew her down last night with the Hallelujah Chorus on nine valves and a stentorphone. Say! What's this Armstrong's super-regenerative circuit like?"

Geary's motto now is: "Let Mars know it."

## MOUNTING HONEYCOMB COILS.

A SIMPLE, but effective, mounting for honeycomb coils is shown in the diagram. By making use of this arrangement, delicate adjustments can be made to the apparatus, and self-capacity effects from the hand can be obviated.

The device should be mounted on the back of the panel, and the method of construction can be seen from the illustration.

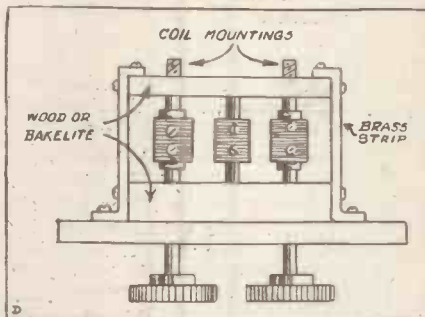

The two rods to which the movable mountings are attached are brought through holes drilled in the two pieces of bakelite or wood.

Two strips of fairly heavy brass are used as supports, being fashioned to the shape required and firmly attached by screws, as shown.

## HINTS TO AMATEURS.

IT will be found quite simple to wind a resistance for the filament, or some other similar control, if tackled in the following manner: Assuming that a straight resistance with a slider is to be made, a large slate-pencil, or piece of slate shaped to suit the panel, is first shellacked with varnish, and then wound with two wires close together. After the full length is wound fasten the ends, and shellac the whole again, and when quite dry take off one wire carefully; this will leave a space the thickness of the wire taken off between the turns, and an evenly wound resistance will result.

When drilling slate do not use any moisture, and drill it slowly. If moisture is put on the drill it will soon get its edge taken off, and if drilled too quickly the drill will get hot and in all probability jamb in the slate and break it away.

When slate is being used it should be well dried out in an oven and given two or three coats of black french polish. The first coats will sink in, but a good finish will result after the application of a further one or two.

If your set is made up on a wooden base the insulation value may be greatly increased by screwing or gluing a small piece of ebonite at each of the underside corners of the board. Economical substitutes can be provided from out an old quarter-plate negative. Just cut this into four pieces, and stick them on with seccotine or some similar adhesive.

A good method of joining the ends of two or more wires is to fold a piece of thin copper sheet or copper tube on the ends, which should be thoroughly cleaned, and then press them tightly in the vice or with a pair of pliers. Then make two or three dents with the cutting edge of the pliers, making sure not to press hard enough to cut right through. This applies to wires of 20-gauge and over.

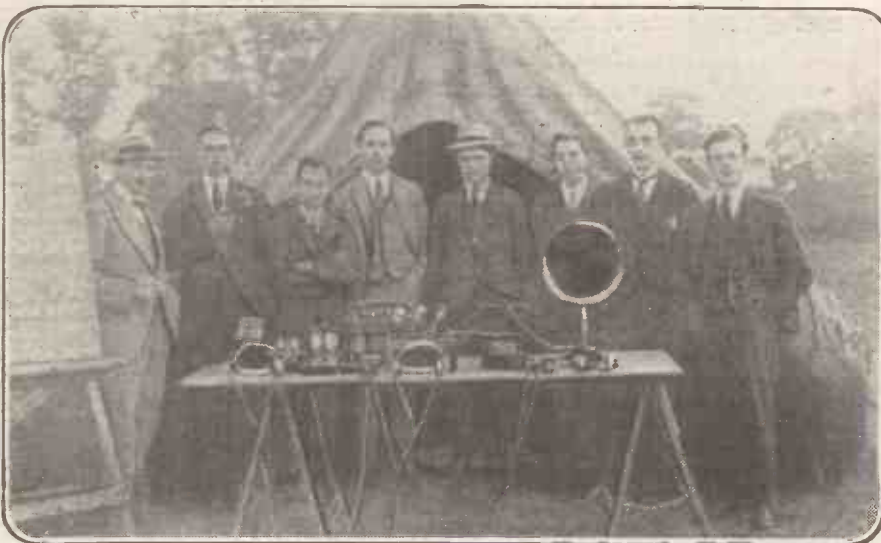

The Anerjey Wireless Society and their Club Set.

# DESIGN AND ERECTION OF MASTS.

THE simplest and cheapest form of steel mast, say about 40 ft. in height, is the tubular type, built up of a number of lengths of weldless tubes. Each length is of smaller diameter than the one beneath it into which it fits, thus giving a tapering effect. One end of each tube is screwed externally and the other internally, for screwing together, end to end.

The tubes are all galvanised and enamelled, to avoid the necessity for frequent painting to protect them from rust. Round one of the sockets are rings for attaching the ends of guy ropes for staying the mast. Instead of supporting the aerial on a fixed cross-bar, at the top of the mast, a metal cap carrying two pulleys may be fixed so that each aerial may be lowered when required for inspection or renewal.

Another type consists of a built-up lattice mast suitable for greater heights, similar in fact to the 210-foot mast illustrated, but lighter in proportion to the height. The corner pieces or legs consist of light, rolled-steel angle bars, rigidly braced together in two directions by other angle and flat bars,

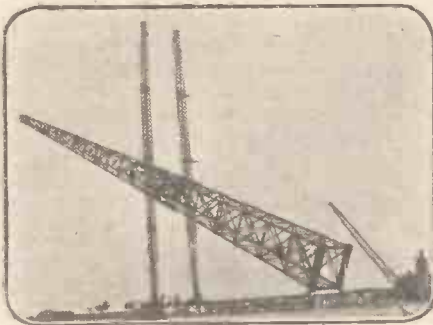

Raising the Mast on supports.

so as to form a tapering box column with either three or four sides, according to whether a triangular or square cross section is desired.

Up to a certain limit of height and weight, such comparatively small masts present no difficulty in the matter of erection, but the erection of big masts for commercial stations presents unusual problems, two solutions of which may now be described.

The mast illustrated is 210 ft. high, with four legs each consisting of rolled-steel channel bars and plates, braced together in panels. This mast was one of a number constructed for the British War Department for experimental purposes, and affords an excellent illustration of how self-supporting masts of moderate height may be rapidly erected. The legs form four corners of a square in plan and are spaced 12 ft. 6 in. apart centre to centre at the base, and 3 ft. 1 in. at the top. At intervals there are steel plate platforms inside the tower supported by brackets on the tower legs, with ladders rising from one platform to another from ground level to the top of the mast.

The foundation consists of a concrete slab measuring 25 ft. by 25 ft. and 2 ft. thick, supported on piles driven down to a firm foundation. There are three diagonal guys

of steel wire rope 3 in. in circumference, from the top of mast to three points 127 ft. from the centre of tower, where they are anchored to concrete blocks buried in the ground.

## Various Methods.

The method of erection was as follows: The mast was riveted up complete, in a horizontal position, on stagings, so that it lay across its permanent concrete foundation, with the base end some distance from it, the portion lying across the foundation being strengthened by additional bracing bars. A pair of steel channel guides were laid on one of the stagings, and at the feet of two of the tower legs a pair of wheels was mounted.

A pair of temporary, vertical, light steel posts, of about half the height of the tower, were then erected and stayed temporarily by guy ropes. On top of these a set of pulley blocks was mounted, round which steel wire lifting ropes from a winding winch were passed. The other ends of the ropes were secured to the reinforcing framing of the mast by means of steel shackles and a huge shaft, 5 in. in diameter, passing right through the tower and projecting on each side of the bracing, where the shackles were secured.

The centre of gravity of the whole mast, which weighed 40 tons, had to be carefully calculated so that the lifting pull should occur as near the centre of gravity as possible, but at the same time so that the weight of that portion of the tower from the shaft to the base should slightly overbalance the portion on the other side.

When everything was in readiness the winches were started and, as the tower rose, the base travelled towards its foundation on the rollers in the channel guides until the tower reached a vertical position, when the whole weight of 40 tons was suspended on

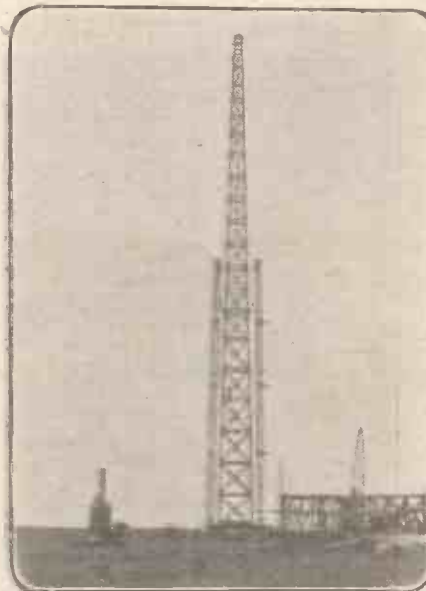

Showing the two "Lifting Masts."

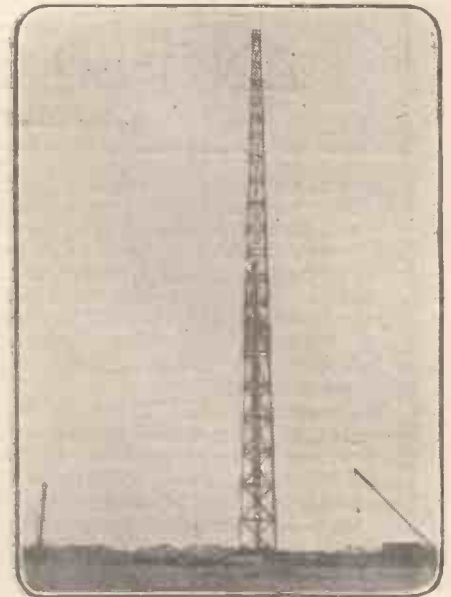

The completed Aerial Support.

the steel wire lifting ropes, clear of the concrete foundation. The whole operation was carried out in 30 minutes, without a hitch. The guide wheels and channel guides were then removed, and the tower was lowered on to its foundation, to which it was securely bolted. The guy ropes were then attached, and the temporary lifting masts and tackle were dismantled ready for erecting the next tower.

Whilst this ingenious method is eminently suitable for self-supporting towers up to a certain height, other methods have to be resorted to in the case of tall masts that depend upon guys for support, and of great wireless masts four or five hundred feet or more high and weighing far more. These cannot be lifted bodily, since the cost of suitable erecting tackle, added to that of stiffening the masts themselves sufficiently to stand the stresses set up during erection, would be prohibitive.

In the case of such a tower, the lowest completed section could be lifted in a similar manner, but it is more usual to erect them vertically, a panel at a time, from ground level. Even so, the erection of the higher portions, and the lifting and attachment of the guy ropes, the weight of which alone runs into tons, presents no mean problem. Elaborate precautions have to be taken against storms that may arise, and for the safety of the workmen. Moreover, at such great heights it is difficult to secure even good workmanship from the men, since it requires an iron nerve to withstand the distressing influence of working in a comparatively small space at such elevations.

On one occasion the writer mounted to the very top of a completed steel tower 500 ft. high, when work was not proceeding. There was a brisk wind blowing, and the vibration was such that, although there were no loose or unfinished joints, there was a metallic rattle like a dozen pneumatic riveting hammers at work. The top of the tower swayed several inches and, although there was an iron railing, I do not mind confessing that I did not remain up there any longer than was necessary.

We are indebted to Messrs. Braithwaite and Co., of London, for the photographs reproduced.



# T.M.C. Wireless

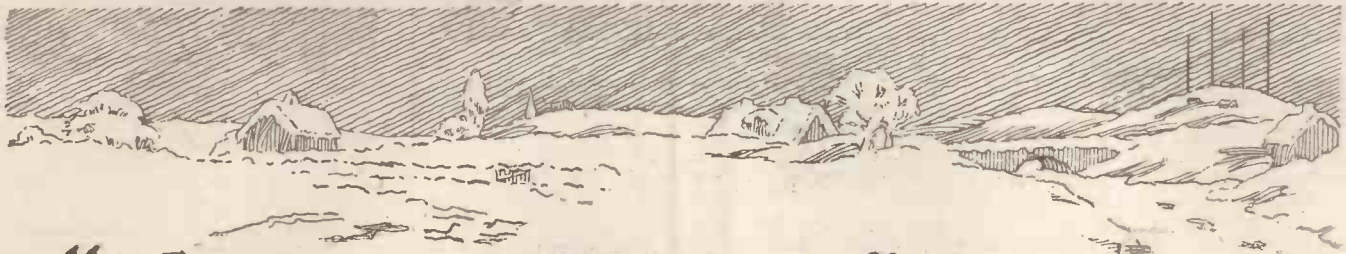

## “A Merry Xmas” Say it with wireless

and give a Present, which is new and brings continuous enjoyment.

T.M.C. offer you a complete range of wireless receivers from simple crystal receivers to cabinets de luxe.

The illustration shows a

T.M.C. CRYSTAL SET No. 2, with patent Everset Crystal, which needs no adjusting.

**£5 : 7 : 6 each**

(Plus Broadcasting Royalty)

T.M.C. Wireless Receivers give vocal, orchestral and dance music from the British Broadcasting and ensure **A Merry Xmas.**

**CALL AND CHOOSE YOUR PRESENT TO-DAY.**  
If you cannot call, full particulars will be sent on request.

**The Telephone Manufacturing Co., Ltd.,**  
Telephone: MUSEUM 5581., **68, Newman Street, W.1.**

We have engineers in every large town, who install the wireless to your satisfaction.  
**London, Manchester and Birmingham are Broadcasting Now!**

# T.M.C.

## makes Wireless worth while

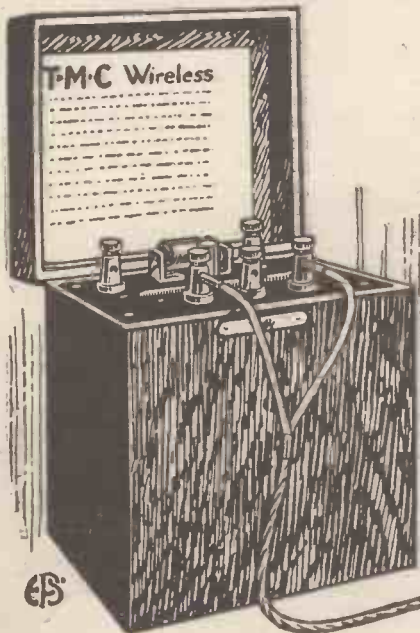

# HOW TO MAKE A D.F. STATION

By MICHAEL EGAN.

## PART 5

IN the previous articles we have seen how directions and positions of wireless transmitting stations can be obtained by means of one or two frame aerials respectively. In each case, it will be remembered, the "minimum" method was employed. That is, directions were found with reference to the point of weakest signals on the compass card.

The advantage of working on weakest signals is, of course, due to the high sensitivity of the aerial when its plane is at right angles to the transmitter. There are, however, circumstances under which it is not possible to take advantage of this

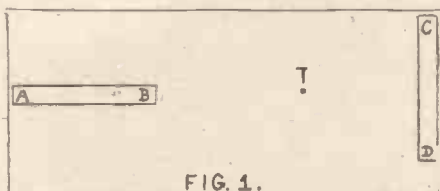

FIG. 1.

increased sensitivity. For instance, it would be quite useless to attempt to work a frame aerial on minimum signals in an aeroplane.

### An Important Advantage.

The noise of the engine would completely drown the weak signals that would be received when the aerial was swung round to the minimum position. On the other hand, maximum signals which could be read through the roar of the engine would give such insensitive results that an error of 10 degrees might pass unnoticed.

For this reason wireless research was for a period directed to the problem of devising a method of direction-finding which would be capable of combining *loudest* signals with *greatest* sensitivity. This was successfully achieved; the results are embodied in a system which is usually referred to to-day as the "maximum method."

One of the most important advantages of this system for the amateur is that signals can be read with ease throughout the process of taking bearings. This is not possible when working on the minimum method, as in this case signals are usually so weak as to be unintelligible at the actual moment when their direction is being ascertained.

### An Example.

The distinguishing feature of the maximum method lies in the fact that two aerials are invariably used. Fig. 1 shows two aerials, AB and CD, placed respectively at maximum and minimum positions with reference to the transmitter, T. As was explained in a previous article, these two aerials must be at right angles to one another.

Also, whilst AB can be swung away from its maximum position through an angle of about 10 or 15 degrees without it being possible to detect any decrease in signal strength, a change of one or two degrees

in the position of CD will immediately give rise to an appreciable increase in signal strength.

In Fig. 2 the aerials are still in the minimum and maximum positions with respect to T, but in this case they are both on the same side of the transmitter; and, in actual practice, this is exactly how they are placed. Both aerials are balanced at right angles to one another on a common vertical spindle, about which they can be revolved simultaneously by equal amounts.

That is, when AB is moved, say, 10 degrees in a clockwise direction, CD automatically moves through the same angle in the same direction. From this it follows that whenever AB is set to receive maximum signals from a certain transmitting station, CD will be brought automatically into minimum position with respect to that station.

### A Matter of Luck.

Let us now assume that we have some ready means of connecting up each aerial in turn to our receiving apparatus; as, for instance, by means of a "tumbler" switch. First of all, the aerial AB is connected up by itself, the aerial CD being cut out of the circuit for the moment. As we have already seen, if we revolve AB, CD will also revolve with it. In this position of the tumbler switch, however, the latter aerial will not pick up any energy.

With AB we can find a "rough" *maximum* position. In doing so, of course, we may by chance settle upon the *exact* maximum point. But when that happens it is usually a matter of luck; one would need to possess very good hearing indeed in order to determine the loudest signals within one degree. Having found the approximate maximum point, however, we now switch over on to the other aerial.

That is, we connect up our receiver to CD. Since CD is at right angles to AB, when we replace AB by CD in our circuit the latter aerial will already be in the approximate *minimum* position with respect to the transmitter. This means that if we had really succeeded in putting AB in the *exact* maximum position in the first instance, CD would now be in the *exact* minimum position, and *no signals would be heard in the telephones on changing over from one aerial to the other.*

### Finding the Minimum Position.

Therefore, if, on changing from AB to CD, we hear even the faintest signals in the telephones, we know for a certainty that AB cannot be on the exact maximum point with reference to the particular station from which we are receiving. In this way, then, the sensitive minimum coil (CD) can be used for checking the accuracy of the less sensitive maximum coil (AB). By switching backwards and forwards from one coil to the other the *exact* maximum position of AB can be found.

We have not yet, however, overcome the difficulty of finding the minimum position of CD under noisy conditions. Yet this

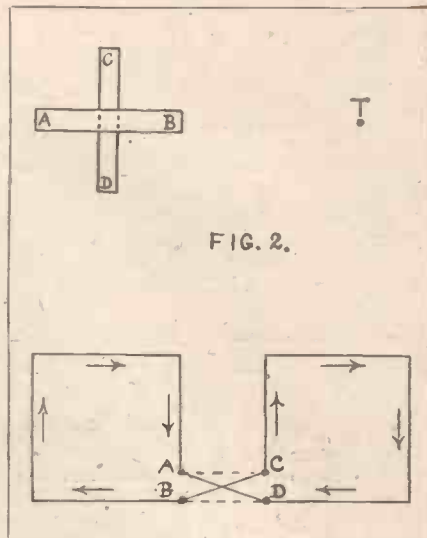

FIG. 2.

can be done with a similar combination of coils. The mode of operation is as follows:

The approximate maximum position for AB is first found. Then, whilst keeping AB in the circuit, CD is suddenly connected up *in series* to it by means of a switch. AB and CD thus form a single aerial, one part of which is, approximately, pointing towards the transmitting station, and another part of which is, approximately, at right angles to it. As in the previous instance, if AB is really in the exact maximum position, no difference in signal strength should result from switching in CD at right angles to it. (Normally, of course, the circuit would be thrown out of tune by introducing this extra inductance; but this is provided for in a special manner, as will be shown later.)

### The Maximum Point.

Furthermore, if no energy is being picked up by CD, it should make no difference in the strength of signals being received in AB, if the coils be connected to one another in a reverse manner. The importance of this point will be appreciated by reference to Fig. 3. AB and CD are the extremities of two coils (shown in the same plane for the sake of simplicity).

Suppose a current to be flowing simultaneously in each of them, in the direction indicated by the arrows. When one circuit is made of these two coils by connecting A to D, and B to C, the two currents will oppose each other. But when connected so that A is joined to C, and B to D (as shown by dotted lines), they will mutually assist one another. The manner in which this fact is made use of in connection with maximum direction-finding will be fully explained in the next article.

(To be continued.)

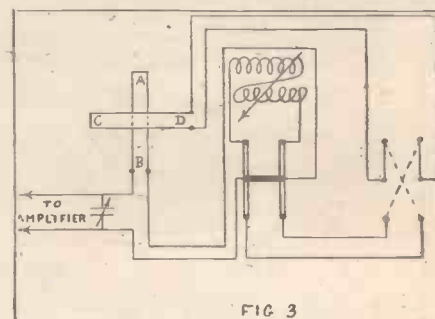

FIG. 3



Introducing the

Registered N<sup>o</sup> 1045 Passed by P.M.G.  
**BROADCAST BABY**



Every Instrument tested on an Aerial before despatch and a signed Certificate attached to each.

Here's an ideal Xmas Gift—one all the family can enjoy 365 days in the year. Receives speech and music perfectly, and is *tuned by one knob only*—no irritating adjustments to make. Further Valves can be added to enable a Loud Speaker to be used. In addition, by the aid of a special Loading Panel—to be attached to terminals A and E—its present wave-length limits of 300 to 500 metres can be increased to receive the Paris and Hague Concerts.

Size 7 in. by 5 in., mounted on polished mahogany Cabinet, complete as illustration but without Valve. Catalogue of phones, loud speakers, batteries and other components sent post free.

**50/-**

If for use with Broadcast Licence each instrument must be stamped B.B.C. at an extra cost of 32.6.

OFFICES & SHOWROOMS:

FEATHERSTONE HOUSE,  
 64, HIGH HOLBORN, W.C.1.



MARSHALL AD.

**DO YOU WISH TO GIVE  
 A REALLY USEFUL AND  
 PLEASING XMAS GIFT?**

If so, why not

**A WIRELESS OUTFIT?**

**No. 1 Set.**—Crystal Receiving Outfit, fitted with Genuine Hertzite Crystal, 12-inch Coil, pair of British-made Head Phones, 4,000 ohms, Aerial Wire, Insulators, Lead-in Wire, &c.

Price, £3 10s. the Complete Outfit.  
 Postage, 1/6 extra.

**No. 2 Set.**—A Complete Receiving Set, fitted with Genuine Hertzite Crystal, Variable Condenser, mounted on Ebonite Panel, suitably engraved and enclosed in Hand Polished Mahogany Case, with pair of British-made 4,000-ohm Head Phones, Aerial Wire, Insulators, Lead-in Wire, &c.

Price, £5 the Complete Outfit.  
 Postage, 2/- extra.

All our sets are passed by the P.M.G., and include the cost of Fee for Licensing the set.

**WILL DAY, LTD.,**

19, Lisle St., Leicester Sq., London, W.C.2.

Phone: Regent 4577. Telegrams: Titles, Westrand, London.

**“Ever-Ready”**  
*British Made*  
 The Standard of Quality

FIRST AND FOREMOST



**HIGH  
 TENSION  
 BATTERIES**

As supplied to H.M. Government. The highest electrical efficiency maintained.

Any size or voltage with any tappings or sockets at 3 or 6 volt intervals for use with Wander Plugs can be supplied to order. With 13 sockets as illustrated.

No. W.19. 36 volts, 24 cells, 8'6 each.  
 Size 6½ x 2½ x 3½. Weight 2 lb. 8 ozs.  
 With 2 Spring Contacts.

No. W.11. 15 volts, 11 cells, 3'6 each.  
 Size 9½ x 4 x 2½. Weight 1 lb. 2 ozs.

Art Catalogue of Standard Sizes and Voltages and list of Accumulators for Valve Filament Supply sent on request. Dept. P.W.

THE EVER-READY WORKS, Hercules Place, Holloway, N.7

# A BALD STATEMENT

The NEW "POLAR"

Earth-Screened

VARIABLE CONDENSER

Range from .0001 to .001 mfd.

Costs only **14/9** Post Free.

Measures 3 in. x 3½ in. 1 in. only.

Is Now Available from Stock.

Is made and guaranteed for 12 months by

**THE RADIO COMMUNICATION CO., LTD.**

Direct from 35, NORFOLK STREET, LONDON, W.C.2.

Or at Branches:

NEWCASTLE: 17, Sandhill. LIVERPOOL: 67, Dale St. CARDIFF: Atlas Chambers, James St.  
SOUTHAMPTON: 19, Queen's Terrace. GLASGOW: 116, Hope St.

**— THAT MAKES YOU THINK —** E.P.S. 18.

## WIRELESS SUPPLIES

Order at Once if You Require Prompt Delivery.

**PERRY 'PHONES**

4,000 Ohms **21/-** per pair



Specially designed for Wireless Telephony. Receivers arranged in series, Aluminium Cases and fitted with extremely light and efficient Head Bands, and Twin Connecting Cords. Offered subject to being in stock on receipt of order.

Illustrated Wireless Catalogue now ready. Post Free 3d.

**The JEARY Electrical Co<sup>LD</sup>**

8, LAMBETH HILL, & 97, Queen Victoria St., London, E.C.4

## A NEW FILAMENT RESISTANCE OF EXCEPTIONAL MERIT

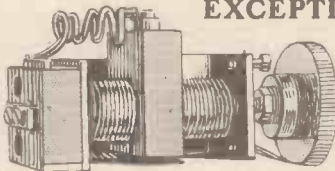

Prov. Pat.

**5/-** EACH

POSTAGE 4d.

1. ABSOLUTELY DEFINITE ON or OFF POSITION, at any point of control. Operated by simply pulling or pushing the knob.

Perfect Micrometer adjustment. Silent in use, Standard Fixing.

Sole Manufacturer and Patentees.

**BLAXLEY CABLES** 3, NORFOLK ROAD, ERDINGTON, BIRMINGHAM.

**C.T.C.**

## MULTUM-IN-PARVO CRYSTAL RECEIVERS



Come and listen-in any evening until eight.

No technical knowledge is necessary to listen-in at once on the MULTUM-IN-PARVO. Full instructions are given with every set.

Sets as Illustrated comprise:—

**TUNER.**—Inductance which can be varied by means of tappings taken to switch giving correct wavelengths, 280/650 metres.

**MICROMETER DETECTOR. FIXED CAPACITY CONDENSER.**—Fitted with best ruby mica.

**VARIABLE CONDENSER** for selective tuning.

**RANGE** 30 miles. Telephony Morse up to 6,00 miles.

**AERIAL.**—Complete equipment—120 ft. Wire Earthing Wire, Lead-in Tube, and Two Insulators.

**EVERY SET IS FITTED WITH BROWN'S 'PHONES** (4,000 OHMS.)

"MULTUM-IN-PARVO."

Complete as Illustrated

**BLACK LEATHERETTE**...£5 15 0

**MAHOGANY** ... £5 15 0

**COW-HIDE** ... £6 15 0

All Prices PLUS TAX, 7/6.

**JUNIOR ASSEMBLY** £1 12 6

**SET, range 10 miles**... Post Free.

One minute Chancery Lunc Tube.

*J. Bridge & Sons*



ASSOCIATED WITH **CONSOLIDATED TRADING & MANUFACTURING CO., LTD.,**

FULWOOD HOUSE, FULWOOD PLACE, HIGH HOLBORN, W.C.1.

Call or Write for List, Threepence.



# WIRELESS CLUB REPORTS.

The Editor will be pleased to publish concise reports of meetings of Wireless clubs and associations, reserving the right to curtail the report if necessary. Hon. secretaries are reminded that reports should be sent in as soon after a meeting as possible. Reports sent in cannot appear in this paper in less than ten days after receipt of same. An Asterisk denotes affiliation with the Radio Society of Great Britain.

## Bromley Radio and Experimental Society.

At a meeting on November 1st at the club room, Ex-Service Men's Club, London Road, the secretary stated that the present meeting place had been secured as a permanent headquarters, and that the future meetings would be held there regularly on every Monday at 7.30. A lecture or demonstration had been arranged for every meeting this year.

He then introduced Mr. L. Stopes (chairman of the society), who gave an interesting and instructive lecture on "Primary Cells and Accumulators." The lecturer described the various types of cell, their chemical action, and their use with special reference to wireless purposes. The second half of the lecture was devoted to secondary cells—both the Planté and Edison form being dealt with, and charging methods described. A representative collection of cells—kindly lent by Messrs. Siemens Bros. of Woolwich—showed the practical application of the lecturer's remarks, and were examined with interest by the members.

All interested—who are not already members—are invited to apply to the hon. sec., "Gowrie," Wendover Road, for particulars of joining, or to attend one of the meetings of the society, to which they are welcomed.

## Croydon Wireless and Physical Society.

The above society held its annual general meeting at the Central Polytechnic, Croydon, on Saturday, December 2nd, 1922, at 7.30 p.m.

A most interesting lecture was delivered by L. F. Fogarty, Esq., A.M.I.E.E., on "Different Methods of Charging Accumulators from A. C."

The lecture was illustrated by a number of very clear drawings depicting the different methods which were demonstrated by means of a large number of instruments, including Electrolytic, Vibrating Reed, and Vacuum Tube Rectifiers.

The treasurer, Mr. E. E. Hart, 267, Lower Addiscombe Road, Croydon, will be pleased to receive subscriptions which are still outstanding. The secretary, Mr. B. Clapp, A.M.I.R.E., "Meadmoor," Brighton Road, Purley, will be pleased to furnish all particulars.

## The North London Wireless Association.

The one hundred and second meeting of the association was held on Monday, October 16th, at 8 p.m., at the Northern Polytechnic Institute.

The chairman pointed out the objects of the association in assisting members over any technical difficulties they may be up against, and that they had only to ask any question relating to wireless to bring forth willing help in the matter. Attention was specially drawn to this, as a new member had nearly left the previous meeting without some necessary information in connection with a set he was building.

Mr. F. S. Angel was then called upon to deliver the first paper of his series, "The Elementary Principles of Radio Telephony."

The lecturer started by discussing the nature of electricity as a form of energy. He then performed some experiments dealing with static electricity. After showing that different kinds of charges were produced by friction between various materials, he went on to talk about static induction. From this point he led up to the action of a condenser, and showed an arrangement to illustrate the difference there is in the dielectric constant of various materials by means of weights hung at the centres of horizontal cords and rubber strips. By means of an electrostatic plate capable of being moved nearer to the leaf system, Mr. Angel demonstrated that the capacity of a condenser increases as the thickness of the dielectric is diminished.

This being the end of the first paper, a discussion then took place, and Mr. Angel was able to give satisfaction to a number of questioners.

Full particulars of the association may be had on application to the hon. secretary, Mr.

V. J. Hinkley, Northern Polytechnic Institute, Holloway Road, N.7.

## St. Helens Radio Club.

Meetings of the above club will be held in the Y.M.C.A. Buildings, North Road, every Tuesday night at 7.30.

Arrangements are being made to provide interesting and instructive meetings.

Applications for membership should be made to

Hon. sec., C. Hodgson, Crescent House, Liverpool Road, St. Helens.

## The Portsmouth and District Amateur Wireless Society.

The usual monthly business meeting of the society was held at the John Pile Rooms on October 18th. There was a good attendance of members, and further new members were elected. Various other matters were dealt with, and it was suggested that the society should hold a social evening at an early date. A committee was elected to deal with this matter.

After the meeting an address was given by our member, Mr. Harrold, on "Detectors." Mr. Harrold dealt with the earliest form of detectors used, and various diagrams were passed among the members to illustrate these detectors. Unfortunately, there was no time for Mr. Harrold to complete his lecture with regard to valve detectors, but we trust that it is only delayed. A very hearty vote of thanks was given Mr. Harrold.

Hon. sec., Mr. R. G. H. Cole, 34, Bradford Road, Southsea.

## Radio Society of Birkenhead.

The opening night of the above society was held on Tuesday, November 21st, at 8 p.m. at 36, Hamilton Square (top floor), Birkenhead. A demonstration of radio telephony was arranged, and various parts of radio apparatus belonging to members were exhibited and demonstrated at the meeting.

Subscriptions are 10s. for members over eighteen, 5s. for members under eighteen, and 2s. 6d. for lady members. All subscriptions should be sent direct to the hon. treasurer, G. A. King, 17, Kingsland Road, Birkenhead. The secretary will be glad to hear from any who wish to join the society.

Hon. sec., R. Watson, 35, Fairview Road, Oxtou, Birkenhead.

## Ealing and District Radio Society.

The meetings of the society are attracting many new members, and the new series of lectures recently arranged has proved to be a valuable asset in this respect.

At a meeting held recently the society unanimously decided to forward the following protest to the responsible authorities:

"That the Ealing and District Radio Society strongly protests against the inadequate representation that the wireless experimenter has received at the meetings of the British Broadcasting Company held recently, and asks that the position of the bona-fide wireless experimenter be more explicitly defined."

The secretary, Mr. W. F. Clark, 52, Uxbridge Road, Ealing, W. 5, will be pleased to forward particulars of the society to any interested amateur applying.

## New Clubs.

A society has now been formed called the Sale, Altrincham, and District Radio Society, with headquarters at the Reform Club, Sale. It is proposed to form a ladies' section and also a junior section. Full particulars from the hon. sec., Mr. H. Fowler, Alston, Old Hall Road, Sale.

The Berkhamsted District (Y.M.C.A.) Wireless Club has been formed. All interested please communicate with the hon. sec., W. F. Eager, 12, Lower King's Road, Berkhamsted.

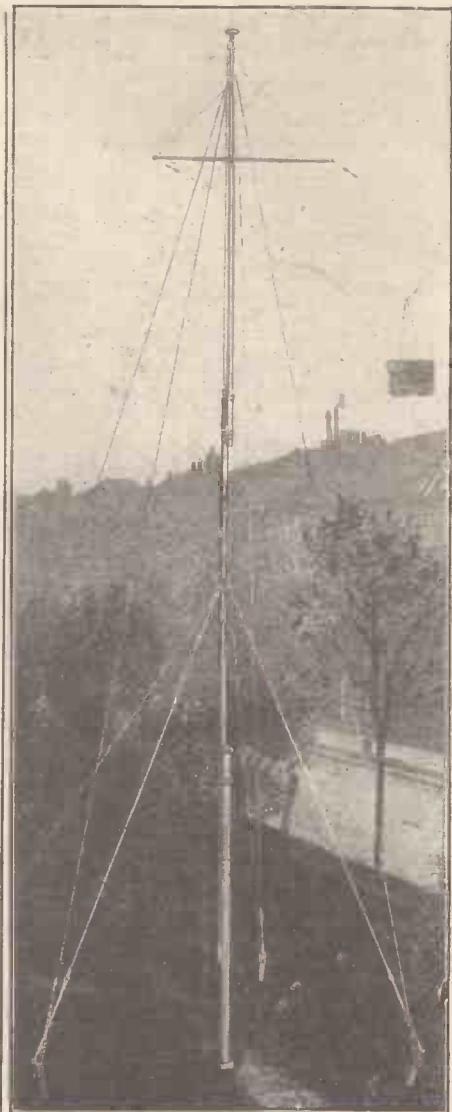

## TURRET WIRELESS MAST FOR BROADCASTING AND LISTENING IN

Photo of Columbian pine Mast with 1/2 CWT. of bricks suspended from Aerial. Designed by Naval Experts.

It is rigid, easy to fix, unbreakable, weighs 56 lbs. Sent complete with all fittings and 4 oak posts with metal ferrule, shoe, and 15 in. straining bolts.

28-ft. Mast in 2 sections, complete 49/6  
36-ft. Mast in 3 sections, complete 69/6  
42-ft. Mast in 3 sections, with telescopic top mast - complete 79/6

**SIMPSON & BLYTHE,**  
8 & 9, Sherwood Street, Piccadilly, W. 1.

## WIRELESS BARGAINS

Loud Speakers, 10/6; Crystal Detectors, 3/-; Phones, All British, 4,000 ohms, 21/- All Post Free. Trade Supplied.

Illustrated Catalogue P, including list of stations, 6d. post free.

**EONS WIRELESS SUPPLY CO.**  
115, FLEET ST., E.C.4.

## That book you want

On Wireless, or any Technical subject. Foyles have it, or will quickly obtain it. 1,000,000 vols. (Second-hand and New) on every conceivable subject in stock.

Write for Catalogue 120 (free) mentioning requirements.

**FOYLES, 121, Charing Cross Rd., London.**



# RADIOTORIAL

All Editorial Communications to be addressed The Editor, POPULAR WIRELESS, The Fleetway House, Farringdon Street, London, E.C.4.

Some interesting remarks on the use of electric light wires as aerials appeared in the December 11th issue of "The Times." They referred to the opinions of Mr. W. Dubilier, who has just returned from America, and dealt with the possibilities of the general householder using electric light wires as aerials. In "The Times" issue of December 12th, Mr. Philip R. Coursey's remarks on the subject, made before a meeting of the Radio Society of Great Britain, are of considerable interest to amateurs who are buying this type of aerial.

Mr. Coursey states that the electric lighting wires, when used for intercepting radio signals, acted in exactly the same manner as the ordinary elevated aerial wires supported on poles over the housetops. The principle of operation was much more closely allied to that of the "frame aerial," to which also reference was made in "The Times" article. This being the case, Mr. Coursey said, the nature of the insulation of the electric lighting wires was quite immaterial.

A filter attachment to be plugged into the electric lamp socket was essentially a safety device, designed to eliminate all possible risks of shocks or short circuits when the electric light wires were used in this manner.

Many amateurs will, I feel sure, find this type of aerial preferable to an outside wire, especially when within the London area. And it will doubtless reassure many to hear Mr. Coursey's considered opinion on the safety of the device.

The cartoon shown below is, of course, only a cartoon—but the subject has humorous possibilities.

THE EDITOR.

## Questions Answered

Owing to the enormous number of queries received daily from readers of POPULAR WIRELESS, I have decided to reply individually by post. A weekly selection of questions will, however, be printed on this page, together with the answers, for the benefit of readers of POPULAR WIRELESS in general. Questions should be clearly and explicitly written, and should be numbered and written on one side of the paper only.

All questions to be addressed to: POPULAR WIRELESS, Queries Dept., Room 132, The Fleetway House, Farringdon Street, London, E.C.4. Readers are requested to send necessary postage for reply.

"PUZZLED" (Bromley, Kent).—I am still rather puzzled with regard to the licence problem. I know a little about wireless, but am not an expert. Which licence do you advise, and why?

Apply to the secretary, G.P.O. for an experimental licence form. You should be able to fill this up fairly easily. The advantages of this licence over the other are obvious. In the broadcasting licence you are pinned down to one set—stamped—and cannot experiment or make your own apparatus. Besides the advantage of experiments and making your own apparatus, the experimental licences give a certain amount of freedom with regard to the reaction problem. They allow the use of reaction on certain wave-lengths at certain times, which is very desirable if one valve is being used. This does not mean that interference may be caused, however.

H. H. B. (Birmingham).—I am only 17 years of age and hope to build my own receiving set. Can I get an experimental licence, or am I too young? What wire is best for an earth lead?

(1) You can apply for a licence from the secretary, G.P.O., but it will have to be taken out in your father's or guardian's name. (2) Use No. 18 gauge wire, or, better still, the same as is used for the aerial.

"TWO-VALVE" (Radlett, Herts).—I was listening in the other night upon about 1,500 metres, and I heard a voice talking and then some music was sent. The time was about 9 p.m. Can you tell me who it was, please?

The station you heard was probably the Radio-Électrique, Paris, transmitting their nightly concert. The speech, of course, is in French, thus accounting for the apparent vagueness that you mention. The wave-length is about 1,565 metres, and the station transmits from about 8.45 for an hour or so. See the broadcasting programme in P.W. each week.

"HOPEFUL" (Ilfracombe).—Do you think it is possible for me to hear the American stations broadcasting? I have a four-valve set, one H.F. and two L.F. amplification.

Provided your H.F. circuit is a good one, you stand quite a good chance of hearing one or two of the American stations when the weather is exception-

ally favourable. Listen in from about midnight onwards. W.J.Z. (Newark) is the most likely one that you will hear. The wave-length is 360 metres.

K. P. R. (Hammersmith).—I have a small fixed condenser marked 900 cms. Can you tell me what this means?

The condenser is marked according to the centimetre scale of capacity. In this case the 900 cms. means the condenser has a capacity of 900 cms., or .001 mfd. One mfd. = 900,000 cms.

How can I calculate the wave-length of my aerial if I know the capacity and the inductance.

If the inductance is in microhenries and the capacity in microfarads the wave-length is given by  $\lambda$  (wave-length) =  $1,885 \sqrt{K \times L}$ , where K = capacity in mfd. and L = inductance in mhy.

If the inductance is in cms. and the capacity also in cms., use the formula  $\lambda = 60 \sqrt{K \times L}$ .

"INDUCTANCE" (Felstead, Essex).—(1) What is my wave-length range with a coil 10 in. by  $3\frac{1}{2}$  in. wound with 24 S.W.G. enmelled wire? (2) Could I reach 2,600 metres if I loaded the above with a coil of 10 in. by 3 in., using the same wire?

(1) Your range is about 200-1,700 metres. (2) Yes, you should easily tune to 2,600 metres using the coil you mention.

"FRAME AERIAL" (Norwich).—I have constructed a frame aerial, using 4 turns of 24 S.W.G. on a 4 ft. square frame. This I understand will give me wave-lengths round about 400 metres. How do I tune up to higher wave-lengths, such as 1,000, 1,500, etc.?

For this purpose you will have to add inductance. Up to about 800 metres the ordinary basket coil inductances may be added in series with the aerial. Above that figure a new aerial will have to be constructed, in order to give satisfactory results. In dealing with these high wave-lengths you can, of course, increase the size of the aerial to 6 or 8 ft. square, thereby greatly increasing its sensitivity.

M. W. M. (Sandown, I.W.).—I have constructed the loose-coupler described in a recent edition of POPULAR WIRELESS. What wave-length can I get with it? Do I have to use two variable condensers, or will one be sufficient?

The loose-coupler referred to will tune from 300—2,700 metres approximately.

It is advisable to use two condensers. One across the secondary is necessary to obtain results. The condensers should be about .0005 mfd., and .001 mfd. across the primary and secondary respectively.

(Continued on page 698).

## WHERE WAS FATHER WHEN THE LIGHT WENT OUT?





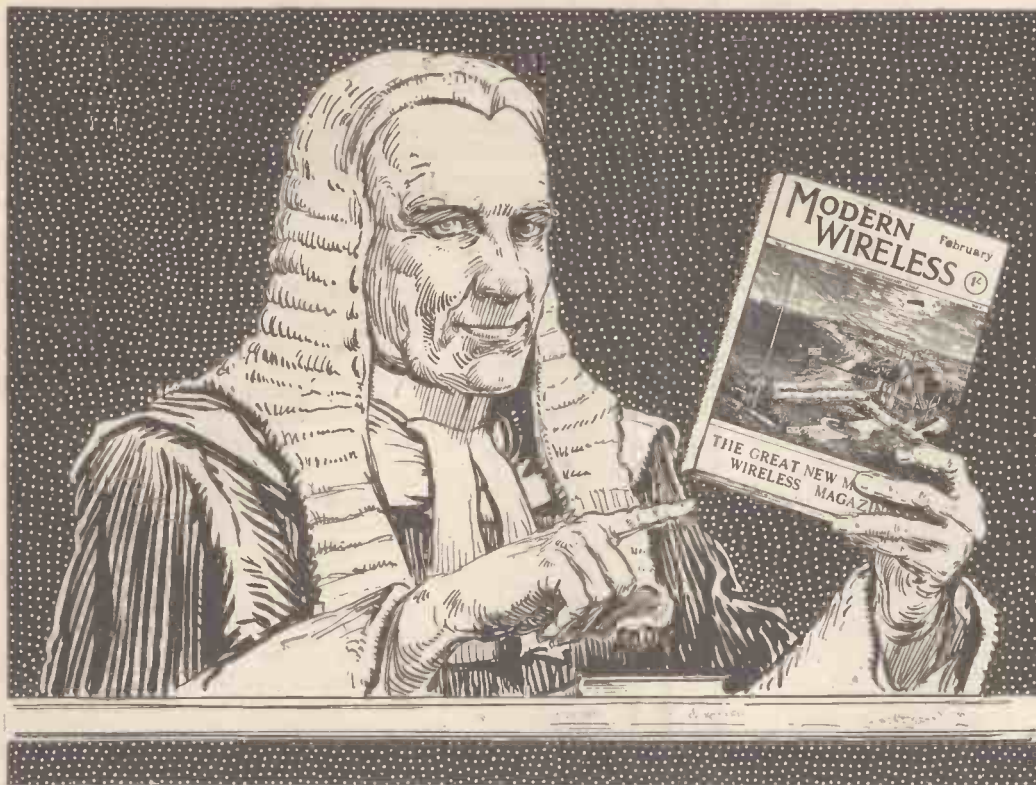

**JAN. 15th**

On this day will appear the great new Monthly Wireless Magazine

**"MODERN WIRELESS"**

**ORDER NOW**

From your Newsagent.

**1/- net.**

This Magazine will be written by Wireless Engineers, edited by Wireless Engineers, and published by Wireless Engineers.

Edited by **JOHN SCOTT-TAGGART**  
(F.Inst.P., M.I.R.E.),

assisted by

**PAUL T. TYERS,**  
Author of "Construction of Wireless Receiving Apparatus,"

and

**E. REDPATH,**  
late Wireless Expert of "Work," and author of Cassell's "Work" Handbook, "Wireless Telegraphy and Telephony."

*A good judge* of a wireless periodical will not fail to buy the brilliant First Number of this Magazine, published by **RADIO PRESS, Ltd., Devereux Court, Strand, London, W.C.2**

**BROADCASTING RECEPTION SETS**

One-Valve Set Complete for Working £7 : 10 : 0

Passed for  
Broadcasting  
Licence  
G.P.O.  
No.  
1038

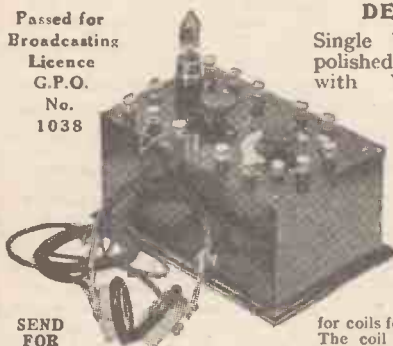

SEND FOR CATALOGUE

**DESCRIPTION:**

Single Valve, mounted on polished 1/2-in. Ebonite Panel with Variable Condenser, smooth acting resistance, grid leak and condenser and all terminals clearly engraved in white, in a Mahogany Polished Cabinet, 9 in by 5 in. by 5 in. **£3 : 15 : 0**

A TAPPED COIL for wave-lengths up to 900 metres with 2 terminals for coils for any higher wave-lengths. The coil is enclosed and the tapings are brought out to an 8-way switch mounted in the front of the cabinet.

**ACCESSORIES INCLUDED:**

- Siemen's 54 volt high-tension Battery with plugs for altering the voltage **£0 : 15 : 0**
- 4 volt 50 amp. hour low tension Accumulator in case with carrying strap **1 : 4 : 0**
- One pair of Sensitive Head Phones of 4,000 ohms resistance **1 : 1 : 0**
- One Detecting Valve **0 : 15 : 0**
- Total £7 : 10 : 0**

Satisfaction Guaranteed or money refunded.

**WIRELESS INSTALLATIONS LTD.**  
15, ALDERSGATE STREET, LONDON, E.C.  
AGENTS WANTED.

**HERE'S REAL RADIO SERVICE!**

**A SPECIAL OFFER FOR CHRISTMAS**

To those who are expecting Xmas visitors who will also want to "LISTEN IN."

- TELEPHONES 4,000 ohms, Guaranteed, per pair **1 0 0**
- 8,000 " " " " **1 2 6**
- Single Earpiece 2,000 " with cords, " " **10 6**
- DETECTOR PANEL, mounted in cabinet ... **1 0 0**
- INTERVAL TRANSFORMERS, remarkable value ... **11 0**
- COIL-HOLDERS, three-way ... **14 0**
- BASKET COILS, set of seven ... **5 0**
- SLAB COILS, set of eight ... **7 6**
- LECLANCHE CELLS, miniature for H.T., each ... **1 0**
- (1 1/2 oz. Sal Ammoniac charges, 12), per doz. ... **10 6**
- AERIAL WIRE, 7/22 bare copper, per 100 ft. ... **3 3**
- AERIAL WIRE, 7/22 enamelled, per 100 ft. ... **4 6**
- INSULATORS, reel, 2, Shell, 9d. and ... **6**
- RHEOSTATS, Best Quality, 3/9 and ... **2 6**
- HERTZITE CRYSTALS, 2/- and ... **1 6**

These are but a few of our many bargains taken from our Price List. Post free on application.

**WATERLOO ELECTRIC Co.,**

Electrical and Wireless Engineers,

129, Waterloo Road, London, S.E.1.  
(1 min. Waterloo Station.) Tel.: Hop 5649.



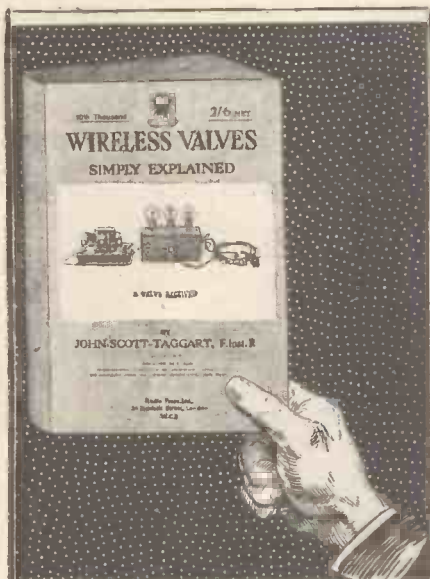

Whether you buy a complete receiving set or design it yourself, this book at 2/6 will save you time, trouble and money.

GET IT TO-NIGHT AS YOU GO HOME.

Obtainable from all newsagents and bookstalls, or send us P.O. for 2/6 and your copy will reach you in two days.

Radio Press Ltd. DEVEREUX COURT, Strand, LONDON, W.C.2.

Have you seen them?  
Have you HEARD them?

L. F. TRANSFORMERS.  
The last word in efficiency.  
Price 21/- each.

H. F. PLUG-IN TRANSFORMERS.  
350-450 metres - Price 6/6 each  
900-1100 " - Price 7/6 each  
Manufactured at our Works.  
Liberal discounts to the trade.

P. H. BOYS & CO.,  
Electrical & Wireless Engineers,  
187, GOSWELL ROAD, LONDON, E.C.1.  
Phone: Clerkenwell 4454.

LUNCH HOUR RAMBLE

STROLL ROUND TO  
SPENCER'S STORES,

4-5, MASON'S AVENUE,  
BASINGHALL STREET,  
LONDON, E.C.

CHEAPEST HOUSE IN CITY  
FOR WIRELESS PARTS & SETS  
PRICE LISTS FREE.

WIRELESS INVENTORS.

Advice Handbook on Patents and Trade Marks.  
Consultations free.—B. T. KING, Regd. Patent  
Agent, 146a, Queen Victoria Street, E.C.4.  
Phone: Central 682.

MATERIALS, TOOLS, & WORKSHOP SUNDRIES

OUR 1923 LIST of above (64 pages) is now ready. Wireless experimenters cannot afford to be without a copy. SENT POST FREE on receipt of Post Card.

GEORGE ADAMS (DEPT. P.W.), 255-6, HIGH HOLBORN, LONDON, W.C.1.

## RADIOTORIAL QUESTIONS AND ANSWERS.

(Continued from page 696.)

T. R. (Chatham).—My telephones do not seem so sensitive as they used to be. Can you give any reason for this?

Several factors may be contributing to this lessening of sensitivity. Assuming that the winding and connections of the telephones are O.K., you should carefully remove the diaphragms. It is very likely that these have become rusty at the edges. This will increase their weight, and also render them stiff in action, both causing a considerable loss in efficiency. If they are rusty, wipe carefully with vaseline or sewing-machine oil, taking care that you do not bend the diaphragms. Another cause may be that the magnets of the phones need remagnetising; but this is not likely unless they have been used for a considerable period.

J. R. S. (Redbourn).—I have no means of having my accumulators charged unless I take them some distance. Can I employ Leclanché or dry cells for my filament? I am using a one-valve set.

No, the cells you mention are quite useless for the ordinary type of valve. If, however, you care to employ low temperature valves, such as L.T.1 or L.T.3 type, you can use dry cells for the filament current. These valves are rather more costly than the ordinary type, but are specially designed to meet cases like your own.

"ANODE" (Bexhill).—I have been advised to use the tuned anode method of H.F. amplification rather than the ordinary transformer type of coupling. Is there any real advantage of this method of coupling?

We prefer the tuned anode type of H.F. amplification coupling, as it is more selective than the transformer method. Incidentally, the transfer of energy from one valve to the other would appear to be more complete using the tuned anode. You will find it critical in tuning, but it gives very good results when correctly tuned in.

"CARBORUNDUM" (Brentford).—I wish to use carborundum as a detector in my crystal set. What will the size of my potentiometer have to be?

The potentiometer should be about 300 ohms. If you wind a 4 in. by 1 in. former with 36 "Eureka" wire, it should give you about the right value.

J. O. N. (Tottenham).—I have a carborundum crystal, but do not quite see how to connect the potentiometer. Which side does the battery go—the plate or crystal side of the detector?

The battery and potentiometer must be arranged so that the potential applied to the plate of the detector is positive.

"TRANSFORMER" (London Colney).—I have been constructing an H.F. panel, and intend winding my own transformers. Do you advise the transformer method of coupling or the tuned anode type? If the latter, what size should the anode coil be?

The anode coil should be approximately of the same size as the A.T.I. since it has to be tuned to the same wave-lengths. You will probably find that the tuned anode will give better results than the transformer method of coupling.

H. Y. (Birkenhead).—Is there any means whereby I can test the efficiency of my aerial and earth, as I have not yet obtained a receiving set?

The aerial could be tested for insulation resistance with a "megger," and also the earth could be tested

for resistance, but that is all. Anyway, if you are using good insulators and have the lead in well away from roofs and walls with an efficient lead-in insulator, there is no need to doubt that in point of insulation all is quite O.K. If the earth lead is fairly short, and of heavy wire, and makes good connection to a water pipe or metal plate in damp soil, that too will doubtless be all right. Other points to consider are whether good height has been obtained, no screening from trees or buildings, well away from power and telegraph wires, and lead-in end pointing to direction from which strongest signals are required. However, you will be able to consider yourself fortunate if your aerial can obtain all those conditions.

"PUZZLED" (Grantham).—You state in one of your articles in connection with a portable crystal set, that a battery and potentiometer is required with a "Perikon" detector. Surely that is an error?

No, not in that case, because the crystal adjustment is very heavy, and therefore sensitivity is not obtainable without a slight applied potential. As a matter of fact, practically any crystal detector will show slight increase of sensitivity with the application of perhaps only a very small fraction of a volt of local pressure, but the improvement is invariably transitory and so slight as not to warrant the inclusion of a battery and potentiometer in the circuit. In the case mentioned a "Perikon" detector on a table set with fine adjustments would not require a local potential.

W. B. (Ealing).—Is the flat plate formula for condenser capacities applicable to tubular condensers?

For purposes of approximation—and that is after all, all that mathematical calculation of capacitances—yes, but a nearer or more correct formula, which is slightly more involved, is as follows:

$$K = 1/(4.148 \times 10^6 \times \log \frac{r^2}{r_1}) \text{ mfd.}$$

where  $r^2$  = Outer radius of inner conductor;  $r_1$  = Inner of outer conductor;  $l$  = Length in cms.

The result, of course, can in other cases than air be multiplied by the figures of the specific inductive capacity of the dielectric. The log is the ordinary log to base ten. In case you haven't handled logs before, a common log is the power of ten (the base) which produces the number in question. For example, Log 100 equals 2 because 100 is 10<sup>2</sup>, and 2 is the required power of 10 to produce 100.

M. O. (Derby).—Does one require high resistance phones or loud speakers with these Mk IV. service amplifiers?

Not unless the telephone transformer has been removed. 120 ohm phones are required.

L. E. A. (Tenderton).—Is it an electrical effect or wind that causes telegraph wires to hum, because I am thinking seriously of writing to the G.P.O. about those which are attached to my house, as the noise they make at times renders reception quite difficult with weak signals?

Certain atmospheric conditions cause that humming and the sound is transmitted via the walls of the house, and resonance causes annoying amplification. We should certainly advise you to communicate with the P.O. as they have many methods of at least partially silencing such noises. Suggest "Sourdis Cael Beau," which is a binding on the wire of yarn, rubber and lead, and that may cut out some of the "red tape," which is, of course, useless for the purpose.

"INTERESTED" (London, W.).—To what extent does heat affect the resistance of conductors?

In the case of all metals, the resistance will rise as the temperature is increased, but very slightly. For example, the resistance of a copper wire would increase about .428 per cent. per degree centigrade, or .238 per cent. per degree Fahrenheit. In the case of carbon resistance decreases with increase of temperature, and the same applies also to most liquid conductors, with the exception of mercury.

How does heat affect insulators?

More greatly than it does conductors, but in the opposite direction. The rise in the temperature of most insulators decreases their insulating power, which is the same as saying that it lowers their specific resistances.

C. T. Y. (Tring).—I am using a three-valve set and am troubled lately with a great deal of "crackle" in the phones, I have just had the

(Continued on page 700.)



**1923  
DIARIES**

Let your 1923 Diary be a  
Wireless One.

**The Amateurs'  
Diary & Notebook**

consisting of

Charles Letts & Co.'s  
Standard Diary in Pig-skin.  
Grain Leather Case.

A section of 32 pages  
is included, giving matter of  
interest to Wireless Amateurs

Don't be without a  
Wireless Diary.

Price 2/6 net  
(Postage 3d).

The Wireless Press, Ltd.  
(Dept. P.W.),  
12/13, Henrietta Street,  
London, W.C.2.

*Extracts from our Catalogue.*

(3d. POST FREE.)

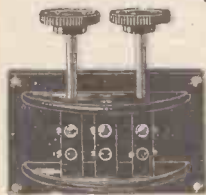

**THREE COIL STAND  
FOR PANEL MOUNTING**

**12/6 EACH.**

**EXTENSION HANDLES**

**1/6 PER PAIR.**

**VARIABLE CONDENSERS.**

Approx. Capacity in MFDS.	No. of Vanes.	Parts ready to assemble for panel mounting.	Price assembled for panel mounting.
.001	57	13/-	16/-
.00075	43	10/-	13/-
.0005	29	9/-	12/-
.0003	19	8/-	10/6
.0002	13	7/-	9/-
.0001	7	5/6	7/6
.00005	3	—	5/-

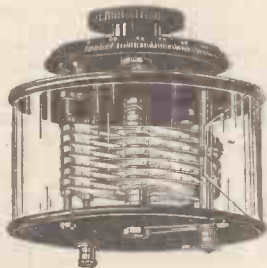

Ivory Scale and Pointer, 1/- extra. Ebonite Dial, 1/6 extra. Sufficient Celluloid, 1/- extra.

'Phone:  
Central  
4209.

**J. L. Cartwright & Co.**

'Grams:  
Platnam,  
Manchester.

(Dept. 2.) 24, LONDON ROAD, MANCHESTER.  
Works: Berry Street.

Business Hours: 9 a.m. to 6 p.m. Except Fridays, 9 a.m. to 8 p.m.; Saturdays, 9 a.m. to 1 p.m.

Wholesale Agents for Scotland: THE GRAMOPHONE STORES, BOWLING OLD LANE.  
J. GORSTON SINCLAIR & CO., 47, WATERLOO STREET, GLASGOW.  
Retail Agents for Dundee: PONSFORD & McHARDY, LTD., 32, REFORM STREET, DUNDEE.



TYPE F  
"Featherweight"

Actual weight including cords is 6 ozs. only

**BROWN'S**

*"Featherweight"*

**HEADPHONES BRITISH AND BEST**

The Finest Headphones Procured for— **30s.** This price is for one pair of either 120 or 1,000 ohm. phones, including cords of good quality. Catalogue, post free, gives you details of our Wireless Headphones, Loud Speakers and Microphone Amplifiers.

**S. G. BROWN, Limited.**

LONDON SHOWROOMS:  
**19, MORTIMER STREET, LONDON, W.1**  
HEAD OFFICE AND WORKS:  
VICTORIA RD., NORTH ACTON, LONDON, W.3

THE  
**SIMPLASET**  
WIRELESS RECEIVING OUTFIT

Range 25—30 Miles.

The Detector, being of the permanent Crystal Type, requires no adjustment. Tuning-in is effected by turning one knob only.

No Batteries or Accumulators. Cost of upkeep—nil.

The "Simplaset" complete with aerial and earthing equipment and head-set, including Broadcast Licence and Royalty, installed and tested complete - - **£8 5 0**

Ditto do., but without fitting up **£7 2 0**

The "Simplaset" only - - - **£4 5 0**

Aerial Equipment only - - - **£1 5 0**

Write for Illustrated Descriptive Booklet.

**SIMMONDS & WEBSTER,**  
4, Brunswick Place, Hoxton,  
LONDON, N.1.

Telephone:—  
Clerkenwell 3127.

Telegrams:—  
Audmysim, Hox, London.

**WIRELESS FOR ALL**  
SIMPLIFIED WIRELESS  
JOHN SCOTT THREAGEL  
Author of 'The Wireless Handbook' and 'The Wireless Encyclopedia'

**No. 1.** The most fascinating story of the age told in simple non-technical style. Price 6d. (7½d. post free).  
**No. 2.** The sequel to the story, with full instructional and constructional details. Price 1/- (1½ post free).  
From all Newsagents or in two days from  
**Radio Press, Ltd.** Devereux Court, Strand, LONDON, W.C.2.

## OMNIPHONE Wireless Service

**VARIOMETERS**—A complete tuner for waves 300-500 metres. Complete with engraved dial for panel-mounting, 15/6.  
**AERIAL EQUIPMENT**—100 ft. 7-strand enam. copper wire, 3 "shell" insulators, and ebonite leading-in tube, 6/6.  
**EBONITE**—"A" grade polished sheet, cut to any size required, at 3d. per superficial sq. inch.  
All above post free. Send stamp for list.

**OMNIPHONE WIRELESS CO.,**  
24, Warwick St., Regent St., London, W.1.

**ACCUMULATORS, etc.** New and Guaranteed  
4-Volt, 25-Amp. Celluloid, 11/3. Postage 1/-.  
4-Volt, 40-Amp. 17/6 6-Volt, 40-Amp. 25/6  
4 " 60 " 21/3 6 " 60 " 31/-  
4 " 80 " 27/- 6 " 80 " 36/-  
Packing, 1/6 extra. Packing, 2/- extra.  
7/22 Aerial, 5/6 100 ft.; Mullard Ora Valve, 15/-;  
15-V. Siemens H.T. Batteries, 4/-; Marconi R. Valves, 17/6; Accumulator Charging Board, 37/6;  
Voltmeters, Watch pattern, 0/12 Volts, 6/-.  
Cash with order. Goods despatched per return.  
**LOWKE & SONS, Ltd., Northampton.**

**DON'T WASTE MONEY! BUY DIRECT.**  
Special offer! New 4,000 ohm Double Headphones, complete with cords, 17/9, elsewhere at 25/- to 30/-.  
Get our quotation for anything you require. 50 per cent. easily saved. **HARLEY'S, 115, Shaftesbury Lane, Dalston, London, E.8.**

## PORTLAND'S Parts by Post.

### "EBONITE"

	s. d.		s. d.
4 x 4 . . . . .	1 3	12 x 7 . . . . .	5 2
7 x 5½ . . . . .	2 8	12 x 8½ . . . . .	6 5
8 x 6 . . . . .	3 0	12 x 10 . . . . .	7 6
9 x 6 . . . . .	3 5	15 x 8 . . . . .	8 0
10 x 6 . . . . .	3 9	12 x 12 . . . . .	9 0
12 x 5½ . . . . .	4 2	17 x 8 . . . . .	9 6
9 x 8½ . . . . .	4 10	14 x 12 . . . . .	10 5
17 x 6 . . . . .	5 3	18 x 18 (halfsheet) . . . . .	12 10
		36 x 18 . . . . .	21 3 0

7 lbs. . . . . £1 3s. Od. 28 lbs. . . . . £4.  
No charge for cutting, waste, or postage.  
Delivery by return of post.  
Quality A 1. DRILLING, manufacture—BRITISH  
Thickness One Quarter; Surface Mat.  
**JAMES PORTLAND, 39, Sinclair Road, Olympia, W.14.**  
N.B. Mr. Portland stocks 200 Wireless Parts.

## RADIOTORIAL QUESTIONS AND ANSWERS.

(Continued from page 698.)

accumulator charged, so I don't think it is that. Can you offer any solution to the problem?  
There are many causes of this "crackle."—Look over the whole set for a loose connection, especially the 'phone leads. See that your H.T. voltage is quite O.K., if you have a faulty cell in that battery it will give no end of trouble. If the accumulator is overcharged it may be causing the "crackle" through delivering an unsteady current to the filaments of the valves.

A. P. M. (Chadwell Heath).—I have been reading about the reception of the American stations, and I noticed in several cases that the aerials of the receiving stations were stated to be well over the 100 feet allowed by the P.M.G. Have the restrictions been revised in this respect?

The restrictions still hold good, granting the 100 feet total height and length, but if you apply for special permission to erect a larger aerial, it is granted. This is, of course, provided that you have some definite and experimental reason why the larger aerial is necessary or desirable.

"H. T. BATTERY" (Hendon).—I am thinking of using small pocket-lamp batteries connected in series for my H.T. battery. Is this possible? If so, which is the positive pole of the battery?

This arrangement works quite satisfactory, though it is not so economical as the usual method. In using the small pocket batteries you certainly have an advantage in that faulty cells can be removed and replaced by good ones, but these cells form a rather untidy battery and one which is not very handy in its manipulation or portability. The positive terminal is usually the smaller one of the two.

E. K. R. (Exeter).—I am using a crystal set, but cannot get good results: The crystal appears to be set quite correctly but the signals come in very irregularly. First I hear a loud one, and then soft and so on.

You should test your crystal with a buzzer. Connect the buzzer to a battery and erect a small "aerial" from one of the buzzer terminals. Then listen in on your set with the buzzer working. When loudest signals are heard, the crystal is adjusted on its most sensitive point. At present your crystal appears to be adjusted just off its sensitive point, and the signals come in very irregularly. If you are using galena you will need the buzzer frequently as the above mineral requires frequent adjustment.

W. A. S. (Maldon) asks for the wave-length of his coil, 11 inches by 3 inches wound with 24 S.W.G. enamelled, and also if his diagram is correct.

Your diagram is quite O.K. You should be able to hear Writtle using the crystal detector. The wave-length of your coil is about 200-1700 metres. You will need a loading coil in series with the above to enable you to hear Paris.

Make a loading coil of about 100 turns of 24 S.W.G. on a former of about five inches diameter. This should easily cover the range required.  
V. M. A. (Leatherhead).—Why is it that telephony is distorted when a valve set is oscillating?

Because of the fact that a regeneration is taking place from the plate circuit at a slightly different frequency to that of the incoming signals; therefore the resultant impulses are broken into "beats" as in the case of the reception of C.W., of an audio or low frequency which naturally, splits up the uneven modulation of speech into a more or less regular "growl."

THE MARK OF RELIABILITY

Filament Resistances 2/- each.  
with Pointer & Knob Panel Type  
1 to 12 volts.  
**VOLT & AMMETER**  
1 to 35 amps.

Potentiometer 300 Ohms  
4/6 each.  
Panel Type on Ebonite.

Combined Dead Beat Pocket Type. New and not German. Splendid Instrument in Nickel-Plated Case. Ideal for Testing Cells and Filament Current.

POST PAID 5/6 NUMBER LIMITED OTHER EXCEPTIONAL VALUES.

Aerial Wire, Bright Hard Drawn, 7/22 Copper, 3/6 per 100 ft.; same enamelled, 5/-.  
Aerial Insulators, 2 x 2½ ins., Shell type, 9d. each; 2 in. Reel Type, 2d. each.  
Telephone Transformers, (Army type), 9/- each; L.F. Transformers, 15/- each.  
Vernier Condenser, 5 Plate for Panel mounting, 4/- each; 001, 16/-; 0005, 12/-.  
Wireless Jacks, with Plugs, 1/- the pair.  
High Note Buzzer, (Army type.) Worth treble.  
3/- each; Tapping Keys, 5/6 each.  
Dewar Switches. D.P. Change over, panel type, 2/- each; Small Switch Arms, 6d. each.

Write for "Complete Supplementary Price List of Exceptional Values," sent Post Free.  
All goods sent CARRIAGE PAID, but with orders under 5s. 6d. add 6d. for postage.

**J. H. TAYLOR & CO.,**  
ELECTRICAL AND RADIO ENGINEERS,  
Macaulay St., HUDDERSFIELD.  
Telephone, 341. Telegrams: "Thorough," Huddersfield

**Beginners Guide to Wireless**

Explains, in plain everyday language, everything beginners wish to know about wireless telegraphy. **HOW TO ERECT, CONNECT, AND MAKE** all the apparatus required for reception of telephony or morse, and full instructions and diagrams for making coils, tuners, and complete valve and crystal sets. 112 pages, price 1/-, post free.—**SAXON RADIO CO.** (Dept. 14), South Shore, Blackpool. 32-page cat. of wireless apparatus, 3d.; post free.

## ELECTRADIX RADIOS.

Immediate Delivery from our Huge Stocks.  
Everything from a Recorder to an Earth Clip.  
The best-equipped City depot.  
**COME AND SEE US.**  
9, Colonial Avenue is first opening on left in the Minorities, near Aldgate Station, Metropolitan Railway.  
**LESLIE DIXON & CO.** Tel. Avenue 4160.  
9, Colonial Avenue, London, E.1.

## An Ideal Xmas Gift

JUST OUT  
**WIRELESS HANDBOOK & DIARY 1923**  
Price 2/6 net.

A complete Letts' Diary with 40 pages of valuable wireless information and the usual pages of useful general information. Beautifully bound in leather, it will form an ideal Xmas gift. Get someone to buy you one.

Obtainable through all Booksellers or direct post free 2/8 from  
**Radio Press Ltd.,**  
DEVEREUX COURT, STRAND, LONDON, W.C.2.



# Where there's Electric Light there's Wireless

Your electric light catches the wireless exactly as an aerial does. Plug a "Ducon" into any lamp holder or wall socket, connect it to your wireless receiver and you will receive the broadcasting perfectly. Use a "Ducon" and you don't need an aerial. "Ducons" are perfectly safe—each one is tested to 1,000 volts, *they consume no current* and do not affect the electric light in any way.

## The DUCON 10/-

is obtainable from leading wireless dealers, electrical contractors and stores, or direct from the makers.

*Dealers not yet stocking are invited to write for trade terms.*

**Over 50,000 in use.**

**The Dubilier Condenser Co. (1921) Ltd.,**  
 Ducon Works, Goldhawk Road, Shepherd's Bush, London.  
 Telephone: Hammersmith 1084. Telegrams: Hivoltcon, Phonz, London.



### Single Valve Broadcast Receiving Set

PRICE :  
**14 Gns.**  
 Including  
 Broadcasting  
 Fees.  
 Carriage Paid in  
 U.K.

Wave-length 300-2,300 metres. Complete with all Accessories, including Valve, 'Brown's' Phones, High Tension Battery, Accumulator, 100 ft. Aerial Wire, Insulators, Lead-in Tube, and Earth Wire.

**ALL TINGEY Instruments**  
 bear the B.B.C. Stamp.

*Send for our beautifully  
 illustrated catalogue, con-  
 taining full details of our  
 2, 3, and 5 valve sets to—*

## TINGEY WIRELESS LTD.

Offices and Works :—  
 Phone—Hammersmith 1916.  
 Telegrams—"Tingoidar,"  
 London.

Offices and Showrooms:—  
 92 QUEEN St., HAMMERSMITH,  
 LONDON, W.6.

TINGEY WIRELESS LTD.

# Exide

BATTERIES

H.T.

## Batteries for Valve Sets

24v. 28v. 32v.

Type B.K.

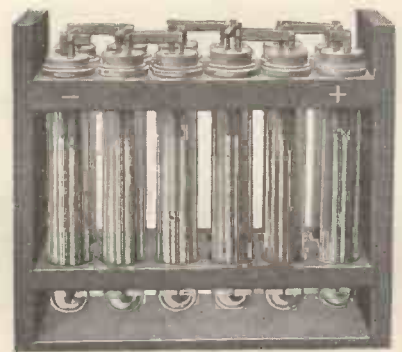

Owing to the demand for these batteries,  
 all orders will be dealt with in strict rotation.  
 Prices approximately one shilling a volt.

:: Ask for Leaflet 4030 ::

## THE Chloride ELECTRICAL STORAGE COMPANY LIMITED.

CLIFTON JUNCTION, 219-229, SHAFTESBURY  
 Nr. MANCHESTER. AVENUE, W.C.2.  
 58, DALE END, BIRMINGHAM.

Why not  
"LISTEN-IN"  
with ease?

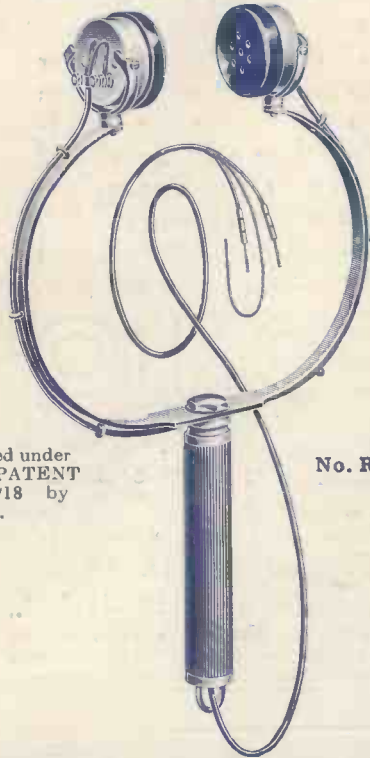

Manufactured under  
BROWN'S PATENT  
No. 134353/18 by  
Sole Licence.

No. R1281

# "Radio" Ladies' Hand 'Phone

INTRODUCE THESE TO YOUR CUSTOMERS  
AS A NOVEL XMAS GIFT TO LADIES  
INTERESTED IN BROADCAST RECEIVING.

Designed to give the user the greatest comfort and convenience  
when receiving, and particularly desirable for use of ladies,  
enabling them to "listen-in" without the necessity of wearing  
overhead straps; thus avoiding disarrangement of their coiffure.

**A High-Grade Instrument.**  
Weight 22 ozs.

**Ideal for Broadcast Receiving.**

To be obtained from all Dealers or direct from:

**Sterling Telephone & Electric Co.,**  
TELEPHONE HOUSE. LTD.

210/212, Tottenham Court Road, London, W.1.

Telephone No.: 4144 Museum (7 lines). Telegrams: 'Cucumis, Wesdo, London.'

Works: DAGENHAM, ESSEX.

Branches: NEWCASTLE-ON-TYNE: 9, Clavering Place.  
CARDIFF: 8, Park Place.

Write for LEAFLET No. 333.

We guarantee that all Broadcast Radio Apparatus sold by us  
conforms with the conditions of the Broadcaster's Licence issued  
by the Postmaster-General.

**DON'T** Let Violence in Advertising  
Rush Your Judgment  
FOR YOUR PROTECTION

**INSIST** on a comparative demonstration  
before you purchase

It is all we ask to prove the demonstrable  
superiority in signal strength, purity of tone,  
simplicity in operation of

THE  
**Crystophone**  
REGISTERED

P.M.G. BROADCAST RECEIVERS

SOLD BY ALL LEADING STORES  
AND WIRELESS AGENTS

All Crystophone Receivers are exclusively fitted with the  
**LATTIKONE TUNER**

The ONLY Tuning Coil which actually builds up and  
strengthens the incoming signal current and thus enables  
us to claim a

**50% INCREASE** in Signal  
Strength. Such is the reserve of power of

THE  
**Crystophone** Type 33  
REGISTERED (two valves)

that 4 Invisible wires stretched across the  
ceiling of ANY ROOM,  
on ANY FLOOR,

in ANY HOUSE in  
LONDON, BIRMINGHAM, MANCHESTER,  
is sufficient for use with 6 pairs of head-  
phones, while with a P.M.G. Aerial it is

**Guaranteed for 100 Miles**  
**PRICE £15** (INCLUDING  
ALL ROYALTIES.)  
Crystophone Crystal Receivers  
with Lattikone Tuner,  
PRICES from £3 10s. 0d.

**Demonstrations Daily**  
ON BROADCASTING  
FROM 4 TO 10 p.m.

**WIRELESS SUPPLIES CO.,**  
64, Mortimer St., London, W.1.

Phone: Museum 2672. Grams: "Adragonax, Wesdo, London."

All Applications for Advertisement Space in POPULAR WIRELESS to be made to JOHN H. LILE, Ltd (Sole Agents), 4, Ludgate Circus, London, E.C.4. Phone: 10808 Central.



No. 31. AN ARTICLE BY WILLIAM LE QUEUX.

# POPULAR WIRELESS

3d  
Weekly

No. 31. Vol. 2.  
Dec. 31, 1922.



The Broadcasting Studio at Marconi House. Mr Jefferies, the musical director, is at the piano, and behind him are the famous tubular bells.

## SPECIAL FEATURES.

Notes on the Scottish Ether.  
Forming a Wireless Society.  
Automatic Wireless.

How to Make a Vario-Coupler.  
A Useful Accessory.

An Easily Made Crystal Detector.

Education and Broadcasting: Letters from Mr. G. B. Shaw and others.

**It Speaks for Itself—**  
 and in no uncertain voice.

**THE WORLD'S STANDARD  
 LOUD SPEAKER.**

**AMPLION**

WIRELESS  
 LOUD  
 SOUNDING  
 RECEIVERS  
 are supplied in  
 a series of

**Ten Models**

Suitable for  
 every service:

**The Home,  
 Laboratory  
 and the  
 Concert Hall**



**At Prices**  
 ranging from  
**£2 : 10 : 0**  
 to  
**£15 : 15 : 0**

**DAILY  
 DEMONSTRATIONS**

at the  
**GRAHAM  
 SHOWROOMS**  
 The ALGRAPHONE SALON

25-26 Savile Row,  
 Regent Street, W.1  
 'Phone : Regent 1075.

**"MUSIC MASTER" HORN.**

- Type AR 13, 120 ohms .. .. . £6 : 0 : 0
- Type AR 15, 2,000 ohms .. .. . £6 : 2 : 6

"GRAHAM" WIRELESS  
 PRODUCTIONS INCLUDE  
 "HIGH EFFICIENCY"  
 TELEPHONE HEADSETS  
 OF IMPROVED DESIGN  
 AND CONSTRUCTION.  
 THE "GRAHAM" IS THE  
 BEST HEAD GEAR MONEY  
 CAN BUY.

Full Particulars forwarded  
 upon request.  
 Ask for Folder P.W.

*Patentees and Manufacturers:*

**ALFRED GRAHAM  
 AND COMPANY**  
 St. Andrew's Works, Crofton Park  
**LONDON S.E. 4**

'Phone : Sydenham 952. 'Grams : Navalhada, Brock, London

**SCOTLAND—**

Mr. F. M. Milligan,  
 25, Rentrue Street,  
 GLASGOW.

**IRELAND—**

Mr. Alex. R. Munday,  
 41, Chichester Street,  
 BELFAST



**NEXT WEEK.**  
**NOTES ON THE SHEFFIELD ETHER.**  
**HOW MY SET GREW UP.**  
**IDEAS FOR EXPERIMENTERS.**  
**A VISIT TO CROYDON WIRELESS STATION.**  
**AN ACCUMULATOR CHARGING BOARD.**

# Popular Wireless

TOPICAL NEWS AND NOTES.

**THIS WEEK.**  
**THE "HOME-MADE" SET BAN.**  
 An interview with a G.P.O. Official.  
**NOTES ON THE SCOTTISH ETHER**  
**USEFUL IDEAS FOR THE EXPERIMENTER.**  
**COMING SHORTLY.**  
 An Article by Dr. Lee de Forest.

**2 L O and the Piano.**

ON Sunday evening (December 17th) 2 L O gave one of the best concerts I have yet heard. One item in particular, was simply first rate—I refer to the Chopin Piano Scherzo in B flat minor. On a small loud speaker, and using only 2 valves, the result was beyond all praise. There is no doubt that the radiophone has the gramophone beaten hollow as far as instrumental music goes; the sonority and clarity of the music was remarkable.

**The Black List.**

MR. BURROWS has commenced a new feature which, I hope, will have some effect. During the course of each concert he reads out the names of various districts from which complaints are being received about the misuse of reaction. Peckham, Windsor, Forest Hill, and Palmers Green were on the black list the other night. I wonder what the delinquents felt like when they heard Mr. Burrows' reproving voice!

**Last-Minute Changes.**

BY the way, as Mr. Burrows pointed out, it is not always possible for the wireless papers to give notice of the alteration of the hours of transmission. 2 L O makes her first call nowadays at 7 p.m.; but as this alteration was made at the last minute it was obviously impossible for POPULAR WIRELESS to make the necessary correction in the current issue.

The daily papers, however, are now printing particulars about the concerts, and readers of POPULAR WIRELESS should consult them for last-minute alterations.

**Provincial Broadcasting Notes.**

THE Metro-Vick station at Trafford Park will shortly commence Sunday transmissions, and the station will also soon be operating on its full power of 1,500 watts.

With the completion of the Glasgow station and the Cardiff station in a few weeks' time, the chain of broadcasting stations will probably be completed for some time. It is not likely that the Aberdeen and Plymouth stations will be erected until wireless has become more popular.

**Mr. John Scott-Taggart.**

READERS of POPULAR WIRELESS will learn with regret that Mr. John Scott-Taggart has resigned the position of chief technical adviser to POPULAR WIRELESS.

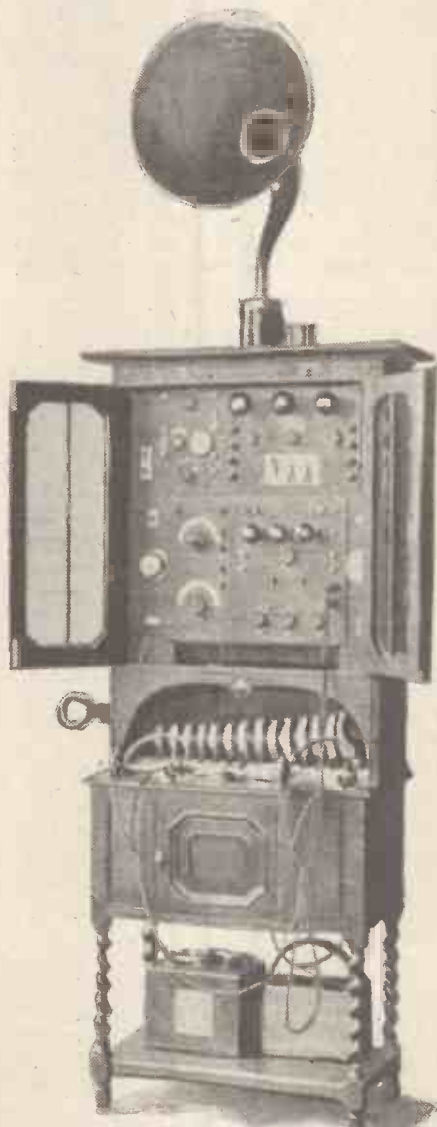

A Cabinet Valve Set, made by J. J. Smithers, Ltd., Rochdale.

On January 15th Mr. Scott-Taggart is publishing a new shilling wireless magazine, and his new editorial duties compel him to relinquish his connection with this paper.

Mr. Scott-Taggart's new journal will be called "Modern Wireless," and wireless men all over the country are awaiting its appearance with keen interest. It is good news, however, to learn that Mr. Scott-Taggart will continue to contribute articles on the valve to POPULAR WIRELESS. All good luck to him and his new venture.

**2 Z Y.**

I HEAR that aerials are springing up like mushrooms in Manchester and Birmingham now that both these towns have got well under way with regular broadcasting transmissions.

In Manchester suburbs—Hale especially—amateurs are rapidly increasing in numbers. I listened to the Manchester concert the other night, and on the whole the transmission was good. The only fault I had to find was that the announcer at the station had hardly mastered the technique of speaking by radio or else the microphone was a bit off colour. Anyhow, practice makes perfect.

**B.B.C.'s New Year Plans.**

SIR WILLIAM NOBLE has stated that all the details for the extension of the broadcasting service are now completed. Within a very few weeks the erection of the stations at the remaining five centres will be well under way, and in two or three cases completed. At the new studio in Savoy Street and at the branch distributing stations throughout the country the best artistes are being engaged, and when the broadcasting stations are fully manned and the various contracts definitely drawn up, the concerts and news services will be very considerably extended and improved. Sir William Noble also stated that the negotiations with owners of copyrights are proceeding amicably, and that their demands are not at all unreasonable.

**Radio Dancing.**

A CONTEMPORARY expresses the opinion that the advent of broadcasted dance music will cause the introduction of special steps with radio titles. The possibilities are alarming, and the moment I perused the paragraph Wireless Wobbles and Condenser Crawls loomed up in all their gauntness. No doubt Dialectic Dips, Loading Coil Lounges, Microphone Minuets, Heterodyne Hops, Thermionic Trots, Wave-length Wobbles, etc., will figure prominently upon future dance programmes. Where will it end? Probably in a Short Circuit Shiver—the supper dance.

**That Radio Voice.**

SCHOOLS for the special training of singers and artists for broadcasting were declared necessary by Mr. A. P. M. Fleming, chief of the Wireless Research Department of the Metropolitan Vickers Electric Co., Ltd., at a demonstration given at Trafford Park, Manchester, recently.

Mr. Fleming said they had tried many singers with excellent reputations, but they had not been a success because they lacked the qualification necessary for broadcasting. There would have to be schools for training artists and speakers in the particular technique required.

#### B.B.C. Appointments.

I HEAR several important positions have been filled by the Broadcasting Company. A Director of Programmes has been appointed (Mr. A. Burrows), an assistant director (Captain Lewis), and a manager (Mr. Keith).

#### The Xmas Programme.

L O's announcement of a special Christmas programme was rather belated, and consequently arrived at POPULAR WIRELESS Office, to late to include in the December 23rd issue, but most readers realize that the daily papers are the only journals in which last minute announcements can appear.

#### The Radio Association.

SINCE broadcasting commenced, the necessity for the establishment of a really active organisation for the protection of amateur experimenters and licence-holders in general has become apparent, and the Radio Association has been founded for this purpose. The policy of the association will be guided entirely by the members, and the support it has already received has exceeded the most optimistic expectations of the organisers. The development and the application of radio science will be one of the objects in view, as well as the protection and furthering of the interests of licence-holders and potential licence-holders. Technical advice will be given to users of wireless receiving sets, and matters affecting patents will be dealt with in co-operation with the Institute of Patentees. Lectures and debates are being organised in districts to stimulate interest in radio science, including schools and colleges. The head offices of the association are at 44, Great Russell Street.

#### Various Items.

A CONCERT at Oundle School was recently "broadcasted" by the school wireless corps, the music being well heard in various parts of England.

Communication by wireless telegraphy has been established between France, Algeria, and Tunis on the one part, and Syria, Palestine, and Egypt on the other part.

#### Local Interference.

HAVING heard many complaints about reaction," writes a reader, "and having a three-valve set myself with a reactionary circuit, I understand that there is no way out of the trouble. Does it mean, therefore, that people like myself have to dispense with their sets? I have an experimental licence myself, which, I believe, entitles me to use reaction on wave-lengths other than the broadcasting stations' wave-length. Is this correct?"

"The London station said recently that

a crystal set was good enough for the London area, but evidently they were taking a view that only one person wanted to listen. What about families who were all eager to listen-in, and to do this only a valve set with a loud-speaker is possible.

"I had my set some time before the company started transmitting regularly, and I think it is rather hard that persons like myself have to suffer for other folks who let their sets oscillate or howl.

"If I hear a set oscillating I always assume that the operator is doing his level best to stop it, seeing that he cannot get results while his set is oscillating. Cannot persons who have such sets as myself do something (other than do away with it) to come under the requirements of the P.M.C.

I belong to a society, but they seem to be unable to suggest anything for such sets."

One of these days the reaction fans will wish they'd been more careful. I hear drastic steps are to be taken unless the nuisance abates.

ARIEL.



Mr. J. A. Orr's set, 40, Old Park Road, Belfast.



# Broadcasting Programmes

What you can hear every evening of the week on your set.

**TELEPHONY AND MUSIC TRANSMISSIONS.**

Station.	Call sign.	Wave-length in metres.	Remarks.
Marconi House, London, Broadcasting Station	2 L O	360	Every evening, 7 to 7.30 p.m. (News Bulletin); 8 to 9 (Concert); 9 to 9.30 (Late News); 9.30 to 10 (Concert and Dance Music.) Continuous service to be given shortly.
Manchester Broadcasting Station	2 Z Y	335	Every evening, 6 to 10 p.m. (News, vocal and instrumental music).
Birmingham (Witton) Broadcasting Station	2 W P	425	Every evening, except Sunday, 6.30 to 10 p.m. (News, Concerts, etc.)
Croydon	GED	900	Throughout day to aeroplanes.
Writtle, Essex	2 M T	400	Tuesdays, 8 p.m. (Concert.)
Paris	FL	2,600	7.20 a.m., 11.15 a.m., 5.10 p.m. Also occasional telephony at 10.10 a.m. and 9.20 p.m.
Königswusterhausen	LP	2,800	Between 6 and 7 a.m., between 11 and 12.30, and between 4 and 5.30 p.m.
The Hague	PCGG	1,035	Sundays, 3 to 5 p.m. (Concert.)
Haren	OPVH	900	Practically every 20 minutes past each hour from 11.20 to 4.20, giving messages to aeroplanes on the Brussels - Paris, Brussels - London, and Brussels-Amsterdam lines.
Radio-Electrique, Paris	—	1,565	Concerts at 8.45 p.m.
Brussels Meteorological Institute	Q P O	1,500	Slow C.W. and Morse. Easy reading for amateurs.

Note.—See announcements in daily Press for last minute alterations in times of Broadcasting Programmes.

NOTE.—The Bar Lightship, Liverpool, sends telephony at 7 a.m., 9 a.m., 11 a.m., 12 noon, 1 p.m., and every two hours until 9 p.m. Calls "Dock Office." Liverpool answers "Bar Ship."

In addition to the regular transmissions, carried on between the British amateur stations, much telephonic conversation may be heard from St. Ingelvert (A M), Le Bourget (Z M), and Brussels (B A V). These stations are quite powerful, but they call for a little extra care in tuning. Wave-length, 900 metres.

All times given are G.M.T.  
An asterisk denotes transmissions made purely for experimental purposes.



# FOREIGN LISTENERS TO BRITISH AMATEURS.

By WILLIAM LE QUEUX, M.I.R.E.

IN the course of my experiments in the transmission of telephony, I have from time to time received reports from listeners in France and Holland, and therefore it has occurred to me that there are many experimenters holding transmission licences who would like to get into touch with enthusiasts across the Channel, with the object of obtaining reports.

In France, there are three principal amateur radio associations: the Radio Club of France, 95, Rue de Monceau, Paris; the Society of Friends of Wireless Telegraph, 102 bis, Rue Didot, Paris, and the French Society for the Study of Wireless Telegraphy, 12, Rue Hoche, Juvisy-sur-Orge. To this last—known to French amateurs as the S.F.E.T.S.F.—most of the provincial societies are affiliated, in the same way as our radio clubs are affiliated to the Radio Society of Great Britain.

### Enthusiasts All.

In the north of France, the region where British amateurs are heard, there is the Rouen section of the S.F.E.T.S.F. with M. Restout of 8, Rue de la Haie, Boisguillaume (Seine Inferieure). At Havre there is another section, with its headquarters at 56, Rue de Lycée; while at Caen, M. Jeanne, 263, Rue Saint Jean, is an enthusiast, and has heard British amateurs.

At Rheims there is a very enthusiastic circle of amateurs headed by M. de la Morinerie, whose address is Au Foyer Civil, Rheims. In Brittany there is another group who hear British stations, and occasionally amateurs. The society is known as the Société Quimperoise d'Electricite et de T.S.F., and its energetic secretary is M. Picquenard, 19, Rue de Brest, Quimper, while the North of France Radio Club has its headquarters at 55, Rue Neuve, Roubaix. At Nantes there is a very ardent experimenter in the person of M. Fonteneau, 19,

Rue Contrescarpe, who has occasionally heard music from London transmitted from British amateur stations.

Again, there is Monsieur Cremailh, 15, Rue de Vitre, at Rennes, and Monsieur P. Merimée, 15, Rue de Medicis, Paris, of the Section Scolaire de T.S.F. at the Lycée Henri IV. Away in Savoy, where British amateur stations have also been heard occasionally, is the Radio-Savojarde, with M. Ritz of the Caisse d'Epargne at Annecy as its moving spirit.

### Willing to Assist.

At Compiègne there is the ever-courteous Monsieur Bornot, 111, Rue de Paris; at Lyons, M. Reynard, whose address is 1, Rue Camille-Jordan; at Agen, Monsieur de Sevin, Pont-de-Pierre; and at Le Mans, Monsieur Lardry, of 61, Boulevard Négrier, is secretary of the Radio Club of Western France. And yet another keen enthusiast and listener is Monsieur Doidie, of 22, Rue Palissot, at Nancy.

In Holland a constant listener and transmitter is M. F. L. Leistra, 4, Waldenburgstraat, Rotterdam, who has a most efficient set, and to whom I have transmitted from Guildford. And another enthusiastic listener to British amateurs is Monsieur F. L. Meyer, Prinsengracht 315, Amsterdam, who has also reported on my transmissions.

Several of the gentlemen whom I have named are known to me personally, and I therefore venture to give their addresses for the benefit of any British experimenters who may wish to get into touch with them. Most of them are very courteous, and are not over prone to put down failure to hear as inefficient transmission. In my own case, some of them listened night after night in patience, until more than one was able to report that they heard 2 A-Z calling. I trust my fellow-experimenters will meet with the same gratifying results.

# NOTES ON THE SCOTTISH ETHER

By 2 M G.

THE ether in Scotland is much more thinly populated than that in England. There are various reasons for this, among these being the following: Scotland has a much smaller population than England, and, also, comparatively little popular interest was taken in wireless until broadcasting was introduced.

It is notorious that the country north of the Border is very badly off for telephony; Paris can be heard with two valves (1 H.F.), but, although The Hague and Writtle are audible, there is really no pleasure in listening to them, owing both to their comparative faintness and to interference from ships, Admiralty stations, and other sparks.

This lack of powerful telephony is not, however, without its advantages. Amateurs have been forced to improve their sets, and especially to experiment in the various methods of high-frequency amplification, which is, of course, absolutely essential for efficient reception of weak telephony.

Three years ago, when post-war experimenters were allowed to begin, it was not by any means the usual thing to use valves, or even a single valve. Now the amateur who has not at least one stage of amplification is regarded as having a long way to progress in the science.

### Limited Local Transmissions.

As stated before, Scotland is lacking in transmitting stations sending telephony. At present there are no broadcasting stations and even of experimental stations there are, to the writer's knowledge, only three, all limited to the usual 10 watts. These are situated at Huntly, Aberdeenshire (2 J Z), Edinburgh and District Radio Club (2 T F), and Bearsden, near Glasgow (2 M G). These stations, of course, are purely experimental, so that "listeners-in," except a few who have been previously informed, do not know when to try to receive these telephony transmissions, nor whether the 440-metre wave or the 150-200 ones will be used.

No data is available as to the results of the other two stations, but it may be mentioned that 2 M G using 10 watts and a single Mullard transmitting valve with grid control is regularly heard with 'phones on table in Stirling (20 miles), the speech and music being clear and articulate. The receiver used is made up from Sullivan's components and has four valves (1 H.F.). Reports have also been received of reception of this telephony in Ayr (35 miles). The type of receiver was not stated.

### Long Range Work.

Some very good results have been obtained locally in the reception of Writtle's transmissions. Perhaps the atmospheric conditions just now are exceptionally favourable, for although up till recently reception of 2 M T in Glasgow with one valve would have been regarded as the merest freak, yet there are at least two experimenters in the district who have been successful. A few words had previously been received near Edinburgh, and reception has been successful in Cornwall (250 miles) on a single-

(Continued on next page.)



Miss José Collins has fitted up a wireless set. She is seen here listening to 2 L O with some friends.

# THE P.M.G. AND HOME-MADE SETS.

"POPULAR WIRELESS" INTERVIEWS A G.P.O. OFFICIAL ON AN IMPORTANT SUBJECT.

**D**EFINITE information with regard to the position of the wireless amateur has been obtained by POPULAR WIRELESS in an interview with Mr. J. W. Wissenden, who is in charge of the Wireless Licence Department of the G.P.O.

Discussing the position of the amateur who has made, or wishes to make, his own apparatus, Mr. Wissenden said: "Licences for home-made sets will be granted wherever possible, provided that sufficient evidence is given that the owner is a bona-fide experimenter." He explained that home-made sets must be *home-made*. Sets that have been bought complete in parts, and which "only need a screwdriver and a pair of pliers" to put the parts together, do not constitute home-made apparatus.

## Defining "Home-Made."

It has lately been reported that certain amateurs have received licences to permit the use of apparatus made up from parts which are sold in sets ready for the construction of complete receivers. This cannot be taken as a precedent for all such apparatus, and persons buying complete sets of parts, and then building their apparatus, cannot hope to obtain any concession in the way of special permission to use the set with a broadcast licence. Such persons must apply for and obtain a full experimental licence before they are authorised to use the set.

"It will be just as well to explain what is meant by a home-made set," said Mr. Wissenden. "Any set which does not contain bought parts—such as transformers, inductances, condensers, etc., constitutes a home-made set, and the owner may apply for a special licence allowing him to use the set without having to take out a full experimental licence. Any complete instruments or parts of apparatus that *have to be bought* for the set should be stamped by the B.B.Co. In other words, all coils and condensers, etc., not so stamped, must be built up at home from the "raw" materials.

## NOTES ON THE SCOTTISH ETHER.

(Continued from previous page.)

valve set, but to hear a complete transmission, not "scraps," says much for the efficiency of both receivers.

Since broadcasting started in London, and later in Manchester and Birmingham, a large number of Scottish amateurs have heard excellent speech and music with what would have been thought inadequate apparatus.

The special sets made and sold for broadcasting are proving their worth. At Bridge-of-Allan, near Stirling, good results are obtained from 2 L O using the two-valve Marconiphone, the guaranteed range of which for the purpose is only 50 miles. A Glasgow gentleman using an Etherphone III, which has a range of 80 miles, but with only 2 valves in operation, has received the

"The reason why these parts of a set must be stamped by the British Broadcasting Company is that unless this is enforced, the British manufacturer has no protection from the invasion of foreign firms, who are, of course, prohibited from joining the Broadcasting Company.

"In applying for special permission to use home-made apparatus, an experimental form from the Secretary, G.P.O., should be used, and the full details and wiring diagrams of the set must be forwarded with the application.

"All that is possible," said Mr. Wissenden, "will be done to help the *bona fide* experimenter who really makes his set, and does not just put it together from bought parts.

"Those who want to have the Broadcasting, and do not wish to construct their own apparatus, must buy complete sets bearing the B.B.Co. mark.

## Amateur Transmissions.

"Amateurs who have sets in operation and do not possess licences should be warned that there is thus no excuse for not having a licence, and that the Wireless Telegraph Act gives the Post Office right to search any house on suspicion, and to confiscate the apparatus should any unlicensed parts be found. Furthermore, offenders are liable to fines up to £100, or a maximum penalty of twelve months' imprisonment."

While discussing the position of the amateur transmitter, we were told that even though broadcasting has very largely closed him down as regards the 400 metre wave-length, he is still allowed to work on wave-lengths below 300. This is allowable under the rule regarding reaction, which states that no reaction upon wave-lengths of 300 to 500 metres may be employed during certain hours. Thus the wave-lengths of 150 to 200 metres are quite clear at all times for amateur transmission, even when the broadcasting stations are working.

London concerts comfortably on two pairs of phones. This shows that an adjustable reaction, though a help, is not essential to efficiency, provided the design of the set is good.

A Johnstone worker with a two-valve set using 1 L F, writing to an evening paper, states that he gets 2 M T clearly. "It was specially loud," he says, "on the 12th October, and very good on the 24th. I also get telephony from FL, LP (Berlin) and Rome, and have further had 2 M G. FL telephony is very bad now, but 2 M G (Bearsden) was extremely good. In Morse I hear all Continental stations and lots of American ones."

There are so many cases of reception of Manchester and even London broadcasting on one valve, that it would be tedious to detail them; although, for some reason, reception of the Prince of Wales' speech on the occasion of his inspection of the Boy Scouts was a failure, even with several valves. A Dollar experimenter who raised the point has had a letter from the Marconi

## RADIO CHARTS.

**T**HE first of a series of Radio Charts, by G. D. Hinks, A.M.I.E.E., Hardington, Yeovil, has been forwarded to us, and it promises to be the forerunner of a very useful collection of hints and wireless knowledge. The first chart, on the care of accumulators, is a very concise and valuable little booklet, dealing as it does with a part of apparatus which is so often neglected and misused. If all Mr. Hinks's charts are to be of the same type, they will form a most useful collection for the wireless amateur.

## CATALOGUES.

**W**E have received from Hobbies, Ltd., Dereham, Norfolk, leaflets describing their patent wooden latticework wireless masts. These can be obtained in 50, 60, and 70-foot sizes, each consisting of the required number of 10-ft. sections.

The design is original and excellent in respect of portability, lightness, and simplicity. Moreover, for the wireless club and serious amateur, splendid height is obtainable with comparative ease. Last, but not least, an attractive feature is the pleasing similarity in appearance to the orthodox lattice masts employed by the large commercial wireless stations.

Company stating that his failure to receive the speech in Scotland was by no means exceptional. The company had received no reports of the reception of this transmission north of Rotherham (180 miles), although in the West of England it was heard at Newquay (240 miles).

Glasgow schools are beginning to awaken to the educational value of wireless. Allan Glen's School has had its set for about two years, but another has now started. Glasgow Academy has been presented with a 4-valve set by a former pupil, now a partner in a wireless firm. This set is provided with two sets of accumulators, a luxury which most amateurs appreciate but few possess.

There has been much delay in establishing a broadcasting station here. "Glasgow or Edinburgh" is what was originally said. A little time ago there was a rumour that a town midway between was to be selected so that neither city could complain, but it is understood that Glasgow has now been settled on. The difficulty was probably that of obtaining first-class artistes outside the large towns. If a convenient site in the city is chosen, performers at concerts will be able to contribute to the broadcast programme between their turns, thus saving expense while maintaining the efficiency of the service.

A start is expected to be made with the erection of Glasgow's station about the beginning of the year, and one will follow later at Aberdeen. Glasgow will cater for all Scotland except the North, and in addition should serve the North of Ireland.



# HOW TO MAKE A VARIO COUPLER.

By A. W. DRANSFIELD.

**M**OST wireless instruments have various alternative methods of construction, but the variometer, or vario-coupler, will appear to most amateurs as being difficult to construct on account of the rotor, but a rotor is really not difficult to make, and does not require a lathe if carried out in the following way, and certainly will not be expensive.

Like most appliances in wireless gear, care in construction is necessary, and the rotor will require a little patience, as it is very desirable to get it as round as possible.

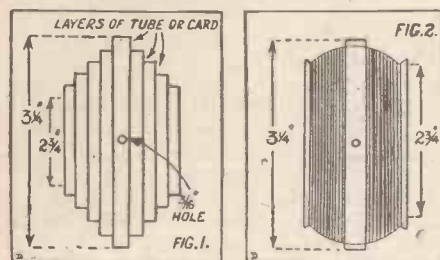

In the first place, procure a length of cardboard tubing, which should measure about 2 3/4 in. inside diameter. This will have to be built up to get the desired thickness, and it will be seen by the drawing how this is accomplished. If possible obtain some tubing that will just slip over in layers until the required thickness is made up, when the total outside diameter should reach 3 1/4 in. (Fig. 1.)

All these layers, whether they are made up with tube or cardboard, should be well stuck with shellac varnish, and when dry all the sharp corners should be sand-papered or filed off until a rotor (Fig. 2) is the result. It will be noticed that a ridge is left on the outside edge which will keep the wire from slipping off during the winding.

### Winding the Rotor.

The wire for the rotor should be 26 gauge C.C., and there should be 16 turns on each half.

A small hole should be made at the extreme outside edges, and also at each side of the centre strip in the recess to take the winding. Start winding at one of the outside holes, fastening off by means of a small plug allowing about a foot of wire for the connection. Wind the layers closely until the 16 turns are on, then leave about an

inch to spare, and pass the end through the hole into the inside of the rotor, this will make the winding easier.

Then pass the end of your wire through the following centre hole, taking care to see that it is long enough to join on at the point where you have just left off. Join up and carry on with the winding in the same direction until there are 16 turns on the other half. Well shellac the whole lot and allow to thoroughly dry, whilst the stationary portion of the instrument is being made.

This portion, the primary, is a much easier job. It consists of a piece of cardboard tube that will have to be 3 3/8 in. inside diameter and 4 in. long. Well shellac this tube and wind on 40 turns of 20 gauge C.C. wire, and after winding, well shellac and dry. Then mark off 6 to 8 equal divisions on the winding for taps (Fig. 3A). These are easily made by inserting the tang of a file under the wire, and stretching up a small loop of wire, which must be cleaned off to receive the connecting wire that is to lead off to the stud on the selector switch.

### Assembling.

The length of these wires will depend on the distance the switch is away, but 3 in. or 4 in. should be ample. The same kind of wire will do for the tappings, and the ends should be cleaned off and passed round the

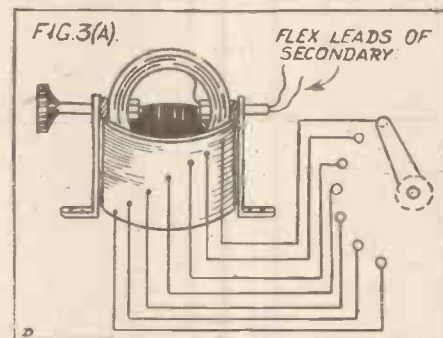

loops once or twice, and then pinched on tightly with a pair of pliers. For preference, the joint should be soldered.

The direction of these wires to the switch are shown in Fig. 3A. The rotor will be quite hard by this time, and it will be noticed that the drawing shows a 3-16 in. hole, which goes right across the rotor and should be quite central so that a continuous axle would be exactly across the centre (Fig. 3).

The axle, however, is in two halves, and made of 3-16 in. copper or brass tube, and fastened as shown in Fig. 3. The wood washers should be made thick enough to cover the space between the uprights, which consist of springy brass, so that when all is assembled the uprights will give a slight pinch and cause a brake-like action that will hold the rotor in any position.

To help to stiffen the axle and provide a better support, two small blocks of wood

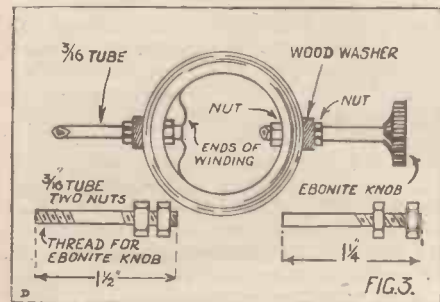

may be stuck to the inside of the rotor. It will also be noticed that the wires from the rotor pass through the axle, and a good plan is to solder two pieces of flex wire on to the coil ends to pass through the axle—they are less likely to get damaged.

The various diagrams show the other necessary particulars. This vario-coupler should work up to 400 meters, and is well worth any trouble that may be expended on its construction.

## A USE FOR PHONOGRAPH RECORDS.

By W. GRIBBIN.

**P**HONOGRAPH records of the cylindrical pattern can be turned to very good use in wireless. These are often to be seen in second-hand furniture shops and can be purchased for a few pence each.

They make excellent inductance tubes, being far more rigid than the ordinary cardboard tube. Indeed, they are quite as good—being composed mostly of shellac—as ebonite tubes, and, of course, infinitely cheaper.

In making holes through which to take wires, it is best to employ a piece of red-hot wire. This melts its way through the tube, leaving a fairly clean-cut hole.

If cut down lengthways, and then immersed in hot water, these tubes become soft and pliable and can be flattened out. They can then be cut into squares, or any other convenient shape, and used for mounting small pieces of apparatus upon, or can be moulded while soft into any required shape.

When, as in a loose coupler, one tube is required to slide into another, the smaller can be reduced in diameter by cutting a strip of the required width out of it lengthwise.

The tube should then be immersed in warm water, and, when pliable, can be bent round a piece of wood, or a tin, to the required diameter. The strip cut out should have been of such a width as to allow the two ends of the tube to meet. These can then be joined by running a hot soldering iron or poker along the tube just where the two ends meet, thus melting the material of the tube and closing up the joint, which can then be smoothed by means of sandpaper.



A Neat Portable Set made by Mr N. Kitching, 23, Cherry Orchard Road, Croydon.

# FROM AN UNOFFICIAL LOG BOOK.

Being a few uncensored extracts from the private journal of a sea-going operator, between the years 1916—1919.

By N. F. E.

**R**EADERS of POPULAR WIRELESS may be interested in the following extracts from a private log kept during the three years I spent at sea. The extracts selected are ones having a wireless interest, and if that taboo subject, the war, crops up here and there, it is only because the writer's sea-going radio experiences coincided with that hectic period.

Turning over the pages of the log, I find the following harrowing account, which, if it chances to meet the eyes of professional operators, will, I hope, encourage tears of sympathy to flow.

**MARCH 24TH.** 7 a.m.—I am just jotting this down in the lull of the excitement. We are now doing an asthmatic twelve knots away from what the Chief Officer vividly terms, "a blankety tin fish." I have informed Land's End of our position, and the possibility of our obituary notices being published, but G L D refuses to reply.

Considering the 600-metre traffic is practically nil just now, I can't make out the station's silence. The set is functioning O.K.—but as it is Telefunken gear, the explanation may be in the Hun's quenched gap.

## A Curious Static.

The gunners are rapidly approaching that crisis when apoplexy becomes imminent. They are repeatedly firing, but with no luck. The Chief Officer, attired in a cork belt and a pair of pyjamas, stands on the after-hatch exhorting them. Possibly his appearance—which is far from *décolleté*—has something to do with the rotten results.

7.25 a.m.—Have called G L D again, but there seems to be nobody at home. Had a suspicion that the crystal detector (Type 31, Marconi's) might be off colour, but buzzer signals disproved this. Made another adjustment though, and refrained from audible remarks.

Crystals are such sensitive souls; a harsh word, and they sulk for hours. The sub. we have lost—no thanks to the gunners; and the engineer-in-chief is now straining his ears for the main boiler's long overdue protest at excessive pressure.

**APRIL 1ST.**—Arrived Gibraltar, and had 'phones nearly blown off my head by the station at Europa Point. Lizzie, the off-side crystal of the (un)balanced crystal detector, promptly went into a fit of sulks, and refused nourishment from the local dry cells. Confound all carborundum.

The aerial of B W W, the north front station at Gib., is one of the finest for "natural erection" I have yet seen. Wires are taken from some point near the neutral border (separating Spain from the Rock) right up to the top of the North Front, the highest point of the Rock.

B W W jams badly on all wave-lengths when using "spark," and the row from the Spanish stations on 600 metres is ghastly. Counted fifteen all pumping Morse at once at about 25 a minute.

**APRIL 3RD.** TUNIS.—We are anchored in Tunis Bay awaiting the departure of a convoy of which we are to be a proud unit. I say proud, because the Commodore has selected our boat as his flag-ship. It

means shaving and all that, but the dignity of the affair is worth it.

While listening for press to-day, I had a curious experience. Heard a long-drawn rushing sound in the 'phones—like the expiring wail of a tyre punctured by a small pin. This curious static, so I had been told, heralded the approach of a bad hailstorm. I risked it, and informed the C.O., with result unprintable—but hail fell five minutes later.

**APRIL 4TH.** 8 a.m.—Our cruiser escort, H.M.S. —, arrived this morning, and was greeted by the waiting convoy (some forty ships) with varying degrees of warmth and affection. The super-courteous French cruiser dipped her flag (as was correct), but the discharge of a blank cartridge and "Rule Britannia" on a cracked gramophone seemed superfluous.

"Lizzie."

One or two hide-bound Socialists didn't dip their flags at all, but the cruiser, after responding courteously, had her own back on the rude ones later on.

To the accompaniment of much bad language and erratic signalling, the convoy cleared the harbour at 10 o'clock, and we are now heading for Port Said.

8 p.m.—It has been a trying day. At noon I found a nest of cockroaches in the armature of the motor-generator, but electrocution proved effective, even at the cost of six yards of fuse wire.

Lizzie is better to-day, and Poldhu (M P D), and Paris (F L) are as loud as one could wish.

Traffic on buzzer sigs. with the rest of

the convoy is brisk, the Commodore keeping me busy with code stuff.

One code call the Commodore ship is allowed to use means: "Put a competent operator on watch."

I used that call a lot and with infinite gusto. One likes to get one's own back a bit.

**APRIL 5TH.** 11 a.m.—More trouble. We are now steaming a bare three knots, for an antique Norwegian old-age pensioner began to lag last night, and this morning was out of sight. The cruiser has gone off to look for her, after ordering the rest of the convoy to slow down. Last night, too, our near companion got erratic, and nearly rammed us. The moon turned quite pale, poor thing, at the subsequent polite remarks.

3 p.m.—An hour ago the Norwegian tramp made a gallant effort to catch up with us. Smoke poured from her funnels in a thick and Stygian black cloud. With incredulity and dismay we saw she was overtaking us—US!—the Commodore ship!

At last she got so near we had to hop forward to avoid a shove from the rear. . .

But it was too good to last. A little later there was a terrific bang, and a cloud of steam hid the poor wretch's shame.

The cruiser went fussing up, her attitude exactly like that of a worried hen: a kind of "Now what have you done, you naughty boy" attitude. The naughty boy had burst his boilers or some such silly thing—so we left him.

**APRIL 4TH.**—Press from M P D. Makes one feel quite at home. . . And, war warnings from B Y B and S U C makes one wish we were.

(To be continued—perhaps.)

## A SMALL CABINET FOR VARIABLE CONDENSERS.

By S. V. HEAP, A.C.P.

**W**ITH the advent of broadcasting, many wireless amateurs are doubtless making and assembling their own apparatus. Many firms are supplying complete parts for the construction of variable condensers. Usually the cabinet to accommodate the finished instrument is an extra. In some instances the parts are intended for panel mounting. Whichever be the case, it is an acknowledged fact that something in the way of a box or container is desirable for the protection of the condenser parts, and the exclusion of dust.

### Inexpensive Material.

A very simple and efficient cabinet may be made, at practically no cost whatever, from plates of old glass negatives of one's own, or exacted from a photographic friend.

A yard of "passe-partout" binding, insulating tape, or rubber adhesive bandage holds the assembled box together. Such a cabinet has the advantage of being dust and damp proof, of permitting the move-

ment of the vanes to be seen, and of being readily dissected and put together again in a minute, at the cost of but an inch or two of adhesive binding.

The writer has found a cabinet thus made from three quarter-plates ( $3\frac{1}{2} \times 4\frac{1}{2}$ ), and two lantern plates ( $3\frac{1}{2} \times 3\frac{1}{2}$ ), most serviceable, without any waste of space, for a condenser of .0003 mfd. capacity.

### Varying the Sizes.

The three larger plates form two sides and the bottom of the case, and the smaller plates constitute the ends, the top being either the ebonite plate of the panel, or the piece of ebonite forming the top of the condenser. Should this not be of the exact size required, a good fit may be assured by covering it with a piece of cedar from a cigar-box, carefully cut to size, and drilled for the spindle and terminals.

For cabinets of larger or smaller size different sized plates may be used, and these may easily be cut to any required dimensions by means of a glass-cutter or glazier's diamond.



# A USEFUL ACCESSORY.

By F. T. SMITH.

OF the many amateur experimental receiving stations one sees, the frequent absence of meters of any description is to be commented upon. Meters, after all, are visible indications of part at least of what is actually happening when circuits are being tested and compared, and they assist largely in showing the true merits of each. For instance, an amperemeter in the filament circuit of a valve receiver provides a valuable indication as to the amount of current taken by different valves at minimum and maximum points of operation and the correct distance for the best possible results. It will also indicate slight variations in filament current due to the batteries which cause some of the telephone noises that are so frequently attributed to atmospherics.

The object of this article is to suggest to those who possess complete valve receivers, and who wonder what to get next in order to add to the fascination and interest of their sets, a meter that will provide for them endless scope for thought, tests, and experiments.

## Visible Signals.

This is a high-tension milliamperemeter for the anode circuit of valves, and is placed in the positive lead from the H.T. battery to the instruments. (See Fig. 1.) A suitable instrument would be of the moving coil type, reading two ways—that is, the zero reading being in the centre of the scale, and the pointer able to move

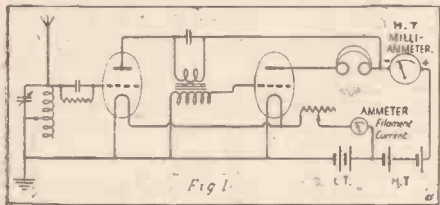

towards either side in accordance with the direction of the current.

The total reading should be from 5 to 10 milliamps. on a scale divided into ten divisions, each division being divided into ten further sections. Provided with such an instrument, wireless signals become not only audible in the phones, but visible on the needle of the milliammeter, and with two needle valves it is possible to read the Paris time signals by this means and to check the clock by watching the dial of the meter.

Croydon, 2 M T, and other loud telephony stations produce most fascinating movements, which may be watched while at the same time hearing the signals in the telephones. Rendering signals visible as well as audible provides a means of comparing the relative strength of signals from the same station from two different circuits or directions of the aerial, showing just those slight improvements which cannot be judged by the telephones alone.

Most of us believe the results obtained by our own sets are superior to those of any other wireless neighbour, but this fact is open to conclusive proof, for when Jones, Junior, says he hears Paris twice as loud

on his three valves as you do, just note the maximum deflection Paris gives on your H.T. meter with both sets, and prove after all that your own set is superior.

Now, as to the method of working. The milliammeter is connected in the anode circuit the whole time, and indicates the amount of current passing from the H.T. batteries. This should be a steady reading when no signals are present, and if any irregular deflections are noted, they are

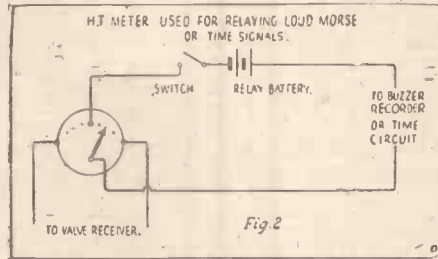

due either to atmospherics, irregular L.T. battery current, or to a failing cell in the H.T. batteries, provided all connections are satisfactory.

If the aerial is disconnected and the meter still gives deflections, then the trouble is not due to atmospherics, and provided the filament current meter does not vary, we know at once that the trouble is a failing cell in the H.T. battery. Thus are we provided, not only with a means of experimenting, but also of locating faults.

## Relaying Signals.

Presuming the reaction coil is adjusted in a position where it is not reacting, and then is brought steadily tighter, at the point of coupling the meter needle will move back considerably. Then, as the aerial tuning condenser (in parallel with the A.T.I) is moved to increase the capacity, the less becomes the H.T. current reading—

that is, the two are inversely proportionate. But supposing the reaction coil to be of the rotary magnetic type, and is back-coupled, the relation between the H.T. current and A.T.C. capacity becomes directly proportionate.

In all wireless sets the external connections are really most important, for a movement of these in relation to one another often produces a movement on the H.T. meter, their best positions being naturally where they cause no indication at all, just as in wiring one's own set the best position of connections is easily found, whereas it is acknowledged that much efficiency is lost in wireless sets by interactions of incorrectly placed connections.

## An Essential Item.

It is highly interesting to know the amount of H.T. current in relation to filament current in any given valve in given circuits, and by plotting these curves on squared paper for different arrangements, complete comparison is obtained, showing all data.

It may be mentioned also that, with such signals as the beats of time checks and with three valves, the H.T. milliamperemeter can be made to ring a bell acting as a type of relay. See Fig. 2. A clock may be arranged to switch on the valves at a given period of time, and the milliammeter will ring the bell without any attention of an operator.

All these details can be left for the experimenter to work out, but this type of meter becomes really essential to the genuine wireless worker, and it is something the writer would not be without.

## READERS, PLEASE NOTE !

Short articles, giving useful, bright suggestions for the amateur, are welcomed. If you have any good ideas, send them along to "Popular Wireless." We pay well for all copy accepted for publication in this paper.

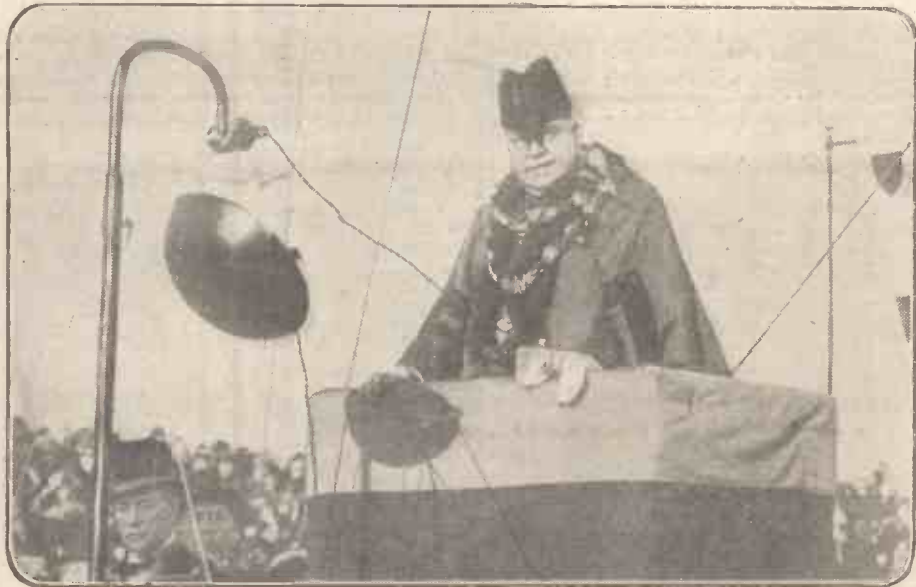

The Mayor of Blackpool addressing a large crowd by means of a magnifier.

# EDUCATION AND BROADCASTING.

**N**OW that broadcasting has begun in however limited a service, there has been appearing in the daily press speculative articles as to the manner in which radio can be used for educative purposes.

Some writers say it behoves those responsible for the broadcasting service to make the most of their opportunities, for it is obvious that a vast public is ready to be eagerly appreciative of broadcasting. This is well demonstrated by the success of the service in America.

The following letters from well-known people have been written at the invitation of the Editor of POPULAR WIRELESS, giving varied opinions for and against the use of radio broadcasting as a medium for educating the public.

From Mr. George Bernard Shaw.

Sir,  
I suggest getting Sir Johnston Forbes Robertson to speak good English to them every day for half an hour to give them some notion of their own language. That would be a startling novelty to most of the subscribers.

G. BERNARD SHAW.

From Mr. H. C. Colles, Music Critic to "The Times."

Sir,  
It is only, of course, with regard to music that I venture to give my opinion on the educational opportunities of broadcasting by wireless. My view is that there is an incalculable opportunity for good in this direction, and that the chances of using it will depend on how far those responsible for the broadcasting service can learn by the experience of others. The gramophone has been broadcasting music by its own means now for a good many years. Unfortunately, a beginning was made by recording any old thing which could tickle the ears of people wanting a new toy. It was not till the gramophone had earned a reputation for dinning rubbish into the ears of the multitude that its promoters realised that they were heading for disaster. Then the companies called in musicians to advise them, and formed educational departments to counteract the evil—a very uphill task.

My suggestion, then, is: begin by getting the advice of people who know good music from bad, not highbrows, but men of experience and commonsense; trust them, and let the world know that only things worth listening to will be broadcasted.

Yours faithfully,  
H. C. COLLES.

From Miss Sybil Thorndike.

Dear Sir,  
The only suggestion I can make with regard to broadcasting is that it will be a most excellent thing if it were to be well rubbed in by radio the fact that "We want a national theatre." If that could be repeated, say, fifty times during each programme it might be a great public benefit!

Yours faithfully,  
SYBIL THORNDIKE.

From Colonel Chedwode Crawley, of the Wireless Department, G.P.O.

Dear Sir,

There must be few who can now doubt that broadcasting by radio telephony has possibilities which would have delighted Jules Verne, and may yet, we hope, delight H. G. Wells.

The few doubters we might refer, as a start, to the British Broadcasting Company, but if that remedy should fail, their conversion can only be delayed, as the immense possibilities of radio broadcasting for news, education, and entertainment, will inevitably pass from prophecy to fact.

Yours faithfully,  
CHEDWODE CRAWLEY.

From Miss Rebecca West, the well-known Critic and Novelist.

Dear Sir,

Any person who cannot acquire information much more rapidly through the eye than through the ear must be such an idiot that he is not worth educating. I fail to see why those associated with radio in its infancy should make the same mistake as those associated with the cinematograph and gramophone, and should try to conceal the fact that what they have to sell is a gorgeous toy under cover of a pretence that it is a means of education.

The "educational" work the cinematograph does in showing our little dears how mustard is quarried in Borioboola does not matter a twopenny dash: the work it does in enlarging their hearts and their imaginations by showing them Charlie Chaplin is beyond all praise. The "educational" work done by the gramophone in teaching our little dears how to pronounce French and German is also not worth a twopenny dash; but the work it is doing in bringing music into the home is beyond all gratitude.

The "educational" work you will fire on the little dears (who will yawn and reflect that they could have got all this out of a reading book with teacher at hand in half the time) will also be not worth a twopenny dash; but the work to be done in bringing

music into the home, in making life more musical and eventful by such devices as the bed-time story, in bringing the sound of the human voice to those souls who find themselves marooned in loneliness, and in making the universe easier for poor struggling man by making communication easier—that is what I'd be proud of, without resorting to guff about education by broadcasting.

Yours faithfully,  
REBECCA WEST.

From Sir Woodman Burbidge, Managing Director of Harrod's, Ltd.

Sir,

I certainly think that the development of broadcasting along educational lines will be for the good of the country in general and particularly for the rising generation. It occurs to me that it might be a good thing to engage competent professors to lecture at given times, and a suitable announcement might be made as to when these lectures would be transmitted.

I also think it would be good to broadcast such educational items as the Science of Domestic Economy. At the present time there are many items which could be explained, such as lectures on housekeeping, cookery, how to select labour saving apparatus—which, I believe, are very helpful in household management.

True, to the majority, music is unquestionably the most pleasing from an entertainment point of view, and I consider that the best singers should be procured for this purpose. Although this broadcasting business has taken such a long time to start I must congratulate the Broadcasting Company upon the manner in which they are endeavouring to conduct the transmissions, and I am sure that a good deal of the success will depend upon the way in which this part of the business is handled.

A new industry has been started which, I am sure, will be for the good of the country in general, and the better the transmission and the more interesting it can be made, the better the success will be.

Yours faithfully, WOODMAN BURBIDGE.



Mr. R. G. Wooler's home-made set, 91 Londonderry Road, Stockton-on-Tees, County Durham



# Good Things for Crystal Enthusiasts from GAMAGES of HOLBORN

Valve or Crystal, Complete Set or Smallest Accessory, you cannot go wrong at GAMAGES. Stocks are so complete, prices for warranted apparatus so keen, and the firm's desire to help the Beginner so genuine, that it would seem almost folly to go elsewhere.

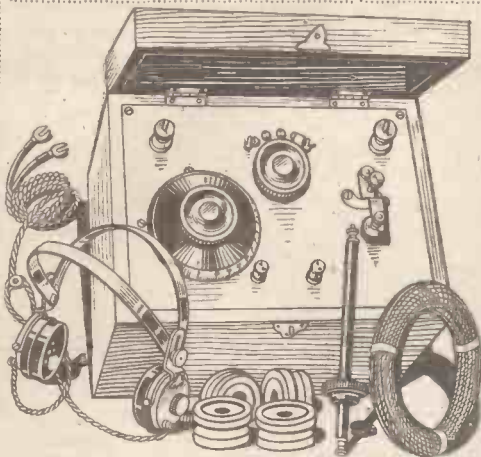

## Fully Licensed CRYSTAL RECEIVER

Fully Licensed and passed by Postmaster-General. The neat, most efficient and most compact receiver to-day. The Crystal combination is the "Perikon," being Zincite and Copper Pyrites. The wave-length covered is 170 to 300 metres. Beautifully finished and mounted in polished mahogany box, and certainly makes a suitable and desirable present. The total cost of this instrument with high-resistance phones, 100 ft. Aerial wire, Aerial insulators and lead-in tube is

**£5-19-6**

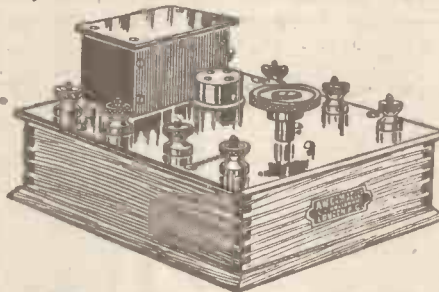

## THIS AMPLIFIER WILL IMPROVE YOUR CRYSTAL SET TO A SURPRISING DEGREE

This single-stage Amplifier, finished in polished mahogany with ebonite top, and ebonite container for the transformer, forms a handsome and efficient instrument. The transformer used is of a 4 to 1 ratio.

This Amplifier will considerably increase volume of sound, thus making Telephony and Signals normally weak a pleasure to listen to.

Price **42/-**  
Extras: Valve, 15/-  
High-Tension Battery, 15/-  
Low-Tension Battery, 25/6.  
Post free.



Read. No. 176.

## THE GAMAGE CRYSTAL BROADCASTER No. 1

This set constitutes a complete receiving station, comprising tuning coil with ratchet Slider capable of fine adjustment Crystal Detector, Phones, Aerial and Earth Terminals, Insulators, Aerial wire, Terminals, etc., etc., as illustrated. Well finished and proved satisfactory under tests. The wave-length covered is approximately 180 to 950 metres. Ideal set for beginner, and can be used for Telephony (Concerts, etc.) up to 20 miles, and also for Telegraphy up to 200 miles.

Price, complete as shown, **70/-** ready for use. Post free



## FIXED CONDENSERS

All capacities. Mounted in polished mahogany box with ebonite top. Well made and efficient.

**6/9**

Cheaper quality. Condenser mounted between ebonite plates. All capacities, Mullard or Dubilier type, 3/6

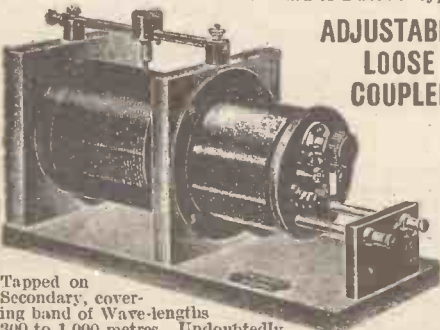

## ADJUSTABLE LOOSE COUPLER

Tapped on Secondary, covering band of Wave-lengths 300 to 1,000 metres. Undoubtedly the most efficient for shorter wave-lengths, especially with Crystal receivers. Price Superior type with long and short wave-switch, 84/-

**47/6**

GAMAGE CRYSTALS			
Best Quality. Fine Large Specimens.			
Bornite	1/- each	Silicon	1/- each
Copper Pyrites	1/- "	Tellurium	1/6 "
Galena	1/- "	Permanite	2/6 "
Carborundum	1/- "	Zincite	2/6 "

Large selection of Crystals in stock.

## Cast Aluminium END HOOKS

For Aerial spreading. Secured by means of a screw. Per pair **2/6**



## VARIABLE CONDENSERS

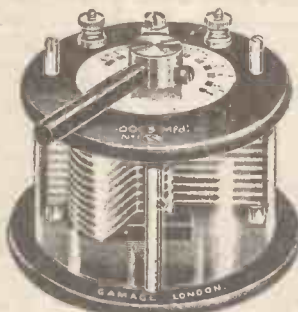

## AIR DIELECTRIC TYPE

Faraday House Calibration. These condensers are the best obtainable. Of the best workmanship, electrically and mechanically perfect.

No. 1.—As illustrated. Circular, with 10 fixed and 9 moving vanes and a maximum capacity of .0003 mfd. Fitted with matt ebonite top and base, and engraved ivory scale. Price **25/-**

No. 2.—As above, with .00045 mfd. capacity. Price **33/6**

No. 3.—.0005 mfd. Circular, with ebonite top, bottom and sides, and engraved ebonite scale. Price **40/-**

Ditto in Square Mahogany Case **33/6**

No. 4.—.0006 mfd. Circular with ebonite top and base. Encased in celluloid. Price **40/-**

No. 5.—.0007 mfd. otherwise as No. 4. Price **50/-**

## PERMANITE DETECTOR

For use with Crystals requiring a fine wire contact, such as "Permanite," Silicon, Galena, etc. The Crystal is enclosed in an air-tight celluloid vessel which keeps it free from dust—the enemy of all Crystals. Ball-joint action with variable pressure. Mounted on ebonite base, 4 1/2 by 1 1/2 by 1/8 in. Price without Crystals **15/6**

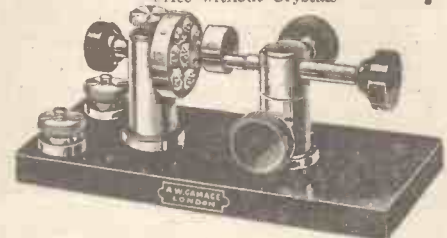
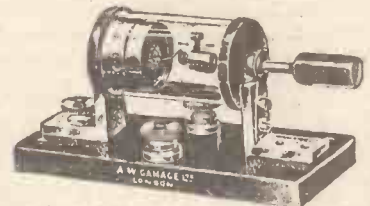

## THE "AURO" CRYSTAL DETECTOR

Combines simplicity, delicacy and quickness of adjustment with strength and first-class workmanship. Made of brass and mounted on ebonite base. Price without Crystals **21/-**

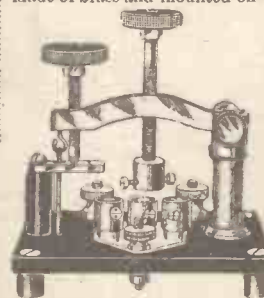

## 4-Cup CRYSTAL DETECTOR

As illustration. Original design, and very efficient. The top cup encloses a gold point for use with "Silicon." Micrometer adjustment. Vulcanite knobs and base; metal parts of lacquered brass. Price without Crystals **19/6**

**WRITE TO-DAY for FREE WIRELESS CATALOGUE**

**A. W. GAMAGE, Ltd., HOLBORN, LONDON, E.C. 1.**



# "POLAR"

## Variable Condensers

Now available in 3 ranges: '0001 to '001 mfd.  
'0001 to '0005 mfd.  
'0001 to '0002 mfd.

ALL ONE PRICE **14/9** POST FREE.

Compare these for price, for efficiency and for compactness with the old-fashioned multiplate condenser. See comparative illustration below:—

BOLTON, 9:12:22.

"We beg to thank you for the early delivery of the three R.A. 36 Condensers, Credit Note and Lists. These 'POLAR' CONDENSERS are undoubtedly the finest we have come across yet, and we have been handling Wireless material for a matter of twelve years or so.  
"They are a credit to your designers."

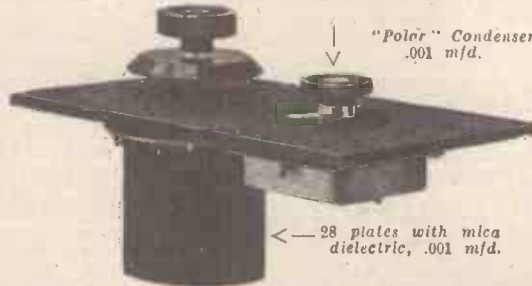

"Polar" Condenser  
'001 mfd.

← 28 plates with mica dielectric, '001 mfd.

## THE RADIO COMMUNICATION CO., LTD.

(Suppliers of the G.P.O. Installations at North Forland (G.N.F.) and Scaforth (G.N.V.), of Coastal Stations for various Colonial Governments, and of Ship's Radio for most of the great Shipping Companies.)

**35, NORFOLK STREET, LONDON, W.C.2.**

Telephone: Central 1021 and 3005.

Telegrams: Radiocomco, Estrand, London.

BRANCHES: Newcastle, 17, Sandhill; Glasgow, 116, Hope Street; Liverpool, 67, Dale Street; Cardiff, Atlas Chambers, James Street; Southampton, 19, Queen's Terrace. (E.P.S.) 29.



**"SSH!—PCCG  
is through!"**

IT'S waste of time trying to tune continental or distant stations through inferior 'phones. Perhaps you've reconditioned head-pieces. Often as not they're pure "junk." And however expensive and selective your set may be, "dud" 'phones won't pick out weak signals.

Fit Ericsson 'Phones. The Services use them—for their never-failing sensitivity and ability to stand up to the hardest test. The Admiralty adopted them as standard in 1909, the R.A.F. in 1917. Easy to the head, robust in construction, delicate and sensitive in operation.

Write to-night for free illustrated list  
The BRITISH L.M. ERICSSON  
MANUFACTURING CO., LTD.,  
International Buildings,  
67/73, Kingsway, W.C.2.



"The Services use them."

# Ericsson

2,000 ohms, price 31/-; 4,000 ohms, price 32/-. All resistances in stock.

## Telephones

**DO YOU WISH TO GIVE  
A REALLY USEFUL  
AND PLEASING  
NEW YEAR GIFT?**

If so, why not

**A WIRELESS OUTFIT?**

**No. 1 Set.**—Crystal Receiving Outfit, fitted with Genuine Hertzite Crystal Detector, 12-inch Coil, pair of British-made Head Phones, 4,000 ohms, Aerial Wire, Insulators, Lead-in Wire, &c.

Price, **£3 10s.** the Complete Outfit.  
Postage, 1/6 extra.

**No. 2 Set.**—A Complete Receiving Set, fitted with Genuine Hertzite Crystal, Variable Condenser, mounted on Ebonite Panel, suitably engraved and enclosed in Hand Polished Mahogany Case, with pair of British-made 4,000-ohm Head Phones, Aerial Wire, Insulators, Lead-in Wire, &c.

Price, **£5** the Complete Outfit.  
Postage, 2/- extra.

WRITE FOR NEW CATALOGUE JUST ISSUED.

All our sets are passed by the P.M.G., and Bear the B.B.Co. Stamp.

**WILL DAY, LTD.,**

19, Lisle St., Leicester Sq., London, W.C.2.

Phone: Regent 4577. Telegrams: Titles, Westrand, London.



# THE FORMATION OF A WIRELESS SOCIETY.

By GEORGE SUTTON, A.M.I.E.E.

THE formation of a wireless society or club is such an easy matter that it is a wonder that such institutions are not more numerous. It is very much more simple than obtaining a receiving licence. Of course, you can get the B.B.C. variety at any head post office for 10s. But this edition, perhaps owing to its ease of obtainment, bears certain restrictions.

The licence that is easier to operate with, but is much more difficult to obtain, is the "experimental" type, and is only procurable from the Secretary of the Post Office. It is well worth while, however, but we digress.

The formation of a wireless society is, as has been previously mentioned, quite an easy matter. Perhaps it is a thing which you have not attempted before, but that consideration should not be allowed to deter you.

## The Club Room.

The wireless broadcasting era is upon us, and a comparatively large number of people know nothing at all about it. If these ignorant people would only club together, they would be able to tell each other, and it would become easy, as we have said before.

The meeting could always find someone who had failed to receive signals on the apparatus which he had made, and he would doubtless be very eloquent in describing his methods, and the others would just avoid those that he had adopted. Easy, is it not? But you must have somewhere to hold the meeting.

Find a person with a large heart and an expansive drawing-room, and make him your chairman. It is only right that a chairman should sit in his own chair, even if he does not consume all his own cigarettes. His wife might say things, but that would usually be after the meeting, when she could again see patches of her carpet where muddy feet had not been resting.

You may be able to do without a secretary, and it often happens that you cannot do much with him. He is very useful, however, for providing three-halfpenny stamps for the club letters, which are sent out periodically to remind the other members of forgotten subscription liabilities.

## Secretarial Duties.

Sometimes he writes to the Secretary of the General Post Office, and then he often forgets to affix the three-halfpenny stamp. His letters, however, are not returned for that reason, but they more often come back because he has omitted the 10s. for the club licence fee. We have not, so far, shown any need for a club licence, but every club should possess one.

The secretary really is an important person, and he has quite a lot to do. Sometimes he does it, but never quite all, because, if he did, he would have no excuse for eternally scribbling all through the meetings.

He never pays any attention to what is going on, but just writes. Nobody has ever seen any of his writing, and torn-up scraps of his notes are rare.

## The Committee.

When you want to know anything you write to the secretary. When you want a licence you ask the secretary to certify that you are British. Some misguided individuals have been known to ask the secretary to suggest a reasonable line of experiments which would satisfy the authorities that they were *bona fide* experimenters. Up to the time of writing these people have had to be content with the B.B.C.

A treasurer is handy, and if, after paying for the club stationery, he has enough private funds left, he is urged to present the lady whose drawing-room carpet has been spoiled with a pair of silver saltspoons. This is called pouring oil on troubled waters, and the chairman beams.

A committee should be elected, but it is hopeless to expect them to commit themselves, even to the extent of turning up regularly at the meetings.

As we have shown above, the formation of a wireless society is a ridiculously easy matter, and one which no group of serious experimenters should neglect.

## AN EASILY MADE DETECTOR.

THE detector shown in the sketch can be constructed quickly and cheaply from odd material. A and B are two telephone terminals. C and D are two washers of brass tubing, or may be improvised from ordinary flat washers, the number required depending on the height to which it is required to raise the terminals.

E and F are two crystal cups which can be obtained for twopence each. A short length of brass rod I, is fitted into the base of the cup and then pushed through the hole in the terminal, after which the second cup is fitted on to the other end of the brass rod.

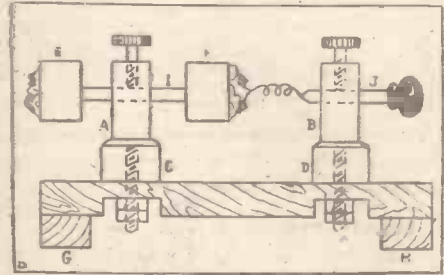

The other terminal is fitted as shown with a piece of brass rod, on one end of which is a small ebonite knob, and on the other the usual "cat's-whisker" of fine wire.

In fitting the terminals to the baseboard, the lock nuts underneath should be screwed against one another to allow just sufficient play for the terminals to be turned round as required. Should one crystal fail it is only necessary to turn round the terminal A to bring the other crystal into action.

The other terminal, B, can be moved round in like manner for the purpose of adjusting the "cat's-whisker." G and H are two battens fixed underneath the baseboard to enable the terminal screws to clear the baseboard of the tuner.



Mr. Leonard Lawton, 50, Market St., Milton, Stoke-on-Trent, and his single valve set.

## RADIO ASSOCIATION.

To Professor A. M. LOW, D.Sc., A.C.G.I.,  
M.I.A.E., F.C.S., Hon. Treasurer.  
RADIO ASSOCIATION,  
44, Great Russell Street, W.C.1.

Dear Sir,

Please enrol me as a Member of the Radio Association, for which I enclose annual subscription of 2s. 6d.

Name in full (with Titles) .....

Address .....

# AUTOMATIC WIRELESS.

By G. V. DOWDING, Grad. I.E.E.

**T**HERE is every indication that the majority of automatic telegraphic systems as employed for landline and cable work will eventually be applied to commercial wireless. With very few exceptions this should not present any very great difficulty to the future wireless engineers. Some of these systems are already in daily wireless use, as, for example, the Wheatstone and Creed. Automatic telegraphy is an incomprehensible mystery to the majority, although the main principles are really quite simple.

Invariably the systems are based upon either isochronous or synchronous actuation of apparatus at the two stations between which exists the connecting link, whether it be a wire or the ether. This latter is possible in at least the two cases mentioned above, so but little imagination is required to picture the possibilities of the extension of such economy. There are, of course, still many seemingly unsolvable problems to prevent that happening, but what is impossible to-day may be probable to-morrow, and in the enlightened future, not only probable, but practicable.

Isochronisation and synchronisation are, after all, purely mechanical arrangements. To thoroughly understand the meaning of these two words, picture two clocks, one at each of two stations. To be synchronous the hands of both clocks must move at exactly the same speed and register exactly the same time; but to be isochronous only the former is essential.

## Possible Developments.

Systems relying upon synchronised apparatus, such as the Hughes and Baudot, but with the exception of the Siemens high speed, which produces synchronisation locally by means of the received signals themselves, will prove more difficult to handle through the ether than isochronous apparatus which has already been largely adapted to wireless communication.

The latter category includes such well-known systems as the Creed and Wheatstone. By means of the latter, messages can be transmitted at a speed of 300 words per minute over the landline. Reception is, however, in the form of printed dots and dashes, which must, of course, be translated by hand upon a typewriter.

That necessitates an unduly heavy staff. But at a slightly less speed the Wheatstone signals can be received upon a Creed automatic perforator, which reproduces a punched tape similar to that employed at the transmitting station. This can be used to repeat the messages through another Wheatstone transmitter or to actuate a Creed printer, which will, at the speed of 100 words per minute, print the messages in Roman letters on a blue paper tape. When there is continuous traffic several operators are required to do nothing but gum up the tape into the form of messages.

The next system to be employed for wireless purposes will, doubtless, be the Siemens, or some similar high-speed automatic direct-printing system, where, at the speed of 170 or so words per minute, the message could be printed directly upon the

paper tape instead of requiring a further process, as in the case of the Creed.

Having accomplished this, wireless ambition will doubtless turn to synchronous apparatus, and it is not at all unlikely that the Hughes system will be marked down as having many very commendable qualifications. This system employs for transmission a keyboard very similar to that of a piano with the black and white keys marked with the various letters and numbers in such an order as to facilitate manipulation.

This will represent a very distinct step, as it will be the first system to employ direct letter to letter transmission and reception. Thus a key marked A is depressed at the transmitting end, and, as A on a revolving wheel at the receiving station happens at that very moment to pass the paper tape, it is a foregone conclusion that A will, by some little mechanical "wangling," strike and impress that paper tape with its inky outline. Of course, should it be required to transmit two successive impressions of A, it would be necessary to wait until the wheel had completed its revolution.

The Hughes is extensively employed on the Continent, and differs from all other systems in requiring only one impulse of

a few words as to the principles involved in landline practice to achieve this seeming miracle will suffice to render it at least believable.

Imagine two wheels, one at each of the stations, both divided into five sections of 5 segments; making 25 segments in all. Brushes are arranged to make contact with the segments. Both wheels are in absolute synchronisation, and as 1 2 3 4 5 of number one section passes the brush of one of the wheels, so does 1 2 3 4 5 of number one section pass the brush of the other wheel situated at the far station. This section will represent one receiver and transmitter at each station, and when the brushes make contact with the segments of their particular section they are, as it were, monopolising the line for a brief period of time. This occurs in rapid succession to all the other pairs of sets, each obtaining for a few moments the use of the line and five contacts running in succession.

## A Wonderful System.

Of course, each set is arranged so that it will take the opportunity at that particular moment to communicate just the combination of segments that will represent

a certain letter or figure. It might, for instance, send out current as the first, third, and fifth segments are passing, and that would induce a current at the receiving station on its own particular receiver's first, third and fifth segments, which would print "T" and so on. Really it is so simple.

Having tackled this system with complete satisfaction, the next to be attempted would doubtless be the Western Electric.

This is similar in

fundamental principles to the Baudot, but instead of using five keys to make the necessary combinations, an instrument similar in appearance to a typewriter is employed.

More wonderful still, reception is not by means of paper tape, which requires to be gummed up, but on the actual telegraph form itself. One operator could, although he would not enjoy it, deal with the messages received from half-a-dozen such machines, because each would print its message and, where necessary, turn up and commence a new line, etc., absolutely automatically. All that is necessary with these wonderful machines is the removal of the messages which, apart from numbering, are all ready to be delivered to the addressees.

I cannot help wondering what they will be doing on the landlines when they introduce such marvellous apparatus as that into wireless.

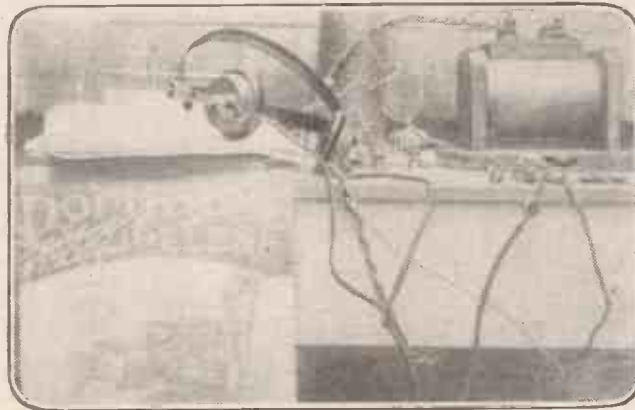

Home-made set by Mr. E. Longbottom, 15, Clearmont Road, Rodwell, Weymouth, Dorset.

current for each character printed. For that reason it will doubtless lead the way in providing directly transmitting and printing automatic wireless communication.

## Really Quite Simple!

It is inevitable that the Baudot will follow the Hughes. The invention of that system is reputed to have driven a Frenchman mad, and it has been perilously near to having that effect upon many who have subsequently handled the necessary apparatus. Possibly in the future ether will lend itself more easily to uninterrupted communication (especially synchronisation) than the long-distance landline wires. It is to be hoped so, because that would render it possible to utilise the Baudot principles. In effect this would admit the possibility of five or six sending and receiving points at each of the two stations simultaneously dealing with directly printed messages.

That may sound utterly impossible, but



# SAFETY AT SEA.

By SIR J. KENNETH D. MACKENZIE, BT.

POSSIBLY no branch of applied science has had more thought and ingenuity expended upon it than that of providing means of securing safety to life and property at sea, especially during the past four or five decades. "There is peril on the sea" is a text inculcated into our minds from earliest childhood; and probably the fact that peril does exist is the source of the fascination the sea exercises over all youthful minds, and leads boys to run away to sea, for to them "peril" generally spells "adventure."

Generally speaking, the perils mostly feared by landsmen are storms and consequent shipwreck, but these are not the chief risks and dangers which beset seamen. Collisions with other vessels or icebergs, entering ports and harbours, avoiding rocks, shoals, and promontories, etc., are the risks requiring most care in navigation, and never more so than in fog, the sailor's worst enemy. In addition to these a means to summon assistance in need and distress was what sailors wanted above everything, cut off as they were from all communication with land or other ships out of sight. To these dangers and requirements applied science has devoted its attention, but, strangely enough, had to struggle hard against the apathy of authorities and ship-owners, who seemingly did not welcome, as one would have naturally thought they would, every appliance which might mitigate the risks ships ran, and consequently the lives of those aboard them, as well as the loss of valuable cargoes.

## Overcoming Prejudice.

Although Signor Marconi had proved in 1899 that wireless telegraphy was a practical success, and that consequently a means did exist whereby ships could signal to each other or to land over considerable distances in case of need, it took the terrible catastrophe of the loss of the Titanic in April, 1912, to arouse public attention to his invention by which on that occasion over seven hundred lives were saved; and yet another year passed before wireless began to receive the serious notice it deserved from maritime authorities. Since then progress has been rapid, and the paramount importance of radio communication during the war necessitated its perfecting in every way possible and adoption for all purposes wherever applicable.

Direction finding by radio, though partially developed prior to the war, became then a matter of the greatest importance, for use in aircraft especially. The radio compass likewise proved of great value in navigation, but to the discovery of the thermionic valve is due the perfection to which it was brought, rendering more accurate observation over long distances possible.

## Submarine Signalling.

Long before signalling by radio was invented, it was known that as sound travels faster through water than through air, and that without either reflection, refraction, or distortion, some method might be devised for warning ships when approaching shoals, rocks, or narrow harbour entrances by

means of a bell sounded below the surface, and made audible to those aboard a ship by the use of some suitable receiving device. The first patent granted in connection with submarine signalling was to Mr. Henry Edmunds, of Halifax, Yorkshire, in 1878, the pioneer of electric lighting on board ships, he having lit the S.S. City of Richmond of the old Inman Line with Brush arc lamps, the very first vessel ever lit electrically. In his patent, wave motion was utilised to sound a bell under water attached to a buoy, and he suggested the use of an ordinary telephonic microphone to act as a receiver. But the fundamental idea of signalling under water is very old, and has been in use in the East since ancient times. The great drawback, however, to its practical employment was the fact that it was almost impossible to tell from whence the sound proceeded; and it was not till 1894 that a patent was granted to Messrs. Mundy and Millet for a system of direction finding which solved the difficulty. Various

which was received by the Marconi station at Siasconsett, which managed to get into touch with the S.S. Baltic, a ship nearing New York, and told her of the Republic's trouble. The Baltic then got into touch by wireless with the Republic, who informed her that she was lying within sound of the Nantucket bell, a point which the Baltic had already passed some hours previously, but not within sight of the disabled vessel. The Baltic thereupon put about, steamed back until she picked up the bell again, and from there, guided by its sound, made an almost straight line for where the Republic lay. Having found her, she took off all aboard, turned round, and headed straight for New York, making that port in a dense fog, but guided into harbour by the submarine signal station there.

## The Fessenden Oscillating System.

A great advance in submarine signalling was effected by the invention of the Fessen-

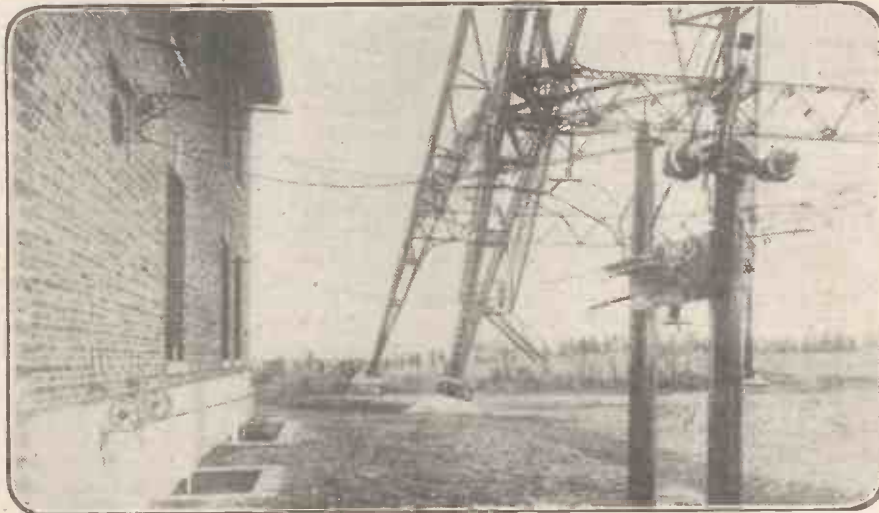

The "leading-in" wires at the Radio Station at Arlington, U.S.A.

types and sizes of sounding bells were tried, until it was found that one weighing 220 lb., with a vibratory rate of 1,215 per second, gave the best results.

## Wireless Steps In.

Their method was very ingenious but simple, and was based on the principle of swinging the ship on its course until the loudest sound was heard in two receivers equally on both port and starboard sides, thus showing she was heading towards the point from which the sound came. The Allan liner Tunisian was the first transatlantic vessel to be so equipped when the system had been fully developed and perfected, after many experiments carried out in the U.S. of America.

It was through a combination of wireless and submarine signalling by the Mundy and Millet system that the rescue of the crew and passengers of the American steamer Republic was effected; the first marine disaster, in fact, in which radio played a very important part. This vessel had sent out the old C.Q.D call (now the S.O.S.),

den oscillator, in which a steel diaphragm is made to vibrate rapidly by an alternating current, producing a shrill note much louder and more effective than any a bell can produce. It was also found that this steel diaphragm, although three-quarters of an inch thick, acted admirably as a receiver, especially when the sounds were increased by a valve amplifier. In this way it fulfilled the functions of transmitter and receiver; and not only could sounds be heard by means of it through telephones, but phonographic records of them could be taken, and what is more, even photographs.

## Means of Identification.

These valuable properties of a submarine detector were taken full advantage of during the war, and carefully developed to such an extent that the sound produced by the propeller blades of ships enabled them to be distinguished by experts so accurately that not only could the type of vessel be recognised but even an individual ship when

(Continued on next page)



## A RADIO RE-UNION DINNER.

**T**HERE must be several thousands of amateur wireless experimenters scattered around the country whose first introduction to wireless took place at No. 1 (T) Wireless School during the late war. This school was the H.Q. of wireless-instruction in the Royal Air Force for a number of years, and hundreds of operators were trained in it each month during that period. It remains to-day the chief training centre for wireless personnel, but, needless to say, its output is nothing like what it used to be.

### An Influential Factor.

The annual reunion dinner of the past and present officers of "No. One Toc" school, was held at the Holborn Restaurant last week. A remarkable feature of the evening was the extent to which the subject of "broadcasting" was discussed in the course of several speeches. Quite a number of the ex-officers are associated with some of the best-known wireless firms in the country, and the general opinion expressed was to the effect that wireless broadcasting showed signs

of becoming the most influential factor of modern times in shaping the growth of society.

### "Territorial" Wireless.

Representing Service interests, as distinct from civilian, Wing-Commander J. B. Bowen, O.B.E.—formerly Commandant of this famous wireless school, and at present a member of the Directorate of Research at the Air Ministry—called attention to the fact that the development of wireless broadcasting would result in the training of several hundreds of thousands, even millions, of amateur wireless operators throughout the country. Although he hoped for nothing more devoutly than for a permanent peace, he was sensible to the extraordinary advantage which would accrue to the country from this fact in the event of another war.

Greetings from those present to their "absent friends" were despatched by wireless to the Near East and other areas of active service in the course of the evening.

## SAFETY AT SEA.

(Continued from previous page.)

once her "note" had been recorded. The writer recollects attending a lecture given by an officer sent by the Admiralty to Plymouth in 1917 to demonstrate to the Patrol Service there this important fact; and the lecturer showed gramophone records of various types of "notes" made by the propellers of different vessels, ranging from battleships to submarines and motor launches. The various tones were very distinctive, and it was quite possible for even an untrained ear to recognise that of a submarine by its distinctive "hum," and for a practised one to differentiate that of a British from a Hun U-boat.

In fact, during the war, submarine detection by sound became greatly developed,

and not even when he lay on the sea-bed, thinking he was safe from discovery, was an enemy U-boat secure from detection by our hydrophones unless, like Ole Brer Rabbit, he "lay low an' sed auffman."

### Direction Finding.

Much has been written on this subject, and it would be beyond the limits of this article to go into the matter except very briefly. In No. 10 of POPULAR WIRELESS a very complete and interesting account is given of a system by which a ship's position can be located in foggy weather. The full-page diagrammatic illustration of the principles involved, and how they are applied, makes the method clear to anyone with but even little knowledge of the subject. A vertical aerial-frame capable of being revolved round the points of a compass forms the basic principle of this method of direction finding, the incoming sounds being heard at their

loudest when an edge of the frame faces their point of origin with but a small margin of error. Such an apparatus need not necessarily be carried by the ship itself, for this can be done ashore at the wireless station, and the position shown on the compass there notified to the vessel. But as at least two such bearings must be taken in order to find her actual position, these must be obtained from two shore stations fairly widely apart, which when found gives her position accurately, it being where these two cross-bearings intersect each other when plotted on

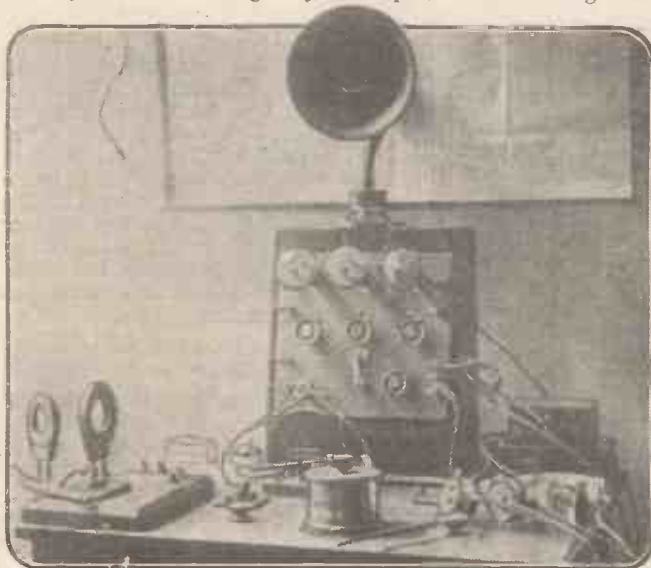

F. S. Smith's set, 108, Clive Road, Canton, Cardiff.

a chart. The seaboard of most countries now are provided with such wireless position finding stations, especially in the neighbourhood of harbours and ports, and exceedingly useful have they been found, especially in foggy weather.

A further great aid to harbour and estuary navigation as well as through narrow channels is that of the submarine cable which is laid along the fairway, and through which an alternating current is sent so that the sound can be picked up with suitable receivers fitted aboard the ship on each bow or quarter. By means of this she can be steered by the sounds heard more or less distinctly to port or starboard as she steams along. That is really another application of wireless, the ether in the water being used to convey the electro magnet waves instead of those otherwise created in the air.

Methods of measuring distances at sea by means of synchronous signals, one being aerial, either audible or visual, and the other aqueous and audible only, have been developed and found practicable. The principle involved is that of the difference in time between the reception of the signals. If visual or by radio, the aerial signal is instantaneous, whereas the aqueous one requires time, the factor for which is approximately 4,800 feet per second, the difference in time, therefore, being the distance required. In such methods, as in fact all where the human element comes in, "personal error" has to be allowed for when great accuracy is required. An ingenious instrument in the form of a stop-watch was devised by Fessenden which indicated without calculation the distance by the difference in time between the reception of the two signals. A similar instrument is used in gun-trials to show how far off a shell explodes by taking the time between seeing the flash and hearing the report of the explosion, also for locating the position of a distant gun.

### Tragic Reminders.

By means of a comparatively simple device designed by Professor Joly, the navigating officer of a ship can ascertain whether a collision is possible or likely, supposing both vessels hold their courses and the same speeds are maintained; but its employment does not appear to have become general.

Hitherto, this has been carried out by the old method of swinging the lead, applicable only for shallow waters; or by a special instrument such as the Thomson deep-sea sounder. Trials have, however, been made of a method which has proved fairly reliable which may more truly be called "sounding," since it is based on the principle of measuring the time which the sound from an oscillator, such as has been described, when sent from a ship to the sea or ocean bed takes in returning, or is, in other words, "echoed" back. Where the ocean bed is very irregular, such a system would not be very accurate, but use for it might also be possibly found in ascertaining the proximity of icebergs and such-like large submarine floating masses.

The great obstacle to all such devices for ensuring safety at sea lies in what one cannot help calling the apathy of shipowners and marine authorities generally. After some great disaster at sea a general clamour is made by the public for greater care and surer methods of prevention; but it soon dies away, and little more is heard until re-awakened by a further maritime tragedy.



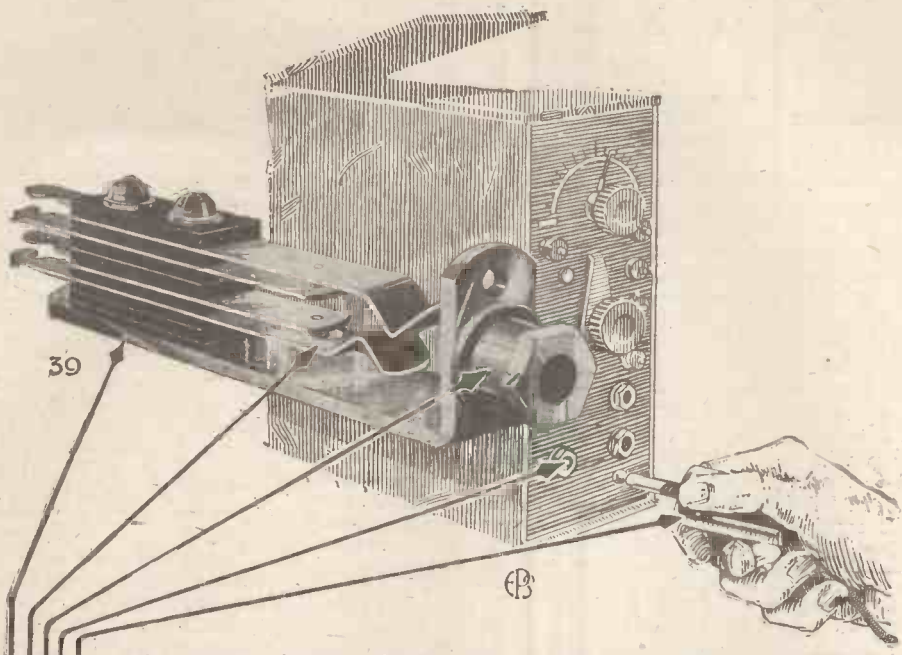

GET THE BEST OUT OF YOUR SET BY USING

# THE ELWELL JACK SYSTEM.

- (a) Any standard telephone plug can be used, but preferably the special spiral Elwell plugs, which are fitted with self-tightening connection grips.
- (b) The Jacks fit neatly on the panel, and, being heavily nickel-plated, add considerably to its appearance.
- (c) They are easily fixed to any panel up to  $\frac{1}{2}$  in. thick. No fixing screws are required.
- (d) Five types of jacks are available, from a simple telephone jack to one controlling telephone, transformer, and filament battery.
- (e) Insulation tested up to 1,000 volts.

Once connected up on the Elwell Jack System your receiving set becomes far more convenient to use both for broadcast reception and for experimental purposes.

The following operations become quite automatic:—

1. Filaments switched on.
2. Telephones or loud speaker put across any desired number of valves.
3. Intervalve transformers disconnected at point of insertion so ensuring maximum efficiency.
4. Only the required number of valves light up. The remainder stay out of circuit.
5. Removing Plug completely switches off set. No errors can afterwards be made in connections or switching. Loose contacts and broken leads are permanently prevented. Comparative tests of telephones and loud speakers can be made with ease and accuracy.

Write for descriptive leaflets.

**C. F. ELWELL, LTD.,** Radio Engineers,  
 CRAVEN HOUSE, KINGSWAY, LONDON, W.C.2.  
 Telephone: MUSEUM 1384

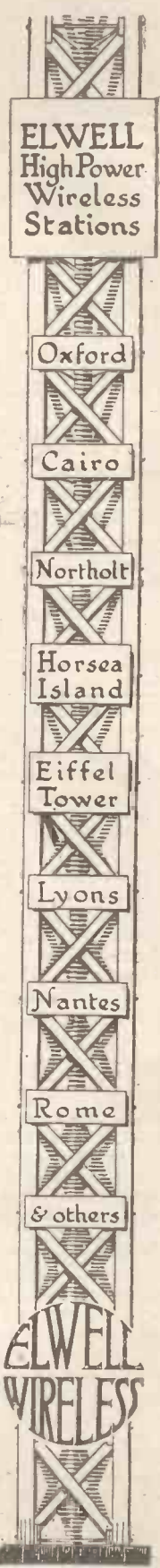

# HOW TO MAKE A D.F. STATION

By MICHAEL EGAN

## PART 6.

WE have already seen how two frame aerials at right angles to each other can be used as a mutual check in finding the direction of a transmitting station. We saw also that, in order to accomplish this, some means had to be devised for preserving the same inductive value of the circuit when the second coil was introduced into it.

The method of doing this is shown in Fig. 1. The "main" coil AB (by means of which the approximate maximum position is found in the first instance) is connected to the centre of a "double pole" switch. To one end of the switch the extremities of the "auxiliary" coil CD are joined; the other end being connected to the extremities of a small "balance coil" EF, the inductive value of which is equal to that of the auxiliary coil.

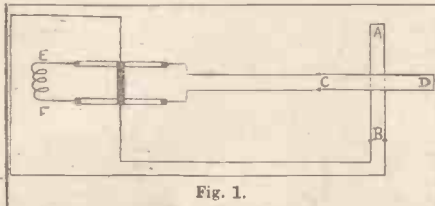

Fig. 1.

Thus, when the switch is put in the left-hand position, the main coil and the small balance coil are both connected in series. When the switch is put in the right-hand position, the balance coil is automatically cut out and the main and auxiliary coils are both connected in series with one another.

The function of the balance coil is to maintain an equal inductive value in both circuits. If this were not done the circuits would be tuned to different wave-lengths, and signals received on one circuit would not be received on the other. Since the balance coil and the auxiliary coil are substituted for each other as the switch is thrown into either position, this difficulty is overcome.

### Sensitivity and Loudness.

Although the small balance coil has the same inductive value as the big auxiliary aerial coil, it does not pick up any energy from passing ether waves. It usually takes the form of a very closely wound "pancake" inductance, and its sole function is to obviate the necessity of re-tuning the circuit when the introduction of the auxiliary coil tends to throw it out of tune.

We now come directly to the question: How is sensitivity obtained when working on maximum signals? The clue to this problem was already suggested in the last article when reference was made to the effect produced by reversing the connections of two coils joined in series to one another.

We then saw that, when joined in one of the two alternative ways, a current induced in one coil will flow in such a way as to augment, or assist, a current that is simultaneously induced in the other coil. If the connections between the two coils be reversed, however, the two induced currents will oppose and tend to negative each other.

The reader who is not quite clear as to why this effect should take place will find it helpful to trace the circuits shown in Fig. 2.

In this simple diagram two aerials AB and CD are connected together through a double pole switch similar to that used in Fig. 1 for the purpose of substituting the auxiliary coil for the balance coil in the receiving circuit. In this case, however, the terminals at one end of the switch are joined diagonally to those at the other end by two short pieces of wire, as indicated by the dotted lines.

The terminals on this "reversing switch," as it is usually called, are marked K, L, M, N, O, P. When the switch is put in the upper position (as shown in diagram), the arms of the switch connect M to K, and N to L. If now we suppose that at a particular moment a current is induced in each of the coils in the directions shown by the arrows, it will be found, on tracing the individual paths of these currents, that they flow in the same direction in the circuit. That is to say, the total current flowing in the circuit will be the sum of the two individual currents.

### Combining Results.

When the switch is thrown into the lower position, however, the opposite effect takes place. Contact is now made between M and O, and N and P, and it will be seen, on tracing the circuits, that the two currents oppose each other in their direction of flow. In effect, this means that the resultant current flowing in the circuit is equal to the difference of the two induced currents.

Referring once more to Fig. 1, the application of this device to the problem of achieving sensitivity with the maximum method will be appreciated. The "change-over" switch is first put in the left-hand position, so as to exclude the auxiliary coil from the circuit. The double aerial is then swung on its pivot until the (approximate) maximum position of the main coil AB has been found. The switch is then changed over to the right-hand position, bringing the auxiliary coil into series with the main coil.

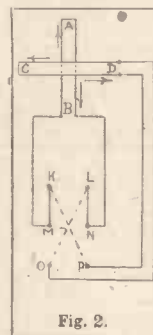

Fig. 2.

Assuming that the exact maximum position of the main coil has not been found, it follows that the auxiliary coil must now be picking up some energy. The reversing switch (which is not shown in Fig. 1) is now brought into action. By throwing it backwards and forwards from one position to the other, whatever current is flowing in the auxiliary coil is made to oppose and assist, alternately, the current flowing in the main coil.

In practice this gives rise to successive variations in the strength of the signals in the telephones, which can be detected quite easily. Whilst signals are being received, the reversing switch is thrown swiftly backwards and forwards. Each time a difference in signal strength is detected the double aerial is swung gently in whatever direction tends to diminish this difference. In this way a point will be found at which no difference in the strength of signals will result from altering the position of the reversing switch.

It is obvious that when this point has been found, the auxiliary aerial will have ceased

to pick up any signals whatever; that is, it will be in the exact minimum position with respect to the transmitting station. In other words, the main coil will be in the exact maximum position. In this way, maximum sensitivity and maximum loudness of signals are combined in one system.

In the complete circuit for operating by the maximum method the change-over and reversing switches, the balance coil, and the fine tuning condenser can all be fitted into one small box. For ease of adjustment the balance coil should be made in two small flat pancakes, so that they can be set to the required value by sliding one over the other.

### Size of Frames.

From this "tuner switch-box" three pairs of leads are taken from terminals to the main aerial, the auxiliary aerial, and the valve amplifier. It is also found best in practice to make the ratio of the "area  $\times$  turns" of the main coil to that of the auxiliary coil about 1:3. As the auxiliary coil has to deal with very small quantities of energy it is desirable to make it as large as possible. The main coil, however, must also be capable of picking up a good deal of energy if the full advantages of the system are to be realised.

To Captain Robinson, R.A.F., is due this very important development in wireless direction-finding.

(Next week's article will contain some practical hints for the amateur who contemplates the erection of a direction-finding station.)



Lord Gainford, the Chairman of the British Broadcasting Company.

### AMATEUR PHOTOS.

If you have built your own set, send a photograph of it along to "Popular Wireless." A fee of 10s. 6d. is paid for every Amateur Photo used, and 25s. if printed as a Cover Plate.



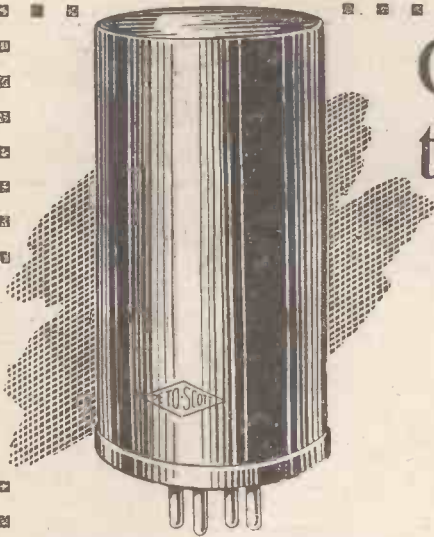

# Congratulations on the success of the

## For all wave lengths over 1000 **MULTI-WAVE AMPLIFIER**

(Made throughout by the Peto-Scott Co.)

For H.F. amplification above 1,000 metres, you will find the Multi-wave Amplifier absolutely ideal. There is no tuning required: simply plug it into its socket and immediately you will begin to pick up Stations which have previously been out of your reach. Excellent telephony is being transmitted daily from Paris and Berlin and the MULTI-WAVE will enable you to hear them with the greatest ease.

In this letter, Mr. J. K. P. admits that this MULTI-WAVE does not work quite as well on The Hague wave-length as on the others. Every Set has peculiarities of its own, and perhaps in his particular case, for 1050 metres (the wave-length used for The Hague) transformer coupling is to be preferred. But for the Paris and Berlin concerts the MULTI-WAVE stands alone its results are almost unbelievable.

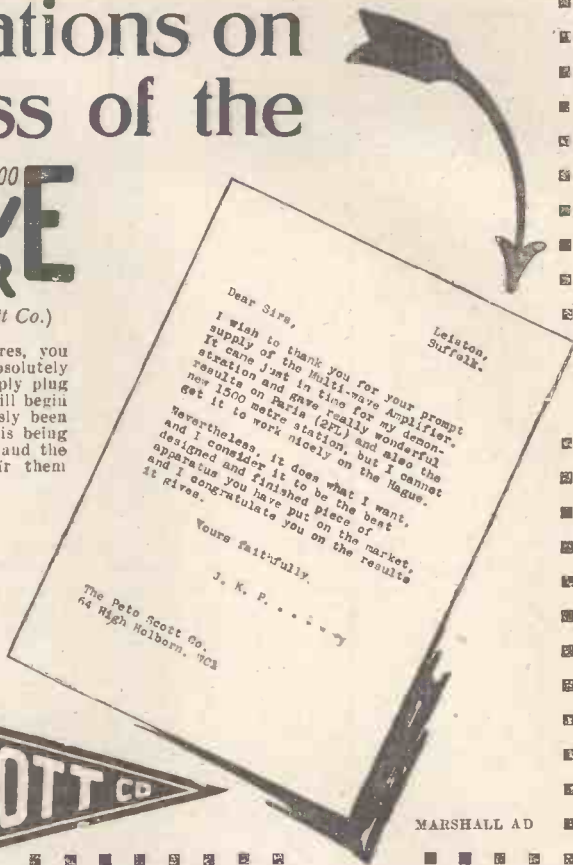

Made in two styles in solid ebonite throughout. No. 1 for use with one H.F. Valve and No. 2 for more than one stage of H.F. amplification (in this case No. 2 is used as coupling between first and second H.F. Valves and No. 1 between second H.F. Valve and Detector).

No. 1.—For use with one H.F. Valve **8/6**  
No. 2.—For more than one stage of H.F. amplification **12/6**

Thinking of building your own Set? Send 6d. for a copy of "RADIO," which gives full descriptions of home-constructed Radio Sets. Fully illustrated and well written.

Head Office and Showrooms:  
**FEATHERSTONE HOUSE,  
64, HIGH HOLBORN, W.C.1.**



MARSHALL AD

# WIRELESS

at the  
"Model Engineer" Exhibition,

Royal Horticultural Hall,  
Vincent Square, London, S.W.

JAN. 5th to 12th,

A splendid show of the latest in wireless apparatus will be a feature in this exhibition. Broadcasting, wireless control of trains, and wireless instruments and supplies of all kinds will be on show.

This is the most fascinating, scientific exhibition of the year. Hundreds of beautiful models of engines, boats, and aeroplanes; three model railways, 72 feet long, constantly at work; all the newest lathes, tools, and workshop accessories, electrical apparatus, scientific novelties, and hundreds of other things to interest you. Do not miss it.

OPEN DAILY, 12 till 10 p.m., 1s. 6d. (Tax Included)  
Tuesday, Jan. 9th, 12 till 6 p.m., 3s. (Tax Included).

# RELIANCE RADIO SERVICE CO.

THE "RELIANCE"  
CRYSTAL RECEIVING CABINET.

Consisting of Ebonite Panel mounted in Oak Cabinet with lid; Tuning Coil and condenser, Patent Crystal Detector, totally enclosed in glass; 4,000 Ohms Double Headphones; 100 feet of Stranded Copper Wire; 2 Shell Insulators.

No further outlay, no batteries required. Each set has been tested and carries our guarantee, and we confidently assert that for the price it is the most compact and reliable that is obtainable.

PRICE COMPLETE  
**£3-5-0**  
INSTRUMENT ONLY  
**£1-12-6**

We have also a complete range of Valve Sets in stock from £7 to £20. Call and inspect the famous FELLOPHONE 2-Valve and 4-Valve Receiving Sets, prices complete, £10 10s. to £17 10s. respectively. Also the FELLO-CRYST SUPER Crystal Receiving Set, price £4 7s. 6d. complete. All our sets are passed by the P.M.G. for reception of broadcasting. All sets open to inspection at our London address. Demonstrations given daily. Hours 10 a.m. to 6-30 p.m.

ILLUSTRATED CATALOGUE  
POST FREE.

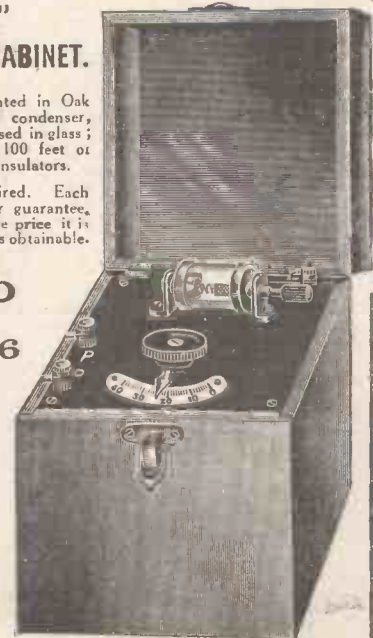

(P.O. Registered No. 277.)

RELIANCE RADIO SERVICE CO.,  
283, St. John Street, Clerkenwell, London, E.C.1.

PHONE: CLERKENWELL 4290.

**C.T.C.**

## MULTUM-IN-PARVO CRYSTAL RECEIVERS



Come and listen-in any evening until eight. No technical knowledge is necessary to listen-in at once on the MULTUM-IN-PARVO. Full instructions are given with every set.

**Sets as Illustrated comprise:**  
**TUNER.**—Inductance which can be varied by means of tappingz taken to switch giving correct wavelengths, 280/650 metres.  
**MICROMETER DETECTOR.**  
**FIXED CAPACITY CONDENSER.**—Fitted with best ruby mica.  
**VARIABLE CONDENSER** for selective tuning.  
**RANGE** 30 miles Telephony Morse up to 600 miles.  
**AERIAL.**—Complete equipment—120 ft. Wire Earthing Wire, Lead-in Tube, and Two Insulators.  
**EVERY SET IS FITTED WITH BROWN'S PHONES (4,000 OHMS.)**

**"MULTUM-IN-PARVO."**  
Complete as Illustrated

<b>BLACK LEATHERETTE</b> ...	£5 15 0
<b>MAHOGANY</b> ...	£5 15 0
<b>COW-HIDE</b> ...	£6 15 0

All Prices PLUS TAX, 7/6.

<b>JUNIOR ASSEMBLY</b>	£1 12 6
<b>SET, range 10 miles...</b>	Post Free.

*One minute Chancery Lane Tube.*

ASSOCIATED WITH  
**CONSOLIDATED TRADING & MANUFACTURING CO., LTD.**  
 FULWOOD HOUSE, FULWOOD PLACE, HIGH HOLBORN, W.C.1.  
 Call or Write for List, Threepence.

*J. Bridge & Sons*



## Listen in with the Fellows

Handphone which has been specially designed for ladies. It has no head band to catch or tear the hair. Beautifully finished, very comfortable to use and wound to 4,000 ohms.

15/- each. Postage, 1/-.

*He will use Fellows Headphones with two earpieces in light die cast non-ringing metal and wound to 4,000 ohms.*

21/- per pair.

Postage 1/-.

*All Fellows radio instruments are British Made throughout and guaranteed.*

**FELLOWS MAGNETO Co., Ltd.**  
 LONDON, N.W.-10.

Telephone: WILLESDEN 1580-1.      Telegrams: "QUIXMAG," PHONE, LONDON



Telephones: Hammersmith 443.

## VARIABLE H.T. BATTERIES

AGENTS WANTED.

THE W.A.S. VARIABLE H.T. BATTERIES will increase the efficiency of your set, and give you undistorted speech and music. These batteries being made from a special formula, have a longer life than any that are on the market, and are perfectly SILENT in working.

30-VOLT, tapped every 3 volts	7/-
60-VOLT, " " " "	13/6

The above prices include insulated Wander Plugs.  
 To be obtained from most Radio Dealers, or Post Free from Sole Manufacturers:—**W. A. SAXBY & CO.**  
 3, GAYFORD ROAD, SHEPHERD'S BUSH, LONDON, W.12

## HERE'S REAL RADIO SERVICE

QUALITY GOOD.      PRICE LISTS FREE.  
 PRICES RIGHT.      DELIVERY PROMPT.

<b>TELEPHONES</b> 4,000 ohms, Guaranteed, per pair	1 0 0
8,000 " " " "	1 2 6
Single Earpiece 2,000 with cords,	10 6
INTERVALVE TRANSFORMERS, remarkable value	14 0
COIL-HOLDERS, three-way	14 0
LECLANCHE CELLS, miniature for H.T., each	1 0
(11 oz. Sal. Ammoniac charges, 12), per doz.	10 6
AERIAL WIRE, 7/22 bare copper, per 100 ft.	3 3
AERIAL WIRE, 7/22 enamelled, per 100 ft.	4 6
INSULATORS, reel, 2, Shell, 9d. and	2 6
RHEOSTATS, Best Quality, 3/9 and	2 6
HERTZITE CRYSTALS, 2/- and	1 6

These are but a few of our many bargains taken from our Price List. Post free on application.

**Waterloo Electric Co.,**      Electrical and Wireless Engineers.  
 129, WATERLOO RD., LONDON, S.E.1.  
 Telephone: Hop 5649.      1 m. Waterloo Station.

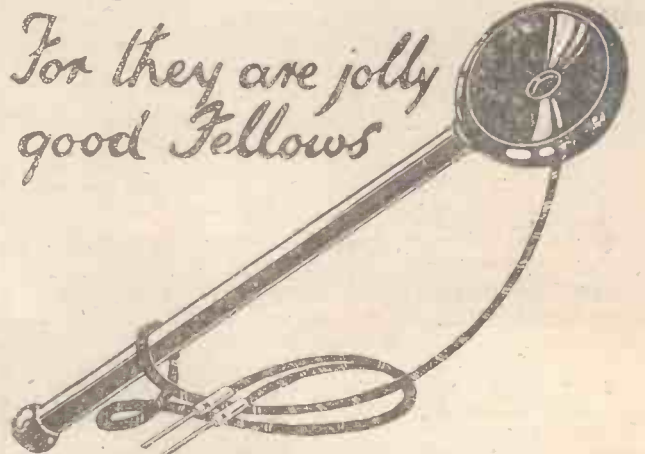



# WIRELESS CLUB REPORTS.

The Editor will be pleased to publish concise reports of meetings of Wireless clubs and associations, reserving the right to curtail the report if necessary. Hon. secretaries are reminded that reports should be sent in as soon after a meeting as possible. Reports sent in cannot appear in this paper in less than ten days after receipt of same. An Asterisk denotes affiliation with the Radio Society of Great Britain.

## Stockton and District Amateur Wireless Society.

A meeting of the above society was held recently in the concert hall of the Malleable Workmen's Institute, Norton Road, Stockton.

The president stated that during the evening a member had come forward and had kindly arranged to provide the society at once with a very handsome receiving set. A set of rules was submitted to the members and accepted. The question of entrance fees, etc., was left in the hands of the committee.

The membership is steadily growing, and now numbers over eighty.

After the meeting a lecture was given by Mr. R. King, of the Middlesbrough Wireless Society, on "The Application of the Three Electrode Valve to Receivers."

Hon. sec., W. F. Wood, 4, Birkley Square, Norton-on-Tees.

## Fulham and Chelsea Amateur Radio and Social Society.\*

The attendance at our last meeting was again very satisfactory, and the ever-increasing number of new members is a proof of its popularity, despite the many "jams" the wireless amateur is experiencing.

The secretary seems little daunted by the restrictions, and seems to be on the "reaction," for he gave the members a diagram of a single valve circuit that produces louder signals and is devoid of all "howl," the oscillations themselves being hardly audible. A short but interesting lecture was given by Mr. Hubbard, a member, on elementary electricity.

The remaining part of the evening was devoted to humorous wireless stories, ranging from "Fire-grate aerials to dustbin earths," this social side being a happy "reception" to all present.

Total membership now numbers eighty-seven.

## The Liverpool Wireless Society.\*

A meeting of the above society was held on Thursday, November 16th, at the Royal Institution, Colquitt Street, Liverpool, Mr. E. B. Grindrod in the chair. There was a record attendance.

A very interesting and instructive demonstration was given by the hon. treasurer, Mr. J. H. Swift, who had brought to the meeting his exceedingly well-made and entirely home-made five-valve receiver, consisting of 2 H.F. detector and 2 L.F. valves. A "Brown" microphone relay and Magnayox loud speaker having been very kindly lent for the evening by Messrs. Pufford Brothers, Liverpool, enabled the results to be made audible to all present all over the hall. With the assistance of Mr. A. W. Robinson, excellent results were obtained. A special transmission was given to the society by the Metropolitan-Vickers Electrical Co.'s station (2 Z Y) at Trafford Park, Manchester, and both the speech and the musical items were very loudly and clearly received. The Birmingham Broadcasting Station (2 W P) was also picked up very clearly. Some little trouble was caused by unwanted interference from the Seaforth G.P.O. Station, and in a rather amusing duet between this station and the Metro-Vickers Broadcasting Station the latter easily came out on top. Some local amateurs were also picked up clearly.

All interested persons, of either sex, desirous of joining the society should apply without delay to the hon. sec. A continuance of interesting evenings throughout the winter session is assured.

Hon. sec., C. L. Lyons, 76, Old Hall Street, Liverpool.

## Hackney and District Radio Society.\*

At the weekly meeting of the above society on Thursday, December 7th, a letter from the Radio Association was read with regard to affiliation to that body. It was decided to refer

the matter to the committee for their consideration.

A very interesting lecture on insulators and insulating materials, was given by a member of the society—Mr. Sandford. In the course of his lecture Mr. Sandford demonstrated the insulating qualities of various materials.

Hon. sec., Mr. E. R. Walker, 48, Dagmar Road, E. 8.

## Birmingham Experimental Wireless Club.

At the regular fortnightly meeting held at Digbeth Institute, Birmingham, on December 1st, a very fine four-valve set was shown by the president of the club, Dr. J. R. Ratcliffe (1 valve H.F., 1 rect., and 2 L.F.).

The set was home-made, but the workmanship throughout was very fine and was much admired by all the members present. Excellent results were obtained on the club's aerial, and a very interesting discussion ensued.

Hon. sec., A. Leslie Lancaster, c.o. Lancaster Bros. & Co., Shadwell Street, Birmingham.

## The Hornsey and District Wireless Society.

A meeting of the above society was held on Monday, the 16th ult., at 7.30 p.m., and was conspicuous by a large attendance of members. One of the members brought his set to the club for the purpose of demonstrating the possibilities of a single valve receiver.

The meteorological report from G F A at eight o'clock was utilised as practice in Morse reception; and later, some musical telephony from 2 O N and 2 K T was received—this being particularly enjoyed by new and prospective members.

After the enrolment of several new members the proceedings terminated.

Hon. sec., Mr. H. Davy, 134, Inderwick Road, Hornsey, N. 8.

## Ilkley and District Wireless Society.\*

On Monday, December 4th, at 7.30 p.m. at the Regent Café, there was a general meeting of the above society, followed by the installation and testing out of the society's single valve receiver.

Hon. sec., E. Stanley Dobson, Lorna House, Richmond Place, Ilkley.

## Gowes District Radio and Research Society.\*

The society held the first meeting of the second year at the headquarters, East Cowes, recently, and the evening was devoted to an exhibition of receiving sets, owned—and mostly made—by the members.

Hon. sec., L. Ingram, 1, Mill Hill Road, Cowes.

## Sunderland Y.M.C.A. Radio Society.\*

At a meeting of the society in the Y.M.C.A. recently, Mr. J. L. Holbrooke gave a lecture on "Waves." This was the first of a series of lectures which have been arranged.

Hon. sec., Mr. N. Draper, Borough Road, Sunderland.

## The East London Radio Society.\*

A highly successful and well-attended meeting of the above society was held in the Lecture Hall, Woodstock Road, E. 14, recently. It had been arranged that Mr. Keens should have proceeded with the second half of his lecture on "Coils," but, to the regret of all present, it was announced that urgent business prevented the lecturer's attendance, and that the lecture would be postponed.

However, the members were consoled somewhat by listening to 2 M T's transmission of "Cyranos de Bergerac," and various other transmissions.

Hon. sec., Mr. W. O. Simmonds, 60, East Ferry Road, E. 14.

# ACCESSORIES FOR WIRELESS



Vacuum Protector

**VACUUM PROTECTORS** (for protecting the aerial). They secure protection against risk of fire or damage by lightning.

**TELEPHONE HEAD SETS** specially designed for wireless work. Terminals enclosed to prevent receiving circuit being interfered with.

**SWITCHES** for series-parallel switching of condensers, adding to or reducing the number of valves in simultaneous use.

**FUSES** for protecting the filament accumulators and batteries in the event of a short circuit.

**AERIAL WIRE & INSULATORS, EARTHING DEVICES, JACKS & PLUGS, H.T. BATTERIES, etc., etc.**

Also manufacturers of

## BROADCASTING RECEIVING SETS.

Descriptive pamphlet and prices on application to

**SIEMENS BROTHERS & Co., Ltd., WOOLWICH, LONDON, S.E.18.**

Telegrams: Siemens, Woolwich. Telephone: City 6400

AND AT

Belfast, Birmingham, Bristol, Cardiff, Glasgow, Leeds, Manchester, Newcastle, Sheffield, Southampton.

**30 FINEST QUALITY GOVERNMENT ACCUMULATORS**, unused, made by Chloride Co., all 3-cells, in teak case with strap. 6-Volts, 36-40 amps. constant discharge, 72-80 intermittent. £2 each. **BENTLEY, BROWN & CO., 59, Gracechurch Street, London, E.C.3. Tele: Avenue 4819.**

## WIRELESS BARGAINS

Loud Speakers, 10/6; Crystal Detectors, 3/-; Phones, All British, 4,000 ohms, 21/- All Post Free. Trade Supplied.

Illustrated Catalogue P, including list of stations, 6d. post free.

**EONS WIRELESS SUPPLY CO., 115, FLEET ST., E.C.4.**

**ACCUMULATORS, etc.** New and Guaranteed  
 4-Volt, 25-Amp. Celluloid, 11/3. Postage 1/-  
 4-Volt, 40-Amp. 17/6 | 6-Volt, 40-Amp. 25/6  
 4 " " 60 " 21/3 | 6 " " 60 " 31/-  
 4 " " 80 " 27/- | 6 " " 80 " 35/-  
 Packing, 1/6 extra. Packing, 2/- extra.  
 7/22 Aerial, 5/6 100 ft.; Mullard Ora Valves, 15/-;  
 15-V. Siemens H.T. Batteries, 4/-; Marconi R. Valves, 17/6; Accumulator Charging Board, 37/6;  
 Voltmeters, Watch pattern, 0/12 Volts, 6/-.  
 Cash with order. Goods despatched per return.  
**LOWKE & SONS, Ltd., Northampton.**

Tele. :—  
HOP 134

# IMPORTANT

We have opened very commodious premises at  
**54, GRACECHURCH STREET, LONDON, E.C.3**  
for the demonstration and sale of all types of  
**WIRELESS RECEIVING SETS** and **"CLARITONE" LOUD SPEAKERS.**

*Amateurs and Experimenters will be able to obtain every part required for any type of Set*

INCLUDING—

- |  |   |
|--|---|
| Transformers, L.F. and H.F.                      | Brass W.O. and Telephone Type Terminals,    |
| Headphones (all types, all resistances).         | Nuts, Washers, Contact Studs, and all other |
| Condensers, variable and fixed (all capacities). | parts.                                      |
| Vario-Couplers and Variometers.                  | Accumulators.                               |
| Coil-Holders and Coils.                          | Dry Batteries.                              |
| Anti-Capacity Switches (all types).              | Aerial Wire.                                |
| Rheostats (all types).                           | Insulators.                                 |
| Radial Switches (5, 10, and 15-way).             | Hertzite and Galena Crystals.               |
| Valves (M.O. and Mullard's).                     | Cotton and other Tubings (all colours).     |
| Ebonite Valve Holders, Dials, Scales, other      | Etc., etc.                                  |
| parts and in Sheet.                              |   |

PRICE LIST ON APPLICATION

**PETTIGREW & MERRIMAN, LTD., 122-124, TOOLEY STREET, LONDON, S.E.1.**

NOTE—54, Gracechurch Street is a few yards from Monument, Eastcheap, Bank, Cannon Street, and London Bridge.

A NEW FILAMENT RESISTANCE OF  
EXCEPTIONAL MERIT

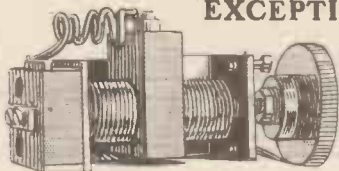

**5/-**  
EACH

Prov. Pat.

POSTAGE 42.

1. ABSOLUTELY DEFINITE ON or OFF POSITION,  
at any point of control. Operated by simply pulling or  
pushing the knob.  
Perfect Micrometer adjustment. Silent in use, Standard  
Fixing.

Sole Manufacturer and Patentees.

**BLAXLEY CABLES** 3, NORFOLK ROAD,  
ERDINGTON, BIRMINGHAM.

HAVE YOU TRIED OUR VERNIER CONDENSER ?  
IF NOT—WHY NOT?

INVALUABLE for tuning distortionless **SPEECH**  
and **MUSIC.** Mounted on Polished Walnut Stand.  
Long Operating Handle.

With Graduated Scale	8/6 each
Without	7/6 "
Superior Condensers '001	28/- "
" " '0003	16/6 "

Other sizes to order.

We Supply Condenser Fittings.

Small Spacers, 125 in., 1/6 Gross. Large Spacers, 125 in., 2/6 Gross.

**COMPONENTS ENGINEERING CO.,**  
QUEEN'S ROAD, CHEETHAM, MANCHESTER.

JUST OUT

## Wireless Handbook & Diary 1923

Edited by PAUL D. TYERS.

Contains more pages of wireless data than any other similar Diary.

PRICE 2/6 NET.

A complete Letts' Diary with 40 pages of valuable wireless  
information and the usual pages of useful general information.  
Beautifully bound in leather, it forms an ideal gift.  
Get someone to buy you one.

Obtainable through all Booksellers or direct, post free 2/8, from

**Radio Press Ltd.,**

DEVEREUX COURT, STRAND, LONDON, W.C. 2.

### WIRELESS GEAR OF EVERY DESCRIPTION

VARIABLE AIR CONDENSERS.	Dust-Proof, Celluloid-Cased Condensers.
Panel Type, with knobs.	
.001	15/-
.0005	10/6
.0003	9/-
Vernier 3 or 5 plate, 5/-	Vernier 3 or 5 plate, 10/-
BEVELLED SCALES	3/6 extra
CONDENSER VANES	7d. doz.
IVORINE SCALES	9d. each
H.F. (15-volt) BATTERY	3/-
MARK III TERMINALS	1/6
BABY VALVE PANELS	21-10-0
DETECTOR PANEL	1/9 each
FILAMENT RESISTANCES	3/6 and 2/- each
LAMINATED SWITCH ARMS	1/9 each
VALVE HOLDERS (with nuts)	1/- each
SHORT WAVE BASKET COILS	6d. each
MULLARD ORA VALVES	15/- each. Osram, 17/6
INSULATING SLEEVING	5d. yd.; 4/6 doz. yds.
EGG INSULATORS	4d. each; 3/6 doz.
SINGLE VALVE H.F. AMPLIFIER PANEL	41-10-0
SINGLE VALVE L.F. AMPLIFIER PANEL	42-10-0
2-VALVE PANEL L.F. AMPLIFIER	43-10-0
L.F. TRANSFORMERS	12/6

**BRUCE I. HOUSTON, 65, Endell St., London, W.C.2.**

PHONE: REGENT 4911.



# RADIOTORIAL

All Editorial Communications to be addressed The Editor, POPULAR WIRELESS, The Fleetway House, Farringdon Street, London, E.C.4.

From all parts of the country I am receiving reports from correspondents which clearly show that broadcasting has really "caught on."

Aerials are springing up like mushrooms, and if things go on at the present rate there is every likelihood of the radiophone becoming one of the most popular forms of entertainment of modern times.

Two articles in this number of "Popular Wireless" are of especial interest—namely, the interview given to this paper by a G.P.O. official, who discusses the position of the amateur who wishes to make his own set, and the opinions of several well-known people with regard to broadcasting as an educational medium.

The former article will probably give the would-be experimenter much food for thought, but if there are any points upon which the readers of "Popular Wireless" are still not clear, I shall be pleased to outline the position at great length by post.

THE EDITOR

## Questions Answered

Owing to the enormous number of queries received daily from readers of POPULAR WIRELESS, I have decided to reply individually by post. A weekly selection of questions will, however, be printed on this page, together with the answers, for the benefit of readers of POPULAR WIRELESS in general. Questions should be clearly and explicitly written, and should be numbered and written on one side of the paper only.

All questions to be addressed to: POPULAR WIRELESS, Queries Dept., Room 131, The Fleetway House, Farringdon Street, London, E.C.4.

Readers are requested to send necessary postage for reply.

"MAC" (East Ham).—I am constructing a crystal panel set, and would be obliged if you would answer the following: (1) What is the range of my coil, 525 turns of 26 S.W.G. on a 3-inch former? (2) Does it matter if various gauges of wire are used to connect up the set? (3) Is my diagram O.K.? (4) What is the best contact for Hertzite? (5) Can I use the following condenser: 12 fixed vanes, 3½ inches, and 11 moving?

(1) About 250-2,300 metres; (2) No, any gauge, as long as it is not too fine; (3) Your diagram is quite correct; (4) Use a "cat's whisker" contact of German silver; (5) You do not give sufficient details for accurate calculation, but approximately the capacity of your condenser is .0003 mfd. It will be quite suitable for fine tuning purposes.

E. R. (Carlisle).—Does the protection given to the B.B.C. for two years mean that it is absolutely forbidden to import foreign wireless apparatus into this country?

No; but such apparatus cannot be sold for broadcasting purposes.

A. H. E. (High Wycombe).—I have connected up a crystal set from components according to a diagram given in No. 2 of POPULAR WIRELESS, but so far, although I have heard plenty of Morse, I cannot hear telephony.

There is, as far as we know, no telephony within the scope of your crystal set. Marconi House, about 30 miles from you, under exceptionally good conditions, might just be audible, but signals would not be obtained from them without the finest possible adjustments. Twenty miles is a good average limit of range for the reception of telephony on a crystal set.

L. G. S. P. (Royston).—Can I use just one wire for my aerial and lead in, or must

they be separate or different wires joined together?

Certainly you can employ but the one length if a suitable method of fastening the wire to the insulator is adopted. There is a special type of insulator on the market specially constructed for such a method.

S. E. D. (Thorpe Bay).—If I leave accumulators on charge all day without attention, what could I do to prevent the possibility of damage to the cells, owing to the polarity of the mains reversing, which I believe is liable to happen.

Although it is just within the bounds of possibility that for short periods during generator change-overs (which occur very infrequently, and then mostly at night) there happens to be a reversal of current flow, it will not take place during the day-time. Therefore if the mains are tested for polarity in the mornings before placing the cells on charge, there is little fear that the condition will be reversed during the period of charging.

Is there any means of employing a crystal for amplification purposes? I have a crystal set, but it does not work very well, as signals are very weak.

No; the crystal is simply a rectifier, and does not possess any of the amplifying properties that a valve has. We advise you to employ a valve amplifier.

F. B. (Leyton).—Must the licence be obtained before purchasing the set and erecting the aerial?

Yes, the first consideration is the licence.

"QUERY" (Leicestershire).—(1) Could I hear Birmingham transmitting if I use a frame aerial 6 feet square, using a two-valve set? The distance is about forty miles.

This is too much to expect from a two-valve set and frame aerial. The range of such a set is only about 10 miles at the most.

"NO NAME" (Radlett).—My set is very liable to oscillate when tuning in on low wave-lengths. Is there anything I can do to stop this? Will it cause interference very much?

You should not use reaction that is capable of causing the valves to oscillate. No doubt you are causing a great deal of interference in the neighbourhood, and spoiling the pleasure of many fellow-amateurs. If you are using H.F. amplification, you can use reaction on to the transformer, thus cutting out any possibility of interference. Otherwise, you should "short" your reactance when tuning in on low wave-lengths. If there are any neighbours near you when you are tuning in, and they are listening it is probable that you completely "jam" all signals and that they can only hear the howl of your valves.

J. F. T. (Birkenhead).—Is there any great advantage in using three coils on a valve set?

Yes, there is an increased amount of selectivity. Very often unwanted signals can be tuned out by this means, whereas with only the aerial coil and no secondary, this is often impossible. One coil, of course, is used for reactance.

"THREE VALVES" (Hampstead).—I am thinking of using an indoor aerial for myself, and would be pleased to have your advice on the various methods employed. Which do you advise—frame, electric main, or parallel type of aerial? How could reactance be used on either of these?

In our opinion the best type of indoor aerial is the frame type, using the diamond shape, so that no side, is parallel to earth. In this case you need no earth connection; the return path being completed back to the aerial. This type of aerial is especially to be preferred over the other types in that it is fairly selective,

being most sensitive to the waves which strike it edge-ways. The reaction can be used in either of two methods. The better method is to employ a frame coil of exactly the same size as that used for the aerial. The distance between this and the aerial is varied according to the degree of coupling required. The other method consists of connecting a coil in series with the frame aerial and reacting upon this coil exactly in the manner employed when dealing with outdoor aerials.

M. T. M. (N. London).—While listening in the other afternoon on a three-valve set—1 H.F.—I heard a low, humming sound on about 400 metres. Is this a carrier wave or merely due to parasitic noises? I could not get any speech at the time.

In all probability you merely came across Croydon's carrier wave. This wave is very peculiar and emits that low humming sound.

The fact that it was heard on so low a wave-length is due to a harmonic effect.

"PUZZLED" (S.E.27).—In your No. 29 of POPULAR WIRELESS, "Amplifier" (Cricklewood) asks how to make two L.D. signals louder, and you reply that H.F. amplification will be better than L.F. In the next reply you say that for distances up to 100 miles L.F. is to be preferred for stronger signals. I want to add an amplifier to my crystal, what shall I do?

At first sight those answers may be a little puzzling, but you must not forget that they are to be used on different sets.

The first is for use with a crystal and the other for a valve. A crystal is very much less sensitive than a valve, and therefore it needs the incoming oscillations to be as powerful as possible before they can be rectified successfully. Hence the advantage of H.F. amplification. A valve, however, has far greater sensitivity and will respond to telephony up to about 100 miles without the need for amplification of input. The signals may be very faint after 50 miles, and almost unnoticeable, but the energy will be there and it only needs a L.F. valve amplifier to turn energy into sound.

"ACCUMULATORS" (Thundersley).—With regard to your answer on charging accumulators some weeks ago, may I ask how large

(Continued on next page.)

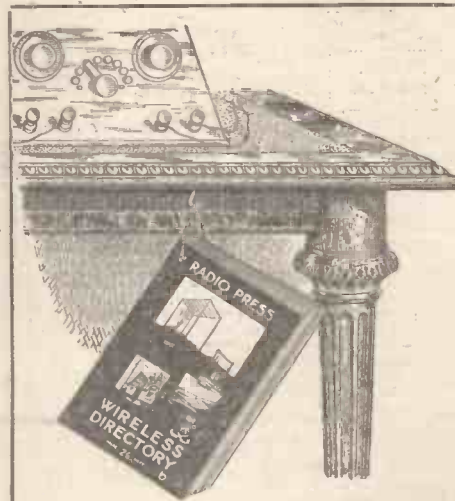

## HANG IT!

Hang this up-to-date and very complete directory of wireless telephone and telegraph call-signs, from your table. Over 12,900 call-signs of amateurs, ships and land stations. As indispensable to a "listener-in" as a telephone directory is to a subscriber.

Price 2/6 net.

Obtainable through the usual channels or direct (post free 2/8) from

Radio Press Ltd. DEVEREUX COURT, Publishers of Authoritative Strand, LONDON, W.C.2. Wireless Literature.



Whether you buy a complete receiving set or design it yourself, this book at 2/6 will save you time, trouble and money.

**GET IT TO-NIGHT AS YOU GO HOME.**

Obtainable from all newsagents and bookstalls, or send us P.O. for 2/8 and your copy will reach you in two days.

**Radio Press Ltd.** DEVEREUX COURT, Strand, LONDON, W.C.2.



**Your aerial screened?**  
Then have it indoors on **IND-AERIAL HOOKS.**

They support your aerial indoors *one foot* from walls on an insulated arm.

These hooks can be attached (and taken down) in a second to the picture rail of any Room, Hall, Lobby, Passage, Office, Nursery, etc. Almost any length of aerial can be arranged by hanging aerial round walls or across room. No screws or nails required. Makes any set portable, astonishing results being obtained. Try it.

**IND-AERIAL CO. (Dept. B),** 47, Victoria St., London, S.W.

**PRICES.**

2/9 each.  
Set of four,  
10/6

Post Free.  
Send P.O.  
to-day and  
secure yours.

**Beginners Guide to Wireless**

Explains, in plain everyday language, everything beginners wish to know about wireless telegraphy. **HOW TO ERECT, CONNECT, AND MAKE** all the apparatus required for reception of telephony or morse, and full instructions and diagrams for making coils, tuners, and complete valve and crystal sets. 112 pages, price 1/-, post free.—**SAXON RADIO CO.** (Dept. 14), South Shore, Blackpool. 32-page cat. of wireless apparatus, 3d., post free.

**ELECTRADIX RADIOS.**

**Immediate Delivery**  
from our Huge Stocks.  
Everything from a Recorder to an Earth Clip.

The best-equipped City depot.  
**COME AND SEE US.**

9, Colonial Avenue is first opening on left in the Minories, near Aldgate Station, Metropolitan Railway.

**LESLIE DIXON & CO.** Tel. Avenue 4188.  
9, Colonial Avenue, London, E.1.

**RADIOTORIAL**  
**QUESTIONS AND ANSWERS.**

(Continued from previous page.)

the cells should be, and how many are needed for various accumulators?

The cells should be as large as possible, so that the capacity of each shall be as great as possible. A useful rule in this connection is that the total E.M.F. supplied by the Daniell cells should be about 30 per cent. greater than that of the accumulator to be charged. This method of charging is, of course, very slow compared with the usual method.

S. P. (S. Wales).—I have a quantity of slate at my disposal. Is this of any use instead of ebonite for valve panels?

Slate can be used for this purpose, though it is not such a good insulator. Moisture is apt to condense on the surface of slate, and thus form a conductive path for the H.F. currents. The slate may be prepared, however, by giving it a thin, even coat of shellac varnish, which will tend to prevent this accumulation of moisture.

"POTENTIO" (Glasgow).—Would you please tell me from what distance I could receive (1) telephony, (2) telegraphy, and what wavelengths I could cover with a set as below—12" x 4" diam. coil wound with 26 S.W.G. enamelled, using 520 turns, a galena detector, and 8,000 ohm 'phones? Would a double aerial improve matters? It would be 16 ft. long, 34 ft. high. Would a double detector circuit be any advantage for increasing the range?

Unfortunately, your aerial is rather short, though it is fairly high; the results will thus be about 15 miles for telephony and about 200 miles for telegraphy, this depending largely upon the power of the transmitting station. Your wave-length will be approximately 250-2,800 metres.

A double circuit will not have any effect in increasing the range of reception. You should try and lengthen your aerial as much as possible. A double or even treble wire aerial will be an advantage. The wires should be about 5 ft. apart.

G. E. C. (Birmingham).—Will you please let me have the wave-length of my loose coupler? The primary is 7" x 5", with 350 turns of 26 S.W.G. enamelled, and the secondary is 6" x 4", with 337 turns of 28 S.W.G. cotton-covered.

Your secondary is a little small for the best results; 450 turns of 30 S.W.G. would have been better. The wave-length is roughly from 300-2,800 metres.

G. B. D. (Enfield).—I am fixing up an H.F. panel to fit my two-valve set. Can I use resistance coupling, or must I employ a transformer? I want it so that I can listen-in to Birmingham and Manchester.

The resistance coupling method is not suitable for low wave-lengths, and should not be used under about 1,200 metres. You should employ either the usual plug-in transformers or else the tuned anode circuit. The latter will give good results under about 1,500 metres, while above that the transformer method should be used.

T. K. B. (Clapton).—I have just completed building a crystal set, but have been told that I must have an experimental licence before I can use it. Is this correct? I know nothing about wireless.

You should apply to the Secretary, G.P.O., for an experimental licence form, and then fill that in as far as you can. Explain on the form, or by an accompanying letter, that you have built your own set and would like permission to use the set with an ordinary broadcasting licence. Send a diagram and details of the set with your application, and the necessary licence fee of 10s.

F. E. B. (Berwick).—Would a tree make a good earth, as I see that it could be used as an aerial?

No, it would not make an efficient earth, owing to the fair amount of resistance that would exist.

"ENQUIRER" (Walthamstow).—Generally speaking, do electric tramways cause more interruption than telephone wires, as when

erecting my aerial it must run parallel to one or other of the two?

If you are close to the tramways, that is, within a distance of twenty or thirty yards, the overhead wires of these will cause more interference than fairly close telephone wires, owing to the sparking that occurs when the trams pass. Surely you can adopt some alternative such as to run the aerial obliquely to both the telephone wires and tram cables, because by so doing you would, to a certain extent, be minimising the risk of interference from both.

L. C. D. (Thorpe-le-Soken).—Is there any method by means of which the harmonics of the large C.W. stations can be cut out?

We are afraid not. The introduction of a closed circuit giving greater selectivity than just a single open circuit, however, will very greatly diminish their strength.

L. V. A. (Bath).—Can telephony be transmitted by means of an induction coil, as I have seen this instrument included in a picture presumed to be the apparatus used in wireless telephony?

Not in the direct sense, as telephony requires a continuous wave and not the interrupted wave-trains of a spark discharge in its transmission. However, an induction coil has been more or less successfully employed to supply the H.T. current for valve telephony transmission by using a rectifier and smoothing device, but the results did not warrant further experiments.

I. N. O. (Balham).—If it was a question of increasing the height of the aerial at the sacrifice of length, would it be worth it?

Yes, within limits; but without knowing how much height will be gained and the length of the aerial before and after doing so it is impossible to give a definite answer. If 10 or so feet is gained with a loss of 10 feet in length in a 50 feet aerial it would decidedly be an advantage.

T. S. I. (Basingstoke).—Having purchased a three-valve outfit I find that I am unable to use it owing to terrible noises induced from close at hand power mains. Would it be impossible to overcome this, or must I scrap the set?

There are several things you can try before you adopt the last drastic measure. First, try screening the wiring and set with soft iron; and then, if you have no H.F. stage of amplification, try introducing one, as it will act as a filter to a certain extent to L.F. interruptions (as such noises invariably are). Then try a capacity earth, details of which have appeared in these columns several times. See that all your wiring and aerial is as far away from parallel to the offending mains as possible and try reducing your H.T. to its minimum.

F. A. M. (Bristol).—In bringing the down lead into the house, will it be essential to knock a hole through the brickwork, as the frame is so sunk into the wall that it either means that or leaving the window open all the time if there is no other alternative?

A very good plan is to substitute one of the panes in the window for a sheet of plate glass through which should be drilled a hole. Through this hole a double-sided terminal with ebonite washers can be fixed, the down lead being screwed on from the outside and a lead-in inside screwed on the other side and taken to the set.

"H.T. BATTERY" (Ingleton).—I have been told that I can make up my H.T. battery from a number of Leclanché cells. Is this so? What are the component parts of these cells?

Yes, this is quite correct, though, considering the prices of dry cells, it is hardly worth the fuss and bother. These cells only give about 1.5 volts each and thus you would need a large number to reach the necessary high voltage. The principle parts are: positive plate, zinc rod; negative plate, carbon slab in a porous pot, packed tight with powdered carbon and oxide of manganese. The zinc rod is placed in the outer vessel in a solution of sal-ammoniac.

You will find it much simpler to use dry cells, however.

J. S. P. (Blackburn).—Is there any special type of zinc necessary when using Daniell cells? What is the strength of the acid?

Yes, the zinc should be well amalgamated—of the type used in the Leclanché cell, you may find it useful to place a little mercury on the bottom of the porous

(Continued on page 724.)





This is to announce that on

**JAN. 15th**

RADIO PRESS LTD., the well-known publishers of authoritative wireless books, will publish a new monthly wireless Magazine entitled:



# MODERN WIRELESS

112 Pages. **1/- NETT** 20,000 Copies already ordered.

Make sure of **YOUR** copy by ordering at once.

Every reader of "Popular Wireless" should obtain the brilliant first number. The Magazine is Edited by John Scott-Taggart, F.Inst.P., assisted by E. Redpath, Author of Cassell's "Work" Handbook, "Wireless Telegraphy and Telephony," and by Paul D. Tyers, Author of "Construction of Wireless Receiving Apparatus," well-known contributors to the pages of "Popular Wireless."

Order your copy from your newsagent, bookseller, from a railway bookstall, or direct (1/3 post free) from

**Radio Press Ltd.,** DEVEREUX BUILDINGS, STRAND, LONDON, W.C. 2.

## BROADCASTING RECEPTION SETS

One-Valve Set Complete for Working £7 : 10 : 0

Passed for  
Broadcasting  
Licence  
G.P.O.  
No.  
1038

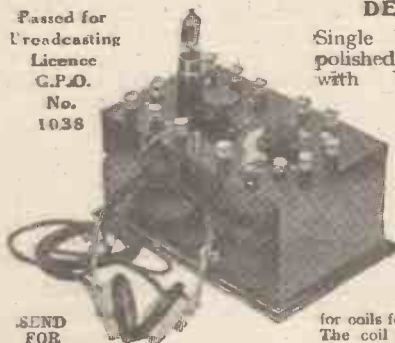

### DESCRIPTION:

Single Valve, mounted on polished 1/2-in. Ebonite Panel with Variable Condenser, smooth acting resistance, grid leak and condenser and all terminals clearly engraved in white, in a Mahogany Polished Cabinet, 9 in by 5 in. by 5 in. **£3 : 15 : 0**

A TAPPED COIL for wave-lengths up to 900 metres with 2 terminals for coils for any higher wave-lengths. The coil is enclosed and the tapings are brought out to an 8-way switch mounted in the front of the cabinet.

### ACCESSORIES INCLUDED:

- Siemen's 54 volt high-tension Battery with plugs for altering the voltage **£0 : 15 : 0**
- 4 volt 50 amp. hour low tension Accumulator in case with carrying strap **1 : 4 : 0**
- One pair of Sensitive Head Phones of 4,000 ohms resistance **1 : 1 : 0**
- One Detecting Valve **0 : 15 : 0**
- Total £7 : 10 : 0**

Satisfaction Guaranteed or money refunded.

**WIRELESS INSTALLATIONS LTD.**

15, ALDRSGATE STREET, LONDON, E.C.

AGENTS WANTED.

## The Battery with 40 Years' manufacturing experience behind it.

THE finest quality materials and experienced workmanship go to make this a battery to be absolutely relied upon to give the steady, high voltage so necessary to insure the best results in Wireless Reception.

### PYRAMID H.T. BATTERY.

15-Volt - - - - - 3/6  
30-Volt (with variable plug connection) 7/-  
(Post orders delivered within 24 hours.)

We also manufacture complete Wireless Sets and all component parts, of which the following is a much abbreviated list.

### BROADCAST RECEIVING SET.

Price, complete with British-made headphones, aerial, and everything ready for firing—

**£5 0 0**

plus 2/6 Broadcasting fee.

Low-Frequency Amplifiers, for use in conjunction with this set, having special transformers. Price—

**£5 0 0**

Two of these amplifiers are capable of working a loud-speaker with excellent results within a distance of 20 miles from London



- Filament Resistances... 3/9
- "Ideal" Valve Accumulators in case
- 4 Volt 50 amp. 25/- (Carriage 2/-)
- 6 Volt 50 amp. 35/- (Carriage 3/-)
- Variable Condensers of various capacities) ... From 6/-
- Fixed Condensers ... 2/6
- 3-Coil Holder, complete Unit for use with Standard Coils ... 20/-

Illustrated Lists free on request, or Visit our Showrooms.

**Wates Bros.** 13/14, Great Queen Street, KINGSWAY, LONDON, W.C.2

"We reply by return"

# APPARATUS AT YOUR PRICE

The following are a few items from our lists, and should interest you.

Every article carries our money-back guarantee with it,

Filament Resistance Panel Mounting	2/6
Crystal Detector, Single cup	2/9
Do. Double cup	3/6
Crystals, all kinds, per packet	6d.
Woods Metal, per stick	8d.
Buzzers for testing Crystals	2/6
Inductance Sliders, to fit 1/2-in. rod	9d.
Brass Rod, square, 1/4 in. by 1/4 in. per ft.	6d.
Brass Rod, round, 1/4 in. do.	6d.
Do. do. 3/8 in. do.	5d.
Do. do. 1/2 in. do.	3d.
Strip Brass, 1/2 in. by 1/4 in. do.	6d.
Aerial Wire, 7/25 Stranded Copper, per 100 ft.	4/6
Insulators, Egg pattern, each	3d.
Voltmeter, 0-6 volts, each	6/6

Postage extra on all above.  
Send to-day for your copy of our FREE list.

**ELECTRICAL SUPPLY STORES,**  
5, Albert Terrace, King Cross, HALIFAX,  
ENGLAND.

# OMNIPHONE Wireless Service

**VARIOMETERS**—A complete tuner for waves 300-500 metres. Complete with engraved dial for panel-mounting, 15/6.  
**AERIAL EQUIPMENT**—100 ft. 7-strand enam. copper wire, 3" sheil" insulators, and ebonite leading-in tube, 6/6.  
**EBONITE**—"A" grade, polished sheet, 3/16th inch thick, cut to any size required, at 1d. per superficial sq. inch.  
— All above post free. Send stamp for list.

OMNIPHONE WIRELESS CO.,  
24, Warwick St., Regent St., London, W.1.

## GLASGOW WIRELESS SUPPLY CENTRE

**W. & J. JAMIESON, LTD.,**  
68, Shamrock Street,  
St. George's Cross,  
GLASGOW.

SOLICIT your enquiries and specifications for accessories and parts for making complete RECEIVING SETS

### WIRELESS INVENTORS

Patents and Trade Marks. Advice Hand-book and Cons. free.—B. T. KING, Regd. Patent Agent, (G.B. & U.S.A.) 146a, Queen Victoria St., E.C.4. Phone: Central 682. 36 yrs. refs.

# PORTLAND'S Parts by Post. "EBONITE."

8 x 1.....	s. d. 7	12 x 10 ..	£ s. d. 7 6
4 x 4.....	13	17 1/2 x 8 1/2 ..	9 6
7 x 5 1/2.....	2 8	18 x 18 ..	12 10
10 x 6.....	3 9	36 x 18 ..	1 3 0
17 x 5.....	5 8	7lbs. ....	1 3 0

Quarter, Mat, British.

Postage Free. Any size cut.  
**JAMES PORTLAND,**  
39, Sinclair Road, Olympia, W.14.  
Mr. Portland stocks  
200 Wireless Parts

# RADIOTORIAL QUESTIONS AND ANSWERS.

(Continued from page 722.)

pot, and let the zinc just dip into it. This will help to keep the zinc in good condition. The strength of the acid solution should be between 1-12 and 1-20. The best proportion to use will be found after a little experiment. Remember to keep the cells as large as possible and also to have the copper sulphate solution well saturated. When this becomes too strong, a little of the liquid should be removed, and pure water added.

**T. P. O. (Ilkley).**—Would it be better to have a long lead-in running from the back room to where the set is situated, or place the set in the back room and have a long loud-speaker lead?

The long loud-speaker lead would be preferable.

**R. W. L. (Manchester).**—Why are electric mains always of great voltage?

That depends upon what you base your comparison. 110 or 220 volts cannot in the ordinary electrical engineering sense be styled high tension, but when used as with valve wireless receiving sets against the 4 or 6 volts low tension it can be styled thus. Perhaps you are referring to the 10,000 volts and more, as used on electric railways, and power and lighting distribution over extended areas. The reason why such great pressure is used is in order that the current can be carried by fairly light conductors. For instance, suppose it was desired to carry a main to a town 20 miles distant. If the pressure was but 220 volts the resistance of the main would have to be but a small fraction of an ohm to allow the required current to flow—which would be practically speaking impossible. Therefore, the pressure is brought up to some 10,000 volts, and if the resistance of the wire was, say, using only S.W.G. 1, 20 or so ohms, 80 amps. would be available, allowing for drop in potential, on transforming down to 100 volts.

**T. G. (High Barnet).**—Can you tell me what side-tone is?

A method whereby an operator when transmitting can listen-in and judge whether his transmission is up to standard. This is arranged generally by having a third winding, which is known as a side-tone coil, on the microphone transformer.

**H. N. B. (Wanstead).**—Is any special sort of sulphuric acid required for accumulators?

Yes; you should obtain fresh acid broken down to correct strength, as required, from a reliable electrician. Acid made from iron pyrites by the contact process, which is using iron oxide as a catalyser, frequently contains iron, which is a very serious impurity in accumulator acids. It is, of course, quite possible to thoroughly purify pyrites acid, but comparing the ordinary commercial grades, that made from Sicilian brimstone by the lead chamber process is to be preferred, because lead is not harmful unless it exists in excess. Reliable electricians realise that any metal electro-negative to lead or ammonia must be avoided, and will supply reliable electrolyte.

**"GRID" (S. Mims).**—I have just finished my one-valve panel, but it seems quite dead. Can you suggest anything?

Probably, if all connections are O.K., you have not fixed a suitable grid leak and condenser. Vary these until the best results are obtained. It is said that the best combination of leak and condenser is when the product of the two values (in ohms and microfarads, respectively) equals 200.

**J. S. T. (Taunton).**—What is the difference between conductors in "shunt" and in "parallel"?

The term "shunt" is used when the resistances of the conductors have a marked difference. "Parallel" is used when the resistances are more nearly equal. Actually the exact electrical connections are the same.

**"LICENCE" (Bedford).**—I have a two-valve home-made set which has been passed by the P.M.G. for use with a broadcasting licence. I now wish to add a third and perhaps a fourth valve to this set. Do I have to notify the P.M.G.?

We believe that this notification is not necessary provided all additions to the set are stamped by the B.B.C.; also provided that the additions do not involve a reconstruction of the wiring of the present set. If the proposed additions do not bear the B.B.C. stamp, the P.M.G. must be notified of the change of circuit, and fresh permission obtained to use the set with your present licence.

**"TRANSFORMER" (Southsea).**—(1) With an interval transformer, ratio 1-5, does this mean that the energy from the secondary is five times as great as that put into the primary? (2) I propose to have a two-valve set; shall I use high or low frequency amplification to hear 2 L O, P C G G, and Paris? (3) Does a H.F. transformer marked 350-450 metres only act on those wave-lengths? (4) What is the range of a coil 12 inches by 6 inches wound with 22 D.S.C. wire?

(1) No, this is quite impossible, as it would mean that the problem of perpetual motion was solved. You cannot take more out of a transformer than you put in; 1-5 ratio means that the voltage of the secondary is 5 times the voltage of the primary (there are 5 times as many turns of wire), but, at the same time, the amperage will have dropped an equal amount. (2) Use H.F. amplification. (3) Approximately, yes. This is the range over which it will give best results. (4) About 350-3,000 metres.

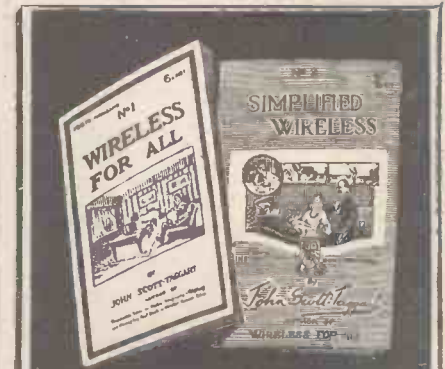

No. 1. The most fascinating story of the age told in simple non-technical style.  
Price 6d. (7d. post free).

No. 2. The sequel to the story, with full instructional and constructional details.  
Price 1/- (1/1s post free).

From all Newsagents or in two days from  
**Radio Press, Ltd.** Devereux Court, Strand, LONDON, W.C.2.

# LUNCH HOUR RAMBLE

STROLL ROUND TO  
**SPENCER'S STORES,**

4-5, MASON'S AVENUE,  
BASINGHALL STREET,  
LONDON, E.C. 3.

CHEAPEST HOUSE IN CITY  
FOR WIRELESS PARTS & SETS  
PRICE LISTS FREE.

## TO THE TRADE.

**Ebonite—Copper Wire, Bare & Covered—Aerials—Sleeving, &c.**

Wireless Supplies. Prompt Delivery.

Cables & Electrical Supplies, Mica House, Offord St., Caledonian Rd., London, N.1. Telephone: North 305

## CRYSTAL SETS

Assembled and unassembled.

And all component parts.  
Write for illustrated catalogue. Post free, 3d.

**VALVE PANELS ON THE UNIT SYSTEM**  
Unassembled

Simple to build. Full instructions sent with each set. Ask for particulars.

**P. H. BOYS & CO.,**  
Electrical & Wireless Engineers,  
187, GOSWELL ROAD, LONDON, E.C. 1.  
Phone: Clerkenwell 4454.



# The World listens in on MULLARD PHONES

Specially made for the reception of wireless broadcasting, Mullard phones are thoroughly well made and fit comfortably to the head, etc.

*British Manufacture*

The two high resistance ear-pieces (4,000 ohms total) are flexibly attached to the fully adjustable, double head bands.

The set is nicely finished in nickel-plate and supplied complete with standard flexible cords.

Send the coupon to-day to secure immediate delivery.

These telephones are made by the makers of the famous "ORA" valve and Mullard valve accessories.

## Mullard "Ora" Valves

We hope to get a greatly increased output of these famous valves at our large new factory. Meanwhile **ORDER AT ONCE.**

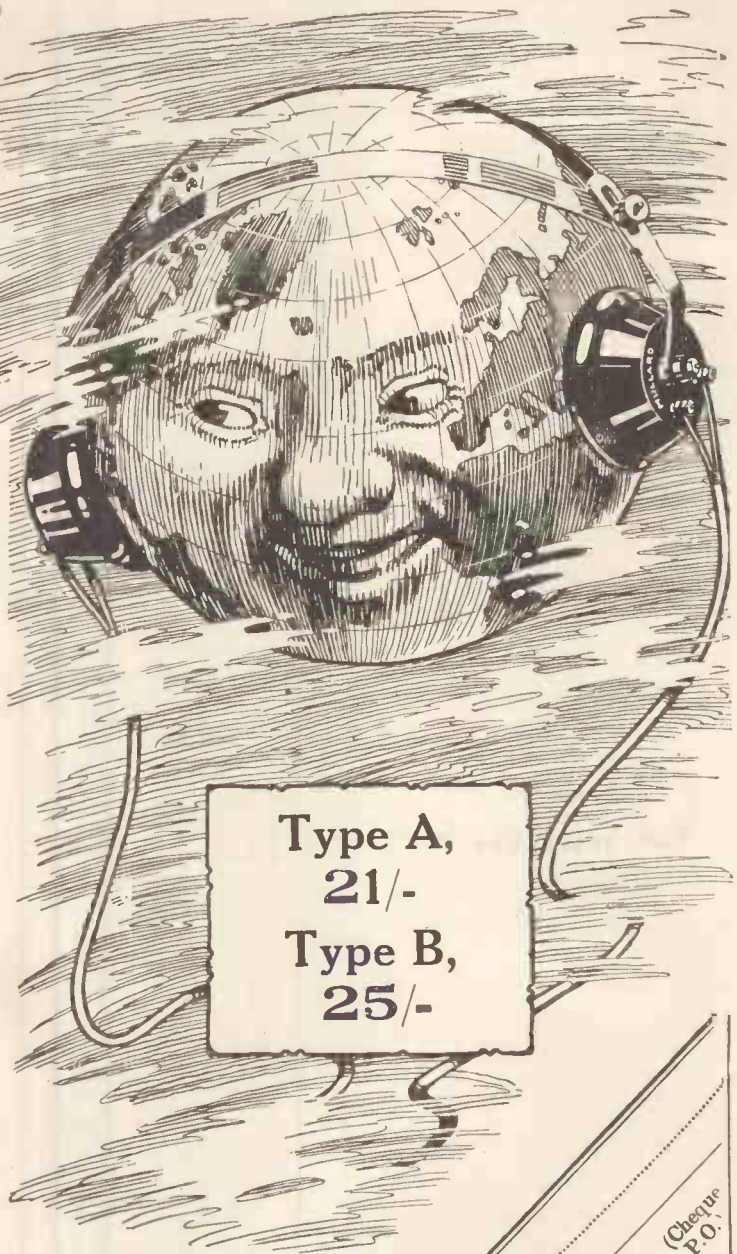

## Mullard Radio Valve Co. Ltd.

45, Nightingale Lane, Balham, S. W. 12.

Contractors to H.M. Admiralty

War Office, Royal Air Force & Post Office.

Telephone: Battersea 1068    Codes: ABC(5Ed)    Telegrams: Radiovalve Wandscom, Bentley's London.



*Please send me post free*

Quantity	Description	Price
.....	Telephone Head Sets	(Type A—21/-, Type B—25/-)
.....	"ORA" Valves	15/- each
.....	Grid A or B Resistances	5/- each
.....	B.A. Condensers	5/- each
.....	Combined Resistor and Condenser	2/6 each
.....	Valve Bases with Terminals	7/6 each
.....	Valve Sockets	5/- each
.....	Terminal Clips	1/8 each
.....	.....	sd. per pair

Name and Address.....

To the **MULLARD RADIO VALVE CO., LTD.**, 45, Nightingale Lane, Balham, S.W.12.

Name of usual Wireless Dealer.....

I enclose (Cheque, Money Order, P.O. value)..... to cover the cost.

**SEND THIS TO-DAY.**

# Radio Head 'Phones

(Manufactured under Brown's Patent No. 134353/18 by Sole Licence)



No. R1238

To obtain the best results from your receiving set use high quality Head 'Phones.

The instrument illustrated is of the highest efficiency and has an unequalled popularity by reason of its sensitive and selective qualities.

Gives a comfortable fit to the ear of the user.

Write for leaflets Nos. 321 and 325.



MARCONI

STANDARD

To be obtained from all Dealers or direct from :

**Sterling Telephone & Electric Co.,**

TELEPHONE HOUSE, LTD.

210/212, Tottenham Court Road, London, W.1.

Telephone No.: 4144 Museum (7 lines). Telegrams: 'Cucumis, Wesdc, London.'

Works: **DAGENHAM, ESSEX.**

Branches: **NEWCASTLE-ON-TYNE**: 9, Clavering Place.

**CARDIFF**: 8, Park Place.

**MANCHESTER**: 14, St. Peter's Square.

*We guarantee that all Broadcast Radio Apparatus sold by us conforms with the conditions of the Broadcaster's Licence issued by the Postmaster-General.*

**DON'T** Let Violence in Advertising  
Rush Your Judgment  
**FOR YOUR PROTECTION**

**INSIST** on a comparative demonstration  
before you purchase

It is all we ask to prove the demonstrable  
superiority in signal strength, purity of tone,  
simplicity in operation of

THE  
**Crystophone**  
REGISTERED

**P.M.G. BROADCAST RECEIVERS**

SOLD BY ALL LEADING STORES  
AND WIRELESS AGENTS

All Crystophone Receivers are exclusively fitted with the

**LATTIKONE TUNER**

The ONLY Tuning Coil which actually builds up and  
strengthens the incoming signal current and thus enables  
us to claim a

**50% INCREASE** in Signal  
Strength. Such is the reserve of power of

THE  
**Crystophone** Type 33  
REGISTERED (two valves)

that 4 Invisible wires stretched across the  
ceiling of ANY ROOM,

on ANY FLOOR,

in ANY HOUSE in  
LONDON, BIRMINGHAM, MANCHESTER,  
is sufficient for use with 6 pairs of head-  
phones, while with a P.M.G. Aerial it is

**Guaranteed for 100 Miles**

**PRICE £15** (INCLUDING ALL ROYALTIES.)

Crystophone Crystal Receivers

with Lattikone Tuner,

PRICES from £3 10s. 0d.

**Demonstrations Daily**

ON BROADCASTING  
FROM 4 TO 10 p.m.

**WIRELESS SUPPLIES CO.,**  
64, Mortimer St., London, W.1.

'Phone: Museum 2672. 'Grams: "Adragonax, Wesdc, London."

Phone : 10806 Central. Ludgate Circus, London. E.C.4. (Sole Agents), 4, Ludgate Circus, London. E.C.4. JOHN H. LILE, Ltd. to be made to POPULAR WIRELESS in space for Advertisement