

# Personal Computer

US\$2.95/SFr4.8/ir£1.76/BFr127  
Lire4,500/Dkr31.00

World September 1987 £1.20

Amstrad PC1640:  
Is it worth  
buying?

BRITAIN'S BIGGEST MICROCOMPUTER MAGAZINE



**THE PORTABLE PC LOSES POUNDS**  
Cheaper, lighter laptops Benchtested

# The new JUKI super-printer: major features



A true masterpiece from the Master Printers – that's the new JUKI 7200!

A sophisticated 24-wire flat-bed dot matrix printer, the JUKI 7200 is packed with outstanding and innovative features that take it far beyond the performance and capability of the average dot matrix machine.

**First:** with the JUKI 7200, there's no longer any need to worry about changing paper format. Continuous paper is fed automatically by tractor; single sheets and multi-part sets are fed automatically by the AMF (Automatic Multi-Part Feeder). If you need to interrupt a print run, documents can also be fed manually from the front.

**Second:** the JUKI 7200's flat-bed print system solves many of the problems associated with conventional dot matrix printers. The absence of a roller platen allows you to print perfectly on virtually many sorts of

paper, card or board, including business cards, stiff-backed envelopes, photographs and so on.

**Third:** the JUKI 7200 offers all these features – and more – at a very competitive price. Its Full Letter Quality output is ideal for word processing and graphics, while its fast print speed allows it to double as an operational plotter. All in all, the JUKI 7200 gives you maximum performance at minimum price.

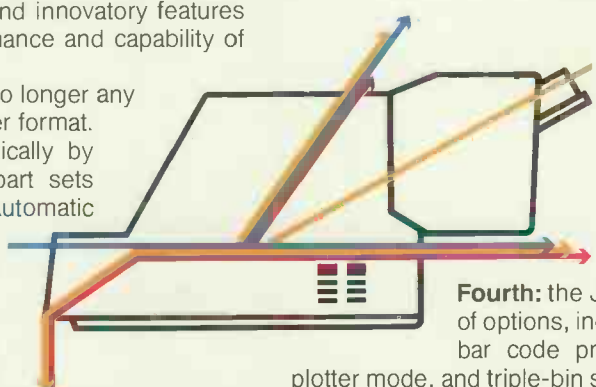

**Fourth:** the JUKI 7200 offers a wide range of options, including interchangeable fonts, bar code printing, OCR printing, colour plotter mode, and triple-bin single-sheet feeder. No matter what your business, expansion and flexibility are no problem with the JUKI 7200!

## JUKI

The Master Printers

JUKI (EUROPE) GMBH · Eiffestraße 74 · 2000 Hamburg 26 · F.R. Germany · Tel.: (040) 2512071-73 · Telex: 2163061 (JKI D) · Fax.: (040) 2512724  
 Sole distributor:  Intec 2, Unit 3, Hassocks Wood, Wade Road, Basingstoke, Hants, RG 24 ONE.  
 Tel.: (0256) 473232 (32 lines) Telex: 859669 MICRO PG, Facsimile: (0256) 461570

## ASSEMBLERS

Phar Lap 386-the first 386 assembler on DOS.  
The Visible Computer 8088 is a new assembly tutorial package.

2500AD 8086 Asm.	MS-DOS	£ 80
Dig.Res. RASM-86	MS-DOS	£ 180
MS Macro-86 v4.0	MS-DOS	£ 90
Phoenix PASM-86	MS-DOS	£ 115
Phar Lap 386	MS-DOS	£ 415
Visible Computer 8088	PC-DOS	£ 60
2500AD 8086 Asm.	CP/M-86	£ 80
Dig.Res. RASM-86	CP/M-86	£ 180
2500AD Z80 ASM	CP/M-80	£ 80
Dig.Res. RMAC	CP/M-80	£ 180
Microsoft Macro-80	CP/M-80	£ 60
SLR Z80ASM	CP/M-80	£ 45
SLR Z80ASM-PLUS	CP/M-80	£ 175
SLR MAC	CP/M-80	£ 45
SLR MAC-PLUS	CP/M-80	£ 175
SLR 180 (Hitachi)	CP/M-80	£ 45
SLR 180-PLUS (Hitachi)	CP/M-80	£ 175

Not all assemblers are supplied with a linker.  
Check before ordering.

## DISK COPYING SERVICE

We can copy files to and from 400 disk formats including CP/M, CP/M-86, MS-DOS, PC-DOS, ISIS, APPLE, SIRIUS, BBC, TORCH, APRICOT, HP150, TRSDOS, DEC RT-11, IBM BEF, ATARI520, AMSTRAD.

Our charge is £10.00 + disk + VAT with discounts on small quantities and disks are normally despatched within 24hrs of receipt.

For more information call us.

## C LIBRARIES

### DATABASE

Btrieve v4	MS-DOS	£190
Btrieve/Multi user	MS-DOS	£460
Btrieve/Network	MS-DOS	£460
CBTREE (source any C)	£ 80	
C-Index/Plus (source any C)	£175	
C-ISAM (L,MS)	MS-DOS	£225
C-to-dBase (source CI)	MS-DOS	£120
C-tree (source any C)	£230	
R-tree	MS-DOS	£175
db-VISTA (most C's)	MS-DOS	£145
db-VISTA (with source)	MS-DOS	£345
db-QUERY single-user	MS-DOS	£145
db-QUERY multi (w.sce)	MS-DOS	£345
Lattice dBCII (L)	MS-DOS	£160
Lattice dBCIII (L)	MS-DOS	£160
SoftFocus Btree (source any C)	£ 55	
Softfocus ISAM (source any C)	£ 30	
Virtual Memory File Man.	PC-DOS	£150

### GRAPHICS

Essential Graphics	PC-DOS	£150
GFX Graphics	PC-DOS	£ 50
Graphic (CI,L,DS,MS3)	PC-DOS	£255
GSS Kernel	PC-DOS	£350
GSS Lattice Binding	PC-DOS	£110
GSS Graph.Tlkt (L,MS,+)	PC-DOS	£335
GEM Prog.Toolkit (L)	PC-DOS	£405
GSX Prog.Toolkit (DR)	PC-DOS	£270
Multi-HALO (CI,L,MS3)	PC-DOS	£175
MetaWINDOWS (CI,L,MS3)	PC-DOS	£100
MetaWINDOWS Plus	PC-DOS	£130

### SCIENTIFIC LIBRARIES

Wiley Scientific Lib.	ANY C	£125
Mathpak 87 (L,MS)	MS-DOS	£ 80

## PRICES AND DELIVERY

Prices do not include VAT or other local taxes but do include delivery in UK and Europe. Please check prices at time of order, ads are prepared some weeks before publication. This page lists some of our products. Call us for a complete pricelist.

Order by phone with your credit card.

## THE C LANGUAGE

Superb Metaware High C now available for Concurrent Dos and for the 386.  
Turbo-C really is wizard.

### C COMPILERS

Alcor C	Z80 + CP/M-80	£85
Aztec C Personal 1.06D	CP/M-80	£120
Aztec Commercial 1.06D	CP/M-80	£205
BDS C 1.60	Z80 + CP/M-80	£ 70
Eco-C v3.48	Z80 + CP/M-80	£ 50
Hi-Tech C	Z80 + CP/M-80	£ 99
Mix C	Z80 + CP/M-80	£ 40
Toolworks C/80 v3.2	CP/M-80	£ 45
Advantage C++	MS-DOS	£440
Aztec Apprentice	MS-DOS	£ 40
Aztec Prime	MS-DOS	£ 75
Aztec C86 Developer	MS-DOS	£190
Aztec C86 Commercial	MS-DOS	£310
CI C86 Plus	MS-DOS	£290
De Smet C88 Starter	MS-DOS	£ 85
De Smet C88 Programmer	MS-DOS	£125
De Smet C88 Enhanced	MS-DOS	£165
De Smet C88 Prof.	MS-DOS	£200
ECO-C88 v3.22	MS-DOS	£ 50
HIGH C (Metaware) v1.4	MS-DOS	£345
HIGH C 386	MS-DOS	£595
Hi-Tech C	MS-DOS	£99
Lattice C v3.20	MS-DOS	£235
Mark Williams MWC86	MS-DOS	£385
Mark Williams LETS C	MS-DOS	£ 60
Microsoft C v4.0	MS-DOS	£245
MIX C	MS-DOS	£ 35
Turbo C v1.0	PC-DOS	£ 75
Toolworks C v3.2	MS-DOS	£ 45
Wizard C v3.0	MS-DOS	£300
Zorland C v2.05	PC-DOS	£ 29
Zorland C Power Pack	PC-DOS	£ 59

Aztec C86 Developer	CP/M-86	£250
Aztec C86 Personal	CP/M-86	£150
CI Optimizing C86	CP/M-86	£270
De Smet C Starter	CP/M-86	£ 85
De Smet C Programmer	CP/M-86	£125
De Smet C Enhanced	CP/M-86	£165
Hi-Tech C	CP/M-86	£ 99
Lattice C v1.04	CP/M-86	£260
HIGH C (Metaware)	C-DOS	£345
Aztec C65 V1.05	Apple DOS	£195
Aztec C65 V3.20	Apple PRO-DOS	£250
Aztec C65 Prime	Apple DOS	£ 75
Aztec C68 Commercial	MACINTOSH	£310
Aztec C68 Developer	MACINTOSH	£190
Hi-Tech C	ATARI	£ 99
Lattice C	ATARI	£ 80
Mark Williams C	ATARI	£140

### C CROSS COMPILERS

We supply Aztec, Lattice, IAR and Hi-Tech Cross Compilers hosted on MS-DOS and targeted on Z80, 8085, 6502,6801, 68HC11, 6301, 8051 and 68000.

Please call for information or advice.

### C INTERPRETERS

C-terp	PC-DOS	£180
Interactive C	PC-DOS	£195
Introducing C	PC-DOS	£ 85
Living C-personal	PC-DOS	£ 70
Living C Plus	PC-DOS	£135
Instant-C v2.0	MS-DOS	£380
RUN/C	MS-DOS	£ 60
RUN/C Professional	MS-DOS	£120
Instant-C v1.27	CP/M-86	£380

## PROGRAMMING TOOLS

Ada Compilers	Algol Compilers
Assemblers	Assembler Libs.
Basic Compilers	Basic Interpreters
Basic Utilities	Basic Libraries
BCPL Compilers	C Compilers
C Interpreters	C Libraries
C Utilities	Cobol Compilers
Comms.Libraries	Cross Assemblers
Database Libs.	Debuggers
Dis-assemblers	Editors
Engineers Libs.	Expert Systems
Forth	Fortran Compilers
Fortran Libraries	Graphics Libraries
Icon	Linkers
Lisp	Modula-2
Nial Interpreters	OPS 5
Pascal Compilers	Pascal Libraries
Prolog	Rexx
Screen Libraries	Smalltalk
Snobol	

We stock many items for which there is no space in these advertisements.

## ADA COMPILERS

Recent additions AdaVantage and Artek Ada now provide some choice.

AdaVantage v1.5	PC-DOS	£ 380
Artek Ada v1.25	MS-DOS	£ 350
JANUS/Ada C-Pack	MS-DOS	£ 90
JANUS/Ada ED-Pack	MS-DOS	£ 285
JANUS/Ada D-Pack	MS-DOS	£ 825
JANUS/Ada S-Pack	MS-DOS	£2890
Augusta (with source)	CP/M-80	£ 75
JANUS/Ada C-Pack	CP/M-80	£ 80
JANUS/Ada D-Pack	CP/M-80	£ 260
Supersoft Ada	CP/M-80	£ 250

## LINKERS

Plink-86 Plus v2.22	MS-DOS	£285
Link & Locate	MS-DOS	£250
Plink-II	CP/M-80	£315
SLRnk (Z80)	CP/M-80	£ 45
SLRnk-PLUS (Z80)	CP/M-80	£150

# CONTENTS

Vol 10 No 9 September 1987



Cover photography by Chris Bell  
Cover story begins on page 98

## BENCHTESTS & REVIEWS

### PC LAPTOPS

It is now possible to buy a PC-compatible laptop for not much more than the cost of a desktop machine. John Donaldson Benchtests three fully-configured laptops which cost less than £1000 and offer true battery power — the Datavue Spark, the Toshiba T1000 and the Sharp PC-4501A.

### AMSTRAD PC1640

Alan Sugar has upgraded the Amstrad PC — it now has enhanced graphics and 640k of RAM. Robert Schifreen looks at the improvements.



### CAMBRIDGE COMPUTER Z88 108

It has taken four months to get here, but now Sir Clive Sinclair really *is* shipping his Z88 laptop. Robert Schifreen takes delivery of one of the first production machines, and finds it to be truly portable and very capable.

### 98 KURZWEIL DISCOVER 114

The new Kurzweil scanner isn't cheap but it is very smart. Using artificial intelligence techniques, it is capable of reading printed text regardless of size, font or format. David Tebbutt investigates this ingenious piece of hardware.

### C COMPILERS 124

Borland's Turbo C is fast, easy to use and conforms to existing C standards, but the market is well-stocked with powerful competitors. Nick Walker compares Turbo C with Zorland C and Mix C.

### OMNIS QUARTZ 136

Five hundred programs are being developed for Microsoft Windows, but there is only one fully relational database among them — Omnis Quartz from Blyth Software. Derek Cohen and Nick Walker take a long, hard look at this friendly but powerful database.

### DESQVIEW 142

Owen Linderholm can now run multiple PC applications with true multi-tasking — and most within windows. No, he hasn't taken delivery of OS/2 or a new 386 machine — all this is possible on a standard PC with the latest version of DESQview.

### XPRESS 146

The Apple Macintosh has always been a popular choice for desktop publishing and now, with Xpress, it offers an even more professional set-up, with unprecedented typographic control over page layout. Graham Jones considers it to be a new standard.

Founder Angelo Zgorelec Editor Derek Cohen Deputy Editor Nick Walker Production Editor Ginny Conran Deputy Production Editor Lauraine Danker Technical Editor Owen Linderholm Staff Writer Robert Schifreen Editorial Assistant Chris Cain Consultant Editors David Tebbutt, Dick Pountain Art Director Martyn J Rowbotham Art Assistant Soo Abram Publishing Director Mike Agate Publisher Mike James Production Controller Judith Middleton Production Manager Rachel Wynne Group Advertisement Manager Jan Pitt Advertisement Manager Moira Thomson Deputy Advertisement Manager Nick Ascough Sales Executives Julie Carter, Janett Harrison, Stephen Babb, Sally McLester Anthony Lavelle, Helen O'Driscoll Advertisement Assistant Val Young

# FEATURES

## MEMORY MEDIA

118

Optical disk technology is still in its infancy, but two forms of optical media, the CD-ROM and the WORM drive, are fast becoming popular means of high-capacity storage. Nick Hampshire explains.

## GRAPHIC ALGORITHMS

130

Amassing a collection of graphics primitives is a time-consuming task, but they can be an invaluable programming tool. Mark Parlour presents a detailed collection of Turbo Pascal algorithms which could lead to some impressive graphic output.

## SILICON SURGERY

150

Dr Andrew Herd charts the progress of computing technology in the doctor's surgery, from the great claims of early mainframe expert systems to the use of personal 'credit card' patient records.

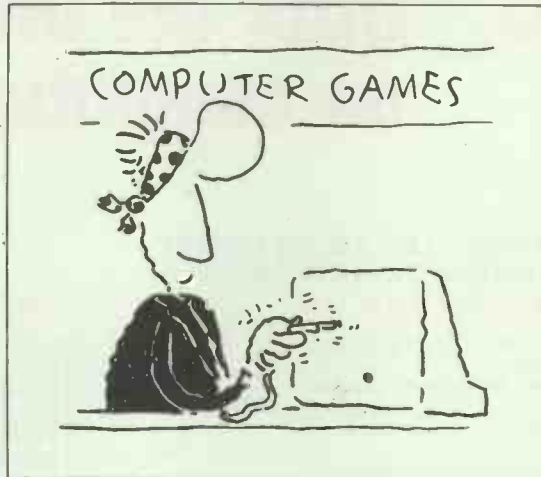

## SHOWING OFF!

154

The PCW Show is ten years old this year, and is bigger and better than ever. We present a preview of all the major exhibitors and give details of some of the many new products due to be launched.

# REGULARS

## NEWSPRINT

68

Guy Kewney sifts through the latest news, and uncovers the truth behind the lack of IBM desktop publishing products and the Amstrad rumours.

## WEST COAST CONNECTION

85

There's no doubt in the States about the IBM PS/2, which is selling in vast quantities. Tim Bajarin describes the latest happenings in the American computer industry.

## LETTERS

91

There's scepticism about the 'free' IBM PC being given away with PC/ATs; and the famous AI researcher, Donald Michie, responds to a recent PCW article.

## BANKS' STATEMENT

94

Martin Banks is disturbed by the poor quality of certain printed matter which has dropped through his letter-box, and tracks the problem down to the misguided use of desktop publishing packages.

## SCREENPLAY

168

The deluge of Infocom adventures continues with the release of *The Lurking Horror*. Stephen Applebaum's sprite-battered screen swings into action.

## COMPUTER ANSWERS

172

Steve Gold applies his mind to the computer-related problems of PCW readers.

## BIBLIOFILE

174

Operating systems come under the scrutiny of PCW's literary team.

## MAILBOX

178

Peter Tootill gives a guided tour of the Microlink online service, and reels in horror at the increase in Telecom Gold charges.

## SUBSET

180

David Barrow concentrates on short but powerful 'bit twiddles' for a variety of machines.

## PROGRAM FILE

182

Owen Linderholm selects the best from the many excellent readers' programs. The Program of the Month is a hard-disk file manager and program launcher for the IBM PC and compatibles.

## END ZONE

212

A full list of UK user groups can be found among the regulars.

## ADVERTISERS' INDEX

The quick way to find the advertisers you want.

## CHIP CHAT

More humorous happenings.

PCW Subscription Enquiries Stuart Cruickshank Subscription Rates UK £15, Overseas £33 Subscription and back issues address: 32-34 Broadwick Street, London W1A 2HG, tel: (01) 439 4242 Advertising address 32-34 Broadwick Street, London W1A 2HG, tel: (01) 927 9016 Editorial address 32-34 Broadwick Street, London W1A 2HG, tel: (01) 439 4242. All departments Telex: 23918 VNUG — No material may be reproduced in whole or in part without written consent from the copyright holders © VNU Business Publications by 1987. Typeset by Phase Communications, Pioneer House, 44/48 Clerkenwell Road, London EC1. Printed by Chase Web Offset, St Austell, Cornwall. Distributed by Comag Ltd, Tavistock Road, West Drayton, Middlesex, tel: (0895) 444055

**I.S.C.**

# Offer the UK's Best Service on computer software

**COME TO THE EXPERTS — I.S.C. ARE THE LARGEST  
INDEPENDENT PEGASUS DEALER IN THE U.K.**

## PEGASUS ACCOUNTING

*(All Pegasus includes FREE 2 year support)*

PEGASUS SINGLE USER .....	£160
Multi Company, Eight Module Integration	
PEGASUS SENIOR .....	POA
Multi Company, Currency, Consolidations	
PEGASUS MULTI USER .....	POA
Multi Company, Currency, Workstation, MSDOS	
INFORMATION MANAGER .....	£160
Reads Data directly from Pegasus Files	
ELITE SENIOR DATABASE .....	£345
Reads + Writes Pegasus Data Files	
WORK INVOICING .....	£295
Integrated with Pegasus Single User for Complex Invoicing and Repeat Billing	
SUPPORT CONTRACT .....	£50

Prices per Module over 2 Years  
Free to ISC Customers  
(Multi User 100 pounds per module)  
Data Transfer, Upgrades, Bespoke, Training  
+ Installation Services Available.

## STATIONERY

*Prices are per 500, total order minimum 1000*

2 PART STATEMENTS .....	£26
3 PART STATEMENTS .....	£27
2 PART INVOICES .....	£29
3 PART INVOICES .....	£31
4 PART INVOICES .....	£43
PAYSLIPS .....	£21
REMITTANCE ADVICE .....	£32
BANK GIRO .....	£19
P14/P60 .....	£34
P35 .....	£34
STATEMENT ENVELOPES .....	£22
PAYSLIP ENVELOPES .....	£21

*Please Call for Sample Sets.  
Free Delivery Mainland U.K.*

## I.S.C. OFFER A FULL TECHNICAL ADVICE, SUPPORT AND INSTALLATION SERVICE + CUSTOMISED SINGLE AND MULTI USER SYSTEMS

### SMART INTEGRATED SOFTWARE

SMART SYSTEM V3.0 .....	£395
Includes Database, Spreadsheet + WP	
DATABASE MANAGER .....	£275
SPREADSHEET .....	£275
WORDPROCESSOR .....	£195
SPELLCHECKER .....	£95
SMART LAN MULTIUSER .....	£1395
For Networking, Three User Access	
SMART SYSTEM USER ACCESS .....	£450
For Unlimited User Access	

## TRAINING

I.S.C. offer training at your premises,  
on a wide range of Software and  
Hardware Products.

WORDSTAR PROFESSIONAL

LOTUS 1-2-3

SMART INTEGRATED SOFTWARE

PEGASUS ACCOUNTS

NETWORKING PRODUCTS

DBASE 2/3/+

\* \* \* Many Other Single and Multi  
User Products

## MULTIUSER

TANDON PCA30 30MB 80286 PROCESSOR 1MB RAM  
2 IBM STYLE TERMINALS  
5 MODULES OF MULTI-USER PEGASUS ACCOUNTING  
2 DAYS INSTALLATION AND TRAINING  
2 YEARS HOT LINE SUPPORT .....

**£5995**  
(EQUIVALENT TO 33% DISCOUNT)  
(THE ABOVE IS ONLY AN EXAMPLE, OTHER COMPUTERS OR  
SOFTWARE AVAILABLE

**I.S.C.****XEN IN STOCK****AMSTRAD PC  
MAIN DEALER****\* Guarantee the UK's lowest  
prices on computer systems****COMPUTERS***All Computers include Mono Screen, MS DOS and KB*

TANDON PCX10 /256K/10MB/360K .....	£695
TANDON PCX20 /256K/20MB/360K .....	£895
TANDON PCA20 /512K/20MB/1.2MB/SP/HERC .....	£1395
TANDON PCA30 /512K/30MB/1.2MB/SP/HERC .....	£1595
TANDON PCA40 /512K/40MB/1.2MB/SP/HERC .....	£1795
TANDON PCA70/512K/70Mb/1.2Mb/SP/HERC .....	£2295
AMSTRAD PC1512/512K/TWIN DRIVE/MONO .....	£499
AMSTRAD PC1512/512K/TWIN DRIVE/COLOUR .....	£649
AMSTRAD PC1512/512K/20MB/360K/MONO .....	£799
AMSTRAD PC1512/512K/20MB/360K COLOUR .....	£949
APRICOT XEN X120/512K/20MB 1.2MB .....	£1950
APRICOT XEN XD20/1MB/20MB/1.2MB .....	£2095
APRICOT XEN XD45/1MB/45MB/1.2MB .....	£2695
APRICOT XEN 386 1MB/30MB/1.2MB .....	£2695
APRICOT XEN 386 2MB/45MB/1.2MB .....	£3445
IBM XTSDD/640K/TWIN 360K .....	£1395
IBM XTSFD/640K/20MB/360K .....	£1595
IBM XT286/640K/20MB/1.2MB .....	£2260
IBM ATX/512K/30MB/1.2MB .....	£2999
AST M20/640K/20MB/1.2MB/10MHZ/EGA COLOUR .....	£2195
AST M40/640K/40MB/1.2MB/10MHZ/EGA COLOUR .....	£2495
AST M70/640K/70MB/1.2MB/10MHZ/EGA COLOUR .....	£2695
COMPAQ D286M2/512K/30MB/1.2MB .....	£3095
COMPAQ D286M3/640K/70MB/1.2MB .....	£4595
COMPAQ D386 .....	POA
OLIVETTI .....	POA
ZENITH .....	POA
KAYPRO .....	POA

**COLOUR SYSTEMS ADD  
THE FOLLOWING:-**

APRICOT 195 ... TANDON 215 ...  
OLIVETTI 250 ... AMSTRAD 150 ...  
IBM 220 ... COMPAQ 220 ... ZENITH 215 ...

DEMONSTRATION AND SECOND  
USER MACHINES AVAILABLE

**COMPANY SERVICES  
INCLUDE:**

LEASING, LEASE RENTAL + HIRE PURCHASE  
CUSTOMISED DATABASE SYSTEMS,

**MAINTENANCE CONTRACTS, AT 10% OFF RRP**

INSTALLATION CONTRACTS,  
NETWORK SYSTEMS, MULTI-USER SYSTEMS

TRADE AND EXPORT  
ENQUIRIES WELCOME

All products carry 12 months guarantee and

**HOTLINE**  
PHONE SUPPORT

**\* PROVIDE A CURRENTLY ADVERTISED LOWER PRICE  
WITHIN 7 DAYS AND DIFFERENCE WILL BE REFUNDED**

**I.S.C. LIMITED**

FORESTER HOUSE  
BRAMLEY ROAD  
ST IVES  
CAMBRIDGESHIRE  
PE17 4WS

TEL: 0480 300530  
(16 lines)  
TELEX: 329115 ISC LTD

**PRINTERS**

EPSON LX800 120CPS/20NLO/80COL .....	£205
EPSON EX800 300CPS/50NLO/80COL .....	£395
EPSON FX800 200CPS/50NLO/80COL .....	£305
EPSON LQ800 180CPS/60NLO/80COL .....	£430
EPSON EX1000 300CPS/50NLO/132COL .....	£515
EPSON FX1000 200CPS/50NLO/132COL .....	£395
EPSON LQ1000 180CPS/50NLO/132COL .....	£575
EPSON LQ2500 270CPS/90NLO/132COL .....	£815
FUJITSU 2100 220CPS-55NLO/80 COL .....	£295
FUJITSU 2200 220CPS/55NLO/132COL .....	£395
CANON A55 180CPS/45NLO/132COL .....	£375
CANON LBP8A1 LASER 8 PAGE PER MIN .....	£1495
CANON LBP8A2 LASER 8 PAGE PER MIN/GRAPHICS .....	£2295
CANON LBP SERIES 2 8 PAGE PER MIN/GRAPHICS .....	£1695
HP LASERJET 8 PAGE PER MIN .....	£1695
HP LASERJET+ 8 PAGE PER MIN .....	£2295
HP SERIES 2 8 PAGE PER MIN .....	£1795
JUKI 6100 15CPS/DAISYWHEEL .....	£275
JUKI 6200 30CPS/DAISYWHEEL .....	£425
JUKI 6300 35CPS/DAISYWHEEL .....	£645
JUKI 7200 PRINTER .....	£1350

**SOFTWARE**

PEGASUS SINGLE USER .....	£160
(2 YEARS SUPPORT)	
PEGASUS SENIOR .....	£POA
(2 YEARS SUPPORT)	
PEGASUS MULTI USER .....	£POA
(2 YEARS SUPPORT)	
DELTA 4 PROFESSIONAL .....	£335
DBASE2 .....	£245
DBASE3+ .....	£355
WORDSTAR PROFESSIONAL .....	£209
WORDSTAR 2000 .....	£259
MICROSOFT WORD .....	£270
LOTUS 1-2-3.V1 .....	£179
LOTUS 1-2-3.V2 .....	£239
LOTUS SYMPHONY .....	£359
SMART INTEGRATED SYSTEM .....	£385
OPEN ACCESS .....	£335
LOGISITIX .....	£255
SAGE BOOKKEEPER .....	£80
SAGE ACCOUNTANT .....	£120
SAGE ACCOUNTANT+ .....	£150
VENTURA .....	£645
ABILITY .....	£90
WORDPERFECT .....	£295

**SPECIALS**

APRICOT 256K RAM .....	£99
APRICOT 512K RAM .....	£119
IBM 256K RAM .....	£119
IBM 384K RAM .....	£139
SONY 3.5 INCH D/S DISKS .....	£32
20MG UPGRADE FOR IBM .....	£395
E.G.A. CARD + MONITOR .....	£695
HERC/CGA/EGA .....	

Prices Exclude only VAT and Delivery



SCOTTISH OFFICE:  
I.S.C. SCOTLAND  
19 CARDEN PLACE  
ABERDEEN  
AB1 1UQ

TEL: 0224 639944  
(3 lines)

# BACKUP your troubles **£29.95** in your old **CLIP** bag!

## CLIP — THE BACKUP PROGRAM STANDARD

**The PROBLEM —**  
Your free backup utility is slow, difficult to use, and can only restore files into ready-made directories.

It does not record its progress — so you backup everything to be safe.

Or nothing because it's such a bore.

CLIP has the longest track record of all backup programs and an enviable reputation for reliable service. Purchasers of 1000+ copies of CLIP include British Telecom, Philips and Ashton-Tate.

Only the best will do for backup.

**The SOLUTION —**  
CLIP keeps a log of its backups, so you can afford to be selective.

It maintains a menu of your customised commands, so you do not have to stop and think. It is fast, and it compresses data.

Result — fewer disks, less time, less effort, no worry, greater security.

- ★ High-speed data compression
- ★ Execute by highly visual Menu or by command line entry
- ★ On-line help at every point
- ★ Can select new files only
- ★ Multiple wildcard select, include or exclude basis.
- ★ Save to any media-floppy, hardcard Bernoulli etc
- ★ Save to remote/network drive
- ★ Restores directories + files
- ★ Recovery after media errors
- ★ Log of all backup operations

For an experimental period, CLIP 4.0L is offered at £29.95. (The previous advertised price was £67.85). Order now and prove that the trial price is the right one for you and us.

Available for PC/XT/AT and compatibles, PCDOS/MSDOS  
Price includes VAT and UK postage. c.w.o. or Access



**KEELE CODES LTD**

University of Keele, Keele, Staffordshire, UK Tel: (0782) 629221 Telex: 36113

## Almo Computer Systems

New Number  
More Lines  
**0730 68877**

### THIS MONTHS SPECIALS : CANON LASER PRINTERS

#### TOSHIBA 24 Pin Head

P321 (216/72cps)	£415
P341E (216/72cps)	£489
P351 (288/100cps)	£736
P351C (288/100cps) Col	£988

#### EPSON Dot Matrix

LX86 (120/16cps)	£168
LX800 (150/25cps)	£201
FX800 (240/40cps)	£307
FX1000 (240/40cps)	£393
LQ800 (180/60cps)	£447
LQ1000 (180/60cps)	£597
LQ2500 (270/90cps)	£747
SQ2000 (176/105cps)	£1219
SQ2500 (270/90cps) P/S	£962
EX800 (300/50cps)	£397
EX1000 (300/50cps)	£533

#### JUKI Daisywheel Printers

6100 (20cps)P	£261
6200 (30cps)P	£388
6300 (40cps)P/S/IBM	£602
6500 (60cps)P	£738

#### MICRO P D/wheel Printers

MP26 (26cps) P&S	£197
MP40 (40cps) P&S	£264

#### BROTHER D/wheel Printers

HR20 (20cps)P/S	£343
HR25XL (25cps)P/S	£535
HR40 (40cps) P/S	£766
TwinWriter Daisy/D. Mat	£997

#### BROTHER Dot Matrix

2024L (160/96cps) P/S	£612
M1409 (180cps)	£296
M1509 (180/45cps) P&S	£381
M1709 (240/50cps) P&S	£458
M4018 (480/67cps) P&S	£1151

#### OKI Microline Dot Matrix

182 (120/60cps)P/I	£203
182HS (H/Speed Ser)	£245
192 (160cps)P/I	£287
192 (160cps)S	£328
193 (160cps)P/I	£372
193 (160cps)S	£417
292 (200/100cps)Col	£446
293 (200/100cps)Col	£595
294 (400/100cps)Col	£816

#### Citizen Dot Matrix

120D (120/25)P	£159
120D (120/25)S	£169
10E (160/40)P	£208
15E (160/40)P	£243

#### CANON Dot Matrix Printers

PW1080A+(160/27cps)	£208
A55 (180/34cps)	£380
A60 (200/100cps)P	£368
A65 (200/100cps)P	£434

#### LASER PRINTERS

Canon LBP-8A1 (8pm)P/S*	£1404
Canon LBP-8A2 (8pm-Gr)*	£2612
Canon Series II*	£1580
HP Laserjet	£1486
HP Laserjet Plus (P&S)	£2162
HP Laserjet 500 Plus (P&S)	£2976
HP Series II	£1950
Epson GQ3500 Laser	£1310
QMS PS800 (Postscript)	£2979
QMS PS800+ (Postscript)	£3528

#### MICRO P Dot Matrix Printers

MP135 (135/27cps) P	£130
MP165 (165/35cps) P	£161
MP200 (200/40cps) P	£245
MP201 (200/40cps) P	£266
MP480 (480/74cps) P	£269

P=parallel, S=serial, I=IBM, col=colour

### AMSTRAD

#### SYSTEMS

PC1512 SD/MM	£449
PC1512 DD/MM	£559
PC1512 SD/CM	£619
PC1512 DD/CM	£729
PC1512 HD20/MM	£899
PC1512 HD20/CM	£1069
PC1640 SD/ECD	£799
PC1640 DD/ECD	£899
PC1640 HD20/ECD	£1199

#### ON-SITE MAINT 12 MONTHS

PC1512 SD/MM	£39
PC1512 DD/MM	£49
PC1512 SD/CM	£55
PC1512 DD/CM	£65
PC1512 HD20/MM	£85
PC1512 HD20/CM	£99
PC1640 SD/ECD	£75
PC1640 DD/ECD	£85
PC1640 HD20/ECD	£109

Plus Delivery & VAT

Access/Visa/Applec card accepted. All prices are exclusive of VAT. Telephone for prices for other printers and accessories. Prices correct at time of going to press. Cables from £15 extra. Carriage Printers £8, Laserprinters £20.

Terms cash with order - Mail order only

Phone (0730) 68877 16a College Street, Petersfield, Hampshire. GU31 4AD



## LOWEST PRICES IN UK?

### MICROS

Sinclair Spectrum 128K + 2 (Software) .....	£139
Sinclair Spectrum Plus .....	£87
Sinclair QL .....	£126
Commodore Amiga 500 .....	£460
Commodore 128 .....	£205
Commodore 128D .....	£435
Amstrad CPC 6128 G Monitor .....	£260
Amstrad CPC 6128 C Monitor .....	£347
Amstrad PCW 8526 .....	7POA
Amstrad PCW 8512 .....	7POA
Amstrad PC 1512 SD Mono .....	£449
Amstrad PC 1512 SD Colour .....	£619
Amstrad PC 1512 DD Mono .....	£559
Amstrad PC 1512 DD Colour .....	£729
Amstrad PC 1512 HD20 Mono .....	£899
Amstrad PC 1512 HD20 Colour .....	£1069
Amstrad PC 1512 business pack (PC 1512 DD Mono, DMP3000 Printer Best selling Wordstar Supercalc) .....	£699
Ateri 520 STM package .....	£390

### PRINTERS

Epson LX 800 - The Best Seller .....	£205
Star NL10 - The Best Seller .....	£205
Citizen 120 D-A Hot Seller .....	£156
Panasonic 1081 - The Hot Seller .....	£150
MP 135 - Cheap & Good Quality .....	£139
Amstrad DMP 2000 NLQ .....	£135
Amstrad DMP 3000 NLQ .....	£140
Amstrad DMP 4000 NLQ .....	£305
Citizen 120D for Commodore .....	£161
Commodore MPS 1000 .....	£211
Brother M 1190, 120 cps, 80c .....	£175
Brother M1409, 180 cps, 110c .....	£295
Brother HR20, 20 cps D-Wheel .....	£335
Brother HR25 XL .....	£529
Brother M1509 136 col 180cps .....	£375
Brother M1709 136 col 240cps .....	£535
Canon PW1080 BN/LQ 160cps 80c .....	£239
Juki 6100 20cps 110c D-Wheel .....	£250
Juki 5510 NLQ 180cps 80c .....	£235

### PHOTOCOPIERS & FAX MACHINES

Canon FC3 .....	£399
Canon FC5 .....	£599
Canon PC14 .....	£760
Canon Fax-220 .....	£258
Sharp Fax-4D-200 .....	£1615

### PSION

Psion II CM .....	£82
Psion II XP .....	£115
8K Datapak .....	£11
16K Datapak .....	£17
32K Datapak .....	£30
64K Datapak .....	£52
128K Datapak .....	£86
Formatter .....	£39

### CASIO

Scientific .....	£8
FX62A .....	£11
FX100 .....	£17
FX451 .....	£14
FX570 .....	£22
FX580 .....	£15
FX3600P .....	£17
FX3800P .....	£78
FX8000G .....	£43
FX7000G .....	£26
FX4000P .....	£26

### Packet Computers

PB1000 .....	£120;
FX5200P .....	£35
FX720P .....	£47
PB410 .....	£35
FX730P .....	£69
FX750P .....	£78
PB700 .....	£103

### TYPEWRITERS & CANON

Typewriter 7 .....	£175
Typewriter 611 .....	£148
Typewriter 5 II .....	£129
Canon S200 .....	£159
Canon S300S .....	£315
Typesyles .....	£22
Ribbons 1 bx .....	£10
Ram 4k, 8k, 16k PDA .....	£164

### DISK DRIVES & MONITORS

Commodore 1541C .....	£164
Commodore 1571 .....	£233
Amstrad 3" DD1 or FD1 .....	POA
Commodore Green Monitor .....	£70
Commodore 128 Colour Monitors .....	£260

### Textbase .....

Numbase .....	£43
Finance Pack .....	£26
Maths Pack .....	£26
PC Four .....	£60
Pocket Spd Shi .....	£34
RS232 Link .....	£41
Comms RS232 .....	£52

### Date Bank

SF3000BK .....	£56
BC 300 .....	£56
PF 7000 .....	£34
PF 3200 .....	£37

### ACCESSORIES

RP8 .....	£14
RP16 .....	£29
RC2 .....	£21
OR4 .....	£26
RC4 .....	£33
DR4 .....	£33
DR8 .....	£60
FA3 .....	£20
FP-12-S .....	£34
FA7 .....	£60
FP40 .....	£86
FP100 .....	£225
MD100 .....	£286

### CALCULATORS

Casio .....	£199
CW25 .....	£100
CW110S .....	£89
DR120S .....	£79
HR100 .....	£30
HR16 .....	£29
Watch DB510 .....	£28
Watch DBC60 .....	£29

## Special Offers on Macintosh Products

A Selection of Excellent Value Products for your Macintosh

	Price Ex VAT	Inc VAT
<b>WORKS: Microsoft</b> Spreadsheet, Database, W/P, Comms	245.00	281.75
<b>MORE: Living Videotext</b> The Successor to ThinkTank 512	275.00	316.25
<b>RAGTIME: Orange Micro</b> A Complete DeskTop Publishing Program	249.00	286.35
<b>LASERSERVE: Infosphere</b> For Laser-Spooling to disk - per User	99.00	113.85
<b>INTERMAIL: Internet</b> Send Messages and Files on AppleTalk (5-10 Users)	349.00	401.35
<b>COMICWORKS: Macromind</b> Design Your own Comics and Storyboards	60.00	69.00
<b>GRAPHICWORKS: Mindscape</b> Low Cost Publishing on your Mac	60.00	69.00
<b>MAC PLUS CARRY CASE</b> Holds Mac Plus, Keyboard and Hard Disk	39.90	45.88
<b>IMAGEWRITER // CARRY CASE</b> Matching Carry Case for Imagewriter & Cables	36.50	41.97
<b>SONY 400K 3.5" Disks</b> Box of Ten Sony Single-Sided Disks	17.30	19.90
<b>SONY 800K 3.5" Disks</b> Box of Ten Sony Double-Sided Disks	26.00	29.90
<b>POSTAGE per Item</b>	1.74	2.00

Telephone Orders - Monday to Friday: 9.30am-6.00pm  
Credit Cards Welcome

Authorised Apple Dealer

## STIRLING MICROSYSTEMS

The Specialist Centre for Apple Macintosh Systems

231 Baker Street, London NW1 6XE

01-935 5262



## K.K. STATIONERS



187 Edgware Road  
Marble Arch  
London W2 1ET  
Tel: 01-723 1436

126 Edgware Road  
Marble Arch  
London W2 2D2  
Tel: 01-402 4592

# MIR MICRO-RENT

## MICRO-RENT DO MORE!

### MAC-PLUS



### TANDON PCX



### H-P LASERJET

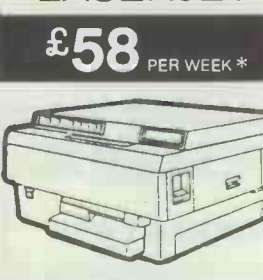

### IBM PC AT

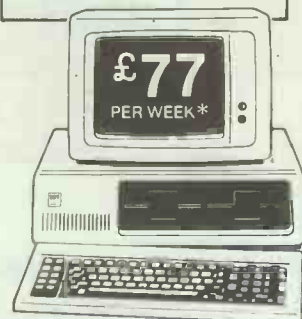

Micro-Rent do more than offer you the best rental deals on microcomputers. They rent printers, hard-disk systems, monitors - even some software!

Micro-Rent - the complete rental service - saves you time and money, and solves your problems fast.

Buying? Ex-rental machines often available at reduced prices.

AND NOW - FAX MACHINE RENTAL FROM £40 PER WEEK!  
Ring for details

01-700 4848



St. Marks Studios, Chillingworth Road, London, N7

APPLE · APRICOT · IBM PC & XT · OLIVETTI  
MACINTOSH · TANDON · SIRIUS · COMPAQ  
LASER PRINTERS · DESK-TOP PUBLISHING

\*Prices quoted are based on 3-month rental, excluding VAT.

# ATT peripherals

## CORPORATION

### SPECIALISTS IN EXPORT

#### PRINTERS

EPSON LX 800	£205	NEC P5	£799
EPSON FX 800+	£305	NEC P6	£425
EPSON EX 1000			£515
EPSON LQ 1000			£575
EPSON LQ 2500			£765
BROTHER HR20			£355
BROTHER HR25 XL			£532
BROTHER M1509			£385
BROTHER M1409			£299
BROTHER TWINWRITER			£975
FULL RANGE OF SIEMENS PRINTERS AVAILABLE			

#### MODEMS

HAYES SMART MODEM	£360
DOWTY QUATRO	£612
DOWTY MINIMO + 2	£209
DACOM DSL 2123	£172
MIRACLE WS2000	£105
PC COMMS QUATROCARD	POA
RACAL MILGO	POA
THORN DATATECH	POA
PACE SERIES IV	POA

#### MONITORS + ADD-ON BOARDS

NEC MULTISYNC	£544
SONY 10" COLOUR	£495
TAXAN EGA	£418
INTEL INBOARD 386	£1260
ORCHID JET 386	£740
AST PREMIUM/RAMPAGE	POA
HERCULES MONO	£199
HERCULES COLOUR	£105

#### DRIVES + TAPE BACK UP

SEAGATE 20Mb ST225 Inc WD Cont	£372
SEAGATE 30 Mb ST238 + Cont	£504
SEAGATE 40Mb ST251	POA
RODINE	POA
EVEREX INT 20 Mb T/S	£665
EVEREX INT 60 Mb T/S	£890
EVEREX EXT 20 Mb T/S	£746
EVEREX EXT 60Mb T/S	£970

#### MOUSE DEVICES + SOFTWARE

MS MOUSE	£142
PC MOUSE	£130
LOGIMOUSE	£76
SUMMA MOUSE	£89
MS WORD	£245
DB3+	POA
LOTUS 123	POA
SUPERCALC	POA
MULTIMATE ADV	POA
SMART	POA

#### LAP TOP COMPUTERS AND ACCESSORIES

NEC MULTISPEED	POA
KAYPRO 200	POA
DRAMS 64K	£1.50
DRAMS 256K	£5.00
DRAMS 128K	£9.00
MATHSCO-PRO 80287 - 6MHz	£175
MATHSCO-PRO 8087 - 5MHz	£105
MATHSCO-PRO 8087 - 8MHz	£140

#### SPECIAL OFFERS

PARALLEL PRINTER CABLES	£12.50
EP TONER CART	£74.95

## RING NOW: 01-739 4596

# ATT peripherals

Corporation Ltd

(T1) INDUSTRIAL UNITS STANWAY STREET LONDON N1 6RY

TEL: 01-739 4596 Telex 895 1182 GECOMS G CALLERS BY APPOINTMENT ONLY



AMERICAN  
EXPRESS



BANKAMERICARD  
VISA

# ATT Corporation Ltd

## PRICE GUARANTEE

PROVIDE A WRITTEN LOWER QUOTATION FROM AN AUTHORISED DEALER WITHIN 7 DAYS OF PURCHASE AND THE DIFFERENCE WILL BE REFUNDED!

CALLERS BY APPOINTMENT ONLY "PRICES SUBJECT TO FLUCTUATION. VAT NOT INCLUDED"

## SPECIALISTS IN EXPORT

### APPLE

MACINTOSH SE 2x800	£1875
MACINTOSH SE 1x800/20MB	£2450
Keyboard for the above	£75
MACINTOSH PLUS	£1550
IMAGEWRITER II	£365
MAC DRIVE 800K	£310
HARD DISK 20Mb	£850
APPLE LASERWRITER	£3750
LASERWRITER PLUS	£4400

### APRICOT

★ SPECIAL ★	£1950
XEN XI/512k/20Mb/1.2Mb	£2095
XEN I/1Mb RAM/20Mb/1.2Mb	£2695
XEN XD/1Mb RAM/40Mb/1.2Mb	£2350
XEN 80386/1Mb RAM/30Mb/1.2Mb	£3150
XEN 80386/2Mb RAM/45Mb/1.2Mb	£280
P/WHITE MONITOR	£140
GREEN MONITOR	£160
MONO CARD	£299
EGA CARD	£625
EGA COLOUR MONITOR	

### LASER PRINTERS

★ SPECIAL PRICES ★	£1350
EPSON 6Q LASER	£4500
T.I. OMNILASER MODEL 2015	£1650
CANON LBP SERIES II Pand Sports	£1495
HP LASER JET	£1900
HP LASER JET II P+S SPORTS	£2100
HP LASER PLUS	

products carry a 12 months Full Guarantee with HOTLINE Phone Support

### AFFORDABLE DESKTOP PUBLISHING

#### COMPUTER — KAYPRO 286i

Intel 80286 Processor  
20Mb Hard Disk  
1.2Mb Floppy Drive  
640k RAM  
Tri Mode Video Card  
Mono Monitor

#### LASER PRINTER — HEWLETT PACKARD (SERIES II)

8 Pages per minute  
300 DPI  
512k RAM to 4 Parallel or Serial Ports  
Including Cable + Toner

#### SOFTWARE

Ventura Publishing  
Microsoft Word V3

★ **£4500** ★

COLOUR SYSTEM add £200  
80386 Machine Add £2400

### FINANCE

LEASE RENTAL  
CASH  
LEASE PURCHASE  
HIRE PURCHASE  
INSTANT CREDIT (Subject to Status)

## RING NOW: 01-729 7033

# ATT Corporation Ltd

(TI) INDUSTRIAL UNITS STANWAY STREET LONDON N1 6RY

TEL: 01-729 7033

Telex: 895 1182 GECOMS G



# RSC Ltd



(0923) 243301  
(24 hours)  
(0923) 241921

**ALL PRICES EXCLUDE VAT**  
Export, Government & Educational Orders Welcome  
All enquiries & payments to  
**RSC Ltd, 75 Queens Road, Watford WD1 2QN**  
Telex: 265871 MON REF G. REF CJJ128  
Tel: (0923) 243301/241921  
**Callers Welcome**

All prices subject to change without notice—all goods subject to availability.

## ALL PRICES EXCLUDE VAT — CARRIAGE FREE

### AMSTRAD PC1512

AMSTRAD PC1512 SINGLE DRIVE MONO	£415.00
AMSTRAD PC1512 DOUBLE DRIVE MONO	£520.00
AMSTRAD PC1512 SINGLE DRIVE COLOUR	£575.00
AMSTRAD PC1512 DOUBLE DRIVE COLOUR	£675.00
AMSTRAD PC1512 20MB HD MONO	£835.00
AMSTRAD PC1512 20MB HD COLOUR	£995.00

AMSTRAD SUMMER SPECIAL OFFER PC1512 D/D MONO + DMP3000 PRINTER + WORDSTAR 1512 + SUPERCALC 3	£645.00
SUMMER SPECIAL WITH COL MONITOR	£849.00

### AMSTRAD PC1640 ECD

PC1640 ECD SINGLE DRIVE	£759.00
PC1640 ECD DOUBLE DRIVE	£849
PC1640 ECD 20MB HARD DISK	£1139.00

### RSC's OWN COMBINATION

PC1512 S/D MONO + 32MB CARD	£705.00
PC1512 S/D COLOUR + 32MB CARD	£865.00
PC1512 D/D MONO + 32MB CARD	£810.00
PC1512 D/D COLOUR + 32MB CARD	£965.00
PC1640 ECD S/D COLOUR + 32MB CARD	£1039.00
PC1640 ECD D/D COLOUR + 32MB CARD	£1129.00

### COMMUNICATIONS

AMSTRAD PACE CARD MODEM FOR PC & COM- PATIBLE (DATATALK SOFTWARE INCLUDED)	£138.00
LINNET V21/V23 (AUTO)	£129.00
MIRACLE WS4000 V21/V23	£156.00
SAGE CHIT CHAT SOFTWARE	£69.00
SAGE CHIT CHAT PACK (MODEM SOFTWARE/CABLE)	£182.00
SAGE CHIT CHAT PACK 2 (INCLUDING V22AA/AD MOD- EM)	£475.00
SAGE CHIT CHAT PACK 3 (INCLUDING V22 BIS AA/AD)	£585.00

### HARD CARDS

TANDON 10MB HARD CARD	£245.00
TANDON 20MB HARD CARD	£295.00

### SCRIBECARD 30

Breakthrough: New-tech performance at old-tech prices.  
32Mb disc  
Card — a fast card low power consumption comes format-  
ted. £300.00



### COMPUTER ADD-ONS

TAPE STREAMER-CIPHER 1525	£405.00
128K UPGRADE PC TO 640K	£19.50
MATHS CO-PROCESSOR 8087-2	£135.00
NEV30-REPLACEMENT 8086	£28.00
RSC 50-LOCKABLE DISK BOX	£10.00
RSC 100-LOCKABLE DISK BOX	£13.00

### DISKS

BOXED IN 10'S	
TDK 5.25" D/S D/D 48TPI	£12.00
TDK 5.25" D/S D/D 96TPI	£14.00
TDK 5.25" D/S D/D HIGH DENSITY	£24.00
TDK 3.5" D/S D/D	£24.00
RSC 5.25" D/S D/D 48TPI	£8.70
RSC 3.5" D/S D/D	£17.00

### DOT MATRIX PRINTERS

EPSON LX86 100CPS/20NLQ/80COL	£189.00
EPSON LX800 (NEW-LATEST)	£194
EPSON LQ800 180CPS/60NLQ/80COL	£435.00

EPSON LQ1000 180CPS/60NLQ/132COL	£570.00
EPSON EX800 300CPS/50NLQ/80COL	£384.00
EPSON EX1000 300CPS/50NLQ/136COL	£515.00
EPSON FX800 200CPS/50NLQ/80COL	£305.00
EPSON FX1000 200CPS/50NLQ/80COL	£399.00
EPSON LQ2500 270CPS/90NLQ/136COL	£724.00
EPSON SQ2500 INK JET	£985.00
CANON PW1080 AT 160CPS/27NLQ/80COL	£234.00
CANON A55 180CPS/45NLQ/132COL	£399.00
CANON A60 200CPS/100NLQ/80COL	£399.00
CANON A65 200CPS/100NLQ/132COL	£491.00
PANASONIC KX-P1081 120CPS/20NLQ/80COL	£149.00
PANASONIC P1592 180CPS/38NLQ/136COL	£343.00
AMSTRAD DMP3000 80COL	£145.00
AMSTRAD DMP4000 200CPS/50NLQ/WIDE	£285.00
MICRO-P135 135CPS/27NLQ/80COL	£147.00
MICRO-P165/35NLQ/80COL	£169.00
MICRO-P200 200CPS/40NLQ/80COL	£235.00
MICRO-P201 200CPS/40NLQ/132COL	£275.00
MICRO-P480 480CPS/74NLQ/80COL	£369.00
BROTHER TWINWRITER 5	£826.00
JUKI 3510-180CPS/45NLQ/80COL	£265.00
STAR NL10	£210.00
STAR NX15	£288.00
STAR NB24-10	£415.00
STAR NB24-15	£525.00
STAR NB15	£699.00
NEC P6	£389.00
NEC P7	£447.00

### DAISYWHEEL PRINTERS

PANASONIC KX-P3131U 17CPS	£240.00
MICRO-P26 26CPS	£225.00
MICRO-P40 40CPS	£330.00
JUKI 6100 20CPS	£257.00
JUKI 6200 30CPS	£417.00
JUKI 6300 40CPS	£675.00
JUKI 6400 60CPS	£965.00

### LASERS

EPSON Q3500 (LATEST)	£1345.00
CANON LBP-8 MARK II	£1850.00
HP LASERJET II	£1940.00
OKI LASERLINE 6	£1450.00

### PLOTTERS

ROLAND DXY 880A	£649.00
ROLAND 980A	£950.00
EPSON HI 80	£350.00

### PRINTER ACCESSORIES

PC PARALLEL PRINTER CABLE	£11.00
EPSON LX86 TRACTOR FEED	£20.00
EPSON LX86 SHEET FEEDER	£55.00
EPSON LQ800 TRACTOR FEED	£39.00
EPSON LQ1000 TRACTOR FEED	£50.00
EPSON SQ2500 TRACTOR FEED	£72.00
EPSON EX800 5/BIN SHEET FEEDER	£135.00
EPSON EX1000/LQ2500 5/BIN S/F	£182.00
EPSON FX800/LQ800 5/BIN S/F	£135.00
EPSON FX1000/LQ1000 5/BIN S/F	£154.00
EPSON SQ2500 D/BIN S/F	£299.00
JUKI 6100 TRACTOR FEEDER	£130.00
JUKI 6100 5/BIN S/F	£240.00
STAR NL10/NB24-10 SHEET FEEDER	£50.00
STAR NX15 SHEET FEEDER	£130.00
STAR NB24-15 SHEET FEEDER	£179.00

### COLOUR PRINTERS

JUKI 5520 COLOUR PRINTER	£335.00
EPSON EX-COLOUR UPGRADE	£54.00
EPSON LQ2500 COLOUR UPGRADE	£54.00

### PC & COMPATIBLE SOFTWARE

LOTUS 123 VER 2.1	£260.00
LOTUS SYMPHONY	£347.00
dBASE III PLUS	£399.00
SUPERCALC 4	£213.00
WORDSTAR PROFESSIONAL FRAMEWORK II	£POA
JAVELIN	£347.00
JAVELIN	£395.00
SMART INTEGR. SYSTEM	£395.00
WORDSTAR PROFESSIONAL 4	£275.00

### PROGRAM DEVELOPMENTS

TURBO PASCAL	£55.00
TURBO TUTOR	£25.00
TURBO EDITOR TOOLBOX	£41.00
TURBO GRAPHICS TOOLBOX	£41.00
TURBO PROLOG	£55.00
TURBO BASIC	£55.00
TURBO LIGHTNING	£55.00
TURBO WORD WIZARD	£41.00
RELLOX (THE ANALYST)	£78
SIDEKICK (BARLAND)	£55.00
TRAVELLING SIDEKICK	£55.00
QUICK BASIC COMPILER (MICROSOFT)	£69.00
LEARNING DOS (MICROSOFT)	£26.00
MS-DOS USERS GUIDE	NO VAT £60.00
MS-DOS PROG REF	NO VAT £80.00
ZORLAND C—VERSION 2	£26.00
ZORLAND POWERPACK	£52.00
ZORLAND LINKER	£18.00
TURBO C	£63.00
TURBO EUREKA	£55.00

### INTEGRATED

ABLE ONE	£67.00
ABILITY	£67.00
ABILITY PLUS	£120.00
PSION-FOUR	£54.00
LOGISTIX	£67.00
ABC (NEWIN)	£120.00
FIRST CHOICE	£130.00
FIRST FRAMEWORK	£69.00

### ACCOUNTS

SAGE BOOKKEEPER	£72.00
SAGE ACCOUNTANT	£110.00
SAGE ACCOUNTANT PLUS	£150.00
SAGE PAYROLL	£70.00
SAGE FIN CONTROLLER	£240.00
DAC-EASY ACCOUNTING	£60.00
ABILITY ACCOUNTS	£79.00

### DATABASES

SAGE RETRIEVE	£72.00
TAS +	£60.00
VP INFO	£67.00
PC PROMISE	£45.00
CAXTON (CARDBOX)	£38.00

### WORD PROCESSING

SAGE PC WRITE	£69.00
WORDSTAR 1512 (AMSTRAD)	£46.00
WORD PERFECT JUNIOR	£73.00
WORD PERFECT PERSONAL	£155.00
VOLKSWRITER3	£160.00
GEM 1ST WORD	£55.00

### SPREADSHEETS

SUPERCALC3 (AMSTRAD)	£46.00
MULTIPLAN JUNIOR	£30.00
VP PLANNER	£67.00
WORDS AND FIGURES	£73.00
MICROSOFT MULTIPLAN	£130.00
SAGE PC PLANNER	£72.00

### DESKTOP PUBLISHING

FLEET STREET EDITOR	£79.00
PRINTSHOP	£26.00
FONTOSY	£59.00
VENTURA	£595.00
AUTO SKETCH	£59.00
TURBO CAD	£75.00

### GENERAL & GRAPHICS

GEM DRAW	£69.00
GEM GRAPH	£69.00
DELTA GRAPH	£52.00
GEM WORD CHART	£69.00
GEM FONT EDITOR	£73.00
FLYING START	£52.00
PROTEXT	£82.00
MICROSOFT WINDOWS	£59.00
VP EXPERT	£67.00

**FULL ON-SITE MAINTENANCE CONTRACTS AVAILABLE**  
**NEXT DAY DELIVERY FOR MOST HARDWARE**  
**ALL PRICES INCLUDE FULL 12 MONTHS WARRANTY**

# COMPUMART

WATFORD (0923) 55633

(25 lines)



Our prices are so consistently competitive that we've already undercut them by the time they appear in print – so why quote them at all? 'Phone us direct and we'll give you the best prices on the day.

We guarantee:-

- ★ The most competitive prices anywhere in the industry.
- ★ All makes of Hardware & Software – 100% Manufacturers Own.
- ★ Full PDI on all stock and rapid delivery.
- ★ Huge stocks – No delays, no quibbles.
- ★ 24-Hour Answering Service.
- ★ **A Number One service from the Number One company.**

## SPECIAL OFFERS

### olivetti

Fantastic prices on BRAND NEW OLIVETTI systems with full manufacturers warranty. These are guaranteed 100% genuine Olivetti units with no hidden third-party components and the price we quote includes keyboard, monitor and DOS.

#### M24

**£1405.20**

(640k RAM 360k+  
20Mb Disk)

#### M24SP

**£1502.40**

(640k RAM 360k+  
20Mb Disk)

#### M28

**£2040.60**

(512k RAM 1.2Mb  
20Mb Disk Bs.Con.)

We hold vast stocks on all the following:-

#### COMPUTERS

IBM  
Olivetti  
Compaq  
Toshiba

#### PRINTERS

NEC  
Epson  
Toshiba  
HP

#### SOFTWARE

Database  
Spreadsheet  
Word Processing  
Graphics

Modems, Tape Backup, Monitors, Harcards & Consumables

Your needs guaranteed just a 'phone call away!



**Please ring for an immediate response and today's prices**

Prices exclude VAT & Delivery. All orders are subject to C.W.O.

# THE MOST INCREDIBLE PRICES ON EPSON and TOSHIBA PRINTERS EVER!

In fact, find a genuine, nationally advertised, lower price published before the 16th August; and we will give you a printer **FREE**.

## EPSON LX86 £155



- ▶ Draft 120 cps
- ▶ NLQ 16cps
- ▶ Cut Sheet Feeder Option (for only another £35)
- ▶ Tractor Feed Option

The LX86 is an 80 column compact printer that is exceptionally easy to use. Just press the buttons on the front to switch between NLQ and draft modes, or to change the font or character size. Or attach the EPSON cut sheet feeder that holds up to 75 pages and sit down with your favourite WP package to print page after page of text with a quality that you will be proud of.

### Options Available:

- ▶ Epson Cut Sheet Feeder ..... £35 (fits the LX80 or the LX86)
- ▶ Epson Tractor Feed ..... £15
- ▶ Parallel Cable ..... £12.50

## TOSHIBA P321 £345



- ▶ 24 Pins giving Superb Quality
- ▶ Draft 216cps
- ▶ NLQ 72cps
- ▶ Cut Sheet and Tractor Options

The P321 is an 80 column printer, fully IBM Printer Compatible that delivers superb letter quality text. The reason? Unique 24 pin design with fine 8-mil pins that create tiny, precisely placed, overlapping dots for a quality difference that you will see immediately.

### Options Available:

- ▶ Tractor Feed ..... £69
- ▶ Cut Sheet Feeder ..... £145
- ▶ Second Bin for Cut Sheet Feeder ..... £85
- ▶ Qume Emulation ..... £18
- ▶ Serial Interface Kit ..... £25
- ▶ Downloadable Type Font Kit ..... £45
- ▶ Parallel Cable ..... £12.50

There's a good deal going on at  
**Surplus Computer Sales Ltd**  
 20A Horseshoe Park, Pangbourne, Berks  
**07357-5455**

Export orders welcome

Prices exclude only  
VAT and Delivery

Maintenance Available

Telephone Orders Welcome

Next day delivery  
on all orders

Demonstration Facilities

30 day Money Back Guarantee. 12 month Warranty on all printers

# OPTIMUM TECHNOLOGY

## MORE THAN JUST LOWER PRICES

LISTED BELOW IS JUST A SELECTION FROM OUR WIDE RANGE OF PRODUCTS — AVAILABLE IN A WIDE RANGE OF FORMATS — PLEASE CONTACT US WITH YOUR REQUIREMENTS

# SEPTEMBER'S OPTIMUM CHOICE



## OPTIMUM

*Our Sales Desk has moved*  
— see details below

### WORD PROCESSORS

Lotus Manuscript	£259
Multimate Adv. II (NEW!)	POA
Volkswriter Deluxe	£39
Word 3.1 - Microsoft	£239
Wordcraft V3	£345
Word Perfect 4.2	£245
Word Perfect Library V1.1	£124
Wordstar Prof. V4 (NEW!)	£199
Wordstar 2000 PLUS Rel 2	£269

### DATABASES

Cardbox Plus V3.5	£245
Delta Professional	£345
dBase-III Plus V1.1 (unprot.)	£339
Clipper (new version)	£349
Foxbase Plus	£369
Geniffer app. gen.	£229
Quicksilver Compiler	£369
Paradox V2.0 (NEW!)	£369
Q & A V2 (inc. spell. chk.)	£199
Rbase-5000	£245
Rbase SYSTEM-V	£445
Rapid File (Ashton Tate)	£229

### SPREADSHEETS

Logistix V1.18 - new low price!	£95
Lotus 1-2-3 V2.01	£227
Lotus HAL/Metro	£98/£65
Lotus Report Writer	£69
MATHPLAN-3	£295
Multiplan V3.02 (NEW!)	£139
Supercalc-4 V1.1	£219

### INTEGRATED PACKAGES

ABC	£139
Ability/Ability Plus	£79/£154
Account-Ability	£96
PFS: First Choice inc. Spell Chk	£119
Framework-2 V1.1 (unprot)	£325
Smart-3.1	POA
Smart Spell Checker	£89
Symphony V1.2	£329
Pision Xchange	£235
Pision PC-Four	£65

### SPARK LAPTOP

Hi-Value IBM Compatible Portable from Datavue

*SPARK options include single or dual 720K 3.5" disc drives, 384K or 640K Memory, LCD or EL-Backlit LCD Display.*

SPK-3841 1 x 720K/384K/LCD	£747
SPK-3842 2 x 720K/384K/LCD	£896
SPK-6401 1 x 720K/640K/LCD	£843
SPK-6402 2 x 720K/640K/LCD	£994
SPK-3841EL 1 x 720K/384K/EL-LCD	£843
SPK-3842EL 2 x 720K/384K/EL-LCD	£994
SPK-6401EL 1 x 720K/640K/EL-LCD	£937
SPK-6402EL 2 x 720K/640K/EL-LCD	£1088

**Options:**  
5 1/4" external disc drive £168  
Rechargeable Standard Battery £35  
Rechargeable Hi-Capacity Battery £57  
Carry Case £39

NOTE:  
Please add £10 carriage & VAT for above.

### MISCELLANEOUS CAD/Graphics/Utils/Lang. etc

'Above-Disk' (NEW!)	£95
Autosketch (Autodesk)	£75
COPY II PC	£47
Gem Collection	£89
GEM Draw Plus — (NEW!)	£163
GEM Graph	£145
Hard Disc Optimiser	£39
Harvard Pres. Graphics	£275
Intelligent Backup V2.1 (NEW!)	£79
Living C Plus	£149
LOTUS FREELANCE PLUS	£269
MS C Compiler V4	£249
MS Flight Simulator V2.13 with Free MS CO-Pilot Book	£43
MS Macro-Assembler V4	£115
MS Project	£225
MS QUICKBASIC V3 (NEW!)	£69
MS WINDOWS	£69
The Newsroom	£49
Norton Utilities V4 (NEW!)	£69
Norton Advanced Utils (NEW!)	£99
Norton Commander	£55
Norton Editor	£87
ProDesign-2 V2.5	£238
Sideways V3.1	£43
SOZI/Lotus Compressor V1.53	£55
WordPerfect Library V1.1	£124
Xtree V2	£47

### DTP

Aldus Pagemaker V1.0A	£575
Gem Desktop Publisher	£295
Harvard Prof. Publisher	£485
Ventura Publisher V1.1	£695

### BORLAND

EUREKA: The Solver	£65
REFLEX-UK (NEW)	POA
Reflex Workshop	£59
Sidekick (unprotected)	£59
Travelling Sidekick	£59
Sidekick & T/Sidekick	£79
Superkey	£59
Turbo Basic (NEW!)	£65
Turbo C (NEW!)	£79
Turbo Prolog V1.1	£54
Prolog Toolbox (NEW!)	£59
TURBO PASCAL V3 (inc. 8087)	£57
Turbo Database Toolbox	£44
Turbo Editor Toolbox	£42
Turbo Gameworks	£42
Turbo Graphics Toolbox	£39
Turbo Numerical Toolbox	£67
Turbo Tutor V2	£28
Turbo Holiday Jumbo Pk	£175
Turbo Lightning	£59
Word Wizard	£42

### COMMUNICATIONS

Our Free communications consultancy means that you can simply telephone or write for free datapaks and/or advice on modems and software.

**Modems:** All modems are Auto-Dial/Auto-Answer and BABT approved. Baud rates are V21=300/300 V23=1200/75 V22=1200/1200 V22bis=2400/2400.

We also supply modems from Dowty/Racal/Tandata/Stebeck/Dacom/PC at best prices.

IBM PC Modem Cables	£15
Modem Cables for other computers	£23

DACOM SYSTEMS (internal cards - all include DataTalk software)	
Unity V21/23	£299
Unity Gold V21/V22/V23	£389
Unity Quad V22bis/V22/V21/V23	£589

MIRACLE TECHNOLOGY	
WS SERIES — EXTERNAL	
WS4000 V21/V23 (Economy)	£149
WS3000 V21/V23 Professional Series	£259
WS3000 V22 (& V21/V23)	£395
WS3000 V22BIS (& V22/V21/V23)	£545
DataTalk with WS Modems	£80

PACE SERIES-4/LINNET — EXTERNAL	
Pace Linnet V21/V23 (Economy)	£139
Series-4 2123S (V21/V23)	£229
Series-4 1200S (V22/V21/V23)	£359
Series-4 2400S (V22bis/V22/V21/V23)	£449

HAYES 1200 V22	£395
HAYES 1200B V22 Internal	£375
HAYES 2400 V22bis	£595
MICROTELEX (inc software)	£795
ORATOR — Modem & Speech	£695
TD400 Teletext Card (NEW!)	£269

<b>Comms Software:</b>	
Carbon Copy Plus (each)	£137
Crosstalk-4 (NEW!)	£149
Crosstalk XVI	£99
DataTalk	£133
Sage Chit-Chat	£85
Smartcom-2	£135
Vicom with GEM Desktop	£139

### SAGE

<b>All Sage products available at best pricing</b>	
Financial Controller	£225
Bookkeeper	£84
Accountant	£118
Accountant Plus	£159
Payroll	£82
Retrieve	£82
Chit-Chat	£85

### HARDWARE

Hercules Graphics Cards	CALL
Logimouse C7+ (PC or AT)	£94
Logimouse - Bus (NEW!)	£109
MS Mouse V6 (Bus or Serial)	£135
Orchid Tiny-Turbo 286	£385
SummaMouse (Opto)	£95
EGA Wonder Card (NEW!)	£249

- FREE SHORTFORM CATALOGUE —
- FREE DATAPAKS
- SPARK — The Laptop!  
Finally the IBM compatible Laptop 'price barrier' has been broken! Optimum are delighted to announce the Spark quality laptop from Datavue — prices starting at only £747 for the basic single drive LCD model, up to the top model with a backlit display at only £1088. (Eat your heart out — Toshiba!) — ideal for home/business/travel use (weighs only 9lbs!), includes 4.77/9.54Mhz hi-speed processor, a superb hi-contrast anti-glare 'Supertwist' LCD display with backlit EL option (that needs to be seen to be believed!), 80 character x 25 lines/640 x 200 bit mapped graphics, single or dual 720K 3.5" drives, removable battery pack, wide range of output ports include RGB/Composite, RS232, Parallel Printer, Internal Modem port, Ext Disc Drive etc.
- FREE 'OPTIMUM SPREAD' GAME WITH EACH ORDER (excluding Flight Simulator — disc is 5 1/4" — IBM Format — While stocks last.)

# YES!

PLEASE RUSH ME

The following good(s):

---



---



---

A FREE Datapak on:

---



---



---

A FREE shortform Catalogue.

I enclose £ .....  
(I have added carriage, then VAT)  
CARRIAGE: Most software/hardware items add £5 + vat.  
dBase/Smart/Spark/Modems/Express Delivery add £10 + VAT.  
EXPORT: Please phone/write with details or estimate the amount and we will refund any extra.

Name

Address

Phone No.

## OPTIMUM TECHNOLOGY LTD

Rowlandson House, 289-293 Ballards Lane, Finchley,  
London N12 8NP

Sales Desk: 01-446 2223

Telex: 923729 (Roland G) Fax: 01-446 1963 Telecom Gold: 72:MAG 10834

PLEASE ADD CARRIAGE, THEN VAT TO ALL PRICES

The above is a sample of the goods we supply — please ask for latest shortform catalogue.  
We welcome official Govt./Educational/Local Authority and Export orders.  
Pro-Forma invoices available on request. Ask for further quantity discounts. Above software is in IBM 5 1/4" format — please enquire for other formats. Prices/specifications subject to change without notice. Please phone to arrange demonstrations or to collect goods.



- ▲ UNBEATABLE PRICES
- ▲ FRIENDLY SERVICE
- ▲ HOT LINE SUPPORT
- ▲ PROFESSIONAL ADVICE

**PEGASUS ACCOUNTS**  
£155 per module

**SOFTWARE    ▲    BOARDS    ▲    PRINTERS    ▲    SYSTEMS**

<b>LOTUS 1-2-3</b> £239	<b>dBASE 3 +</b> £349	<b>MULTIMATE ADVANTAGE</b> £265	<b>WORDSTAR PROFESS. 4.0</b> £215	<b>FRAMEWORK</b> £299	<b>SUPERCALC 4</b> £215	<b>SUPER-PROJECT +</b> £295
----------------------------	--------------------------	------------------------------------	--------------------------------------	--------------------------	----------------------------	--------------------------------

**SOFTWARE**

**WORDPROCESSING**

Multimate	199
Multimate Advantage	265
MS Word 3.1	260
Wordperfect	260
Wordstar Professional 4.0	215
Wordstar 2000	245
Wordstar 2000+	295
Manuscript	275
Displaywrite 3	345
Displaywrite 4	395

**DATA BASES**

dBase III +	349
DataEase	POA
RBase System	395
Paradox	395
Delta 4.3	345
Foxbase +	345
Clipper	395
Quicksilver	375

**FINANCIAL MODELLING**

Lotus 1-2-3 V. 2.01	239
Supercalc 4 1.	215
Supercalc 3.21	99
Javelin	380
Report Manager	POA
Multiplan 3	145

**INTEGRATED**

Framework	299
Symphony	339
Smart	385
Q & A	195

**GRAPHICS**

Freelance Plus	275
EGA Paint	89
PC Paintbrush	99
Domino	395

**PROGRAMMING**

Microsoft C 4.0	265
Lattice C	275
MS Quickbasic	79
MS Fortran	245
RM Fortran	395
MS Pascal	195

**COMMUNICATIONS**

Chit Chat	79
-----------	----

**UTILITIES**

Norton Utilities	67
Mace +	59
Sideways	47
DS Backup +	89
Fastback	145
XTree	49

**GEM PRODUCTS**

Gem Collection	99
Gem Draw Plus	135
Gem Graph	135
Gem Wordchart	99
Programmers Toolkit	345

**WINDOWS**

MS Windows	69
Windows Draw	115

**BORLAND PRODUCTS**

Turbo Pascal	55
Turbo Tutor	28
Graphics Toolbox	45
Editor Toolbox	45
Database Toolbox	45
Gameworks	45
Jumbo Pack (includes all above)	165
Turbo Basic	55
Turbo C	79
Turbo Prolog	65
Turbo Lightning	65
Sidekick	55
Superkey	55
Reflex	79
Eureka	55
Word Wizard	49

**HARDWARE**

**MATHS CO-PROCESSORS**

8087 - 5MHz	125
8087 - 8MHz	165
8087 - 10MHz	245
80287 - 6MHz	185
80287 - 8MHz	245
80287 - 10MHz	295

**GRAPHICS CARDS**

Hercules Mono Graphics +	179
Hercules Incolour	295
Paradise Autoswitch EGA 480	295

Vega Deluxe	275
Genoa Level 3	275
Genoa Level 4	325
EGA Wonder	295

**MONITORS (EGA+)**

Taxan Supervision 760 14"	495
Taxan Supervision 860 16"	795
Taxan Multisynch 770 14"	595
NEC Multisynch 14"	595
Taxan Viking I 1280x960 19"	POA
Genius DTP, 1008x736 A4 size	1495

**EXPANDED MEMORY**

Intel Above Board PC 2.0Mb	495
Intel Above Board AT 2.0Mb	645
Intel Above Board PS 1.5Mb	495
AST Rampage PC 2.0Mb	495
AST Rampage AT 2.0Mb	695
AST Six Pak Premium 1Mb	495

**TURBO BOARDS**

Orchid Tiny Turbo 286	395
Orchid Jet 386	795
Intel Inboard 386	1495

**MICE**

Microsoft Mouse	145
Mouse Systems PC Mouse	145
Summamous	89
Logimouse	89

**LASER PRINTERS**

Kyocera F1010	2495
Kyocera F2010	3795
HP Laserjet	1495
HP Laserjet +	2195

**TAPE STREAMERS**

Tecmar Qic-60 Internal	995
Tecmar Qic-60 External	1295
AST 40MB Internal AT	495

**ROLAND PLOTTERS**

DXY 880A A3	675
DXY 980 A3	935
DXY 885 A3	935
DXY 990 A3	1095
DPX 2000 A2	2545
DPX 3300 A1	4095

**MODEMS**

Entire HAYES range  
Entire DOWTY range  
Prices on application

ALL PRICES SUBJECT TO VAT AND CARRIAGE

NEC MULTISYNCH +  
VEGA DELUXE  
£795

TAXAN MULTISCAN 770  
+ PARADISE 480  
£795

HERC MONO GRAPHICS +  
£179

NEC PRINTERS  
P.O.A.



**TRISOFT LIMITED**  
DARLEY DALE  
MATLOCK  
DERBYSHIRE  
DE4 3BP

**TEL: 0629 733111**  
**TELEX: 377233 TRISOF G**  
**FAX: 0629 733389**  
**TELECOM GOLD**  
**83: NTG344**





# COMPUTER PRECISION

## TOSHIBA LAPTOP COMPUTERS

**T3100/20:** 80286 8MHz, 640K RAM 20MB Hard Disk, 720k Floppy Plasma Display, Ser/Par, 15lbs

**T1200:** 8086 9.54 MHz, 1Mb RAM 20Mb hard disk, 720k floppy Supertwist LCD, Ser/Par 7 hour battery, 11lbs

**T1100 PLUS:** 8086 8MHz, 640K RAM 2 x 720K Floppy, Supertwist LCD Ser/Par, 8 Hour Battery 10 lbs

**T1000:** 8088 4.77 512k RAM 720k floppy, Supertwist LCD, Ser/Par 5 hour battery, 6.4lbs

Please Call for Latest Prices

## NEC COMPUTER SYSTEMS

**MULTISPEED:** NEC V30 9.54MHz .... £1,295  
640K RAM, 2 x 720K Floppy Supertwist Display, Ser/Par 6-hour Battery, 11lbs

**APC IV40:** 80286 8MHz, 40MB HD . £2,495  
1.2MB Floppy, 640K RAM, Ser/Par MultiSync Monitor & EGA Adaptor Enhanced Keyboard, MS Dos

**APC IV20:** 80286, 8MHz, 20MB HD . £2,250  
1.2MB Floppy, 640K RAM, Ser/Par MultiSync Monitor & EGA Adaptor Enhanced Keyboard, MS Dos

## TANDON COMPUTER SYSTEMS

**PCA70:** 70MB HD, 1.2MB Floppy ..... £2,250  
512K RAM, 14" Mono Monitor Ser/Par, MS Dos, GW-Basic

**PCA40:** 40MB HD, 1.2MB Floppy ..... £1,795  
512K RAM, 14" Mono Monitor Ser/Par, MS Dos, GW-Basic

**PCA30:** 30MB HD 1.2MB Floppy ..... £1,575  
512K RAM, 14" Mono Monitor Ser/Par, MS Dos, GW-Basic

**PCA20:** 20MB HD, 1.2MB Floppy ..... £1350  
512K RAM, 14" Mono Monitor Ser/Par, MS Dos, GW-Basic

## ENHANCED GRAPHICS

NEC MultiSync Monitor EGA, PGA .... £550  
Princeton HX12e EGA Monitor ..... £395  
Taxan EGA Monitor ..... £425  
Taxan MultiScan Monitor EGA, PGA .. £595  
AST 3G Plus EGA Card ..... £245  
Orchid EGA Card ..... £225  
VEGA Deluxe Auto EGA ..... £249  
ATI EGA Wonder Card ..... £249  
TVM EGA Monitor & Adaptor ..... £499

## MOUSE DEVICES

Microsoft Mouse v6 ..... £135  
Mouse Systems PC Mouse ..... £135  
LogiMouse C7 ..... £76  
SummaMouse ..... £89

## MATHS CO-PROCESSORS

8087 5MHz ..... £125  
8087 8MHz ..... £155  
80287 6MHz ..... £175  
80287 8MHz ..... £225  
80287 10MHz ..... £295

## MEMORY BOARDS

AST Rampage XT 2MB ..... £395  
AST Rampage AT 2MB ..... £595  
AST 6 Pack Plus 384K ..... £249  
AST Six Pack Premium 1MB ..... £395  
Intel Above Board XT 2MB ..... £495  
Intel Above Board AT 2MB ..... £625

## TAPE STREAMERS

Alloy APT40 Internal ..... £475  
Archive 60MB External ..... £595  
Everex Stream 20 Internal ..... £675  
Everex Stream 60 Internal ..... £975

## DOT MATRIX PRINTERS

Epson LQ2500 270cps, 90nlq ..... £730  
Epson LQ1000 180cps, 60nlq ..... £585  
Epson LQ800 180cps, 60nlq ..... £435  
Epson EX1000 250cps, 50nlq ..... £525  
Epson EX800 250cps, 50nlq ..... £390  
Epson FX1000 200cps, 40nlq ..... £385  
Epson FX800 200cps, 40nlq ..... £305  
Epson LX800 150cps, 25nlq ..... £199

## DAISY WHEEL PRINTERS

NEC Spinwriter Elf ..... £310  
Brother HR20 ..... £340  
Brother HR40 ..... £750

## LASER PRINTERS

HP LaserJet II, 8ppm ..... £1,995  
HP LaserJet, 8ppm ..... £1,495  
Epson GQ-3500 6ppm ..... £1,350  
Oki Laserline 6, 6ppm ..... £1,500  
Citizen Overture 110, 10ppm ..... £1,595  
AST Turbo Laser 8ppm 1.5MB Ram . £3,295

## COMMUNICATIONS

WS4000 V21, 23 AA AD ..... £145  
WS4000 V21, 22, 23 AA AD ..... £339  
WS3000 V21, 22, 23 AA AD ..... £399  
WS3000 V21, 22, 23, 22BIS AA AD .. £520  
Keycard 3000 V21, 23 ..... £290  
Keycard 3000 V21, 22, 23 ..... £465  
Keycard 3000 V21, 22, 23, 22BIS ..... £595  
Linnnet V21, 23 AA AD ..... £129  
Pace V21, 22, 23 AA AD ..... £320  
Pace V21, 22, 23 22BIS AA AD ..... £399  
Quattro V21, 22, 23 22BIS ..... £635  
Orator ..... £715  
Procomm 20 Telex on a Card ..... £695

## SOFTWARE

dBase 3 Plus vl.1 ..... £350  
Framework II ..... £335  
FreeLance Plus ..... £285  
Lotus 1-2-3r2.01 ..... £239  
MS Flight Simulator ..... £45  
MS Multiplan 3 ..... £125  
MS Word 3.1 ..... £260  
Norton Utilities v4 ..... £59  
Advanced Norton Utilities ..... £99  
SuperCalc 4 ..... £225  
Ventura Publisher ..... £595  
VP Info ..... £65  
VP Planner ..... £65  
Word Perfect 4.2 ..... £260  
Wordstar Professional v4 ..... £235  
Ability Plus ..... £135

## BORLAND SOFTWARE

Turbo C ..... £59  
Turbo Basic ..... £55  
Turbo Pascal 8087/BCD ..... £49  
Turbo Tutor ..... £25  
Turbo Database Toolbox ..... £35  
Turbo Editor Toolbox ..... £35  
Turbo Graphics Toolbox ..... £35  
Turbo Gameswork ..... £35  
Turbo JUMBO Pack ..... £159  
Turbo Numeric Methods Toolbox ..... £55  
Turbo PROLOG ..... £49  
Turbo Prolog Toolbox ..... £55  
Eureka the Solver ..... £55  
Reflex ..... £70  
Reflex Workshop ..... £49  
SuperKey ..... £49  
SideKick (unprotected) ..... £49  
Travelling Sidekick ..... £49  
Turbo Lightning ..... £49  
Lightning Word wizard ..... £40

Toshiba 3 1/2" format available.

Official orders are accepted from GOVERNMENT & EDUCATIONAL AUTHORITIES & PLCs  
Prices exclude VAT. EXPORT enquiries welcome

AUTHORISED **TOSHIBA NEC Tandon** DEALER

Comprehensive service includes: Consultancy, Demonstrations & Hotline support

 **01-226 3043** 

TELEX 268048 EXT LDN ATTN COMPRE FAX 01-226 7948  
271 UPPR STREET, ISLINGTON, LONDON N1 2UQ

### Paragon Provides More...

Mitac's small-footprint Paragon family provides you with a complete line of elegant office solutions. What's more, Mitac adds proven reliability backed by our years of OEM manufacturing experience.

#### ...386 Superpower

Paragon 386 brings new speed and power to the world of small-footprint microcomputers.

#### ...On-board Graphics

Paragon's 286's and 8088 provide on-board graphics for vivid color and high resolution on virtually any PC monitor.

#### ...Flexibility

A host of other on-board features get your system up and running right away, leaving five expansion-slots free. Storage options include 5-1/4" and 3-1/2" high-capacity disk drives.

#### ...Reliability

Mitac insures the quality of every Paragon microcomputer by subjecting it to the same 5-phase test performed for our largest OEM's — and we quietly manufacture for some very large firms.

#### ...Support

Mitac's international branch offices serve your local needs. Currently Mitac is seeking new distributors in many parts of the world. Contact our nearest branch office

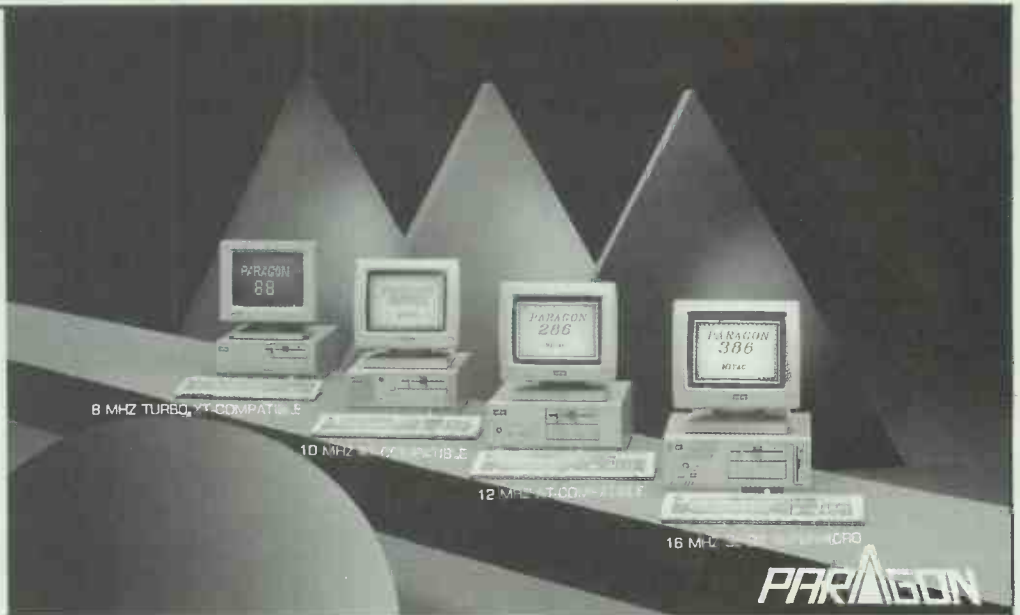

# PETITE... PRODUCTIVE... PERFECT... PARAGON

small-footprint personal computers

BRANCH OFFICES — □ North America ■ Distributors/Dealers — American Mitac Corp. (90C) 321-8443 ■ OEM/private label — Mitac Research Corp. (408) 988-0258 □ Europe ■ Mitac GmbH (W.G.) — 0211-41-2086 □ Japan ■ Mitac Japan Corp — 03-586-1631 □ Other ■ Mitac International Corp. Taipei — 886-2-501-5231  
 Distributors: □ Asia Pacific ■ Australia — Techno-lic Pty Ltd (03)6909055 ■ New Zealand Auckland — Pacific Computers (09)577246 ■ Singapore & W. Malaysia — Ace Computer Pte Ltd. 2741144 ■ Comprehensive Computer System Sdn. Bhd. (03)1997462 ■ Indonesia Jakarta — P.T. Multipolar Corp. 5782080 ■ Thailand Bangkok — Computer Management Limited 253-0614-9 ■ Philippines Manila — Integrated Computer Systems, Inc. 722-4111 to 18 ■ Hong Kong — Indoprim Ltd. 5474112 ■ East Malaysia — Capital Associates (S) Sdn. Bhd. 420234-5 ■ Pakistan Karachi — Selling Business Systems 526075 □ Europe/Middle East/Africa ■ Italy — Dylag Italia Srl. 011-650-3933 ■ Lebanon — Advanced Computer Systems and Electronics 354587 ■ Oman — Arabian Trading Establishment 703048 ■ South Africa — Micromax (PTY) Ltd. 864-2150x 235 □ Spain — ELSI 52-338 308 ■ Sweden — Betona Data AB 08-820280 ■ Switzerland — Rotronic AG 01-492-3211 ■ United Kingdom — Instagraphics Ltd. 0532-589893 ■ Structures and Computers 01-678-5115 ■ West Germany — Hetrion Computertechnik GmbH 089-858060 ■ Compuconic Computersystems GmbH 02422-1017 □ Central/South America ■ Argentina — Halcomp S.A. 54-135-1873 ■ Chile — Equipos Y Servicios Sincelar Ltda 56-2-251-6343 ■ Mexico — Digma Victor, S.A. 52-5-514-1042 ■ Panama — Catim, S.A. 507-27-5553 ■ Peru — Cosapi Data, S.A. 51-14-710137

**mitac**

When reliability is a decisive factor

# SEX

NOW THAT WE'VE GOT YOUR ATTENTION LOOK WHAT'S FALLEN OFF OUR LORRY

Bulk Diskettes Prices each	50	100	250	500	1000
3 1/2" Sony Single sided	97p	87p	77p	72p	67p
3 1/2" JVC Double Sided	£1.07	97p	87p	82p	77p
5 1/4" DSD 48/96tpi	39p	35p	32p	28p	25p

Branded Diskettes Price Each	50	100	250	500	1000
3M 5 1/4" SSDD 48tpi 7440.0	89p	84p	77p	71p	64p
3M 5 1/4" DSD 48tpi 745.0	£1.07	94p	89p	82p	78p
3M 5 1/4" high density	£1.99	£1.87	£1.77	£1.71	£1.65
Sony 3 1/2" Single Sided	£1.40	£1.30	£1.20	£1.10	£1.10
Sony 3 1/2" Double Sided	£1.85	£1.70	£1.55	£1.45	£1.35

3M Branded Data Cartridges	5	10	20	50	100
DC300XLP	£17.64	£16.64	£15.64	£14.64	£13.64
DC600A	£18.75	£17.75	£16.75	£15.75	£14.75
DC2000	£19.95	£18.25	£17.00	£16.00	£14.50

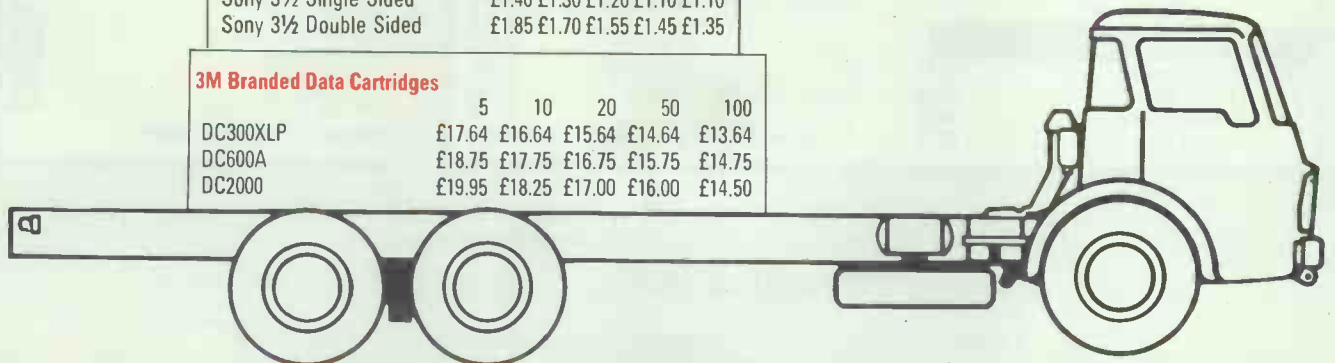

**A1 COMPUTER SUPPLIES LTD, 58 LONDON RD, LEICESTER LE2 0QD  
 TEL: 0533 550015**

Please add 15% VAT to all items. Carriage Free in UK

**GET YOUR ORDER IN NOW, BEFORE SCOTLAND YARD DOES**



NOW AT  
Queens House, 2 Holly Road,  
Twickenham, Middlesex TW1 4EG

**OLIVETTI M19**  
256k, 20Mb HD, Monitor, Kbd, DOS £895

**01-891 6433**

All orders subject to carriage and VAT at 15%

## SYSTEMS SPECIALS

### FREE PRINTER and CHOICE OF SOFTWARE!\*

with all TANDON PCA SYSTEMS.  
Includes FREE EPSON FX800 (220cps)  
and ANY SOFTWARE PACKAGE WITH  
RSP UP TO £400

\* As specified

TANDON PCA20 1Mb, RAM, 20Mb HD, Mono Screen, Graphics, P/S Ports, Keyboard Dos 3.1	£1899
TANDON PCA30, 1MB, 30Mb HD	£2099
TANDON PCA40, 1MB, 40Mb HD	£2399
TANDON PCA70, 1MB, 70Mb HD MONO SYSTEMS	£2999
For colour systems	add £220
For EGA systems	add £495

### We are NET- WORKING SPECIALISTS

Full consultation, Installation,  
Software and System Support,  
Hotline and Maintenance Contracts  
on **NOVELL NETWORK, G-NET,  
TOKEN RING, ARCNET,  
ETHERNET.**

Call for consultation.

### FREE LASER PRINTER AND CHOICE OF SOFTWARE!\*

with all COMPAQ DESKPRO 386  
SYSTEMS. Includes FREE HEWLETT-  
PACKARD 2686AU LASER-JET  
PRINTER, 8 PAGES/MINUTE, and  
ANY SOFTWARE PACKAGE WITH  
RSP UP TO £400.

\* As specified

COMPAQ 386 M40 (16MHz), 1Mb RAM 40Mb HD, Mono Screen, Kbd, P/S Ports, DOS 3.2	£5875
COMPAQ 386 M70 1Mb, 70Mb HD	£6475
COMPAQ 386 M130 1Mb, 130Mb HD	£7969
For colour systems	add £220
For EGA systems	add £395

### SOFTWARE TOP 10

LOTUS 1-2-3 .....	£235
WORDSTAR 2000 .....	£220
DBASE III+ .....	£385
SUPERCALC 4 .....	£195
SMART 3 .....	£395
SYMPHONY .....	£335
MULTIMATE ADVANTAE .....	£265
MS WORD .....	£245
DATAEASE .....	£395
PEGASUS MODULES (SU) .....	£175
WORDCRAFT .....	£315

### COMMUNICATIONS

IRMA 3270 CARD .....	£875
IRMA 3279 GRAPHICS .....	£1475
AST 3270 CARD .....	£695
SMART ALEX 5250 Emulation .....	£695
AST 5251 (Local) CARD .....	£575
QUATTRO CARD V21, 22, 22Bis, 23 .....	£595
PACE SERIES 4, V21, 23, AA, AD, Hayes .....	£220
HAYES SMART MODEM 1200B .....	£345

### PRINTERS

BROTHER 1109, 120cps, 80 col .....	£175
BROTHER 1509, 180cps, 132 col .....	£375
BROTHER 4018, 480cps, 100 NLQ .....	£1195
NEC P6, 180cps, 80 col .....	£410
NEC P7, 180cps, 132 col .....	£495
NEC P5XL 220cps, 132 col .....	£799

### LASERS/PLOTTERS

CANON LBP8 A1 LASER .....	£1595
EPSON LASER PRINTER, 6PPM .....	£1395
QUME LASER 10 PLUS, 10PPM .....	£2095
HP7440 PLOTTER, A3 .....	£775
HP7475 PLOTTER, A3/A4 .....	£1395
ROLAND DXY 880A, A3 .....	£675

### MEMORY

AST Rampage (XT), 2Mb .....	£395
AST Ramvantage (AT), 2Mb .....	£495
AST Rampage (AT), 2Mb .....	£595
Everex Minimagic 128k (AT) .....	£110

### ENHANCED GRAPHICS

Paradise Switchable EGA Adaptor .....	£210
Everex EGA+ Card, 256k, Parallel Port .....	£245
Taxan EGA Compatible Colour Monitor .....	£399
NEC Multisynch Hi-Res Colour Monitor .....	£530

### HARD DISKS

NEC 20MB HD with Controller Card .....	£350
Tandon 20Mb Business Card .....	£395
Tandon 20Mb hard disk with Controller Card .....	£295
Miniscribe 30Mb Hard Card .....	£435
Tandon 40Mb hard disk (half height) .....	£495
Tandon 40Mb with Controller Card .....	£575

### SYSTEMS \*\*

OLIVETTI M24, 640k, 20Mb HD .....	£1195
OLIVETTI M24SP, 640k, 20Mb, (10MHz) .....	£1595
OLIVETTI M28, 512k, 20Mb, 1.2Mb .....	£2095
APRICOT XEN Xi, 20Mb, 512k RAM, 1.2Mb .....	£1595
APRICOT XEN I XD, 45Mb, 2Mb (10MHz) .....	£2545
APRICOT XEN I 386, 45Mb, 2Mb RAM .....	£3095
TOSHIBA 1100 Plus, 2x 720k FD, 640k .....	£1495
TOSHIBA 3100 Laptop, 10Mb, 640k .....	£2595
All TANDON/AMSTRAD Systems .....	£POA
COMPAQ PORTABLE 3 available now .....	£POA

\*\* All systems include keyboard, monitor and DOS

ADVICE-LINE

# 07357-4466 for PRINTERS GALORE!

**LOW, LOW PRICES but with FULL BACK-UP SERVICE**

Call our Engineers for advice on printer selection.

## OKI MICROLINE PRINTER SPECIALISTS

Superb range of dual mode printers, speeds of 100 cps NLQ and 400 cps draft. Competitive performance and features with unique Print Menu giving user friendly operation. PC Compatibility. Call for engineering advice.

Competitive prices to match any competition. DEALER ENQUIRIES WELCOME.



### OKI LASERLINE 6

NOW LASER JET PLUS COMPATIBLE AT £1895 + VAT  
An ultra quiet compact H.P. compatible laser printer. Low noise, long life and a wide range of emulations. Large capacity input and output stackers. Face down output stacking. High reliability. TRADE ENQUIRIES WELCOME

**FREE 1 YR ON SITE MAINTENANCE**

### OTHER LEADING PRINTERS

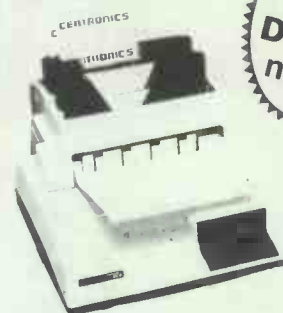

● CENTRONICS ● NEC  
● STAR ● TOSHIBA  
DEALER ENQUIRIES WELCOME.

### MOBILE/CAR POWER SUPPLIES

INPUT 12v, 24v, 48v. OUTPUT 240v 50HZ  
IDEAL FOR MICROS, PRINTERS ETC

FROM £249 + VAT

## AMSTRAD Appointed Dealer

AMSTRAD 1512	Single Disc Mono	£449
AMSTRAD 1512	Dual Disc Mono	£559
AMSTRAD 1512	Single Disc Col.	£619
AMSTRAD 1512	Dual Disc Col.	£729
AMSTRAD 8256	Single Disc + Ptr	£399
AMSTRAD 8512	Dual Disc + Ptr	£499

### SPECIAL SUMMER PACKAGE

- P.C. 1512 Dual disk mono
- D.M.P. 3000 PRINTER
- SUPERCALC 3 Spreadsheet
- WORDSTAR 1512 WORD-PROCESSING

ONLY £699 + VAT.

### SOFTWARE

WORDSTAR 1512	£59
SUPERCALC 3	£59
VOLKSWRITER deluxe	£39
WORDS & FIGURES	£99
SAGE SOFTWARE	EPOA



SAVE £150 ON SPECIAL PACKAGE

Amstrad printer cable £12.00

## OKI MICROLINE PRINTER SPECIALISTS

Superb range of 100 cps NLQ or performance or Menu giving Compatibility. Competitive prices to match any competition. DEALER ENQUIRIES WELCOME.

ad able .0

CALL FOR PRINT SAMPLES

MICROLINE OFFICIAL APPOINTED DISTRIBUTOR

Ring for a DEMO now!

## THIS MONTH'S DISCOUNT OFFERS

CALL FOR PRINT SAMPLES

### EPSON PRINTERS

LX 800	£205
FX 800	£325
FX 1000	£395
LQ800	£450
LQ1000	£595
EX800	£395
EX1000	£525
LQ2500	£799

### JUKI PRINTERS

6100	£259
6200	£435
6300	£675
6500	£999

### LASER PRINTERS

Canon Laser LBP-8 MK II	£1850
Canon Laser LBP-8 DA I	£3150
Canon Toner Cartridge	£86
Canon Font Cartridge from	£179
Centronics Line Printer 8	£1995
H.P. Laser Jet series II	£1995
H.P. Laser Jet 500 plus	£3750
Centronics pp 8	£1595
Epson GQ 3500	£1550

### OTHER PRINTERS & PLOTTERS

Canon PW1080A 160 cps	£255
Roland DXY880A A3 Plotter	£725
Star NL - 10	£235
Epson FX 105 +	£350
Centronics GLP 8 Tractor	£145
Hitachi 672 Plotter A3 Size	£535
OTC 700 700cps	£1995

### DAISYWHEEL SPECIALS

1/2 PRICE DAISYWHEEL SPECIAL OFFER	DYNEER DW20 20cps RRP £569	NOW ONLY £199
Dyneer DW-40(40cps)		£749
Dyneer 20 Tractor Feed		£115
Quendata Tractor Feed		£75

- £1850
- £3150
- £86
- om £179
- 8 £1995
- £1995
- £3750
- £1595
- £1550

### LOW PRICE LASER TONER CARTRIDGES

CANON LBPB	£74.75
CANON LBPB Mk II	£74.75
CITIZEN	£22.95
EPSON GC3500	£18.50
HP LASER JET	£74.75
HP SERIES II	£74.75
KYOCERA	£28.50
OKI LASERLINE 6	£18.50
TECHNITRON TLP-12	£17.50

- ERS
- 3 cps £255
- 3 Plotter £725
- £235
- £350
- actor £145
- r A3 Size £535
- £1995

BI P As the usu pr



COMPLETE RANGE OF PRINTER BUFFERS, INTERFACES, CABLES AND RIBBONS AVAILABLE. PLEASE CALL FOR ADVICE 07357 4466. Specialists in MICRO and PRINTER technology  
Dept(PCW9) Unit 25, Horseshoe Park, Pangbourne, Reading, RG8 7JW

TELEPHONE ORDERS taken 9-5.30 Mon to Fri. & 9-12.00 Sats. Delivery Charge of £9 + VAT on all printers and computers. ALL PRICES EXCLUDE VAT & CARRIAGE. Prices subject to change without notice.

FOR THE  
EXECUTIVE  
ON THE MOVE  
**TOSHIBA**  
TOP  
PERFORMANCE  
AND COMPACT  
DESIGN

**TOSHIBA  
IBM COMPATIBLE  
PORTABLE COMPUTERS  
AT GULTRONICS**

# T1100 PLUS

*The portable that thinks  
it's a desktop PC!*



**T1100 PLUS specification.**

- Operating system** • MS-DOS 3.2
- Processor** • 80C86 running at 7.16 MHz or 4.77 MHz
- Memory** • 640K
- Disk drives** • Two 3.5" 720KB offering 1.4MB total storage
- Display** • Supertwist technology
- 80 characters x 25 lines
- 9.1 x 4.7 inches
- 640 x 200 pixels
- Position adjustable a full 90°
- Keyboard** • 81 keys, full size
- Standard interfaces** • RGB colour monitor
- Monochrome composite monitor
- IBM compatible parallel printer/5.25 disk drive
- RS-232C serial communications
- I/O bus for Expansion Box

- Dimensions** • 12.1" wide, 2.6" high, 12" deep
- Weight** • Less than 10lbs
- Power** • Built in rechargeable NiCad batteries

- Included accessories** • 240VAC adaptor for recharging and mains power operation
- MS-DOS manual
- Owner's manual
- Carrycase with grip handle and shoulder strap

- Options** • Internal V21, V22, V23 Hayes compatible modem (BAPT approved)
- External 5.25" floppy disk drive
- Universal Floppy Link to desktop PC disk drive
- Car cigarette lighter power adaptor/charger
- Expansion Box with five IBM compatible slots
- Bi-Synchronous Communications Adaptor

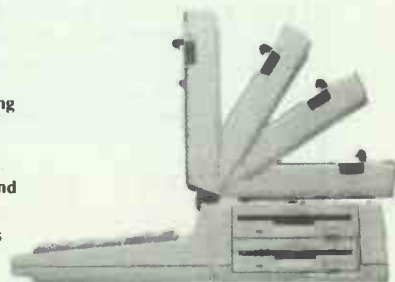

# T3100 (ALSO AVAILABLE NOW T3100 20Mb)

**Features**

- Enormous processing power – this is the main feature of the T3100.
- The basic version of the T3100 comes with 640 KB of main memory which can be expanded to 2.6 MB.
- The T3100 also has a built-in 3 1/2" drive with 720 KB storage capacity for exchanging data and programs with other computers.
- The hard disk – a standard feature of the T3100 – provides even greater storage capacity than the diskettes.
- The enormous storage capacity, the hard disk offers two other important advantages: considerably faster access to stored data, which means much faster response time for the computer, and greater data security.

# GULTRONICS

## COMPUTER CENTRE

223 TOTTENHAM COURT ROAD, LONDON W1P 9LA TEL: 01-323 2838/323 4612 TELEX: 295358 (OPPOSITE GOODGE ST. TUBE STATION)

London's main stockists for Amstrad, Atari, Commodore, Epson, Brother, Citizen, Star, Sinclair. Also extensive range of software, Modems and peripherals.

All offers also available at: 43 Church Street, Croydon, Surrey. Tel: 01-681 3344

CONSULT GULTRONICS BEFORE COMMITTING.

# The Best Software from HiSoft

## Atari ST

HiSoft DevpacST assembler development system	£49.95
HiSoft Saved! invaluable desk accessory	£29.95
HiSoft BASIC super-fast and standard compiler	£79.95

### With CP/M Emulator

Nevada COBOL excellent learning package	£39.95
HiSoft Devpac80 Z80 assembler development	£39.95

## Amstrad PCW

FTL Modula-2 interactive compiler/editor	£54.95
FTL Editor Toolkit complete source code	£39.95
FTL Editor Toolkit when bought with compiler	£34.95
HiSoft Pascal80 fast, interactive, GSX graphics	£39.95
HiSoft Devpac80 version 2 full Z80 development	£39.95
HiSoft C integer K&R with GSX graphics	£39.95
Knife Plus full disc recovery and editing	£19.95
Nevada COBOL ideal for learning	£39.95
Nevada FORTRAN close to ANSI-66, easy-to-use	£39.95

## Special Offers

Until 1 October, we are offering a free calculator with every order from PCW. This offer does not apply to HiSoft ST BASIC which, until 1 September, will be shipped with a free copy of Saved!. You must quote ref. PCW987, when ordering, for this offer.

All prices include VAT and postage within the UK. You can order by telephone using Access or Visa or send a cheque or postal order to the address below. We always despatch by first class post and delivery is usually within 5 working days. Please write or phone for a full catalogue, trade details, export information etc. Please state your computer when ordering or requesting a catalogue.

**HiSoft** The Old School, Greenfield, Bedford, MK45 5DE. (0525) 718181

## Amstrad CPC

HiSoft Pascal80 fast, interactive with firmware lib	£39.95
HiSoft Devpac80 standard Z80 development	£39.95
HiSoft C integer K&R compiler tape/disc	£19.95/£39.95
Nevada COBOL ideal for learning	£39.95
Nevada FORTRAN close to ANSI-66, easy-to-use	£39.95
HiSoft TurboBASIC integer CPC BASIC compiler	£9.95

## PC & Compatibles

FTL Modula-2 small memory compiler	£54.95
FTL Modula-2 large memory with 8087 support	£69.95
FTL Editor Toolkit full source code	£39.95
Knife86 disc sector editor plus many utilities	£29.95
Utah COBOL, FORTRAN, PILOT, PASCAL each	£19.95

## ZX Spectrum

HiSoft BASIC full floating point compiler	£24.95
HiSoft Devpac the standard Z80 assembler	£15.95
HiSoft Pascal full compiler with Turtle Graphics	£25.00
HiSoft C integer K&R compiler	£25.00

## Amiga

HiSoft Devpac complete assembler/debugger	£59.95
---	--------

## Soft Landings for Hard Disk Data

You buy a hard disk because your business data needs lots of space. That data becomes vital to your business. If your disk buys the farm today, where are your records of customers and orders, your letters, notes, accounts and plans?

With **HoldFast** you can back up your data daily, even hourly, at low cost and great convenience. The process runs as quickly as most tape drives but needs only the diskette drives your personal computer already has. Check these features:

- ★ runs at up to 1 megabyte per minute.
- ★ runs on any MS/PC-DOS since version 2.0.
- ★ uses any diskette: 3.5", 5.25", 8", or other.
- ★ you can select by file and/or directory names.
- ★ you can also select files or directories to ignore.
- ★ the backup is indexed to find files or directories fast.
- ★ backup diskette space is more compact than on DOS hard disk and your backups.
- ★ you can back up just the recently changed files, for typical daily backup under one minute.
- ★ the data is stored with error correction code, for safe reading even if a diskette proves faulty.

**HoldFast** is the backup utility you need. At a price of £20 + VAT including post and packing, it's a precaution you'll never regret.

**HoldFast** from Zima Computing Ltd., telephone Woking (04862) 72431 or write to us at P.O. Box 167, Woking, Surrey, England. GU21 5YU



**ZIMA**  
Computing Ltd

# XT-Compatible 20 Megabytes 4.77/8 MHz

# £795

- The PC88 Turbo
- Legal BIOS
- NEC V20 Super Processor
- Switchable 4.77/8 MHz Clock
- 640K RAM
- 20MB Half Height Hard Disk
- 360K half Height Floppy
- Parallel Printer + RS 232 Serial ports
- Monographic/Printer card
- 130W Power Supply
- Professional Keyboard
- "Hi-Res 12"" Green Monitor
- MS-DOS 3.2
- Full Set of Manuals
- 8 Expansion Slots
- 12 Months Warranty
- Clock/Calendar with Battery Back-up

# AT-Compatible 20 Megabytes 6/8/10 MHz

# £1295

0 or 1 Wait States

- The PC-286 Turbo
- Legal Bios
- Switchable 6/8/10 MHz
- 640K RAM
- 20 MB Half Height Hard Disk
- 1.2 MB Half Height Floppy
- Parallel Printer + Two RS232 Serial Ports
- Clock/Calendar with Battery Back-up
- Monographic/Printer card
- 200W Power Supply
- Professional Keyboard
- "Hi Res 14"" Green Monitor
- MS-DOS 3.2
- Full Set of Manuals
- 8 Expansion Slots
- 12 Months Warranty

## OPTIONS

- 30 MB Hard Disk Drive Upgrade £265
- 40 MB Hard Disk Drive Upgrade £365
- 14" Colour Monitor Upgrade £175
- 14" Hi Res Colour Monitor and EGA Card Upgrade £395
- EGA Card £165
- On-site maintenance available



# ELONEX (UK) Ltd.

*Please feel free to visit our showroom for demonstration*

**RAYS HOUSE, NORTH CIRCULAR ROAD, STONEBRIDGE PARK,  
LONDON NW10 7XR TELEPHONE: 01-965 3225**



# WESTONE BUSINESS SYSTEMS

## NEW IBM Personal System 2 Available now Telephone for Demonstration

Model 30-021 with 20Mb Hard Disk, one 720k Floppy drive serial and parallel port, 640k memory, and enhanced keyboard.....	£1395
Model 50 10MHz 80286 Desk Top system with 20Mb Hard Disk, one 1.2Mb Floppy drive, serial and parallel port, 1Mb memory and enhanced keyboard.....	£2195
Model 60 10MHz 80286 free standing system with 44Mb Hard disk, one 1.2Mb Floppy drive, serial and parallel port, 1Mb memory and enhanced keyboard.....	£3095
For Model 80 prices please call 01-636 7142.	
IBM Mono Monitor 8503.....	£148
IBM Colour Monitor 8513.....	£439
IBM DOS 3-3.....	£49
IBM Colour Monitor 8512.....	£389

## LIMITED OFFER!

IBM ATX 80286 processor with 30Mb Hard disk, one 1.2Mb Floppy, serial and parallel port, 512k RAM, enhanced keyboard.....**£1995**  
 IBM XT286 80286 processor, with 20Mb Hard disk, one 1.2Mb Floppy drive, serial and parallel port, 640k RAM, enhanced keyboard.....**£1695**

### 35% Discount on IBM ATX and 286 Systems!

A complete range of IBM peripherals available including Monitors, Memory Upgrades and Printers.

Telephone for details

## Authorised IBM DEALER

## TRAINING AND INSTALLATION

Full onsite training and installation is available on all products. Ask us for a quotation! We also supply and install a range of Multi user and Network products including Xenix and Novell. Telephone for further details on 01-636 7142 or 01 323 2840.

## The Akhter P.C. IBM Compatible System

All systems with keyboards Hercules compatible Adaptercard, Turbo Main Board 4.77 8MHz, Serial/Parallel port, games port, 150 watt P.S.U. and 8 expansion slots.

P.C. 1000 Single 360k floppy drive, 256k RAM.....	£495
P.C. 1500 Dual 360k floppy, 256k RAM.....	£595
P.C. 2000 Single 360k, 20Mb hard disk, 512k RAM.....	£795
P.C. 2500 Dual 360k, 20Mb hard disk 512k RAM.....	£849
P.C. 3000 Dual 720k-3.5" disk drives 512k RAM.....	£845
P.C. 3500 Single 720k-3.5" disk, 20Mb hard disk 512k.....	£829

## MONITORS

Philips 7513 IBM compatible Monochrome Monitor.....	£79
Philips 8833 IBM compatible Colour Monitor (Resolution 600x200).....	£225
Philips 8873 IBM compatible EGA Multi-scan (max resolution 850x285).....	£562

## DISK DRIVES

20Mb hard disk and controller.....	£295
40Mb hard disk and controller.....	£445
360k 5.25" floppy disk drive.....	£82
1.2Mb 5.25" floppy disk drive.....	£109
720k 3.5" floppy disk drive.....	£112
Mono chrome adapter Card.....	£72
Colour adapter Card.....	£79
640k Multi Function Card.....	£195
EGA Card.....	£195
3Mb AT Multi Function Card.....	£195

Call 01-636 7142 for more information on products

## PRINTERS

Superb range of High Quality Star and IBM Printers

Star NL10 - 9pin, 120cps draft - 30cps NLQ 80 col.....	£199
Star ND 15 - 180cps, 136 col, NLQ 45cps.....	£399
Star NX 15 - 9in, as above but 132 col.....	£295
Star NR 15 - 9pin, 240cps draft - 60cps NLQ 132 col.....	£495
Star NB 24/10 24pin, 216cps draft - 72cps LQ 80 col.....	£475
Star NB 24/15 24pin, as above but 132 col.....	£575
IBM Quietwriter Model III.....	£749
Epson FX 800 200cps draft/40cps NLQ.....	£329
Epson FX 1000 200cps draft/40cps NLQ.....	£399
Hewlett Packard Laserjet II.....	£1995
Full range of Epson printer available - Telephone for details	

Sanyo Special Offer

## Sanyo Special Offer

Sanyo 550 with Dual 800k Drives, Monitor, Wordstar and Calc Star including a Daisywheel Printer all for **£599**

Sanyo 775 Portable IBM compatible high resolution 9" colour monitor, complete with Wordstar and Calcstar at

**£1295**

## The Akhter PC AT IBM Compatible System

Features 80286 Processor, 6/8/10 MHz speed. Switchable EGA, Colour, Mono or Hercules adapter card. Serial parallel, clock-calendar and light pen interface, 30Mb hard disk, 1Mb memory, 102 key enhanced keyboard. MS DOS 3-21, GW Basic and Windows II. Complete with Monochrome monitor.

**£1595**



## BAD NEWS FOR YOU KNOW WHO

How compatible is you know who?

The systems below has been designed and manufactured for the discriminating user that wants a no nonsense compatibility and an affordable price. Couple all this with our after sales service, support plus one of the best guarantees around, we believe we are making you an offer you cannot refuse.

BETTER  
DESIGN



QUALITY  
MANUFACTURE

EXCELLENT  
SUPPORT

MONEY BACK  
GUARANTEE

12 Months  
Warranty

### IBM/AT Compatible Supercharged Speed 12MHz!! Only £895

- ★ INTEL 80286-10 microprocessor
- ★ 512K ram expandable to 1Mb
- ★ 8 expansion slots
- ★ 200W power supply
- ★ Monographic/Printer card
- ★ Hi Res TTL Monitor
- ★ Hard disk and floppy controller
- ★ One 1.2Mb floppy disk drive
- ★ Super AT Keyboard
- ★ Baby 286 turbo case
- ★ RS232 plus printer port
- ★ 20Mb hard disk (add £250)

### 16 Mhz 32 bit 386 system, MOST POWERFUL PC yet!! ONLY £2199

- ★ INTEL 80386 microprocessor
- ★ 512k ram expandable to 16Mb
- ★ Multiple Operating Systems
- ★ Hardware and software compatible with AT systems
- ★ Monographic/Printer card
- ★ Hi Res TTL Monitor
- ★ Vertical Floor Model (add £500)
- ★ Hard disk and floppy controller
- ★ One 1.2Mb floppy disk drive
- ★ RT enhanced keyboard
- ★ 200W power supply
- ★ Super Stylish AT size case
- ★ RS232 plus printer port
- ★ 20Mb hard disk (add £250)

Colour Options: 14" colour RGB monitor upgrade (add £150).  
14" Hi Res EGA monitor and card (add £297) to above prices.

### NETWORKS COMPATIBLE WITH THE INDUSTRY STANDARDS!!

The ideal network must be compatible with IBM's PC network and token ring network. Compatibility with Novell's network environment is also essential as thousands of multiuser applications software use this environment. Cost effectiveness, Easy Installation, eg the Trans-net can be installed in minutes. Specifications are below.

- ★ Protocol: CSMA/CD
- ★ Data rate: Trans-Net 1 Mega bits/Sec, RPTI-NET 10 Mega bits/sec
- ★ Addressable Users: Trans-Net 255, RPTI-NET 1024
- ★ Cabling System: Trans-Net RS422 twisted pair (AWG20) RPTI-NET Ethernet or Cheapernet cabling.
- ★ Distance: Trans-Net 300M to 1200M with repeater RPTI-NET 500M to 2500M with repeater Software Supported
- ★ IBM PC Network, Novell's Advanced Network
- ★ RPTI-NET network utilities, sign on/off Disk Sharing, Printer/Plotter Sharing, Printer File spooling, interactive message communications.
- ★ Electronic Mail
- ★ Disk server
- ★ Class room/screen monitoring system.
- ★ Data Base Management System, allows software development of multi user applications under DOS. Function calls in Cobol, Basic, Fortran, Pascal, C and Assembly.

Prices: Trans-Net Card £180. Starter kit £399  
RPTI-NET Card £289 Starter kit £599

### MODEMS

Mini Modem CCITT V21/V23 300,1200/75, half duplex RS232C £49  
Modem Card CCITT V22,A,B,V21 300, 1200bps, Hayes Smartmodem compatible runs Hayes Smartcom, Cross Talk, PC Talk 3 etc £89

Notes: Prices are exclusive of VAT and Delivery.  
Sales Office open for demonstrations.

Exports are welcome.

We acknowledge all trademarks used in this advertisement.

## ITCO LTD

Suite 13, Whitehill House, 6 Union Street  
Luton LU1 3AN England

Tel: 0582 418851

Telex No: 825353/825562 Chacom G

# MITAC BRINGS A LITTLE STYLE TO THE "XT" CLASS

## THE PARAGON 88 XT TURBO

30Mb  
£995



### SMALL-FOOTPRINT XT-COMPATIBLE WITH EVERYTHING ON-BOARD!

- ★ 8088-2 processor operating at 8Mhz
- ★ Hard-soft switching to 4.7Mhz Turbo
- ★ Provision for 8087-2 Maths processor
- ★ Full 640kb on board as standard
- ★ 360Kb single Drive
- ★ 30Mb Hard Disk
- ★ 128Kb Ram Disk
- ★ 5 × IBM compatible expansion slots
- ★ FDC/RTC on board plus MDA/HGA/CGA Plantronic
- ★ Mono to colour at a flick of a switch without extra cards (Changing the monitor of course)
- ★ 150W switching power supply
- ★ 1 × SIO port: 1 × PIO port
- ★ Reset button enabling cold boot without switching off
- ★ Strong attractive two-tone metal cabinet.
- ★ 84 key AT style keyboard
- ★ Phoenix BIOS \*MS DOS 3.2 and GW Basic
- ★ Excellent software compatibility
- ★ One year parts and labour warranty (on-site maintenance availability)

AT VERSION ALSO AVAILABLE

When reliability is a decisive factor

# BCL

Demonstrations:  
Mon-Sat 9am-6pm

227 Tottenham Court Road, London W1

Tel: 01-631 0139/5379

TELEX: EASYLINK 19010780 G

All prices exclude carriage and VAT



# Slough Computers



**COMMODORE**  
**AMIGA** **A500 & A2000**

Come and see the superb Commodore Amiga 2000 starting at only £1095 including one year's on site service Limited quantities of the new A500 Now available from only £499

## Tandon

PCA20 512K. 6/8MHz. 80286. MSDOS 3.1  
1.2Mb FLOPPY. 20MB WINCHESTER  
£1695

AT NO EXTRA COST WE WILL SUPPLY THE ABOVE SYSTEM WITH EGA CARD AND MONITOR SAVING £500 NEW 70MB PCA 70 NOW AVAILABLE FROM £2295



The new target range and other models available

## NEW BRITISH AT — THE SBC MISTRAL

Based on a state of the art 6 layer VLSI motherboard designed in the UK and built by British Aerospace. A range of soft selectable clock speeds and wait states to give incredible speed. Serial and parallel ports, clock, 6 free slots, 1Mb RAM, 1.2Mb floppy, 30Mb Winchester 6/8/12 MHz 80826 is available now. Not a cheap import. This quality product will be available within weeks at prices starting at only £1799. Including 1 years on-site service.

## PC/OPUS EGA UPGRADE BARGAIN

14" Enhanced colour monitor with multiple choice colour switch PLUS EGA/CGA/HGC Graphics card, all to suit PC's and compatibles at at previously unheard of price of only **£399**

## TAPE STREAMER BACK UP

Archive 40Mb internal tape streamer only £349

245 HIGH STREET, SLOUGH, BERKS SL1 1BN Tel: SLOUGH (0753) 21594/32753  
VAT & CARRIAGE MUST BE ADDED TO ALL PRICES. TELEPHONE/MAIL ORDERS WELCOMED  
ALL PRICES SUBJECT TO CHANGE WITHOUT NOTICE

## MORE PC FOR YOUR MONEY

RPP DOS UTILITIES allows you to realise the full potential of any PC running DOS 2.1 or upwards. Order one of these powerful programs now or write or phone for our full catalogue.

Tel: 01 959 7344 x101

### ■ SQUISH: £99.00 inc. VAT

Working interactively, SQUISH reduces files by up to 85% of their present size without the user being aware of its presence.

### ■ ABOVE DISK: £99.00 inc. VAT

Allows you to address your hard disk as up to 8 Meg. RAM. Works with all EMS prog. such as Lotus, Auto Cad, Reflex, Symphony (tm) etc.

Buy both at £89.00 each or any other from the range for a 10% reduction if bought within 8 weeks of the first, direct from us, the European distributors.

Name: \_\_\_\_\_

Address: \_\_\_\_\_

Post Code: \_\_\_\_\_

AMOUNT	PROGRAM	PRICE	TOTAL
	SQUISH	£99.00	
	ABOVE DISK	£99.00	

£1.25 PER PROG. POST & PACKING

Please send me a catalogue  VAT  
of the complete range:  TOTAL

Complete & return to...

R.P. DIRECT SERVICES, Dept.PCW 101  
91, Riverdene, FREEPOST, Edgware, Middx HA8 9BR

## COMP. STAND. LTD.

# NOW HAVE STOCK OF THE NEW OLIVETTI M240 PC

### Olivetti M24

20Mb Hard Disk  
360 Kb Floppy Drive  
640 Kb RAM  
Monochrome Display  
Keyboard  
MS-DOS £1195  
As above with 30 Mb hard disk £1245

Olivetti M24 SP (complete) £1445  
(Colour supplement on all above £210)

Olivetti M28  
20 Mb complete system £CALL  
40 Mb complete system £CALL

Olivetti M19  
20 Mb Hard Disk 640 Kb RAM  
(Complete system) £1120  
Best prices on all configurations £CALL

OLIVETTI M240  
OLIVETTI M380  
CALL FOR PRICES

### Tandon

PCA20 £1310  
Special Offer PCX10 £559  
PCX20 £875  
Add £288 for EGA colour monitor and card

### AMSTRAD

Dual Drive, Mono £539  
20 Mb Hard disk, Colour £1045

### Hard Disks

20 Mb Dysan Hard card £395  
30Mb Miniscribe Hard card £395  
20 Mb Seagate Kit £255

### Software

Multimate 3-31	£185
Multimate II	£285
DBase III +	£347
Symphony	£315
Lotus 123	£225
Smart V.3	£345
Framework II	£299
Wordstar	£139
Wordstar Prof V.4	£189
Wordstar 2000/2	£210
Wordstar 2000 +	£256
MS-Word	£239
Sage Accountant Plus	£140
Sage Finance Controller	£215
Multiplan II	£108
SuperProject Plus	£245
Supercalc 4	£189
Lotus HAL	£80
Lotus Manuscript	£235

(Most other packages available)  
ALL LATEST VERSIONS

Full range of Dot Matrix, Daisy Wheel and Laser printers — Call for best prices.

Prices for Add on Boards, Hard Disks, Modems and other software available on request.

CALL US NOW ON CHICHESTER (0243) 771786.

**COMP. STAND. LTD.** Quarry Lane, Chichester,  
West Sussex, PO19 2NY

All prices include full 12 months warranty but are exclusive of VAT and delivery.

# FROM THE BEDROOM TO THE BOARDROOM

Satisfy your computer fit a protector

**£15.50** inc. p+p and Vat  
4-way socket strip with 3 metre cable

**£12** inc. p+p and Vat  
Plug

**£15.39** inc. p+p and Vat  
Adaptor

## 3-MODE SURGE PROTECTION PRODUCTS

Please send me socket strip/plug/adaptor as indicated below:

PRODUCT DESCRIPTION	QUANTITY	NAME
4-way socket strip with cable		ADDRESS
Plug		
Adaptor		

I enclose my cheque/crossed postal orders for £ \_\_\_\_\_ made payable to: BOWTHORPE EMP LTD.

OR please debit my Access/Visa Account with the sum of £ \_\_\_\_\_

My Account No. is:

Signature \_\_\_\_\_  
Stevenson Road, Brighton, Sussex BN2 2DF, England

Orders to: BOWTHORPE EMP LTD.

## 'COMPUTEREYES' VIDEO IMAGE CAPTURE



COMPUTEREYES is a low cost, high resolution, professional image capture system which will digitise and store on disc images from any video source, including camera, video recorder, video disc and TV. Versions are available for:

PC and compatibles: half-size board, supports both CGA and EGA (up to 640 x 350 resolution).....	£249
Apple II GS, IIe and II+: plug in board.....	£129
Software for double hi-res and image processing.....	£29
II GS software for 320 x 200 resolution, 16 grey levels.....	£19
Atari ST: 640 x 400 in high resolution mode.....	£149
Commodore 64/128.....	£109
Atari 800/800X/130.....	£99

IPrices exclude VAT and carriage at £3.45!

- ★ Complete camera systems including high quality b/w camera and connecting cable can be provided to order.
- ★ COMPUTEREYES software is menu driven and modular, allowing personal customisation of programs. Where appropriate, software is available to modify images for compatibility with popular graphics packages.
- ★ Applications include graphic art, pattern recognition, spatial measurements, desktop publishing, education, information technology, entertainment, etc.

# Stem Computing

3 Blackness Avenue, Dundee DD2 1ER Tel: 0382 65113

## Slough Computers



### AMSTRAD PC1512

FLOPPY AND HARD DISK SYSTEMS FROM £399  
RANGE OF BUDGET PRICED SOFTWARE IN STOCK

### BONDWELL PC PORTABLES

SUPERTWIST SCREENS NOW AVAILABLE

MODEL 8 LAPTOP £799  
512K 3 1/2" DRIVE. LCD  
MODEL 18 PORTABLE £699  
640K, 2 x 5 1/4" DRIVES. CRT  
ALL WITH DOS/BASIC 2.11



FREE!  
1 YEARS ON-SITE SERVICE



### THE OPUS PC II RANGE

1024K, 2 DRIVES + RAM DISK.  
HERCULES COMPATIBLE GRAPHICS.  
4.77-8MHz TURBO V20  
AT STYLE KEYBOARD.  
TILT & SWIVEL MONITOR £679

SYSTEMS FROM £499-20Mb £969  
EGA SYSTEMS FROM ONLY £799  
VARIOUS OPTIONS AVAILABLE INCLUDING  
1.2MB & 3 1/2" FLOPPIES AND 8087

PC USER "THIS IS THE ONE I'D BUY"

### NEW FROM OPUS — PC VAT

New low cost AT has just been released by Opus. It's a small footprint machine with a 1.2Mb floppy, 30Mb Winchester, 10MHz zero weight 80286, mono graphics, amber flat screen display and enhanced keyboard at a cost of only £1295

245 HIGH STREET, SLOUGH, BERKS SL1 1BN Tel: SLOUGH (0753) 21594/32753  
VAT & CARRIAGE MUST BE ADDED TO ALL PRICES. TELEPHONE/MAIL ORDERS WELCOMED  
ALL PRICES SUBJECT TO CHANGE WITHOUT NOTICE

## FORTRANSOFT LTD

PROFESSIONAL SOFTWARE FOR THE IBM PC/XT/AT AND COMPATIBLES, eg. OLIVETTI, COMPAQ, AMSTRAD, OPUS...

BASIC is fine for short programs and when speed and portability are not important. Besides, you can draw pretty pictures on the screen with BASIC. However, if you are writing large programs and wish to protect all the hours (in some cases years) you spent in writing your software then Fortran comes into its own. Whilst most languages are 'here today — gone tomorrow', Fortran, designed in the late fifties, still remain the dominant language for scientific and general purpose programming today. This means that programs you write today will work tomorrow on future generation of machines with little or no change.

Fortransoft now brings you an affordable ANSI 77 Fortran Compiler. And you can still draw pretty pictures on the screen because the GRAPHKIT library comes with the compiler and is included in the price.

FS-Fortran 77 is now at level 3.15 and current users may obtain a copy of the compiler for £2 all incl.

FS-Fortran 77 with CGA graphics routines.....	£29.95
FS-Fortran 77 with CGA and Hercules mono graphics routines.....	£39.95
FS-FORTAN 77 with CGA and Olivetti 640x400 graphic routines.....	£44.95
FS-FORTAN 77 with CGA and EGA colour graphics routines.....	£49.95

### NEW!! NEW!! NEW!!

FS-BASICON is a translator program for converting your IBM BASIC and GW-BASIC programs, including some of the graphics calls, into Fortran 77. A virtually complete translation may be obtained, thus enabling you to have your converted BASIC programs up and running within hours instead of weeks.....

FS-Graphkit is a comprehensive suite of graphics and sound routines, including routines for drawing lines, circles, ellipses, painting, read/write to port, get time and data, reading a single key from the keyboard, etc.

FS-GRAPHKIT is available for use with Microsoft Fortran, Ryan McFarland Fortran, IBM Professional Fortran, Lattice C, and Zorland C. (Please specify which compiler when ordering).

CGA colour graphics.....	£19.95
CGA and Hercules mono graphics.....	£29.95
CGA and Olivetti 640x400 graphics.....	£34.95
CGA and EGA colour graphics.....	£39.95

FS-Sortmerge is a suite of Fortran-callable routines for sorting/merging an unlimited number of records on multiple keys. Any combination of alphabetic and numeric keys may be specified.

FS-Sortmerge for FS-Fortran 77 Compiler.....	£19.95
FS-Sortmerge for Microsoft Fortran Compiler.....	£19.95
FS-Sortmerge for Ryan McFarland/IBM Professional Fortran.....	£24.95

FS-Smutil — A sort/merge utility program which may be used on its own without requiring any other software suitable for sorting large files on several combinations of numeric and alphabetic collating sequences.....

Fortransoft acknowledges all trademarks and registered names in this advert. Please indicate Compiler and Computer type when ordering. All prices include packing, postage and VAT, but please add £3 for air delivery where applicable. All software comes on 5.25" 360K/1.2M diskette (please specify). COD's and purchase orders are NOT accepted. Send cheque with order to: (or write for further details)

### FORTRANSOFT LTD

60 HARNESS WAY, ST. ALBANS HERTS AL4 9HB.  
(Tel: (0727) 32409)

# PRESENTING THE 386VAT

**\*\* AGENTS WANTED \*\***



**837 LPT  
937 LPAT**

**386 VAT  
931 VAT**

**830 LP  
930 LP**

## **386 VAT (Vertical 386)**

- 80386 Processor, 16 MHz, 200W
- 10.75"W x 16"H x 16"D
- Vertical tower type, 6-Drive space
- 8-Slot, legal BIOS

## **931 VAT (Vertical AT)**

- 80286-10 Processor 8/10 MHz, 200W
- 10.75"W x 16"H x 16"D
- Vertical tower type, 6-Drive space
- 8-Slot, legal BIOS

## **830LP (Low Profile PC)**

- 8088-1 Processor, 10MHz, 60W
- 15"W x 3.5"H x 14.5"D
- Low profile, Diskless
- CPU card, legal BIOS

## **930 LP (Low Profile AT)**

- 80286-10 Processor, 10 MHz, 60W
- 15"W x 3.5"H x 14.5"D
- Low Profile, Diskless
- 3-Slot, legal BIOS

## **837 LPT (Low profile PC)**

- 8088-1 Processor, 10 MHz, 60W
- 15"W x 3.5"H x 14.5"D
- 2 x 3.5" FDD or 1 x 5.25" FDD space
- CPU card, legal BIOS

## **937 LPAT (Low Profile AT)**

- 80286-10 Processor, 10MHz, 60W
- 15"W x 3.5"H x 14.5"D
- 2 x 3.5" FDD or 1 x 5.25" FDD space
- 3-Slot, legal BIOS

## **767 SAT (Baby AT)**

- 80286-10 Processor, 6/10 MHz, 150W
- 17.13"W x 6.2"H x 16.5"D
- 8-Slot, Legal BIOS
- 3 x 5.25" FDD, 1 x 3.5" HDD space

## **747 SPT (Turbo XT)**

- 8088-2 Processor, 4.77/8 MHz, 150W
- 17.13"W x 6.2"H x 16.5"D
- 3 x 5.25" FDD, 1 x 3.5" HDD space
- 8-Slot, legal BIOS

## **Other Products**

- \* Monochrome, color, EGA, Multisync, Touch screen monitor
- \* CPU card, 2M RAM card and more add-on cards



**747 SPT  
767 SAT**

**OEMTEK**

## **OEMTEK TAIWAN, INC. (OTI)**

Head Office: 168, Chang-An E. Rd., Sec. 2, Taipei, Taiwan, R.O.C.  
Tel: (02)721-5544, 721-5932. Fax: 886-2-7112504.

Factory: 2-1, Science Rd., 1, Science-Based Industrial Park, Hsin Chu, Taiwan, R.O.C.

Tel: (035)772187/9. Telex: 34527 OEMTEKTN. Fax: 886-35-776208.



# Goto Computers

10 Old Crown, Windsor Road, Slough, Berks SL1 2DL

Sales Hotlines:



Slough (0753) 34191

Slough (0753) 824767

Telex 847698 GOTOCO G

**130 MILE FREE DELIVERY** — (Over 120 miles and under £100 add £5)

## COMPUTERS

Amstrad PC 1640 EGA iFD 640k .....	799
Amstrad PC1640 20meg HD EGA 640k .....	1199
Atari PC 512k 1FD Mouse Mono Monitor .....	434
EFI PC AT 1FD Hi-Res Mono Mon KB .....	875
Epson PC AX 20mg 640k 10Mhz Ex Mon .....	1585
Epson PC AX 40mg 640k 10Mhz Ex Mon .....	2075
Epson PC AX Mono Display/Adaptor .....	235
GOTO Xtra PC 1FD 640k 4.77/8mhz etc. ....	395
NEC APC 1V20meg Multisync/EGA 640k .....	2195
NEC APC 1V40meg Multisync/EGA 640k .....	2495
NEC Multisync Lapheld PC 2x720K Dr .....	call
Olivetti M28 40meg 8Mhz 512k .....	2195
Olivetti M-15 Lap Held 2x720K FD .....	1295
Olivetti M24 20meg 1FD KB Mon Mn DOS .....	1225
Olivetti M24SP 640k 20meg 1FD 10Mh .....	1450
Opus PC11 AT 20meg NEW .....	Call
Opus PC11 EGA 640x360 16cl 20meg .....	1225
Opus PC11 EGA upgrade kit Mon + Card .....	395
Opus PC11 System 3 Turbo 2FD Mono .....	645
Opus PC11 System 4 20meg Mono mon .....	925
Packhard Bell PB286 AT 20m 1FD Mono .....	1275
Packhard Bell VX88 XTV40 8Mz 20Meg .....	949
Tandon EGA Monitor and Adaptor .....	440
Tandon PAC 286 Removable Winchester .....	call
Tandon PCA20 640k 20meg 1FD Mono .....	1310
Tandon PCA20 640k 20meg EGA Monitor .....	1595
Tandon PCA30 640k 30meg 1FD Mono .....	1565
Tandon PCA40 1024k 40meg 1FD Mono .....	1755
Tandon PCA70 1024k 70meg 1FD Mono .....	2150
Tandon PCX10 256k Mon KB DOS .....	785
Tandon PCX20 640k Par/Ser Mon Mon .....	875
Tandon Target 20 20meg HD 1mg Ram MKB .....	1675
Zenith Z-181 Lapheld PC 2x720k Dr .....	1365

## MONITORS/ADAPTORS

Hercules Color Graphics .....	100
Hercules InColor Card 720x348 RAMfon .....	275
Hercules Mono Graphics Card Plus .....	175
NEC JC 1401 P3E Multisync EGA PGA 800 .....	518
Paradise 480 EGA Board .....	215
Phillips 8833 600dots 285lines NEW .....	245
Phillips 8873 Multisync 14" EGA/PG 850 .....	475
Princeton HX12E EGA + Vega Delux EGA .....	525
Sony CPD-1420E Multisync .26mm Dot .....	585
Taxan 660 12" EGA 797 .....	395
Taxan 760 14" EGA .....	420
Taxan 770 + Multivision 15/35Khz PGA .....	585
Taxan 860 16" EGA 0.39dot .....	645
Taxan 980 20" EGA + 1016 card CAD .....	4150
Taxan KIF3800SP HI-SCAN I/F Card .....	85
Taxan KX 1212/13 Green or Amber .....	120
Taxan Supervision IV 16" NEW .....	730
Taxan Viking 119" HiRes 1280x960 .....	2220
VEGA Delux Video7 EGA card 640/350 .....	265
Wyse 60 + IBM K/board Green .....	463

## ADD-ONS & UPGRADES

AST Mini 11 I/O Exp Ser Par C1/ca et .....	135
AST PC/Short Memory Board 384k .....	136
Brother 3.5" Floppy Drive PC/XT NEW .....	165
Cypher 1525 CT 20meg 1meg/min .....	410
Cypher 5210 XT/AT Streamer .....	575
Fujitsu Copyboard A4 Presentations .....	1825
High Fidelity Half Pint Par/2xSer Et .....	95
High Fidelity Mem-Plus PC to 640k .....	135
Indentica 60meg External Streamer .....	585
Intel Above Board AT 2.0Mb .....	615
Intel Above Board PC 2.0Mb .....	485
Intel Inboard 386 .....	1260
Kodak Datashow PC to Overhead Proj .....	995
Logimouse C7 .....	76
Microsoft Mouse Bus/Ser + Paint etc. ....	130
MiniScribe 30Mg HardCard only 9.5w .....	325
NEC 20Mg H/Hi HD + WD Cont + Kit .....	280
Orchid 286 EGA Turbo .....	450
Orchid Jet 386 16Mhz 3x AT Speed .....	715
Orchid Tiny Turbo 3x XT Speed .....	355
PVC Moulded PC 2 Metre Cable .....	15
Parallel Switchbox 1 to 2 way .....	29
Serial/Parallel Card PC/XT .....	78

Sysgen 60Mb Smart Image Streamer Int .....	750
Tandon 20Mb Business Card .....	290
Tandon 20 MEG Hard Disk & Controller .....	285

## DOT MATRIX PRINTERS

Brother 1709 50/240cps 136cl NEW .....	435
Brother 2024L NLQ/190cps .....	595
Brother M4018 100NLQ/480cps 18pin .....	1180
Canon A60 34WPQ/100NLQ/200cps 80 col .....	385
Canon A65 34WPQ/100NLQ/200cps 132col .....	465
Citizen 120D 25NLQ/120cps 80 col .....	155
Citizen HQP-45 66NLQ/200cps 136c .....	515
Doconix 150(cps) Ink Jet Portable .....	315
Epson EX 800 50NLQ/300cps 80 col .....	375
Epson EX1000 50NLQ/300cps 136 col .....	499
Epson FX1000 40NLQ/200 132 col NEW .....	385
Epson FX800 40NLQ/200 80 col NEW .....	297
Epson LQ 1000 80LQ/160cps 156c24pi .....	558
Epson LQ 2500 Colour Option .....	54
Epson LQ 800 60LQ/160cps 80c24 pin .....	420
Epson LQ2500 90LQ/270cps 24pin .....	690
Epson LX800 NLQ/180 cps F/T .....	199
Juki 7200 24 wire flatbed AMF NEW .....	1750
NEC P565XL Colour .....	740
NEC Pinwriter P5XL 88NLQ/264 136c .....	705
NEC Pinwriter P6 72/216 24P 80col .....	376
NEC Pinwriter P7 72/216 24P 136c .....	438
OTC 850XL Printnet 850cps 240 1pm .....	1495
Olivetti 285/1 Colour 35NLQ/160 JX 80 .....	418
Olivetti DM 250 .....	329
Olivetti DM 296/2 18p 90/220cps 132 col .....	760
Panasonic 1083 48NLQ/205c/240D 15" .....	395
Panasonic KX-1592 38NLQ/180 136c .....	340
Panasonic KX-P 1082 NLQ/180cps NEW .....	210
Panasonic KXP 1081 NLQ/120 IBM/Epson .....	155
Star NL10 30NLQ/120 80col + interface .....	210
Star NX 15 30NLQ/120cps 136col + interface .....	282
Taxan 815 NLQ/180cps IBM set NEW .....	258

## DAISYWHEEL PRINTERS

Brother HR25XL 25cps dual 132 Col .....	515
Brother HR40 FT 30sheet Sheetfeed .....	710
Brother Twinwriter 40cps/160 matrix .....	975
Citizen Premier 35cps Fric/Frac .....	445
Juki 6200 30cps 132 col .....	370
Olivetti DY 450/1 45cps 132 col .....	799
Panasonic KX-P3131 17cps 132 col .....	245
Panasonic KX-P3151 22cps 132 col .....	365

## COMMUNICATIONS

Amstrad Comms Pack Card + Datatalk .....	145
Datatalk Software V3.27 .....	110
Hayes 2400 V22bis .....	575
Hayes Smartmodem 1200 V22 .....	360
Hayes Smartmodem 1200B Internal .....	340
Miracle Keypad 3000 V21 V23 .....	275
Miracle WS3000 V21 V22 V23 Auto .....	375
Miracle WS3000 V21 V23 Auto .....	230
Miracle WS3000 V22bis 2400/2400 .....	510
PACE Series 4 Modem V21/V23 .....	215
Panafax UF-600AT Facsimile Machine .....	2825
SAGE Chit Chat Software .....	82
SAGE Comms pack Modem + Chit Chat .....	215
Trend Opal telex Slimline Display .....	1415

## PROCESSORS/RAM CHIPS

Intel 80287 6Mz .....	160
Intel 80287 8Mz .....	185
Intel 8087 5Mz .....	100
Intel 8087-2 8Mz (Amstrad/Comp/M24) .....	138
NEC Drams 64k 150ns 9 chips .....	18
NEC Drams 256k 150ns 9 chips .....	25
NEC V20 replaces 8088 .....	14
NEC v30 replaces 8086 .....	14

## SOFTWARE

Ability Plus NEW .....	110
Autocad 2.6 Basic .....	275
Autosketch .....	69
Borland SuperKey/Lighting/Pro/Stick Ea .....	59
Borland Reflex The Analyst V 1.1 .....	69
Borland Turbo Basic NEW .....	65
Borland Turbo C NEW .....	89
Borland Turbo Holiday Jumbo Pack .....	160
Borland Turbo Pascal 3.0 .....	50
Clipper dBase III Compiler NEW .....	335
Compoft DELTA 4 Professional .....	299
DS BACKUP + Hard Disk Backup NEW .....	95
Dbase III + V 1.1 Unprotected .....	378
Fleet Street Editor .....	99
Fantasy Ver 2 On-Screen Fonts/Draw .....	75
Framework II V 1.1 .....	295
GEM Desktop Publisher + Desktop NEW .....	285
Harvard Graphics NEW Software Pubs .....	285
Harvard Professional Publisher .....	550
Lotus 123 Rel 2.01 .....	230
Lotus Freelance Plus .....	270
Lotus HAL .....	99
Lotus Manuscript Word Processor .....	237
Lotus Measure (Scientific) NEW .....	325
Lotus Metro NEW .....	60
Lotus Symphony 1.2 .....	325
MACE + Unformat etc. ....	75
MathCad Mathematical Scratchpad .....	245
Microsoft Flight Simulator V 2.13 .....	39
Microsoft QuickBasic ver 2.01 NEW .....	70
Multimate Advantage 11 NEW .....	278
Norton Advanced Utilis NEW .....	95
Open Access II V2 NEW .....	365
Org Plus Organisation Chart Maker .....	73
Paradox Rel 2.0 Relational DBase NEW .....	565
Pro-Design 11 ver 2.5 CAD .....	245
Protel PCB Designer .....	795
SAGE Accountant AND Payroll .....	149
SAGE Accountant Plus .....	140
SAGE Financial Controller NEW .....	220
SAGE Payroll V 7 NEW .....	75
Schema 11 Circuit Design .....	499
Smart System 3.1 LAN Ready V3.10 .....	375
Statgraphics Ver 2.1 NEW .....	435
SuperProject Plus UK Vers. ....	305
Supercalc 4.1 .....	200
Ventura Desk Top Publishing V 1.1 .....	640
What's Best! Liar Programming System .....	Call
Wordperfect 4.2 NEW .....	244

## PLOTTERS/DIGITISERS/LASER

Canon LBP-8A2 Mark 2 More fonts etc .....	1845
Centronics PP-8 Laser 8ppm 300 dpi .....	1350
Cherry A3 Digitiser Mk II NEW .....	465
Citizen Overture 110 10ppm NEW .....	1499
Epson GQ-3500 6ppm 640k + Onsite Wnty .....	1385
Hermes/Kyocera 1010 Laser+ 1yr OSW .....	1995
Hermes/Kyocera 2010 Laser+ 1yr OSW .....	3575
Hewlett-Packard 7475A A3 6 Pen Plt .....	1325
Hewlett-Packard LaserJet Series 2 .....	1945
Hewlett-Packard ScanJet Imager .....	1575
Hitachi 672-XD A3 Plotter NEW .....	505
OKI Laserline 6.6ppm .....	1475
Roland DFX-3300 A1 8 Pen .....	3775
Roland DFX2000 A2 8pen HP GL Comp. ....	2475
Roland DXY 880A A3 8 pen 200mm/sec .....	640
Roland DXY 885 A3 .....	920
Roland DXY 980A A3 8 pen .....	875
Roland DXY 990 A3 .....	999
Summasketch Graphics Tablet + Gem .....	495

## NETWORK SYSTEMS

ASTorus AST-RSN HW + Tapestry S/ware .....	1435
Novelle Advanced Network 286/Ethernet .....	3800
Novelle Advanced Network 286/G-NET .....	2700
Novell Network Server 286A-30Mb .....	6600
Vanilla Token Ring Network 8088-2 .....	1275

ORDERS TAKEN FROM UK GOVERNMENT BODIES — EDUCATIONAL ESTABLISHMENTS —

COMPANIES EXPORT ORDERS UNDERTAKEN LEASING AND H.P. ARRANGEMENTS. PRICES SUBJECT TO CHANGE WITHOUT NOTICE



OPEN 9.00AM TO 5.30PM MON THRU FRIDAY AND 9.30AM TO 12.15PM SATURDAY



WE MOVE SERVICE NOT BOXES — Please add VAT to all prices

# Computers by Post

**LOWEST U.K. PRICES GUARANTEED**



## PRINTER RIBBONS



		2+	5+	12+	
ACORN	AP80	£2.70	£2.20	£2.00	
	AP100	£2.70	£2.20	£2.00	
AMSTRAD	DMP1	£3.90	£3.30	£3.10	
	DMP2000/3000	£4.40	£4.10	£4.00	
	PCW8256/8512	£4.30	£4.00	£3.80	
BROTHER	HR5	£3.00	£2.80	£2.60	
	HR15 Corr	£2.90	£2.50	£2.30	
	HR15 FAB	£3.30	£2.90	£2.60	
	HR15 MS	£3.20	£2.80	£2.50	
	HR15 also for HR25/HR35				
CANON	EP44	£2.90	£2.50	£2.30	
	M1009	£3.40	£2.90	£2.70	
	PW1080A Black	£3.10	£2.60	£2.40	
	PW1080A Red or Blue	£4.50	£4.10	£3.80	
	PJ1080 Ink Jet Colour. One Off			£10.90	
	PJ1080 Ink Jet Black. One Off			£8.90	
	1515	£2.70	£2.20	£2.00	
	1525	£2.70	£2.20	£2.00	
	MPS801	£3.60	£3.00	£2.80	
	802/1526	£3.70	£2.90	£2.70	
	803	£3.40	£2.90	£2.70	
	MPS1000	£2.70	£2.30	£2.10	
4022	£2.70	£2.30	£2.10		
MSC801 Colour. One Off			£18.50		
DPS1101 SS	£2.40	£1.90	£1.75		
DPS1101 MS	£2.90	£2.50	£2.30		
DPS1101 Corr	£1.80	£1.50	£1.40		
CENTRONICS	GLP 1/2	£3.40	£2.90	£2.70	
CITIZEN	120D	£5.00	£4.60	£4.30	
DAISYSTEP	2000 MS	£3.10	£2.60	£2.40	
	2000 FAB	£4.90	£4.20	£4.00	
EPSON	MX/FX/RX80 Black	£2.70	£2.30	£2.10	
	MX/FX/RX80 Red or Blue	£3.90	£3.20	£3.00	
	100 Series	£3.70	£3.30	£3.00	
	LX80/LX86	£2.70	£2.30	£2.10	
	JX80 Colour. One Off			£18.50	
	LQ800	£3.70	£3.30	£3.10	
JUKI	LQ1000	£4.50	£3.90	£3.60	
	6000/2200 MS	£4.00	£3.60	£3.40	
	6000/2200 Corr	£3.10	£2.70	£2.50	
	6100 MS	£2.90	£2.50	£2.30	
	6100 SS	£2.40	£1.90	£1.75	
	6100 Corr	£1.80	£1.50	£1.40	
	KAGA	KP810 Black	£3.10	£2.60	£2.40
		KP810 Red or Blue	£4.50	£4.10	£3.80
M/TALLY	MT80	£3.70	£2.90	£2.70	
	80/82	£1.40	£1.10	£1.00	
	84	£3.90	£3.40	£3.20	
OKI	Mate 20 Colour	£7.00	£6.50	£6.20	
	Mate 20 Black	£6.60	£6.20	£6.00	
PANASONIC	Dot Matrix	£5.00	£4.60	£4.30	

		£3.10	£2.60	£2.40
QUENDATA	DWP1120 MS	£4.90	£4.20	£4.00
	DWP1120 FAB	£2.80	£2.30	£2.10
	Sprint 7/9 MS	£4.00	£3.70	£3.40
GUME	SP1000	£6.00	£5.50	£5.20
	GP50	£2.70	£2.20	£2.00
	GP80	£2.60	£2.20	£2.00
	GP100/250	£3.90	£3.30	£3.10
	GP500/550			£18.50
	GP700 Colour. One Off			£18.50
SEIKOSHA	SP1000	£6.00	£5.50	£5.20
	CP80	£3.70	£2.90	£2.70
	Fostext 80 (Twinpack)	£11.70	£11.20	£10.90
	TPI M/5	£5.70	£5.25	£4.95
	TPI Fabric	£5.00	£4.70	£4.50
	D100/200	£4.80	£4.40	£3.90
	D300	£6.00	£5.50	£5.30
	DP/GEMINI/SG	£1.40	£1.10	£1.00
	SR15	£4.90	£4.50	£4.30
	NL10	£5.40	£4.70	£4.40

## DISK STORAGE



MODEL	SIZE	CAPACITY	PRICE
DD40L	3 3/4" 5"	40	£8.50
GS100	3.5"	100	£13.90
DD50	5 1/4"	50	£8.90
DD100	5 1/4"	100	£11.70
LIBRARY CASE	5 1/4"	10	£1.50
<b>NON-LOCKABLE DISK BOXES</b>			
MD12/30	3 3/4" 5"	24	£7.20
MF50	5 1/4"	50	£8.00

## COMPUTER STATIONERY



PLAIN WHITE WITH MICRO-PERF EDGES	PRICE
<b>SIZE</b>	<b>QUANTITY</b>
11 x 9 1/2	60
11 x 9 1/2	70
EXACT A4	70
11 3/8 x 9 1/2	90

## LASER PRINTER CONSUMABLES

TONER CARTRIDGES		
Epson GQ3500	£18.50	Canon A1/A2 £74.95
Oki Laserline 6	£18.50	Canon A8 Mk II £84.95
HP Laserjets	£74.95	QMS K8 £74.95
HP Laserjet Mk II	£84.95	Citizen Overture £22.95

## FLOPPY DISKS



5 1/4"		BOXES OF 10 DISKS		
JVC inc Plastic Case		1-2	3-9	10+
MD-1D	S/side D/dens 40TR	£9.99	£9.50	£9.25
MD-2D	D/side D/dens 40TR	£11.99	£11.50	£11.25
MD-2DD	D/side Q/dens 80TR	£15.99	£15.50	£15.25
MD-2HD	D/side H/dens 1.6MB	£26.99	£25.99	£25.49
<b>MEMOREX</b>				
MD-2D	D/side D/dens 40TR	£11.99	£11.50	£11.25
MD-2DD	D/side Q/dens 80TR	£15.99	£15.50	£15.25
MD-2HD	D/side H/dens 1.6MB	£26.99	£25.99	£25.49
<b>VERBATIM - DATALIFE</b>				
MD525	S/side D/dens 40TR	£11.60	£11.00	£10.60
MD550	D/side D/dens 40TR	£14.80	£14.00	£13.60
MD577	S/side Q/dens 80TR	£14.99	£14.75	£14.49
MD557	D/side Q/dens 80TR	£19.50	£19.00	£18.60
MD HD	D/side H/dens 1.6MB	£27.99	£26.99	£25.99

FUJI \*S/side D/dens 40TR £10.99 £10.50 £10.25  
\*D/side D/dens 40TR £13.49 £12.99 £12.75  
\*Coloured Disks - red, green, blue, beige, grey £1.00 per box extra.  
D/side D/dens 80TR £17.99 £17.50 £17.25

3 1/2"		BOXES OF 10 DISKS		
JVC	S/side D/dens	£17.99	£17.25	£16.99
SONY/FUJI	S/side D/dens	£18.99	£18.25	£17.99
FUJI/MEMOREX	D/side D/dens	£26.99	£26.50	£25.99
SONY	D/side D/dens	£27.99	£27.50	£26.99
<b>3" DISKS</b>				
CF2	5 Disks	£2.89 each	£14.45 pack	
CF2	10 Disks	£2.49 each	£24.90 pack	

## SPECIAL OFFERS ON DISKS

	20 disks	50 disks	100 disks
TDK 5 1/4" SS/DD	£8.50	£8.00	£7.50
BASF 5 1/4" SS/DD 40TR	£8.75	£8.25	£7.75
3M 5 1/4" DS/DD	£11.90	£11.50	£11.25
DYSAN 5 1/4" HD/1.6MB	£20.95	£19.95	£17.95
<b>Bulk Disks</b>			
5 1/4" SS/DD 40TR	£6.40	£5.90	£4.80
5 1/4" SS/DD 40TR	£7.40	£6.90	£5.80
5 1/4" DS/DD 80TR	£8.40	£7.90	£6.80
Life time guarantee. Disks include envelopes, labels, hub-rings and write protect.			
3 1/2" DS/DD	£18.80	£17.80	£16.80
Life time guarantee.			

## PRINTER CABLES



Amstrad CPC	Parallel	£8.90
BBC	Parallel	£6.50
IBM/Amstrad PC/Atari ST	Parallel	£14.50

## PRINTERS

Silver Reed EXP500	£159.95
Epson LX800	£192.95
Epson FX800	£299.95
Epson FX1000	£385.95
Epson EX800	£389.95
Epson EX1000	£519.95
Epson LX800	£437.95
Epson LQ1000	£584.95
Epson LQ2500	£729.95
Epson GQ3500 Laser	£1259.95
Amstrad DMP3000	£149.95
Amstrad DMP3160	£164.95
Amstrad DMP4000	£299.95
Juki 6100	£269.95
Panasonic KXP1081	£139.95
Star NL10 inc I/F	£194.95
Star NX15	£272.95
Star ND15	£342.95

## AMSTRAD 1512

Star NR15 £412.95  
Star NB24-10 £419.95  
Star NB24-15 £531.95  
Star NB15 £659.95

## LASER PRINTERS

Epson GQ3500 Laser	£1259.95
HP Laserjet Mk II Laser	£1989.95
Canon LBP Mk II Laser	£1599.95
Oki Laserline 6 Laser	£1495.95
QMS KB Laser	£1549.95
Citizen Overture Laser	£1495.95

## NEW PC1640 IN STOCK AT SPECIAL PRICES - PHONE!

**DELIVERY** All consumables and software post free Hardware £5 + VAT 4 Day Delivery £9 + VAT 24 Hour Delivery

## FAMOUS SOFTWARE BIG DISCOUNTS

MS Word 3	£239.95	Smart	£379.95
Word Perfect 4.2	£239.95	Symphony	£329.95
WordStar Professional V.4	£199.95	Ventura Publisher 1.1	£599.95
DBase 3 Plus	£319.95	Open Access II	£379.95
Lotus 123	£235.95	PFS-1st Choice	£109.95
Supercalc 4	£195.95	VP Planner	£59.95
		VP Info	£59.95

**COMPUTERS BY POST GUARANTEE** If after buying any of the hardware or software in this advertisement, you find the same item offered at a lower price locally within one week, we will refund the difference.

All prices exclude VAT

**CREDIT CARD HOT-LINE**



**01-760 0014**

Computers by Post (PCW), 14 Emmabrook Court, Sea Road, Rustington, West Sussex.

## Export Enquiries Welcome

To: Computers by Post, 14 Emmabrook Court, Sea Road, Rustington, West Sussex. I wish to order.

My computer is \_\_\_\_\_

I enclose cheque/PO for £ \_\_\_\_\_ inc VAT

or charge my Access/Visa No: \_\_\_\_\_

\_\_\_\_\_

Name \_\_\_\_\_

Signature \_\_\_\_\_

Address \_\_\_\_\_

Postcode \_\_\_\_\_ Tel No: \_\_\_\_\_

# IGNORE THE REST – WE ARE THE VERY BEST

# PiCCADILLY microS

## olivetti M28

40Mb Hard Disk  
8MHz Clock Speed  
512 RAM MSDOS  
Olivetti Monitor  
Olivetti Keyboard **£2695.00**

## olivetti M28

20Mb Hard Disk  
8MHz Clock Speed  
512K RAM MSDOS  
Olivetti Monitor  
Olivetti Keyboard **£2195.00**

## olivetti M24 SP

10MHz Clock Speed  
20Mb Hard Disk  
640K RAM MSDOS  
Olivetti Monitor  
Olivetti Keyboard **£1545.00**

## olivetti M24

20Mb Hard Disk  
Olivetti Monitor  
Olivetti Keyboard  
640K RAM MSDOS **£1395.00**

## olivetti M24

Twin Floppy Disk Drive  
Olivetti Monitor  
Olivetti Keyboard  
640K RAM MSDOS **£1095.00**

## PRINTERS

Epson FX800 160CPS & NLQ **£339.00**  
Epson FX105 160CPS & NLQ **£420.00**  
Epson LQ800 180CPS & NLQ **£475.00**  
Epson LQ1000 180CPS & NLQ **£625.00**  
Epson SQ2000 Ink Jet Printer **£1295.00**  
Brother Twinwriter 40CPS Daisywheel 160CPS Matrix **£850.00**  
Brother HR40 40CPS Daisywheel **£795.00**  
Brother M1109 100CPS & NLQ **£195.00**  
Brother M1509 180CPS & NLQ **£420.00**  
Brother M1709 240CPS & NLQ **£500.00**  
Olivetti DY300 30CPS Daisywheel **£548.00**

WE SUPPLY EVERYONE FROM LEADING UK COMPANIES, GOVERNMENT DEPARTMENTS, EDUCATIONAL ESTABLISHMENTS, LOCAL AUTHORITIES, THE COMPUTER TRADE TO SMALL BUSINESSES AND THE PRIVATE INDIVIDUAL – ANYWHERE IN THE WORLD!

## CALL US NOW – IN YOUR AREA!



EDINBURGH

031 556 9903

NEWCASTLE

091 276 6887

MANCHESTER

061 228 7965

NOTTINGHAM

0602 583716

BIRMINGHAM

021 643 5072

LONDON

01 481 3929

BRISTOL

0272 273665

## AMSTRAD

Complete systems  
Discount for quantity

PC1512DD – Mono Monitor **£559.00**  
PC1512DD – Colour Monitor **£729.00**  
PC1512HD 20Mb – Mono Monitor **£889.00**  
PC1512HD 20Mb – Colour Monitor **£1069.00**  
PCW 8256 Word Processor **£379.00**  
PCW 8512 Word Processor **£479.00**

Free UK Delivery on all  
Amstrad PC orders

Olivetti DY800 80CPS Daisywheel **£1050.00**  
NEC Pinwriter P6 **£395.00**  
NEC Pinwriter P7 **£460.00**  
Canon LBP-8A1 Laser Printer **£1995.00**  
Canon LBP-8A2 Laser Printer 1.25Mb RAM **£2995.00**  
Amstrad DMP3000 110CPS & NLQ **£169.00**

All Microsoft Packages Large Discounts

All Lotus Packages Large Discounts

All Multisoft Accounting Packages Large Discounts

## IBM ATX

30Mb Hard Disk  
512K RAM  
80286 Processor, Monomonitor,  
Keyboard and PCDOS **£2995.00**

## IBM XT 286

20Mb Hard Disk  
640K RAM  
80286 Processor, Monomonitor,  
Keyboard and PCDOS **£2175.00**

## IBM XT SFD

20Mb Hard Disk  
640K RAM  
8088 Processor, Monomonitor,  
Keyboard and PCDOS **£1450.00**

## CALL FOR PRICES ON THE NEW IBM PERSONAL SYSTEM 2

## Tandon Complete Systems

PCX 256K, 10Mb, Screen, Keyboard, MSDOS **£799.00**  
PCX 256K 20Mb, Screen, Keyboard, MSDOS **£995.00**  
PCA 20 512K 20Mb, Screen, Keyboard, MSDOS **£1495.00**  
PCA 30 512K 30Mb, Screen, Keyboard, MSDOS **£1750.00**

## SOFTWARE

DBase III Plus **£349.00**  
Framework II **£330.00**  
GEM Collection **£75.00**  
Lotus 123 **£249.00**  
MS Word 3 **£249.00**  
Multimate Advantage **£275.00**  
Multiplan II **£125.00**  
Olitext **£125.00**  
Psion Exchange **£199.00**  
SMART Software **£395.00**  
Symphony **£349.00**  
Wordstar 2000 **£236.00**  
Sidekick for Amstrad **£25.00**  
Relflex for Amstrad **£55.00**  
Superkey for Amstrad **£25.00**

# PiCCADILLY microS

Piccadilly Micros, 9 Grosvenor Terrace, Broad Street, Birmingham B15 9AU. Telephone: 021 643 5072

★ 12 months warranty ★ 7 day money back guarantee ★ Next day del. available  
★ On site maintenance contracts available ★ Finance plans available

All prices exclude VAT and delivery and are correct at going to press. Piccadilly Micros reserve the right to vary prices without prior notice.  
Trade enquiries welcome. Additional discounts for bulk orders.

# FAMOUS HIGH ST NAME: £3/4 MILLION CLEARANCE

## COMPAQ



### TAPE STREAMER

Compaq internal tape streamer, 10mb, easily fitted, for Deskpro. Takes DC 1000 cassette **£150**

- \*HP150 Wordstar ..... £100
- \*HP150 Mailmerge ..... £75
- \*HP150 Multiplan ..... £65
- \*HP150 128k ram upgrade .. £100
- \*HP150 256k ram upgrade .. £135
- \*IBM Brainstorm ..... £25
- QED+ for Apricot & IBM .. £95
- \*Micropro Planstar ..... £35
- \*ABC programme generator . £75
- Brother HR25 RS232 & Cent . £195
- \*HP150 Pertmaster ..... £95
- Apple IIc inc monitor as new . £350
- Delta 4 ..... £195

## MAC SOFT

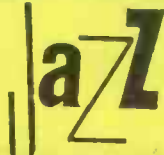

**MACINTOSH JAZZ PACKAGE**  
Software from Lotus, inc word processing, spreadsheet, database, comms, (NEW) **£100**

## NLQ PRINTER



**BROTHER M1109 PRINTER**  
100 cps draft mode, 25 cps NLQ. Epson & IBM codes, inc tractor feed, (NEW) **£150**

## WP PACKAGE



**IBM DISPLAYWRITER II**  
Industry std. WP software - used in many office environments worldwide (NEW) **£50**

## 5mb HARD DISK



**FLOPPY DISK PRICE**  
5mb full height internal hard disk for IBM, BBC. Controller extra, tested (DEMO) **£50**

Part exchanges accepted.

## IBM PRINTER



### IBM QUIETWRITER

IBM Quietwriter model 1 produces better than daisywheel printout fraction of noise **£450**

## IBM 512k PC



**EX SHOWROOM MODELS**  
Min spec 2 X 360k floppy, Dyneer mono mon, 512k, IBM kbd, DOS, basic & manuals. **£695**

## PLOTTER

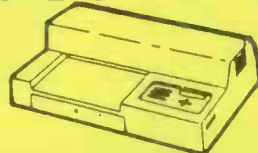

**HP 7550A PLOTTER**  
Hewlett-Packard 8 pen A3 plotter. RS232 and HB-IB i/f. (NEW, manuals) **£2500**

- Apple 20mb hard disk demo . £595
- \*HP150 internal printer ..... £95
- \*IBM Displaywrite II ..... £50
- \*IBM Displaywrite III upgrade . £75
- HP 40mb internal hard disk . £500
- V22 Quattro modem ..... £295
- Assorted acoustic hoods ... £125
- \*IBM Writing assistant ..... £35
- \*IBM Filing assistant ..... £35
- Dataproducts DP55 ..... £395
- \*IBM Planning assistant ..... £35
- 10md hardcard for IBM ..... £195
- Brother Twinriter ..... £495

## BULK STORAGE



**TALLGRASS 20mb+ 20mb**  
external 20mb hard disk plus 20mb tape backup includes interface card & software **£450**

## APPLE MAC



**EX-DEMONSTRATION AREA**  
Apple Macintosh models from 128k to Mac plus, inc software & manuals, (DEMO) from **£595**

## LAPTOP



### DATA GENERAL/One

Industry-standard MS-DOS, full size screen, 4 1/2 kilos, inc case, software, (DEMO) **£495**

## COMPAQ



### COMPAQ PORTABLE

IBM compatible, minimum spec 512k, twin floppies, printer card, diags, manuals, (DEMO) **£750**

## HP 150



**HEWLETT PACKARD 150**  
Complete system inc terminal, dual floppies, keyboard and manuals, (DEMO) from **£695**

## TOP QUALITY



**DYNEER DAISYWHEEL 36**  
Takes 15 inch paper, 36 cps, tractor feed and sheetfeeder as optional extra, (DEMO) **£150**

## COMPAQ



**COMPAQ PORTABLE II**  
IBM compat, 512k, 2x360k, 80286 processor, 9" text & graphics mon (DEMO) **£1200**

- Quadjet 4 colour, 80 Col printer £195
- HP150 Programmers tool kit . £95
- Apricot Easy Junior V2.2 .... £95
- \*dBase III C tools ..... £95
- HP150 Lotus 123 ..... £150
- Tandon AT compatible 20Mb . £1195
- Lotus Symphony version 1 . £125
- Olivetti M24 2 X 360k, 640k . £625
- Mountain 20mb hard card .. £395
- HP 110 external drive ..... £250
- Ventura desktop publishing . £350
- Amstrad PCW 8256 inc printer £250
- Brother HR 35 serial ..... £295

- Fujitsu DPL 24C colour printer £795
- Ricoh 1300 parallel printer .. £250
- \*Epson SQ-2000 sheetfeeder £150
- Fujitsu DPL 24,288 cps, 96 NLQ £495
- \*Gem Collection software ... £45
- Brother 2420L dot matrix ... £395
- V21 acoustic coupler ..... £25
- \*Epson Taxi mouse & Software £75
- IBM Wheelprinter ..... £495
- Qume Letterpro 20 RS232 ... £225
- Crosstalk for IBM ..... £75
- IBM pro graphics monitor ... £1000
- IBM pro graphics adaptor ... £300

## KIMTRON



### 3 USER SYSTEM

Uses your AT or compat. Includes card, 2 Kimtron terminals, software installation. **£695**

## FAST DAISYWHL



**LATE MODEL RICOH 1600**  
60 cps office quality daisywheel printer. Double daisy-wheel 100+ ctrs, (DEMO) **£350**

## PORTABLE 286



**COMPAQ PORTABLE 286**  
IBM compatible, 640k, 1 X 1.2mb floppy, 20mb hard disk, printer card, (DEMO) **£1750**

## MODEM



**PC COMMUNICATIONS**  
Missing Link internal modem for IBM. Ideal electronic mail, Prestel etc. Auto-dial. **£150**

## HP LASERJET



**HP PART NUMBER 2686**  
Hewlett Packard laserjet printer, RS232 inc cartridge & A4 tray, mans, (DEMO) **£1150**

\* indicates brand new goods

# Morgan Computer Co.

ACCESS AND VISA ACCEPTED  
PRICES SUBJECT TO 15% VAT  
MAIL ORDER (CARRIAGE EXTRA)

179 TOTTENHAM COURT ROAD, LONDON W1. 01-636 1138

OPEN MONDAY TO SATURDAY  
PRICES SUBJECT TO CHANGE  
GOODS SUBJ. TO AVAILABILITY





Q: DO YOU WANT A COMPUTER  
WITH MORE PERFORMANCE  
OR DO YOU WANT TO SAVE  
MONEY?



A: YES.

At Tandon we've always thought you can have the best of both worlds.

And to prove it we're cutting the price of three of our advanced range even further.

The PCA20 is down to £1,795. The PCA30 has fallen to £2,095. And the PCA40 now costs only £2,395.

But you won't simply be buying high-powered computing at low-powered prices.

You'll be buying a micro that's compatible with the reliable, familiar, established industry standard.

To find out more fill in the coupon.

It could answer all your questions on computers.

Please send me more information on Tandon's low price, high quality PCA Range. Tandon (UK) Ltd., Freepost, Redditch, B97 4BR. Telephone: (0527) 46800.

Name \_\_\_\_\_

Job Title \_\_\_\_\_

Company/Address \_\_\_\_\_

\_\_\_\_\_

Postcode \_\_\_\_\_ Tel \_\_\_\_\_

Nature of Business \_\_\_\_\_

No. of Employees \_\_\_\_\_

No. of installed PCs \_\_\_\_\_

**Tandon**  
PCWS

Lotus

# Get the best for less at Ness

ARABIC VERSIONS  
AVAILABLE  
EXPORT ORDERS WELCOME

**THE  
NEW PC 386**  
FROM  
**£2995**



**THE NESS SUPER XT  
TURBO 20MB £795**

- NEC V20 Super processor
- switchable 4.77/8 mHz clock
- 20MB hard disk
- 1 x 360K floppy drive

**THE NESS SUPER AT  
TURBO 20MB £1395**

- a true 10 mHz computer
- switchable 6/8/10 mHz
- 20MB hard disk
- 1.2MB half height floppy

**FEATURES FEAT  
URES FEATURES**

- 100% industry compatible
- high performance
- quality build
- top-grade components
- fully supported by NESS technicians
- stand-alones or systems
- installation and after-sales engineering
- wide range of upgrades available
- many peripherals in stock
- comprehensive software
- satisfaction or money back in 14 days

**THE NESS  
SUPER  
PC-386T**  
**£2995**

- Intel 80386 processor
- up to 2MB RAM on mother board
- fast 16 mHz clock
- 1.2K floppy drive
- full AT compatibility



★ 30MB, 40MB, 80MB AND MORE UPGRADES AVAILABLE

**ALL NESS COMPUTERS COME WITH THE FOLLOWING  
AS STANDARD:**

- |                                       |                               |
|---------------------------------------|-------------------------------|
| ● professional keyboard               | ● high-resolution 12" monitor |
| ● parallel and RS232 serial ports     | ● full set of manuals         |
| ● clock/calendar with battery back-up | ● 8 x expansion slots         |
| ● monographic and printer cards       | ● 12 month guarantee          |



**ADDITIONAL OVERSEAS AGENTS REQUIRED**

**NESS INDUSTRIES LIMITED**

38-40 Upper Clapton Road, London E5 8BQ

Telex: 261840 NESS G Fax: 01-806 2743

**PHONE: 01-806 1072/8904**

**AT  
COMPATIBLE**  
FROM  
**£995**

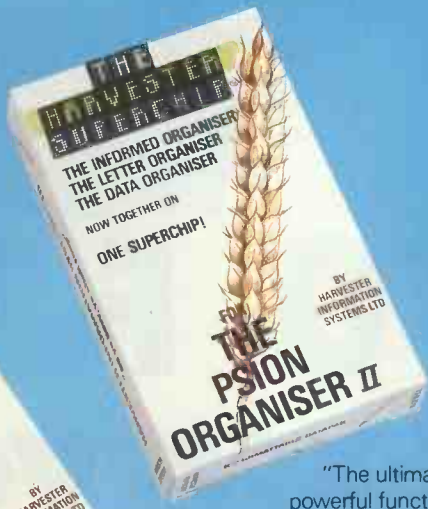

"The ultimate chip . . . all the powerful functions of the Letter Organiser, Data Organiser and Informed Organiser cleverly grafted onto one Superchip!"



" . . . the word processor for people on the move. The work is done by the time you return to the office . . . no tape for the audio typist to type . . . no messy handwritten notes to decipher . . . download and print for drafts or export to PC. Wordprocessor for final polishing . . ."



"Smartest address book yet . . . sorts into alphabetical order on surname or company name, selective printing and categorising and lots more . . . Toolkit for data file and data pack management. Indispensable . . ."



"A standard others will seek to emulate . . . simply fantastic. Uncomplicated and quick to use for anyone who needs facts at their fingertips. Up to 16 prompts, 238 characters per record, any file length subject only to available storage, sorts alphabetically or numerically, comprehensive selective print features and much, much more."



" . . . teaches you to use the Psion Organiser keyboard naturally . . . makes typing information into the Organiser II quicker and easier. It's a lot of fun too! . . ."

Helps to make typing information into the Psion Organiser II quicker and easier . . . It's a lot of fun too!

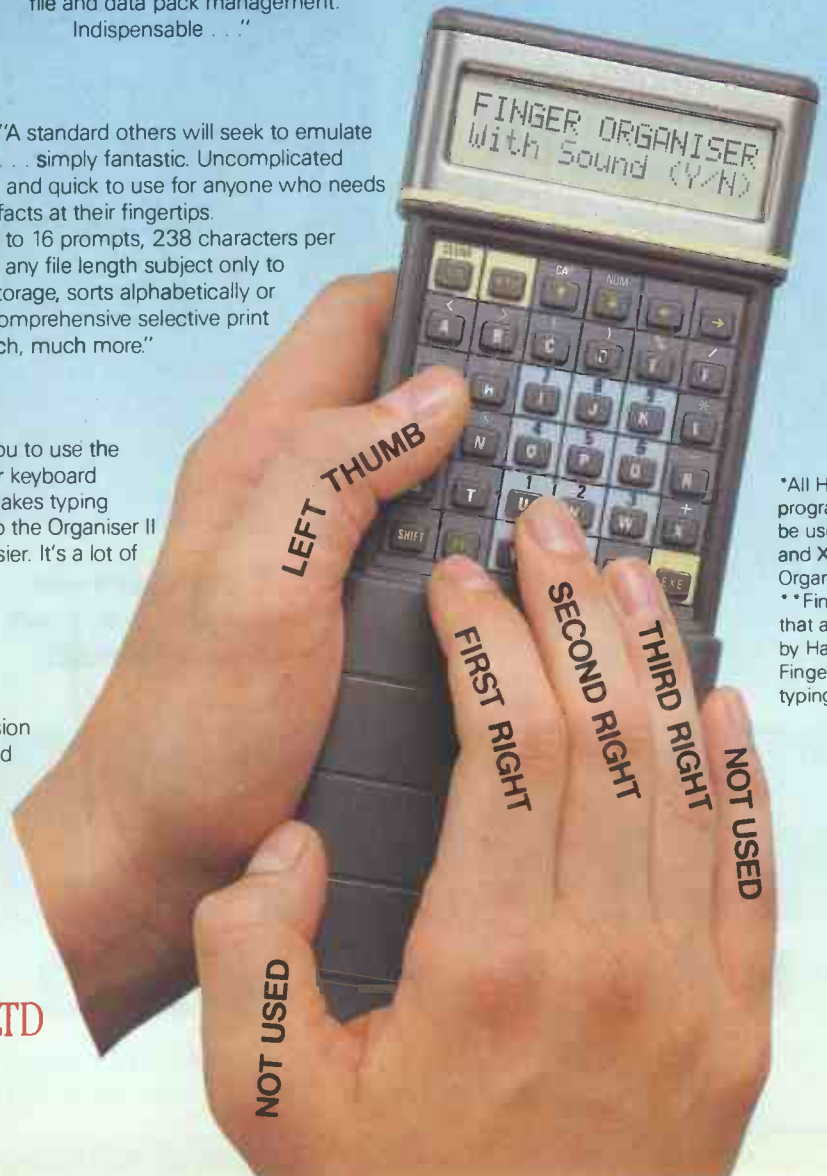

\*All Harvester programs can be used on CM and XP Organiser II's.  
\*\*Fingering is that advocated by Harvester's Finger Organiser typing method.

by  
**HARVESTER INFORMATION SYSTEMS LTD**

"as ye sow, ye shall reap"

Available from your local Psion stockist

# DIGITASK

## SOFTWARE Massive Discounts

### DATABASE

CARDBOX +	325	268
CLIPPER COMPILER	595	343
DBASE III+	595	365
DATAEASE	545	469
DELTA PROFESSIONAL	495	328
PARADOX	550	390
Q & A SYMANTEC	250	159
R-BASE 5000	295	208
RAPIDFILE	275	198
REFLEX	100	57
REFLEX WORKSHOP	70	57
SAGE RETRIEVE	99	71
SSI DATA	195	169
VP INFO	65	61

### WORD PROCESSORS

LOTUS MANUSCRIPT	395	237
MULTIMATE	375	193
MULTIMATE ADVANTAGE II	495	285
PFS PROFESSIONAL WRITE	189	169
PFS WRITE	115	99
SAGE PC WRITE	99	71
TURBO LIGHTNING	70	47
VOLKSWRITER III	325	187
WORD III	425	243
WORDCRAFT	475	309
WORD PERFECT	425	244
WORDPERFECT LIBRARY	149	124
WORDSTAR	295	144
WORDSTAR 2000	465	229
WORDSTAR 2000 +	549	269
WORDSTAR PROFESSIONAL	399	193

### DTP/GRAPHICS/CAD

ALDUS PAGEMAKER	CALL	
AUTOCAD	2500	CALL
CHARTMASTER	295	221
EASY CAD	353	251
FASTCAD	2525	CALL
FONTASY	80	67
FRELANCE +	320	289
HARVARD PRESENTATION GRAPHICS	295	219
PUBLISHERS PAINTBRUSH	225	162
VENTURA DESKTOP PUBLISHING	795	469
VUTRAX PCB DESIGN	CALL	

### OTHER

COPY II PC	50	38
COPY II PC OPTION BOARD	90	74
DESQVIEW	98	67
FLIGHT SIMULATOR	45	34
GEM COLLECTION	130	73
GEM DRAW +	130	119
GEM GRAPH	180	123
GEM PROGRAMMERS TOOLKIT	450	369
GEM WORDCHART	130	83
LIGHTNING (CACHE) Copy Protected	70	94
LIGHTNING (CACHE) Non-copy Protected	99	94
LOTUS MEASURE (SCIENTIFIC)	395	343
MICROCACHE Non-copy Protected	125	119
NORTON UTILITIES	85	52
S/KICK (PROTECTED)	50	38
S/KICK (TRAVELLING)	70	48
S/KICK (UNPRDTECTED)	70	43
S/KICK (TRAV) & S/KICK NCP	109	89
SAGE DESK SET	69	49
SAGE PC CHART	99	89
SIDEWAYS	50	34
SUPERKEY	70	47
V-FEATURE	95	89
V-FEATURE DELUXE	125	119
VCN CONCORDE	550	495
WINDOWS (MICROSOFT)	85	57

### SPREADSHEETS

JAVELIN	595	343
LOTUS 123	395	227
LOTUS HAL	120	81
MULTIPLAN	175	107
NOTE IT	69	59
SAGE PC PLANNER	99	71
SOZ	69	55
SUPERCALC IV	396	192
VP PLANNER	75	61

### PERSONAL PRODUCTIVITY

ABILITY	99	67
ABILITY +	159	103
EXCEL (MICROSOFT) FOR MAC	395	345
FRAMEWORK II	550	297
LOTUS SYMPHONY	550	319
PFS FIRST CHOICE	149	113
SMART	695	398
SMART SPELLCHECKER	95	87
SUPERPROJECT +	495	297
WORKS (MICROSOFT) FOR MAC	245	219

### ACCOUNTS

ACCOUNTABILITY	99	68
DAC EASY ACCOUNTS	85	79
MULTISOFT ACCOUNTS (PER MODULE)	390	270
SAGE ACCOUNTANT	149	110
SAGE ACCOUNTANT +	199	143
SAGE BOOK-KEEPER	99	71
SAGE FINANCIAL CONTROLLER	299	216
SAGE PAYROLL	99	71

### PROGRAM DEVELOPM'T & LANGUAGES

MICROSOFT C	345	245
QUICK BASIC COMPILER	85	75
TURBO BASIC	70	47
TURBO C	70	55
TURBO DATABASE TOOLBOX	50	34
TURBO EDITOR TOOLBOX	50	34
TURBO GAMEWORKS	50	34
TURBO GRAFIX TOOLBOX	50	37
TURBO HOLIDAY JUMBO PACK	165	157
TURBO PASCAL	70	47
TURBO PROLOG	70	47
TURBO PROLOG TOOLBOX	70	47
TURBO TUTOR	30	23
ZORLAND C	30	27

### COMMUNICATIONS

CROSTALK XVI	169	93
SAGE CHIT-CHAT (S/WARE)	99	71
SMARTERM VT-100	135	119
DATATALK		129

*If you don't see  
what you want call  
for more details*

We are the most consistently low priced advertiser in the UK. Our prices and products are genuine. Excellent service, totally comprehensive range and a same day delivery service\* make Digitask the best choice every time.

**PHONE 0342 24631 NOW**

or Contact Digitask, Unit M, Charlwoods Business Centre, Charlwoods Road, East Grinstead, West Sussex RH19 2HH. Telex 957418 G

\*Please call for details

OVERSEAS CALLERS WELCOME

Prices Do Not Include VAT or Carriage

# FARNHAM COMPUTERS

We are dealers for

## AMSTRAD

## Acorn

and **ATARI ST**

For your Computer,  
Software and  
Peripherals  
requirements

Call Us for Prices:

1 South Street,  
Farnham, Surrey  
Tel: 0252 723107



1040 STF+SM 125 (Mono)

£627.15

ATARI

SH 204 20Mb HARD DISC\*

£537.56

£5 for delivery

FUJI MF2DD DS/DD 3.5" DISCS\*

Box of 10 £14.95

SONY DS/DD 3 1/2" DISCS\*

BOX OF 10 £16.95

P&P included

\* While stocks last

## PYR MID

Video & Software

(Inside Osprey Business Computers)

5 The Bridge, Wealdstone

Middlesex, HA3 5AB

01-861 2407

ALL PRICES INCLUDE VAT



## KEYBOARD WIZARD?

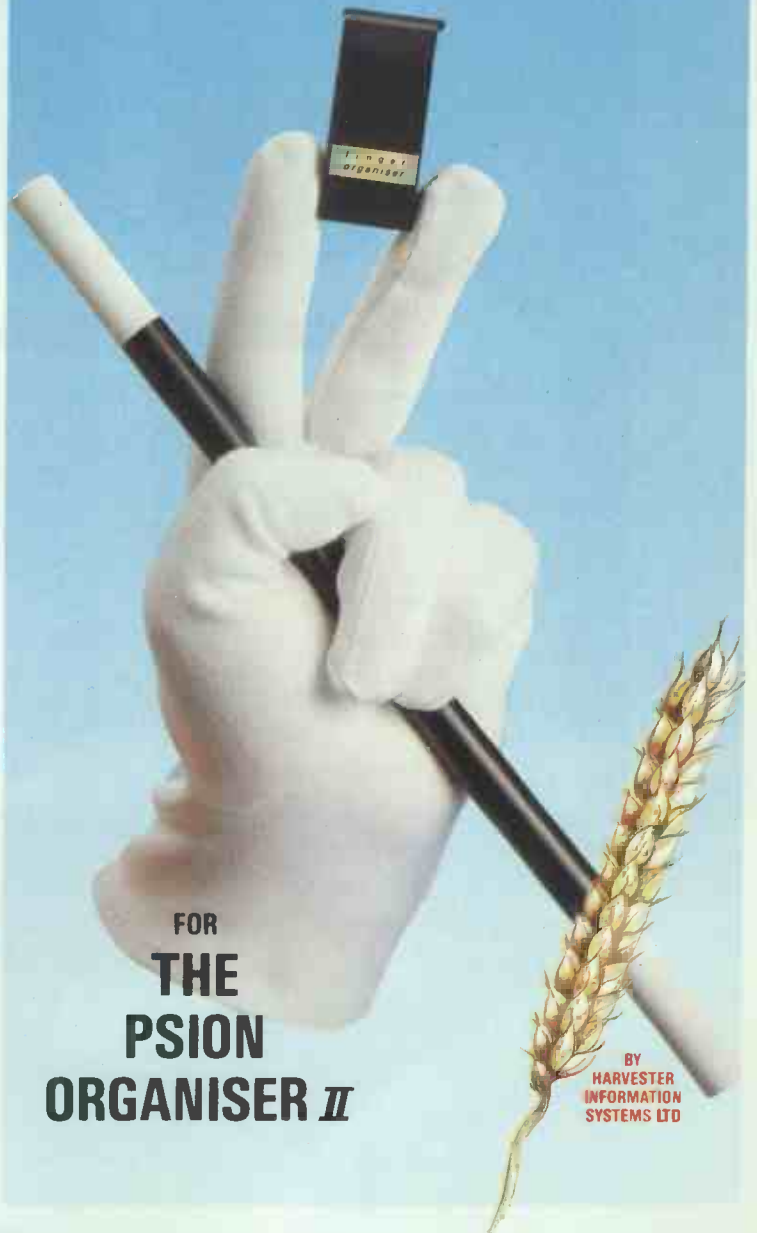

FOR  
**THE  
PSION  
ORGANISER II**

BY  
HARVESTER  
INFORMATION  
SYSTEMS LTD

# DIGITASK

## OUT OF THE BLUE

The ACER 1100 – the 386 from Multitech



SYSTEMS  
START  
FROM  
£2600

Represented in over 60 countries Multitech's commitment to research and development has yet again peaked with the introduction of the ACER 1100 series of computers.

Based around the Intel 80386 processor driven to 16MHz the 1100 is certainly one of the fastest personal computers in its class today, exceeding most of its rivals by a factor of some ten per cent. It runs over three and a quarter billion pounds worth of existing software some 300 per cent faster than a standard AT. And as a bonus tomorrow's 32 bit programs up to 1000 per cent faster than today's AT.

With 32bit architecture, unique interleaved memory and massive expansion capabilities it is very much tomorrow's technology today.

Users will find the 1100s generous memory and lightning processing speed indispensable for financial applications, CAD-CAM, CAE, AI and even software development . . . to say nothing of multiuser and server applications.

*For More Information Contact  
Digitask, Unit M, Charlwoods Business Centre, Charlwoods Road, East Grinstead, West Sussex RH19 2HH.  
Telephone: 0342 24631 Telex: 957418 G*

 **Multitech**

**XT-PC 20Mb XT Comp. — £755**

- 640 Kb
- 4.77 and 8.0 Mhz switchable
- 20 Mb
- 360K floppy
- 8 Expansion Slots
- 150 W Power
- 2 parallel and 2 serial ports
- Clock calendar

**XT-PC  
— £455**

- Single floppy
- 640 Kb
- 4.77 and 8.0 Mhz switchable
- 8 expansion slots
- 150 watt power
- 2 parallel and 2 serial ports
- Clock calendar

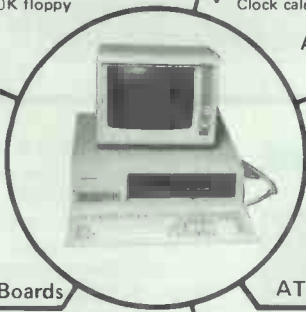

**AT 20 Mb Comp.  
— £1295**

- 6/8/10 Mhz switchable
- 640 Kb expandable to 1 Mb
- 1.2 Mb floppy
- 8 Expansion Slots
- Mono or colour graphics adaptor
- Clock calendar

**XT Add-on Boards**

- XT Colour Graphics Card . . . . . £79
- 384 Kb Multi Function Card (NILRAM) £89
- Mono Graphic Hi-Res Hercules Card . . . £79
- 1/0 + Card 2 Serial/1 Parallel . . . . . £69
- /clock calendar/Upgradable . . . . . £29
- XT Single Serial Card . . . . . £79
- PSU XT 150 W . . . . . £79

**AT Add-on Boards**

- AT upgrade EGA Card enhanced graphics adaptor . . . . . £199
- 2.5 Expansion Card . . . . . £95
- 3 Mb Multi Function Card . . . . . £199
- PSU 225 W . . . . . £145
- 20 Mb upgrade with Western Digital Controller (inc cables) . . £339

PHILIPS COLOUR MONITOR (AT/XT Comp) — £249

SERVICE AND REPAIR CENTRE FOR IBM, BBC, COMMODORE, EPSON, MICROVETIC/SOFTWARE SUPPORT  
MONITORS AND PRINTERS VERY COMPETITIVE PRICES



200 Earlsdon Avenue North  
Earlsdon, Coventry CV5 6GP  
Phone 0203 - 716126/73813

Visit our Showroom

ESTABLISHMENT AND EDUCATION ORDERS  
WELCOME

# WORLD'S SMALLEST WORD PROCESSOR O.K.?



FOR  
**THE PSION  
ORGANISER II**

BY  
HARVESTER  
INFORMATION  
SYSTEMS LTD

A PACK FOR  
C16/PLUS 4  
NOW AVAILABLE

## TROJAN CAD-MASTER

THE ULTIMATE IN GRAPHICS TOOLS

Come and see us  
at the PCW Show  
23-27 September  
Stand No. 3096/17

**SUPERB GRAPHICS SOFTWARE  
PLUS  
A TOP QUALITY LIGHT PEN**

CBM  
64

SPECTRUM

Discover the exciting world of creating your own graphics on screen.

- **FREEHAND DRAW** - 5 pen thicknesses inc. Quills
- **PAINT BRUSH** - for the artistic touch
- **FILL ANY SHAPE** - use 16 colours and 11 patterns.
- **GEOMETRIC SHAPES** - circles, boxes, triangles, lines & banding.
- **DYNAMIC RUBBER BANDING** on all geometric options.
- **PIN-POINT FUNCTION** - for pixel accuracy on all functions.

Plus many more too numerous to mention in this ad. All these features in the Program + a top quality Light Pen and an instruction booklet in one reasonably priced package. Easy to use for creating colourful pictures or technical drawings. Ideal for use by all ages of micro users. Full back-up service from manufacturers: Available at good dealers or direct from Trojan Products.

Please state which Micro.

ONLY  
**£19.95**  
per pack



## TROJAN

Micro Computer Software & Accessories  
Send cheque/P.O. to:  
**TROJAN PRODUCTS**  
Dept Y. Com. 2, 166 Derlwyn, Dunsant,  
Swansea SA2 7PF Tel: (0792) 205491  
TRADE ENQUIRIES WELCOMED

# TECHNOMATIC

17 Burnley Road, London NW10 1ED Tel: 01-208 1177  
305 Edgware Road, London W2 Tel: 01-723 0233

## INTEGRATED PACKAGES

Smart V 3.10	£359(a)
Framework II V 1.1	£325(a)
Symphony V 1.2	£329(a)
Open Access II V 2.0	£375(a)
Open Access V 1.03	£235(a)
Lotus 1.2.3	£239(a)

## WORD PROCESSORS

Wordstar Professional V 4.0	£210(a)
Wordstar 2000 plus Rel 2	£269(a)
Wordstar	£165(a)
Microsoft Word V 3.10	£249(a)
Microsoft Word Junior	£49(b)
Multimate Advantage	£269(a)
Word Perfect V 4.2	£239(a)
Word Perfect Personal	£159(a)
Word Perfect Junior	£79(b)

## DATABASE

dBase III Plus V 1.1 unpr.	£395(a)
Quicksilver - Compiler dBase III	£365(a)
Clipper - Compiler dBase III	£365(a)
Genifer - App. Gen. dBase III	£199(a)
Paradox V 1.1i	£365(a)
Delta 4 Professional	£429(a)

## SPREADSHEET

Supercalc 4	£219(b)
Farsight	£99(b)
Javelin	£359(a)
Mathplan	£299(a)
Logistix	£95(c)

## LOTUS SERIES

Manuscript	£269(b)
Hal	£95(b)
Report Writer	£75(c)
Measure	£345(b)
Freelance Plus	£299(b)
Quickcode	£49(c)
Spot Light	£52(c)
Metro	£65(c)

## META i

Assembler/Disassembler/Emulator handles the following CPU's.  
6500 family, Z8X family  
6800 family, 808X family  
Emulator for all single rail eproms up to 27512 Full details on request. **£695(a)**

## ARCHIMEDES

Please send for details on Acorn's latest 32 bit Super Fast RISC Computer.

## AMSTRAD PCs

### PC1512

SDMM (Single Drive Mono Monitor)	£429(a)
DDMM (Dual Drive Mono Monitor)	£529(a)
SDCM (Single Drive Col. Monitor)	£589(a)
DDCM (Dual Drive Col. Monitor)	£699(a)
HD20-M (Hard Disc 20Mb, Mono)	£849(a)
HD20-C (Hard Disc 20Mb, Col.)	£1019(a)

Call us for details of Amstrad summer special offers. Enquire about 1640.

### CO Processors

8087-5MHz	£120 (c)	8087-8MHz	£160 (b)
8087-10MHz	£199 (b)	80287-6MHz	£160 (b)
80287-8MHz	£245 (b)	80287-10MHz	£299 (b)
V-20 5MHz	£10 (b)	V-30 5MHz	£10 (b)
V-20 8MHz	£12 (b)	V-30 8MHz	£12 (b)

### AT Interface Cards

EMS Card 4Mb OK	£169(b)
(incl Ser/Par Ports) 2Mb	£349(b)
Dual I/O Card - 1 Par/1 Ser Port	£69(c)

## BUSINESS SOFTWARE

### ACCOUNTING SOFTWARE

Accountability	£99(b)
Sage Book Keeper	£85(b)
Sage Accountant	£125(b)
Sage Account Plus	£160(b)
Sage Financial Controller	£269(b)
Sage Payroll	£85(b)

### PROFESSIONAL CAD

Autosketch	£79(d)
AutoCad Basic V 2.6	£300(a)
AutoCad ADE1 2&3 V 2.6	£2500(a)
Pro-Design II V 2.5	£245 (b)

### DESKTOP PUBLISHING

Ventura Publisher	£749(a)
Pagemaker	£595 (a)
Fleet Street Editor	£199(b)
GEM Collection	£89(b)

### SUMMER SPECIALS

Microsoft Mouse V 6.02 (Bus or Serial)	£129(b)
Borland Turbo C	£65(b)
Borland Turbo BASIC	£55(b)

### BORLAND SOFTWARE

Reflex Ver 1.1	£85(b)
Reflex Workshop	£55(b)
Turbo Pascal BCD/8087	£55(b)
Turbo Tutor	£22(b)
Turbo Prolog	£55(b)
Turbo Prolog Toolbox	£55(b)
Turbo Lightning	£55(b)
Lightning Word Wizard	£39(b)
Turbo Editor Toolbox	£39(b)
Turbo Graphix Toolbox	£39(b)
Turbo Database Toolbox	£39(b)
Turbo Numerical Toolbox	£55(b)
Eureka The Solver	£55(b)
Sidekick	£52(b)
Traveling Sidekick	£52(b)
Superkey	£52(b)
Turbo Gameworks	£39(b)
Turbo Holiday Jumbo Pack	£149(b)

### INTERFACE CARDS

for IBM PC/XT & Compatibles

#### Auto Switch 560 Card

The 560 card recognises EGA, CGA, Monographics adaptor and Hercules Software. It automatically switches modes to suit the application software. 256K Video memory. Flicker free scrolling in all modes. dip switches on external edge to configure for a particular monitor

#### EGA Board

\* Multimode card including all the capabilities of IBM, EGA, Hercules mono card, IBM colour and mono card.

#### Monochrome Graphics Card

£65(b)

#### Colour Graphics Card

£59(b)

#### 2Mb Multifunction Card

for AT OK RAM £169(b)

with 2Mb

#### Multi I/O Card

\* Parallel/Serial Ports £179(b)

\* Battery backed calendar/clock. £79 (b)

#### RAM Card with 384K

(Expandable to 512K). £86 (b)

## LANGUAGES & O.S.

MicroSoft Basic Interpreter	£245(b)
MicroSoft Quick Basic V 3.0	£65(c)
Microsoft Pascal Compiler	£190(b)
Microsoft C Compiler V 4.0	£235(a)
Microsoft Cobol Compiler	£399(a)
Microsoft Macro Assembler	£92(b)
Microsoft Windows V 1.03	£72(c)
Digital Research C Compiler	£249(b)
Digital Research Fortran 77	£249(a)
Digital Research Level II Cobol	£470(a)
Digital Research Assm. & Tools	£169(b)
Zorland C	£29(d)
Zorland C - Power Pack	£59(c)
Learning DOS	£24(c)

## COMMUNICATIONS

Datataalk (inc. Prestel) V3.27	£129(d)
Crosstalk XVI	£95(d)
Sage ChitChat V2.2	£85(d)
Dial-up Personal	£78(c)

## PROJECT MANAGEMENT

Super Project Plus	£325(a)
PertMaster	£475(a)
PertMaster & PertPlotter	£525(a)
MS Project	£245(a)

## BUDGET SOFTWARE

Ability V 1.2E	£59(c)
Psion PC-Four	£65(c)
VP Planner	£65(c)
VP Info	£65(c)
WordStar 1512	£59(b)
dBase II 1512	£95(b)
Delta 4 1512	£85(b)
Supercalc IV 1512	£59(b)
Sidekick 1512	£29(c)

## UTILITIES

Norton Utilities V 4.0	£55(c)
Copy II PC	£40(c)
Fastback	£165(c)
Xtree V 2.0	£49(c)

## MISCELLANEOUS

MS Flight Simulator	£42(c)
Psion Chess	£29(c)

### RS232 Serial Card

Short slot card with option for 2nd port £35(c)

Extra for 2nd port £16

### Parallel Interface Port

Short slot card, Epson/Centronics compatible £19(c)

## POINTING DEVICES

### Logimouse (Serial)

£89 (b)

### PC Compatible Witty Mouse

Plugs into serial port, adaptor for parallel conn. to k/bd. MS software compatible. £79 (b)

### RB2/Cad 5 Tracker Ball

£175(b)

## NETWORK ADAPTORS

Economical interlink between IBM PC, XT, AT and compatible including Amstrad PC1512.

### TRANSNET Starter Pack

Links two stations with adaptors, cabling, NETBIOS and easy to use menu driven software. £399 (a)

Transnet Pack for additional station. £225 (b)

Ask for full details



MAIL ORDER  
RETAIL  
7 Burnley Road  
London NW10 1ED  
Tel: 01-208 922800  
WEST END BRANCH  
205 Edgware Road  
London W2

Visit our  
Edgware Road shop  
for demonstrations.

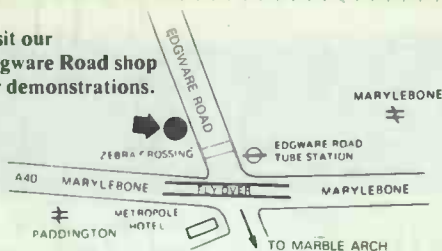

For fast delivery telephone  
your order on 01-208 1177  
using VISA/Access Card



Orders welcome from  
government depts &  
educational establishments

All prices ex VAT.  
All prices subject  
to change without  
notice. E & O accepted.  
Please add carriage  
(a) £8.00 (Datapost)  
(b) £2.50 (c) £1.50  
(d) £1.00

## SICON AT TURBO

### Fastest AT with 80286-12 CPU

The first AT with Dynamic Speed  
Control for full time 12.5MHz operations  
on CPU and memory.  
Auto Speed switching allows use  
of conventional add-on cards.

#### System Spec:

30286-12 CPU, 12.5/8 MHz modes, 1Mb Ram.  
30287 Socket 8 Expansion Sockets  
Mono or Colour Graphics Adaptor  
1 x 20 Mb Winchester, 1 x 1.2 Mb floppy,  
Real Time clock with battery back up,  
200W Power Supply, 1 Parallel/1 Serial Port,  
AT Style Keyboard



**SICON SAT01 £1195(a)**

## SICON PC/XT TURBO

3088-8 cpu, 8/4.77 MHz Modes, 640K Ram  
3087 Socket, 8 Expansion Slots,  
Mono or Colour Graphics Adaptor,  
2 x 360K floppies for PC,  
1 x 360K floppy + 1 x 20 Mb  
Winchester for XT  
Real Time Clock + battery back up  
1 Parallel/1 Serial/1 Games Port  
150W PSU/AT Style Keyboard



**£469(a)  
£675(a)  
£55(b)**

## SICON PC TWO TURBO SICON XT TWO TURBO

MS-DOS with GW BASIC (Available only when purchased with Sicon)

## PRINTERS

### DOT MATRIX PRINTERS:

#### EPSON PRINTERS:

**LX800** £229 (a)  
**FX800** £315 (a) **FX 1000** £439 (a)  
**EX800** £409 (a) **EX 1000** £595 (a)  
**LQ800** £439 (a) **LQ1000** £609 (a)  
**GQ 3500 Laser Printer** £1700 (a)  
**Taxan KP815** £269 (a)  
**Taxan KP915** £369 (a)

**National Panasonic KX P1081** £159 (a)  
**Star NL 10 with IBM Interface** £209 (a)  
**Amstrad DMP3000 Printer** £159 (a)

### DAISY WHEEL PRINTERS

**Juki 6100** £310 (a)  
**Brother HR20** £349 (a)  
(Parallel & Serial Interface)

**National Panasonic KX P3131**  
with 38K buffer £249 (a)  
**Integrex Inkjet Colour Printer** £549 (a)  
**IBM EGA/CGA dump** £45 (b)  
64 colour screen dump for Integrex.

### PLOTTERS

**Hitachi 672 A3 4 colour**  
High speed, high precision plotter  
Serial & Parallel Interface. **£495 (a)**  
We can also offer Roland & Watanabe  
plotters at competitive prices  
**IBM Type Parallel Printer Lead (2m)** £12 (d)

### SHARERS & BUFFERS

**PB 128K Buffer**  
Internal buffer suitable for most  
EPSON printers. Easy to instal.  
Instructions supplied. **£89 (b)**

#### Printer Sharers:

(All lines are switched).  
2 computers to one printer **£25 (c)** **£25 (c)**  
3 computers to one printer **£39 (c)** **£39 (c)**  
4 computers to one printer **£45 (c)** **£45 (c)**  
2 computers to 1 or 2 printers. **£49 (c)** **£49 (c)**

**Cable sets for all popular computers available.**  
External Serial/Parallel **£37.50(c)**  
Parallel/Serial converter **£37.50(c)**

A wide range of printer interfaces, sheetfeeders,  
tractor units, acoustic hoods, ribbons available  
from stock.

## WINCHESTER DRIVES

Seagate ST225 20Mb with  
Controller & Cables **£265(b)**  
Seagate ST238 30Mb with  
Controller & Cables **£299 (b)**  
Seagate ST4038 30Mb with  
Controller & Cables **£560(a)**  
Seagate ST 4051 40Mb with  
Controller & Cables **£670(a)**  
Mini Scribe 30 Mbyte  
File Card **£375(a)**

## MONITORS

### Mono 12" Composite

Philips 7502 Green **£69(a)**  
Philips 7522 Amber **£75(a)**  
Taxan KX 117 Green P31 **£85(a)**  
Taxan KX 118 Green P39 **£90(a)**  
Taxan KX 119 Amber **£90(a)**

### Mono 12" TTL

Philips 7513 Green **£85(a)**  
Taxan 123 Green P31 **£99(a)**  
Taxan 124 Amber **£109(a)**

### RGB

Acorn/Philips 14" **£195(a)**  
Taxan 620 12" **£269(a)**  
Taxan 625 12" **£319(a)**

### RGB EGA

Taxan 760 14" **£499(a)**  
Taxan 770 Multi Scan 14" **£659(a)**  
Mitsubishi 1440 14" **£479(a)**

## 3M DISC & CARTRIDGES

### Winter Olympics Offer

Thousands of prizes to be won plus entry in a  
raffle for a trip for two to the Canadian Olympics

Discs in packs of 10  
5.25" 745 48 TPI DSDD **£10.50(d)**  
5.25" 747 96 TPI DSDD **£13.25(d)**  
5.25" HD 1.6 Mb for AT **£28(d)**  
3.5" 96 TPI DSDD **£19(d)**

### Cartridges

DC1000 **£12.00(d) each**  
DC300 XLP **£16.50(d) each**  
DC600A **£18.50(d) each**  
DC2000 **£27(d) each**

We can only show a small range of the products  
stocked by Technomatic in this advertisement. If  
you would like further information, please  
indicate your interest by ticking the appropriate  
box and we will send you a brochure.

Sicon  Software  Modems  
 Printers  Monitors  BBC Systems

NAME \_\_\_\_\_  
ADDRESS \_\_\_\_\_

POST CODE \_\_\_\_\_

Return to Technomatic Ltd 17 Burnley Road,  
London NW10 1ED PCW 9/87

# DIGITASK

## ONE STOP SHOPPING AT THE BEST PRICES

### DOT MATRIX PRINTERS

	RRP	Our Price
BROTHER		
M1109 80col 100cps 25NLQ F/T P & S	220	162
M1409 110col 180cps 45NLQ F/T P & S	385	289
M1509 136col 180cps 45NLQ F/T P & S	495	353
M1709 136col 240cps 65NLQ F/T P & S (dual interface) IBM/FX	595	439
CITIZEN		
120D 80col 120cps 25NLQ F/T P	245	152
MSP-10 80col 160cps 40NLQ F/T P	349	259
MSP-15 136col 160cps 40NLQ F/T P	449	325
MSP-50 80col 300cps 60NLQ T P	525	387
MSP-55 132col 300cps 60NLQ T	695	512
EPSON		
LX-800 80col 160cps 25NLQ F/T P NEW	275	197
FX-800 80col 200cps 40NLQ F/T P	430	299
EX-800 80col 300cps 50NLQ T P	555	399
FX-1000 136col 200cps 40NLQ F/T P	550	396
LQ-800 80col 180cps 60NLQ F P 24 pin head	625	423
EX-1000 136col 300cps 50NLQ T P	745	536
LQ-1000 136col 180cps 60NLQ F P 24 p h	835	559
P-80 XS PORTABLE 80col 45cps		250
FUJITSU		
DX2100 80col 220cps 44NLQ F/T P (S OPT)	435	335
DX2200 136col 220cps 44NLQ F/T P (S OPT)	565	422
DX2300 80col 324cps T P OR S IBM/EP S comp.	625	479
DX2400 136col 324cps T P (S OPT) IBM/EP S Compatible	760	582
DL3300 80col 324cps 24 p h BI-T P IBM/EP S/D630 Compatible	710	545
DL3400 136col 324cps 24 p h BI-T P (S OPT) Compatible as 3300	825	632
MICRO-P		
MP201 132col 200cps 40NLQ F/T P	399	305
NEC		
P6 80col 216cps 72NLQ F P 24 p h	549	389
P7 136col 216cps 72NLQ F P 24 p h	649	447
OKI		
ML 182 80col 120cps NLQ F P	269	189
ML 192 80col 160cps NLQ F P	375	283
ML 193 132col 160cps NLQ F P	485	367
OLIVETTI		
DM100/4 80col 120cps 25NLQ F P	295	199
DM280/1 180col 160cps 35NLQ F/T P	466	307
DM290/1 136col 160cps 35NLQ F/T P	581	363
STAR		
NL-10 80col 120cps 30NLQ F/T P	278	197
SD-15 136col 160cps 40NLQ F/T P	489	279
SR-10 80col 200cps 50NLQ F/T P	489	279
NX-15 136col 120cps 30NLQ F/T P	389	289
NR-15 136col 240cps 60NLQ F/T P	589	399
PANASONIC		
KXP1081 80col 120cps 28NLQ	245	195
KXP1092 80col 180cps 35NLQ	395	315
KXP1592 132col 180cps 38NLQ	495	395
KXP1595 132col 240cps 51NLQ	695	473

### TOP RANGE DOT MATRIX PRINTERS

BROTHER 2024L 132col 160cps 96NLQ 24 pin head P OR S	795	635
BROTHER 4018 132col 480cps 100NLQ 67LQ IBM-EP S Compat 18 pin head	1495	1269
EPSON LQ2500 136col 270cps 90NLQ T P 24p h	1045	695
EPSON SQ2500 Ink Jet	1345	989
OKI ML84 80col 200/400cps NLQ F/T P	779	618
OLIVETTI DM600 132col 200cps 70NLQ P & S	1179	929
STAR NB 24-15 136col 216cps 72NLQ F/T P 24 p h 360d.p.i.	759	525
STAR NB 24-10 80col 216cps 72NLQ F/T P 24 p h 360d.p.i.		
STAR NB 15 136col 300cps 100NLQ F/T P 24 p h 260d.p.i.	949	679
NEC PINWRITER P5 136col 264cps 88NLQ F P 24 p h	1066	745
TOSHIBA P351/2 136col 300cps 100NLQ P & S	1099	884
FUJITSU DL 2400 136col 220cps P IBM/Diablo/EP S compat	1010	863

CLAIM YOUR FREE  
Printer Cable with every Printer  
Purchase over £400

(OFFER AVAILABLE WHILE STOCKS LAST)

### LASER PRINTERS

EPSON GQ3500 6p min LJ+/Diablo630/Pageprinter	1795	1342
AST TURBOLASER 8p min FX/Diablo/IBM/NEC/Qume	4150	3319
KYOCERA F1010 10p min LJ+/FX/Diablo/Qume NEC/IBM	2795	2348
KYOCERA F2010 10p min Dual BIN LJ+/FX/Diablo/Qume NEC/IBM	4595	3859
CENTRONICS PP8 8pm S OR P FX/Diablo/IBM	1595	1339
CENTRONICS PP8 8pm LJ+	1995	1675
CANON LBP8 MARK II 8pm S & P Epson/Diablo	2195	1813
CANON 1X-12 SCANNER (Without Interface)	850	702
MANNESMAN TALLY MT910 10pm Dual Bin P OR S	3290	2717
OKI LASERLINE 6 6pm LJ/FX/Diablo/Qume/NEC	1899	1568
CITIZEN OVERTURE 110 10pm FX/Diablo	1995	1556
QUME LASER 10+ 10pm LJ+ FX/Qume/IBM	2683	2216
H.P.LASERJET 8pm LJ+	2618	2162
OLIVETTI PG101 8pm Diablo/Epson/LJ	3203	2499
H.P.LASERJET 500+	3995	3299

### DAISY WHEEL PRINTERS

BROTHER		
HR20 117col 22cps F P & S (dual i/face)	445	327
HR25XL 132col 25 cps F P & S (dual i/face)	695	529
HR35 132 col 20cps F P	995	699
JUKI		
6000 80col 12cps F P	199	147
6100 132col 20cps F P	399	259
6200 132col 30cps F P	579	397
6300 132col 40cps F P	899	660
6500 132col 60cps F P	1299	997
OLIVETTI		
DY450/1 132col 45cps F P Diablo compat	1140	799
DY800/2 132col 80cps F P & S (dual i/f)	1483	1059
FUJITSU		
SP 320E 48cps P Diablo compat quiet	999	766
QUME		
11 80col 40cps (without i/face) P OR S	1210	956
12 80col 20cps	450	355
RICOH		
3200Q 30cps 7K P D630 compat	445	367
3400Q 50cps 7K P D630 compat	995	821
DATAPRODUCTS DP20 136col 20cps S	445	200

### COLOUR PRINTERS

OLIVETTI		
DM 285/1 80col 160cps 35NLQ F/T P JX compat	555	415
DM 295/1 132col 160cps 35NLQ F/T P & S (dual i/face) JX compat	707	526
DM 590/1 132col 192cps 120NLQ F P JX/Qume/Diablo compat	1137	846
TOSHIBA 351C 136col 288cps 100NLQ F P & S IBM compat	1475	1130
FUJITSU DL 2400 180cps LQ60 24 p h P & S IBM/FX80/JX80 compat	1135	870

### PLOTTERS

EPSON HI-80 4 pen A4	400	345
HP 7440A 8 pen A4	1160	985
HP 7475A 6 pen A3	1796	1469
HP 7550A 8 pen A3	3813	3399
ROLAND DXY 880A 8 pen A3	775	645
ROLAND DXY 980A 8 pen A3	1100	924

### MICE & DIGITISING TABLETS

LOGIMOUSE & SOFTWARE (SERIAL)	99	77
LDGIMOUSE & SOFTWARE (BUS)		83
MICROSOFT MOUSE (bus or serial)		133
MOUSE SYSTEMS MOUSE + PC PAINT		145
GENIUS MOUSE		55
SUMMASKETCH 12 x 12 W. CURSOR		425
SUMMASKETCH 12 x 12 & GEM DRAW		569
SUMMASKETCH 9 x 6 & GEM DRAW		479
CHERRY A3 GRAPHICS TABLET		455
GRAPTECH A4 NEW		546

If you don't see what you want call for more details

We are the most consistently low priced advertiser in the UK.

Our prices and products are genuine. Excellent service, totally comprehensive range and a same day delivery service\* make Digitask the best choice every time.

# PHONE 0342 24631 NOW

or Contact Digitask, Unit M, Charlwoods Business Centre, Charlwoods Road,  
East Grinstead, West Sussex RH19 2HH. Telex 957418 G

\*Please call for details

OVERSEAS CALLERS WELCOME

Prices Do Not Include VAT or Carriage

## COMPUTERS (Inc Monitor + Keyboard)

DIGITASK PC16X STARTER SYSTEM XT compat. Single 360KB floppy drive	499
DIGITASK PC16X FULL FEATURE SYSTEM XT compat. dual 360KB floppy drive	695
DIGITASK PC16X BUSINESS PRO SYSTEM XT compat. 20 MB hard drive, 1 x 360KB floppy	879
DIGITASK PC16X BUSINESS PRO PLUS SYSTEM XT compat. 20 MB hard drive, 1 x 1.2MB, 1 x 360KB floppy drive	1069
DIGITASK AXIOM SILVER 286 AT compat. single 1.2MB floppy drive, 1 MB RAM	1165
DIGITASK AXIOM GOLD 20 AT compat. 1 x 1.2 MB floppy, 20MB hard drive	1275
DIGITASK AXIOM GOLD 20 EGA. AT compat. 1 x 1.2MB floppy, 20MB EGA Monitor + EGA Contr. NEW	1799
DIGITASK AXIOM GOLD 40 2 x 20MB H/D 1 x 1.2MB floppy	1589
DIGITASK PORTABLE STARTER as per PC16X STARTER SYSTEM (9" TTL internal monitor)	699
DIGITASK PORTABLE FULL FEATURE	779
DIGITASK PORTABLE BUSINESS PRO	965
DIGITASK PORTABLE BUSINESS PRO PLUS	1135
DIGITASK PORTABLE AXIOM SILVER as AXIOM 286 above (9" TTL internal monitor)	1155
DIGITASK PORTABLE AXIOM GOLD 20	1375
DIGITASK PORTABLE AXIOM GOLD 40	1575
MULTITECH ACER 1100 386 SYSTEMS FROM TAILORED SYSTEMS OUR SPECIALITY. OTHER CONFIGURATIONS PLEASE CALL.	2600

## WINCHESTER DRIVES

20MB H.H.T SEAGATE ST225 (65ms)	195
30MB H.H.T SEAGATE ST238 + Rll Contr. & Cables XT only	295
40MB H.H.T SEAGATE ST251 (40ms)	448
80MB H.H.T QUANTUM SC551 Drive & Contr. + SW (12ms)	999
44MB H.H.T SEAGATE M60553 (28ms)	576
30MB F.H.T SEAGATE ST4038 V.COIL (40ms)	435
40MB F.H.T SEAGATE ST4051 (40ms)	525
72MB F.H.T SEAGATE M6085 (28ms)	773
80MB F.H.T SEAGATE ST4096 (28ms)	999
WD/NCL XT Hard Drive Controller & Cables NCL SHORT CONTROLLER (up to 16MHz) FDD/HDD for AT	169
AT HARD DRIVE Cable set	12
XT HARD DRIVE Cable set	12

## TAPE STREAMERS

XR4 40MB Internal streamer XT & AT	468
XR4 40MB External streamer XT & AT	576
XR4 DRIVER BOARD for External streamer	85
ARCHIVE 3540 40MB Internal streamer (XT or AT)	499 389
CRISTIE THE REEL ONE 1020i 20MB Internal streamer	695 559
EVEREX STREAM-20 20MB Internal streamer	895 585
EVEREX STREAM-60 60MB Internal streamer (XT OR AT)	1295 815
QIC-125 Fast Prof 125MB b.up Novell, 3COM comp	1499 1349

## T-SWITCHES & BUFFERS

T-SWITCH Parallel 1-2 (or serial 1-2)	35
INTELLICOM LONGLINK Parallel to parallel inc 50ft cable (up to 7000ft)	149 135
UPGRADE TECH BUFFER 64KB P-P stand alone	140 119
UPGRADE TECH BUFFER 256KB P-P stand alone	256 219
UPGRADE TECH BUFFER Half Megabyte Dual Channel full feature stand alone	395 335
UPGRADE TECH BUFFER One Megabyte Dual Channel full feature stand alone	495 419

## EGA MONITORS

NEC MULTISYNC 14" Hi Res TTL/Analog EGA/IBM/CGA/PGA 0.31 Dot	649	579
PHILIPS CM8873 MULTISYNC 14" Hi Res TTL IBM/RGB/RGBI CGA/ EGA/PGA	499	425
TAXAN SUPERVISION 660 12" Hi Res TTL/EGA	549	389
TAXAN SUPERVISION 760 14" Hi Res TTL/EGA	579	409
TAXAN SUPERVISION 860 16" Hi Res TTL/EGA	899	699
THOMSON 4470D 14" Hi Res TTL/ IBM/EGA/CGA	495	419
THOMSON 4270M MULTISCAN 14" Super Hi Res TTL/IBM/MDA/CGA/ EGA/PGA 0.31 dot NEW	669	559
<b>EGA &amp; MONITOR COMBI</b>		
TAXAN K14SV760 14" SUPERVISION 760 MONITOR Non Glare, High Contrast 21.85/15.75KHz/Paradise AUTOSWITCH EGA-MDA, CGA, Hercules compat	649	
PACKARD BELL MONITDR + ADAPTOR EGA, CGA, MDA COMPAT	559	
PRINCETON 12" & AST 3G EGA card, MDA, CGA, Hercules compat	575	

## COLOUR MONITORS

TAXAN SUPERVISION II 12" Hi Res IBM/RGB	389	265
TAXAN SUPERVISION III 12" Ultra Res IBM/RGB	459	309
TAXAN SUPERVISION IVm 12" Hi Res IBM/OL/RGB	499	349
TAXAN SUPERVISION IV 12" Ult Res IBM/OL/RGB	579	409
THOMSON 36512VP1R 14" Med Res TTL- RGB/RGBI/PAL Comp 0.48 dot	261	225
THOMSON 36382SIR 14" Hi Res TTL/ RGB/RGBI 0.38 dot (inc cable)	385	329

## MONO MONITORS

SAMSUNG SM 125F 12" Amber, Med Pers, Hi Res TTL/IBM With T & S	139	95
TAXAN KX-1201 12" Green comp P31 Short Pers	109	85
TAXAN KX-1202 12" Green comp P39 Long Pers	119	89
TAXAN KX-1203 12" Amber comp PUL Long Pers	119	95
TAXAN KX-1212 12" Green Hi Res P39 Long Pers TTL/IBM	149	109
TAXAN KX-1213 12" Amber Hi Res PUL Long Pers TTL/IBM	149	109

WYSE 700 (1280 x 800)	895	779
GENIUS A4 (736 x 1008)	1649	1475

## MAINBOARDS

SUPER TURBO XT 4.77/8 MHz (up to 640K - with OK)	149
SMALL FOOTPRINT PC/AT comp 6/8/10 MHz (OK)	499

## SPECIAL OFFERS

SEAGATE ST238 30 MB H.H.T + Controller	575	295
INFOREM MULTIFUNCTION CARD 640 KB Max Pop. to 384KB, Comms 1, Comms 2 opt. 1P, 1G, 1C, SW	195	95
IBM PC-ATE 512KB Ram, 1.2 MB K Board	3467	2295
2MB Above Function Card Fully Populated Z-NIX TURBOMOUSE SERIAL XT ONLY	385	357

## DIGITASK PERIPHERALS

576K Rammaster Expansion Card (OK)	59	
640K Multifunction Card (OK) 1P, 1S, 1G, 1C, SW	97	
2MB Above Function Card (OK) 1P, 1S, 1G, 1C Multi I/O Adapter 1P, 1S, 1G, 1C, 2F1, SW	179	
Multi I/O Adapter & Display Adaptor 1P, 1S, 1G, 1C, 2F1, CGA, MGA, LP, SW	95	
8255 I/O Card	159	
Async Comms Adaptor (dual port) 2S	89	
Async Comms Adaptor (1 port)	39	
4 Port Multi Async Comms Adaptor 4S	27	
Clock Adaptor	119	
Games Adaptor	47	
PSIO-XT Short Multifunction Adaptor 1P, 1S, 1C, ISW	24	
Floppy Drive Adaptor (4 drive) 4FL	99	
Floppy Drive Adaptor (2 drive) short 2FL	65	
360/1.2 MB Floppy Adaptor (XT)	54	
Diamond (D10-500) I/O card (AT)	79	
Diamond (D10-300) I/O card (XT)	89	
Colour/Graphics Adaptor	79	
Colour/Graphic Printer Adaptor RGB, 2 comp LP	79	
EVA-480 Graphics Adaptor, EGA, HGC, CGA, MDA	129	
Mono/Graphics (Hercules Compat) card	829	
Parallel Printer Adaptor	87	
4 Bank eprom Programmer/Analyser	18	
PCP-128 TO 128K SW	259	
Eprom Eraser	149	
FDD/HDD Controller for PC/AT	129	
Serial/parallel card (AT)	249	
Copy Board	69	
40 Track Disk Duplicator	99	
Sine Wave Uninterrupted Power Supply for 1.8KVA	979	
Sine Wave UPS for 1000VA	1995	
Sine Wave UPS for 750VA	1499	
Sine Wave UPS or SUPS for 500VA	1249	
Sine Wave UPS or SUPS for 300VA	495	
Trans Net TR001	395	
Trans Net Utility S/W	299	
	99	

DEALER ENQUIRIES WELCOME

## BRANDED PERIPHERALS

<b>RAM EXPANSION</b>	
AST ADVANTAGE OK 1S, 1P (AT only) upgradeable to 3MB	349
AST ADVANTAGE PAK OK (up to 1.5MB) PC/XT	119
AST RAMPAGE (2MB) pop to 256K XT	199
AST RAMPAGE 286 (2MB) pop. to 512K AT	449
AST RAMVANTAGE with 128K (upgradeable to 3MB) for PCAT	369
AST SIXPACK PLUS 64KB, 1C, 1S, 1P (upgradeable to 384K)	249
AST SIXPACK PREMIUM 512KB, C, 1S, 1P, (EMS)	329
INTEL ABOVE BOARD XT	249
INTEL ABOVE BOARD AT	395
INFOREM 256K ramcard (256K pop) (128K for AT)	109
PERSYST PC/short memory board (OK pop) to 384K	95
PERSYST MEGA memory AT/XENX up to 3MB (OK pop)	289
PERSYST STRETCH (Lotus/Intel/MS) up to 2MB(OK pop)	219
EVEREX Mini Magic 60K pop up to 576K	85
EVEREX RAM 3000 AT (OK pop) up to 3MB	219
EVEREX RAM 2500 AT (OK pop) up to 2.5MB	199
EVEREX Magic Card AT 1P, 1S, WS. (OK pop) up to 2MB	259
INTEL INBOARD 386/AT OK	1131
INTEL INBOARD 386/AT 1MB	1450
<b>NETWORKS</b>	
AST-PC NET II (RSN 34 PCS more with repeaters 5Mbps)	345
3-COM	CALL
IRMA Emulators & Accessories	CALL
CHASE AT-8 8MHz 32K Ram 32K Rom 50-38400 Baud 8 port serial intell controller using 80186 PC/AT-ATE-ATX Xenix 5/concurr PCDOS-5 comp with drivers	1099
<b>GO-FASTER BOARDS</b>	
AST FLASHPAK (NEC V30 at 9.45MHz)	289
INTERQUADRAM QUADSPRINT	329
MAYNARD SURPRISE TURBO (state PC or compatible)	189
MOUNTAIN RACECARD 80286	459
ORCHID TINY TURBO	439
ORCHID TURBO EGA	499
ORCHID PC-TURBO 186 with 256K	699
ORCHID JET 386 PC/AT upgrade up to 3 x faster! NEW	799
ORCHID TURBO PGA	949
TITAN ACCELERATOR PC 512K	729
TITAN ACCELERATOR PC 256K	659
<b>DISPLAY ADAPTERS</b>	
VIDEO SEVEN VEGA DELUXE	264
AST 3-G EGA, card 256K, MDA, Herc, CGA & EGA compat	218
AST COLOURGRAPHPLUS (full spectrum) 32KB, 1P	159
EVEREX THE EDGE Mono/Colour 80/132col, Lotus/Symphony compat	319
EVEREX GRAPHIC EDGE as above with graphics	339
ORCHID EGA, (MDA, CGA & Hercules compat)	233
TAXAN KIF3810 IBM comp (640 x 400 dots)	229
TAXAN KIF 3800 IBM CGA comp supervision IV/IVM 840	145
TAXAN KIF3650SP IBM CGA MDA, Herc comp (short) 1P	169
TAXAN KIF3600SP IBM CGA compat (short) 1P	119
HERCULES PLUS CARD	178
HERCULES COLOUR CARD	94
HERCULES Monochrome/GR Adaptor	145
<b>OTHER</b>	
RADCOM BAR CODE READER	449
ADDONICS SERIAL/PARALLEL CARD for AT	89
ADDONICS MULTI-ASYNC CARD for AT (4 port)	195
BROTHER 3.5" FLOPPY DRIVE for PC/XT (INTEGRAL PSU)	159

## RAM CHIPS & PROCESSORS

INTEL 8087 (8087-3) 5MHz math co-processor chip (PC/XT)	97
INTEL 8087-2 8MHz math co-processor chip (TURBO PC/XT)	139
INTEL 80287-6 5MHz math co-processor (PC/AT Apricot)	149
INTEL 80287-8 8MHz math co-processor (PC/ATX Apricot)	220
INTEL 80287-10 10MHz math co-processor	289
NEC V-20 FAST PROCESSOR (8088 equiv.)	14
NEC V-30 FAST PROCESSOR (8088 equiv.)	14
SAMSUNG 4164 DRAM CHIP 150ns (set of 9)	9.50
SAMSUNG 41256 DRAM CHIP 150ns (set of 9)	25
SAMSUNG UPGRADE 256KB - 640KB	42.50
SAMSUNG ONE MEGABYTE CHIP SET (144 x 4164) or (36 x 41256) multiples of 1MB only	99

## PC/XT/AT HARDWARE

POWER SUPPLY 135/150 max Watt Switch Mode XT	89
AT Keyboard replacement (84 Key)	109
MITSUBISHI FLOPPY DRIVE 360KB Half HT	69
MITSUBISHI FLOPPY DRIVE 1.2MB for PC/AT	125
FLOPPY DRIVE 360KB Half HT DS/DD (Grey front) for AT	95
GREAT COMMUNICATOR 1.2 floppy drive w contr cables ROM S/W XT	179
KEYBOARD K-150M AT-Style for XT (84 Key)	89
CASE PC/XT Swingtop (Incl hardware kit)	55

VISA

ALL VISA AND ACCESS  
CARDS ACCEPTED



THE QUALITY PACKAGE IN 32 BIT COMPUTING

# HI SPEC 80386 PC

## STANDARD FEATURES INCLUDE

- INTEL Motherboard and 32 Bit RAM
- PARADISE Display Adaptor - EGA, CGA  
-Monochrome compatible
- Enhanced Key Board
- 1.2 MB Floppy Drive
- Clock Calender
- Choice of Monitors

FROM

**£2295**

## INCLUSIVES

### ALL SYSTEMS SUPPLIED WITH

**3 YEARS ON-SITE**  
Maintenance and  
Support contract

**PC MOS 386**  
PC DOS Compatible,  
Multi Tasking, Multi  
User, operating system

Hard Drives from 20 MB. Internal Tape Drives recommended

For orders and enquiries or to discuss custom specified systems, contact:

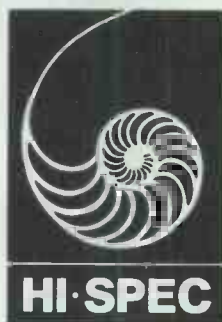

Hi-Spec Systems Limited  
Brettenham House, 5 Lancaster Place, London WC2E 7EN

Telephone: 01-379 5562

**BONDWELL MASTER DEALER**  
OFFICIAL DEALERS ★ AMIGA ★ AMSTRAD ★ ATARI

**COMPUTERS**

Commodore AMIGA 2000 1Mb RAM & Col Mon	1395.00	Commodore 1301 Col 14"	260.00
Commodore AMIGA 500 + Deluxe Paint	451.30	Philips 8833 14" col RGB/Comp Med Res	251.30
Commodore AMIGA 500 + 1081 Col Mon	720.87	Philips 8M7502 Green 12" Comp Video + sound	72.00

Amstrad PC1512 Series incl ON-SITE

**MAINTENANCE**

Amstrad PC1512 DDM + OMP3000 + Wordstar

1512 + Supercalc 3	639.00	Ataria 0.5 Mb Disk Drive	119.00
Atari 1040STF Mono System	539.00	Atari 1 Mb Disk Drive	159.00
Atari 520STFM Mono System	385.00	Atari 20 Mb hard Disk	559.00
Atari 520STFM	309.00	Supra 20 Mb hard disk for Atari	503.48
Atari 520STM + Disk Drive, Mon, mouse & 1st Word	359.00	Cumana CSA354 1Mb Disk Drive for Atari ST	123.00
Atari 520STM including Mouse	199.00	Cumana CDA358 2 x 1Mb Dual Drive for Atari ST	209.00
Bondwell 8s Laptop 512k Drive SuperTwist LCD	849.00	Scribe card 30Mb PC Disk Drive on a card	339.00
Bondwell 18 Transportable 640k Ram dual 5.25" drives	649.00		
Bondwell 38 Professional PC 4.77/8 Mhz	599.00		
Bondwell 38 with 20 Mb Winchester	950.00		

**PRINTERS**

Citizen 120D dot Matrix 120/25cps	164.35	PEP Smart Printer Buffer 256kb	99.95
Citizen 120D for Commodore 64/128	169.57	PEP Smart 2-Printer Switch	89.95
Commodore DPS1101 Daisywheel	155.65	PEP Smart 4-Computer Printer Sharer	129.95
Okimate 20 Ribbon Transfer Colour Printer	159.00	PEP Printer Networks and Cables	PHONE
Okimate 20 for Amigo	173.04	PC Multifunction Card—RS232 + Clock/calendar	86.95
SBC TP180-9 Dot Mat 180/36cps	199.00	PC Monographics Card	86.95
Star NL10 (various interfaces) 120/25cps	207.83	Surge Protector 13amp Plug or Adapter	10.39/13.00

**MONITORS**

Atari High Res Mono Monitor	119.00		
Atari Med Res Colour Monitor	319.00		

Please add 15% VAT to above prices  
CARRIAGE £8, EXPRESS DELIVERY £12, Software & Small Items FREE.

**Delta Pi Software Ltd**

8 Ruswarp Lane, WHITBY, N. Yorks. YO2 1ND.  
Tel: 0947 600065 (9am-7pm)

**COTSWOLD PRESS LIMITED**

**Desktop Publishing Bureau**

- From Macintosh or IBM disks
- All major programmes supported
- 24 hour turnaround
- Full range of Adobe Fonts
- High quality output on Linotype 300
- Modem service available
- IBM to Macintosh disk conversions
- Full training and advisory service.

**VENTURA BUREAU**

**Typesetting**

- Cotswold Press are a conventional typesetting house, using Linotype equipment with a full page-make-up system.
- Most major word processing programmes are being supported.

**Hardware**

- We can supply full IBM AT Compatible Systems with full training on software and hardware.

For further information contact: Kaye Morrison or Pierre Macke.  
Cotswold Press Limited,  
Stanton Harcourt Road, Eynsham, Oxford.  
Telephone: Oxford (0865) 880608.

**NTS Group**

Call 031-220 1115  
or 01-581 3556



Made in Japan.  
Best quality.

**NTS PC-8MHz**

From **£399**  
only

Spectacular low cost IBM compatible entry level system. Full 640K RAM, dual RS232C and parallel printer interface. NEC V20 processor dual clock speed 4.77/8.00 MHz, one 360K floppy drive. Hercules compatible. AT style 84 key keyboard. Free PC-Write word processing software. Full 12 months parts/labour warranty—unbeatable. Call now!



NEC V20-8MHz

**NTS XT-8MHz**

From **£705**  
only

Amazing Amstrad beater, fast NEC V20 dual 4.77/8.00 MHz processor, 20 Mb hard disc, one 360K floppy drive, dual RS232 ports and parallel printer port, 640K RAM, AT style 84 key keyboard. Hercules compatible graphics, 12" high resolution TTL monochrome monitor with tilt-swivel base. Free PC-Write word processing software, PC—Calc spreadsheet, PC-File III database. Games disc and hard disc utilities.



80286-12  
Norton SI 13.9

**NTS AT286-12**

From **£895\***  
only

We think that this is the fastest AT on the market, with Dynamex speed control it will run most applications at 12 MHz. Clock speed with 0 or 1 wait states, one 1.2 Mb floppy drive, one fast access 20 Mb hard disc, dual RS232 ports and parallel printer port. 101 key enhanced keyboard, full 1 Mb RAM 12" high resolution TTL paper white, green or amber monitor.

\* Zenix V version with 10 I/O ports available for £2,475. Handles up to six concurrent users—call for further details.



80386-16

**NTS AT386-16**

From **£1,995\***  
only

A fast 80386 based mini-computer with 20, 40 or 80 Mb hard disc, one 1.2 Mb floppy drive, dual RS232 and parallel printer ports, 12" paper white, green or amber monitors.

\*Unix system 5 available with up to 16 I/O ports supporting up to 10 concurrent users, call for further details.

**HOW TO ORDER**

Order with confidence, 7 days money back guarantee, full 12 months part/labour warranty. Call 031-220 1115 (Edinburgh) or 01-581 3556 (London) for further details or mail cheque/Postal Order with coupon to: NTS Ltd. Access and Visa welcome. All prices exclude VAT at 15% and carriage of £6 ex VAT per order. Personal callers by appointment only. Generous discounts to dealers and Education. On-site maintenance available UK-wide.

Ref PCW/0907

Name .....

Address .....

Tel No ..... (Day)

Please send: .....

Price inc VAT and carriage £ .....

Mail to:

NTS Ltd or NTS Ltd

Head Office: London Office:

9 St Colme Street 1 Elystan Place

Edinburgh EH3 London SW3

Tel 031-220 1115 Tel 01-581 3556

# The new Cherry 1000. Multi-functional Keyboard. Compatible with PC, XT and AT Systems.

For AT03, XT286 and  
386 Systems.  
Interchangeable  
between PC, XT SFD/SDD  
and AT02 Modes  
via sliding Switch.  
Also for Use  
with Terminals.

#### The main Advantages of the Cherry 1000:

- US version (101 keys).
  - International versions for European countries (102 keys).
  - International symbols "ASCII" according to DIN 66003 and 66303.
  - Superior Cherry MX keymodules with gold-crosspoint contacts.
  - 4mm full travel keyswitches.
  - Tactile feel optional.
  - Mechanically strong construction.
  - Low profile design, minimum height.
  - 2-shot moulded keycaps, wear resistant, in "cylindrical style" keylayout.
  - With housing and cable.
  - IBM\*-overlay fits onto housing.
  - Height of 3rd keyrow < 30mm, according to latest ergonomic requirements.
  - Separate cursor pad.
  - N-key rollover.
  - LED-indicators show selected mode.
  - Electro Magnetic Compatibility: ESD 15kV; RFI: VDE/FCC, Class B.
  - Safety: VDE 0806, ZH 1/618.
  - Reliability: MCBF =  $1 \times 10^9$  operations, MTBF = 20 000 hours.
  - Long life of each keymodule:  $> 50 \times 10^6$  operations.
- Send today for further technical details!

\* IBM ist the registered Trademark of the International Business Machines Corporation.

# CHERRY



## New Generation Keyboards.

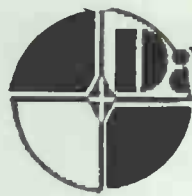

# Da Vinci Computers Ltd

## OFFER

# THE ULTIMATE SUPPORT SERVICE FOR YOUR NETWORK OR STAND ALONE SYSTEM

Whether your system is based next door or half way around the world, our unique support solution will give you the most instant online help facilities available today. A simple device allows our technical support personnel instant access to your system to solve your urgent problems. You retain full visual and physical control on the system which is also secured by full password protection.

Our methods are proven and have become invaluable to all our customers who have joined our scheme. You can even use our system to communicate with your other branches or offices whatever the distance. Furthermore, this service is complimented by our own hardware maintenance division?

*We are the main suppliers of the following:*

**IBM — Compaq — Victor — Toshiba Token-ring — Ethernet —  
GNET — Arcnet — Snet Netware — Open Access — Pegasus —  
DBase III + all major affiliated products.**

**For Further details of our unique support solution, contact:**

**Da Vinci Computers Ltd.**  
112 Brent Street, Hendon,  
London NW4 2DT. UK

Tel: 01-202 2272  
Tlx: 265871 (MONREF G) &  
refer to 81:MMD102  
Fax: 01-202 4982  
Telecom Gold: 81:MMD102

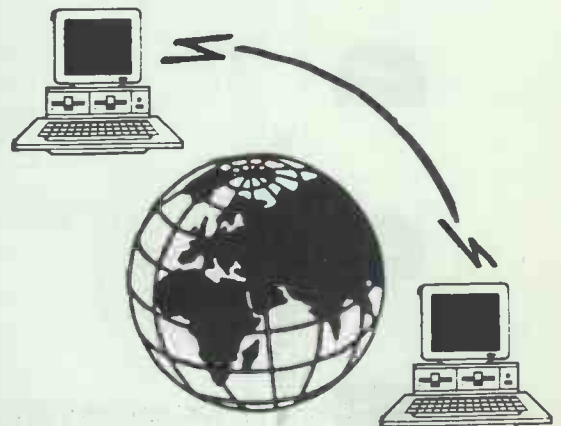

### Further Cherry Input Systems:



The new Cherry 2000.  
IBM compatible. With card reader,  
barcode reader, mouse.



The new Cherry Graphics Tablet Mk.2.  
Stretching the limits of creativity.



The new Cherry VoiceScribe 1000.  
speech recognition system for voice  
command of IBM/XTs, PC-ATs  
& compatibles.

SAME DAY DELIVERY SERVICE AVAILABLE\*



SAME DAY DELIVERY SERVICE AVAILABLE\*

# M O D E M S E L E C T O R

MANUFACTURER	MODEL	SPECIFICATION	DESCRIPTION	AUTO ANS	No. STORE	AUTO DIAL	ERR CORR	AUTO SENSE	BUFF IFACE	PULSE TONE	AUTO LOG ON	RRP	OUR PRICE
ANSWERCALL	MINIMODEM	V21	Simple direct connect modem									(75)	59
DACOM	DSL 2123AD	V21, V23	Mainstay of Dacom range	Y		HAYES	Y	Y	Y	BOTH		(255)	195
DACOM	DSL 2123GT	V21, V23	Fully buffered to 5600 intelligent	Y	Y	HAYES	Y & EPAD	Y	Y	BOTH	Y	(386)	359
DACOM	PC123	V21, V22, V23	Latest IBM multispeed internal	Y		HAYES	Y & EPAD	Y	Y	BOTH		499	359
DACOM	PC123BIS	V21, V22, V22BIS, V23	Latest IBM high speed internal	Y		HAYES	Y & EPAD	Y	Y	BOTH		699	549
INTERLEKT	PORTMAN	V21, V23	Reliable no frills modem	Y					OPT			173	139
INTERLEKT	PROSPECT	V21, V23	Reliable no frills modem									125	99
MIRACLE	WS2000	V21, V23	Low cost manual modem	OPT		OPT		Y	Y	BOTH		108	89
MIRACLE	WS3000 2123	V21, V23	Cost effective multispeed	Y	Y	HAYES		Y	Y	BOTH		295	235
MIRACLE	WS3000 22	V21, V22, V23	Cost effective multispeed	Y	Y	HAYES		Y	Y	BOTH		495	365
MIRACLE	WS3000 22BIS	V21, V22, V22BIS, V23	Multispeed top of Miracle range	Y	Y	HAYES		Y	Y	BOTH		690	519
MIRACLE	WS4000	V21, V23V22 OPT1	Budget "Hayes" multispeed	Y	Y	HAYES		Y	Y	PULSE		170	133
MODULAR TECHNOLOGY	INTERMOVER 5021	V21	Low cost compact stand alone	Y								98	79
MODULAR TECHNOLOGY	INTERMOVER 5022	V22	Low cost compact stand alone	Y								265	269
PACE	LINNET	V21, V23	Pace best selling buffered modem	Y	Y	HAYES		Y	Y	BOTH		139	119
PACE	NIGHTINGALE	V21, V23	Low cost manual modem	Y	Y	HAYES		Y	Y	BOTH		99	77
PACE	SERIES 4 2123S	V21, V23	Latest multispeed (Space Age)	Y	Y	HAYES		Y	Y	BOTH		265	224
PACE	SERIES 4 1200S	V21, V22, V23	Latest multispeed (Space Age)	Y	Y	HAYES		Y	Y	BOTH		389	339
PACE	SERIES 4 2400S	V21, V22, V22BIS, V23	Top pace range multispeed	Y	Y	HAYES		Y	Y	BOTH		499	429
MISSING LINK	BREAKOUT 2123	V21, V23 & S/W	IBM internal card & software pack	Y	Y	Y	Y	Y	Y	BOTH	Y	525	440
MISSING LINK	BREAKOUT 2400	V21, V22, V22BIS, V23 & S/W	IBM internal card & software pack	Y	Y	Y	Y	Y	Y	BOTH	Y	945	819
MISSING LINK	QUATTRO CARD	V21, V22, V22BIS, V23	Multispeed IBM internal card	Y	Y	Y	Y	Y	Y	BOTH	Y	795	665
RACAL	MPS1222	V22	Stand alone professional modem	Y		OPT		Y				625	599
RACAL	V12422	V21, V22, V22BIS	High spec PSTN multispeed	Y	Y	Y	OPT	Y		AUTO		865	819
RACAL	MPS24	V26	Synchronous leased line & PSTN	Y	Y	Y		Y		AUTO		530	509
RACAL	CP2123	V21, V23	Stand alone	Y	Y	Y		Y		AUTO		356	299
RACAL	CP2123PM & S/W	V21, V23 & SPEAKEASY	IBM internal card & software pack	Y	Y	HAYES	Y	Y		AUTO	Y	450	395
RACAL	CP2123PM	V21, V23	IBM internal card	Y	Y	HAYES		Y		AUTO		385	295
RACAL	PM22	V22	IBM internal card latest Racal	Y	Y	HAYES		Y		AUTO		495	395
DOWTY	QUATTRO	V21, V22, V22BIS, V23	Multispeed modem top Dowty range	Y	Y	HAYES	Y	Y	Y	BOTH	Y	795	POA
DOWTY	TRIO	V21, V22, V23	Intelligent multispeed	Y	Y	HAYES	Y	Y	Y	BOTH	Y	595	POA
DOWTY	DUO	V21, V23	Multispeed modem plus!	Y	Y	HAYES	EPAD	Y	Y	AUTO	Y	340	POA
DOWTY	MINIMO + 2	V21, V23	Auto Manual direct connect	Y	Y	HAYES		Y	Y	P.T.OPT1	Y	245	POA
DOWTY	SB1212	V22	UK best selling V22 stand alone	Y	Y	OPT	OPT	Y	Y	BOTH	Y	495	POA
DOWTY	TRIO CARD	V21, V22, V23	Multispeed IBM internal card	Y	Y	OPT	Y	Y	Y	BOTH		595	POA
DOWTY	SB2426	V76BIS	PSTN or LL synchronous modem	OPT		HAYES						317	POA
DOWTY	SB4827	V71	High speed Sync/Async private line									795	POA
DOWTY	SB9829	V79	High speed Sync/Async private line									995	POA
TANDATA	TM512	V21, V23	Easy to use professional modem	Y	Y	HAYES	EPAD OPT	Y	Y	AUTO	Y	255	195
TANDATA	TM602	V21, V22, V23	Cost effective reliable multispeed	Y	Y	Y		Y	Y	BOTH		465	397
THORN	VX543	V21, V23	Thorn's best selling low cost modem	Y	Y	Y	Y	Y	Y	AUTO		195	165
THORN	VX512	V21, V22, V23	New multispeed high tech modem	Y	Y	HAYES	Y	Y	Y	BOTH		389	335
THORN	VX524	V22, V22BIS	Top of the range multispeed	Y	Y	HAYES	Y	Y	Y	BOTH		499	459
LION SYSTEMS DEV	ORATOR	Call for details	Integrated speech & data comms centre									795	CALL

★ SPECIAL OFFER - FREE Chit-Chat S/W & IBM Cable with every V22, V22BIS (RRP £119) OR only £45 with every V21, V23. ★

\* Please call for details

Prices Do Not Include VAT or Carriage

# P H O N E 0 3 4 2 2 4 6 3 1 N O W

or Contact Digitask, Unit M, Charlwoods Business Centre, Charlwoods Road, East Grinstead, West Sussex RH19 2HH. Telex 957418 G



# Computer Manuals Limited

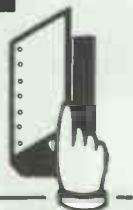

Suppliers of books  
Literature  
Manuals  
Software  
Training Programmes

30 Lincoln Road Olton Birmingham B27 6PA England  
Telephone: 021-706 6000  
Telex: 334361 Compco G

## We Connect You To Profitmaking

### Rotary data selector

- \* RS-232 series (DB-25)
- \* Centronics parallel
- \* Others: DE-9, DA-15, coaxial, twinaxial, etc.

### Cable and connector

- \* Multiconductor shielded cable assembly.
- \* Flat ribbon cable assembly.
- \* Other special cable assemblies such as individual shielded cable, low capacitance cable, high flexibility and temperature resistance cable, etc.
- \* D-subminiature series connector.
- \* Centronics series connector.
- \* I.D.C. socket, double row.
- \* I.D.C. card edge connector.
- \* Dip plug.

### Balun

- \* Coaxial type - for IBM 3270 series devices
- \* Twinaxial type - for IBM systems 34, 36, 38, 5250, 5520

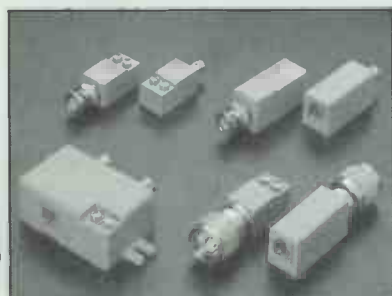

## UNIXSTAR TECHNOLOGY, INC.

3F., 3, LANE 538, CHUNG CHEN RD.,  
HSIN TIEN TAIPEI, TAIWAN, R.O.C.  
TEL: 886-2-9188863/4, 9170822  
FAX: 886-2-9170833 TLX: 10251 TSRCO



TEL: 0789 765295  
0380 870867

AMSTRAD · APRICOT · COMPAQ · TANDON · TATUNG · OLIVETTI · ZENITH

COMPUTERS ALL IN STOCK

### A FEW EXAMPLES OF OUR COMPREHENSIVE RANGE—

Make	Model	Specification	£
APRICOT	XEN XI20	512K/1.2Mb/MB	1924
APRICOT	XENXD20	1MB/1.2Mb/MB	2075
APRICOT	XEN386/30	1MB/1.2Mb/MB	2777
SPECIALS F2£520 F10 £725 XIO £1295			
COMPAQ	D286	Model 20 640K/1.2Mb/20 MB	2829
COMPAQ	D286	MODEL 2 640K/1.2Mb/30 MB	3251
COMPAQ	386	MODEL 40 IBM/1.2Mb/40 MB	P.O.A
★ TANDON RANGE - CALL FOR BEST PRICES ★			
TATUNG	7001	640K/1.2Mb/20 MB	1586
TATUNG	7003	640K/1.2Mb/40 MB	2157
★ PORTABLES ★			
ZENITH Z-181	1350	TOSHIBA T110+	1525
ZENITH Z-183	1995	TOSHIBA T3100	2825
COMPAQ PORT 11 MODEL 2	2000	TOSHIBA T3100/20	3326

★ All systems include Monitor, Keyboard, MS-DOS.

### CONSULTANCY

NETWORK, COMMUNICATION PRODUCTS,  
BESPOKE, SPECIALIST SOFTWARE DESIGN,  
INSTALLATION, MAINTENANCE, FINANCE

### ENHANCEMENTS

Hercules M.G.A. +	190	Orchid PC Net (adaptor)	312
Hercules C.G.A.	103	Orchid PC Net (Advanced)	
Hercules Incolour G.A.	310	8 User V2.0	625
C.G.A. Compatible	82	Transnet Starter Kit	362
E.G.A. Compatible	154	Transnet Lincard	250
14" Monitor + E.G.A.	468	10MB H.D. + Controller	217
Interquadram Prosync	225	20MB H.D. + Controller	270
Miniscribe 30Mb	350	40MB H.D. + Controller	513
M. S. Mouse	130	Tandon 20Mb Business Card	281
Orchid Tiny Turbo 286	365	Taxan 14" EGA Monitor	442
Orchid Jet 386	795	Taxan 16" EGA Monitor	685
80287 10Mhz	330	Microvitec 14" EGA	431
Intel 386 + Imb	12745	Apricot 256K RAM	93
		Apricot 512K RAM	119

### PRINTERS

EPSON LX800 150cps + tractor	205	BROTHER Twinwriter 160cps/40	995
EPSON FX800 160cps/32/80clm	306	OKI182 120cps 20/80(P)	190
EPSON FX1000 160cps/32/132clm	391	OKI 182 120cps 20/80(S)	235
EPSON LQ800 180cps/32/80clm	435	OKI 192 160cps/40/80(P)	285
EPSON LQ1000 200cps/60/132clm	575	OKI 192 160cps 40/80(S)	325
EPSON EX800 250cps/50/80clm	395	OKI 193 160cps 40/136(P)	375
EPSON EX1000 250cps/50/132clm	530	OKI 193 160cps 40/136(S)	400
EPSON LQ2500 200cps/90/132clm	735	OKI 292 200cps/100/80(SP)	435
BROTHER 1409 180cps/45/80clm	335	OKI 293 200cps/100/136(SP)	575
BROTHER 1509 180cps/45/132clm	378	OKI 294 400cps/100/136(SP)	750
BROTHER M4018 NEW 408CPS	1187	* OTHER PRINTERS P.O.A.	

### LASER PRINTERS

EPSON GQ3500	1427	APRICOT 10 P.P.M.	2187
CANON SERIES II	1806	H.P. LASERJET II	2081

★ DESKTOP PUBLISHING - P.O.A. ★

### SOFTWARE

Lotus 1-2-3 v.2	250	Javelin	350
Symphony	375	Harvard Pres. Graphics	223
Supercalc IV	235	First Choice	115
Multimate Adv.	299	Sage Accountant	125
Smart	410	Sage Accountant +	165
Wordstar 2000	250	Sage Payroll	90
Wordperfect	298	Wordstar 1512	60
Framework 2	355	Reflex	99
Delta 4	335	Sidekick	55
Cardbox +	256	Gem Collection	99
D Base III +	350	Gem Draw 1512	90
Wordcraft	325	Gem Graph 1512	90
Perfmaster	575	* Other software prices on request	

### TERMINALS

WYSE 50	380	ESPRIT 6515	459
WYSE 60	420	ESPRIT 6310	430
WYSE 85	390	ESPRIT 6110	307
WYSE 99GT	685	OPUS II	410
WYSE 700	687	AMPEX 220	390

### TRADE AND EXPORT ENQUIRIES WELCOMED

RAGLEY DATA SYSTEMS LTD  
Pendennis House, Keevil  
Trowbridge, Wilts BA14 6NA. Telex: 449148  
All prices exclude VAT/Delivery  
After hours answerphone 0789-765295)

RANGE OF SECOND-USER, EX-DEMO EQUIPMENT AVAILABLE

# THE GREAT COMMUNICATOR

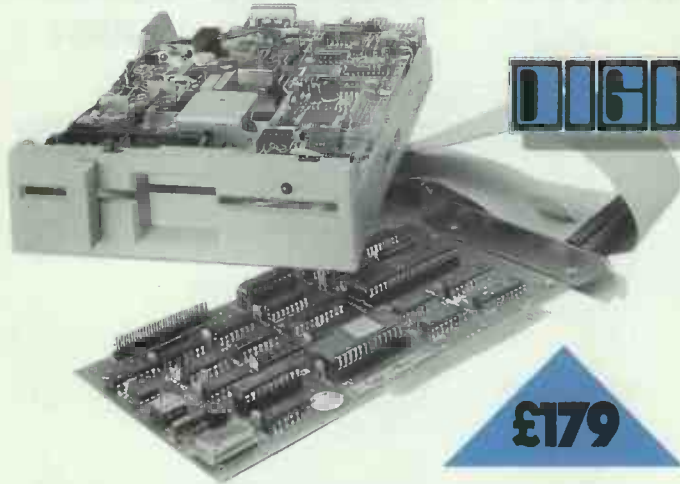

## DIGITASK

**£179**

- Allows free interchange between XT® and AT® computers
- Dual drive controller and Brand Name 80TR, 1.2MB formatted drive
- Achieves more than 3-times capacity of normal 360KB floppy drive
- Controller handles (intelligently with on-board ROM) combinations of 1.2MB and 360KB floppies
- FAST data transfer (500K Bits/sec) in 1.2MB format. Excellent for Winchester backup
- 1.2MB drive reads/writes and formats 360KB using normal DOS 3-X commands
- No messy DOS patch software necessary!
- Standard DIGITASK ONE YEAR parts and labour warranty

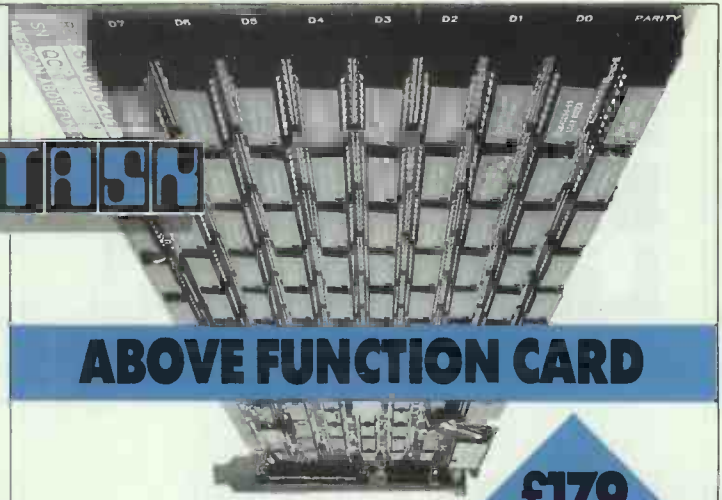

## ABOVE FUNCTION CARD

**£179**

- Up to 2MB expansion memory (2048KB)
- First 384KB may be configured as conventional memory
- LIM, LOTUS®, INTEL®, MICROSOFT®, (EMM) specification
- Async Comms adaptor (configurable as COM1 or COM2 or disable)
- Parallel Printer Port (configurable as LPT1 or LPT2 and Hercules® compatible)
- Real time clock/calendar with battery backup
- Games adaptor
- Utility software includes expanded memory manager, clock, ramdisk and printspooler
- Includes cables
- Fully compatible with IBM® PC/XT/AT computers
- Standard DIGITASK ONE YEAR parts and labour warranty
- (Unpopulated) Ram at £99/megabyte

**PHONE 0342 24631 NOW**

or Contact Digitask, Unit M, Charlwoods Business Centre, Charlwoods Road, East Grinstead, West Sussex RH19 2HH. Telex 957418 G

OVERSEAS CALLERS WELCOME

Prices Do Not Include VAT or Carriage

ALL VISA AND ACCESS CARDS ACCEPTED

Uninterruptible Power Supply For Complete Computer Protection

# POWER BANK PLUS



Introducing the latest protection for your computer hardware and software. Saves your time and costs.

## POWQUIP

POWER EQUIPMENT LIMITED, Kingsbury Road, London NW9 8UU. Telephone: 01-205 0033. Telex: 8952887.

# The database that's as easy to use as a VCR!

**Superbase™**  
**PERSONAL**  
**RELATIONAL DATABASE SYSTEM**

## Superbase is easy to use

If you're new to databases, or find them difficult to use, Superbase is your perfect choice. Unrivalled ease of use, unsurpassed power – a combination that's never been achieved before! Click your mouse on the VCR style symbols to speed through your data. Pick out a single record in the blink of an eye. Complete complicated searches in an instant. Display your text and graphic files.

## VCR style symbols



Pause Stop First

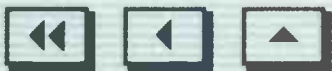

Rewind Previous Current



Next F/Forward Last

Review records with CURRENT, FIRST, LAST, PREVIOUS, and NEXT. Scan automatically with FAST FORWARD and REWIND. Interrupt or terminate scanning with PAUSE or STOP.

## Key Look-up



Call up a single record from a file instantly by clicking on this button.

## Filter



Select and work with any category of records from your file. The Superbase

Filter can be applied to several applications in turn – say from updating a set of address records to printing labels for the next mailing to that group.

## Superbase is relational

Link files together in a free and flexible way. Form new links between files whenever you choose. Split one database into several or create a new database from information in several files. Save your Queries to use again.

## Superbase is flexible

Change file definitions at any time – add or delete fields, change their names or types, with no need to re-enter data.

## Unique visual database



Click the camera gadget and view text or picture files alongside their database records. Spectacular slide show option!

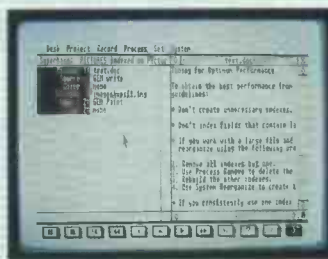

## Specifications

Fields per record	No limit
Record length	No limit
Records per file	16 million
Files per database	No limit
Key fields per file	999
Files joined	84
Sort levels	170
Report break levels	34

"No limit" implies memory or system dependent.

For 100% IBM PC™ Compatibles (including Amstrad PC1512™), Atari ST™ and Commodore Amiga™ **£99.95**

PC version also available with GEM Desktop™ **£149.95**

PC version with GEM Desktop™ and mouse **£230.00** (all prices include VAT)

PC versions require

- 512K RAM
- Graphics Card (CGA, EGA or Hercules™)
- Mouse (Microsoft® Bus or Serial, Summa Mouse™, Summa Sketch™)



## For your nearest dealer call:

Lightning Distribution 01-965 5555  
 SDL (UK) Ltd 01-309 0300  
 Eltec Services Ltd (0274) 722 512  
 GEM Distribution (0279) 412 441  
 Precision Distribution 01-330 7166  
 Software Express 021-328 3585  
 Hugh Symons (0202) 745 744  
 CentreSoft 021-356 3388  
 Software Limited 01-278 2377

Demonstration disks are available for £4.00 from Precision Software. Send your cheque to:  
 Superbase Demonstrations  
 Precision Software Ltd, 6 Park Terrace  
 Worcester Park, Surrey KT4 7JZ

Precision Software has a track record of outstanding success in productivity software: with over 450,000 users of its productivity software packages worldwide, Precision promises and delivers the best in reliability, performance and support. Precision Software acknowledges all trademarks referred to.

Precision Software Ltd, 6 Park Terrace



Precision Software

Worcester Park, Surrey  
 KT4 7JZ  
 Tel: 01-330 7166  
 Fax: 01-330 2089  
 Telex: 8955021 PRECIS G





# HI VO

## London's Largest

LONDON'S LARGEST SPECIALIST AMSTRAD DEALER

### NEW AMSTRAD PC1640 EGA MODELS

**AVAILABLE NOW**

- EGA HI-RES COLOUR
- 640K RAM

**PC1640 SD** Single Disk Colour ECD

**£799 + VAT**

**PC1640 DD** Double Disk Colour ECD

**£899 + VAT**

**PC1640 HD20** 20 Meg Hard Disk Colour ECD

**£1199 + VAT**

#### NEW PC CATALOGUE PHONE NOW

**SILVER REED EXP500**  
Full specification Daisy Wheel Printer.  
From the famous typewriter manufacturer. Special Offer Price

**£165 + VAT**

#### PORTABLE PC

**Zenith Z-171**

2 x 360K DD

**£959 + VAT**

**Zenith Z-181 Mk II**

8MHz 2 x 720K DD

**£1595 + VAT**

**Zenith Z-183**

10 Meg Hard Disc

**£2395 + VAT**

**Bondwell BW-8**

New Supertwist Screen

1 x 720K DD

**£889 + VAT**

#### AMSTRAD 1512 PLUS HARD CARD

20 Megabyte **£729 + VAT**

30 Megabyte **£849 + VAT**

#### PCW 8256/8512

USED MODELS - GUARANTEED FROM

**£299 + VAT**

(£343.85 inc VAT)

#### DAISY WHEEL PRINTER PACKAGE FOR PCW8256/8512

**£199.96 + VAT**

(£229.95 inc VAT)

Use **LOCOSCRIPT** with a **DAISY WHEEL**. New LSPRINT enables you to print your Locoscript text files on a daisywheel printer.

**£29.95 inc VAT**

**PART EXCHANGE YOUR PCW 8256 or PCW 8512 FOR THE NEW AMSTRAD PC - PHONE FOR PRICES**

#### HARD DISKS ON A CARD

Including formatting and configuring

21 Megabyte **£299 + VAT**

30 Megabyte **£399 + VAT**

#### Low cost Networking

From **£249** per PC + VAT

#### CHRISTIE TAPE STREAMERS FOR HARD DISK BACK UP

10 MEG | 20 MEG

**£389.00 + VAT** | **£489.00 + VAT**

#### 8087-2 8 MHz Maths Co-processor

Including test software

**£159 + VAT** | **£182.85 inc VAT**

#### PC SOFTWARE AT BIG DISCOUNTS

MS Word 3 **£259.95**

Word Perfect 4.2 **£259.95**

Word Star Professional V.4 **£229.95**

DBase 3 Plus **£359.95**

Lotus 123 **£259.95**

Symphony **£399.95**

Ventura Publisher 1.1 **£659.95**

Open Access 2 **£399.95**

PFS 1st Choice **£119.95**

VP Planner **£69.95**

VP Info **£69.95**

#### LOW COST PC SOFTWARE

Plus over 100 titles in stock

Prices shown exclude VAT

### OPUS PC's

We carry all models of this popular range of PC clones.

Prices from **£499 + VAT**



20 meg Hard disc models.

Prices from **£799 + VAT**

Extra for EGA.

Now only **£399 + VAT**

### SBC PC COMPATIBLES

#### SBC PC-Turbo

8 MHz Turbo. NEC V40 CPU. MS DOS 3.2 + GW Basic. 640K Ram. 12 months on site service free.

**SBCFD** **£599 + VAT**  
2 x 360K disc drive mono monitor

**SBC HD 20** **£999 + VAT**

20 Mb hard disc mono monitor  
CGA colour **£199 + VAT** extra  
EGA colour **£499 + VAT** extra

#### SBC Mistral 286 AT

12 MHz AT80286  
30 Meg hard disc, 1 Meg Ram.  
British designed and built. 12 months on site service free.

**SBC 286 AT** with mono monitor

**£1799 + VAT**

**SBC 286 ATC** with colour monitor **£1999 + VAT**



**SBC 286 ATE** with EGA colour monitor **£2199 + VAT**

# VOLTAGE

## Computer Shop

**DON'T TAKE A CHANCE  
— COMPARE BEFORE YOU BUY**



**OVER 40  
PRINTERS ON  
DISPLAY. MOST  
ON DEMONSTRATION**

### DOT MATRIX PRINTERS

All prices include VAT.

Amstrad DMP2000 NLQ .....	£159.95	Star NB 24-10 NLQ 80 col 24 pin 216cps .....	£549.95
Amstrad DMP3000 NLQ IBM .....	£194.95	Star NB24-15 NLQ 132 Col. 24 Pin 216 cps .....	£699.95
Amstrad DMP4000 NLQ 132 col 200cps .....	£399.95	Star NB15 NLQ 132 Col. 24 Pin 300 cps .....	£879.95
Canon PW1080A NLQ .....	£289.95		
Citizen 120D NLQ IBM .....	£199.95		
Epson LX800 NLQ (150cps) .....	£239.95		
Epson FX800 NLQ 200cps .....	£399.95		
Epson FX1000 NLQ 132 col 200cps .....	£515.95		
Epson EX800 NLQ 300cps .....	£519.95		
Epson EX1000 NLQ 132 col 300cps .....	£699.95		
Epson LQ800 NLQ .....	£585.95		
Epson LQ1000 NLQ 132 col 180cps .....	£799.95		
Epson LQ2500 .....	£979.95		
Oki-Mate 20 Colour + software .....	£199.95		
Micro P. 165 NLQ .....	£229.95		
Micro P. 201 NLQ 132 col 200cps .....	£399.95		
Star NL10 NLQ incl I/F .....	£259.95		
Star NX15 NLQ 132 col .....	£359.95		
Star NR15 NLQ 132 col 240cps .....	£559.95		

### DAISYWHEEL PRINTERS

Dyneer DW12 .....	£139.95
Juki 6100 .....	£329.95
Juki 2200 Typewriter Serial .....	£249.95
Silver Reed EXP500 16cps .....	£189.95
Silver Reed EXP550 19cps serial .....	£279.95

All popular interfaces, cables, etc. available from stock. Custom cables made to order.

Let our experts match your computer to the printer of your choice. Printers - All models parallel-centronics interface Serial RS232C available at same or slightly higher prices.

## LASER PRINTERS

Prices from only **£1395 + VAT**

**THE UK'S LARGEST RANGE OF LASER PRINTERS ON DEMONSTRATION**

Are you confused by the variety of lasers available? No problem! Visit our showroom and compare before you buy. Off the shelf delivery on most models.



**Plus full ranges from  
Canon and Hewlett Packard**

## LONDON'S AMIGA CENTRE

Hi-Voltage are the Amiga experts. As Commodore's largest computer store we are proud to give the world's most advanced computer pride of place in our showroom. We stock the most comprehensive range of peripherals and software including colour printers, as they become available. New items are arriving every day so contact us now!

**NEW AMIGA A500**  
INCLUDING  
FREE SOFTWARE  
PRICES FROM **£499 + VAT**  
**NOW IN STOCK**



**NEW AMIGA CATALOGUE  
JUST PRINTED -  
PHONE FOR YOUR FREE COPY.**

\*Price excludes monitor

**NEW AMIGA  
A2000  
NOW IN STOCK**

Including on site maintenance

Standard versions from **£1095 + VAT**  
IBM Compatible version from **£1595 + VAT**

**LARGE RANGE OF DISCOUNTED  
AMIGA SOFTWARE.**

**FULL RANGE OF CBM 64C/128D  
COMPUTERS AND PERIPHERALS IN STOCK**

## PROFESSIONAL PC DESK TOP PUBLISHING SYSTEM

Amstrad PC1512 Mono  
20 Meg Hard disc  
Ventura Publisher 1.1  
Epson GQ3500  
1.5 Megabyte Memory

**£2995 + VAT**

**EXPORT CUSTOMERS SUPPLIED  
TAX FREE - ASK FOR EXPORT LIST**

Official orders welcomed from PLC's  
government and education establishments

**ALL PRICES INCLUDE VAT  
(except where stated)**

**OPEN MONDAY-SATURDAY  
9AM-6PM**

**HI VOLTAGE**

**Largest range of floppy disks and printer ribbons  
available in London over the counter.**

**London's largest range of games and software.  
Thousands of titles in stock.**

**Mail Order + Export Hot Line Phone 01-686 6362**



Delivery by Securicor (4 day) please add £5.75 per item.  
Delivery by Securicor 24 hour please add £9.95 per item.



Send off or order by 'phone quoting your Access, Visa No. 'Phone 01-686 6362.  
Immediate despatch on receipt of order or cheque clearance. Or Telex your order on:  
946240 Attn 19001335. **EXPORT CUSTOMERS SUPPLIED TAX FREE.**

**Dept. PCW, 53-59 High Street, Croydon, Surrey CRO 1QD. Tel: 01-681 3022**

Prices correct at copy date. Subject to change without notice due to currency fluctuations etc. E. & D. E.

# ‘I LIKE THIS MACHINE... FOR THE MONEY IT’S UNBEATABLE’

*Benchtest of the Dell 286<sup>12</sup> in Personal Computer World, July 1987.*

This review, our first in the UK, concluded that the 286<sup>12</sup> ‘has a higher specification than just about any standard machine’...

- Intel 80286 running at 6 or 12 MHz
- High resolution Monochrome Monitor
- One megabyte of RAM on the system board
- 1.2 megabyte, 5.25" floppy disk drive
- Combined floppy and hard disk controller
- 192 watt power supply
- Eight expansion slots (five available)
- System Clock/Calendar/Configuration Data in CMOS RAM with battery back-up
- Hercules compatible monochrome graphics card
- 2 Serial and 2 Parallel Ports
- Enhanced 102 key keyboard
- The unique Smart VU™ system displaying computing speed and diagnostic checks

Plus a year's on-site maintenance, 12 month warranty and Technical Hotline included in the price.

286<sup>12</sup> with 40 Meg, 28 MS hard drive **£1,799**  
with 70 Meg, 28 MS hard drive £2,099

## EGA COLOUR SYSTEMS

Exactly the same specifications as the above system but incorporating:

- High Specification EGA card
- EGA high resolution monitor
- 2 Serial and 1 Parallel Port

286<sup>12</sup> with 40 Meg, 28 MS hard drive £2,199  
with 70 Meg, 28 MS hard drive £2,499



## 286<sup>8</sup> MONOCHROME SYSTEMS

Exactly the same specification as the 286<sup>12</sup> but with:

- Intel 80286 running at 6 or 8 MHz
- 286<sup>8</sup> with 20 Meg, 65 MS hard drive **£1,299**  
with 40 Meg, 40 MS hard drive £1,599

## EGA COLOUR SYSTEMS

Exactly the same specifications as the above system but incorporating:

- High Specification EGA card
- EGA high resolution Monitor
- 2 Serial and 1 Parallel Port

286<sup>8</sup> with 20 Meg, 65 MS hard drive £1,699  
with 40 Meg, 40 MS hard drive £1,999



## 386<sup>16</sup> MONOCHROME SYSTEMS

- Intel 80386 running at 16 MHz
- High resolution Monochrome Monitor
- One megabyte of Static RAM on the system board
- 1.2 megabyte, 5.25" floppy disk drive
- Combined floppy and hard disk controller\*
- 192 watt power supply
- Eight expansion slots (five available)\*
- System Clock/Calendar/Configuration Data in CMOS RAM with battery back-up
- Hercules compatible Monochrome Graphics card
- 2 Serial and 2 Parallel Ports
- Enhanced 102 key keyboard
- The unique Smart VU™ system displaying computing speed and diagnostic checks.

\*The 150 Meg system has a separate ESDI hard disk controller and four available slots.

386<sup>16</sup> with 40 Meg, 28 MS hard drive **£3,199**  
with 70 Meg, 28 MS hard drive £3,499  
with 150 Meg, 18 MS hard drive £4,199

## EGA COLOUR SYSTEMS

Exactly the same specifications as the above system but incorporating:

- High Specification EGA card
- EGA high resolution Monitor
- 2 Serial and 1 Parallel Port

386<sup>16</sup> with 40 Meg, 28 MS hard drive £3,599  
with 70 Meg, 28 MS hard drive £3,899  
with 150 Meg, 18 MS hard drive £4,599



# SEE HOW IT PAYS YOU TO DEAL DIRECT

Since the UK launch of the Dell Computer Corporation in June this year, our fast and powerful compatibles have been creating quite a stir. People were surprised by our prices for high quality machines which could earn reviews like the one quoted opposite.

## Astonishingly Low Prices

And when we announced that those prices even included a year's on-site maintenance and a free Technical Hotline Service, credibility was stretched still further.

The main reason for our low prices is that we sell our computers direct to you, the end user. There are no Dell appointed dealers, so you pay considerably less because you don't have to pay a dealer's profit margin.

## The Fastest Computers In Their Class

Our parent company designs and builds each one in Texas, employing some of the best technical brains in the business.

Consequently our machines aren't simply clones; they have original features you don't find on expensive machines. And Dell Computers are fast. Here's what the *Europa Report 1987* has to say:

*"The (Olivetti) M380/C rated 6.4 on our primes test: a reasonable result, although Compaq's Deskpro, with its own flashy RAM card, rated 7.15. IBM's PS/2 Model 80 comes in at 6.97, but the Dell 386<sup>16</sup> blows them all away, scoring 8.25."*

*PC Business World* puts it more succinctly:

*"An 80386 pc, the fastest ever tested by PC Business World."*

Besides this, all Dell Computers are compatible with programs that run on the IBM PC, XT and AT – and also run Microsoft's OS/2.

## Chosen By Major US Users

The Dell approach has struck a chord with end users in the States. After just three years, our annual turnover is on course for \$150M thanks to more than 80,000 satisfied users, amongst them organisations of the stature of Rockwell International and NASA.

They have found that ordering a computer over the 'phone doesn't mean you are left on your own.

In fact, you get something that no dealer can give – a direct relationship with the designer and manufacturer of your machine.

For that relationship to work in the UK we have to provide an unparalleled service to ensure that you are fully satisfied. From the start we actually guarantee your satisfaction.

## 30-day Money-Back Guarantee

If you are not entirely happy with your Dell Computer, you can return it within 30 days and we will refund your money in full. When you keep your machine, parts and labour are covered by a 12-month warranty.

## 12 Months' Free On-Site Service

In addition, it comes with that full year's on-site maintenance contract included in the price. If your hardware needs service, a fully-trained engineer will be with you before the end of the next working day.

And should you have a software problem or any questions, you can call our free Technical Hotline Service. At the end of a 'phone will be an expert who has access to a full history of your machine.

## Contact Dell To Save Money Now

Your machine is delivered by courier within days of us receiving your order. It all takes just minutes to set up and if you need help, you can call our Technical Hotline.

*Find out how you can save money with Dell today. Ring us on 0344 863423 or return the coupon below. If you 'phone we'll give you a price for the configuration you need. 'Phone with a purchase order number and you could have exactly the machine you want in days.*

Prices do not include VAT. IBM and Microsoft are registered trademarks of their respective operating companies.

## **DELL COMPUTER CORPORATION** *More computer, less money.*

Dell Computer Corporation, Farley Hall, London Road, Bracknell, Berkshire RG12 5EU. Tel: 0344 863423.

To: **Andrew Harris, Managing Director, Dell Computer Corporation,**  
**FREEPOST (RG 1462), Bracknell, Berkshire RG12 1BR, or phone 0344 863423.**

- Please call me on (day) \_\_\_\_\_ at (time) \_\_\_\_\_ to talk about the model(s) ticked
- Please send me details of the following Dell Computers  286<sup>8</sup>  286<sup>12</sup>  386<sup>16</sup>  
All models are supplied with mono or EGA monitors.
- Please send me a complete and unabridged copy of the PCW Review of the 286<sup>12</sup>.

Name \_\_\_\_\_ It would help us to send you the most useful information if you would also complete the following:

Position \_\_\_\_\_ Type of business \_\_\_\_\_

Company \_\_\_\_\_ No. of employees using pc's \_\_\_\_\_

Address \_\_\_\_\_ No. of pc's in company \_\_\_\_\_  
No. of pc's likely to be purchased in the next 12 months \_\_\_\_\_

Postcode \_\_\_\_\_ Type of pc's currently used \_\_\_\_\_

Telephone \_\_\_\_\_

# How to write your own software without the help of a programmer!



Mailing List Menu

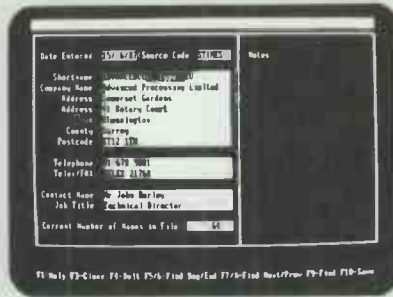

Entry Screen



Print out to Screen

## Develop your first application on day 1.

With TAS you can take any type of information like names and addresses or stock records and design an entry form by simply "painting" the screen. TAS then writes the data entry program for you.

When you run this program you enter your information and store it on disk. This is a database. And you can create as many as will fit on your disk. With another function, the "database browser" you can display this information on the screen and browse through it and change it.

Reports are just as easy. You tell the report generator which file you want to report from and then simply answer the questions it asks you.

When you've finished, TAS will generate a program that produces the report you want and you can run that report time after time.

## A Relational Database.

You may know that with any database application you enter, store, retrieve and manipulate data. "Relational" means that you can simultaneously "relate" more than one file to another.

For example a sales order "relates" to both stock records and a customer record. The resulting invoice "relates" to the customer record and a sales daybook record. With TAS you can simultaneously access and relate more files than any other database package and do so with ease.

## "How not to do it".

One thing is certain. After you finish a database application, you usually know exactly what's wrong with it. With TAS it is easy to subsequently change and modify both your files and your applications without having to re-enter your data.

Excellent documentation and on-screen help will show you how to use the 4th generation language, add more powerful features which include extensive calculations, pull down menus, multiple windows, business graphics, 128 colour combinations and much more.

Result... your applications are more user-friendly, easier to use, look better and have more "polish" than some of the very expensive "professional" packages. And YOU have written them.

TAS Plus is fast and easy to learn. All you need is a little application and an IBM PC or compatible computer (including the AMSTRAD PC1512) with 512KB RAM and a hard disk or two floppy disks. TAS Plus Multi-User for MS-Net compatible Networks costs £349.00 plus VAT.

**TAS**™  
*Relational Database*  
**£99**

**MEGATECH** Quote Ref: PCW9

111-113 Wandsworth High Street, London SW18 4HY.

Tel: 01-875 6511 (6 Lines), Telex: 21768

## We use it ourselves.

Our in-house fully integrated sales order processing and financial accounting system (yes it is for sale) was developed using TAS. Running on a multi-user network we can provide instant answers to such questions as "who bought what, when and at what price". And that's only part of it.

"Excellent value for money, especially for novices wanting to learn and developers wanting economic runtime systems." **Personal Computer World Magazine**

"There is no doubt that TAS is a very capable product. It handles serious sized applications and does so with speed." **What Micro Magazine**

"TAS manages to pack plenty of power into its small price." **PC Magazine**

"On a value for money basis this must be one of the most attractive databases on the market."

**Accountancy Age**

"If you cannot find a commercial package to suit your organisation then most certainly this must be one of the first places to start looking in order to produce a system of your own." **Personal Computing with the Amstrad**

## Never run out of steam.

TAS is so fast and powerful that most of the TAS utilities are developed in TAS itself. No other database is remotely capable of doing this. And that is exactly where you benefit. It's simple enough for the first timer but powerful enough for the professional software developer. So you have little to worry about whether TAS is suitable for your particular application or not.

As PCW Magazine said in their review of TAS Plus: "Excellent value for money, especially for novices wanting to learn and developers wanting economic runtime systems."

## Build a reputation for efficiency.

TAS is for people like you. You like using a computer. You know that it is vitally important to have accurate, up-to-date information instantly available. You also know of many applications that can be done easier, better and quicker with a computer. Cut down on shuffling bits of paper. Cut down repetition. Everyone performs better because the job is more interesting and more fun. That's what TAS is all about. With TAS you can make a computer do what you want it to do.

## Nothing else needed.

At £99.00 TAS-Plus is complete. It consists of the Relational Database, Screen Painter, Program Generator, Report Generator, Database Browser, 4th Generation Language, "Idiot Proof" (no disrespect) drop-down menu-driven Command Editor, Runtime Compiler for fast program execution, Tutorial and Manual.

Simultaneously access up to 16 files, each with 16 indices. Each file may have 65,000 records of up to 10,000 characters each. Import and export data with other software packages including dBase-III, wordprocessing packages and spreadsheets.

## Multi-User Version Available.

This version supports full file and record locking and works on all MS-Net compatible networks. Software you develop now will run without change if you upgrade to TAS Plus Multi-User later on.

## 30-Day Money Back Guarantee.

The parcel you receive is fully operational but limited to saving 250 records. Provided the sealed, unlimited copy remains unopened you can return the goods within 30 days (in good condition) FOR A FULL, NO QUIBBLE, REFUND. Have a go. Order your copy today with the coupon below. We also accept purchase orders from PLC's and Government.

**We despatch by 1st class post on the same day we receive your order**

**TAS**™ Send to MEGATECH, Ref: PCW9  
111-113 Wandsworth High Street,  
London SW18 4HY

YES! Please send me 1 Copy of TAS Plus. I enclose a cheque for £115 (incl VAT and P&P) made payable to MEGATECH or charge my Access or VISA card

Number: ..... Expiry Date: .....

Signature: .....

(Card) Name: .....

(Card) Address: .....

Postcode: ..... Tel: .....

**PRIORITY ORDERS**  
01-874 6511  
Use Access/Visa Card  
Quote Ref: PCW9

A VAT invoice will be included in the parcel. Enclose a company letter-head if invoice name and address are different from card name and address.



## THE GOOD SOFTWARE CO.

EVERYTHING AVAILABLE, JUST RING FOR THE **BEST PRICE** IN TOWN

BORLAND, AMSTRAD, SAGE, DBASE, PRODESIGN, SNIP ACCOUNTS, IMPACT ACCOUNTS, ZORLAND C, ABC, ABILITY+, TAS+, LOTUS, SYPHONY, WORDSTAR, ROBOCAD, GENERIC CAD, FIRSTCAD, MICROPORT, UNIX SYSTEM V/AT, FARSIGHT, VENTURA, MICROLEDGER II, ETC., ETC.

## PRICE TOO GOOD TO PUBLISH

(HARDWARE TOO)

TANDON, OPUS PC II, AMSTRAD, NEW AMSTRAD PC1640, INTER-ORIENT ADD IN BOARDS, MULTI-USER SYSTEMS, NETWORKS

FOR **YOUR BEST DEAL** RING

**0703-685002**



SEND FOR FULL STOCK AND PRICE LIST TO  
DEPT PCW, 109 DEACON RD, BITTERNE, SOUTHAMPTON, SO2 8PT

At last BBC BASIC to run on YOUR IBM or IBM Compatible running under MSDOS

## BBC BASIC (86)

All the features of BBC BASIC including:-

- ★ Multi-lined named procedures
- ★ In-line assembler using standard mnemonics
- ★ Serial random and indexed disk files plus the ability to access any byte in the file
- ★ BBC BASIC VDU commands; graphics; sound
- ★ Full screen editing
- ★ Plus all the standard commands
- ★ 500 page user manual
- ★ Program examples on disk
- ★ Price £95.00 + £3.00 p&p + VAT

You need never say GOTO again but we won't stop you!

Also available comms program including serial lead to download from Acorn to IBM. Please state 40 or 80 track Acorn Format.

Price £16.00 plus £1.00 carr plus VAT

M-TEC COMPUTER SERVICES (UK)  
4 Church Hill, Reepham, Norfolk NR10 4EL  
Tel: (0603) 870620 Fax: (0603) 870436

## DISKS DISKS DISKS

**FREE**  
SENATOR RIPPLE  
retractable ballpen  
with every order  
(while stocks last)

## ACCUTRACK FLEXIBLE DISKS

Engineered for critical accuracy and reliability  
by Dennison Magnetic Media

## top quality

certified 100% error free

**lifetime warranty**

post and packing free

## why pay more?

Cash with order only. Please complete the order form below and send it to -

**Moor House Marketing**  
Moor House, Ratcliffe Wharf Lane  
Forton, Preston, PR3 0AN

or telephone 0524 792101 with Access Card No.

MD7	Per box of 10 disks			Qty	Amount
	Prices				
	1	2-9	10+		
5¼"					
48tpi SS/DD	10.95	10.45	9.95		
DS/DD	13.95	13.45	12.95		
96tpi SS/DD	13.95	13.45	12.95		
DS/DD	16.95	16.45	15.95		
HE (IBM-AT)	26.95	25.45	23.95		
3½" SS	19.95	19.45	18.95		
DS	23.95	22.95	21.95		

Remember,  
post & packing  
free

TOTAL  
VAT @ 15%  
Payment

PCW9

Name \_\_\_\_\_

Address \_\_\_\_\_

Access Card No \_\_\_\_\_

Expiry  
Date

Signed \_\_\_\_\_

Date \_\_\_\_\_

## DISKS DISKS DISKS

# WHAT MORE DO YOU NEED TO KNOW ABOUT ZORLAND C?

## The C specialists!

Zorland sells more C compilers than anyone else in Europe. We started shipping in September 1986 and we haven't looked back since. Now we are considered to be the C specialists!

Our aim is to provide a 'one-stop' service for the C programmer whether novice or professional.

## What about the others?

Independent sources say Zorland C is the top selling C compiler in Europe. The Independent 1512 User Group confirmed that 65% of their customers bought Zorland C as against only 9% for Turbo C!

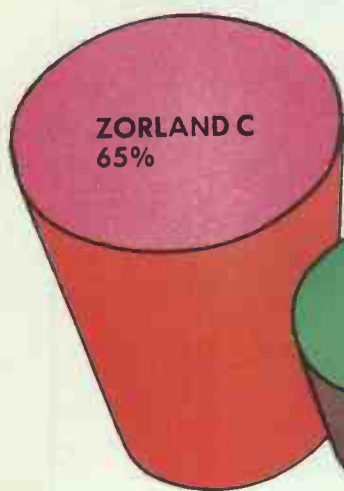

## Six good reasons!

Here are six good reasons why you should consider Zorland C as your first choice in C compilers:

1. Zorland C has a low-cost entry point of only £29.95
2. Zorland offers the full source code to the library for only £19.95! This is invaluable for professional programmers and students wishing to study the inner workings of the library.
3. Zorland's new Optimizer will accelerate your programs to execute by up to 30% faster than Turbo C!

Zorland's Optimized C beats any compiler — period.

4. Zorland's range of add-on libraries can save you weeks or even months in the production of serious application programs.

5. Zorland's Technical Hotline has earned itself the reputation of being one of the best in the business! FREE!

6. Zorland produce ZCNEWS — the only monthly magazine of its kind in Europe. Full of

## The family grows!

Here are just a few of the new add-on libraries that will be available shortly. No other C compiler offers such a wide range of support products.

**Graphics TOOLKIT £29.95** An excellent collection of functions for drawing boxes, circles, ellipses, lines, graphic fonts, fills, patterns, etc. The program you write is 'device independent'

**ZASM — Zorland's Assembler Fully MASM compatible with**

**BIG manual/beginners guide.**

**DATA ENTRY — You draw screens and this prog generates the source code!**

**BTREE MULTI-USER** Make your database applications Multi-User with this BTREE add-on.

**TSR/MACROS —** Make your program Memory Resident with our TSR functions. Includes Keyboard Macros!

**COMMS TOOLKIT —** Save hours with this ready made comms toolkit. Supports up to eight serial ports!

**ZORLAND'S UTILITES —** £19.95 Comprehensive set of utilities. Examine disk sectors, command line editor, etc. etc.

**DISK OPTIMIZER —** £19.95 Reduce the time taken to access files on your hard disk, easily.

**SUPERTEXT TOOLKIT** £29.95 More than 90 text

processing functions together with full source code for a full-blown wordprocessor! Includes 'Wordstar' compatible keys, customizing, 'dot' commands, etc. Now you can include a Wordprocessor into your applications!

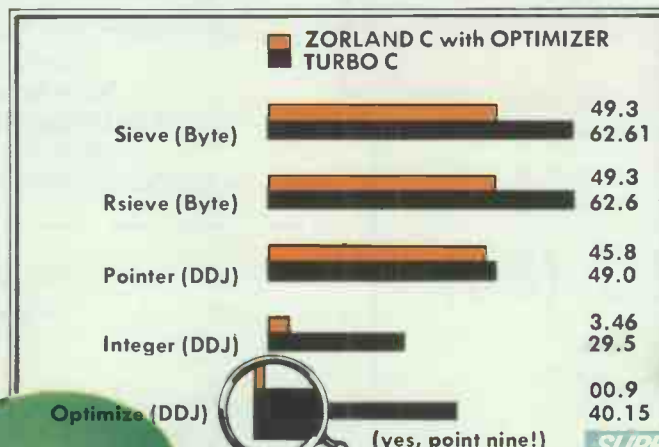

thus allowing you to use external drivers for screens, plotters, lasers etc. Includes 70 page manual and drivers for CGA, EGA, Hercules, etc.

**GAMES TOOLKIT £29.95** Chess, Backgammon and Wari 150 page manual explains how to write your own games of skill and strategy. Comes with three ready to play games and the full source code.

technical help, advice and listings for the C programmer.

## Reviewer's rave!

"High quality . . . impressive performance at a knock-down price!"  
Personal Computer World

"Actually an improvement on some of the more expensive packages from America!"  
Amstrad Professional Computing

"There is nothing to touch Zorland C . . . even at a much higher price!"  
PC PLUS

## SPECIAL OFFER

Until 31st December 1987  
Get the Linker and Librarian software (worth £19.95) FREE when you buy Zorland C at £29.95!

# ZORLAND

## VERSION 2

FOR IBM PC/AMSTRAD 1512

**NEW!** LATTICE/  
UNIX/ANSI  
Compatible!  
Now Zorland C is even  
more compatible! It is  
probably the most up-to-  
date ANSI standard C  
compiler on the market  
today! Why waste hours  
waiting for programs to  
compile! ZORLAND C is 3  
TIMES FASTER! Even  
major companies like  
IBM, XEROX and  
FUJITSU use ZORLAND C!

**NEW!** Integrated  
Compiler/Editor  
Environment! Our new  
environment is truly  
amazing! Gives TOTAL  
control! It's a wonderful  
way to program in C!  
Compile in memory! Edit  
FIVE files at once!  
Keyboard Macros!  
"123" style menus! On-  
Line Help! Compiling C  
programs has never  
been so easy!

**NEW!** Massive  
350 Page  
Manual! The tutorial  
takes you step-by-step  
into the World of C! Start  
with the "idiots" guide  
and then (hopefully!) —  
move on! Build-up to the  
more advanced features!  
Lots of examples! Over  
210 functions explained!  
Write your own libraries!

**C**  
**Only**  
**£29.95!**  
ZORLAND  
INTERNATIONAL

**NEW!** ZORLAND BTREE/ISAM DATABASE  
package. Get your business application  
off to a flying start! Includes FULL SOURCE CODE and  
an example indexed Name & Address application  
showing how easy it is! Supplied complete and  
ready-to-go with our great 70 page manual!  
Only £29.95 + vat!

**NEW!** ZORLAND WINDOWS gives your  
program that professional look — just  
like "Framework" and "123"! Fast Exploding and  
Zooming windows with automatic saving and  
buffering in memory. "Pop-Up" and "123" style  
menus — comes with fantastic demo progs and 50  
page manual! FULL SOURCE CODE! Only £29.95 + vat!

**NEW!** ZORLAND OPTIMIZER! will "fine-  
tune" your progs during compilation  
by running a THIRD pass to OPTIMIZE your code using  
state-of-the-art "Global Optimizing" techniques  
found only on mainframe C compilers! Now you can  
squeeze that last ounce of speed out of your code!  
Does NOT replace assembly code! — Does NOT  
replace good programming! Only £29.95 + vat!

Here's your chance to save over £300! Buy ZORLAND  
C at £29.95! Learn how to use our industry standard  
C compiler! The same as LATTICE and MICROSOFT!  
ZORLAND C applications are even being ported up to  
VAX mainframes! ZORLAND C is three times faster  
than the Giants! One tenth the price! No wonder most  
U.K. universities and polytechnics are now switching  
to ZORLAND C!

# Save £300!

TECHNICAL SPECIFICATIONS — POWER PACK — A complete  
FULL K&R specification C compiler with ALL the UNIX V  
extensions and ANSI enhancements! Supports & emulates  
8087/80287 maths co-processor, assembly language interface,  
Compact, Small, Data & Large models, includes FULL SOURCE  
CODE to the library, over 210 functions! Including trigs, fast  
screen access, disk sector read/write, dos/bios calls, interrupts,  
etc. 64 bit precision. MS-LINK compatible linker and librarian  
are included together with many UNIX programming utilities  
like MAKE and TOUCH. Powerrrrrrfull!!!

★ ZCNEWS MAGAZINE!  
Now ZC Users have  
their own monthly  
magazine containing  
articles on a whole range  
of topics for ZC  
enthusiasts! You can  
submit an article for  
publication with the  
opportunity of winning a  
£250 prize for "Article  
of the Month". Each  
issue contains at least 30  
pages full of interesting  
articles for C  
programmers!

★ ZC USER GROUP! FREE!  
Subscription to ZCNEWS  
gives you free  
membership! Here to  
help you get technical  
support and quality  
control that you need!  
Telephone hotline  
provided for members  
who need to talk through  
any problems.  
ZCNEWS/ZC USER  
GROUP £15.75 p.a.

### Highly Recommended Books!



**C Primer Plus — £19.95**  
This 500 page book from USA  
is highly recommended for  
those new to C! It takes you  
through the basics in an easy  
to follow, easy to read,  
enjoyable style. It has many  
example programs that utilize  
sound, graphics and disk files.

**Advanced C Primer — £19.95**  
This 500 page book starts  
where most other books stop! It  
gets right down to the nitty  
gritty of File I/O, PC Memory,  
BIOS & DOS calls, Graphics  
displays and integrating your  
Assembly Language routines  
into your progs.

### Yes, Send me ZORLAND C now!

- ZORLAND C  
£34.44 inc. vat.  
C compiler with integrated  
editor and big 250 page  
manual!
- DEVELOPER'S UPGRADE  
£22.94 inc. vat.  
Allows you to compile progs  
larger than 64k (P,D,L  
models) and includes FULL  
LIBRARY SOURCE CODE!
- LINKER/LIBRARIAN  
£22.94 inc. vat.  
MS-DOS compatible  
LINK.EXE prog and Librarian  
for creating your own  
function libraries.  
30%-200% faster than MS-  
DOS LINK! (Needed for  
PC1512)
- ZORLAND C POWER  
PACK! £68.94 inc. vat.  
SAVE £10! Buy all three for  
only £59.95! This is the full  
ZORLAND C compiler with  
the DEVELOPER'S UPGRADE  
and LINKER/LIBRARIAN!
- ZCNEWS/ZC USER  
GROUP £15.75 inc.  
12 issues of ZCNEWS direct  
to your door, plus ZC USER  
GROUP membership.
- C PRIMER PLUS £19.95  
500 pages for beginners!
- ADVANCED C PRIMER  
£19.95  
500 pages for advanced  
users!
- BTREE/ISAM DATABASE  
£34.44 inc. vat.
- ZC WINDOWS LIBRARY  
£34.44 inc. vat.
- OPTIMIZER KIT!  
£34.44 inc. vat.

Name \_\_\_\_\_

Address \_\_\_\_\_

For Overseas AirMail orders please add £5.00.

TO: ZORLAND LTD, 65-66 WOODROW, LONDON SE18 5DH  
Tel: 01-854 1194 (4 lines) Fax: 01-317 1284

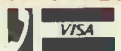

**QUOTE: KIRKLANDS ARE SELLING PRINTERS FOR LESS THAN DEALERS CAN BUY THEM  
YES, WE ARE BACK, WITH A LARGER RANGE OF PRINTERS AT BETTER THAN EVER  
PRICES, LOOK AT THESE:**

**STAR**

Product No.	
XS1 NL-10 (including Interface)	£175
XS2 NL-10 (including serial I/f)	£205
XS3 NX-15 (parallel)	£275
XS4 ND-15 (parallel)	£335
XS5 NR-15 (parallel)	£410
XS6 NB-24/10	£405
XS7 NB-24/15	£515

**EPSON**

Product No.	
XE8 LX800	£193
XE9 FX800	£295
XE10 FX1000	£380
XE11 EX800	£380
XE12 EX1000	£510
XE13 LQ800	£420
XE14 LQ1000	£570



120cps (30cps NLQ)  
Bi-directional logic seeking  
9pin print head. 5Kb standard  
buffer, full front panel control,  
push tractor, single sheet feed.

To order either: Ring 0782 744700, ask for Paul and quote your  
Access Visa number or fill in the order form below.

**AND EVEN CHEAP LASERS**

Product No.	
XL15 Epson GQ 3500	£1320
XL16 Canon LBP 8 Series 2	£1575
XL17 QMS K8 (inc. toner)	£1380
XL18 QMS PS800 (postscript)	£2895

**POSTSCRIPT UPGRADE**

XL119 (for any Canon engine)	£1810
------------------------------	-------

Also available, Oki, Brother, Qume, Kyocera etc., We also have  
a large range of cables available. Call us on **0782 744700** to  
discuss your requirements.

All prices quoted are exclusive of carriage and VAT.  
These prices only apply to mail order custom.

**NOW YOU'VE SEEN THE PRINTERS, JUST LOOK WHAT'S  
ON OFFER IN THE PC MARKET**

**THE KBM CANARY SERIES III**

**Product No.**

**K1 PC XFD Comprising:**

- 1 x 4.7/10MHz Mother board (Baby case)
- 1 x 512k RAM
- 1 x Mono/Graphic/Printer Card
- 1 x Serial Card
- 1 x 360k Floppy drive
- 1 x TTe Monitor
- 1 x Mouse
- 1 x User Guide
- 1 x Keyboard

**Price: £495**

**K2** as above but with STD case and 2 x 260k  
Disk drives

**Price: £575**

**K3** as K1 but with 1 x 30k Floppy disk,  
1 x 25Mb Hard disk  
Clock Calendar and battery back-up

**Price: £775**



As used by Tamworth College, F.E. Halton College, Keele University,  
South Cheshire College, N.S. Polytechnic, TNT, Staffordshire C. Council,  
and many, many more satisfied users.

**OTHER PRODUCTS**

- Product No.
- K4 AT Comprising:**
- 1 x 6/9/10 MHz Mother  
Board
  - 1024k RAM
  - 1 x 1.2Mb Floppy
  - 1 x 20Mb hard disc
  - 1 x Mono/Graphic/Print  
Card
  - 1 x TTL Monitor
  - 1 x User guide
  - 1 x Keyboard

**Price: £1195**

- Product No.
- 1 x Serial-Parallel card
  - K5 MS DOS & Basic**..... £55
  - K6 Second 360k Disk**  
drive..... £80
  - K7 Mouse**..... £49
  - K8 EGA card**..... £125
  - K9 20Mb Hard card**..... £270

Other options available.  
Please ring. All products carry  
1 year warranty and on site  
maintenance available at £30  
per unit.

To: Kirklands Business Systems Ltd  
Kirkland House, Lytton Street, Stoke on Trent ST4 1DH  
Tel: 0782 744700  
(Education/Dealer enquiries welcome). Telex: 36393 KBLSTD G.  
Fax: 0782 744566

**ORDER FORM**

Name.....  
Address.....  
Tel:.....  
ORDER DETAILS  
Product Number Description  
.....  
.....  
.....  
.....  
.....  
Postage (insured next day) £12 per product.  
UK mainland only VAT.....  
Total Price.....

Acceptable methods of payment: Please tick  Cheque  
 Access/Visa Number.....  Official order (enclosed)  
 Cash  Other (please specify)

ALL PRICES EXCLUDE VAT.

# TECHNOLOGY SO ADVANCED ...

- MEMORY**
- 512Kbytes RAM (520ST-M, FM)
  - 1024Kbytes RAM (1040ST-F)
  - 192Kbytes ROM
  - 128Kbytes external plug-in ROM option

- ARCHITECTURE**
- Motorola 68000 Central Processing Unit (CPU) with a clock speed of 8MHz
  - 16-bit external data bus
  - 32-bit internal data bus
  - 24-bit address bus
  - 64x32-bit data & address registers
  - 7 levels of interrupts
  - 56 instructions
  - 14 addressing modes
  - 5 data types
  - DMA (Direct Memory Access)
  - real time clock as standard

- GRAPHICS**
- full bit-mapped display
  - palette of 512 colours
- Using Atari Monitors (on 520 & 1040):
- 640x400 high resolution - monochrome
  - 640x200 medium resolution - 4 colours
  - 320x200 low resolution - 16 colours
- Using Domestic TV (on 520):
- 640x200 medium resolution - 4 colours
  - 320x200 low resolution - 16 colours
  - 40 columns x 25 line text display

- SOUND AND MUSIC**
- 3 programmable sound channels
  - frequency programmable 30KHz - 125KHz
  - programmable volume
  - wave & dynamic envelope shaping
  - programmable attack, decay, sustain, release
  - Musical Instrument Digital Interface (MIDI)
  - MIDI allows connection of synthesizers etc.



- MOUSE**
- high precision
  - 2 button control
  - free with 520ST-FM/1040ST-F
  - non slip ball motion sensor
  - removable ball for easy cleaning

- STANDARD SOFTWARE**
- GEM desktop + TOS operating system
  - ST BASIC Interpreter/language system

- INPUT/OUTPUT**
- MIDI out ..... (5 pin DIN) 31.25K baud
  - MIDI in ..... (6 pin DIN) 31.25K baud
  - audio out ..... 1.0V DC peak to peak, 10K ohm
  - audio in ..... 1.0V DC peak to peak, 10K ohm
  - RGB monitor ..... 1.0V DC, 75 ohm
  - mono monitor ..... 1.0V DC, 75 ohm
  - mono horizontal scan rate ..... 35.7KHz
  - mono vertical scan rate ..... 71.2KHz
  - sync ..... 5V DC (active low) 3.3K ohm
  - modem/serial ..... RS232C, 50 to 19,200 baud
  - floppy disk ..... 250 Kbits/s
  - hard disk ..... 11.3 Mbits/s
  - mouse ..... standard Atari connector
  - joystick ..... standard Atari connector
  - cartridge port ..... 128K capacity
  - RF output (520ST-FM) ..... for TV use

- OPERATING SYSTEM**
- TOS with GEM environment in ROM
  - hierarchical file structure with sub-directories and path names
  - user interface via GEM, with self explanatory command functions
  - multiple windows + icons
  - window resizing, re-positioning and erasing
  - drop down menus (selected by mouse)
  - GEM virtual device interface

- COMMUNICATIONS**
- RS-232C serial modem port
  - 8-bit parallel printer port
  - MIDI port (also for networking use)
  - variable auto-repeat & key click response
  - VT52 terminal emulation

- KEYBOARD**
- standard QWERTY typewriter format
  - 95 full stroke keys
  - 10 function keys
  - 18 key numeric keypad + cursor keys
  - variable auto-repeat & key click response
  - keyboard processor reduces CPU overhead

## IT'S AFFORDABLE

### ONLY FROM SILICA

Finally, there's a personal computer that not only solves problems like other computers, but also solves the one problem that other computers have created. Affordability. Silica Shop are pleased to present the ST range of personal/business computers from Atari. The ST was designed utilizing the most recent breakthroughs in semiconductor technology, producing a personal computer that performs tasks with fewer parts. Which means it costs less to make, and less to buy. The latest ST computers now include built in power supply and built in disk drives. The TOS operating system and GEM window environment are now on ROM chips which are already installed in the ST keyboard. This enables automatic instant booting when you switch on. Silica Shop are pleased to offer the complete Atari ST range. Our mail order department is situated in Sidcup and we have 4 retail outlets at Sidcup, Orpington, Lion House (Tottenham Court Rd) and Selfridges (Oxford Street). We have eight years experience of Atari products, longer than any other UK company, and are well established as the UK's No.1 Atari specialist. With a group turnover of over £5 million and in excess of 70 staff, we provide unbeatable service and support. We provide several facilities which you will find invaluable during your Atari computing life and most of these facilities are available ONLY FROM SILICA. We suggest that you read through what we have to offer, before you decide where to purchase your Atari ST.

**FREE STARTER KIT - Only From Silica**

When you purchase any Atari ST keyboard, you will not only receive the best value for money computer on the market, but you will also receive the following from Atari Corporation as part of the package:

- BASIC Language Disk
- BASIC Manual
- ST Owners Manual
- TOS/GEM on ROM

If you buy your ST from Silica Shop, you will also receive:

- NECrom - colour graphics program
- 1st Word - Word Processor

In addition, we at Silica would like to see you get off to a flying start with your new computer, so we have put together a special ST STARTER KIT worth over £100, which we are giving away FREE OF CHARGE with every ST computer purchased at our normal retail prices. This kit is available ONLY FROM SILICA and is aimed at providing users with a valuable introduction to the world of computing. We are continually upgrading the ST Starter Kit, which contains public domain and other licensed software, as well as books, magazines and accessories all relevant to ST computing. Return the coupon below for full details.

**DEDICATED SERVICING - Only From Silica**

At Silica Shop, we have a dedicated service department of five full time Atari trained technical staff. This team is totally dedicated to servicing Atari computer products. Their accumulated knowledge, skill and experience makes them second to none in their field. You can be sure that any work carried out by them is of the highest standard. A standard of servicing which we believe you will find ONLY FROM SILICA. In addition to providing full servicing facilities for Atari ST computers (both in and out of warranty), our team is also able to offer memory and modulator upgrades to ST computers.

**1MB RAM UPGRADE:** Our upgrade on the standard Atari 520ST-M or 520ST-FM keyboard will increase the memory from 512K to a massive 1024K. It has a full 1 year warranty and is available from Silica at an additional retail price of only £86.96 (+VAT = £100).

**TV MODULATOR UPGRADE:** Silica can upgrade the 1040ST-F to include a TV modulator so that you can then use it with your TV set. This is an internal upgrade and does not involve any untidy external boxes. A cable to connect your ST to any domestic TV is included in the price of the upgrade which is only £49 (inc VAT). The upgrade is also available for early 520ST computers at the same price.

**THE FULL STOCK RANGE - Only From Silica**

We aim to keep stocks of all Atari related products and our warehouse carries a stock of £6 million. We import many software titles direct from the USA and you will find that we have new releases in advance of many of our competitors. Unlike dealers who may only stock selected titles, we have the full range. In addition, we carry a complete line of all books which have been written about the Atari ST. A range as wide as ours is something you will find is available ONLY FROM SILICA.

**AFTER SALES SUPPORT - Only From Silica**

Rest assured that when you buy your ST from Silica Shop, you will be fully supported. Our free mailings give news of releases and developments. This will help to keep you fully up to date with what's happening in the Atari market. And in addition, our sales staff are at the end of a telephone line to service all of your Atari requirements. If you purchase an ST from Silica and would like any programming or technical advice, we have a full time technical support team to help you get the best from your computer. Because we have both the staff and the systems specifically dedicated to providing after sales service on Atari ST computers, we are confident that our users enjoy an exceptionally high level of support. This can be received ONLY FROM SILICA.

**FREE CATALOGUES - Only From Silica**

At Silica Shop, we recognise that serious users require an in-depth information service, which is why we mail free newsletters and price lists to our ST owners. These are up to 48 pages long and are crammed with technical details as well as special offers and product descriptions. If you have already purchased an ST and would like to have your name added to our mailing list, please complete the coupon & return it to us. The information service is available ONLY FROM SILICA.

**FREE OVERNIGHT DELIVERY - From Silica**

Most orders are processed through our computer within 24 hours of receiving them. Most hardware orders are sent by the overnight METRO courier service FREE OF CHARGE to customers within the UK. This method helps to ensure minimum delay and maximum protection.

**PRICE MATCH - Only From Silica**

We hope that the combination of our low prices, FREE UK delivery service, FREE Starter Kit and FREE after sales support, will be enough to make you buy your Atari equipment from Silica Shop. If however, there is something you wish to purchase, and you find one of our competitors offering it at a lower price, then please contact our sales department, providing us with our competitor's name, address and telephone number. If our competitor has the goods in stock, we will normally match the offer (on a 'same product - same price' basis) and still provide you with our normal free delivery. We realise that we are not the only company who will match a competitor's price. However, if you come to us for a price match, you will also be entitled to our after sales service, including free newsletters and technical support. This makes our price match promise rather special, something you will receive ONLY FROM SILICA. We don't want you to go anywhere else for your Atari products so shop at Silica, the UK's No.1 Atari Specialist.

**SIDCUP (& Mail Order) 01-309 1111**  
1-4 The Mews, Hatherley Road, Sidcup, Kent, DA14 4DX

**LONDON 01-580 4839**  
Lion House (1st floor), 227 Tottenham Court Rd, London, W1

**LONDON 01-629 1234 ext 3677**  
Selfridges (1st floor), Oxford Street, London, W1A 1AB

### 520ST-M

The affordability of Atari computers is reflected in the price of the 520ST-M keyboard, which is a mere £259 (inc VAT). This version of the ST comes with 512K RAM, as well as a modulator and lead for direct connection to any domestic TV. The price does not include a mouse. In addition, when you buy your 520ST-M from Silica, you will also receive the FREE Silica 'ST Starter Kit'. During 1987, many software houses will be producing games software on ROM cartridges, which will plug directly into the cartridge slot on the 520ST-M keyboard, giving instant loading without the expense of purchasing a disk drive. With the enormous power of the ST, you can expect some excellent titles to be produced, making this the ultimate games machine! If your requirement is for a terminal, then the 520ST-M can fulfil this role too. Leads are available to connect the ST to a variety of monitors, and with the imminent introduction of terminal software on ROM cartridge, the ST provides a low price terminal for business use. If you wish to take advantage of the massive range of disk software available for the ST range, you will need to purchase a disk drive. Atari have two floppy disk drives available, a 1/4 Mbyte model £149 and a 1Mbyte model £199. Full details of these drives, as well as the Atari 20Mbyte hard disk are available on request. If required at a later date, the mouse may be purchased separately.

**£259**

### 520ST-FM

The 520ST-FM with 512K RAM and free mouse, represents a further breakthrough by Atari Corporation in the world of high power, low cost personal computing. This model is the latest addition to the ST family, and is not only powerful, but compact. It is priced at only £399 (inc VAT) a level which brings it within the reach of a whole new generation of computer enthusiasts. When purchased from us, it comes with the FREE Silica 'ST Starter Kit' see paragraph on the left. To make the 520ST-FM ready for use straight away, Atari have built into the keyboard a 1/4 megabyte disk drive for information storage and retrieval, allowing you easy access to the massive range of disk based software which is available for the ST. This new computer comes with all the correct cables and connections you will need to plug it straight into any standard domestic television set. You do not therefore have to purchase an Atari monitor. If you do require a monitor however, these are available with the 520ST in the following money saving packages:

- 520ST-FM Keyboard Without Monitor - £399 (inc VAT)
- 520ST-FM Keyboard + High res mono monitor - £499 (inc VAT)
- 520ST-FM Keyboard + Low res colour monitor - £599 (inc VAT)
- 520ST-FM Keyboard + Med res colour monitor - £699 (inc VAT)

Because the 520ST-FM has its own power transformer built into the keyboard, there are no messy external adaptors to clutter up your desk space. You are left with only one main lead, serving both the disk drive and the computer. You couldn't ask for a more stylish and compact unit.

**£399**

### 1040ST-F

For the businessman and the more serious home user, Atari have their most powerful model, the 1040ST-F with 1028K RAM. This low cost powerhouse can be introduced into a business environment as a stand-alone system, or can support a mainframe computer as a terminal. The 1040ST-F not only features twice as much memory as the 520ST-FM, but also includes a more powerful built-in disk drive. The 1040ST-F is also supplied from Silica Shop with a free software package and 'ST STARTER KIT'. In the USA, the 1040ST-F has been sold with a TV modulator like the 520ST-FM. However, for the UK market, Atari are manufacturing the 1040ST-F solely with business use in mind and it does not currently include an RF modulator, this means that you cannot use it with a domestic TV (Silica Shop do offer a modulator upgrade for only £49). The 1040ST-F keyboard costs only £599 (inc VAT) and, unless a modulator upgrade is fitted, will require an Atari or third party monitor. There are three Atari monitors available and the prices for the 1040 with these monitors are as follows:

- 1040ST-F Keyboard Without Monitor - £599 (inc VAT)
- 1040ST-F Keyboard + High res mono monitor - £699 (inc VAT)
- 1040ST-F Keyboard + Low res col monitor - £799 (inc VAT)
- 1040ST-F Keyboard + Med res col monitor - £899 (inc VAT)

The 1040ST-F comes with a mouse controller and includes 1Mbyte of RAM. It has a 1Mbyte double sided disk drive and mains transformer, both built into the keyboard to give a compact and stylish unit, with only one main lead.

**£599**



To: Silica Shop Ltd, Dept PCW 9, 1-4 The Mews, Hatherley Road, Sidcup, Kent, DA14 4DX

**PLEASE SEND ME FREE LITERATURE ON THE ATARI ST**

Mr/Mrs/Ms: ..... Initials: ..... Surname: .....

Address: .....

Postcode: .....

Do you already own a computer  
If so, which one do you own? .....

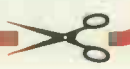

# HARVEST

## A CHALLENGE TO YOUR CHOICE

Reaping from your choice of HARVEST Keyboard



- Versatile choice  
KB-5349A 101-Key. ARC-Profile KB-5349 101-Key. LOW-Profile  
KB-5160A 84-Key. ARC-Profile KB-5160 84-Key. LOW-Profile
- Positive Tactile Feedback Mechanical Switch. CLICK Sound
- XT/AT Switchable
- Superior Quality and Immediate Delivery
- Excellent touch feeling

# HARVEST

**TOP HARVEST  
INTERNATIONAL CORP.**

B1, 11F, NO. 126, NANKING E. Road, Sec. 4, Taipei, Taiwan 10569, R.O.C.  
Tel: 886-2-771-3170 Fax: 886-2-731-2259 Telex: 26747 JHARVEST

## REAL CONNECTIVITY FROM ARCLINK

ARCLINK, BASED ON ARCNET MODIFIED TOKEN PASSING PROTOCOL, PROVIDES ONE OF THE MOST EASY-INSTALLATION AND COST EFFICIENCY NETWORK CONTROLLER FOR IBM PC XT/AT AND COMPATIBLES.

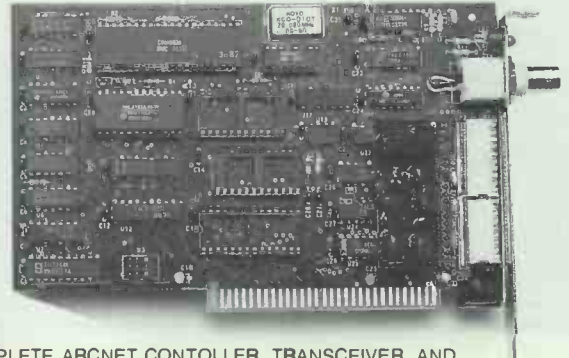

- COMPLETE ARCNET CONTROLLER, TRANSCEIVER, AND HYBRID WITH GREATER RELIABILITY.
- 2.5 MEGABITS TRANSMISSION SPEED.
- DIAGNOSTIC LEDS & CONFIGURATION DIP SWITCHES LOCATE ON THE REAR BRACKET FOR EASY TROUBLE-SHOOTING AND INSTALLATION.
- A FLEXIBLE SYSTEM THAT STARTS SMALL AND OFFERS GREAT ROOM FOR EXPANSION.
- SUPPORT UP TO 255 NODES PER NETWORK SEGMENT.
- COMPATIBLE WITH SMC'S PC-100, AND NOVELL AND VIANET SOFTWARE.

## QUALITY SERVICE + UNMATCHED PRICES

Computers	£
TANDON PCX 20	899.00
PCA 20	1325.00
PCA 30	1525.00
PCA 40	1745.00
PCA 70	2175.00
For EGA Systems add £300 Target and PAC 286 now available	
AST PREMIUM 20 MB	1575.00
AST PREMIUM 40 MB	1850.00
VICTOR V286 30 MB	1749.00
VPCII 30 MB	1299.00

Also Authorised Dealers for  
AMSTRAD, APRICOT and KAYPRO

**PACKAGE  
DEAL  
£4775**

Tandon PCA 20  
Wyse 700 Monitor  
HP Laserjet II  
Ventura  
Microsoft Mouse  
PC Paintbrush  
plus 1-day training

All prices are CWO and exclusive of VAT.

Desk Top Publishing	£
Software	Ventura 695.00
	Pagemaker 525.00
	Gem Publisher 295.00
Laser Printers	Epson GQ 3500 1395.00
	HP Laserjet II 1995.00
	AST Turbolaser 2225.00
	Ricoh Postscript 4250.00
Monitors	Wyse 700 725.00
	Genius A4 1325.00
	Taxan 19" 695.00
Scanners	HP ScanJet 1350.00
	Canon 999.00
	AST Turboscan 1150.00
	Microtek Flatbed 1199.00
Training (per day)	150.00

**MICRO  
MINDER CONSULTANTS LTD**

68 Upper Richmond Road, London SW15 2RP  
**01-870 4650/7431**

# THOUGHTS & CROSSES

(COMPUTERS) LTD.

33 MARKET STREET, HECKMONDWIKE, WEST YORKS

COMPUTERS		DISK DRIVES		DISKETTES		AMSTRAD PC PRODUCTS		PSION ORGANISER PRODUCTS		ATARI ST SOFTWARE		DAISY PRINTERS		PRINTER ACCESSORIES		EXTERNAL CENTRONICS TYPE		PRINTER RIBBONS		LEADS		MONITORS	
Amstrad PCW 8512	£573	Amstrad PCW 512k Upgrade - 720k Second Drive	£169	5 1/4" SS DD 48-p	10 for £9	10 MByte Hardcard - Controller Card (Dysan)	£349.00	Organiser 11 CM (8KRam 032KRom)	£99	PCB Designer	£179.00	Juki 6100	£320	Epson LX80 86 Tractor Unit	£25	Commodore 64 - Citizen 1200	£49	Amstrad PCW8256	£5.50	Amstrad Centronics Printer Lead	£10	Microwrite 1431 MS (Standard res)	£215
Amstrad PCW 8256	£458	Alan SF354 - 540 Drive	£100	5 1/4" DS DD 48-p	10 for £9	3 MByte Hardcard - Controller Card (Storage Master)	£399.00	Organiser 11 XP (16KRam 32KRom)	£139	GFL Football	£22.50	Juki 6200	£549	Epson LX80 86 Sheet Feeder	£65	Hempton interface E-Rom based for Spectrum...	£39.95	Brother EP44	£2.30	Amstrad Centronics Printer Lead	£10	Microwrite 1451 MS (Medium res)	£269
Amstrad CPC464 (Colour Monitor) + £100 FREE software	£299	Alan SF314 11Mb Drive	£190	5 1/4" DS DD 36-p	10 for £9	FD-3 Second Disk Drive	£169.95	16K Ram Upgrade	£19	Little Computer People	£22.50	Citizen 2000	£195	Epson LX80 86 Sheet Feeder	£65	QL Centronics interface	£20	Brother HR4	£2.99	Amstrad Centronics Printer Lead	£10	Microwrite 1451 DO Sinclair QL	£275
Amstrad CPC6128 (C64 & disk drive) + FREE software	£399	Cumana (Alan) 1Mb Drive	£139	3" CP2	10 for £16	Hard Disk Backup Unit (including Cartridge)	£530.00	32K Ram Upgrade	£34	MUSIC SHUHO	£26.95	Citizen Premier 35	£649	Epson LX80 86 Tractor Feeder	£159	Trispar 20 64 for CB VIC20 64	£50	Brother M1009 Centronics GLP	£3.80	Dragon Centronics Printer Lead	£10	Philips 7522 anti-glare screen monitor (20MHz)	£95
Amstrad PC1512 (Single Drive, Mono Monitor)	£516	QL 720K Drive - Interface	£199	3 1/2" Double Sided	10 for £22			64K Ram Upgrade	£79	PrintMaster	£45.00			Epson LX80 86 Sheet Feeder	£65			Brother M1009 Centronics GLP	£3.80	Dragon Centronics Printer Lead	£10	Philips 7542 anti-glare amber screen monitor	£95
Amstrad PC1512 (Twin Drive, Mono Monitor)	£542	Amstrad FD-1 (Second Drive)	£99							Fast Comm	£45.00			Epson LX80 86 Sheet Feeder	£65			Brother M1009 Centronics GLP	£3.80	Dragon Centronics Printer Lead	£10	Philips 7542 anti-glare paper white monitor (20MHz)	£95
Amstrad PC1512 (Single Drive, Colour Monitor)	£710	Cumana CSK 400	£135							Prates of Barbary Coast	£14.65			Epson LX80 86 Sheet Feeder	£65			Brother M1009 Centronics GLP	£3.80	Dragon Centronics Printer Lead	£10	Philips 8533 RGB TTL Audio Med Res	£290
Amstrad PC1512 (Twin Drive, Colour Monitor)	£838	Commodore 1541C	£195							Back Pix	£45.00			Epson LX80 86 Sheet Feeder	£65			Brother M1009 Centronics GLP	£3.80	Dragon Centronics Printer Lead	£10		
Amstrad PC1512 Hard Disk 20Mb Mono	£1033	Commodore 1541C	£195							Fast Basic	£81.00			Epson LX80 86 Sheet Feeder	£65			Brother M1009 Centronics GLP	£3.80	Dragon Centronics Printer Lead	£10		
Amstrad PC1512 Hard Disk 20Mb Colour	£1229	Cumana CD800S	£319							Arctic Box	£36.00			Epson LX80 86 Sheet Feeder	£65			Brother M1009 Centronics GLP	£3.80	Dragon Centronics Printer Lead	£10		
Alan 5205TFM	£369									GFA Basic	£54.00			Epson LX80 86 Sheet Feeder	£65			Brother M1009 Centronics GLP	£3.80	Dragon Centronics Printer Lead	£10		
BBC Master Series	£425									GFA Basic Compiler	£54.00			Epson LX80 86 Sheet Feeder	£65			Brother M1009 Centronics GLP	£3.80	Dragon Centronics Printer Lead	£10		
BBC Master Compact with green screen monitor	£458									1st Word Plus	£72.00			Epson LX80 86 Sheet Feeder	£65			Brother M1009 Centronics GLP	£3.80	Dragon Centronics Printer Lead	£10		
BBC Master Compact with medium res colour monitor	£531									Haba Winter 2	£67.00			Epson LX80 86 Sheet Feeder	£65			Brother M1009 Centronics GLP	£3.80	Dragon Centronics Printer Lead	£10		
Alan 10405TF with 1Mb Disk Drive & Philips 8533 Colour Monitor	£870									Depac	£44.95			Epson LX80 86 Sheet Feeder	£65			Brother M1009 Centronics GLP	£3.80	Dragon Centronics Printer Lead	£10		
BBC Master Compact + TV Modulator	£417									Hysoft	£23.50			Epson LX80 86 Sheet Feeder	£65			Brother M1009 Centronics GLP	£3.80	Dragon Centronics Printer Lead	£10		
Sinclair Spectrum Plus 2	£149									Hysoft Arts	£54.00			Epson LX80 86 Sheet Feeder	£65			Brother M1009 Centronics GLP	£3.80	Dragon Centronics Printer Lead	£10		
Commodore Amiga 500	£545									Beaurocracy	£21.50			Epson LX80 86 Sheet Feeder	£65			Brother M1009 Centronics GLP	£3.80	Dragon Centronics Printer Lead	£10		
Amstrad PC1512 twin drive mono with Amstrad DMP3000 Printer Wordstar 1512 A + Supercalc 3	£804									Enchanters	£26.95			Epson LX80 86 Sheet Feeder	£65			Brother M1009 Centronics GLP	£3.80	Dragon Centronics Printer Lead	£10		

EXPORT ORDERS WELCOME ASK OR SEND FOR PRICE LIST

TELEX 556577 CROSS Shop open 9-5pm Mon-Sat; Mail Order 9-8pm Mon-Fri.

ALL PRICES INCLUDE VAT AND CARRIAGE

# Unlimited Creativity in a complete Pack. The new Cherry Graphics Tablet Mk.2.



The new A3 Graphics Tablet Mk.2 is more versatile, easier to use and available in a complete Pack. For architectural, designing, draughting, educational and research Applications.

### The main Advantages of the Mk.2

- Standard A3 working area of 384x260mm. ● Increase of working area to 384x290mm if menu strip is not being used
- Change over from stylus to cursor puck at the flick of a switch. ● Stable and accurate display under all normal operating conditions. ● Resolution 0,1mm with accuracy  $\pm 0,5$  mm. ● Actual accuracy through "zoom" option of virtually all painting and CAD software in effect almost infinite. ● Configuration can be altered with 16 set-up DIP switches in easily accessible position
- LED "power-on" indicator. ● Single industry standard 25 pin "D" connector provides parallel and serial ports. ● Calculator-style independent power supply for cases where power cannot be supplied from host computer
- Re-legendable menu. ● Supports RS232 serial and serial or parallel TTL interfaces, all with optional handshaking. ● Choice of standard ASCII or fast packed binary formats. ● User-selectable baud rates of 300, 600, 1200, 2400, 4800, 9600 and 19200 in point stream or switch-stream modes. ● Attachable to practically any type of computer system. ● Compatible with Summagraphics protocols. ● Pack includes digitising tablet, 4-key crosshair cursor puck, stylus, power supply, interface cabling user-definable menu strips, marker pen and documentation

Send today for further technical details  
Or contact one of the following Distributors

- |  |  |   |   |
|--|--|---|---|
| <p>P.M.S.<br/>(Instruments) Ltd.<br/>Waldbeck House,<br/>Reform Road,<br/>Maidenhead, Berks.<br/>Contact: Mr. Bill Webb<br/>Tel.: 0628-38036</p> | <p>S.K. Micro Systems Ltd.<br/>St. Michaels House,<br/>Norton Way South,<br/>Letchworth, Herts.<br/>SG 6 1PB<br/>Contact: Mr. Noel May<br/>Tel.: 0462-679331</p> | <p>Kingsland<br/>Data Services Ltd.<br/>1, Wood End Road,<br/>Erdington, Birmingham,<br/>B24 8AA<br/>Contact: Mr. John Blyth<br/>Tel.: 021-384-8080</p> | <p>Environmental<br/>Equipment Limited<br/>Environ House<br/>Welshmans Lane<br/>Off Welsh Row<br/>Nantwich, Cheshire<br/>CW5 6AJ<br/>Contact: Mr. Roger Hill<br/>Tel.: 0270-625115/62660.</p> |
|--|--|---|---|

# CHERRY

## New Generation Graphics Tablets.



# SOFT TOUCH COMPUTERS



APPROVED DEALER

AMSTRAD APPROVED DEALER

## APRICOT

XEN XI10, 512k Ram 3 1/2" or 5 1/4" Floppy, Keyboard, Green Monitor, Standard Apricot Software **£1,499.00**  
 XEN XI20, 512k Ram 3 1/2" or 5 1/4" Floppy, Keyboard, Green Monitor, Standard Apricot Software **£1,849.00**  
 New XEN-I 386, 30Mb Monitor, Standard S/W M.R.P. **£3,367.00**  
 Our Price **£2,549.00**  
 New XEN-I 386, 45Mb Monitor, Standard S/W M.R.P. **£4,367.00**  
 Our Price **£3,549.00**

## MULTI-USER PACKAGE

Apricot VX70 3 1/2" or 5 1/4" drive, 70Mb HD, 125Mb tape back up. XEN-IX operating system, 2 terminals and cables  
**Total Price £6,800.00**

Call for more details on Apricot multi user systems or desk top publishing systems

## AMSTRAD

PC1640 Single drive and software **£699.00**  
 PC1640 Double drive and software **£799.00**  
 PC1640 Hard Disk 5 1/4" disk drive, 20Mb Hard Disk and software **£999.00**

All above with Colour Monitors

## SHARP

Laptop Computers and Printers **Call**

## EPSON

Laptop Computers and Printers **Call**

## SOFTWARE

Wordcraft	£299.00	Sage PC Planner	£70.00
Superwriter	£149.00	Framework II	£375.00
Easywriter	£199.00	Javelin	£399.00
Wordstar Version 3.4	£200.00	Database III Plus	£399.00
Word Perfect Word Library	£285.00	Sidekick	£40.00
Open Access Version 1.06	£299.00	Xchange	£299.00
Volkswriter Version 3.0	£189.00	Clipper	£399.00
Sage Accountant	£108.00	SUP Calc4	£199.00
Sage Accountant Plus	£140.00	Lotus 123	£275.00
Sage Payroll	£70.00	Sage Bookkeeper	£75.00

## MODEMS

Pace **Call**  
 Miracle Technology **Call**  
 Steebek Dowty **Call**  
 Racal Mitgo **Call**  
 Tandata **Call**  
 Hayes Modem **Call**

## ACCESSORIES

Disks 3 1/2", 5 1/4"	<b>Call</b>	Data cartridges	<b>Call</b>
Laser Consumables all	<b>Call</b>	Ribbons for 99% of all makes	<b>Call</b>
Laser	<b>Call</b>	of printers	<b>Call</b>
Acoustic Hoods	<b>Call</b>	Printer Stands	<b>Call</b>
Cable, serial or parallel	<b>Call</b>	Power Supplies	<b>Call</b>
Expansion Boards	<b>Call</b>	Etc Etc Etc	<b>Call</b>

## PRINTERS

Epson FX85 160cps	<b>£317.00</b>
Epson LX86	<b>£219.00</b>
Epson LQ800 180cps	<b>£425.00</b>
Epson EX1000 Dual/Tractor Colour Option	<b>£599.00</b>
Epson LQ1000 180cps	<b>£565.00</b>

Brother HR20 Dual Daisywheel	<b>£335.00</b>
Brother HR25 XL	<b>£549.00</b>
Brother Twinwriter 5	<b>£999.00</b>
Brother M1409 180cps/45cps 110 columns	<b>£325.00</b>

Panasonic KXPLO81	<b>£199.00</b>
Panasonic KXPLO92	<b>£320.00</b>

Citizen Premiere 35P	<b>£550.00</b>
----------------------	----------------

Juki	<b>Call</b>
------	-------------

Qume II series	<b>Call</b>
----------------	-------------

Star	<b>Call</b>
Canon	<b>Call</b>
Ricoh	<b>Call</b>
Silver Reed	<b>Call</b>

## COLOUR PRINTERS

Okimate 20	<b>£149.00</b>
NEC Pinwriter 7	<b>£575.00</b>

Jukiprinter	<b>Call</b>
-------------	-------------

## LASER PRINTERS

Hewlett Packard Laser Jet	<b>£1,599.00</b>
Hewlett Packard Jet Plus Serial parallel	<b>£2,199.00</b>
Canon 8A1 Serial Parallel	<b>£1,599.00</b>
Kyocera F-1010 Serial Parallel	<b>£2,699.00</b>
AST Turbolaser	<b>£3,000.00</b>
New Canon LBP8 Mark III	<b>£1,699.00</b>
New Hewlett Packard Laser Jet Series II	<b>£1,999.00</b>

## MONITORS

Colour option IBM Compatible	<b>Call</b>
Taxan	<b>Call</b>
Phillips 20"	<b>Call</b>
Wyse	<b>Call</b>
Microvitec	<b>Call</b>
Sanyo	<b>Call</b>
Zenith	<b>Call</b>
Qume Esprit	<b>Call</b>
NEC	<b>Call</b>

EGA Card or CGA Card required for colour monitor.

## SPECIAL OFFER

All orders over £5,000 receive a free Oki-Mate 20 colour printer and free delivery.

ALL PRICES EXCLUDE VAT AND DELIVERY

FOR YOUR ONE STOP SUPPLIES CALL FOR DISCOUNTS ON BULK ORDERS NOW

PLEASE DO NOT HESITATE TO CONTACT SOFT TOUCH COMPUTERS, AS ADVICE AND INFORMATION IS ABSOLUTELY FREE. CALL SOFT TOUCH COMPUTERS ON

# 01-571 7614

**SOFT TOUCH COMPUTERS**  
**24 ORCHARD AVENUE, SOUTHALL**  
**MIDDX UB LG**

WE'RE WITH YOU ALL THE WAY

The Features.



Attachment for stylus or cursor puck.



Set-up DIP switches.



LED "power-on" indicator.



Legendable menu.



Pin "D" connector.



Complete pack.



SEIKO-sha SL-80AI

# PERFECT LETTER QUALITY

## *The New Standard for Printers*

The remarkable new SEIKOSHA SL-80AI sets new standards in printer performance.

IBM and Epson compatible, it zips effortlessly along in draft mode at more than a line a second. Switch modes and its **24 pin** print head gives you **50 cps PLQ** performance – and that's a whole new dimension of quality and clarity in low-cost printers.

Naturally, the SL-80AI has a range of print characteristics to match this quality.

Designed to meet all the style and function requirements your business and

*The SEIKOSHA SL-80AI – because when it comes to Quality, Nearly is not Enough.*

professional documents demand, they include:

- ★ 6 standard fonts + 6 italic versions + proportional spacing;
- ★ 7 graphic densities, up to 1920 dots;
- ★ 185 standard characters and symbols; 49 international characters; plus 128 user defined characters;
- ★ Bold, double-width, double-strike, superscript, and subscript characters.
- ★ 16K buffer
- ★ Automatic single sheet feeder
- ★ Parallel interface

**DDL**

Distributed in the UK by Data Distributors Limited  
710 Birchwood Boulevard, Birchwood, Warrington, WA3 7PY.

Dealers enquiries welcome.

**JUST £399.00**  
FROM GOOD DEAL  
EVERYWHERE

# The old technology is dead.

# Join the revolution!

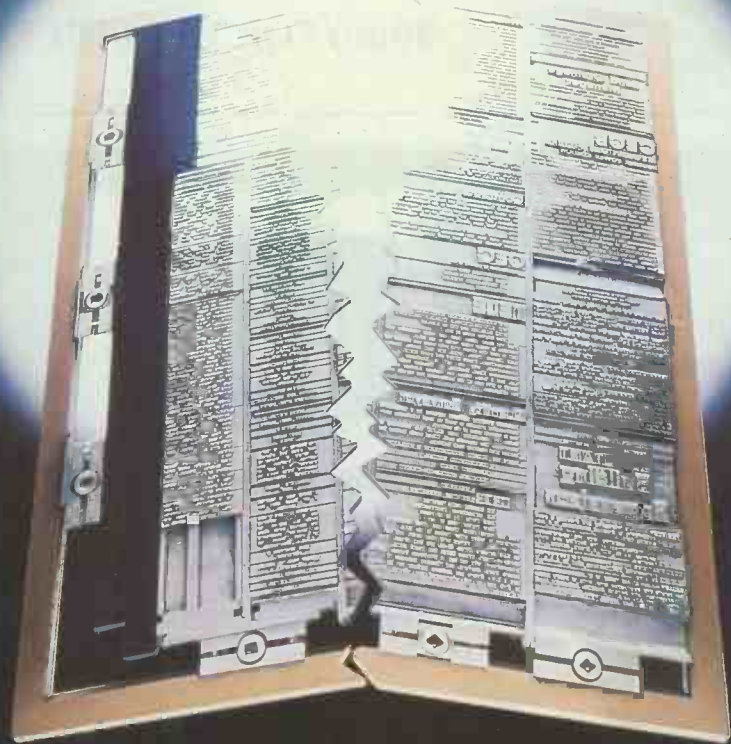

The printing industry has been rocked to the core by an ever-growing series of developments in the exciting new field of Desktop Publishing.

Traditional ways of producing the printed page have been revolutionised.

Now anyone can use a home or office micro to design and typeset anything from books and newsletters to advertisements and company reports.

With the latest methods it can all be done at a fraction of the conventional cost. And much quicker and easier than ever before.

Here's a unique opportunity to find out more about this bustling new industry – the first Desktop Publishing Show. All the major companies will be demonstrating their latest products. And there will be seminars throughout each day to tell you exactly how you or your company can benefit most from the Desktop Publishing revolution.

In addition, each visitor will receive a free copy of the Desktop Publishing Yearbook, worth £5 – packed with facts and figures on the most fascinating development in print technology since Caxton.

# Desktop Publishing SHOW 1987

**October 15, 16 & 17**

**Business Design Centre  
Islington, London N1**

Organised by Database Exhibitions



Sponsored by Pira, the UK technology centre for the printing and publishing industry

**No admission charge. Please complete this coupon for your tickets.**

**Post to: Norah Hodgson, Database Exhibitions, Europa House, 68 Chester Road, Hazel Grove, Stockport SK7 5NY.**

Please send me \_\_\_\_\_ FREE tickets to  
The Desktop Publishing Show 1987

Name \_\_\_\_\_

Position \_\_\_\_\_

Address \_\_\_\_\_

\_\_\_\_\_ Postcode \_\_\_\_\_

NO PERSONS UNDER 18 ADMITTED

**SHOW HOTLINE: 061-480 0171**

A060

# FREE 10mb WITH EVERY AMSTRAD PC

30mb FOR THE PRICE OF 20mb



## AMSTRAD PC 1640

**NOW IN STOCK!**

1512 Mono with 360K floppy + 30mb £899

1512 Colour with 360K floppy + 30mb £1069

1640 EGA Colour with 360K floppy + 30mb £1199

1640 EGA Colour with 2 x 360K floppies £899

10 free disks containing games, ● etc with all computers

### CALL US FOR EXCELLENT PRICES ON ALL PRINTERS e.g.

CANON PW 1080A	£248	£244
CANON A-55	£408	£399
PANASONIC 1081	£240	£186
MP 201	£249	£285

(£8 Carriage to pay on all printers)

#### CLASSIC INTEGRATED ACCOUNTS

<i>Classic</i> Accounts	£1140	£189
<i>Classic</i> Accounts + Stock	£1428	£1340
<i>Classic</i> Stock Control	£286	£69
<i>Classic</i> Payroll	£385	£88

32Mb MINICRIBE HARD CARD	£345
21Mb HARD CARD	£295

(£5 Carriage on Hard Cards)

### Free 12 Months On Site Maintenance with all SANYO MBC16 computers

MS.DOS 3.2 with GW Basic	
RS232 and Centronics Parallel	
Small footprint	
Switchable 4.77/8 mhz clock speed	
8088-2 16 bit microprocessor	
TWIN 360K FLOPPY MONO	£699
20mb + 360K FLOPPY MONO	£999
TWIN 360K FLOPPY COLOUR	£949
20mb + 360K FLOPPY COLOUR	£1199

**ARKEL COMPUTER SERVICES LTD  
7A MILL HILL ROAD, MARKET HARBOROUGH,  
LEICS LE16 7DN**

**TELEPHONE: 0858 32495**

**Please add 15% VAT to all U.K. orders**

# We Connect You To Profitmaking

## Rotary data selector

- RS-232 series (DB-25)
- Centronics parallel
- Others: DE-9, DA-15, coaxial, twinaxial, etc.

## Cable and connector

- Multiconductor shielded cable assembly.
- Flat ribbon cable assembly.
- Other special cable assemblies such as individual shielded cable, low capacitance cable, high flexibility and temperature resistance cable, etc.
- D-subminiature series connector.
- Centronics series connector.
- I.D.C. socket, double row.
- I.D.C. card edge connector.
- Dip plug.

## Balun

- Coaxial type - for IBM 3270 series devices
- Twinaxial type - for IBM systems 34, 36, 38, 5250, 5520

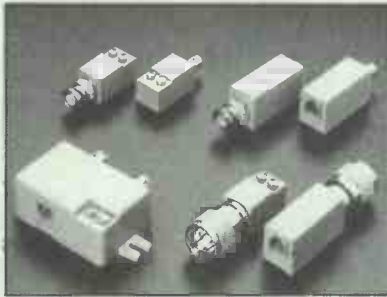
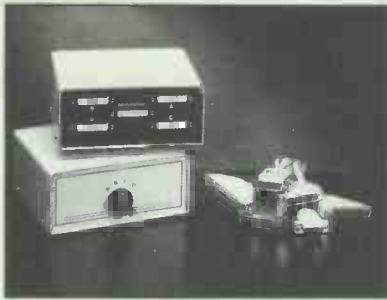

## UNIXSTAR TECHNOLOGY, INC.

3F., 3, LANE 538, CHUNG CHEN RD.,  
HSIN TIEN TAIPEI, TAIWAN, R.O.C.

TEL: 886-2-9188863/4, 9170822

FAX: 886-2-9170833 TLX: 10251 TSRCO

# System Science

## C COMPILERS

<b>AZTEC</b> AZTEC C86/COMM—MS-DOS & PC-DOS £295.00 large mem. linker, ASM, 8087 support AZTEC C86/PERS—ASM, link (MS-DOS) £149.00 AZTEC C68/COMM—MAC, AMIGA £295.00 AZTEC C for CP/M80, APPLE DOS, PRODOS £ Call	<b>LATTICE</b> LATTICE C Compiler ver 3-8087, all mem. models. £245.00 LATTICE Screen Editor £95.00 LATTICE C SPRITE Debugger £129.00 LATTICE dbc-II or III Dbase library £175.00
--	---

MICROSOFT C 4.0 with Code View £295.00	INSTANT C full prof. Interpreter £345.00
DESMET C-ASM, LINK, 8087 Editor £119.00	RUN/C-PROFESSIONAL Interp. £125.00
C CROSS compilers, many targets £ Call	RUN/C—Interpreter excellent tutorial £60.00
	LIVING C—Plus Interp and compiler £145.00

## C LIBRARIES

<b>GRAPHICS</b> Metawindows—many languages £99.99 Essential Graphics Library £175.00 GraphiC—source, colour, EGA £245.00 Multi-Halo—specify compiler £175.00	<b>COMMUNICATIONS</b> GREENLEAF COMMUNICATIONS £125.00 Ints, Ring Buff., Status & Control BLAISE ASYNCH MANAGER £125.00 Port control, XMODEM protocol
<b>SCREEN and DATA ENTRY</b> PANEL entry screens—most languages £215.00 Vitamin C—Screen, print layout code £145.00 Windows for Data, Windows for C £215.00	<b>GENERAL</b> GREENLEAF GENERAL FUNCTIONS £125.00 Dos, Disk, Video Strings, Date, Keybd. PforCe—source lib, comms, dbase, screen etc £245.00 The C programmers toolkit
<b>ISAM &amp; DATAFILE</b> CTREE—Faircom (source) B tree lib. £245.00 R TREE—Reports generator for C TREE £195.00 Btrieve—database library, many lang. £195.00 Btrieve/N—Novell, PC-NET networks £425.00 C-ISAM for Microsoft and Lattice £225.00	<b>BLAISE C TOOLS PLUS—source</b> £125.00 DOS, Dos, screen, windows, keyboard etc C Scientific Subroutines—source £125.00 Matrix, polynomial, diff. eqn. etc TIMESLICER Multi tasking £195.00 V8 virtual memory manager £225.00

<b>PHOENIX</b> PLINK-86 Plus—overlay caching £325.00 PMATE-86 programmers editor £120.00 PRE-C Lint utility £195.00 PFIX-86 Plus debugger £225.00 PDISK—backup, disk cache & utils £95.00	<b>BRIEF multi-file editor</b> £145.00 EPSILON—Emacs style editor £145.00 PETER NORTON EDITOR £36.00 QUILT Software Revision Management £95.00 PC-LINT by Gimpel £99.00 CLIPPER—Dbase III Compiler £495.00
--	---

## ASSEMBLERS and CROSS-ASM

Microsoft 8086 macro Asm (SYMDEBUG & LINK) £115.00	2500AD 8086 and linker (MS-DOS) £89.00
DR Assembler Plus Tools £175.00	Cross Assemblers £ Call
68xx, 68000, Z80, 8080, 6502, 8048, 8051 etc £ Call	Simulators—Z80, 8048, 8051 etc £ Call
Visible Computer 8088—Assembler Interpreter £75.00	

## LMI Forth-83

PC-FORTH, asm, Editor, DOS access £125.00
Options: Floats, 8087, Graphics
UR-FORTH high perf., 8087, graphics £245.00
PC-FORTH+ provides 32 bit pointers £225.00
8086 FORTH for MS-DOS and CP/M-86 £35.00
METACOMPILRS 8080, Z80, 8036, 6303 etc £95.00
Z80 FORTH-83 for CP/M (Amstrad PCW)

<b>BORLAND</b> TURBO PASCAL £69.00 TURBO PASCAL JUMBO PACK £165.00 Turbo Tutor £29.00 TURBO PROLOG new £69.00 TURBO LIGHTNING £69.00 Superkey or Sidekick £69.00	<b>TURBO Database Toolbox</b> £49.00 TURBO Graphics Toolbox—PC-DOS £49.00 TURBO Editor Toolbox—PC-DOS £49.00 BLAISE Power Tools Plus £75.00 BLAISE Asynch Plus £75.00 TURBO Power Utilities £75.00 TURBO Power Extender £75.00 TURBO Numerical Methods Tool 30+ £69.00
--	---

## FORTRAN/PASCAL/BASIC MOD-2

Fortran Graphics, Scientific Libraries £ Call
Microsoft FORTRAN-77 with Codeview £275.00
Pro-FORTRAN-77 £395.00
RM-FORTRAN-77 £375.00
PRO-PASCAL MS-DOS £295.00
Microsoft Pascal £185.00
QUICK BASIC—Microsoft (PC-DOS only) £75.00
FARBWARE Modula 2 £75.00

## LISP and PROLOG

TURBO PROLOG (PC Only) £69.00
micro-PROLOG PROF (full mem., wind.) £245.00
micro-PROLOG entry level version £95.00
MuLISP/MuSTAR (Common LISP) £195.00
Golden Common LISP (PC-DOS only) £495.00
MuMATH/MuSIMP Symbolic maths £275.00
WALTZ Lisp—Franz like (MS-DOS and CP/M) £125.00
TURBO PROLOG TOOLBOX £69.00

## COMMUNICATIONS, DISK & PRINT UTILITIES, etc.

CROSSTALK for IBM £120.00	PETER NORTON UTILITIES DISK £69.00
MOVE-IT for MS-DOS and CP/M-80 £145.00	FINAL WORD 2—authoring WP £275.00
UNIFORM-PC rw, format CP/M disks £65.00	MicroTEX—scientific typesetting from £395.00
CONVERT—PC add formats £89.00	Dan Bricklin's DEMO program £65.00
MATCHPOINT—read Apple disk £175.00	MICROSTAT—comprehensive statistics £315.00
UNIDOS—run CP/M software on PC £65.00	STATGRAPHICS £495.00
VENTURA Desktop Publishing system £745.00	WINDOWS Software Dev. kit £345.00

<b>NEW FROM BORLAND</b> Turbo Basic with Editor etc £69.00 Turbo C All model compiler £69.00	<b>C High Summer Offer</b> Living C Interpreter with the book C Programmers Guide by Purdom £73.00 This special price include VAT and postage
--	---

All prices are exclusive of VAT. Please add £3.00 p&p, plus VAT to your order

6-7 West Smithfield,  
London EC1A 9JX  
Tel: 01-248 0962  
BTGOLD 76: CJJ028

# MAXTOR

## AT UPGRADE KITS

### FORMATTED Exc VAT

AT 70Mb .....	£1136
AT 120Mb .....	£2650
AT 160Mb .....	£2995

Includes: Speedstor Software, Drive, Slides, Cables, Manual and Fitting Instructions.

## OPTICAL WORM DRIVE

800Mb Internal .....	£4432
800Mb External .....	£4952

Includes: Drive, Cartridge, Coral Software, Slides, Manual and Fitting Instructions

## IDENTICA TAPE BACK-UP

60Mb Internal .....	£725
60Mb External .....	£799

Includes: Sy-Tos Software including Sy-Clock (allows pre-timed back-up)

## MICROSCIENCE UPGRADE KITS

20Mb Kit .....	£320
30Mb Kit .....	£348
40Mb 28 MS ACC Kit .....	£899

Includes: Drive, Controller, Slides, Cable, Manual and Fitting Instructions.  
(Carriage £7 + VAT)

**Enquiries: PUMA PERIPHERALS**  
10 Cliff Parade, Wakefield,  
West Yorkshire WF1 2TA  
Tel: 0924 371021 Fax: 0924 371022  
Telex: 556100 RAINES G



*The runaway success of Amstrad has impressed many people, but his pricing policy following the launch of the PC1640 has cast a cloud. Guy Kewney searches for a silver lining, as he kicks off this month's news review.*

## What price an Amstrad PC?

The news that the price of an Amstrad 1640 will be only £130 more than the equivalent PC1512, leaves me (for the first time since I met him) doubting some of the marketing wisdom of Alan Sugar.

Alan Sugar is (he says) totally convinced that he has no need to cut prices of his original PC1512, even though his new PC1640 (Benchtest, page 106, this issue) is priced at only £130 more than the equivalent 1512 models.

Sugar believes that the PC1512 will continue to sell strongly, because it will

appeal to a 'less discriminating buyer.' In other words, a schmuck.

He said: 'I am assured by my people — and I know this is right — that the 1512 is now positioned for the consumer electronics market.'

One of Amstrad's distributors put it less tactfully: 'To you or I, who know about computers, the difference is slight. But to the sort of nerds who buy Amstrad, £100 is £100 — it's worth two days in Majorca, and they will go for the low-cost option.'

Actually, this theory has been well-proven, in general, by Tandy's experience with two remarkably similar price/performance machines in the US. Despite the fact that one (the Model 1000) is an awful

piece of work, and costs the earth to upgrade and really needs upgrading, people save a pitiful \$160 by buying it, and not the Model 3000.

Sugar nailed his colours firmly to the price mast. 'I think we will sell far bigger quantities of 1512s than 1640s,' he said. 'I'm not normally wrong, and will be prepared to stand by this in six months' time.'

Well, he *isn't* often wrong. He is sometimes marginally wrong. He was wrong when he predicted large sales of single-floppy or double-floppy monochrome PC1512 machines. Instead, he sold lots of hard-disk machines, many with colour.

Financially, this hardly matters; I expect him to come out of that mistake smelling of roses, since these machines make much more profit for him.

And when he unveils his half-year figures, they will accordingly be good, and he will certainly say that this 'proves' that the press invented stories about flagging PC1512 sales.

I'm afraid the press didn't, and it doesn't.

The price of the 1640 may be another mistake. The trouble with his prediction is that it depends on the buyer staying ignorant.

You can count on that — up to a point. Not everyone will be ignorant. *PCW* readers will be told (here it comes) fair and square: 'Don't touch the 1512, go for the 1640 — it's a *much* better machine.'

But I told *PCW* readers to avoid WordStar 1512 because it was awful and wasn't even WordStar. And there are more than enough people out there who don't read computer magazines (or don't believe what I tell them) and they made WordStar 1512 the best-selling program in the country.

Some readers will even say: 'What the heck, that £130 will buy me a printer,' and will only discover a year later that the printer is not that beautiful, and that they want to plug in a different

screen after all, and can't.

But this time, Sugar doesn't have the shopkeeper on his side.

WordStar 1512 was a great deal for the shopkeepers — an extra £70 on the sale. Naturally, they didn't reveal my rude comments to the potential buyer.

But the 1512 and the 1640 are going to stand side by side in the shops. Side by side, the 1640 is very, very clearly the nicer machine, even before you start counting the internal slots and asking intelligent questions about what you can or can't plug into it.

Of course, the PC1512 starts at £500. People will go into the shop because they see that price in the window. But someone who goes into the shop to buy the Amstrad PC because 'it costs £500' will not buy that single-floppy mono machine. I know that, because they don't: they quickly change their minds and go for the hard-disk, colour machine. That's what's been selling.

When the shopkeeper has explained to the customer why they are buying the colour machine, the temptation to switch them to the 1640 will be strong. Not only is it an extra £130 on the price, it's an extra £100 profit to the shopkeeper because Amstrad gives an extra six per cent margin on the 1640.

I don't mind watching Alan Sugar putting his trust in the gullibility of fools. But relying on the generosity of shopkeepers?

Frankly, I find it hard to believe. I think that something else is coming — probably, the extinction of the 1512 and the release of an 80286, or 80386, system.

As detailed in the 'Lost in the woods' story on page 78, you can buy an 80386 system in London for £1595, including a floppy disk and a mono screen. And you can buy a Dell 286 system with a hard disk and colour for £1799.

The problem doesn't just face Amstrad. There are lots of people out there planning

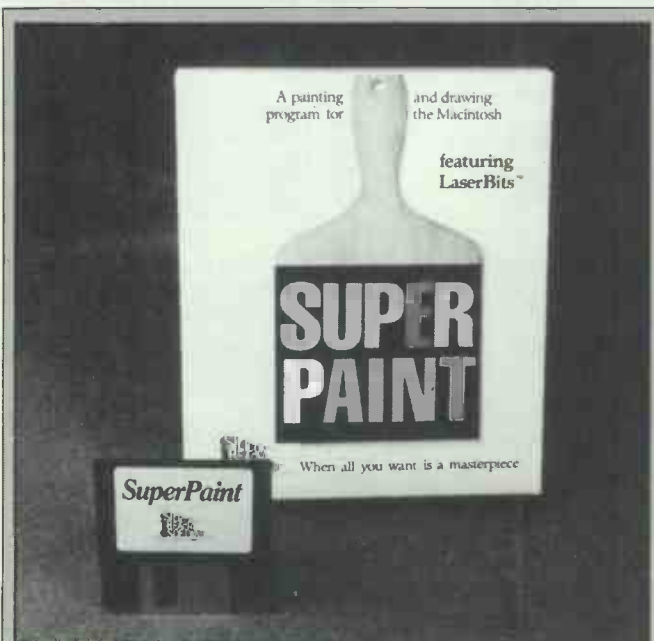

**SuperPaint for the Macintosh is quite a lot more than a 'latest version' of Macpaint.**

**Where MacPaint lets you put text into pictures but treats it like graphics, SuperPaint treats it as text which you can actually edit.**

**Where MacPaint sees only pixels, SuperPaint sees 'shapes' and has a 'draw' layer where they can be moved.**

**There are multiple windows, and a whole host of goodies like 300 dots per inch 'laserbits', and dot-by-dot editing of pictures at ultra-high resolution.**

**Full details can be obtained from the importer, P&P Micros, on (0706) 217744, but SuperPaint should be on sale in Mac shops.**

to release super machines based on the 80286, who have been working on them for a year or so, and who were counting on selling them for £2400 each.

A lot of these people are going to stare ruin straight in the face. A lot of *those* people will dodge ruin, by dumping their entire stock on the market for whatever price people will pay.

By Christmas, there's a good chance that prices will be tumbling down. And by then, honestly, I expect Alan Sugar to have no PC1512; for the PC1640 to cost just over £1000 with a hard disk; and for him to have a 386 machine announced — or ready for release as a desktop publishing package — for around £1800.

People who think they know what's going on behind silicon screens in Brentwood, assure me that the 286 machine has been scrapped. But they also suggest that the 80386 system, to be launched soon, will not actually be available until the end of the year — or even later.

And they suggest that this system will include some clever extras — in desktop publishing, facsimile equipment, scanners, laser printers, and so on. I've even been assured that the new Digital Research desktop publisher program will be bundled with it.

We'll find some clues at the PCW Show next month.

## DosEdit's lurking memory

When playing an Infocom adventure on a PC-compatible, use DosEdit. But beware! If you are playing something like Lurking Horror, DosEdit will give you away to your colleagues.

DosEdit is one of those indispensable programs of unknown origin, which was 'found' inside Microsoft. All it does is repeat the last command given to DOS.

Normally, you can do that with the F3 function key. What makes DosEdit nice is that it remembers the previous 15 commands, too. And it lets you edit them.

So, when you type a complex command such as:  
`pco /r/m = %1/q/l = c:\out\pro.cfg`  
and then find that you should be in a different directory, you can type 'cd\pco', hit the up arrow, and the previous command will reappear.

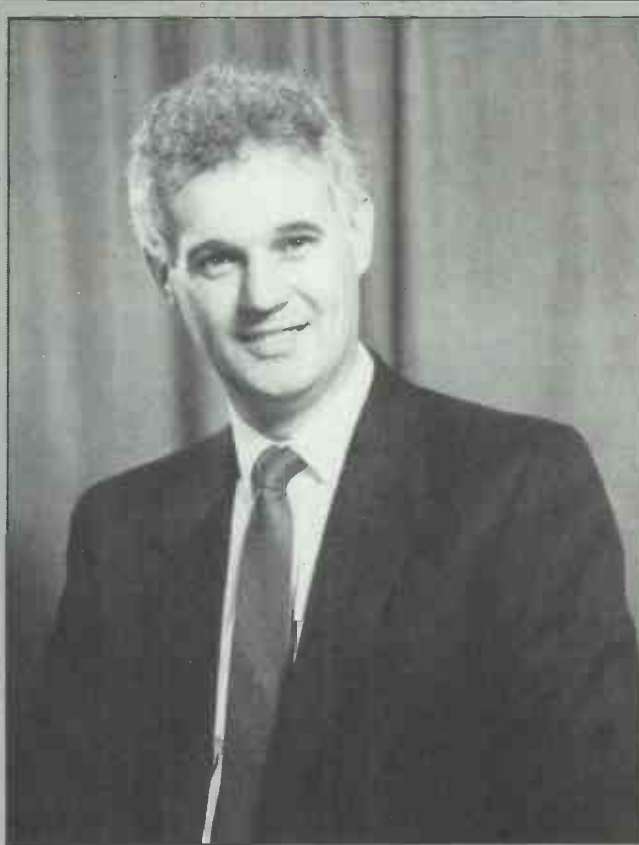

*I'm not going to make a habit of printing pictures of industry figures, but this striking portrait of the white-headed gent I think of as Sir David Whitehead, charming ex-boss of Adda Computers, was just too nostalgic for me to pass over.*

*Time was, you know, when Commodore was the country's leading supplier of business micros. Then Jack Tramiel fell in love with the Vic-20 and the Commodore 64, and the company abruptly jilted all its business dealers.*

*Each time PCW printed a story about how badly they were being treated, and how they were dropping Commodore and selling alternative micros, Commodore would phone up. 'It's nonsense,' a representative would say. 'Just ring up any of our dealers — try David Whitehead, for instance — and ask him.'*

*And each time, Whitehead would respond that Commodore was a benevolent company, wonderful to dealers, reliable in delivering products when it said it would. And we would wonder what had got into him.*

*I visited Commodore recently and met someone from the old days, and I said: 'Do you remember Sir David Whitehead, who has now taken over as head of SPI?'*

*'Oh, yes,' said this person thoughtfully. 'His company was virtually bankrupt from the day it started until the day it was finally wound up. He would say anything we asked him to ...'*

And if, in an Infocom game, you type:

get red indian headdress  
with cowboy lasso  
and the system says 'You Already Have It', and you realise it was really the Spanish sombrero you wanted, then don't retype — just hit the up arrow.

But don't be too sure you're safe. Most Infocom games are played by 'serious computer users' at their place of work. And it is generally regarded as good policy, when a supervisor

happens by, to be working on something less entertaining — a spreadsheet, perhaps, or copying a list of files onto someone's floppy.

Unfortunately, DosEdit will remember the last 15 commands you typed in Lurking Horror. It can be embarrassing to hit one too many up arrows after typing:  
`copy *.dif c:\lotus\bak\`  
if the last command you gave the game was:  
kill professor with magic stone.

## Love conquers all

As the person who put his reputation on the line by testing Sir Clive Sinclair's Z88 before he built it (Benchtest Preview, PCW March), I have to say I'm very, very relieved by the appearance of the real thing.

If anything, the working Z88 is better than I expected. It has been given the full Benchtest treatment on page 108 of *this* issue so I won't bore you by repeating things here. But, having the thing has changed my life.

Previously, I simply couldn't manage without my Tandy Model 100. I used it for note-taking in press conferences, meetings (I was a whizz at the PTA), and for communications with the office from strange locations.

With the Z88, I have five times the machine in half the weight. And the weight is the single most important thing about a portable computer.

Grouses? I hate the space bar on the keyboard, which only works if you hit it in the right place. The keyboard took a little getting-used to, but then any new keyboard needs adjustment on the part of the user. I can certainly type fast enough on it, but I do miss a positive space bar.

And worse, I find that all my spell-checkers are useless at spotting missing spaces, so editing my notes takes longer than it should, once I've transferred the data from the Z88 to the PC.

One day, I dare say I will accidentally drop my Z88. When I do, I'll report on how robust it is. But at the moment, I love it too much to take the risk.

## Cake eaten, and kept

We have all vastly enjoyed the spectacle of Rod Canion, boss of Compaq, producing in public the cake he ate three months earlier, when IBM launched OS/2.

On the day that IBM announced its PS/2 systems (2 April), Canion went on record deriding OS/2 as useless since there was no software that used it, and the operating system wouldn't be ready for months, if not years.

In June, Canion changed his tune because his biggest customers came to him,

saying (along the lines of):

*Dear Mr Canion, We're sorry to hear that you won't be supporting OS/2 on your machines. We have put a recommendation to the board that we go with OS/2, and this, of course, means we will have to remove your machines from the recommended list...*

He didn't change his tune in private.

He invited several UK journalists to a New York conference with Microsoft, Lotus, Oracle and DCA (the Irma firm), and paid their air fares and hotel bills, too.

There, he spoke reassuringly about how he could demonstrate OS/2 on one of his machines (and there it was, switching tasks, see?) and there was his very good friend, Bill Gates, head of Microsoft, the company which wrote OS/2.

We sent Owen Linderholm over to the Big Apple and, after enjoying the show, he buttonholed Bill Gates, producing the short — but sweet — item that follows.

*Owen Linderholm writes:* Bill Gates of Microsoft has proved that black is white.

After the OS/2 conference in New York, I had the chance to question Bill Gates more closely about the system — specifically, why it could only run one 'real-mode' task.

A real-mode task is one that can be found on any PC; and, under OS/2, if you are running one of these tasks, you can't use its famous ability to run more than one program at once. All other programs 'freeze'.

Programs exist, like DESQview 2.0 (see page 142, this issue), which manage to run more than one real-mode task. They do it by partitioning the tasks off, on an 80286 machine, and monitoring them to ensure that conflicts don't occur.

Bill Gates had an easy answer: 'It's not worth doing.' An easy answer perhaps, but not one I could accept. This didn't impress him: 'I'm the world's greatest expert on this subject' (operating systems) he said, modestly.

Finding this self-praise possibly true but unconstructive, I pointed out that it was possible to run two 320k programs in 640k of memory; and that it was quite possible to run a communications program (like Mirror) in the background, and another

program in the foreground.

Gates responded by muttering something about 'bound to trash the hard disk' and rushed off. I have to admit to feeling rather offended by this arrogant and insulting behaviour — after all, there were plenty of sensible things he *could* have said in reply.

My feelings after the conference and this encounter with Bill Gates are: he tried to hijack the conference as a platform for hyping OS/2, and for persuading all the major manufacturers to endorse the system before it is shipped.

In other words, Bill Gates and Microsoft are trying to force users to buy OS/2, even before they have had a chance to try it.

This is dangerous — it could lead to the current DOS being left behind as a kind of ghetto for unsophisticated users. But, since many users are quite happy with things as they are, they will resent being pushed into spending more money than they need to.

There was one bright note at the conference: Jim Manzi of Lotus, talking about the likely price of OS/2 software, revealed a secret design concept for his company's products.

'We will stick,' he said solemnly, 'with our algorithm of eight cents per byte, for software.'

## Byzantine British Telecom

It is the natural reaction of our country's Authorities, when they find that their employees have been caught doing something naughty, to rush off and do something about it.

Not, as you might expect, to stop the naughty people, no: they stop the people who have caught *them*, from talking about it.

My PCW colleague, Robert Schifreen, together with another colleague, Steve Gold, have mercifully been de-convicted of forgery after they used the password of the Duke of Edinburgh to gain access to Prestel. The Appeal Court judge, Lord Lane, described British Telecom's attempt to pervert the law of forgery into a protection against password misuse as 'Byzantine', and I almost agree.



**With luck, this is the last daft pic of an Amiga that PCW will have to print for some time. I actually feel that the machine will be selling well by the end of the year.**

**Displayed onscreen is an application developed for the Amiga by Bell & Howell, called 'automated inline mailing'. Whoopee! (yawn).**

**But a visit to Commodore's new management team at Maidenhead produced... well, not exactly optimism, but relief, at least.**

**At least there are now people at Bell & Howell who admit that Amiga sales weren't good, that the price was high, and that the Amiga 2000 and the Amiga 500 are both better machines than the original model. They seem to be refreshingly free from mediaphobia, too.**

**You really do want an automated inline mailing system? Details from Bell & Howell, on (0784) 51234.**

Laws about secrecy are becoming crucially important to people in the computer world, and it's time we took them more seriously.

Our governmental system gives self-confessed criminals immunity from prosecution if they will give evidence against other criminals. But, when it comes to investigating its own malpractices, strangely, the same system suddenly becomes a stern upholder of the 'doctrine of confidentiality'.

British Telecom (BT) operates in exactly this double-faced manner. If I print a story about a communications program which can automatically log on to Telecom Gold, I receive tetchy complaints that I'm encouraging poor security practices.

But when Gold and Schifreen contacted BT in order to point out that its own security practices were slack, the company refused

to listen.

Then, when Prince Philip's mailbox was used by the 'offenders' to prove their point, a whole bunch of policemen were sent to their homes to arrest them and their equipment was confiscated.

If you, the reader, are prepared to tolerate the government (I don't mean the current Party of Government specifically) insisting that Secrecy Is Good For You, then you must expect lesser powers like BT to try playing the same game.

Secrecy is *not* good for you. It gives corruption a place to fester, and it keeps truth out of circulation. Of course, we all want to keep prying eyes out of our private lives, but major state bodies and state-serving corporations cannot remain totally free from examination.

Write and tell your MP so. After all, what have these people got to hide?



IF YOU WORK WITH COMPUTERS, YOU'LL BE AWARE OF RAPID ADVANCES IN GRAPHICS SOFTWARE. YOU'LL ALSO KNOW OF THE CONSEQUENCES. NEW STANDARDS NEED NEW HARDWARE TO BENEFIT FROM THEM. AND NEW HARDWARE IS OFTEN UNABLE TO SUPPORT THE OLD STANDARDS. WHICH MEANS THAT THE MONITOR YOU BUY TODAY MAY BE UNABLE TO RUN THE SOFTWARE YOU USED YESTERDAY. WORSE STILL, IT MAY BE INCAPABLE OF ADAPTING TO THE GRAPHICS STANDARDS OF TOMORROW. IT'S A PROBLEM. BUT NOW THERE'S A SIMPLE SOLUTION. TAXAN'S NEW MULTIVISION

## TAXAN'S NEW MULTIVISION 770 PLUS IS ONLY COMPATIBLE WITH 3 GRAPHICS STANDARDS.

770 PLUS COLOUR MONITOR. MULTIVISION 770 PLUS WILL ADAPT TO ANY HORIZONTAL SCANNING FREQUENCY BETWEEN 15 AND 35KHz. WHICH MEANS IT WILL SUPPORT ALL MAJOR GRAPHICS STANDARDS. WHAT'S MORE, YOU'LL FIND THAT YOUR PICTURE SIZE REMAINS CONSTANT AS YOU SWITCH BETWEEN THE VARIOUS GRAPHICS STANDARDS - A FEATURE OF THE 770 PLUS UNMATCHED BY THE COMPETITION. TO COMPLEMENT THE MONITOR, TAXAN HAVE



DEVELOPED THE 565 AUTO EGA-480 DISPLAY ADAPTER. THIS VERSATILE CARD ENABLES THE MULTIVISION 770 PLUS TO SUPPORT HERCULES™, IBM™ MONOCHROME, CGA, EGA AND OUR NEW 640 x 480 AND 132 COLUMN TEXT MODES. THE MULTIVISION 770 PLUS IS, THEN, MORE THAN CAPABLE OF SUPPORTING THE STANDARDS OF BOTH THE PAST AND PRESENT. BUT WHAT ABOUT THE FUTURE? WELL, THE 770 PLUS IS PERHAPS THE FIRST TRUE MULTIPLE SCAN MONITOR. IT CAN ADAPT TO ANY VERTICAL SCANNING FREQUENCY BETWEEN 50 AND 90 KHz. WHICH MEANS THAT, IN ADDITION TO SUPPORTING THE VERY LATEST DISPLAY STANDARDS OF THE IBM PERSONAL SYSTEM/2™ AND THE APPLE MACINTOSH II™, IT SHOULD EVEN BE ABLE TO SUPPORT THOSE THAT HAVE YET TO BE INVENTED. SO, WHEN THE TIME COMES TO UPDATE YOUR MONITOR, LOOK INTO TAXAN'S MULTIVISION 770 PLUS. YOU'LL FIND THAT THE PAST, PRESENT, AND FUTURE LOOK EXTREMELY BRIGHT.

# TAXAN

A KAGA COMPANY

PERFECTING THE IMAGE

TO FIND OUT MORE ABOUT THE TAXAN RANGE OF PRODUCTS, CALL US ON 0344 484646.

# The secret of Borland's success is "Quality, Speed, Power, & Price"

We're one of the biggest software companies in the world—and we got that way by making "Quality, Speed, Power, & Price" essential characteristics of every Borland software program. Look for Borland software—then look no further.



## **Turbo Prolog™**

Our new Turbo Prolog has drawn rave reviews—which we think are well deserved—because Turbo Prolog brings 5th-generation language and super-computer power to your IBM PC and compatibles. Turbo Prolog is a high-speed compiler for the artificial intelligence language, Prolog, which is probably one of the most powerful programming languages ever conceived. We made a worldwide impact with Turbo Pascal, and you can expect the same results and revolution from Turbo Prolog, the natural language of Artificial Intelligence. Minimum memory: 384K.

## **Reflex® and Reflex Workshop™**

No matter what business you're in, if you use Lotus 1-2-3® or dBASE® you need Reflex and the new Reflex Workshop to give you all the tools and views to see what your numbers mean. The new Reflex 1.1 with expanded memory support allows you to manage huge databases of up to 8 megabytes of RAM, 32,000 records, and 250 fields per record with "Reflex Lightning Speed." The Reflex Workshop gives you a wide range of analytical tools written for specific applications like Finance/Accounting, Administration, Sales and Marketing, and Production and Operations. You can use the tools "as is" or modify them to suit your business needs. Minimum memory: 384K.

## **SuperKey® Turns 1000 Keystrokes Into 1!**

If you use SideKick, you need SuperKey. They're designed to work together—and work for you. SuperKey's an amazing keyboard enhancer for your IBM PC and compatibles. With easy-to-write macros, you and SuperKey can turn 1000 keystrokes into 1. Minimum memory: 128K.

## **SideKick® Instant Desktop Management!**

Powerful desktop management program and the #1 best seller for the IBM PC. SideKick includes notepad, calendar, calculator, appointment scheduler, telephone directory, autodialer, and ASCII table. It's RAM-resident—which means SideKick is always there ready to react when you need to do something, call someone, or find out something in a hurry. And it does all this while you run other programs. Minimum memory: 128K.

## **Traveling SideKick®**

It's the electronic organizer for this electronic age. Neither you nor your secretary need to face 1987 with old-fashioned 1887 diaries. Traveling SideKick has everything they have—and a lot more. (Unlike dusty old diaries, Traveling SideKick doesn't "expire" at the end of '87, because it's electronic and good for '88, '89, '90 and on and on and on.) It's a professional binder, a software program, and a report generator—a modern business tool that prints your ever-changing appointments in daily/weekly/monthly/yearly form. (If your schedule changes hourly Traveling SideKick handles the changes instantly.) Whether you use your own personal computer or have someone's help with that, Traveling SideKick is the smart new way to take your computer with you—without taking your computer with you. Minimum memory: 256K.

## **Turbo Lightning® Solves All Your Spelling Problems!**

While you use SideKick, Reflex, Lotus 1-2-3®, and most popular programs, Turbo Lightning proofreads as you write! If you misspell a word, Turbo Lightning will beep at you instantly, and suggest a correction for the word you just misspelled. Press one key, and the misspelled word is immediately replaced by the correct word. And if you're ever stuck for a word, Turbo Lightning's thesaurus is there with instant alternatives. Minimum memory: 256K.

## **Lightning Word Wizard™ Technical Reference Manual For Turbo Lightning!**

An important addition to Turbo Lightning, Lightning Word Wizard includes fascinating and challenging word games like "Akerue" (try reading that backwards), "That's Rite," "CodeCracker," "CrossSolver," "MixUp," and "FixUp," to name some of them. Lightning Word Wizard introduces you to the "nuts and bolts" of Turbo Lightning technology, and gives you more than 20 different calls to the Lightning engine. Minimum memory: 256K.



*Turbo Pascal, the worldwide standard  
in high-speed compilers, and Family.*

## **Turbo Database Toolbox®**

A perfect complement to Turbo Pascal, because it contains a complete library of Pascal procedures that allows you to search and sort data and build powerful database applications. It comes with source code for a free sample database—right on disk. Minimum memory: 128K.

## **Turbo Editor Toolbox®**

Recently released, we call our new Turbo Editor Toolbox a "construction set to write your own word processor." Source code is included, and we also include MicroStar, a full-blown text editor with pull-down menus and windowing. It interfaces directly with Turbo Lightning to let you spell-check your MicroStar files. Minimum memory: 192K.

## **Turbo GameWorks®**

Turbo GameWorks is what you think it is: "Games" and "Works." Games you can play right away (like Chess, Bridge and Go-Moku), plus the Works—which is how computer games work. All the secrets and strategies of game theory are there for you to learn. You can play the games "as is" or modify them any which way you want. Source code is included to let you do that. Minimum memory: 192K.

## **Turbo Tutor® 2.0**

The new Turbo Tutor can take you from "What's a computer?" through complex data structures, assembly languages, trees, tips on writing long programs in Turbo Pascal, and a high level of expertise. Source code for everything is included. New split screens allow you to put source text in the bottom half of the screen and run the examples in the top half. There are quizzes that ask you, show you, tell you, teach you. Minimum memory: 192K.

## **Turbo Graphix Toolbox®**

Includes a library of graphics routines for Turbo Pascal programs. Lets even beginning programmers create high-resolution graphics with an IBM®, Hercules®, or compatible graphics adapter. Our Turbo Graphix Toolbox includes all the tools you'll ever need for complex business graphics, easy windowing, and storing screen images to memory. It comes complete with source code, ready to compile. Minimum memory: 192K.



# Introducing Turbo Basic, the high-speed BASIC you'd expect from Borland!

Turbo Basic is the BASIC compiler you've been waiting for. And it's so fast that you'll never have to wait again. Turbo Basic is a complete development environment; it includes an amazingly fast compiler, an interactive editor, and a trace debugging system. Because Turbo Basic is compatible with BASICA, chances are that you already know how to use Turbo Basic.

*With Turbo Basic your only speed is « Full Speed Ahead »!*

You probably already know us for both Turbo Pascal® and Turbo Prolog®. Well, we've done it again! We created Turbo Basic, because BASIC doesn't have to be slow. In fact, building fast compilers is a Borland specialty; both our Turbo Pascal and our Turbo Prolog outperform all their rivals by factors, and with Turbo Basic, we're proud to introduce the first high-speed BASIC compiler for the IBM® PC. If BASIC taught you how to walk, Turbo Basic will teach you how to run!



“ Borland has created the most powerful version of BASIC ever... Turbo Basic compiles faster than anything I have seen. What's more, the programs it creates execute faster than those produced by other compilers  
*Ethan Winer, PC Magazine*  
 Borland's Turbo Basic has advantage over the Microsoft product, including support of the high speed 8087 math chip.

*John C. Dvorak* ”



**Only £ 69.95**

**Turbo Basic ends the basic confusion**

There's now one standard: Turbo Basic. It's fast, BASICA-compatible, and because Turbo Basic is a Borland product, the price is right, the quality is there, and the power is at your fingertips. You see, Turbo Basic's part of the fast-growing Borland family of programming languages — we call it the "Turbo Family". Hundreds of thousands of users are already using Borland's languages, so you can't go wrong. So join a whole new generation of smart IBM PC users — get your copy of Turbo Basic today. You get an easy-to-read 300+ page manual, two discs, a free MicroCalc spreadsheet and an instant start in the fast new world of Turbo Basic. All of this for only £ 69.95... Order your copy of Turbo Basic today!

**Free spreadsheet included, complete with source code!**

Yes, we've included MicroCalc our sample spreadsheet editor, complete with source code, so that you can get started right away with a "real program": You can compile and run it "as is," or modify it.

**A technical look at Turbo Basic**

- Full recursion supported
- Standard IEEE floating-point format
- Floating-point support, with full 8087 (math co-processor) integration. Software emulation if no 8087 present
- Program size limited only by available memory (no 64K limitation)
- EGA and CGA support
- Access to local, static, and global variables
- Full integration of the compiler, editor, and executable program, with separate windows for editing, messages, tracing, and execution
- Compile, run-time, and I/O errors place you in the source code where error occurred
- New long integer (32-bit) data type
- Full 80-bit precision
- Pull-down menus
- Full window management

Borland products are trademarks or registered trademarks of Borland International, Inc. or Borland Analytica Inc. Other brand and product names are trademarks of their respective holders. Copyright 1987 Borland International



DEPARTMENT E9  
 ONE GREAT CUMBERLAND PLACE  
 LONDON W1H 7AL  
 (01) 258 3797

**YES! I want the best!**

Copies	Product	Price	Totals
___	Turbo Basic	69.95 £	_____
___	Turbo C	£ 89.95	_____
___	Turbo Pascal w/8087 & BCD	69.95 £	_____
___	Turbo Prolog	69.95 £	_____
___	Reflex: The Database Manager	*129.95 £	_____
___	Reflex Workshop	69.95 £	_____
___	Reflex & Reflex Workshop	**129.95 £	_____
___	Turbo Database Toolbox	49.95 £	_____
___	Turbo Graphix Toolbox	49.95 £	_____
___	Turbo Tutor 2.0	39.95 £	_____
___	Turbo Editor Toolbox	49.95 £	_____
___	Turbo GameWorks	49.95 £	_____
___	Turbo Numerical Methods Toolbox	69.95 £	_____
___	†Eureka: The Solver	69.95 £	_____
___	Turbo Lightning	69.95 £	_____
___	Lightning Word Wizard	49.95 £	_____
___	SideKick	69.95 £	_____
___	Travelling SideKick	69.95 £	_____
___	SideKick & Travelling SideKick	125.00 £	_____
___	Superkey International Version	69.95 £	_____
___	Turbo Jumbo Pack	245.00 £	_____
___	Outside UK add £10 shipping per copy	£	_____
___	Add 15% VAT	£	_____
___	Amount enclosed	£	_____

Prices include shipping to all UK cities  
 Carefully describe your computer system : D8  
 Mine is : \_\_\_\_\_ 8 bit \_\_\_\_\_ 16 bit  
 I use : \_\_\_\_\_ PC-DOS \_\_\_\_\_ CP/M 80  
 \_\_\_\_\_ MS-DOS \_\_\_\_\_ CP/M 86  
 My computer's name and model is \_\_\_\_\_

The disc size I use is  5 1/4"  3 1/2"  3"  
 Payment: Access Visa Money order Cheque  
 Credit card expiration date: \_\_\_\_\_  
 Card No. \_\_\_\_\_

Signature \_\_\_\_\_  
 Name : \_\_\_\_\_  
 Shipping Address : \_\_\_\_\_  
 Postal Code : \_\_\_\_\_  
 Telephone : \_\_\_\_\_

COds and purchase orders WILL NOT BE accepted by Borland. Outside UK make payment by credit card or International Postal Money Order.  
 \*New UK version (check shipping date)  
 \*\* Time limited promotional offer, now shipping  
 † New product now shipping

**NOT COPY PROTECTED**  
**60 DAY MONEY-BACK GUARANTEE**  
 If within 60 days of purchase you find that this product does not perform in accordance with our claims call our customer service department and we will gladly arrange a refund.  
 All prices are suggested list prices and are subject to change without notice.

System requirements  
 PC, XT, AT and true compatibles, PC-DOS (MS-DOS) 2.0 or later,  
 floppy drive, 320 k.  
 PERFECT COPY PAID FOR

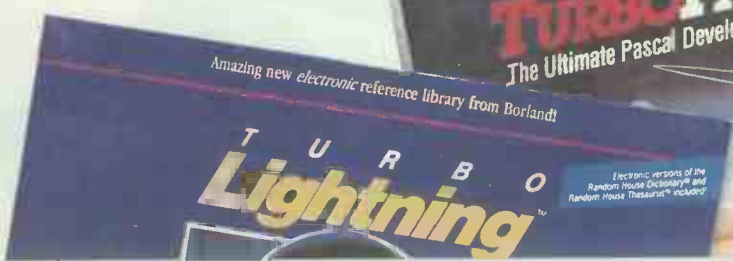

BE 1010

# MAYFAIR NEWS

## AST PREMIUM 286 £

MODEL 120 1MB + 20 MB MONO	1895
MODEL 140 1MB + 40 MB MONO	2195
MODEL 170 1MB + 70 MB MONO	2595
EGA Colour Display (Extra)	295
40 MB Tape Streamer	450

## OLIVETTI

M24 640K 1 x 360K	1035
M24 640K + 40 MB	1695
M24 SP 640K/20MB	1570
M28 512K 20MB	2195
M28 512K 40MB	2695
Colour Display Extra	220
M28 40MB Tape Backup	480

## SPERRY

MICRO IT 512K 20MB	2295
PC/IT 512K 44MB	2990
PC/IT 1MB 69MB	4295
PC/IT 1MB 117MB	6195
EGA Colour Display Extra	450
XENIX for PC/IT	650
4 Port Terminal Adaptor	245

## TANDON

PCX 10 256K 10MB	799
PCX 20 256K 20MB	949
PCA 20 1MB 20MB	1495
PCA 30 1MB 30MB	1745
PCA 40 1MB 40MB	1945
PCA 70 1MB 70MB	2395
EGA Colour Display Extra	450

## PORTABLE MICROS

<b>NEC</b>	
Multispeed 640K 2 x 720K LCD	1295
<b>OLIVETTI</b>	
M15 512K 2 x 720K LCD	995
<b>TOSHIBA</b>	
T3100 640K 10MB Plasma	2495
T3100 640K 20MB Plasma	2895
T1100 PLUS 640K 2 x 720K LCD	1395
<b>ZENITH</b>	
Z181 640K 2 x 720K LCD	1495
Z183 640K 10MB LCD	1999

## HARD DISKS

Seagate 20MB + Controller	295
Seagate 40MB + Controller	745
Quantum IQ Kit - 80MB + Controller + Software	895
Tandon 20MB Disk Card	295

## MODEMS

Datalflex Stradcom V21, 22 (INTL)	165
Stebek Quattro V21, 22, 23 (INTL)	695
Paçe Series 4 V21, 22, 23 (EXTL)	399



NEC APC IV

Superb new high spec AT with EGA and brilliant Multisync display; 80286; 640K RAM; Fast Disk (40 MS); EGA Adaptor and Multisync Monitor; Enhanced Keyboard; MS DOS 3.2. £2,195 (20MB) £2,495 (40MB)



OLIVETTI M24

Superior performance and excellent display from Europe's no 1 PC compatible. 640K RAM, 20MB compatible hard disk; serial/parallel: 7 slot bus; keyboard; mono display; MS DOS. £1,295

## BOARDS £

Persyst 2MB EMS	349
AST Rampage AT 2MB EMS	575
AST Advantage 1.5MB S + P	425
AST Six Pak Premium 2MB EMS	449
Orchid Turbo 286 (12MHZ)	895
Orchid Jet 386	765
Intel Inboard 386	1295
Intel Inboard Cable	145
Hercules Mono Plus	180
Hercules InColour	299
AST 3G+ 256K EGA	230
Vega Deluxe EGA	235
AST 3780	595
AST 5251/11	595
AST 5251/12	525
AST 3270 COAX	745

## MONITORS

NEC Multisync	495
PRINCETON HX12E EGA	450
WYSE WY700 1280 x 800 B/W	695

## NETWORKING SYSTEMS

PC NET; ARC NET; Novell Netware  
Please Call For Full Details.

## STOP PRESS

NEW OLIVETTI M240  
AVAILABLE FROM STOCK.  
CALL FOR FULL DETAILS.

## MATRIX PRINTERS £

<b>BROTHER</b>	
M1509 180CPS/45CPS NLQ	375
M1709 240CPS/50CPS NLQ	435
4018 480CPS/100CPS NLQ	1145
<b>EPSON</b>	
LX 800 150CPS/25CPS NLQ	199
FX 800 240CPS/35CPS NLQ	320
FX1000 As Above 130 COL	399
LQ 800 180CPS + LQ	445
LQ 1000 As Above 130 COL	595
LQ 2500 270CPS + LQ	745
EX 1000 300CPS/50CPS NLQ	525
SQ 2500 INK JET 450CPS	995
<b>NEC</b>	
P6 180CPS + LQ	395
P7 180CPS + LQ	465
P9 380CPS/120CPS LQ	995
<b>OLIVETTI</b>	
DM 100 120CPS + NLQ	209
DM 290 160CPS + NLQ	365
DM 296 220CPS + NLQ	595
DM 600 200CPS 70CPS LQ	795
PCPR 3 400/100CPS NLQ	1250

## DAISYWHEEL PRINTERS

Brother HR40 SSF/Tractor	795
Juki 6100 18cps	249
Juki 6200 30cps	475
Juki 6300 40cps	699
Olivetti DY 200 25cps	345
Olivetti DY 300 30cps	495
Olivetti DY 450 45cps	849
Olivetti DY 800 80cps	999

## LASER PRINTERS

AST Turbolaser*	8PPM..... 2995
AST Turbolaser Plus*	15PPM..... 3995
Canon LBP-8 Mk 11	8PPM..... 1695
Epson GQ3500	6PPM..... 1345
H-P Laserjet*	8PPM..... 1490
H-P Laserjet Series 11*	8PPM..... 1995
H-P Laserjet Plus*	8PPM..... 2170
Oki Laserline 6	6PPM..... 1395
Qume Laser 10 Plus*	10PPM..... 2095

(\* = Incl. On-Site Maintenance)

## SOFTWARE

Microstuf Crosstalk	95
Ashton Tate dBase 3Plus	375
Ashton Tate Rapid File	195
Symantec Q+A	199
Sapphire Database	375
Compsort Pro Delta	375
GEM Collection	80
Lotus 123	235
Lotus Symphony	335
Lotus Freelance Plus	275
Microsoft Windows	59
Migent Ability	89
Micropro Multiplan 3	120
Innovative Smart System	425
Multimate Advantage	265
Micropro Wordstar 4	225
Micropro Wordstar 2000/2	265
Microsoft Word 3	265
Wordperfect 4.2	245
Xerox Ventura DTP	695

Blenheim House,  
Podmore Road,  
London SW18 1AJ  
01-871 2555/Telex 936066

**MAYFAIR  
MICROS**

## A Portable resurrection

You believe that a product launched by IBM will sell because of those three magic letters, don't you?

I received a short, terse illustration of just how false that theory is when I was scrolling through *The Source*, a (costly) American bulletin board recently.

The *Source* quoted the Boston Computer Exchange, which reflects the prices of all micro systems new, second-hand, obsolete or simply available. And it had prices for the IBM Convertible (the laptop machine).

I was highly amused to find that the Convertible had reached a high point, on the open market, of \$650. That was the maximum price you could hope to get, were you a dealer; and (a footnote added) you'd be lucky to find anyone interested, even at that price.

Amusingly, there was another IBM computer there — the Portable. The Portable was launched a couple of years after Compaq launched its machine, in an attempt to take Compaq's market away. Software which would run happily on the ordinary PC and the Compaq, wouldn't run on the Portable; and, after a few unhappy months, IBM began to deny that it was no longer making the Portable. Then it did stop making it.

The Portable, obsolete, unloved and out of date, now sells for \$100 or so more than the Convertible.

I assure you that both machines have the letters 'IBM' emblazoned in large, friendly script all over them.

## Full of UK promise

Michael Dell, the whizz-kid who started his American company, PC's Limited, when still a teenager, tells me that he may launch a laptop 386 machine in the UK within six months, at quite a low price.

He also treated me to a few predictions for the future: among them, that IBM will find the demand for the PS/2 very low.

This American 'wunderkind' has now

officially started shipping machines in the UK, and I was sufficiently impressed by the razzmatazz — and also by the *PCW* review of the Dell 286 (July issue) — to ask the company for the loan of a machine.

Not everything has gone according to plan, naturally. I've found the Dell 286 reluctant to handle its serial port in a totally standard way; its clock gave me a fright for a few hours (see 'Clocking on to real time', page 78, this issue); and, like all machines which arrive in the *PCW* office, it has crashed once or twice, with pretty things all over the screen. And it won't run Digdug, and I can't find out why.

Dell launched his company and three products at the PC User Show in June, and astonished me with the biggest exhibit — an 80386 machine costing nearly £4000, with a colour screen. 'I thought this was meant to be cheap,' said a consultant to Michael Dell.

The point was worth making. With the Euromicro 386 machine selling for £1595 around the corner, including a big slice of profit for dealers (it would cost less than £1300 at trade price), the Dell's absence of a colour screen and a hard disk didn't seem to cover the difference.

In reply I got, not an explanation, but a very interesting dissertation on the micro market from Dell.

Part of his theory includes the fact that his 386 machine is using 'static' memory chips, in a low-power semiconductor technology called CMOS. Not only do these memory chips run far faster than standard 'dynamic' chips, but they use a tiny fraction of the power.

'This will enable us to increase the specification of this machine when Intel gives us faster chips,' he said, 'up to 48MHz.' I didn't know that Intel was planning a 48MHz version of the 80386, but never mind; it certainly is planning 24MHz versions, so this is reassuring.

'And also, because it is static, all we need is a CMOS CPU chip, and we can run the whole thing off batteries.'

Interpreted, I gather that this means: 'We don't have enough 80386 chips at the moment, so there's no point in bringing the price down to encourage buyers.'



*I like to encourage David Philips, boss of the big micro distributor Northamber, when he does something sensible.*

*This picture of Philips (the big man in the white jacket) actually shows him doing something remarkable: opening his new premises and inviting a technology leader, rather than a politician who is far removed from the industry, to cut the ribbon.*

*The technology leader is Masa Sakisaka, who runs Epson in the UK, and who is doing his level best to get us to take his company seriously as a supplier of computers, not just printers.*

*The word is, astonishingly, that he is succeeding. I've spoken to several computer retailers who are suddenly talking quite enthusiastically about the new Epson AT range, when, as little as a year ago, they spoke of Epson as 'not understanding the PC market.'*

*Look for more Epson machines in the shops — and on desks, too, if the company gets its pricing right.*

## People in glass houses . . .

To nobody's great surprise, Research Machines has denounced the BBC's sponsorship of its rival, Acorn's new Archimedes range. Even less surprising — the British Micro Federation, headed by David Fraser, has joined in.

Fraser didn't enjoy my verbal suggestion that he was biased (he's head of Microsoft in the UK) by a desire to see MS-DOS become an education standard. He insisted he was

on the side of the deprived kids who wouldn't have an opportunity to learn MS-DOS — as did Research Machines, naturally.

I heartily agree that the BBC did a pretty daft thing in one way, but I think the mistake was in making the Master an official BBC micro, not in choosing an Archimedes for the role.

Apart from the fact that the Archimedes is going to be overpriced for too long, I really think the range is a step forward of the sort the BBC ought to be associated with.

And over-pricing is something which Research Machines is no stranger to.

# SELTEC

## LOW-LOW-LOW-COST PROGRAMS

Out of the thousands of programs we have collected, for a small service charge from £6 we bring you a SELECTION OF THE BEST that have been carefully tested and documented. Suit IBM-PC and compatibles, 5 1/4", DOS 2 or greater.

Please note that in those instances where Basic is required, users should have Basic/GWBasic (not Basic2) or our shareware compatible version on disk M9001.

There is a separate catalogue for MacIntosh, CP/M and Amstrad CPC (3").

### MS-DOS GAMES

**M1020+ : MORE GREAT TRIVIA.** A two disk set. Categories for science and nature, entertainment, sports and recreation, and general. £18.

**M1022: SUPER COMPILED GAMES (3).** Arcade type games. Includes Kong, Striker, Spacevade, Life2 and Frog. Needs CGA.

**M1023: GREAT BASIC GAMES.** Over a dozen, including Wizard, Xwing, Combob, Mars, Racecar, CIA. Requires Basic.

**M1025: AMULET OF YENDOR** - Adventure with graphics. 20 levels of play against many monsters and powerful magic. Choose your roles.

**M1026: 5 TEXT ADVENTURE GAMES** - of different types, including murder mystery, horror, pirate, etc.

**M1027: SUPER HANGMAN.** Challenged with quotations, riddles, music, words. Fascinating and educational.

**M1028: SUPER COMPILED GAMES (4).** Another excellent selection of compiled games, ready to run. Includes Flightmare, Solitaire, Jumpjoe and more. Needs CGA.

**M1030: PROVOCATIVE PICTURES (1)** Collection of hi-res digitized naughty pictures.

**M1041: GAMES OF STRATEGY (1).** Match wits in a Naval Battle Simulation, Big Truck Haulage Business, and the Stock Market.

**M1042: GAMES OF STRATEGY (2).** Has Empire (War Simulation), Golf Tee, and Bermuda Triangle Sailing.

**M1043: PROVOCATIVE PICTURES (2).** Pin-up type posters to enliven the office. Needs Epson compatible printer.

**M1044: MARTIAL ARTS.** Match your skills against all sorts of villains and dangers.

**M1045: EGA GAMES.** World Domination for those with Enhanced Graphics Board.

**M1046: SUPER COMPILED GAMES (5).** With World Domination (Risk), Beast, Locust, Rockets, Subchase, etc. Needs CGA.

**M1047: SUPER COMPILED GAMES (6).** With Wheel of Fortune, Forest Fire, Zoarre Dungeons, Quarterback, etc. Needs CGA.

**M1048: GOLDEN WOMBAT.** Fine British text adventure searching for Lost Empire. Needs CGA.

**M1049: MURDER MYSTERY.** Puzzle your way through suspects and clues.

### UTILITIES

**M2007+ : UNPROTECTION METHODS.** Hints and programs that help you to back up a variety of copy protected programs. 3 disk set for £24.

**M2012: DISK DOCTOR COLLECTION.** Excellent debugging and file repair programs.

**M2016: MENU SYSTEMS.** Create your own menus. Contains Sysmenu, Automenu, EZMenu.

**M2021: UNIX COMMAND SHELL.** Control your programs with commands like those in Unix.

**M2022: TSHLL DOS MANAGEMENT.** Efficient environment for managing DOS. With help screens.

**M2023: BATCH LANGUAGE ENHANCEMENT.** More features and control in creating .bat files.

**M2027+ : EXCEPTIONAL UTILITIES.** With fast format, clock, alarm, disk wipe, colour as shades of grey, create files from memory, cursor speed-up, many more. £18.

## TOP QUALITY PUBLIC DOMAIN & USER SUPPORTED SOFTWARE

**M2038: DIAGNOSTIC AND TESTING UTILITIES.** Extensive collection to test and report on performance of equipment and software.

**M2040: HARD DISK MENU SYSTEMS.** Comprehensive. Excellent choices for managing files.

### WORD PROCESSING

**M3007: SPELLING CHECKER.** Works with most word processors. We've added thousands of new words incl business/computer terms.

**M3008: OUTLINER FOR WORD PROCESSING.** Considered by many to be best ideas processor available.

**M3014: SIDEWRITER.** Generates printed output sideways to fit wide reports on a page.

**M3016+ : WORDSTAR UTILITIES.** Alternative and customer designed character sets, strip/alter text, number paras. 2 disks £18.

**M3018: DIAGRAM AND TEXT EDITOR.** Combine text with simple diagrams.

**M3020: EXCELLENT WORD PROCESSOR.** Galaxy is compatible with Wordstar, has clear, easily followed commands on screen.

**M3021: QUALITY MULTI FONT PRINTING** on dot matrix, incl Courier, Greek, Helvetica, Palatino, Roman, Italics, etc.

**M3023: BEGINNER'S WORD PROCESSOR.** Many good features plus a built in tutorial.

### GRAPHICS

**M4001: SELECTED GRAPHICS.** Some of the best, including picture graphics of commercial standard.

**M4009+ : BUSINESS GRAPHICS.** Convert figures into business charts.

**M4011: ICON CREATOR.** Prepare symbols and logo-type characters.

**M4012: TALK ILLUSTRATOR.** Easy to use special features for slide presentation.

**M4014+ : COMPUTER-AIDED DESIGN.** Dancad3d will do complex drawing, 2 or 3 dimensions, print sharp lines for mechanical

drawing, illustration, animate parts. We've squeezed 4 disks on to 2. £18. Needs CGA.

**M4015: FULL FEATURED PAINT PACKAGE** with pull down windows, icons, hi-res, 4 colours.

**M4016+ : GRAPHICAL ANALYSIS.** Inputs data directly or from DBASEIII. Does statistical analyses, reports, charts. 2 disks. £18.

**M4017: ONE-PAGE DESK-TOP PUBLISHING.** Suits preparation of flyers, notices.

### LANGUAGES

**M9001: BASICA/GWBASIC COMPATIBLE INTERPRETER.** Runs Basic programs written in industry standard Basic. Suits Amstrad 1512.

**M5022: WINDOWS FOR BASIC & C.** Gives windowing capability to your programs.

**M5025: TURBO PASCAL DEBUGGER.** Interactive, with pop-up help, formatters, spell check, editor, random nos. etc. £24.

**M5031: CROSS ASSEMBLER FOR APPLE.** Creates code for 6502 processor.

**M5032: SCREEN GENERATOR FOR TURBO PASCAL.** Produces code for input and help screens.

**M5033: TURBO PASCAL ROUTINES FOR HERCULES GRAPHICS.**

### COMMUNICATIONS

Some excellent programs for contacting bulletin boards. Many features. Recent releases for:

**M6008: QMODEM**      **M6009: KERMIT**  
**M6010: PROCOMM**

### BUSINESS/CALCULATION

**M7004: STOCK MARKET ANALYSIS.** Special aids to help you "think and grow rich". For managing and evaluating portfolios and prospects. Needs Basic.

**M7006: STATISTICAL ANALYSIS.** Many programs in Basic for analysis - Chi, Regression, Fisher, Binomial, Variance, Histogram, Poisson, Correlation, etc.

**M7016: PROJECT MANAGEMENT.** Handles 1000 tasks; does critical path analysis, cash flow, bar charts, stock reports. Needs Basic.

**M7029: INTEGRATED ACCOUNTING.** General ledger, Cash Book, Debtors, Payroll, etc. - all on one disk.

**M7031: PERSONAL FINANCE MANAGER.** Manages cheque and credit card accounts, savings, purchases, withdrawals, interest, budgets.

**M7032: SMALL BUSINESS SELECTION.** Includes small spreadsheet, mail list manager, printer controller, typewriter emulator, text reader, word processor, & UK accounting system for income/expenditure/reports - all on one disk!

**M7033+ : SALES MANAGEMENT.** Controls prospecting, sales managing, order processing, job costing, profit analysis, labels, letters. Needs hard disk. 3 disks. £24.

**M7034+ : BUDGETING.** Keeps track of estimated expenses, actual, variances. For hard disk. 2 disks. £18.

**M7035: OPTIMAL DECISION MAKING.** Linear programming with spreadsheet style data editor. Contains Gulp.

**M7036: PHARMACY SYSTEM.** Prints contents on labels from database of up to 2000 ingredients.

**M7037+ : MARKET RESEARCH ANALYSIS.** Analyses results of surveys. 25 variables, 50 data columns, 9 values per variable. 2 disks.

**M7038: EMPLOYEE PERSONALITY PROFILES.** Lets you develop benchmarks/standards for position requirements.

**M7039: REAL ESTATE PROPERTY SALES.** Stores info re properties, sales, agents, commissions. Gives reports.

**M7040: 123 COMPATIBLE SPREADSHEET.** Also does graphs and pie charts. 52x200 cells. Many good features.

### DATABASE

**M8003+ : FAMILY TREE/GENEALOGY.** Recording, tracing, grouping, printing family tree. In Basic. 2 disks. £18.

**M8010: FILE MANAGER.** 2 disks on 1. Does mailing lists, calculations, inventories.

**M8012: LABEL PRINTING.** Collection that allows you to print labels for all sorts of uses, as well as control mailing lists.

**M8013: RELATIONAL DATA BASE MANAGER.** Menu driven, easy to use. Allows 100 fields and up to 2 billion records.

**M8018+ : DBASEIII COMPATIBLE DATA BASE MANAGER.** Bargain with similar features to DBaseIII and is compatible with files generated by it. 2 disks £18.

### EDUCATION

**M9001: GWBASIC/BASIC COMPATIBLE INTERPRETER WITH TUTORIAL.** Suits Amstrad 1512 and other compatibles.

**M9008+ : "C" TUTOR.** Comprehensive, easily followed. Needs 2 drives. 2 disks. £18.

**M9010: INTRODUCTION TO BASIC PROGRAMMING WITH GAMES.**

**M9018: EDUCATIONAL GAMES FOR PRESCHOOLERS.** Special fun collection.

### GENERAL

**M9503+ : BIBLICAL QUOTES.** 14,800 cross-references to 7956 verses of the new testament for talks, sermons, essays. £18. 2 disks.

**M9504+ : RECIPE MANAGEMENT.** Contains hundreds of recipes and excellent searching. Add your own. 2 disks £18.

**M9505: WORLD FACTS & FIGURES.** Details of population, income, capitals, area, births, deaths, etc. for each country.

**M9507: NUTRITIONAL MEAL PLANNING.** Plan varied meals, nutrition, substitutes, evaluate recipes.

**M9508: GOLF SCORER.** Keeps track of scores, putts, courses. Shows progress and averages. Needs Basic.

PHONE NOW WITH YOUR ORDER

0344 863020

**SHAREWARE REQUIRED FOR INTERNATIONAL DISTRIBUTION**  
We have extensive marketing and distribution facilities locally and overseas and require quality software for international distribution. Adequate documentation should be on the disk.  
Please forward submissions to our Chief executive at the address below.

**CP/M, MACINTOSH, AMSTRAD CPC.**  
Call or write for free catalogue.

**PUBLIC DOMAIN NEWSLETTER**  
For news, reviews, views and how to use public domain and user-supported software subscribe to our bi-monthly newsletter and keep informed on the free programs that help your computer to serve you. Only £12. (VAT not applicable.)

**ORDERS:**  
For individual disks the first disk costs £10, the second £8, and each disk thereafter is £6. Sets are as specified.

Add £2 post/pack (£3 foreign). UK residents add 15% VAT to total.

**ORDERS MUST BE PREPAID.**

**PAYMENT BY MAIL TO:**  
SELTEC COMPUTER PRODUCTS LTD,  
"Farley Hall", Wokingham Rd, Bracknell,  
Berkshire, RG12 5EU UK.

**TELEPHONE ORDERS: (0344) 86 3020**  
Pay by Access/Mastercard or Barclay/Visa.

We cannot guarantee the suitability of public domain/user-supported software for users' needs or equipment. AK1001

**MORE**

# PC PROGRAMMES FOR ONLY £2!

From the thousands of programmes we have collected from public-domain and user-supported software we bring you a special selection of the best utilities available - special purpose programmes that you may choose in any combination that you wish.

Choose any number for only £2 each (service charge), with a minimum of six programmes, and we transfer them on to one (or more) of our disks for you.

We include source coding where possible. The programmes are documented, where required. Disks are formatted for MS-DOS ver 2 or greater. 360k 5 1/4" disks.

Programmes are intended for IBM-PC or close compatibles. If Basic is specified then Basica or GWBasic is required. Most programmes are compiled.

## EFFICIENCY WITH FILES AND COMMANDS

- U14. **FAKE A KEY** to provide the input expected when batch processing.
- U15. **MULTI-CHOICE MANAGER**. Very cleverly apportions memory so that you can switch between three files.
- U16. **SOUND A TUNE** that lets you know a stage has been completed in batch processing.
- U17. **REQUESTS INFORMATION** in batch file processing. A timed ask utility.
- U18. **MULTIPLE FORMATTING** of disks. Lets you format a lot at same time.
- U19. **SMALL, FAST SUPER DIRECTORY**. Lists directory in 2,4, 6 columns, sorts, etc.
- U20. **SORTED DIRECTORY**. Screen listing that automatically shows hidden files and offers 2 or 4 columns. Various sorts.
- U21. **PERMANENT DIRECTORY SORT**. Resorts your directory and saves it to file. Will work on subdirectories and hard disks, as well as floppies.
- U22. **SUBDIRECTORY LIST**. Shows subdirectories in a given directory.
- U23. **SPACE ALLOCATION**. Combines Dos Tree and Dir commands to show amount of space to be allocated when files transferred to hard disk.
- U24. **FILE MANAGER** with execution facility for running programmes. Will also copy, view, delete, etc.
- U25. **MEMORY-RESIDENT FILE MANAGER** with multiple windows, variable size. Needs CGA card.
- U26. **BATMAKER**. Creates bat files containing all matching files. This is great when using Find in a text search.
- U27. **MENU PROGRAM**. Allows for tailor made menus. Good screen appearance.
- U28. **GO TO DIRECTORY** directly on a hard disk. Reduces amount of keyboard work.
- U29. **SECONDARY DOS**. Lets you suspend currently executing application and invokes a secondary Dos command processor so new commands can be executed.
- U30. **ALLBUT** the programmes you specify can be acted on. Eg, delete, copy, etc.
- U31. **MEASURE** the time your computer takes to execute commands.
- U32. **DISK ERROR MONITOR**. A resident programme that monitors disk errors and gives more information than the abort/retry/ignore message.
- U33. **REMEMBER COMMANDS**. Remembers last 50 commands which may be edited or executed.
- U34. **RENAME A DIRECTORY**.
- U35. **DISPLAY COMMENTS FROM CONFIG.SYS** file when booting up.
- U36. **BUILD DIRECTORY FILE WITH COMMENTS**. Has asm source code so that you can tailor to own needs. Produces list of files with size, crc, file no. and space for comments.

## FILE PRINTING/EDITING

- U130. **PRINT ITALICS**. Set printer for output in italics. Epson compatible.
- U131. **PRINTER RESET**. Resets printer to power-up mode.
- U132. **GRAPHIC SCREEN DUMP** for Epson compatibles.
- U133. **SET 51 LINES PER PAGE** on Epson compatible computer.
- U134. **SET 132 COLUMNS PER PAGE** on Epson compatible computer.
- U135. **SET UNDERLINE MODE** on Epson compatible printer.
- U136. **SET COMPRESSED PRINT** on Epson compatible printer.
- U137. **SET ENLARGED PRINT** on Epson compatible printer.
- U138. **SET WIDE PRINT** on Epson compatible printer.
- U139. **SET EMPHASISED PRINT** on Epson compatible printer.
- U140. **SET EXTENDED CHARACTERS** on Epson compatible printer.
- U141. **PRINT SPOOLER**. Creates a 16k buffer in memory, which allows you to do other work whilst printing.
- U142. **DISK-BASED PRINT SPOOLER**. Uses capacity of disk as buffer for printing, allowing you to continue with other work.
- U143. **SEND ESCAPE (ESC) SEQUENCES** as part of command, such as for printing.
- U144. **WORD FREQUENCY**. Counts number of times each word is used in a text file.
- U145. **FAST WORD COUNT**. Provides count of words, characters, lines, plus a mathematical check sum, which allows you to compare text files for changes.
- U146. **APPOINTMENT REMINDER**. Stores data on disk like a daily appointments diary. Prints details of next 7 days.
- U147. **PRINT WITH NUMBERED LINES**. Great for listing source coding.
- U148. **SIMULTANEOUS EDIT** of multiple text files. Lets you make the same text changes to several files at once.
- U149. **WORD LENGTH ANALYSER**. Checks the length of words in text and compares with readers' level of schooling.
- U150. **TEXT CHECKER**. Examines Wordstar files for typing errors such as missing brackets and quotes.
- U151. **TEXT FILE SORT**. Fast and works with very large files.
- U152. **LIST NON-ASCII BASIC FILE** without loading Basic. Also helpful for listing if you don't have Basica/GWBasic.
- U153. **PAUSE LISTING** so that printer will produce 55 lines on a page.

## EQUIPMENT HANDLING

- U406. **CONTROL BACKGROUND/ FOREGROUND COLOURS** as displayed on your monitor.
- U407. **HARD DISK PERFORMANCE TEST**. Checks the running of hard disks.
- U408. **COMPUTER LOG** to keep track of amount of time of computer usage, how time spent.
- U409. **ELECTRIC TYPEWRITER**. Converts computer into electric typewriter (for notes, envelopes, etc.).
- U410. **KEYBOARD OPTIMISER** that will set cursor size, give type ahead buffer, more. Easy to use command line editing.
- U411. **MAP RESIDENT PROGRAMS**. Shows program addresses, possible conflict.
- U412. **TRACK MEMORY** as programs are running. Has windows and more.
- U413. **MEMORY ORGANISER**. Determine, mark, release, allocate, display memory. Shows how files are loaded in memory.
- U414. **MULTI-SCREEN**. Allows output to be directed to more than one screen. Needs CGA. Multitasking features.
- U415. **NEW ANSI.SYS** that may aid screen presentation and allow faster execution of many functions.

- U416. **BLACK & WHITE MODE** can be switched on colour graphics card.
- U417. **TIMEPARK HEAD** of hard disk after a specified time has elapsed.
- U418. **SET 40 or 80 screen columns** BW mode on colour systems.
- U419. **STATUS REPORT** on system, including information about drives, memory available.
- U420. **SPEED TEST (1)** checks processor speed and compares with IBM-PC. Similar to Norton test.
- U421. **SPEED TEST (2)** checks computer speed in two areas, including Sieve calculation and track to track access time, and compares with IBM-PC.
- U422. **SPEED TEST (3)** comprehensive checks on processing, including block write, register/memory, multiply, divide, stack operations, far jumps, etc, and compares with IBM-PC.
- U423. **RAM TEST**. Tests and tests ram. Identifies faulty memory.
- U424. **DOS ENVIRONMENT VARIABLE EDITOR**. Make changes to edit path, prompt, etc.
- U425. **EXPAND DOS ENVIRONMENT SPACE TO 1K**.
- U426. **FLIP ON/OFF (TOGGLE) DOS PARAMETERS**. Works on several standard Dos parameters.
- U427. **WHAT PROCESSOR?** Examines and identifies the processor/s being used, such as 8088, 8086, etc.
- U428. **WHAT DEVICE DRIVERS?** Examines and reports on devices (eg ports) installed in your computer.
- U429. **WHAT DOS CONFIGURATION?** Examines and reports on memory, vector addresses, and statistical information about version of Dos you are using.
- U430. **WHAT EQUIPMENT?** Examines your equipment and reports on the installed drives, type of cards (eg, printer, colour, mono, RS232) etc.
- U431. **EDIT RAM STORAGE** in your computer.
- U432. **DRIVE STATUS**. Reports on no. of bytes, sectors, clusters-what capacity is and how much is free.
- U433. **DIAGNOSTICS**. Performs large number of computer diagnostics and reports on serial, parallel ports, video, etc.
- U434. **DRIVE TEST**. Floppy disk test drive utility.

## FILE MOVING

- U511. **HARD DISK UNERASE**. Exceptional features. Most unerase utilities don't work on hard disk - this one does!
- U512. **DELETE ALL BUT** those programs you identify.
- U513. **INTELLIGENT COPY PROGRAM** that creates sub-directories as part of the transfer. Also renames rather than over writes.
- U514. **SUPERIOR COPY PROGRAM** that checks and evaluates target before copying. Eg, copies last dated version.
- U515. **UNIQUE COPY PROGRAM** with same function as U514 but does not copy those already on target disk.
- U516. **TREE SURGERY**. Prune files unwanted/ duplicated on hard disk. Has source code and compares files with the same name.
- U517. **KILLDIR**. Delete a branch of a directory. Reduces steps and saves time.
- U518. **MOVE DIRECTORY** around if you prefer it stored in different location.

## FILE ORGANISATION & CHECKING

- U611. **BOMB ALERT**. Examines new files for malicious intent and reports on possible danger to other files.
- U612. **BASIC MENU GENERATOR**. Better access to your Basic files through a menu. For Basica/GWBasic.
- U613. **UNSCREEZE ARC FILES**. Small, efficient utility that occupies less space and is simpler to use than Arc.Exe.

- U614. **HARD DISK OPTIMISER**. Related group of files that optimise hard disk usage and eliminate file fragmentation. Helps pack the disk.
- U615. **FILE RE-ORGANISER**. Regroups a fragmented file into contiguous sectors on a disk for more efficient disk access.
- U616. **RECOVER BAD SECTORS**. Records data on disk. Does 12 retries and thus may recover bad sectors.
- U617. **COLLECT BAD SECTORS**. Marks bad sectors for collection into a separate file that will not be used. Works with floppies and hard disk.
- U618. **ADVANCED COMPARE** facility that can save as edlin script, generate and update deck.

## SPECIAL FEATURES

- U805. **PREPROCESSOR FOR "C" COMPILERS**. Has "C" source and helps organise coding into efficient form for compiling.
- U806. **VOICE EMULATION**. Compiled with Basica source module which allows extensions, revision or use as tutorial.
- U807. **DEMONSTRATION OF COMPUTER GRAPHICS** for those who have CGA.
- U808. **DAYS SINCE JAN 1ST**. Calculate no. of days elapsed since beginning of year. Needs Basica/GWBasic.
- U809. **BINARY FILE CONVERTER**. Converts files from machine language to hex equivalent for examination and modification.
- U810. **CAPTURE BIOS** contents and store in a separate file.
- U811. **EXPLORE FAT (FILE ALLOCATION TABLE)**. Shows the table entries, starting clusters of files, etc.
- U812. **MINICALC**. A small, easy to use spread sheet with 11 x 22 cells for quick every day use.
- U813. **PROGRAMMER'S CALCULATOR** which does special hex and other calculations for those writing programs.

## ORDERS:

The service charge for each program is £2. There is a minimum charge of £12 (six programs) plus £2 for postage and packaging (£3 foreign). UK purchasers add 15% VAT to total.

## ORDERS MUST BE PREPAID.

**PAYMENT BY MAIL TO:**  
SELTEC COMPUTER PRODUCTS LTD,  
Farley Hall, Wokingham Rd, Bracknell,  
Berkshire RG12 5EU UK.

**TELEPHONE ORDERS:**  
Pay by Access/Mastercard or Barclay/Visa.  
Tele: (0344) 86 3020

We cannot guarantee the suitability of programs for users needs or equipment.

**CIRCLE NUMBERS BELOW AND SEND TO US WITH PAYMENT AND YOUR NAME AND ADDRESS. OR TELEPHONE US WITH THE PARTICULARS. SEE ABOVE.**

- |     |     |     |     |     |     |     |     |     |
|-----|-----|-----|-----|-----|-----|-----|-----|-----|
| 14  | 15  | 16  | 17  | 18  | 19  | 20  | 21  | 22  |
| 23  | 24  | 25  | 26  | 27  | 28  | 29  | 30  | 31  |
| 32  | 33  | 34  | 35  | 36  | 130 | 131 | 132 | 133 |
| 134 | 135 | 136 | 137 | 138 | 139 | 140 | 141 | 142 |
| 143 | 144 | 145 | 146 | 147 | 148 | 149 | 150 | 151 |
| 152 | 153 | 406 | 407 | 408 | 409 | 410 | 411 | 412 |
| 413 | 414 | 415 | 416 | 417 | 418 | 419 | 420 | 421 |
| 422 | 423 | 424 | 425 | 426 | 427 | 428 | 429 | 430 |
| 431 | 432 | 433 | 434 | 511 | 512 | 513 | 514 | 515 |
| 516 | 517 | 518 | 611 | 612 | 613 | 614 | 615 | 616 |
| 617 | 618 | 805 | 806 | 807 | 808 | 809 | 810 | 811 |
| 812 | 813 |     |     |     |     |     |     |     |

## Lost in the woods

An 80386 system for £1600: it was on offer at the PC User Show.

It caused no little annoyance to another company, Mission, whose identical machine was on sale at the same show, at £2000.

The system was imported by Jim Wood, whose Euromicro outfit in North London has been quietly supplying low-cost machines for some time now, but has suddenly hit the jackpot.

Wood buys his machines from Wearnes Brothers in Singapore, and so, after a diversion to ALR (Advanced Logic Research) in California, does Mission. Wood claims (it seems watertight to me) that he therefore pays less for his stock.

It looks very likely that Wearnes will now take over Euromicro and establish that company as its European headquarters, as ALR is its American subsidiary. At that time, you can expect Mission to start buying through Euromicro/Wearnes; but, in the meantime, things will be rather confused.

All my information indicates that Wood's machine, lacking a hard disk and colour but including a 1.2Mbyte floppy, 1Mbyte of RAM, MS-DOS 3.2 as well as full expandability, is a sound, reliable piece of hardware. He is entitled to label it as a Euromicro system, an ALR system, or a Wearnes system; and the price is the retail price, so if you see the system in a store, don't let anyone talk you into paying more.

Full details of retail outlets can be obtained from Euromicro on (01) 341 2447.

## Playing the waiting game

Dear old IBM UK is trying to get Britain worked up into a frenzy over the development of a new desktop publishing division, which it plans to announce some time in September.

The company is going to have trouble. It's missing the star performer — a 600 dots per inch laser printer that produces genuine lithography plates. Without

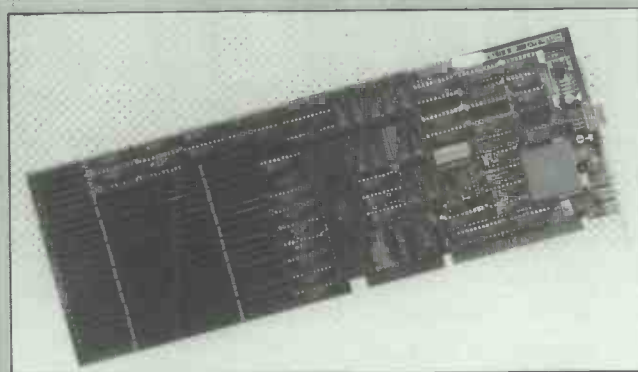

*Real World Graphics' reputation as a leader in graphics technology isn't going to be hurt by this announcement: the company has announced its AT 2500 graphics board at £2600, with a two million pixels per second drawing speed — twice that of the Amiga — but designed to plug into the PC/AT, says Graham Rowan, managing director. Fierce. Details on (0992) 554442.*

that, the show may flop — badly.

The new division has done one thing right, say my sources: it has refused to sell the same stupid Model 30-based PS/2 system that IBM showed in the US when it launched PS/2.

The main product will be running Windows and Aldus' PageMaker, but on a new laser printer (probably Canon-based). And it will be using the Model 50.

Talk to any IBM executive involved in the project, and they will concede: 'Confidentially, we don't think much of the US system, and we think the Model 30 with its 8086 processor isn't fast enough to run Windows and PageMaker. And the method of plugging a card into the computer with its own Motorola 68000 processor on it, is just silly and expensive. We're waiting for something better.'

The 'something better' hasn't appeared because there is a shortage of Model 50 computers, and the software which was going to link them to 'something better' isn't ready, and the 'something better' has turned out to be vastly expensive.

The 600 dots per inch laser printer exists, certainly, but it costs £16000. And there is no evidence of any software to drive it, yet.

IBM UK has, accordingly, begun a new design project in its Hursley laboratory where an upgraded card is being designed. It will fit into the 80286-based PS/2 machines, the Model 50 and the Model 60.

It sounds promising. The only problem is that the shortage of Model 50s and the design cycle delay makes it likely that nothing will be available until December or later.

## Clocking on to real time

One of the little throwaway programs that Amstrad gives to PC1512 users is a utility, RTC, which sets the real-time clock to the same date as the computer thinks it is.

You may consider this to be of trivial interest to users of the Dell 286 machines. You may even think that I'm potty, trying to make a computer have two clocks.

In fact, some MS-DOS computers have three clocks — a DOS clock, a BIOS clock, and a battery-powered chip. Theoretically, when you start up the system, it reads the date and time off the battery clock, or asks you for them if there is no battery clock.

In the case of Amstrad's machine and Dell's 286, you can tell the system it's Tuesday if you like, but it won't believe you until you talk direct to the real-time clock.

The PC1512 has a patch in MS-DOS which does this. The Dell 286 has a system where you punch Control/Alt/Return, and it then lets you decide what day it is. But if you run the Amstrad under PC-DOS, that patch isn't there.

Running RTC (real-time clock) solves the Amstrad's problems. It has another, quite useful, function — you

can leave the machine on overnight.

A normal Amstrad, left on overnight, will just carry on counting seconds. It will fail to reset the time at 24.00 hours, and will go on dividing bigger and bigger numbers of seconds until it has a number too big to handle.

Amusingly, this doesn't bother the machine until you try to save a file to disk. At that point it tries to read the clock, and discovers that the division needed to produce the number of hours is more than it can manage.

The Dell, however, has another irritating aspect: the clock may know the date and time, but it isn't going to tell the rest of the system.

In an attempt to synchronise the clocks, I ran the Amstrad RTC. Result: the wretched machine decided the date was 1 January 1980. The clock knew it was July 1987, but DOS wouldn't believe it.

Dell has promised to fix it.

## Making the customer pay

The only reason I can think of for using Telecom Gold for electronic mail, is that other people do.

This obviously offends the people at Telecom Gold. In an effort to reduce the number of users, they have come up with a new pricing policy, designed to reduce the amount of data you can get into the system or out of it, and also designed to make you use a slower modem.

The new pricing structure coincides with a similar effort on the part of Packet Switch Stream, a company inside British Telecom (BT) which links remote users at local call rates (plus a fee).

I freely forecast a switch to Mercury, despite that company's tiny advertising budget.

The new Gold charges actually reduce the amount spent on connection. You pay (standard rate) 6.5p per minute, where you used to pay 11.5p per minute. But, these days, you also pay 4p per 512 characters.

There's a similar change at cheap rate from 3.5p down to 2p per minute, but 1p per 512 characters.

The effect will be felt most by people using fast modems — both 1200 and 1200/75 bits per second —





that you've chosen a printer that is fast, reliable, easy to use and what is more, gets the job done first time.

Take the S series for example. A collection of 9-pin matrix printers designed for today's business user. From the 120 cps SG-15 to the 200 cps SR models, all provide excellent value for money. Indeed, measured against the competition, you could be getting as much as 25% more for your money.

All Star printers give exceptional print clarity, even in draft mode. The S series has one of the clearest draft fonts available and its near letter quality printing has been widely acclaimed by reviewers and users alike.

Of course, the S series is fully IBM compatible, ensuring that it will work happily in any modern business environment, using either serial or parallel versions.

Whether your paper requirements are for single sheets or continuous with additional copies, the S range has a tractor feed as standard. The SR models even come with an automatic single sheet feed to make your letterheads really easy to load.

The Star pedigree is inherited from many years in the manufacture of precision machine parts and a long

Countless users have made the right decision - why not join them?



**THE Star**  
PRINTERS FOR BUSINESS

Star Micronics U.K. Ltd.  
Craven House,  
40 Uxbridge Road,  
Ealing, London W5 2BS.  
Telephone: 01-840 1800.

A division of Star Micronics Co. Ltd. Japan

I would like to be sure I'm making the right decision. Please send me details on the Star range of printers.

Name: \_\_\_\_\_  
Company: \_\_\_\_\_  
Address: \_\_\_\_\_  
Postcode: \_\_\_\_\_ Telephone: \_\_\_\_\_  
Or just call Belinda on 01-840 1829. **ICT011**

# He's made the right decision... So can you.

It's not easy choosing a printer.

So many to choose from, so many different features.

But more and more companies are discovering that after looking at the Star printer range there is no doubt as to the right choice.

Take the ND-15 and the NR-15 for example.

Both are IBM compatible, offering proportional, elite, pica, expanded, super and subscripts in NLQ.

Which means they're ideal for word processing as well as spreadsheets and listings.

With 180 CPS in draft mode and 45 CPS in near letter quality mode for the ND-15 and 240 CPS in draft mode and 60 CPS in near letter quality mode for the NR-15 you won't be kept waiting for your copies.

Every function you'd normally use is on a single touch panel on the front of the printer. The ND-15 and NR-15 let you forget the days of fiddling with little dip switches.

Add to that the fact tractor and single sheet feed are fitted as standard and you'll see you're looking at a pair of star performers.

All Star printers are supported through a nationwide dealer network backed-up by the finest distributors, so you're never on your own.

Discover the Star printer range today.

Fill in the coupon or just 'phone Belinda on 01-840 1829 for more information.

It'll be one decision you certainly won't regret.



Star Micronics U.K. Ltd.  
Craven House,  
40 Uxbridge Road,  
Ealing, London W5 2BS.  
Telephone: 01-840 1800.



A division of Star Micronics Co., Ltd., Japan.

I would like to be sure I'm making the right decision. Please send me details on the Star range of printers.

Name \_\_\_\_\_  
Company \_\_\_\_\_  
Address \_\_\_\_\_  
Postcode \_\_\_\_\_ Telephone \_\_\_\_\_  
Or just call Belinda on 01-840 1829. **PCW 9**

# DIGITASK

## BANISH THE

Like many others you've probably found your head swimming with facts, jargon, prices and names, some you've heard of and some you'll never hear of again! But Digitask is one name you're going to hear a lot more of.

Digitask have been producing PC compatibles and supplying compatible hardware for nearly four years, to end users, corporates and dealers. Our customers include some of the biggest names in the business and nearly every university and technical college in the land.

Why not take a closer look at our range of PC's... there's a package in the range to suit you! If you're not sure which system will meet your needs, then give us a call and talk to someone who not only knows the systems but who actually builds them! Our components are individually sourced throughout the world and imported to the UK. This allows us to choose the best of all the available options and then to build and test the systems in-house. So when you call, our technical staff are fully conversant with all aspects of system design and maintenance.

Our reputation for service is second to none, our clients keep coming back for more.

A 100% British owned company based in the UK, we are going to be around when others have long gone. Maybe that is why over 8000 computer users have chosen Digitask.

**BUSINESS  
PRO  
£879**



### DIGITASK PC16-X

- NEC V20 super processor operating at 4.77 MHz
- Soft/hard switchable to 8 MHz Turbo (provision for 8087-2 co-processor)
- Full 512 KB on-board memory as standard
- Single floppy drive
- 8 IBM® compatible expansion slots (7 on portable)
- 1 × parallel port, 1 × serial port (2nd serial opt.)
- 1 × clock, 1 × games port, 1 × light pen interface
- Easy access flip-top lid (slide on portable)
- 84 key, AT® style keyboard
- Colour display adaptor
- Composite green/amber monitor (internal 9" TTL on portable)
- Free Application/Utilities Software
- One year parts and labour warranty (on-site maintenance available)

**STARTER SYSTEM** (Specifications as above) **£499**

**FULL FEATURE SYSTEM** Dual 360KB Floppy **£695**

Drive 640K Ram

High Resolution TTL Monitor, Mono-Graphics Adaptor

**BUSINESS PRO SYSTEM** 20MB Hard Drive, **£879**

Single 360KB Floppy Drive

**BUSINESS PRO PLUS SYSTEM** **£1069**

20MB Hard Drive, 1 × 1.2MB + 1 × 360KB Floppy Drive

# PHONE 0342 24631 NOW

or Contact Digitask, Unit M, Charlwoods Business Centre, Charlwoods Road,  
East Grinstead, West Sussex RH19 2HH. Telex 957418 G

OVERSEAS CALLERS WELCOME

Prices Do Not Include VAT or Carriage

# DIGITASK

## PC BLUES!



**AXIOM  
GOLD 20  
£1275**

### DIGITASK AXIOM 286-10

- 80286-10 processor (6/10 MHz switchable) •
- Optional 80287 co-processor • Phoenix BIOS • Full Megabyte on-board memory supplied • 1.2 MB floppy drive • 6 × 16 bit IBM® compatible expansion slots (5 usable on portable) • 2 × 8 bit expansion slots • 2 × parallel ports, 1 × serial port (2nd serial opt.) • Easy access flip-top lid (slide on portable) • Small Footprint • 84 key, AT® style keyboard • Mono/graphics adaptor • High resolution TTL monitor (internal 9" on portable) • One year parts and labour warranty (on-site maintenance available)

<b>AXIOM SILVER</b> (Specifications as above)	<b>£1165</b>
<b>AXIOM GOLD 20</b> 1 × 20MB Hard Drive	<b>£1275</b>
<b>AXIOM GOLD 40</b> 2 × 20MB Hard Drive	<b>£1475</b>
<b>AXIOM GOLD 20 EGA</b> 1 × 20MB Hard Drive with EGA card and monitor	<b>£1799</b>

Other configurations - please call



**AXIOM  
GOLD 20  
£1375**

### THE DIGITASK PORTABLE RANGE

<b>PC16-X STARTER SYSTEM PORTABLE</b>	<b>£699</b>
<b>PC16-X FULL FEATURE PORTABLE</b>	<b>£779</b>
<b>PC16-X BUSINESS PRO PORTABLE</b>	<b>£965</b>
<b>PC16-X BUSINESS PRO PLUS PORTABLE</b>	<b>£1135</b>
<b>AXIOM SILVER PORTABLE</b>	<b>£1155</b>
<b>AXIOM GOLD 20 PORTABLE</b>	<b>£1375</b>
<b>AXIOM GOLD 40 PORTABLE</b>	<b>£1575</b>

Specifications as desktop systems



**BUSINESS  
PRO  
£965**

# PHONE 0342 24631 NOW

or Contact Digitask, Unit M, Charlwoods Business Centre, Charlwoods Road,  
East Grinstead, West Sussex RH19 2HH. Telex 957418 G

OVERSEAS CALLERS WELCOME

Prices Do Not Include VAT or Carriage

# Whoever got this ...

# ... into that?

- \* 18 user configuration maximum, with little loss of response time
- \* link 254 other 4EP's or PC's of any description
- \* 3-19 10Mhz processors per 4EP, each with 512Kb or 1Mb RAM
- \* internal Winchester drives of 20-300 Mb capacity
- \* 60Mb Tape Streamer backs up in 12 minutes
- \* maximum 40 serial ports
- \* ARCNET local area network
- \* SCSI interface
- \* Optional internal high capacity tape unit up to 2,300Mb



## HM Systems.

## The new Minstrel 4EP.

If you don't believe us, ask ACAS, Action Aid, Alton Towers, Banham Locks, BBC, Beecham Pharmaceuticals, British Gas, British Library, British Telecom, BUPA, Consumers' Association, DHSS, DTI, Kodak, London Regional Transport, MOD, numerous hospitals ... and many, many more users of Minstrel multi-user networking systems.

Six years ago, HM Systems was one of the first companies to get into multi-user micro-computing. We soon pulled ahead of the competition, and we've stayed in the lead ever since.

To get more out of your computer, contact HM Systems, the people who put more into the system. Ring 01-209 0911, Telex 266828 HMSPLC G. Or post this coupon.

To: HM Systems plc, 220 The Vale, London NW11 8HZ.

**HM** Systems plc

-----

----- Please tell me more about the Minstrel 4EP multi-user computer. -----

-----

----- Name -----

----- Title -----

----- Company -----

----- Address -----

-----

----- Telephone ----- PCW1 -----

-----

because they can read through more text in the same time. And people who did as recommended by BT, and prepared messages offline, will be equally heavily hit.

For the life of me, I can't see the logic of it.

For example, the cost of downloading a weatherlink picture from Microlink (see 'Mailbox', page 178, this issue) would rise from a minimum (cheap rate) of 28p to £1.05, including VAT. Reading through the Infomatics Daily Bulletin would carry a similar penalty. In fact, any of the 'added value' information services in Gold is going to show an average three-times price rise.

When 2400 bits per second becomes the standard modem speed, things will get worse, not better.

If there were no competition, it wouldn't matter, perhaps; but there is, in EasyLink (now MercuryLink) which has only one serious drawback compared to Gold — you can't store files online.

With the new pay-for-data rather than pay-for-time charging system, the temptation to keep files online becomes very small.

The rise in charges for packet-switching is even sillier. Mercury's X.25 network appears to be friendlier, uses digital-only links (less noise) and allows you to use any Mercury network in the country, rather than charging a fee for every number that will accept your password.

Funny, isn't it, how a monopoly mentality just can't adapt to reality, but feels entitled to 'tax' its customers, rather than serving them?

## Enthusiasm wins

The free APL (A Programming Language) interpreter for small machines was due to be demonstrated in Dallas in May, but is still under development.

It has been developed in the UK by enthusiasts and runs on the PC and smaller machines like the BBC B, the Commodore 64, the Spectrum, the Apple and all CP/M systems.

To obtain a copy, write to The Chairman, The I-APL Project, 2 Blenheim Road, St Albans, Herts AL1 4NR.



*People will tell you that Ashton-Tate's Javelin is a spreadsheet — it isn't. It's an analysis tool that looks like a spreadsheet, but it's vastly more flexible and powerful.*

*Because it takes so long to explain to people what Javelin does, the company was faced with a dilemma. Should it increase the price, so that dealers could afford to train customers in using it? Or should it make Javelin so cheap that people could try it out?*

*First Software, the UK distributor, has now decided to follow the example of Ashton-Tate and sell it for £100.*

*Details from retailers, or from First Software on (0256) 463344.*



*The PCW staff have been prepared to barricade the doors to stop this printer from being taken away.*

*Kyocera's 1010 laser printer is fast, quiet, non-smelly, and provides almost perfect IBM graphics printer and HP Laserjet+ emulation. Other emulations supported include Epson FX-80, Qume Sprint and Diablo 630.*

*There are 36 resident fonts including landscape and portrait Times and Helvetica in sizes from 6pt through to 14.4pt, and fonts can be downloaded as well.*

*Kyocera's printers come with their own language — Prescribe, a plain text command language which can be used to change fonts and spacing, or to draw geometric shapes. For example, 'PIE' draws pie charts of a given radius with a number of sector markers; and 'FPAT' defines a fill pattern.*

*It's a pity that more software packages don't support the Kyocera in its native mode, but its HP emulation worked fine with Fantasy and Ventura, producing the latter's Scoop page in about two minutes.*

*Distributor Mekom has just reduced the price of the 1010 to £2495, and can be contacted on (01) 248 1711.*

Derek Cohen

## European suicide

Ventura Publisher is currently the leading UK desktop publishing program, so it was somewhat bewildering to users who ordered the new wonder-upgrade, to discover that Xerox had sneakily made it copy-protected.

This is usually suicide in the corporate market, just for the problems it causes legally, but Xerox outdid itself by using a system which: (a) was easy to break; and (b) caused the program to crash.

In the UK, the copy protection lasted about four weeks, and most buyers will never know it happened. In Europe, however, the less well-educated Xerox subsidiaries have insisted on keeping it. I predict a huge drop in European sales.

## Persecution complex

Alan Sugar told the world (via Channel 4 News, no less) that the Press doesn't like him and makes his life difficult. We must presume it was this hostility which caused the industry's writers to swallow his interesting theory that he 'launched the PC1640 unexpectedly at the PC User Show, after pressure from distributors and dealers.'

He launched the machine at Comdex in Atlanta earlier this year, and told everyone that he wouldn't launch it in the UK until 'much later in the year, maybe even next year.' Three weeks later, he said, he'd 'changed his mind.'

I'm not sure which I find funnier: the idea of Alan Sugar bowing to pressure from dealers; the notion of his buying space at the PC User Show to show his old machine; or the sight of this 'hostile' army of scribblers, all solemnly reporting this nonsense as fact.

## Beebug challenge

There is a theory that a C language compiler can't be sensibly written for the 6502 chip. Beebug, the club for BBC micro owners, has challenged that by launching a full Kernighan & Richie-specification C on two ROMs, with a disk library, for £59.

Details on (0727) 40303. END

# SURPLUS COMPUTER STOCKS

**SAVE £1230**

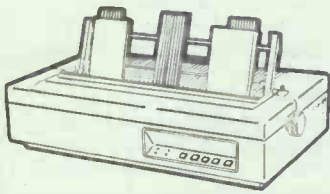

**EPSON SQ 2000 PRINTER**

Special purchase of high quality industrial standard printers, 175 CPS draft, 105 CPS NLQ mode Parallel interface, 2k buffer, self test switch, ink cartridge etc. This full-size, heavy duty (weight 39.6lb) printer has a 24 jet print head with a choice of 175 cps draft or an amazing 105 cps NLQ, plus proportional spacing, bit image graphics. Boxed, with full one year warranty, includes manuals and mains lead. Limited supply. Original price £1825. Optional sheet feeder £150. Optional tractor feeder £75. (BRAND NEW) **£595**

**100 CPS**

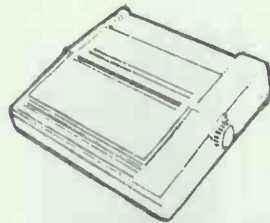

**COPAL SC1000**

Direct from the liquidator, Copal SC1000 standard parallel interface dot matrix printer. Uses Epson escape codes. Specification includes friction and tractor feed 100 CPS, subscript and superscript, condensed and dual density, takes fan-fold, roll, cut-sheet and copy paper, eight international character sets selectable by dip switch settings. Compatible with most popular PC programs. (Also available Copal SC 1200, 120 CPS £110). Brand new boxed including manuals tractor mains lead and ribbon. **£99**

**UNDER DEALER**



**IBM PC CONVERTIBLE**

Convertible spec includes twin 3 1/2 inch floppies 360k LCD 80 column by 25, 256k RAM expandable to 640k by RAM cartridges. Full size "QWERTY" keyboard, runs a host of popular 3 1/2" disk size packages and many useful facilities can be ported over. Powered by 240/110 volt A/C mains adaptor (included) or optional battery pack. We have a limited supply of these innovative "clam shell" style machines, which have had nominal demonstration use. Complete with manuals & covered by 3 months parts & labour warranty **£995**

**M10 SYSTEM**

**olivetti**

**ALL PARTS AVAILABLE**

Olivetti M10 battery powered portable. 40 column by 10 lines display, 16k RAM (expandable to 32k) bundled software includes word processing, address book, communications package, BASIC, appointment scheduler, takes 4xAA size batteries, continuous clock/calender, £125. MC 10 portable acoustic coupler for use with M 10 or similar, takes 4xAA size batteries. MP10 4 pen printer/plotter. Twin mode text and graphic operation, 40 characters per line text mode, programmable to 80 in graphics £45. Computer alone **£125**

**DP 20 £195**

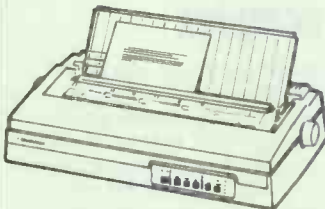

**DATAPRODUCTS DP 20**

£499 list price. Dataproducts DP 20 daisywheel spec includes 22 CPS serial interface, full width 136 column, heavy duty for commercial applications. Printer has a choice of 10, 12, 15 CPI, daisywheels and proportional. Complete with ribbons, mains lead & Courier 10 daisywheel. Works on COM 1 with IBM or compatible, emulates Diablo 630 escape codes for easy software installation. Single bin sheetfeeder £150 extra, double bin sheetfeeder £250. Tractor feed £75. All units brand new, boxed inc manuals **£195**

**FRONT END**

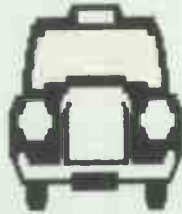

**EPSON TAXI INC MOUSE**

Epson Taxi with mouse, card, and software for IBM PC and 100% compatible. Includes 3 button mouse, software to turn MS-DOS into Macintosh type front end, clock, calender, pop-up calculator, notepad and Epson printer setup utility. All work and no play?—Othello strategy game included. System requirements are IBM PC, XT, AT, or 100% compatible, 192k, IBM Colour graphics adaptor, and colour monitor. Compatible with Microsoft I/O routines. Brand new, boxed, 12 months parts & labour warranty. Lists at £199 **£75**

**LAST FEW**



**EPSON HX20 PORTABLE**

Small batch of brand new and demo Epson HX 20 portable re-chargeable battery powered computers. 16k RAM (Expandable to 32k with optional expansion unit) 20 character by 4 line display. Complete with built in micro cassette and dot matrix printer. Full "QWERTY" keyboard, 10 programmable function keys and numeric keypad. Links to external peripherals such as disk drives, printers & modems. Stocks are some slight demo (at £150) & brand new complete with briefcase style case, A/C charger, **£195**

**M O D E M**



**BUZZBOX MODEM**

BT approved Buzzbox battery operated portable modem, conforms to international CCITT V21 standard and operates full duplex at 0-300 bps asynchronously. Can be used to originate or receive. Takes two PP3 batteries that are self contained in the modem or can be connected to the included A/C adaptor for mains useage. Requires the terminal computer to have an RS232 Serial output. Comes with manual and 5 pin DIN plug for connection to your cable. Brand new but unboxed for testing. 3 months parts & labour warranty. **£35**

**FLEA MARKET**

PARTS ONLY, NO WARRANTY GIVEN  
 ACT Sirius complete ..... **£295**  
 Linokey 2 inc disk drive ..... **£450**  
 Decwriter II ..... **£95**  
 IBM 5 1/4 inch 360k floppies ..... **£30**  
 No-name 132 col printer fast ..... **£75**  
 Osborne I brown case ..... **£95**  
 \*OKI IBM Plug'n Play ..... **£25**  
 Tandy Model III 16k ..... **£45**  
 \*DRE ICL 2348 hard disk ..... **£995**  
 surplus 5 1/4 floppies 10s ..... **£6**  
 Bit 24 for BBC ..... **£15**  
 \*Scotch DC300 A data cart ..... **£10**  
 110v Nec Spinwriter ..... **£250**  
 Apple disk drives uncased ..... **£35**  
 Ricoh 1600 ..... **£99**

**MISCELLANIOUS**

Compaq 286 Deskpro 30mb ..... **£1895**  
 Apple Europlus CPU ..... **£195**  
 Apple IIe ..... **£325**  
 Kaypro 2000 EXP box ..... **£250**  
 Televideo 1605 pc compatible ..... **£595**  
 Televideo 1605H ditto inc 10mb ..... **£795**  
 PR1 acoustic coupler ..... **£25**  
 Compaq Plus inc 256k 10mb ..... **£1100**  
 Apple Macintosh 128k ..... **£595**  
 \*Dacom Auto answer modem ..... **£65**  
 Tandon PCA 20 mono AT comp ..... **£1500**  
 Polaroid Palette demo ..... **£750**  
 Compaq Deskpro 10mb ..... **£995**  
 Kaypro 2000 inc software ..... **£695**  
 \*Steebek-Dowty SB1212 V22 ..... **£250**  
 Kimtron terminal ..... **£250**

**IBM SOFTWARE**

\*Calc-it 3D Spreadsheets ..... **£35**  
 \*Show-it graphs package ..... **£25**  
 \*Ask-it compliments Keep-it ..... **£15**  
 \*Sort-it ditto ..... **£15**  
 \*Micropro Dastar ..... **£65**  
 \*Keep-it database ..... **£35**  
 \*dBase II Multi user ..... **£350**  
 \*Edit-it simple text editor ..... **£25**  
 \*Peachtree Dec Manager ..... **£45**  
 \*Easy Junior A/C package ..... **£150**  
 \*Word Plus PC inc BOSS spell ..... **£75**  
 \*Calcmaster ..... **£75**  
 \*Fox & Geller Quickcode ..... **£75**  
 \*Superterm 400 ..... **£95**  
 \*Ultimate word processor ..... **£95**  
 \*Graphwriter ..... **£250**

**IBM HARDWARE**

IBM PC 64k, inc monitor & kbd ..... **£550**  
 IBM PC 512k complete ..... **£695**  
 IBM XT 640k 10mb complete ..... **£995**  
 IBM AT co-processor ..... **£95**  
 IBM SDLC card ..... **£50**  
 IBM Async Comms card ..... **£50**  
 \*Orchard PC turbo 186 ..... **£295**  
 \*AST Colourgraphplus ..... **£50**  
 AST Rampage AT ..... **£200**  
 \*AST Sixpak inc 64k Sidekick ..... **£150**  
 \*Quadboard 384k card etc ..... **£125**  
 Mountain 30mb internal drive ..... **£350**  
 \*Microsoft Pascal compiler ..... **£195**  
 Ideadisk 10mb & 5mb backup ..... **£500**  
 \*5250 card, cable, program ..... **£395**  
 \*IBM uncased 5 1/4 floppies ..... **£65**

**Morgan Computer Co.**

ACCESS AND VISA ACCEPTED  
 PRICES SUBJECT TO 15% VAT  
 MAIL ORDER (CARRIAGE EXTRA)

179 TOTTENHAM COURT ROAD, LONDON W1. 01-636 1138

OPEN MONDAY TO SATURDAY  
 PRICES SUBJECT TO CHANGE  
 GOODS SUBJ. TO AVAILABILITY

# THE WEST COAST CONNECTION



*Better known as an industry-standard chip manufacturer, Intel has, in fact, many irons in the fire — including the development of a fax card. Tim Bajarin connects up to this month's important US news.*

## When the chips are down, Intel strikes

When you think of Intel, you normally think of a powerful chip manufacturer. But although this is Intel's main line of business, it is not the company's *only* business.

Sources close to Intel claim that this leading-edge company is working diligently on many products, including some similar to those which Chips and Technologies (C&T) has developed in the way of chip integration. Intel plans to give C&T a real run for its money on comparative VLSI products.

However, Intel's PCEO group in Corvallis, Oregon, has been busy, too. This is

the division which produces various Intel-labelled memory expansion boards, maths chips and add-on cards.

Now, this entrepreneurial part of Intel is jumping on the PC/fax card bandwagon and is about to release a card of its own.

Designed for PCEO by SpectraFax, a small company in Naples, Florida, this card will fit into the PC and turn a desktop computer into a fax sending and receiving device.

It will have its own fax modem onboard, and Intel insiders claim that it will offer features which most of the other boards on the market

do not presently have.

This development is Intel's first foray into the complicated field of communications, and could be a sign that the company is looking seriously at modem chips and advanced communication logic devices.

Considering the strong competition that Intel is receiving from Motorola and Texas Instruments, it makes sense for the company to enhance some of its capabilities and examine new areas to broaden its product line.

The Intel fax card should be available by the end of the year.

## Postscript: Apple's slice of the pie is cut

For some time now Apple has enjoyed a long spell as the price-setter for laser printers. The standard LaserWriter retails for \$4295, while the LaserWriter Plus costs around \$5000.

But, now that AST Research has introduced a \$3995 Postscript printer, you can expect to see Apple — as well as Digital, Texas Instruments, Wang and QMS — react quickly to these new pricing pressures.

At the same time, IBM could be forced to lower the target price of its Postscript printer which, at the time of writing, is still under wraps.

In the meantime, Hewlett-Packard (which recently announced support for Postscript) may find it necessary, because of these lower OEM prices, to deal directly with Adobe instead of sub-leasing a printer from QMS, as has been widely speculated.

Adobe has been charging a standard \$200,000 OEM entry fee, plus a hefty royalty tied to each laser printer with Postscript on the system. As a result, the prices of the Postscript printers have stayed high.

But, the new, lower prices reflect the pressure which Adobe is under from the Postscript clones that are being announced almost daily.

Adobe's most formidable opponent seems to be Phoenix Technologies. Rumour has it that this company, known primarily for its PC-clone BIOS software, will produce a Postscript clone superior to Adobe's.

Although this is bad news for Adobe, it is great news for consumers. Within 12 months, we could see Postscript, or Postscript-compatible, printers as low as \$2495.

## Email system offers vastly improved comms service

Electronic mail (email for short) is rapidly becoming a prime area in American business, but it has also created some real frustrations for those who use it. One of the biggest problems with email is that you may subscribe to one service, while the person to whom you want to send a message is on another service.

To allow users of different email services to communicate with each other, DA Systems of

Campbell, California, has introduced DASnet. DASnet allows the exchange of email between the users of most of the major US systems and some foreign systems.

DASnet currently links the following email systems, conference systems and networks: Arpanet, AT&T mail, Bitnet, DCMETA, Dialcom, EIES, EasyLink, MCI Mail, NWI, PeaceNet/Econet, Portal Communications, The Source, Telex, TWICS (Japan), Unison, UUCP and The Well.

For individuals the charges comprise \$4.50 per month, a \$33.50 signing-on fee, and usage fees on both mail systems. (For example, sending 200 words from Bitnet to The Source would cost 59 cents in usage fees.)

This new service is long overdue and could be the catalyst for the serious advancement of email in the US.

Further information can be obtained from DA Systems in California on (408) 559 7434.

## Sony is on the move with portable video system

As a constant traveller who often finds himself stranded in airplanes and hotels, I have fantasised about a combination TV and VCR which I could pack into my briefcase and carry with me wherever I go.

I could watch a colour VCR tape even while hurrying through an airport terminal or while standing in a queue waiting to buy tickets, if I so desired.

Word is just beginning to leak from Japan that Sony is

actually showing a device like this to selected dealers, and could have it on the market by January 1988.

Called the Personal Video, it is about twice the size of a standard Sony Walkman, uses 8mm video tapes that are the size of audio cassettes, and has a built-in 5in TV screen which will have an improved flat-panel, liquid crystal display. It will use conventional NiCad batteries, and can be recharged to give four hours of use.

The Personal Video is expected to cost between \$1000 and \$1500.

Although Sony does not plan to launch this combined unit until next year, it will have, by the end of this year, the first product in its 'Personal Video' line. This will be a plug-in VCR and TV unit which has been designed for busy desks and kitchens. It will use Sony's standard 5in Trinitron tube and is expected to cost less than \$1500.

# THE WEST COAST CONNECTION

## IBM consolidates its lead position with PS/2 range

In early June, two major US publications printed stories which claimed that the IBM PS/2 computers had met with real market resistance and, as a result, were not selling well.

Even though the PS/2 had only been on the market for about two months, the articles cited unnamed sources who claimed that these new PCs were moving slowly through retail channels and that the demand was low. Financial analysts on Wall Street heard this news and became edgy about their position on IBM's stock and earnings.

By mid-June, IBM decided it was time to bring out the big guns and let the world know that the PS/2 was alive and well, and that the company was selling PCs at a greater rate than at any other time in the history of the IBM PC.

This move by IBM came at a time when the market in general is experiencing some confusion over the PS/2.

Industry analysts and observers alike hailed the machine's technology as leading-edge material, but have questioned IBM's drastic change in direction. The company's XT and AT models are still selling well, but, according to Bill Lowe, president of ESD at IBM, both machines will be phased out by the end of the year.

At an emergency securities analyst meeting in June, IBM claimed that it had already shipped over 250,000 PS/2 systems, and that it had back orders of over 500,000 at the time of writing (mid-July).

IBM claims to be making 2000 Model 30s, 1000 Model 50s and 800 Model 60s each day, and is about to add another manufacturing facility to accommodate demand.

Although some dealer channels are still suspect of the PS/2 line, this statement from IBM about early demand signals a very important market direction, and spells more trouble for clone manufacturers than they expected.

One research firm has stated that over 50 per cent of corporate customers which it contacted, claim that they plan to standardise on the PS/2 line within the next 12 months. And, this same firm has shown that even the Model 30 is selling well — although much of this is due



Workstation of the future: the IBM Personal System/2 Model 60 with colour monitor and an IBM 5202

to major price cuts at dealer level.

This means that IBM, even with its drastic move to specifically provide power that only a typical mainframe or minicomputer company could even want or understand, looked into the future and determined that the specification of the PS/2 would eventually be the minimum configuration the market will demand.

By using this proprietary technology as a base, IBM can continue to expand the PS/2's power and functionality; and, even if someone legally clones the machine, the company still

has so many other tricks up its sleeve to add to this base, that it could keep clone companies chasing it for years.

Although Compaq and most of the other clone companies will continue to tout the fact that OS/2 will continue to work on existing ATs — and there are still over 10 million of these machines in use — IBM's PS/2 will evolve into a standard much faster than was originally anticipated.

From discussions with companies such as Chips and Technologies and Phoenix Software, it looks as though the demand for true PS/2

compatibility is the top priority in most clone manufacturers' minds. And, you can bet that if corporations standardise around the PS/2 power quickly, it will become a 'do or die' problem for these clone manufacturers.

How soon can the PS/2 be cloned?

Industry observers expect to see the first versions of these micro-channel clones by November. But, even if the manufacturers succeed, the first boards will have to withstand immediate legal action from IBM: the company will force the courts to move on this before any other clone makers could have their products available.

IBM's legal department has told some clone manufacturers that they can submit their own versions of the micro-channel architecture to see if any patents or copyrights have been violated. The company has hinted that anything which is violated may be subject to IBM consideration to license it.

But, IBM could use this measure to stall anyone from legally having a similar machine until its own machines were well established, and it didn't feel pressure from the competition.

It seems that IBM's all-knowing powers have peered into the future and pulled off an interesting feat by giving the market what it will need — and has caused the rest of the pack to keep on with the chase.

If you, for even a moment, thought that IBM could lose ground with the PS/2, think again!

## Integrated file management software: take two

A new concept in integrated software is currently being developed.

When you hear the term 'integrated software', you expect to see a database, a spreadsheet and a word processor, at the very least. But this term is beginning to apply to the world of utility software as well.

A Washington DC company, US Software (USS), has just launched a new product called TakeTwo Manager.

The original TakeTwo product was rated as one of the best in the area of disk back-up. But, according to

Steve Hicks, president of USS, he was constantly reminded about other needs that transpired as a result of saving and managing the data on a disk. So, he coined the term 'integrated file management', and produced a program which provides a range of features for the same price as one of the better disk back-up programs alone.

TakeTwo Manager gives you automatic back-up. It also has a full, pop-up file manager, with which you can scroll through a list of files and perform functions such as 'Rename', 'Delete', 'Copy',

'Find', 'PEEK' and 'OOPs!' (the OOPs! feature is an undelete and has much of the same features as the Norton Utilities).

You can scroll through a tree-structured list of directories, and you can rename, create, remove and even add a memo to each of your files with the 'As Noted' feature.

TakeTwo Manager also includes a report facility, so you can print reports of your system and file configurations, plus your back-up history. It costs \$139. USS can be contacted on (703) 556 0007.

END



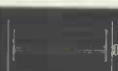

**MULTI-USER SYSTEMS**

**DESK TOP PUBLISHING**

**ON SITE TRAINING**

**ON SITE SERVICING**

**AFTER SALES SUPPORT**

**CALL FOR A PRICE  
AND GET  
PROFESSIONAL ADVICE  
(0280) 816087**



Visit our demonstration showroom and see the complete Apricot range including the Xen multi-user system.

Also see Apricot's high performance Desk Top publishing system incorporating Aldus PageMaker and both the Kyocera and the Apple Laserwriter Plus printers.

Bristle Hill Buckingham  
Bucks MK18 1EZ  
**(0280) 816087**



 **apricot**

**Panasonic**  
Office Automation 

**EPSON**

**Amstrad**

**FRASER**  
Associates Limited

**For under £5,000\***  
A new A1 plotter including stand

**THE  
DPX 3300**

1985 - A3  
1986 - A2  
1987 - A1

**The Roland DG  
Plotter Range Grows!**

A choice of 6 plotters from  
A3-A1 with full supporting range  
of Cables, Paper, Film and Pens.

**PLUS** optional maintenance  
contract through  
**olivetti CES**



\*£4,800 + VAT

**Roland** 

983 Great West Road, Brentford, Middx. TW8 9DN  
Telephone: 01-568 4578 Fax: (01)8471528 Telex: 934470

A B R I T I S H B R O A D C A S T I N G C O R P O R A T

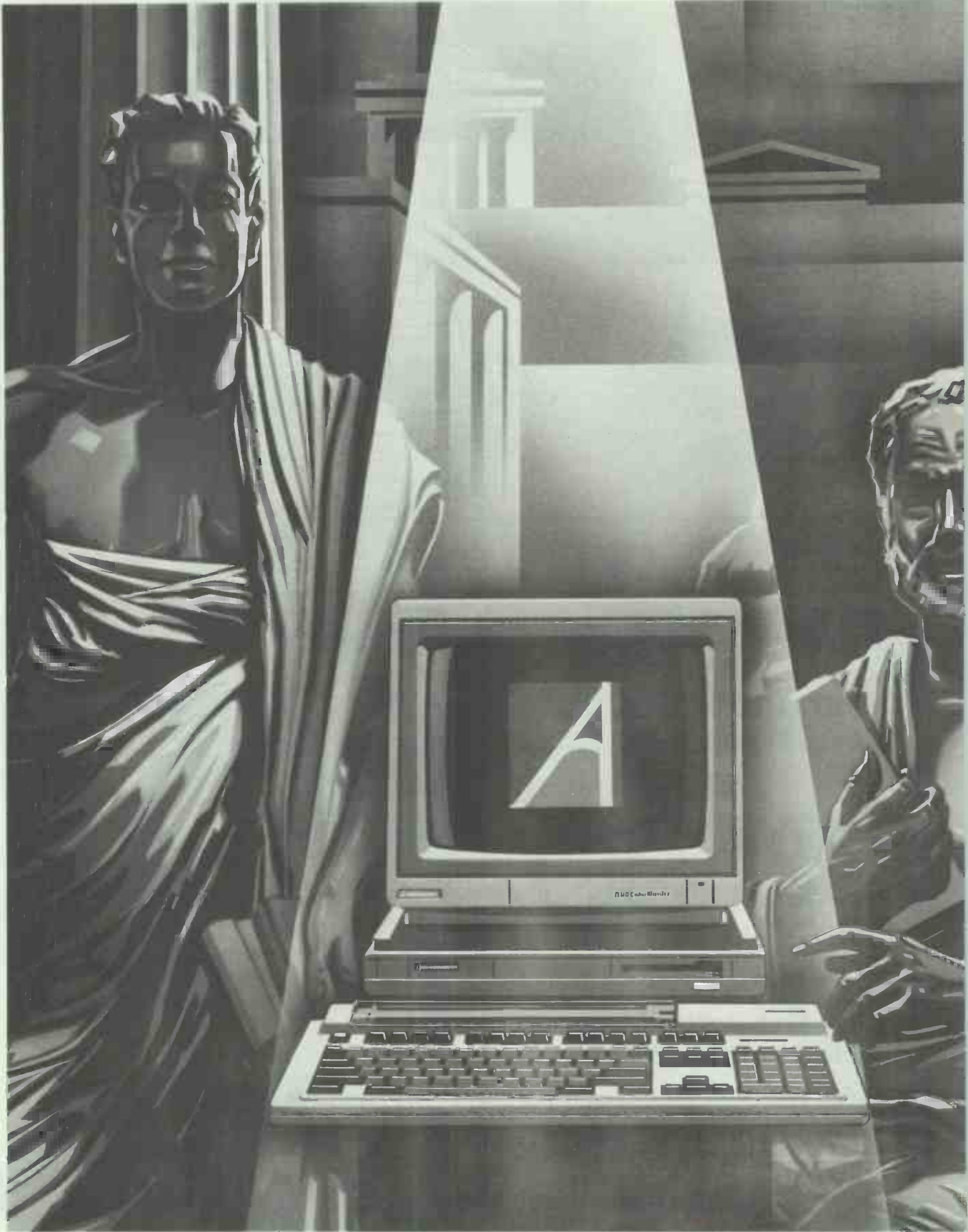

ARCHIMEDES 305 SHOWN HERE TOGETHER WITH COLOUR MONITOR. DISC DRIVE AND MOUSE COSTS £999 EXCLUDING VAT. DISCOUNTS ARE AVAILABLE TO EDUCATIONAL ESTABLISHMENTS FOR VOLUME PURCHASES

N M I C R O C O M P U T E R



\*MS-DOS IS A TRADE MARK OF MICROSOFT CORPORATION ARCHIMEDES IS A TRADE MARK OF ACORN COMPUTERS LTD.

# HAIL ARCHIMEDES

△  
FASTEST  
OF ALL  
MICROS  
▲

▷ Acorn are proud to announce the fastest micros in the world ▷ The Archimedes High Performance Computer Systems ▷ Using a 32 bit RISC chip, Archimedes represents a breakthrough in microprocessing technology allowing a new order of magnitude in power ▷ Power to run programs in BBC Basic that outperform those in assembler code on rival machines ▷ Power to deliver 6502 and MS-DOS\* emulation and high level languages such as C and FORTRAN ▷ Power to provide sound of digital stereo quality and graphics that have to be seen to be believed ▷ The Archimedes High Performance Computer Systems start at £799 excluding VAT ▷ To find out more ask your dealer or ring 01-200 0200 for an information pack ◀

**Acorn**  
The choice of experience

MACHINE	LANG	INTMATH	REALMATH	TRIGLOG	TEXTSCAN	GRAPHSCRN	STORE	NOTES (1) 300 SERIES ARE ACORN MEASUREMENTS USING PCW ALGORITHMS
ARCHIMEDES	BBC BASIC	0.26	0.39	1.03	4.3	4.5	4.5	ALL OTHER FIGURES ARE TAKEN FROM PCW REPORTS (2) ENTRIES WITH AN ASTERISK UNDER STORE WERE NOT AVAILABLE FOR FLOPPY DRIVES
IBM PC	GW BASIC	0.99	1.05	3.09	35.9	48.5	*	
IBM Model 50	BASIC	1.1	2.04	12.5	28.0	7.93	10.7	
IBM Model 50	BASIC	2.6	2.4	15.4	16.3	14.1	17.4	
IBM PC	BASIC A	6.2	6.2	47.0	100.0	49.0	*	
AMIGA 2000	AMIGA BASIC	1.2	2.2	6.7	150.3	25.0	37.7	
OLIVETTI 486	BASIC	2.1	2.0	15.0	38.4	11.8	*	
ATARI ST	ST BASIC	1.5	3.5	7.0	44.8	22.7	36.0	
MASTER 128	BBC BASIC	3.5	4.3	49.0	14.2	22.0	16.8	
COMPAQ 186	GW BASIC	1.0	0.4	3.85	25.5	4.8	*	

A R C H I M E D E S

AVAILABLE FOR AMSTRAD PC1512

AVAILABLE FOR IBM COMPATIBLES\*



12 Programmable Function Keys

Extra-size Keys where you need them

Separate Numeric Pad

Made in the UK

2 Alt and Control Keys

Dedicated Cursor and Function Pad



OUR UTILITIES SOFTWARE AVAILABLE FOR ONLY £24.99 WHEN ORDERED WITH A DASHBOARD

Just about everybody agrees that using an "enhanced" keyboard is a great improvement. But it can also be a great expense - and if your investment has gone into AMSTRAD PC1512\* machines it will also prove a great difficulty.

At ELECTRONE we decided to do something about all this and set out to produce the DASHBOARD. It is reasonably priced, comes in two versions - one to fit the AMSTRAD port and one to fit the IBM† standard port (which means it will work with most industry standard machines available).

But there's more. Like all our keyboards, the DASHBOARD is "soft," which means that if you buy our easy-to-use DASHBOARD UTILITIES Software you can dedicate keys to perform selected tasks whenever you want.

Consider the possibilities. Whole macros at the touch of a button (even if your software doesn't have a facility for macros), regularly used sentences, paragraphs or whatever, again at the touch of a button - then there's all

those hard to remember printer control codes, you can store those on whichever keys you want, if you're writing software you can even store mini programs on a button.

The potential is virtually limitless, because you can use each key in all its modes and you can change the whole keyboard configuration according to what you are doing.

So, if you want to enhance your machine with something a bit more meaningful we suggest that you fit a new DASHBOARD and for extra acceleration, install our DASHBOARD UTILITIES and really start motoring.

Electrone

† Copyright IBM Corp. \* Trademark of Amstrad Consumer Electronics Plc \*\* IBM Compatible must have standard keyboard port

# OUR NEW DASHBOARD MAKES YOUR MACHINE EVEN FASTER

Electrone Ltd. Haywood House, High Street, Pinner, Middlesex HA5 5QA Telephone: 01-429 2433

# LETTERS



## Anyone got a spare PC?

I have seen an ad which offers a free IBM PC-compatible to anyone who bought an AT-compatible. If any PCW staff member did buy an AT and hasn't any need for their PC, could I have it?

Seriously, I've noticed an increase in PC-compatibles in the £400-£500 price bracket. As Atari STs and Commodore Amigas — also in this price bracket — are more powerful and have better graphics, will we see PC prices fall even further?  
**Jason Palmer, Huddersfield**

*What do you mean, a member of staff buy a computer?*

## Excellence in reading matter

In his article 'Working to rule' (PCW, June) Jack Weber uses Microsoft's Excel spreadsheet-cum-programming system for the Macintosh to illustrate very pleasingly the art of rule induction, whereby executable decision rules are semi-automatically generated from example decision data. He mentions the original CLS (Concept Learning System) of Earl Hunt; JR Quinlan's development of this algorithm, known as ID3; and also my company's commercial program, Expert-Ease, which embodies the ACLS (Analog Concept Learning System) extension. (The latter was introduced by Andrew Blake of Edinburgh University to cope with numerical attributes in addition to logical ones.)

Since it is clearly Jack

*This is the chance to air your views — send your letters or contact us on Telecom Gold 83: VNU200. The address to write to is: Letters, Personal Computer World, 32-34 Broadwick St, London W1A 2HG. Please be as brief as possible and add 'not for publication' if your letter is to be kept private.*

Weber's intention to encourage readers in a serious approach, it seems a pity that his 'Further reading' section does not include references to these contributions.

The following are some original sources:

**For CLS:**  
*Experiments in Induction* by EB Hunt, J Marin and PT Stone (Academic Press, New York 1966)

**For ID3:**  
*Discovering rules by induction from large collections of examples* by JR Quinlan, in *Expert Systems in the Microelectronic Age* (ed D Michie, Edinburgh University Press)

**For ACLS:**  
*ACLS User Manual* by A Paterson, T Niblett and A Shapiro (Intelligent Terminals Ltd, Glasgow: 1983)

**For Expert-Ease:**  
*Expert-Ease User Manual* by R McLaren (Intelligent Terminals Ltd, Glasgow 1983)

Statistically-minded readers will also find much interesting material, particularly on the treatment of error, in *Classification and Regression Trees* by L Breiman and colleagues (Wadsworth Int Group, Belmont, California 1983)  
**Professor Donald Michie, technical director, Intelligent Terminals Ltd, Glasgow**

*Thanks for the information, and we're pleased to have you among our readers.*

## It pays to advertise

I appreciated your flattering comments in the 'ChipChat' column of the July issue of PCW, in which you focused attention on the great success of Tandem's TV advertising campaign.

However, you made one small error, and that is to assume that the cycle race

featured in the ad was sponsored by Apple Computers.

It is indeed true that Apple's logo was clearly positioned on the cyclist's shirt because a selection of major worldwide customers were exhibited there. Apple uses large Tandem computer systems in its factories to monitor and control its manufacturing program. That a major international supplier of small computer systems should select Tandem for this key activity is, of course, flattering, but from an advertising viewpoint it does help to position our products as large computer systems if we highlight Apple as a major user of Tandem computers.

I hope this clears up any confusion.  
**Mike Lambert, UK marketing manager, Tandem Computers, Northolt, Middlesex**

*You bet it does.*

## Déjà vue for Big Blue?

I was interested in Martin Banks' article, 'Fond farewell' (PCW, July). Twenty-five years ago the British motorcycle industry tried to compete with the newly-introduced Japanese 'scooterettes'. It failed, withdrew, and announced various middle-sized motorcycles of advanced design to replace the ageing designs it was trying to sell to those who wanted more power.

But hardly anyone bought British middle-sized bikes. Instead, they chose the scooterette manufacturers' increasingly powerful offerings. Similarly, why buy IBM's offerings if Amstrad or Atari can develop their models as customers' needs grow?

Brand loyalty among corporate purchasers has served IBM well. But, when the majority of PCs are bought by personal

purchasers, brand loyalty will favour those who stay in the personal computer market.

Perhaps the 'Fond farewell' is not just to IBM's personal computers but, like British motorcycles, to 'Big Blue'. The 'inconceivable' has happened before.

**John R Hudson, Huddersfield**

*As an unashamed Japanese-bike rider, I must say that I barely shed a tear for the British bike industry. The Japanese had a world market view (and world market level of sales as a result) which enabled them to pour vast sums of money into R&D. IBM is in the same position, and its sales worldwide show that it can keep one step ahead of the market.*

*Fortunately, British computer manufacturers such as Apricot and Research Machines have been able to produce high-performance machines that aren't handicapped by the prestige price tags which later British bikes suffered.*

## Verbal overkill promises nothing

I am becoming thoroughly sick and tired of reading in the computer press the recent airings of some software houses, prognosticating their intention, 'at some future date', of releasing software which will do this, that and, more than likely, the other as well.

The industry has coined a choice expression for this indecision — 'vapourware'.

Companies which, a year or two ago, would not have dreamed of dropping a whiff, inkling or hint of their development plans, are now falling over themselves to proclaim to the world what they are going to release *mañana*.

Witness the recent ballyhoo over Lotus' carefully stage-managed leak regarding the LAN version of 1-2-3, and the company's subsequent red-faced

admission that this launch was being pushed back to the Autumn.

Notwithstanding that little episode, we have been entertained recently with more prophetic verbalisations from the software industry's most famous and persistent litigant. Support for VGA and OS/2, 3½in media, a mainframe version of 1-2-3 and a DBMS have all been promised definitely ... sometime in the future ... probably.

Never before has so much vapourware been released into the atmosphere at one sitting. One can only surmise that the PR pundits at Lotus have been feeding on an exclusive diet of curry, sultanas, radishes and lager recently.

What is the reason behind all this huffing and puffing? Could it be the old wile of keeping the opposition at bay while you buy time to grind your own development effort into top gear? We should be told.

I would lay myself open to a charge of false modesty if I failed to mention that SuperCalc 4 has supported all major LANs for the last three months; is supplied on both 5¼in and 3½in media at no extra cost; was demonstrated by IBM at its launch of PS/2, running with IBM's new VGA; and has a big brother — SuperCalc/MF, currently the biggest-selling mainframe spreadsheet in the world.

Needless to say, not one of these developments was pre-announced by Computer Associates.

**Tony Beken, manager, Micro Products Division, Computer Associates, Slough**

## Taking technology too far

My initiation into computers involved bashing out punch cards which I never quite learned to read reliably, and waiting two days for a short (twelve-page) printout which could best be summarised as 'Program crash on line 20'. (Notice the helpful addition of a line number which was probably a facility added by a mad, hacker student.)

The new, cheap PC-compatibles have produced lots of new users who know nothing of computing, and

are able to jump direct to the very high-level interpretative languages of, say, Word-Perfect, Lotus 1-2-3 or GEM Basic.

But while there is a market being served here, the computer user base is becoming complacent and — in some 'yuppie' quarters — arrogant about its understanding of computers.

GEM and Windows may be blatantly annoying both to use and to program within, but I fear they are the punch card of tomorrow's computing. Soon, the user interface programmer will become more important than the researching, register-juggling and generally innovative in-house subroutine/utility programmer.

Sure — the world will end up with lots of slow, unimaginative, beautifully packaged, over-hyped, mindlessly over-graphic, intentionally incompatible total office environments. In response, the manufacturers will have to make faster and faster machines in order to get these programs up to a sensible speed.

I'm not sure who will benefit in the long run. But, when I am woken up with a cup of tea and a digitally-synthesised 'Good Morning!' from my 25GHz, 1024-bit, 804586 Motorintel-based IBM clone, I will still be worried that, if I add just one more background utility, I'll use up my last gigabyte of memory; or I might drop my terabyte holographic optical disc down a crack in the floorboards and never find it again.

**Will Roberts, Guildford, Surrey**

*Floorboards! Luxury.*

*But seriously, do we really want everyone to re-invent the wheel before we let them drive a car? How many people would have persevered with using their Amstrad 1512s if it weren't for their initial handholding under GEM?*

*Surely, as with most things, there is the lazy way of doing something and the creative way. As long as we continue to see windowing as a burden, we'll keep re-inventing the Mac desktop.*

*Once we make windowing our slave rather than our master, we can start adding those little extra touches — just like your hacker student friend with his line numbers.*

## The wrong accent



I find Amstrad's attitude towards its customers very strange indeed.

I bought a PCW8512 with a French manual and software and an 'AZERTY' keyboard. As I am in fact a native English speaker, I thought the English manual and software would be easier for me to learn with, and, therefore, wrote to Amstrad which referred me to its spares and service department in Shoeburyness.

Seven weeks later, I received the manual for the Amstrad CPC464 and a 'Welcome to Amsoft' cassette. Also included was a *pro forma* invoice for the Locoscript disk and manual which I had previously ordered and paid for.

It has taken me six months and many letters to obtain this disk and manual.

Later on I saw an ad for Locospell and, being a forgiving soul, wrote again to Amstrad asking if Locospell would work on an AZERTY keyboard.

The reply stated that Locospell would work on an AZERTY keyboard (Locoscript itself doesn't) but 'it will not recognise any French accents you may wish to use.'

Quite why I would want to use an English spelling-checker on French text is beyond me, and I certainly don't know of many English words with accents.

**Philippe Achener, Pauillac, France**

*Plus ça change ...*

## Don't blink, you'll miss it

If you bought a car, you'd expect parts to be available for some time after the model had been discontinued, wouldn't you? How long, though? Three years? Five? A decade, perhaps? If you buy a computer, it seems the answer to this same question is five minutes.

I bought an IBM PC about 30 months ago, at a time when clones were only just a whisker cheaper than the real thing. It worked fine until a week ago, when the space bar ceased to function.

I rang my friendly dealer/repair man, who told me that a repair 'wasn't economic' and recommended a replacement. I asked him to get me an IBM keyboard, even at the mind-boggling price of £140, because: (a) I like the feel of the keys; (b) I'm familiar with the key positions; (c) I have function key templates that fit the IBM; and (d) I use the machine very heavily — I'm a journalist.

I have now learned that IBM has discontinued the PC/XT keyboard, and that further supplies are unavailable. Since I need to use a computer daily, I have been forced to buy a clone keyboard that is unsatisfactory for the four reasons outlined above.

I don't really subscribe to the 'IBM Conspiracy' theory, but to me, this artificially-generated obsolescence looks like an attempt to force PC users to 'upgrade' to a new product that they don't necessarily need.

**Richard Platt, London N16**

*While currently in short supply, PC keyboards are still available from IBM (the company says). Perhaps it was your dealer who was trying to encourage you to upgrade.*

## Election plea

Now that the General Election is over and done with, I would like to know if anyone supplies, or has written, software to help political parties run their local election campaigns.

**Nicholas Gregory, 3 Triangle Road, Haywards Heath, W Sussex RH16 4HN**

END



£3



£2

# Which Fish?

Whatever you're buying, you can often end up paying over the odds. Identical products can vary in price dramatically, depending on where you cast your net. This was never more true than in today's computer hardware market. • At Kudos we aim to make your fishing easy. Our company policy is to supply top quality peripherals and IBM AT compatibles at the best prices you'll find. For instance, the KudosRAM 128 memory upgrade at £19.95 plus VAT is one third less than you could pay elsewhere. • Below you can see a few of the products in our range – all priced lower than you'd expect. • All products are available from stock and carry our 12 month 'no-quibble' guarantee. • If you want to order or just find out more then complete the coupon or ring 01-200 6511. • But before you do, check out the competition – we know you will come back to Kudos.

### 1 Kudos HarDisk 30 – £299 (ex. VAT)

Transform the way you work with your micro with the complete 30MB hard disk upgrade for your Amstrad PC or IBM compatible. The Kudos HarDisk 30 has the massive storage capacity of over 80 floppy disks. The package includes – Seagate ST238 hard disk (65-85ms access time, power consumption is under 15w), Western Digital half size controller card, manual, cables and utility disk. For Amstrad owners a mounting kit and modified, colour coded bezel are included in the package at no extra cost. The Kudos HarDisk 30 is easy to install, however, we can install it in your micro for £29.50 (ex. VAT)

### 3 Stradcom Modem – £159 (ex. VAT)

A BT approved 1200/1200 Full Duplex (V21-22) intelligent modem with full Hayes compatibility, auto dial, auto-redial, auto dial directory, auto answer, pulse, tone or auto sense dialing. Free registration to Easylink worth £40.00. Async software is included with Prestel mode. Plug in and talk to the world.

### 6 8087-2 Maths Co-Processor for PC1512 – £149 (ex. VAT)

A cost effective way of speeding up maths intensive applications by 500%. Suitable for use with Lotus, Supercalc, Turbo, Pascal, etc. The package comes complete with full instructions and software.

### 7 Amstrad PC1512 + HarDisk 30 + Colour Monitor – £949 (ex. VAT)

The best selling PC compatible now available with the best selling Kudos HarDisk 30. The package comes complete with mouse, bundled software and full 12 month warranty. Maintenance contracts are also available. Mono monitor version also available at £749 (ex. VAT).

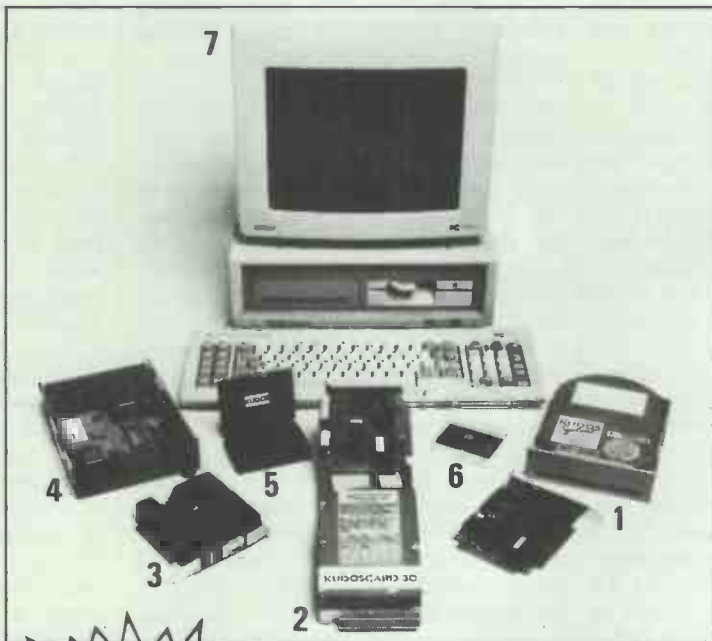

### 2 KudosCard 30 – £299 (ex. VAT)

The KudosCard 30 is ideal for PC owners that have dual floppy disk drives and want to retain their second floppy. Its rugged design includes a shock suspension system which allows it to cope with shocks up to 60g, making it ideal for portables too! The card takes up the space of 1.5 slots, just plug in and go. The card comprises: Miniscribe 3/5 drive (65ms access time, ultra low power consumption under 14w) Western Digital controller card, manuals and software.

### 4 Everex Excel Stream 20 (Internal) – £547 (ex. VAT)

Chosen by top corporations and recognised as one of the most powerful tape streamers available. All Everex Streamers have the following powerful features – 5MB per minute back-up speed; tape does not require preformatting; context sensitive help windows; scheduler program for unattended back-up; 60MB, 120MB, internal and external models available as well as newly released Apple version.

### 5 KudosRAM 128 – £19.95 (ex. VAT)

Upgrade your Amstrad PC1512 to a maximum of 640K. 150NS memory IC's ensure optimum performance and cool running. Easy and quick to install with full instructions.

"AMSTRAD 1640'S AVAILABLE NOW WITH 20Mb DRIVE – £1099 (exc VAT)"

If you're a government department, education authority or PLC, just send us an official order and your goods will be despatched on the same day. If you're a corporation and would like details of our on site demonstration scheme call Gary Munz on 01-200 6511.

Kudos Systems Ltd  
72 Capitol Way  
Edgware Road  
LONDON  
NW9 0EW  
Tel: 01-200 6511  
TLX: 8813241  
Fax: 01-205 3911

Personal Callers Welcome – Call in and save on delivery charges.

To Kudos Systems Ltd, Capitol House, Edgware Road, London NW9 0ED

Please send me your latest information pack

Please rush me the following products:

_____ (Qty)	Kudos HarDisk 30	£357.65
_____ (Qty)	KudosCard 30	£357.65
_____ (Qty)	KudosRam 128	£26.39
_____ (Qty)	Everex Excel Stream 20	£642.85
_____ (Qty)	8087-2 Maths Co-Processor	£174.80
_____ (Qty)	Stradcom Modem	£194.35
_____ (Qty)	Amstrad PC1512 + 30MB Colour	£1108.60
_____ (Qty)	Amstrad PC1512 + 30MB Mono	£878.60

★ Prices include VAT and Carriage.

TOTAL \_\_\_\_\_

I enclose a cheque for \_\_\_\_\_

or debit my Visa Card Number \_\_\_\_\_

Name \_\_\_\_\_

Company \_\_\_\_\_

Address \_\_\_\_\_

Postcode \_\_\_\_\_

Approx No. of PC's in Company \_\_\_\_\_

**KUDOS**  
*Systems*  
LIMITED



All tradenames and product names are the property of their respective manufacturers/owners.



## BANKS' STATEMENT

# Dressing up

*Martin Banks has been thinking long and 'painfully' hard about the 'flexibility' or not of our computer systems — and finds that it all boils down to 'the same thing'.*

For reasons that are quite beyond me and my acumen with anything numerical, I was recently sent a copy of the *Economic Progress Report* from HM Treasury. That organisation claims to be good with numbers in a way that is diametrically opposed to my own avowed skills with the damned things. And the *Progress Report* is a cunning device to try and prove the point beyond doubt.

As I don't really understand any of it anyway, there was little point in sending me a copy: it was all graphs, statistics and bar charts (funny, I had always thought that a bar chart was a map of the pubs of Central London). Still, I studied the *Report's* contents 'personfully' for ... well ... thirty-five seconds at least, but there was no hope; it was full of gibberish which proved conclusively that the nation was doing absolutely splendidly, or not, as the case may be.

In the end, I found the whole thing fairly depressing reading, but then a thought struck me. (I ducked too late and it caught me right between the eyes. Which was unfortunate, for it took me a second or two to see what the thought had been driving at.) If I didn't understand a word or graph of what was in the *Report*, why did I find it depressing? I have never been one to want to be a smart-ass at things numerical, so it seemed an odd reaction on my part.

The answer appeared at the top of the *Report*, where it was stated that the thing had been reproduced by a well-known combination of snazzy word processor and pretty-pictures graph-producer. That was it; how could I have missed it before? The thing was dull beyond belief; not just in content — that goes without saying — but it was also excruciatingly 'dull' to look at.

It has come to my attention over the last six months or so that there is something happening to the world of the published written word. That something is the combination of the laser printer with a desktop publishing set-up of some description, be it the grandest all-bells-and-

whistles package, or a straight word processor (which some dirty dealer *might* try and pass off as a DTP system). The 'thing' in question can be broadly categorised as 'the same'. It doesn't seem to matter what DTP system is used or what make or type of laser printer. Everything comes out looking 'the same' as everything else that comes out of a desktop publishing system and laser printer.

There are two possible reasons for this, one of which I must admit to finding quite disturbing. The first, and not so disturbing one, is that nobody yet really understands how to use the things. This is quite possible, for the packages are designed to bring all the arts and crafts of publishing and layout to the average individual, and the average individual is not necessarily going to be any good at all at being 'arty' and 'crafty'.

The *more* disturbing possibility, however, fits into a horrid little theory that has been growing in my brain over the last year or so. You can call it paranoia if you like — go on, you know you're dying to — but I am becoming slightly suspicious of some aspects of the application of computers to the real world. Desktop publishing is just one example. The manufacturers in their advertising and literature wax lyrical about the capabilities of their products. Even if they don't use the actual words, one is left with the distinct impression that one can achieve just about anything with these packages — and make information appear in any conceivable form.

Indeed, you can, if you are willing to pay the real price of having all the right gizmos built-in to make such things happen. But even then I suspect that it would not be possible to reproduce the work of a good artist and a real printer on any DTP and laser printer set-up.

Somehow, though, the word 'flexible' is often seen bandied about in computer advertisements; the actual effect of the application of computer technology, however, is to create an 'inflexible' uniformity. Like I say,

most DTP documents have a 'sameness' that is instantly recognisable.

My horrid little theory takes this idea a stage further. Wearing a different one of my many writing hats, I have recently been involved in scribing about factory automation systems. (I even got to see IBM's Personal System/2 Model 50 being made, but that's another story.)

In this work, another thought has struck me. (This time I didn't even bother ducking.) There are companies out there which are spending zillions of greenbacks on investments in automated manufacturing facilities. This makes it possible, or so they say, to be far more flexible in what they manufacture, as the machinery is clever enough to be quickly reprogrammed to make it.

True, but only up to a point. The machines can only manufacture what they are physically capable of handling. A car parts assembly line can only make things that are roughly the same size and shape as car parts, otherwise more massive investment is required to make the changeover. So, as the companies make their investment in 'flexibility', so they become increasingly inflexible. Having spent zillions on one line of automated manufacturing, they are honour and bank manager-bound to make sure it is utilised to the full.

That way leads inevitably to fewer innovations and new product developments, because such efforts might result in something that won't fit the production line; so it had better stick to something safe, and readily saleable.

To some extent, the results can be seen in our High Street shops already. You can buy plastic bomber jackets in 350 different shades of pink, but underneath they are all exactly the same. I fear that, with computers, the word 'flexibility' is doomed to become synonymous with your own 'personal choice' of the colour pink (from a palette of however many it is that graphics systems can now offer). It won't be allowed to mean much else. **END**



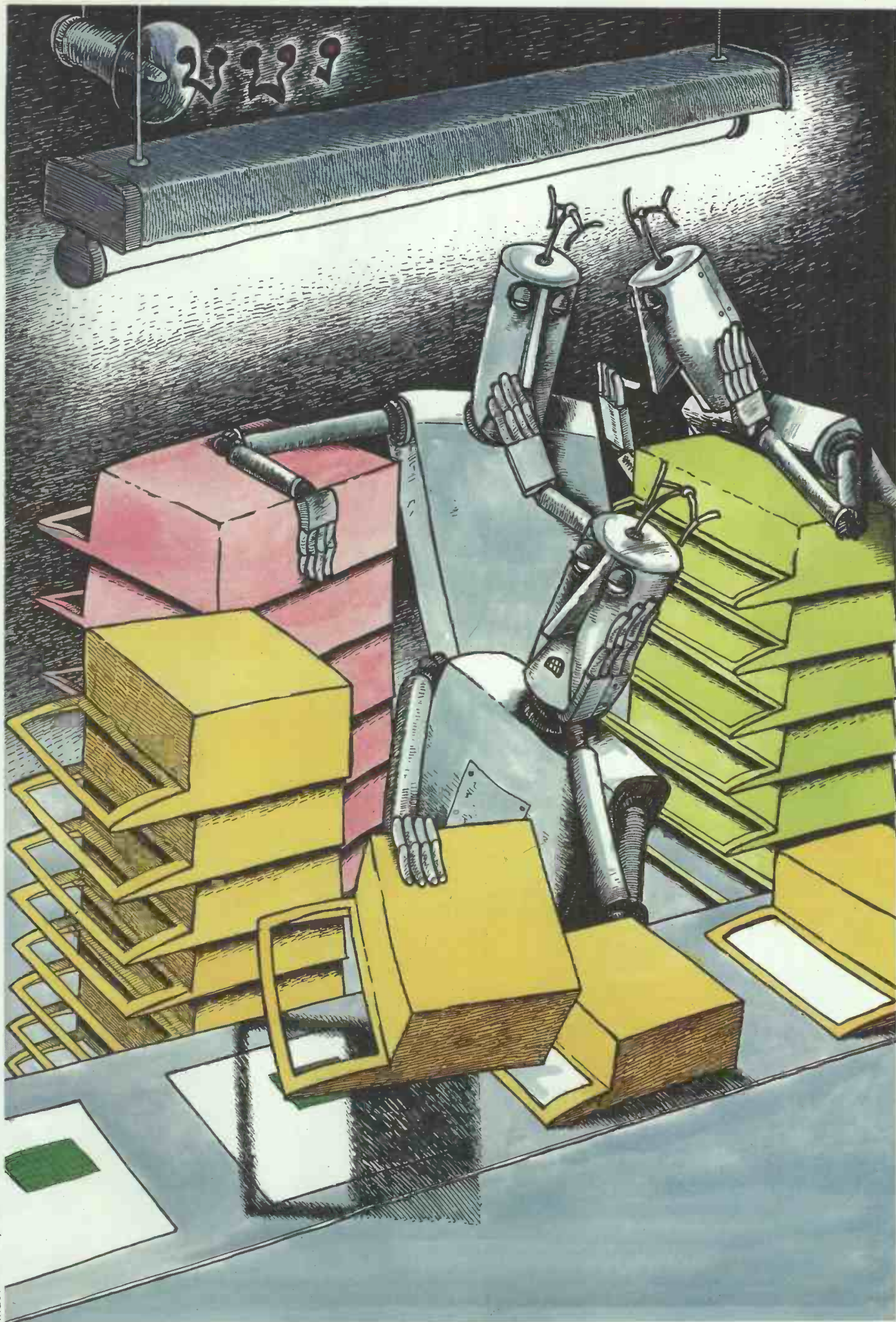

Illustration by Mark Hackett

# Two great prints the new Ep

A1 COMPUTER SUPPLIES  
224 Main Street, Croydon, Surrey

01-Epson LX800 Printer  
RRP [exc. VAT]..... £275.00

02-TOTAL..... £275.00

03-Cheque..... £275.00

04-Change..... £ 0.00

PLEASE CALL AGAIN  
001379 0006 1.32 09/05/87



EPSON

# outs you get with son LX800.

For the price on the left, you might not have expected any sort of business printer let alone an Epson.

But for only £275 RRP ex. VAT (or even less), you can buy the new LX800, which can produce superb-quality print like this ..... and like this. The LX800 has two correspondence-quality fonts built in (Roman and Sans Serif).

This is by no means the only outstanding feature of the LX800, however. In fact, it boasts a far higher spec than any other printer in its price range.

It is certainly very fast. In draft Elite, it can shoot along at 180 characters per second while in letter quality mode (at 10 cpi) it manages a respectable 25 cps.

Furthermore, changing between the different fonts is extremely simple. All you have to do is press a couple of buttons on the "Selectype" panel on the front of the machine.

The LX800 is very flexible in several ways. As well as having two correspondence modes, it can produce an enormous range of typestyles - even italics. It can also draw pies, graphs and charts.

A range of paper feed options is available - though a tractor-feed unit (previously an optional extra) is actually included in the price.

A variety of interface options means that the LX800 is compatible with any make of PC, and the IBM character set is built in as standard.

Also fitted as standard is a 3K buffer. This frees your computer for other tasks more quickly.

Of course, the LX800 is every bit as reliable as you would expect an Epson to be. Each pin in the print head can strike the paper at least 200 million times before it needs replacing.

Yet there's even more to tell about the LX800 than this. If you would like further information, simply print your personal details in the coupon below and return it to us today. (Alternatively, call up Prestel \*280# or ring 0800 289622 free of charge.)

-----  
Please send me information on the LX800 printer at once. (I am very much looking forward to its receipt.)

Name ..... Position .....  
Company ..... Address .....  
..... Tel No ..... BPW1

To: Epson (UK) LTD, Freepost, Birmingham, B37 5BR

# PC laptops

*The innovative supertwist LCD technology means that 'truly' portable computing is here at last. John Donaldson compares three 'cheap and cheerful' PC-compatible laptops which embody the state of the art.*

The micro business is full of good ideas that don't work. For the past three years one of these has been the idea of a battery-powered laptop computer which you can carry around with you and which has all the capability of a desktop micro. Certainly there have been no lack of laptop machines on the market, but unfortunately they have all had their shortcomings — either the LCD screen was too small, or they were mains-operated only which meant that you couldn't use them on the move.

About a year ago things started to change. A new 'supertwist' LCD screen was invented which was truly easy to read and, as a result, 'proper' laptops started to appear. Then the question changed from: 'Do they work?' to 'Are they worth the money?' Now even that criticism has been answered by the introduction of a new breed of useful and cheap laptop micros.

## Datavue Spark

Of the three companies represented here, Datavue is the least well-known. Its machines are distributed in this country by Quadram of PC 'add-on board' fame. The Spark is one of two new portable machines from the company; the other is called the Datavue Snap — and it is a far more upmarket machine.

On paper, at least, the Spark looks like it should offer very good value for money. The entry-level price of £895 buys you a machine with an NEC V20 processor, 384k of RAM, one 3½in 720k disk drive and an 80-column 25-line supertwist LCD display. However, before you get too impressed, life isn't as cheap as it may at first appear, because the price doesn't include the AC mains adaptor or any Ni-Cad batteries.

When it was delivered, my first impressions of the Spark were not good. One of the main things you expect from a portable computer is strength and durability and the casings of the Spark didn't exactly inspire me with confidence. The machine's outer casings are made out of lightweight, dark grey moulded plastic of the kind favoured by Commodore for a time with its Plus 4. This kind of plastic tends to be brittle and my hopes were not raised by a sticker on top of the main casing saying: 'CAUTION. Do not place any heavy objects on the machine. Excessive weight may destroy the floppy disk drives.' Not impressive.

## Hardware

The overall design of the Spark is fairly standard for a laptop of this type. The whole unit weighs about nine pounds and closed up should fit inside a large briefcase. In addition to the main unit, the Spark also needs an external mains adaptor. This provides power for the machine if you are not using batteries and trickle-charges the batteries if you have Ni-Cads installed. It connects to the main unit via four feet of lightweight twin core cable and a jack plug.

The mains unit is very compact and should fit into the briefcase alongside the Spark. One advantage is that the adaptor is auto-mains-sensing and can work on any mains voltage from 90 up to 264 volts. This could come in very handy if you plan to do a lot of international travelling.

The main unit contains all the elements of the computer: the keyboard, display, disk drives and I/O ports, with the display hinging down over the keyboard in normal laptop fashion to create a neat, portable unit. The machine comes complete with a pull-out handle.



PC laptops from left to right:

The disk drives live towards the rear of the machine, one along each side. The back panel houses a surprisingly large number of interface ports. From left to right they are: a reset button; a 9-pin RS232 port; RGB and composite monitor outputs; an IBM-style parallel printer port; and a connector for the optional 5¼in external IBM disk drive. The machine also comes with a blanked-off expansion port for adding yet-to-be-announced external add-ons. The rear left-hand corner of the machine also houses a blanking plate for the optional internal modem.

Usually it is very difficult to get inside a laptop because of the compact nature of the machine and the fact that most laptops house lots of CMOS electronics which could easily be zapped by prying fingers. Datavue, however, includes instructions on how to get inside the Spark. All you do is remove three screws and lever the top panel off. Once inside, you can't see much because everything is crammed so tightly together.



*the Sharp PC-4501A, the Datavue Spark and the Toshiba T1000— the technology finally catches up with the dream*

However, there are two small expansion slots: one for the internal modem, and one for a miniature 256k RAM card which brings the total RAM up to 640k.

The main processor in the Spark is an NEC V20 which is code-compatible with Intel's 8088 and 8086 processors. The Spark can run the processor either at 4.77MHz for true PC-compatibility or at a very creditable 9.54MHz to give the machine truly 'Sparkling' performance (*sic*). The machine also has a socket for an optional 8087 maths co-processor.

The machine is available with either one or two internal 3½in 720k floppy disk drives. However, the entrances to the drives are totally unguarded and there is nothing to stop dirt or old toffee wrappers getting into the drives and gumming them up. The machine is also available with an optional external 5¼in PC-compatible drive. This could be useful for downloading PC software and data; however, as IBM's PS/2 machines gain in popularity, the

need for a 5¼in drive should diminish.

When in use, the display hinges up to reveal the keyboard which actually feels nicer than it looks. As with all laptop keyboards, it is something of a compromise because of lack of space. However, the main qwerty typing section gets most of the space with the ten function keys running along the top of the keyboard. The main problems centre around the editing keys. The Spark starts off well by having a separate section for the four 'Cursor Control' keys and then goes and spoils it by putting the 'Insert' and 'Delete' keys miles away in the top right-hand corner of the unit.

The display is by far the most interesting section of the machine. In common with most modern laptops, it is an 80-column x 25-line supertwist LCD. These new supertwist screens are miles ahead of the older LCDs; they offer much higher contrast and are readable in most lighting conditions. For the ultimate in readability, an electroluminescent

(EL) backlit screen is available as an optional extra.

The Spark screen is mounted on a friction hinge which can be tilted at virtually any angle, although the review machine had quite a lot of play in the hinge which made it difficult to tilt the screen to the optimum viewing angle. Contrast can be altered via a small thumbwheel underneath the keyboard.

The Spark display is fully compatible with IBM CGA graphics and it can display either 320x200 or 640x200 graphics. Also, it is possible to hook up an IBM colour monitor to the RGB port on the rear of the machine and use the monitor as an alternative to the Spark's LCD display.

One of the most interesting aspects of the Spark's LCD display is that it works in colour. Because the LCD crystals are blue and the reflective background of the screen is yellow, the Spark somehow manages to produce four colours on the screen — bright blue, a couple of different shades of purple, and bright yellow.

# BENCHTEST

This can look very odd indeed; however, the Spark is also provided with a software utility which allows you to choose between different foreground and background shades until you find the one which is the most readable.

## Software

### Operating System

The Spark is claimed to be IBM-compatible and I could find little reason to doubt it. As standard, the machine is supplied with good old MS-DOS version 2.11. Because this version was not designed for 720k 3½in disk drives, Datavue has patched it so that it runs happily on the Spark.

Although MS-DOS version 2.11 is supplied with the machine, there could be advantages in going out and buying a copy of the new IBM PC-DOS version 3.3. (This version was released with the PS/2 machines and was designed specifically to work with 3½in disk drives like those used in the Spark.)

Also, as you will see later, there is some evidence that the Spark is more PC-compatible when it is running PC-DOS version 3.3 than when it is using its own MS-DOS version 2.11.

In addition to the usual operating system software, the Spark is supplied with its own disk-based diagnostics software and some ROM-based utility software.

The diagnostics routines are supplied on the master operating system disk and are called up by typing 'Diag' at the A> prompt. Using the diagnostics routines it is possible to check the CPU, the keyboard, the display unit, the floppy disk drives, the speaker, the printer port, the RS232 port and the onboard battery-backed clock.

When you first switch the machine on, the screen displays a list of the current system settings. If you want to change one of them, you have three seconds to hit a key and stop the machine from going into its boot-up procedure.

If you hit a key, the system asks you to press 'R' to reconfigure the system. Once you do this, you can work your way down the menu changing the system defaults. These will then be stored in battery-backed RAM and will remain in force until you change them again. Luckily, if you totally mess up the system, you can opt to return to the factory-set defaults and start again.

It is also possible to play around with most of the system settings while the machine is in the middle of an applications program by using a combination of the left shift, control

and letter keys. The main difference is that any changes you make at power-on are stored in battery-backed RAM while changes made with the keyboard are lost as soon as you switch the machine off.

The main key combination to remember is 'left shift', 'control', 'T'; this displays a list of all the keyboard commands on the screen. What follows will be a brief outline of the functions of the different commands. Instead of saying 'left shift' 'control' all the time I'll just list the appropriate letters. The '+' and '-' keys allow you to change the volume of the keyclick when you use the keyboard. Hitting 'D' allows you to make drive A into B and B into A.

None of this makes any sense until you realise that the Spark can only recognise drives A and B. If you have a twin-disk machine with an external 5¼in drive, you have three disks trying to be two logical drives. Datavue gets around this by allowing you to toggle logical drive B between the second internal drive and the external 5¼in drive.

Hitting 'S' allows you to change the colour palettes on the LCD display and 'I' allows you to invert the screen. If you have a backlight fitted to your display, 'O' allows you to switch it on and off. 'M' allows you to toggle between the internal LCD and an external monitor and 'B' allows you to check the battery level. Finally, 'F' allows you to toggle the processor speed between 4.77 and 9.54MHz.

One of the main compatibility problems for laptops at the moment is that they use 3½in disks and most IBM software is still only available on 5¼in disks. This doesn't have to be a problem because you can always copy the software across; the main problem is with copy-protected software which requires the original disk.

One very good test of compatibility is a public-domain game called Zaxxon which makes heavy demands on the display. When I first tried it on the Spark with MS-DOS 2.11 it nearly worked and then crashed. I then tried it under MS-DOS 3.2 which I happened to have lying around. This time it did worse than the first time. Finally, I tried it with PC-DOS 3.3 and suddenly Zaxxon ran perfectly. It all goes to show what a strange thing PC-compatibility is.

## Documentation

The review machine was supplied with a pre-production copy of the Spark owner's manual and an MS-DOS manual relating to another machine from the same company, the Datavue 25.

The preliminary Spark owner's

manual was laserprinted and ring-bound. The text was complete and I found everything easy to follow and easy to find. The final version should have screenshots and illustrations.

## Toshiba T1000

Of all the companies competing in the laptop market, Toshiba is probably the most successful. It now has a whole range of laptops stretching from the powerful and elegant T3100 down through the T1100 Plus to its newest machine, the T1000.

Each machine in the range addresses a different segment of the market. The T3100 uses a powerful Intel 80286 processor and a gas plasma display to produce an extremely powerful laptop micro. When this is combined with the all-black design of the casings, you have the ideal machine for people who are just as interested in looking flash as they are in raw computing power.

Up until now the T1100 has been the mainstay of the Toshiba laptop line. The original machine featured PC-style performance in a small neat package. The later T1100 Plus added a supertwist LCD screen for improved legibility.

The new T1000 fits in at the bottom of the range. It is competitively priced, but does not compete with the other two machines in terms of either processing power or storage capacity. It does, however, offer full PC-compatibility, a supertwist screen and a single 720k 3½in floppy disk drive.

## Hardware

Unlike the Datavue Spark, my first impressions of the T1000 were very favourable. It is very small, extremely light at only 6.4lbs and, above all, it feels very sturdy and reliable. All the casings are made out of strong, thick, cream-coloured plastic and the overall feel was of a very well-built machine.

The overall design is fairly standard; the front of the machine features a flip-up lid which holds the display and protects the keyboard when the machine is being carried around. The bottom of the casing features a small carrying handle which flips up when it is in use and then folds back flat against the underside of the casing when the machine is not being used.

The right side of the casing features a single 720k 3½in floppy disk drive. However, like the Spark, the drive on the T1000 is open to the elements and therefore susceptible to dust and dirt (and toffee wrappers!). The best idea for disk drives is the method used by the Zenith

Z181 where the disk drives are kept under the lid out of harm's way.

The left side of the casing houses a thumbwheel for adjusting the contrast of the LCD screen, a socket for the optional external numeric keypad, and a switch to select whether the optional external 5¼in floppy disk drive should appear to the operating system as drive A or B.

The rear panel of the T1000 offers exactly the same selection of I/O ports as the Spark. From left to right these are: a nine-way RS232 socket, a parallel printer port, a socket for the optional 5¼in external disk drive, and RGB and composite video outputs for connecting an IBM CGA-compatible monitor to the system.

The final two pieces of hardware on the back panel are the on/off switch and a socket for the 9-volt DC input. The T1000 is supplied with an external mains transformer, but unfortunately it will only accept 240-volt AC input. If you want to use the machine in a country which has a different mains voltage, you will have to buy another transformer.

The review machine was also supplied with the optional internal modem. This comprises a telephone socket and its own on/off switch. The unit on the machine was designed for use in the States and is therefore illegal in the UK.

Getting inside the machine is simply a question of removing six screws and persuading a couple of press catches that they *want* to open. When this has been done the whole top panel and screen lift up to reveal the workings of the machine.

All the circuitry is incorporated onto one PCB, which looks like a miniature work of art. The vast majority of the components are surface-mounted to save space and there are a large number of custom chips all bearing the Toshiba logo.

The main processor is an 80C88 running at a sedate 4.77MHz. There is no high-speed option. As standard, the machine comes with 512k of RAM and 256k of ROM (more of which below).

The RAM can optionally be extended to a total of 1.2Mbytes, of which the first 640k is used as system RAM and the second 640k is available as LIM EMS memory. However, this is only of use for applications programs conforming to the LIM standard.

The T1000 comes with rechargeable batteries as standard and Toshiba claims about five hours use on one charge. As always this is dependent on how much you use the disk drive and the I/O ports, but it turned out to be an accurate figure during the test.

The keyboard consists of 82 keys arranged very sensibly. Considering the small space available, it is very

easy to use. The main qwerty typing section takes up most of the available space and is nicely laid out with the exception of the \ key which has been banished to a far-flung top right-hand corner of the typing section. All the qwerty keys are cream-coloured, while the other keys are grey.

Above the qwerty typing section is a row of fifteen compressed keys. Ten of these are function keys, the left-most is the ESCape key and the other four cover Num Lock, Scroll Lock, Print Screen and Sys Req.

In the top right-hand corner of the keyboard are two LEDs; one glows red when the disk is being accessed and the other glows green in normal use and red if the batteries are getting low.

The bottom right-hand side of the keyboard is taken up by the editing keys. Here we have the cursor control keys surrounded by the page movement and the insert and delete keys. Although this layout isn't ideal, it is much better than the Spark's.

A makeshift numeric keypad is provided by allocating numbers to some of the qwerty keys. If you do a large amount of numeric work, Toshiba can supply a proper external numeric keypad. This should make entering numbers much easier.

The display is a fairly standard 80-column x 25-line supertwist LCD. Unlike the Spark's it uses just two colours, and is all the better for it. There was no evidence of flicker and the characters were well-formed with excellent contrast. The LCD is compatible with software written for IBM's CGA graphics standard and can display graphics at a resolution of 640x200 pixels. The angle can be easily altered, so achieving a good picture is no problem.

The T1000 does not have the option of an EL backlighter, so its performance in very low light conditions suffers. However, in average light, I had no problems reading the screen.

My main criticism of the T1000's display also applies to the other machines in this review and con-



The Toshiba T1000 and the Datavue Spark have identical ports at the rear, consisting of serial port, parallel port, RGB, external floppy disk and composite video. The Sharp PC-4501A has only a serial port, a parallel port and an external floppy disk mounted on its right-hand side

cerns the aspect ratio provided by standard LCDs. All three displays in this review are much wider than they are deep, whereas most CRTs are virtually square. This means that a pie chart which would be circular on a normal IBM display ends up being egg-shaped on these LCDs. The only machine I know of which doesn't have this problem is the Zenith Z181. This has a special LCD with an aspect ratio similar to that of a normal CRT.

## Software

Like the other machines in this review, the T1000 is supplied with MS-DOS version 2.11. However, unlike the other machines, the T1000 has its DOS stored in ROM instead of on disk. This is a *very* good idea.

When you first switch the machine on, it goes through its RAM check and then looks for a DOS disk in the floppy drive. This is done to allow you to use a version of DOS other than version 2.11 which is built into the machine. Some people may want to use version 3.2 or 3.3, for example.

Assuming there is no DOS disk in the drive, the machine goes on to boot from ROM and then goes on to display the usual MS-DOS copyright notices. When it has booted up, the ROM is presented as drive C:. A quick look at the directory reveals that not only is DOS present, but so are all the usual DOS utilities and even some Toshiba utilities. The ROM looks for all the world just like a normal disk drive except that it is write-protected.

### Benchmarks: Datavue Spark

	4.77MHz	9.54MHz
Intmath	5.9	3.6
Realmath	6.9	4.3
Triglog	50.3	30.0
Textscrn	1min 33.9secs	1min 02.1secs
Grafsrn	36.5	21.8
Store	21.4	12.3

### Benchmarks: Toshiba T1000

		9.54MHz
Intmath		5.9
Realmath		7.2
Triglog		54.1
Textscrn	1min 32.3secs	
Grafsrn		37.2
Store		20.9

### Benchmarks: Sharp PC-4501A

	4.77MHz	7.16MHz
Intmath	5.2	4.4
Realmath	6.1	5.2
Triglog	43.5	37.7
Textscrn	2min 49.4secs	2min 17.6secs
Grafsrn	32.3	27.9
Store	22.4	21.6

All timings in seconds unless otherwise specified. For a full explanation of the PCW Benchmarks, see the December 1986 issue, page 164.

The main utility provided with the T1000 is called 'Setup 10'. When it is run it provides a menu which allows you to alter certain system parameters. The first two options are by far the most interesting and cover the placement of the 'Config.sys' file belonging to MS-DOS. One problem with putting MS-DOS on ROM is that it isn't possible to change the entries in Config.sys. As the ROM version of the file only contains the statement 'Country=001', this could be a problem.

Luckily, those clever people at Toshiba have considered this and give you the option of either using the ROM version of Config.sys or copying your own version from disk to a section of battery-backed RAM where it will stay for ever more (or until you change it again). This solution works well and means that you can play with all your files, buffers and devices to your heart's content.

The other options are quite boring by comparison and allow you to play with the RS232 port, display mode and the printer port; this can be set to bi-directional which could be handy for downloading IBM software.

As far as software compatibility is concerned, the T1000 seems to be very compatible with PC software, although perhaps not quite as compatible as the Spark.

## Documentation

No documentation was available with the review machine.

## Sharp PC-4501A

Sharp has been in the laptop market longer than most and has been one of the major innovators. Unfortunately, because of the problems associated with laptops, Sharp's laptops haven't been all that successful. For instance, the company's PC5000 was a real innovator in its day and it had one of the first 80-column screens, a built-in printer and bubble memory storage, but people weren't exactly queuing in the streets to buy one.

Sharp's latest attempts to crack the laptop market centre around its new PC-4500 range. At the moment this consists of two machines: the PC-4501A which is cheap, and the PC-4502 which is a bit more expensive. Both machines are basically the same, but the top model has an extra disk drive, more RAM, a numeric keypad and is painted black.

## Hardware

The review machine was the entry-level PC-4501A which at £850 plus VAT is comparable with the other two machines in this review.

When I was handed the PC-4501A, it was cunningly disguised as a Sainsbury's plastic carrier bag. When I lifted it up, I was convinced that the bag would contain the week's shopping rather than a 'portable' laptop machine. Sharp claims that the machine weighs 10lbs; all I can say is that it feels like a lot more. Unfortunately the PCW regulation bathroom scales were on loan to someone else, so I couldn't check the weight for myself. At just over 12ins wide x 13ins deep x 3ins high, the PC-4501A is quite large by laptop standards. This becomes very obvious when you compare it with the diminutive Toshiba which is a model of compactness and lightness.

The general design and layout of the Sharp is very similar to the other two machines, with a hinged lid holding the display which folds down to protect the keyboard. Sharp has tried to spice things up a bit by putting the hinge to one side instead of in the centre of the lid. Said hinge, by the way, is designed to hold the screen at any angle you like.

The left side of the machine contains all the I/O ports. These consist of one full 25-way RS232 port, one parallel printer port and a connector for an external 5¼in floppy disk drive. Unlike the other two machines in this review, the Sharp doesn't come with monitor ports to allow you to attach CGA screens to the machine. However, a CRT card is available as an optional extra.

The rear of the machine is empty except for a single blanked-off external expansion slot. This is provided to allow you to attach the optional external expansion box which will take up to three Sharp expansion cards.

Underneath the machine are: the carrying handle which flips up for use and then clips neatly out of the way, and a set of DIP switches.

Finally, the right side of the machine contains the disk drive, the on/off button, a 9.8-volt power input socket, and two thumbwheels to adjust the brightness and contrast of the display.

Although the casing has room for two disk drives, the PC-4501A only comes with a single disk. The other slot is blanked off. Unlike the other two machines in this review, Sharp has taken the sensible precaution of fitting a spring-loaded flap to the mouth of the disk drive. This stops any dirt (and toffee papers) accidentally gumming up the works. Sharp has also mounted the disk drive on rubber shock absorbers to aid reliability.

Like the other machines, the PC-4501A is supplied with an external



main power transformer, and, like the Toshiba, it isn't possible to alter the main voltage on the Sharp unit, so using it abroad could be a problem.

The machine comes with internal re-chargeable batteries as standard and Sharp claims five to seven hours use between charges. However, this 'go-anywhere battery-power' did prove to be a headache during the review.

The problems centre around the fact that the Sharp doesn't have a proper on/off switch. Instead of having a normal switch which cuts the power when you flick it, the Sharp has a microprocessor-controlled on/off button. Even when it is switched off, the machine constantly monitors the on/off button and when you press it, the machine switches itself on. When you want to switch off, you press the button again and the machine closes down its files and switches itself off.

This is all well and good, but it is possible to have a software crash which stops the processor from monitoring the on/off switch. On mains-based machines you can always pull the power lead out of the wall, but the Sharp runs on its own internal batteries. If a reset is necessary you have to flick dip switch one. A hardware reset button is promised on the production machine, and I discovered that Ctrl-Alt-Setup will perform the same task.

The main processor inside the machine is the NEC V40 running at 4.77 or 7.16MHz. This is compatible with the 80188 which is best described as the bastard child of the far more popular 8088 processor. If it were a horse, its breeding would be described as 'by DMA out of 8088'.

The PC-4501A comes with 256k of RAM as standard. This seems rather mean when compared with the other two machines in this review, but it can be increased to 640k onboard. The machine also comes with an internal expansion slot which can be used for an optional EPROM card or for an EMS memory board which adds another 1Mbyte of RAM.

The keyboard is nicely laid out with plenty of room between the keys and a nice large 'Return' key. The function keys are strangely laid out in two rows above the qwerty typing section. In addition to the ten function keys, these rows also play host to the 'Num Lock', 'Scroll Lock', 'Ins', 'Del' and 'Esc' keys. There is also a key marked 'Set Up'.

Overall, the Sharp's keyboard had the nicest action of the three machines in this review. The only point I didn't like was the separation of the cursor control keys which were at the bottom of the keyboard and the insert and delete keys which were at the top. In common with the

other two machines in this review, the PC-4501A doesn't have a separate numeric keypad, unlike the more upmarket PC-4502.

One area where you would expect the Sharp to excel is in its display and this was the only machine in this price range to come with an EL backlighter as standard. This means that the Sharp's screen actually glows and there are no worries about having enough light to read the screen.

In use, the Sharp's screen is certainly good; however, it says much for the development of supertwist LCD screens that, even with its backlighter, the Sharp isn't that much better than the Toshiba or the Spark. Sharp claims that the machine also uses a supertwist screen, but when the backlighter is switched off the contrast is very bad.

In most lighting conditions, I wouldn't say there was much to choose between the Sharp with its backlighter and the other two without. However, in low-light situations the Sharp literally shines through

and provides a very impressive display. My only criticisms on the review machine were the high-pitched scream from the EL unit and the slight shortening of battery life which goes with using an EL backlighter.

## Software

Like the other machines in this review, the Sharp is supplied with MS-DOS version 2.11 modified to accept 720k 3½in disk drives. Like other Sharp machines, the PC-4501A uses compatibility ROM software from Vadem Inc in the States. In use, DOS behaves quite normally with no visible changes from Sharp.

The main area of interest is the ROM-based set-up software. This may be called up at any time by pressing the 'Set Up' key on the keyboard. The system then displays a very long and comprehensive menu of system options which may be changed. All options are selected by using the cursor keys and then changed by using the space bar to scroll through the options.



All three machines feature 720k 3½in disk drives, and as this format appears on IBM's entire PS/2 range, there should be no shortage of software. The Spark and the PC-4501A can be fitted with second internal drives, but in the T1000 DOS in ROM means that one drive is adequate

# BENCHTEST

Using the set-up menu it is possible to set the date and time, set an alarm for a certain time, play around with the display, alter serial port baud rates, change the printer interface and change the processor clock speed.

The display options which can be set include cursor type, blinking or not and normal or reverse video. It is also possible to turn the backlighter on or off and alter the time, after which the backlighter automatically switches itself off. As standard, if you don't ask the machine to do anything for two minutes, the backlighter will switch off.

As far as software compatibility with IBM software is concerned, the review machine was indeed far from 'sparkling'.

I should point out, however, that the machine was using pre-production hardware, and compatibility should have been improved by the time the retail version hits the streets. Sharp intends the production machine to be fully IBM-compatible, although much of this is being achieved through the ROM BIOS.

## Documentation

No documentation was available with the review machine.

## Conclusion

When I started this review, I didn't think there would be much to choose between these three laptops as they are all relatively cheap and all offer a similar performance. However, I was surprised that they all have their own unique selling points, and they all have their weaknesses. I was *most surprised* by how good all the machines were: I gave up trying to use laptops about a year ago because I found them too limiting. This is not the case today. Supertwist screens and full PC-compatibility mean that these machines are truly useful.

For me, the clear winner of the contest is the Toshiba T1000. It is small, very light and has a good screen and keyboard. Above all, it is extremely well-built with beautiful attention to detail. Its main failing, however, is its slow processor speed, but if Toshiba doubled the clock speed I wouldn't have anything to criticise.

Second place goes to the Spark. This machine is *technically* more advanced than the Toshiba — it is much faster and offers a wider range of options — but it is let down by its poor build quality and flimsy design. The screen, also, is slightly inferior.

Last comes the Sharp. Its main failings are its relative size and weight

and a question-mark over its PC-compatibility. I'm sure that the retail versions of the machine will be much better than the review machine in this respect, but the use of the V40 processor could still be a problem. If you want to run something ill-behaved on your laptop, you'd be wise to try it on the Sharp before buying. Nonetheless, Sharp is aiming

to run all the major PC packages on the machine. The main advantage of the machine is its backlit screen which is very good in low light conditions.

The Datavue Spark costs £895 (excluding VAT) from Datavue on (0753) 34421.  
The Toshiba T1000 costs £995 (excluding VAT) from Toshiba on (0276) 62222.  
The Sharp PC-4501A costs £845 (excluding VAT) from Sharp on (061) 205 2333.

END

### Technical specifications: Datavue Spark

Processor: NEC V20 switchable to 4.77MHz or 9.54MHz  
RAM: 384k expandable to 640k  
ROM: 32k  
Mass storage: Single 720k 3½in floppy  
Storage options: Extra 3½in drive, external 5¼in drive  
Keyboard: 77 keys  
Monitor: Four-colour supertwist LCD; CGA-compatible  
Standard interfaces: RS232, parallel printer, disk drive  
Expansion: Internal modem  
Size: 13.2insx2.5insx13ins  
Weight: 9lbs  
Bundled software: None

### Technical specifications: Toshiba T1000

Processor: 80C88, 4.77MHz  
RAM: 512k expandable to 640k plus 640k LIM  
ROM: 256k including MS-DOS 2.11  
Mass storage: Single 720k 3½in floppy  
Storage options: External 5¼in IBM-compatible drive  
Keyboard: 82 keys; optional external numeric pad  
Monitor: Supertwist LCD, IBM CGA-compatible  
Standard interfaces: RS232, parallel printer, disk drive, RGB monitor  
Expansion: Internal modem, LIM memory  
Size: 12.2insx2.05insx11.0ins  
Weight: 6.4lbs  
Bundled software: None

### Technical specifications: Sharp PC-4501A

Processor: 80188 switchable to 4.77MHz or 7.16MHz  
RAM: 256k expandable to 640k; optional 1Mbyte LIM  
ROM: 32k  
Mass storage: Single 720k 3½in floppy  
Storage options: Optional second floppy, external 5¼in drive  
Keyboard: 78 keys  
Monitor: Backlit supertwist LCD, CGA-compatible  
Standard interfaces: RS232, parallel printer, disk drive  
Expansion: One slot, optional LIM, EPROM card or RGB interface  
Size: 12.1insx3insx13.75ins  
Weight: 10lbs  
Bundled software: None

### In perspective

There was a time, not so long ago, when laptops were regarded as a niche market. Now even this 'niche' is being further sub-divided into power laptops, mid-range laptops and cheap laptops.

The Datavue Spark, the Toshiba T1000 and the Sharp PC-4501A are all competing at the bottom end of the market in terms of price. However, in terms of features the lines are very blurred between these machines and the next echelon of mid-range laptops.

The Toshiba T1000 suffers most from the need to differentiate itself from its larger and more expensive brother, the T1100 Plus. The lower clock speed imposed by the need for limited performance spoils an otherwise excellent machine.

The Datavue Spark is a much more versatile machine and is available in a wide range of specifications and prices. The main problem is likely to be gaining market support for a relatively unknown brand, but Quadram's distribution deal is likely to help here.

The Sharp's main claim to fame is its backlit screen and the chunky, reliable feel of the machine. The market has been educated to think that backlighters are a good thing, so having one as standard at this price level has to be a big plus. However, in areas such as standard RAM and video output, the Sharp lags behind the other machines, so it could well prove to be a case of swings and roundabouts.

# SCREENS SCREENS SCREENS

## BEST EQUIPMENT! BEST DEALS! BEST CHOICE!

### Forget the rest – check the best – SCREENS



#### ST100 BEGINNER PC

An exceptional 16Bit Beginner PC at an incredible price. Add to the basic kit the peripherals of your choice!

- 8088-2 CPU (4.77/8MHz) ● 512K Ram ● 360K Floppy Disk Drive ● Mono Graphic Card ● Parallel Printer Port ● 150W Power Supply ● 84 key keyboard ● 6 Free full sized Expansion slots.

ENHANCED ST100 AVAILABLE including all basic specifications plus 1 x Serial Port 12" High Resolution Amber Monitor MS-DOS 3.1 only **£399.00**

**£299.00!**

PROFESSIONAL PERFORMANCE PERFECTION



#### CL-20 TURBO XT

Desktop Turbo XT Computing at an affordable price and NO HIDDEN EXTRAS. Another SCREENS Exclusive!

- 8088-2 CPU (4.77/8MHz) Hardware Selectable ● 640K Ram ● 360K Floppy Disk Drive ● 20MByte Winchester Hard Disk ● 2 Free Floppy Disk Cavities ● Serial Port ● 2 x Printer Ports ● Real-time clock with battery backup ● Slim AT Type keyboard ● 12" High Resolution Amber/Green Screen Monitor included ● 5 Free Expansion slots ● Games Port ● Turbo Indicator ● MS-DOS/GW BASIC v3.2 ● ONE YEAR ON-SITE MAINTENANCE

**£945.00!**

PROFESSIONAL PERFORMANCE PERFECTION



#### CL-1D TURBO DESKTOP

An incredible value for money package exclusively from SCREENS

- 8088-2 CPU (4.77/8MHz) Hardware Switchable ● 640K Ram ● 360K Floppy Disk Drive ● 3 Spare Floppy Drive cavities ● Serial Port ● 2 x Parallel Ports ● 1 x Games Port ● Real-time clock & battery backup ● Slim AT type keyboard ● Turbo indicator ● Power on LED ● Maintenance option ● 12" High Resolution Amber Monitor on swivel/tilt stand ● MS-DOS v3.2 ● GW BASIC v3.2 included in price ● 5/6 Full sized IBM Expansion slots.

**£499.00!**



#### ST420 BABY 12MHz TRANSPORTABLE AT

One of the best offers on the market today, at any price! Brought to you exclusively from SCREENS a simply amazing price.

- 80286-10 CPU (6/10/12 MHz clock) ● 512K User Ram installed ● 5" High Res Paper White Monitor ● 165W Power Supply ● FDD/HDD Controller Cards ● 1.2MByte Floppy Disk Drive ● 20MByte Winchester Hard Disk ● Parallel Printer Port ● Serial Port ● Full Sized Expansion slots ● MS-DOS v3.2 ● ONE YEAR ON-SITE MAINTENANCE INCLUDED IN PRICE.

**£1199.00!**

PROFESSIONAL PERFORMANCE PERFECTION



#### CL-2D TURBO DESKTOP

Everything a small office could want plus more. Compare our specification to price and buy with confidence today!

- All specifications as CL-1D plus ● Dual 360K Floppy Disk Drive ● One year On-Site Maintenance

Who else but SCREENS could bring you the BEST EQUIPMENT! BEST DEALS! BEST CHOICE!

**£599.00!**

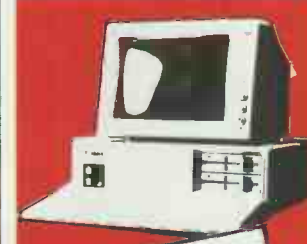

#### ST320 ENHANCED BABY 12MHz AT

UNBEATABLE! UNBELIEVABLE! UNSTOPPABLE!

- Small Footprint AT ● 80286-10 CPU (6/10/12 MHz) ● 1 MByte Ram ● 101 Key AT Professional Keyboard ● 200W Power Supply ● 1.2MByte Floppy Disk Drive ● 30MByte Winchester Hard Disk ● Serial Port ● Parallel Port ● Hercules compatible mono graphic card ● 14" High Resolution Amber Monitor on swivel/tilt stand ● MS-DOS v3.2 ● ONE YEAR ON-SITE MAINTENANCE

40M Byte Hard Disk Version also available CGAVEGA VERSIONS AVAILABLE **£1699.00!**

**£1499.00!**



#### CL-2P TRANSPORTABLE PC

The power of a Desktop Turbo in a transportable case, ideal for the businessman on the move. At an unbelievable price!

- 8088-2 CPU (4.77/8MHz) Hardware Selectable ● 640K Ram ● Built in 9" Amber Monitor ● Dual 360K Floppy Disk Drives ● Real-time clock with battery backup ● 2 x Parallel Ports ● Dual RS232 Ports ● Four free full sized expansion slots ● Provision for external monitor ● Low profile keyboard ● Reset button ● Security lock ● MS DOS/GW BASIC v3.2 ● ONE YEAR ON-SITE MAINTENANCE INCLUDED IN PRICE ● XT 20MB VERSION ALSO AVAILABLE

**£699.00!**



#### ST386 16MHz DESKTOP

Who else but SCREENS could bring you the latest specifications 386 at a price to leave the competition standing!

- Small Footprint ● 80386 (16MHz) ● 2 MByte Ram ● 2xRS232 ● Parallel Printer Port ● 101 Key Keyboard ● Real-time clock with battery backup ● 1.2MByte Floppy Disk Drive ● 40MByte 28ms Winchester Hard Disk ● 200W Power Supply ● 14" High Resolution Amber Monitor on swivel/tilt base ● Socket for Maths CoProcessor ● MS-DOS v3.2 included.

**£2995.00!**

**FREE!** A PUSH BUTTON 14" PORTABLE COLOUR T.V. WITH ANY HARD DISK XT/AT SYSTEM. OFFER MUST END WHEN T.V. STOCKS ALLOCATED. HURRY NOW!

CHECK OUR ROCK BOTTOM PRICES ON EXTENSIVE RANGE OF ADD-ONS, PRINTERS, MONITORS, CONSUMABLES & SOFTWARE. SEND LARGE S.A.E. FOR OUR PRICE LISTS TODAY.

# SCREENS MICROCOMPUTERS & ELECTRONICS LTD

TRUST SCREENS TO DELIVER



MAIN AVENUE · MOOR PARK · NORTHWOOD · MIDDLESEX · ENGLAND

TEL: SALES 09274 20527 TEL: EXPORT 09274 20664 TLX: 929224 SCREEN G FAX: 0923 240402

CORPORATE - EDUCATIONAL - EXPORT ENQUIRIES WELCOME · PRICES QUOTED EXCLUDE VAT & DELIVERY · 24 HOUR DELIVERY SERVICE AVAILABLE · ALL PRODUCTS CARRY ONE YEAR WARRANTY  
 PRODUCTS SUBJECT TO AVAILABILITY · ON-SITE MAINTENANCE - INSTALLATION - TRAINING & CREDIT FACILITIES AVAILABLE · IBM IS REGISTERED TRADE MARK OF INTERNATIONAL BUSINESS MACHINES INC  
 MS-DOS/GW BASIC ARE TRADE MARKS OF MICROSOFT INC · SCREENS ARE LICENSED CREDIT BROKERS · DELIVERY CHARGES: SOFTWARE = £2. HARDWARE UNDER £200 = £6. OVER £200 = £10. OVER £2000 F.O.C.

SCREENS  
TRUST SCREENS TO DELIVER  
SCREENS

# Amstrad PC1640

*The Amstrad PC1512's poor reception in the US has led Alan Sugar to redefine the needs of the market at which it is aimed. The PC1640 offers more memory and, above all, EGA compatibility. Robert Schifreen assesses the machine's rejuvenation.*

Arguments still rage over the exact sales figures, but few people dispute that Amstrad's launching of the PC1512 affected the industry to almost the same degree as IBM introducing the real thing in 1981. The PC1512 didn't go down well in the US though, as clones there are ten-a-penny and products that seem good value in the UK aren't always greeted with the same applause over there.

So, the 1640 was developed and launched. With built-in EGA capability and a suitable monitor included, this was more like the type of machine Americans wanted.

At the initial announcement at Comdex Spring, Alan Sugar said that the 1640 would start life only in the US, and that British customers would have to wait until at least the end of the year for the first glimpse of the new model. For a number of reasons — probably because sales of the 1512 suffered in the same way that IBM couldn't sell any PCs immediately before the PS/2 launch — the 1640 has been launched in the UK and is now starting to appear in dealers' showrooms and High Street shops such as Dixons.

The 1640 is essentially the same as the 1512, with a number of additions and a couple of subtractions. Rather than review the machine in detail — most of which has already been covered before — this article concentrates only on the *differences* between the 1640 and the 1512.

## Appearance

Every couple of weeks, Amstrad's PR company phones PCW and asks to borrow our long-term-loan 1512 for a few days. And each time the machine comes back, yet more of the plastic casing has had slits cut in it to provide ventilation, or more of the motherboard has been covered in silver foil to reduce the radio interference. The 1640 system unit is the same shape as the older model, and still more of the plastic casing has



had slits cut in it (the motherboard is now totally oven-ready). There is still no fan in the system unit, although there *is* one in the monitor which still contains the power supply.

For some reason the review machine's DIP switches come factory-set for use with a mono monitor, and a large sticker on the screen tells you to change these before switching on.

The monitor is called the ECD, or enhanced colour display, and is noticeably bigger and heavier than the original colour display. The glass is not coated, and the shiny surface reflects, mirror-like, anything in the room. The screen measures 10.5ins x 7.5ins x 13ins diagonally.

The monitor now connects to the

system unit via an IBM-standard 9-pin socket, so you could use a different monitor — though you'd still need the Amstrad unit to provide power for the machine.

The keyboard is identical to that of the 1512, except for the wording of the logos which now say '1640' and '640K' instead of '1512' and '512K'.

## The changes

When I did my 'interested customer' impression and called Amstrad's technical department, no-one was initially prepared to give me a list of differences between the 1640 and the 1512. Eventually, Amstrad's marketing manager told me what I needed to know. These are the changes that turn a 1512 into a 1640:

### ● The display

The standard monitor supplied with the 1640 is EGA- and CGA- compatible. EGA, the enhanced graphics standard, has a resolution of 640×350 compared with the CGA's 640×200. You can have 16 colours, from a palette of 64, on the screen at a time. The motherboard contains an extra 256k of video RAM to handle the EGA display data.

Hercules compatibility is also built-in on the motherboard and, with a mono monitor, will provide graphics resolution in two colours (black and white) of 720×350. When the system is first switched on, the 'Please Wait...' message appears in CGA mode, but the system then switches by default to give the MS-DOS prompt in EGA mode.

The hardware to handle the switchable display is a custom chip made by Paradise, the EGA card manufacturer which was taken over in the US by Western Digital, maker of hard disk controllers.

The software to change screen modes comes in the form of a short MS-DOS utility called 'DISPLAY' that is used from the MS-DOS command line. Typing DISPLAY CGA, DISPLAY EGA or DISPLAY HERC sets the correct mode, altering the sync rate of the monitor to match and giving a loud click as it does so. Typing DISPLAY HERC with the EGA monitor installed produces a blank screen.

The DISPLAY program allows you to reboot the machine but preserve the current screen mode. There is no documented way of allowing your programs to do what DISPLAY does, but it shouldn't be too difficult to examine the program's code to see which commands are used.

The quality of the display is a huge improvement over the standard IBM CGA, though not as crisp as, say, an IBM EGA card connected to an NEC multisync monitor. Still, considering that the list price of the NEC monitor is over £700, this isn't surprising.

Amstrad's EGA emulation seems fairly sturdy and IBM-compatible. EGAPAINTE, from RIX, worked properly (driven by the Amstrad mouse) and the system had no trouble producing a 43-line display — a standard feature of the EGA, though you need special software to make use of it. Unlike some clones (including the ARC machine which I normally use) DOS used the whole of the 43-line screen and didn't insist on scrolling

after 25 lines. The credit for this belongs to the BIOS on the Paradise card.

The CGA mode seems to work in exactly the same way as on the 1512, as I encountered no problems with the programs I ran. It ran 130COLOR, a Basic program that produces 130 different colours by reprogramming the CGA controller chip, with no problems. Some devious copy-protected games which have to be booted also worked, including BurgerTime and Zaxxon. I did notice a high-pitched whistling noise while the monitor was in CGA mode, but I was impressed with the amount of software it ran.

### Prices

PC1640 with single 360k floppy drive	£799
PC1640 with twin 360k floppy drives	£899
PC1640 with single 360k floppy drive and 20Mbyte hard drive	£1199

*(The specification includes an EGA monitor, DOS, keyboard, GEM and Basic. All prices exclude VAT.)*

With a monochrome monitor attached instead of the EGA one, the system supports Hercules graphics modes too, though I didn't have a chance to try this. The 16-colour graphics mode on the 1512, which was half-way between CGA and EGA, has been dropped.

One of the biggest complaints about the 1512 is that you can't disable the internal graphics adaptor. This means that, although you can put extra graphics cards in the machine, there is a chance that they will clash with the existing Amstrad hardware and neither will work.

A DIP switch setting now allows the IGA (internal graphics adaptor) to be disabled, and standard colour, mono, Hercules or EGA cards to be installed.

### ● Software changes

DOS Plus, Digital Research's MS-DOS lookalike, has been dropped. Although it is shipped free with the 1512, enthusiasm was limited as it offered nothing over and above MS-DOS and was supported by very few companies. Latest rumblings from the rumour mills suggest that the next Amstrad machine will come with Microsoft's Windows.

There are still four coloured disks supplied with the machine, contain-

ing MS-DOS version 3.2, GEM version 2.0 and Locomotive Basic 2. With the extra space on the disks now that DOS Plus has gone, Amstrad has found space for 'LINK', a programmer's utility missing from the 1512 pack. The extra space also accommodates the hard disk format and 'PARK' utilities.

GEM is supplied configured for an EGA and the display is infinitely better — it uses its own typefaces for screen display rather than the CGA's.

### ● Memory

The PC1640 comes with 640k of RAM as standard. If you don't need all of this, there's a RAM disk device driver on the MS-DOS disk.

### ● Expansion slots

As before, there are three expansion slots. However, the 1640 also has a fourth half-length slot buried inside the machine (with no cut-out in the casing) whose official purpose is to take the hard disk controller. This means that hard disk users still have three vacant slots. If you don't have a hard disk, you can use the fourth slot for any short expansion card that doesn't have 'outside' connections.

### ● Clock

The BIOS bug in the 1512's real-time clock appears to have been fixed in the 1640. On previous machines the clock was not reset after midnight, and the system informed you that it was 27 o'clock and promptly crashed. This shouldn't happen now.

### Documentation

The 1640 is supplied with a 500-page manual that looks very similar to the 1512 documentation. It's slightly thinner, though, as references to DOS Plus have been removed. Only two chapters appear to have been rewritten, namely those dealing with display modes and adding extra graphics cards.

### Conclusion

Upgrading any PC from 512k to 640k is not the hardest job in the world, so the 1640's main selling point comes down to the EGA compatibility. It's often risky to launch an EGA machine and to claim that, in CGA mode, it's compatible with existing CGA software, as sometimes the emulation is far from perfect. Amstrad's implementation, which seems to use separate circuitry for each mode, impresses me, though the praise probably belongs to Paradise more than Alan Sugar.

Even so, with the PS/2's capabilities making software developers aware of the importance of good graphics, no-one can deny that the EGA is far from dead and that the 1640 is good value for money.

Amstrad is on (0277) 228888.

END

### In perspective

From the start, everyone told Alan Sugar that he had to do it, and he finally has. To launch a PC that can't take an EGA card, when the world of presentation graphics and desktop publishing is just opening up, is ludicrous, and it's hardly surprising that it was the US that forced his hand.

The 1640 is terrific value for money (though you can start to understand why it's so cheap when you look inside the plastic case) and I can't help feeling that this machine could be the basis for a number of future products. If he can get as good a price for any Digital Research product as he's no doubt getting for GEM, we could be looking here at half of the decade's best-value DTP system.

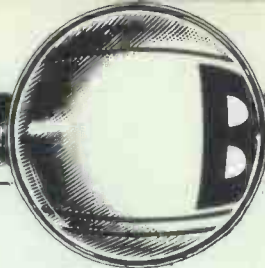

# Cambridge Computer Z88

*The prototype of the Cambridge Computer Z88 previewed in the March issue of PCW has developed into its retail vision — a sub-£300 laptop with admirable facilities. Robert Schifreen tests its mettle.*



Although Toshiba would have you believe otherwise, many people — myself included — don't really need or want all this laptop power. Rather than using a laptop as an extension of the office desktop, they'd be content with a light, thin machine with built-in proprietary software that functioned as a word processor, diary, calendar, spreadsheet, database, and so on. Expensive, heavy disk drives would not be necessary: non-volatile RAM and/or EPROM would suffice, as long as there was a printer socket and a way of easily transferring data into the PC when you were back at work.

This is exactly the philosophy which, hopes Sinclair (the man — the company name now belongs to Amstrad), will make people buy his £250 laptop (excl VAT) rather than a portable PC for ten times the price.

The Z88 is not the first machine like this — as Tandy and Psion would be the first to tell you. But the market has not yet really taken off in a big way. Sir Clive's marketing manager puts this down to the industry not having had Clive Sinclair's name behind it before.

## Hardware

The machine itself looks remarkably like the wood mock-up which was featured in the March issue of *PCW*. Within a millimetre, it's the size of a copy of *PCW* and 2cms thick. The LCD screen doesn't tilt up, but a stand underneath lifts the whole machine up by 4cms. With its four Walkman-size batteries fitted, the machine weighs 21lbs 2ozs, or the same as a well-stuffed Filofax.

The display is a 100-column super-twist LCD made by Epson and not a flat screen TV as was once rumoured.

Going round the edges of the machine, the mains input (via an optional adaptor) and LCD contrast knob are on the left. There is also a reset button, set deep into the case as you shouldn't need to press it. On the right is the RS232 connector, which is a female 9-pin socket. Sir Clive has learned from the Spectrum's mistake — this time it's a full RS232 interface with all lines present, and can handle split baud rates (1200/75 for Prestel).

This connector is the system's only link with the outside world — there is no parallel printer port so you'll need a serial printer or an extra interface for your parallel one.

A flap next to the RS232 socket conceals a 20-way, double-sided edge connector. There is no documented use for this at the moment, though no-one denies that disk drives will, hopefully, be available soon.

The front edge of the machine provides three slots. These hold special

cartridges designed by Cambridge Computer, each slightly larger than a Microdrive cartridge. My review machine had a 128k RAM cartridge in slot one (to extend the basic 32k supplied internally) and a 128k EPROM in slot three. Like the Psion Organiser, the Z88 will blow files onto EPROMs (using just the batteries for power). An eraser costs £39.95. The RAM and EPROM cartridges are also available in a 32k size, and 1Mbyte ones are promised.

There is no battery on the RAM cartridges, so removing one will lose its contents. Although the EPROMs are more permanent, I don't think I'd pass my Z88 through customs' x-ray machine without first removing them and asking for them to be hand-examined.

There is no socket for connecting to a full-screen monitor. The designers say that this is impossible.

The keyboard looks like a QL and feels like a Spectrum. It's rubber — a return to the days of dead flesh. Underneath the one-piece rubber mat, the electronics of the keyboard is the thickness of a piece of cling-film — a revelation to take apart and look at but a pain to put back together afterwards.

The official reason for using a rubber keyboard is that it's quiet enough to use in a meeting without disturbing anyone. Unlike some of Clive's earlier excuses for various disasters, this one stands in my opinion. It takes some getting used to, but you really can work up quite a speed. It's not too fussy which part of a key you hit. If you find it too quiet, an option on the control panel (a popdown application) will turn on a click.

I used the Z88 for a couple of days on the Tube in London and, although the train's movement led to some missed keys, the final result was infinitely more readable than my mobile handwriting.

The rubber gets grubby quickly, as you can't just brush crumbs and things off it. The official cure is a damp cloth and this worked wonders, but don't use tissues as they leave bits of fibre everywhere.

The two most important keys are the square and the diamond. The square is used to launch an application (square B starts Basic, for example), while the diamond selects an option within an application (diamond BC for block copy while in the word processor). If you don't remember the diamond key combination for a particular function, there's a complete Help system that lets you drive everything through menus; these menus also give you the correct diamond key combination so you won't forget next time.

My biggest keyboard gripe is the layout. If your thumb falls short of the left-hand side of the space bar

and hits the square, you'll be back at the applications menu but won't know it unless you look at the screen. A warning beep on pressing this key would be helpful.

Also, the Index key (to return you to the top-level menu) is far too easy to hit with the palm, especially if the train rocks more than it should.

## Inside

The single PCB contains just four chips and a collection of transistors and resistors. There's also a large capacitor that will power the whole system for six minutes while you change the batteries. (The figure of six minutes is for a machine with no cartridges fitted. With all three slots filled, you have only 60 seconds.)

The four chips are a Zilog Z80, a custom ULA manufactured by NEC, a 32k DRAM chip and a 1Mbit EPROM containing all the software. Although the machine is Z80-based, it isn't CP/M in any shape or form.

Surprisingly, the Z80 is not of the less power-hungry CMOS type. Even so, battery life is quoted at 20 hours' use, or up to a year if the machine is never used.

The control panel lets you specify a number of minutes of inactivity, after which the machine switches itself off to preserve power. (Actually, the Z88 is never truly switched off — the display is blanked and memory is still preserved.)

## System software

Assuming that you haven't bought any third-party software on EPROM (Cambridge Computer won't be marketing any), you are tied to the software in the internal 128k of EPROM. System software is divided into 'Popdowns' and 'Applications'. Both types are selected from the same menu — the only difference is that when you exit a popdown, it disappears from memory and is not suspended. The advantage of applications is that you can suspend them, do something else, then return to the program and find your data intact.

It's strange not being able to quit an application — you have to leave it suspended and kill it from outside. I tended to build up a collection of suspended activities and then do a general massacre when memory was getting short.

With my review machine (32k internal memory plus 128k extra), I could easily have six copies of Pipe-dream (the spreadsheet/word processor) suspended, each containing a (different) short document.

When you switch on the machine (by pressing both Shift keys simultaneously) the screen displays the Applications menu and a list of suspended applications. Entries are selected and programs loaded by use

# BENCHTEST



The most impressive component of the Z88 is the 'dead-flesh' keyboard (which is quiet in operation). The electronics are contained in a thin, plastic film, and are activated when your fingers touch them through the rubber mat

of the cursor keys and the Enter key. If you do buy extra software on EPROM, the operating system will find the program's name and add it to the applications menu.

The suspended applications list gives the name of the applications, the file being worked on and the date it was created or last amended. In one of the most user-friendly ways I've ever seen, the date is displayed as 'Today', 'Yesterday', and so on.

To remove an application from the suspended list, you point to it with the cursor and press the diamond key, then type KILL. The screen blanks for a second while the system frees the memory previously being used by that task.

## The Popdowns

### Calculator

On the face of it, the calculator is a four-function calculator with a memory. There are no scientific functions like logs and trig. There is, though, the useful facility of being able to convert to and from Gallons/Litres, Miles/Km, MPG/Litres per Km, Acres/Hectares, Pounds/Kg, Oz/G and Fahrenheit/Centigrade.

### Calendar

The calendar shows one full month

at a time and highlights the current day (the computer has a built-in real-time clock). Cursor keys, in conjunction with Shift, move the highlight forwards and back in steps of a day, week, month or year.

The calendar will calculate dates back to the year 1753 — useful if you want to know that American Independence day (4 July 1776) was a Thursday, or that my hundredth birthday will be a Monday (better keep the party short or I'll miss *Blue Peter*).

### Clock

This popdown opens a small window on the screen containing the current day, date and time. There are two options on the window, selectable with the cursor keys: 'Exit' returns you to the previous task; while 'Set' allows you to adjust the system's clock calendar.

While the clock (or any other application for that matter) is active, other applications on the screen are dimmed. This is pretty clever, since LCD displays work on the On or Off principle — there is nothing in between. Cambridge Computer seems to be achieving the dimming by refreshing some parts of the screen more often than others.

### Alarm

There is no real limit to the number of alarms you can have set, except that each takes up some of the machine's memory and will probably slow down the system by a slight amount while the processor keeps checking to see if any of the alarm times have been reached.

At the duly appointed time, the alarm goes off and the bleeper bleeps. Even if the machine is 'switched off' the alarm will still sound, though unless the machine is actually on your desk you're unlikely to hear the noise it makes. I miss not being able to edit alarms: if you make a mistake, you have to clear the entry and try again.

There's a field in the alarm popdown to enter a message of up to 22 characters. Normally, this message will pop up in a window at the duly selected time to remind you that your meeting is about to start, that your Pot Noodle is almost ready, or whatever. Alternatively, you can set the machine to send the string to the keyboard as a command, which provides a timed execution facility to, say, run a Basic program to download your electronic mail during the night (though you'd have to write such a program yourself).



# GOLD that can't be worn out !

For Superiority and Reliability in Data Storage and Retrieval  
GO FOR GOLD ..... GOLD MASTER DISKS

Gold Master floppy disks are engineered for exceptional high performance and are manufactured to the highest possible quality levels to provide maximum accuracy, data integrity, long archival life and matchless reliability.

A full line of Gold Master 5.25 inch floppy disks are available in all configurations compatible with any microcomputer system.

Gold Master floppy disks start with a premium magnetic oxide base material burnished to a mirror smooth surface for maximum disk life and minimal head wear. The disk is then housed in a superior jacket design which optimises recording surface cleaning, protects it from creasing and damage as well as provides a uniform low turning torque to reduce drive motor wear and data errors caused by variations in disk spinning speed.



## Pure Gold for Accuracy, Data Integrity, & Matchless Reliability

### CERTIFICATION

Each disk individually certified 100% error free at levels equal to and above ANSI, DIN, ECMA, ISO and JIS Standards.

### FULL TECHNICAL SPECIFICATIONS

Available on request in our book "Know Your Disk".

### TRACEABILITY

Each box with Warranty Card and Serial Number for traceability.

Soft Sector, Double Notch or Single Notch available.

### LIFE EXPECTANCY

3.5 million revolutions on any one track.

### FULL LIFE TIME WARRANTY

For as long as you own the disk, with 2 for 1 no quibble replacement.

### DESPATCH AND DELIVERY

Same day within London Area (in some cases within 1 hour).  
Next day within UK and within 5 days anywhere in the World.

### SAMPLES

Available on request to Companies (please request on headed note paper).

### FULL TECHNICAL SUPPORT

Our technical department is only a phone call away to answer all your questions. (Phone our Head Office and ask for our Technical Department).

#### 5.25 inch Disks

GM422 48TPI Double Sided, Double Density  
GM922 96TPI Double Sided, Double Density  
GM92H 96TPI Double Sided, High Density 1.6 Meg

#### 3.5 inch Disks

MF2DD 135TPI Double Sided, Double Density  
MF1DD 135TPI Single Sided, Single Density



### GOLD MASTER PRIORITY ORDER FORM

Send Cheques/P.O.s to:

A. R. Enterprises (UK) Limited. FREEPOST,  
76 Bedford Road, Ruislip, Middx, HA4 6NA

Name .....

Address .....

Postcode .....

Please Rush me:

..... Box(es) of GN422 @ £10.50 per box  
..... Box(es) of GM922 @ £13.50 per box  
..... Box(es) of GM92H @ £20.50 per box  
..... Box(es) of MF2DD @ £19.95 per box  
..... Box(es) of MF1DD @ £15.95 per box  
tick box if double notch required

All prices include VAT and Carriage. COD on request.  
Account Customers welcomed.

I enclose a cheque/P.O for £ ..... made payable  
to A. R. Enterprises (UK) Limited or

CONTACT OUR DIRECT SALES ON 0895 637290  
For Qty Rates and Trade Rates call our Sales Dept 0753 656466

PCW1

Our self imposed demands match yours exactly  
"Nothing less than perfection"

Head Office, Block H, Pinewood Studios, Iver Heath, Bucks SL0 0NH  
Tel: 0753 630004/656466 Telex: 847505 PINEW G

# BENCHTEST

## Filer

Documents are saved in files, just like on a PC. Filenames can be up to 12 characters plus a three-character optional extension. You can have separate directories, too.

The filer is the nearest you get on the Z88 to the MS-DOS command line on a PC. Even here, you can't TYPE a file that was created by any of the applications, but you can get a directory listing and rename, copy or delete entries. Surprisingly, the directory doesn't show the total RAM free on a cartridge, though Pipedream's option screen does give you this facility. The size of individual files is shown, though.

You can also copy to and from the EPROM cartridge. You can't run programs or load data files direct from EPROM — you have to copy them into RAM first. This is a serious problem, as having 1Mbyte of EPROM doesn't mean that you can run bigger programs.

## The applications

### Printer Editor

The machine comes configured for an Epson FX printer, and will send out the correct ESCape codes for bold, underline, italics, subscript, and so on. If you have a different printer, the 'Printer Editor' lets you change the codes which the machine sends. You can also specify whether each code is turned off at the end of a line or is to remain in effect until it is explicitly cancelled.

If you have more than one printer, sets of definitions can be saved to files and loaded as required.

### Diary

The diary is a free-form database. For each day, you are presented with a blank eight-line scrolling screen to use as you wish — it is not divided into 30-minute time segments like SideKick, for example.

The designers of this accessory have thought of some novel touches. If you call up the alarm clock from within the diary, the date for the alarm defaults to the date you're currently looking at. Also, if you call up the calendar and select a date, the diary moves to the selected date when you put the calendar away.

The diary is unique in that you can't have multiple suspended copies of it in memory. This means that you can't easily keep the diary of more than one person and switch between them, but you'll have to keep saving and loading different data files.

### Pipedream

Unless you're a Basic programmer, Pipedream is the application you'll use most, as it's the Z88's word

## Prices

Z88 with 32k of RAM (incl VAT):	£287.45
RAM cartridge (32k):	£14.95
(128k):	£49.94
EPROM cartridge (32k):	£12.95
(128k):	£49.95
Mains adaptor:	£9.95
Printer cable:	£9.95
EPROM eraser:	£39.95
300 baud modem:	£99.95
(not yet available)	

(All prices include VAT.)

## Benchmarks

	Z88	BBC Model B
Intmath	11.8	2.6
Realmath	10.2	5.8
Triglog	62.0	80.6
TextScrn	63.0	13.7
GrafScrn	n/a	n/a
Store	n/a	n/a

All timings in seconds. For a full explanation of the PCW Benchmarks, see the December 1986 issue, page 164.

processor, spreadsheet and database rolled into one.

When you first enter Pipedream, the cursor is in cell A1 (the maximum size is cell AS,32768). Although Pipedream looks like a spreadsheet, it's actually a word processor unless you tell the machine otherwise. To enter a document, you just start typing. As you do, a one-pixel-per-character map builds up on the right-hand side of the screen to show you what the current, full 66-line page will look like.

You can split long documents into separate files. You just make a special file containing a list of all the component files, and load this as the document. The system takes care of everything, like loading the next file in the sequence if you keep cursoring down. Beautiful.

To use Pipedream as a spreadsheet, you move the cursor to a cell and press the diamond key followed by X. This tells the system that you want to put an expression in a cell and not just straight text. You can mix text and expressions as you wish (an expression can be a number or a function). Inserting a row or column automatically adjusts references in formulae.

There's no real database package supplied — the manual explains how to set up the spreadsheet to behave as one. The spreadsheet is fairly complex: it will sort blocks of cells, replicate, move things around, search, and so on.

### Basic

The Z88 uses a cut-down version of BBC Basic. There is no editing facility except by retyping lines (there is no

Copy key). Also, all graphics and sound commands are removed, and give a 'Sorry, Not Implemented' error message if you try to use them. Adval is missing, too. Thankfully, Sir Clive has given up the idea of single-keyword entry.

There's a Z80 assembler built-in. When the technical manual is available, which will list all 400-odd operating system calls, Basic programmers should be able to produce sound and graphics through machine code routines.

### Terminal

The VT52 terminal works, but is very basic and can't send or receive files. The business person on the move (at whom the machine is aimed) will want to store their Telecom Gold messages to a file and will be disappointed at not being able to.

The baud rate is set from the control and governs all use of the RS232 port, even the printer (which is a pain, as you don't run serial printers at 300 baud or even 1200).

### Import/export

The PC Link, which Guy Kewney mentioned in March's 'Preview', has not materialised in the final version. As I understand it, this would have allowed you (via special software) to use a PC's disk drive as a Z88 storage device directly. Instead, Cambridge Computer sells a kit called, imaginatively, the Input/Output Software, which consists of a PC disk and RS232 cable that will transfer ready-made files to and from the PC and Z88. The PC end of the software also has a facility for transferring WordStar and Lotus files to and from Pipedream format.

## Documentation

The Z88 comes with a 212-page typeset manual. After a setting-up chapter, the manual starts with task-based chapters. A detailed reference on each application follows.

As for Basic, a list of the commands is available, but nothing else.

## Conclusion

Like every one of Sir Clive's previous inventions, the basic machine is marvellous, good value and will sell in the thousands. Also, like every machine before, there is a major flaw and, in the case of the Z88, it's the flimsy physical construction.

As for the software, I am impressed at what has been crammed into 128k of EPROM (soon to be ROM when the machine goes retail).

If you want a portable micro but don't need a full MS-DOS PC when you're on the move, buy one.

Cambridge Computer is on (0223) 312216. **END**

# £149.95

+ VAT

## Put your PC in its place

FREE  
CHAIR



# Space-Maker

If you're losing ground to your computer, put it smartly in its place with the new Space-Maker desk from Opus. It'll accommodate your system beautifully and still leave lots of room for you.

What's more the Space-Maker is every bit as generous on price as it is on space. At just £149.95+VAT Opus have thought of everything including a free matching chair.

The Space-Maker is a desk for the new PC age, attractively styled and sensibly constructed, as good to work at as it is to look at. A top shelf accommodates both monitor and printer and below, the main desktop is equipped with two smooth-flow paper feed channels.

With an ingenious system to remove all that troublesome keyboard cable and shelves to house both your computer and manuals, there's a remarkable amount of useable desktop space available.

Open the Space-Maker's drawer and you'll find a few more surprises, like the built-in lockable diskette box to safeguard your software and a tidy-tray for all those odds and ends.

This British-built Opus desk also features scratch resistant surfaces, sturdy steel underframes, heavy duty castors and simple assembly. It's designed for all leading PC systems including those from Opus, Amstrad, IBM, Olivetti and Compaq etc.

So if your PC system needs putting in its place call Opus today on **0737-765080** or simply post the coupon below. Delivery in mainland Britain is free and generous education and government discounts are available. We also welcome dealer and export enquiries.

Desk Measurements: Height 27"; Width 47"; Depth 32".

To: Department SP, Opus Supplies Ltd., 53 Ormside Way, Holmesthorpe Industrial Estate, Redhill, Surrey.

Please send me the following:

\_\_\_\_\_ Space-Maker Desk(s) at **£172.44 each** (inc. VAT)

I enclose a cheque for £ \_\_\_\_\_ or please debit my

credit card account with the amount of £ \_\_\_\_\_

My Access  Barclaycard

no. is: (please tick)

Name \_\_\_\_\_

Address \_\_\_\_\_

Telephone \_\_\_\_\_

PCW9187  
**Opus**



# Kurzweil Discover

*The Discover 7320 text and graphics scanner from Xerox subsidiary, Kurzweil, 'learns' typefaces as it goes, and incorporates templates and a dictionary to improve its pattern-matching performance. David Tebbutt describes the workings of this impressive, 'intelligent' product.*

A scanner which teaches itself to recognise most text fonts has got to be worth investigating, even if it does cost around £8000. Unlike other text-recognition scanners, Kurzweil's Discover doesn't hold images of a series of fonts in its memory. Instead, it applies rules relating to the general appearance of letters and uses dictionaries, both embedded and user-defined, to try to make sense of what it's reading.

Again, unlike other scanners, this approach gives Discover the ability to read proportionally spaced text. Where it falls down is that it cannot read draft dot-matrix characters, because the lines and curves of the letters are not continuous.

Discover also handles graphics, producing files in PCX, TIFF and RES formats. These graphic images may be captured as straight black and white — fine for line art — or as continuous tones, for photographs and the like. These tones are encoded in 'dithered' form where the sixteen levels of grey are represented by either random or spiral patterns of dots.

Textual information is encoded according to either IBM's Document Content Architecture (DCA) format or in an ASCII-based, user-defined format. This means that the output files can be read by any word processor and, if a user-defined format is used, will contain control character sequences pertinent to that program. These sequences look after such things as the treatment of tabs, indents, line centring, paragraph ends and page breaks.

## System & set-up

The Discover system comprises a scanner, a PC-compatible plug-in board, a connecting cable and the Discover software. The scanner is a badged Ricoh SS30 which feeds sheets (up to ten) from a hopper on top, out through a slot in the bottom



front edge. This gives the machine the advantages of multiple document handling but the disadvantage of not being able to handle books and periodicals unless they are sliced up.

The processor card is driven by a 68020 processor, controlled by a custom logic array, and carries its own 2Mbytes of memory. An optional 2Mbytes, for faster throughput, may be added as a 'piggy-back' at the non-slot end of the card. The slot end is already taken up with its own piggy-back card containing the scanner logic. This suggests that other, more sophisticated scanners might be in the offing.

Kurzweil has covered the outside face of the piggy-back card with a mylar panel, which is just as well since it only just squeezes in between neighbouring cards.

The nice thing about this single-slot approach is that Discover can scan documents in background mode since all its processing is done on the card, independent of the PC and its bus. Within limits (no resident programs) you may run DOS applications or other parts of the Discover software suite while scanning and analysing your document.

Hooking the system up is so easy that it doesn't warrant description,

and installing the 1Mbyte of software is simply a case of copying it to your hard disk.

## Discover software

The Discover software looks crude at first glance but turns out to be a gem to use. Kurzweil has used the Lotus menu bar approach and then added what I'd call 'route maps and signposts'. This way, you always know where you are among its 150-odd options. Because the screen's only job is to control the Discover hardware and software, it can be dedicated to displaying the options available and how to access them, even if they're not part of the current menu bar. Most programs are forced to compromise between putting user information on the screen (words, graphics, numbers, and so on) and giving operating guidance.

Discover lists, in the body of the screen, all the things you might want to access while in a particular section of the program. Thus, if you choose the 'Settings' option within 'Text scanning', the screen will list 'Contrast', 'Units of Measure', 'Page Height', and so on (see the box for a full list). Alongside each entry is the name of the key you have to press to get nearer to that option.

Similarly, alongside Page Height will be the letter 'P' which selects the 'Page' option from the menu bar. Having pressed this, the menu bar changes and the letter alongside the option will change to 'H' for 'Height'. If you find yourself down the wrong branch of the program, an up arrow alongside the option tells you to press <ESC> to go back up. As you move from level to level and branch to branch, a display on the top line shows the path you followed to get to the current option. For example, when you reach Page Height this path will read:

Main—>Scan—>Text—>Settings—  
>Page

This combination of route map and signposts makes Kurzweil's Discover one of the easiest programs I have ever come across.

## Scanning

Whether scanning text or graphics, you have to input the page measurements and, if appropriate, the window within the page you wish to scan. The window facility can be a great time-saver when scanning graphics because Discover won't waste time scanning outside the window. But when you're trying to scan a page of a magazine, it can be a real pain. You have to describe the position of each rectangular area of text or graphics before scanning it — one rectangle per scan. The Newsprint section in PCW, for example, changes from page to page, which

### Text scanning settings

Main—>Scan—>Text—>Settings

Scanner contrast  
Units of measure  
Page height  
Page width  
Next page number  
Page number increment  
Assurance level  
User lexicon  
Language  
Lexical context  
Text type  
Scanning window

### Graphics scanning settings

Main—>Scan—>Graphics—>  
Settings

Graphics file name  
Graphics file extension  
Scanner contrast  
Units of measure  
Page height  
Page width  
Scanning window  
Graphics resolution  
Tones  
Output format

### Conversion settings

Main—>Convert—>KCP—>  
Detailed settings

Vertical space  
Horizontal space  
Horizontal tab  
Decimal tab  
Centre begin  
Centre end  
Block indent begin  
Block indent end  
Questionable characters  
Illegible characters  
End-of-line hyphens  
Underline begin  
Underline end  
Soft page end  
Soft page end  
Hard page end  
End of line  
End of paragraph  
Beginning mark-up  
Ending mark-up  
Prefix file name  
Suffix file name

means a lot of measuring and re-loading the document. Not to put too fine a point on it, this can be very tedious.

Minor gripes apart, though, scanning is a doddle. You simply feed the document into the scanner and press 'Go'.

If you're scanning graphics, a file of the page or window is created in one of the three formats. You may

set the resolution of the scan to 180, 200, 240 or 300 dots per inch. Dithering is a function of the Ricoh scanner and works just fine. I scanned some photos of my children and found that the spiral dither worked best.

Text scanning is similarly straightforward once the windows have been defined. Unlike graphics, a multiple-paged document may be scanned and, assuming single-column text, you may stack double-sided pages and teach Discover to collate pages read into a correctly sequenced file. This is done by making the page increment '+2' on pass one, then turning the stack over and making the increment '-2' on pass two.

You may vary the level of assurance you find acceptable, and also the way in which the system will flag characters it is unsure of. A 'highlight the next character' sequence is ideal, though you have to experiment to find the right balance between Discover being overconfident and unduly nervous.

You may give the name of one of your own dictionaries; so, for example, if you were to scan names and addresses, you might find it helpful to use a town and county name list. If you are reading unintelligible text, it would help to feed a page or two of normal words first so that Discover can get the hang of the typeface before starting real work. Although Discover theoretically treats each document as a brand new challenge, you can fool it into remembering what it has learnt and applying this knowledge to any subsequent documents.

As well as trying to read the words on the page, Discover also attempts to assess page layout and embed the appropriate format codes in the text. It doesn't always work — I ended up with some quite exotic line spacing and tabs at times. It was a great improvement on getting a string of continuous text, though. Tabs, especially, can be a nightmare because Discover hasn't a clue where they will be set on the target word processor.

## Conversion

When Discover has finished reading a document, you have to convert it into DCA or your own defined format by running it through the associated CONVERT program. One of the nice things about Discover is that you can do this while processing the next document on what Kurzweil calls its Lamprey board. (Lamprey, incidentally, was the code name cooked up by the development team. They wanted to use the name of an animal which formed a symbiotic relationship with another. Too late, the team found out that a Lamprey eventually kills the fish on which it is a parasite.)

Once converted, you can access your word processor, a further con-

## How the Kurzweil Discover works

The most intriguing aspect of Discover is its intelligent character recognition (ICR) system. How on earth does it learn to understand text without any help from the operator?

Firstly, it tries to break the scanned text up into lumps that look like lines, or parts of lines, of text. This can be likened to your standing a few feet away from a document — you can easily see which bits are text lines and which are pictures.

When Discover has stripped out the graphics and general noise from the document, it focuses on the text lines and strips away obvious clutter such as underlines and boxes around the text. In the case of the underline, this information is stored with other details of the current text fragment.

Now Discover analyses the fragments to find word breaks and parcels them into word-like objects called clusters. These tend to be the most active structures in Discover. A cluster manager keeps sending them off for analysis until it finally discovers what they are.

The cluster manager has access to a number of recognition experts, each of which is able to return information about the cluster. When the cluster manager has a number of opinions, it calls on a team of resolvers to help choose between the guesses of the various experts.

The main expert is a topological, or geometric, recogniser. This looks for the number, position and size of loops, identifies concavities, convexities, whether a perimeter reaches certain points in the image, and assesses symmetry. Most of this work is organised as trees of experiments.

One of the key tasks is to identify the baseline. When one or two characters in a word have been recognised, the baseline becomes obvious and greatly simplifies the recognition of other characters.

The trickiest things to recognise are broken and touching characters. A fragmentation expert has to figure out what the broken character is closest to in the one case, and decide where to split characters in the other. Some of the results can be quite bizarre. The 'P' in Prolog, for example, came out as 'l' followed by an apostrophe when I scanned a PCW page. Common ligatures, where two letters are always joined in typesetting, are easily handled because Discover is programmed to expect them.

Ambiguities are handled by the resolvers. For example, it is darned difficult for Discover to differentiate between 'e', 'c' and 'o'. Some 'e's, for example don't have closed loops. This is where statistical information about letter frequencies and common sequences come into play.

When the lexical resolver is given a 'word', it looks it up in the dictionary and passes the result up to the main resolver. A successful match will then spread the good news around, reinforcing the shape recognition expertise of the program.

But, if the lexical resolver fails to find a match, the main resolver will try other, less likely, possibilities. If it still draws a blank, it might decide to change decisions made by lower-

level experts. For example, it may decide that word breaks should be altered, either by merging two 'words' into one, or by splitting one into two.

As you can see, the whole process is recursive and, as each new piece of information is discovered, old unresolved clusters are re-examined until, hopefully, the whole page makes sense. Discover does this analysis on a page by page basis, accumulating its findings for the duration of a document.

You can, however, fool Discover into remembering information between documents by 'interrupting' work on a document. This creates three temporary disk files: one contains the page format analysis; another contains the parameters set by the user; and the third contains the important stuff — the character descriptions discovered so far. Judicious deleting and renaming of files enables you to use them on a new document but, since it usually only takes half a page or so to train Discover, you would need a special reason for doing it.

Discover knows the difference between numbers and letters and will arrange numbers into columns if appropriate. It also knows that '1st', for example, is acceptable and doesn't try to turn it into 'lst'. This means that it will also accept '2st' which perhaps isn't so smart. When scanning mixtures of numbers and letters it can sometimes have problems with 'l' and 'i'. January i makes more sense to Discover than January 1, for example, though it should know not to accept the word 'i'.

Recognising words is only part of the Discover story, though. The program also analyses the layout of the page so that it can approximate this layout in the output document. To keep track of the page, Discover maintains a network of paragraph hypotheses. For example, an end of paragraph after the second line leads to an expectation of an end of paragraph after the fourth or fifth line. As the analysis proceeds, it uses earlier discoveries to help it decide the likelihood of its new hypotheses.

The system is far from foolproof. The text in one ordinary letter I scanned had an exceedingly ragged right edge. Discover decided that the first line actually constituted a paragraph and tucked a double-line feed at the end. The program then had a high expectation that each line was a paragraph, so the actual paragraph it was analysing ended up double-spaced.

The system already has the logic necessary to make it interface well with desktop publishing systems. Because it can recognise indents and vertical spacing, it clearly has the potential to help build DTP style sheets. But, since Discover works on general character shapes, it is unlikely to help much when it comes to identifying fonts or distinguishing between bold and normal type.

Don't get the wrong idea: Discover is clever and useful, and, by fiddling with the user parameters, you can get it to produce quite good results. I think we can expect to see regular improvements to the product, though, especially in the areas of text formatting, DTP interfaces and the ability to scan existing graphic image files for textual content.

version program (DCA to something else, perhaps) or a comms program directly from the Discover menus. It will automatically pick up the last file converted for further processing. You may also use a 'back door' to DOS, but don't try to load resident programs because you might not get back again.

I had problems with some resident programs but SideKick seemed to hold up all right provided I loaded it first. Kurzweil seemed doubtful when I mentioned this so I'd suggest you take great care. Again, processing can take place on the Lamprey board while you are performing any of these activities.

Finally, you can run Discover from a command line in DOS by providing a document name and, optionally, the name of the parameter file you wish to use. In the event of a paper

jam or other mechanical problem, jobs can be restarted from the current DOS application by pressing a hot-key combination.

## Conclusion

At more than £8000 and an annual maintenance cost of 12 per cent, based on delivery to Kurzweil, this machine has been priced beyond the reach of most single PC users. It is targeted at those work groups who can't justify the £20,000 needed for big brother, the Kurzweil 4000.

The scanner scores over flat-beds and the DEST because it can read up to ten pages at a time, but it loses points because it can't handle books and magazines. Discover scores over conventional OCR systems because it isn't limited to a rigid set of typefaces but can learn most things you give it in reasonable time, and can

handle proportionally spaced text. On the other hand, it can't read draft dot matrix material.

My guess is that the most likely buyers are going to be those who need to share the device in a work group which requires relatively straightforward data capture from single-column typeset material. Those who can tolerate a high degree of operator intervention might consider using it for more complex work.

My view on the price is that if it's the only machine that can do your job, then you don't have a lot of choice. And if, as I suspect, the sales volume is going to be quite low, then Kurzweil would be mad to pitch it at the kind of price more common in the PC market-place.

Kurzweil is on (0734) 668421.

END



# The new Eizo Flexscan monitor keeping an eye on the future- helping you live with the past

New technology, with all its benefits, has a habit of making existing technology obsolete before it need be. This can leave you with an uncomfortable choice between relying on your existing technology or investing in the new, with the obvious costs involved in either option.

Eizo have solved that problem. By tailoring leading edge monitor technology to users' needs they have produced a new, highly versatile 14" multi-sync colour monitor - The Eizo FLEXSCAN.

The FLEXSCAN is an unbeatable combination of quality, style, value for money and true versatility with both the future and the past built-in. Providing you with one monitor to suit almost all PCs and applications past, present and future.

Not only is the FLEXSCAN compatible with the new IBM PS/2 series, but when used with EIZO utility software produces a far superior resolution (upto 1056 x 480 pixels). In addition to this the FLEXSCAN combined with an EGA board and any IBM pc or compatible, will produce a resolution equal to the PS/2 monitor.

The FLEXSCAN works with all major software and all current graphics standards - CGA, MDA, Hercules, EGA, PGC and VGA right up to tomorrow's standard of 35 KHz bandwidth.

So whatever your PC now or in the future, whatever the software or application, from wordprocessing to CAD/CAM the FLEXSCAN will outperform the rest and for a lot less than you might think.

**DDL**

Distributed in the UK by Data Distributors Limited, 710 Birchwood Boulevard, Birchwood, Warrington WA3 7PY. Dealer enquiries welcome.

# Memory media

*Optical disk technology is still in its infancy — and prohibitively expensive for most users — but in a few years' time it could well replace conventional methods of magnetic data storage. Nick Hampshire looks at the application and potential of two forms of optical media: the CD-ROM and the WORM drive.*

The idea of having over 500Mbytes of data storage attached to your personal computer may seem to be a prospect that is both exciting and a little daunting. After all, that is sufficient memory to store over a quarter of a million pages of written text — or enough books to fill over 50 feet of shelf space. However, this is the prospect offered by optical disk technology — an entirely new form of computer data storage media, a media which uses light rather than magnetism.

This media, in the form of the audio compact disc, has become familiar to most of us as a means of reproducing, and economically mass distributing, very high-quality sound recordings. The use of this technology for computer data storage has been a subject of much discussion over the last ten years, but little has been seen apart from a few very complex and expensive products aimed at the mainframe computer market. However, in the last two years this technology has started to become a reality, and promises to bring to personal computer users enormous data storage capacity and economical access to large commercial databases.

The development of optical disk technology for personal computer data storage has resulted in two different forms of optical drive and media. The most widely available and best developed is the CD-ROM. This is a read-only form of optical media which has been directly developed from the audio CD and is being used by an increasingly wide range of information suppliers to commercially disseminate very large databases.

The other form of optical disk tech-

nology is just beginning to come on the market and is called WORM, which stands for Write Once Read Many. As this name implies, it is possible for the user to write data onto such optical disks as well as read data from them.

## Applications

Visually, a CD-ROM is identical to a standard audio CD: it is a 12cm disk of plastic with a metallised layer sandwiched in the middle. The digital data is recorded on this reflective metallic layer on a long spiral track, with over 16,000 turns of the spiral on each inch of the disk surface. The data is stored on this spiral track as a sequence of tiny pits in the reflective metallic layer; these are read by a laser beam which scans along the track. Each pit corresponds approximately to a single 'one bit' and each reflective space to a 'zero bit'.

CD-ROMs are likely to attract a considerable number of users even though they cannot be used for recording user data; one reason being that they offer a serious challenge to online databases and microfilm for the supply of specialist information. It is far more economical to put a 500Mbyte database onto a CD-ROM and distribute it to a range of customers than to perform an update of their databases using telecommunications links. To some extent the widespread application of CD-ROMs will be at the expense of datacom facilities and services. Data communications will only retain the advantage when database updates are very frequent.

The vast storage capacity of CD-ROMs, coupled with the relatively low cost of producing and distributing



them, makes the optical disk the ideal medium for supplying databases which are not subject to rapid change. Databases which are suitable for putting on CD-ROM range from parts catalogues through collections of scientific abstracts, lists of all current books in print, and the financial history of all public companies.

The list of databases which are being placed on CD-ROM is growing daily. So far most are internal applications within large companies, but an increasing number are now being sold to the general public as either one-off publications or information subscription services.

Another area of application for CD-ROMs is as computer-based reference books, which range from encyclopaedias and dictionaries to trade directories. Typical of this type of product is Microsoft's Bookshelf, which provides the user with a range of standard reference books on a single CD which can be transparently accessed from a word processor or other program. The retrieved text can be examined and, if required, pasted into the user's text. The reference books available on this CD include a full dictionary, a thesaurus, a dictionary of quotations, works on writing style, grammar, an almanac of useful up-to-date information, plus a comprehensive guide to the best sources of busi-





ness information. At the moment this is a US-orientated product, but it will not be long before a UK or European version is produced.

The price of material being produced for CD-ROM varies from under £100 to several thousand pounds; again, as the volume of sales increases, so prices should fall.

For the publisher, CD-ROM technology offers a whole new publishing medium which can integrate standard text with static or animated graphics as well as sound or speech. Drive manufacturers are already producing hardware which can output high-quality sound as well as digital data, and a technique was recently demonstrated for storing up to 30 minutes of video film on a single disk, thereby opening up further opportunities for the publication of interactive video products.

The CD-ROM is also a product which is quite cheap to produce, thanks mainly to the enormous investment which has already been made in facilities to mass produce and master audio CDs. Cost savings resulting from the similarity between audio CDs and CD-ROMs have also substantially reduced the cost of CD-ROM drives, where the hardware and much of the electronics are identical for the two applications.

Now let's look at WORM drives. Data

is stored on a WORM disk in much the same manner as on a CD-ROM: as a long spiral of pits in a reflective metallic layer. The disks are, however, slightly larger at 5¼ins and the metallic layer is a special alloy of Selenium-Tellurium which is sandwiched between two sheets of glass mounted in a protective cartridge. The special metallic film has been designed to easily evaporate and produce small pits when exposed to the light from a low-power laser.

Whereas the CD-ROM is essentially a means of cheaply and easily distributing large amounts of information, the WORM disk is a mass data storage device which complements existing magnetic data storage in the form of either floppy or hard disks. WORM disks will probably find their greatest application in creating information and data archives, where they will be used to replace paper and microfilm.

This is potentially a very large market since over 95 per cent of the world's information is still stored on either paper or microfilm. The use of optical disks for such data archiving will have radical effects on the way people utilise and retrieve information since, like CD-ROMs, the WORM disks are also able to store digitised images, sounds and computer programs.

Although the user can write data onto a WORM disk, it is impossible to

change the data once it has been written without writing a new copy of it. This means that systems utilising WORM disks will store a full record of all changes which have been made to a database. This feature will prove very attractive to financial users since it will automatically provide them with data security and a full audit trail.

WORM drives will also find considerable use in applications where it is necessary to have a large file of library data. These include CAD programs which usually require extensive libraries of sub-assemblies and components. Another potential area of application which is likely to develop over the next few years is artificial intelligence, with intelligent databases and systems which incorporate rudimentary common sense. This is another application where the archival recording of all previous consultations could prove valuable.

### Optical disk hardware

CD-ROM disk drives for personal computers have been *commercially* available for nearly three years. The reason why they have not been *widely* available was not that they were initially rather expensive, but that until September 1986 there was no internationally agreed standard for CD-ROMs. This lack of standards held up development of the market, as pub-

# FUTURE TECHNOLOGY

lishers of CD-ROM material were unwilling to invest in the production of disks in a range of different formats. The standards agreed by an association of all the major drive manufacturers and software companies known as the High Sierra Group and published as the *Yellow Book* have now removed this constraint, and sales of both drives and CD-ROM publications are starting to boom. One manufacturer alone, Hitachi, is making over 5000 drives a month and has plans for substantial increases in this volume of production.

As the volume of drive production increases, so the price of drive hardware will fall from the current level of about £1000 to a price similar to that currently charged for audio CD drives. Concurrent with its announcement of increased production, Hitachi has dropped the price of its CDR-2500S drives by five per cent to £895.

The production of WORM drives is, however, still suffering from a lack of international standards, although it is expected that such standards will be agreed in the early autumn of this year. WORM drives are, however, far more complex than CD-ROM drives and do not benefit from being able to share components with audio CDs. It is therefore unlikely that the cost of such drives will fall to the same degree; the current price is between £2000 and £3000 each.

A typical product is the WORM drive just launched by Hitachi, the OD101, a 5¼in 600Mbyte IBM PC-compatible drive which has an OEM price of £2000. Any cost reduction here will depend on how quickly a large PC manufacturer like IBM ships WORM drives as a component in its systems, plus the ready availability of WORM drive support software — both of which will be needed to generate volume sales.

Most CD-ROM and WORM drives are able to interface to IBM PCs and compatibles. Drives are either connected directly to the PC using a plug-in card or by means of the SCSI (small computer systems interface). Both methods work equally satisfactorily, although it is likely that the SCSI interface will eventually become the standard in much the same way that magnetic disk drives are increasingly adopting *this* interface standard. Manufacturers are producing CD-ROM and WORM drives for either full-height mounting within a PC or as separate standalone units.

## Comparison

Besides the greatly increased storage capacity of optical media, in excess of ten times that of a magnetic hard disk of comparable size, the principle difference between optical media and magnetic media is that optical media is currently non-erasable. This non-

volatility imposes limitations on the user which make it particularly important that designers of optical disk-based systems do not think of optical media in terms of conventional magnetic disk usage and programming practices. This primarily means that optical disks cannot be used as virtual memory in the way that most system designers use magnetic disks.

Virtual memory systems are those where disk storage is used to enlarge the system's memory by temporarily storing any data which is not currently required by the program. As soon as this data is required it is loaded back into RAM, a process which is entirely transparent to the user.

The non-volatility of optical disks also means that their file structure has to be carefully designed in order to make the best use of the system. Many CD-ROM systems exhibit poor performance because of the designers' 'magnetic disk think' which has considerably reduced the optical disk's performance. This file structure is further complicated by the large amount of data which can be stored on an optical disk and the fact that the data is stored in what is essentially a serial format.

The differences between optical disks and magnetic media mean that they cannot, given the current state of development, be considered as replacements for conventional magnetic disks. Optical disks must instead be seen as complementary products which have their own unique strengths in certain specific applications, and which overcome some of the weaknesses of magnetic disks.

The non-volatility and relative robustness of optical media has given it considerable appeal in applications involving data archiving. The reliable life of magnetic media is quite short — it is usually recommended that valuable data is re-recorded every four years. Optical media has a much longer life — well over ten years — and is far less vulnerable to environmental hazards such as magnetic fields or X-rays than any other form of data storage.

Initially there were some doubts about the life expectancy of optical disks due to micro-cracking of the plastic substrate and consequent oxidation of the metallic layer, but research and improved production techniques have now virtually eliminated this problem.

However, because of this initial doubt, a very powerful error-correction technique was built into the design of optical data disks. This error-correction procedure is able to reconstruct the data in corrupted blocks as large as 400 bytes, which is well in excess of any data loss which could result from any age-induced micro-cracks.

Relative to conventional magnetic

media, optical media is still quite expensive. WORM disks cost over £100 each, although as volume production increases this is expected to fall to about £25 within the next 18 months. The cost of CD-ROMs is not really comparable since the cost of creating a master has to be added to the cost of each individual disk.

Creation of the CD master from the digital data supplied by the information publisher costs about £3000. This mastering process converts standard digital data into the format in which it is internally stored on a CD-ROM, and adds the error-correction coding as well as creating a glass master from which disk copies will be pressed. For a hundred copies of this disk there is then a unit charge of about £15.

## CLV & CAV recording techniques

In order to understand why it is undesirable to think of optical disks in terms of the more familiar magnetic disks, it is necessary to look at how data is stored on an optical disk. Because of the digital audio parentage of CD-ROMs, the data is stored sequentially as a long spiral (this is identical to the spiral track which can be seen on any conventional record). For music recording this format is essential, but for computer data recording it imposes severe limitations on the disk's performance, particularly when attempting to perform random access of disk data.

The data format of an optical disk is based on constant linear velocity, or CLV, recording, which differs from magnetic disks which use constant angular velocity, or CAV. The difference between these two formats is shown in the box on the opposite page. With a CAV format the disk has a constant rotational speed, which means that the linear velocity of the head relative to the disk surface is greater on the outside tracks than on the inside tracks. With a CLV format the relative speed of the disk head relative to the disk surface remains constant, irrespective of whether the head is on the outside or inside tracks of the disk.

A CD-ROM drive maintains this CLV by changing the disk's rotational speed as the head moves across the disk, a feat achieved by the drive's sophisticated control electronics. Since the speed at which the head moves across the surface of the disk is constant, so the linear length of each sector on the disk is the same. The number of sectors encountered on a single rotation therefore varies from nine on the inside of the disk to about twenty on the outside, thereby achieving the maximum possible data storage density. This is also the

reason why CLV recording has to be on a spiral track rather than in a series of concentric rings, where the gradual increase in track storage would be impossible.

The advantage of CLV recording is its high data storage density, but this is achieved at the expense of a feature naturally inherent in the CAV format where its organisation makes it easy to find the start of any desired sector. With CAV format it is easy to translate a sector number into a track and sector address, a feature which makes the random accessing and indexing of CAV format disk files a relatively simple procedure.

However, with CLV format files there is no simple relationship between a CLV track and the number of sectors on that track, and thus no method of translating a sector number into a track and sector address. This accounts for the relatively slow 'seek' times shown by CD-ROMs, a problem which is compounded by the fact that the mechanical movement of the head must be accompanied by a change in the rotational speed of the disk.

The use of a CLV format by CD-ROMs means that we cannot apply the familiar concepts of track and sector, or cylinder, surface and sector addressing schemes to them. In fact, it is probably best to think of a CD-ROM's data storage in terms of a serial tape device. This concept is reinforced by the digital audio origins of the CD-ROM, which have resulted in the disk having a 60-minute 'playing time', each minute of this recording being divided into 60 'seconds' and each second accessing 75 sectors, with each sector containing 2k of data.

A CD-ROM can hold 270,000 sectors of 552,960,000 bytes of data. The CD-ROM drive electronics allow the user to address any sector on the disk, a 2k sector being the smallest addressable unit. The required sector

is addressed by specifying it in terms of the minute of play in which it is located, the second within that minute and the sector within that second. The first sector on the disk would thus have the address 00:00:00 or zero minutes, zero seconds and sector zero; the 15465th sector would have the address 03:26:15 or three minutes, 26 seconds and sector 15, which is calculated by:

$$(3 \times 60 \times 75) + (26 \times 75) + 15 = 15465.$$

The average user of CD-ROMs does not have to worry about the physical organisation of data on a CD-ROM since this is usually converted to a logical view by an operating system such as Microsoft Extensions, which is a version of the familiar MS-DOS which has been designed for optical disks. This allows the user to view the disk as a collection of named files rather than as a set of numbered sectors. However, an understanding of the physical characteristics and constraints of the CD-ROM's format is essential if the designer of CD-ROM systems is to get the optimum performance from the system.

## Design

Faced with over 500Mbytes of storage and the unavoidably slow search times inherent in optical disk systems, it is vital that the design of the data structure and associated indexing is made as efficient as possible. These problems are particularly acute in WORM disk systems where the user has the further complications of directory management, and file updating with a write-once non-volatile media.

The designer of a CD-ROM database can obtain an off-the-shelf database system into which he or she can simply slot his or her own data and data indexing. Operating system software is also available to handle file access on CD-ROMs. Following

the High Sierra agreement on CD-ROM standards, Microsoft has announced an extension to its MS-DOS 3.2 which allows users to access the entire 550Mbytes on a CD-ROM, thereby overcoming the previous 32Mbyte file size limitation of standard MS-DOS. With this new operating system, the CD-ROM appears to the user exactly like a large magnetic disk drive.

No such assistance exists for users of WORM drives, who are left to sort out the complexities of the system for themselves. The problems associated with handling a media where data once written is not erasable or amendable, require a whole new range of techniques. Until there is agreement on an international standard for 5¼in WORM disks, it is unlikely that any of the software companies will make the investment in producing WORM drive operating systems and support software.

One of the problems encountered in using WORM drives is that the smallest addressable unit on an optical disk is a 2k block, a limitation which is essentially imposed by the error-correction system. Each 2k block is actually 2352 bytes long, the extra bytes being devoted to the error-correction code for that block.

The error-correction technique is a fairly complex and very powerful procedure. It does, however, create the limitation that once a block on a WORM drive has had data written to it, then it is impossible to add further data to that block because the error-correction code is set up for an entire block during the first write to that block. This error-correction code cannot then be changed to allow the addition of further data to the block. This is not such a serious limitation though, since optical disks have such a large data storage capacity.

A far more serious problem is the slow access time of optical disks. The major culprit is the mechanical

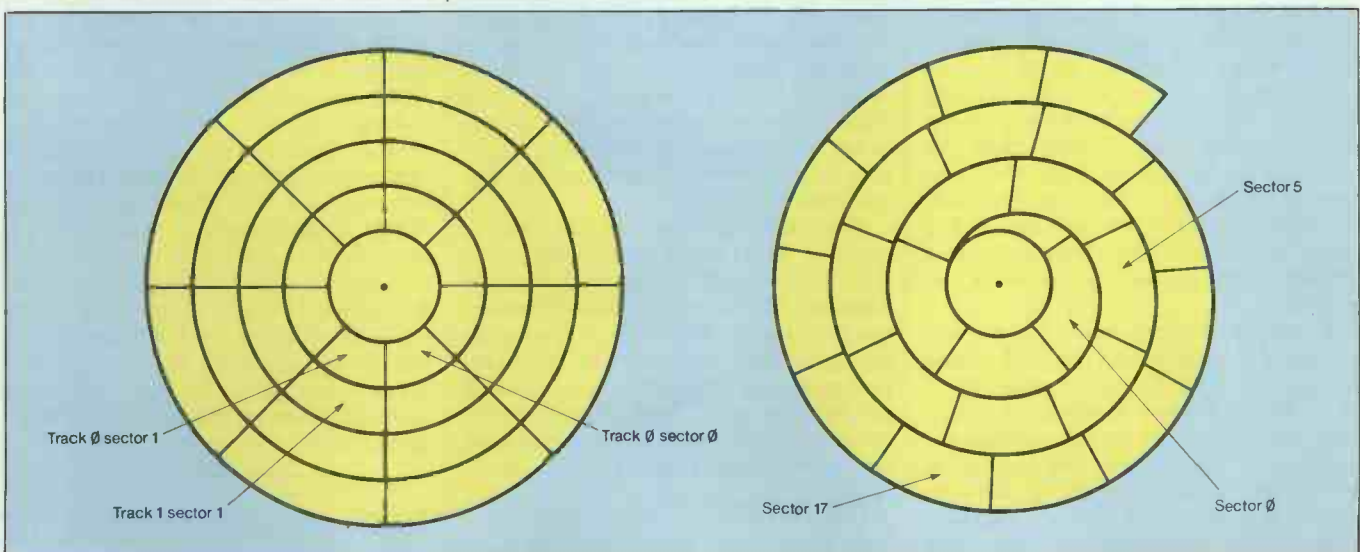

**Left:** Sector organisation of a CAV disk. The sectors on the outer tracks are larger than those on the inner tracks. **Right:** The spiral sector organisation of a CLV disk. All sectors are the same length

# FUTURE TECHNOLOGY

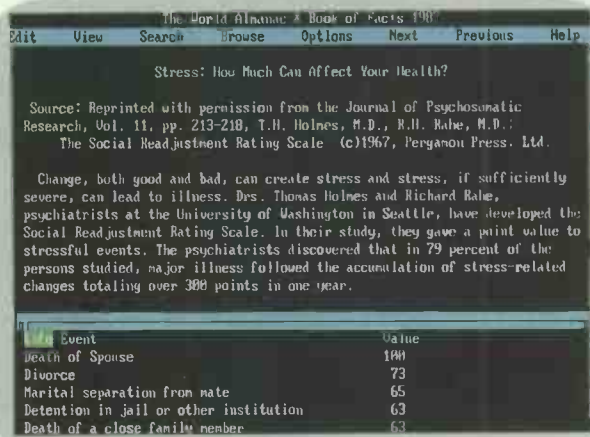

Improve your writing skills and general knowledge with a complete collection of reference sources in the form of the Microsoft Bookshelf CD-ROM Reference Library. This is an example from the World Almanac disk

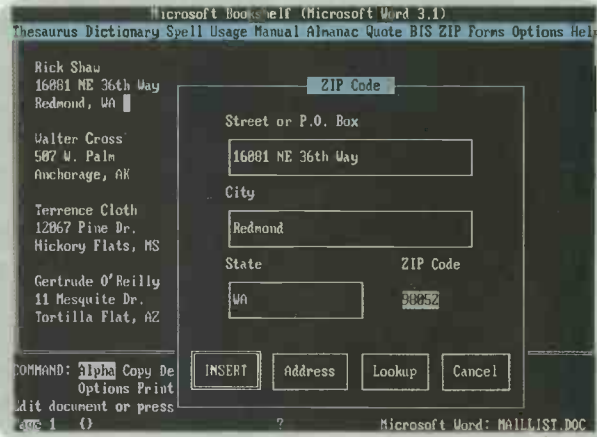

CD-ROM technology allows a phenomenal amount of information to be stored on each Bookshelf disk. The US ZIP Code Directory is just one of the many comprehensive information tools which comprise the Microsoft library

movement of the read head and the necessity to change rotational speed in order to handle the CLV format. The time taken to perform a seek for a block that lies within a few dozen rotations of the current head position is minimal; the large delays occur when moving the head from one side of the disk to the other. If seek times are to be minimised, then the organisation of data on the disk should be such that the majority of seeks are to blocks which lie close to the existing head position (large head movements should be avoided).

The file management technique which can reduce access times is to interleave blocks of data and their associated directories and indexes. This allows rapid access of data associated with a particular directory and longer access times when moving from one directory to another. By grouping related data items together and organising the directories into a tree structure, access time can be reduced to an acceptable level.

Directories of this kind are usually built up using shallow binary trees: however, the type of tree used depends very much on how the user wishes to access data from the disk. Accessing all occurrences of a key word requires different types of tree structure to access single-block records.

Probably the biggest problem encountered by users of WORM drives is that of updating and appending files. There are two techniques which can be applied to updating files on write-once media, and the technique which is chosen depends on the size of the file. With small files occupying just a few megabytes or less, the easiest method is simply to rewrite

the entire updated file onto disk. This approach is easy to implement but should only be used where files are small and updates are infrequent. In situations where updates are frequent, it is best to use magnetic disk storage as a cache memory and then archive the file to optical disk at regular intervals.

An alternative method of updating files on WORM disks is used when the files are large — for example, it is impractical to rewrite a 100Mbyte file when updating just 2k of that file. This technique involves using indexed addressing, which involves creating an index file that contains the address location and sequence of each block of data within the file.

Updating a file using this method simply means rewriting the block of data which is to be updated, replacing the address of the old block in the index file with that of the new block and then rewriting the updated index file. In some systems the index file is stored on magnetic disk in order to reduce the space taken by repeated index rewrites, but this does pose the potential risk that the index will be lost and should, therefore, be avoided unless absolutely necessary.

This technique can also be used to append files since the position of data on the disk is independent of its position in the index file. However, the one major drawback is that scattering blocks of data in different places across the disk (which is likely to happen after frequent updates), necessitates a lot of head movement and, consequently, slows access time.

## The future

The application of optical disk technology to computer data storage is

in its infancy. Large sums of money are being invested by companies like Sony, Kodak, Hitachi and 3M in the development of new optical media, and in particular media which is capable of true multiple read/write. There have been some major advances in the laboratories of these companies over the last few months, and it looks increasingly likely that these new forms of media will start to come onto the market within the next five years.

With the advent of multiple read/write media, the optical disk will at last take its place as a competitor and replacement for magnetic disks.

The other branch of the optical disk family, the CD-ROM, is now a relatively mature technology and has a considerable number of users and manufacturers. This is a product which we will all probably be using within the next few years, with the number of users accelerating rapidly as prices fall and the number of CD-ROM publications increases. Many people have predicted that the CD-ROM will replace books as a publishing medium: this I doubt, but optical disks will certainly occupy an important position in the supply of information. The importance of CD-ROMs in the supply of information is underlined by a recent report from the market research company, Frost & Sullivan, which showed that by 1990, the market for CD-ROMs in the US alone would be worth over \$2.5 billion per year. All the indicators seem to point to the rumblings of an optical disk revolution.

Technical author Nick Hampshire has edited three magazines and written numerous articles. He recently lost contact with the outside world: an engineer hacked his telephone cable in half! **END**

# "THE SYSTEM" from I.Q.

Buy the package - Buy the components. Either way YOU WIN!

**WORLD EXCLUSIVE**

**IQ 161YS**  
Workstation ONLY £283  
Other workstations from ONLY £118  
Brochure on request

**PC 1640**  
21 Megabyte Seagate Hard Drive ONLY £998  
32 Megabyte Seagate Hard Drive ONLY £1,098

**DMP 4000**  
200CPS Dot Matrix  
Printer ONLY £288



**PLUS**  
Personalised Delivery,  
Installation and Initiation  
ONLY £59  
On site servicing contracts  
and training available  
nationwide

**SAVE 5%**  
On all orders for the  
complete package

**IQ 110 CHAIR**  
Pneumatic action with  
heavy duty base ONLY £98



**IQ 161PS Workstation**  
Professional model for wide  
printer ONLY £208

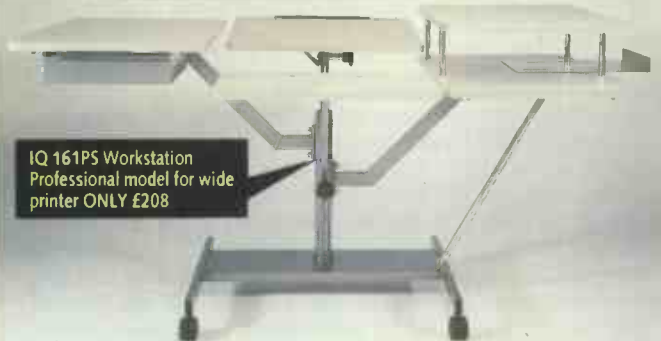

## I.Q. COMPONENTS AND PRICES

### COMPUTERS

AMSTRAD PC 1512, 640K mono, 21 Megabyte Seagate Hard Disc  
ONLY £698  
AMSTRAD PC 1512, 640K mono, 32 Megabyte Seagate Hard Disc  
ONLY £798 For colour monitors add just £150

### PRINTERS

AMSTRAD DMP 3160, 160 CPS Dot Matrix Printer ONLY £199  
STAR NL10 with interface ONLY £238  
MP 26 Daisywheel ONLY £225 All others on request

### SOFTWARE

Pro Packs Plus - Request our comprehensive list of professional business packages with specialist software and support i.e. Pro Pack Lawyer ONLY £1998 (includes everything needed to computerise a Law Practice).

### EXTRAS ALL AT I.Q. PRICES!!

Networks, Tape Back-ups, Modems, Surge Protectors, Turbo Cards, Maths Processors, Plotters, Printers, Furniture, Acoustic Cabinets.



**ORDER NOW**  
FREE Surge Protector and Mouse Pad if  
we receive your order within one month  
of publication date.

Intelligence Quotient (IQ) Ltd., Argyll House, 6-13 Chamber Street,  
London E1 8BW. ☎ 01-480 5516/0860-357148  
Fax: 01-480 5830 Telex: 915183 WICKS'G  
ALSO AT: Ascot Court, 71-73 Middlewich Road, Northwich, Cheshire  
CW9 7BP. ☎ 0606-2777

All prices plus carriage and VAT

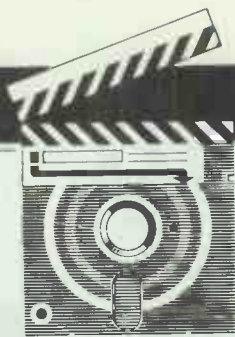

SCREENTEST

# C compilers

*Prices of compilers have plummeted ever since Borland set a realistic precedent with its launch of Turbo Pascal. With the increasing number of C compilers now on the market, prices are falling further. Nick Walker looks at two inexpensive versions against Borland's Turbo C.*

Prior to Borland's launch of Turbo Pascal in 1983, compilers for the PC and compatibles cost at least £500 and were about as friendly as a wild boar in a pigsty. Since then the market for budget-priced compilers has rocketed, and an increasing number are now offering a 'Borland-like' integrated environment. Particularly numerous are C compilers, probably because C has rapidly become the favourite language among hackers, and hackers as a rule don't have vast amounts of money to spend.

This proliferation of C compilers has given Borland's own version of C, Turbo C, more direct competition than any other Borland language. In this review, I've taken Turbo C and compared it with two of its better rivals — Mix C and Zorland C.

## Mix C

Mix C from Mix Software was one of the earliest of the budget-priced C's, and has been available in the US for some time. Now, courtesy of Analytical Engines, it is available in the UK.

## Overview

Three components are required to turn C source code into an executable program: an editor to create the source code; a compiler to reduce the code into a machine-understandable form (object code); and a linker to collect all the relevant object code from other sources such as libraries, and from these create an executable program. Mix C includes a compiler and a linker but no editor,

but any editor capable of producing an ASCII file (all editors in use today, in fact) can be used. Mix Software does produce a program editor at extra cost, and it was this which I used for the review.

The Mix 'Editor' is a general-purpose editor tailored with features which aid the creation of programs, and like many editors and word processors is fully configurable: its initial WordStar-like configuration can be mapped onto any key combination you wish to use.

Because of its common features it isn't necessary to go into too much detail about the Mix Editor, but the following is a description of some of its more appealing features.

Unusually, for a micro-based program editor, the Mix Editor provides a macro command language which allows you to combine existing commands into commonly used combinations. For example, one of the pre-defined macros is BOX: typing 'Esc BOX' prompts you for height and width, and you then use the IBM graphics character to draw a box — a feature I frequently use to highlight comments within a program.

Other useful features include: no restriction on file length; the ability to execute DOS commands or run a program from within the editor; and split-screen operation. A macro called 'CC' allows you to run the Mix C compiler over the text in the editor's memory. When CC is used in conjunction with the split-screen facility, you can display the C source code in one window and compile errors in another. This allows you to display and correct multiple errors — unlike some integrated environments which

stop at the first reported error. The linker and the final program can also be run from within the editor but not from menus such as those found in Zorland C or Borland C.

Mix C is a command-line driven compiler. Unless a '/1' switch is given as an argument, the compiler will list the whole C listing — plus error messages — to the screen, which is fairly meaningless unless you have a degree in speed reading. Mix C is also a single-pass compiler, although like most C compilers it has one very fast pre-processing pass which establishes all external references. Further switches control stack size and destination of the object code.

The IBM PC and its compatibles have what is called a 'segmented' architecture: that is, the whole of the memory area is divided into 64k segments. Compilers which produce code for this architecture have a choice of 'memory models' for the final program (code and data in the same 64k segment; code in one segment, data in another; or code in many segments, data in many segments). Mix C produces object code for one, and *only* one, memory model — the large one (code in many segments, data in many segments), so it is rather inefficient for programs with less than 64k of object code.

The Mix C compiler accepts the full C language as specified in *Kernighan & Richie (K&B)* but with one exception — you cannot use an array element address as an initialiser (a silly thing to do, anyway). Also, the following extensions have been added: support for the enumerated data type (an integer that will only take speci-

```

/* char converts to int */
c1 = 'c';
i1 = c1 - 'a' + 'A';
c3 = i1; /* truncate to character */
printf("c1 = %c, i1 = %d, c3 = %c\n", c1, i1, c3);
i1 = 321;
c2 = i1; /* convert integer to char */
c3 = i1 - 1; /* truncates value */
printf("i1 = %d, c2 = %c, c3 = %c\n",
i1, c2, c3);

/* automatic conversion from int to float */
f1 = 299; /* converted to float */
f2 = 358 * i1; /* 358 converted to float */
/* 7 converted to float - result truncated */
i3 = 3.4 * f1;
/* 358 converted to float - result truncated */

Mix C - Version 2.5.0
(C) Copyright 1985, 1986 by Mix Software

main
No errors detected

(Press any key to continue)

```

Used in conjunction with an editor macro, Mix C offers a crude but effective integrated environment. This is one of the many excellent tutorial programs

```

0 main [source]
1 main() /* Example 2.6 */
2 {
3   int xx, jj;
4   int yy, jj;
5
6   ii = ii + 0;
7
8   xx = jj** **jj;
9   printf("xx = %d, jj = %d, ii =
10
11   yy = jj = xx** **ii + 3;

```

MATRIX C 3126 1-01-87 12:02a  
JUMP C 927 1-01-87 12:02a  
20 File(s) 67584 bytes free

A)ctr exan26

Ctrace - Version 1.0.0  
Software Copyright 1987 Dr. Neil Bennet  
Licensed to MIX Software, Inc.  
Loading file = .....

there are no watchpoints set

Ctrace is an excellent debugger for Mix C only. It maintains six windows of debugging information, of which any four can be onscreen simultaneously

fied named values); structures can be assigned, passed by value to functions, and functions may return structures; locally declared arrays and structures can be initialised; and there are compiler options which allow nested comments, the passing of actual char and float values to a function, and automatic initialisation of local variables to zero.

Mix Software divides the library functions of Mix C into four distinct groups — standard, non-standard, DOS and BIOS. Library header files may contain functions from each group — for example, the 'miscellaneous' library includes: a non-standard random number generator, 'drand'; the C-standard 'exit', to exit a program; 'getcseg' from DOS, to return the current code segment; and the BIOS call, 'sound', to drive the IBM's speaker. Although the functions are listed according to which files they are in, there is no mention of the actual file names in the Mix C manual. Consequently, you have to snoop around before '#include'ing a library file.

The usefulness of any compiler is defined by its system-specific functions. Mix C is particularly well-endowed with numerous pre-defined BIOS calls, DOS functions and non-standard functions as well as all the standard C functions. For the 'real' hackers, there is a general-purpose BIOS call which gives full access to the IBM ROM.

The Mix C linker is an unusual beast in that it doesn't link .OBJ files — the standard files of practically every other compiler and assembler on the market. This means that you can't link your existing routines from other languages. Also, the .MIX files which are created by the Mix C compiler are not linkable with any of the standard linkers.

Most professional C programmers use different manufacturers' compil-

ers and linkers in their own customised set-ups, but this is not possible with Mix C.

The linker can be run as a command-line program: a number of switches can define options to the linker, to control stack size, for example. Unless the '/i' option is included, the linker will produce an executable file that requires the file 'RUNTIME.OVY' in order to run; this gives you very small object files but less portability. Alternatively, for those people who like fine control over the linking process, simply typing 'LINKER' with no arguments will take you to a linker menu screen. All stages of the linker (load file, find functions, run, build, and so on) can be controlled manually.

Although Mix C does include some conditionally compiled diagnostics to aid debugging, an independent debugger is really needed to track down the more elusive bugs. Mix Software provided me with Ctrace, a bolt-on extra for Mix C, and specifying '/t' after the 'compile' and 'link' commands will allow it to do its job.

The program 'CTR' will run Ctrace and it requires your executable file as an argument. Ctrace then maintains six windows of information: position in source code; program output; variables and their values; a 'watch' window that allows you to define a particular set of variables, and a course of action should they reach certain values; a 'symbols' window which shows the address of functions and variables; and a 'memory map' window. Programs can be executed single-step, trace speed or at full speed. Whenever a breakpoint occurs or a watch variable meets its value, a pop-up window appears which specifies exactly what has occurred.

Ctrace includes an animated trace feature which shows you the flow of execution; not just line by line, but

statement by statement. Watching the red cursor follow every movement of the program almost made me want to sing along! What a shame that it's limited to Mix C programs.

Ctrace is by far the most delightful debugger I've come across — I actually found myself enjoying debugging!

## Installation

Mix C requires a 128k MS-DOS computer with one disk drive, but I would advise 256k and two disk drives as working with less can be limiting.

Mix C is the only C compiler I know of that is usable on a floppies-only machine. Unusually, it will run on a generic MS-DOS machine although it obviously won't be able to use any of the IBM BIOS calls. Mix Software also produces a CP/M version of the compiler which is functionally very similar to the one featured here and requires a 55k, CP/M-80, two-drive machine. For floppies-only machines the files are organised correctly, so it's just a matter of copying the disk and getting started. Similarly, installation on a hard disk simply involves copying the files to a suitable directory.

Mix C is not copy-protected and has a simple 'treat me like a book' type copyright notice. Programs created under Mix C do not require a run-time licence and can be freely distributed.

## In use

As a test of compilation speed, linker speed, object code size, execution speed and K&R compatibility, I used the source code of a public domain game called Hack. This consists of approximately 60 C source files and header files with a total source code size of around 700k. Hack was originally written for Microsoft C which, with Lattice C, is one of the tradition-

al heavyweight compilers. (Incidentally, the authors of Hack claim that they haven't overstepped the boundaries of *K&R*.) Under Microsoft C, Hack compiles down to an executable file of 255k. The program embraces a wide range of features including real and transcendental arithmetic, file handling, data structures and even graphics via calls to the BIOS.

The idea behind this 'Hack test' was to see which, if any, problems arose when using the compilers reviewed here on a 'real' application. All three compilers were run from the command line and, where possible, used the 'MAKE' system of showing dependencies and grouping multi-source file compilations.

Mix C performed extremely well, with the Hack Test taking approximately three hours to get the application up and running, including: the creation of a suitable batch file, sorting out the few errors that occurred, and linking the whole system. (The test times for all three compilers can be seen in the box on this page).

Mix C found two errors in the Hack source — and, of course, over such a large application, found them many times. These errors were nested comments and a possible unintentional assignment (using 'if (a=b)' rather than 'if (a==b)'). Both these errors can, in theory, be converted to warnings with the setting of a compiler switch. However, with the switch set, Mix C still objected to some of the nested comments. I eventually solved the problem by putting an extra pair of comment delimiters around the offending code.

I also ran the *Personal Computer World* Benchmarks on all three compilers (see *PCW*, December 1986). In many respects Mix C came off worse: its execution times were the slowest in all tests. Despite the use

of the 'shrink' utility, the executable file size was almost always the biggest, although this was due to the large memory model used and would not be so noticeable on large programs.

On the plus side, though, Mix C is a very fast compiler. If you switch off the listing to the screen it's almost a match for Turbo C, because Mix C operates entirely within memory and creates no intermediate files on disk.

## Expansion

The three utilities supplied with Mix C are 'shrink' (mentioned above), 'speedup' and 'convert'. Shrink takes an object file as input and attempts to optimise it for object code size; the typical space saving is 10-25 per cent. Speedup operates in a similar manner but optimises for speed. (The effectiveness of these routines can be gauged from the test results box.) Convert takes a Mix C-format object code file and turns it into ASCII.

No extra libraries are available with Mix C, although it is compatible enough to run most of the commercial C libraries.

## Documentation

Mix C comes with a 434-page manual in the usual 'budget paperback' form pioneered by Borland. Approximately 150 pages are dedicated to one of the most complete C tutorials I've seen bundled with a compiler.

The rest of the manual consists of a fairly standard C reference section and a comprehensive description of the library functions.

## Price

The Mix C and Ctrace package retails for £34.44, while the split-screen editor costs £22.94. Alternatively, £80.44 will purchase all three programs plus a utility to link assembly code, and an examples disk.

## Zorland C

'No — I want a *real* compiler.' I don't know how many times I have heard that remark after advising someone to buy Zorland C. Despite its low £34.44 price tag, Zorland C is a true compiler and in some ways more at home alongside the £200-plus compilers such as those produced by Lattice or Microsoft, than the two it is pitted against here. Zorland C was initially reviewed in the November 1986 issue of *PCW*, but since then it has developed into Version 2 and has sprouted an integrated 'Borland-like' environment.

## Overview

Zorland C, the cheapest C compiler reviewed here, includes an editor and a compiler but no linker. However, any standard linker can be used, such as the one bundled with MS-DOS. Zorland does provide a linker at additional cost, either as part of the company's 'Developer's Upgrade' or separately, and it was this linker which I used during this review.

Zorland C Version 1.0 had a primitive WordStar-like editor. Its successor, Version 2.0, has retained the original dozen or so WordStar commands and has added to them, thereby upgrading it into a full-function text editor. The additional commands are available via two-line horizontal Lotus 1-2-3 style menus rather than the more usual pull-down style menus, and can be accessed by 'Alt' key combinations.

Everything you would expect from a text editor is here in the new Zorland C but, for some reason, it still feels a little crude. Perhaps it's the monochrome screen or the speed of operation — very slow with big files.

The menu options include 'compile': the system is configured so that compile calls the linker being used and runs the program if no errors are detected. If an error is detected, the compiler is stopped and the cursor is placed near the error. If the error is a warning, pressing Enter will continue the compilation; otherwise, the error must be corrected and the compiler invoked again.

One word of warning about using the Zorland integrated environment — it does *not* like the presence of any memory-resident programs. SideKick, PC Outline, DeskSet and even Mode would cause it to crash.

Zorland C is a *K&R* implementation, and also features the complete ANSI and Unix System V extensions. Additional features include: the ability to define constant and volatile types (a constant type never changes under any circumstances, and is typically used for data in ROM, whereas

### Benchmarks

	Mix C	Zorland C	Borland Turbo C
Intmath (File size bytes)	0.075 (22561)	0.058 (9600)	0.045 (5484)
Realmath (File size bytes)	5.7 (22824)	4.1 (9744)	3.7 (19288)
Triglog (File size bytes)	101.9 (22735)	68.7 (20244)	26.1 (19356)
Textscrn (File size bytes)	153.1 (22672)	64.1 (9584)	72.3 (5460)
Grafscrn (File size bytes)	12.8 (23271)	—	—
Store (hard disk)	5.3	4.7	4.6
(floppy disk)	14.1	13.0	12.8
(File size bytes)	(24221)	(19871)	(19323)
Hack compiling	48mins 12secs	78mins 35secs	45mins 49secs
Hack linking	25mins 21secs	32mins 9secs	15mins 33secs
File size	(312823)	(275261)	(249888)
	(295661)	(after running 'Shrink')	

All Benchmarks were run on an Amstrad PC with a MiniScribe 30Mbyte h/disk





*Zorland C offers an integrated environment similar to Mix C and Turbo C, but uses 1-2-3 style 'across the screen' menus without windows*



*When used as an integrated environment, Zorland C stops at the first error it finds. This interruption can be tedious on an initial compilation*

a volatile type can change even if the program doesn't, and is exclusively used for memory-mapped devices such as ports); argument checking, for functions; enumerated data types; and void types, for functions which don't return a value.

Zorland C is a two-pass compiler arranged as two separate programs to perform each pass. The £34.44 version of Zorland C is limited to small systems (up to 64k executable code, 64k data), but an additional £19.95 will buy a Developer's Upgrade which provides a further three memory models to exploit the full addressing space of the IBM PC architecture.

Zorland C implements a full range of file-handling, arithmetic and input/output libraries, both standard C format and MS-DOS specific, and the complete library is 98 per cent compatible with the more expensive Lattice C libraries. The Developer's Upgrade contains the full source code for these libraries and means that you can create your own customised libraries. While the Zorland libraries do include the necessary DOS and BIOS calls, these are limited to low-level calls — for example, there are no graphics mode calls. This can be a little off-putting for beginners, as consequently there is no easy way to access the more interesting 'goodies' of the machine.

As I have already explained, no linker is supplied as standard with Zorland C but the program's object code files conform to the MS-DOS standard. This means that the linker supplied with MS-DOS operates fine; it also means that the object code from other compilers and assemblers can be linked in.

The cut-down MS-DOS shipped with the Amstrad PC1512 does not include a linker. For this reason, Zorland has produced its own much-improved version of the 'LINK' prog-

ramming facility which is roughly twice as fast as Microsoft's and includes a simple 'librarian' to help create your own libraries.

The one component missing from the Zorland collection, even at extra cost, is a debugger. Unfortunately, the recommended conditionally compiled commands are not really adequate for any serious debugging. If only Mix C's Ctrace would work with other compilers, things wouldn't be so bad, but as it is you could end up paying more for a decent debugger than for a complete, upgraded Zorland C.

### *Installation*

Zorland quotes no minimum-system configuration but, as far as I can determine, a twin-floppy 256k IBM PC or compatible is the basic system required in order to use Zorland C successfully. To get the most out of it, you really need a hard-disk system.

There is no copy-protection on any Zorland product, so installing the C compiler is just a matter of copying the file over or, if you're feeling lazy, running the 'Install' program. I recommend separate directories for libraries and source code, but this means changing the path within 'CONFIG.SYS' as Zorland C doesn't really understand directories. Not unsurprisingly for a company called Zorland, the licensing agreement is a clone of Borland's aforementioned 'no-nonsense, treat me like a book' agreement. This allows you to use the program on the machine of your choice, provided it is never in use on two machines at the same time.

Programs created with Zorland C can be freely distributed.

### *In use*

Zorland C made a valiant attempt to compile the Hack system, throwing up warnings about nested comments and then deciding that one of the

nested comments was in fact an error. Zorland C doesn't include an option allowing nested comments, so I had to go through the source, 'un-nesting' wherever they occurred. This tedious process, combined with the slowest compiling time of the three programs, meant that it took me about 5½ hours to get the game up and running.

Interestingly, memory-resident programs wouldn't work with the Zorland version of Hack whereas they would with the Borland and Mix implementations.

The execution times of Zorland C programs are fast: it consistently beat Mix C, and independent sources assure me that Zorland C produces quicker programs than either Lattice C or Microsoft C. However, with the exception of the 'Textscrn' text mode screen-handling routine, Turbo C had the upper edge.

Don't let this put you off, though — Zorland C produces fast, compact, executable programs.

Two utilities which have been borrowed from the Unix C environment, 'MAKE' and 'TOUCH', give Zorland C a very professional feel. MAKE is an automatic program maintenance facility that comes into its own on large systems spread across many source files. Rather than re-compiling the complete system, in just one source file MAKE will determine which files have changed since the last compilation, which files depend on them, and then compile just the requisite files.

TOUCH changes the last modified date to the current date, and so forces compilation.

An optimiser can be purchased at extra cost, and performs a third pass on the compiler code, so improving execution speed. Unfortunately, this wasn't supplied with the review package, so I am unable to comment on its effectiveness.

# SCREENTEST

## Expansion

There are two additional libraries for Zorland C. The BTREE/ISAM Database provides the facilities of a simple database, such as indexing. Zorland Windows gives easy controls for the creation and manipulation of ANSI character windows, and also provides a Lotus 1-2-3 menu control.

## Documentation

Zorland C's accompanying literature is a 350-page manual. A rather feeble tutorial occupies the first 80 pages, but otherwise the rest of the book is adequate. The technical information for the professional C programmer is excellent, and includes a discussion of such problems as producing ROM-able code, memory model difficulties and linking other languages.

## Price

In its cut-down form Zorland C costs £34.44, but I would recommend the power package. This includes the fast Zorland linker, all four memory models and the full source code for the libraries and retails at £68.94. Alternatively, the memory model upgrade on its own costs £22.94.

Zorland also sells a linker/librarian for £22.94, the database and the Windows libraries for £34.44 each, and an optimiser at £34.44.

## Borland Turbo C

It's an interesting reflection of the state of the software market that Borland's Turbo C is the most expensive of the three compilers reviewed here. While everyone else has cut their prices to less than Borland's, Borland hasn't budged from the £80-£100 price bracket that established the

budget PC software market. Still, why reduce the price when the product is selling so well?

## Overview

Turbo C is the most complete of the three programs tested and comprises a compiler (in both integrated environment and command-line versions), an editor, a linker and a number of extra utilities, all as standard. Professional programmers will be pleased that this Borland language incorporates a command-line-driven version. The integrated environment is fine for small applications, but most larger applications are controlled by custom batch files.

The editor supplied with Turbo C is an integral part of the Borland integrated environment and can't be used in any other way. The default editor window occupies the upper two thirds of the screen and is 80 columns wide. This is an improvement over programs such as Turbo-Prolog which default to a quarter-screen editing window. The bottom third of the screen is used for reporting error messages.

As with all recent Borland languages, all windows can be resized as required.

The Turbo C editor has the most complete WordStar command set of the three programs looked at here. It is also the most program-orientated, with such features as auto-indent and very fast handling of large files. There is no facility to customise the control commands, so if your favourite word processor happens to be WordPerfect, you're stuck with having to learn WordStar. Perhaps this lack of configurability has to do with the forthcoming Borland word processor, Sprint, which is very, very configurable.

The compiler, linker and practically all other aspects of the Turbo C system can be called into action via the pull-down menus at the top of the screen. These can be called up either by Alt and the first letter of the menu or by hitting F10. In either case, the cursor keys are used to navigate around the menus while the Return key selects the desired entry.

Turbo C is a single-pass compiler which conforms to the K&R standard. It creates standard .OBJ files which can be linked in with other object files. Borland has implemented all the ANSI extensions and, as far as I can tell, all the Unix System V extension are included, although Borland makes no mention of this.

Borland C has the richest choice of memory models, capable of producing six different memory mappings for an executable file. These models are labelled 'Tiny', 'Small', 'Medium', 'Compact', 'Large' and 'Huge'.

Turbo C has too many additional facilities over and above K&R and ANSI standards to mention here, but suffice it to say that they include nested comments and more-relaxed identifier-naming conventions. Also, Turbo C is the only compiler of the three capable of producing 80286 protected mode object code for use with the full 16Mbyte address space of this processor. This will be a great asset for those people interested in upgrading to OS/2 when it becomes available.

When using the integrated environment, the Turbo C compiler reports all its errors in the lower window. It is possible to specify a certain number of errors, after which the compiler gives up and allows you to correct the errors made so far. This is particularly useful in the initial stages of program development because of the

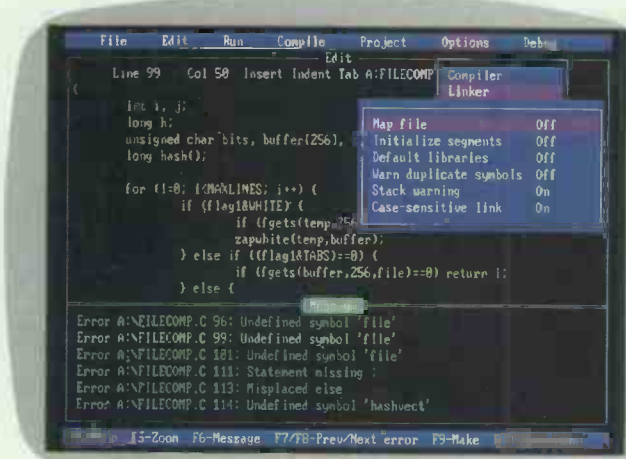

The Turbo C version of Borland's integrated environment is the best yet, with 80-column default windows and the most comprehensive control menus

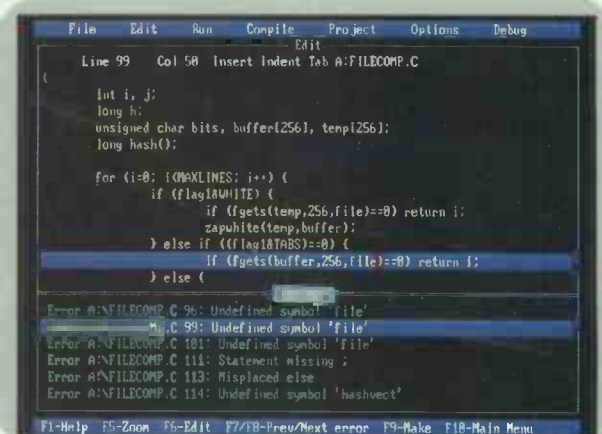

The Turbo C pull-down menus, plus the reporting of multiple source errors. You can set a maximum limit on the number of errors reported

knock-on effect of certain errors in C.

One wonderful feature of the Turbo C integrated environment is the ease with which you can test individual functions and procedures. With a little effort, you can ask Turbo C to prompt you for a procedures argument and then print the results you wish to see. This feature alone could save hours of development time.

In terms of the quality of functions provided, Turbo C has the most comprehensive library of the three compilers. However, the Turbo C and Zorland C libraries share that same failing — they are both too low-level. I know that C has been likened to a high-level assembler but, nonetheless, it is very frustrating, for example, not to be able to run the PCW graphics Benchmark, Grafscrn, because there is no 'plot' command.

The Turbo C linker, like the compiler, can be run from the integrated environment or as a command-line program. Borland describes the linker as 'lean and mean', which is fairly accurate as it's very fast, although it does lack a lot of the 'bells and whistles' of other linkers.

No debugger is included with Turbo C, although the program does have a decent collection of optional compiler directives to aid debugging.

## Installation

Turbo C requires 384k or more of memory and a single floppy; any serious work requires a hard disk. For a Borland product installation was quite complex, requiring a different kind of file from each of the four disks to be copied into different directories. No installation batch file was provided.

Turbo C is not copy-protected and has a simple licensing schedule that forbids running two copies of the program at the same time. Any programs developed under Turbo C can be freely distributed or sold.

## In use

It took less than an hour to get the Hack program up and running with Turbo C, and the program compiled the Hack C source code first time without so much as a squeak. This was an impressive performance.

Turbo C also lived up to its 'Turbo' label when running the PCW Bench-



## Specifications

Passes (compiler)	1	2	1
Creates .OBJ files	No	Yes	Yes
Memory models	1	4 <sub>1</sub>	6
8087/80287 support	No	Yes	Yes
ROM code generation	No	Yes	No
Integrated development environment	Yes	Yes	Yes
Kernighan & Richie standard	Yes	Yes	Yes
ANSI extensions	Yes	Yes	Yes
MAKE utility	No	Yes	Yes
Command-line operation	Yes	Yes	Yes
Approx number of lines per second being compiled <sub>2</sub>	3500	1800	6500
Library source code	No	Yes <sub>1</sub>	No <sub>3</sub>
Size optimisation	No	Yes	No
Speed optimisation	Yes	No <sub>4</sub>	Yes
Number of library functions	190	210	390
Graphics functions	Yes	No	No
Number of compiler error messages	80	105	130
8087/80287 co-processor support	No	Yes	Yes
80286 protected mode code generation	No	No	Yes

1 Only with the Developer's Upgrade or the professional pack

2 With a meaningless large single file containing no include files

3 Available at an extra cost of £200

4 An optional optimiser is available from Zorland at extra cost

marks. In all tests bar one (Textscrn), the Borland product came out on top.

## Expansion

Included as standard with Turbo C are the TOUCH and MAKE utilities familiar to C programmers in a Unix environment. Between them these utilities take a lot of the effort out of maintaining a large system, as they can be configured to compile only the files which have been affected by any change. I particularly like the inclusion of a 'baby' MAKE facility within the integrated environment, as this allows beginners to become familiar with the concept.

Borland usually releases a set of additional libraries for numeric work, graphics, database design, and so on, some time after the release of a language. In the case of Turbo C, the company hopes to have a collection similar to that of Turbo Pascal released by 1988.

## Documentation

Over 700 pages of documentation is supplied with Turbo C in the form of two manuals, a *User Guide* and a *Reference Guide*. My only criticism is of the tutorial which is good but far too short, and the wealth of advice it contains on using Turbo C with other languages is directed only at Borland products.

Overall, though, the manuals are excellent, and cover most aspects of using Turbo C. In places, they were interesting enough to be read as guides to programming the PC.

## Price

Borland C retails for £89.95, and the source code for the libraries can be purchased at what, for Borland, is the exorbitant price of £199.95. No prices were available for the libraries

at the time of writing, but they should cost around £50.

## Conclusion

It's easy to write a conclusion when there is a clear winner but, unfortunately, in this case there isn't. All three programs are excellent, and any one would make a good choice for PC owners looking for a C compiler.

At first sight Mix C looks the least attractive because it produces large, slow programs and does not include advanced features such as the MAKE utility. However, Mix C has a truly excellent tutorial which probably makes it the best buy for an absolute C novice who has to start from scratch. If, after using Mix C, you want to create a large program, you would be well advised to upgrade to one of the other two compilers.

Zorland C and Turbo C are more than a match for the so-called professional C compilers costing in excess of £250. The best overall performance was given by Turbo C. It is eminently qualified to take a Basic programmer, for example, and lead him or her all the way to the creation of real applications under C; firstly, with the integrated environment, and then onto a true multiple source file with conditional compilation.

Experienced programmers might find Zorland C the easiest to work with as it's the most similar in function to existing heavyweight C compilers. It is also cheap and very compatible with the very successful Lattice C environment — two arguments that certainly weigh heavily in its favour.

Mix C is distributed by Analytical Engines on (0703) 262099. Zorland is on (01) 854 1194. Borland is on (01) 258 3797.

END

# Graphic algorithms

*When you have mastered the basic mathematical principles, creating simple algorithms for computer graphics should result in some sophisticated drawing programs. Mark Parlour guides you step by step through the routines involved.*

This article outlines simple algorithms for plotting lines and circles and for filling areas of the screen. The algorithms can be used in high or low-level languages, and rely on some knowledge of mathematics to explain how the techniques are derived from the equations of lines and circles.

Before considering line plotting, it is necessary to investigate the problem at a lower level: that of plotting individual points (pixels) on the screen.

### Plotting points onscreen

Consider a high-resolution screen of 640x200 plottable points: that is, X coordinates of 0-639 and Y coordinates of 0-199. It is essential that we are able to set or test the colour of any pixel of our choice on this screen.

Ideally, we should be able to directly access any point by reference to its coordinates, but there are three principle reasons why this is usually impossible. Firstly, the pixels are not stored in a simple sequence reflecting their position on the screen. Secondly, although each pixel needs only one bit to represent on or off, encoding colour may involve a sequence of bits or multiple images of the same screen encoding different primary colours. Thirdly, we may want to access a single bit but the smallest data item we can read or write directly is a byte, so some extra manipulations (shifts and logical operations) will have to be performed to access individual bits.

Fig 1 shows a fairly typical screen layout for a monochrome display in which we want to access pixel (13,5). The screen is composed of 80 columns by 50 lines of blocks, where each block comprises four bars of eight pixels. To access the pixel we must first access the byte (bar) in which it resides.

Given an X coordinate, we know that if we divided this by eight we would get a result of the block position with a remainder which indi-

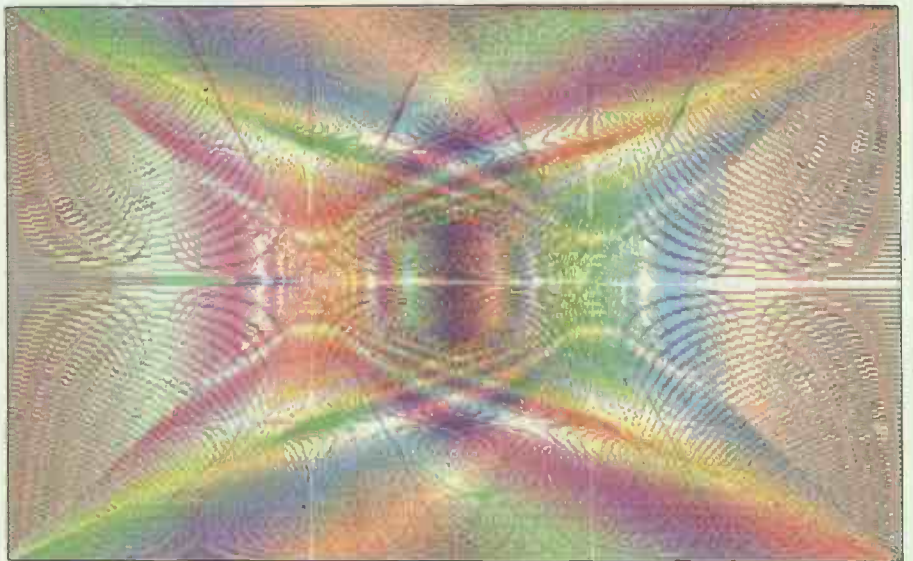

*Patience and perseverance with basic mathematics could lead to programming skills which enable you to create elaborate graphical displays*

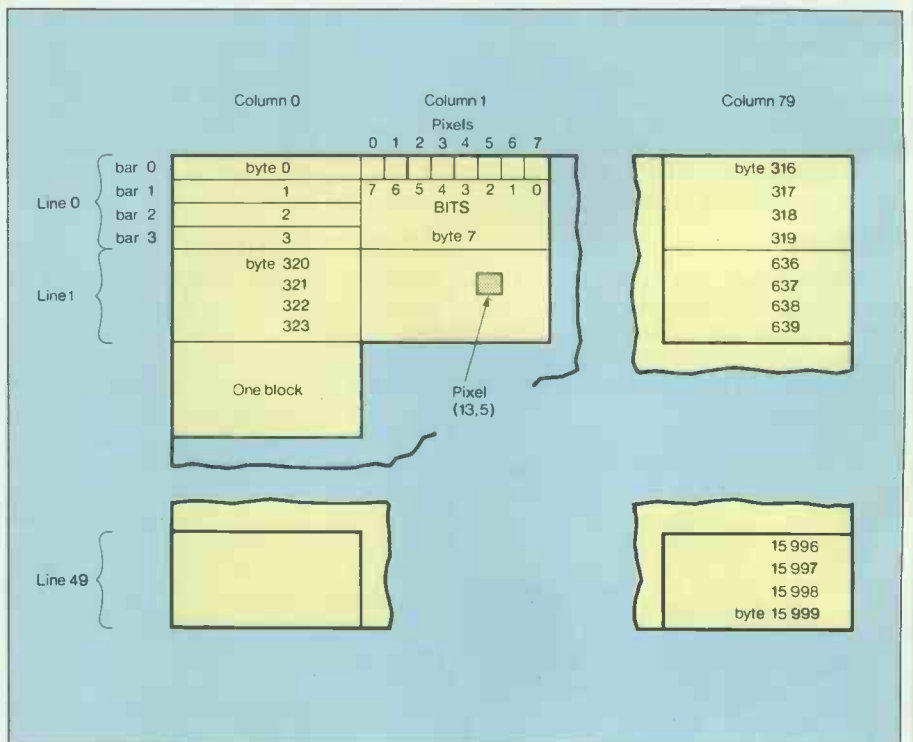

*Fig 1 This diagram represents a screen which is 80x50 lines and 640x200 pixels. Most screens are organised similarly but with differing sizes*

cated the bit position within that byte. More specifically:

block = X div 8  
 pixel = X mod 8 (equivalent to X AND 7)

which for X=13 gives block 1, pixel 5. Likewise, dividing the Y coordinate by four gives us the line number with a remainder which denotes the bar position on that line. Hence:

line = Y div 4  
 bar = Y mod 4 (equivalent to Y AND 3)

which for Y=5 gives line 1, bar 1. Thus the address of any byte (its offset from the start of the screen) can be calculated as:

total bars = (line \* 80 \* 4) + (block \* 4) + (bar)  
 total bars = ((line \* 80 + block) \* 4) + bar

Thus for pixel (13,5), the address = (1 \* 80 + 1) \* 4 + 1 which is byte 326 of the screen.

In Pascal we may access the byte simply as:

address = (X div 8) \* 4 + Y div 4 \* 320 + Y AND 3

In the calculation, AND is used rather than MOD because it is quicker.

In a low-level language the coordinates have to be split first (as shown in Fig 2 for the Intel 8086/8) by using shift operations on the register specified. The offset can then be calculated by a series of multiplications and additions.

To set any pixel we need some knowledge of the logical operators NOT, AND, OR and XOR shown in the logical truth tables (Fig 3).

A	NOT A
0	1
1	0

A	B	A AND B
0	0	0
0	1	0
1	0	0
1	1	1

A	B	A OR B
0	0	0
0	1	1
1	0	1
1	1	1

A	B	A XOR B
0	0	0
0	1	1
1	0	1
1	1	0

Fig 3 Truth tables

Fig 4 shows the situation of a screen bar containing the pattern 10100001 in which we want to set

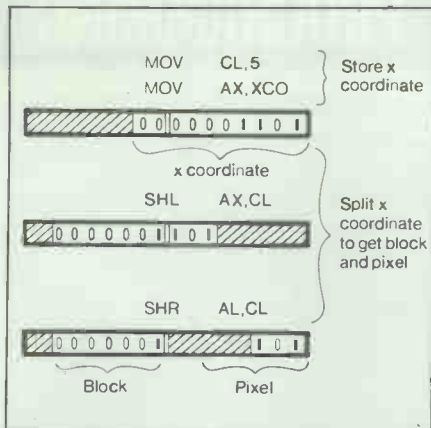

Fig 2 Splitting coordinates in a low-level language (the Intel 8086/8)

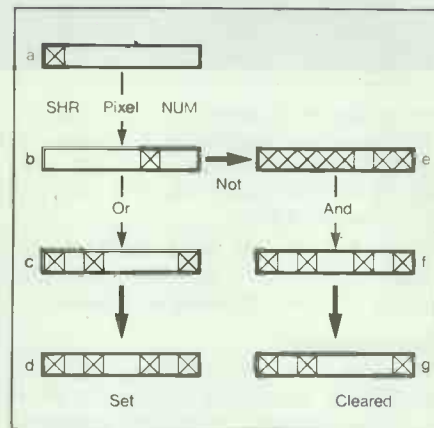

Fig 4 The situation of a screen bar containing the pattern 10100001

```

VAR
  address : integer ; mask : BYTE;
  screen : array [0..8000] of byte absolute $3C00:$0000;
  procedure PSET (X : integer; Y, C : byte);
  begin
    address := (X DIV 8) * 4 + Y DIV 4 * 320 + Y AND 3;
    mask := 128 SHR (x AND 7);
    screen[address] := screen[address] OR mask
  end;
  function pget (X : integer; Y : byte):boolean;
  begin
    address := (X DIV 8) * 4 + Y DIV 4 * 320 + Y AND 3;
    mask := 128 SHR (x AND 7) ;
    if (screen[address] AND mask)>0 then pget:=1 else pget:=0
  end;

```

Fig 5 Constructing the OR mask with mask := 128 SHR (X and 7)

pixel 5 (or bit 2). We must first create an 'OR mask' by loading a bit into an empty byte (a) and shifting it into place (b). If we perform logical OR with this mask on the screen byte (c), you will see that this sets only bit 2 and leaves the others unchanged (d). The mask acts as a stencil: you create the mask to 'expose' the byte to be affected and then 'spray' the operation through it onto the byte. Likewise, to clear that same bit at a later time we must prepare an 'AND mask' (e) by inverting the OR mask using the NOT operator.

In fact, XOR operations are frequently used employing the OR mask because the required bit is set on the first call and cleared when called again using the same mask. Note, however, that if the bit is already set it will be cleared on the first call using this technique. The main use of this technique is in overlaying a simple moving image (for example, a cursor or a sprite) over a complex background image without corrupting it.

In Pascal, the OR mask is constructed by mask := 128 SHR(X AND 7) and the relevant bit is set by ORing or read by ANDing it with the current byte at the calculated address, as shown in Fig 5.

### Drawing a line

Shown below is a representation of a line from position (0,0) to position (9,5). Because the difference in the X axis (dX) is greater than the difference in the Y axis (dY) there is only one point plotted for every X value within the range, whereas there are always one or more points plotted for every positions of the Y axis. The axis which only has one point plotted is called the major axis and the one which has one or more points plotted is called the minor axis.

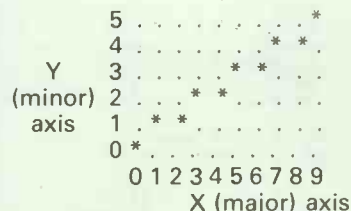

I'll now consider three methods of drawing the line, each relying on looping through every value on the major axis and plotting the point using the corresponding minor axis coordinate. Because of this, there exist four types of line depending on which is the major axis and whether

# PROGRAMMING

the gradient is positive or negative. The decision algorithm is shown in Fig 6. Given coordinates are X1, Y1, X2, Y2 for the points (X1,Y1), (X2,Y2) at the ends of a line.

For each of the three methods of drawing the line I'll now consider the case of X major positive as above.

## Direct method

We know that a line through the origin (0,0) is described by the equation  $y = mx$  (where  $m$  is the gradient  $dY/dX$ ). So, by adding 1 to the major axis displacement and adding the gradient to the minor axis displacement (rounded down, we may calculate the new coordinates each time: because we are using the minor axis, the gradient will always be less than one, ensuring that no points are omitted during plotting.

```
let Y = Y1
for X = X1 to X2
  pset(X, round(Y))
  let Y = Y + gradient
```

There are problems with precision if we try to store these values accurately (while at the same time making the routine as fast as possible) and there are many elaborate ways of solving this problem — for example, using fixed point arithmetic (see 'Simple arithmetic', PCW, June 1986).

```
let dx = X2-X1
let dy = Y2-Y1
if abs(dx) > abs(dy)
  then (X_MAJOR)
    if X1>X2 then swap
      (X1,Y1) with (X2,Y2)
    let gradient = dy/dx
    if gradient < 0
      then call X_MAJOR
        POSITIVE routine
    else call X_MAJOR
      NEGATIVE routine
else (Y_MAJOR)
  if Y1>Y2 then swap (X1,Y1)
  with (X2,Y2)
  let gradient = dx/dy
  if gradient < 0
    then call Y_MAJOR
      POSITIVE routine
  else call Y_MAJOR
    NEGATIVE routine
```

Fig 6 Decision algorithm

## The integer digital differential analyser method

Rather than calculate the gradient directly, it is possible to set up a guide value or 'dump'. This dump is a constant value and its use simplifies the calculations which the computer has to perform. This in turn means that the calculations will pro-

ceed more quickly, so the line will be drawn more quickly. In this case,  $dX$  is 9 and  $dY$  is 5, so the gradient is  $5/9$ . This is not an integer and its addition to  $Y$  followed by rounding  $Y$  down takes longer than if only integer operations were used. The best way to understand the use of a dump is to try out these values in the algorithm below. We subtract  $dY$  from the dump each time we increment  $X$ , and only increment  $Y$  when the dump drops below zero (at which time  $dX$  is added to it). At the end of the process we will have added 5 steps of 9 and subtracted 9 sets of 5, so the gradient will be preserved. The dump is initialised to half  $dX$  to ensure that the line appears balanced around a central axis.

```
let dump = dX div 2
for loop = X1 to X2
  pset (x,y)
  let x = x + 1
  let dump = dump - dY
  if dump < 0
    then
      let y = y + 1
      let dump = dump + dX
```

Through using integer arithmetic, this is a very simple and fast routine. However, the problem with it is

## Listing 1: 8088 machine code for setting individual pixels on a Sanyo MBC555

```
;PIXEL SETTING ROUTINE FOR SANYO MBC INTEL 8088
;R.M.FARLOUR. FOR TURBO PASCAL defined by
;PROCEDURE PSET(X,Y:integer;C:byte);external 'pset';

CSEG SEGMENT 'CODE'
assume cs:cseg
pset PROC near
;
  X      EQU [BP+0B]
  Y      EQU [BP+06]
  COLOUR EQU [BP+04]
  RED    EQU 0F000H
  GREEN  EQU 03C00H
  BLUE   EQU 0F400H
;
  PUSH  bp      ; save the base pointer
  MOV  BP,SP   ; save SP to access parameters
  PUSH  DS     ; DS must not be corrupted
;
;split the x coordinate into columns + pixels
;-----
;
  MOV  AX,X     ;load the x coordinate
  MOV  CL,05    ;prepare 5 bit shift
  MOV  DX,AX    ;copy x coord into DX
  AND  DL,0000111B ;DL = 3 bit pixel position
  SHL  AX,CL    ;AH = 7 bit column position
  MOV  DH,AH   ;DH = column position
;
;split the y coordinate into lines + bars
;-----
;
  MOV  AX,Y     ;load the y coordinate
  INC  CL      ;prepare 6 bit shift
  MOV  BX,AX   ;copy y coord into BX
  AND  BL,00000111B ;BL = 2 bit bar position
  SHL  AX,CL   ;AH = 5 bit line position
  MOV  BH,AH   ;BH = line position
;
;calculate the pixel's byte offset from screen start
;-----
  XOR  AH,AH   ;clear AH
  MOV  AL,BH   ;AL = lines
  MOV  BH,50h ;BH = 80 (columns per line)
  MUL  BH,AX   ;AX = lines*80 = blocks
  XOR  CH,CH   ;clear CH
  MOV  CL,DH   ;CL = columns within line
  ADD  AX,CX   ;AX = total columns offset
  SHL  AX,1    ;AX = AX*2
  SHL  AX,1    ;AX = AX*2 = offset in bars to block
  MOV  CL,BL   ;CL = bars within block
  ADD  AX,CX   ;AX = total offset in bytes
  MOV  SI,AX   ;load memory pointer with offset
;
;prepare byte and masks for plotting
;-----
  MOV  CL,DL   ;load pixel position for shift
  MOV  AL,10000000B ;set leftmost bit
  SHR  AL,CL   ;and shift into position
  MOV  AH,AL   ;copy OR MASK into AH
  NOT  AH      ;convert to AND MASK
;
;test and plot pixel on each screen in turn
;-----
  MOV  CH,colour ;load CH with pixel colour
  MOV  DH,00000100B ;initialise test bit (red)
  MOV  BX,red    ;operate on red screen
  CALL DISPLAY  ;display pixel
  MOV  BX,green  ;operate on green screen
  CALL DISPLAY  ;display pixel
  MOV  BX,blue   ;operate on blue screen
  CALL DISPLAY  ;display pixel
;
  POP  DS
  MOV  SP,BP
  POP  BP
  RET  6        ;return from pset and discard parameters
;
;display procedure
DISPLAY PROC NEAR
  MOV  DS,BX    ;load screen offset into DS reg
  MOV  CL,CH    ;copy colour test bit into CL
  TEST DH,CL   ;test whether to set or clear pixel
  JZ   CLEARPIX ;if no match clear the pixel
  OR  [SI],AL   ;else set pixel using the OR mask
  JMP NEXTCOL  ;and jump over to the colour rotate
CLEARPIX:
  AND [SI],AH   ;clear the pixel using the AND mask
NEXTCOL:
  SHR  DH,1    ;shift next colour test into position
  RET
DISPLAY ENDP
PSET ENDP
CSEG ENDS
END
```

that a number of calculations are performed each time to find whether the minor axis shift ( $y = y + 1$ ) should occur. Also, in this version, the plotting position is calculated afresh each time whereas only the relative change from the last position need be known.

### Residual gradient dump using relative shift plotting

We know that the gradient is never greater than 1 because of the way we define the major and minor axes. It is possible to use an extension of the first algorithm a 'residual fractional dump' (from 0 to 0.999.) to which the gradient is added each time and a minor axis shift is only performed when the dump becomes greater than one. Only now is the fact that there is a surplus *significant*. All points are now plotted by shifts relative to the last point without reference to its absolute position. Therefore, the necessary accuracy is achieved using a dump of two bytes on which addition alone is performed, and then the decisions are reduced to a simple test of carry so the speed of the routine is maximised (Fig 7).

```
let loop counter = dX + 1
set pixel (X1,Y1)
repeat
  dump = dump + fractional
  gradient
  shift pixel right (increment X)
  if carry signalled then shift
  pixel up (increment Y)
  decrement loop counter
until loop counter = 0
```

Fig 7 Residual gradient dump using relative shift plotting

## Shift logic

The shifting procedure warrants some description as it can be used in a wide variety of graphics algorithms and has the benefit of being very fast (for example, to recalculate the screen address and offset each time on the 8088 takes around 221 clock cycles, whereas to shift takes between 32 and 40).

Fig 8 shows pixel 13,5 marked X. To move up we simply subtract 1 from the address pointer; likewise, to move down we add 1. Similarly, to move right we shift the mask right (or divide it by two) and to move left we shift the mask left (or multiply it by two).

Needless to say, it isn't always this simple, and peculiar conditions exist at the block boundaries as shown in Fig 9. When pixel A moves up we expect to subtract 1 from the address, but, in fact, in crossing the boundary we have to subtract an extra 316. That's simple, but how do we know when it's at the boundary? By simple inspection you will see that the addresses of the top bars within each block are 0,4,8, and so on, which means that the last two bits of the address are clear when in this bar. Therefore, the complete 'shift up' (or decrement Y) routine is as follows:

```
if (address AND 3) = 0
  then let address = address - 316
  let address = address - 1
```

Likewise to shift down (increment Y):

```
if (address AND 3) = 3
  then let address = address + 316
  let address = address + 1
```

When considering horizontal moves we must test the mask to see if we are at the boundary. For pixel B moving left this is:

```
if mask = 128
  then let mask = 1
  let address = address - 4
  else let mask = mask SHL 2
```

and for pixel C moving right (increment X):

```
if mask = 1
  then let mask = 128
  let address = address + 4
  else let mask = mask SHR 2
```

## Drawing circles

It is possible to calculate all the points of a circle by rotating through 360 degrees and calculating the X and Y coordinates using trig functions. However, this is inefficient for three reasons. Firstly, the circle has an 8-point symmetry (Fig 10) which we may utilise by calculating points only in the first 45 degrees and calculating the seven corresponding points by simple algebra. Secondly, plotting by radius may give us more than one point plotted per pixel on a small circle (wasteful in time and some unexpected results using XOR plotting) and gaps in large circles (unsightly and difficult to fill). Thirdly, the processing time is prohibitively long for the functions and various multiplications involved. However, simple integer difference methods using addition and subtraction alone may be used.

The equation for a circle of centre 0,0 is  $X^2 + Y^2 = R^2$ . Thus if we start at

### Listing 2: Turbo Pascal procedure to draw a line on a Sanyo MBC555

```
procedure FGDLINE(x1,v1,x2,y2:integer;rc:byte);
(* uses 14 bit fractional gradient placed in a dump *)
(* with a carry to signal the minor axis update *)
(* written in Turbo Pascal for the SANYO MBC 555 *)
(* by R.M. PARLOUR . DECEMBER 1986 *)
VAR
  address : integer ;
  mask : BYTE ;
  gs : array[0..8000] of byte absolute $3C00:$0000;
  rs : array[0..8000] of byte absolute $F000:$0000;
  bs : array[0..8000] of byte absolute $F400:$0000;
  x,y : integer;
  gradient, dx,dy,absdx,absdy,dump:pointer,loop:integer;
  carry_set:boolean;
procedure plotpoint;
begin
  if C>3 then BS[address]:= mask OR BS[address];
  if (C AND 2)>0 then GS[address]:= mask OR GS[address];
  if (C AND 1)>0 then RS[address]:= mask OR RS[address];
end;
function grad(dy,dx:integer):integer;
begin grad := trunc(32767.0*dy/dx) end;
procedure update_dump;
begin dump:= dump+gradient;carry_set:=false;
  if dump<0 then begin dump:=dump+maxint;carry_set:=true end;end;
procedure calc_offset(x,y:integer);
begin
  address:=x div 8 * 4 + y div 4 * 320 + y and 3;
  mask:=128 shr(x and 7);
end;
procedure increment_x;
begin
  mask:=mask div 2;
  if mask = 0
  then begin masks:= $80 ;address := address + 4 end;
  end;
procedure decrement_x;
begin
  if mask < 128
  then mask:=mask * 2
  else begin mask:=1 ; address := address - 4 end;
  end;
procedure decrement_y;(* update the y coordinate *)
begin
  if ((address and 3)=0 ) then address := address - 316;
  address := address -1;
end;
procedure increment_y;(* update the y coordinate *)
begin
  if ((address and 3)=3 ) then address := address + 316;
  address := address +1;
end;
begin dx:=x2-x1; dy:=y2-y1;
  absdx:=abs(dx); absdy:=abs(dy);
  if absdx > absdy
  THEN (* X MAJOR *) begin
    dump:=absdx div 2; gradient:=grad(dy,dx);loop:=absdx+1;
    if x1>x2 then calc_offset(x2,y2) else calc_offset(x1,y1);
    if gradient < 0
    then begin gradient :=-gradient;
      repeat plotpoint;increment_x;update_dump;loop:=loop-1;
        if carry_set then decrement_Y;
          UNTIL loop = 0; end
    else begin
      repeat plotpoint;increment_x;update_dump;loop:=loop-1;
        if carry_set then increment_Y;
          UNTIL loop = 0; end
    end
  ELSE (* Y MAJOR *) begin
    dump:=absdy div 2;gradient := grad(dx,dy);loop:=absdy+1;
    if Y1>Y2 then calc_offset(x2,y2) else calc_offset(x1,y1);
    if gradient < 0
    then begin gradient :=-gradient;
      repeat plotpoint; increment_y;update_dump;loop:=loop-1;
        if carry_set then decrement_X;
          UNTIL loop = 0; end
    else begin
      repeat plotpoint; increment_y;update_dump;loop:=loop-1;
        if carry_set then increment_X;
          UNTIL loop = 0; end
    end;
  END;
END;
```

# PROGRAMMING

**Listing 3: IBM program to draw circles**

```

program gtest;
var
  xc1,yc1,r,i:integer;
procedure pset(x:integer; y:byte);
var
  address:integer;
  pix:byte;
  sc: array[0..16192] of byte;
begin
  absolute $b800:$0000;
  address:=(x div 8)*(y div 2)*80
    + (y AND 1)*8192;
  pix:=128 SHR (x AND 7);
  sc[address]:= pix OR sc[address];
end;
procedure circle(xc,yc,r:integer);
var
  x,y,ydump,xdump,res:integer;
begin
  x:=0;
  y:=r;
  ydump:=-2*r+1;
  xdump:=1;
  res:=ydump+xdump;
  repeat
    pset(xc+y*2,yc+x);
    pset(xc+y*2-1,yc+x);
    pset(xc+x*2,yc-y);
    pset(xc+x*2-1,yc-y);
    pset(xc-x*2,yc-x);
    pset(xc-x*2-1,yc-x);
    pset(xc-y*2,yc+x);
    pset(xc-y*2-1,yc+x);
    pset(xc-x*2,yc+y);
    pset(xc-x*2-1,yc+y);
    if res<0 then begin
      x:=x+1;
      xdump:=xdump+2;
      res:=res+xdump;
    end;
    if res>=0 then begin
      y:=y-1;
      ydump:=ydump+2;
      res:=res-ydump;
    end;
    pset(xc+x*2,yc+y);
    pset(xc+x*2-1,yc+y);
    pset(xc+y*2,yc-x);
    pset(xc+y*2-1,yc-x);
    pset(xc-x*2,yc-x);
    pset(xc-x*2-1,yc-x);
    pset(xc-y*2,yc+x);
    pset(xc-y*2-1,yc+x);
    pset(xc-x*2,yc-y);
    pset(xc-x*2-1,yc-y);
  until x>y;
end;
begin
  hires;
  hirescolor(15);
  for i:=1 to 40 do begin
    xc1:=random(440)+100;
    yc1:=random(120)+40;
    r:=random(40);
    circle(xc1,yc1,r);
    fill(xc1,yc1);
  end;
end.

```

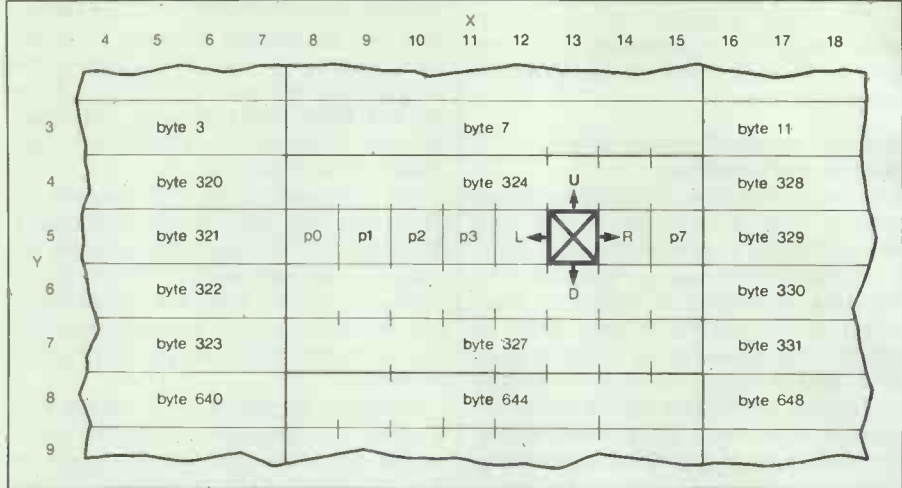

**Fig 8 Travelling up, down, left or right from the central pixel can be done by adding/subtracting 1 from the byte address or by shifting the bits in the byte left or right**

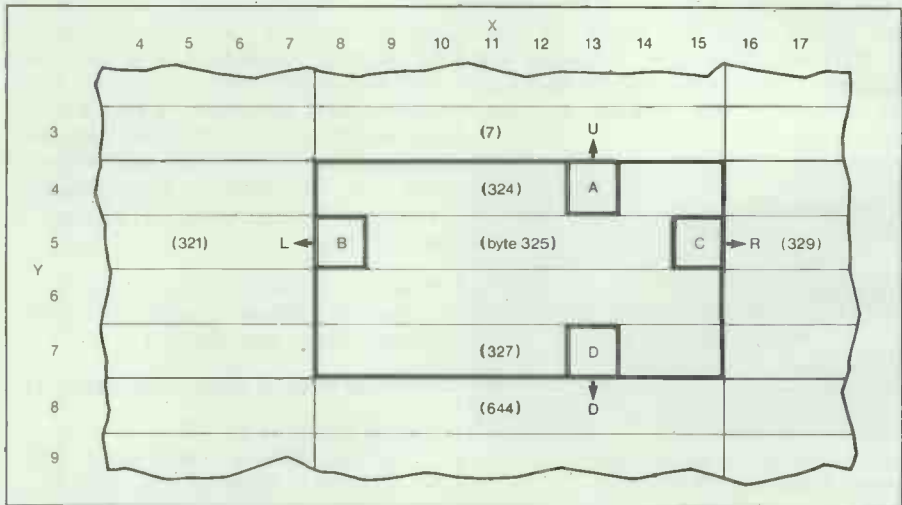

**Fig 9 Problems arise in the shift method when a block boundary is reached (indicated by the darker line)**

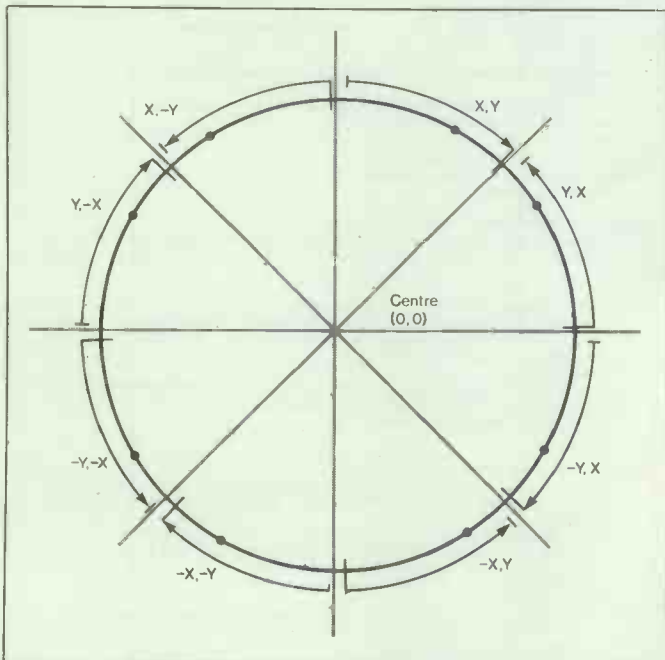

**Fig 10 Eight-fold symmetry from algebraic calculations**

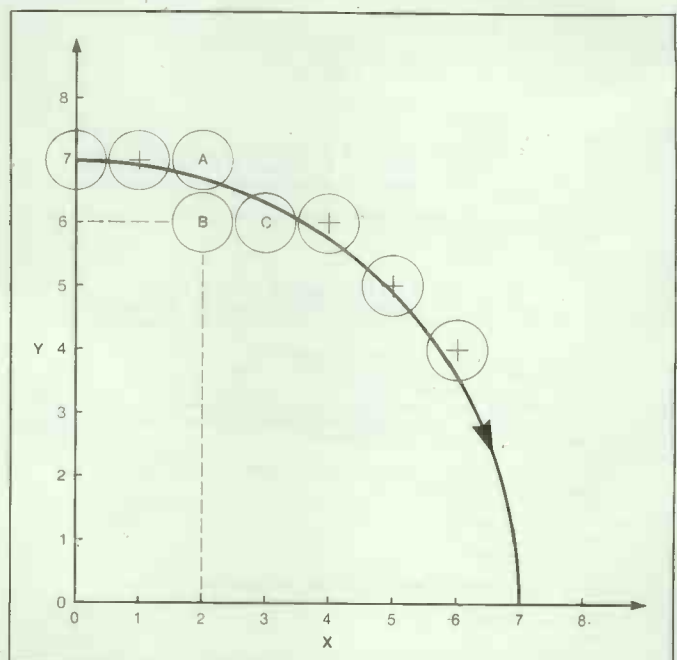

**Fig 11 Plotting pixels as near as possible truly on the circle**



X	=	0	1	2	3	4	5	6
X <sup>2</sup>	=	0	1	4	9	16	25	36
diff	=		1	3	5	7	9	11
diff	=			2	2	2	2	2
Y	=	R	R-1	R-2	R-3			
Y <sup>2</sup>	=	R <sup>2</sup>	R <sup>2</sup> -2R+1	R <sup>2</sup> -4R+4	R <sup>2</sup> -6R+6			
Y <sup>2</sup> -R <sup>2</sup>	=	0	-2R+1	-4R+4	-6R+9			
diff	=		2R+1	2R+3	2R+5			
diff	=			2	2			

Fig 12 Differential analyses

X = 0. We know Y = R. We can rearrange the equation to get  $X^2 + (Y^2 - R^2) = 0$  which simply means that this equation holds true when on the line describing the circle. Consider now the point in Fig 11. If we were at point A(2,7) then the equation would yield  $4 + (49-49) = +4$  which means we are off the line. It is clear by inspection that the Y coordinate needs to be decremented, and when this is done the new point B(2,6) yields a value of  $(4+36-49) = -5$  which, being negative, indicates that it is time to increment the X axis. In practice, we can use a dump (as before) as our guideline to the true value.

When the dump is positive we must decrement Y such that the term  $(Y^2 - R^2)$  becomes more negative

and the updated dump is moved towards or through zero. Similarly, when the dump is negative we must increment X and update the dump's X<sup>2</sup> term, and only then plot the point. (Note that this is not an 'either/or' situation and that both updates must be considered before the next point is plotted.)

At the moment we still need to calculate the terms  $(X^2)$  and  $(Y^2 - R^2)$ , but a simple method of solution comes to light when we consider the differential analyses in Fig 12 for the two terms:

These results show that we can generate the main dump's X and Y update terms simply by adding a calculated amount which itself is changed by two each time it is used.

```
let X=0
let y=R
let x_update = 1
let y_update = -2 * R + 1
```

```
let dump = x_update + y_update
repeat
  set_pixel(xc+y, yc+x)
  set_pixel(xc+x, yc-y)
  set_pixel(xc-y, yc-x)
  set_pixel(xc-x, yc+y)
```

```
if dump < 0 then
  let x = x + 1
  let x_update = x_update + 2
  let dump = dump + x_update
  if dump >= 0 then
```

```
  let y = y - 1
  let y_update = y_update + 2
  let dump = dump + y_update
  set_pixel(xc+x, yc+y)
  set_pixel(xc+x, yc-x)
  set_pixel(xc-x, yc-y)
  set_pixel(xc-y, yc+x)
until x = y
```

Fig 13 Completed algorithm for a circle of radius R and centre (xc,yc)

The completed algorithm for a circle of radius R and centre (xc,yc) is shown in Fig 13.

In practice, this method sometimes leaves the edges of the circle too widely spaced. This problem is easily solved by plotting an extra pixel each time with an x coordinate one lower than the points listed above. An example of this is given in Listing 2.

So far I have used techniques involving iterations — that is, performing a simple function a number of times within a loop such that fairly complex solutions may be effected with minimal code. A second technique is that of recursion where a procedure is able to call itself (or disappear up its own stack!) and this is shown in the case of an algorithm for filling a space bounded by an unbroken line of pixels. By now you should be able to see how it works for yourself.

```
procedure fill(x,y)
  if not pixel_set_at(x,y) then
    set_pixel(x,y)
    fill(x+1,y)
    fill(x-1,y)
    fill(x,y+1)
    fill(x,y-1)
  (end if)
```

## Conclusion

This has been a fairly sketchy introduction to drawing lines and circles on a graphics screen, and the techniques used are complicated but very fast. Some of them, such as shifting, are applicable to a wide range of graphics techniques and can be used as a basis for techniques like scrolling areas.

Mark Parlour is a teacher at Bloxham School, Banbury and a dedicated computer enthusiast.

END

## Converting the graphics routines to other computers

The problem with using these routines on other computers stems from different screen sizes and the different ways in which screens are mapped out in memory. The article assumes that a 640x200 pixel screen is used. It also assumes a monochrome screen and that the organisation in memory is as given in Fig 1 (that is, that blocks of four bytes represent 8x4 blocks of pixels).

To access individual pixels, you need to be able to convert an (x,y) coordinate into an address consisting of a byte and a pixel number. For the screen described in the article (a Sanyo MBC555), the conversion is as follows:

address (byte value) =  $x \text{ div } 8 * 4 + y \text{ div } 4 * 320 + y \text{ and } 3$   
 mask (bit value) =  $128 \text{ shr } (x \text{ and } 7)$

The mask is simply a single bit positioned at the correct place in a byte, and the above formula holds true for any screen with pixels stored as single bits within bytes. If your machine uses several bits per pixel, with the bit pattern representing a colour, then you will need to put the bit pattern in the top part of the byte and shift all the bits to the correct place. For example, if you use a four-colour screen with groups of two bits representing pixels, then you would use colour patterns. The formula would be:  $\text{mask} = \text{colourpattern shr } ((x \text{ and } 3) * 2)$  where colourpattern is a preset value for whatever colour you want to set the pixel to.

The address can be much more complicated. In the above example, the (y and 3) represents the groups of four bytes, the  $y \text{ div } 4 * 320$  represents the lines of blocks and the  $x \text{ div } 8 * 4$  represents the columns. To convert to your screen's organisation, you will have to draw a diagram such as that shown in Fig 1 and work out the conversion. Here is an example for the high-resolution screen on an IBM-compatible CGA:

The IBM CGA monochrome screen is 640x200 pixels. These are organised in memory as a sequence of bytes, with each row across the screen as a block of 80 bytes. This should mean that the screen is represented as 200 rows of 80 bytes in strict sequence. The problem is that the IBM display is interlaced, which means that the even-numbered rows are kept in one place and the odd-numbered rows in another. So, converting an x coordinate is simply a matter of dividing the value by 8 to obtain the byte address. If no interlacing were used, then the y coordinate part would be simply y times 80. However, since the y coordinate part is split into two lumps, the even coordinates can be represented by  $(y \text{ div } 2) * 80$ . The odd coordinates follow immediately after the even coordinates. The even coordinates fit into a block of memory which is  $80 * 200 / 2$  bytes or 8000 bytes long. In fact, it is 8192 bytes long because of the way in which memory is organised, so the odd coordinates all need to have 8192 added to them. This is achieved by  $(y \text{ and } 1) * 8192$ .

The final formulas for a monochrome CGA screen are:  
 address =  $(x \text{ div } 8) + (y \text{ div } 2) * 80 + (y \text{ and } 1) * 8192$   
 mask =  $128 \text{ shr } (x \text{ and } 7)$

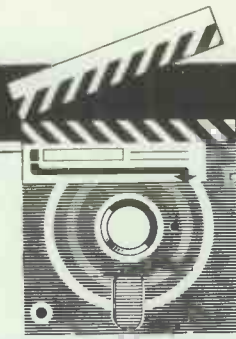

## SCREENTEST

# Omnis Quartz

*Omnis Quartz is a powerful relational database for the PC which can be heavily customised, and which runs under Microsoft Windows — the first database to do so — in a multi-tasking environment. Derek Cohen and Nick Walker tackled its comprehensive facilities.*

Back in 1982, a Suffolk Apple dealership, Blyth Software, decided to apply its expertise in building turn-key systems to developing its own product. Thus was born Omnis — a database management system for the Apple II. Later came Omnis 2 and, two years ago, Omnis 3 for the Macintosh. Omnis 3 Plus, the latest Mac version, has for a long time been outselling all the other Mac database products put together, both in Europe and in the difficult to enter US market.

Omnis 3 Plus is available in a multi-user version and is the basis of Blyth's multi-user accounts system, Omnis Accounting, for networked Macs. Omnis 3 for PC-compatibles was launched in 1986, but was a poor text-based shadow of the Mac product, although it shared many of the same capabilities. It has, however, spawned the vertical market Blyth Craftware range of applications.

Now Blyth has produced the first fully programmable relational database to run under Microsoft Windows. Omnis Quartz bears many similarities to its Mac predecessor, but has the added advantage of being able to use the multi-tasking capabilities of Windows including running in the background.

### System requirements

Omnis Quartz is designed to run on an 80286 or 80386-based PC with a minimum of 640k of RAM and a hard disk.

During this review, Quartz was run mainly on a Victor V286 but was also tried on an Amstrad PC with 512k RAM. The reduction in speed was quite noticeable and, while Quartz will run on much less well-endowed machines, it is wise of Blyth to spe-

cify such a minimum-desirable configuration.

Additionally, Quartz needs a full version of Microsoft Windows installed for your particular machine and printer. A mouse is desirable, as using Windows-based applications totally from the keyboard is possible but tiresome. A colour monitor is not essential but colour does improve the organisation of the application.

Windows cannot at present make use of extra memory operating under the Lotus/Intel/Microsoft standard, but when it does Blyth claims that Quartz will use it too.

### General description

Quartz operates totally within the Windows environment, using the pull-down menus, overlapping windows, scaleable fonts, scrollable lists and dialogue boxes common to all Windows applications.

A Quartz application consists of a number of different elements, all of which are under the programmer's control. The end-user will interact with the finished program through pull-down menus, entry layouts, reports, lists (which are in effect onscreen summary reports) and dialogue boxes. In conjunction with a set of file formats which define the fields for the various record types, the user can process the information held in a separate data file. One application library of file formats, layouts, menus, and so on, can be applied to an unlimited number of different data files.

Quartz is also accessed by means of these Windows elements. Entry layouts, pull-down menus and scrollable list windows are used to make selections, build up sequences of commands in the Quartz program-

ming language, and define the functions of the finished database application. Because the programming environment and the resulting product share a common interface, Quartz itself becomes a model application from which to learn.

Anyone used to the multiplicity of disk files common to databases like dBasell will find the Quartz organisation slightly alarming at first. Quartz consists of just two files: QUARTZ.EXE, the 420k program; and QUARTZ.INF, a 512-byte file which holds the product registration details, system defaults and the name of the last application used.

Each application will typically produce only two disk files. The first, with an extension 'QAP', holds all the fixed information such as layouts, file and report formats, and menus. All the data is held in another file with the extension QD1; this can hold up to 2560Mbytes of data. And if this is not enough (though it's not clear where at present you'd hold files this big), you can chain on further data files with the extensions QD2, QD3, and so on.

Quartz organises the information within the single data file, and up to 60 separate or related sets of records can be stored with their indexes. Nonetheless, it is useful to be able to describe each set of records as belonging to an imaginary file, even if this is a logical rather than a physical entity. Up to twelve fields can be indexed within each file format, and indexes are automatically selected and maintained whenever the file format is used.

Each pull-down menu can display up to 20 items, with the option of separator bars to group the choices. There can be up to twelve menus

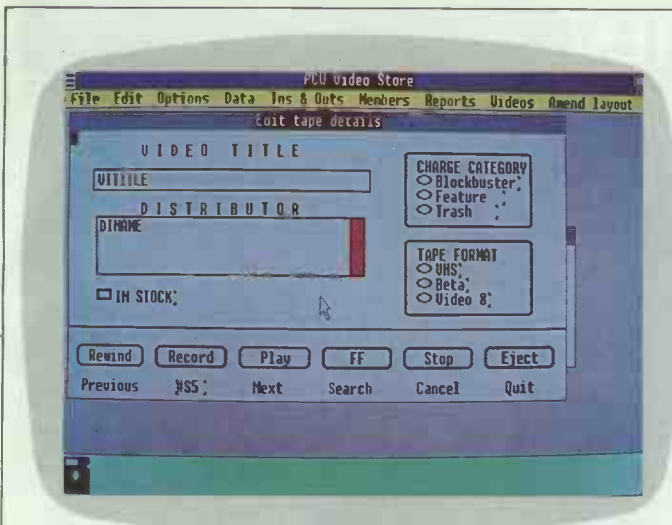

Entry Layout

The two boxes on the right of this entry screen contain radio buttons with each box linked to a particular field. The central box is a list field and, in use, a list of distributor names will be displayed with scroll buttons in the red bar. The programmer can determine the effect of clicking on a line in a list field. When any of the push-buttons at the bottom are clicked, they activate procedures stored in the menus.

In this application, the 'Record' button was designed to perform two functions: to start editing a record; and to indicate that the edit had been completed. A conditional loop in the connected sequence changes the value of the button's label variable — #55 — as the process takes place and tests this variable to determine whether to start editing or save the edited record

installed at once, and commands are available to add or remove menus, to place a check mark against particular choices, and to 'grey out' certain items which are either not applicable or require an access level the current user does not have. All Quartz windows and menus can be password-restricted with up to eight access levels available.

Selecting a menu item can lead to further menus being installed or, more frequently, the opening of windows on the screen carrying entry layouts or the production of printed reports.

Unlike most databases, where the programming instructions are stored in a file of their own, Quartz stores these instructions, known as 'sequences', within the menu structure.

Each menu can contain 100 items, though only the first 20 can be displayed. Associated with each menu line can be a sequence of commands, with each sequence holding up to 5000 bytes, and a total limit of 30,000 bytes of storage available per menu. Each line has a number, and can be given a name which will appear on the menu bar if that line is visible. A window alongside shows the sequence of commands attached to that line; and the lines below 20 — or below those visible if this is less than 20 — are where the prog-

rammer enters and stores the sequences of commands. These sequences may be called by other sequences, or by clicking on menu choices or push buttons on any entry layout.

Entry layouts can each consist of up to twelve separate, sizeable and positional windows. On each layout window the programmer can position fields of the following types: entry or display fields; check boxes for setting the logical value of a field; lists, complete with a vertical scroll bar; radio buttons; and push buttons. In addition, free text and box rules can be used to annotate and organise the layout.

Radio buttons take their name from the channel selectors on car radios — only one button can be selected at any one time, and choosing one (by clicking on it with the mouse) de-selects the current choice.

Push-buttons are a feature common to most WIMP environments — they are the buttons the user clicks to initiate some activity. Standard push buttons are available for moving forwards and backwards through a file, and for finding, adding or deleting records.

However, push-buttons can be linked to the programmer-defined sequences which are stored in the menu formats. Thus a push-button marked

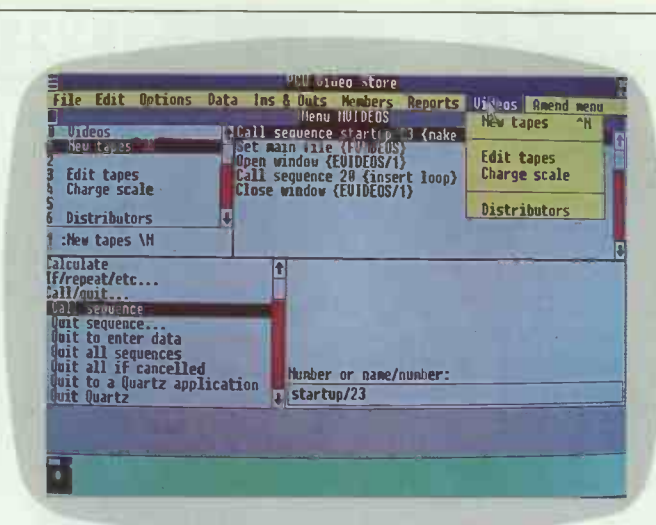

Amend Menu

The sequences of commands or procedures which drive Quartz are stored inside the menus. The menu line names are defined on the left, and the commands which are executed when that line is clicked or called are defined in the right-hand window. Leaving two blank lines in a menu defines the end of the visible part of a menu, and the rest of the lines can be used to store procedures called by number, by pushing buttons or other sequences. 'New tapes' has been associated here with a hot key — control-N.

Creating a sequence of commands involves clicking on a series of available commands from the bottom right-hand list. Any parameters expected (such as the parent menu and number of a sequence called as a subroutine) are prompted for bottom right

'New Title' could invoke a sequence that opens a fresh window with the cursor in the first field ready to accept data for a new record, checks the data, adds the record, and then returns to the original window.

Lists are one of Quartz's most novel features. Up to eight lists can be current at any one time. Each is defined by a series of commands which specify the list number, the fields which will form one line of the list, and how the list will be made up. Lists can be used as a 'window' onto the records of another file, or as a way of displaying the options available to the user — for example, which reports are available.

Reports can be printed to screen, to printer or to a parallel or serial port. This latter option allows a Quartz application to make use of serial links or modems to send data down the line at the click of a button. Commands are available to set serial port parameters like baud rate, and to send a pre-determined string of characters to the port. This could be an auto-dial sequence to a modem, or a set-up string to initialise a printer.

A range of different fonts and font styles can be incorporated in a report, and the report design window shows these onscreen — very WYSIWYG, indeed. Sort and search

# SCREENTEST

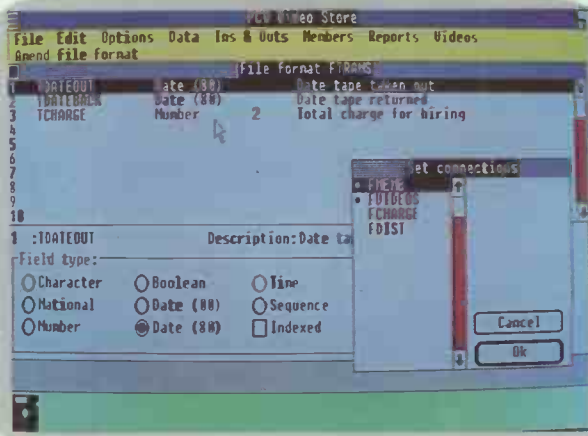

## File Formats

Among the field types available in a file format are two date options — one starting at 1900, the other at 1980. National fields are sorted in a different way to character fields to cope with accented characters. To set the connections between records in FTRANS and other files, the file format names in the Set connections box are double-clicked. The maximum length of each field is defined here, though on an entry or report format, the amount of data displayed can be stretched or shrunk using the mouse

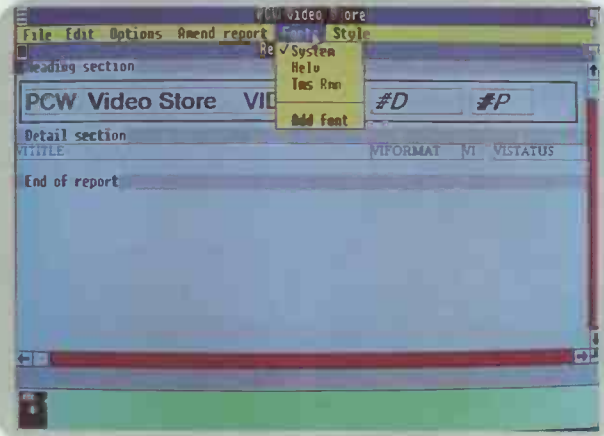

## Amend Reports

Reports can consist of a number of different sections including headers and footers, and sub-total headings. Any number of records can be printed across a page, which is useful for printing labels; and the report destination can be changed at print time between the available ports, the screen or a file. Text and fields can be printed in various fonts and font styles and these attributes are shown on the report design screen. As well as fields, system variables such as the date (#D) and page number (#P) can be included

formats can be included either automatically, or by being selected at print time by the user.

## In use

To test Quartz we designed a simple video rental store application. We set up file formats for membership, video tapes and distributors. The tapes file was connected to the distributors' file: we limited each tape to one distributor, and had only one copy of each title.

Throughout Quartz, options are nearly always of the multiple choice type. The most typing we did was in specifying the text for the menus and entering textual descriptions.

Quartz does not support many-to-many linking of files, so we added a transaction file which would connect members with the video tapes they had rented. Having set up the basic file formats, we clicked the menu choice to set the connection between the transaction file and the membership and video tape files. Quartz opened up a window listing the other existing file formats, and creating the links involved merely double-clicking on the required file names. This file list was in fact an ordinary Quartz list that can be created for use on an ordinary layout window.

We next designed the menus. Each menu has a name and a description, the latter being what actually appears on the menu bar. If a menu is given the name 'Startup' it will be automatically installed when an ap-

plication is opened. Additionally, the commands stored as menu line zero will be automatically executed.

Line zero of the start-up menu was as follows:

```
Set Quartz window title (PCW Video Store)
Install menu (MMEMBS)
Install menu (MREPORT)
Install menu (MVIDEOS)
Set 'About ...' sequence 10 (About PCW ...)
Call sequence 23 (make dist list)
```

This command sequence was created with very little use of the keyboard. A window at the bottom left of the screen displays a list of all the available commands or group of commands. Clicking on an item with three dots after it opens up — outline processor fashion — further options. Double-clicking any line copies it into the current sequence. Where a command requires parameters, check boxes or further lists of valid options will appear on the bottom right of the screen. Therefore, selecting the command to set the main data file will open a list of the existing file formats, and clicking the required file name copies the completed command line into the sequence.

To call another sequence, it is necessary to specify it by number, or menu format and number if it is not within the current menu. Names cannot be used, unfortunately. However, the actual name of the sequence is

entered, and if the 'sub-routine' sequence is later edited and re-named, this change will be reflected in the name shown in the calling sequence. In the aforementioned menu, sequence 23 was referred to by number, and the description added automatically by Quartz.

This may all sound quite convoluted, but it is possible to establish a complex sequence of commands quite quickly once you become familiar with where the command you want is in the list. When a menu has been set up, printing the entire set of sequences provides not just a fully commented program listing, but a note of how much space has been used and how many errors have been found.

A 'find' facility will locate where a particular string is in your own sequence of commands or menus, but, unfortunately, it cannot be used on the command list to help you find the particular command you want which somehow isn't in the place you expect it to be. For example, the commands to open and close a window are in the group called 'Select ...' — there is no group called 'Windows' which would have seemed obvious. And the report-printing commands are scattered between the 'Print ...' and 'Select ...' sections.

As there is no way that a command can be typed in — it must be clicked on — there is no way you can make a syntax error (as opposed to a

logical error caused by placing the commands in an incorrect or nonsensical order). But, conversely, there is no way to enter the command line you want directly. The reason is that the command lines don't exist as text, but as pointers to the routines in Quartz. The other consequence is that sequences cannot be created in a text editor and imported as ASCII files. You may work out the structure of an application on your word processor, but you will have to click your way through the lists to enter it up.

Entry layouts consist of one or more windows containing fields, buttons and lists. There are four window types available, from the simple window used for warning messages to the ornate with a title bar containing a combination of fixed information such as a heading, and possibly variable information such as the date, or the user's name or some other locally calculated information. At any one time, a main data file must be specified, and it is only records in this file that can be edited. Data from connected files can only be displayed. However, it is a simple matter to change the main data file upon some user action such as clicking a button.

To place a field on a layout, you double-click where you want its first character. This opens up another window where there are choices for field type, name, calculations and range checks. Fields on one layout can be from any number of different file formats, and fields from connected files can be specified as auto-find. When data is entered into such a field, Quartz will fetch the matching record — assuming the field is an indexed one. Thereafter, any data from that record can be displayed automatically.

The size of the data displayed can be set independently of the actual file format, though this does not affect the file format itself and data is subject to the constraints of the original format. A character field can be up to 2400 characters long, and will automatically word-wrap within a rectangle specified as part of the entry layout. If the rectangle is smaller than the text, the use of the mouse or cursor keys will scroll the text within the rectangle. This is a great improvement over the memo fields of dBaselll.

If a list is chosen as the field type, then you can determine the format of each line in the list, adding text or other variables to the fields that were used to build the list. List boxes can be sized on the layout, and can be as small as just one line. The sequences attached to the entry layout determine the consequences of double-clicking on a list line, but could be used to establish a link with a record in a connected file.

Cut and paste and drag options

allow for the tasteful or ergonomic layout of the entry form, and seven different rectangle types can be used to group together related fields. Any field or box can be coloured, though strangely, text entered onto the layout window itself, such as field descriptions, must be black.

A check box associated with a particular field returns a value of 1 or 0 depending on whether it is checked or not. While there is text associated with the box — for example, 'IN STOCK' — this text is not passed to the current record; only the number is. This seems a pity as a constant translation between number and text has to take place. In practice, you would probably store the data as numbers, but it means that whenever the field is used, the same translation has to be done.

The same is true for radio buttons. In our video store application we used a set of radio buttons for tape format — VHS, Beta or Video 8. Radio buttons are useful when the number of options is fixed for all time, so to speak. If the choices were changing, a list would have been better, with the tape formats stored in a data file of their own and the list created each time the application was run or a format-editing layout used.

The three buttons we used were all linked to the same field. During data entry, Quartz returns a number which specifies the location of the radio button which has been pressed: thus VHS would return a '0', Beta a '1' and Video 8 a '2'. While it might have been better if the associated text had been stored in the record, Blyth argues that this causes difficulty when the record is called from the file for editing. Quartz has to show one of the radio buttons as being selected and would have to evaluate the text on the screen to choose a button. Using numbers, if the field in a record has a value of 1, then Quartz checks the second button in the group.

Push-buttons, as has been mentioned before, can be used to invoke standard record management functions like edit, insert, find, next, and so on, or they can be customised to call any of the sequences contained in the menu formats. The text on the buttons and their size can be changed, though the buttons can only be stretched horizontally and not vertically. Buttons can be designed to disappear during data entry or when there is no current record. Therefore, the 'Edit' button could be hidden while there is no current record, and the buttons to move through the records need not be seen while the user is editing a record. The text which is displayed on a push-button can be variable and can be changed as the user progresses through an application.

Quartz provides a range of system variables, but no user-defined ones except as fields in a file format. There are 60 numeric variables, five string variables, and others representing the system date and time, the state of a logical 'flag', the current workstation number on a multi-user system, attributes of the current list, and the status of various aspects of the data entry process currently taking place.

There is no way that names can be assigned to the variables, which is a pity. A formula #6=(#3-#2)\*#4 makes a lot less sense than RENTAL=(DATEIN-DATEOUT)\* DAY-RATE, and variable names could be assigned dynamically through sequence commands.

All of these variables can be displayed onscreen and manipulated under sequence control. To include them in a calculation or layout, they are selected from the file format list which is always invoked by pressing F10. Again, in keeping with the click approach, calculations can be built up by clicking on the variables and field names in the lists popped up by Quartz. If, on checking, an invalid variable or field name has been entered by hand, it is highlighted and the options presented for clicking into place.

While building a Quartz application, shortcut keys can be used to activate certain functions. Thus Control-M will bring up an editing window for the current menu; Control-W will toggle between editing the current layout and using it; and Control-R will allow you to edit the current report, with the same key being used to start it printing.

Such shortcuts can also be assigned to menu lines, so we assigned Control-N to the 'Add a new member' option, and Control-V to the 'Add a new video' line. For frequently used choices, such shortcuts would speed up a user's operation considerably.

Reports are designed by painting a screen. Each report consists at a minimum of a detail section which is repeated for as many records as satisfy the search criteria, if any, in force at the time. Additionally, headers and footers, sub-totals and sub-total headings are available.

Any item on a report, be it a field or fixed text, can be assigned a font, font size and style such as bold or underlined. Quartz printer handling is determined by Windows and, annoyingly, we had to run Windows' Control program to change printers.

Quartz was run with an Epson LQ800 24-pin dot matrix printer and a Kyocera 1010 laser printer. Using the Epson, Quartz insisted on printing in graphics mode, which would be very time-consuming except for the most elaborate but short report. Long reports containing much data

## Quartz vs dBaselll (the 'biased' views of a dBaselll user)

It took me approximately three months of sporadic working, from knowing nothing to developing the basic structure of a working application using dBaselll. The video shop system we developed under Quartz, although somewhat less complex, took around a week to get into a similar semi-operational state. At first sight this twelve-fold increase in speed seems nothing more than amazing, but then I started to reflect on the process of database creation under Quartz.

Quartz is incredibly easy to use because everything is interactive: creating a procedure under Quartz consists of literally pointing at the statement you want and then pointing at the arguments you want to use with it. This is great fun and a very quick way to create procedures or 'sequences', as Blyth calls them. It's also a very dangerous way of performing any kind of programming — it tempts you into making hasty alterations without considering their repercussions. It is very difficult to sit down and write all the sequences on paper in true top-down fashion.

The majority of programmers spend their time maintaining the source code of existing programs, and my experience suggests that the same is true for database designers. A large Quartz program could be many times more difficult to maintain than its equivalent in dBaselll; not only because of the problems generated by its interactive nature, but also because of other problems. When the sequences are printed, they are printed purely sequentially and so cannot reflect the structure of the overall system; it isn't possible to give meaningful names to variables; and there is no way to build up a library of general-purpose routines (although I am told that an additional Quartz toolkit will make this possible).

Despite these reservations, there is no doubt that Quartz is an immensely powerful package capable of creating applications that are many times more friendly than anything created with dBaselll. All the power of Windows is fully utilised, for example: creation of entry forms, producing reports and utilis-

ing pull-down menus are all exceedingly easy. There were times during the course of this review when I could have cried, as a feature that took me weeks to create under dBaselll took less than five minutes using Quartz.

The most difficult concept for a dBaselll programmer to get used to with Quartz is that of sequences, and the fact that they are hidden away among Windows' pull-down menus. I still find it peculiar to have to examine the depths of a menu in order to find a system's source code. Once you accept that sequences are roughly equivalent to subroutines in dBaselll, things become somewhat easier. But even then the process of converting a dBaselll program would not be a simple line-by-line translation, because so many of the features of Quartz are tied up in interactive set-up screens. Building a Quartz application involves creating all the components of the system (input forms, menus, reports, and so on) and glueing them together with sequences. dBaselll applications are created from the ground up, as in the source code (discounting The Assistant, Ashton-Tate's rather feeble attempt at a friendly application development environment).

I was expecting one of the trade-offs of the Quartz environment to have been speed. Surely, as Quartz has Windows to support, it would be abysmally slow in comparison with dBaselll. When developing applications this is definitely true — running Quartz on anything less than an AT is painful, but when running an application the difference is less noticeable.

My initial (non-scientific) experiments suggest that dBaselll is the quicker of the two programs but not by much. Of course, dBaselll developers have one major advantage in the search for speed — for extra cost they can purchase a dBaselll compiler.

Will I be using Quartz for my own applications? Not right away, no, but I suspect that when the pressure is on and I need a prototype up and running within a week, that I might succumb. Eventually the superior quality of an application generated under Quartz will decide for me, providing of course that the hefty £695 price tag is within my budget.

Nick Walker

need to use a printer's fastest draft mode, but the only way to use this is to change the default Windows printer to a text-only device, in which case we lost the box rules.

When a snazzy, stylish report was required, Quartz turned out some good work with the different fonts and sizes reproducing well. The penalty is speed, but that is a problem for printer manufacturers, not database designers.

On the Kyocera speed was less of a problem, though even there it would have been useful to be able to turn off the fancy fonts and run off a quick draft without relying on Windows' ability to run two programs at once and invoke the Control program.

Additional features available include an import and export facility using industry-standard formats such as DBF, SYLK and WKS.

### Documentation

We worked with a pre-production version of Quartz and the documentation was not finished. However, we did have a fairly complete reference guide and this included a brief description of the function of every command and option, often with brief command listings.

The retail version will include an introductory tutorial manual and an advanced programmer's manual.

This will include sections on database development and design. A quick reference guide will be in loose-leaf format so that updates can be easily inserted.

Quartz will also be supplied with a full sample application of a project management system. This will manage files of people and tasks.

### Price

Omnis Quartz will retail at £695 plus VAT. Blyth has decided not to include Microsoft Windows with the package on the basis that an increasing number of manufacturers are bundling Windows with *their* machines. This decision is questionable, and if you don't have Microsoft Windows it will set you back an extra £75 (plus VAT).

Blyth will be marketing run-time modules for Quartz at around £120 each, and a full multi-user version will be available later this year, although existing applications will need minimal or no modification to run multi-user.

### Conclusion

This review has only provided a taste of what Quartz can do. There is no doubt that it is an extremely powerful programmable database, both in its data-handling capabilities and in the tools it gives the programmer to design applications.

The point and click approach of Quartz to programming, and the use of menu lines rather than separate program files to store sequences, will seem strange to most existing programmers. But when the habit has been acquired, it is possible to set up the bones of a slick-looking application very quickly.

Quartz doesn't lend itself easily to a top-down approach to database design either. Ideally you would start with the visible pull-down menus. But, having designed the file formats, lists and entry layouts, you have to go back to the menus to do the nitty-gritty work of programming. Fortunately it is easy to hot-key between the layouts and the menus, but the process does seem rather circuitous.

Finally, you have to question whether a graphics environment is ideally suited to all data applications. Certainly the screens can be designed well, and push-buttons and scroll bars can prevent users from making mistakes. But in a heavy-duty data entry system, an operator doesn't want to have to keep taking his or her hand off the keyboard to use the mouse, and greater opportunity to design in hot keys would be essential in this situation. Nonetheless, these are small criticisms compared to the power and ease of use of the finished applications.

Blyth Software is on (0728) 3011.

END



# Train your computer to deliver the mail

That's electronic mail of course.

All you need is a Miracle modem and your PC becomes a postman. A Miracle modem may look unremarkable – just a small, black box beside your computer. But it lets you do some astonishing things. Take electronic mail . . .

It's faster than going via the post office. Our slowest modem speeds your message at 1200 bits per second. That's 30 lines of text in just ten seconds.

It's cheaper too. Each message can cost less than a second-class stamp.

And with Miracle, you also get modem features like 'auto-dial' and 'auto-answer', so you can send and receive messages when it suits you.

That's really just the beginning. There's also software for telex, file transfer and access to Prestel and over 200 independent databases. (All

this, because Miracle modems support Hayes protocols, the industry standard.)

Perhaps most remarkable of all is the price. You can have a Miracle modem complete with software for as little as £226. And if you buy now, we'll give you a year's subscription to an electronic mail service absolutely free.

To demonstrate exactly what Miracle modems can do, we've produced a booklet: '70 new tricks to teach your computer.'

For your complimentary copy, complete and mail the coupon. It'll be with you as quickly as the post office allows.

MIRACLE TECHNOLOGY (UK) LTD, ST PETERS STREET, IPSWICH, IP1 1XB.

TEL: 0473 216141 6 LINES. FAX: 0473 50080.

TELECOM GOLD 79: KEY 001. TELEX: 948240 CWEASY G 19002985.



TO: MIRACLE TECHNOLOGY (UK) LTD, ST PETERS STREET, IPSWICH, IP1 1XB.	
PLEASE SEND MY FREE COPY OF '70 NEW TRICKS'	
NAME	_____
POSITION	_____
COMPANY	_____
ADDRESS	_____
	_____
	POSTCODE
TELEPHONE	_____
	PCWORLD/9/87

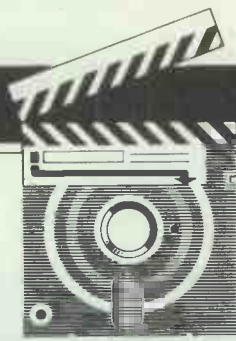

## SCREENTEST

# DESQview

*Now that multi-tasking is finally becoming a reality, DESQview's innovative form of 'partitioning' will appeal to anyone who wants it now — rather than later, in the shape of OS/2.*

*Owen Linderholm assesses the product's capabilities.*

Quite possibly you are sitting reading this article in front of a PC waiting for a long operation to be performed, like recalculating the accounts spreadsheet or compiling your newest program. Naturally, since you can't use the PC while this is going on, you pick up *PCW* to keep up with the industry and you start to read and dream about OS/2. If that was available, then you could switch to a new task and carry on working on something else.

Here's some exciting news; you could be working *now* even with a humble 8088-based PC. The program that allows this is DESQview 2.0 from Quarterdeck, an American software house.

### *The view from the round window*

DESQview is essentially a resource manager for your PC. It starts from the assumption that you want to use a number of programs on the computer *simultaneously*. Normally this would be completely impossible since both programs would need to use the same bit of memory at once or write to disk at the same time. If you imagine trying to watch two programmes on TV simultaneously, then you will get some idea of the difficulty. The two TV programmes will both be trying to send conflicting information to the screen and speaker at the same time and the result will be a real mess.

Trying to get two computer programs to run on a PC at the same time is even more complicated since there are far more things that the two programs will need access to.

DESQview must manage all of the resources like the screen so that such conflicts do not arise. It does this by

partitioning each program in its own area of memory which it is not allowed to break out of. If programs need to write to the same part of the screen, then DESQview only allows one of them to display at any time and the user has to switch between them. With many programs, this is the only way they can be run under DESQview. In this case, DESQview is simply switching the programs about and the user sees this as something like switching channels on TV; just switch over and you are immediately back in the middle of another program.

However, DESQview *can be* cleverer than this. Let's get back to the TV analogy for a fuller picture. There *is* one way that two TV programmes can be shown at the same time on a TV set. This is to put one (or more) pictures in a box within the full screen. Although this obscures part of the main screen, if carefully placed, the boxes can let you see two things at once without losing any important parts of the picture. Some of the more recent TV pop programmes do this quite a lot and I have seen up to five inset boxes on the screen at once.

DESQview does something similar with computer programs. As long as a program is known to be 'well-behaved' and one that won't try to break the operating system's rules, then DESQview can display it in a window on the screen. This window can be any size, from one character to the whole screen. Information inside the window can be scrolled around and the window can be resized and moved about.

DESQview can also actually have more than one program running and operating at the same time as long

as it can fit them both into memory. It can have lots of programs ready to run, but if they don't fit in ordinary memory then they need to be swapped in and out from disk or extended memory.

To do all this, DESQview needs to be able to manage the processor and memory very carefully. It is a fairly simple matter to shove programs into separate areas of memory and even to prevent them writing data to other areas of memory where other programs have been stored. This is done by having DESQview take over most of the operating system. It intercepts all the calls that a program makes to the processor and data bus and decides whether to let them through, stop them or to modify them to go where DESQview wants them to.

Obviously memory management is an important function of DESQview, but even more important is processor control and multi-tasking. DESQview is essentially a sort of parasitic control program that squats on top of the operating system and controls it so that more than one program can run at once. DESQview also dynamically determines how much of the processor time each program running under it gets. It monitors the passage of time and every now and again — every few hundredths of a second — it switches control from the current program to another on its list. This is known as time-slicing and allows a single processor to run several programs by giving each one a short turn to run.

When DESQview switches between tasks, it needs to save the status of the processor, registers, stacks and other areas of system memory. If there is insufficient memory when it



starts a new task, it also needs to switch one of the old tasks out of main memory and save it somewhere in temporary storage. This can either be expanded memory or a cache on disk that DESQview manages itself. This process is almost instantaneous when swapping to or from expanded memory, and very quick when swapping out to a hard disk.

Even allowing for the huge overheads involved in switching whole programs back and forth, managing and saving memory, registers, program stacks, and so on, the processor can manage quite well at performing several tasks. As a simple test, I set my HP Vectra AT compatible to work downloading a large file from The Source using ProComm, then set it printing an equally large file from WordStar and finally opened up another copy of WordStar and bashed away at the keys as fast as I could — no attempt to write properly, just enter letters as fast as possible. Even at about 200wpm typing speed, I could detect no slowdown in the word processor and both the file download and printout performed beautifully.

Since DESQview controls the programs and windows running under it, it is also possible to use it to cut and paste information to and from any window on the screen. As well as simple cut and paste, these operations can be buffered so that different sections from within one application or several applications can be run together. DESQview also provides a wide range of options for pasting information back in so that it will remain aligned in the same way as it was in the original window from which it was taken.

## Features

DESQview 2.0 is considerably changed from the previous version, DESQview 1.3. This allowed multi-tasking and windowing of up to ten programs at a time as long as they were well-behaved and were text mode only. DESQview 2.0 allows multi-tasking and windowing of up to 250 programs at once and these may include graphics programs as well. Support for the 80386 processor has been added and, in addition, DESQview 2.0 works properly with the new IBM PS/2 range. Many programs are now claiming PS/2 compatibility because they are shipped in 3½in disk versions as well as 5¼in. However, DESQview 2.0 and Turbo Basic are the only two programs I know of that support the VGA graphics modes of the PS/2.

In addition, the range of 'badly-behaved' programs that DESQview can work with (such as GEM or Windows) has been enlarged. It does this by providing a special loader for

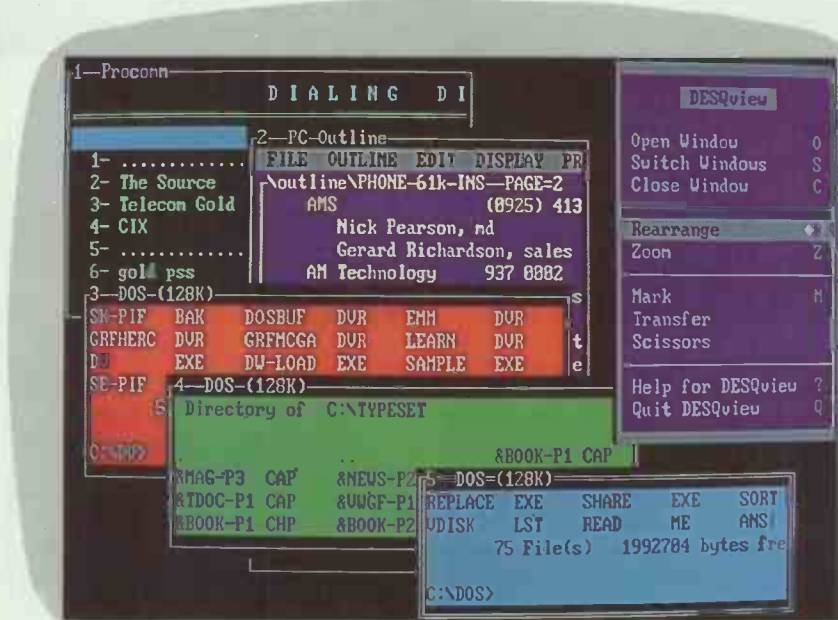

DESQview 2.0 in action. There are several ordinary DOS windows open in the background, each with 128k available to it. Other open applications are available after a couple of keystrokes and include WordStar and ProComm. The main DESQview menu is at the top

them that lets it control them rather than be controlled by them. Unfortunately, the list of applications supported in this way is still too small. Many of my favourites were not on the list, although a large number of standard business programs such as Lotus 1-2-3, were.

Graphics programs can also be run, but unless you are using an 80386 machine with Quarterdesk Extended Memory Manager 386 (QEMM386), then they will need to be run as full-screen applications. The graphics screen can be put in a window, but the application will be frozen. With QEMM386 and an 80386 processor, however, you can have as many CGA graphics mode screens in windows as you like, all still running. Also, using enhanced expanded memory (EEMS) rather than other forms of extended or expanded memory is an advantage. EEMS is a proper virtual memory system and allows programs residing within the expanded memory to be actually running, so you can have several megabytes of programs all running at once.

DESQview 2.0 also comes with a built-in DOS 'Services' manager. This lets you get directories and mark, copy, delete and move files around. Besides this, you can also open a DOS window at any time with 128k of memory available. This can be used for simple DOS functions or running short, simple and well-behaved programs.

One other major facility of the program is its ability to learn 'scripts'. These let the user assign any sequence of operations in DESQ-

view or in any set of programs running under DESQview to a single key. For example, you could set DESQview up so that it automatically started your word processor and loaded in (or even typed from scratch) a business letter template, then paused while you entered in a name and, finally, continued by filling in all the greeting part of the letter at the start, leaving you to type in the main paragraphs in the middle to produce a complete business letter with no fuss. Or DESQview could be used to open up your monthly accounts on the spreadsheet, mark the relevant figures for a regular report and paste them into a word processor document ready for you to add some final notes to complete the report.

Many of the ordinary operating parts of DESQview 2.0 have been considerably improved since DESQview 1.3. A particular example is that communications tasks have been optimised. If you are using a communications program under DESQview 2.0 — even as a background task — it runs as smoothly as if it were the only program running on the machine. The only noticeable change is that large chunks of text appear to come in bursts rather than steadily from the communications program.

Another nice touch is that any window on the screen can be scrolled — as if the window were looking through a frame onto a full-sized screen underneath. Also DESQview automatically scrolls the window when anything is printed in it so that the printed information appears in

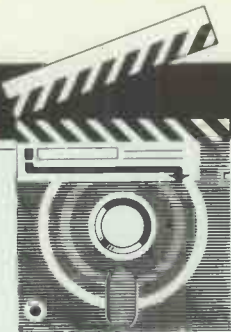

# SCREENTEST

the visible part of the window.

Finally, DESQview comes set up in such a way that a programmer can easily write their own applications to make full use of DESQview windows, menus, subtasks and message-passing between tasks. Some of these functions are only available to programs specially written for DESQview; hooking your own programs into DESQview in this way can help you to produce extremely powerful and useful multi-tasking programs. For example, DESQview specific applications can perform proper inter-task communication, so that a DESQview communications program could be set to send parts of any received information to a DESQview word processor automatically; or a program could be downloaded from a remote database and automatically installed and run under DESQview.

## In use

DESQview may all sound a bit too good to be true, but it is true except for some details: there are problems with the amount of available memory for extremely large programs, and it may not be possible to run more than one copy of some programs with I/O problems. Also, there are a few programs which when run require the operator's attention continuously and, if paused, might as well be removed from the machine. (Games programs are a good example of this.) Once these limitations are understood, it's easy to tell what will and what won't work well.

Installation of DESQview is critical to its correct operation, so Quarterdeck has made the set-up program simple and easy to use and, more importantly, it can be rapidly re-

installed at any time. To install the program, simply run the set-up program and follow the instructions. You are given the option to perform a simple or advanced set-up. The simple set-up is enough to get you going and get used to the program, after which you will need to run the advanced version.

As soon as DESQview has been installed, you will need to install different applications under it; this is a more complicated process. Many applications are listed on the installation menu and, with these, installation is merely a matter of telling DESQview where to look for the applications program. Any programs not on the list must be manually installed and this can be a difficult business. The hardest part is allocating the amount of memory a program will need. Too little and it won't work; too much and you will waste space that could be occupied by another application. For those applications for which I did not know the amount of memory needed, I found it best to start with too little and kept testing and allocating more memory until the program worked properly. (It is very important to experiment properly since if an application does run out of memory under DESQview, it will try to grab more and it is sometimes not possible for

DESQview to prevent this. The result is that the whole machine freezes or crashes spectacularly.)

DESQview can be installed for use with either a mouse or the keyboard. The keyboard tends to be quicker, but the mouse feels better in use since it can be used, Mac-like, to size, scroll and move windows on the screen. It is probably a good idea to try both and see which you find more useful. It is important to realise that if DESQview is installed for the mouse, it may well not work properly in your application program. If you set DESQview to use the keyboard, however, then the mouse will work properly in the application.

Using DESQview is a little odd. It is exactly the opposite of using a memory-resident pop-up program. Memory-resident programs pop up over any current application and disappear when no longer needed. DESQview pops the applications up and is always there lurking in the background, monitoring. All your ordinary applications become pop-up and memory-resident; available at the touch of a key and shoved away in windows. Only the one you are currently working on seems to be active, even though other tasks may be running quietly in another window. It is a very strange environment to work in and I am still accustoming myself to it.

In DESQview it is also very easy to zoom an application up to full window size and forget about other open applications. If you then quit DESQview, you will have lost work in other windows. Fortunately, DESQview can be set up so that it won't close unless all the windows have been shut down separately.

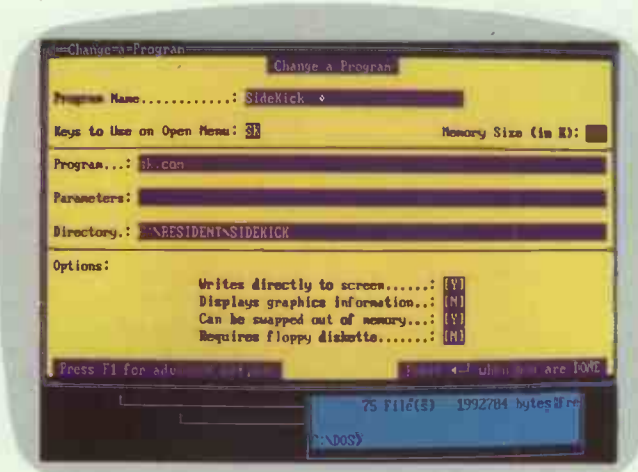

Setting up a program to run under DESQview is a critical operation. Although there are only a few choices to make, the answers must be right for the program to work properly with DESQview

DESQview has a few applications available immediately before any new ones are installed. Shown here are the memory display (being resized), a DOS window and the rearranged sub-menu of DESQview

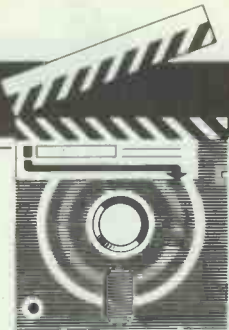

# SCREENTEST

One thing that is hard to do is to 'get lost'. The whole program is controlled by menus accessed either entirely with the mouse or using the 'CTRL', 'ALT', 'SHIFT' and 'cursor' keys. Short-cuts using initial letters from the pop-up menus are available but you don't have to use them. I found this side of the program extremely easy to use, and a sheer delight.

DESQview makes use of EGA and even VGA modes properly and I was able to get displays of up to 43 lines using EGA. This meant that I could have one 80x25 application and one 80x14 application at once, which could be very useful. However, graphics didn't seem to work so well. Although the program worked with graphics, it would only do them full-screen. If the application is frozen, then the graphics screen could be put in a window, but not while it was working. The manual says that CGA screens can be freely put in windows on 386 machines while continuing to work, but I was unable to try this.

The application I found DESQview most useful for was transferring information and files via various online services in the background while continuing to work on editing a document in the word processor or outline processor in the foreground. This operation worked perfectly the first time I tried it; it was also useful for continuing to work while sorting my phone list in the database. The only thing to watch out for is clearly indicated in the manual: communications programs must be run only when held in the computer's normal memory.

The other main use I found for DESQview, and the one that would make me seriously consider buying it, was keeping several applications open at once and ready to use. This may sound a little unnecessary, but I

found it very convenient to have my communications program, word processor, phone list, disk manager and a programming language all available at the touch of a key.

## Problems

There were, however, a few problems, but most of them were of my own making when I tried to do ridiculous things in order to push DESQview to its limit. The worst problem was with printer conflict. I tried to get three different versions of WordStar to print different files at the same time on the one printer. I set DESQview up to manage printer conflicts and let the three programs start. DESQview seemed to manage okay, but when I came to look at the output it had only partly succeeded. All three printouts were printed in large contiguous chunks, but DESQview had decided to switch between the applications halfway down a page. This meant that I got five and a half pages of one document, then five and a half of another, and so on. Unfortunately, half-pages aren't very useful. Printing one document while doing other non-printer tasks worked fine, so I recommend not doing anything silly like trying to do lots of printing with DESQview all at once.

Subsequently I discovered that installing DESQview to manage printer conflict caused problems even when printing a single WordStar file. This is to do with WordStar's inability to properly manage sending all the in-

formation to the printer. WordStar pauses once the printer buffer has been filled and has to manually be told to restart. When WordStar pauses, DESQview does something to manage task-switching that messes up the printer.

By resolving printer conflicts, DESQview ensures that only one application can print on any one page, but because of the PC's hardware idiosyncrasies it is unable to tell when an application has reached the bottom of a page. This means that if an application such as WordStar pauses halfway down a page, DESQview detects the pause and switches to a new application — which starts on a new page. Of course, everything will work fine if the application that is printing only pauses at the end of pages.

Another problem I deliberately created with WordStar was to have four different versions of WordStar editing the same file. Not surprisingly, WordStar got very confused (but not DESQview). It occurred to me that programs which can do file-locking for network access would probably not mind this, but I hadn't set my WordStar to do this and every single one of them refused to save the file. On quitting I discovered I had lost it — fortunately, I used a test file rather than something I needed.

One area in which I expected to encounter problems was in using large numbers of applications; I didn't have any. I got up to forty programs open at once before I got bored, but none of them had any problem running. However, swapping applications in and out of memory took a while. Expanded memory in the form of a Quadram Quadboard-AT helped, but forty applications easily fills up expanded memory too.

Although DESQview works fine on floppy-based systems, problems can arise if you use too many applications since swapping memory out to disk takes much longer. However, using only two applications at the same time worked well.

## Conclusion

If all you want is to run several of your current MS-DOS applications at once, then DESQview is a convenient and cheap solution. Remember, though, that DESQview works better on hard-disk systems and even better with extended or expanded memory. Also, watch out for those problems with allocating memory and printer clashes!

DESQview 2.0 costs £125 and is available from Xionics, 4 Dollis Park, Finchley, London N4  
Tel: (01) 346 0247. **END**

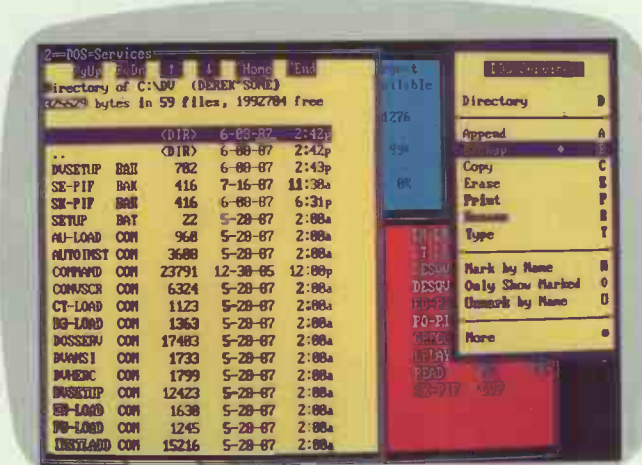

*This screenshot shows the disk manager program, DOS Services, that comes with DESQview. It is a fully-fledged disk manager similar in function to products like X-Tree and Directree. It can call up DESQview menus or run its own multi-tasking sub-programs*

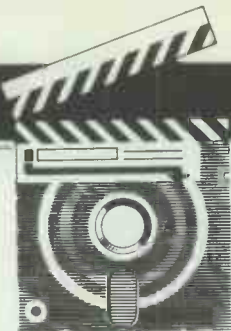

SCREENTEST

# XPress

*Described as a truly professional, if pricey, page make-up system for the Mac, XPress from US company Quark Incorporated offers unprecedented typographic control over page layout, and has set a new standard for desktop publishing software. Graham Jones gives his verdict.*

When the vogue for desktop publishing really began to take off last year, one program stood head and shoulders above the rest as the 'Rolls-Royce'. That program was PageMaker, from Aldus, and it was used as a yardstick by developers hoping to gain a slice of the rapidly expanding desktop publishing market.

However, PageMaker has some limitations, especially for professional users who have become increasingly frustrated by them, and by the slowness of Aldus in introducing upgrades. Enter Quark, a US company, with a new desktop publishing package called XPress.

## New standards

Quite simply, XPress is the best desktop publishing package available for the Macintosh. It outshines the old

yardstick of PageMaker — even the new version — and sets new standards of its own.

There are two main advantages to XPress. Firstly, it has a degree of typographical control which is so fine that it will allow you to alter the spacing of type to within 0.00014 of an inch, or 1/100th of a point — that is, one fifth of a dot even on a 1270 dots-per-inch typesetting machine! Secondly, XPress allows you to wrap text around complicated graphics simply, efficiently, and quickly. To date this has only been possible on the Macintosh with extreme difficulty using PageMaker, or by programming in PostScript.

XPress has a number of advantages over PageMaker and another page make-up program, Ready, Set, Go! 3; it combines the best of both of these and provides a truly profes-

sional page make-up package.

The program comes on three disks. One contains the application itself, a second has the system folder and a few examples of XPress documents on it, while the third disk contains two utilities to allow the program to be copied to floppies or to a hard disk. (To run the program efficiently a hard disk is necessary.) The program is copy-protected, but you are allowed to make up to three copies for personal use. Also included with the program is a utility called 'Frame Editor' which allows users to construct borders to surround pages, text, or illustrations.

## In use

Once the program has been loaded you have the usual option to open up an existing document, or start a new publication. When choosing a



Pages in XPress can be viewed in a variety of sizes. The toolbox always appears on the left of the work area, and is not movable. Rulers can be in a variety of units and can be removed if not required

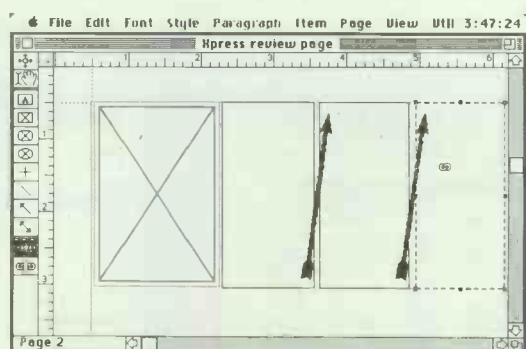

The three text boxes are linked (shown by the onscreen arrows) by using the chaining tool, highlighted bottom left in the tool palette. Other tools allow picture boxes to be drawn, and lines and arrows to be positioned

new document from the 'File' menu a dialogue box asks you to decide on the size of the page, the number of columns, the margins, and so on. The page can be any size from three inches square to a poster-sized 36 inches by 36 inches.

Once you have decided on your basic page size you can open up the first page. However, you do need to enter the paper size in the 'Page Set Up' dialogue box before printing anything you work on. This is an annoying little problem with some Mac programs. Why the paper size cannot be included in the new document dialogue box is a mystery!

Nevertheless, the Page Set Up dialogue box does contain quite a bit of information, and even allows users to determine the grey level, in lines per inch, of PostScript laser printers such as the Apple LaserWriter. By adjusting this value you can get improved grey tones. The default is 60 lines per inch, which in my view is too low. A value of 80 or greater achieves much better grey resolution on the LaserWriter and avoids the coarse-looking tints of other desktop publishing programs.

Once the page has been set up as you want it, you can set to work. The document always opens at the top left of the first page — no matter where you stopped working. This is not too much of a problem since travelling around the pages is fast and efficient.

### Page design

XPress, unlike PageMaker, asks you to define areas of text or graphics prior to entering any copy onto the page. This is similar to Ready, Set, Go! 3 and, at first sight, has always seemed to me to be an unnecessary additional step which PageMaker cleverly avoids. However, it does provide a much greater degree of design flexibility, allowing you to simply move items around the page to redesign any aspects you don't like.

You can define text boxes, or three types of picture boxes in XPress. Each text box can be altered by using the 'modify' command from the 'Item' menu. This allows precision control over the position of the text box, allowing you to move it around the page if you have not drawn it exactly where required. You can change text box positions to within an accuracy of 1/1000th of a point! The modify dialogue box also allows you to specify the number of columns in a text box, alter the gutter (space) between them, and to request the 'text offset' — the space between the outer edges of the columns and the start of the text. This is very useful if the text has a rule around it, thus ensuring that there is a space between.

You can also make text boxes

## XPress — the best page make-up package for the Mac?

Xpress enables you to perform a number of tricks which are not easily possible with the most popular Macintosh page layout program, PageMaker.

It is very easy to make text run around irregularly shaped objects such as the picture on the right, something which PageMaker has not been able to do without a lot of effort.

The next version of PageMaker should be able to do this, but the US version I have seen does not cope with such sophistication, and by the end of June the British update had still not been made available, despite months of speculation.

Running text around complicated

graphics is not the only advantage of XPress when compared to PageMaker. XPress also possesses a unique feature in its ability to be able to control the grey levels of PostScript printers such as the LaserWriter. This means that it is

possible to achieve much less coarse tints than are available with many other programs. XPress also

includes a printer driver to run a Linotype machine or a Data Products laser printer. It is highly likely that XPress will find widespread use as a front end typesetting solution in many graphics orientated publishing houses.

XPress provides a much greater degree of typographic control which is necessary in such situations.



### Frame editor allows design flexibility

The XPress package also includes a program called 'Frame Editor'. This is a utility which allows you to design and modify borders for text, pages, and pictures, just like the one around this page.

Most of the examples included with the XPress package are pretty horrible, including this one!

But the Frame Editor utility does allow you the flexibility to produce

your own borders from any kind of graphics you care to import.

Such a system is not available with other leading page make-up programs for the Mac, such as Ready, Set, Go! 3 or PageMaker 2.0.

Fancy frames are not widely used in publishing, but there will always be a day when producing something and a frame editor will be required.

Another simple utility provided within the

XPress package is the ability to truly change the horizontal scaling of fonts.

So it is possible to stretch type to achieve some pretty unusual effects, some of which will, nevertheless, have a use, especially in magazine work.

Graham Jones

transparent by using the modify command. This means that you can place other text or illustrations behind these boxes and they will be seen through the text. The default is for opaque text boxes. Should any other material, such as a picture box, be included inside, then the text runs around this. Text boxes can also be chained together so the text will flow automatically from one to another. This is a very useful facility, especial-

ly in magazine work where text may be split between pages which are a long way apart.

The three types of picture boxes available are those which are rectangular, oval, or rectangular with rounded corners. Pictures can be included within these boxes from MacPaint, PICT, or Encapsulated PostScript files, such as those created in Illustrator. Like text boxes, picture boxes can be modified for accurate

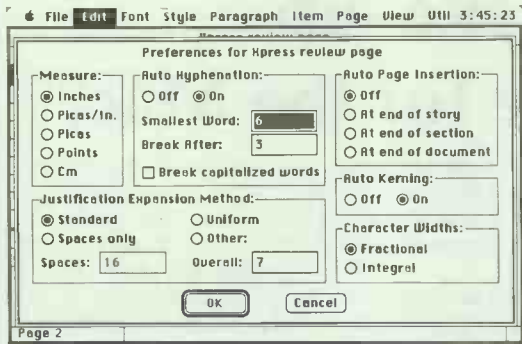

*Setting up a page in XPress allows you to decide the system of measurements you use; whether hyphenation will happen, and if so, how; the method of justifying lines of type; whether kerning will occur; how character widths are calculated; and so on*

positioning. You can also change the radius of corners for rectangular boxes with rounded corners, and you can decide how far text outside boxes will be offset when it is to run around them. Like text boxes, picture boxes can be transparent. You can also make picture boxes transparent but make the text run around the picture itself.

All boxes, whether for text or graphics, can have background shades, and you can specify the colour of such shades. This is very useful in professional publishing since XPress will print off each colour item separately, thus allowing you to produce colour separations for litho printing. Incidentally, XPress also provides other useful printing luxuries, such as the ability to produce wrong-reading negative film, thus saving additional costs and time at the printers. The colour option, which also allows you to specify colours for text, will work with colour ImageWriters — though anyone who has bothered to buy XPress will almost certainly never use an ImageWriter. The colour flagging will also be useful when colour laser printers start to appear sometime within the next year.

When you have placed your boxes precisely, flagged them for shades and colour, and so on, you can then place a 'frame' around them if necessary. Basically, an XPress frame is a rule around the box which can be one of a wide variety available, or one you have constructed using the Frame Editor utility. Like everything else, frames can be flagged for colour, and size can be precisely controlled.

## Entering text and graphics

With a page designed with boxes for text and pictures, and shades, frames, colours, and so on, having been decided upon, you can begin

entering text and graphics. Naturally, you can alter all of the specifications set for the items on the page at any stage in the production of the publication, but it is often useful to set them all initially since this is more professional and it does save time in the long run.

Text can be entered directly in XPress, much faster than in PageMaker, though it is still slower than standalone word processors. Text can also be imported from the standard Macintosh word processors, MacWrite and Microsoft Word, as well as text only or ASCII files. Before entering text it is a good idea to alter the default settings under the 'Preferences' option of the 'Edit' menu. The default is for no hyphenation, and for no kerning. Considering that XPress allows such a degree of typographic control, to leave these two options switched off seems daft!

Hyphenation and kerning can also be manually controlled, even overriding the automatic feature if required. Kerning can be controlled to 1/100th of an em, thus providing control suitable even for high-resolution typesetting machines.

Leading (the spacing between lines of type) can be controlled very finely, and the parameters of each paragraph, such as indenting the first line, and so on, can also be fine tuned. Text can be in any size from the smallest you can read up to 500 points. Cleverly, XPress also allows you to precisely alter the horizontal scale of text. You can compress the text to 25 per cent of its original width, or expand it fourfold.

Pictures in XPress can also be precisely altered in either width or height to within one per cent of their original size. This is a much more accurate method of changing the size of illustrations than allowed for by the manual resizing in PageMaker.

Using XPress is a delight. Features like the horizontal text scale adjust-

ments, the accuracy of positioning items, and the ability to run text around complicated graphics, mean that it places design much more in the hands of the operator who is less at the mercy of the program.

## User image

The program is fairly easy to learn, but its range of features means that it demands a few weeks of fairly regular use before you become truly proficient, rather than the few days of less ambitious programs.

Without a doubt, XPress will have given the PageMaker developers at Aldus a few sleepless nights. It is considerably more sophisticated than PageMaker 1.2, and even gives version 2.0 a run for its money. XPress allows precision control over typography which would please even the fussiest typesetter. Consequently, XPress is likely to be the program of choice for professional publishers, and for many people entering desktop publishing for the first time.

## Documentation

The manual is well put together, though it does not cover everything the program is capable of doing, such as the ability to produce well-fitting 'drop caps' (large capital letters) at the beginning of articles.

## Price

At £695 XPress is a very pricey program; but despite the high price, it is exceptional value. Two years ago such precision control would only have been available in some front-end typesetting solutions, at a cost of around £4000.

## Conclusion

For anyone involved in desktop publishing on the Macintosh, XPress is well worth investigating, especially if you need to produce material with a great deal of typographical control, or if you want to have the output typeset. It is particularly valuable in magazine design, as well as, say, for advertisement production.

XPress has set new, very high, standards for desktop publishing software, and this time next year commentators will doubtless be saying that anyone without XPress is not really a desktop publisher.

XPress from Quark Incorporated is available in the UK from Heyden and Sons Ltd, Spectrum House, Hillview Gardens, London NW4 2JQ. Tel: (01) 203 5171.

Graham Jones is a freelance journalist and author of *The Desktop Publishing Companion* (Sigma Press, £14.95). He offers a consultancy service and uses his Mac and LaserWriter Plus to produce a variety of desktop publications for commercial clients.

END

# 'DOUBLE YOUR MEMORY AND TAKE IT AWAY'

Most PC's limit your memory, haven't catered for expansion and certainly haven't even thought about moving data from one computer to another - easily, securely and inexpensively.

**VICTOR HAVE!**

The VPCIII combines Victor's 70 years of experience and achievement with today's needs for flexible data control and tight budgets.

By simply adding a removable 30Mb hard disk, the VPCIII allows you to upgrade capacity as and when you need it and have reliable, fast back-up.

And there's more . . . . .

At the touch of a button or two you simply detach the 'Add-pak' and off you go - locking away sensitive data, or moving data to another site, another PC - simply and safely.

Interested?

Find out more about the Victor VPCIII and a simpler, safer way to double your memory and take it away.

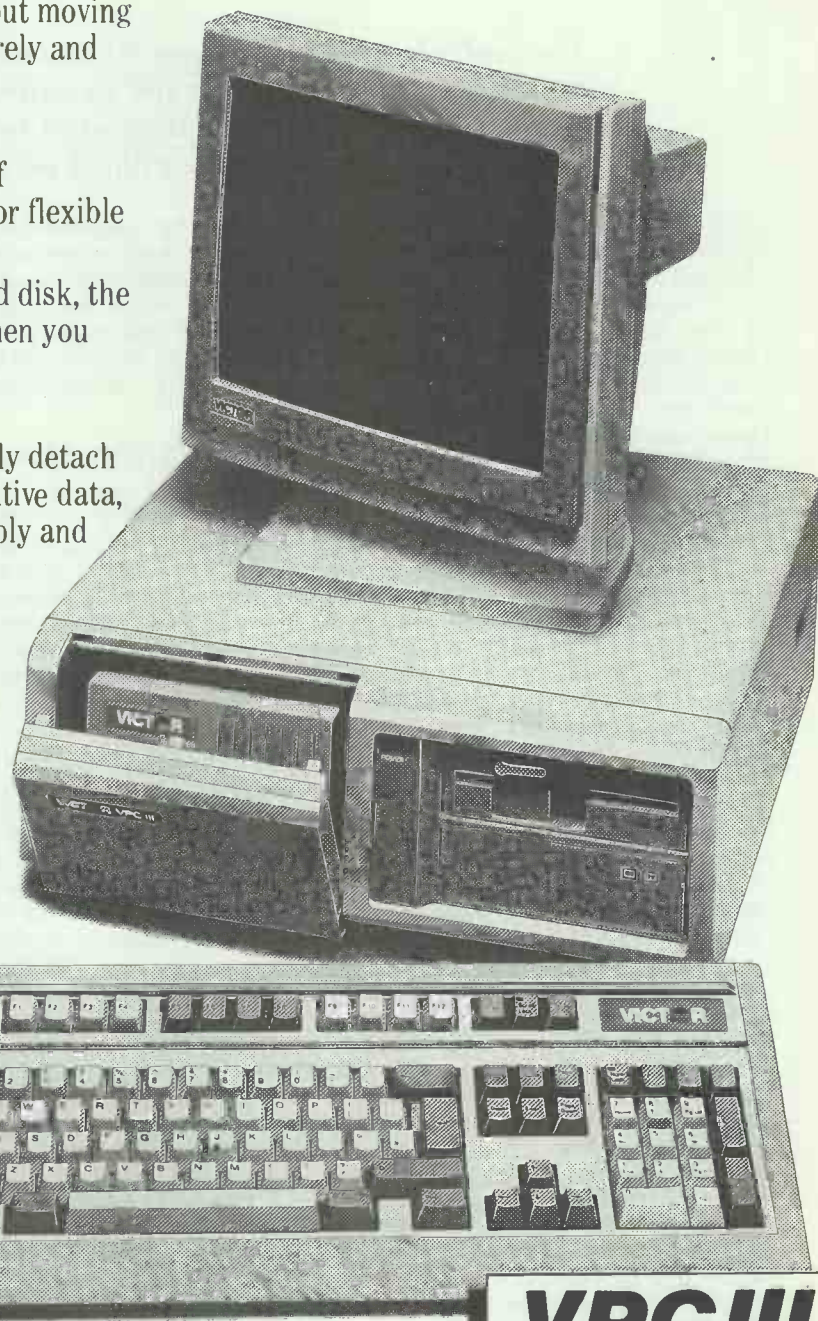

See us on  
Stand 2106

## VICTOR

Complete the coupon or phone 0494 461600 for our VPCIII information pack.

Victor Technologies (UK) Ltd  
Unit 1, The Valley Centre, Gordon Road  
High Wycombe, Bucks. HP13 6EQ  
Telephone: (0494) 461600  
Telefax: (0494) 461641  
Telex No. 837225

Please tell me more   
Please contact me soon

Name \_\_\_\_\_

Position \_\_\_\_\_

Company \_\_\_\_\_

Address \_\_\_\_\_

\_\_\_\_\_

Tel \_\_\_\_\_

Industry Type \_\_\_\_\_

## VPCIII

# Silicon surgery

*The inefficiencies and delays of the NHS make it a prime target for computerisation. But despite the excellent 'Micros for GPs' scheme and the proven record of medical diagnosis systems, progress has been slow.*

*Dr Andrew Herd examines what has been achieved.*

The involvement of general practitioners in computers dates from the 'Micros for GPs' scheme announced on 7 June 1982. At that time, beyond a few Apple IIs, the most sophisticated computer in general use was the Sinclair Spectrum. One hundred and fifty practices around the UK were equipped with computers, with the Department of Trade (as it then was) meeting half the capital cost and providing some support costs. The machines were relatively slow 8-bit systems, the software poorly conceived and support patchy. Many practices underestimated the data conversion task, some finding the strain on clerical procedures intolerable. Hardware proved unreliable with stories of several hard disk failures being not unknown. One of the software companies withdrew almost all support at the end of the scheme. Nonetheless, many practices forged ahead, soon outstripping the boundaries of their software — to find that what they possessed was an end-user system and slow developments.

A period of retrenchment has followed. Less than five per cent of the 27,000 GPs have access to a practice computer at present. Money is hardly a restriction, as a four-man practice might have a gross income of nearly £200,000. A number of new companies have now moved in on the software scene, and more sophisticated 16-bit hardware is in use. The reason for the lack of enthusiasm within the profession is more likely to be due to the restricted ambitions of the software developers, whose systems are often merely faster interpretations of existing manual systems. At present the benefits of computerised recall are almost exactly cancelled out by the extra time taken to load the data on in the first place, and you have to keep written notes anyway, so why bother?

The other spectre on the horizon is the major difficulty of data conversion from one software format to another, which a few practices have faced when their suppliers folded — a number of GPs are sitting back and

waiting for dependable firms to establish themselves before getting their feet wet. It can take months or years to enter even the meanest amount of information about the patients on the practice list and GPs are not usually overwhelmed by DP staff!

## Information storage

The smallest unit of information in general practice is the patient's notes. These belong to the Secretary of State for health and constitute a legal document. At present, the great weakness of conventional data storage systems is their reliance on easily altered magnetic media. Written documents are much less liable to unintentional or intentional alteration and this has remained one of their supporters' greatest arguments.

Information is recorded onto your medical record each time you attend, but not necessarily in a form which enables easy deductions about patterns of attendance, or which helps diagnosis. There is no clear view of what is going on. Written notes do not aid data structure and interpretation, but are relatively inexpensive, relatively hard to destroy, and even harder to alter. Magnetic media are easy to alter and it's important that one remembers this, as the National Security Council has recently found to its cost.

You have doubtless observed your own doctor attempting to work out what he wrote in your notes last time you visited the surgery, and this is one of the most cogent arguments for some kind of change. The other is that there is no insurance against loss of your folder, something that occurs more often than one would imagine. Present day magnetic media are limited in storage capacity, and have the disadvantage of allowing undetectable alterations to be made to the information stored upon them. This is undesirable in the case of a medical record, which the doctor may one day have to use to defend his actions.

One way ahead may well be the

'WORM' drive. When information has been committed to the disk, it is burnt in, and this would prove a great strength of the system. Coupled with the ability to store up to a gigabyte per side, the days of your Lloyd George folder may well be numbered, as this kind of capacity would allow text storage as well. The technology already exists, but as usual, no-one wants to be the first to use it.

## Play your cards right!

Have you ever been to the hospital outpatients and been unable to remember when you had your frontal lobotomy? A system currently under trial may have the answer for this. 'Smartcards' the size of credit cards have been around for some time now, begging for applications (see 'West Coast Connection', June 1987). The Honeywell Bull smartcard presently stores 16k — enough to store vital details, previous medical history, current active diagnoses, drug history, allergies, next of kin and significant pets. By 1988 it should hold 64k of data — enough to store most of a medical record used in general practice.

Smartcards are already being used in national and regional schemes in France, as a method of short circuiting the incredible amount of paperwork threatening to engulf their health system. Savings have been estimated at £600m so far! Depending on the parent scheme, cards are issued by GPs, pharmacists or hospitals and a total of 250,000 cards have gone into circulation over the last 4-5 years. One advantage of the smartcard is that the consent of the patient who possesses the card is required before the card can be used to upload information, which limits confidentiality problems.

As yet their medical use in the UK has been confined to one experimental scheme in Cardiff. The aim is not to replace surgery-held computer records, but to facilitate information transfer while leaving control of confidential information in the



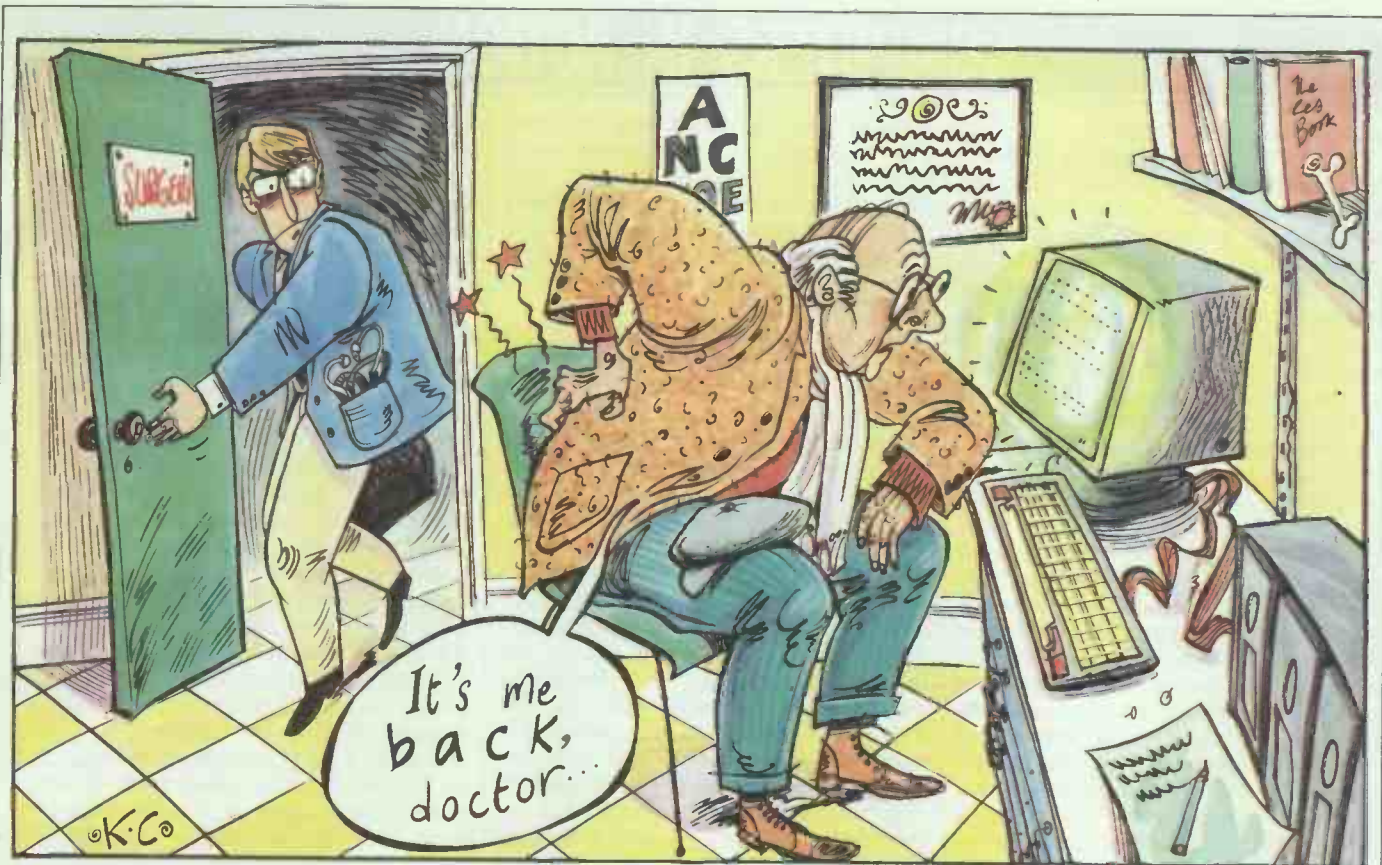

hands of the GP. At present, the system, which has been live since August 1986, relies on the GP separating patient information into two files on his surgery hard disk. One of the files, containing non-confidential information, can be downloaded onto the patient's smartcard with the other remaining on the surgery disk. Access to the hard disk record is limited by matching of a keyboard-entered password with that held on a 'password' smartcard held by the GP and entered in the surgery card reader. (I should point out that this represents at least one more security level than your existing computerised surgery record is likely to have at present; most systems relying entirely on single-level password protection alone.) Card readers are held at surgeries within the area and also at pharmacies participating in the scheme. A portable reader has been developed, which interfaces with a battery-operated printer, the entire machine fitting in an *attaché* case and hopefully being robust enough for the doctor to take on his calls. Uploading of 16k from card to surgery terminal takes about three seconds, and in addition to diagnostic use, the information held on the card can be used for the automatic production of repeat prescriptions in the surgery and of labels in the pharmacy.

If all GPs and hospital doctors had access to card readers, then the patients could effectively carry their medical history around with them. Not only would this prevent mistakes occurring but details could be up-

dated as required, bypassing the often crucial paperwork delays during which treatment progresses on a 'best-guess' basis as to what the little white tablets actually were. This venture could be regarded as a very sophisticated form of the 'medic alert' bracelets worn by epileptics, for example.

Honeywell says that the technology is already available to store features such as retina patterns, voice and fingerprints. If this is so, then it might also be possible to store digitised images such as X-rays, for instance; more RAM, and it might even be possible to squeeze on the entire text of the notes. The Honeywell smartcard at least, will use standard software, and card readers will cost about £250 with cards at present costing between £3-7 depending on the quantity ordered. Existing Honeywell cards can only be written to once, but an EEPROM (electrically-erasable programmable read-only memory) card is promised by 1988, and this will allow rewriting of data.

The question of alteration of card data arises at this point. In theory any patient with a little bit of know-how, and minimal hardware, could read and write to his own card. Lost cards would be vulnerable to the same manipulation. The latter case could be covered by protected areas on the card, only accessible by code entry; existing cards have this feature already. In the same way that your cashcard is useless without the PIN, the smartcard would lock the data without the code.

Future developments, discussed

earlier, will allow fingerprint, retinal pattern or voice-recognition identification keys. The Honeywell chips, at least, also contain encryption keys to the Telepass algorithm, allowing for protection and decoding of transmitted data. Obviously, a patient who was minded to change the data on his card himself could do so, but the information could not be protected from him in any case, since it is available under the Data Protection Act. Such manipulation would not go unnoticed for long, however, because of mismatches with the data held on the GPs files.

### Enter the experts!

In recent years, the limits of medical knowledge have accelerated away from the origin at meteoric speed. In consequence, areas of specialisation have shrunk, and the art of diagnosis has grown more complex — there are simply too many *known* diseases. Once a diagnosis has been made, treatment has also become more complex. The NHS has probably only survived this far as a result of the 'general practitioner' concept, a screening system which catches 95 per cent of all illness and keeps it out of the hospitals' itchy (and expensive) fingers.

However, the very nature of the GP means that by definition he is not an expert, and is bound to miss some subtle clues that the more narrowly-sighted specialist will pick up. However, as the specialists race over the horizon after new knowledge, even identifying the correct consultant to refer to can be a problem.

# COMPUTERS IN ACTION

## Enter the expert system?

There are curiously few AI applications targetted at general practice, but one stands out for its breathtaking vision — something few medical software houses can be accused of suffering from. The 'Oxford System of Medicine' (OSM) is possibly one of the most ambitious AI projects ever attempted. It is being financed by the Oxford University Press, and is being developed by John Fox at the Imperial Cancer Research Fund. The prototype alone has a domain knowledge of 3000 facts, and the definitive system will rely on at least one million. The OSM will aim to cover all aspects of medicine, from diagnosis to treatment. It will be an evolving product, updated as medical know-how advances. A great deal of attention has been paid to ease of use; for example, the prototype's diagnostic process can be interrupted to review patient history or an explanation of current conclusions. OSM will use a 'WIMP' interface, a radical departure from the menu-based software most GPs are used to. There are mouth-watering mutterings about graphics capabilities and laserdisc pictures. All this innovation means it won't be available overnight and, to a certain extent, the developers are also waiting for an appropriately powerful desktop micro on which to run it. The OUP has a release date in the late 1990s in mind, and I wish them luck.

The current leading-edge AI models are all hospital-based, and some promise a great deal. One computer-aided diagnostic system was used in eight centres to treat 17,000 patients with abdominal pain. Diagnostic accuracy rose from 45.6 per cent to 65.3 per cent. The number of operations which were carried out and at which no operable cause for the pain was found fell by half (a frightening

statistic for those of us who still have our appendix!). The savings were assessed as 278 operations and £748,000 over two years. Nationally the *direct* saving would be £5m and indirect resource savings about £20m. And this is just for abdominal pain admissions!

The software was designed for use by the non-computer literate and the down-time was less than one per cent, mostly due to disk corruptions. However, the system was only personally used by the doctor 45 per cent of the time and 30 per cent of doctors said the system was time-consuming if they were busy, despite the fact that most users were familiar with the system in 2-3 days. Four users disagreed with the computer on principle, a factor which is unfortunately a real pitfall in medicine. Some of the problems with the trial may have related to the computers used (the Commodore PET and Apple IIe). A good deal of the diagnostic improvement was probably due to the systematic way doctors had to consider the information, but the trial has a clear message: computers improve diagnosis, even when not all the users are willing! This system is in fact now being used by paramedics on US nuclear submarines, traditionally a bad place to have your appendicitis misdiagnosed!

Limited expert systems already exist for the diagnosis and treatment of bacterial infection, diabetic management (developed at St Thomas') and diagnosis of cardiac arrhythmias. The most extensive system in operation is probably 'Internist', predictably an American model, which has 600 stored diagnoses, with the most frequently used languages being Lisp and Prolog. More recently, expert system shells have been developed, and languages such as OPS5, Heresay-II and ROL have come to the

fore. In the future, self-learning inference strategies are likely to become more common, and interfaces which can cope with the rather archaic terminology medicine demands, will be necessary.

The imprecision of data collection and patient and disease variability, has caused modern systems to move away from rule-based systems towards frame-based systems, where data with common features are grouped together in order to describe a subset of knowledge. The effects of social background and psychological variables, for instance, cloud even simple diagnoses. Causal networks are now being developed, with the *deep* knowledge that rule-based systems lack, allowing the additional interaction of physiology, pathology, and anatomy. One such model is being defined in the University of Sussex, under the guidance of a Brighton-based cardiologist. Some of these newer systems are even able to give an explanation of how they arrived at the diagnosis, something most doctors can't do!

Standing in isolation as they do, medical expert systems can contribute little at present to general practice, but as part of integrated software suites, or as pop-up applications, they may one day prove indispensable. New patients could be assessed and problems identified, then management tested. In particular, they may prove invaluable for GPs on home visits, when decisions have to be taken on the move, using the minimum amount of information. The expert system is likely to prove particularly useful for the recognition of the clusters of apparently unrelated symptoms which point towards the rarer diagnoses, and for the provision of help with their investigation and management. On this basis, real savings in terms of hospital referrals

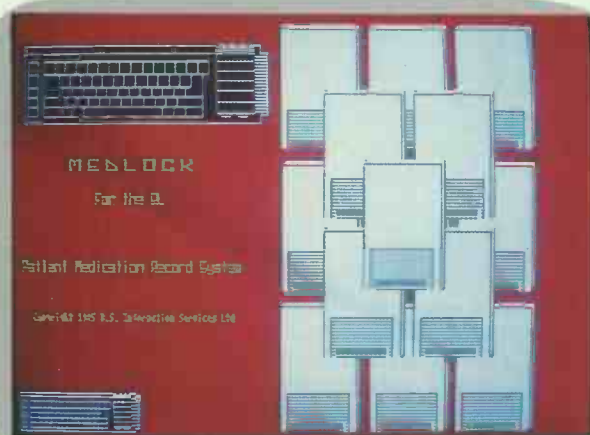

The Medlock system, developed by Dr RG Stevens, is the only UK-developed medical record system

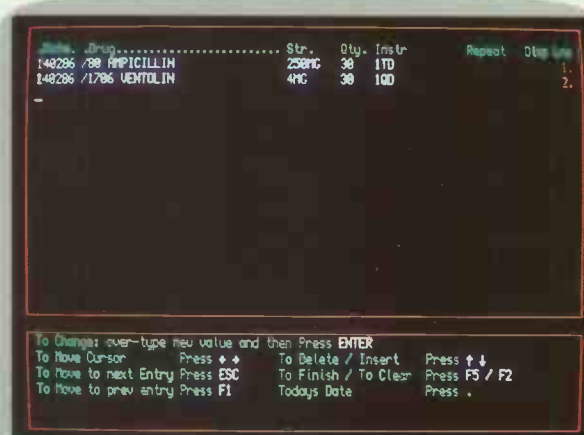

Processing the issue and dispensing prescriptions in the National Health Service, using the Medlock system

are likely to be shown.

An obvious future problem will be responsibility for errors in diagnosis. Who will be liable when a medical expert system makes a mistake? The clinician using it, the programmers, the experts or the manufacturers? The recent Lotus suit may give some pointers in this area, as Lotus was not held responsible for the financial loss one company attempted to pin on its use of 1-2-3, but more clarification will be needed in this area.

## Communications

Armed with an expert system, and drug database, who could ask for more? Well, modem links with the surgery, for one thing! This is a development that probably lies a long way off at present. Of the five per cent of GPs who currently possess a computer, only about 5-10 per cent have a modem, on my estimation, and few of these are linked to software which would allow any kind of remote access to the system. I have not yet discovered any GP who can access patient records remotely, and given the current state of security development, this is probably a good thing.

Can you imagine a hacker gaining access to your medical records? This is not just a remote possibility, as many individuals and corporations, such as insurance companies, would give their eye-teeth for a confirmatory check through your record, particularly in view of the rise of diseases such as AIDS. (I am not suggesting for a moment that big business would indulge deliberately in such criminal activities, but certain parties might find the temptation too hard to resist.) Secure phone lines will therefore have to be found and probably also some form of data encryption used. Modem access to central notes might well ease the pace of the somewhat 'on the hoof' quality of home consultation management decisions, but the time involved in getting online would probably render it a dubious advantage.

More likely, from the comms viewpoint, will be access to hospital databases. Some hospital information is already available on Prestel, on an ICL-based system. I bet you all wondered where the One Per Desk — the machine that refused to die — had gone to? Look no further; GPs in one health authority are using it to access regularly updated pages of information about laboratory reference levels and sample transfer requirements. Another online database carries information about social and community services available within its particular area — an outstanding development, as these agencies are springing up so fast that available printed lists are always way out of date. 'Clinical Notes Online' is a data-

base of case reports, which can be keyword-searched, as well as allowing the entry of new cases remotely.

## Life or death

I feel that the above are peripheral to a more important area that is almost unexplored as yet, but promises great improvements in efficiency — hospital mail. Unless you live in a particularly efficient area, it can take up to two weeks for any hospital communication, however vital, to reach the GP and vice versa — such are the vagaries of the system. Vast quantities of literally life-saving data, such as recommended adjustments to medication, or referral letters, are stuck in the hospital mail at this very moment. The only way around this that I know is to ring up and bother the specialist concerned personally, assuming he can remember the patient and is not on holiday or at another hospital! Electronic mail has been with us for several years and would solve this particular problem entirely, leaving only the dictation and secretarial delays, which usually only amount to a few days.

Another comms area that could be developed now is the downloading of blood test results, at present held on laboratory minis into which they are read direct from the analysers. Incredibly, the results are then dumped as hard copy and proceed to get delayed in the post — like everything else. Results could be available within hours, if these computers were online. I could go on and on — if waiting lists were available, GPs could check outpatient waiting times and refer to the shortest list and the same could be applied, with benefit, to operating lists.

## Choices

With hardware prices falling so dramatically, it is easy enough to visualise the 80x86 supermicro network in the surgery, linked to optical record storage and a terminal on every desk. Such a system could completely replace every aspect of manual data recording, from the receptionist booking appointments to clinical note-taking. Voice recognition could have a crucial role to play here, obviating the need for doctors to develop the typing skills they have so far successfully resisted acquiring — such systems are said to be under development by IBM. Improved record display techniques, allowing the graphical reproduction of trends in information such as weight and blood pressure, would allow easier recognition of trends and facilitate better preventative medicine. Artificial intelligence systems will aid and confirm diagnosis and drug databases will take the chore out of thumbing through endless books. Disk-based drug databases already

exist and, if they were more widely available, could be used routinely to ensure that correct treatment is prescribed and to limit drug interactions.

Much of a GP's work is done on the move, and portables will assume crucial importance here. Currently available hardware is simply too large, and when you are dealing with a sick child, you won't want to lug in your bag and 20lbs of computer. A system that fitted in half a briefcase would be the largest practical, maybe with a 10-line supertwist screen and a smartcard reader. Modem links remain a tricky problem, for reasons already discussed, and given present technology, the surgery database will only remain comparatively secure as long as the file-server stays offline.

Compatibility with hospital systems will be a significant problem. There is no country-wide policy on hardware purchasing and until recently the result has been chaos; only two years ago was any attempt made by the health authority for whom I worked to find out even what the spread of machines was that it owned. The situation is slightly better in hospitals than general practice, where there has been a free-for-all over the last five years which will take at least another five years to sort out. Steering groups with real authority are desperately needed.

## Conclusion

Will your GP ever have a computer on his desk? Much depends on professional insecurity. Statements such as 'What if someone presses the wrong key?'; 'It would upset the patients'; and, 'I can make my own decisions, thank you!' are common. Many GPs are still in either shell or culture shock after their first experience of computers under the 'Micros for GPs' scheme. Money is not infrequently mentioned; there is no obvious link between having a computer and increased earnings. And here we begin to run into a difficult problem.

The market for computers in general practice will have to expand a good deal before it is likely that profit margins are high enough for the development of the specialist software I have outlined above to be a commercial proposition. On present showing, GPs will not buy computers until they are shown to be cost-effective, and some systems are only marginally so at present. Catch 22. Medical conservatism will not vanish overnight, and we will probably be watching some doctors trying to extract crumpled pieces of paper from bulging folders for a long time yet.

Dr Andrew Herd's medical career has included experience in ear, nose and throat surgery, orthopaedics and plastic surgery.

END

# Showing off!

*The PCW Show celebrates its tenth anniversary this year at Olympia, and once again an impressive line-up of companies will be there. Maggie McLening is your guide to the biggest and best annual computing show.*

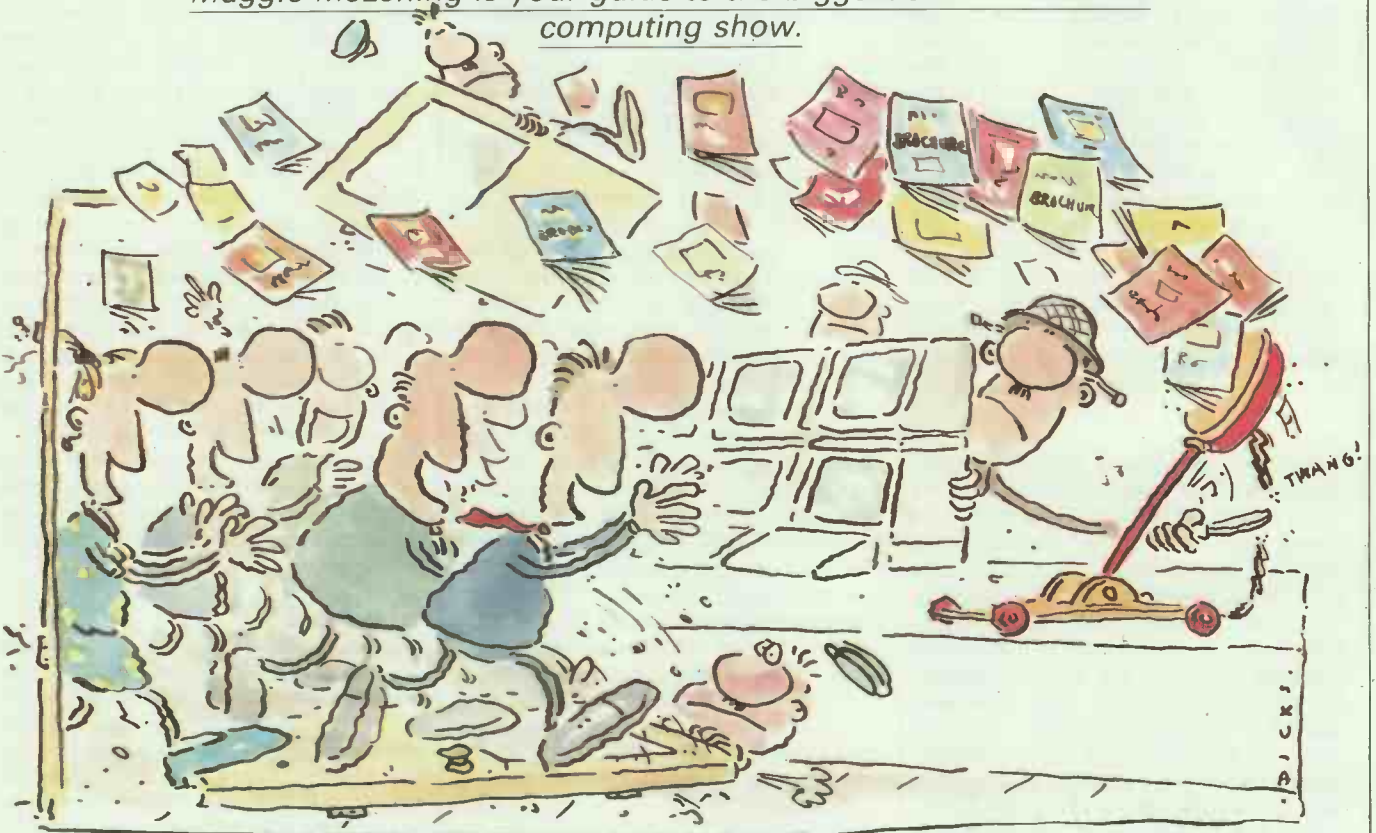

Summer may be almost over but the hotspot of the personal computing year is yet to come, with the PCW Show at Olympia from 23-27 September 1987. Celebrating its 10th birthday this year, the PCW Show has grown with the industry to be the definitive source of information, whatever your interests. This year's Show is crammed with every conceivable micro product from the latest 386 business micros and RISC machines to a new generation of video arcade games. Many of the exhibits have been nominated for prestigious British Microcomputing Awards, and the winners will be announced at a gala dinner at The Gloucester Hotel in Kensington, on the first day of the Show.

As in past years, the first two days are restricted to trade, business and professional visitors, who will find registration very much easier this year, with the introduction of a new bar-coded system. Each visitor will receive a badge bar-coded with their name, title and company, so that ex-

hibitors can transfer the details to index cards using a light pen, for follow-up information or contacts.

## Business . . .

The main Business Hall is again in Olympia Two, and the general exhibition is in the National Hall, although some companies, like Atari, have feet in both camps. Whatever the type of product you're looking for, the PCW Show is the place to see it in action, and get impartial — and free — advice from the experts. The Federation of Microsystem Centres, for example, will have up to ten consultants on hand to offer advice on hardware and software, and visitors will be able to try its popular database, spreadsheet and word-processing packages for themselves in booths with standalone PCs. The Data Protection Registrar, too, will be on hand to explain the full implications of individuals being able to find out computerised information about themselves from November.

Last year, the PCW Show attracted

47,528 business visitors, out of a total attendance of 66,030. Many expressed interest in specific growth areas of the industry, each of which has become the focus of a special 1987 feature.

PC Productivity, on Level Two of the Business Hall, is sponsored by PC magazine and covers the four most requested topics: desktop publishing (DTP); networks; expert systems; and, last but not least, online information services.

DTP proved an enormous attraction last year — so much so that it hindered our first attempt to produce the exhibitors' PCW Show News *in situ!* Nevertheless, we shall try again this year, with the benefit of a much larger stand and the staff of *Desktop Publisher* magazine, who will also be bringing out an issue at the Show, standing by. In addition to the live production unit running a variety of equipment, there will be an information centre manned by DTP systems in other parts of the exhibition.

Vitalmatch, a newly-formed com-

pany in Holland Park, London, plans to show some of the customised DTP systems developed for customers, and others available for lease to produce one-off newsletters or brochures. PCW Show regular Mirrorsoft has moved into the Business Hall to show the Fleet St Editor DTP system on the Amstrad PCW and the full-blown Fleet St Publisher system on the Atari ST. Aussedat Rey Burotic is travelling from France to show its range of DTP consumables, including papers and transparencies for electronic printing and publishing, by laser, impact printers, plotters or fax machines.

Over 17,000 of last year's visitors expressed an interest in networking, so this year PC Productivity is geared up to tell them where to go — for anything from modems to LANs! Low-cost networking of different manufacturers' machines is a priority and Nine Tiles, for example, will be demonstrating Multilink interfaces to its Superlink LAN, for Amstrad CPCs, PCWs, BBCs, and PC-compatibles.

Also building on last year's success is the Open University, which plans to repeat its programme of daily showings of the Alvey Directorate-sponsored videos. Three tapes will be shown: 'Expert Systems in British Industry', 'Image Processing' and a review of the 'Alvey Report' itself. Remember to get there early if you want a seat!

ASLIB, the Association for Information Management, is running the fourth PC Productivity feature covering online information services. This year, the emphasis is on individual help and practical advice; because the number of databases and the choice of equipment to access them have both grown so dramatically that it is difficult for ASLIB's consultants to generalise.

Outside the PC Productivity area, visitors can expect a patter of tiny footprints amid the bumper crop of 386 machines. Olivetti will be showing its new range of PCs including the M20, M240 PC, and M380 Compact with bundled TopJob 386 operating environment. Holland's largest PC manufacturer, Tulip Computers, commences UK operations at the PCW Show. In addition to the AT 386 announced in Hanover earlier this year, Tulip plans to unveil a 286-based AT Compact and a new PC which is still under wraps. Sources at Tulip say that the latest PC will offer a 'tiny footprint and revolutionary design, at a tiny price'.

### ... and pleasure

PCW Show's wealth of business systems in Olympia Two is matched by an equally exciting entertainment and leisure section in the National Hall. This year sees more launches than ever — companies as well as

products, many from abroad.

US entertainment software publisher, Electronic Arts, has timed its European launch for the Show and will be announcing several new 68000 titles, as well as showing the Deluxe range, Marble Madness, and Bard's Tale games for which it is already well-known in the UK. Microprose is sharing space with Origin Systems and Suncom, and will be bringing 'a real flight simulator' over from the US, it says, in a bid to steal the Show.

Some of the newcomers reflect a Far Eastern influence in both presence and presents. The Taiwanese World Trade Promotion Corporation is arranging personal appearances for a group of Taiwanese companies, one of which is Datex. Amazingly, Taiwan imported \$578 million-worth of computers and related products in 1986 — it exported \$2.1 billion!

Two British companies are launching Japanese products likely to end up in Christmas stockings. Toy manufacturer Mattel will be demonstrating the Nintendo Entertainment system, while Mastertronic plans to introduce the Sega arcade games console, as well as its own Arcade machine. Back on Level Two of the Business Hall, two lucky visitors will win the chance to sample some oriental delights for themselves, by winning a draw for a fortnight's holiday in Thailand, worth about £2500.

### Atari vs Commodore

There are likely to be some surprises from Atari, too, according to Jack Tramiel, who plans to put in an appearance. Atari has the same space as last year, between the Business and National Halls, and will be sharing it with about 35 Atari software houses and suppliers. Renamed Atari World, this year's stand has special Atari pavilions, with themes such as 68000, PC-compatibles, DTP and software. They are clustered around the central company stand featuring the full range of products, including the Mega ST and the 520ST, whose price was cut to £299 in August.

Tramiel is forecasting that Christmas will see a massive resurgence of the games market for sub-teenagers, so there will also be a chance to try out the new 2600, XE and 130XE games machines, and preview Atari's Christmas TV campaign on video.

Commodore has taken the entire ground floor of the Addison Suite to set up its own 'Village' for the Amiga this year. One of the villagers, software house Taurus, is introducing a powerful CAD system for the Amiga, capable of producing over 3000 lines per second, as well as showing the Acquisition and Acom database packages. Busbyte will be demonstrating networking for the Amiga, Scicom its

touch-sensitive screens, and other companies will be offering business and DTP applications, digitising graphics and sound-sampling systems. Commodore itself plans to feature the Amiga 500, A2000 and PC 40/40 AT-compatible models.

Regular exhibitor Acorn has gone for a high-RISC profile, with the Archimedes on its stand, and Minerva Systems in Devon plans to present some of the first RISC software for it, including the System Delta Database Management System, and 18 other programs converted from BBC format.

Once again, graphics and music will be much in evidence in the National Hall. Llamasoft will be revealing the ColourSpace 'light synthesiser' currently under development for the Atari ST. Demonstrations combining the output of several STs via a video mixer will be shown on an eight-foot video screen.

On the music front, Electromusic Research (EMR) plans to give live computer-controlled keyboard demos, while Syndromics will have a full recording studio on hand.

From pianos to piranhas, of which there will be a live tankful waiting to celebrate software publisher Piranha's first birthday with anybody who feels so inclined. They could be waiting a long time!

In the meantime — see you there!  
**And a final word from PCW's editor, Derek Cohen ...**

### PCW steals the show

Don't miss PCW's own stands. In the National Hall we will be letting you get a close-up look at the machines which have graced our covers over the past year, all of them running demos which show off their abilities. In the Business Hall you'll find our back numbers service and a rolling panel of experts to answer your queries. Finally, watch out for the goodies stand where T-shirts and other mementoes can be bought.

Tickets are available either from the PCW Show's organisers, Montbuild Ltd, or from Keith Prowse ticket agencies, or at the door. The Show is open from 1000-1900hrs daily, except on Sunday 27 September, when it will close at 1700hrs. (Also see Chip-Chat on the back page for a special ticket offer.)

### Guide to stand numbers FLOOR NUMBERS BEGINNING WITH

<b>GENERAL</b>	
National Hall (Ground)	1
National Hall (Level 2)	3
<b>BUSINESS</b>	
Olympia 2 (Ground)	2
Olympia 2 (Level 1)	4
Olympia 2 (Level 2)	5

# PCW SHOW PREVIEW

Here we present an alphabetical index to the exhibitors who will be displaying their wares at the PCW Show.

(Where available, the PCW Show stand number and telephone number are given at the end of each entry.)

## A1 PRIMARY DISTRIBUTION

Combining success as a distributor with support of the latest state of the art comms, A1 Primary Distribution promises dynamic and efficient distribution and warehousing to computer software houses. Services offered include: an on-line computer link, with monitored security for management information; credit administration and control; telesales; and statistical information.

Stand 3033 (0977) 797777

## ACORN COMPUTERS

The 'extremely user-friendly' *Archimedes* micros recently launched by Acorn will be on view. Based on 32-bit Risc technology, they provide low-cost workstation applications for school, business and home use. Also on view will be the PC card, *Springboard*.

Stand 1303 (0223 245200)

## ACTIVISION

Visitors can gain hands-on experience of 10 new titles, including the cream of the Christmas arcade releases. A game based on the Schwarzenegger movie, *Predator*, will be previewed, and there will be a host of other releases.

Stand 1417 (01) 431 1101

## ADVANCE ELECTRONICS

Advance offers a wide range of power conditioners: fitted between a computer system and the mains supply, these units eliminate the 'spikes' and voltage variation which can corrupt or even wipe out precious data.

Stand 4019 (0978) 821000

## ADVANCED SYSTEMS & TECHNIQUES

Essex-based AS&T is a major Atari dealer, offering over 50 complete ST systems from £420. Choices available include five different sizes of RAM, four floppy disk drives, Atari hi-res mono and colour monitors, and hard disks. An extensive range of ST add-ons is stocked. The ST service centre is open Mon-Sat.

Stand 4136 (0702) 510151

## ALTERNATIVE SOFTWARE

'The fastest growing budget software house in Europe', claims Alternative, now in the top four of budget software houses. A wide range of software is available at £1.99, its packaging commended by the Design Council; all well supported. Its new line is double and triple games packs.

Stand 3037 (0977) 797777

## AMSTRAD

The Amstrad products at the PCW Show will be split into four ranges: games/home machines; word processors; PC compatibles; and printers. There will also be a selection of other peripherals and software packages.

Stand 1403 (0277) 228888

## ANCO SOFTWARE

This company's new emphasis is on budget (£9.95) games for the Amiga and Atari ST, though it will continue producing quality software for the C16/Plus 4 as long as there is a demand.

Stand 3053/3059 (0322) 92513

## ANGLO COMPUTERS

The Show will see the launch of 'a totally new concept in computer peripherals' from Anglo, producer of the *Enterprise* range of modems, and a range of interfaces, leads and cables. Anglo's *Enterprise Turbo* range has full Hayes compatibility, V21 and V23 modes, and automatic entry to the Mercury Network.

Stand 0316 (0970) 4321

### Guide to stand numbers FLOOR NUMBERS BEGINNING WITH

#### GENERAL

National Hall (Ground) 1

National Hall (Level 2) 3

#### BUSINESS

Olympia 2 (Ground) 2

Olympia 2 (Level 1) 4

Olympia 2 (Level 2) 5

## APPLICATIONS ADVISORY SERVICE

*Micro Decision* magazine will be offering a free consultancy enabling visitors to get expert advice about any computer queries.

In conjunction with VNU, *Directories* will also be providing a free facts and figures service. Issues and subscription details for both titles will be available on the stand.

Stand 4011 (01) 439 4242

## ARNOR

First-time exhibitor Arnor is using the occasion to launch its *PC Protex* word processor. Originally designed for the Amstrad, *Protex* has been completely re-written for the PC and compatibles. It costs £60 and includes a spelling checker and mail-merge facilities.

Stand 1915 (0733) 239011

## ASPEN/SPRINT

The company specialises in interactive video production, but also produces computer-based information and training systems. A range of Amiga-based programs will be on display.

*Commodore Village*

## ATARI

Atari will be showing its entire product range on a massive feature exhibit. Atari president Jack Tramiel will fly in for the Show — and surprises are promised. Products shown will include the *Mega ST* range and video consoles. There will be a large collection of business and entertainment software.

*Atari World* (01) 388 9871

## AUSSEDAT REY BUROTIC

Under the *Alrey* brand name, Ausseadat Rey Burotic provides papers and transparencies for electronic printing and publishing, in A4 sheets, continuous paper, fanfold, rolls and coils.

Stand 4217 (01) 263 6241

## BATH COMPUTER SHACK

One of the first Atari dealerships in the UK, BCS now has a wide customer base. It is a specialist in the education market and takes pride in its back-up and after-sales service. In-house programmers write for vertical markets in the business sector. Two programs, *Cars* — a GEM-based program for the motor trade — and *Take Stock* — a stock control program — will be demonstrated at the PCW Show.

Stand 4129 (0225) 310300

## BERNARD BABANI (Publishing)

Babani will be showing 'the finest and most comprehensive range of computer books available' at the Show. Recent publications include *Getting Started With Basic and Logo on the Amstrad PCWs* and *A Concise Introduction to MS-DOS*. Free 1988 catalogue available on stand.

Stand 1001 (01) 603 2581

## BUBBLE BUS SOFTWARE

A selection of good quality games and utilities for 8-bit computers will be on the Bubble Bus stand. The company is launching its first 16-bit games and expanding its *Mini Bus* range. Business programs for the PC include the *Supernews* news delivery system and the *Supervideo* video hire system.

Stand 1008 (0732) 355962

## CAMBRIDGE COMPUTER

Sir Clive's *Z88* laptop, with peripherals and software, will be the focus of the Cambridge stand.

Stand 1607 (0223) 312216

## CAROUSEL TAPES

Gloucestershire-based Carousel, already established as a distributor of blank video and audio tape, is expanding to take on the *Nashua* disk range and *Trackmaster* storage cases.

Stand 3096 (045382) 2151

## CASCADE GAMES

Within crawling distance of the balcony bar, Cascade is ready to shower visitors with five new titles and its biggest ever presence at PCW. On the stand will be *Ace2*, follow up to *Ace*, and the amazing *PD System* of software development.

Stand 3015 (0423) 504526

## CDS SOFTWARE

Among the games being launched by CDS at the Show are *Casino Roulette* — the ancient strategy game; and *Colossus 4 Bridge* — with raw recruits being taken through the rubbers to club level. Also on the stand: four youngsters compete in the final of the *Brian Clough's Football Fortunes* challenge.

Stand 1010 (0302) 21134

#### CENTRAL TECHNOLOGIES

Now one of the largest UK computer media stockists, Central supplies over 700 companies with computer diskettes, ribbons, cartridges, stationery, and so on.  
**Stand 1809** (021) 233 4041

#### CHEETAH

Peripheral maker Cheetah exhibits its range of computer and music products. Launches include: the *PC Powerplay* joystick for the IBM, Amstrad and compatibles; and the *Midi Interface for the Commodore 64*.  
**Stand 3061** (0222) 555525

#### CHERRY

Keyboard manufacturer Cherry will be highlighting its *A3 Graphics Tablet Mark II* digitiser and the *VoiceScribe 1000* speech-recognition system. Cherry is launching its state-of-the-art IBM-compatible *G80-2000* keyboard at the show.  
**Stand 2003** (05827) 631100

#### COLUMBIA COMPUTER PRODUCTS

*Cleanprint*, a brand new concept in printer maintenance, is being launched at the PCW Show by Columbia. *Cleanprint* is a complete print-head cleaning kit (cleaning material cassette; aerosol; pre-saturated wipes) which is claimed to improve print quality and reduce wear on the print head. A selection of Columbia's other products will also be on show.  
**Stand 3051** (01) 656 8233

#### COMMODORE BUSINESS MACHINES (UK)

Commodore has taken over the Addison Suite on the ground floor and transformed it into the 'Commodore Village' to demonstrate its home computer, the *Amiga 500*; the *A2000* business computer; and its PC range, including the *PC40/40* AT compatible. A variety of companies will be in the 'village' to demonstrate the range of applications available.  
**Commodore Village**

#### COMPUPRINT

Compuprint offers high-quality computer forms, labels and cheques, with delivery suited to customer requirements, and many other related products — such as payroll slips, continuous envelopes, and clean edge microperfed letterheads.  
**Stand 4002/5** (0264) 59222

#### COMPUTER ASSOCIATES

Important announcements regarding a major new line of software programs are to be made at the PCW Show by Computer Associates, which claims to be the world's largest independent software company. CA's spreadsheet *SuperCalc 4* and project management software *Super-Project* will be on show.  
**Stand 4047** (0753) 77733

#### COMPUTER BOOKSHOPS

This company is a wholesaler of computer books whose service to the retail trade includes full merchandising, initial stock recommendations and stock balancing.  
**Stand 2212** (021) 706 4518

#### COMPUTER CONCEPTS

*Calligrapher*, a new word processor/DTP program for the Atari STs, will be launched. Among other products on show will be: *ST Doctor* desk accessory and the *Fast ASM 68000* assembler.  
**Stand 4108** (0442) 63933

#### COMPUTER FRONTIER (UK)

The recently-launched *Flyer A286* will be among the range of *Flyer* PCs on the Computer Frontier stand. The *A286*, based on the Intel 80286, has a standard memory of 1Mbyte, expandable to 8.5Mbytes. The *A286* is claimed to be the first portable to offer a 1.2Mbyte/360kbyte dual speed floppy disk drive and also includes a 20Mbyte ruggedised hard disk.  
**Stand 2102** (0462) 673939

#### COMPUTER TRADE WEEKLY

CTW is an established magazine covering the whole home and small computer industry. It has expanded its editorial to cover both business and leisure product retailers. CTW invites its readers to drop by its stand for a frank exchange of views.  
**Stand 3000** (0438) 310106

#### CONNEXIONS

Connexions will be showing its complete range of computer cables, data switches, connectors, testers and protectors. New at the Show will be a range of networking accessories, and the latest additions to its peripherals range.  
**Stand 2002** (07072) 69444

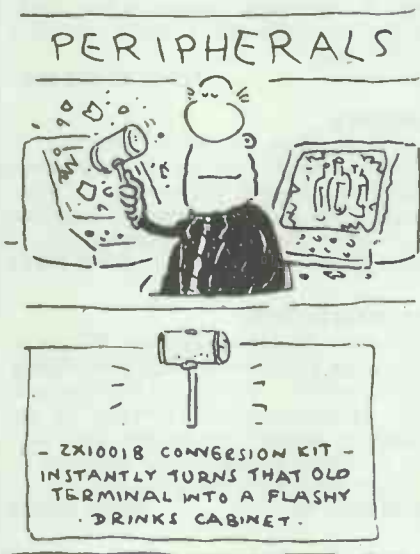

#### CROWN DUST COVERS

A full range of dust covers and padded luggage for computers is on offer, and a design service for cases not covered by the existing range.  
**Stand 2201** (0984) 33377

#### CYBERSOFT

The full range of its *Cybercom* IBM-compatible PCs will be on display. Scheduled for release are a gas plasma *Cybercom-Portable* and the *Cybercom-386*. Visitors will also be able to buy a large collection of low-cost software.  
**Stand 4041** (0734) 591873

#### D&H GAMES

A new software house interested in producing high-quality strategy games, D&H will be focusing at the Show on its latest game, *Football Director*.  
**Stand 3096/1** (0438) 728042

#### DATA PROTECTION REGISTRAR

The Office of the Data Protection Registrar will be providing guidance to data

users in preparation for the full implementation of the *Data Protection Act* on 11 November 1987, when failure to register will be punishable by fines. Eight new guideline booklets have been published and these will be available free on the stand.  
**Stand 3148** (0932) 225526

#### DATABASE PUBLICATIONS

A special show offer of free registration and instant documentation for the *Micro-link* electronic messaging system is available from the Database stand.

*Microlink* offers many extras, including free telesoftware which can be downloaded over the phone. Database is the publisher of *Atari User* and *Atari ST User*.  
**Stand 4107** (061) 456 8383

#### DATAPHONE

Dataphone will be displaying a complete range of comms equipment, including its recently-launched modems, *Demon II* and *Designer Modem*. A new easy-to-use comms package for the PC, *Kiwichat PC*, is being launched.  
**Stand 3110** (0378) 78137

#### DATATRADE

*Systemizer*, 'a unique printer-sharing concept', will be exhibited at the PCW Show by Datatrade. *Systemizer* allows up to 15 VDUs and/or PCs to share one or more printers. With its 64k buffer and priority-access function, *Systemizer* will, it is claimed, make disputes over printer access a thing of the past.  
**Stand 5126** (0604) 250541

#### DIGITAL INTEGRATION

Reinforcing its position in the field of simulations, Digital Integration launches: *F-16 Combat Pilot* — seek promotion and fame in the war machine of the 1990s; *ATF* — test your mind and dexterity in a hostile world; and, *Bobsleigh* — race on simulated slopes at terrifying speed.  
**Stand 1201** (0276) 684959

#### DIRECT DISK SUPPLIES

DDS claims to offer the highest quality and lowest prices on disks at the Show. Special '25 Packs' and 3M disks on offer. Flippies (reversible disks) will also be on sale.  
**Stand 3096/18** (01) 979 7811

#### DIRECT TECHNOLOGY

*Automator mi* is a 'software robot': a program which can be taught how to drive other programs. Applications include automatic log on/off, automatic data retrieval and integration of several packages into one. *Automator mi* from Direct Technology will drive the majority of 3278, 5250 and VT100 emulations.  
**Stand 2204** (01) 847 1666

#### DISCOPY LABS

New facilities added by this long-established disk duplicator include: duplicating flexibility; on-disk printing; programmable ink-jet printing; and turnkey software protections.  
**Stand 1200** (01) 871 2629

#### DOMARK

The publishers of *Trivial Pursuit* are launching a major new software label at the PCW Show: *TV Games*. It will consist only of popular TV quiz shows, such as *Treasure Hunt* and *Blockbusters*.  
**Stand 3035** (01) 947 5622

# PCW SHOW PREVIEW

## DURELL

Durell Software on Stand 3146 will be releasing two new compilations for the Spectrum, Commodore 64 and Amstrad CPC. Durell Computers on Stand 4200 will be exhibiting a range of its business software for the IBM; for example, *Insurance Master V2*, *Investment Manager* and *Store Manager*.

**Stands 3146/4200 (0823) 254029**

## DYNAMICS MARKETING

Designer of the original *Competition Pro 5000* joysticks, Dynamic Marketing is to launch at the PCW Show the *Pro Extra* joystick. The *Pro Extra* has been designed to enable users to win even more points per game by allowing the user to select an auto-fire option or slow-motion movement for finer control.

**Stand 1823 (061) 626 7222**

## EASI-BIND INTERNATIONAL

Attractive and competitively priced systems for maintaining and presenting computer paperwork, like *Store-It* binders, plus the convenient handling of floppy disks, are displayed on the Easi-bind stand.

**Stand 4213 (0773) 761341**

## ELECTRIC DISTRIBUTION

Leading software distributor Electric Distribution will have over 40 products for the Atari ST at the PCW Show, including a CAD 3D package from Antic, which will be demonstrated with *Stereotek 3D* glasses. *1st Word Plus ST* will also be on display. Visiting dealers will get a full range of POS material free from Stand 4131. On Stand 3079, Electric will be showing the complete range of *Timeworks* products for the Commodore 64 & 128k, the Atari ST and IBM/Amstrad PCs, including a full feature low-cost package.

**Stands 3079/4131 (0954) 61258**

## ELECTROMUSIC RESEARCH (EMR)

New recording, editing and score-writing products will be on sale at the PCW Show at special offer prices on the EMR stand. Virtuoso performer Mike Beecher will give live computer-controlled music demonstrations of EMR's range of computer midi software and hardware.

**Stand 3036 (0702) 335747**

## ELECTRONIC ARTS

US home software publisher Electronic Arts is announcing over 20 new titles. It aims to show at the PCW Show its commitment to long-term growth, new standards of technology, product quality and entertainment.

**Stand 1517 (01) 938 2222**

## ELITE SYSTEMS

Developments in both the coin-op licence and compilation fields will be demonstrated by Elite. From the creators of *Frank Bruno's Boxing* and *Paperboy* come *Ikari Warriors* and *Buggy Boy*; compilations ready for Autumn and Christmas will be released through the *Hit Pak* brand label.

**Stand 1209 (0922) 55852**

## ELR INTERNATIONAL

The low prices on its *Isis* brand of XT's and AT's do not mean poor quality, according to ELR: 'no 'grotty drives, flimsy keyboards and fuzzy monitors', it claims.

At the Show, ELR is displaying the *Isis-200 XT-compatible*.

**Stand 4222 (04830) 505605**

## EMAP BUSINESS & COMPUTER PUBLICATIONS

The publishers of *Computer & Video Games*, *Commodore User* and *Sinclair User* are creating an arcade games centre where punters can play against US champions, or even the *Commodore User* team. Stickers, t-shirts, bags, mags galore — and journals to chat with.

**Stand 1717/1721 (01) 430 1200**

## ENCYCLOPAEDIA BRITANNICA INTERNATIONAL

The latest tomes of the new edition of Britannica will be at the PCW Show. Its reference power is claimed to be doubled by a two-volume index.

**Stand 1911 (01) 482 5238**

## EPSILON

Now available on the Atari ST is *MProlog* from Berlin-based Epsilon. Features include over 140 built-in predicates, a dedicated Prolog editor, interactive help facility, garbage collection and tail recursion optimisation.

**Atari World (01049) 30 882 6991**

## EUROMAX

The *Free Style VI* from Euromax is claimed to be the first truly multi-propose customised joystick because of its additional hand grip and handles. Euromax also markets *Kao* and *Wiz* brand disks.

**Stand 3094 (0262) 60251**

## EVESHAM MICROS

Mail order supplier Evesham Micros is making its PCW Show debut, exhibiting its *Excelsator+* disk drive (Commodore 1541 replacement); the *Slimline 64* replacement case for the 64; the latest version of *Freeze Frame*; and a range of its own and other PC-based products.

**Stand 3096/12 (0386) 765500**

## EXECON

Execon will be showing its powerful set of modular/integrated business software, *Accounts, Invoicing & Stock-Control*.

**Stand n/a (01) 567 6285**

## EXECUTIVE CLUB INTERNATIONAL

A comprehensive business, travel and leisure service, Executive Club International offers reductions on air fares and hotel accommodation, and membership to private clubs around the world.

**Stand n/a (01) 739 2861**

## FIREBIRD/RAINBIRD/SILVER

A trinity of leading software labels on one stand. New releases from Firebird include *Flying Shark*, *Bubble Bobble* and *Star Trek*. Rainbird invites people to feast their eyes on the latest Sandy White blockbuster, *EPT*. Among Silver goodies are *Decathlon*, *Pitfall II* and *Hero*.

**Stand n/a (01) 240 8377**

## FORMSCAN

The *Codem Disk Reader* from FormScan takes seconds to translate 8in diskettes to all the leading 5¼in word-processing packages. Old documents come up 'IBM new' with virtually no editing.

FormScan subsidiary Lexisystems distributes DEST products in the UK, including *PC Scan*, *PC Scan Plus* and *Publish Pac*.

**Stand 5040 (0373) 61446**

## FRONTIER SOFTWARE

Frontier is the sole UK distributor of the Supra range of Atari peripherals. The Supra range of hard disk drives will be on show, including a 20Mbyte unit smaller and faster than the Atari SH204. The 60Mbyte drive is the fastest hard disk currently available for the ST, claims Frontier. Also being shown is the £500 64k *MicroStuffer* printer buffer.

**Stand 4141 (0423) 67140**

## FUTURE PUBLISHING

Binders, back issues and chat, and the latest copies press-hot are promised by the publishers of *Amstrad Action*, *8000 Plus*, *PC Plus* and *Advanced Computer Entertainment*.

**Stand n/a**

## GARWOOD GROUP

Garwood Distribution is a low-cost software distributor, specialising in the Amstrad, IBM PC and compatibles market, and with a nationwide dealer base. Garwood Software supplies software, computer consumables and stationery wholesale to dealers and retail to large corporates, government agencies and the education sector in Essex and North London.

**Stand 1907 (0245) 460788**

## GLENTOP PRESS

Glentop's substantial presence covers both its full range of technical and computer books and (in Atari World) its range of GFA products as well as its ST books.

**Stand 0311 (01) 441 4130**

## GOLLNER PUBLISHING

*ST World* (formerly *ST User*) was the first UK magazine exclusively dedicated to the Atari ST. It offers in-depth reviews, scoops, interviews, and reader help and advice.

**Stand 4126 (0243) 783932**

## GREMLIN GRAPHICS SOFTWARE

Christmas comes early this year as Gremlin launches its festive offerings. One can choose between Dolph Lundgren in *Masters of the Universe* or the rodent hero of *Basil the Great Mouse Detective*. Compete against Ivan 'Chernobyl Breeze' Karamazov in *Tour de Force*, or inoculate yourself against the Olympics with *Alternative World Games*.

**Stand 1211 (0742) 753423**

### Guide to stand numbers

#### FLOOR NUMBERS BEGINNING WITH

GENERAL	
National Hall (Ground)	1
National Hall (Level 2)	3
BUSINESS	
Olympia 2 (Ground)	2
Olympia 2 (Level 1)	4
Olympia 2 (Level 2)	5



## GULTRONICS

This leading London computer centre will be making special Show offers on its full range of computers, printers, disk drives, monitors and peripherals. It will be demonstrating the 'mind-blowing' features of the Toshiba range of portables.

Stand 1807 and 2009 (01) 323 4612

## HARVESTER

An independent producer for the *Psion Organiser II*, Harvester offers *The Letter Organiser* and *The Finger Organiser*, enabling users to turn the *Organiser II* into a very creditable, very small word processor. Harvester's range also covers the commercial, institutional and construction sectors.

Stand n/a

## HEWSON

Hewson is launching several games at the Show. *Morpheus* won't let you sleep as *Dreadnought* bites back; and *Evening Star* will keep you steaming along the Somerset and Dorset (aka *Slow and Dirty!*) Railway. Aficionados can get a glimpse of the new Steve Turner game, *Mag-natron*, sequel to *Quazatron*.

Stand 1622 (0235) 832939

## HILTON COMPUTER SERVICES

The main attraction of its *Personal Banking System*, according to Hilton, is its ease of use in managing finances in an ordinary way. A PC version has just been launched, bringing to eight the number of computers *PBS* runs on.

Stand 3096/14 (0689) 70911

## IANSYST

A surprise new mind-boggling program to test IQ and improve mental alertness is promised by Iansyst for the PCW Show. It will join stable-mates: the *lankey Crash Course in Typing for Beginners*; the *lankey 'Two Fingers to Touch Typing' Conversion Course*; and the powerful programming tool, *VICAR*.

Stand 4002/4 (01) 607 5844

## INTERCEPTOR

*Satar*, a space odyssey arcade adventure game, is to be launched at the Show. Interceptor's new 'Players' image and its born-again budget label, *Autumata UK*, will also be on view.

Stand 3072 (07356) 71500

## JOSTY UK

The *Josty RS232-Kit* — 'everything you need to accomplish an RS232 connection' — will be launched. As sole UK distributor, Josty will also be showing the *Posso* media storage system. A wide range of cables and other accessories will also be available.

Stand 4032 (0642) 76900

## KEMPSTON

The *Kempston PCW Mouse* uses a WIMP system, and includes a hi-res mouse, interface, and GSX and RSX drives that allow it to be used in conjunction with CP/M software like *DR Draw*, *DR Graph*, and so on.

There will also be system launches for the Sinclair Plus 3.

Stand 3077 (0908) 690018

## KONAMI

Computer conversions of arcade favourites *Jackal* and *Iron Horse* are due for release at the PCW Show, as are



Old rivals Sinclair and Amstrad at last year's show.

several MSX cartridge games. The *WEC LeMans* sit-in arcade simulator will be available to test drive. The Konami Software Club will be making its debut at the Show.

Stand 3083/3090

## KUMA COMPUTERS

The Kuma range of GEM-based business applications products for PC compatibles, Atari ST and Amiga will be demonstrated, including: *K-Spread 2* spreadsheet; *K-Data* database; and *K-Graph 2* business graphics.

The *K-Max* transputer development system for the Atari ST and the IBM PC compatibles, with associated software, will be on show.

Stand 3154 (07357) 4335

## LEISURESOF

Leisuresoft is a national distributor of computer software and peripherals, servicing the independent retailer with over 5000 product lines in: full-price and budget games; business software; joysticks, blank disks and accessories.

Stand 1709 (0604) 768711

## LIGHTWAVE LEISURE

Lightwave supplies a large range of quality-tested computer cable assemblies, components and dustcovers for most home and business computers. All products have a one year guarantee.

Stand 1018 (051) 639 5050

## LITTEX

Litex will be organising a display of sales literature mainly from companies not otherwise represented at the PCW Show. It will also pass on enquiries and generally act on behalf of companies, with literature on display.

Stand 2202 (04515) 799

## LLAMASOFT

Ask the Sphinx how to help you deal with *The Return of the Mutant Camels* on the Llamasoft stand. It also hopes to be able to demonstrate the *Colourspace II* light synthesiser, which is able to combine, via a video mixer, the output of several STs onto one screen.

Stand 3093 (07356) 4478

## MAGNAM PRODUCTS INTERNATIONAL

As one of the leading suppliers of computer software packaging in Europe, Mag-nam offers a wide range of prestigious packaging and is also able to undertake bespoke design and production projects. Staff will be on hand to discuss all aspects of packaging.

Stand 1020 (0635) 65509

## MARTECH

All Martech's recent titles, like *Nemesis the Warlock* and *Catch 23*, will be on offer at reduced prices. The PCW Show will see the launch of *Slaine*, licensed from 2000AD comic, and first previews of *Nigel Mansell's Grand Prix*.

Stand 3009 (0323) 768456

## MASTERTRONIC/MELBOURNE HOUSE

Mastertronic promises to show off its large selection of budget software games, including its most recent, *Americana* and *Ricochet*. It will also be demonstrating its arcade machines — *Arcadia* — and the *Sega* games console. Lucky entrants have the chance of winning a *Sega* system.

Stand 1109 (01) 377 6880

## MATTEL TOYS

Nintendo, claims Mattel, represents the new generation of video games: true arcade quality on a dedicated machine. Nintendo is initially targetted at boys aged 8-14 and their fathers. Mattel will be operating a Nintendo Hotline to provide a specialist service to trade and consumers.

Stand 3023 (0533) 826666

## MICRODEALER INTERNATIONAL

Microdealer is a large distributor of full price and budget software, and has over 4000 lines in stock. It has become a distributor for Ashton-Tate and Borland.

Stand 1222 (0908) 74000

## MICRONET

User-friendly access to Telecom Gold at local call rate is promised to Micronet members via Interlink. It claims this is the first stage in the generation of complete message interchange being developed by Telecom. Micronet's new online PC magazine is *PC Support*, with news, reviews, tips, help desk and software.

Stand 3133 (01278) 3143

## MICROPROSE SOFTWARE

MicroProse's first appearance at the PCW Show will be in tandem with Origin Systems and Suncom. MicroProse is bringing from the US a real flight simulator and a selection of simulations. Origin will be there exhibiting its *Ultima* series, including the latest, *Warriors of Destiny*. Suncom *Tac* and *Starfighter* joysticks will be there too.

Stand 1511 (0666) 54326

## MICROSOFT PRESS

New releases from the books division of Microsoft include: *Music Through MIDI: The New Writer*; and *Command Performance: dBase III Plus*.

Stand 3045 (01) 938 2200

# "It's a great machine".



**From only  
£499**

**A PC which can beat the likes of Amstrad, Tandy and Zenith in a press comparison of IBM-compatibles, deserves your attention. So does a company whose computer sales in Britain now exceed the entire production of some of its rivals.**

The Company in question is Opus and its class-beating compatible is the PC II Turbo, now being built in Britain in monochrome, colour and EGA versions. 'PC User' Magazine which conducted the comparison test said of the PC II Turbo:

*"Even in its basic £499 form, it is a superior beast.  
This is a great machine."*

# • their words not ours

But what really makes the PC II Turbo stand out from the compatible crowd? The answer it seems depends on which computer magazine you read.

"Performance is above average, thanks to the NEC V20 chip. The PC II exhibits excellent compatibility, no doubt due to its US-registered legal ROM Bios."

'What Micro?'



"The Opus PC II looks and feels like a solid beast. Expansion cards fit firmly inside, the keyboard doesn't feel like it might break if you hit it too hard and the monochrome display offers a clean and rock-steady picture."

'Which PC?'



"It is extremely solid and well built. It lacks the thrown together feel of many cheaper clones from small companies."

'Which Computer?'



## NEED WE SAY MORE? ... YES NOW THE PC II TURBO IS EVEN BETTER

Even our £499 entry level PC is now equipped with a new dual-mode graphics card supporting both the Hercules monochrome and IBM colour graphics standards and featuring a mouse port. It keeps the PC II Turbo's standard specification out in front:

- Software switchable NEC V20 super processor 4.77/8 MHz
- Dual-mode mono/colour graphics card
- High resolution monochrome monitor, tilt and swivel base and anti-glare screen
- Quality AT-style keyboard
- 256K of RAM expandable to 1MB on motherboard creating 384K RAM disk
- 360K floppy disc drive
- 8 expansion slots
- Highly compatible BIOS
- Parallel printer, mouse and joystick interfaces
- Real-time clock/calendar with battery back-up
- Keyboard security lock
- 150 watt UL-approved power supply
- 12-month guarantee
- Comprehensive user manual.

Options include dual drives, 20 Megabyte Winchester and 1 Megabyte RAM expansion, maths co-processor and on-site maintenance cover.

We offer special education and government discounts and welcome dealer and export enquiries. For details call Opus today on 0737 765080. Price quoted exclusive of VAT and carriage.

Ask about our  
high specification  
AT-compatible

**PC II TURBO**  
A small price to pay for quality

**Opus.**

Opus Supplies Ltd, 53 Ormside Way, Holmethorpe Industrial Estate, Redhill, SURREY RH1 2LW.

# “Most graphics help you present. These graphics help me decide.”

want other people to go along with my decisions. So my recommendations had better be better.

Give me Lotus, the sales figures, and an hour or two, and I can make those figures dance. But no matter how clever the number-crunching, it shows me nothing.

So give me Decision Graphics. It takes the Lotus file, and puts it all in a line graph.

I want more. Just a few seconds to type in directly the cost of sales data. And then show the gross margin as a pie chart,

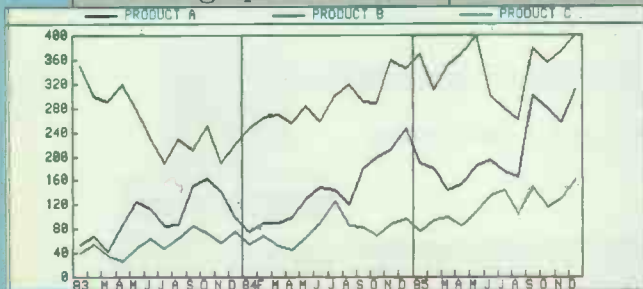
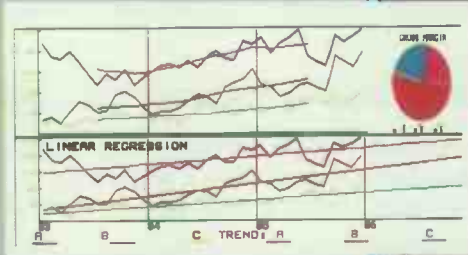

A few keystrokes later, using split windows, and the pattern gets clearer.

Now for the trends

Immediately. With no scales to set. I push two keys and it's now a bar graph. We're getting somewhere towards a decision.

here – the growth rates – and the profitability picture.

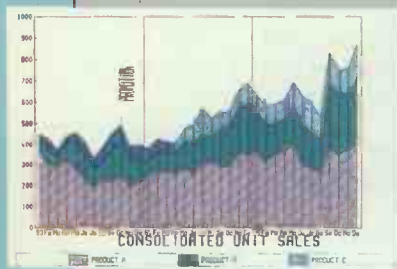
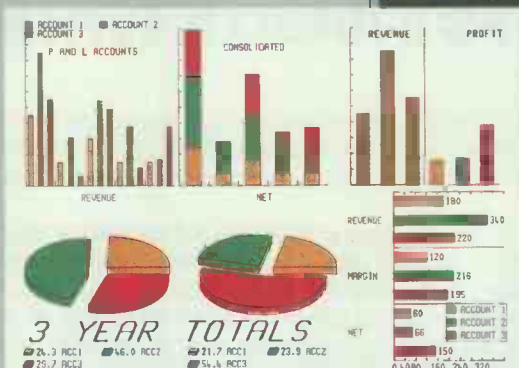

I like to see the trends. The last 36 months, and the next 12 months forecast. Done. And seen to be done.

Decision Graphics gives me the true picture. Now you can make the right decision.

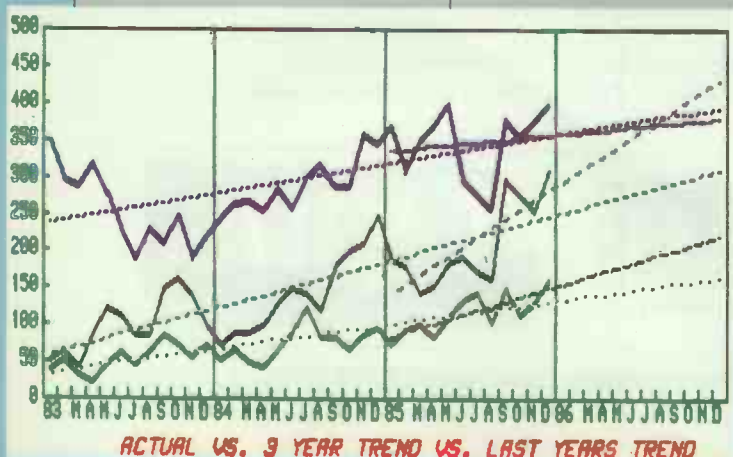

Decision Graphics imports Lotus, Multiplan, dBase III, SuperCalc, ASCII, and even mainframe-held data, fast and simply.

Decision Graphics displays 375 different graph variations, types and options, calculates with 30 built-in functions, records your macro-commands for re-processing, and outputs to printers, plotters, slides and as a PC slide show.

Decision Graphics displays data, calculated data and hypotheses for your analysis, exploration and interpretation – all before you present. And Decision Graphics helps to show the thinking behind your proposals when you present.

Picture Decision Graphics working for you.

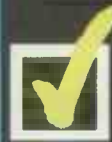

## Decision Graphics

Worth more than a thousand words.

Mercator Ventures Ltd., Southbank House, Black Prince Road, London SE1 7SJ. Telephone: 01-587 1121

Decision Graphics is sold and supported by Mercator Ventures Ltd. Lotus is a trade mark of Lotus Development Corporation. Multiplan is a trade mark of Microsoft. dBase III is a trade mark of Ashton-Tate. SuperCalc is a trade mark of Sorcim.

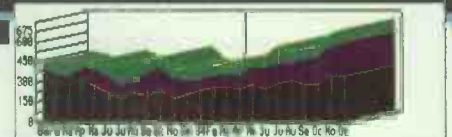

Decision Graphics could show me the way. Send me samples, specifications, and ordering details.

Name \_\_\_\_\_

Position \_\_\_\_\_

Company \_\_\_\_\_

Address \_\_\_\_\_

Phone \_\_\_\_\_ PCW \_\_\_\_\_

Mercator Ventures Ltd., Southbank House, Black Prince Road, London SE1 7SJ Telephone: 01-587 1121

**NEW DG3 AVAILABLE NOW!**

# PCW SHOW PREVIEW

## MICROWARE

The theme of Microware's participation in this year's Show is the link between the technology of the future from IBM and the services and support for its goods from Microware. A wide range of products, including the PS/2s, will be on display.

**Stand 4043** (01) 940 8635

## MINERVA

Data-handling specialist Minerva's product ranges include Risc products for the Archimedes; the System Delta Database management System on BBC Micros, and other BBC products; and an inexpensive learner-friendly range for Amstrad PCWs.

**Stand 4002/3** (0392) 37756

## MIRACLE TECHNOLOGY

Miracle will be previewing its new generation of modems at the Show; they are said to incorporate sophisticated features as standard. Its *Keycard 3000* and *WS3000* and *WS4000* modems will be demonstrated. The stand will also have a number of guest exhibitors from software houses and service providers.

**Stand 4042** (0473) 216141

## MIRRORSOFT

On Stand 1601, Mirrorsoft will be sharing with four other companies to present a display of games software, including its 'autumn biggie', *Mean Streak* (makes the Wild Bunch look tame). Mirrorsoft is also showing in the Business Hall for the first time (stand 5053). Its range of DTP and presentation software includes *Fleet Street Editor 1.1* for the IBM and *Graphic-Works 1.1* for the Mac.

**Stands 1601 & 5053** (01) 377 4837

## MONDEC

Mondec designs, manufactures and distributes comms products, in particular for printer/plotter applications. It will show its range of automatic peripheral sharers, and introduce its latest products, *M-Box*, *A-Box*, and *C-Box*, and all its data buffer units.

**Stand 4209** (0272) 230383

## NEUTRAL

Neutral is exhibiting the *Essex* point-of-sale terminal, a low-cost standalone unit that stores all product information and a day's transactions in its solid state memory. It's available in 256k or 1Mbyte versions. Also on show: an easily-installable low-cost network, *NeuNet*.

**Stand 4049** (01) 474 6010

## NEWSFIELD PUBLICATIONS

The publishers of *Crash* and *Zzap! 64* are launching a new magazine at the PCW Show — *The Games Machine*. In Newsfield's first floor mini village, visitors can meet the staff, buy the magazines — and add-ons such as hats, sweat shirts and carrier bags.

**Stand 3047**

## NINE TILES

*Superlink*, exhibited by Nine Tiles, is an inexpensive 1.5Mbaud LAN, allowing networking via direct interface cards or standalone units. Two new products will be demonstrated: *SimpleNetBIOS*, which allows NetBIOS software to be used across Superlink; and *CatenaNet*, running

on Triplos/Superlink computers like the Amiga 2000. The range of *Multilink* interfaces will be available.

**Stand 4051** (0223) 862125

## NOAH SYSTEMS

Texas company Noah is a first-time exhibitor at the PCW Show. It will be showing a number of MS-DOS products for the first time in the UK, including *Friendly Finder*, a pop-up search utility for dBase-III; and the powerful programming languages *Snobol4+* and *Icon*. A £2 shareware diskette will be on sale.

**Stand 0096**

## NOVAGEN

Novelties from Novagen include the *Mercenary* sequel *Mercenary II*, and a fast-action solid 3D combat simulation.

**Stand 3062/3** (021) 449 9516

## OCEAN

The Ocean Stand is promised to be bigger and better this year, displaying Ocean's latest releases in every category of leisure software, from arcade game conversions to original strategy projects on the *Ocean* and *Imagine* labels.

**Stand 1411** (061) 832 6633

## OLIVETTI

Olivetti will be showing its new range of PCs, including the *M240* and *M380*, and the *386-Top Job*, an operating environment that makes full use of the powerful 386-based *M380*.

**Stand 2018** (01) 785 6666

## THE OPEN UNIVERSITY

OU video tapes on applications for artificial intelligence in industry and other AI topics will be shown and on sale at its stand, as well as other videos and materials from the Open University.

**Stand n/a** (0906) 653779

## PACE MICRO TECHNOLOGY

A full range of Pace modems will be on display. Its *Series Four* (three models) is easily upgradable, powerful but simple in operation, claims Pace. Its latest model, the *Linnet*, offers features not normally available on modems in its price range.

**Stand 4026** (0274) 488211

## PAGE 6 PUBLISHING

*Page 6*, the longest-established Atari users' magazine in the UK, will have an Accessory Shop at the Show; a wide selection of public domain software for Atari 8-bit micros and STs; and, of course, copies of *Page 6* itself.

**Stand 4137** (0785) 213928

## PALACE SOFTWARE

Palace will be launching its new label *Outlaw* and giving a first outing to its Autumn and Winter releases at the PCW Show. It will also be exhibiting new versions of its existing games; for instance, the 16-bit version of *Barbarian*.

**Stand 3041** (01) 278 0754

## PALAN ELECTRONICS

As a leading Commodore supplier, Palan will be exhibiting a complete range with full product support. Launches at the Show: the *NCE Hyper-Mouse*, to run with the IBM and compatibles; *Magic Key* diskettes, to enable PC/XT/AT CGA software

to run on Hercules; and the *EVA/480 Enhanced Video Adaptor Board*, fully compatible with IBM's EGA.

**Stand 3001/3003** (01) 368 1276

## PATH GROUP

Path's Allsop product range will be on display — accessories that include media storage, printer stands and drive head cleaners — all elegantly engineered, according to Path.

**Stand 4017**

## PC MAGAZINE

The largest circulation magazine for IBM compatibles will be illustrating aspects of PC productivity. One of the new IBM PS/2s will be on display. Professional PC users will be invited to register for complimentary copies of *PC* magazine.

**Stand 5000** (01) 439 4242



*Personal Computer World* will have three stands at the PCW Show: one in Olympia 2, and a further two in the National Hall.

## OLYMPIA 2

**Stand 2014**

The *Personal Computer World* stand will give visitors the chance to meet face to face the key *PCW* editorial staff and get advice about any computer queries or problems they may have. The October issue of *PCW* and the *Show Catalogue* will be on sale, together with a Back Issues service. *Personal Computer World* will also have a very special subscription offer available throughout the Show.

The stand will feature a great free competition with the prize being a 'holiday for two' in Thailand. To enter this prize draw, just come along to the stand, fill in an entry form and deliver it to stand 5000 on Olympia 2, Level 2.

## NATIONAL HALL

**Stand 1009**

Take a closer look at ten of the computers featured on the front covers of *PCW* in the last year, with reprints of the reviews to take away. Come and talk to the *PCW* editorial team who will be offering advice on problems visitors may have with their own machines. The *Show Catalogue* as well as the October issue will be on sale.

## NATIONAL HALL

**Stand 1400**

*Personal Computer World* will have bags, balloons, badges, T-shirts and hats available on this stand, together with the October issue and the *Show Catalogue*.

# PCW SHOW PREVIEW

## COMPUTER GAMES



HAVE HOURS OF FUN  
WITH  
'PLUG THE LEAD INTO  
THE TERMINAL'  
INCORPORATING  
LATEST BLINDFOLD  
TECHNOLOGY!

### PHILIPS CONSUMER ELECTRONICS

Philips will be showing its latest range of personal monitors, a wide choice of mono or colour, in standard high resolution with a choice of phosphors and built-in compatibility with most PC makes.

Stand 2006 (01) 689 2166

### PIRANHA

Beside a tankful of its namesakes, Piranha will be featuring its latest games: *Yogi Bear* and *Roy of the Rovers* are popular tie-ins, and for those desiring a brain-straining game set in Buck House with bizarre Royals, there is *Flunky*.

Stand 1617 (01) 836 6633

### PITMAN PUBLISHING

Pitman will be displaying and selling the latest in quality books from a range of publishers, including new releases and previews. Software for the Mac, Commodore and Amstrad machines and repair data sheets for all major brands will be on show.

Stand 4027 (01) 379 7383

### PRAYBOURNE

Praybourne offers dust covers and padded luggage to specification, and manufactures sports/promotion bags, T-shirts, and so on. It is launching *Stat Mats* at the PCW Show, a range of economically-priced anti-static mats.

Stand 4005 (0527) 61221

### PRECISION SOFTWARE

'A radical new concept in databases' is how Precision describes *Superbase Professional* to be launched at the PCW Show. Precision is promising to have a major presence, demonstrating its own-badged hardware, PC and Amiga software, and the *Abacus* range of specialist books and software it imports from the US for the ST.

Stands 4208 & 4132 (01) 330 7166

### PRESTON

Preston is the sole importer of the *Enhancer 2000* Commodore 64-compatible disk drive. It will be exhibiting the drive, and a range of Dragon software, peripherals and books.

Stand 3040 (0656) 880965

### PRISM LEISURE CORPORATION

Prism promises something for everyone (distributors, retailers and programmers anyway) at its stand. The computer adaptation of what Prism says will be the board game of 1987 will be released at the Show.

Stand 1423 (01) 804 8100

### PROSPERO SOFTWARE

Two new products are to be launched at the Show by Prospero: *Prospero Gem Pascal* and *Prospero Gem Fortran-77*. They can run on any PC which uses MS-DOS and GEM.

Stand 4000 (01) 741 8531

### PSION

The *Psion Organiser II* and associated software and peripherals will be on view; also *PC-Four*, a suite of four popular business programs for the IBM PC and compatibles, and the *XChange* fully integrated pack of business applications using Xen.

Stand 4022 (01) 723 9408

### PSL MARKETING

Export distributor PSL is only interested in trade customers and so will only be present for the first two days of the Show. Argus Press shares the stand, and will be present for the whole Show, previewing its Autumn releases such as *Red October*.

Stand 1621 (0462) 675544

### PST (TRADING)

PST (Trading) specialises in the export of computer hardware, and welcomes trade customers interested in bulk buying. It will be offering 'PCW Show, Specials' — computers, printers and monitors at low prices.

Stand 1217 (06284) 6911

### R&R DISTRIBUTION (Entertainment)

A private family company big enough to cope and small enough to care, is how R&R describes itself. This distributor of computer software promises following-day courier delivery of the many thousand title range always in stock.

Stand 3039 (0977) 795544

### RAM ELECTRONICS

The *Ram Turbo* joystick interface for the Spectrum and its latest product, *Music Machine*, are among Ram's successes. It is now expanding into OEM projects, confident that the UK is now regarded as an excellent manufacturing base.

Stand 4015 (0252) 850031

### ROBTEK/DIAMOND GAMES

Robtek will be introducing its products for all popular and expanding fields of personal computing. Among them, its DTP package, *Lazer Set*; the *Artpak* drawing, music and animation package; and a video digitiser/scanner.

Diamond games will have a range of games predominantly for 16-bit machines.

Stand 1117 (01) 847 4457

### ROCKFORT PRODUCTS

The *Disciple* disk upgrade system for the Spectrum and relevant software developed by the *Disciple's* User Group will be demonstrated on the Rockfort stand.

Stand 1501 (01) 203 0191

### SAHARA SOFTWARE

Sahara will be showing the *Mirage* operating system for the Atari ST, with a range of software. *Mirage* is a powerful and sophisticated operating system for larger 68000-based computers like the Stride 400 Series and the H-P 300 Series.

Stand n/a

### SAMSUNG ELECTRONICS (UK)

The major launch will be of the Samsung PC/XT and AT compatibles, the *SPC 3000* and the *MFC-6000*. It will also be demonstrating its new range of data monitors, including 12in mono and 14in CGA and EGA screens.

Stand 2010 (01) 391 0168

### SATELLITE COMPUTING

PCW Show regular Satellite will be featuring *Dataplus*, its fourth generation database and application generator. The package can be used by anyone wishing to design their own software applications. Satellite will also be demonstrating presentation systems, including its own *Presenter* product.

Stand 2208 (01) 940 1810

### SENTINEL SOFTWARE

Sentinel, exclusive UK distributor for *WordPerfect*, will be launching an Atari ST version of *WordPerfect*, the word processor, which now runs across 12 mini/micro environments. Among other products demonstrated will be *WordPerfect Executive*, an integrated software suite for managers.

Stand 2116 (0932) 231164

### THE SMALL COMPUTER COMPANY

The company's training centre is the first independent computer education unit in the UK to be totally Atari ST-based. A number of courses are offered in the company's ten-desk classroom located at Bognor Regis.

Stand (0243) 860717

### SOFTSHOP/ADAMS WORLD

Two computer retailers from the South East join forces to offer a broad range of software and peripherals for most popular makes. They promise unbeatable bargains on printer purchases.

Stand 3138 (0753) 889010

### SOFTWARE EXPRESS

Specialist Atari software distributor Software Express will be displaying its *Flagship* range of offerings for the educational, personal productivity and business markets. Guesting on the stand will be Voglar Software of Austria, launching its multi-warehouse stock-control and merchandising program.

Stand 4128 (021) 328 3585

Guide to stand numbers	
FLOOR	NUMBERS BEGINNING WITH
GENERAL	
National Hall (Ground)	1
National Hall (Level 2)	3
BUSINESS	
Olympia 2 (Ground)	2
Olympia 2 (Level 1)	4
Olympia 2 (Level 2)	5

INTRODUCING

# The **TWIN** Classic

**A program so similar to 1-2-3™, that if you know how to use 1-2-3™, then you know how to use the **TWIN****

**SPECIAL  
INTRODUCTORY  
OFFER**

**£49.95**

- A spreadsheet amazingly similar to 1-2-3
- Fantastic presentation level graphics
- 1-2-3 Macro compatible
- Reads and writes 1-2-3 files directly
- Site licensing plans available
- No copy protection.

## PC MANAGEMENT

*"Clones Challenge LOTUS"*

The first clone for LOTUS 1-2-3 is out, and is being sold under the claims of "amazingly similar to 1-2-3" which it is. Software clones of this kind could have a major effect on the market for all PC software. The **TWIN** was developed by MOSAIC SOFTWARE."

## PC MAGAZINE

"Companies currently using 1-2-3 could safely introduce **TWIN** into the same environment. In spreadsheet and database functions it is a true 1-2-3 clone. Represents excellent value for the money. A powerful spreadsheet with very good graphics."

## WHAT'S NEW IN COMPUTING

"The **TWIN** offers the chance to buy a program which has a spreadsheet compatible with 1-2-3 and a number of improvements as well."

## 30-DAY MONEY BACK GUARANTEE

YES, you may try the **TWIN** on your IBM PC/XT, Amstrad PC1512 or compatible (min 512k RAM is needed) for 30 days. If you find that **TWIN** does not perform in accordance with our claims and provided that all goods returned to us (in a good condition) within 30 days of purchase, we will refund your purchase price.

**The **TWIN** offers so much more for so much less!**

**The **TWIN** advantages . . . above and beyond 1-2-3's features, the **TWIN** has the following additional capabilities.**

1. No copy protection for full backup
2. Supports the 8087 coprocessor chip
3. Spreadsheet can import its own and 1-2-3 print files
4. Displays available memory on status line
5. User selectable 16 color display for spreadsheet and graphics
6. Financial functions IRR, NPER, and RATE
7. Bi-level analysis and presentation level analysis
8. Up to 15 different types of graphs
9. 11 text fonts displayable on screen
10. 2 and 3 dimensional graphs
11. Horizontal bar charts
12. Pie-bar combination graphs
13. Logarithmic scales
14. 2 vertical Y axes
15. Optional "Fill in the blanks" for complete user control
16. On-screen slide presentation. Single or sequence of graphs
17. Simple configuration of hardware
18. Point at range names
19. Meaning of function keys is displayed in ready mode
20. Space/backspace operate cursor movement in flip menus
21. Reads and writes DIF files without leaving program

**ORDER YOUR COPY TODAY** New UK version \*\*Time limited promotional offer



SOFTWARE INC.  
0604 830496

**YES I'M IMPRESSED! PLEASE SEND ME A **TWIN** CLASSIC** at the Special Offer price of **£49.95**. I enclose a cheque/money order for £59.40 (includes VAT & Postage) Cheques made payable to MOSAIC SOFTWARE INC.

NAME \_\_\_\_\_

TITLE \_\_\_\_\_

ADDRESS \_\_\_\_\_

POST CODE \_\_\_\_\_

TELEPHONE \_\_\_\_\_

Post to: MOSAIC SOFTWARE INC.  
P.O. BOX 97 NORTHAMPTON NN4 0YY

MOSAIC and the **TWIN** are Trademarks of MOSAIC SOFTWARE INC. Other brand and product names are Trademarks of their respective holders.

# PCW SHOW PREVIEW

## NEW INNOVATIONS



STOP INDUSTRIAL  
ESPIONAGE WITH OUR  
USER UNFRIENDLY  
PROGRAM!

### THE SOFTWARE SELECTION

The Software Selection will be selling a wide variety of games for all computers.

Stand 1100 (021) 378 1371

### SOUTHDATA

The latest release of its advanced *Superfile* database manager will be on show, now running on WORM disks.

Stand 4053 (01) 995 7587

### START SYSTEMS

Start Systems, a dealer in advanced graphical equipment, will be demonstrating the *SAM* realtime video digitiser and the *GEN* professional genlock.

Atari World (0304) 363566

### SUN MICROSYSTEMS

The latest of the *Sun-3* family of colour and mono workstations based on the MC68020 will be exhibited, along with a number of DTP third party software.

Stand 5051 (0276) 62111

### SUPERIOR SOFTWARE

'Fast becoming legendary' Superior brings its latest releases and previews for the BBC and Electron markets. *Codename Driod* and *Craze Rider* follow the *Repton* series and the *Superior Collections*.

Stand 3096 (0532) 459453

### SUPERTEC

Atari, Amstrad and Acorn dealer Supertec also offers printers, plotters and modems, as well as 16-bit software.

Stand 4100 (0268) 282308

### SYBEX COMPUTER BOOKS

For the most up-to-date information on computers and how to use them, there is a Sybex book for every level of business and professional user.

Stand 4029 (0279) 26721

### HUGH SYMONS DISTRIBUTION SERVICES

High-profile marketing techniques, professional sales teams, efficient warehouseing and strong back-up services are promised by distributor Hugh Symons, which is planning its biggest stand this year.

Stand 1701 (0202) 745744

### SYNDROMIC MUSIC

MIDI applications on the Atari ST will be exploited by Syndromic Music, showing a range of applications dedicated to the control of MIDI instruments. These include visual editors, librarians, stereo samplers and software. It will be launching the *MIDI MAZE* interactive game at the Show.

Stand 4133 (01) 444 9126

### SYSTEMS ARCHITECTS

Some of the most visually stunning point-of-sale graphics currently available are promised for the Systems Architect stand.

Commodore Village

### TAURUS

Amiga specialist Taurus will be showing its *Acquisition*, a user-friendly, fully-fledged relational programmable database system. It will also show its new fully-professional CAD package, *XCAD*.

Commodore Village (0483) 579399

### TROJAN PRODUCTS

Trojan is launching a Graphics/Lightpen pack for the Amstrad PCW, consisting of the Trojan lightpen and *Cadmaster+* software specially written for the Amstrad.

Stand 3096/17 (0792) 205491

### TULIP COMPUTERS

Tulip (from Amsterdam) is opening its UK subsidiary in September and launching its IBM PC-compatible range at the PCW Show. Three machines will be released:

PC Compact, AT Compact and AT 386 Compact.

Stand 2112

### TYNESOFT

Tynesoft and its budget label Microvalue will be demonstrating its new top line titles, autumn and winter compilations and previews.

Stand 1722 (091) 414 4611

### US GOLD

An arcade coin-op extravaganza is promised by US Gold. It has new titles, new games under a new label, and US classics from Epyx will make the stand resound.

Stand 1311 (021) 356 3388

### VITALMATCH

This is a new company founded by Peter Reich to market DTP systems, customised to clients' specifications and budget, and incorporating an advisory bureau for those needing guidance in their choice of system.

Atari World (01) 243 1062

### WHAT MICRO?

*What Micro?* is a monthly buyers' guide for business users. Editorial focuses on hardware tests, software surveys and vertical market features and peripheral tests. Each issue incorporates a classified buyers' guide. Complementary copies of the October issue (with a 36-page software supplement) will be available.

Stand 4227 (01) 439 4242

## How to get there

### BY RAIL

Olympia has its own BR station. Direct rail services from the Midlands, North West and South coast.

### BY TUBE

From Earls Court (District and Piccadilly lines) take the special PCW Show service to Olympia.

### BY ROAD

Olympia is just off the main M4 route into London and well signposted from the city centre.

### BY AIR

From Heathrow take the Piccadilly line to Earls Court and change for Olympia. From Gatwick take the direct rail link OR the fast service to Victoria and then travel by tube.





See us on  
Stand 2116 at the  
PCW Show

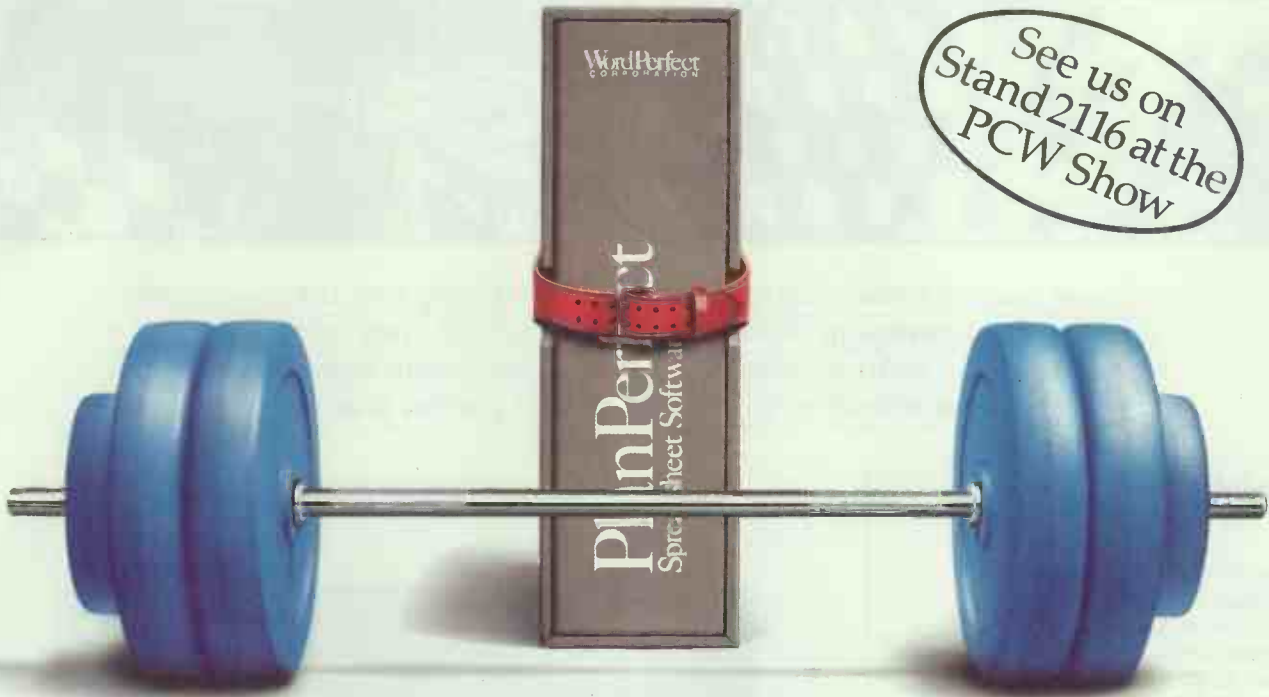

# PlanPerfect spreadsheet. Easier to work out by our calculations.

PlanPerfect is the heavy weight spreadsheet that's easy to work out but with the muscle to handle your financial planning.

For example, memory isn't wasted storing empty spreadsheet cells. And if you should run out of RAM (after all, PlanPerfect can take advantage of 8 Mb, creating spreadsheets of up to 256 columns by 8192 rows), then elegant handling of virtual memory allows your work to spill over onto disk.

PlanPerfect can increase your output, without the downside of a long learning curve. It's simple yet sophisticated, offering a text processor, dual document editing, and over 80 built-in functions – arithmetic, financial, logical, calendar and text. Don't worry if

you use some esoteric calculations; simply define your own special functions.

Another definite plus is that text graphics are provided in addition to bit mapped, so you don't necessarily need a graphics adaptor. PlanPerfect integrates perfectly with WordPerfect, the world's leading word processor, for the simple transfer of graphs and spreadsheets into letters and reports. PlanPerfect also adopts a similar easy-to-learn, easy-to-use function key and template approach, with many features in common, and offers you time-saving single keystroke macros in just the same way.

Now call for our brochure and weigh up the advantages of PlanPerfect for yourself.



SENTINEL  
SOFTWARE

Wellington House, New Zealand Avenue,  
Walton on Thames, Surrey KT12 1PY.  
Telephone: (0932) 231164  
Telex: 916005. FERGUS G.

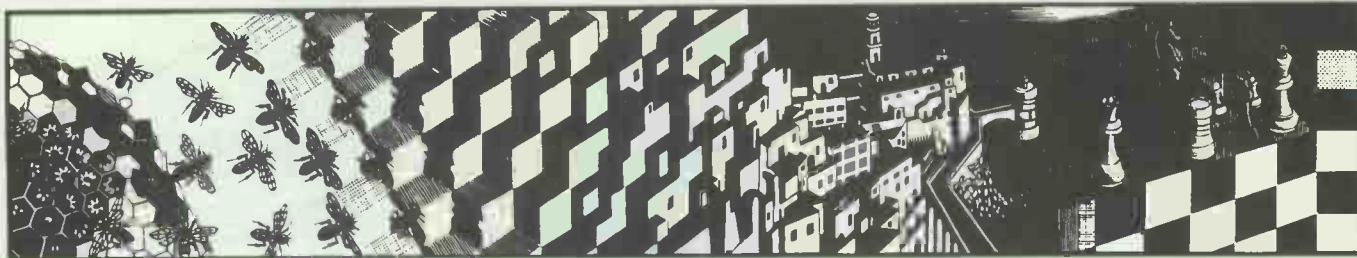

*Some people never learn. If they're not chasing evil uncles around volcanoes or ravaging cities in search of petrol, they're studying at a very gruesome school indeed. Stephen Applebaum tests his nerves in this month's review of the best games around.*

## A night to remember

**Title:** The Lurking Horror  
**Computer:** Many formats  
**Supplier:** Activision  
**Format:** Disk  
**Price:** £24.99 (8-bit version);  
 £29.99 (all others)

It is almost impossible to pick up a computer magazine at the moment and not read the name Infocom; a situation largely due to the company's recent collaboration with Douglas Adams, creator of *A Hitchhiker's Guide To The Galaxy*, and author of the frustratingly difficult and highly overrated adventure, *Bureaucracy*.

Adams' involvement with Infocom generated so much interest that other, better adventures, launched around the same time or just after *Bureaucracy*, have gone relatively unnoticed. One such game, *The Lurking Horror*, is a powerful exercise in interactive terror that should not be missed by anyone interested in the genre.

Using every trick in the horror writer's repertoire, Dave Lebling has created a claustrophobic atmosphere of all-consuming dread similar to that pervading stories by Poe and two of his greatest peers, Lovecraft and King.

Although *The Lurking Horror's* setting is contemporary, its tone is gothic. Lebling's characters inhabit a superficially mundane world where things look familiar and yet nothing is quite what it seems. Everyday objects gush malevolence, and give *The Lurking Horror* a nightmare quality guaranteed to set your spine tingling.

In keeping with other Infocom adventures, *The Lurking Horror* is entirely text-based; which doesn't matter, because Lebling's descriptions are stomach-turning enough without graphic support.

The story begins in the ominously titled 'terminal room' of the George

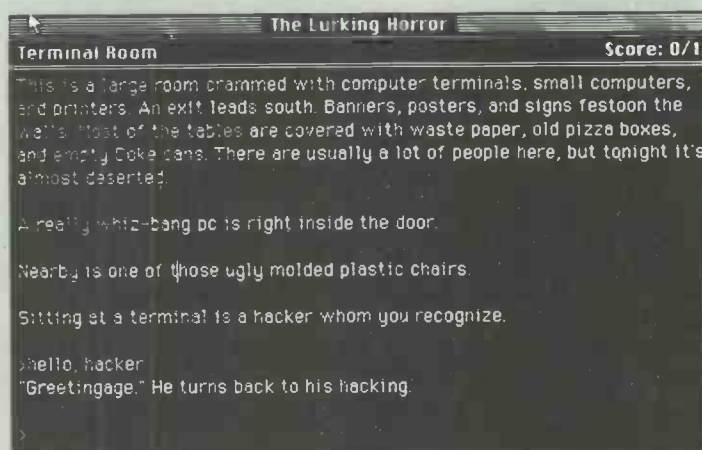

Underwood Edwards Institute of Technology (GUE), on the eve of the final day of term. You are there to finish a 20-page paper for presentation the following morning.

Outside a blizzard is blowing hard and the roads are buried beneath impassable snow drifts. Even the elements conspire to make this night one that you will never forget — should you survive long enough to remember it, that is.

Nothing much happens in the game unless you switch on a spare terminal and try to access the file containing your assignment. Instead of your term paper you find some worthless verses and a fuzzy picture showing an unidentifiable animal. Examining the picture propels you into a dreamworld peopled by strange and inhuman creatures. This is your first encounter with the dark forces at work below GUE.

With you in the room is a 'hacker' (a dedicated computer enthusiast), whose only notable feature is a large keyring hanging from his belt. One of

the keys — I won't reveal which — is of vital importance and must be borrowed before you can search several locations. How to persuade the hacker to give you the correct key is your first major problem.

*The Lurking Horror*, like most of its predecessors, is full of minute detail; detail which extends beyond location descriptions to include the tasks you are required to perform at various junctures. For example, in a kitchen adjacent to the terminal room, there is a refrigerator containing food and a microwave oven. It is possible to take food from the fridge and place it in the microwave, wherein it can be cooked. However, to complete this part of the game successfully, you must set the correct cooking time and temperature, or the food will be ruined.

Much of the action in *The Lurking Horror* occurs in basements and interconnecting tunnels located underneath the numerous buildings of GUE. Wandering around is like being one of those characters in a horror

movie who, against all logic, goes for a midnight stroll through a wood, despite his family, best friend and pet budgie having been massacred there the previous night by a rabid, axe-wielding psychopath.

Hidden in these benighted locations are artefacts totally incongruous to the modern surroundings described earlier. A blood-spattered altar bearing cryptic symbols and a sacrificial knife indicate cabalistical practices; while a metal panel hides something unspeakably bad. This could have some connection with the black creature which follows you at various points in the adventure, though I have not yet discovered its true significance.

Not everything evil in *The Lurking Horror* is as obvious or anachronistic as an ancient altar. Even someone as unassuming as a maintenance man can turn out to be one of the undead.

The only way to find out whether people are actually on this side of the veil or not is to stick an axe or other such instrument into them. You have to be careful, though, as this invariably makes them angry.

Notwithstanding my previous allusion to Poe, Lebling's style is much closer to Lovecraft and King in that he revels in lurid descriptions of carnage. I mentioned the maintenance man just now. When he finally lays down and dies he does not croak in the normal way, but 'shortens and dissolves ... undergoes a convulsion, and then explodes into a crowd of small, squealing creatures.'

No Infocom game is packaged without a number of superfluous goodies. Some of which come with *The Lurking Horror* are a laminated student ID card; an amusing guide to help freshmen settle into the college environment; and a synthetic cen-

tipede. Both the ID card and the guide contain information giving access to your files on the PC at the start of the game, but they are all just another Infocom give-away.

So that's *The Lurking Horror*. It is creepy, tasteless in places, as gory as any shock-horror movie and just as fun. Since Infocom has dispensed with its rating system, which indicated the difficulty of each adventure, you cannot tell how you might fare without actually playing the game. I would say, however, that *The Lurking Horror* is ideal for anyone who has some adventuring experience. Complete novices might find it a little too heavy.

If Adams' super-hyped *Bureaucracy* was a slight disappointment, *The Lurking Horror* is a triumph in the traditional Infocom mould. Buy it and lose a few nights' sleep — it will be well worth it.

## Under the volcano

**Title:** Barbarian  
**Computer:** Atari ST; Commodore Amiga  
**Supplier:** Psygnosis  
**Format:** Disk  
**Price:** £24.95

Psygnosis has been around for some time, but the company has never really made its mark on the games market because its products, which are always visually stunning, have lacked gameplay. This is not the result of insufficient programming talent, but the company's apparent belief that if a game looks good it will sell, regardless of whether it is fun to play.

*Arena*, a sports simulation, suffered badly from this philosophy. Not even its excellent graphics could hide the fact that it was just an overblown Track and Field rip-off — and an expensive one at that. What a surprise it was, therefore, to discover that *Barbarian* not only offers the best graphics that ever graced an ST monitor, but also a degree of gameplay far in excess of any previous Psygnosis product.

*Barbarian* is an arcade (graphical) adventure set in a world where good and evil battle for supremacy. As Hegor, a dragon-slaying, beer-swilling, womanising barbarian, you must descend into the Tartarean depths of Durgan, a volcano, in pursuit of Necron, your evil uncle. When found, he has to be destroyed; only then can the people of Thelston, the village in which you grew up, escape from the dark shadow Necron has cast over them.

The only problem with this plan is that Necron lives in the deepest region of an underground kingdom. To reach him, you have to battle your



way past the many creatures that guard the tunnels leading to his lair; the most terrible of which is a giant dragon, Vulcuran, who guards the final entrance to Necron's *sanctum sanctorum*.

Vulcuran is a lumbering mass of scales, made fat on the flesh of countless human victims. His sheer size makes it impossible for Hegor to kill him with a sword — only a bow is potent enough to despatch him.

On his way through Durgan, Hegor must find a bow and collect as many arrows as he can; one is not enough to kill Vulcuran. When the dragon and his master have been destroyed, Hegor can then return to the surface before Durgan finally erupts. The amount of time Hegor has to get back depends on how long it takes to reach Necron and destroy him.

*Barbarian*, like previous Psygnosis titles, relies heavily on visual impact. As soon as the title screen depicting a Tarzan-like figure swinging a broadsword appears, you just *know* you are in for something special.

When the game has loaded, the display divides horizontally to form two windows. The larger of these takes up about two thirds of the screen and features a view onto the current scene; the bottom one contains numerous options for controlling Hegor's movements and posture.

David Lawson and Garvan Corbett,

*Barbarian's* programmers, have done their best to make sure players feel at home with the game's controls. Rather than dictating the type of control device that must be used, they have configured the program to accept input from a joystick and the Atari's mouse and keyboard, none of which need be specified at the beginning of a game since all three can be used at any time.

Unless the keyboard is being used, all actions are initiated by icons chosen from a range of twelve. These make Hegor run, jump, flee, fight, defend himself, pick up and use a weapon, and climb up and down ladders.

Hegor and Necron's wicked minions are all depicted as large and extremely finely detailed animated characters, and how Hegor attacks and defends is dependent on the foe encountered at any one time. If things get too hot, he can be made to run away using the aforementioned 'flee' option. Selecting flee causes Hegor to let out a fearful scream, drop everything he is carrying and bolt towards safety. Running from danger does not always pay off, however, as Hegor sometimes simply runs from one creature into the clutches of another.

Fearsome as his appearance is, Hegor does not cut quite as awesome a figure as his assailants, who

# SCREENPLAY

range from dog-like men in chain-mail to blue rhinos and zombies. Although these look dangerous, most can be killed with one swing of Hegor's sword. Once hit they change into a cloud of vapour, in which can just be seen some skeletal debris, composed of a skull and rib cage.

On top of its amazing graphics, Barbarian also boasts the best digitised sound in an ST game. Here you

have screams, grunts, groans, growls and the clanking of metal. It just goes to show that anything the Amiga can do, the ST can do.

Although Psygnosis would appear to have changed its approach to game design, it has made little headway toward improving its quality check. My copy of Barbarian, like other Psygnosis products I have used, failed to load unless the disk

was held down inside the drive, and even then the game did not always load correctly.

Loading problems aside, Barbarian is an impressive game of outstanding graphic and audio quality. Psygnosis has taken a turn for the better with this one, and has at last overcome the memory of albatrosses like Arena and Bratticas. I look forward to the company's other new titles.

## On the road

**Title:** Roadwar 2000  
**Computer:** Atari ST; IBM; Amiga; Macintosh  
**Supplier:** US Gold  
**Format:** Disk  
**Price:** £24.99

Roadwar 2000 is set in an America torn apart by bacteriological warfare at the dawn of the twenty-first century. Law and order has crumbled, and small pockets of survivors have formed themselves into road gangs who battle for petrol.

Your role in the game is that of a gang leader still loyal to the last remaining fragment of the Federal Government. You are on a mission to find eight scientists who collectively hold the formula for a vaccine to destroy the virulent microbes which continue to poison the land, long after the war has ended. When you have located the scientists, they have to be transported to an underground lab where they can develop the vaccine. Finding the scientists depends on your ability to survive the hostile gangs who control whole regions of America.

Roadwar 2000 is a kind of futuristic dungeons and dragons, in as much as it plays like games of that ilk. Instead of adventurers, however, you have cars. A gang can comprise as many as 15 vehicles, each with its own individual ratings in 24 categories. To acquire the maximum number of cars can take a long time, so, as in most other adventures, it is possible to save a game at any point. I am not sure how long it would take to complete Roadwar 2000, but the packaging cites 50-plus hours as the average playing time.

Roadwar 2000 is played on a map of America. In the Atari ST version tested here, a small icon, representing your gang's position, is moved around the map using the numeric keyboard. At certain instances, messages appear warning of an encounter with another gang. Generally, you have to fight your way out of such a meeting.

The majority of people in a gang



come from one of the categories known as armsmaster, bodyguard, commando, dragoon and escort; the list being in order of decreasing effectiveness. Other members, known as 'cronies', can be doctors, drill sergeants or politicians, and are usually recruited as a result of forays into towns and cities.

Recruiting in cities is dangerous because they swarm with mercenaries, street gangsters, armed rabble and cannibals, among a host of other undesirables. And, as if these were not bad enough, the residents include survivalists, renegade national guardsmen and satanists. Sometimes it is possible to negotiate with the locals, especially if you have a politician in your gang, but, more often than not, force is the only way to get what you want.

Road combat is different to foot combat and is considerably more complex. In all there are three modes available: abstract, tactical and quick. When an encounter occurs, you begin your attack by allocating gang members to whatever vehicles are at your disposal. Depending on how quickly you want to complete this phase, you can either deploy the men manually or get the computer to do it.

After you have deployed all your men, the display changes to show a tactical map whereupon small icons indicate the positions of your vehicles. These can be moved — within certain limitations — to positions where they will be most effective during combat.

Also shown on the map are the positions of the opposing gang's vehicles. Moving one of your cars into an occupied position causes a



'ram' to occur; the amount of damage caused by this move depends on the speeds and masses of the vehicles involved. Before ramming another car it is possible to accelerate, thus increasing the damage potential of the manoeuvre.

Cars need not only be rammed: they can be shot at using a variety of weapons, and even boarded and their crews killed (which is how you increase the number of vehicles under your control). You start a game with six vehicles and increase your total by one each time you win a battle with a rival road gang.

Quick combat is much faster than tactical combat but does not allow enemy vehicles to be captured. Using this method, you are required to set the ram ratio and aiming priorities for each of your groups.

The ram ratio determines the size of enemy vehicles which your vehicles ram. Aiming priorities, on the other hand, refer to the targets you want your men to shoot.

If the pressures of life on the road get you down, you can enter a town or city under the control of another gang, defeat it in combat and take the location for yourself.

Having to worry about rival gangs and mutant bikers means that it's quite easy to forget about the scientists you are supposed to find. Your search can be shortened considerably by a piece of kit called a Radio Direction Finder (RDF). This picks up signals being sent out from a homing device worn by the scientists.

Roadwar 2000 is an imaginative twist on the dungeons and dragons-type scenario. It is intelligent, challenging and, above all, entertaining. What more could you ask for? **END**

*Newsflash*  *Newsflash*  *Newsflash*

**At  
last!**



*Arnor's incredibly successful  
word processing system*

**PROTEXT**

*is now available for the IBM  
PC range — and compatibles —  
including the Amstrad PC1512  
and PC1640.*

*Buy it today! — Call 0733 239011*

*only*  
**£59.95**

**Releasing your micro's potential...**

**ARNOR**

*Arnor Limited, Protex House, Wainman Road,  
Peterborough, PE2 0BU.*

# COMPUTER ANSWERS

Steve Gold takes his toolkit to your problems.  
The address to write to is: *Computer Answers, PCW,*  
32-34 Broadwick Street, London W1A 2HG

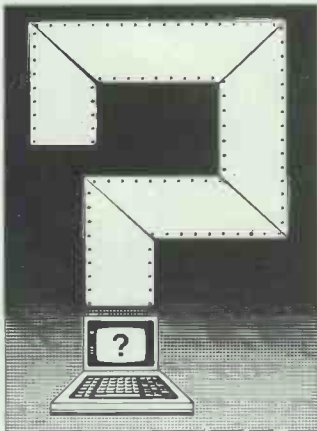

Computer Answers is PCW's help column. We offer advice about all kinds of specific hardware and software problems through the pages of the magazine. We also welcome further information in response to published queries.

## DOS format for hard disk

Having bought a 30Mbyte hard card from my dealer, who formatted the disk for me, I find that I can't get my machine to boot up to DOS properly. Even when I reformat the hard disk using the DOS FORMAT command, it still comes up with a 'Wrong Command.Com File'. Is the hard disk faulty? Should I take it back?  
*Alan Crane, Plymouth*

The problem lies in the DOS you're using. You'll probably find that your version of DOS differs from the one your dealer used to format the hard disk. Unfortunately, it's not simply a matter of re-formatting the hard disk with your version of DOS, as there are fundamental differences between the way that some DOSs format hard disks; right down to the underlying interleave format (how the consecutively numbered sectors are laid down on the disk).

If you are familiar with hard disk formatting, follow the procedure given here precisely; otherwise, return the unit to your dealer and ask him to reformat the disk for your new DOS.

- 1) Place your DOS disk in the drive and type DEBUG, followed by a <Return> or <Enter> at the > prompt.
- 2) At the resultant Debug prompt, start the format program by typing in the following after the '-' appears:  
g=c800:5 followed by a <Return> or <Enter>
- 3) Your screen should say something like this:  
WX2 Format Revision 1.5  
(C) Western Digital Corp  
1986. Current Drive is C:,  
select new drive or (Return)  
for current drive
- 4) Your screen will then tell you:  
Interleave is 3; Select new interleave or hit (return) for current interleave.  
Enter 4 (return) to select interleave 4
- 5) After selecting the interleave factor specified in your hard-disk manual (usually 4), the computer will then ask:

Are you dynamically configuring the drive? Y/N  
6) Select N and press (return) and the drive will commence formatting. This can take up to five minutes or more, depending on the speed of your machine and the size of the hard disk being used.

You may hear the drive making rattling noises, followed by a 'ping'. This is quite normal and merely indicates that the format program has found some bad hard-disk sectors. It may take a few minutes for the program to map these sectors out, so don't panic if the screen display seems to have frozen on a particular sector number.  
7) At the end of the interleave format, the screen should show:

Format Successful

>

You may then proceed with the FDISK and FORMAT :C commands as usual, since your hard disk has now been interleave-formatted for your respective DOS.

## Apple upgrades

I recently bought a second-hand Apple IIe as a partner to my Macintosh and Imagewriter II printer. Can I use the IIe to drive the Imagewriter?  
*R Reidford, Sheffield*

Yes. You'll need to connect the IIe to the Imagewriter with a special cable and a serial interface card such as Apple's Super Serial Card. Almost any serial card will do — keep an eye on the second-hand columns for bargains. The cable which Apple recommends for the Imagewriter II to a IIe is part number A9C0314.

## Printing gaps

I THINK IT'S A  
READ-BETWEEN-  
THE-LINES FACILITY!

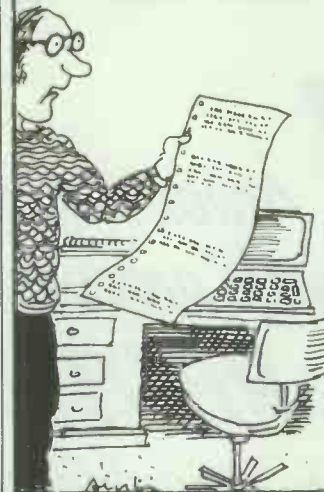

My word processor seems to be incompatible with my printer. It prints out two pages as normal, neatly formatted and numbered. Then, for no apparent reason, it prints a line and proceeds to the next page, leaving great gaps in my printout. What's wrong?  
*P Reid, Barrow-in-Furness*

This is a common problem, particularly with the wide variety of word-processing packages and printers around today.

The problem may be caused if either your software or printer is set up to leave a top and/or bottom margin on each sheet, but is set for the wrong-size paper. First, check the settings on your software — is the package installed for your printer? If in doubt, select 'Epson-compatible' as a reference point.

If this fails, carefully check that the DIP switches on your

printer are set for Epson or IBM-compatibility. Again, when in doubt, select Epson-compatibility as a reference point.

The problem may be caused if you have installed your software for one of the latest generation of 24-pin printers now available, instead of the more common 9-pin printer. The problem lies in the fact that some software uses an <ESCAPE J> to perform a line feed. If this is the case, you will also notice that the gap between the lines on your problem printouts is slightly too wide, owing to the fact that the <ESCAPE J> command instructs the printer to step 1/180in on 24-pin printers and 1/216in on 9-pin printers.

If all else fails, check your computer/printer combination with other software which has been correctly configured. Close examination of the parameter or installation program for your respective programs may reveal the source of your problems.

Another common problem is telling your printer how long your pages are, particularly if you are using A4 paper which is 11 2/3in or 70 lines long. DIP switches or configuration programs invariably only specify 11ins or 12ins.

To set the page length correctly, your software has to send the printer an initialisation string to tell it how long the page is. Otherwise, your software will think there are 70 lines per page, and your printer will think there are only 66 lines and wind the paper on after that number.

If you want to check that your printer is set up correctly, the following method will work on MS-DOS machines and may be adapted for others.

Align the perforations of your continuous paper with the top of the print head. From the keyboard at the DOS prompt type <Ctrl-P>; this echoes anything that appears on the screen to the printer. (The same command turns the echo off.) Type <Ctrl-L>, which is a form feed character, and the paper in the printer should move up. If the perforations no longer align with the print head, then your printer is set to a different form length from the paper.

## Disk failures

**My disks keep failing in my second drive, yet they format OK in both drives. Does my drive need replacing or realigning?**

**Paul Webster, Solihull, Birmingham**

It sounds like you have either bought cheap disks or may have a misaligned disk drive. Try using better-quality disks (yes, I know they cost more, but you do get what you pay for in the disk market).

It could be that your drive heads need cleaning more frequently. Which head cleaner do you use? If you *don't* use a drive head cleaner, then that may be the answer to your problem!

## Lost characters using a modem

**While accessing online services such as Telecom Gold and Prestel, the service didn't appear to accept instructions. This meant that I had to rekey the commands several times before they had any effect. Is there a problem with my modem?**

**Tim Paxton, Ealing, London**

You don't say which software, modem and computer combination you're using, but the chances are it's your modem cable that's at fault. Many modems these days are speed-buffered: that is, they buffer data received until the online service is ready to accept it. In the case of Prestel, for example, data comes in at 1200 baud, while outgoing data goes at 75 baud.

Some computers, notably the IBM PC, Tandy Model III/IV and some Apple II machines, cannot handle such split baud rates, and so communicate with the modem at 1200 baud full duplex or higher, relying on the modem to buffer data as required.

Many modems will work with the ground, signal earth, RX and TX connectors linked correctly. In the case of speed-buffered modems, the DSR (Data Set Ready) and CTS (Clear To Send) connections must be connected through to your computer's serial port. If this is not done, then the X-on/X-off flow control signals that your modem generates may not be received correctly, allowing your outgoing data to be lost, and requiring rekeying before it has been successfully transmitted to the online system.

The exceptions to this rule are the QL and Sinclair Spectrum computers. Since these machines have only a very simple serial port, true duplex (both-way) serial communication is not possible. Instead, outgoing data must wait for the incoming data to finish (and vice versa) if it is not to be 'lost' to the system. In such circumstances, you should wait until all incoming data has been received before issuing commands to the database you are on.

In extreme circumstances, it might be worth investing in a more flexible modem to cope with the inadequacies of your computer's serial port.

## Cheaper hard disks

**I've noticed that 30Mbyte hard disks have become more prevalent in dealer adverts. On enquiry I find that these units are selling for about the same price as 20Mbyte units were earlier this year. As I intend to buy a hard disk for my Amstrad PC in the next few months, should I hold on and wait for the price to fall still further, or buy now? Steve Hemmens, Belper, Derbyshire**

Your question raises a number of points regarding hard disks and Far Eastern equipment generally.

If you've ever examined the video recorder market, you'll have noticed that some machines can squeeze twice as much material onto a single four-hour tape to give up to eight hours of recordings. Such machines are called twin-speed machines, and work by cramming twice as much information onto a tape as normal. While manufacturer claims for such machines are good, often there is a noticeable drop in picture quality when such double-density tapes are viewed.

In the hard-disk world, things have moved similarly. A new type of hard-disk controller is now available that uses a special data format (RLL) which squeezes one and a half times the amount of data into the same amount of space on a hard disk. In theory, therefore, a 20Mbyte hard disk could accommodate up to 30Mbytes of data, with similar performance increases *pro rata* for other hard disk sizes.

The problem is that, like videotapes, the signal quality on such hard disks is not quite

as high as that seen on the old non-RLL controlled hard disks. And, while on video the only bother is slightly more fuzzy picture and sound, there is a greater possibility that such high-density hard disks will produce errors.

As a result, the ST225, which is the most popular hard disk unit around at the moment, is not usually recommended to be used with an RLL controller. That's not to say that RLL-controlled hard disks won't work. On the contrary, many of them do work and work well. The slightly higher-rated ST238 is the best hard disk unit to use with an RLL controller.

If you do find yourself a bargain RLL-controlled hard disk with an ST225 hard disk unit, don't despair. My sources say that, provided the hard disk formats okay, you have only a 20 per cent chance of your hard disk having an error at some stage in its life.

Whatever kind of hard disk you use, it's always wise to use some sort of back-up program to make a copy of your valuable files — 20Mbytes is a lot of information to have to recreate.

On your other point regarding 'buy now or wait for prices to fall further', I say buy now. The Japanese Yen — and several Far Eastern currencies — are doing rather well at the moment, and there's every indication that Far Eastern computer kit prices are set to rise, as importers end up having to pay more for their imported equipment, so don't delay too long.

## SideKick problems

**I use an Amstrad PC1512 with a hard disk and SideKick. Sometimes, for no apparent reason, when I attempt to call up SideKick, the speaker just chirps at me and nothing happens. Is this a problem peculiar to the Amstrad PC? Paul Thompson, Bridgewater, Somerset**

This problem is invariably encountered by SideKick users. Just as you can type ahead of the prompt on the PC, allowing the machine to 'catch up' with you in due course, so PC-DOS or MS-DOS will return control of the machine to you (via the > prompt) when, in fact, it's still carrying out certain housekeeping tasks.

If the DOS task involves certain portions of memory

or reading/writing to disk, SideKick senses the situation and will not page in until it thinks it is safe to do so. At your own risk, it is possible to force SideKick to page in by pressing the ENTER key. This will interrupt the DOS task and bring up SideKick as usual.

## Shareware dollars break the bank

**I regularly download shareware programs for use on my computers, which include a Tandy Model IV and an Amiga A500, from bulletin boards. I also obtain shareware software from my local computer club. I like some of the packages and intend to use them a lot.**

**When I try to register as a user of the software, however, my bank says that it costs at least £10 to send a dollar cheque to the American companies concerned. Since the registration for the software only costs ten to twenty dollars, I think this is an incentive for people not to register.**

**Is there a solution? G Rhodes, Newcastle-upon-Tyne**

Since the 'shareware' idea originated in the US, most registrations have to be made in US currency. Some companies accept credit cards (Access, Visa, and so on) to register, but for individuals and small firms, it is a major disincentive against 'going legal' and registering your software.

Lloyds Bank now has a solution for such situations which is available to both customers and non-customers alike. Thanks to an agreement with American Express, Lloyds now offers dollar money orders for a flat rate of £3 (rather less than many other banks).

The American Express dollar money orders are available 'while you wait' at most Lloyds branches, so it's a relatively easy matter to pop in and get one from your local branch. This is the cheapest way to send dollars to the US at the moment, and the money order is treated as a normal cheque by the US banks.

Steve Gold is a freelance journalist who specialises in computers and computer communications. He writes regularly for several computer publications, both in the UK and abroad.

END



# BIBLIOFILE

*Under the spotlight this month come books on operating systems. Our reviewers help you sort out the good buys from the bad.*

## Introduction to Operating Systems

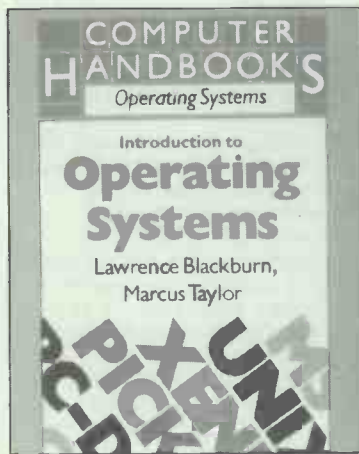

**Authors:** Lawrence Blackburn and Marcus Taylor  
**Publisher:** Pitman  
**Price:** £3.95

I have rather a penchant for handbooks, and I do mean *handbooks*, not those massive volumes that masquerade under that description and yet would have Popeye reaching for his extra can of spinach.

It's probably because I do equate the idea of something being explained simply with the reality of short and unambiguous statements. Why say in 100 words what could be said in 20? You may have guessed by now that I wholly approve of the *Pitman Handbook: Introduction to Operating Systems*. Any book that I can't read as comfortably as a novel and yet pick up and dip into at any point really counts a lot with me: two books for the price of one, really.

This book can be used as a general introduction, summary, top-up or leader volume for other 'handbooks' in the series on 'Operating Systems'. (Unix and CP/M are also available as separate books by the same authors.) *This short text attempts to touch upon the general design principles used to build operating systems*

*which will efficiently manage the resources of the system.* No space is wasted: a general introductory chapter encompasses all the most important principles, followed by specific chapters on 'Storage Management' through to 'File Management'. 'Chapter 8: Systems Management' ties up all these ideas by considering the management of the system as a whole rather than as separate parts and 'Chapter 9' is invaluable as a brief guide to contemporary popular operating systems for microcomputers, with pages devoted to Unix, Pick, CP/M and MS-DOS among others.

It's not going to answer every question that you may have on operating systems, but then that really wouldn't give any incentive to future authors, would it?

Lorna Kyle

## Essential Concepts of Operating Systems

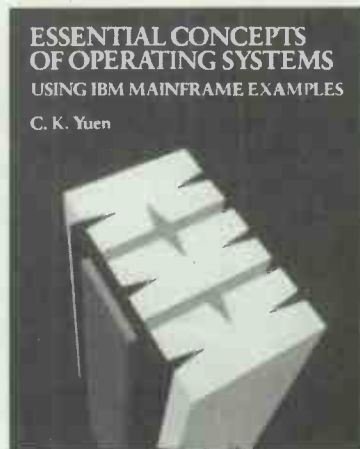

**Author:** CK Yuen  
**Publisher:** Addison-Wesley  
**Price:** £13.95

Professor CK Yuen states that this book is mainly *'concerned with the concepts of operating systems, rather than the systems themselves.'* If he can make 'concepts' last nearly

200 pages, it makes you wonder what he could do with a fully-blown detailed analysis. It is pretty serious stuff and not a book for light reading or to be dipped into occasionally, especially as mainframe examples are quoted. You are either the type of user who needs and wants to know more about mainframe operating systems or one who wouldn't touch a book like this with a barge-pole.

Topics discussed have been organised by operating system functions but the reader is advised to leave 'Chapter 3: Memory Management' and 'Chapter 6: Data Management' until after 'Chapter 2: I/O Operations', 'Chapter 4: The Management of Concurrent Processes' and 'Chapter 5: Device Management and Resource Sharing' have been covered. If you can try and keep the basic definition in mind, namely *'an operating system is a set of interconnected programs that control the hardware and data resources of a computer and perform system-related functions on behalf of users and user programs'*, then all will not appear lost when diving into the realms of channel programs: that is,

CP CCW X'11', DATA, X'40', 80 monoprogramming, multiprogramming, dynamic partitions of memory management, paging registers, address buffers, task control tables, context switching and PSW registers.

The benefits of an 'industry-standard' operating system, such as Unix, versus machine-incompatible system programs are discussed and the author feels that the concurrent task call facilities of ADA makes it one of the forerunners for a general system programming language.

Each, rather long, chapter ends with a very short summary. Odd exercises are dispersed throughout the text. These are mainly of a discussion type, with twenty additional exercises provided at the end of the book. The diagrams consist mainly of memory maps, block figures and tables. *Essential Concepts of Operating Systems* is a tool for the enthusiast rather than the vaguely interested.

Lorna Kyle



# Systems Management under Unix

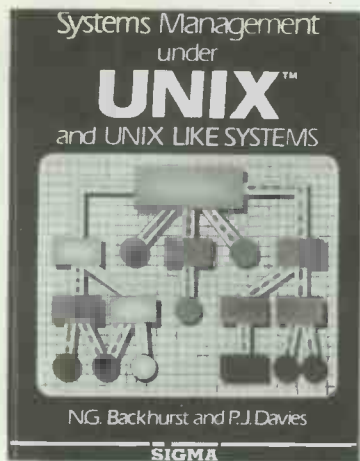

**Authors:** NG Backhurst and PJ Davies  
**Publisher:** Sigma Press  
**Price:** £12.95

*Unix — the book*, also from Sigma Press, is accepted by most as the best introduction to Unix for new users. *Systems Management under Unix* is a companion volume for those privileged few who consider themselves system managers. It is intended to be an understandable reference book to sit alongside those cryptic system manuals and steer you in the right direction when problems occur; reading it from cover to cover is a tedious and fruitless task.

The book leads off with a brief description of the history of Unix from its origins in the failure of Multics, through its years with the academics, to its acceptance as a small multi-user business system. It was reassuring to hear the authors express some doubts as to the suitability of Unix for a business environment, and by the end of the first chapter it's made clear that:

- there are better business operating systems but they may not have the applications you need;
- the authors are not blinkered academic Unix gurus; and
- the job of a Unix system manager is not an easy one.

I felt particular empathy with the quote from a toilet wall in a large Unix installation: *'We were promised a pearl, but it turned out to be cultured and there are signs that it might be artificial.'*

The book then continues with 18 chapters that address the majority of situations a Unix system manager might encounter. The emphasis throughout is on the 'management'

of 'business' installations, which is exactly what it should be. In general, the non-technical explanations of the vagaries of Unix were excellent, particularly the chapter on the cryptic, but immensely powerful, Unix filing system. The discussion of the human factors involved, however, was less satisfactory — an area better described in many general management books.

Overall, I found this book a worthy companion to *Unix — the book*; although I feel it would be of more use in the home of a system manager to be read the night before performing any major task.

Graham Wood

## MS-DOS — A Quick Program Reference Guide

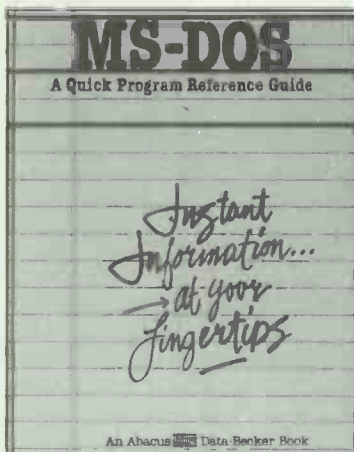

**Author:** J Schieb  
**Publisher:** Abacus Data-Becker  
**Price:** UK price not yet available

The *MS-DOS Program Reference Guide* is intended to be a quick reference tool for knowledgeable MS-DOS users. It is *not* an introductory text and *does* assume some experience of an IBM PC or compatible. As one who has spent considerable time studying the original PC-DOS manual I wondered how much I might discover that I didn't already know; to which the answer proved to be: *nothing*.

*MS-DOS — A Quick Program Reference Guide* provides a list of all the MS-DOS commands in an alphabetical order with instructions that are remarkably similar to the official Microsoft documentation. Other than this there are two chapters on configuring DOS using CONFIG.SYS and batch processing.

I personally find the manuals that come with MS-DOS just as quick and easy to use as this book, and far

more comprehensive. The only justification I can see for buying this very slim volume is to save desk space. Users of portable and laptop computers might also find it handy, but otherwise save your money for something more worthwhile.

Graham Wood

## Mastering DOS Plus

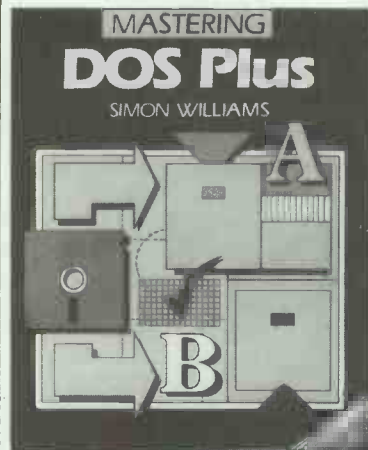

**Author:** Simon Williams  
**Publisher:** Sigma Press  
**Price:** £12.95

DOS Plus is an operating system that will run both MS-DOS and CP/M-86 programs. It was produced by Digital Research (DR) in an attempt to regain a little ground on the most successful 16-bit operating system, MS-DOS. Unlike other DR products, DOS Plus has the advantage of being bundled with the Amstrad PC1512s. *Mastering DOS Plus* is one of the many books that aim to be an alternative to, and more understandable form of, the official manual.

The back cover claims that the book is relevant to the users of a variety of different machines including the IBM PC, the Amstrad PC1512, the BBC Master and the Philips: Yes. Suggesting that the book will be of interest to BBC Master owners is very misleading, as the Master needs an expensive hardware upgrade in order to run DOS Plus. Including the Philips: Yes in the list is also a bit dubious considering that Philips did not actually sell any in the UK.

Simon Williams divides the book into three main sections: a description of the facilities of DOS Plus; an introduction to GEM and Basic2; and a 'quick reference guide to all those tricky problems you're bound to encounter.' I'm sorry to say that all three sections failed to inspire me. The description of DOS Plus offers little that can't be found in the standard documentation and in places I actually found it less comprehensi-

ble. The guide to GEM proved to be yet another DR advertisement hiding under the guise of editorial (if I see that GEM Paint tiger once more . . .). Possibly the most useful section is the trouble-shooting guide which is good but fails to address a lot of important questions such as 'Why do memory resident MS-DOS programs not work under DOS Plus?'

Despite its general title and the claims of the back cover, the real market for this book is given away in an example 'Expert System' written in the DOS Plus batch language. Using the age old example of choosing a micro, this program recommends Amstrad machines for nine of its ten possibilities. *Mastering DOS Plus* is yet another disappointing book attempting to gain a few bucks at the expense of the naive Amstrad PC owner.

Graham Wood

## Liberating Technology

### LIBERATING TECHNOLOGY

*Steps towards a benevolent society*

John Graves

Author: John Graves  
 Publisher: Peter Owen  
 Price: £12.50

There are two prevailing attitudes towards technological innovation: that of the optimists who claim that it will replace dull, repetitive jobs with exciting, new ones; and that of the pessimists who fear for their very livelihoods as jobs are forfeited in the name of 'progress'. Both stances have their adherents, but the fact of the matter is that there is no simple solution to the 'inevitable reality' of increasing unemployment.

John Graves, a lecturer in Economics and Political Thought and author of *Liberating Technology*, does not claim to have any easy answer to this ongoing dilemma. What he does have, though, is his

personal vision of the future: a vision of a world where work is no longer the be-all and end-all of life (and one where only a few people have to do it, anyway), and where man has discovered his lost humanity and lives in harmony with his neighbours (in every sense of the word) in an all-providing society. He urges us to believe in the liberating potential of this radically new technology, and to use it in a positive way: 'the primary purpose of technology is the enhancement of human life, and the production of tools and time necessary for creative, life-affirming activities . . .'. Mr Graves envisages a post-industrial society which is based on a totally new socio-economic framework, within which technology works for us, rather than against us. To date, he argues, this has not been possible as our 'market' economy forces technology to be linked to purely commercial criteria.

But don't get me wrong; *Liberating Technology* is not an attack on the existing Government (although it's clear that Mr Graves did not vote Tory at the Election), but a *cri de coeur* for facing up to a new world. This new world will involve turning current values and practices on their head, and evaluating our 'real' needs for the future.

The book lucidly espouses Mr Graves' doctrines for ridding society of its present day *malaise* (I can almost see his students, fresh with their idealism, meticulously scribbling down all his utterances) as he paints a pretty picture of the automated factory and office, and moves on to present his 'ideal' society by redefining the concept of work, and showing how it will become inextricably linked with 'life-affirming activities' (such as voluntary work, and — feminists will love this bit — getting men back into the household) in the 21st century.

Despite what many will no doubt rebuff as 'pure idealism' and 'Utopia' he *has* done his sums and presents a monetary breakdown of how everyone (irrespective of whether they work or not) will have sufficient for their needs under his 'egalitarian social dividend scheme'.

Perhaps I've been watching too many party political broadcasts of late or I've already been brainwashed by eight years of Thatcherism, but in a world without incentive it seems to me that many jobs would never get done at all. *Liberating Technology* is a thought-provoking book which elucidates many universally felt sentiments, but just like a clever politician Mr Graves seems to evade many of the real issues.

Joanna Murchison

## Basic Computer Adventures

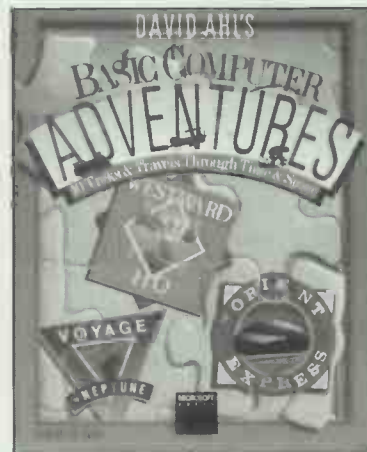

Author: David Ahl  
 Publisher: Microsoft Press  
 Price: £6.95

Ex-PCW West Coast columnist David Ahl is well-qualified to write computer adventure games, having worked with Digital Equipment Corporation and AT&T, as well as having founded the first (now folded) consumer magazine devoted to personal computers, *Creative Computing*. In this book he presents us with ten Basic simulations, ranging from the foot-destroying trek of Marco Polo in 1271, through the pedal-pushing power of the Tour de France and ending with a futuristic journey to the planet Neptune in 2100. Each simulation has five unique parts: an introduction to the game; some historical background; program notes; program variables; and the program listing itself.

The games are primarily of a similar theme — that is: how much fuel/food can you carry/consume in order to reach the destination/pick up the jewels in time. A couple of the games even use similar frameworks, but, in all fairness, the proof of the book is in the pudding, or in the playing so to speak, and not in the reading of program listings. If you enjoy simulation games then I'm sure you'll love it, although I personally would have preferred slightly more variety. A disk containing all the programs is available from the author for those with lazy fingers.

Lorna Kyle

Graham Wood runs a computer consultancy in Cheshunt, Hertfordshire. Lorna Kyle is a systems analyst/programmer for a leading UK retail group. Joanna Murchison is a freelance computer journalist.

Next month: artificial intelligence and expert systems.

END

# SYBEX

## COMPUTER BOOKS NEW TITLES '87

**Programming the 80386**  
John H Crawford,  
Patrick P Gelsinger  
0 89588 381 3  
£24.95



**Wordperfect Desktop Companion**  
Sybex Ready Reference Series  
Greg Harvey and  
Kay Yarborough Nelson  
0 89588 402 X  
£26.95

**The ABC's of Wordperfect**  
Alan R Neibauer  
0 89588 425 9  
£15.95



**Expert dBASE III PLUS**  
Judd Robbins and  
Ken Braly  
0 89588 404 6  
£22.95



**Understanding Postscript Programming**  
Daniel A Holzgang  
0 89588 396 1  
£22.95



**Mastering Appleworks**  
Second Edition  
Elna Tymes  
0 89588 398 8  
£19.95

**Advanced Techniques in Microsoft WORD**  
Alan R Neibauer  
0 89588 416 X  
£19.95

**Understanding Javelin PLUS**  
J R Levine,  
M Levine Young,  
J M Young  
0 89588 358 9  
£19.95

**Advanced Techniques in Turbo Pascal**  
Charles C Edwards  
0 89588 350 3  
£19.95

**Amiga Programmer's Handbook**  
Volume II  
Eugene P Mortimore  
0 89588 384 8  
£24.95

**Turbo Pascal Programs for Scientists and Engineers**  
Alan R Miller  
0 89588 424 0  
£19.95

**Turbo Basic Programming for Scientists and Engineers**  
Alan R Miller  
0 89588 429 1  
£19.95

**Mastering Lotus HAL**  
Mary V Campbell  
0 89588 422 4  
£19.95

**Mastering Supercalc 4**  
Greg Harvey  
0 89588 419 4  
£19.95



**Mastering AutoCAD**  
George Omura  
0 89588 378 3  
£29.95



**Programming the 80286**  
C Viellefond  
0 89588 277 9  
£22.95

Sybex Computer Books from your local bookseller or telephone 0279 29655.  
For a complete catalogue return coupon to Dept. LS2, Longman Group UK Ltd, Longman House,  
Burnt Mill, Harlow, Essex CM20 2JE.

Name

Address



**Longman**

# BUSINESS EFFICIENCY ON A SHOESTRING

"OUR STAND  
NUMBER AT THE  
PCW SHOW IS 3133"



- National and International Telex
- Electronic Mail
- Access to 120,000 Telecom Gold™ and PRESTEL™ users
- Business information including share prices
- Up to the minute worldwide news
- Remote banking and accounts facilities
- Free and discounted business software
- Electronic Yellow Pages
- Company search facility

- PC Technical support
  - Telepurchasing—hotel, rail, air etc.
- MICRONET\* gives you all this and more in one, cost effective, on-line connection. Improve the efficiency of your business. Call Lynne Thomas on 01-278 3143 for your free MICRONET brochure.

\*MICRONET is the trading style of Telemap Ltd an EMAP/BT/Teledirect (Canada) Company.

MICRONET, Durrant House, 8 Herbal Hill, London EC1R 5EJ.  
Telephone 01-278 3143. Please send me a free MICRONET brochure.

Name

Address

Tel.  Age

Micro

**MICRONET**  
MICRONET, Durrant House,  
8 Herbal Hill, London EC1R 5EJ.

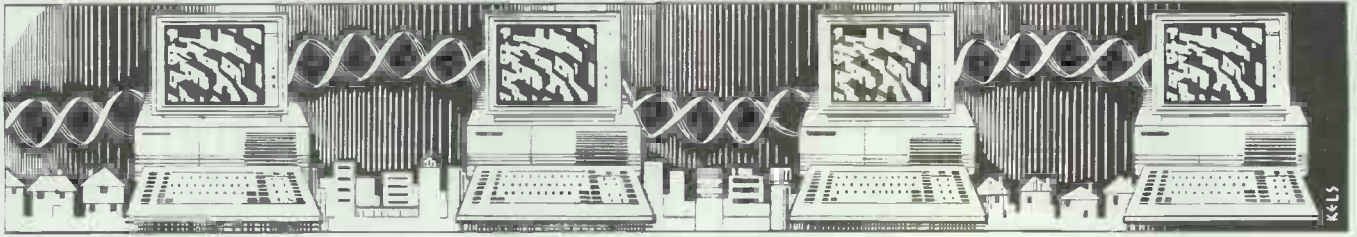

# Microlink live!

*Microlink is a two-year-old online service which boasts European access points and a flexible email system. Peter Tootill logs on to its facilities.*

Microlink was launched in 1985, and rather than working from scratch, it used the messaging services of Telecom Gold as a base and added a number of other features in an attempt to produce a comprehensive online service. The nature and quantity of those extra features are fairly dynamic, so it's time to find out how Microlink stands after two years' trading.

There are now 7500 Microlink subscribers, and the addition of access points in Europe on the Comshare network (Ian McNaught Davis's company) has attracted a number of European subscribers (for comparison, Micronet has around 20,000 members).

## Electronic mail

Before looking at the 'extras' that Microlink provides, I'll outline the basic services available to any Telecom Gold subscriber. The main one is, of course, electronic mail (known as email for short).

Microlink's electronic mail is a flexible system with all the usual features including advice of receipt, multiple addresses, personal directories and automatic addressing of replies. A batch of messages can be prepared offline and uploaded in one file, even if they are going to different people.

Telecom Gold is just one point on a global email network called Dialcom. The two-digit number that precedes your mailbox number identifies which computer on the network holds your mailbox's contents. UK systems use numbers 72,81,82 and 83, among others.

It is as easy to send a message to a Dialcom subscriber in, say, Canada, as it is to send one to a Gold subscriber in the UK, and costs are economical. Just make sure that you specify the correct computer number on the front of the mailbox; if you don't, or you get the number wrong, the message is returned, undelivered, to your mailbox.

This method, it is generally agreed, is insane. According to the way in which Dialcom is arranged, it is impossible for two systems on the network to have a mailbox with the same name and number, so there's no reason why the user should have

to know which system the message is to go to — Dialcom should work this out for itself.

It is even more aggravating when Gold moves a batch of mailboxes from one computer system to another (which *does* happen). You have to inform your correspondents, or their messages to you will be returned.

Gold users can also send and receive telexes, which is a big incentive for many small businesses who would not otherwise be able to justify the cost of a dedicated telex terminal.

An interesting recent development is the Gold 400 service, which is an implementation of a new international X.400 standard that allows messages to be transferred between electronic mail systems. The impact of this service will depend on how quickly it is implemented by other email systems.

## Services

A number of other services are also provided by Gold to all subscribers and, in some cases, these are run on the system by other organisations. For example, there is a 'World of Lotus' for users of Lotus 1-2-3; general and company news with sys-

### Main menu

BB .... Bulletin Board  
 BR .... British Rail  
 EE .... Electronic Mail  
 EG .... Exhibition Guide  
 FL .... FloraLink  
 GG .... Telecom Gold  
 GT .... Golden Tips  
 GU .... Gold Users Entry  
 GW .... Gateways from MicroLink  
 LL .... List of Bulletin Boards  
 MM .... Microlink Menu  
 NB .... NewsBytes  
 NL .... Microlink Newsletter  
 PP .... MemoPad  
 RR .... Press Reviews  
 SW .... Shop Window  
 TM .... Telemessages  
 TT .... Telex  
 UU .... User Guide  
 WL .... WeatherLink  
 WW .... Who's Who in Microcomputing  
 XX .... TeleSoftware

### Some systems available on Telecom Gold

<b>AIMS</b>	Info on Government and EEC grants for UK businesses
<b>BACS</b>	Bankers Automated Clearing Services pilot scheme
<b>BBC</b>	BBC <i>Micro Live</i> Fact Sheets
<b>DS</b>	DATASOLVE news and information database
<b>FINTECH</b>	FinTech on Gold — Financial Times service on technology
<b>GAMES</b>	Computer games: Lunar Lander, adventures, and so on
<b>IDB</b>	Infomatics Daily Bulletin (info on the computer industry)
<b>INFOCHECK</b>	Companies House info and interpretation
<b>JORDANS</b>	Companies House info with extensive detail on large companies
<b>LOTUS</b>	World of Lotus
<b>OAG</b>	Official Airline Guide
<b>PEM</b>	Petroleum Monitor — daily info on North Sea oil and gas
<b>TEXTNET</b>	Translation, typesetting and other text-related services

tems such as Datasolve (including World Reporter) and Fintech; and, of course, PCW publisher VNU's own IDB — the Infomatics Daily Bulletin — that is a daily news digest of computer and information technology news. It occupies about 20k and can be read, scanned and searched using keywords.

Unfortunately, you have to pay extra charges to use these services, and some are quite steep: Infocheck costs £2.50/min and World of Lotus a mere 5p/min. All these costs are on top of normal Gold charges (and exclude VAT).

### **Microlink extras**

What do you get if you join Microlink? Apart from all the aforementioned facilities, there are a number of services aimed primarily at the domestic user. There are no online multi-user games or conferencing facilities, but there is a bulletin board-type message area; it isn't as flexible as the average Fido or TBBS system, but neither is it engaged as often.

Floralink allows you to send flowers via Interflora; and Press Reviews is a summary of the contents of some of the current micro magazines. The British Rail area only covers services to and from London (although Microlink plans to introduce a comprehensive weekend break feature) and the Exhibition Guide gives details of forthcoming exhibitions. NewsBytes is a weekly computer news magazine; and Shop Window is an area for advertisers which features price lists of computer-related items.

The Telesoftware section currently only covers home micros such as the BBC, the Amstrad CPC and Apple machines. The software has to be in ASCII format which severely restricts the type and length of program that can be provided. Microlink informs me that it now has Kermit file transfer protocols available and is busy adding software for IBM and Atari ST systems. Xmodem protocols should also be available later this year.

Also of interest on Microlink are 'gateways', which are routes to other systems that can be used via Microlink.

There's also a one-way gateway which allows Micronet users to send messages to Telecom Gold subscribers. Contact Micronet for details.

### **Costs**

Joining Telecom Gold direct costs £40 (excluding VAT), but it's cheaper to join through a user group or other system. Joining through Microlink costs £5 and Micronet subscribers who want to use the gateway can register free of charge.

Time charges for Gold are 11p/min during the day and 3.5p/min between

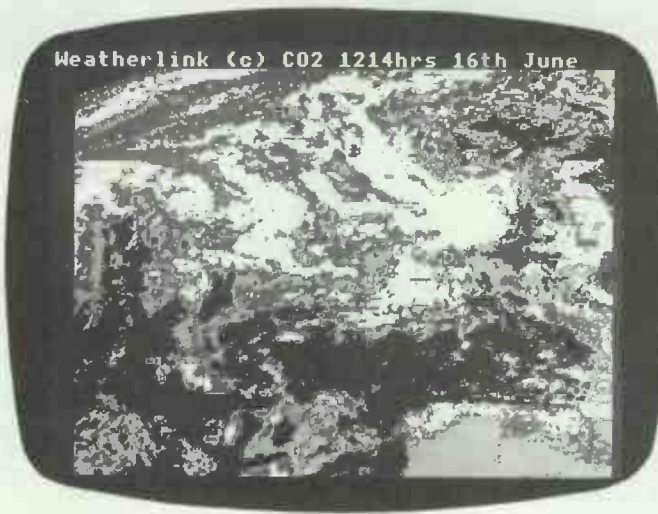

*Microlink's comprehensive services include the facility to download satellite information about the weather*

7pm and 8am weekdays, plus all day Saturday, Sunday and Bank Holidays. If you don't live in the London local call area, there is an extra charge for using PSS to access the system. This is 2.5p/min at 300 bits/sec and 3p/min at 1200 (including 1200/75).

Using Gold from Micronet is cheaper as there is only a 1p/min gateway surcharge on top of normal Telecom Gold charges — there is no PSS access charge.

On top of the time charges there are storage charges at 20p per 2k unit per month. You need three or four files to run your mailbox effectively, so that can add another £1 a month to the bill. There are no additional charges for sending messages in the UK. Overseas messages cost 20–30p for each 2k block, and telex charges are on a sliding scale and rates depend on destinations. For example, for each 100 characters, a telex sent within the UK costs 5.5p and to the US, 18p. Telexes can even be sent to ships via Inmarsat, at a cost of £2.75 per 400 characters. Incoming telexes are free. If you have a radio pager, you can arrange to be 'bleeped' when a message arrives in your mailbox (this is free).

Microlink charges a flat-rate subscription of £3 a month on top of the normal Gold charges — there are no additional charges, except for the special gateways. If you are a bulletin board addict, used to calling long-distance to your favourite systems, then Microlink via PSS costs about the same.

The documentation provided when you join the system is somewhat superficial, but there are online help files (although you do have to pay to read them).

### **Conclusion**

If you want to send messages to other people who use Telecom Gold, then Microlink is a very useful service. Currently it is the biggest by far of the UK electronic mail companies, with around 76,000 subscribers — the worldwide Dialcom network has

a quarter of a million subscribers. However, the costs can be rather expensive. Gold has recently dropped the £10 minimum monthly charge, but I suspect that few regular users will see any real benefit. For business users £10 is not a lot of money, but for home users Prestel offers many more facilities at considerably less cost, especially as Micronet users can also access Telecom Gold. (Gold's messaging system is streets ahead of Prestel's and much more appropriate for the serious user.) If you have a viewdata terminal you cannot use Telecom Gold directly: you have to use it via a Prestel gateway such as Micronet's Interlink.

On the minus side the Microlink system tends to be slow, with pauses of several seconds not uncommon. Microlink informs me that it is currently rewriting all the software, and this should result in a dramatic improvement in speed.

### **Telecom Gold charges shock**

Just as this column went to press, Telecom Gold announced a change to its price structure. The net effect will be a significant increase in charges for those calling with V23 and V22 modems. The effect will be especially felt by those who use the system efficiently — that is, they log on to briefly collect messages and then prepare replies offline.

See this month's Newsprint for more details.

### **How to join**

Microlink is on (061) 456 8383. You can join Telecom Gold direct by calling (01) 403 6777 and asking for an information pack. You can also join Gold through a number of other organisations and user groups, but you will probably already be aware of Microlink if you are in contact with one of these. Micronet subscribers can obtain online information by typing \*INTERLINK#.

You can contact Peter Tootill electronically on: Fidonet node 511/71, Telecom Gold 83:VNU202, Prestel 219991119, or CompuServe 72746.3202.

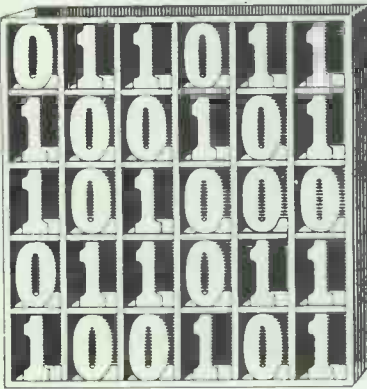

*David Barrow presents more machine code routines and information for assembly language programmers. All helpful programming hints and short, useful new routines are welcome, as are improvements to or conversions of those already printed. Submissions must be printed or typed clearly and be documented to the SubSet standard, although documentation may be amended for publication. Send your contributions to SubSet, PCW, 32-34 Broadwick Street, London W1A 2HG.*

## 8080 or Z80?

Dave Nicholls of Dartford suggests that although most 8080 programs will run without error on a Z80 system, some will not.

One minor problem is that there are slight timing differences between some instructions that are otherwise identical. For example, the 8080 instruction 'OUT port' (code D3 nn)

takes 10 T-states; but the same instruction in Z80, 'OUT (port), A' (code D3 nn) takes 11 T-states.

A more serious difficulty is that bit 2 of the flags register, F, is always a parity flag in the 8080 but has the double use of parity for logic operations and overflow for arithmetic operations in the Z80. Thus 8080 programs which rely on parity checking after an arithmetic operation cannot be run on a Z80 system.

```

;=====
PCHECK SUB  A          ;A - A = 0. This resets the      97
;overflow (=parity) flag on
;the Z80 but sets the parity
;flag on the 8080.
;skip if P(/V) flag reset.      E2 XX XX
;
; JPO  Z80
;
; 8080          ;put "processor is 8080" message here.
; Z80          ;put "processor is Z80" message here.
;=====
    
```

Fig 1

The parity/overflow discrepancy can be used to check which processor is running a program and abort

if necessary. Include the code in Fig 1 at the start of any sensitive program and you should have no trouble.

## CP/M links

Dave Nicholls has also submitted details of the CP/M linkage editor he uses. This is a Microsoft-compatible linker called ProLink by NightOwl Software and is apparently free, being licensed for non-commercial use and distribution. Dave found the linker on the MBBS Leconfield bulletin board.

ProLink supports batch execution, module placement, symbol file control, patching and automatic library search as well as normal linkage.

Dave also recommends

using a very powerful public domain macro assembler of unknown origin called ZASM. This supports conditional assembly nesting to eight levels, macro nesting to eight levels and file nesting to four levels.

If you don't have a modem for accessing the free software to be found on bulletin boards but wish to try these utilities, Dave has offered to supply both of them along with a useful public domain screen editor free of charge. Send any formatted 3in or 5¼in disk or IBM 8in single-sided disk, full format details and an *sae* to Dave Nicholls, 18 Morgan Drive, Stone, Dartford, Kent DA9 9DT.

## Batcher's short

BATCHZ, from John Kerr of Glasgow, is the only datasheet sent in response to January's request for a sequential implementation of Batcher's parallel sort method.

The algorithm, given in volume three of Knuth's *The Art of Computer Programming*, works on record numbers and requires seven variables. John's routine manipulates record or record key addresses and has no less than eleven

variables — far more than the Z80's available registers. This has made it necessary to store variables on stack and access them by (SP) exchanges and stack indexing. John has also changed the inner section of the algorithm since that given in Knuth cannot deal with addresses.

The two sample comparison routines submitted by John will be published next month, along with a discussion of the differences between the parallel method described by Knuth and John's sequential algorithm.

## DATASHEET 1

```

;=====
;BATCHZ Merge exchange sort based on Batcher's algorithm.
;ASORTZ Ascending order entry into BATCHZ.
;DSORTZ Descending order entry into BATCHZ.
;=====
    
```

### STRUCTURAL CONCEPTS

```

;DATA
;KEYFILE: Simple in-RAM list of same type record keys to be
;sorted into ascending or descending order of
;record. Sort comparison may be on key or record
;value depending on data type & compare routine.
;KEY: Fixed length number or descriptor corresponding
;to a single record. May be same as record.
;RECORD: Unknown, possibly variable length value.
    
```

```

;PROGRAM
n = no. of keys. f = 1st key addr. x = data type.
s <- key length (x).
CMP??? <- comparison operation (x).
g <- f + s * (n - 1).
m <- s * 2 ^ INT (LOG2 (n - 1)).
p <- m.
WHILE p >= s
{
  r <- 0; d <- p; q <- m.
  REPEAT UNTIL q < p
  {
    
```

```

      r <- r + f; d <- d + r.
      WHILE d <= g
      {
        t <- LEAST (g, (d - s + p)).
        WHILE d <= t
        {
          CMP??? record (r), record (d).
          IF compareflag = SET THEN
          {
            SWAP key (r), key (d).
          }
          r <- r + s; d <- d + s.
        }
        r <- r + p; d <- d + p.
      }
    
```

```

      }
      r <- p; d <- q - p; q <- q \ 2.
    }
  }
  p <- p \ 2.
}
    
```

### SYSTEM REQUIREMENTS

```

;PROCESSOR Z80
;HARDWARE RAM containing keyfile.
;SOFTWARE "CMP???" - comparison routines for all data types
Input: B = 0, C = key length,
DK & HL address 1st bytes of two keys.
Output: Entry at CMP??? (descending order):
Cy = 1 if record (HL) > record (DE);
Entry at CMP??? + 1 (ascending order):
Cy = 1 if record (DE) > record (HL).
    
```

### PROGRAM DETAILS

```

;INPUT Cy=1 (or entry at ASORTZ): ascending order sort.
Cy=0 (or entry at DSORTZ): descending order sort.
A = x (data type index (0 - 255), not greater
    
```

```

; than maximum index at (VECTBL)).
; DE = n (number of keys in keyfile).
; HL = f (1st byte of first key).
; OUTPUT
; Cy=0: keyfile sorted into required order.
; Cy=1: sort not performed because of non
; implemented data type, file > 64K, file
; less than 2 keys or memory wraparound.
; STATE CHANGES AF BC DE HL changed.
; I/O ERRORS None.
; OPTIMISATION Use of known Cy status & 0's left in registers.
; INTERRUPTS May be interrupted and re-entered only if
; "CMP???" can be interrupted and re-entered.
; LOCATION NEED Contains absolute address references. PROMable.
; PROGRAM BYTES 227 + VECTBL size (3 bytes per data type + 1).
; STACK BYTES 22 + "CMP???" stack use.
; TIMING To sort randomly generated file into ascending
; order (clock frequency 4 MHz, no interrupts) -
; 1,000 strings of length 0-30: 5 secs.
; 10,000 2-byte signed integers: 1 min 4 secs.
;=====  

; APPLICATION NOTES  

; KEY SORTING The program section which swaps keys can be
; bypassed to allow sorting of complete records or
; other subfields. In this case CMP??? must perform
; the exchange when necessary and return Cy=0.
; LARGE FILES Large random access files may also be sorted by
; assigning a data type index with key size 1.
; Call BATCHZ with DE = n, HL = 1. BATCHZ will work
; on record numbers. CMP??? must read from disk and
; compare records numbered DE & HL, write the
; records back in reverse order if necessary and
; return Cy=0 to bypass BATCHZ's swap code.
;=====  

ASORTZ SCF ;Set Cy for ascending order. 37
JR BATCHZ ; 18 01
DSORTZ CP A ;Clear Cy for descending order BF
;=====  

BATCHZ PUSH HL ;Get start-of-file (f) in IX, E5
EX (SP),IX ;saving original IX on stack. DD E3
PUSH DE ;Save number of keys in file (n). D5
LD D,0 ;DE <-- data type index, x. 16 00
LD E,A ; 5F
LD HL,VECTBL;HL <-- table base 21 XX XX
LD A,(HL) ;A <-- max type index 7E
INC HL ;HL = 1st type length 23
PUSH AF ;Save sort order flag (Cy) F5
ADD HL,DE ;Add data type index * entry 19
ADD HL,DE ;length to base, getting 19
ADD HL,DE ;(HL) = data type length. 19
POP AF ;Restore sort order flag. F1
LD C,(HL) ;C <-- length byte (s) 4E
INC HL ;address CMP??? vector 23
LD B,(HL) ;"LD HL,(HL)" to get 46
INC HL ;CMP??? vector (descending) 23
LD H,(HL) ;order comparison entry address) 66
LD L,B ;in HL. 68
JR NC,NOBUMP;Skip if descending, else bump 30 01
INC HL ;vector for ascending entry. 23
;=====  

NOBUMP EX (SP),HL ;HL <-- number of keys (n). E3
EX (SP),IY ;(SP) <-- IY, IY <-- vector. FD E3
LD B,D ;Clear B, BC = data length (s) 42
PUSH BC ;save as initial value of m. C5
CP E ;If input data type index > max BB
JR C,GIVEUP ;then exit, Cy set. 38 28
;=====  

LD A,16 ;Compute g: count 16 bits 3E 10
LD E,D ;Clear DE as initial product (g) 5A
DEC HL ;Hl = n - 1. 2B
;=====  

JUSTFY ADD HL,HL ;Find ms-bit of n. If ms-bit 29
JR C,MSTART ;appears, skip out to multiply 38 0E
DEC A ;else loop until ms-bit or 3D
JR NZ,JUSTFY;count out with no ms-bit. 20 FA
SCF ;no ms-bit, n was = 1, so 37
JR GIVEUP ;exit, Cy set. 18 1B
;=====  

MLTPLY ADD HL,HL ;mul loop: shift left product 29
JR C,GIVEUP ;exit, Cy set if overflow. 38 18
EX (SP),HL ;access m and shift it left too E3
ADD HL,HL ;to compute m = s*2*int(lg(n-1)) 29
EX (SP),HL ;restack m, restore g E3
EX DE,HL ;access multiplier (n-1) to get EB
ADD HL,HL ;next multiplier bit to Cy 29
;=====  

MSTART EX DE,HL ;(mul entry) HL = product (g) EB
JR NC,MCOUNT;skip if no add in this bit place 30 03
ADD HL,BC ;else add in s 09
JR C,GIVEUP ;exit, Cy set if overflow. 38 0D
;=====  

MCOUNT DEC A ;Repeat for 16-bit product 3D
JR NZ,MLTPLY;HL = g = s * n-1. 20 EF
;=====  

PUSH IX ;copy start-of-file (f) DD E5
POP DE ;to DE and add to HL to complete D1
ADD HL,DE ;HL = g = f + (s * n-1). D9
JR C,GIVEUP ;Exit, Cy set if overflow. 38 04
PUSH HL ;Save g while checking if E5
DEC HL ;the last key straddles 2B
ADD HL,BC ;the 0FFFFH to 0000H memory 09
POP HL ;boundary. E1
;=====  

GIVEUP JP C,NOSORT ;Exit, no sort if Cy = 1. DA IX XX
LD A,C ;A = s 79
POP BC ;BC = initial p from stacked m C1
PUSH BC ; C5
;=====  

FULSCN POP DE ;get m to reset q D1
PUSH DE ;re-save m D5
PUSH DE ;(SP) = q <-- m D5
LD DE,0 ;DE = r <-- 0 11 00 00
PUSH BC ;(SP) = d <-- p C5
EX (SP),HL ;Hl = d, (SP) = g E3
;=====  

SUBSCN PUSH IX ;Copy f to HL while DD E5
EX (SP),HL ;saving d on stack to compute E3
ADD HL,DE ;r <-- r + f 19
EX DE,HL ;in DE EB
POP HL ;HL = d again E1
ADD HL,DE ;HL = d <-- d + r. 19
;=====  

JOBLOT PUSH BC ;Stack p, d, r. C5
PUSH HL ; E5

```

```

PUSH DE ; D5
LD D,0 ;Compute address limit for this 16 00
LD E,A ;set of comparisons; this is 5F
SBC HL,DE ;either the address of the last ED 52
EX DE,HL ;key, g, or else d-s+p, EB
LD L,6 ;whichever is the lesser. g is 2E 06
ADD HL,SP ;buried on stack so point 39
EX DE,HL ;HL to it. EB
ADD HL,BC ;t <-- (d-s) + p 09
EX DE,HL ;in DE. EB
LD C,(HL) ;"LD HL,(HL)" to get g. 4E
INC HL ; 23
LD H,(HL) ; 66
LD L,C ;HL = g. 69
JR C,BEYOND ;computed t wraps, HL = t <-- g. 38 06
SBC HL,DE ; If t < g ED 52
ADD HL,DE ; then use t = g. 19
JR C,BEYOND ; else use t = d - s + p. 38 01
EX DE,HL ; D5
;=====  

BEYOND POP DE ;DE = r D1
EX (SP),HL ;HL = d, (SP) = t E3
LD B,0 ;BC = s (key size) 06 00
LD C,A ; 4F
;=====  

ONEJOB PUSH BC ;Save s, r, d (key size, lower C5
PUSH DE ;and higher pointers). D5
PUSH HL ; E5
CALL JUMPIY ;Call CMP???, compare records r,d CD XX XX
POP DE ;Restore d, r, s, with pointers D1
POP HL ;reversed (HL = lower pointer r). E1
POP BC ; C1
JR NC,NOSWAP;CMP??? said don't swap. 30 10
;=====  

EI DE,HL ;Swap: set higher pointer at EB
ADD HL,BC ;key length + 1. 09
EX DE,HL ; 2B
ADD HL,BC ;Set lower at key length + 1. 09
PUSH BC ;Save s. C5
LD B,C ;B = s for swap count. 41
DEC DE ;Swap loop: Index next bytes 1B
DEC HL ; 2B
LD A,(DE) ;exchange key bytes 1A
LD C,(HL) ; 7E
LD (HL),A ; 44
LD A,C ; 79
LD (DE),A ; 12
DJNZ EXDR ;repeat for s bytes, leaving r, d 10 F7
POP BC ;as before swap. Restore BC = s. C1
;=====  

NOSWAP ADD HL,BC ;Bump r <-- r + s, and save 09
EX (SP),HL ;while getting limit t E3
SBC HL,DE ;to check if pre-bump d = t ED 52
ADD HL,DE ;(SBC sets Z, unchanged by ADD) 19
EX (SP),HL ;re-save t, restore r E3
EX DE,HL ;to DE, HL = d EB
ADD HL,BC ;bump d <-- d + s. 09
JR NZ,ONEJOB;Repeat compares until d > t. 20 DB
;=====  

LD A,C ;Restore A = s. 79
POP BC ;Discard t and restore BC = p. C1
POP BC ;If last bump d <-- d + s wrapped C1
JR C,MEMRAP ;past 0FFFFH, subscan complete. 38 0F
EX DE,HL ;bump r <-- r + p. EB
ADD HL,BC ; 09
EX DE,HL ; EB
ADD HL,BC ;bump d <-- d + p. Again, subscan 09
JR C,MEMRAP ;finished if d wraps. 38 09
EX DE,HL ;Final check; DE = d EB
EX (SP),HL ;HL = g (last key) E3
SBC HL,DE ;check if d > g ED 52
ADD HL,DE ; 19
EX (SP),HL ;restore (SP) = g, E3
EX DE,HL ;DE = r & HL = d EB
JR NC,JOBLOT;continue subscan if d <= g. 30 A7
;=====  

MEMRAP POP DE ;End of subscan; DE = g D1
POP HL ;HL = q E1
CP A ;clear Cy and BF
SBC HL,BC ;compare q, p ED 42
ADD HL,BC ; 09
JR Z,SCNEND ;If q = p, scan ends 28 0D
PUSH HL ;else save value of q E5
SRL H ;q <-- q \ 2 CB 3C
RR L ; CB 1D
EX (SP),HL ;(SP) = new q, HL = old q E3
SBC HL,BC ;HL = d <-- q - p ED 42
PUSH DE ;(SP) = g again D5
LD D,B ;DE = r <-- p 50
LD E,C ; 59
JR SUBSCN ;Go do another subscan. 18 8B
SCNEND EX DE,HL ;HL = g. EB
LD E,C ;E = old p. 59
SRL B ;BC = p <-- p \ 2. CB 38
RR C ; CB 19
CP E ;If old p > s then go do another BB
JF NZ,FULSCN;scan else exit with Cy=0. C2 XX XX
;=====  

NOSORT POP HL ;Discard m, E1
POP IY ;restore saved index registers FD E1
POP IX ; DD E1
RET ;Exit BATCHZ with Cy=0 if sorted. C9
;=====  

JUMPIY JP (IY) ;Transfer control to CMP???. FD E9
;=====  

; CMP??? vector table for particular applications of BATCHZ.
; 1st byte gives maximum data type (one less than number of
; entries in VECTBL).
; Remainder of table consists of 3-byte entries, one for each
; data type:
; 1st byte: key length in bytes.
; 2nd, 3rd bytes: address of associated comparison routine.
; CMPSTR & CMPINT are sample comparison routines.
;=====  

VECTBL DEFB 1 ;Maximum data type index. 01
;=====  





DEFB 3 ;Data type 0: keys sorted are 03
DEFW CMPSTR ;3-byte descriptors of strings. XX XX
;=====  

DEFB 2 ;Data type 1: keys sorted are 02
DEFW CMPINT ;2-byte signed integers. XX XX
;=====  

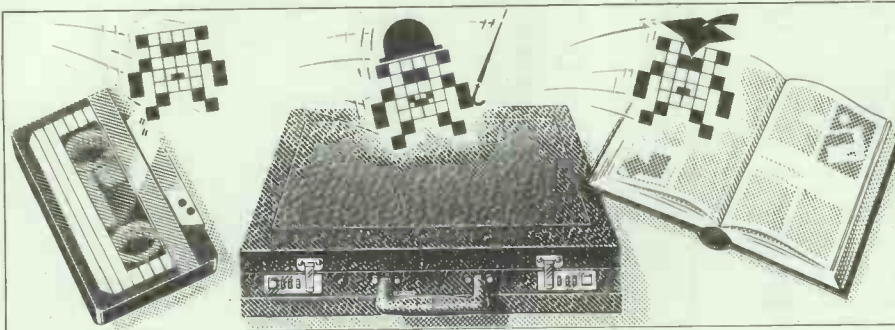
```

# PROGRAM FILE



-  Games
-  Scientific/mathematic
-  Business
-  Toolkit/utilities
-  Educational/Computer Aided Learning

## All change!

*Perceptive readers have spotted some inconsistencies in the algorithms which have been featured recently. Owen Linderholm presents the changes, along with this month's program selection.*

Despite my recent requests, I haven't received any good-quality algorithm submissions from PCW readers for inclusion in my introductory feature each month. Why not get writing and earn a bit of money? Any algorithms featured in Program File will be paid for at our usual rates (see box on this page). Remember that the algorithm itself will require plenty of explanation, so include up to 1000 words as documentation — plus diagrams, if possible.

I have had some correspondence regarding algorithms, however. Many people have been a little confused about some of the programs that include subroutines which are not used by the main program. These subroutines are included as

examples: although they are not used by the program to demonstrate the algorithm, they are working and useful routines.

### Eagle eyes

A sharp-eyed reader has spotted the errors I made in the addition and subtraction routines in the July issue; so sharp, in fact, that he spotted the 'deliberate' mistake I had left in *after* the corrections. However, he missed one of the little gremlins! Full marks to Keith Holmes for his detective work and for having the courage to try out the program in the first place.

Here is the one other change to make to the program besides those given in the August issue. Line 4090

should be changed to read:

```
4090 IF C<>1 THEN RETURN.
```

Other readers have been just as eagle-eyed about some of the reader programs published recently. Two people wrote in about Mads Dam-Larsen's tip on converting Roman numbers to decimal and vice versa (PCW, June). John Paton and Andrew Simpson sent in a few corrections — amazingly, they sent in almost exactly the *same* corrections. Andrew's observations were very slightly better, so here they are:

● Line 103: Add :IF A=0 THEN 105 at the end of the line.

● Change line 106 to:

```
106 DATA DCCCC, CM, CCCC, CD, LXXXX, XC, XXXX, XL, VIII, IX, III, IV)
```

● Change line 107 to:

```
107 FOR N=1 TO 6: READ A$,B$:Q = INSTR (R$,A$)
```

● Change line 108 to:

```
108 IF Q THEN R$=LEFT$(R$,Q-1) + B$+MID$(R$,Q+LEN(A$))
```

Finally, Dave Swinburn found the output of the BBC/QL Solitaire program (Program of the Month, PCW June) rather confusing in that the board was only displayed when traversing *down* the tree of possible moves; no intermediate states are displayed. Although this does not affect the way in which the program finds solutions, it could be confusing.

The following changes will cause the program to display all the moves and states checked. Note that this will take longer.

```
765 olddep%=dep%
```

```
840 IF sol%=0 AND olddep%-1=dep% THEN VDU 7:
```

PCW is interested in programs written in any of the major programming languages for all home and small business micros. When submitting programs please include a cassette or disk version of your program, brief but comprehensive documentation, and a listing on plain white paper — typed if you have no printer. Please ensure that the software itself, the documentation and the listing are all marked with your name, address, program title, machine (along with any minimum requirements) and — if possible — a daytime phone number.

Check through the previous Program Files to see the kind of programs we prefer. As a rough guide, original ideas are always welcome, as are good implementations of utilities and applications. Obviously the programs should be well-written, easy to understand, and preferably not too long (remember that other readers have to type them in). All programs should be fully debugged and your own original, unpublished work. We prefer to receive programs with a maximum 80-column width printed in emphasised typeface. If possible, please include printed sample output.

We will try to return submissions if they are accompanied by a stamped, addressed envelope of the appropriate size, but please keep a copy of everything. Programs are paid for at the rate of £50 per page of published listing, plus a £50 bonus for the Program of the Month.

Send your contributions to Owen Linderholm, Program File, PCW, 32-34 Broadwick Street, London W1A 2HG.



PROCboardplot (lx%,by%,  
rx%,ty%)

841 IF dirc%<4 GOTO 760

## This month's programs

The Program of the Month is a very useful utility for hard-disk MS-DOS computers. The program is written in standard Microsoft Basic (GW-Basic or BasicA) and can be compiled by a compiler such as Microsoft's Quick-Basic.

The program is a menu and manager system for file access, which allows you to run all and any of your programs on a hard disk from a menu. Some file utilities are also provided and you can drop out to DOS and return to the menus again. Also provided is password protection so that you can keep unauthorised users out of your computer when you aren't at your desk.

Unidraw has been written in Amiga Basic for any Amiga with at least 512k of memory.

There's also a tip for the Apricot which enables you to attach a colour monitor to it; and a suite of programs for the Psion Organiser.

## Program of the Month MS-DOS Basic XT Manager by Richard Jones

XT Manager is a hard-disk menu program that was developed in order to make the loading of programs from hard disk an easier task, and which contains some useful facilities. There is a password protection 'lock': when you are at a menu page and want to leave the computer, no-one can use XT Manager unless they know the password. When the correct password has been input, the current menu page is re-displayed.

There is a floppy disk file where an up-to-date record of all your floppy disks can be kept. An extra use for this file is if the user wants to copy a certain disk to hard disk: the search option can be specified and, if found, the disk(s) matching the specified criteria can be shown. Then, another option can be chosen to copy a disk in drive A: to a specified directory of drive C:.

Another useful feature is the DOS utility menu where the user can specify DOS routines and save them for use in the future — such as running a CHKDSK of A: or B:, for example.

There is also a command by which the user can SHELL to DOS. This means 'pop' back to DOS to do a short task, such as send the directory to the printer; and, on typing EXIT and <Return> at the DOS prompt, the XT Manager program reappears.

There are 10 menu pages within the program, each holding 60 entries. Up to 600 programs can be held in a file, which should be sufficient for most applications.

### Hardware required

- IBM PC/XT or compatible (XT Manager was written on a Ferranti PC/XT)
  - One floppy disk drive (A:)
  - One Winchester hard disk (C:)
  - One colour or mono monitor (if a mono monitor is used it is advisable to alter some of the colours, otherwise the highlighting of menu options may not be apparent)
  - At least 64k RAM
- (Note: This program runs well after compilation with MS QuickBasic, but more memory is needed for this.)

### Loading up

After booting up on drive C, change to the directory containing all the XT Manager files by typing CD\XTMAN. To load XT Manager, a batch file is used; type X.BAT.

The first menu now appears. From here, you can configure XT Manager (a good idea once you have got the hang of using it), exit back to DOS, or load the menu.

### The main menu

On loading, menu page one will appear (as indicated at the top right of the screen). To select a program to run from this page, move the arrow around the screen with the cursor keys until it points to the program you want to run. If, on pressing the cursor keys, nothing happens, press [NumLock] and try again. If nothing happens *still*, check that you have typed in the program correctly. With the arrow pointing at the program you wish to run, press Enter/Return and it will load. Note that if you press Enter at a vacant space on the menu nothing will happen, as the program will have detected that there is no specified program at this position.

To change to another menu page, press '+' and a window will appear. Here, another page can be selected by highlighting the required page number and pressing Enter.

To lock the program while you leave the computer, press L. To return to the menu page, type in the password. As you type, a marker character will be shown on the screen rather than the letters being typed. This prevents casual users seeing your password.

To select the floppy disk file, press 'F' and a window will appear at the top left of the screen. To select an option, press its first letter. To return to the menu page operations, press [Esc] and the floppy disk window will disappear.

The colour of the programs on-screen can be altered, and is done by pressing 'C'. A window pops up

showing the colours available. Move the cursor up or down and select a colour; that colour will be used every time XT Manager is run until you change it once again.

Pressing 'A' shows a different screen. This is used when you want to copy the contents of a disk in drive A: to the root or a sub-directory on C:.

Pressing [TAB] accesses the editor screen.

### The Edit option

**Edit** Invokes the menu page editor.

**Quit-NO SAVE** Returns to the current page menu with no changes made.

**Quit-SAVE** Saves changes and returns to the current page menu.

**Help** Shows a general Help screen.

**Delete an entry** Delete an entry from the current page menu.

**Configure** Allows configuration of menu titles, pages and password (can also be accessed from the initial load-up screen).

Whereas the other options are straightforward enough, 'Edit' has to be explained. When this option is chosen, a coloured block of 10 lines appears and it is here that you type any loading specifications needed for the program. These loading operations should be entered in order, one per line, as this information is directly written to a batch file if the program is selected. This batch file, XTEEXEC.BAT, is then executed. Move the cursor arrow up and down using the up-& down cursor keys (remember [NumLock] if nothing happens). To choose a place to type in a loading command, press Return/Enter. Type in the command. Press Return/Enter. Continue until all the loading details have been entered. When satisfied, press [TAB] and the Editor menu will reappear. In order to save this addition to the current page menu, select the 'Quit-SAVE' option.

### Basic version used

When I wrote this program, I wrote it in MS GW-Basic 3.10 running under MS-DOS 3.1. To shorten typing, I've renamed GW-Basic as GW.EXE. So, in the batch file X.BAT, at the point where GW MAN2.BAS appears, replace 'GW' with whatever your Basic name is: for example, BASIC MAN2.BAS, BASICA MAN2.BAS or GWBASIC MAN2.

Remember that it is vital to load XT Manager from DOS by typing X and *not* by jumping straight in and typing GW MAN2 yourself. The program should be regularly saved while being typed in and it should always be saved before trial running. Unless the program is completely finished and saved before you try to run it, you will be returned to DOS and any new XT Manager program instructions will be lost.

The main program listing contains box-drawing characters for single-

# PROGRAM FILE

line boxes; these can be changed to double-line boxes if preferred. To enter the special characters, you may have to check the necessary ASCII values for your machine.

One other point to remember: your

copy of Basic should be in the same directory as the XT Manager batch files. You should create a directory XTMAN for all the XT Manager files and copy Basic into this.

You will also have to type in and

run the following Basic programs to create the data and batch files that XT Manager needs.

The programs themselves need not be saved (apart from the main program, of course).

## MS-DOS XT Manager file creation

The following details regard the creation of the other files that XT MANAGER needs in order to run correctly.

### COLOUR.DAT

Create this with the following:

```
10 OPEN "O", #1, "COLOUR.DAT"
20 PRINT #1, C
30 CLOSE
```

### DOS.DAT

This contains information used in the DOS CUSTOM command. To create a dummy file, type the following:

```
10 FS="DIR A:"
15 OP1="ECHO INSERT DISK INTO A:" OP2="PAUSE"
20 OP3="DIR A:/P:" OP4="ECHO OK." OP5="ECHO RETURNING TO XT-MAN"
30 OPEN "O", #1, "DOS.DAT"
40 WRITE #1, FS, OP1, OP2, OP3, OP4, OP5
50 CLOSE
```

### FLOPPY.DAT

This file contains information regarding the filing of floppy disks. A dummy file must first be created, for example:

```
10 T="WORDSTAR":D="DISK NO.1":N=1
20 OPEN "O", #1, "FLOPPY.DAT"
30 WRITE #1, T, D, N
40 CLOSE
```

For each disk in the file, there is the TITLE, DISK NAME and its NUMBER.

### XTXEC.BAT

This is the batch file used when a program has been selected to run. This file must be created before XT-MAN can run. This example assumes that PARK.COM resides in the root directory. Change this if need be as where XT-MANAGER is exited, the hard disk is automatically PARKED.

```
10 OPEN "O", #1, "XTXEC.BAT"
20 PRINT #1, "C:\PARK"
30 CLOSE
```

### TYPEIT.BAT

Despite its name, this batch file is used for executing a selected CUSTOM command from the DOS UTILITIES CUSTOM menu. This file is automatically created in the program so a dummy is therefore not needed.

### COPY.BAT

### INSTALLC.BAT

This batch file, run from DOS, installs XT MANAGER onto hard disk C: in sub-directory XTMAN. Type the following:

```
COPY CON:INSTALLC.BAT
echo off
cls
echo
echo This batch file installs all of the
echo files needed for XT-MANAGER to load
echo in directory C:\XTMAN. Many other
echo disk menu's reside in the root part
echo of the directory, but I feel it is
echo neater & more organised to have it
echo tucked away within a sub-directory.
echo
echo To exit this installation, press
echo (Ctrl)(C) (Break) otherwise just
pause
cls
cd \
cd xtman
cd xtman
a:
copy *.* C:\v
cls
echo
echo All files are now loaded over to C:
echo To load XT-MANAGER, just type :
echo C:
echo CD\XTMAN
```

```
ECHO
ECHO
ECHO
ECHO
ECHO
ECHO
ECHO
ECHO
ECHO
ECHO
ECHO
ECHO
```

However, it is far more convenient to include this procedure within the AUTOEXEC.BAT file so that XT-MAN will load automatically on booting up your computer. If this is the first time you have loaded XT-MAN, run the configuration section.

[ Remember ! keep this backup disk safely hidden away. ]

### X.BAT

This batch file MUST be used to load XT MANAGER. If XT MANAGER is loaded directly from BASIC (v.3.10) the program selected WILL NOT LOAD. Type the following to create X.BAT

```
COPY CON:X.BAT
ECHO OFF
@W MAN2.BAS
XTXEC.BAT
```

After typing the above, press F6 and X.BAT will now be saved to disk.

### XT-MNU

This data file contains the screen positions for the 3 columns on the screen. This must also be created before XT MANAGER can be run.

```
5 OPEN "A", #1, "XT-MNU"
10 F(1)=1:F(2)=29:F(3)=59
20 FOR L=1 TO 3
30 FOR T=1 TO 25
40 WRITE #1, T, F(L)
45 NEXT T
50 NEXT L
55 CLOSE
```

This program creates XT-MNU.

```
XT1, XT2, XT3, XT4, XT5, XT6, XT7, XT8, XT9, XT10, XT11, XT12
```

At present, XT MANAGER is designed to run using 10 menu pages. The above files contain all program loading data for the 10 pages. These 10 files must first be created using the program below:

```
5 BS=" "
10 INPUT FS
30 OPEN "A", #1, FS
40 FOR R=1 TO 60
50 WRITE #1, BS, BS, BS, BS, BS, BS, BS, BS, BS, BS, BS
60 NEXT R:CLOSE
```

The above program can be used to create the underlined files above. Run the program repeatedly, entering the file names underlined above, one at a time until each file, underlined above, has been created. The file to be created is input at line 10 of the above program.

### XT6

This file contains all the menu page titles wanted. At present the main program, MAN2.BAS, is set up to only read the first 5 menu titles as I only use the first 5 pages. To change this, alter the loop at line 220 to input the number of menu page titles you want to use.

```
To create this file:
10 T="Demo title"
20 OPEN "O", #1, "XT6"
30 FOR R=1 TO 10
35 PRINT #1, T
40 NEXT R
```

### XT7

Contains the password in encrypted form. Type the following program. This creates XT7 and writes data to it for the password. The password, on loading XT MANAGER, is IBM (in capitals) until you change it (from configuration option).

```
10 OPEN "O", #1, "XT7"
20 PRINT #1, 237.25
25 PRINT #1, 214.5
30 PRINT #1, 250.25
40 CLOSE
```

## MS-DOS Basic XT Manager main listing

```
1 WIDTH 80:SCREEN 0,1:KEY OFF:COLOR 2,1,1:CLS
2 COLOR 4,6:LOCATE 0
3 LOCATE 2,2:PRINT " "
4 LOCATE 3,2:PRINT " "
5 LOCATE 4,2:PRINT " "
6 LOCATE 5,2:PRINT " "
7 LOCATE 6,2:PRINT " "
8 LOCATE 7,2:PRINT " "
9 COLOR 5,6
10 LOCATE 3,4:PRINT "XT-MANAGER J.S. 1987."
11 COLOR 3
12 LOCATE 4,4:PRINT "-----"
13 COLOR 17
14 LOCATE 5,4:PRINT " Loading .... " :COLOR 2,1
15 FOR P=1 TO 2500:NEXT P
17 CLS
20 COLOR 2,1:LOCATE 2,2:PRINT " "
25 LOCATE 3,2:PRINT " "
30 LOCATE 4,2:PRINT " "
35 LOCATE 5,2:PRINT " "
40 MS(1)="Run XT-MAN" :MS(2)="Configure"
MS(3)="Quit program" :M(1)=3:M(2)=4:M(3)=5
41 OPEN "O", #1, "xtxec.bat":PRINT #1, "C:\park":CLOSE
42 CHECK=1:DIM R(200)
43 LOCATE M(1),4:PRINT MS(1):LOCATE M(2),4:PRINT MS(2):LOCATE M(3),4:PRINT MS(3)
45 Q=3:GOTO 70
```

```
50 Z$=INKEY$
52 IF Z$="8" THEN 80
53 IF Z$="2" THEN 70
54 IF Z$=CHR$(13) THEN 80
55 GOTO 50
60 LOCATE M(Q),4:COLOR 2,1:PRINT MS(Q):COLOR 6,4:IF Q=J THEN Q=3:GOTO 75
65 Q=Q-1:GOTO 75
70 LOCATE M(Q),4:COLOR 2,1:PRINT MS(Q):COLOR 6,4:IF Q=3 THEN Q=1 ELSE Q=Q+1:GOTO 75
75 LOCATE M(Q),4:PRINT MS(Q):GOTO 50
79 STOP
80 IF Q=1 THEN 100
85 IF Q=2 THEN 90
87 IF Q=3 THEN SYSTEM
90 GOTO 3060
100 CH=1:PAGE=CH:COLOUR=1
105 DIM S(200)
106 DIM F(200)
110 DIM FILES(70),OP1$(70),OP2$(70),OP3$(70),OP4$(70),OP5$(70),FED$(60),S$(500),SN$(500),DN$(500)
120 DIM OP6$(70),OP7$(70),OP8$(70),OP9$(70),OP10$(70),X(70),Y(70)
125 COLOR 2,1:LOCATE 12,30:PRINT " "
128 LOCATE 13,30:PRINT " "
128 LOCATE 14,30:PRINT " "
128 LOCATE 15,30:PRINT " "
130 COLOR 3:LOCATE 13,34:PRINT "Loading"
135 LOCATE 14,34:PRINT " XT-MAN ... "
140 REM
```

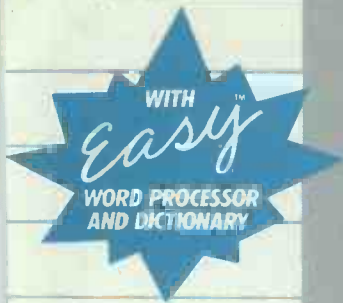

# THE BEST BUY IN PERSONAL COMPUTERS

There are plenty of PC compatibles but you'd be hard put to find one that can match the X'PRESS 16P in terms of value for the money.

The X'PRESS 16P provides the ideal combination of compact size, superior functionality, outstanding performance and economical price.

Take a close look at what the X'PRESS 16P has to offer. Compare for yourself!

You'll find, dollar for dollar, the X'PRESS 16P delivers more computing capability for the money than any other computer of its class.

For complete information, visit your nearest SpectraVideo dealer or write to us directly at the address below.

## KEY FEATURES OF THE X'PRESS 16P

- ✓ PC compatible
- ✓ Compact size, over 40% smaller than the PC
- ✓ 512 kilobytes of random-access memory—expandable to 640 kilobytes on board
- ✓ One built-in 360 kilobyte 5 1/4" floppy disk drive and a cavity for a second floppy disk drive
- ✓ PC compatible keyboard with 84 full-stroke keys
- ✓ Standard PC/XT\* expansion slot
- ✓ Built-in color graphics adapter and parallel printer, joystick and mouse interfaces
- ✓ Economical price—sells for a fraction of the price of most other PC compatibles

*Excellent!*

**SVI**<sup>®</sup>  
SPECTRAVIDEO

SPECTRAVIDEO INTERNATIONAL LTD.

International Sales Office: 2/F, Chung Nam Centre, 414 Kwun Tong Rd., Kowloon, Hong Kong. Tel.: 3-419370, 3-419371 Tlx: 36929 SVL.HX, Fax: 3-7978059

Specifications are subject to change without prior notice.

© 1987 SpectraVideo International Ltd. \*TM International Business Machines Corporation EASY IS A TRADEMARK OF MICROPRO INTERNATIONAL CORP.

**OEM  
Customers  
Invited**

# MICROMART



## Computer Dust Covers

IN WASHABLE PROOFED NYLON FABRIC  
FINISHED WITH TONING PIPING



### A SELECTION FROM OUR WIDE RANGE OF COVERS FOR COMPUTERS

Model	Price	Colour	Price
Act Sirius	£9.00		£9.50
Amstrad PC1512 Mono	£9.00	Olivetti M28	£9.50
Colour	£9.00	Tandon PCX	£9.50
Apricot XRN 12"	£9.00	PCA	£9.50
Compaq Desk pro	£9.00	Victor 3000	£9.00
IBM-PCXT	£9.00	VPC II	£9.00
IBM-PCAT	£9.50	Zenith 148/158	£9.00
IBM System 2 Mod. 30	£9.00	Wyse 30, 50, 60	£9.00
Olivetti M-24 Mono	£9.00	Wyse 286	£9.00

### CHOOSE FROM OUR COLLECTION OF OVER 200 PRINTER COVERS e.g.

Amstrad DMP-2000	£4.50	Amstrad DMP 4000	£5.50
Amstrad DMP-3000	£4.50	Apple Imagewriter II	£5.00
Brother M1109	£4.50	Brother HR-15	£5.50
Citizen 120D	£4.50	Epson EX-1000	£6.50
Epson EX-800	£4.50	Epson LQ-1000	£5.50
Epson LX-80/95/96	£4.50	Juki 6100	£5.50
IBM Proprinter	£4.50	Panasonic KXP-1592	£5.50
Panasonic KX-P1080	£4.50	Star NB15, NX15	£5.50

### OTHER ITEMS ON OFFER

The 'Ming'	£5.99	Strong and well made, of shell
Mouse Mat	£5.95	and drawer construction. In
IBM to Centronics printer		two tone grey. Two or more
cable	£11.95	sets can be joined together.
Anti-Stat Wipe	£8.50	Please send for leaflet.
Anti-Stat Cleaner	£8.50	5.25" (56 discs)
		3" 3 1/2" (58-100+)
		Locking Modules
		£4.50

BBD DUST COVERS are specialist manufacturers of high quality tailored dust covers. We make a wide range of covers for other Business computers, Printers, Photocopiers etc and we match printer covers to computer covers wherever possible.

Make cheques payable to  
**BBD COMPUTER DUST COVERS**  
The Standish Centre, Cross Street,  
Standish Wigan WN6 0HD  
Tel: (0257) 422968 ext 45 Fax: 0257  
423909 Dealer enquiries welcome.

# ATARI

inc VAT

Mega ST 2/4Mb	£Call
Laser Printer	£Call
520 STFM	£359.95
520 STFM + Mono	£449.95
520 STFM + Philips col.	£656.00
1040 STF + Mono	£629.95
1040 STF + col	£980.90
ST Turbo drive 20MB	£677.35

Delivery £12 inc VAT  
ACCESS welcome

## ORDER NOW FOR SOFTWARE DISCOUNTS

- ★ FULL SUPPORT ★
- ★ SOFTWARE & PERIPHERALS ★
- ★ ON SITE MAINTENANCE ★

## Gould Computer Services

12 Stainburn Drive, Leeds LS17 6NX  
Tel: 0532 692946  
callers by appointment

# PACE ELECTRONICS

Why not increase the speed of your PC by using the 8087/80287 Numeric Data Processor

8087/2 (8MHz) prices 1-10 PCS	£135
80287/8 (8MHz) prices 1-10 PCS	£198
80387 (16MHz)	£495
Upgrade your memory	
256K D RAMS 256K x 1	£1.85

All prices excluding VAT/P&P  
If you purchase Super Calc 4/Ability/Smart we offer discount on 80 87 products. Competitive prices.

Pace Electronics offer the PC user technical support and advice on the above products.

## PACE ELECTRONICS LTD

84 HIGH STREET, STONY STRATFORD,  
MILTON KEYNES MK11 1AH  
Tel: 0908 562664 Telex: 826679 PACE G

# PROGRAM FILE

```

150 Fs(1)="xt1":Fs(2)="xt2":Fs(3)="xt3":Fs(4)="xt4":Fs(5)="xt5"
155 Fs(6)="xt6":Fs(7)="xt7":Fs(8)="xt8":Fs(9)="xt9":Fs(10)="xt10":Fs(11)="xt11":Fs(12)="xt12"
160 Ps="xt6":Ts="xt7"
170 OPEN "I",E1,Fs(CH)
180 FOR I=1 TO 60:INPUT E1,FILES(I),OP1$(I),OP2$(I),OP3$(I),
    OP4$(I),OP5$(I),OP6$(I),OP7$(I),OP8$(I),OP9$(I),OP10$(I):NEXT I:CLOSE

185 T=1
190 OPEN "I",E1,"xt7"
191 WHILE NOT EOF(1)
192 INPUT E1,R(T)
193 T=T+1
194 WEND
195 CLOSE:T=T-1:GOSUB 3000
200 CLOSE
203 OPEN "I",E1,"COLOUR.DAT":INPUT E1,COLOUR:CLOSE
210 OPEN "I",E1,"xt6"
220 FOR R=1 TO 5:INPUT E1,T$(R):NEXT R:CLOSE
230 OPEN "I",E1,"XT-MNU"
240 FOR R=1 TO 60:INPUT E1,X(R),Y(R):NEXT R:CLOSE
245 IF CHECK=2 THEN 425 ELSE 250
250 LOCATE 16,1:COLOR 2:PRINT
252 LOCATE 17,1:PRINT
253 LOCATE 18,1:PRINT
255 COLOR 3:LOCATE 17,3:PRINT "Password :":COLOR 2
257 LOCATE 19,1:PRINT

:REM full screen width
258 LOCATE 20,1:PRINT
:REM full screen width
260 LOCATE 21,1:PRINT

:REM full screen width
262 TRYS="":LOCATE 20,3
263 FOR R=1 TO LEN(Ps)
264 Z$=INKEYS
265 IF Z$="" THEN 264
266 PRINT "E ";TRYS=TRYS+Z$:NEXT R
270 IF TRYS=Ps THEN 425
275 LOCATE 20,2:PRINT "Incorrect Password ....."
:FOR P=1 TO 2000:NEXT P:GOTO 257

425 WIDTH 80:CLS
430 REM RETURN HERE
440 COLOR 3,0,0:CLS
450 LOCATE 1,1:PRINT"XT-MAN - ":COLOR 6:PRINT "R. Jones 1987 FERRANTI PC860XT Disk Menu."
460 COLOR 4
470 LOCATE 2,1:PRINT

:REM full screen width
480 COLOR 3,1:LOCATE 1,68:PRINT "Page ";:COLOR 2,1:PRINT PAGE:
490 COLOR 2,4:LOCATE 2,40-LEN(T$(PAGE))/2:PRINT " ";Ts(PAGE);
500 COLOR COLOUR,0
510 L(1)=1:L(2)=27:L(3)=53
520 C=1
530 FOR O=1 TO 3
540 FOR I=4 TO 23
550 LOCATE I,L(O)
560 IF C<10 THEN PRINT " ";
570 COLOR 1:PRINT C:;COLOR 6:PRINT " ";:COLOR COLOUR,0:PRINT FILES(C)
580 C=C+1
590 NEXT I,0
600 LOCATE 3,3:COLOR 6,0:PRINT " L ":;COLOR 3:PRINT "ock ":;COLOR 6:PRINT "TAB ":;COLOR 3:PRINT "Edit ":;COLOR 6:PRINT "Q ":;COLOR 3:PRINT "uit ":;COLOR 6:PRINT "+- ":;COLOR 3:PRINT "Page ":;COLOR 6:PRINT "C ":;COLOR 3
605 PRINT "olour ":;COLOR 6:PRINT "A ":;COLOR 3:PRINT "dd to C ":;COLOR 6:PRINT "D ":;COLOR 3:PRINT "OS Utilities ":;COLOR 6:PRINT "F ":;COLOR 3:PRINT "lopples
610 Y=4
620 XP=1:YP=1
630 FILE=XP
640 YC(1)=1:YC(2)=30:YC(3)=60
650 LOCATE X(XP),Y(YC(YP)):COLOR 3,0,0:PRINT CHR$(16):COLOR 2
660 LOCATE 1,53:PRINT " Selection:":;COLOR 3:PRINT FILE
670 Z$=INKEYS
680 IF Z$="2" THEN 780 '***** DOWN
690 IF Z$="8" THEN 820 '***** UP
700 IF Z$="4" THEN 860 '***** LEFT A COLUMN
710 IF Z$="6" THEN 900 '***** RIGHT A COLUMN
720 IF Z$=CHR$(13) THEN 940 '***** SELECT
730 IF Z$=CHR$(9) THEN 1200 '***** EDITOR
740 IF Z$="Q" OR Z$="q" THEN 2510 '*** QUIT
750 IF Z$="+" THEN 2290 '***** PAGE ON
760 IF Z$="-" THEN 2300 '***** PAGE BACK
762 IF Z$="C" OR Z$="c" THEN 5000
763 IF Z$="A" OR Z$="a" THEN 6000 '***** ADD NEW DISK TO c: & INSTALL
764 IF Z$="D" OR Z$="d" THEN 7000 '***** DOS UTILS
765 IF Z$="L" OR Z$="l" THEN 9000 '*** LOCK
767 IF Z$="f" OR Z$="F" THEN 9200 '*** floppy search
770 GOTO 670
780 '***** DOWN
790 LOCATE X(XP),Y(YC(YP)):PRINT "
800 IF XP=20 THEN XP=1:FILE=FILE-19:GOTO 650
810 XP=XP+1:FILE=FILE+1:GOTO 650
820 '***** UP
830 LOCATE X(XP),Y(YC(YP)):PRINT "
840 IF XP<2 THEN XP=20:FILE=FILE+19:GOTO 650
850 XP=XP-1:FILE=FILE-1:GOTO 650
860 '***** LEFT
870 LOCATE X(XP),Y(YC(YP)):PRINT "
880 IF YP=1 THEN YP=3:FILE=FILE+40:GOTO 650
890 YP=YP-1:FILE=FILE-20:GOTO 650
900 '***** RIGHT
910 LOCATE X(XP),Y(YC(YP)):PRINT "
920 IF YP=3 THEN YP=1:FILE=FILE-40:GOTO 650
930 YP=YP+1:FILE=FILE+20:GOTO 650
940 '***** SELECTION *****
945 IF FILES(FILE)=" " THEN 650
950 COLOR 2,0,0:CLS
960 LOCATE 2,1:LENGTH=8+LEN(FILES(FILE)):LOCATE 3,3:PRINT "R":
FOR R=1 TO LENGTH:PRINT "=";NEXT R:PRINT "
965 LOCATE 4,3:PRINT " ";:FOR R=1 TO LENGTH:PRINT " ";:NEXT R:PRINT "
968 LOCATE 5,3:PRINT "L":;FOR R=1 TO LENGTH:PRINT " ";:NEXT R:PRINT "
970 COLOR 19,1:LOCATE 4,4:PRINT "Loading ":;PRINT FILES(FILE)
1015 KILL "xtexec.bat"
1020 OPEN "A",E1,"XTEXEC.BAT"
1030 PRINT E1,"ECHO OFF"
1040 PRINT E1,"CLS"
    
```

# PROGRAM FILE

# MICROMART



**MARC ADLER**  
**NEW YORK WORD**

Marc Adler, author of New York Word, took his Bachelors degree in Computer Science from State University of New York at Albany. He received his Masters degree, in Computer Science, from the University of Arizona. He pursued his Ph.D at the Kourant Institute of Mathematics at N.Y.U. before he determined it was hopeless. His word processing program is an easy to use, powerful, text editing and formatting tool. In fact, it contains many features such as:

Automatic table-of-contents & Footnote capabilities. Index generator, Macros, Mail merge facility. Two calculator modes and Split screen editing.

- 528 NEW YORK WORD £6
- 198 PC-CALC make a spreadsheet to track expenses, a budget or whatever £6
- 233 NEWBASE beginners menu driven database £6
- 273 BEST UTILITIES a collection of our most powerful and useful utilities £6
- 294 EDIT very simple to use type editor and word processing programme £6
- 403 COMPUTER TUTOR learn to use your computer, great for new users £6
- 405 DESKTEAM a memory resident calculator, calendar, printer utility, phone dialer and other desk organisational tools £6
- 457 ARCADE GAMES Shoot 'em up, spacewars, helicopter rescues and more £6
- 478 HARD DISK UTILITIES some of the most useful utilities for the hard disk user £6
- 487 REFLEX POINT fast action arcade game with excellent graphics £6
- 498 DOS-A-MATIC load multiple programmes into memory and switch between them with a keystroke £6
- 499 PRO-COMM V. 2.42 communications with XMODEM, KERMIT, ASCII protocols, supports, IBM-3101, DEC VT52/100, ADM-3 and ANSI £6
- 517 IMAGEPRINT get excellent letter quality from your dot matrix printer £6
- 558 PC-PROMPT memory resident helper for DOS commands and syntax £6
- 576 PC-TICKLE the perfect reminder for appointments and things to do list £6

UK AUTHORS - submit your programmes to PC-SIG for worldwide distribution (at no cost to you)

### PC-SIG MEMBERSHIP

*On going benefits for the enthusiast*  
PC-SIG Catalogue - Bi-Monthly Newsletter  
Coupon for three FREE Disks of your choice  
Only £35 for one year

### QUICK START

*Everything needed for the new user*  
Catalogue listing 705 disks

- 403 COMPUTER TUTOR
- 199 PC CALC
- 294 EDIT
- 233 NEWBASE
- 405 DESK MATE
- 273 BEST UTILITIES
- 476 PATRICK'S BEST GAMES
- £57 VALUE - ONLY £40

Most Programmes have documentation on disk and request a donation from satisfied users.

ADD £2.00 Shipping & VAT Total enclosed £.....

Name .....

Address .....

.....

Phone.....



ISD INTERNATIONAL  
SOFTWARE DISTRIBUTORS LTD  
P.O. Box 872, Sutton Coldfield,  
West Midlands, B75 6UP  
Telephone: 021-378 2229

```

1050 IF OP1$(FILE)=" " THEN 1060 ELSE PRINT £1,OP1$(FILE)
1060 IF OP2$(FILE)=" " THEN 1070 ELSE PRINT £1,OP2$(FILE)
1070 IF OP3$(FILE)=" " THEN 1080 ELSE PRINT £1,OP3$(FILE)
1080 IF OP4$(FILE)=" " THEN 1090 ELSE PRINT £1,OP4$(FILE)
1090 IF OP5$(FILE)=" " THEN 1100 ELSE PRINT £1,OP5$(FILE)
1100 IF OP6$(FILE)=" " THEN 1110 ELSE PRINT £1,OP6$(FILE)
1110 IF OP7$(FILE)=" " THEN 1120 ELSE PRINT £1,OP7$(FILE)
1120 IF OP8$(FILE)=" " THEN 1130 ELSE PRINT £1,OP8$(FILE)
1130 IF OP9$(FILE)=" " THEN 1140 ELSE PRINT £1,OP9$(FILE)
1140 IF OP10$(FILE)=" " THEN 1145 ELSE PRINT £1,OP10$(FILE)

1143 PRINT £1,"C:"
1145 PRINT £1,"CD\XTMAN
1146 PRINT £1,"X"
1160 FOR P=1 TO 200:NEXT P:CLOSE:CLOSE
1165 COLOR 0
1170 SYSTEM
1190 CHECK=2:GOTO 100
1200 CLS
1205 FOR R=1 TO 10:OP$(R)=" " :NEXT R
1210 CLS
1220 LOCATE 1,1:COLOR 6:PRINT"XT-MAN Menu Editor 1987.":COLOR 2:
PRINT" Jonahsoft (C).":COLOR 3:PRINT" Richard Jones."
1230 LOCATE 2,1:COLOR 4:
PRINT"
:REM full screen width
1240 COLOR 6,4:LOCATE 2,40-LEN(T$(PAGE))/2:PRINT T$(PAGE)
1250 M$(1)=" Edit ":"M$(2)=" Quit-NO SAVE ":"M$(3)=" Quit-SAVE ":"M$(4)=" Help ":"
M$(5)=" Delete an entry ":"M$(6)=" Configure "
1255 N$(1)="Edit a position in the current page menu":
N$(2)="Return to current page menu & don't save changes":
N$(3)="Return to current page menu with latest changes included"
1257 N$(4)="Display general guidance in operation of XT-MAN":
N$(5)="Remove (blank) position on the current page menu":
N$(6)="Configure page menus, password, page titles"
1260 COLOR 6,0
1270 M(1)=1:M(2)=7:M(3)=21:M(4)=32:M(5)=38:M(6)=55
1280 FOR R=1 TO 6:LOCATE 4,M(R):PRINT M$(R):NEXT R
1290 LOCATE 4,67:COLOR 6,1:PRINT " ":"CHR$(27); " :CHR$(26);+" Cursors "
1300 S=2:GOTO 1360
1310 COLOR 8,0:LOCATE 5,1:
PRINT"
COLOR 7,0:LOCATE 5,1:PRINT "Use:":COLOR 3:PRINT N$(6)
1318 Z$=INKEY$
1320 IF Z$="4" THEN 1360 ***** LEFT
1330 IF Z$="6" THEN 1390 ***** RIGHT
1340 IF Z$=CHR$(13) THEN 1420
1350 GOTO 1318
1360 COLOR 6,0:LOCATE 4,M(S):PRINT M$(S)
1370 IF S=1 THEN S=6:COLOR 6,4:LOCATE 4,M(S):PRINT M$(S):GOTO 1310
1380 S=S-1:COLOR 6,4:LOCATE 4,M(S):PRINT M$(S):GOTO 1310
1390 COLOR 6,0:LOCATE 4,M(S):PRINT M$(S)
1400 IF S=6 THEN S=1:COLOR 6,4:LOCATE 4,M(S):PRINT M$(S):GOTO 1310
1410 S=S+1:COLOR 6,4:LOCATE 4,M(S):PRINT M$(S):GOTO 1310
1420 ***** SELECT ONE OF EDITOR OPTIONS
1430 ON S GOTO 1440,1790,1810,1950,2020,90
1440 COLOR 0,0:LOCATE 5,1:
PRINT"
COLOR 4,0:LOCATE 5,1:PRINT"
1445 FOR Q=1 TO 10:OP$(Q)=" " :NEXT Q:NO=0:FED$(NO)
1450 COLOR 2,0:LOCATE 6,1:INPUT "No to edit (1-60).....":NO
1460 LOCATE 6,1:INPUT "Enter name of file (>19 chars).....":FED$(NO)
1465 IF FED$(NO)=" " THEN FILES$(NO)=FILES$(NO) ELSE FILES$(NO)=FED$(NO)
1470 IF LEN(FILES$(NO))>19 THEN 1460
1480 COLOR 3:BLOCK$="
1485 OP$(1)=OP1$(NO):OP$(2)=OP2$(NO):OP$(3)=OP3$(NO):OP$(4)=OP4$(NO):O
P$(5)=OP5$(NO):OP$(6)=OP6$(NO):OP$(7)=OP7$(NO):OP$(8)=OP8$(NO):
OP$(9)=OP9$(NO):OP$(10)=OP10$(NO)
1490 FOR L=8 TO 17:LOCATE L,40-LEN(BLOCK$)/2:PRINT BLOCK$:
IF OP$(L-7)=" " THEN 1495 ELSE COLOR 4,3:LOCATE L,40-LEN(BLOCK$)/2+1:
PRINT OP$(L-7):COLOR 3
1495 NEXT L
1500 LOCATE 20,1:COLOR 6,1:
PRINT"
:REM full screen width
1510 COLOR 6,1:LOCATE 21,1:
PRINT"[To enter data to a field : press Enter : type in loading command :
press Enter]":LOCATE 22,1:
PRINT"[Press up & down cursors : check [NumLock] : when done : press <TAB
> for menu: "
1520 LOCATE 23,1:COLOR 6,1:
PRINT"
:REM full screen width
1530 COLOR 2,4:LOCATE 7,29:PRINT"Commands:"
1540 COLOR 2,1
1550 FOR L=1 TO 10:LOCATE L+7,(40-LEN(BLOCK$)/2)-4:PRINT L:
IF L<10 THEN COLOR 1:PRINT" :COLOR 2,1
1560 NEXT L
1565 LOCATE 18,2:PRINT" Editing no.":NO
1570 P=8
1580 COLOR 6,0:LOCATE P,(40-LEN(BLOCK$)/2)-5:PRINT CHR$(16):COLOR 1,3:
LOCATE P,(40-LEN(BLOCK$)/2)+1
1590 LOCATE 18,59:PRINT " Command ":"P-7;"/10 "
1600 Z$=INKEY$
1610 IF Z$=CHR$(13) THEN 1650
1620 IF Z$="8" THEN 1670
1630 IF Z$="2" THEN 1690
1640 IF Z$=CHR$(9) THEN 1710 ELSE 1600
1650 COLOR 4,3:LOCATE P,(40-LEN(BLOCK$)/2)+1:LINE INPUT OP$(P-7)
1660 GOTO 1580
1670 COLOR 8,8:PRINT " :IF P=8 THEN 1580 ELSE 1680
1680 LOCATE P,(40-LEN(BLOCK$)/2)-5:PRINT " :P=P-1:GOTO 1580
1690 COLOR 8,8:PRINT " :IF P=17 THEN 1580 ELSE 1700
1700 LOCATE P,(40-LEN(BLOCK$)/2)-5:PRINT " :P=P+1:GOTO 1580
1710 ***** END
1720 FILES$(NO)=FED$(NO)
1730 OP1$(NO)=OP$(1):OP2$(NO)=OP$(2)
1740 OP3$(NO)=OP$(3):OP4$(NO)=OP$(4)
1750 OP5$(NO)=OP$(5):OP6$(NO)=OP$(6)
1760 OP7$(NO)=OP$(7):OP8$(NO)=OP$(8)
1770 OP9$(NO)=OP$(9):OP10$(NO)=OP$(10)
1780 COLOR ,0:GOTO 1200
1790 ***** NO SAVE
1800 CLOSE:COLOR ,0:CHECK=2:GOTO 125
1810 ***** SAVE
1820 CLOSE
1830 IF PAGE=1 THEN F$="XT1"
1840 IF PAGE=2 THEN F$="XT2"
1850 IF PAGE=3 THEN F$="XT3"
1860 IF PAGE=4 THEN F$="XT4"
1870 IF PAGE=5 THEN F$="XT5"

```



# PROGRAM FILE

# MICROMART

```

2305 COLOR 0:FOR R=8 TO 13:LOCATE R,4:PRINT "          ":NEXT R
2307 COLOR 4:LOCATE 8,3:
PRINT "
2309 LOCATE 9,3:
PRINT "
2311 LOCATE 10,3:PRINT "
2312 LOCATE 11,3:PRINT "
2313 LOCATE 12,3:PRINT "
2317 COLOR 0:FOR R=14 TO 19:LOCATE R,1:
PRINT "
NEXT R
2319 COLOR 2,1:LOCATE 14,1:
PRINT "
2320 LOCATE 15,1:
PRINT "
2322 LOCATE 16,1:
PRINT "
2323 LOCATE 17,1:
PRINT "
2324 LOCATE 18,1:
PRINT "
2325 LOCATE 19,1:
PRINT "
2340 M$(1)=" I ":M$(2)=" II ":M$(3)=" III ":M$(4)=" IV ":M$(5)=" V "
2345 M$(6)=" VI ":M$(7)=" VII ":M$(8)=" VIII ":M$(9)=" IX ":M$(10)=" X "
2350 M(1)=6:M(2)=9:M(3)=13:M(4)=18:M(5)=22:M(6)=27:M(7)=33:M(8)=39:M(9)=45:
M(10)=51
2360 COLOR 1,0,0:FOR R=1 TO 10:LOCATE 10,M(R):PRINT M$(R):NEXT R
2370 LOCATE 12,9:COLOR 6,1,0:PRINT " ":CHR$(27):" ":CHR$(26):" ESC exit "
2380 S=2:GOTO 2440
2390 LOCATE 16,3:COLOR 2,1:PRINT "Menu : ":COLOR 3:PRINT T$(S)::
R=80-LEN(T$(S)):R=R-11:FOR L=1 TO R:PRINT " ":NEXT L
2395 Z$=INKEY$
2400 IF Z$="4" THEN 2440 "***** LEFT
2410 IF Z$="6" THEN 2470 "***** RIGHT
2420 IF Z$=CHR$(13) THEN 2500
2425 IF Z$=CHR$(27) THEN 430
2430 GOTO 2395
2440 COLOR 1,0:LOCATE 10,M(S):PRINT M$(S)
2450 IF S=1 THEN S=10:COLOR 6,4:LOCATE 10,M(S):PRINT M$(S):V=1:GOTO 2390
2460 S=S-1:COLOR 6,4:LOCATE 10,M(S):PRINT M$(S):V=S+1:GOTO 2390
2470 COLOR 1,0:LOCATE 10,M(S):PRINT M$(S)
2480 IF S=10 THEN S=1:COLOR 6,4:LOCATE 10,M(S):PRINT M$(S):V=5:GOTO 2390
2490 S=S+1:COLOR 6,4:LOCATE 10,M(S):PRINT M$(S):V=S-1:GOTO 2390
2500 IF S=CUR THEN 430 ELSE PAGE=S:CH=PAGE:CHECK=2:CLS:GOTO 125
2510 SYSTEM
3000 '
3005 G$=""
3010 FOR LOOP=1 TO T
3020 A=R(LOOP)/3.25
3030 C$=C$+CHR$(A)
3040 NEXT LOOP
3050 P$=C$:CLOSE:RETURN
3060 KEY OFF:T=1:Y=0
3080 CLOSE:OPEN "I",E1,"XT7"
3090 WHILE NOT EOF(1)
3100 INPUT E1,Y(T)
3110 T=T+1
3120 WEND:T=T-1:CLOSE:GOSUB 3890
3130 COLOR 6,1
3140 CLS:LOCATE 1,1:
PRINT "XT-MAN Configuration Program R.Jones 1987. JS Corp.
3150 COLOR 2:LOCATE 2,1:
PRINT "Please enter the current system password below to gain acc
ess
3160 COLOR 3:LOCATE 4,1:
PRINT "
3170 COLOR 2:LOCATE 6,1:PRINT "PASSWORD:=>";
3180 TRY$=""
3190 FOR R=1 TO LEN(P$)
3200 Z$=INKEY$:IF Z$="" THEN 3200
3210 PRINT "E ":TRY$=TRY$+Z$:NEXT R
3220 IF TRY$=P$ THEN 3240
3230 LOCATE 8,1:PRINT "Invalid password => Access Denied (<=":FOR P=1 TO 3000:
NEXT P:SYSTEM
3240 LOCATE 8,1:PRINT "Password => Accepted
3250 LOCATE 10,1:COLOR 6:
PRINT "
3260 PRINT
3270 COLOR 3
3280 PRINT "In this program you may install XT-MAN for your own needs; you are
asked for a system Master password, 5 file menu titles which can contain
labels for the types of application used."
3290 PRINT "or perhaps have them display your company title & phone number for
example. You may also install new menus, simply by answering question
s. Be warned !! if you choose to install new menus."
3300 PRINT "all previous data held in the menus will be cleared out in preparat
ion for you adding new programs to the menus. It is important for you to
choose an obscure password, otherwise unauthorised"
3310 PRINT "users may be able to access your system & corrupt data even! If you
wish to discontinue this program now, press Q otherwise press C to co
ntinue
3320 PRINT:COLOR 6:
PRINT "
3330 Z$=INKEY$
3340 IF Z$="C" OR Z$="c" THEN 3370
3350 IF Z$="Q" OR Z$="q" THEN CLOSE:SYSTEM
3360 GOTO 3330
3370 FOR R=1 TO 9:PRINT:NEXT R
3380 VIEW PRINT 16 TO 20
3390 COLOR 3
3400 P$="" : CLEAR OLD PASSWORD
3410 PRINT "Qn 1. Please enter a system password => ";
3420 Z$=INKEY$:IF Z$="" THEN 3420
3430 IF Z$=CHR$(13) THEN 3450
3440 P$=P$+Z$:PRINT " ":GOTO 3420
3450 PRINT:PRINT:GOSUB 3960
3460 INPUT "Qn 2. Menu title E1 => ":M$(1)
3470 INPUT "Qn 3. E2 => ":M$(2)
3480 INPUT "Qn 4. E3 => ":M$(3)
3490 INPUT "Qn 5. E4 => ":M$(4)
3500 INPUT "Qn 6. E5 => ":M$(5)

```

Variations on an

## OPUS

The Incomparable Compatible

£ 495	Opus PCII Turbo 8MHz
£ 599	512k Twin Floppy
£ 635	512k 1.2Mb Floppy
£ 657	256k 5Mb Hard Disk
£ 675	512k 5Mb Hard Disk
£ 725	512k 10Mb Hard Disk
£ 765	512k 15Mb Hard Disk
£ 839	512k 20Mb Hard Disk
£ 883	1024k 20Mb Hard Disk
£ 930	512k 30Mb Hard Disk
£ 974	1024k 30Mb Hard Disk
£1149	512k 40Mb Hard Disk
£1193	1024k 40Mb Hard Disk

Add for colour upgrades

£ 199	CGA Card and Philips 8533 Med. Res. VDU
£ 399	EGA Card and AOC EGA VDU
£ 465	EGA Card and Taxan 660 EGA VDU
£ 645	EGA Card and NEC Multisync All Standards VDU

### THE OPUS ULTIMATE

80286 Accelerator board; 1024k RAM;  
1.2Mb floppy disk drive; 40Mb 33n/s  
hard disk; monochrome hi-res  
monitor; AT style keyboard

£1499

Multi-user multitasking systems  
40Mb to 125Mb Hard Disk storage

3 User £3444

4 User £4400

XT Upgrading to AT. Call for quote.  
Maintenance Contracts on all systems.

## PACKARD BELL BUSINESS COMPUTERS

80286 CPU; 640k RAM  
1.2Mb Floppy drive  
Monochrome hi-res monitor  
AT style keyboard

£1360 with 20Mb hard disk. 65 n/s  
£1575 with 30Mb hard disk. 65 n/s  
£1670 with 40Mb hard disk. 40 n/s  
£1700 with 40Mb hard disk. 33 n/s  
£2040 with 71Mb hard disk. 28 n/s

8088 VX Turbo; 640k RAM; 360k Floppy  
drive; monochrome hi-res monitor;  
AT style keyboard.

£ 499 Single floppy  
£ 599 Twin drives  
£ 819 one floppy and 20Mb hard disk  
£ 900 one floppy and 30Mb hard disk  
£1000 one floppy and 40Mb hard disk

### PACIFIC COMPUTERS (UK) LTD

565-569 Chiswick High Road,  
London W4 3AY  
Call 01-994 1054  
Telex: 291432 Bellil G

MicroCom Systems  
**OUTSTANDING SOFTWARE**  
 For IBM PC's and Compatibles

£ 350 PER DISK  
 SMALL QUANTITIES

£ 300 PER DISK  
 FOR TEN OR MORE

£1 OFF 5 DISKS OR MORE WITH THIS COUPON

- BUSINESS 1—EZ-Forms business form generation, completion and printing program.
- CAD 1—Altamira, a 4 color object oriented drawing program. Color required.
- COMM 4a,b,c,d,e—(5 disks) RBBS Bulletin Board System 14.1D.
- DATABASE 1a,b—(2 disks) File Express menu driven general purpose database mgr.
- EDUCATION 1—Interactive DOS tutorial for new PC users. Makes learning DOS painless.
- GAMES 1—3-D PacMan, Kong, SpaceWar, JanitJoe, and more. Color required.
- GAMES 2—Qubert, Pango, Centipede, Monopoly, Zoarre, and more. Color required.
- GAMES 3—Blackjack (you set rules), Arm Chair QB, and Empire (War Game).
- GAMES 4—Castle, StarTrek, and the original Colossal Caves Adventure.
- GAMES 5—The Hack adventure game from the universities. Like Rogue, only more complex.
- GAMES 6—Pinball, Othello, Dragons, Sopwith (fly one), and more. Color required.
- INFO 1a,b—(2 disks) Cooking recipes database with keyword/ingredient retrieval.
- LANGUAGE 5—Turbo Pascal interactive debugger, pop-up help, formatters, et cetera.
- LANGUAGE 7—Complete Pascal interpreter/compiler. Great for learning Pascal!
- ORGANIZER 1—DeskMate, a Sidekick clone, and the Judy calendar program.
- PINUP 2—Provocative high res digitized graphics pinups. Graphics required.
- PRINTER 1—Font and sideways utilities, spoolers, banner makers, and more.
- UTILITIES 1—A collection of invaluable general purpose DOS utilities. A must!
- UTILITIES 2—More invaluable DOS utilities. Too many to list here!
- UTILITIES 3—A comprehensive set of debugging and diagnostic utilities.

**NEW RELEASES/UPDATES**

- CAD 2a,b—(2 disks) An advanced 2D/3D drafting prog. 640k and color required.
- COMM 1a,b—(2 disks) Version 2.4 of the ever-popular Qmodem comm. program.
- COMM 2a,b—(2 disks) Procomm 2.42, an excellent modem program with terminal emulation.
- EDUCATION 2—Learn the Presidents, States (and capitals) and more. Color required.
- EDUCATION 5—Learn Origami, the Japanese art of paper folding. Color required.
- FINANCES 3a,b—(2 disks) Express Calc 3.12, a powerful spreadsheet program.
- GAMES 8—Striker helicopter attack, and Risk, world domination. Color required.
- GAMES 9—EGARisk, the game of world domination in very high resolution. EGA required.
- GAMES 10—Solitaire, Teed-Off golfing, and Sailing in the Bermuda triangle. Color required.
- GAMES 12—MyChess (9 levels), Backgammon, and Wheel of Fortune. Color not required.
- GRAPHICS 1—Record and play back screen images! Excellent for demo, etc. Color required.
- INFO 2a,b—(2 disks) Zip-Phone, national areacode/ prefix to zip-code cross reference.
- LANGUAGE 3a,b—(2 disks) The A86 2.18 macro assembler and debugger.
- SHELL 4—Automenu and HDM II 4.04 hard disk menus. Create custom full-screen menus.
- UTILITIES 5—Utilities for formatting, parking, and optimizing hard disk drives.
- UTILITIES 6—Advanced utilities including Dpath, Esc, Hotdos, Resident program utilities.
- UTILITIES 7—More Advanced utilities including MasterKey (undeletes files from hard disks).
- WORD 1a,b—(2 disks) PC Write 2.7, a powerful word processing system, w/spell checker.

Catalog available, add £2. 3.5" format add £1/disk.

MicroCom Systems Cost of Items  
 P.O. Box 51657 Ship/Handling £5  
 Palo Alto, CA 94303  
 U.S.A. Total Enclosed



Phone Orders  
 0101-(415) 325-6500



# PROGRAM FILE

```

3502 INPUT "Qn 7.          £6 ==> :Ms(6)
3503 INPUT "Qn 8.          £7 ==> :Ms(7)
3504 INPUT "Qn 9.          £8 ==> :Ms(8)
3505 INPUT "Qn 10.         £9 ==> :Ms(9)
3506 INPUT "Qn 11.        £10 ==> :Ms(10)
3510 FOR P=1 TO 8:PRINT:NEXT P
3520 PRINT "Qn 12. Clear all menus Y/N ==> ";
3530 Qs=INKEY$
3540 IF Qs="Y" OR Qs="y" THEN 3570
3550 IF Qs="N" OR Qs="n" THEN 3740
3560 GOTO 3530
3570 '***** CLEAR ALL MENUS
3580 PRINT Qs;
3590 KILL"XT1"
3600 KILL"XT2"
3610 KILL"XT3"
3620 KILL"XT4"
3630 KILL"XT5"
3631 KILL"xt8"
3632 KILL"xt9"
3633 KILL"xt10"
3634 KILL"xt11"
3635 KILL"xt12"
3640 Fs(1)="XT1":Fs(2)="XT2":Fs(3)="XT3":Fs(4)="XT4":Fs(5)="XT5"
3645 Fs(6)="xt8":Fs(7)="xt9":Fs(8)="xt10":Fs(9)="xt10":Fs(10)="xt11"
3650 Bs=""
3660 FOR O=1 TO 10
3670 OPEN "A",#1,Fs(O)
3680 FOR I=1 TO 60
3690 WRITE #1,B$,Bs$,Bs$,Bs$,Bs$,Bs$,Bs$,Bs$,Bs$,Bs
3700 NEXT I
3710 CLOSE
3720 NEXT O
3730 CLOSE:PRINT "-cleared"
3740 PRINT:PRINT
3750 PRINT "Processing password + titles ....";
3760 KILL"xt7"
3770 KILL"xt6"
3780 OPEN "a",#1,"xt7":FOR R=1 TO LEN(Ps):PRINT #1,B(R):NEXT R
3790 CLOSE:OPEN "a",#1,"xt6"
3800 PRINT #1,Ms(1)
3810 PRINT #1,Ms(2)
3820 PRINT #1,Ms(3)
3830 PRINT #1,Ms(4)
3840 PRINT #1,Ms(5)
3850 CLOSE
3860 PRINT:PRINT "Loading XT-MAN ...."
3870 VIEW PRINT
3880 CLEAR:GOTO 1
3890 ' DSKFILE-> PROGRAM READABLE
3900 Cs=""
3910 FOR LOOP=1 TO T
3920 A=Y(L)/3.25
3930 Cs=Cs+CHR$(A)
3940 NEXT LOOP
3950 Ps=Cs:CLOSE:RETURN
3960 'program readable -> disk file
3970 FOR L=1 TO LEN(Ps)
3980 A=ASC(MID$(Ps,L,1))
3990 B(L)=A*3.25
4000 NEXT
4010 CLOSE:RETURN
5000 'IF COLOUR=9 THEN COLOUR=1 ELSE COLOUR=COLOUR+1
5010 'GOTO 500
5020 COLOR 6,0
5030 LOCATE 3,50:PRINT "
5040 FOR R=4 TO 15
5050 LOCATE R,50:PRINT "
5060 NEXT R
5070 LOCATE 16,50:PRINT "
5075 LOCATE 4,51:COLOR 2:PRINT " Selection :
5080 FOR R=1 TO 9:LOCATE R+5,52:COLOR R,0:PRINT "
5085 P=COLOUR:GOTO 5125
5090 Zs=INKEY$
5100 IF Zs="2" THEN 5120
5110 IF Zs="8" THEN 5130
5115 IF Zs=CHR$(13) THEN 5150
5117 GOTO 5090
5120 LOCATE P+5,62:PRINT "
5123 IF P=9 THEN P=1 ELSE P=P+1
5125 COLOR 7:LOCATE P+5,62:PRINT CHR$(17):GOTO 5090
5130 LOCATE P+5,62:PRINT "
5135 IF P=1 THEN P=9 ELSE P=P-1
5140 GOTO 5125
5150 COLOUR=P:CLOSE:OPEN "O",#1,"COLOUR.DAT":PRINT #1,COLOUR:CLOSE:GOTO 430
6000 CLS
6005 COLOR 2,0,0:LOCATE 1,1:
PRINT "
6010 LOCATE 2,1:
PRINT "
6015 LOCATE 3,1:
PRINT "
6030 COLOR 6:LOCATE 2,3:PRINT " Add floppy programs to winchester C:"
6035 LOCATE 5,2:PRINT " To continue & copy a floppy over to C: and then install
it in XT-MAN, press Y otherwise press N to return to page menu :":
COLOR 6:PRINT PAGE
6040 Zs=INKEY$
6045 IF Zs="Y" OR Zs="y" THEN 6100
6050 IF Zs="N" OR Zs="n" THEN 430
6060 GOTO 6040
6100 LOCATE 8,1:COLOR 3:PRINT "
6103 LOCATE 9,1:COLOR 3:PRINT "
6105 LOCATE 10,1:COLOR 3:PRINT "
6110 LOCATE 9,3:COLOR 2:PRINT "Insert disk in A:
6115 LOCATE 11,3:PRINT " and press ENTER when ready.
6120 Zs=INKEY$:IF Zs=CHR$(13) THEN 6125 ELSE 6120
6125 LOCATE 13,3:COLOR 3:PRINT "Directory to copy disk to (C:) .....":
INPUT DIR$
6130 IF LEN(DIR$)>8 THEN 6125 ELSE 6135
6135 LOCATE 15,3:COLOR 2:
PRINT "Ensure disk is in A: with the latch down & press ENTER
to begin copy of disk. ";
6140 Zs=INKEY$:IF Zs=CHR$(13) THEN 6150 ELSE 6140
6150 COLOR 6:PRINT " <ENTER>"
6160 KILL"XTEXC.BAT":CLOSE
6170 OPEN"a",#1,"XTEXC.BAT"
6171 PRINT #1,"ECHO OFF"
6172 PRINT #1,"CD\"
6173 PRINT #1,"IF EXIST C:\DIR$ GOTO PC"
6177 PRINT #1,"MD C:\DIR$"
6179 PRINT #1,"":PC"
    
```



# PROGRAM FILE

```

6181 PRINT £1,"CD\XTMAN
6185 PRINT £1,"a:"
6190 PRINT £1,"copy *.* c:\DIR$
6195 PRINT £1,"C:"
6200 PRINT £1,"chdir C:\xtman"
6205 PRINT £1,"cls"
6210 PRINT £1,"dir C:\DIR$"
6215 PRINT £1,"pause"
6220 PRINT £1,"x"
6225 CLOSE
6230 PRINT:COLOR 2:PRINT"Processing now ....."
6235 CLEAR
6240 CHDIR"C:\XTMAN
6245 VIEW PRINT 20 TO 23
6250 SYSTEM
7000 '***** dos utils
7003 CLEAR
7005 COLOR 2,1:LOCATE 7,20:PRINT"
7006 COLOR 2,1:LOCATE 8,20:PRINT"
7010 FOR R=9 TO 14:COLOR 2,1:LOCATE R,20:PRINT"
7020 LOCATE 15,20:COLOR 2,1:PRINT"
7040 COLOR 2,4:LOCATE 8,22:PRINT"Dos Utilities"
7045 COLOR 18,1:LOCATE 9,22:PRINT"
7050 LOCATE 10,22:PRINT"Directory A:"
7055 LOCATE 11,22:PRINT"Directory B:"
7060 LOCATE 12,22:PRINT"Directory C:"
7065 LOCATE 13,22:PRINT"TYPE file"
7070 LOCATE 14,22:PRINT"Custom"
7075 M(1)=10:M(2)=11:M(3)=12:M(4)=13:M(5)=14
7078 C=5:GOTO 7100
7080 Z$=INKEY$
7085 IF Z$="2" THEN 7100
7090 IF Z$="8" THEN 7150
7095 IF Z$=CHR$(27) THEN CHECK=2:GOTO 100
7095 IF Z$=CHR$(13) THEN 7200 ELSE 7080
7100 LOCATE M(C),21:COLOR 6:PRINT"
7105 IF C=5 THEN C=1 ELSE C=C+1
7110 COLOR 2:LOCATE M(C),21:PRINT CHR$(16):LOCATE M(C),35:PRINT CHR$(17)
7115 GOTO 7080
7150 LOCATE M(C),21:COLOR 6:PRINT"
7160 IF C=1 THEN C=5 ELSE C=C-1
7170 GOTO 7110
7200 ON C GOTO 7220,7290,7350,7450,7550
7220 CLS:LOCATE 2,3:PRINT"
7223 LOCATE 3,3:PRINT"
7225 LOCATE 4,3:PRINT"
7230 LOCATE 3,5:COLOR 3
7232 PRINT"Directory of A:"
7235 PRINT:PRINT
7237 COLOR 2:LOCATE 5,5:PRINT"Insert disk in A: and press ENTER. "
7239 Z$=INKEY$:IF Z$=CHR$(13) THEN 7245 ELSE 7239
7245 CLEAR:COLOR 6:PRINT" DIR A:/P "
7247 PRINT:COLOR 2:SHELL"dir A:/p"
7250 GOTO 7000
7254 Z$=INKEY$:IF Z$="R" OR Z$="r" THEN 7000 ELSE 7254
7290 CLS:LOCATE 2,3:PRINT"
7293 LOCATE 3,3:PRINT"
7295 LOCATE 4,3:PRINT"
7297 LOCATE 3,4:PRINT"Directory of B:"
7300 PRINT:PRINT
7305 COLOR 2:LOCATE 5,5:PRINT"Insert disk in B: and press ENTER. "
7307 Z$=INKEY$:IF Z$=CHR$(13) THEN 7310 ELSE 7307
7310 CLEAR:COLOR 6:PRINT" DIR B:/P "
7315 PRINT:COLOR 2:SHELL"DIR B:/P"
7320 GOTO 7250
7350 CLS:LOCATE 2,3:PRINT"
7352 LOCATE 3,3:PRINT"
7355 LOCATE 4,3:PRINT"
7357 LOCATE 3,4:PRINT"Directory of C:"
7360 PRINT:PRINT
7365 COLOR 2:LOCATE 5,5:PRINT"C: Directory to view :":INPUT D$
7367 IF D$="" THEN D$="" ELSE D$=D$
7370 PRINT:COLOR 6:PRINT" DIR C:\D$"/P":PRINT:DR$=CHR$(34)+""+D$+CHR$(34)
7375 OPEN "O",£1,"D.BAT":PRINT £1,"ECHO OFF"
7377 PRINT £1,"CLS"
7378 PRINT £1,"DIR C:\D$"/P"
7379 PRINT £1,"PAUSE"
7380 CLOSE:CLEAR:CLS:COLOR 2,0,0:CLS
7385 SHELL"D.BAT"
7390 KILL"D.BAT"
7395 GOTO 7000
7450 CLEAR
7455 CLS:LOCATE 2,3:PRINT"
7456 LOCATE 3,3:PRINT"
7457 LOCATE 4,3:PRINT"
7460 COLOR 3:LOCATE 3,4:PRINT"Type a file."
7465 COLOR 6:LOCATE 5,4:PRINT"Type file (*extn) to view .... "
7470 COLOR 1,3:LINE INPUT V$:DR$="TYPE "+V$
7473 PRINT:PRINT:COLOR 2,3,4:LOCATE 6,4:PRINT"Viewing ";V$
7475 PRINT
7480 SHELL DR$
7485 FOR P=1 TO 2000:NEXT P:GOTO 7000
7550 CLS
7560 COLOR 2:LOCATE 1,1:PRINT"
7565 LOCATE 2,1:PRINT"
7570 LOCATE 3,1:PRINT"
7575 COLOR 7
7580 LOCATE 2,3:PRINT"DOS Custom Procedure."
7585 CLOSE
7590 M(1)=" Create a new command file "
7595 M(2)=" Utilise a command file "
7600 M(1)=5:M(2)=7
7605 COLOR 3,1:LOCATE 10,20:PRINT"Use up & down cursors & select an option"
7606 LOCATE 11,20:PRINT"by pressing ENTER. <ESC> for DOS menu."
7610 LOCATE M(1),23:PRINT M(1)
7615 LOCATE M(2),23:PRINT M(2)
7617 C=2:GOTO 7650
7620 Z$=INKEY$:IF Z$="" THEN 7620
7625 IF Z$="2" THEN 7650 'down
7630 IF Z$="8" THEN 7670 'up
7640 IF Z$=CHR$(13) THEN 7700
7645 IF Z$=CHR$(27) THEN 7000
7650 COLOR 7,1:LOCATE M(C),23:PRINT M(C):IF C=2 THEN C=1 ELSE C=C+1
7655 COLOR 6,4:LOCATE M(C),23:PRINT M(C):GOTO 7620
7670 COLOR 7,1:LOCATE M(C),23:PRINT M(C):IF C=1 THEN C=2 ELSE C=C-1
7675 GOTO 7655
7700 ON C GOTO 7710,8000
7710 CLOSE:OPEN "I",£1,"dos.dat"
7715 C=1
7720 WHILE NOT EOF(1)
7725 INPUT £1,F$(C),OP1$(C),OP2$(C),OP3$(C),OP4$(C),OP5$(C)

```

# MICROMART

Please call to trade in  
IBM/Amiricot PC's

**P.B. ELECTRONICS LTD**  
P.O. BOX 96, WARRINGTON WA4 1LD  
09251 415635  
TLX 837400 ONEONE G. Quorn Ref: 7908001

**EPSON GQ3500 Laser inc 12 months on-site warranty £1425**

EPSON FX800	£312.00	EPSON LQ800	£453.00
EPSON FX1000	£399.00	EPSON LQ1000	£599.00
EPSON EX800	£395.00	EPSON LQ2500	£749.00
EPSON EX1000	£535.00	EPSON SQ2500	£975.00

<b>CANON LASER PRINTER LBP-8</b>				<b>£1475.00</b>
<b>EPSON COMPUTERS</b>				
EPSON PC/20Mb 512k MONO mon				<b>£950.00</b>
<b>BROTHER</b>				
M1409	£302.00	M1509		£390.00
M1709	£453.00	M4018		£1049
HR20	£347.00	HR25XL		£521
HR35	£746	HR40		£746

STARNR-15	£405.00	NL-10	£199.00
NB24-15	£525.00	NX-15	£272.00
NB-15	£655.00	ND-15	£339.00
NB24-10	£444.00		

## IBM COMPATIBLE COMPUTERS

SBCFD 540k 2x360k F/D mono monitor, keyboard, MS DOS	£599.00
SBCFDC as above with 14" colour monitor	£799.00
SBCHD 21540k 1x360k F/D 230Mb hard disk, mono mon, keyboard, MSDOS	£999.00
SBCHD 20C as above with 14" colour monitor	£1199.00
SBC 286AT 1Mb RAM 1x1.2Mb F/D 30Mb hard disk green/amber monitor	£1799.00
SBC 286Te as above with 14" EGA colour monitor	£1999.00

Please note all SBC computers inc 12 months on-site maintenance.  
Prices exclusive of VAT  
Major suppliers of a wide range of popular computers, peripherals, software etc. Call for competitive prices.

Tel: 0252312150

GU11 1YH  
HANTS  
ALDERSHOT  
26 BEAUMONT GROVE  
**BERCOL SUPPLIES**

ACCEPTED  
BARCLAYCARD + ACCESS  
S.A.E., FOR FULL LISTS  
RING FOR QUOTE OR SEND  
ATARI AND AMIGA COMPUTERS  
FROM £1.40  
3 1/2" FLOPPY DISKS!  
LOWEST PRICES FOR

## DICOUNT DISCS UNBEATABLE QUALITY AND VALUE

All disks are packed in a sturdy plastic library case and are guaranteed for life.

3 1/2" single-sided 135tpi	<b>£14.95</b>
3 1/2" double-sided 135tpi	<b>£16.95</b>
5 1/4" double sided 40/80 track	<b>£10.95</b>

All prices are for 10 and include VAT and postage and packing

### SPECIAL OFFER

3 1/2" double-sided 25 for £34.95 (bulk packed)

Access, Visa and Mailorders to:

## ALTRA

629 ROUNDHAY RD. OAKWOOD  
LEEDS LS8 4AR

**Telephone: 0532 484961**

Official and Trade Orders Welcome.

# MICROMART

## AMSTRAD

- A New Mail Order Service
- The Full Range
- Immediate Delivery
- Lowest Prices (inc. VAT)
- Authorised AMSTRAD Dealer
- Competitive Software Tailoring
- Specialists for Vehicle Hire
- Professional Consultancy

BUSINESS SYSTEMS		£
• PC1512SM	Single Drive, Mono	491.76
• PC1512DM	Dual Drive, Mono	611.43
• PC1512SC	Single Drive, Colour	677.95
• PC1512DC	Dual Drive, Colour	798.43
• PC1512HM	20Mb H Drive, Mono	984.82
• PC1512	20Mb H Drive, Colour	1170.81
• PCW8256	Disk Based Word Processor 1 Drive	437.00
• PCW8512	Disk Based Word Processor 2 Drive	546.52
HOME MICROS		
• CPC 464	Cassette based Computer green screen, Games pack	190.43
• CPC 464	Cassette based Computer Colour screen, Games pack	285.67
• CPC 6128	Disk based Computer with green screen	285.67
• CPC 6128	Disk based Computer with colour screen	380.90
• SPC 128+2	Sinclair Computer inc. gift pack (six games & joystick)	145.95
PRINTERS		
• DMP2	Printer	151.43
• DMP3	Printer	185.10
• DMP4	Printer 15 Carriage	382.24

Special Offer: PC1512DM - DMP3000 - Wordstar - Supercalc £750 (inc. VAT)  
 Plus - Free delivery and Installation for Business Users - Free Home Delivery for Home Micros - Free Microlink subscription with all orders  
 We also stock a wide range of Software & Consumables.  
 Please ring for details



33 Barkby Road, Leicester LE4 7HN UK  
 Tel: 0533 668134 Tlx: 341419 spce g



Bored with the keyboard?

Accounts not adding up?  
 Spreadsheets not spreading?

**LUCY PARR** has the solution  
 I offer you

accurate LocoScript Typing, also LocoScript Typing 2  
 Also

Pocket Wordstar for PCW8151, Wordstar 1512, Wordstar Original and 1st Word plus Atari ST.

(0243) 863130

15 Somerset Gardens, Bognor Regis, W Sussex. PO21 4AA

### YOU NEVER NEED TO LOOSE DATA AGAIN

LOSING DATA IS THE EASIEST THING TO DO IN COMPUTING, GETTING IT BACK AGAIN IS NOT SO EASY - UNTIL NOW! WE CAN GIVE YOU TOTAL DATA RECOVERY WITH A NEW SOFTWARE PRODUCT CALLED SECOND CHANCE

ALL IT WILL COST YOU IS £75.00 (PLUS VAT)! RETURN THE COUPON BELOW FOR YOUR SECOND CHANCE IN DATA RECOVERY

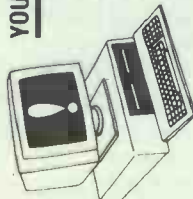

NAME \_\_\_\_\_  
 POSITION \_\_\_\_\_  
 COMPANY \_\_\_\_\_  
 ADDRESS \_\_\_\_\_  
 TELEPHONE \_\_\_\_\_  
 TELEFAX \_\_\_\_\_

**IT SERVICES LTD**  
 62 KELVINGROVE STREET  
 GLASGOW G3 7SA  
 TELEPHONE 041-332 6636  
 TELEFAX 041-221 5318

# PROGRAM FILE

```

7730 C=C+1
7733 WEND
7735 C=C-1
7740 COLOR 3,1:LOCATE 12,20:PRINT"So far there ";;
IF C=1 THEN PRINT "is"; ELSE PRINT"are";
7743 IF C=1 THEN PRINT C"entry so far."
7744 IF C<>1 THEN PRINT C"entries so far"
7745 FOR P=1 TO 1000:NEXT P:CLS:VIEW PRINT 1 TO 23:COLOR 6:FOR R=1 TO C
7755 COLOR 6,1:PRINT R";:COLOR 1,3:PRINT F$(R)
7758 NEXT R:C=C+1:VIEW PRINT:COLOR 2,1
7760 LOCATE 25,3:PRINT"Enter title of NEW operation to ADD to file .... ";
7765 INPUT F$(C)
7770 CLS:LOCATE 2,2:COLOR 3:
PRINT"Enter commands in DOS, pressing ENTER after each. To finish this st
age, <ESC>.";COLOR 2:PRINT
7780 COLOR 7,4:LOCATE 4,2:PRINT"
7785 FOR R=5 TO 10:LOCATE R,2:PRINT"
NEXT R
7790 LOCATE 11,2: PRINT"
7795 COLOR 2,4
7800 LOCATE 5,4:LINE INPUT OP1$(C)
7805 LOCATE 6,4:LINE INPUT OP2$(C)
7810 LOCATE 7,4:LINE INPUT OP3$(C)
7815 LOCATE 8,4:LINE INPUT OP4$(C)
7820 LOCATE 9,4:LINE INPUT OP5$(C)
7830 COLOR 3,1:LOCATE 13,4:PRINT"Are you happy with this routine Y/N ? ";
7835 Z$=INKEY$:IF Z$="" THEN 7835
7840 IF Z$="Y" OR Z$="y" THEN 7890
7845 IF Z$="n" OR Z$="N" THEN 7770
7890 CLOSE:OPEN "O",F1,"dos.dat"
7895 FOR R=1 TO C:WRITE F1,F$(R),OP1$(R),OP2$(R),OP3$(R),OP4$(R),OP5$(R):
NEXT R
7900 CLOSE:GOTO 7000
8000 DIM F$(300),OP1$(300),OP2$(300),OP3$(300),OP4$(300),OP5$(300):
CLOSE:OPEN "I",F1,"DOS.DAT"
8015 C=1
8020 WHILE NOT EOF(1)
8025 INPUT F1,F$(C),OP1$(C),OP2$(C),OP3$(C),OP4$(C),OP5$(C)
8030 C=C+1
8033 WEND
8035 C=C-1
8040 COLOR 3,1:LOCATE 12,20:PRINT"So far there ";;
IF C=1 THEN PRINT "is"; ELSE PRINT"are";
8043 IF C=1 THEN PRINT C"entry."
8044 IF C<>1 THEN PRINT C"entries."
8045 FOR R=1 TO 1000:NEXT R:COLOR 6:CLS:VIEW PRINT 1 TO 23:FOR R=1 TO C
8055 COLOR 6,1:PRINT R";:COLOR 1,3:PRINT F$(R)
8058 NEXT R:C=C+1:COLOR 2,1:VIEW PRINT
8060 LOCATE 25,3:PRINT"Enter routine number to execute (0 to exit) .... ";
8065 INPUT NUM:IF NUM=0 THEN 7550
8070 IF NUM>C OR NUM<1 THEN 8060
8075 C=NUM
8080 CLOSE:OPEN "O",F1,"TYPEIT.BAT"
8085 PRINT F1,"echo off"
8086 PRINT F1,"CLS"
8090 IF OP1$(C)="" THEN 8100 ELSE PRINT F1,OP1$(C)
8100 IF OP2$(C)="" THEN 8110 ELSE PRINT F1,OP2$(C)
8110 IF OP3$(C)="" THEN 8120 ELSE PRINT F1,OP3$(C)
8120 IF OP4$(C)="" THEN 8130 ELSE PRINT F1,OP4$(C)
8130 IF OP5$(C)="" THEN 8150 ELSE PRINT F1,OP5$(C)
8131 PRINT F1,"C:"
8132 PRINT F1,"CD\XTMAN"
8135 CLEAR:CLOSE:CLS:SHELL"TYPEIT.BAT"
8150 GOTO 7550
9000 COLOR 0,0,0:CLS
9005 C$=""
9010 COLOR 2
9020 LOCATE 3,3:PRINT"System Locked : Type password to UNlock":LOCATE 5,3
9030 FOR R=1 TO LEN(P$)
9040 Z$=INKEY$:IF Z$="" THEN 9040
9050 COLOR 6:C$=C$+Z$:PRINT CHR$(4);
9060 NEXT R
9070 IF C$=P$ THEN 9100 ELSE 9000
9100 GOTO 430
9200 COLOR 2,1:S$="" :SNS="" :DNO$="" :CLOSE
9205 LOCATE 1,1:PRINT
9210 LOCATE 2,1:PRINT
9213 LOCATE 3,1:PRINT
9215 LOCATE 4,1:PRINT
9217 LOCATE 5,1:PRINT
9220 LOCATE 6,1:PRINT
9223 LOCATE 7,1:PRINT
9225 LOCATE 8,1:PRINT
9230 COLOR 3,4
9235 LOCATE 2,2:PRINT " Search floppy diskette file "
9240 COLOR 2
9245 LOCATE 3,2:PRINT " Add Change Del Search [ESC]"
9250 LOCATE 7,2,1,0,7:COLOR 2,1
9255 Z$=INKEY$:IF Z$="" THEN 9255
9260 IF Z$="a" OR Z$="A" THEN 9300 'add
9265 IF Z$="c" OR Z$="C" THEN 9400 'change
9267 IF Z$="d" OR Z$="D" THEN 9500 'delete
9270 IF Z$="s" OR Z$="S" THEN 9600 'search
9272 IF Z$=CHR$(27) THEN LOCATE ,,0:GOTO 430
9275 GOTO 9255
9300 C=1:LOCATE 7,2:PRINT" Enter software name "
9305 LOCATE 4,3:FOR R=1 TO 27
9310 Z$=INKEY$:IF Z$="" THEN 9310
9313 IF Z$=CHR$(13) THEN 9320
9315 S$=S$+Z$:PRINT Z$;
9317 NEXT R
9320 R=27
9330 LOCATE 7,2: PRINT" Enter diskette name "
9335 LOCATE 5,3:FOR R=1 TO 27
9340 Z$=INKEY$:IF Z$="" THEN 9340
9345 IF Z$=CHR$(13) THEN 9355
9350 SNS=SNS+Z$:PRINT Z$;
9353 NEXT R
9355 R=27
9360 LOCATE 7,2: PRINT" Enter diskette number "
9365 LOCATE 6,3:FOR R=1 TO 27
9370 Z$=INKEY$:IF Z$="" THEN 9370
9375 IF Z$=CHR$(13) THEN 9385
9380 DNO$=DNO$+Z$:PRINT Z$;
9383 NEXT R
9385 R=27
9390 LOCATE 7,2: PRINT" Save information Y/N ";
9392 Z$=INKEY$:IF Z$="" THEN 9392
9393 IF Z$="y" OR Z$="Y" THEN 9396
9394 IF Z$="n" OR Z$="N" THEN 9200
9395 GOTO 9392
    
```

# PROGRAM FILE

```

9396 OPEN "a",#1,"floppy.dat":WRITE #1,S#,SNS,DNO$
9397 GOTO 9200
9400 REM
9402 OPEN "I",#1,"FLOPPY.DAT"
9404 C=1:WHILE NOT EOF(1)
9405 INPUT #1,S$(C),SNS$(C),DNO$(C)
9407 C=C+1:WEND:C=C-1
9410 MAX=C:C=1
9415 LOCATE 4,3:PRINT"          ":LOCATE 4,3:PRINT S$(C)
9417 LOCATE 5,3:PRINT"          ":LOCATE 5,3:PRINT SNS$(C)
9420 LOCATE 6,3:PRINT"          ":LOCATE 6,3:PRINT DNO$(C)
9425 COLOR 3:LOCATE 7,2:PRINT" Edit Y/N [ESC] ":COLOR 2
9427 Z$=INKEY$:IF Z$="" THEN 9427
9430 IF Z$="Y" OR Z$="y" THEN 9440
9432 IF Z$="N" OR Z$="n" THEN 9435
9433 IF Z$=CHR$(27) THEN CLOSE:GOTO 9200
9434 GOTO 9427
9435 IF C=MAX THEN 9425
9436 C=C+1:GOTO 9415
9440 LOCATE 4,3:PRINT"          "
9443 LOCATE 5,3:PRINT"          "
9445 LOCATE 6,3:PRINT"          "
9450 LOCATE 7,2:PRINT" Enter NEW software name ":S$(C)="" :SNS$(C)="" :DNO$(C)=""
9455 LOCATE 4,3:FOR R=1 TO 27
9457 Z$=INKEY$:IF Z$="" THEN 9457
9459 IF Z$=CHR$(13) THEN 9463
9460 S$(C)=S$(C)+Z$:PRINT Z$:NEXT R
9463 R=27:LOCATE 7,2:PRINT" Enter NEW diskette name "
9465 LOCATE 5,3:FOR R=1 TO 27
9467 Z$=INKEY$:IF Z$="" THEN 9467
9470 IF Z$=CHR$(13) THEN 9477
9472 SNS$(C)=SNS$(C)+Z$:PRINT Z$:NEXT R
9477 R=27:LOCATE 7,2:PRINT" Enter NEW diskette number "
9480 LOCATE 6,3:FOR R=1 TO 27
9482 Z$=INKEY$:IF Z$="" THEN 9482
9484 IF Z$=CHR$(13) THEN 9490
9485 DNO$(C)=DNO$(C)+Z$:PRINT Z$:NEXT R
9490 R=27
9491 LOCATE 7,2:PRINT" Save NEW information Y/N "
9492 Z$=INKEY$:IF Z$="" THEN 9492
9493 IF Z$="Y" OR Z$="y" THEN 9496
9494 IF Z$="N" OR Z$="n" THEN 9200
9495 GOTO 9492
9496 CLOSE:OPEN "o",#1,"floppy.dat":FOR R=1 TO MAX:WRITE #1,S$(R),SNS$(R),
DNO$(R):NEXT R:CLOSE:GOTO 9200
9500 OPEN "I",#1,"FLOPPY.DAT"
9504 C=1:WHILE NOT EOF(1)
9507 INPUT #1,S$(C),SNS$(C),DNO$(C)
9509 C=C+1
9510 WEND:C=C-1
9513 MAX=C:C=1
9515 LOCATE 4,3:PRINT"          ":LOCATE 4,3:PRINT S$(C)
9517 LOCATE 5,3:PRINT"          ":LOCATE 5,3:PRINT SNS$(C)
9519 LOCATE 6,3:PRINT"          ":LOCATE 6,3:PRINT DNO$(C)
9520 LOCATE 7,2:PRINT" Delete Y/N [ESC] ":
9523 Z$=INKEY$:IF Z$="" THEN 9523
9525 IF Z$="Y" OR Z$="y" THEN 9535
9526 IF Z$="N" OR Z$="n" THEN 9530
9527 IF Z$=CHR$(27) THEN CLOSE:GOTO 9200
9528 GOTO 9523
9530 IF C=MAX THEN 9520
9533 C=C+1:GOTO 9515
9535 CLOSE:OPEN "o",#1,"floppy.dat"
9540 FOR R=1 TO C-1:WRITE #1,S$(R),SNS$(R),DNO$(R):NEXT R
9545 FOR R=C+1 TO MAX:WRITE #1,S$(R),SNS$(R),DNO$(R):NEXT R:CLOSE
9550 LOCATE 7,2:PRINT" Deletion complete ":FOR R=1 TO 1000:NEXT R:GOTO 9200
9600 REM
9610 LOCATE 7,2:PRINT" Enter search string ":SER$=""
9615 LOCATE 4,3:FOR R=1 TO 27
9620 Z$=INKEY$:IF Z$="" THEN 9620
9623 IF Z$=CHR$(13) THEN 9630
9624 IF Z$=CHR$(27) THEN CLOSE:GOTO 9200
9625 SER$=SER$+Z$:PRINT Z$:
9627 NEXT R
9630 R=27
9635 LOCATE 7,2:COLOR 18:PRINT" Searching ...          ":COLOR 2
9640 CLOSE:OPEN "i",#1,"floppy.dat":C=1
9645 WHILE NOT EOF(1)
9650 INPUT #1,S$(C),SNS$(C),DNO$(C)
9655 C=C+1:WEND:C=C-1
9660 MAX=C:C=1
9665 FOR C=1 TO MAX
9670 L=LEN(SER$)
9675 IF LEFT$(S$(C),L)=SER$ THEN 9700
9677 NEXT C
9680 LOCATE 7,2:COLOR 2:PRINT" End of file ...          "
FOR R=1 TO 1000:NEXT R:CLOSE:GOTO 9200
9700 LOCATE 7,2:COLOR 3:PRINT" -----Found----- "
9710 LOCATE 4,3:PRINT"          ":LOCATE 4,3:PRINT S$(C)
9715 LOCATE 5,3:PRINT"          ":LOCATE 5,3:PRINT SNS$(C)
9720 LOCATE 6,3:PRINT"          ":LOCATE 6,3:PRINT DNO$(C)
9730 LOCATE 7,2:FOR P=1 TO 3000:NEXT P
9735 LOCATE 7,2:COLOR 2:PRINT" C to continue or [ESC] "
9740 Z$=INKEY$:IF Z$="" THEN 9740
9745 IF Z$="C" OR Z$="c" THEN 9677
9747 IF Z$=CHR$(27) THEN 9200
9750 GOTO 9740

```



## Apricot Portable Monitor Tip

by Paul Hardy

Now that the Apricot Portable has come down in price, many people may want to attach a colour monitor to it. The Apricot puts out an RGBI signal, but the pins are not in a stan-

dard order. Making a cable is not too difficult, however, for those with a little skill with a soldering iron. You will need two female 9-pin D connectors and some 9-strand cable. The

# MICROMART

## Budget TYPESETTING

The pioneers in high quality, budget-priced typesetting of magazines, books leaflets etc. from your disk [IBM, Amstrad, BBC, Apricot etc.] or by modem via our own Typenet system or Telecom Gold.

Send now for your free information pack, to:

**BUDGET TYPESETTING**

53 Rowan Walk

Bromley, Kent BR2 8QW

Telephone 0689 53546

Typenet 0689 50866

Telecom Gold 83: BTL001

## 20Mb Winchester PC/XT Upgrade Kit

SPECIAL OFFER

# £289

excl delivery and VAT

- ★ Seagate ST225 Drive
- ★ Western Digital Controller
- ★ Cables, screws, etc.
- ★ Instructions

Suitable for PC/XT and compatibles (not Amstrad)

Also from: Scotia Computer Services

(041 221 9737), Olympic House,

142 Queen Street, Glasgow G1 3BU

By Post: Send cheque for £336.95 (incl £4 del & VAT) to PO Box 312, Wrexham, Chwyd, LL12 0XX

Allow 7 days for cheques to clear

By telephone: Ring 0244 571677 with your Credit Card Number

Gov Depts, Schools, PLCs: Send Official Purchase Order. Dealer enquiries welcome.

## Western Technology

PO Box 312 — Wrexham, Chwyd LL12 0XX  
Tel: 0244 571677

### EXPANSIONS AND UPGRADES

30110	Floppy Disk Controller for XI, 2 x 360k Drives	35.00
30130	Colour Graphics Card, 320 x 200 dots	65.00
30140	Monochrome Video Card, 80 x 25 Characters only	69.00
30150	Monochrome Graphic/Printer Card	83.00
30160	Enhanced Graphics Card	275.00
30200	Multi I/O with Floppy Controller	89.00
30210	Multi I/O Card	69.00
30220	Serial Card, 1 + 1 optional	29.00
30230	Parallel Printer Card	19.00
30240	54k Buffered Printer Card with 16k RAM	99.00
30250	Game I/O Card, 2 Channels	17.00
30260	384k Multi function Card supplied without RAM	99.00
30270	Serial/Parallel Card for AT	67.00
30280	576k Memory Expansion Card supplied without RAM	52.00
30290	Clock/Calendar Card	39.00
30300	2 5Mb RAM Card for AT, supplied without RAM	126.00
30310	2 5Mb Multi func. Card for AT, supplied without RAM	165.00
30320	Hard Disk Controller, for XT	128.00
31100	AD/DA Card, 12 bit	96.00
31150	Eprom Writer	117.00
31160	Eprom Writer (4 Textool sockets)	245.00
31180	PAL Programmer Card	314.00
31210	8255 I/O Card	91.00
31220	4 Channel RS232 Card for PC/XT	171.00
31225	4 Channel RS232 Card for AT	171.00
31230	8 Channel RS232 Card for PC/XT	332.00
31235	8 Channel RS232 Card for AT	332.00
31240	Bi-Synchronous RS232 Communications Card	105.00
34010	Joystick	15.00
34020	Mouse	49.00
34100	PC/XT Standard Keyboard Type 505A, PC/XT only	59.00
34105	AT Style Keyboard Type 505I, PC/XT/AT	69.00
34110	Selectric Style Keyboard Type 5151, PC/XT/AT	89.00
34200	XT 8 Slot Cabinet	69.00
34310	150W Power Supply Unit for PC/XT	79.00
34320	200W Power Supply Unit for AT	155.00
38120	PC/XT 20Mb Upgrade Kit, 65MS, with control, cables etc	285.00
38130	PC/XT 30Mb Upgrade Kit, with control, cables etc	445.00
38320	PC/XT 20Mb Hardcard	399.00
38330	PC/XT 30Mb Hardcard	458.00
38810	Amstrad Comp 10Mb Tape Backup, Cnsite	399.00
38820	Amstrad Comp 20Mb Tape Backup, Cnsite	499.00

Please add £1 per item (4 per item marked \*) and 15% VAT and send your order (or phone with VISA or ACCESS number) to 0244 571677

## Western Technology

PO Box 312, Wrexham, Chwyd, CL12 0XX

# MICROMART

## SPECIAL OFFERS

Ferranti PC 2860 AT 3 only .....£1750  
 Amstrad PC 1512 DD, MM 512k + .....£475  
 Amstrad PC 1512 DD, MM 640k inc WP, DB, SS, GP Plus  
 Epson LX80 NLQ Printer .....£679  
 Sanyo MBC 555 .....£150  
 Epson LX80 NLQ Printers .....£145  
 Psion II Organiser from .....£79.50  
 IBM Compatibles from .....£448  
 20Mb Hard Card .....£285

Bondwell portables (BW8 & BW18)  
 Fully IBM compatible. Introductory offer price ..... P.O.A.  
 Bondwell 5 1/4 drive BW8 .....£150

SBC COMPUTERS intro price ..... P.O.A.

Sage Software ..... Phone for best prices  
 Upgrade Kits 20Mb hard drive kits .....£295  
 360k Floppy Drive for IBM etc .....£85  
 Amstrad PC1512 Memory Upgrade .....£21  
 Colour monitors ..... from £175

IBM compatible power supplies, upgrade boards,  
 Motherboards, cases, controllers etc  
**ALL AT SPECIAL PRICES**

Several ex-demo printers/modems etc ..... SPECIAL PRICE  
 VAT and carriage extra

## COMPUTER FACILITIES

(A Springall Ltd)

2 Kings Highway, London SE18 2NJ

Tel: 01-854 5313

## SIGNWRITER

Instant display lettering by computer

- Signs printed across or down the page
- Drives most dot-matrix printers etc
- Sharp characters any size - the bigger the better
- Create logos, symbols, fonts in any language
- Extra fonts £5.75 each + disk:

ROME Shop Fair  
 Dawn Hand Olde

£92<sup>a</sup>  
 £49.95<sup>b</sup>  
 £29.95<sup>c</sup>

## LABELWRITER

- Multiple identical labels, any size & number across
- Uses all the printer's type-styles
- Serial numbers and logos too

## PAPERBASE De Luxe

Personal bibliographic database

- Stores, finds, and styles references
- Flexible storage in portable sequential files

PRICES: <sup>a</sup>PC & Apricot <sup>b</sup>Amstrad PCW <sup>c</sup>BBC

All available from the publisher  
**WIGHT SCIENTIFIC**  
 44 Roan Street, London SE10 9JT  
 (01) 858 2699

OXSTAT for statistics  
 HISTO for histograms  
 FREQ for word counts  
 INDEXER

16-bit SIGNWRITER created this advertisement, A4-size

## SHAREWARE

We have the best Public Domain Software For: IBM PC Compatibles, Amstrad PCW, Amstrad CPC 6128. Catalogues are available free of charge. Please state which machine you have.

**Special Offer:** Genuine Amsoft CF2 3" disks at only £2.25 including VAT Individually wrapped and fully guaranteed. Please add £1 per order towards postage.

**PROSPEC Computer Systems,**  
 PO Box 28, Beeston,  
 Nottingham NG9 1PH

# PROGRAM FILE

cable should be made up as shown in Fig 1.

On the Apricot side, pin 1 is unused; and on the monitor side, pins 2 and 7 are unused.

This procedure will, of course, only work with colour monitors taking a 9-pin D connector input such as colour monitors intended for use with IBM CGA displays.

Apricot end	Signal pin number	Monitor end	Pin number
+12v	1	no connection	
R	2	-----	3
I	3	-----	6
Hsync	4	-----	8
Vsync	5	-----	9
+0v	6	-----	1
G	7	-----	4
Ground	8	-----	1
B	9	-----	5

Fig 1



## Psion Organiser Program Suite

by Sean Overend

This suite of programs occupies just under 16k. Not all the programs need be used, but be careful when entering programs since they share several common routines. There are two sets of programs: one to calculate interest rates in various ways; and the other to provide a local train timetable and information about the departure time of the next train.

The program CRSTIAC is used by the timetable program for data entry as well as by the interest rate prog-

ram. Data can be stored in A, B or C. In the programs, it is assumed that interest information is stored in C:STIAC and C:JDR, while timetable information is in A:Tdown and A:Up.

Each new procedure is preceded by asterisks, and the top-level programs that can be called from the Organiser menu (press the Mode key when you switch on) are SKO and TTBLE.

### \*\*\*\*\*GENERAL INPUT ROUTINES\*\*\*\*\*

QZ: (a#)

This (Psion) routine returns an integer through the procedure identifier.

```
LOCAL zX
ONERR I1::
I1::CLS :PRINT a#,CHR$(16);
INPUT zX
CLS
RETURN (zX)
```

Q: (a#)

This returns a non-integer number.

```
LOCAL z
ONERR I1::
I1::CLS :PRINT a#,CHR$(16);
INPUT z
CLS
RETURN (z)
```

### \*\*\*\*\*THE INTEREST PROGRAMS\*\*\*\*\*

(a) The driver program SKO

SKO

The program name "SKO" should be inserted in the main menu display of the computer. When run the user is given three alternatives, namely:

- (i) to subtract two dates, the answer being given in days (inclusive of both dates),
- (ii) to calculate simple interest accruing daily on a given capital sum between two dates (inclusive), the interest rates being those set out in a specified interest rate file - the calculation allowing for the interest rates to vary on any number of occasions between the

# PROGRAM FILE

start and end of the period.  
(iii) to create the interest rate file, containing eg the Short Term Investment Account, or movements in the Bank Rate of one of the clearing house banks etc

```
GLOBAL NZ,MZ,IZ,JZ,IZ,HZ
LOCAL iZ
iZ=MENU("DATES,CALCINT,RATES")
IF iZ=0:RETURN
ELSEIF iZ=3:CRSTIAC:RETURN
ELSEIF iZ=1
NZ=qZ:("Lo day")
MZ=qZ:("Lo month")
LZ=qZ:("Lo year")
JZ=qZ:("Hi day")
IZ=qZ:("Hi mnth")
HZ=qZ:("Hi year")
IF CMPDTZ:(NZ,MZ,LZ,JZ,IZ,HZ)=0
MO=SUBZ:(NZ,MZ,LZ,JZ,IZ,HZ)
PRINT "(MO) ";MO:GET
ELSE PRINT CHR$(16):ENDIF
ELSEIF iZ=2
M1=INT:
PRINT "(M1) interest"
PRINT FIX$(M1,2,-13)
GET
ENDIF
```

(b) The Date subtraction routines

```
*****
CMPDTZ:(SDZ,SMZ,SYZ,ODZ,OMZ,OYZ)
LOCAL Z
IF SYZ>OYZ:RETURN(-1)
ELSEIF SYZ=OYZ:RETURN(0)
ELSEIF SMZ>OMZ:RETURN(-1)
ELSEIF SMZ=OMZ:RETURN(0)
ELSEIF SDZ>ODZ:RETURN(-1)
ELSE RETURN(0)
ENDIF
```

```
*****
SUBZ:(NZ,MZ,IZ,JZ,IZ,HZ)
LOCAL DZ,YZ,ES(2),YS(24),Z
DZ=0
IF HZ=1Z
IF MZ=IZ:RETURN(JZ-NZ+1):ENDIF
YS=MDY$(HZ)
ES=MID$(YS,2*HZ-1,2)
DZ=VAL(ES)-NZ+1
Z=MZ
WHILE Z<(IZ-1)
Z=Z+1
ES=MID$(YS,2*Z-1,2)
DZ=DZ+VAL(ES)
ENDWH
RETURN(DZ+JZ)
ENDIF
YS=MDY$(IZ)
ES=MID$(YS,2*IZ-1,2)
DZ=VAL(ES)-NZ+1
Z=MZ
WHILE Z<12
Z=Z+1
ES=MID$(YS,2*Z-1,2)
DZ=DZ+VAL(ES)
ENDWH
Z=1Z
WHILE Z<(HZ-1)
Z=Z+1:DZ=DZ+365
YS=MDY$(Z)
IF MID$(YS,4,1)="9"
DZ=DZ+1:ENDIF
ENDWH
YS=MDY$(HZ)
IF IZ>1
Z=0
WHILE Z<(IZ-1)
Z=Z+1
ES=MID$(YS,2*Z-1,2)
DZ=DZ+VAL(ES)
ENDWH
ENDIF
RETURN(DZ+JZ)
```

```
*****
MDY$(YZ)
LOCAL KZ
KZ=YZ-4*(INT(YZ/4))
IF KZ=0
RETURN("312931303130313130313031")
ELSE RETURN("312831303130313130313031")
ENDIF
```

(c) To create the interest rate file  
The CRSTIAC program

CRSTIAC

As for the Tax file creation program, this program will either allow a new file to be started, or an existing one to be displayed and/or added to, or the whole deleted. The format is given below.

# MICROMART

**WANTED FOR CASH!!**  
**ALL TYPES OF COMPUTER EQUIPMENT**

ATARI, AMSTRAD, IBM PC, BBC, COM 64 etc.  
BULK QUANTITIES ACCEPTED.

**WE BUY, SELL AND PART EXCHANGE NEW AND USED**

FULL MAIL ORDER SERVICE WITH GUARANTEE

Educational discounts available



(DATA DIRECT LTD)  
53 RUGBY ROAD, WORTHING, SUSSEX  
Tel: :0903) 40509 24 hours

## FLOPPY DISKS

All prices plus VAT  
Free delivery

CODE	PRICE EACH UNIT			
	10-40	50-90	100+	
8"	SS SD FD 1S-128N	1.70	1.61	1.52
	DS DD FD 2D-1024N	2.25	2.13	2.00
5 1/4"	SS DD MD 1D-48SH	1.11	1.04	0.99
	DS DD MD 2D-48SH	1.30	1.23	1.16
3 1/2"	DS 96TPI MD 2D-96SH	1.57	1.48	1.40
	DS 1.6MGB MD 2HD-1.6	2.46	2.33	2.19
NEW	SS 250K MF 1DD	1.65	1.57	1.47
	DS 500K MF 1DD	2.19	2.08	1.96
NEW	DS 1000K MF 2DD	2.39	2.26	2.13
	DS 2000K MF 2HD	5.94	5.57	5.30

**Polanka Video Limited**  
Unit X5 · Acton Business Centre  
School Road · London NW10 6TD  
**01 965 4413**

## COMPUTER REPAIRS

SPECTRUM 16/48 .....	£19.95
SPECTRUM + .....	£19.95
QL .....	£27.95
COMMODORE 64 .....	£35.00
AMSTRAD 464/664 .....	£24.95
AMSTRAD 6128 .....	£27.95
AMSTRAD PCW 8256/512 .....	P.O.A.
AMSTRAD PC 1512 .....	P.O.A.

PLEASE PHONE FOR DETAILS

THE PRICES SHOWN ARE FULLY INCLUSIVE OF PARTS, LABOUR, POSTAGE, INSURANCE, VAT AND 3 MONTH GUARANTEE. SEND ITEM WITH CHEQUE AND DESCRIPTION OF FAULT TO:



DEPT PCW, UNIT 6,  
STANLEY HOUSE, STANLEY AVENUE,  
WEMBLEY, MIDDX HA0 4JB.  
Telephone: 01-902 5218



## DESK TOP PUBLISHING

LIKE THE TECHNOLOGY  
DONT LIKE THE CAPITAL COST

### ACT BUREAU

BRINGS YOU THE BENEFITS  
BUT NOT THE COST

- \* COMPUTERS, SCANNERS, LASER PRINTERS
- \* HIGH QUALITY ORIGINALS WITH TEXT AND GRAPHICS
- \* WORD PROCESSING (M/S WORD)
- \* FULL BUSINESS SUPPORT-DBASE111+, LOTUS 123, ALDUS PAGEMAKER
- \* DATABASE/MAILLIST MANAGEMENT
- \* COMMUNICATIONS LINKS
- \* SYSTEMS CONSULTANCY

ACT SYSTEMS ISABEL HOUSE, VICTORIA RD  
SURBITON, SURREY 01-390-6562

## BUTTONWARE FOR THE IBM PC

**PC-FILE +** — The latest version of PC-File which will still read all your PC-File III/PC-File/R files as well as exchanging data with other programs such as Visicalc DBase II/III, Lotus 123 and many others. PC-File + is easy to use with over 175 help screens, extensive sorting and searching options and user defined entry and report screens.

**PC-Type +** — A fast and easy to use word processor which comes with a 100,000 word spelling checker, undelete key, Macros, search/replace, on-line help, sorting, mail merge and many other facilities. Works with PC-File databases.

Each program comes with extensive documentation, is fully supported and costs £49.95 (+ VAT). Please send your order and check, or write for further information to:

**ASHGATE LTD.,  
UNIT B, BUZZARD WORKS,  
BILLINGTON ROAD, LEIGHTON BUZZARD,  
BEDS LU7 8TN  
(0525) 383274**

An authorised Buttonware Distributor

This program is also used to create a file for the Timetable program'

```
LOCAL y%,Stiac*(8)
PRINT "Create file:"
INPUT Stiac
```

I have used files named C:STIAC and C:JDR to store the Short Term Investment Account rates and the Judgment Debt rates

```
IF NOT EXIST(Stiac*)
CREATE Stiac*,A,d%,m%,yr%,r
ELSE OPEN Stiac*,A,d%,m%,yr%,r
PRINT "Display Y/N" :KSTAT 1
IF GET*(">")="Y"
LAST :ENDIF
DO
PRINT A,d%:"-":A,m%:"-":A,yr%:" " :A,r%:"%" :GET
NEXT
UNTIL EOF
ENDIF
```

The format for data entry is to enter in strict chronological order each change in the interest rate in the sequence: Day Month Year %Rate eg the following, taken from the Judgment Debt Rates:

20	4	1971	7.5(%)
1	3	1977	10
3	12	1979	12.5
9	6	1980	15
8	6	1982	14
10	11	1982	12
16	4	1985	15

The data format for creation of a timetable is shown in the Timetable section below.

```
KSTAT 3
DO
A,d%=Q%("Day or 99")
IF A,d%>31 :BREAK :ENDIF
A,m%=Q%("Month")
A,yr%=Q%("Year")
A,r%=Q%("% Rate")
y%=A,d%
APPEND
UNTIL y>31
CLOSE
PRINT "Done"
PRINT "DELETE Y/N":CHR*(16) :KSTAT 1
IF GET*="Y" :DELETE Stiac*
PRINT "Deleted"
ELSE PRINT "OK"
ENDIF
GET
```

(d) The substantive interest calculation program - INT (using files "C:STIAC" and "C:JDR" as examples)

```
INT
LOCAL dys%,tot%,z%,Stiac*(8),n%,m%,l%,j%,i%,h%,
cap,curr,a%,b%,c%,in,a*(1),pr%
z%=MENU("C:STIAC,C:JDR,another")
IF z%=1 :Stiac*="C:STIAC"
ELSEIF z%=2 :Stiac*="C:JDR"
```

Use your own file names in the preceding three lines if you prefer instead of C:STIAC and C:JDR

```
ELSE PRINT "Which rate file"
INPUT Stiac*
ENDIF
IF NOT EXIST(Stiac*)
PRINT "No such file":CHR*(16) :GET :RETURN
ELSE OPEN Stiac*,A,d%,m%,yr%,r
ENDIF
cap=q%("Capital sum")
n%=q%("Start day")
m%=q%("Start mnth")
l%=q%("Start year")
curr=A,r
DO
z%=CMPD%:(n%,m%,l%,A,d%,A,m%,A,yr%)
IF z%=0 :BREAK :ENDIF
curr=A,r
NEXT
UNTIL EOF
j%=q%("Last day")
i%=q%("Last mnth")
h%=q%("Last year")
PRINT "Details Y/N" :a%=GET%
IF UPPER(a%)="Y"
pr%=-1
ELSE pr%=0 :ENDIF
a%=A,d% :h%=A,m% :c%=A,yr%
PRINT "Calculating"
DO
z%=CMPD%:(j%,i%,h%,a%,b%,c%)
IF z%=0 OR EOF
a%=j% :b%=i% :c%=h% :ENDIF
dys%=sub%:(n%,m%,l%,a%,b%,c%)
IF EOF :z%=0 :ENDIF
in=COMP%:(cap,curr,dys%+z%,pr%)
tot=tot+in
n%=a% :m%=b% :l%=c%
IF EOF :BREAK :ENDIF
curr=A,r
NEXT
a%=A,d% :b%=A,m% :c%=A,yr%
UNTIL z%=0
CLOSE
RETURN(tot)
```

\*\*\*\*\*

# PROGRAM FILE

COMP: (cap,curr,dys%,pr%)  
Calculation of daily interest, with option of display.

```
LOCAL ans
ans=cap*curr/36500*dys%
IF pr%<>0
PRINT dys%;"d:";curr:"% "=";ans :GET
ENDIF
RETURN(ans)
```

\*\*\*\*\* THE TIMETABLE PROGRAMS  
\*\*\*\*\* (a) The driver program TTBLE

TTBLE  
Busy commuters put TTBLE in the computer's main menu as the first entry to reduce the number of key presses to a minimum

```
LOCAL i%,f%(8),ch%,cm%,ct%,cz%
i%=MENU("exAmer,exLondon")
```

Any number of departure stations (airports etc) can be entered here, provided a separate data timetable is created for each. In the example, the times of trains exAmer (sham) are stored in the "A:Tdown" data file, while the times of trains exLondon are stored in "A:Tup" (I know they should be the other way round!). The user selects which timetable he needs by menu selection.

```
IF i%=1
f%="A:Tdown"
ELSE
f%="A:Tup"
ENDIF
OPEN f%,A,h%,m%,t%,z%
ch%=HOOR :cm%=MINUTE
PRINT HOUR,MINUTE
GET
```

Find out the time from the system clock and display it. Then work out the time of the next train by comparing the current time with the chronological list of departures.

```
DO
IF ch%<A.h% OR (ch%=A.h% AND cm%<=A.m%) :BREAK :ENDIF
NEXT
i%=i%+1
UNTIL EOF OR i%>50
```

Hitting the space key repeatedly will give the following entries in the timetable after the next train. Any other key terminates.

```
DO
PRINT A.h%,A.m%:" ";
```

The destinations are printed out in accordance with the code you have chosen. In this case the destination codes are:

```
0 Aldgate
1 Baker St
2 Marylebone
3 Amersham
4 Chesham
```

```
IF A.t%=0
PRINT "Aldgate"
ELSEIF A.t%=1
PRINT "Baker St"
ELSEIF A.t%=2
PRINT "M'bone"
ELSEIF A.t%=3
PRINT "Am "
ELSEIF A.t%=4
PRINT "Ch "
ENDIF
```

The comment codes that follow can be alternative departure points eg

```
1 ex Farringdon
2 ex Baker Street
3 ex Marylebone
```

```
IF A.z%=1
PRINT "exFAR"
ELSEIF A.z%=2
PRINT "exB.St"
ELSEIF A.z%=3
PRINT "exM'B"
ENDIF
```

If you want to insert an ARRIVAL TIME in the Data file instead of a comment code then insert the following 3 program lines here:

```
IF A.z%>3
PRINT A.z%
ENDIF
```

```
NEXT
UNTIL GET%<>" " OR EOF
CLOSE
```

\*\*\*\*\* The Timetable data creation program

Use the CRSTIAC program, by selecting SKO, then RATES on the menu, and then enter A:Tdown or A:Tup (or whatever) when asked for a file name. You then enter the departure times in strict chronological order, each entry

# MICROMART

## COMPUTER PROBLEMS?

### WE HAVE THE SOLUTIONS

Not all data switches and converters are the same. Check these features when selecting your next purchase.

#### DO THEY INCLUDE:

	Us	Them
Computer and Printer Cables	X	?
Direct from manufacturer from stock	X	?
Attractive styling and small size	X	?
No quibble guarantee	X	?
Experienced technical support	X	?
Competitive pricing	X	?
1st class postage and packing	X	?
Customised versions available	X	?

#### WE DO!

\*Converters include printer cables. Additional Cables at reduced prices. Ring us for quotation or further information about our comprehensive range of data switches, data converters and low cost computer cables, or write to (no stamp required)



### TYEPRO LIMITED

Freepost, 30 Campkin Road,  
Cambridge CB4 1BR  
Telephone (0223) 322394

## ALL TYPES OF BUSINESS COMPUTERS AND PERIPHERALS

from micros to mainframes

Bought, sold and exchanged.

For fast efficient service

call Phil Rose on  
(0606) 783338.

or Grant Penaluna

(0606) 783338. Telex: 946 240

Quoting 1902 5795

Fax: 0606 79367

## DELOSTAR ELECTRONICS LTD

Delostar House, Barnton,  
Cheshire CW8 4JS

## PostGraph

A plotter program for scientists, academics and professionals.

Draws high quality line graphs, scatter graphs and histograms

Designed for theses, research papers, project reports.

Complete with built-in text editor for data file preparation.

Imports data as ASCII text files from other programs

Previews plotter output on screen

Can copy preview screen to printer for rough drafts

Plotters supported:

EPSON HI-80 Plotter (all modes)

HEWLETT-PACKARD Graphics Language-compatible

WATANABE (and compatibles)

Requires: IBM-PC/XT/AT or compatible computer (including

AMSTRAD PC1512) running PC-DOS/MS-DOS 2.x or 3.x with at

least 300K of free memory. Graphics board (CGA, EGA or Her-

cules) needed for on-screen preview of plotter output (other-

wise program will run in text-only mode). Epson or compatible

printer with graphics needed for screen dump.

Not copy-protected. You may return the program for any

reason within 30 days after purchase for a full refund.

**Price: £19.95**

No VAT. Price includes airmail to all countries. Disk formats other

than standard IBM 5.25 inch; please call. Orders, stating computer

type, with cheque (all currencies acceptable) to:

## Syntax Systems

6 Caberston Avenue, Walkerburn, Peeblesshire, EH43 6RA

Telephone: (089 687) 222

# MICROMART

## NEW AND USED EQUIPMENT BARGAINS (Used unless stated otherwise)

Dec Vax, Unibus and Qus - Systems and Options	Call
Dec Printers and Terminals - VT100, LA120 etc.	Call
Dec Rainbow's, Pro's, Decmate's	Call
Tektronix 4110, 4014, 4027, 4114, 4631, 4642, 4924, 4953, Emulex SC03, SC21, PE02, UC03	Call
Data Dynamics Sig/Net 3 System with 3FND, 3HND, 3MI-8	Call
Superbrain SD, DD, JF - 1 & II, also Computer	Call
Apple IIe with Symbiotic 20Mb Winchester	1,000.00
Logica VTS 2200 CPU Box (No VDU or Printer)	300.00
Fujitsu Micro 16S Colour CPM/MS-DOS System	750.00
Televideo 13896/02 Multibus CPM System	500.00
Rutshouser RS951 Twin Bin Sheet Feed	100.00
Diablo Tractor (for 630, 1640, 1650, 1345 etc)	75.00
Diablo 630, 630, 1345A, 1641, 1650 Printers	Call
Facit C7500 Serial and Parallel Printer	300.00
Datasouth DS180 Printer	500.00
Olivetti DU130, D0202, D0202A, DU202, D215, D0600	Call
Intel SBC 304 128K Memory expansion NEW	150.00
Intel Various Modules, System Boxes, etc	Call
Xylogics 570, 675 and Wizard Controllers	Call
KMF 34800 Se-Labs 8000 Serial Tape Interface	300.00
Kennedy 9000/800/1600 Magnetic Tape Drive	500.00
Tandberg TOC3000 Cartridge Tape Drive	750.00
Dig-Data 1739, 1743 Magnetic Tape Drives	Call
Timeplex E-Series Concentrator	200.00
Televideo VDU's Model No's 912/914/925/950/970	300.00
Plessey FM-DC1 300 Disk Controller	750.00
SE & L 306 Unibus Int. (Cambridge Ring)	750.00
Microbar DBCS8K Multibus 68000 Single Card	250.00
Archive 90201 Cartridge Tape Drive NEW	350.00
Manox RMB 1300, VGM1000 Multibus RMB Colour	300.00
3CDM Multibus Ethernet Controller NEW	350.00
Claude Lyons LVC800 Line Voltage Conditioner	300.00
Farnell GS-40A Power Supply FS1 - 40A NEW	100.00
Lambda LDS2-S DR LDDX-152 Power Supply NEW	50.00
Mitsubishi D3919 19" Colour Monitor	750.00
Summagraphics Bit Pad One - EEE Int. NEW	300.00
Summagraphics 20 x 20 CGPOP Controller	200.00
Intecolour 8001G Colour VDU	350.00
ODC BR881A Double Sided D/D Floppy drive	100.00
Rafix 33 500 781 Serial Keyboard NEW	50.00
Dataproducs 2230 300.PM Drum Printer	300.00

**ASHLING UK**  
Equipment bought and sold  
Call Tom Tobin on 0788 70618

## JOHN RUSSELL & CO

Sell By Auction of Micro  
Computers, Consumables &  
Computer Furniture

On Wednesday July 29, at 2.30pm  
on the premises of

**DATA EFFICIENCY LTD**  
Maxted Road,  
Hemel Hempstead,  
Hertfordshire

Inc: 50 by Amstrad 1512 20Mb PC's  
Printers, Monitors etc.

Auctioneer:

**JOHN RUSSELL & CO**  
221 Western Road,  
London SW19 2QD

Tel: 640 4424

## NEW EX-DEMO SECOND USER

BUYING-SELLING TRADE

MAKE THE RIGHT  
DECISION

CONTACT THE EXPERTS  
**RAGLEY DATA SYSTEMS**  
LIMITED

FOR

IBM, APRICOT, OLIVETTI,  
COMPAQ, APPLE etc.

Also comprehensive range of Printers

Call

**MARTIN FORD**

on

**0789 765295**

NEW EX-DEMO SECOND USER

# PROGRAM FILE

consisting of four items of  
information, namely: give the  
departure time (in hours and  
minutes) followed by destination  
code and comment code (or arrival  
time):

The computer will ask questions as  
though you were entering interest  
rate information. You should  
answer them as follows:-

Question	Answer
=====	=====
Day	Hour
Month	Minute
Year	Destination
Rate	Comment

EXAMPLE answers from the author's  
ex London timetable

Hour	Min	Dest	Com
.	.	.	.
15	49	3	1
16	9	3	1
16	30	3	3
.	.	.	.
.	.	.	.
.	.	.	.

The first two trains are the 1549  
and 1609 to Amersham ex Farringdon.  
The third train is the 1630 to  
Amersham ex Marylebone. (See codes  
in program commentary)



## Commodore 64 Multiple Conversions

by Chris Swift

This is a short and simple but useful  
program, and it shouldn't be difficult  
to convert to other machines.

For those people who are unfamiliar  
with the C64, the graphics symbols  
in the listing represent display  
formatting commands and can be replaced  
by trial and error.

The program has 38 different conversions  
available, such as centimetres to inches  
or kilometres to miles. You can also  
print any times table of any length to  
screen or printer.

When run, the program presents a  
menu of choices accessed by function  
keys. F1 brings up the conversions  
menu, F3 the 'Times Table' option,  
and F5 exits the program.

Pressing F1 once brings up the first  
half of the conversions menu; pressing  
it again gets the second half. To

choose any of the conversions displayed,  
press the letter corresponding to it.  
To leave the conversions menu, press F3.

When you have chosen a conversion,  
the screen clears and asks you to enter  
a number. At this point, 0 will take you  
back to the main menu and any other  
number will result in the corresponding  
conversion. Another menu will appear  
which allows you to print out the result,  
calculate another conversion or return  
to the main menu.

Choosing the Times Table option leads  
to a screen where you are asked to enter  
the table to be displayed, the start  
position in the table and the end position.  
When the table has been printed to  
screen or printer, you are given the  
option to print another or return to the  
main menu.

```

10 REM *****
20 REM ** MULTI-CONVERTER **
30 REM * PLUS TIMES TABLES *
40 REM * BY CHRIS SWIFT *
50 REM * JANUARY '87 *
60 REM * VERSION 2 *
70 REM **
80 REM * ALL REM'S CAN BE LEFT OUT *
90 REM * THIS LINE 120 IF NO PRINTER*
100 REM *****
110 P=0:Q=SUB1530:REM-CHECK SUM OF DATA
120 Q=EN4,4:P=1:REM-MISS IF NO PRINTER
130 POKE53280,0:POKE53281,0:PRINT"OK"
140 REM
150 REM-----MAIN MENU-----
160 REM
170 PRINT:PRINT" MULTI-CONVERTER PLUS TIMES TABLES."
180 PRINT
190 PRINT:PRINTSPC(14)"MAIN MENU." :PRINTSPC(14)"
200 PRINTSPC(10)" F1= CONVERSION MENU."
210 PRINT:PRINTSPC(12)" F3= TIMES TABLES."
220 PRINT:PRINTSPC(12)" F5= EXIT PROGRAM."
230 PRINT"***** PLEASE ENTER YOUR CHOICE.*****"
240 GETCH$:IFCH$=" " THENGOTO240
250 IFCH$=" " THENGOTO320:REM-CONVERTER
260 IFCH$=" " THENGOTO470:REM-TABLES
270 IFCH$=" " THENGOTO660:REM-EXIT PROG.
280 GOTO240
290 REM-----

```



# PROGRAM FILE

```

300 REM-----CONVERTER BIT-----
310 REM-----
320 GOSUB900:REM-GET CONVERSION
330 PRINT"*****C1$ TO C2$
340 FORT=1:OLEN(C1$)+LEN(C2$)+4:PRINT"::NEXT:PRINT
350 PRINT:PRINT"HOW MANY C1$::INPUTNU
360 PRINT:PRINTNU,C1$="NU*CM;C2$
370 PRINT:PRINT"PRESS: F1= SAME CHOISE F3= MAIN MENU"
380 IFP=1THENPRINT" F5=PRINT OUT"
390 GETCH$
400 IFCH$=" "THENGOTO330:REM-SAME AGAIN
410 IFCH$=" "THENGOTO130:REM-MAIN MENU
420 IFCH$=" "ANDP=1THENGOSUB1270:GOTO370:REM-PRINT OUT CONVERSION
430 GOTO390
440 REM-----
450 REM-----TIMES TABLES-----
460 REM-----
470 PRINT"::PRINTSPC(13)"TIMES TABLES."
480 PRINTSPC(13)"
490 PRINT:PRINT"WHICH TABLE WOULD YOU LIKE":INPUTCH:IFCH=0THENGOTO130:REM-MENU
500 PRINT"OKAY."
510 PRINT"START FROM WHERE":INPUTSC
520 PRINT"OKAY."
530 PRINT"WHERE TO END(MORE THAN"SC")":INPUTEC
540 IFEC<SCTHENPRINT"TOO LOW.":GOTO530
550 PRINT"OKAY.":IFP<1THENGOTO680:REM IFP<1THEN NO PRINTER,DISPLAY ON SCREEN
560 PRINT:PRINT"PRESS: F1= SCREEN OUTPUT F3=PRINTER OUTPUT"
570 GETCH$:IFCH$=" "THENGOTO630:REM-PRINTER
580 IFCH$=" "THENGOTO680:REM-SCREEN OUT-FUT
590 GOTO570
600 REM-----PRINT TABLE TO PRINTER-----
610 REM-----
620 REM-----
630 PRINT"*****PRINTING"CH"TABLE (<"SC"TO"EC")"
640 PRINT#4,CH"TABLE(<"SC"-"EC")":FORT=SC:TOEC:PRINT#4,T*"CH"=T*CH:NEXT:GOTO790
650 REM-----
660 REM-----DISPLAY TABLE ON SCREEN-----
670 REM-----
680 PRINT" "THE"CH"TIMES TABLE("<"SC"TO"EC")":PRINT
690 TT=0:FORT=SC:TOEC:PRINTT*"CH"=T*CH:TT=TT+1
700 IFTT=20THENGOTO720:REM-REACHED BOTTOM OF SCREEN
710 NEXTT:GOTO790:REM-ANOTHER TABLE
720 PRINT:PRINT"PRESS: F1=CONTINUE F3=MAIN MENU F5=TABLES"
730 GETCH$
740 IFHK$=" "THENGOTO760
750 IFHK$=" "THEN T=EC:NEXTT:GOTO130
760 IFHK$=" "THEN T=SC:NEXTT:GOTO470
770 GOTO730
780 PRINT:PRINT" "THE"CH"TIMES TABLE("<"SC"TO"EC")":TT=0:NEXTT
790 PRINT:PRINT"PRESS: F1=ANOTHER TABLE F3=MAIN MENU"
800 GETCH$:IFCH$=" "THENGOTO470:REM-TABLES
810 IFCH$=" "THENGOTO130:REM-MAIN MENU
820 GOTO800
830 REM-----
840 REM-----EXIT PROGRAM BIT-----
850 REM-----
860 POKES3280,14:POKE53281,6:PRINT"X":CLOSE4,4:END
870 REM-----
880 REM-----CONVERSION MENU 1-----
890 REM-----
900 PRINT" "CONVERSION MENU 1"
910 RESTORE
920 FORT=1:TO19:READCM$,CM:PRINT" "CHR$(T+64)" "CM$:NEXTT:REM-DISPLAY MENU
930 PRINT:PRINT" PLEASE ENTER CHOISE,OR PRESS:"
940 PRINT" F1= MENU 2 OR F3=MAIN MENU"
950 GETCH$:IFCH$=" "THENGOTO950
960 IFCH$=" "THENGOTO1930:REM-MENU 2
970 IFCH$=" "THENGOTO130:REM-MAIN MENU
980 C=ASC(CH$):IFC>64ANDC<84THENCD=1:GOSUB1160:RETURN:REM-CONVERSION CHOSEN
990 GOTO950
1000 REM-----
1010 REM-----CONVERSION MENU 2-----
1020 REM-----
1030 PRINT" "CONVERSION MENU 2"
1040 PRINT"
1050 FORT=1:TO19:READCM$,CM:PRINT" "CHR$(T+64)" "CM$:NEXTT:REM-DISPLAY MENU
1060 PRINT:PRINT" PLEASE ENTER CHOISE,OR PRESS:"
1070 PRINT" F1= MENU 1 OR F3=MAIN MENU"
1080 GETCH$:IFCH$=" "THENGOTO1080
1090 IFCH$=" "THENGOTO900:REM-MENU 1
1100 IFCH$=" "THENGOTO130:REM-MAIN MENU
1110 C=ASC(CH$):IFC>64ANDC<84THENCD=18:GOSUB1160:RETURN:REM-CONVERSION CHOSEN
1120 GOTO1080
1130 REM-----
1140 REM--GET TITLE+DATA FOR CONVERSION--
1150 REM-----
1160 RESTORE:C=C-64
1170 FORT=0:TO(C+CD):READCM$,CM:NEXTT
1180 T=1
1190 LC=LEN(CM$)
1200 C1$=LEFT$(CM$,T)
1210 T=T+1:IFMID$(CM$,T,1)=""THENGOTO1230
1220 GOTO1200
1230 C2$=RIGHT$(CM$,LC-T):RETURN:REM-GOT IT
1240 REM-----
1250 REM--PRINT CONVERSION TO PRINTER--
1260 REM-----
1270 IFP<1THENRETURN
1280 CHD4:PRINT#4,CHR$(18)"I"C1$ TO "C2$CHR$(146)
1290 CHD4:PRINT#4,NU,C1$=" "NU*CM;C2$
1300 PRINT"::":RETURN:REM-PRINTED.
1310 REM-----
1320 REM-----CONVERSION DATA-----
1330 REM-----
1340 DATA"CMS-INCHES",0.3937,"INCHES-CMS",2.540,"METERS-FEET",3.281,"FEET-METERS
1350 DATA0.3048,"METERS-YARDS",1.094,"YARDS-METERS",0.9144,"KILOMETERS-MILES"
1360 DATA0.6214,"MILES-KILOMETERS",1.609,"SQ.CMS-SQ.INCHES",0.155
1370 DATA"SQ.INCHES-SQ.CMS",6.452,"SQ.METERS-SQ.FEET",10.76,"SQ.FEET-SQ.METERS"
1380 DATA0.0929,"SQ.METERS-SQ.YARDS",1.196,"SQ.YARDS-SQ.METERS",0.8361
1390 DATA"SQ.KILOMETERS-SQ.MILES",0.3861,"SQ.MILES-SQ.KILOMETERS",2.59
1400 DATA"HECTARES-ACRES",2.471,"ACRES-HECTARES",0.4047,"CUB.CMS-CUB.INCHES"
1410 DATA0.06102,"CUB.INCHES-CUB.CMS",16.39,"CUB.METERS-CUB.FEET",35.31
1420 DATA"CUB.FEET-CUB.METERS",0.02832,"CUB.METERS-CUB.YARDS",1.308
1430 DATA"CUB.YARDS-CUB.METERS",0.7646,"LITERS-CUB.INCHES",61.03
1440 DATA"CUB.INCHES-LITERS",0.01639,"GALLONS-LITERS",4.546,"LITERS-GALLONS",0.22
1450 DATA"GRAMS-GRAMS",0.0648,"GRAMS-GRAMS",15.43,"OUNCES-GRAMS",28.35
1460 DATA"GRAMS-OUNCES",0.03527,"POUNDS-GRAMS",453.6,"GRAMS-POUNDS",0.002205
1470 DATA"POUNDS-KILOGRAMS",0.4536,"KILOGRAMS-POUNDS",2.205,"TONS-KILOGRAMS"
1480 DATA1016,"KILOGRAMS-TONS",0.0009842
1490 DATA"NO MORE",0
1500 REM-----
1510 REM-----DATA CHECK-----
1520 REM-----
1530 T=0

```

# MICROMART

## Mr Retailer Retailers Point of Sale System At Last!

All the benefits of point of sale enjoyed by the Multi Nationals for the smaller Retailer. Replaces old fashioned till, with an easy to use, fast, computerised system. All retailers Bookkeeping including Stock, VAT, Day Books, Salesman's Commission, Balance Sheet etc, etc, up to date at the moment you press the button to put your money in the till.

The Retailers Dream is Now a reality!  
Mr Retailer Software system £495.00  
Dealers required.

Complete High Quality Tandon Hard disk system with printer etc £1,500  
All prices plus VAT

Access Computers  
2 Rose Yard, Maidstone, Kent ME14 1HN  
Phone: 0622 58356

Profiler --- Min=4120.0000 Max=4120.3FF0

4120:2A10	-----	-----
4120:2A20	-----	-----
43C3:0000	-----	-----
43C4:0000	-----	-----

Execution Profiler

- 430 - Memory resident pop-up program for MS-DOS on the XT/AT
- 430 - Uses clock interrupts to make a Histogram of code use.
- 412 - Identify heavily used code and speed-up your .COM, .EXE or Turbo Pascal programs.
- 430 - Lists resident programs and interrupts: see what's in memory.
- 430 - Zoom and scroll the histogram.
- 412 - Break out to MS-DOS DEBUG.

£25+VAT. Analogue I.S. Ltd.  
1 Warrender Park Crescent,  
Edinburgh EH9 1DX

Overseas P&P £1

4120:2B70	-----	-----
4120:2B90	-----	-----
4120:2BA0	-----	-----
4120:2BB0	-----	-----

Int=4120.2B43 --- 64 --- 128

# Nashua

## DISKETTES

	50+	500+	1000+
3 1/2"			
SSDD	1.16	1.12	1.07
DSDD	1.44	1.38	1.32
5 1/4"			
SSDD	0.47	0.45	0.43
DSDD	0.59	0.56	0.54
SSQD	0.73	0.70	0.67
DSQD	0.82	0.78	0.75
DSHD	1.36	1.30	1.24

FROM  
**CAROUSEL TAPES**  
3 Park Parade, Stonehouse  
Glos GL10 2DB  
Tel: 045382 2151  
Prices ex. VAT. Inc Delivery

## SCIENTIFIC SOFTWARE

- STATIS2** - A SCIENTIFIC STATISTICS PACKAGE  
PARAMETRIC AND NON-PARAMETRIC METHODS  
ANALYSIS OF VARIANCE  
LINEAR AND NON-LINEAR REGRESSION  
POWER ANALYSIS  
GRAPHICS\* - AND MUCH MORE £250
- REF** ----- A REFERENCE DATABASE APPLICATION  
ALLOWS REFERENCES TO BE STORED  
AND RETRIEVED FOR PUBLICATION £50
- INTEG** ---- A HARD DISC UTILITY  
ALLOWS USER TO RUN APPLICATIONS  
FROM A SINGLE KEYSTROKE £50

ALL APPLICATIONS WILL RUN ON IBM OR COMPATIBLE  
e.g. AMSTRAD PC1512 & APRICOT XEN under MSDOS

PLEASE SEND CHEQUE OR WRITE FOR DETAILS TO

ClydeSoft  
78 MEADOWS AVENUE  
LARKHALL, LANARKSHIRE,  
SCOTLAND ML9 2JG

\* REQUIRES GSX GRAPHICS (DIGITAL RESEARCH)

## AMSTRAD MAIN DEALER

Entire Range Ex-Stock, plus Stationery,  
Accessories, Supplies, Upgrades, Software,  
Repairs

Vast Printer Range Ex-Stock  
Dot Matrix 80col 100cps from £130  
Lasers 8ppm under £1,600

Training Courses and Maximum Help  
for First Time Users

Authorised AMSTRAD Business  
Dealer. Approved AMSTRAD  
Service Centre

## MICRO-TECH

061-797 6419 (24 hours)  
Fountain St, Bury, Lancs, BL8 2NS

## PACKARD BELL VX88 (IBM Compatible Micro Computer)

A superior quality, robust, high specification Micro Computer

- Small Footprint
- Very fast NEC V40 Processor at 8MHz
- Norton Utilities Rating 3.2
- 360k Floppy, 20mb Hard Disk
- AT style Keyboard
- 14" high resolution tilt and swivel Monitor
- 4 full size Expansion Slots
- 12 months warranty

only £865

with CGA Colour £1065 with EGA Colour £1265



**aptus**

Dormer House, 13 Dormer Place, Leamington Spa  
Tel: 0926 24173

200 PCW SEPTEMBER 1987

# PROGRAM FILE

```
1540 READDC$,DC:IFDC$="NO MORE"THENGOTO1560
1550 T=T+DC:GOTO1540
1560 T$=STR$(T):IFT$=" 1671.91829"THENRETURN:REM-DATA OK CONTINUE PROGRAM
1570 FORA=1TO50:PRINT"XXXXXXXXXXXX A T A E R R O R ! ! XXXXXXXX":NEXTA:END
```

READY.



## BBC Multi-Windows

by John Green

The following four procedures in BBC Basic allow you to have eight windows numbered 0 to 7. Each of these can be written to separately and will scroll separately. The cursor position and colours used within a window are retained, even when you switch to a new window.

The four procedures are:  
**PROC\_SET\_WINDOW**  
(N,X1,Y1,X2,Y2):

this is used to create a window; N is the window number and the others are coordinates of the corners.

**PROC\_WINDOW(N)**: changes to window N.

**PROC\_CLW(N)**: clears window N; CLS only clears the current window.

**PROC\_COLW(N)**: use this instead of COLOUR N.

You can leave out all the remarks when typing in the program, to save memory.

```
10 DIMW%64
Place your program or the demo-program here.
900 END
1000 REM-----
1010 DEFPROC_SET_WINDOW(N,X1,Y1,X2,Y2):IFN<0ORN>7ENDPROC
1020 WZ?(N#8)=X1:WZ?(N#8+1)=Y1 :REM Store window bottom left corner
position.
1030 WZ?(N#8+2)=X2:WZ?(N#8+3)=Y2 :REM Store window top right corner
position.
1040 WZ:(N#8+4)=0:WZ?(N#8+4)=7 :REM Set colours of the window as white or
black and move cursor to home.
1050 IFWZ?64=N VDU28,X1,Y1,X2,Y2,20
1060 ENDPROC
2000 REM-----
2010 DEFPROC_WINDOW(N):IFN<0ORN>7ENDPROC
2020 WZ?((WZ?64)#8+6)=POS:WZ?((WZ?64)#8+7)=VPOS :REM Store the current.
cursor position.
2030 VDU28:LDCAL:A:FDR=0TO3:VDUWZ?(N#8+A):NEXT :REM Create new window.
2040 PRINTTAB(WZ?(N#8+6),WZ?(N#8+7)): :REM Move cursor.
2050 COLOURWZ?(N#8+4):COLOURWZ?(N#8+5)+128 :REM Change colour.
2060 WZ?64=N :REM WZ?64 contains the
current window number.
2070 ENDPROC
3000 REM-----
3010 DEFPROC_CLW(N):IFN<0ORN>7ENDPROC
3020 LDCAL:A=WZ?64 :REM Remembers current window.
3030 PROC_WINDOW(N):CLS:PROC_WINDOW(A) :REM Changes to new window, clears
it and returns to old window.
3040 ENDPROC
4000 REM-----
4010 DEFPROC_COLW(N):COLOURN
4020 WZ?((WZ?64)#8+4)+((N AND 128)/128)=N AND 127 :REM Checks to see if
colour is foreground
or background by bit 8
and then stores the
colour number for the
current window.
4030 ENDPROC
5000 REM-----
The demo-program is:-
20 ONERRORDU26,20,12,10:GOTO900
30 MODE1:PRINTTAB(0,9):REPEATREADA$
40 PRINTA$:CHR$(-(40-LENA$)*11)
50 UNTILA$=""!REPEATUNTILCET
60 CLS
70 DATA"-----" :REM Forty dashes.
80 DATA" MultiWindows by John C. Green."
90 DATA"-----"
100.DATA" On the screen you will now see the"
110 DATA"computer print the words: zero, one,"
120 DATA"two, and so on."
130 DATA" But after every word it will change to"
140 DATA"a new window."
150 DATA" "
160 DATA"-----"
170 DATA"Press the spacebar."
180 DATA"-----"
190 DATA""
200 PRINTTAB(32,17)"By"TAB(31,19)"John"TAB(31,21)"Green"TAB(12,5)"Multi"TAB(11,
6)"Windows"
210 FORA=0TO7:READX1,Y1,X2,Y2:
220 PROC_SET_WINDOW(A,X1,Y1,X2,Y2):PROC_WINDOW(A)
230 PROC_COLW(A AND 3):PROC_COLW(131-(A AND 3))
240 CLS:NEXT
250 DATA0,7,9,0
260 DATA0,31,19,16
270 DATA0,15,19,8
280 DATA20,31,29,16
290 DATA30,31,39,24
300 DATA20,15,39,0
310 DATA10,3,19,0
320 DATA36,23,39,16
330 DIMA$(7):FORA=0TO7:READA$(A):NEXT
340 DATAZero,One,Two,Three,Four,Five,Six,Seven
350 REPEATFORA=0TO7
360 PROC_WINDOW(A):PRINTA$(A) " "
370 NEXT:UNTILFALSE
```

# PROGRAM FILE



## Amiga Unidraw by Ronald In't Velt

This program has been written in Amiga Basic for any Amiga with at least 512k of memory. The program can be rather slow, so if something doesn't work, wait a few seconds and try again. The program works with Workbench versions 1.1 and 1.2, and optional fonts are from version 1.1. If you want to add your own fonts, change the FOR..NEXT loop which reads data into t\$( ) to read exactly the right number of fonts, and then add the name and size of your font to the data statements.

To create Unidraw, make a blank formatted disk called Drawings, and a blank formatted disk called Unidraw holding Workbench, Basic and

the diskfonts. Create an empty drawer called BMAPS. Copy the file Graphics.bmap to the BMAPS drawer from the Extras disk. Type in and run Listing 2; this creates a file named Diskfont.bmap which will be put in the BMAPS drawer. Type in and save Listing 1; this can then be run (under Basic). The program will not request that the Drawings disk should be present when it needs it, so you will have to swap that one into the disk drive when it is required.

The program itself operates in the standard Amiga manner, with menus available at the top of the screen using the right-hand button. Its operation is fairly self-explanatory.

```

CLEAR.50000&

DECLARE FUNCTION openfont&() LIBRARY
DECLARE FUNCTION opendiskfont&() LIBRARY

CHDIR "unidraw:BMAPS"
LIBRARY "graphics.library"
LIBRARY "diskfont.library"
GOSUB setup
SOUND 440.4

main:
  oldtool=Tool
  WHILE MOUSE(0)<>0:WEND
  ON Tool GOSUB tdraw1,tline,tpaint,tcircle,tframe,tbox,tpoly,tairbrush
  SOUND 1000,1
  ON ≤0 GOSUB setbrush,type,colors,misc:SOUND 1000,1
  MENU ON
  GOTD main

END

setup:
mo&=1:GOSUB mode
MENU 1,0,1,"Tools"
MENU 1,1,1,"Draw"
MENU 1,2,1,"Line"
MENU 1,3,1,"Paint"
MENU 1,4,1,"Circle"
MENU 1,5,1,"Frame"
MENU 1,6,1,"Box"
MENU 1,7,1,"Poly"
MENU 1,8,1,"Airbrush"

MENU 2,0,1,"Set Brush"
MENU 2,1,1,"Line brush"
MENU 2,2,1,"Paint brush"
MENU 2,3,1,"Airbrush"

MENU 3,0,1,"Text"
MENU 3,1,1,"Type"
MENU 3,2,1,"Get new font"

MENU 4,0,1,"Colors"
MENU 4,1,1,"Use"
MENU 4,2,1,"Set"

MENU 5,0,1,"Project"
MENU 5,1,1,"Load picture"
MENU 5,2,1,"Save picture"
MENU 5,3,1,"Clear screen"

SCREEN 1,640,400,4,2
WINDOW 1,"Unidraw", (0,0)-(631,186),0,1

DIM g%(15000),pa%(7),c%(7),o(3),t*(20),cc(15,2)
i=&HFFFF:FOR a=0 TO 7:pa%(a)=&HFFFF:c%(a)=&HFFFF:NEXT
Tool=1:abr=10
FOR t=1 TO 13:READ t*(t):NEXT
FOR a=0 TO 15:FOR b=0 TO 2:READ cc(a,b)
NEXT:PALETTE a,cc(a,0),cc(a,1),cc(a,2):NEXT
AREA (10,10):AREAFILL:CLS
ON MENU GOSUB choice
ON ERROR GOTD errors
MENU ON
mo&=0:GOSUB mode
RETURN

choice:
MENU OFF
    
```

# MICROMART

## SPEAKEASY IS BACK

Speakeasy II — intelligent phonetic speech synthesiser.

Incredibly clear speech!

Plugs into printer port — print it using simple "ARAPABET" PHONETICS. £169

The original Speakeasy I still available (SCO1 based). £69

Cables £10 — state computer. P&P £2 VAT extra



Sands Technology

22 Cheddars Lane, Cambridge CB5 8LD  
Tel: (0223) 65717

### NEW COMPUTER DESK & CHAIR FROM OPUS

£149.95

Ideal for most PC Systems including those from OPUS, AMSTRAD, IBM, OLIVETTI & COMPAQ etc



#### \* FEATURES

Swivel chair  
Lockable diskette box  
Tubular steel frame  
Metal castors  
Slots for cables

#### \* DIMENSIONS

Total Height 35"  
Desktop Height 27"  
Desk Width 47"  
Desk Depth 32"  
Shelf Depth 12"

Opus PCII Turbo (XT Compatible) from £499  
Opus PCS (AT Compatible) from £1295

For further details please contact:

### R H COMPUTER CONSULTANTS

Abbey House, 28/29 Railway Approach, Worthing  
Sussex BN11 1UR Tel: Worthing (0903) 213551

### The Lowest Priced 3.5" Disks (Lifetime Guarantee)

#### 100% Error Free

10 DS/DD 3.5" £11.95 inc pp VAT  
10SS/DD 3.5" £10.95 inc pp VAT

All disks by top manufacturers  
Call for quantity discounts

Storage box for 10 disks £1.50 inc.

#### QL Software

QL Turboquill: Speed up Quill by 30%  
'QL Turboquill is essential' QL World 87 and for expanded memory QL's only QL TurboQuill+: Even faster than TQ plus caps lock indicating cursor, glossary (keydefine) £13.50 inc. Taskmaster: The best multitask control program £25 inc.

Spellbound: Real time spellchecker 30,000+ dictionary £29.95 inc.

Mailmaster: Integrated mailing system for the QL £24 inc.

### ATHENE CONSULTANTS

33 Holly Grove, Fareham, Hants PO16 7UP  
Tel/MBX (0) 329 282083

Overseas orders please add required extra postage

## PREMIUM QUALITY DISKS BULK UNLABELLED LIFT TIME WARRANTY

	50/100	200/250	400/500	1000 +
5 1/4" DS/48tpi	29p	27p	25p	??
5 1/4" DS/96tpi	32p	29p	27p	??
5 1/4" AT/1.6Mb	89p	86p	82p	??
3 1/2" SS/135tpi	79p	75p	??	??
3 1/2" DS/135tpi	84p	80p	??	??

### WABASH DATATECH

5 1/4" DS/48tpi	55p	52p	49p	??
5 1/4" DS/96tpi	65p	62p	59p	??
5 1/4" AT/1.6Mb	£1.05	£1.01	97p	??
3 1/2" SS/135tpi	99p	95p	??	??
3 1/2" DS/135tpi	£1.04	99p	??	??

CWO Prices ex VAT. Carriage @ £4.50 + VAT  
No quibble 7 day money back guarantee.  
Government and Educational orders  
welcome.

### ABACOM COMPUTER SUPPLIES

225 Walton Road, Woking, Surrey GU21 5EF  
Tel: 04862 30300/71563

## MS-DOS FLEX UNIFLEX OS-9 OS-9/68K CROSS ASSEMBLERS

A suite of cross assemblers supporting  
the following devices:

1802 1805 6303 6502 6503 6800 6801  
6802 6803 6804 6805 68HC05 146805  
6808 6809 68HC11 8020 8021 8022 8031  
8035 80C35 8039 80C39 8040 8048  
80C48 8049 80C49 8050 8051 8080 8085  
8748 8749 8751 Z8 Z80 68000

Extensive directives support modular,  
conditional and structured programming.  
Supplied with conversion utilities and  
powerful macro preprocessor.

COMPLETE SUITE £295 + vat  
INCLUDING FULL 'C' SOURCE  
(not 68000)

Micro Concepts Tel 0242 510525  
2 St. Stephens Rd · Cheltenham · Glos.

## MEDIA CONVERSIONS

DISK/DISK • TAPE/DISK • TAPE/TAPE

We can transfer your data between over 1000 different  
Minis, Micros and Mainframes.

### Tape

1/2" - 800, 1600, 3200, 6250 BPI

1/2" - QIC-11, QIC-24, (QIC-02)

DEC/DOS; TAR, ANSI, CPIO, IBM Labelled/Unlabelled.

### Floppy

8", 5 1/4", 3 1/2", 3" CPM, CPMB6, MDOS, MSDOS,  
PCDOS, UNIX, XENIX, IDRIS, TAR, RT11, IBM, BEF, ISIS,  
FLEX, OS9, APPLE, ACORN, TORCH, VICTOR-SIRIUS,  
ATARI etc.

### WP/Typesetting

Many formats including DISPLAYWRITER, OLIVETTI,  
WORDPLEX, LINOTYPE etc.

Overnight - Most formats returned by next day's post.

Prices from £10 per disk.  
Usual terms C.W.O.  
Ring or write for a full format list.

### A.L.DOWNLOADING SERVICES

VOYSEY HOUSE  
BARLEY MOW PASSAGE  
LONDON W4 4PT  
01-994 5471



# PROGRAM FILE

```
s0=0:m0=MENU(0)
IF m0=1 THEN Tool=MENU(1)
IF m0>1 THEN s0=m0-1:s1=MENU(1):Tool=0
MENU ON:RETURN
```

```
tdraw:
q=MOUSE(0):PSET(MOUSE(1),MOUSE(2))
WHILE MOUSE(0)<>0
LINE -(MOUSE(1),MOUSE(2))
WEND
tdraw1:
IF Tool<>1 THEN RETURN
IF MOUSE(0)=0 THEN tdraw1
GOTO tdraw
```

```
tline:
m0=2:GOSUB mode
WHILE MOUSE(0)<1:IF Tool<>2 THEN tlineend
WEND:x1=MOUSE(1):y1=MOUSE(2)
WHILE MOUSE(0)--1:WEND
WHILE MOUSE(0)<1
x2=MOUSE(1):y2=MOUSE(2)
LINE (x1,y1)-(x2,y2):LINE (x1,y1)-(x2,y2)
IF Tool<>2 THEN tlineend
WEND
m0=0:GOSUB mode
LINE (x1,y1)-(x2,y2)
WHILE MOUSE(0)<0:WEND
GOTO tline
```

```
tlineend:
m0=0:GOSUB mode
RETURN
```

```
toaint:
WHILE MOUSE(0)<1:IF Tool<>3 THEN RETURN
WEND:x=MOUSE(1):y=MOUSE(2)
rp=WINDOW(B):m0=1
flood& rp&,m0&,x&,y&
GOTO toaint
RETURN
```

```
tcircle:
m0=2:GOSUB mode
WHILE MOUSE(0)<1:IF Tool<>4 THEN tlineend
WEND:x=MOUSE(1):y=MOUSE(2)
WHILE MOUSE(0)--1:WEND
WHILE MOUSE(0)<1
r=ABS(MOUSE(1)-x):a=ABS(MOUSE(2)-y)/(r+1)
CIRCLE(x,y),r,,,a:CIRCLE(x,y),r,,,a
IF Tool<>4 THEN tlineend
WEND
m0=0:GOSUB mode
CIRCLE(x,y),r,,,a:GOTO tcircle
```

```
tframe:
m0=2:GOSUB mode
WHILE MOUSE(0)<1:IF Tool<>5 THEN tlineend
WEND:x1=MOUSE(1):y1=MOUSE(2)
WHILE MOUSE(0)--1:WEND
WHILE MOUSE(0)<1
x2=MOUSE(1):y2=MOUSE(2)
LINE (x1,y1)-(x2,y2),,b:LINE (x1,y1)-(x2,y2),,b
IF Tool<>5 THEN tlineend
WEND
m0=0:GOSUB mode
LINE (x1,y1)-(x2,y2),,b
GOTO tframe
```

```
tbox:
m0=2:GOSUB mode
WHILE MOUSE(0)<1:IF Tool<>6 THEN tlineend
WEND:x1=MOUSE(1):y1=MOUSE(2)
WHILE MOUSE(0)--1:WEND
WHILE MOUSE(0)<1
x2=MOUSE(1):y2=MOUSE(2)
LINE (x1,y1)-(x2,y2),,bf:LINE (x1,y1)-(x2,y2),,bf
IF Tool<>6 THEN tlineend
WEND
m0=0:GOSUB mode
LINE (x1,y1)-(x2,y2),,bf
GOTO tbox
```

```
tpoly:
m0=2:GOSUB mode
WHILE MOUSE(0)--1:WEND
WHILE MOUSE(0)<1
x2=MOUSE(1):y2=MOUSE(2)
IF fpoly=1 THEN LINE (x1,y1)-(x2,y2):LINE (x1,y1)-(x2,y2)
IF Tool<>7 THEN tpolyend
WEND
IF fpoly=1 THEN LINE (x1,y1)-(x2,y2)
AREA(x2,y2)
x1=x2:y1=y2:fpoly=1:GOTO tpoly
tpolyend:
m0=0:GOSUB mode
AREAFILL
fpoly=0
RETURN
```

```
tairbrush:
m0=2:GOSUB mode
tab1:
x1=MOUSE(1):y1=MOUSE(2):IF Tool<>8 THEN tlineend
CIRCLE(x1,y1),abr:CIRCLE(x1,y1),abr
IF MOUSE(0)=0 THEN tab1
m0=0:GOSUB mode
WHILE MOUSE(0)<>0
x%=MOUSE(1):y%=MOUSE(2)
```

# PROGRAM FILE

```

an=RND#7:r*x%=x%+COS(an)*abr#RND
ry=y%+SIN(an)*abr#RND/2
PSET (rx%,ry%):WEND
GOTO tairbrush

setbrush:
GOSUB windowo
ON s1 GOSUB bline,bpaint,bair
GOSUB windowc
RETURN

bline:
FOR a=0 TO 15
  x=300-a#18
  LINE (x,10)-(x-20,25),((11 AND 2^a)/2^a)*3,bf
  LINE (x,10)-(x-20,25),1,b
NEXT a
b11:
b=MOUSE(0):x=MOUSE(1):y=MOUSE(2)
IF b<>0 AND x=0 AND y=0 THEN WINDOW OUTPUT 1:PATTERN 11:RETURN
IF b<1 OR y<10 OR y>25 OR x<10 OR x>300 THEN b11
a=2^(INT((300-x)/18))
IF (11 AND a)=0 THEN 11=(11 OR a) ELSE 11=(11 AND (&HFFF-a))
x=INT(x/18)*18-6:LINE (x+1,11)-(x+17,24),((11 AND a)/a)*3,bf
GOTO b11

bpaint:
FOR a=0 TO 8:LINE (0,a#7)-(175,a#7),1:NEXT
FOR a=0 TO 16:LINE (a#11,0)-(a#11,56),1:NEXT
FOR a=0 TO 15
  FOR b=0 TO 7
    p=2^(15-a)
    LINE (a#11+1,b#7+1)-(a#11+10,b#7+6),((p%(b)AND p)/p)*3,bf
  NEXT
NEXT
bp1:
b=MOUSE(0):x=MOUSE(1):y=MOUSE(2):IF b=0 THEN bp1
IF b<>0 AND x=0 AND y=0 THEN WINDOW OUTPUT 1:PATTERN,pa%:RETURN
IF x>175 OR y>56 THEN bp1
x=INT(x/11):y=INT(y/7):p=2^(15-x)-(x=0)*65536&
v=(p%(y)AND p)/p
IF v=0 THEN p%(y)=(p%(y) OR p) ELSE p%(y)=(p%(y) AND (&HFFF-p))
LINE (x#11+1,y#7+1)-(x#11+10,y#7+6),-(v=0)*3,bf
WHILE MOUSE(0)<>0 :WEND
GOTO bp1

bair:
LINE (0,10)-(160,20),1,b
LINE (abr#10+1,11)-(abr#10+9,19),1,bf
CIRCLE (35,35),abr,1:abo=abr
WHILE MOUSE(0)=0 OR MOUSE(1)>150:WEND
x=MOUSE(1):y=MOUSE(2)
IF x=0 AND y=0 THEN RETURN
LINE (abo#10+1,11)-(abo#10+9,19),0,bf
CIRCLE (35,35),abo,0
abr=INT(x/10)
GOTO bair

colors:
GOSUB windowo
ON s1 GOSUB cuse,cset
GOSUB windowc
IF s1=1 THEN COLOR colsel
RETURN

cuse:
FOR a=0 TO 7
  FOR b=0 TO 1
    LINE (a#30,b#15)-(a#30+20,b#15+10),a+b#8,bf
  NEXT b
NEXT a
WHILE MOUSE(0)<1 OR x>230 OR y>25
  x=MOUSE(1):y=MOUSE(2)
WEND
colsel=INT(x/30)+INT(y/15)*8
RETURN

cset:
GOSUB cuse
CLS
LINE (0,0)-(320,10),colsel,bf
LINE (0,15)-(210,20),1,b
LINE (0,25)-(210,30),1,b
LINE (0,35)-(210,40),1,b
FOR s=0 TO 2
  o(s)=cc(colsel,s)
  LINE (cc(colsel,s)*200+1,(s+1)*10+6)-(cc(colsel,s)*200+9,(s+1)*10+9),1,bf
NEXT

cset1:
WHILE MOUSE(0)=0 OR MOUSE(1)>200:WEND
x=MOUSE(1):y=MOUSE(2)
IF x=0 AND y=0 THEN RETURN
s=0:IF y>13 AND y<22 THEN s=1
IF y>23 AND y<30 THEN s=2
IF y>33 AND y<42 THEN s=3
IF s=0 THEN cset1 ELSE s=s-1
cc(colsel,s)=x/200
cset2:
LINE (o(s)*200+1,(s+1)*10+6)-(o(s)*200+9,(s+1)*10+9),0,bf
LINE (cc(colsel,s)*200+1,(s+1)*10+6)-(cc(colsel,s)*200+9,(s+1)*10+9),1,bf
PALETTE colsel,cc(colsel,0),cc(colsel,1),cc(colsel,2)
o(s)=cc(colsel,s):GOTO cset1

type:
ON s1 GOSUB ttype,ftont
Tool=oldtool

```

# MICROMART

Caspell Computer Services, Dept D, FREEPOST, Poole, Dorset BH15 1BR

+ Smart library boxes (10-disk) £1.20 each +  
- Cheque/PO with order please -

10 for £5.95 ★ 25 for £13.95  
- including VAT & delivery -

The Business! ★ Top Quality Branded Imports  
Lifetime Guarantee ★ Certified 100% error-free both sides

FOR AMSTRAD PC 1512  
Dataflow and Universal 5 1/4" Disks

## DISKS



*Gloucester House*

SONY® - the one and only!

*The makers of the Maxell disk drives only recommend one brand of disks... their own.*

Single Sided (boxes of 10) - £13.00  
Double Sided (boxes of 10) - £17.50  
Single Sided Bulk (boxes of 50) - £60.00  
Double Sided Bulk (boxes of 50) - £75.00

Peak Systems™

*Hard Disks & Tape Drives*

20Mb - £625      30Mb - £795  
50Mb - £1150    80Mb - £1495  
160Mb - £2295

20Mb Tape - £650    60Mb Tape - £850

SCSI kit for 512(E) when ordered with a Peak drive - £99

30 Day Money Back Guarantee

(Prices do not include VAT or Carriage)

*Gloucester House*

*Malvernbury, Wilts. SN76 0LH*

*Tel. (0666) 22665*



## DISKS ★ Major Brands ★

★ MAXELL SONY 3M NASHUA etc

★ Factory fresh in Boxes of 10 Disks

Minimum order 5 Boxes (50 Disks).

Price per Box (depending on Brand):

5 1/4" DS/DD 48 tpi ..... £8.50 - £9.50

HD 1.6Mb for AT ..... £16.00 - £18.00

3 1/2" SS/DD 135 tpi ..... £11.50 - £12.50

DS/DD 135 tpi ..... £16.00 - £18.00

3" CF-2 Maxell ..... £19.50

NEW 3 1/2" HD 2Mb for PS/2 50/60 ... £44 - £46

(Minimum order 2 Boxes)

Official Govt/Educational/Company/Export orders Welcome.

Telex: 923729 ROLAND G (attn: Startex)

Terms: CWO. Prices include VAT and P&P UK

Callers by appointment

Tel: 01-446 6786

## STARTEX

ROWLANDSON HOUSE

289-293 BALLARDS LANE, LONDON N12 8NP

Telephone: 01-446 6786

**S. P. ELECTRONICS**

BBC SPECIALISTS

Amstrad PC1512.....from £516.00  
 Amstrad 8256.....£458.00  
 Amstrad 8512.....£573  
 Disc Operating System BBC.....£75.00  
 Disk drives from.....£85.00  
 ACORN 1770 DFS.....£49.95  
 ADFS.....£29.90  
 30Mb HARD DISK DRIVES FOR PC FROM.....£458.00  
 AMSTRAD FD3 DISK DRIVES.....£115.00  
 Circuit board for RTTY decoder Mk3 (inc. instructions).....£10.00  
 SPECTRUM 48K.....£49.90  
 OPUS DISCOVERY.....£99.00  
 CITIZEN 120D Printer.....£199.00  
 BBC Master 128.....£475  
 Canon PW1080A dot matrix 160cps (NLQ).....£299.00

ACORN + AMSTRAD APPROVED DEALERS  
 FULL REPAIR SERVICE AVAILABLE

Wide selection of software, books, leads, plugs, etc.  
 All available Mail Order  
 All prices apply while stocks last — carriage extra

**48 Linby Road, Hucknall, Notts.  
 NG15 7TS**

Tel: 0602 640377

All prices include VAT

**CENTRAL MEDIA**

3.5 INCH DISCS

10 DATATECH S/S/D/D £14.00  
 10 UNBRANDED S/S/D/D £12.00

5.25 INCH DISCS

10 DATATECH D/S/D/D 96tpi £8.50  
 10 DATATECH D/S/D/D 48tpi £8.00  
 10 UNBRANDED DS/DD 48tpi £4.00

TRADE ENQUIRIES WELCOME

ALL CHEQUES & PO'S PAYABLE TO  
 CENTRAL MEDIA  
 101 SPRING BANK, HULL HU3 1BH  
 TEL: (0482) 26581

WE SELL  
 MSX & DRIC  
 SOFTWARE  
 Please ring  
 for details

WE SELL  
 ATARI ST  
 HARDWARE  
 Ring for  
 details

**EXCEPTIONAL VALUE**

**5.25" DS DD DISKS  
 \$12.50 per 25 disks**

Delivery inclusive  
**NO QUIBBLE GUARANTEE**

Cheques or PO's to:  
**DAYTADISC**  
 Uploads Cottage Four Ashes Road,  
 High Wycombe, Bucks.  
 Tel: 0494 712324

```

RETURN
ttype:
WHILE MOUSE(0)=0:WEND
x%=MOUSE(1):y%=MOUSE(2):ro%=WINDOW(8)
move% rp%,x%,y%
mo%=2:GOSUB mode
t$="":g$="":WHILE g%<>CHR$(13)
g%=INKEY$:IF g$="" THEN ttype1
IF ASC(g%)=8 AND LEN(t%)>0 THEN t%=LEFT$(t%,LEN(t%)-1)
IF ASC(g%)<>13 AND ASC(g%)<>8 THEN t%=t%+g$
ttype1:
move% rp%,x%,y%:PRINT t%:
move% rp%,x%,y%:PRINT t%:
WEND
mo%=0:GOSUB mode
move% rp%,x%,y%:PRINT t%:
RETURN

tfont:
fs=1
GOSUB window
AREA (10,0):AREA (0,5):AREA (20,5):AREAFILL
AREA (10,50):AREA (0,45):AREA (20,45):AREAFILL
rp%=WINDOW(8):x%=30:y%=30
LINE (25,22)-(170,33),1,b
tfont1:
LINE (26,23)-(169,32),0,bf
move% rp%,x%,y%
PRINT t$(fs):
WHILE MOUSE(0)=0:WEND
x=MOUSE(1):y=MOUSE(2)
IF x=0 AND y=0 THEN tfont2
IF x<21 AND y<6 AND fs>1 THEN fs=fs-1
IF x<21 AND y>44 AND y<51 AND fs<15 THEN fs=fs+1
WHILE MOUSE(0)<>0:WEND
GOTO tfont1

tfont2:
t%=LEFT$(t$(fs),LEN(t$(fs))-3)+".font"
h=VAL(RIGHT$(t$(fs),3))
WINDOW OUTPUT 1
textattr%(0)=SADD(t%+CHR$(0))
textattr%(1)=h*65536&
IF LEFT$(t%,5)="topaz" THEN fontptr%=openfont%(VARPTR(textattr%(0)))
IF LEFT$(t%,5)<>"topaz" THEN fontptr%=opendiskfont%(VARPTR(textattr%(0)))
rp%=WINDOW(8)
IF fontptr%>0 THEN CALL setfont%(rp%,fontptr%)
GOSUB window
RETURN

DATA "topaz 08","topaz 09"
DATA "ruby 08","ruby 12"
DATA "opal 11"
DATA "sapphire 14","sapphire 15","sapphire 18","sapphire 19"
DATA "diamond 12"
DATA "garnet 09","garnet 16"
DATA "emerald 20"

misc:
ON s1 GOSUB pload,psave,pcls
Tool=oldtool
RETURN

pcls:
PATTERN,c%
LINE (0,0)-(640,200),0,bf
PATTERN,pa%
RETURN

psave:
GOSUB filename
CHDIR "drawings:"
OPEN f% FOR OUTPUT AS #1
FOR a%=0 TO 2:
GET (0,a%*62)-(631,a%*62+61),g%
FOR b%=0 TO 9950:PRINT #1,g%(b%);:NEXT
SOUND 3000,2
NEXT
FOR a%=0 TO 15:FOR b%=0 TO 2
PRINT#1,cc(a%,b%)::NEXT:NEXT
CLOSE #1
RETURN

pload:
GOSUB filename
CHDIR "drawings:"
OPEN f% FOR INPUT AS #1
mo%=1:GOSUB mode
FOR a%=0 TO 2:
FOR b%=0 TO 9950:INPUT #1,g%(b%):NEXT
SOUND 3000,2
PUT (0,a%*62),g%,PSET
NEXT
mo%=0:GOSUB mode
FOR a%=0 TO 15:FOR b%=0 TO 2
INPUT#1,cc(a%,b%):NEXT
PALLET IF a%,cc(a%,0),cc(a%,1),cc(a%,2)
NEXT
CLOSE #1

plx:
RETURN

filename:
GOSUB window
INPUT "Enter filename":f%
GOSUB window
    
```

# PROGRAM FILE

# MICROMART

## BRANDED DISKS (Box of 10)

3"	MAXELL CF2	£23.95
3.5"	SONY MF2 2DD 135tpi	£21.95
5.25"	MAXELL DS/DD 48tpi	£13.95
5.25"	MEMOREX DS/DD 48tpi	£13.95
5.25"	DYSAN (IBM AT)	£26.50
3.5"	SONY MF2 2DD 135tpi	£49.00

C.W.O. PRICES INCLUDE CARRIAGE  
& VAT. (C.O.D. ON REQUEST)

### ☆ QUANTITY DISCOUNTS ☆

EG 10 BOXES SONY MF2-2DD	£18.50/box
EG 10 BOXES DYSAN (IBM AT)	£21.95/box
1 BOX OF 10 3M D.C.600A DATA CARTRIDGE	£229

## JOHN HOLMES COMPUTERS

FULBECK, GRANTHAM,  
LINCS NG32 3LD

Tel: (0400) 72818

OFFICIAL GOVERNMENT  
AND EDUCATIONAL ORDERS  
WELCOME



## PSPM

Premier Software PM  
47 Alderford Street  
Sible Hedingham  
Halstead  
Essex CO9 3HX  
Tel: 0787 60426

Prestel 219996438 — BT GOLD 74: MIK 140

### SPECIALIST IN 3.5 INCH DISKS

XYDEX	£1.35	VERBATIM	£1.36
DATATECH	£1.38	MEDIALIFE	£1.42
SONY	£1.55	MEMOREX	£1.65

(prices are as per individual disks)

All disks are unbranded and come  
complete with labels and multiples of ten  
come in disk boxes. Branded disks  
available on request.

Extra labels 55p per 10.

Extra disk boxes (holds 10) £1.05

Price includes VAT

Please add 60p P&P

(Minimum order value — £8 please)

Government, Commercial & Educational  
orders welcome.

Please phone for an individual quote.

Credit can be made available on large orders.

RETURN

errors:

SOUND 440,2:SOUND 880,2:SOUND 1760,2  
RESUME pix:

mode:

rp&=WINDOW(8)  
setdrmd&.rp&,mo&  
RETURN

window:

GET (0,0)-(330,60),g%  
WINDOW 2,,(0,0)-(311,50),0,1:WINDOW OUTPUT 2  
RETURN

window:

GET (0,0)-(330,60),g%  
WINDOW 2,,(0,0)-(311,50),0,1:WINDOW OUTPUT 2  
RETURN

windowc:

WINDOW CLOSE 2:WINDOW OUTPUT 1  
Tool=oldtool  
PUT (0,0),g%,PSET  
RETURN

DATA 0,0,0,1,1,1,1,0,0,0,1,0

DATA 0,0,1,1,1,0,0,1,1,0,1,0

DATA .5,.5,.5,.7,.7,.7,.5,0,0

DATA 0,.5,0,0,0,.5,.5,.5,0,0,.5,.5

DATA .5,0,.5

END

rems:

REM ----- Instructions -----

REM - Starting up:  
REM Select Unidraw's icon and double-click the left mouse button  
REM Wait for the program to load  
REM When the program is ready, the screen will turn black and you'll  
REM hear a low tone

REM - Selecting options:  
REM Press the right mouse button and select an option (the program  
REM will beep)  
REM The five options are:  
REM - Tools These are the drawing tool such as paint,line  
REM - Set Brush This is for changing the line,paint and air-  
REM brush shape  
REM - Text This section is for entering text in your  
REM drawing,and for loading other fonts  
REM - Colors This section is for changing and selecting  
REM colors  
REM - Project Contains the Load,Save and Clear functions

REM - Tools  
REM - Draw Plots a point whenever you hold the left mouse  
REM button down  
REM - Line Press once to mark the start of the line;press  
REM again to draw the line  
REM (from the start of the line to the position of  
REM the pointer)  
REM - Paint Flood-fills an area with the current color  
REM Press once to mark the center of the circle.and  
REM move the mouse to change the circle's shape.  
REM Press again to draw the circle  
REM - Circle Press once to mark the start of the frame,and  
REM move to the end of the frame. Press again to  
REM draw the frame  
REM - Frame Same as Frame,but draws a filled frame (a box)  
REM This is for drawing complex filled shapes.  
REM Press the button to mark a corner of the shape.  
REM You can mark up to twenty corners. Selecting  
REM any other tool will draw the shape  
REM - Airbrush Works just as draw,but plots random points  
REM withing a certain radius,thus simulating an  
REM airbrush

REM - Set brush  
REM - Line brush Lets you change the line brush,for drawing  
REM dotted lines etc.  
REM - Paint brush Lets you change the Paint brush,so you can fill  
REM shapes with custom patterns  
REM - Airbrush For changing the Airbrush radius

REM - Text  
REM - Type First,select a position with the mouse and  
REM press the button,then you can enter text.  
REM Press (RETURN) to draw the text  
REM - Get new font shows a box with a font and its height,and two  
REM arrows. Use the arrows to step through the  
REM available fonts,and close the small window to  
REM load the font

REM - Colors  
REM - Use A small window is opened,showing the available  
REM colors. Move the pointer to the color you want

REM and press the button.  
REM Select the color you want to change as is Use,  
REM then you can change the color with  
REM the three 'slidebars' (as in PREFERENCES)

REM - Project  
REM - Load picture Loads a picture from the PICTURE disk  
REM - Save picture saves a picture  
REM - Clear screen clear the screen

REM Notes

REM The functions Line brush,Paint brush,Airbrush,Get new font,Use.

## Disks & Ribbons

<b>DISKS</b>	£1.20	
3.5" DS unbranded	£0.60	
5.25" Memorex branded SS/DD	£0.41	
5.25" %ipi DS, unbranded, labels etc	£1.85	
SEE 10 Storage box 5.25" or 3.5"		
<b>RIBBONS</b>		
Imagewriter	£2.65	Cannon PW 1080A
Citizen 120D	£3.50	Citizen MSP 10
Epson MX/IX/FX80	£2.60	Epson LX 80/86
Epson MX/RX/FX100	£3.10	Koga Takon

Please add 15% VAT; carriage free

## T-Systems Ltd

The Signal Cabin, 61 High Street, Orpington, Kent BR6 0JF  
Tel. 0689 22196

```
REM Set,Load and Save open a small window. to close the window (and
REM thus exiting the function),move the pointer to the upper-left
REM corner of the screen and press the button. (Except for Use,Load
REM and Save. These funtions close the window themselves when you
REM select the color or enter the filename)
```

```
REM Loading and Saving takes a lot of time (+- 3 minutes)
```

```
REM When you select a function for the first time,the program will
REM not react at once,because it has to organize a lot of variables.
REM If nothing happens,try again. Once a function has been selected
REM before,you won't have to wait again.
```

```
REM When you are working with the Setbrush,Text.Color or Project
REM functions,don't select another function until you are finished
REM with the current one. When you are finished,the program will
REM return to the Tool you last used.
```

```
REM Playing with the various functions and Tools is the best way to
REM learn!
```

```
Program 2:use this program to create the diskfont.bmap file
```

```
CHDIR "Unidraw:BMAPS/"
```

```
FOR i=1 TO 35
  READ c$
  c=c+VAL("%h"+c$)
NEXT
IF c<>319B THEN PRINT "Error in data statements":END
RESTORE
OPEN "0".1."Diskfont.bmap"
FOR i=1 TO 35
  READ c$
  c=VAL("%h"+c$)
  PRINT #1,CHR$(c):
NEXT
CLOSE #1
PRINT "Diskfont.bmap has been created"
```

```
DATA 4f,70,65,6e,44,69,73,6b
DATA 46,6f,6e,74,00,ff,e2,09
DATA 00,41,76,61,69,6c,46,6f
DATA 6e,74,73,00,ff,dc,09,01
DATA 02,00,02
```

## NEW 30MB SYSTEMS FOR THE PRICE OF 20MB

### COMPUTER SYSTEM:

- \* 80286 6/10MHz switchable
- \* 640k RAM
- \* Phoenix bios
- \* 8 Expansion slots
- \* Graphics card
- \* Parallel port, 4 serial ports (3 opt.)
- \* 200W power supply
- \* Keyboard

### AT-MONO

1.2Mb FD, mono monito

£ 975

### AT-COL

1.2Mb FD, mono monitor

£ 1175

### AT30-MONO

30Mb HD, 1.2Mb FD,  
mono monitor

£ 1395

### AT30-COL

30Mb HD, 1.2Mb FD,  
colour monitor

£ 1595

### AT30-EGA

30Mb FD, 1.2Mb FD  
EGA monitor/adaptor

£ 1795



AJP Business  
Computers Ltd.

South Bank  
Technopark,  
90 London Rd,  
London SE1 6LN

Tel: 01 922-8849  
01 928-2900

### SPECIAL OFFERS

30Mb Hard Disk +  
WD Controller **£275**

40Mb Tape  
Streamer **£399**

EMS memory card **£155**  
(for Lotus, Symphony, etc)

A full range of add-on cards and  
accessories available from stock

**NEW 30MB TURBO XT's  
ALSO AVAILABLE.  
CALL NOW FOR PRICES.**

All prices exclude VAT.  
Dealer and educational enquires welcome.

**14 days trial period or money back. One year warranty**







**CIS brings you all with minimum cost and maximum reliability, full surface certify and 100% error-free**

**OEM & AGENT WANTED**

- 5/4" 48TPI SS/DD, DS/DD
- 96TPI DS/DD, DS/HD
- 3 1/2" 135TPI SS/DD, DS/DD
- A series of disc value-added storage box available
- Tinted library case(CIS-10T)
- Clear library case (CIS-10SC)
- Jumbo box for 100 pcs of 5 1/4" discs (CIS-100)
- Jumbo box for 50 pcs of 3 1/4" discs (CIS-50S)



**CIS TECHNOLOGY INC.**  
 5 FL., NO. 45 CHI LIN RD., TAIPEI, TAIWAN, R.O.C.  
 TLX: 22553 ASURCO FAX: 886-2-5363405 TEL: 886-2-561-2191

**TOP CREDIBILITY IN PC/XT/AT**



- PRODUCTS INCLUDE:**
- \* "ZERO" AT-5000 AT SYSTEM
  - \* "ZERO" AT-5000B BABY AT SYSTEM
  - \* "ZERO" XT-1000 TURBO-XT SYSTEM
  - \* FULL SERIES OF ADD-ON CARDS

**NEW PRODUCTS:**

- \* PERI-NET LAN
- Novell Ethernet card Compatible
- 10 MHz "Turbo-XT Plus" Motherboard
- Supports Lotus/Intel/Microsoft EMS up to 896KB



Designer & Manufacturer  
**PERIPHERALS ENTERPRISE CO., LTD.**  
 NO. 3, CHUNG CHENG RD. HSIN TIEN CITY, TAIPEI HSIEN, TAIWAN, R.O.C.  
 TEL: 886-2-9477322 TLX: 31159 PERIPHE FAX: 886-2-9154672

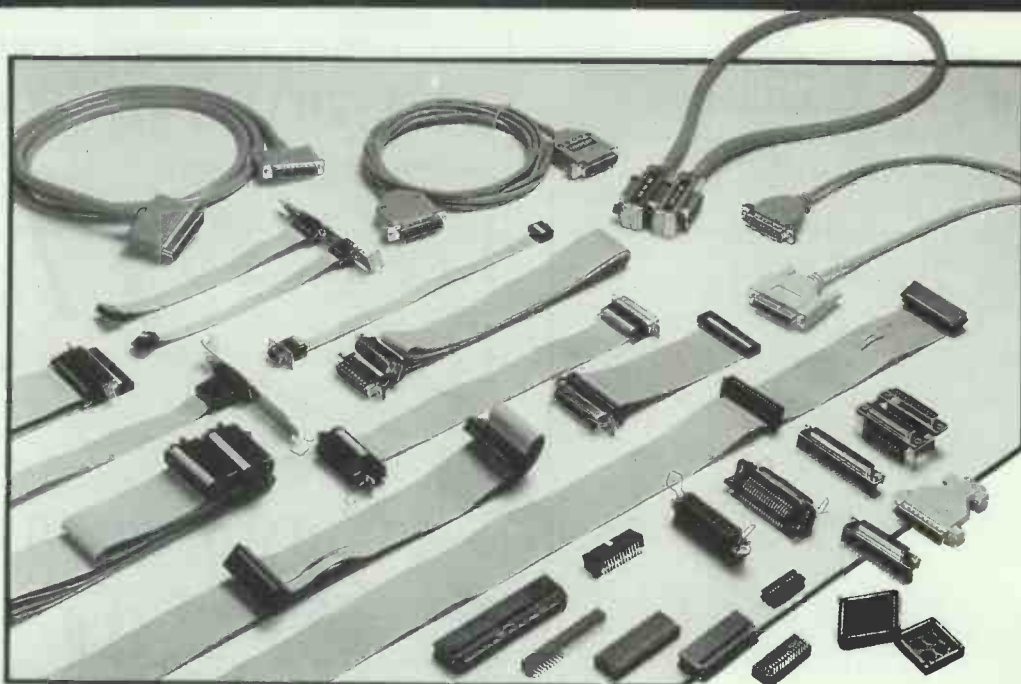

**YOUR BEST CHOICE!**

Cable, connector and cable with connectors assembled the way you design, you just specify the amount, the length, and we go to work for you.

If you are cable and profit minder, call us today. We'll offer at anytime, anywhere with prompt delivery and the best prices.

As a specialized supplier in Taiwan, we are your best source for high quality computer cable, connectors and cable with connectors assembled. We offer warranty in quality reliability and reasonable price.

Orders of customer redesign are welcome. For more information, please contact us now.

**HUNTRIUMPH IND. CO., LTD.**  
 No. 28, Alley 65, Lane 285, Sec. 1, Nei-Hu Rd., Taipei, Taiwan, R.O.C.  
 P.O. Box: 84 Nei-Hu Taipei, Taiwan, R.O.C.  
 Telex: 15338 HUNTIME  
 Fax: 886-2-7965805

## 10 MHZ FULL FEATURE SMALL FOOTPRINT AT COMPATABLE

SINGLE FLOPPY AT ..... 1095.00 + V.A.T.  
TWIN FLOPPY AT ..... 1230.00 + V.A.T.  
20MB AT ..... 1398.00 + V.A.T.

- \* 80286 6-8-10 MHz.
- \* 80287 Maths Co-processor option.
- \* 640K Ram, Expandable to 1Mb on Board.
- \* 8 Expansion Slots.
- \* RS232 Port.
- \* Parallel Printer Port.
- \* Real-time Calendar clock.
- \* 1 or 2 1.2Mb Floppy Disk Drive(s).
- \* or 1 1.2Mb Floppy and 1 20Mb Hard disk.
- \* 180W Power Supply.
- \* ASCII Standard Keyboard.
- \* 14" Hercules Tilt & Swivel Mono Monitor.
- \* Turbo Switch, Activity LED's and Reset on Front Panel.
- \* MS-DOS 3.X.
- \* Colour Versions of the above Systems available.
- \* Colour Graphic Adapter and Colour Monitor + 210.00 + V.A.T.
- \* Enhanced Graphic Adapter and colour monitor + 479.00 + V.A.T.
- \* On site maintenance contract available.



Coming Soon the 12 MHZ AT ..... Call for Info.

FULL FEATURE 80386 with 40Mb Hard Disk & EGA ..... 3850.00 + V.A.T.

### UPGRADE YOUR AMSTRAD 1512 TO 30 MB HARD DISK

HARD DISK KIT — Includes fully documented manual, 30 Mb hard disk, controller card, connecting cable, utilities disk and, of course, our no quibble 12 month guarantee. Also included for AMSTRAD 1512 owners is a mounting bracket and a modified front bezel.

SPECIAL OFFER PRICE ... 315.00 + V.A.T.  
HARD DISK KIT — XT Version. SPECIAL OFFER PRICE ... 299.00 + V.A.T.

BUSINESS SERVICE AGENCY LTD.  
(MAIL ORDER DIVISION.)  
CALL MAIDENHEAD (0628) 26403  
SENTINEL BULLETIN BOARD (0628) 781429 24 hrs. Usual Protocols ....

Prices Exclude V.A.T. and delivery.  
Goods despatched after cheque clearance but allow up to 28 days.  
Terms — Cheque with Order.  
Claims for damage must be reported within 7 days of receipt.

## Go for The Computer That Goes MICROWAY

### M-3355 PC/AT COMPUTER 6/8/10/12 MHz Switchable

- CPU: 80286 W/80287 Socket
- RAM: 1MB on Board
- ROM: 16KB expandable 32K
- ONE 1.2MB Floppy Disk Driver
- Detached Keyboard W/Cursor Pad
- FDD/HDD Disk Controller
- Monochrome Graphics W/Printer Card
- Serial/Parallel Card.
- Power: 200W (Overload and Short Protection)
- Flip-Up Case (Optional Slide-in)
- Built-in Clock Calendar W/Battery Back-up



- With Key-Lock and Power + HDD Light Indicator
- Fully IBM PC/AT Compatible
- Available keyboard in English, French, German, Swedish, Spanish....etc.

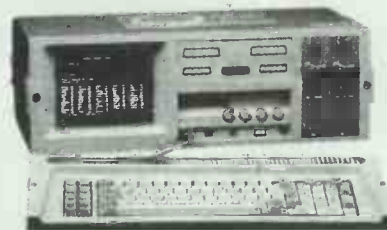

### Portable XT/AT

W/Built-in Monochrome Monitor (B/W, Amber, Green, Optional) Keyboard of English or German optional.

Also on offer are all kinds of add-on cards.



### MICROWAY ENTERPRISES CO., LTD.

MAILING ADDRESS:  
P.O. BOX 32-30 TAIPEI, TAIWAN, R.O.C.  
TEL: (02)7110637, 7218530, 7714809  
TLX: 23125 MICROWAY FAX: 886-2-781-4212



## DISCOUNT COMPUTER SOFTWARE

	List Price	Our Price
PEGASUS SINGLE-USER	£350.00	£155.00
PEGASUS SENIOR	£450.00	£285.00
PEGASUS MULTI-USER	£600.00	£345.00
SAGE ACCOUNTANT +	£199.00	£149.00
LOTUS 123 V2.1	£450.00	£299.00
SUPERCALC 4	£396.00	£260.00
SUPERCALC 3	£95.00	£60.00
WORDSTAR 2000 V2.0	£465.00	£255.00
WORDSTAR 1512	£95.00	£60.00
WORDCRAFT V3.0	£485.00	£355.00
DELTA PROFESSIONAL	£560.00	£335.00
BUDGET DELTA	£95.00	£75.00

Try us for all your software requirements  
Send cheque with order to:

**UK SOFTWARE**  
Third Floor, 42 Baldwin St.,  
Bristol BS1 1PN  
Tel: 0272 298998

Please add £10 carriage and VAT to all orders

## RAMSTRAD BUSINESS SYSTEMS

Are now taking orders for the ultimate  
in user friendly

### ACCOUNTS PACKAGES

for only **£89.50** + VAT & (£1.50 p & p)

- INVOICES / STATEMENTS
- SALES LEDGER
- PURCHASE LEDGER
- NOMINAL LEDGER

- Suitable for first time users, or the disillusioned
- Runs on Amstrad 1512 with hard disk (to save constant floppy changes) or any fully IBM compatible machine
- Included in the purchase price is a fully explicit, easy to follow, manual
- Hot line telephone support is available
- To see for yourself, send £10.00 + VAT for demonstration disk and overview. This is refundable against the purchase price of a full system

All enquiries to:- Dealers also welcome

52 Parliament Street, Ramsey, Isle of Man.  
Telephone: 0860-640204

# Memories are made of this!

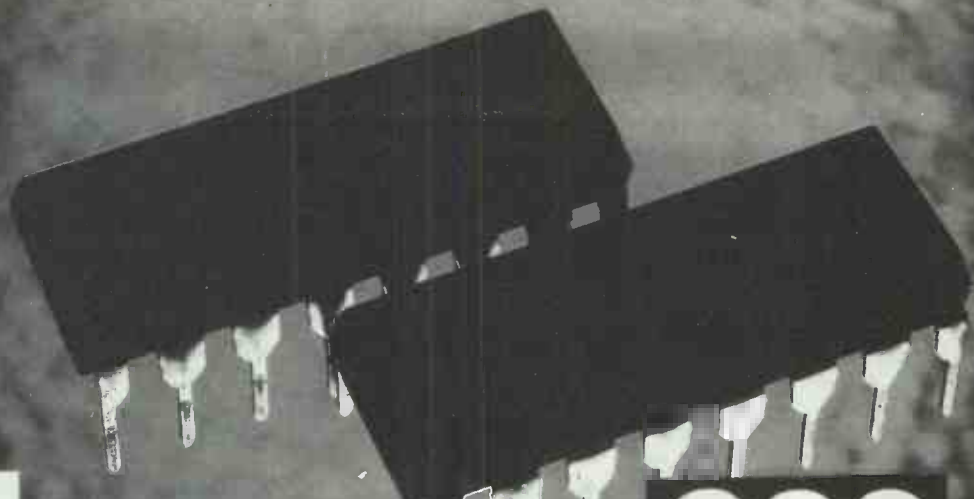

**1 MEGABYTE £99**  
**64 K DRAMS OR 256 K DRAMS (150 NS)**

Order only in complete multiples of one megabyte. Excludes delivery & VAT



**Tel: 0342 24631 Telex: 957418**

Unit M, Charlwoods Business Centre, Charlwoods Road  
 East Grinstead, West Sussex RH19 2HH

## MEGABYTES. MEGASAVINGS.

	PRODUCT	DESCRIPTION	PRICE
FUJITSU	M2242 AS	42MB FULL HT. ST506 DISK DRIVE	£809.86
	M2243 AS	70MB FULL HT. ST506 DISK DRIVE	£873.98
	M2245 E	92MB FULL HT. ESDI DISK DRIVE	£1055.05
	M2246 E	131MB FULL HT. ESDI DISK DRIVE	£1339.83
	M2451 A	0.25" STREAMER TAPE DRIVE	£1235.73
	M1008 A	SCSI INTERFACE FOR M2451 A	£577.57
TANDON	TM262	20MB HALF HT. ST506 DISK DRIVE	£190.70
XEBEC	9710	10MB IBM PC DISK SUBSYSTEM	£489.44
	9720	20MB IBM PC DISK SUBSYSTEM	£588.03
	9730	30MB IBM PC DISK SUBSYSTEM	£2288.73
	OWL	10MB SASI DISK DRIVE	£228.87
	S1210C	IBM PC ST306 DISK CONTROLLER	£77.45
	S1220	AS 1210 & FLOPPY	£102.11
	S1250	AS 1220 FOR AT	£123.24
	S1410	SASI ST506 DISK CONTROLLER	£98.59
	S1420	AS 1410 & FLOPPYS	£133.80
	IBM H/A	HOST SASI ADAPTOR FOR IBM PC	£42.25
APPLE 9720	20MB 9720 APPLE H/A	£559.86	
MEMTEC	20B-IN	INTERNAL IBM PC 0.25" STREAMER 25MB	£408.00
	20I-IN	INTERNAL IBM PC 0.25" STREAMER 25MB	£408.00
	20B-SUB	IBM PC 0.25" STREAMER 25MB SUBSYSTEM	£456.00
	20I-SUB	IBM PC 0.25" STREAMER 25B SUBSYSTEM	£456.00

**ALL PRICES  
 SUBJECT TO CASH  
 WITH ORDER**

There's never been a better time to buy memory products for your data protection, storage and retrieval needs. Right now Logitek have considerable stocks of high-performance memory products to clear. You won't get the opportunity to buy these products at such a low price again, so place your order now.

**Don't let this slip your memory. Phone Logitek on 0257-426644.**

# LOGITEK

Computer Products and Services

LOGITEK PLC., Logitek House, Bradley Lane, Standish, Greater Manchester, WN6 0XQ.

# COMLEX

NEVER BEATEN ON PRICE

MULTISOFT ACCOUNTS

Single User £199 per module

Support and Multi User Software available

Comart Quad plus financial controller super price POA

Single user £275 per module

Amstrad 1640 Colour (20Mb Tandem).....	£999
Amstrad Deal twin floppy mono plus 300 Printer + Wordstar + Super Calc.....	£649
Amstrad 1512 Mono (20Mb Tandem) 640k Memory.....	£699
Amstrad Colour 1512 (20Mb Tandem) 640k Memory.....	£849
Amstrad 128k memory upgrade.....	£29

## ATARI

520STM.....	£205
520STFM.....	£305
520STM + mono monitor.....	£390
520STFM + Philips colour.....	£390
520STFM + Philips colour Hi-Res.....	£556
1040ST + mono.....	£556
1040ST + Philips colour.....	£722
1040ST + Philips colour Hi-Res.....	£722

## CUMANA DRIVES

Atari 3 1/2" Drive.....	£121
Atari 20Mb hard disk.....	£599
Atari 30Mb hard disk.....	£629
Atari 40Mb hard disk.....	£899
Atari 60Mb hard disk.....	£1099

## COMMODORE

Amiga 500.....	POA
Amiga 500 modulator.....	£25
Amiga 1.....	£949
Amiga II.....	£1049
Amiga 2000 1Mb.....	POA
Amiga Bridge +5/4.....	POA
PC Double Disk Drive.....	£799
PC One Disk Drive 20Mb.....	£1099
AT 20Mb 1.2 Disk Drive 20Mb.....	£1175

## EPSON PC PLUS

Epson PC Plus single drive.....	£849
Epson PC Plus twin drive.....	£959
Epson PC 20Mb.....	£1199
Green Screen monitor.....	£99
Colour Monitor.....	£325

## VICTOR

Victor machines.....	POA
----------------------	-----

## OLIVETTI

M24 1 DD.....	£949
M24 2 DD.....	£1025
M24 20Mb (Olivetti).....	£1350
M24 20Mb (Seagate).....	£1250
M24 30Mb (Seagate).....	£1499
M24 SP.....	£1999
M28 20Mb HD.....	£2499
M28 20Mb + T/S.....	£2549
M28 40Mb + T/S.....	£2999

All machines come with Keyboard Monitor and MS-DOS. M24's 640k colour monitor £250 extra.

## SPERRY

HT 100.....	£1050
HT 200.....	£1150
HT 250.....	£1340
HT 300.....	£1775
HT 400.....	£1425
HT 450.....	£1715
HT 500.....	£2100
HT Standard keyboard.....	£85
HT Professional keyboard.....	£149
Parallel Printer port.....	£59

Required for HT 250, 300, 450 & 500.

Micro IT 1200 20Mb Standard or AT keyboard 512k and green monitor £2250.

Full IT 1200 44Mb Standard or AT keyboard 512k and green monitor £2130.

## AMSTRAD PC

1DD Mono.....	£423
2DD Mono.....	£522
1DD Colour.....	£567
2DD Colour.....	£666
20Mb Mono.....	£823
20Mb Colour.....	£877
20Mb upgrade for Amstrad PC.....	£345
1640 1DD Colour.....	£725
1640 2DD Colour.....	£799
1640 20Mb Colour.....	£1099

(if needed if required)

## BONDWELL PC

B8 Portable.....	£679
B18 Portable.....	£599
Other Models Available.....	POA
Colour Monitor add.....	£199

## SBC

SBC Floppy.....	£525
SBC 20Mb.....	£899
SBC 35 20Mb.....	£899
SBC At 30Mb 1.2DD green screen.....	£1499
SBC At 30Mb 1.2DD colour 6.8 + 12 Mhz.....	£1675
SBC At 30Mb 1.2DD ega colour 6.8 + 12 Mhz.....	£1849

Free 12 months a sight maintenance with all Bondwells + SBC measures

## TANDON

PCX.....	£625
PCX 10.....	£699
PCX 20.....	£775
PCA 20.....	£1349
PCA 30.....	£1599
PCA 40.....	£1749
Colour Upgrade.....	£260
Tandon Target 20Mb.....	£1399
Tandon Target 30Mb.....	£1750
Tandon Target 40Mb.....	£2075
Ega colour upgrade.....	£475

## APRICOT

XEN XI 10.....	£1575
XEN XI 20.....	£1975
XEN HD.....	£2199
XEN I.....	£2385
Colour Upgrade.....	£195
Medium res col mon.....	£275 extra
High res col mon.....	£685 extra
Enhanced col monitor.....	£589
Professional keyboard.....	£63 extra

## MULTI USER SYSTEMS

Comart Quad 20Mb.....	£4250
Comart Quad 40Mb.....	£4999
Northstar Terminals 30Mb.....	£3680
Northstar Terminals.....	£295
M28 running Xenix (as other AT's).....	POA
Apricot Multi User Network or Xenix.....	POA
20Mb Hard Disk Upgrades from.....	£325

## HARD DISKS

Seagate 20Mb 65ms.....	£249
Seagate 30Mb 65ms.....	£299
Seagate 40Mb 65ms.....	£425
Miniscribe 20Mb.....	£299
Miniscribe 30Mb.....	£375
Miniscribe 20Mb hard card.....	£259
Miniscribe 30Mb hard card.....	£299
Tandon 20Mb + Cont.....	£225
Tandon 20Mb Hard Card.....	£225

## TAPESTREAMERS

40 MB XT.....	£299
40MB AT.....	£329
60MB AT.....	£325

All drives include controller + leads. For larger drives call.

## MONITORS

Philips 7502 (green).....	£59
Philips 7522 (amber).....	£75
Philips (paper white).....	£79
Philips 8822.....	£239
Philips 8852.....	£265
Philips 8873.....	£525
CAGA 1212.....	£95
CAGA 1213.....	£105
CAGA Supervision II.....	£275
CAGA Supervision III.....	£345
CAGA Supervision 660.....	£389
CAGA Supervision 760.....	£409
CAGA Supervision 860.....	£635

EGA cards to suit monitors.

## DOTMATRIX PRINTERS

Amstrad DMP 3000.....	£149
Amstrad DMP 4000.....	£299
Brother 1109.....	£165
Brother M1409.....	£289
Brother M1509.....	£265
Brother M1709.....	£449
Brother 2024L.....	£625
Brother 4018.....	£1149
Canon 1080A.....	£215
Canon A55.....	£349
Citizen 1200.....	£149
Citizen LSP10.....	£185
Citizen MSP10E.....	£199
Citizen MSP15E.....	£229
Citizen HQP45.....	£525
Epson LX86.....	£545
Epson LX800.....	£199
Epson FX800.....	£299
Epson FX1000.....	£375
Epson EX800.....	£389
Epson EX1000.....	£499
Epson LQ800.....	£425
Epson LQ1000.....	£589
Epson LQ2500.....	£695
Epson SQ2500.....	£949
Micro P MC165.....	£165
Micro P MP200.....	£239
Micro P MP201.....	£289
NEC Pinwriter P6.....	£359
NEC Pinwriter P7.....	£439
NEC Pinwriter P5.....	£399
NEC Pinwriter P5XL.....	£699
NEC Pinwriter 9X.....	£899
NEC Pinwriter 9XL.....	£959
OKI ML192.....	£279
OKI ML193.....	£365
OKI ML292.....	£439
OKI ML293.....	£589
OKI ML294.....	£799
Panasonic 1080.....	£175
Panasonic 1091.....	£235
Panasonic 1092.....	£310
Panasonic 1592.....	£399
Panasonic 1595.....	£525
Panasonic 3131.....	£259
Panasonic 3151.....	£425
Star NL10.....	£195
Star ND15.....	£269
Star NX15.....	£349
Star NX15.....	£399
Star NB24-10.....	£425
Star NB24-15.....	£535
OTC 850XL.....	£1650

Phone for prices on Thom, Dacan, Rascal and Steebek.

## SAGE SOFTWARE

Bookkeeper.....	£72 50
Accountant.....	£112 00
Accountant + Payroll.....	£125 00
Payroll.....	£72 50
Retrieve.....	£72 50
Chitchat.....	£72 50
PC Planner.....	£72 50
Desk set.....	£50 00
PC write.....	£72 50
Financial controller.....	£218 00
Financial controller multi user.....	£725

## CAR PHONES

Clearone CTN8000.....	£710
NEC SA.....	£699
NEC SA.....	£890
Panasonic EB118 with VSP.....	£919
Panasonic C10M.....	£999
Panasonic C30 MHF with VSP.....	£1049
Motorola 4500X.....	£749

## TRANSPORTABLES

NEC GA 2AH Battery and VSP.....	£999
NEC GA 4AH Battery and VSP.....	£1049
Panasonic C50P.....	£1099
Motorola 4500X.....	£1945
Mobira Talkman.....	£1995

## TRANSMOBILES

NEC GA 2AH Battery and VSP.....	£1149
NEC GA 4AH Battery and VSP.....	£1249
Panasonic C70PM.....	£1199
Panasonic C80 PMHF.....	£1245
Motorola 4500X.....	£1999
Mobira Talkman.....	£1999

## HAND PORTABLES

NEC SA.....	£1299
Motorola 8000S.....	£1299
Mobira Cityman.....	£1499
Mitsubishi Romer.....	£1299

Carphone fitting £50 and Hands free available — phone for price.

Prices due to change so phone for better deals

## DAISYWHEEL PRINTERS

Brother HR20 22cps.....	£329
Brother HR25 XL 25cps.....	£519
Brother HR35 35cps.....	£695
Citizen Premier 35.....	£449
Micro Peripheral MP26 (new) 26cps.....	£259
Micro Peripheral MP40 (new) 40cps.....	£379
Oliveri DY450.....	£789
Oliveri DY800.....	£1049
Panasonic 3031.....	£259
Panasonic 3151.....	£425
Juki 6100 20cps.....	£245
Juki 6200 30cps.....	£399
Juki 6300 40cps.....	£629
Juki 6500 60cps.....	£899
NEC Spinwriter EII.....	£275
NEC Spinwriter 8800.....	£765

## LASER PRINTERS

Epson Laser.....	£1299
Centronics.....	£1289
Centronics with HP EM.....	£1599
Canon II.....	£1750
Kyocera F1010.....	£2599
Kyocera 200 A2.....	£3795
HP Laserjet.....	£1799
HP Laserjet Plus.....	£2499
Mannesman Tally.....	£2999
Citizen Overture.....	£1350

## CAD CAM PLOTTERS

Epson H180 4 pen A4.....	£309
HP 7440 8 pen A4.....	£975
HP 7475A 6 pen A3.....	£1445
Roland DXY 880 A3.....	£849
Roland DXY 980 A3.....	£935
Roland DPX 200 A2.....	£3199
Hitachi 672 4 pen A4.....	£435
Taxan KPL 710.....	£635

Phone for details on larger Plotters AD AT, Hewlett Packard, Calcomp, Benson.

## DIGITISERS

Cherry Tablet A3.....	£450
TDS LC12 11 x 11.....	POA
TDS LC20 20 x 20.....	POA
TDS LIR6 18 x 36.....	POA
Calcomp Digitisers.....	POA
Maths Co-Processors 8087.....	£95
Maths Co-Processor 8087-8.....	£125
Maths Co-Processor 80287-6.....	£145
Maths Co-Processor 80287-8.....	£195

## MODEMS

Pace Nightingale.....	£79
Pace Series 421235.....	£219
Pace Series 41706.....	£349
Pace Series 42405.....	£439
Miracle WS2000.....	£85
Miracle WS3000 2123.....	£229
Miracle WS3000 22.....	£279
Miracle WS3000 221315.....	£369
Miracle WS4000.....	£139

Phone for prices on Thom, Dacan, Rascal and Steebek.

## SAGE SOFTWARE

Bookkeeper.....	£72 50
Accountant.....	£112 00
Accountant + Payroll.....	£125 00
Payroll.....	£72 50
Retrieve.....	£72 50
Chitchat.....	£72 50
PC Planner.....	£72 50
Desk set.....	£50 00
PC write.....	£72 50
Financial controller.....	£218 00
Financial controller multi user.....	£725

## CAR PHONES

Clearone CTN8000.....	£710
NEC SA.....	£699
NEC SA.....	£890
Panasonic EB118 with VSP.....	£919
Panasonic C10M.....	£999
Panasonic C30 MHF with VSP.....	£1049
Motorola 4500X.....	£749

## TRANSPORTABLES

NEC GA 2AH Battery and VSP.....	£999
NEC GA 4AH Battery and VSP.....	£1049
Panasonic C50P.....	£1099
Motorola 4500X.....	£1945
Mobira Talkman.....	£1995

</

Your chance to buy, sell or swap equipment.

## ACORN

● BBC-B. 32k Sideways RAM, 400k disk drive, DDFS, Hi-Res colour monitor, mouse & super art. ROMS, leads, 40 disks software, all £750. Disks- 25 DSDD, £25. Tel: Paul 866 1248 Eves.  
 ● BBC MODEL-B. Opus Challenger 512k, twin ramdisk and 800k 40/80 track drive. Also joysticks and tape cassette system and software. All in excellent condition. £250 o.n.o. (01) 989 1691.  
 ● ACORN Electron. ACP AP4 disk interface, Taxan green monitor, 40/80T switchable 400k SD/DD disk drive with PSU. Manuals, software, ROM cartridges. Offers. Brand new printer, Brother M-1109, £120. Northwood (09274) 23025 Eves.  
 ● BBC B. Microvitec monitor, Cumana dual drives 40/80T. 5 ROMS: Wordwise, View etc. Solidisk 128k sideways RAM, extensive software, manuals, literature, disks, tapes, etc. £550. Barfield, 31 Courtney Road, Winchester, Hants. (0962) 66720.  
 ● BBC.B SERIES 7 OS1.2 DNFS 400k 40/80 DISK DRIVE Disc-Doc, Wordwise+ ROMS. Disk software including Masterfile, VU-Type, Chess, V.G.C. manuals. £425. Acorn Z.80 2-processor, £250, Green monitor, £70. Tel: Pearson (021) 503 0212.  
 ● BBC MODEL B. Torch Z80 second processor, perfect software, Torch Unicorn 20MB Winchester and 400K floppy disk. Taxan amber monitor, Taxan 64k two-way printer buffer. Excellent condition. £750. (0205) 820204.

## AMSTRAD

● CPC6128. Colour monitor, CP/M+, manual. Also DMP1 printer (no connector) and lead for second disk drive. £250 o.n.o. (May include some additional software). Tel: (01) 368 2482 after 7pm.  
 ● AMSTRAD PC-1512-HD20 COMPUTER AND COLOUR MONITOR. With original

documentation and five disks. As new. (01) 482 3867 Paul Whitley, 251 Camden High Street, London, NW1.

## APPLE

● TECMAR MacDrive 5Mb removable hard-disk for Apple Macintosh any model. With cables, £300 o.n.o. New. Tel: 373 3191 after 5pm.  
 ● MAC-PLUS. Brand new. Unwanted prize. With pagemaker, Excell, Works, Superpaint, Write now, Macdraw, Pascal, Multiplan, Macwrite, Macdraft, Dark Castle, Flight simulator, Mac golf, cricket graph, and many more. All for £1300. (05827) 69152.  
 ● APPLE II EUROPLUS. Three Drives, all manuals, Software includes Peachtree Accounting, Visiplot, Visitrend and PFS database. £500. Contact Camerons. Bristol 0272 268893.  
 ● APPLE II+. 64k. Twin disk drive with controller card, monitor, Centronix printer, colour card. Software, including: Games, languages, £250. Tel: Muhammad. Office (01) 803 3355 ext. 3640, home (01) 599 1228.  
 ● APPLE II EUROPLUS. 80k, accelerator, twin disk drives, colour monitor, toolkit, copy II+, a few games, printer interface, good condition, £430 o.n.o. Tel: (01) 650 6863, after 7pm.  
 ● APPLE EUROPLUS. With: green screen monitor, disk drive printer card, 80 column card, 64k, speech card, joystick, software, manuals, including wordprocessor. Practical, etc. £280 o.n.o. Tel: (01) 749-1165 anytime.  
 ● 512k APPLE MACINTOSH. 400k external disk drive, imagewriter 1 printer, Macwrite, Macpaint, Multiplan, 10 spare disks and complete set of dust covers. All in excellent condition. £1550. New Romney 66688.  
 ● MACINTOSH 512k. 800k disk drive. Imagewriter, carry case. Software includes: Draw, Paint, Write, Jazz, Pacemaker, plus

others. £1300 o.n.o. Tel: (0702) 73864 Eves.  
 ● APPLE IIe. 128k, two disk drives, Taxan RGB II col.mon; printer card; CP/M card, joystick, keypad, full TABS accounts, Flashcalc, dBase II, Visidex, Format 80 W/P, home accountant, manuals. £475 o.n.o. Tel: (025672) 4059 after 7pm.  
 ● APPLE MACINTOSH PLUS. 1MB RAM. 800k internal and external drives, special carry case, lots of software: £1600 o.n.o. Tel: after 5pm: (01) 373 3191.

## APRICOT

● APRICOT XEN HD. 1MB RAM, 20MB HD. 720K 3 1/2" disk. MS Windows, Write, Paint, Wordstar. White H/R monitor. Little used. £1950 + VAT. Tel: Foster. Day. (0273) 693622. Eves, (0273) 504385.  
 ● APRICOT SOFTWARE FOR F2 AND PORTABLES. Vast amount for sale or exchange. Tel (0222) 482613. Leave name and Tel number if you get Answering Machine.  
 ● APRICOT PORTABLE. 512k with colour monitor, mouse, GEM software, Wordstar, Supercalc, Card box, disks and books. £500 or swap BBC Torch business system. Sleaford (0529) 306776.  
 ● APRICOT F2-512K 2 x 3 1/4 drive. 10Mb harddisk, mouse, Apricot colour monitor. 30 disks, Gem and Actquity software. Bundled games and business software plus manuals. Offers over £700. Tel: Alan (0592) 890321.

## ATARI

● ST OWNERS, £2.50 will get you a public domain sample disk, discount voucher and catalogue from P. Wilson 65 Ecton Ave Macclesfield. Cheshire SK10 1RD.  
 ● ATARI 520ST. With Fast BASIC cartridge, Mono monitor, Fast-com, Starglider, Canon 1080 NLQ printer. Plus other misc. software, books, mags, etc. £650. Tel: Harpenden 65371 after 6.30pm.  
 ● ATARI 520ST. Mono Hire monitor, latest modula II, developer's toolkit, fast Basic plus usual software. TOS in ROM. Dozen ST user mags plus GEM book. All mint condition. £435. Tel (022 023) 3579.  
 ● ST SOFTWARE (originals). Flight simulator, £15. Midi software. Modular-2, £40. Shuttle, £8. Harrier, £12. Music Studio, £10. All new including manuals. 0635 Newbury 42809.  
 ● ATARI 800XL. Plus 1050 diskdrive with hyperdrive which allows 180k per side with warpspeed and can back-up 99% of software. Also 2 joysticks plus about 80 blank disks. £190 o.n.o. (01) 690-5023 Tom.  
 ● ATARI ST UTILITIES DISK (A201). Includes 410k 820k formatter, RAMdisks, directory printer, print spooler, file squeezer, all

public domain for £7. From Abarax K. PO Box 24, London, E10 6HR.  
 ● ATARI 520ST. + 1 MEG Upgrade, 2 x 800k drives. AS & T case. Mono monitor. Epson RX80 printer, dBasell, Modula-2, & games. £850. Tel: (0242) 673133 Gios.

## COMMODORE

● COMMODORE 64. Tape recorder, joystick, lightpen, four games, assembler and dust cover. With manual. £99 o.n.o. Tel: 061 434 0969.  
 ● TELEVIDEO MULTIUSER 816/20. Plus five TS800AS terminals. One TS802, plus cables, assorted software. Best offer over £1500. Tel: Frank Price (0242) 519097 Eves after 8pm.  
 ● CBM 64. 1541 d/drive, 1520 printer, datasette, joystick. Whitby custom softchip. Pascal, Basic compilers. 15 disks of software. Boxed with all leads. Excellent condition. £350 o.n.o. Tel: (0304) 206066 (Dover).  
 ● 8032 COMPUTER. 8050 dual drives, 8023P 132 col printer, SFD 1001 single drive, Superbase, Visicalc, any reasonable offer considered. Can arrange carriage. Tel: Mark Ling on (01) 242-2444 during office hours.  
 ● C64. Datasette, disk drive, software, plus Epson RX80 printer. £290. (0635) Newbury 42809.

## CP/M

● OSBORNE DOUBLE DENSITY. Includes Wordstar, Supercalc, basic etc. Excellent condition. Best offer over £125 secures. Tel: 04862 (Woking) 69360.  
 ● OSBORNE OI CP/M Computer. 52 col sd. with twin disk drives and monitor. Complete with Wordstar wordprocessing, Mailmerge, Supercalc and Basic. £195 Tel: (01) 9044450 Wembley.  
 ● EPSON QX10. 256k twin drives, CP/M + Wordstar plus many useful programmes. £475. Tel: 0222 755334 Eves.  
 ● EPSON PX8 PORTABLE. 120k RAM, bundled software; Wordstar, Cardbox, Scheduler, Plus additional ROMS, also Epson P-80 PRINTER TRANSFORMER. Shoulder bag for both. £700. (0222) 755334 Eves.  
 ● FUTURE FX20. 2 x 800k floppies, 128k, RAM, CPM-86, Spellbinder wordprocessor, DBase II, IBM compatible. Offers £500 + Tel: (01) 301-3930 after 6pm.  
 ● MILLBANK SYSTEM 10 CPM BUSINESS COMPUTER. Twin disk, built-in screen. Wordstar, Dbase II, Accounts, Spellbinder Tachograph, system video library system, plus loads more, really good small business system. White. Tel: (0604) 716109.  
 ● SUPERBRAIN. Single sided, double density disks. Software includes Wordstar, Plannerscale, MBasic,

Cardbox. Manuals. £450. (01) 435 9169.

## IBM & COMPATS

● IBM XT. SFD, 20 MB HDD. Enhanced keyboard, mono graphics and printer card. 640k. 1 month old. With Wordstar, Supercalc3. Ability, Retrieve, Reflex, Stockmarket, Words & Figures. DOS 3.2. Warranty, manuals, only £1550. (01) 935 6907.  
 ● IBM COMPATIBLE MICROVITEC 1456 COLOUR MONITOR £175. Persyst colour board, £60. Multifunction memory board, clock, serial parallel analogue ports, £60. Dacom autodialling modem DSL2123, £155. All as new. Tel: (0952) 501467.  
 ● 256K PC COMPATIBLE. Twin 360K floppies, mono monitor supplied with original manuals and software. £350. Tel: (0702) 584123 Eves and w/e.  
 ● EPSON MX80 F/T TYPE III, excellent condition. Handbook, £180. Viglen 40/80T switchable twin disk drives for BBC "B". £195. G4GOC ROM rtty c/w boxed hardware, £50. Wanted good NLQ Epson. Shepherd (0908) 313379.  
 ● FERRANTI PC860. 512k RAM. Colour monitor. Star printer, Wordstar, perfect suite, Supercalc, DOS 2.11 3.1. £500. No offers. Tel: Wolverhampton 631884.  
 ● COMPAQ PORTABLE II MODEL FOUR. 80286 CPU, 20 Meg. hard drive, 360k floppy, RGB interface. MS/DOS 3.1, utilities, manuals, etc. New condition. Upgrade forces sale. £2600. Huntingdon (0480) 50189 Eves.  
 ● AMSTRAD PC1512 HD20 COLOUR. 9 months guarantee. Perfect condition. £950 o.n.o. Tel: (01) 341 3994.  
 ● FRAMEWORK II VERSION 1.0. Complete with all manuals. £100. Tel: Buckingham 817094. Ask for Paul Ferguson.  
 ● FOR SALE: IBM PC 256k Motherboard, £175. Monochrome display adaptor, £70. Floppy disk adaptor. £50. 5 1/4 inch full height floppy drive, £50. Write to Mr Turner, 19 Grosvenor Square, Sheffield, S2 4NF.  
 ● E.G.A GRAPHICS CARD. £150. Samsung 12" mono monitor, £60. Mono graphics card, £60. Upstart icon driven menu system, £50. Presentation graphics on the IBM by Lambert, £15. Bedford 60792.  
 ● HERCULES COMPATIBLE GRAPHICS CARD. With parallel printer adaptor. Plus high resolution monochrome monitor (amber) (0201) o.n.o. John Chapman (061) 434 6251 Eves.  
 ● TOSHIBA T3100 PC-AT COMPATIBLE. 640k Ram. 10Mb internal hard disk. Internal 720k, 3.5 micro floppy drive. With MS-DOS 3.2. £1800 o.n.o. Tel: 373 3191 after 5pm.

SALE OF COMPUTERS

## ANTIQUES' SECTION

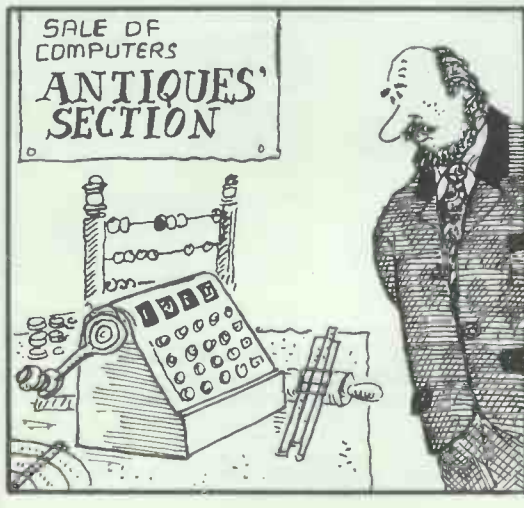

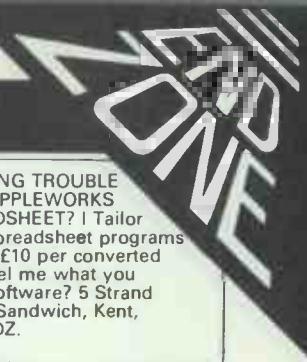

## MISCELLANEOUS

● **RS232 BREAK-OUT BOX.** Imac clear signal interface tester with Tri-state L.E.D.'s on all lines. Also patching facilities. Cost over £200 new. Bargain at £75. Tel: (1734) 478274 Eves.

● **MICROWRITER.** Complete with BBC link £150 o.n.o. Fawdry Milton Keynes (0908) 665806 Eves.

● **OLIVETTI M.19 H.D.** EXPAN KIT. New, boxed, never used, £500. Torch £80 2nd processor card, £100. Other BBC hardware. Tel: Kilmarnock 0563 31068 any evening. Raymond Crane.

● **ACT SIRIUS.** 10Mb hard disk, 1.2 Mb floppy. Software: Wordstar, Multiplan, Crosstalk, Pegasus stock control. Preference manuals included. Good working order, £995. (0606) 556439 Simon.

● **SIRIUS TWIN FLOPPY.** 2 x 600k 256k RAM, MS basic, Assembler, progs, toolkit, Pulsar accounts, MS Fortran + MS basic compilers, manuals etc. In perfect condition. Virtually unused, fair price, £750. Tel: eves Bath (0225) 26329.

● **DATELMODEM 4242**

● **BRITISH TELECOM MERLIN SYSTEM.** Cost £1040 March 1986. Used twice, will accept £500. Tel: (0602) 501196.

● **ACT SIRIUS.** 128k twin floppy, s/sided, £450. 256k twin floppy, d/sided, £650. 256k 10 MEG £875. All with manuals and software. White fronted if preferred. No V.A.T. (0532) 860795.

● **6809 CASED RACK SYSTEM.** PSU, keyboard, flex, SK DOS, Utilities, Forth-83, ED3. £250. Consider exchange QL system. Dynastar RMS McCosh 'C' £100. Tel Tim Bangor (0248) 601049.

## MONITORS

● **TAXAN KAGA COLOUR MONITOR.** Excellent

condition, ideal for IBM, Apple, Oric etc. £150. Tel (0753) 853553 x257 (Mark) work (0628) 74687 after 6.00pm.

● **PHILIPS Green screen monitor.** As new, boxed, £50. Dragon disk drive and interface boxed with manuals and software, £100. Also second hand Demon or WS4000 wanted Maidenhead (0628) 825444.

## PORTABLES

● **EPSON PX-8 PORTABLE.** 120k RAM, PF10 disk drive, P80 Primer, usual software & manuals. £525. Tel: (01) 385 6561.

● **EPSON PX-8.** Including Wordstar, Calc, Card box, Basic software. Plus Philips monitor and UD-80 controller and acoustic modem CX-21. Excellent condition, £650. Tel: Hans on (01) 594 7272 Extension 242.

● **ZENITH Z-181 PORTABLE.** With PCXFER. £1150. Inc MS-DOS and manuals. Excellent machine. No longer required. Tel: (01) 668 3792.

## PRINTERS & PLOTTERS

● **PLOTTER COLORWRITER 6320.** Ex-demo, 10 pen, A3, static, flat, bed HP compatible. £795. Also plotter A3 6 pen flat bed type. Watanaba compatible. £250 new. In box. Tel: (0322) 331984.

● **DAISYSTEP 2000 DAISYWHEEL PRINTER.** As new, in full working condition. Owner selling due to no longer wanting computer. £180. Tel (0272) 638481 after 6pm.

● **BROTHER TWINRITER 5 PRINTER.** Daisywheel and dot matrix combined. Plus electric sheet feeder. Little used, £975 (+ VAT). Foster. Day Brighton (0273) 693622, Eves 504385.

● **JUKI 6100 DAISY WHEEL PRINTER.** Boxed with

manual. Home use only. Excellent machine. Reason for sale, upgrading. Tel: Wantage 02357 69309. Could deliver. £230.

● **HP 7470A PLOTTER.** Virtually unused. Apple II serial card, cable and connector. £950 o.n.o. Tel: (01) 458 5415.

● **HP THINKJET PRINTER.** As new. Parallel interface, with cable. £175 o.n.o. Tel: (06284) 6888.

● **DIABLO 630 DAISYWHEEL.** Tractor feed. Ribbons and print wheels. £350, (01) 435 9169.

● **DIABLO 630 (HPR05) DAISYWHEEL PRINTER** £550. Olivetti PR430 daisywheel printer. £295. Brother HR15 daisywheel printer, £175. Microline 83A matrix printer, £140. Epson FX80 matrix printer, £120. No VAT. (0532) 860795.

## SHARP

● **PC1500 (18k).** RS232 I/F, plotter, software, manuals, magazines (US), pens, paper, etc. £250 the lot. (0635) Newbury 42809.

## SINCLAIR

● **SINCLAIR QL.** With Philips green monitor, ICE Flight Simulator, TALENT workbench, Centronics interface, joystick books, magazines, manuals. £180 Tel: Brighthouse (0484) 721 205 Eves.

● **640k SINCLAIR QL AND PHILIPS MONITOR.** Lots of software. Languages, games, utilities, JM, ROM, Psion 2.3. All v.g.c. £175. Tel: Greg Salt (0603) 614062 anytime.

● **QL CASH TRADER.** (£35), Supercharge and other software for sale, due to computer breaking down, all brand new. Tel: (0223) 322625.

● **SINCLAIR QL SYSTEM.** Microvitec monitor, twin book floppies, printer, modem, interfaces, Psion packages, ICE ROM, Choice, Mailmerge, Multitask,

utilities, McGraw assembler, Chess, many books, will split. £375. Tel 054555 292.

● **QL 640k, 2 x 720k disk drives, parallel printer interface.** Assembler, ICE. Choice, books, magazines. All in good condition. £449 o.n.o. Tel: Bristol (0272) 423860 Eves only.

## SOFTWARE

● **IBM S-WARE for sale.** Flight simulator, DBASE III+, Fortran, Turbo Pascal, SuperCalc, Autocad, and many more. Send s.a.e. for details. Tom Dragic, 2A Sutton Court Mansions, London W4 3JH or Tel: (01) 994 7507.

● **APPLE S/WARE for sale.** Flight simulator, DBASE II Fortran, Pascal, Beagle Graphics and many more. Send s.a.e. For details. Tom Dragic, 2A Sutton Court Mansions, London W43JH or Tel: (01) 994 7507.

● **USED COPIES OF PC1512 SOFTWARE.** Wordstar 1512, £39. Supercalc 3, £39. TAS+, £39. GEM: Draw+, £49. Graph, £49, Business library, £19. Excellent condition. Fully boxed and manuals. Tel: (01) 902 2081. David.

● **SOFTWARE SALE:** Word 3.1, £180. Symphony 1.2, £150, DOS 3.1, £20. Reflex, £40. Lightning, £30. Norton 3, £20. Spotlight, £20. All unused original disk and manuals, in 'mint' condition. Please call Fred at (01) 785 9880.

● **CHESS EXPERT.** BBC micro series disk-based system. Saves games, openings, comments, analysis. Optional 300k openings database. Demo disk £1. Bernard Hill, Hawthorn Bank, Scott's Place, Selkirk, TD7 4DP.

● **IBM COMPATIBLES SOFTWARE:** Microsoft Multiplan, JR spreadsheet (still unopened), £42. Autodesk's Autosketch drawing program, £60. Tel: (061) 256 3257.

● **HAVING TROUBLE WITH APPLEWORKS SPREADSHEET?** I Tailor make spreadsheet programs for just £10 per converted page. Tel me what you want, software? 5 Strand Street, Sandwich, Kent, CT13 9DZ.

## TANDY

● **TANDY MODEL.** 48k plus single disk drive, manuals, Visicalc, printer cable, editor assembler. Tel: Stephen (042) 783202 Lincs.

● **T.R.S. 80** With expansion interface, green screen monitor, Tandy line printer, two disk drives, software including Visicalc books and spare disks. £75 the lot! Milton Keynes 663864.

## WANTED

● **DBASE II OR DBASE II CP/ M2.2** for Memotech MTX512 (64k) computer with 500K twin FSX 5.25 inch floppy disk system. Any offer considered up to £200. Tel (0423) 526267 after 5.30pm.

● **WANTED:** RS232C serial interface for Sanyo MBC 555-2 computer. New or used. Write to John Robinson, 53, Ferrier Road, Stevenage, Herts SG2 0NZ or Tel (0438) 354177 anytime. State price.

● **WANTED.** A1, A2 or A3 flatbed plotter. i.e. Hewlett Packard, Roland, Graphtek or similar: Also, suitable I.B.M compatible digitizer and C.A.D. software etc. Tel Joe Scott 584 3624 office. 352 8806 Eves.

● **WANTED.** Deja Vu Decision analysis system software for IBM. £45. Tel: Edinburgh (031) 228 1142.

● **WANTED.** Date arithmetic formula for use with Datastar, Reportstar, programs. Will swap hard disk utilies for information. Tel: (0959) 76075 office hours, (0959) 74165 Eves. K. Lyward.

# TRANSACTION FILE ADVERTISEMENT FORM

All Transaction File ads must be submitted by readers on this form or a photocopy of this form. Maximum 30 words. Print one word per box, very clearly. Name, address and/or telephone number must be included in the 30 words. All ads must be accompanied by a flat fee of £5. Make cheques or POs payable to *Personal Computer World*. Ads accepted from private readers only. Ads cannot be repeated (unless sent in on another form) and we cannot guarantee to print an ad in any specific issue. Please help our typesetter to help you by printing your ad very clearly. Send your completed form to: Transaction File, PCW, 32-34 Broadwick Street, London W1A 2HG.

Please find enclosed my cheque/PO for £5.

Please tick the appropriate category for your ad from those listed below:

Acorn  Amstrad  Apple  Apricot  Atari  Commodore  CP/M  IBM & Compatibles  Miscellaneous  Monitors  Peripherals  Portables   
Printers & Plotters  Sinclair  Software  Sharp  Tandy  Wanted

*Mike Mudge delves into the factorisation and other properties of Fermat Numbers, with mathematical requirements being kept to the minimum.*

**Definition** 'Fermat Numbers' are defined by  $F_n = 2^{2^n} + 1$ . Thus,  $F_1 = 5$ ,  $F_2 = 17$ ,  $F_3 = 257$ ,  $F_4 = 65537$ .

It can be readily verified that these first four Fermat Numbers are prime; indeed, Pierre De Fermat (1601-1665) conjectured that *all*  $F_n$  were prime. However, such are the dangers of generalisation based upon empirical evidence, and in 1732 Leonhard Euler found that:

$$F_5 = 2^{2^5} + 1 = 2^{32} + 1 = 4294967297 = 641 \times 6700417$$

In 1880 F Landry proved that:

$$F_6 = 2^{2^6} = 2^{64} + 1 = 274177 \times 67280421310721$$

No prime Fermat Number has been found beyond  $F_4$ , so that Fermat's conjecture has not proved to be a very happy one. It is perhaps more probable that although the number of prime  $F_n$  is finite, there are others waiting to be discovered (reference the probabilistic argument given as a footnote in *An Introduction to the Theory of Numbers* by GH Hardy and EM Wright).

The existence of prime  $F_n$  has an interesting geometrical connection, since Karl Friedrich Gauss proved that a regular polygon having  $F_n$ -sides could be inscribed in a circle by Euclidean methods if  $F_n$  is prime. (A 65537-sided regular polygon inscribed in a given circle could provide an interesting challenge in computer graphics, particularly if an attempt was made to simulate the Euclidean methods mentioned above!)

**Theorem 1** No two Fermat Numbers have a common divisor other than 1.

**Theorem 2** If  $F_n$  is prime, then the number:

$$Z_n = 3^{2^{2^n-1}+1}$$

is divisible by  $F_n$ .

For example,  $F_2 = 17$  is prime, hence we know that  $3^{2^3} + 1 = 3^8 = 6561 + 1$  is divisible by 17. In fact,  $6562 = 17 \times 386$ .

**Note** The converse of theorem 2 is also true: that is, if  $F_n$  is *not* prime, then  $Z_n$  is *not* divisible by  $F_n$ .

**Theorem 3** Any factor of  $F_n$  has the form  $k \times 2^m + 1$  where  $m \geq n + 2$  and  $k$  is an odd integer.

For example, the factor 274177 of  $F_6$  cited above is given by  $256 \times 1071 + 1$ , while the factor 6700417 of  $F_5$  is given by  $52347 \times 128 + 1$ .

This month's project is to search for factors of Fermat Numbers; it is suggested that Theorem 3 be used, hence two different ways of organising the search are possible.

The description which follows is due to Professor Wilfrid Keller of the University of Hamburg, who has conducted extensive research in this area using both a Telefunken TR 440 computer in TAS assembly language and a Siemens 7.755 with built-in extended precision floating point arithmetic.

How far can PCW readers get with this work?

**Approach 1 — Trial division** For fixed  $n$ , look for all  $k$  less than some search limit  $L_n$  to see if  $k \times 2^n + 1$  divides some  $F_r$ ,  $r \leq n$ .

**Approach 2 — Tabulation of primes** For fixed  $k$ , list all primes of the form  $k \times 2^m + 1$  for  $m$  up to some limit  $M_k$ . Then, for each prime, look to see if it divides some  $F_n$  where  $n \leq m - 2$ .

Readers are invited to send their thoughts, together with attempts at this project, to Mike Mudge, 'Square Acre', Stourbridge Road, Penn, Staffordshire WV4 5NF, tel: (0902) 892141, to arrive by 1 December 1987.

It would be appreciated if such submissions contained a brief summary of results obtained, in a form suitable for publication in PCW. These submissions will be judged using subjective criteria, and a prize will be awarded by PCW to the 'best' contribution received by the closing date.

Please note that submissions can only be returned if a stamped addressed envelope is provided.

## *Belated review: September 1986*

Regular readers of Numbers Count will be aware that the prize award associated with this problem was deferred (PCW, March) due to a lack of response. Interesting correspondence has since been generated, resulting in a very worthy prizewinner: Fred Hartley of 46 Hughes Road, Hayes, Middlesex UB3 3AP. Fred used a BBC Model B and relied very much upon a set of long integer arithmetic routines written in assembler which cope with integers up to 256 bytes in length.

The computing went hand in hand

with a careful theoretical analysis, and Fred's third communication concludes: 'I suspect that  $s(k)/k$  increases without limit as the number of factors increases, but I have not proved this.' Can any mathematicians help?

I am certain that Fred would welcome enquiries from interested readers regarding the details of his work.

## *Review: March 1987*

This problem was, as expected, extremely popular. It was prompted by the following results quoted in LE Dickson, *History of the Theory of Numbers, Volume 2*.

'Fermat noted that if in (205769, 190281, 78320) we add the area to the square of the sum of the legs, we get a square.

'Frenicle stated that in (17, 144, 145) the sum of the area and the hypotenuse is a square, while the first three right triangles in which the sum of the area and smaller leg is a square, are (3, 4, 5); (16, 30, 34) & (105, 208, 233).

"Calculator" found three right triangles of equal perimeter and areas in arithmetical progression (18601944, 13951458, 23252430); (18559223, 13999464, 23247145) & (18515584, 14048388, 23241860)'. While AH Beiler, *Recreations in the Theory of Numbers*, reports:

'Four primitive Pythagorean triangles having a common perimeter have also been found. Only seven such quadruples exist for a perimeter less than 1000000 so they are quite rare. The smallest of these perimeters is 317460 and the triangles are (153868, 9435, 154157); (99660, 86099, 131701); (43660, 133419, 140381) and (13260, 151811, 152389). Can the reader find the other six?'

Unfortunately, the italics in part (v) of the problem together with the lack of the adjective 'primitive' generated a great deal of computer output — at least one complete answer to that part!

After much consideration, this month's prizewinner is Peter Hicks of 9 Carramar Street, Rye, Victoria, 3941, Australia.

Mike Mudge welcomes correspondence on any subject within the areas of number theory and other computational mathematics. Particularly welcome are suggestions, either general or particular, for future Numbers Count articles; all letters will be answered in due course.

Isolated readers can be put into contact with others sharing the same interests. However, greater efficiency regarding published problems should result from contacting the prizewinner directly.



# USER GROUPS

*News from around the user groups and clubs with Rupert Steele, with a special emphasis this month on our old friend, the ACC.*

One of the most pleasing aspects of the micro 'revolution' in this country is the quite extraordinary efforts made by the various user groups to help people understand and use their micros. Many of the groups are run on a hobby basis, while others may help contribute to the income of the person running them. However, I don't think that there are many examples (industry-sponsored 'captive' user groups being a possible exception) of anyone getting rich through running a user group.

But despite the low-cost approach that is usually taken in user groups, the quality of their output — and its general usefulness — continues to impress me. Several groups now produce their newsletters on laser printers and the results are often very worthwhile.

Perhaps the best user group newsletter I have seen in a long time is the *Apricot File* distributed by TP Group. This is a goldmine of useful technical information about the Apricot. Among the nuggets in 'Release 2.9' of the newsletter are a five-page manual on the screen-driving characteristics of the Apricot, complete with comprehensive details of undocumented features in certain BIOS releases; a program to split large files for use with SuperWriter; an explanation of the MS-DOS 'environment' facilities; IBM emulation (now becoming increasingly important); and advice on how to use SuperWriter with boilerplate text. Yes, I know a lot of this should have been in Apricot's release kit — but it wasn't, and I for one will be keen to see what other issues of *Apricot File* contain. *Apricot File* also has a library of public domain software, plus a collection of utilities and discounted proprietary packages.

I think I have made my point. *Apricot File* is a must for the serious Apricot User — even if you already have undelete and copy-protection breaking utilities. Contact *Apricot File*, TP Group, PO Box 509, London N1 1YL or tel: (01) 833 3501.

*Apricot File* was one of many newsletters to come through my door in response to the new format of the User Groups column. My mailbox has grown considerably over the past few months, so if some groups have to wait a while before being mentioned here, it is simply due to the size of the queue. But I can't write about a club at all if I don't have any information to go on, so it

is most important that you keep writing in.

It will also help if members of user groups write to me relating their good or bad experiences. I obviously have to take a lot on trust from the material I am sent, and the Directory of User Groups published on the next two pages doesn't imply any kind of warranty from me as to the quality of the groups. But if I hear widespread reports that a group is not up to scratch, I will obviously want to avoid pointing people at it. So good or bad, let me know!

I have to report a change from some information I published last month about the Sharp User Group, run by Larry Galliford. I have been told that there is a new secretary for the club, namely Andrew Fergusson, 11 Harcourt Close, Henley on Thames, Oxon RG9 1UZ. The group now publishes its newsletter, of 50-60 pages, three times a year for a total subscription of £6. More information is available from Andrew on (0491) 574850.

I have received a lot of comments about the Directory of User Groups and am pleased to say that most of you seem to like it, and find it useful. This month, as space permits, it appears in its entirety (see over the page).

## ACC news

I have had a newsletter from the Association of Computer Clubs. Although this went out to its member clubs a while ago, it does contain some information of general interest. The Association acts as the umbrella group for all local and national user groups that are organised on a non-profit basis. It has a comprehensive database of all local clubs around the country, with several hundred entries. The newsletter announces that the ACC will be present at the 10th PCW Show this month (see the Preview in this issue on page 154), organising the clubs area and arranging for many other clubs to take part — though some may simply give publicity information to the ACC and avoid having to man a stand for the five days. The ACC will also have two computers running the ACC database so that visitors at the show will be able to get an online pointer to their nearest clubs.

The ACC has also published its timetable for the Annual Council meeting on 14/15 November in Milton Keynes. Any motions must reach

the secretary by 5 October, and clubs should receive a Notice of Meeting by 17 October. The newsletter also mentions a 'magazine' project — the ACC will supply enough copies for every member of every affiliated club to have one. I hope it goes well — back in 1981, I started a similar project in the Amateur Computer Club, but it didn't quite take off.

The ACC's newsletter also lists the ACC services. All affiliated clubs are automatically included in the ACC's insurance scheme for Public Liability, and inexpensive insurance is available to cover club members' computers at, or in transit to, club meetings. And, of course, it mentions the highly successful ClubSpot 810 database on Prestel, run by the ACC's autonomous Electronic Publishing Committee. Finally, the newsletter gives details of a new range of fact-sheets published by the Association on such diverse subjects as Compiling a Press Release and the Data Protection Act. Membership of the Association is a remarkably good deal for almost any local computer club, and I would thoroughly recommend it. For details, see the Association's entry (and ClubSpot's) in the Special Interest' section of the 'Directory'.

## Club news

There is just space to mention a couple of local groups in the West Country. The South West Atari ST User Club has been running about six months. The membership is around 26 and interests cover every aspect of the ST. Meetings start at 7:30pm on the second Tuesday of each month in the General Teaching Block of Plymouth Polytechnic. Details from Karl Fuller, 289 Fort Austin Avenue, Crownhill, Plymouth, Devon PL6 5ST.

The other club is based at the Allendale Community Centre, Hanham Road, Wimbourne, Dorset. Dennis Horn, the activities' organiser for the Community Association, has written to say he is starting a club there. More information is available from Dennis at 6 Richmond Lodge, Victoria Avenue, Swanage, Dorset BH19 1AN.

---

If you would like your user group or club to have a mention in this column, or you wish to be considered for the Directory of User and Support Groups, please write to Rupert Steele, 12 Philbeach Gardens, London SW5 9DY.

---

Turn the page for the Directory of User and Support Groups.

# DIRECTORY OF USER GROUPS



## GROUP

## CONTACT

## NOTES

### ● SPECIAL INTEREST

AMRAC-Amateur Radio & Computer Club	Trevor Tugwell, G6TJT, 6 Kestrel Drive, Mudeford, Christchurch, Dorset BH23 4DE. Or phone Phil Bridges on (0703) 847754 (G6DLJ)	300/300 Bulletin Board on 0736 518818
Church Computer Users Group	Rev Nigel Hardcastle, 112 Rotherfield Rd, Garretts Green, Birmingham, B26 2SH (021) 743 2971	Support group for those using computers in the running of churches
Local Authority Micro-Computer User Group	John New, Borough Engineers Dept, Municipal Offices, North Quay, Weymouth, Dorset DT4 8TA (0305) 785101 (ext 272)	
Seafarers	Mr C E Watson, 29 Doods Place, Doods Road, Reigate, Surrey RH2 0NS	
SNUG — Special Needs User Group	Jeff Hughes, 39 Eccleston Gardens, St Helens WA10 3BJ. (0744) 24608	Computing for the disabled handicapped, and so on
Society of Genealogists	Society of Genealogists, 14 Charterhouse Buildings, London EC1M 7BA (01) 251 8799	Use of computers in tracing ancestors. Monthly meetings
Comms file	TP Group, FreePost, London, N1 1BR (01) 833 3501	Comms users newsletter. Subscription: £75
Amateur Computer Club	Andy Leeder, Church Farm, Stratton St Michael, Norwich, NR15 2QB	Hardware Club. Large SAE for sample newsletter
Association of Computer Clubs	John Dale, 12 Poplar Road, Newtown, Powys SY16 2QG	Umbrella group for all hobby clubs. National database of local groups (SAE)
ClubSpot 810	Andy Leeder, Church Farm, Stratton St Michael, Norwich, NR12 2QB *810#	Hobby Information Provider on Prestel. Clubs may be able to edit own free pages
Find-It	Orkney Computing, 60 Albert Street, Kirkwall Orkney, KW15 1HQ. (085 686) 268	Disk-based index to PCW and five other UK business micro mags. Runs on PC
Christian Micro Users Association	Philip Clark, 138 Bramwell Gardens, Sheffield S3 7PW	
● AMSTRAD		
1512 Independent User Group	PO Box 55, Sevenoaks, Kent TN13 1AQ (0959 2) 2585	£20 subs; PC clone only
Amstrad Professional User Club	John Ainsworth, Amstrad Prof User Club, Victoria House, 1-6 Low Row, PO Box 10 Sunderland SR1 3PY (0783) 673395	Business users only; £49.95 subscription
Amstrad User Software Database	AUSD, PO Box 11, Gosforth, Newcastle-upon-Tyne NE3 1RP (091) 285 6107	Fido bulletin board available
PCW Users Group	Robert Moberley, 37 Clifford Bridge Road, Binley, Coventry CV3 2DW (0203) 441417	Monthly newsletter. SAE with postal enquiries
The PCW Computer Club	Ron Morland, 12 Deneve Avenue, Poole, Dorset BH17 7LR	SAE please for details
Advantage	Jeffrey M Green, 33 Malyns Close, Chinnor, Oxon, OX9 4EW (0844) 52075	All Amstrad machines. SAE please
Amstrad CPC Computing Newsletter	Chris Bryant, 11 Havenview Road, Seaton, Devon EX12 2PF	Home users. Large SAE for sample newsletter
PCW File	Chris Bryant (as above)	Subscription £2 including free PD software. Large SAE for sample newsletter
WACCI (Europewide Amstrad User Club)	Jeff Walker, WACCI, 75 Greatfields Drive, Hillingdon, Uxbridge UB8 3QN (0895) 52430	Newsletter; £12 sub; special offers
Amstrad Groups Federation	4 Sutton Road, Gorton, Manchester M18 7PN	Umbrella organisation for Amstrad User Groups
● HARDWARE		
68 Microgroup	J Turner, 63 Millais Road, London E11 4HB	Hardware/software for 68000/6800
Apricot File	Apricot File, TP Group, PO Box 509 London N1 1YL (01) 833 3501	Detailed technical Apricot newsletter
Atari National User Group	N Lewis, 13 Weavers Walk, Courthouse Green, Coventry CV6 7LG	Newsletter; SAE please
Atari ST-Club	Paul Glover, ST-Club, PO Box 20, Hertford	PD software available
Basug	Sheila Hurst, PO Box 177, St Albans, Herts AL2 2EG (0727) 73990	Apple systems
BOOG	Victor Nollen, 38 Rocks Lane, Barnes London SW13 0DA (01) 833 2526	Osborne support group
Commodore Plus 4	Steve Kent, 203 Wolverhampton Road, Pelsall Walsall, West Midlands WS3 4AW	SAE please
Compucorp University Users Group	c/o Compucorp, Cunningham House, Westfield Lane, Kenton, Middx HA3 9ED	
HICUPS	Bruce Ainge, Foxberry House, 16 Foxberry Road, London SE4 2SP (01) 691 5202	Hitachi MBE 16002 PC group
ICPUG	Jack D Cohen, ICPUG, 30 Brancaster Road, Newbury Park, Ilford IG2 7EP (01) 346 0050 (home); (01) 579 1229 (day)	Commodore machines from PET to Amiga. £10 subs + £1 entry fee

# DIRECTORY OF USER GROUPS

AND ONE

## GROUP

## CONTACT

## NOTES

Independent Psion Organiser User Group (IPSO)	Mike O'Regan, 130 Stapleford Lane, Beeston, Nottingham NG9 6GB	SAE please. Monthly newsletter IPSO FACTO
IQLUB (renamed QUANTA)	Brian Pain, 24 Oxford Street, Stoney Stratford, Milton Keynes MK11 1JU	Sinclair QL and compatibles
IOUG	Gary Ramsay, 1 Kingsway Crescent, Burnage, Manchester M19 1GA	Oric users; newsletter IOU
Jupiter Ace User Domain Resource Centre	Ian Jones, 21 Dene Street, Pallion, Sunderland SR4 6JB (091) 565 2833	Software/hardware ideas exchanged. SAE please
Macintosh User Group UK	John Lewis, 55 Linkside Avenue, Oxford OX2 8JE. (0865) 58027	£25 subscription: professional group
MacTel	David Nicholson-Cole, 15 Elm Tree Avenue, West Bridgeford, Nottingham NG2 7JU Board (0602) 817696 or (0742) 350319	Bulletin board for Mac users 300/300; 1200/75; 1200/1200
Memotech Owners Club	Phil Eyres, 23 Denmead Road, Harefield, Southampton SO2 5GS	SAE please
NATGUG (National Amstrad, Tandy and General Users Group)	Brian Pain, 24 Oxford Street, Stony Stratford, Milton Keynes MK11 1JU (0908) 564271	Tandy, Genie, MS-DOS, Amstrad
NBUG	Gerald McMullon, 36 Armitage Way, Cambridge CB4 2UE	NewBrain SAE please
OPEN#STREAM	1 Ranelagh Road, Deal, Kent CT14 7BG	NewBrain group
Research Machines National User Group	Steve Burrows, Wirral CAE Services Ltd, Gorse Lane, Wallasey, Wirral L44 4HE (051) 639 8237	RML 380Z, 480Z, Nimbus and 80286/80386 machines
Sanyo MBC-550	Mr M H Syed, Wistaria, 53 Acacia Grove New Malden, Surrey KT3 3BP (01) 942 9009	Informal group
Sharp User Group	Andrew Fergusson, 11 Harcourt Close, Henley on Thames, Oxon RG9 1UZ (0491) 574 850	£6 Subscription. Newsletter (60 pages) & software library
SORD/PIPS	Mr B Nicholson, 5 Brunton Place, Edinburgh EH7 5EG (031) 556 2340	Informal group for UK users of SORD M-23
Tangerine	David Cawthorne, 40 Westbourne Road, West Kirby, Wirral L48 4DH (051) 625 7311	Informal info sheet and newsletter; £2/copy
The One And Only	Neil Smith, 42 Hayes Road, Bromley BR2 9AA	ZX Spectrum software exchange. SAE please
T199/4a EXCHANGE	Clive Scally, 40 Barrhill, Patcham, Brighton BN1 8UF (0273) 503968	Subscription £6; quarterly newsletter
UKAS (UK Adam Subscribers)	Keith Marner, 33 Homer Road, Croydon CR0 7SB (01) 654 2184	Coleco Adams. Journal every 2 months; SAE please
UK Einstein User Group	Graham Bettany, UKEUG, 80 Dales Road, Ipswich IP1 4JR	£15 subscription. Monthly newsletter. SAE please
West Midlands & Oxon TI User Group (International)	Gordon Pitt/Peter Brooks, 259 Sneyd Lane Bloxwich, Walsall WS3 2LS Bloxwich 476373	National T199/4 group Subscription £12.50; monthly newsletter
● SOFTWARE SYSTEMS		
Compulink	Frank Thornley, 67 Woodbridge Road, Guildford GU1 4RD (0483) 573 337	FIDO Bulletin Board offering public domain software
CUG (C Users Group UK)	Martin Houston, 36 Whetstone Close, Farquhar Road, Edgbaston, Birmingham	£10 subscription; the group supports the C language
Econet User Group (Scotland)	Michael Ryan, Balkeerie Cottage, Eassie, by Forfar, Angus DD8 1SR	English & Welsh also welcome
Lotus User Group	The Lotus User Group, 78-80 Peascod Street, Windsor, Berks SL4 1DH (0753) 841686	Subscription £95. Magazine, Helpline, consultancy, and so on
Memory Alpha	Memory Alpha, 16 Mayfield, North End, Portsmouth, Hants	MSX Group. SAE please
MSX User Group	Lee Simpson, 3 Mayfair Place, Tuxford, Newark, Notts NG22 0JD	
PC-SIG	ISD International Software Distributors Ltd, PO Box 872, Sutton Coldfield, West Midlands B75 6UP	Public domain software for PCs. £6/disk donation to author. 700+ disks available
PD-SIG	PD Software Library, Winscombe House, Beacon Road, Crowborough, Sussex TN6 1UL (08926 63298)	Public domain software for PCs, CP/M, Apricot. Disk conversions
PIP	PIP, 28 Gordon Mansions, Torrington Place, London WC1E 7HF	Group for CP/M compatibles: Amstrads; Einsteins; Osbornes, and so on. BBS
Serviceline	Clare Winter, Ashton-Tate UK Limited, Oaklands, 1 Bath Road, Maidenhead, Berks (0628) 33123	Telecom Gold Ashton Tate information/supply service
World of Lotus	World of Lotus, Telecom Gold Ltd, 60-68 St Thomas St, London SE1 3QU	Commercial Telecom Gold Lotus support. £9.60/hour to use. Free macros, drivers

An up-to-date list of UK bulletin boards, compiled by Peter Tootill.

## London

Airtel - TBBS (01) 200 3439  
 24 hrs; 3/1275; Pilots' area  
 Brixton iTec (01) 735 6153  
 24 hrs; 1275  
 Communitel (01) 968 7402  
 24 hrs; 1275v  
 Crystal Tower (01) 886 2813  
 24 hrs; 3-24  
 Gen interest; Apple & IBM  
 CyberZone (01) 638 2034  
 24 hrs; 3  
 Dark Crystal Fido (01) 207 2989  
 24 Hrs; 3-12  
 Distel (01) 679 1868  
 24 hrs; 300  
 Display electronics - Commercial  
 3/1275 on 01 679 6183  
 Gnome at home (01) 888 8894  
 24 hrs; 1275v  
 Hackney BBS (01) 985 3322  
 24 hrs; 1275v  
 Health data (01) 986 4360  
 24 hrs; 1275v  
 Hendon Fido £\*(01) 200 7577;  
 (01) 220 8281 24 Hrs; 3/1275  
 Opus system  
 ITCU Training (01) 960 4742  
 24 hrs; 1275v  
 Lots of iTec training materials  
 Link Fido (01) 659 6992  
 24 hrs; 3-12  
 London U'gnd (01) 863 0198  
 24 hrs; 3-24 wildcat BBS  
 Marctel (01) 346 7150  
 24 hrs; 3/1275 FBBS system  
 MBBS Mitcham (01) 648 0018  
 24 hrs; 3/1275  
 Metrotel (01) 941 4285  
 24 hrs; 1275v  
 NBBS London (01) 883 5290  
 24 hrs; 3/1275  
 NNBS London (01) 455 6607  
 24 hrs; 3/1275  
 OSI Lives (01) 429 3047  
 24 Ring back; 300  
 Owlitel (01) 927 5820  
 24 hrs; 1275v  
 PC Access (01) 853 3965  
 24 hrs; 3-24 For IBM PC users  
 Poly Fido (01) 580 1690  
 24 hrs; 3-12  
 Prestel 24 hrs (01) 248 5747  
 24 hrs; 300 baud  
 No graphics on this number  
 Taecom (01) 573 8822  
 MF: 7pm-8am; WE:all day Sun; 300  
 Interak micro section

TBBS Rovoreed (01) 542 4977  
 24 hrs; 3-24  
 TBBS London (01) 348 9400  
 24 hrs; 3-12  
 Techno Line (01) 450 9764  
 24 hrs; 1275v; Commercial  
 Techno-line 2 (01) 452 1500  
 MF: evenings; WE:24 hrs  
 1275v Commercial  
 The Star BBS (01) 586 6882  
 24 hrs; 3/1275; Atari ST area  
 The Village (01) 464 2516  
 24 hrs; 3-24; Atari 520ST based  
 Twigh't Phone Fido (01) 624 5338  
 24 hrs; 3  
 Typnet (01) 676 0283  
 24 hrs; 300; Budget Typsetting  
 WBBS Wimbledon (01) 542 3772  
 Sat 7pm - Mon 8am; 3/1275

## The Midlands

CBABBS; Birmingham (021) 430 3761  
 24 hrs; (not Thurs); 300  
 Atari based. Can send mail to Canada  
 Digital Matrix Fido; Birmingham  
 (021) 705 5187  
 24 hrs; 3/1275 Compu-store on-line  
 Infocom BBS; Birmingham  
 24 hrs; 3/1275

On-Line games;adult stories;BBC  
 The City; Birmingham (021) 353 5486  
 24 hrs; 300  
 Atari 8 bit & ST; Lonely Hearts  
 TUG II; Birmingham (021) 444 1484  
 24 hrs; 3/1275  
 Amstrad;Tandy;online Adventure  
 Wolverhampton BBS (0902) 745 337  
 24 hrs; 3/1275  
 MS-DOS; CP/M; Commodore areas

## The North East

49'ers; Cleveland (0237) 43 920  
 MF:10pm-4am; WE:10pm-4am; 3/1275  
 FBBS colour for BBC users  
 Avon Fido; Weston Supe Mare  
 (0934) 29 570 24 hrs; 3/1275  
 Forum-80; Hull (0482) 859 169  
 MF:7pm-11pm; WE:1pm-11pm; 3/1275  
 Midnight-8am on Bell 103 lines  
 L E M S Fido; Leeds (0532) 670 749  
 Daily 10pm-8am; 3/1275  
 Hamnet; Hull (0482) 465 150  
 MF:6pm-8am; WE:24 hrs; 3/1275  
 Radio Hams  
 Key Board; Milton Keynes  
 (0908) 668 398  
 8pm-8am exc Tues and Thurs; 12h

Runs on a Spectrum.  
 Log On Tyne Fido; Tyneside  
 (091) 477 3339 24 hrs; 3/1275  
 MacTel Sheffield (0742) 350 319  
 24 hrs; 3-24; For Macintosh Users  
 MacTel HQ; Nottingham (0602) 817 696  
 24 hrs; 3-12; Macintosh Users  
 MacTel Green Box; Nottingham  
 (0602) 811 950 24 hrs; 3-24  
 For Macintosh users  
 MBBS Leonfield (0401) 50 745  
 24 hrs; 3/1275  
 N.Yorks Fido; Knaresborough  
 (0423) 862 268  
 MF:10pm-4am; WE:10pm-4am; 3-12  
 Norview; Northants (0604) 20 441  
 24 hrs; 1275v  
 OBBS Bradford (0274) 480 452  
 24 hrs; 3/1275  
 Colour for BBC users  
 On-Line Systems; Cleveland  
 (0429) 234 346; 24 hrs; 3-24  
 Viewdata/scrolling  
 PD-Sig Fido 1; Warwicks (08926) 61 149  
 24 hrs; 3/1275  
 PD software interest group  
 Stockton Fido; Teeside (0642) 605 838  
 Daily 6pm-6am; 300; MSX  
 The Sharrow BBS; Ripon (0765) 707 887  
 24 hrs; 3/1275  
 Viewdata & scrolling BBC based

## The North West

Bolton BBS (0204) 43082  
 MF:8pm-6am; WE:24 hrs; 3-24  
 8am-8pm on ring back  
 CNOL; Lancaster (0524) 60 399  
 24 hrs; 300  
 Clinical-BBS for medics  
 Fido Compulink North; Liverpool  
 (051) 220 3761 24 24 hrs; 3/1275  
 Fido Manchester (061) 773 7739  
 24 hrs; 3/1275  
 Mektronic Electronic design cons  
 Intel-Ace; Oundle (0832) 73 003  
 MF:6pm-8am; WE:24 hrs; 1275v  
 Liverpool Mailbox (051) 428 8924  
 24 hrs; 3-24; UK TBBS HQ system  
 Matrix; Liverpool (051) 737 1882  
 24 hrs; 3/1275  
 Multi-user games; 4 lines  
 NBBS Cheshire (0936) 77 025  
 24 hrs; 3/1275  
 OBBS Manchester (061) 427 1596  
 24 hrs; 3/1275  
 Portal; Wirral (051) 355 0911  
 MF:8pm-6am; WE:24 hrs; 3/1275  
 Pyramid; Leigh; Lancs (0942) 609 611  
 24 hrs; 3  
 Stoke iTec (0782) 265 078  
 24 hrs; 1275v  
 TeePee Link; Manchester (061) 494 6938  
 24 hrs; 3-24  
 Telemac 15; Macclesfield (0625) 33 703  
 24 hrs; 3/1275

## The South East

Acorn BBS; Cambridge (0223) 243 642  
 24 hrs; 1275v  
 ARONET; Colchester (0376) 518 818  
 24 hrs; 300  
 BABBS; Felixstow (0394) 276 306  
 24 hrs; 3-24  
 Banat Board; Oxford (0865) 882 872  
 24 hrs; 3-24; FidoNet UK coordinator  
 BBS09; Portsmouth (0705) 736 025  
 MF:7pm-7am; WE:24 hrs; 300  
 OS9; Sci-Fi; Dragon; CoCo sections  
 BITEC; Basildon (0268) 22 177  
 24 hrs; 1275v  
 BITEC; Basildon (0268) 25 122  
 24 hrs; 300  
 Bloxam; Banbury (0295) 720 812  
 Daily 10pm-1am; 300  
 C A T S Fido; Maidenhead  
 (0628) 824 852 24 hrs; 3/1275  
 V22/bis coming  
 C View Rochford; Kent (0702) 54 6373  
 24 hrs; 1275v  
 CIX; Guildford (0483) 573 337 or 338  
 24 hrs; 3-24; multi-user  
 CP/M User Group; Windsor (0753) 868 196  
 24 hrs; 3-24; CP/M and MS-DOS software  
 Datasoft Opus; Ilminster (04605) 4615  
 24 hrs; 3-24; Inc Datatalk Support area  
 Dr Solomon's Fido; Amersham (02403) 4946  
 24 hrs; 3-24; mostly for IBM programmers  
 Fido PD Software; E Grinstead  
 (0342) 315 636 24 hrs; 3-24  
 PD software database  
 Gosport Apricot BBS  
 (705) 524 805; 24 hrs; 300  
 LABBS; Surrey (0863) 844 164  
 24 hrs; 3/1275; The Prisoner - 2 lines  
 Lasermail Fido; Worthing (0903) 212 552  
 24 hrs; 3/12  
 Maptel; Southend (0702) 552 941  
 24 hrs; 300; commercial system  
 NBBS Essex; Brentwood (0277) 228 867  
 24 hrs; 3/1275; subscribers only  
 Patnet; Colchester (0206) 844 813  
 Daily 8pm-8am; 12h; runs on a Spectrum  
 PBBS-'Adult' BBS; Woking  
 24 hrs; 3/1275  
 PD-SIG System; Uxbridge (0895)  
 24 hrs; 3-24; also on 0895 52685

# UK BULLETIN BOARDS



Pete's Place; Colchester (0206) 862 354

24 hrs; 3-24; good IBM SIG

RICBBS; Basildon (0268) 710 637

MF:5pm-10pm; WE:24 hrs

RSGB; London (0707) 52 242

24 hrs; 1275v

SBBS - Watford (0923) 676 644

9pm-11am plus 11pm-6am daily; 3/1275

TBBS Gamlingay; Sandy; Beds (0767) 50 511

24 hrs; 3-24

Trinity 3; Reading (0734) 484 847

24 hrs; 3/1275 TBBS system

## The South West

BOOG BB; Fleet; Hants (0252) 626 233

24 hrs; 3/1275

Osborne; MS-DOS; CP/M areas

CBBS South West; Exeter (0392) 53 116

24 hrs; 3/1275

Jersey Fido (0534) 39 389

24 hrs; 3/1275

QMC Viewdata; Basingstoke (0256) 471 757

24 hrs; 1275v; Queen Mary's College

TBBS Blandford; Dorset (0258) 54 494

24 hrs; 300; Blandford Computers

Trinity 1; Exmouth (0395) 272 611

24 hrs; 3-12

Trinity 2; Faringdon (0367) 81 507

24 hrs; 3/1275

Sponsored by Courier Consultancy

Vampire's Coffin; Weybridge

(0832) 245 593 24 hrs; 1275v

Viewdata & scrolling

## The West

Access Fido; Worcester (0905) 52 536

24 hrs; 3-24; midi section

Octopus; Bristol (0272) 421 196

MF:6pm-6.30am; WE:24 hrs; 3/1275

## Scotland

Aberdeen ITEC (0224) 641 585

24 hrs; 1275v

Aberdeen Commodore (0224) 781 919

24 hrs; 300; Commodore 64 based

Betelgeuse 5; Inverness (0463) 231 339

24 hrs; 3/1275

Kirklees ITeC; Batley (0924) 442598

24 hrs; 1275v

Information Technology Centre

Livingstone BBS; Livingstone

(0506) 38 526 24 hrs; 300

People's Palace; Glasgow (041) 956 6537

Daily 6pm-6am; 3/1275 Colour

## Wales

Bulletin AT Fido; Swansea (0792) 297 845

MF:6pm-9pm; WE:24 hrs; 3-12

Capital Data Line; Cardiff (0222) 461 824

24 hrs; 300; computer repair company

Cardiff ITeC (0222) 464 725

24 hrs; 1275v

Communitree; Powys (0874) 711 147

24 hrs; 300

Cymrutel; Colwyn Bay (0492) 49 194

24 hrs; 1275

FBBS Swansea (0792) 203 953

24 hrs; 3

MGBBS Mid Glamorgan; Ferndale

(0443) 733 343 6pm-1am daily; 300

Proteus Opus; Porthmadog (0766) 4154

24 hrs; 3-24; ANSI colour graphics

## Northern Ireland

Deep Thought Fido; Bangor NI

(0247) 467 863 24 24 hrs; 3-24

PC-DOS; CP/M; BBC; Tech help Sigs

PBBS 1 Portadown (0762) 333 872

Daily 10pm-1am; ring back; 300

## Eire

DUBBS; Dublin (0001) 885 634

MF:8pm-8am; WE:24; 3-24

Amiga based; astronomy SIG

Dublin Fido; Dublin (0001) 854 522

24 hrs; 3-24

IACCBBS; Eire (0001) 903 341 24

24 hrs; 300

Irish ACC Runs on Commodore 64

# LEISURE LINES

*Brainteasers courtesy of JJ Clessa.*

### Quickie

Can you find a 4-digit number whose digits reverse when it is multiplied by 9?

### Prize puzzle

A simple (!) problem in logic this month. Two families are involved in this. 'Whodunnit': the Smiths; comprising of teachers Alan and Betty and hairdresser Cynthia; and The Jones, where Donald is a teacher and Eric and Fiona are hairdressers.

One evening, two of the above were at the cinema, two were shopping at the supermarket, and two were playing golf. One of the two playing golf murdered the other. The facts are as follows:

- A teacher and a hairdresser were

shopping.

- The two people at the cinema had the same occupation.

- The victim and the murderer were twins.

- The dead person was married to one of the two people at the supermarket, and the murderer was married to the other.

- The victim and the victim's spouse had different occupations.

- Of the two people at the cinema, one was the ex-spouse of one of the two people shopping, and the other was the same sex as the teacher at the supermarket.

*Who was the killer?*

Answers on postcards, please, or backs of envelopes only, to reach

PCW, Leisure Lines September 1987, 32-34 Broadwick Street, London W1A 2HG, no later than 30 September.

### June prize puzzle

Two hundred and two correct solutions were received, plus 21 incorrect ones. Frankly, I didn't think that the optimum grid-crossing problem would be so popular. For some entrants it was nostalgic, as one wrote: 'I never thought I would find a use for dynamic programming...'

The maximum grid total possible was 455 obtainable in several ways, one of which is 38-40-40-40-36-39-40-28-40-37-37-40.

The winning card came from Mr AN Brooks of Cambridge.

# DIARY DATA

### IBM SYSTEM USER SHOW

Olympia 2, London — EMAP International Exhibitions (01) 608 1161

2-4 September 1987

### PERSONAL COMPUTER WORLD SHOW

Olympia, London — Montbuild (01) 486 1951

*(Obviously the UK's No 1 computer show. Make sure you don't miss it!)*

23-27 September 1987

### DEC USER SHOW

Barbican, London — EMAP International Exhibitions (01) 608 1161

6-8 October 1987

### COMPUTER GRAPHICS '87

Wembley Conference Centre, London — Online Conferences Ltd (01) 868 4466

*(Includes a number of conferences)*

13-15 October 1987

END



# MIGHTY MICRO

Mighty Micro Manchester Ltd, Sherwood Centre  
268 Wilmslow Road, Fallowfield, Manchester M14 6WL  
Telephone 061-224 8117 (3 lines)



## BUSINESS COMPUTERS

AMSTRAD\* AMIGA  
ATARI  
FERRANTI\* KAYPRO  
SHARP\* AKHTER  
TANDON  
COMMODORE PC\* OPUS  
OLIVETTI  
EPSON\* SANYO

## HOME COMPUTERS

AMSTRAD\* AMIGA 500  
BBC

## IBM COMPATIBLES

WINCHESTERS  
\*\*\* FREE FITTING \*\*\*  
Seagate 10MG + Card ..... £260  
Seagate 20MG + Card ..... £299  
Seagate 30MG + Card ..... £320  
20MG Winchester on Card ..... £325  
30MG Winchester on Card ..... £340  
20MG Tape Streamer INT ..... £357  
60MG Tape Streamer INT ..... £747  
External Tape Streamers ..... CALL

ADDONS  
\*\*\* FREE FITTING \*\*\*  
PC Mouse from £55  
PC Joysticks from £18  
Cards ..... various  
Memory Upgrades ..... FREE FITTINGS

## PRINTERS

Amstrad DMP2000 ..... £136.00  
Amstrad DMP3000 ..... £160.00  
BROTHER ..... Full Range  
EPSON LX86 + Tractor ..... £199.00  
EPSON LQ800 ..... £475.00  
EPSON LQ1000 ..... £635.00  
EPSON LQ2500 ..... £836.00  
STAR NB25-1S ..... £635.00  
STAR ..... Full Range  
CITIZEN MSP20 ..... £286  
CITIZEN MSP25 ..... £339  
PANASONIC 1081 ..... £173

## LASER PRINTERS

EPSON GQ3500 ..... £1499  
CITIZEN Overture ..... £1550  
CENTRONIC PPB ..... CALL  
QMS K8 ..... £1775  
HP LASERJET 2 ..... £2199  
HP LASERJET ..... £1559

## DESKTOP PUBLISHING

Come and see working  
GEM\* VENTURA  
AUTOCAD  
AUTO SKETCH\* PAGE MAKER  
FLEET ST  
NEWSROOM\* PUBLISHING PARTNER

## SOFTWARE

PC 500 TITLES IN STOCK  
ATARI ..... 100+ TITLES  
AMIGA ..... 100+ TITLES  
BBC ..... All popular titles, ROMS, addons  
AMSTRAD PCW Compilers, accounts  
packages, databases  
AMSTRAD 612B ..... games, compilers,  
languages etc.

## BARGAIN SOFTWARE

(LIMITED QUANTITY)  
PERFECT WRITER 2 ..... £30  
PERFECT CALC 2 ..... £30  
PERFECT FILER 2 ..... £30  
QED ..... £50  
COMMUNICATION EDGE ..... £45  
SALES EDGE ..... £45  
MANAGEMENT EDGE ..... £45  
NEGOTIATION EDGE ..... £45  
SAMNA WORD 1 ..... £45  
DATASOFT ..... £40  
Q&A ..... £150

## ALL EXCLUDE VAT

## WHAT ELSE?

BOOKS  
COMPUTER MAGAZINES  
SPECIALIST CALCULATORS  
MODEMS  
MONITORS  
TELEPHONES  
LISTING PAPER  
DISK DRIVES  
FLOPPY DISKS  
PRINTER RIBBONS  
CABLES  
COMPONENTS

## BARGAINS

TANDON 10MB + MONITOR ... £625  
ZENITH 181 PORTABLE ..... £1150  
KAYPRO 2000 PORTABLE  
LARGE SCREEN ..... £999

AMSTRAD PC1640 IN STOCK  
COMING SOON OLIVETTI'S

## PERSONAL EXPORT SPECIALISTS

Export to over 60 countries in 1986  
Please add 15% VAT to all prices  
Delivery: Free to UK mainland for orders over  
£100

## MANCHESTER

Easy Access from the  
M56, M6, M62, M63, M602

## \*MIGHTY MICRO BULLETIN BOARD\*

Ring 061 224 8117  
Ring for prices/orders/leave messages Upload/Download free  
DDM software Any modem with 300/300 1200/75 and TTY  
software Online from 7pm to 8am Mon-Sat/All day Sunday

## BUFFERED SMART SWITCHES

- BOTH PRINTERS PRINTING DIFFERENT DOCUMENTS SIMULTANEOUSLY •
- SOFTWARE CONTROL • OVERRIDE SWITCH • RESET & MULTIPLE COPY FUNCTION •
- EXPANDABLE • SIMULTANEOUS DATA INPUT • AUTO SELECT •

ACS - AUTO COMPUTER SELECT • SI - SIMULTANEOUS INPUT • C - COPY • SPS - SOFTWARE PRINTER SELECT

### CENTRONICS

PB-DP (64K) • 1 Centronics input and 2 output soft  
select with 64K buffer expandable to  
£249 256K. • C/SPS  
PB-4-2 (256K) • 4 Centronics input and 2 output  
with 256K buffer. ACS/C/SPS  
£345  
PB-6-2 (256K) • 6 Centronics input and 2 output  
with 256K buffer. ACS/SI  
£495  
PB-7-1 (256K) • 7 Centronics input and 1 output  
with 256K buffer. ACS/SI  
£445

### SERIAL

SB-4-2 (256K) • 4 Serial input and 2 serial  
output with 16K buffer at each  
£415 input & a total of 256K memory.  
ACS/SI/C/SPS  
SB-7-1 (256K) • 7 Serial input and 1 serial  
output with buffer at each input  
£595 and a total of 256K memory  
expandable to 1MB. ACS/SI

## UNIVERSAL BUFFER

- SERIAL & PARALLEL INPUT AND OUTPUT • X ON AND X OFF SOFT AND DTR HARD,  
HANDSHAKE • CENTRONICS • 2 FRONT PANEL SWITCH INPUT AND OUTPUT • COPY •
- RESET • EXPANDABLE TO 256K •
- UB (64K) £220

## SMART AUTOMATIC SWITCHES

- AUTO COMPUTER SELECT • SERVICE • REQUEST LED INDICATION • MANUAL OVERRIDE  
SWITCH • UNSERVICED COMPUTER RECEIVES BUSY •

### CENTRONICS

MP-401 • 4 Centronics input and 1  
£150 Centronics output  
MP-801 • 8 Centronics input and 1  
£200 Centronics output

### SERIAL

MS-401 • 4 Serial Input and 1 serial output  
£180  
MS-801 • 8 Serial input and 1 serial output  
£230

## INTELLIGENT PRINTER BUFFERS

- SELF-TEST FUNCTION • BUFFER/PRINTER READY INDICATOR • BUFFER RAM STATUS  
INDICATOR • RESET AND MULTIPLE COPY FUNCTION • BUFFER BYPASS SWITCH •

PB (64) • 1 Centronics input and 1 PB (256) • 1 Centronics input and 1  
£140 Centronics output with 64K buffer  
PB-2 (64) • Above with 2 way manual switch to PB-2 (256)  
£185 connect 2 micros to 1 printer or vice versa  
£235 connect 2 micros to 1 printer or vice versa

## ACCESSORIES

KSM 101 • Serial RS232 to parallel converter  
£65 with PSU  
KSM 104 • Parallel to serial RS232 converter  
£70 with PSU  
KSM 110 • Multi-link serial RS232 switch  
£24 selectable cable

## CABLES (6ft long)

KPC 104R • Ribbon Cable 36pin-36pin £12.00  
KPC 104 F6 • Flex Cable 36pin-36pin £16.00  
KPC 105-6 • Flex IBM Parallel printer  
cable £15.00  
KPC-105-10 • Flex IBM Parallel printer  
cable £17.00  
KPC-106 • Flex (25 lines) 25pin-25pin £14.00  
KSC-101 • Flex (10 lines) 25pin-25pin £12.00

## CUSTOM CABLE-MAKING SERVICE AVAILABLE

Add postage Switches & Buffer £4.00 each, & cable £0.75 each + 15% VAT

## KEYZONE COMPUTER PRODUCTS LTD

U14, Acton Business Centre,  
School Road, London NW10 6TD  
Telephone 01-965 1684/1804 Telex 8813271 GEGOMS G



# PSION XCHANGE

Xchange is a suite of programs including Database, Spreadsheet, Wordprocessor and Business Graphics. Multitasking allows you to run upto 8 applications simultaneously, data sharing allows you to transfer data from one application to another.

## ARCHIVE DATABASE

Multifile relational database. Only memory restricts the number of files in use at one time. Variable length records with a maximum of 255 characters per field, 255 fields per record, 65535 records per file. Command language allows the user to define procedures using a powerful editor. Flexible multifile indices provide fast access and a form designer for screen and printer input and output.

## QUILL WORDPROCESSOR

Text and page formatting, underlining, bold, italic, superscript, subscript, justification, tabs, line spacing, page size, page headers, footers and numbering. On screen editing, fast page access, cut and paste, block copy, block move, insert/overwrite modes, search and find, search and replace, key define and mail merge. Document size only restricted by disk capacity, background printing allows the user to print documents while working on others.

£295  
INC VAT

NETWORK VERSION  
UP TO 10 STATIONS

£990  
INC VAT

## EASEL BUSINESS GRAPHICS

3D Business graphics including bar, line and pie charts, no limit to the number of values or numbers or sets of figures. Automatic rescaling, user define colours, text annotation of graphs at any pixel point. Intelligent evaluation of data formulae or manipulation of existing data. Images stored in internal format; monitor resolution is the only limit on final image quality. Accepts data from spreadsheet, database, etc.

## ABACUS SPREADSHEET

Expansive spreadsheet with 999 rows, 255 columns, virtual memory system buffers to disk only when full, facilitating very large spreadsheets. Efficiency memory used only for full cells, each cell only uses 14 bytes. Variable width cells, block copy, block move, insert/delete columns and rows, merge and consolidation of data from different spreadsheets. Accurate to 15 significant figures, full range of mathematical, scientific, date, average, ASCII and DIF conversion.

## PC FOUR 79-35 INC VAT

Xchange is available from Transform Ltd, to run on the following IBM PC/XT/AT and IBM compatibles, APRICOT PC, F SERIES, XEN, ICL DRS20, DRS300, OPD, LOGICA KENNET MERLIN 4000, VICTOR SIRIUS, TORCH GRADUATE and BT TONTO. We offer onsite training and DATABASE applications to suit your requirements. Network upgrades enables Xchange to run on upto 10 workstations. Evaluation packs available for £10.00p. For further details contact Transform.



TRANSFORM LTD



24 West Oak, Beckenham, Kent BR3 2EZ 01-658 6350

*Here at last!*

# DISK CLUB

*Every Month!*

**A FEATURE-PACKED DISKFUL OF SUPER PROGRAMS . . .**

(\* For IBM/PC, Amstrad, and all Compatibles)

**DISK 1  
CONTAINS ALL  
THESE PROGRAMS**

### SIDEWRITER

PRINTS ANY FILE  
SIDEWAYS — NOW YOU  
CAN PRINT  
SPREADSHEETS WITH  
255 COLUMNS.  
MANUAL ON DISK

### LETTERS & LABELS

SUPERB MAILING LIST  
PROGRAM. PRINTS LETTERS  
AND ADHESIVE LABELS. EACH  
CUSTOMISED TO MATCH  
YOUR CLIENTS; STORES,  
SEARCHES & PRINTS.  
COMPREHENSIVE MANUAL

**SUPER QUALITY  
PROGRAMS FOR  
ONLY  
70p each**

### MASTERKEY

Allows you to do  
just about anything  
you want to a disk —  
Read and change  
sectors, undelete, edit,  
rename, copy, locate,  
alter files.  
25 page Manual

### VIEWDISK

Utility to display or  
print out the contents  
of any sector of  
a disk.  
Includes Manual

## DISK CLUB VOLUME 1



### VF 150

Menu-driven file  
manipulator. Allows  
individual or mass tagging  
of files for copying,  
deleting, renaming,  
viewing, printing or  
running.  
On-Disk Manual.

### ARCADE GAME

Fast action with  
Spacewar.  
1 or 2 players.  
Colour version and  
Hercules.

★ **SPECIAL OFFERS**  
★ **NEWS**  
★ **REVIEWS**

### ADVENTURE GAME

A Scot Adams  
Type Game:  
"Adventure"

**FREE GIFT**  
With every 12  
Issue registration

*Your DISK CLUB  
Volumes are all  
sent post free!*

**12** ISSUES ONLY **£60**

**6** ISSUES ONLY **£40**

**3** ISSUES ONLY **£25**

**1** TRIAL ISSUE **£10**

**WE ALSO HAVE HUNDREDS OF PUBLIC DOMAIN AND SHAREWARE PROGRAMS,  
ALL AT ONLY £5 PER DISK, INCLUDING:-**

#### PC-WRITE 2.7 (Latest version)

2 documents on screen; 50,000 word  
automatic spelling checker; special  
fonts; supports over 300 printers  
(inc laser) 45 help screens — two  
manuals.

**Two disk set..... £10 the pair**

#### 'C' TUTORIAL

Two disk set to teach you  
to program in 'C'

**£10 the pair**

#### PC-OUTLINE

Better than 'Think Tank'  
organises your work load

**£5**

#### DESK TEAM

Sidekick lookalike,  
clock, calculator,  
typewriter, notepad,  
phone book, auto-  
dialler, 75 page manual  
**£5**

Newkey — keyboard macros E2 forms —  
Form generator, Automenu — Pop-up Help  
for DOS Turbo Calc — Spreadsheet  
Family Tree Program.

Checkbook Manager  
General Ledger, Uniforth  
Prolog assembler  
Visible Pascal

P-Base, Q-Modem  
Instant recall, 280 Emulator,  
Hard Disk utilities  
FIDO

All Disks £5 each  
Add £1.50 P&P  
(except for Disk Club)  
**DESPATCHED BY RETURN**

**FULL CATALOGUE SENT  
PLEASE SEND A4 SIZE  
ENVELOPE + 24p STAMP**

## THE LANGUAGE LABORATORY

**55 FELTWELL ROAD, SOUTHERY  
DOWNHAM MARKET, NORFOLK, PE38 0NR**

# WE MUST BE MAD! TO SELL AT PRICES THIS LOW

**DISKS**  
Unbranded superior quality disks at discount prices

	10's	25	50	100	250	500
5 1/4" DSDD 48TPI	7.00	12.50	23.00	44.00	100.00	195.00
5 1/4" DSDD 96TPI	7.50	14.00	26.00	50.00	115.00	225.00
5 1/4" HD (IBM AT)	18.00	36.00	70.00	130.00	320.00	630.00
3 1/2" DSDD 135TPI	18.00	36.00	70.00	130.00	320.00	630.00

10s are supplied in plastic library cases, all disks are supplied with labels. 5 1/4" are also supplied with hub rings (not HD), write protect tabs and sleeves.

PLASTIC LIBRARY CASES	EP TONER CARTRIDGES
Box to hold 10 x 5 1/4"	EP Laser Cartridges £92.00 each
Box to hold 50 x 5 1/4"	Suitable for HP, Apple, Canon, Wang, Divetti, Word-
Box to hold 10 x 3 1/2"	plex, Philips, BDS, Tally, Data General etc.
Box to hold 90 x 3 1/2"	£11.00

**FUJITSU COMPATIBLE RIBBONS**  
For Fujitsu 320 and 830 Printers Box of 4 £19.00

All prices include VAT/P&P (UK only)  
Government, educational and company orders welcome  
Trade and Export enquiries welcome

**RUNNYMEDE COMPUTER HARDWARE LTD**  
IMPERIAL COURT, STATION PARADE, VIRGINIA WATER,  
SURREY GU25 4DH  
TEL: 09904-2877 TLX: 846224/LASERV

## CABINET ELEGANT DESIGN AND POWER FOR YOUR COMPUTER

S-108

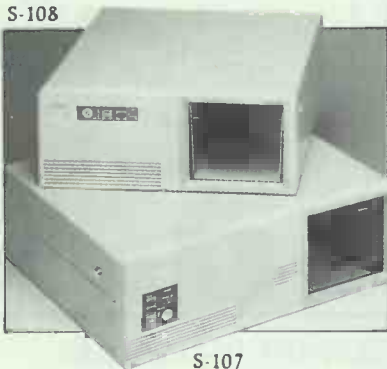

S-107

S-107

**BABY AT CASE (FREE TOP)**  
DIMENSION: 490 x 400 x 155 MM  
CAPACITY: 4 OR 5 DRIVES  
3 EA/CTN 7' GW/29 KGS

S-108

**BABY AT CASE (FREE TOP)**  
DIMENSION: 410 x 400 x 155 MM  
CAPACITY: 3 DRIVES  
3 EA/CTN 6' GW/20 KGS

**OEM  
WELCOME**



**CUBE TYPE POWER**  
180 WATT  
(USE FOR S-108  
CASE)



**SUN'S ELECTRONICS CO., LTD.**  
**HUA CHI ENTERPRISE CO., LTD.**  
No. 9. LANE 10. SEC. 3. SHUANG SHYR ROAD.  
PANCHIAO. TAIPEI. TAIWAN. R.O.C.  
FAX: 886-2-2511438  
TLX: 33263 SUNS TEL: (02) 2525995

## How to make sure your Printer doesn't slow your PC down.



Without a Megabuffer your Printer can slow down the rate your PC outputs to the rate your Printer prints. Turning a 5 minute print file into half-an-hour. Which means that the PC can be out of action for long periods. Merely outputting. With a Megabuffer the PC outputs at its top speed into the Megabuffer memory, the PC is then released for further work, and the Printer prints at its own rate from the Megabuffer memory.

- Allows you to use your PC more
- Can emulate special plotter handshake protocols
- Compatible with most computers, printers and plotters: IBM & compatibles, AMSTRAD, HP, ACT, SHARP, EPSON, CALCOMP and many more • Can cut PC output time to one sixth or less.
- Software-independent
- Data Buffer and interface converter
- Pause, 'reprint page' and multiple copy facilities

Full range of memory sizes for every application: 64K **£160**, 128K **£216**, 256K **£278**, 512K **£388**, 1MB **£556**.

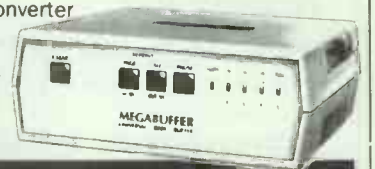

## Flexible Interfacing that keeps them all talking

Eliminate miles of spaghetti and all those 'T' and 'X' switches with a simple Megaswitch which allows your PC to instantly connect to a selection of printers and plotters.

### MEGASWITCH AS - Serial Data Selector

- Single unit multiplexer and demultiplexer • 2K data buffer
  - RS-232 and RS-422 versions • Can operate as RS-232/RS-422 converter • Diagnostic output • Megabuffer compatible
  - Multiplexer - Ideal for printer sharing. 4 inputs and 2 outputs. Can automatically select any channel supplying data
  - Demultiplexer - Ideal for driving several different printers from a PC. 2 inputs and 4 outputs
- Software and manual selection. Downloadable code translation tables.  
Hardware and XON/XOFF handshakes (RS-232) **£189**



### INPUT UP TO 5 PCs

### MEGASWITCH S - RS232 Serial Selector

- Connects any of 5 inputs to either of 2 outputs
- Universally compatible - works with all baud rates and handshake arrangements
- LED indication of data flow
- Use it with a Megabuffer for additional time saving **£99**



### OUTPUT UP TO 2 PRINTERS

### MEGASWITCH AP - Parallel Data Selector

- Connects any of 4 inputs to either/both of 2 outputs
- Can automatically switch to any channel supplying data
- Ideal for laser printer sharing
- Universally compatible - works with all standard centronics computer and printer interfaces
- Use it with a Megabuffer for additional time saving **£169**

## RINGDALE PERIPHERALS

11 Decoy Road, Worthing,  
West Sussex BN14 8ND  
Telephone (0903) 213131  
Telex. 265871 REF: JBC2021

UK delivery £3/UNIT, cables from £15. VAT extra Dealer and Export Enquiries welcome



# PC/AT COMPATIBLES

**BREAKING THE PRICE BARRIER!!!!!!**  
MANUFACTURED IN THE UNITED KINGDOM  
USING HIGHEST QUALITY JAPANESE PRODUCTS  
**NEW LOW PRICES**

## PC/XT £345

## PC/XT, 20MB, MONITOR TTL £675

★ 8088/V20 ★ 640k  
★ "NEC" FLOPPY DRIVE ★ "SERIAL/PARALLEL" PRINTER PORT  
★ HERCULES GRAPHICS DISPLAY ADAPTOR ★ KEYBOARD NUMS +  
CAPS LOCK ★ 8 SLOTS ★ FLAT SCREEN MONITOR



## AT/TURBO £680 WITH 20MB MONITOR £980

★ DYNAMIC SPEED CONTROL ★  
★ 80286 6/8/12 MHZ ★ 512K RAM EXPANDABLE TO 1M  
★ LEGAL BIOS ★ FLOPPY DRIVE 1.2M  
★ PRINTER PORT ★ GRAPHICS DISPLAY ADAPTOR ★ AT STYLE KEYBOARD  
WITH SEPARATE CURSOR PAD  
★ MOUSE £35 ★ 40MB NEC 5146 ★ 30MS UPGRADE £250 ★

### ★ NEW 386 TURBO £2150 ★

40MB HARD DISK £399 (22MS) EGA MONITOR AND CARD £400.  
MONITOR, 40MB 30MS HARD DISK, 640K RAM, 1.2MB FLOPPY KEYBOARD, DOS 3.2

ALL SYSTEMS ARE TOTALLY COMPATIBLE  
HI REST TTL MONITOR £69 20MB HARD DISK £299  
BILINGUAL SYSTEMS EXPORT ORDERS WELCOME  
12 MONTHS WARRANTY AND SUPPORT INCLUDED PRICES EXCLUDING VAT  
FOR ORDERS AND ENQUIRIES PLEASE CONTACT



**C.A.S. COMPUTER POINT LTD**  
**51A DARTMOUTH ROAD, LONDON SE2W**  
**291 5727 TLX: 8952387 ANSWER G**  
**Call for best prices on software.**

# COMPUTER EQUIPMENT

Lowest cost brand new bargains

## PLESSEY Model T24 V22/V22 bis MODEM. For New HI-SPEED PRESTEL

Compact automatic modem featuring the latest technology & the highest possible data rate over the ordinary phone system. Offers:

- \*Both V22 & V22 bis compatibility
- \*1200/2400 Baud operation with auto bit rate recognition
- \*Operates on both ordinary phone line (PSTN) or private circuit (PC)
- \*Auto call & auto answer (V25 compatible)
- \*British Telecom approved
- \*Duplex operation allowing simultaneous transmission & reception of data at 2400 Baud in both directions over a single phone line **£299.00**
- \*Compact size: 9" x 9" x 2 1/2"
- \*Local & remote test
- \*Send S.A.E. for technical details

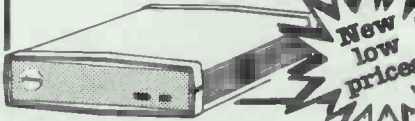

**New low prices**

**HITACHI Model 305S/SX 3" disc drives.** With SHUGART compatible Interface (34 way edge connector) & suitable for BBC with DFS, AMSTRAD 664/6128, TATUNG EINSTEIN & many others. Will usually replace 5 1/4" drives directly. 250k (double density unformatted) per side reversible; 40 track; standard power connector for 12V & 5V; overall power consumption typically 3.7W. Supplied **BRAND NEW** with connector pin-out details etc. but uncased without PSU. Data cables are available for AMSTRAD & BBC (£7.50) and an installation pack including data & power cables is available for the TATUNG EINSTEIN (£12.00)



**£24.95**

## ITT SCRIBE III WORD PROCESSING SYSTEM.

Professional system originally selling at around £6000 without printer. Now offered with software included & a variety of different options available. This system is available from us **ALL BRAND NEW** at the cost of current budget systems, but with office-quality performance & features.

### SOFTWARE INCLUDED:

- \*DATABASE — allows information storage & retrieval by user-selectable criteria
  - \*EDITING — including easy reformatting, global search & replace, save & move, cursor control etc.
  - \*AUTOMATIC LETTERWRITING — with merge, glossary file for much used phrases etc.
  - \*MATHS FUNCTIONS — screen maths allows addition of rows, columns & complete tables
  - \*PROGRAMMABLE COMMANDS — allows format changes, accessing record block files, prompts etc.
  - \*HELP FILES — quicker to use than the comprehensive manual supplied
  - \*BASIC COMPILER
- HARDWARE INCLUDED:**
- \*SCREEN/WORKSTATION — dual processor (16 bit TI 9995 & Z80H) with 128k memory, 12" green screen 25 x 80 character display with slow scrolling, QUME printer interface
  - \*KEYBOARD — low-profile keyboard additionally has 43 clearly marked dedicated function keys
  - \*DISC DRIVES — dual SHUGART 5 1/4" DSDD drives each 430k capacity formatted **£290.00**

### OPTIONS:

- \*10mbyte MiniScribe WINCHESTER disc drive (**£149**)
- \*NEC Model 7700 55cps daisy wheel printer (**£390**)
- \*128K additional memory with spelling check software (**£35**)
- \*Communications hardware & software (**£49**)
- \*\*COLOUR LEAFLET AVAILABLE\*\*

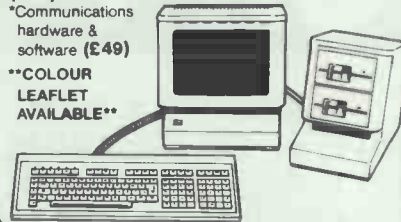

**TOSHIBA Model T300 system** (semi-compatible with IBM PC). With 6MHz 8068 processor, 192KB RAM (easily upgraded to 256KB), single half-height 5 1/4" floppy disc drive (640KB), high resolution green display, serial & parallel interfaces. Included are MS-DOS Ver. 2, MICROSOFT T-BASIC, good manuals & comprehensive diagnostic disc. Available options include a colour monitor and memory extension. **BRAND NEW. £249.00**

### PEACHTREE SOFTWARE NOW AVAILABLE:

WP, spreadsheets; comms; data base; spell at **£25.00 each**

**TOSHIBA Model T100 CP/M system.** With 64KB RAM, dual 500k (unformatted) 5 1/4" floppy disc drives, serial & parallel interfaces & MICROSOFT BASIC in ROM. **BRAND NEW. £149.00**

### VICTOR SpeedPac 286 IBM PC

**ACCELERATOR.** Half-wide 80286 accelerator card for IBM PC or PCXT, VICTOR VPC, and compatibles. Features 8KB cache memory & 7.2MHz 80286 processor. Offers AT/Personal System 2 performance for a fraction of the cost. Runs up to 7.5 times faster. **£199.00**

### FUJITSU Model M2230AS 5 1/4"

**WINCHESTER disc drives.** 6.66 MB capacity (unformatted), 16/32 sectors, 320 cylinders, with ST506 interface. **BRAND NEW. £75.00**

\*VAT & CARRIAGE must be added to all items. Carriage is £3.00 + VAT for 3" disc drives; otherwise, please enquire.

\*All equipment offered here has been bought by us as new surplus from manufacturers & OEMs; often in large quantities. Items offered are full-specification equipment, but may not be the current model. We aim to offer the best value available anywhere, and all items in this advertisement are guaranteed for 6 months.

COMPUTER APPRECIATION, 111 Northgate, Canterbury, Kent CT1 1BH. (0227) 470512 TELEX 966134 COMPAP  
MATMOS Ltd., 1 Church Street, Cuckfield, W. Sussex RH17 5JZ. (0444) 414484/454377

**matmos & COMPUTER APPRECIATION**

# NETWORKING

The Most Cost Effective and Easy to Use Local Area Network Adapter for IBM PC/XT/AT and Compatibles: **RPTI-Net (Trans-Net)**

The RPTI-NET was designed with one person in mind: the user. In real terms that means you can install it yourself in a matter of minutes. And then get straight down to taking advantage of the advanced features of the RPTI-NET networking software. Providing a full range of features to match networks of twice the price, the RPTI-NET can be operated by all your staff after just a few minutes practice. That means everybody in your office has access to the information and equipment they need, when they need it.

### Specifications

- \* Protocol: CSMA/CD
- \* Topology: Distributed Bus
- \* Data Rate: 1 Mega Bits/Sec. Baseband
- \* Addressable Users: 255 Maximum
- \* Cabling System: RS-422 Twisted Pair Wire (AWG 20)
- \* Distance: 300 Meters (1,000 Ft) without Repeater  
1,200 Meters (4,000 Ft) with Repeater
- \* Computer Interface: IBM PC/XT/AT and Compatibles
- \* Operating System: PC-DOS 2.X, 3.1, 3.2  
MS-DOS 2.X, 3.1, 3.2

### Network Software Systems Supported

- \* IBM PC Network (LAN) Program (with RPTI-NET's NETBIOS Emulator)
- \* Novell's Advanced NetWare 86/286/SFT (with RPTI-NET's NetWare Driver)
- \* RPTI-NET Network Utilities  
Sign On/Off, Hard/Floppy Disk Sharing, Printer/Plotter Sharing, Serial/Parallel Printer File Spooling, Interactive Message Communications
- \* RPTI-NET Electronic Mail
- \* RPTI-NET Disk Server  
Workstations (with Remote Boot ROM) are Allowed to Boot DOS System Remotely from Server Station
- \* RPTI-NET Classroom/Screen Monitor  
Providing Screen Broadcasting and Monitoring (Scanning) Capabilities

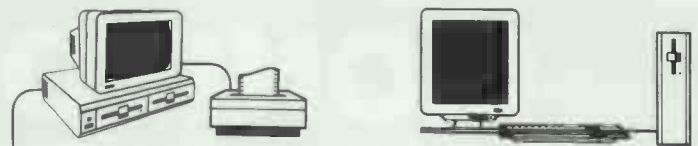

### NETBIOS EMULATOR

The RPTI-NET NETBIOS Emulator is the network interface program that can make the RPTI-NET Local Area Network (LAN) fully NETBIOS compatible with IBM's PC Network and Token Ring Network. Operating transparently, no special settings are necessary, the NETBIOS does all the work. And most important of all, it allows you to run all the application software designed for the IBM LAN's, without any software or hardware modification. After booting up your system, the IBM Network Program can be installed just as if you were running it on an IBM network, and all operations of the multi-user applications software will likewise remain unchanged.

RPTI-Net (Trans-Net) Starter Kit **£ 429**

Complete kit for setting up a two station network, includes cabling, network interface cards and software utilities.

RPTI-Net Network interface card **£ 199**

For further information contact:

**R&D TECHNOLOGY LTD.**

Tel: 01 736 9641.  
Telex: 94013177 RNDT G.

Pulton Place,  
Fulham,  
London SW6 5PR.

# TRANSFER YOUR DATA THE EASY WAY

**CARD DEVICES LTD. PRODUCE A UNIQUE RANGE OF ADD ON DRIVES  
AVAILABLE FOR POPULAR PC'S INCLUDING**

**★ APRICOT ★ IBM ★ SIRIUS/VICTOR 9000 ★ OLIVETTI ★ AND MANY OTHERS**

As there are now many different computer systems available on the market it has become more difficult to transfer data between these machines. CARD DEVICES LTD. have a simple solution to the problem with their AF RANGE OF DISC DRIVE UNITS. Now it is possible to overcome the different disc sizes and formats to enable the user to transfer data simply and effectively.

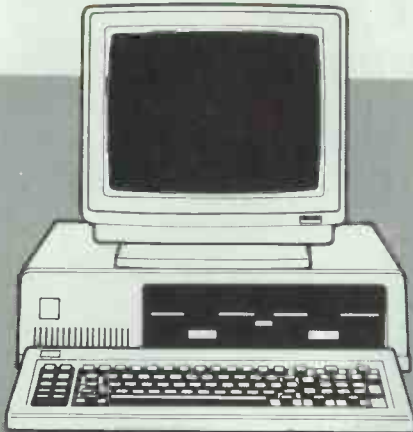

### IBM PC/XT/AT 3.5" ADD ON DRIVE

TO PROVIDE DATA FILE COMPATIBILITY WITH THE APRICOT RANGE OF COMPUTERS AND ALSO THE IBM PERSONAL SYSTEM 2

**AF 300 PC . . . £295.00**

**AF 300 AT . . . £295.00**

ALSO AVAILABLE FOR IBM CLONES

### IBM WINCHESTER UPGRADES

10MB internal **£341.00** external **£413.00**  
20MB internal **£367.00** external **£439.00**  
30MB internal **£371.00** external **£443.00**  
40MB internal **£683.00** external **£754.00**

### IBM WINCHESTER WITH TAPE BACK-UP

10MB Winchester with tape back-up external **£756.00**  
20MB Winchester with tape back-up external **£781.00**  
30MB Winchester with tape back-up external **£786.00**  
40MB Winchester with tape back-up external **£1097.00**  
ALL UNITS INCLUDE CONTROLLER AND CABLES

### IBM TAPE BACK-UP . . . £499.00

UP TO 52 MB EXTERNAL OR INTERNAL

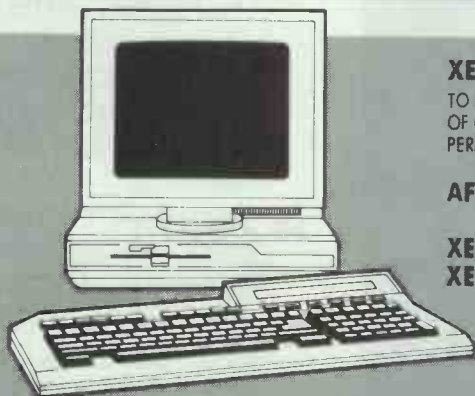

### XENi 3.5" ADD ON DRIVE

TO PROVIDE DATA FILE COMPATIBILITY WITH THE APRICOT RANGE OF COMPUTERS THAT HAVE A 3.5 INCH DISC DRIVES ALSO THE IBM PERSONAL SYSTEM 2

**AF 300 XENi . . . £295.00**

**XENi 512K RAM CARD . . . £175.00**

**XEN 512K RAM CARD . . . £175.00**

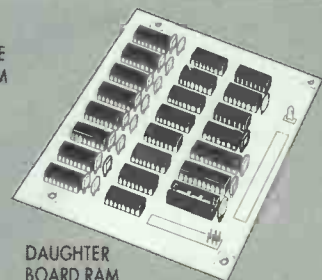

DAUGHTER BOARD RAM

### APRICOT 5.25 ADD ON DRIVE FOR PC/Xi/F SERIES

TO PROVIDE DATA FILE COMPATIBILITY WITH THE IBM PC/XT AND CLONES

AF500A . . . INSTALLED ON THE APRICOT PC/Xi/ F SERIES . . . **£395.00**

AF300F2 . . . INSTALLED AS A SECOND DRIVE ON THE F1 SERIES . . . **£295.00**

ALL ABOVE UNITS ARE SUPPLIED WITH A SEPARATE CONTROLLER CARD WHICH IS FITTED INSIDE THE APRICOT COMPUTER IN ONE OF THE SPARE EXPANSION SLOTS

**APRICOT 512K RAM CARD PC/Xi/F SERIES £120.00**

**APRICOT WINCHESTER UPGRADES . . .**

PLEASE TELEPHONE FOR DETAILS

### SIRIUS/VICTOR 9000 5.25" ADD ON DRIVE

TO PROVIDE DATA FILE COMPATIBILITY WITH THE IBM PC/XT AND CLONES

**AF500S . . . £395.00**

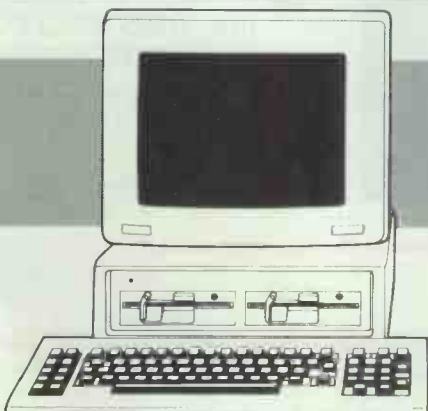

### AMSTRAD 3.5" ADD ON DRIVE AF 300 AMSTRAD . . . £295.00

TO PROVIDE DATA FILE COMPATIBILITY WITH THE APRICOT RANGE OF COMPUTERS AND ALSO THE IBM PERSONAL SYSTEM 2

### AMSTRAD WINCHESTER UPGRADES:

20MB internal **£350.00**  
20MB external **£375.00**  
AMSTRAD TAPE BACK-UP external **£450.00**

  
**CARD DEVICES**

ALL PRICES DO NOT INCLUDE VAT AND DELIVERY

Card Devices Ltd., Unit 9, Padmores Yard,  
St. Johns, Woking, Surrey GU21 1SE  
Tel: 04862 76996/65634 Telex: 858541 ALPHD D

# PLUS



## ONE WAY TO CONVERT FROM 5¼" TO 3½" FORMATS!

But if that doesn't work  
try our:

**PLUS-FD 3½" Floppy  
Drive Sub-System**  
(Only £250 R.R.P.)

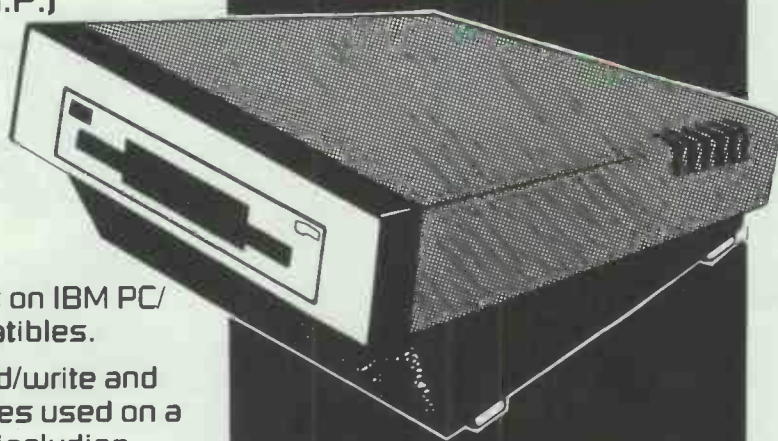

### PLUS-FD

PLUS-FD: Installs on IBM PC/  
XT/AT and Compatibles.

PLUS-FD Will read/write and  
format 3½" floppies used on a  
variety of micros including  
APRICOT, TOSHIBA and  
the new IBM PERSONAL  
SYSTEM/2

PLUS-FD: Comes complete  
with disc drive, case, power  
supply, cables and driver/  
format software.

All PLUS 5 products are covered  
by 12 months warranty on  
parts and labour.

Available from:

## PLUS 5 ENGINEERING LIMITED

Crowborough Hill, Crowborough, Sussex TN6 2EG. Tel: (08926) 63211  
Telex 95538 PLUS G



Mall and Telephone Orders welcome.

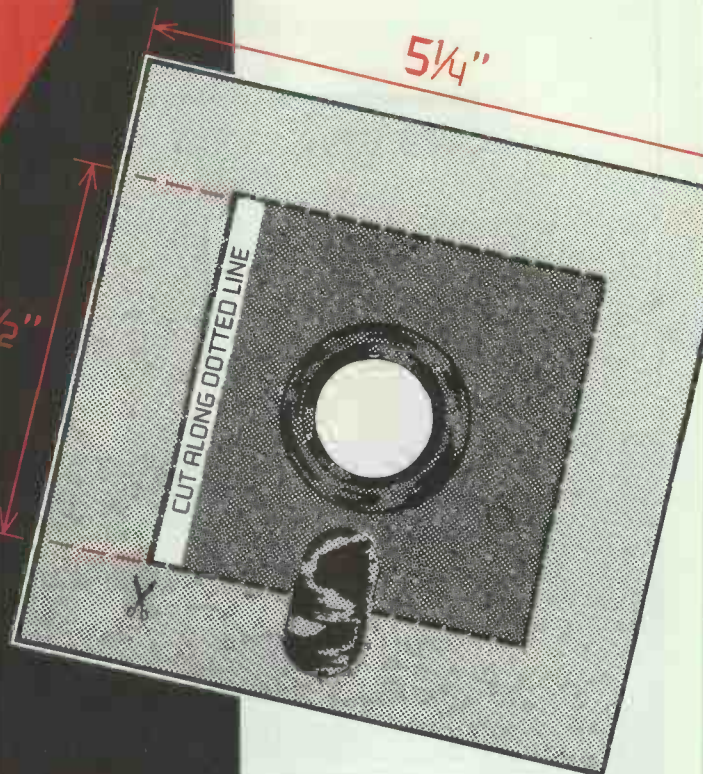

The PLUS 5 PLUS-FD range  
offers many options for  
floppy disk transfer  
between micros of different  
formats and/or drive sizes  
including:

- SIRIUS/VICTOR 9000: 5¼" IBM Compatible drive.
- 3½" APRICOT/IBM Compatible drive.
- NEW, DUAL 5¼" and 3½" DRIVE SUB-SYSTEM
- APRICOT PC AND Xi, 5¼" IBM Compatible drive.
- XEN and XENi/XENXi: 3½" APRICOT/IBM Compatible drive.
- IBM and Compatibles, (inc. AMSTRAD PC1512): 3" AMSTRAD PCW Compatible drive. (N.B. read-only device)

# PLUS



PCW SHOW  
STAND 4002-2  
(LEVEL 1)

# EFi

## Royal PC's

### PC PRINCE

- ★ 8088-2 CPU 4.77/8MHz
- ★ ERSO BIOS
- ★ 640K RAM
- ★ 360KB Floppy Drive
- ★ Mono/Graphics/Printer Card — Hercules
- ★ Hi-Res Mono Monitor — Tilt Swivel Stand
- ★ Multi I/O Card — 1 Serial 2nd Optional/1 Parallel/1 Game/2 Drive/Clock Calendar with battery back-up
- ★ Enhanced quality keyboard (ALPS)
- ★ 150W approved power supply
- ★ Quality Case
- ★ 8 Expansion Slots
- ★ Manuals
- ★ 12 months warranty

**£464**

### PC QUEEN

- ★ 80286 CPU 6/10MHz
- ★ ERSO BIOS
- ★ 1Mb RAM
- ★ 1.2Mb Floppy Drive (NEC)
- ★ Mono/Graphics/Printer Card — Hercules
- ★ Hi-Res Mono Monitor — Tilt Swivel Stand
- ★ 360Kb/1.2Mb Controller
- ★ Serial/Parallel Card — 2s/1p
- ★ 101 Key enhanced keyboard
- ★ 200W approved power supply
- ★ Slide-in quality Case — Led/Lock
- ★ 8 expansion slots
- ★ Manuals
- ★ 12 months warranty

**£840**

### PC KING

- ★ 80386 CPU 6/8/16 MHz
- ★ Phoenix BIOS
- ★ 1Mb RAM
- ★ 1.2Mb Floppy Drive (NEC)
- ★ Mono/Graphics/Printer Card — Hercules
- ★ Hi-Res Mono Monitor — Tilt Swivel Stand
- ★ 40Mb 40MS Hard Disk
- ★ Western Digital Controller
- ★ 101 key enhanced keyboard
- ★ 200W approved power supply
- ★ Slide-in quality Case — Led/Lock/reset Deskpro look-a-like
- ★ 8 expansion slots
- ★ Manuals
- ★ 12 months warranty

**£2398**

HARD DISK — EGA — COLOUR VERSIONS AVAILABLE

Contact:

**GOTO COMPUTERS**  
10 Old Crown Road  
SLOUGH  
Berks SL1 2DL  
(0753) 34191

**JBC MICROS**  
200 Earlsdon Ave. N  
Earlsdon  
COVENTRY  
(0203) 716126

**MICRO UPDATES**  
5-25 Burr Road  
Wandsworth  
LONDON  
SW18 4SG  
(01) 870 6233

**COMPUTER SERVICES**  
45A Bridge Street  
LEATHERHEAD  
Surrey  
KT22 8BN  
(0372) 386254

**EFi** COMPUTER & ELECTRONICS (UK) LTD  
UNIT 10, VINCENT WORKS, VINCENT LANE, DORKING, SURREY RH4 3HH

**Tel: (0306) 888512**

**ADMICRA**

An **AAA** Company

**AMSTRAD**

**Tandon**

**ATARI**

**Roland**

**AUTOCAD**

AUTHORISED DEALER

**MANNESMANN TALLY**

**TAXAN**

**AMSTRAD**

PC1512 from £449 inc. FREE 640K Upgrade

**Opus. PCII** from £499

**Tandon** PCX & PCA SUPPLIED WITH 12 MONTHS FREE ON-SITE MAINTENANCE

**BASIC AUTOCAD SYSTEM**

Opus System 4 (20Mb, 1MB RAM) 720 x 348 resolution mono parallel & serial ports. Basic Autocad, Summouse, Hitachi A3 plotter

**£1799**

**ADVANCED AUTOCAD SYSTEM**

Tandon PCA20 (20MB, 1MB RAM) 720 x 348 resolution on 14" screen, 1 parallel & 2 serial ports Autocad plus ADE 2 & 3. Cherry A3 digitiser, Hewlett Packard 7570AA1

**£7999**

We can tailor Autocad systems to your requirements due to our extremely wide range of support peripherals (see below) Installation and training. Please call for details.

**VIKING ULTRA HIGH RESOLUTION 19" DISPLAY. Ideal for Desk Top Publishing & CAD PLEASE CALL**

**ALLOY MULTI-USER** Turn your XT/AT into a Novell compatible multi-user system from **£1199 per station**

**ATARI 1040 ST Mono £559**

**Multitech 910** Small footprint 80286, 10MHz 20Mb Monographics 1P & 25 — Superb value **£1395**

**HARD DISK & MEMORY UPGRADES**

IBM & Compatibles 20MB .....	<b>£359</b>
<b>IBM &amp; Compatibles 30MB Hardcard</b> .....	<b>£379</b>
Sanyo Memory upgrade to 256K + RAM disk + 25% extra disk capacity .....	<b>£65</b>
Amstrad PC 1512 upgrade to 640k .....	<b>£29</b>

**APRICOT ADD ONS**

512k Memory Board .....	<b>£115</b>
20Mb Hard Disk Upgrade .....	<b>£695</b>
Hi Res Mono Monitor for Portable.....	<b>£109</b>

**PRINTER PROMOTIONS**

<b>PANASONIC 1081</b> .....	<b>£169</b>
<b>MP 165</b> .....	<b>£189</b>
<b>STAR NL10</b> .....	<b>£215</b>
<b>EPSON LX800</b> .....	<b>£219</b>
<b>EPSON FX800/1000</b> .....	<b>£319/£399</b>
<b>M. TALLY MT85/86</b> .....	<b>£299/£399</b>
<b>EPSON EX800/1000</b> .....	<b>£399/£539</b>
<b>NEC P6/P7</b> .....	<b>£409/£499</b>
<b>EPSON LQ800/1000</b> .....	<b>£459/£619</b>
<b>JUKI 6100</b> .....	<b>£259</b>
<b>QUENDATA 1120</b> .....	<b>£169</b>
<b>HP LASERJET 2</b> .....	<b>£2195</b>

**SHEETFEEDERS** Please Call

**ACCOUSTIC HOODS** Please Call

**PRINTER BUFFERS**

Serial/parallel in/out 8K-2MB from **£79**

★ New ★ All Purpose X-buffer — Please call

**FANFOLD PAPER** All sizes available eg

11" x 9 1/2" 60gm	<b>£9.75</b>	(2000 sheets)
12" x 9 1/2" 60gm	<b>£11.69</b>	(2000 sheets)
A4 Clean Edge — 70gm	<b>£15.95</b>	(2000 sheets)*
— 85gm	<b>£9.30</b>	(1000 sheets)
11" x 14 1/2" 60gm	<b>£13.50</b>	(2000 sheets)*

Delivery £2.65 (fixed) + £1 per box.

Extra £1 per order for items marked \*

**LABELS** 89mm x 36mm from **£3.25/1000**.

70mm x 36mm from **£2.95/1000**  
Please call for other sizes.

**RIBBONS** for all printers eg

EPSON FX, MX, RX 80/100	<b>£2.49/£3.75</b>
EPSON LX 80	<b>£2.95</b>
JUKI 6100 single strike	<b>£1.15</b>
SHINWA/M. TALLY MT80	<b>£3.79</b>
KAGA/CANON	<b>£3.99</b>
QUME MS4	<b>£2.65</b>
APPLE IMAGEWRITER	<b>£3.35</b>

**PRINTWHEELS** from **£3.95**

Delivery 95p any Quantity ribbons/printwheels

**SOFTWARE SPECIALS**

<b>VENTURA DTP</b> .....	<b>£595</b>
Supercalc 4 .....	<b>£195</b>
VP Planner .....	<b>£65</b>
VP Info .....	<b>£65</b>
Perfect Writer 2 .....	<b>£99</b>
Wordcraft 3.0 (IBM) .....	<b>£349</b>
<b>WORDSTAR 2000 Plus</b> .....	<b>£225</b>
Wordstar Prof 4 .....	<b>£299</b>
Word Perfect .....	<b>£265</b>
Turbo Pascal (8087+BCD) .....	<b>£55</b>
Turbo Reflex .....	<b>£79</b>
CADpower .....	<b>£259</b>
Turbocad .....	<b>£299</b>
CADD inc. mouse .....	<b>£169</b>
Autosketch .....	<b>£79</b>
Ability-Integrated Package .....	<b>£79</b>
Moneypower .....	<b>£79</b>
Sage Financial Controller .....	<b>£249</b>

**PLOTTERS — DIGITISERS etc.**

Hitachi 672 A3 .....	<b>£449</b>
Roland 880A A3 .....	<b>* £679</b>
Roland 885 A3 .....	<b>£929</b>
Hewlett Packard 7570AA1 .....	<b>£3995</b>
Roland DPX2000 A2 .....	<b>** £2495</b>
Graphtec GP9001 A0 .....	<b>£6,195</b>
Summasketch 12" x 12" digitiser .....	<b>£395</b>
Cherry A3 digitiser .....	<b>£495</b>
Logimouse Plus .....	<b>£85</b>
Summouse with GEM + Write & Paint (IBM) .....	<b>£179</b>

\* inc FREE 11k buffer \*\* inc stand

**DISKS — POST FREE Packed in tens No quibble guarantee**

Prices for ONE box. All extra boxes — **10% EXTRA DISCOUNT**

5 1/4"	DYSAN	SONY	PRECISION
SSDD	<b>£11.90</b>	<b>£10.90</b>	<b>£8.90</b>
DSDD	<b>£15.90*</b>	<b>£13.90</b>	<b>£10.90</b>
DSQD	<b>£17.90</b>	<b>£15.90</b>	<b>£13.90</b>
HD1.6MB	<b>£19.90</b>	<b>£19.90</b>	—

**\* DYSAN DSDD — 1 EXTRA DISK PLUS LIBRARY CASE**

**SONY 3.5" SS £16.90 DS £19.90**

SONY PLAIN LABEL UNBOXED — PLEASE DEDUCT £2

**AMSOFT 3" £28.90** **LOCKABLE DISK BOXES** 40 3 1/2" DISKS **£7.95**  
70 5 1/4" DISKS **£9.95**

**Official Government/Educational Authority orders welcomed.**

Please add 15% VAT to all prices (inc. carriage) Limited space precludes listing of our full range of products.

Please telephone if you do not see the item you require

**ADVANCED MICROCOMPUTER APPLICATIONS LTD 1ST/2ND FLOORS**  
**40, HIGH ROAD, BEESTON NOTTINGHAM NG9 2JP Tel: 0602 252627**

**ADMICRA**  
An **AAA** Company

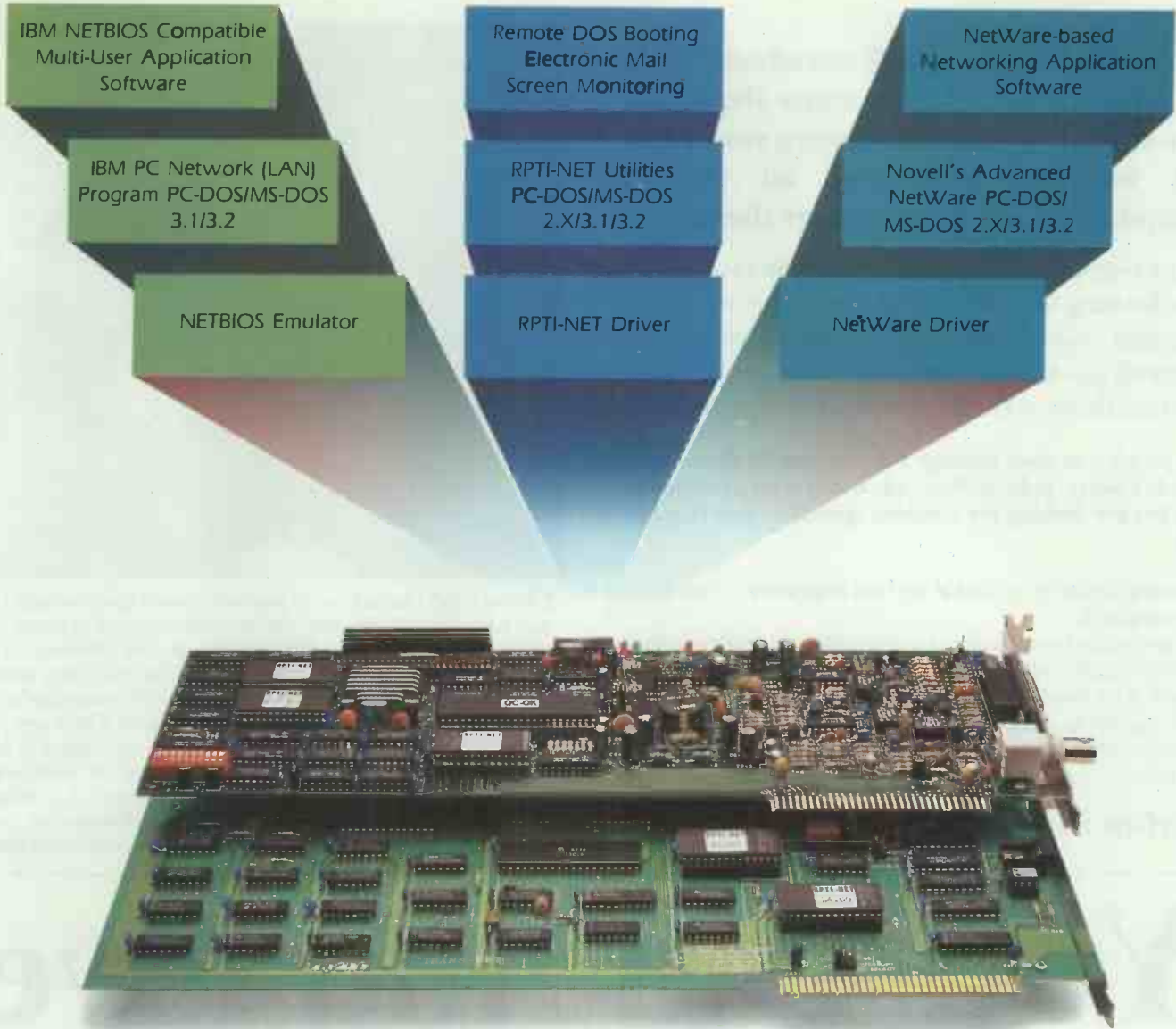

# Run Efficiently At Any Cost

**RPTI-NET™ (Trans-Net™) PC LAN Comes with NETBIOS Emulator, Novell NetWare Driver**

#### Specifications:

- \* Protocol: CSMA/CD
- \* Topology: Distributed Bus
- \* Data Rate: 1 Mega Bits/Sec. Baseband
- \* Distance: 1.2KM Maximum
- \* Cabling: RS-422 Twisted Pair Wire
- \* Addressable Users: 255 Maximum
- \* Computer Interface: IBM PC/XT/AT and Compatibles
- \* Operating Systems: PC-DOS/MS-DOS 2.X, 3.1, 3.2

#### Trans-Modem: TM-1200B

- \* 100% Hayes 2400 command Compatible
- \* Bell 103/212A and CCITT V21/22 Standards
- \* Auto Speed Selection (300/1200)
- \* Auto Dial/Auto Answer
- \* Call Tone Progress Monitoring (Ring, Dial Tone, Busy, No Carrier)
- \* Adaptive Dial/Dial Pulse Ratio Selection (US, UK, etc.)
- \* Dial Specification Selection (Norway, Australia, etc.)
- \* 60-Character Command Buffer
- \* Nonvolatile RAM: Storing Active Configuration Profile and 4 Phone Numbers
- \* 4 Sets of Configuration Profile Available

#### Specifications (Ethernet-based):

- \* Protocol: CSMA/CD
- \* Topology: Distributed Bus
- \* Data Rate: 10 Mega Bits/Sec. Baseband
- \* Cabling: RG-58A/U Coaxial Cable or Ethernet Thick Cable
- \* Addressable Users: 1024 Maximum
- \* Computer Interface: IBM PC/XT/AT and Compatibles
- \* Distance: 2.5 KM Maximum
- \* Operating Systems: PC-DOS 3.1, 3.2 MS-DOS 3.1, 3.2



**See Us AT Booth 5002/1**

Hayes is a registered trademark of Hayes Microcomputer Products Inc. Advanced NetWare is a registered trademark of Novell, Inc. RPTI-NET is a registered trademark of RPTI. IBM PC/XT/AT, PC-DOS, IBM PC Network Program, IBM PC Token-Ring Network are registered trademarks of IBM Corporation. MS-DOS is a registered trademark of Microsoft Corporation



**R.P.T. INTERGROUPS INTERNATIONAL LTD.**  
2ND FL., NO. 280, CHUNG HSIAO E. RD., SEC. 4, TAIPEI, TAIWAN, R.O.C.  
Tel: 886-2-7713366 • Telex: 12219 RPTI • Fax: 886-2-7412946

In 21 years **Dateline** introductions have been the start of many, many thousands of love stories — not just between young people but between people of all ages and occupations, and from all over the country.

Many tens of thousands of people join Dateline every year looking for someone to love. They want to meet someone with the same hopes, ambitions and interests as themselves, and they are simply not meeting them in their own social circles or at work.

The people you meet through Dateline, unlike those you might meet at a party, pub, or disco, know they want a relationship — they too are looking for someone special — and Dateline can help.

- Joining Dateline is simple and not expensive — our service is guaranteed.
- You specify the sort of person you wish to meet and the area they should come from, and you decide who you want to meet, and how you wish to make contact.
- As the largest dating agency in the world, we provide a membership second to none — the kind of people you want to meet living in your area.

**Dateline has the people you want to meet...**



**Carol and David** — 18 year old Carol's family thought she was a fool to join Dateline; she was pretty enough to get any lad she wanted. David, 20, had met lots of girls interested in the glamour of his RAF uniform, but both he and Carol wanted more. The first night David and Carol met he announced to his parents he had met the girl he wanted to marry. Carol says, 'I'd been looking for something special, and no-one seemed to have it, but David has everything I'd ever looked for. He's really gentle and loving and he means the world to me.' A posting to Northern Ireland meant an unacceptable separation, so Carol and David married five months after Dateline introduced them.

# You <sup>too</sup> can find love

The quality of our service simple can't be beaten, proved by the happiness we have brought to so many people. Dateline is a reliable, professional and established company, and we care that you find that special person you're looking for, so are always happy to help with queries either in our offices, or on the phone.



**Sue and Martin** — Sue says 'I met genuine men who wanted to meet new people as much as I did; who wanted to make friends and have a good time — and I met Martin. Dateline was really good fun.'

Dateline is a member of the Association of British Introduction Agencies  
29 Manchester St. London W1



- **Dateline is the world's largest, longest established and most successful computer dating agency — successful because it really does find love for thousands of people.**

Post this coupon today to find out how Dateline could find love for you too...

**Dateline**, 23 ABINGDON RD. LONDON W8 6AH. Tel: 01 938 1011

FREE

### COMPUTER TEST TO FIND YOUR IDEAL PARTNER

I am over seventeen and would like you to send me completely free, in confidence, and without obligation, a description of my ideal partner. Plus a free colour brochure and lots more information about Dateline. I enclose two first class stamps.

**START HERE 1**

Do you consider yourself:

<input type="checkbox"/> Shy	<input type="checkbox"/> Generous
<input type="checkbox"/> Extrovert	<input type="checkbox"/> Outdoor type
<input type="checkbox"/> Adventurous	<input type="checkbox"/> Creative
<input type="checkbox"/> Family type	<input type="checkbox"/> Practical
<input type="checkbox"/> Clothes conscious	<input type="checkbox"/> Intellectual

**2**

Indicate which activities and interests you enjoy by placing a ✓ in the appropriate box. If you dislike a particular activity, put X. If you have no preference, leave the column blank.

<input type="checkbox"/> Pop music	<input type="checkbox"/> Politics
<input type="checkbox"/> Fashion	<input type="checkbox"/> Classical music
<input type="checkbox"/> Pubs	<input type="checkbox"/> Art/Literature
<input type="checkbox"/> Sport	<input type="checkbox"/> 'Live' theatre
<input type="checkbox"/> Pets	<input type="checkbox"/> Science or Technology
<input type="checkbox"/> Folk music	<input type="checkbox"/> Creative writing/painting
<input type="checkbox"/> Jazz	<input type="checkbox"/> Poetry
<input type="checkbox"/> Travelling	<input type="checkbox"/> Philosophy/Psychology/Sociology
<input type="checkbox"/> Cinema	<input type="checkbox"/> History/Archeology
<input type="checkbox"/> Good food	<input type="checkbox"/> Conversation

Your Sex put M or F      Your Height    ft    ins

Your Age    yrs    Age you would like to meet    Min    Max

First Name \_\_\_\_\_

Surname \_\_\_\_\_

Address \_\_\_\_\_

Occupation \_\_\_\_\_

Religion \_\_\_\_\_

Send to: Dateline, Dept PCQ  
23 Abingdon Rd.,  
London W8 6AH  
01 938 1011

Dateline





## GRAPHTEC. THE NEW A3 RANGE OF PLOTTERS — PROGRAMMED FOR VALUE

There are ten plotters in the Graphtec A3 range... costing from as little as £895.

The features and benefits are outstanding and offer an exceptional value which belies the price.

For example, an image area of 416 x 285mm is much closer to a true A3 than other plotters give.

With pen speeds of 40cms per second, you get quicker plots — and a resolution of 0.025mm gives you a better quality plot. And to help you make really attractive plots, there is not only an eight pen facility, but a wide variety of pen types available, from basic fibre tips to specialised ceramic tips and draughting pens. There's even a pencil plotting option.

Graphtec plotters can interface with practically any host computer and having 3 switch-selectable command languages,

including HP-GL, are compatible with most software packages.

A large 24K capacity buffer frees your pc for other duties. And there's more... LCD status report... tilt stand for space saving... a number of pen protection devices... choice of paper holds...

Discover just how much more Graphtec plotters can give you — including value. Phone us now or use the Freepost coupon. We'll send you our colour brochure, a price list and the name of your nearest appointed Graphtec stockist.

**Phone 0270 625 115**

**OR POST FREE** (No stamp needed).

Please send me information on:

A3 Plotters  Large Format Plotters  Range of Digitisers

Name \_\_\_\_\_

Position \_\_\_\_\_

Company \_\_\_\_\_

Address \_\_\_\_\_

County \_\_\_\_\_ Post Code \_\_\_\_\_

Tel: \_\_\_\_\_

Type of Business \_\_\_\_\_ PCW 2

Post to: Environmental Equipments (Northern) Ltd, Freepost, Nantwich, CW5 6BR



Environmental Equipments (Northern) Ltd,  
Environ House, Welshman's Lane,  
off Welsh Row, Nantwich, Cheshire CW5 6AB.

SOLE UK DISTRIBUTORS



# AUTUMN SALE

## PLEASE READ THIS

WHOLESALE PRICES TO YOU THE USER

### ★ BUY 5.25" DISKS

Plain label by leading manufacturers ie. R.P.S. Wabash etc.

	25	50	100	200	500
SS/SD 48tpi	£10.00	£19.00	£35.00	£68.00	£164.00
SS/DD 48tpi	£10.50	£20.00	£38.00	£74.00	£174.00
DS/DD 48tpi	£11.00	£21.00	£40.00	£78.00	£190.00
DS/DD 96tpi	£11.50	£22.00	£42.00	£82.00	£200.00

All above inc. envelopes, label sets and hub rings

UK MADE Library cases bought with above only £0.95 EACH

### 3.5" DS/DD DISKS

Plain label. Made in Japan

	10	20	50	100	200
	£15.00	£26.00	£64.00	£110.50	£198.00

### LOCKABLE DISK BOXES AND LIBRARY CASES

5.25" 10 Capacity Ref. VIS 10 Library case	£1.30
5.25" 50 Capacity Ref. YU-DD50L YA50L	£7.50
5.25" 100 Capacity Ref. YU-DD100L YA100L	£10.00
3.5" 10 Capacity Ref. MCS 10	£1.30
3.5" 40 Capacity Ref. YU-DD40L YA40L	£8.50
3.5" 80 Capacity Ref. YU-DD80L	£9.75

### SPECIAL OFFERS

#### ★ EXCEPTIONAL VALUE ★

25 5.25" DS-DD DISKS  
PLUS  
100 CAPACITY LOCKABLE DISK BOX  
FOR  
ONLY £17.60

OR  
50 5.25" DS-DD DISKS  
PLUS  
100 CAPACITY LOCKABLE DISK BOX  
FOR  
ONLY £27.10

20 3.5" DS-DD DISKS  
PLUS  
40 CAPACITY LOCKABLE BOX  
FOR  
ONLY £29.50

OR  
50 3.5" DS-DD DISKS  
PLUS  
80 CAPACITY LOCKABLE BOX  
FOR  
ONLY £68.20

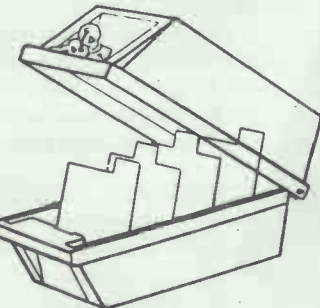
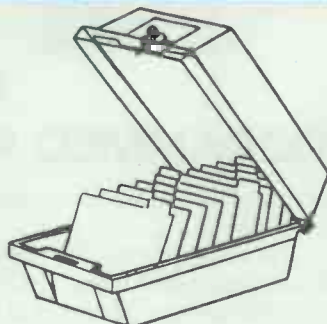

REMEMBER THE PRICE YOU SEE IS ALL YOU PAY. (UK ONLY)  
THEY INCLUDE VAT AND CARRIAGE

Cheque or Postal Order to:



**Manor Court Supplies Ltd**

Dept JT9, Glen Celyn House, Penybont,  
Llandrindod Wells, Powys LD1 5SY  
Telephone: 0597 87784 or 0597 87792

Orders accepted from educational & government depts.  
Dealer enquiries invited.

## 4 WAY AUTO PRINTER SHARER FOR ONLY £99



SPEC: MP401 4 way Auto-switch with 25 wayD type parallel I/O suitable for IBM & Compatible machines.

### OTHER PRODUCTS AVAILABLE:

MECHANICAL		BUFFERS	
2 WAY 25D TYPE	39.95	2 WAY CENTRONICS	£49.95
3 WAY 25D TYPE	£46.95	3 WAY CENTRONICS	£67.95
4 WAY 25D TYPE	£55.00	4 WAY CENTRONICS	£77.95
2 WAY X OVER 25D	£55.79	2 WAY X OVER 36C	£81.95

AUTO-SWITCH PARALLEL AND SERIAL		BUFFERS	
MP/MS401 4 WAY	£99	PB64 64K RAM	£122.95
MP/MS801 8 WAY	£153.95	PB256 256K RAM	£195.00

LINE CONVERTERS		PARALLEL TO SERIAL	
SERIAL TO PARALLEL	£69		£69.00

TO ORDER PLEASE SEND CHEQUES BUT ADD VAT & £3 P&P  
DEALER AND EXPORT ENQUIRIES WELCOME

## BRIGDEN TECHNOLOGY

0322 331984

UNIT24 ERITH BUSINESS CENTRE  
ERITH HIGH ST, ERITH, KENT DA8 1QY

**TELEVISION INFORMATION NETWORK**  
Tel: 01 586 4629

## TELEVISION / COMPUTER INFORMATION SERVICE

**FREE** Business Information  
Across The Nation -  
At Your Fingertips!

For the Recommended Services throughout the UK,  
look us up via your Viewdata Terminal, Micro or PC Now.

(outside London) **014832521**

(within London) **5861221**

Aerial Services	Engineering	Messengers
Air Conditioning	Finance Services	Photographic
Architects	Fork-Lift Trucks	Printing
Blast Cleaning	Galvanizers	Removals
Building Services	Gases	Restaurants
Car Services	Heating	Security Services
Catering Services	Hydraulics	Shopfitters
Data Processing	Industrial	Taxis

And for all your personal and business needs.

# Summer Madness

Abbot customers benefit from our very careful buying and strict control of overheads. If you want to pay less for your computer requirements buy from Abbot.

LOW LOW PRICES

LOW LOW PRICES

Epson Printers		Star Printers		Amstrad PC1512		Top 20 Best Selling Books	
<i>The Worlds best selling range of printers</i>		<i>Superb quality and reliability</i>		<i>Now offered to the public at trade price! This represents incredible value</i>			
LX 800	Popular low cost model 150 c.p.s. draft 25 c.p.s. N.L.Q. parallel interface, friction and tractor	NL 10	Popular low cost model 120 c.p.s. draft 30 c.p.s. N.L.Q., friction feed and tractor feed, parallel, I.B.M., Apple or Commodore interface (state which)	PC1512	Double Disk Mono	£ 474	1 Locomotive BASIC 2 Manual Amstrad 9.95
FX 800	Mid price printer 200 c.p.s. draft 40 c.p.s. N.L.Q. parallel interface, friction and tractor	NL 10	Extra for RS232 serial interface	PC1512	Double Disk Colour	£ 605	2 Using Supercalc 4 Que 17.45
FX 800	Sheet feed	NL 10	Sheet feed	<b>Seikoshia Printers</b>			3 Mallard BASIC book 2 Amstrad 9.95
FX 1000	Wide carriage version of FX 800	NX 15	Wide carriage version of NL 10 parallel interface	<i>From the same company as Seiko watches. All have built in tractor feed.</i>			4 Using MSDOS on the Amstrad PC Newtech 9.95
FX 1000	Sheet feed	NX 15	Extra for RS 232 serial interface	SP180A	Low cost serial printer 100 c.p.s. draft 16 c.p.s. N.L.Q.	£ 159	5 Enhancing your Amstrad 1512 Newtech 14.95
EX 800	Heavy duty model 300 c.p.s. draft 50 c.p.s. N.L.Q. parallel and serial interfaces, friction and tractor feed	ND 15	Mid price wide carriage, 180 c.p.s. draft 45 c.p.s. N.L.Q., friction and tractor feed, parallel interface	SP1200A	80 column, 120 c.p.s. draft, 22 c.p.s. N.L.Q., parallel or serial, state which	£ 189	6 Step by step guide to Locoscript Amstrad 4.95
EX 800	Sheet feed	ND 15	Extra for RS 232 serial interface	MP1300AI	80 column, 300 c.p.s. draft, 60 c.p.s. N.L.Q., parallel and serial	£ 300	7 Using Wordstar 1512 Newtech 9.95
EX 1000	Wide carriage version of EX 800	NR 15	Faster version of ND15 240 c.p.s. draft 60 c.p.s. N.L.Q.	MP1300AI	Sheet Feed	£ 129	8 Amstrad PC Technical Reference Manual Amstrad 19.95
EX 1000	Sheet feed single hopper	NB 24-10	Letter quality, 24 pin head 216 c.p.s. draft 72 c.p.s. letter quality, parallel interface, friction and tractor feed	SL80AI	80 column, 24 pin head, 150 c.p.s. draft, 50 c.p.s. letter quality	£ 399	9 dBase III Plus handbook 2nd Edition Que 18.45
EX 1000	Sheet feed double hopper	NB 24-10	Extra for RS 232 serial interface	MP5300AI	132 column, 300 c.p.s. draft, 60 c.p.s. N.L.Q., parallel and serial	£ 429	10 Amstrad PC Owners Handbook Newtech 19.95
EX 1000	Colour unit	NB 24-15	Sheet Feed	MP5300AI	Single bin sheet feed	£ 159	11 Advanced MSDOS Microsoft 19.95
LQ 800	Letter quality, 24 pinhead, 180 c.p.s. draft 60 c.p.s. letter quality, parallel and serial interfaces, friction feed	NB 24-15	Wide Carriage version of 24-10	BP5420FA	136 column, 420 c.p.s. draft, 106 c.p.s. N.L.Q., parallel and serial	£ 1299	12 Advanced disk User Guide BBC Cambridge Micro 16.95
LQ 800	Tractor feed	NB 24-15	Sheet Feed	BP5420FA	Sheet feed	£ 199	13 Running MSDOS 2nd Edition Microsoft 19.95
LQ 800	Sheet feed	NB 24-15	Second bin for sheet feed	<b>Clearance Bargains</b>			14 Using Supercalc 3 Newtech 9.95
LQ 1000	Wide carriage version of LQ 800	NB 15	Heavy duty letter quality, 24 pin head, 300 c.p.s. draft 100 c.p.s. letter quality, parallel interface, friction and tractor feeds	Epson RX100	136 column wide carriage printer, 100 c.p.s., parallel interface, tractor and friction feed	£ 199	15 Programming the 8086/8088 Sybex 16.95
LQ 1000	Tractor feed	NB 15	Extra for RS 232 serial interface	Epson FX100	+ 136 column wide carriage printer, 200 c.p.s., parallel interface, tractor and friction feed	£ 319	16 Programming the Psion Organiser II Kuma 9.95
LQ 1000	Sheet feed	NB 15	Sheet feed	Epson 8647	upgrade for RX100, FX80, FX100, JX80 gives serial interface, N.L.Q. and 6K buffer	£ 40	17 Programmers Guide to IBM PC Microsoft 16.95
LQ 1000	Wide carriage version of LQ 800	NB 15	Second bin for sheet feed	Phillips 7513	Monitor 12" Green, TTL input ideal for use with Hercules	£ 89	18 Amstrad CP/M Plus M.M.L. Systems 12.95
LQ 1000	Tractor feed	<b>PCW 8256—PCW 8512 upgrade</b>		P.C.	2 Mbyte EMS Card uses 256K DRAM sold unpopulated	£ 129	19 Word Perfect tips and traps Que 18.45
LQ 1000	Sheet feed	Citadel kit with 1 Mbyte internal 3" drive and 256K of memory. Easy to follow instructions, as simple as changing a plug. £129.57		P.C.	internal Modem V21/V22, 1200 Baud full duplex. Hayes compatible, Not telecom approved	£ 149	20 View a dap hand guide Dabs Press 12.95
LQ 1000	Sheet feed double hopper	<b>Parallel Printer Lead</b>		Chinon 5½"	1.2 Mbyte disk drives suitable for AT	£ 99	<i>There is no V.A.T. on books. Post and packing £1 per book order.</i>
LQ 1000	Colour unit	IBM Compatible — Connects most computers to most printers £12 p&p. £1.		<b>Memory</b>			41256—15 256K DRAM £1.90 each £15.20 for 8 £17.10 for 9 Post and packing £1 per memory order.
LQ 1000	Tractor feed						
LQ 1000	Sheet feed double bin						
LQ 1000	Laser page printer, 6 p.p.m., 300 d.p.i., HP identity						
LQ 1000	1.5 Mbyte extra memory						

## Abbot Computer Products Ltd.

50 High Street, Edgware,  
Middlesex. HA8 7EP

Telephone: 01-951 5809

Managing Director: Bruce Everiss

## TERMS AND CONDITIONS

Add VAT at 15% to all items except books.

Add £5 carriage per order in Mainland UK  
— except on items marked £1 p&p.

Cash with order.

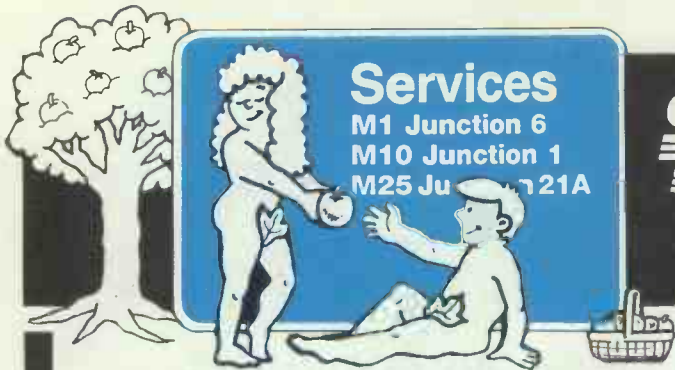

# COMPUTER EXPRESS

**"TWO FULL PAGES OF TEMPTING BARGAINS  
... WOULD YOU ADAM & EVE IT?"**

## WIN A BOX OF DISCS

Test your skill by spotting the difference between the illustration of Adam, Eve and the apple tree on this page and the similar illustrations on the opposite page. When you call to place an order if you are one of the first 25 customers with the correct answer you will receive a free pack of 10 Computer Express 5.25in DS/DD 48tpi Diskettes as advertised opposite.

### SEIKOSHA SP 1200

A high quality, feature packed, printer ideal for home or light office use. 120 cps in Draft, 22 cps in NLQ. 80 column carriage. Automatic single sheet fed. Tractor feed. NLQ front control. 12 months warranty. Parallel interface.  
**£189.00**

### SEIKOSHA MP5300

Wide carriage dot matrix printer. Fast, quiet and a bargain at the price. Ideal for printing spreadsheets and all continuous stationary. 300 cps Draft, 60 cps in NLQ. Automatic single sheet feed. Complete control from front panel. Both Parallel and Serial interface. Optional cut-sheet bin feed available. 12 months warranty.  
**£389.00**

### SEIKOSHA SP180

The quality home printer at an affordable price. 80 column. 100 cps Draft and 16 cps NLQ. Friction feed and drop-on tractor feed. Choice of Serial or Parallel interface. Long ribbon life. 12 months parts and labour warranty.  
**£149.00**



### IRWIN TAPE BACK-UP

Save your data securely before you lose it! Irwin are the worlds most popular tape back-up systems. Automatic back-up so you can save data when you are away from your machine. Full error correction to ensure that you can recover data even from a damaged tape. Suitable for most MS DOS machines. Fire, theft, clumsy fingers, spilled coffee - Irwin can protect you from the consequences of these disasters.

#### INTERNAL

20 MB PC/XT/Compat	£360
20 MB 286/AT/Compat	£360
40 MB AT/386/Compat	£450

#### EXTERNAL

20 MB PC/XT/Compat	£430
20 MB 286/AT/Compat	£430
40 MB AT/386/Compat	£550

### EIZO 3010 MONO MONITOR

Green, amber and white reverse. Compatible with IBM composite PAL output. Will also run on BBC, Acorn, Apple II c/e, Epson. 12" matt black screen for low reflection. Complete with phono-phono cable. 12 months warranty.  
**£55.00**

### MODEMS - FROM RACAL

Top quality modems at low low prices.

2BM external modem V21/V23 with software	£299.00
2BM internal modem V21/V23 with software	£299.00
External modem V22	£399.00
Internal modem V22	£360.00
External modem V22 with autodial	£450.00
Internal modem V22 with autodial	£425.00
High spec, multispeed external modem with error correction	£580.00



All prices exclude VAT and delivery. Prices are correct at the time of going to press although they are subject to change without notification. Official purchase orders welcome. Full back up and support. Open Monday to Friday 9am-6pm. Open Saturday 10am-4pm

FOR FULL PRICE LIST PLEASE CALL  
TELEPHONE ORDERS WELCOME



**0727 - 72790/37451**



SINGLE AND MULTI-USER  
MICRO-COMPUTER  
SOFTWARE SALES AND SUPPORT

**SHOWROOM • 99 PARK STREET LANE • BRICKET WOOD • HERTFORDSHIRE • AL2 2JA • ST ALBANS (0727) 72790**

TELEX: 8950511 ONE ONE G (Quote Ref: 15412001)

OFFICE AND WAREHOUSE • UNIT A • CAXTON CENTRE • PORTERS WOOD • ST ALBANS • HERTFORDSHIRE • AL3 6XT • (0727) 37451

COMPUTER EXPRESS HOLLAND • NIJVERHEIDSWEG • N60 • 3812 PM • AMERSFOORT • NETHERLANDS • (33) 630544



**Services**  
**M1 Junction 6**  
**M10 Junction 1**  
**M25 Junction 21A**

**"THERE'S NOTHING AS TEMPTING AS OUR PRICES"**

**NARROW DOT MATRIX PRINTERS**

Epson LX800 - The Brand New Best Seller!	£195
Star NL10 - The Number Two Seller-Best Spec	£195
Panasonic 1081 120cps & 80 col - Brand New!	£149
Panasonic 1091 - Byte Magazine Says It's No 1	£228
Epson FX800 - Brand New! 240cps! Wow!	£298
Epson EX800 - 300cps & 80 column-Super Fast!	£385
Seikosha MP1300AI - 300cps!	£299
MP 165 - Cheap Fast And Good Quality 180cps	£170
MP 135	£135
Ok! Microline 182 - The Number 2 Brand	£188
Ok! Microline 192 - Perennial Favourite	£282
Citizen MSP 10 - 160cps draft 80 column	£277
Citizen 120D - 120cps draft 25cps NLO	£165
Citizen MSP20 - 200cps draft 50cps NLO	£299

**WIDE DOT MATRIX PRINTERS**

Star NX15 - The New Wide-body NL10!	£288
Star NR15 - Replaces the SR15-A Great Mover	£424
Panasonic 1595 - The Panasonic Favorite	£521
Epson FX1000 - Brand New! Replaces FX105	£385
Epson EX1000 - 300cps & 136 column-Super Fast!	£517
Seikosha MP5300AI - 132col Version of MP1300	£439
MP 200 - 200cps! 132 column!	£260
MP 201 - 132 column 200cps	£295
Ok! Microline 193 - Worth A Look	£366
Ok! Microline 293 - Worth A Long Look	£608

**24-PIN DOT MATRIX PRINTERS**

Epson LQ800 - Letter Quality-24 Pin Pinthead	£423
Epson LQ1000 - Letter Quality-24 Pins-132 Col	£577
Epson LQ2500 - This one is really good!	£694
Star NB15 - The big, up-market Star 24-pin 300cps	£679
Star NB24-15 - Same as above, but 216cps	£525
Star NB24-10 - 80 column 24-pin winner	£415
NEC P6 - Good Buy	£389
NEC P7 - One of the Best Sellers Ever - 24 pin	£447

**DAISY WHEEL PRINTERS**

Star Power Type 18cps - The Current Cheap One	£179
Juki 6100 - 200cps - Very Popular	£254
Juki 6200 - 300cps - Still Popular	£397
Juki 6300 - 400cps - Very Up-Market	£560
Juki 6500 - 600cps - Heavy Duty and Very Fast	£966
Qume Sprint 11/90 - 90cps Daisywheel Printer	£1200
Citizen HQ-45 45 cps	£499
Citizen Premier-35	£510
Brother HR25	£549

**COLOUR PRINTERS**

Okmate 20 Thermal Printer	£159
Juki 5520 - The Market Leader - Fast!	£335
Epson EK-Series Colour Option	£55
NEC P565XL - Heavy-Duty Office Favorite!	£744
Epson LQ2500 Colour Option/Makes LQ2500 Colour	£54
Seikosha MP1300 Colour Kit/Makes MP1300 Colour	£87

**INK JET PRINTERS**

Epson SQ2500 - Ink your jet with this one!	£988
--	------

**PLOTTERS, DIGITIZERS & LASERS**

New Ok! Laserline 6 - 6 pages per minute	£1459
HP Laser Jet II - Newer, Better, Cheaper!	£1945
Cherry A3 Digitizer	£475
Roland DXY-880A Plotter - Best Value A3 Plotter	£649
Roland DXY-990A Plotter	£1099
Epson GQ3500 - Brand new Epson best-seller!	£1359

**CABLES AND THINGS**

IBM-Compatible Centronics Parallel Cable (Round)	£12
BBC Centronics Parallel Cable (Ribbon)	£8
Serial Cables Made to Order	£20
Two-Way Printer T-Switch	£45
Three-Way Printer Switch	£79
Fan-Fold White Paper, 11in long, 1000 sheets	£7
80 Col Printer Stands	£21
132 Column Printer Stands	£28
SpaceBase Adjustable Floor-Standing Printer Stand	£85

**AMSTRAD PC**

Amstrad 1512 Single Floppy/Mono Monitor	£415
Amstrad 1512 Double Floppy/Mono Monitor	£525
Amstrad 1512 Single Floppy/Colour Monitor	£555
Amstrad 1512 Double Floppy/Colour Monitor	£666
Amstrad 1512 20mb Hard Disk/Mono Monitor	£837
Amstrad 1512 20mb Hard Disk/Colour Monitor	£959
Amstrad 1640 Single Floppy (EGA Colour 640k)	£759
Amstrad 1640 Double Floppy (EGA Colour 640k)	£854
Amstrad 1640 20mb Hard Disk (EGA Colour 640k)	£1139

**MACDOUGALL PC'S**

MacDougall 286 AT 512k 10mz/20mb HD/mono monitor	£999
--	------

**EPSON PC'S**

Epson PC+ 640k RAM, 20mb Hard Disk, Video Card	£950
Epson PC AX-20 AT 640k RAM, 1.2mb Floppy, 20mb HD	£1499
Epson PC AX-40 AT 640k RAM, 1.2mb Floppy, 40mb HD	£1899
Epson PC AX-60 AT 640k RAM, 1.2mb Floppy, 60mb HD	£2399
Epson PC AX-80 AT 640k RAM, 1.2mb Floppy, 80mb HD	£2799
Epson PCe	£1050

**OLIVETTI PC'S**

Olivetti M24 Single Floppy Base Unit/640k	£799
Olivetti M24SP 20mb single floppy Base Unit/640k	£1199
Olivetti M28 AT Compatible - 20mb Hard Disk	£1831
Olivetti M28 20mb Hard Disk with 20mb Tape Back-up	£2299
Olivetti M28 40mb Hard Disk, 640k RAM	£2325
Olivetti M28 40mb Hard Disk with 20mb Tape Back-up	£2796
Special Offers:	
M24 20mb Computer System	£1299
M24SP Complete System (Monitor/Keyboard/DOS)	£1499

**SHARP PORTABLES**

Sharp PC7100 20mb Hard Disk SuperTwist Screen	£1399
---	-------

**COMPAQ**

Compaq Portable III Model 2 640K/20MB HD	£2824
Compaq Portable III Model 3 640K/40MB HD	£3136
Compaq Deskpro 286 Model 20 640K/1 FD/20MB H.D.	£2161
Compaq Deskpro 386 Model 40 1024K/40MD HD/Tape Bk	£3999

**MONITORS**

Dyneer 12in 12MHI Mono Monitor & Tilt/Swivel Stand	£99
Eizo ER8042S 14in Ultra-High Res EGA Colour Monitor	£465
ADI 14in Mono Monitor with Tilt/Swivel Stand	£120

**ATARI**

Atari 520STM 512k RAM, TV Modulator, no disk drive	£199
Atari 520STEM 512k RAM, disk drive, mouse	£299
Atari 1040STF 1mb RAM, disk drive, mouse, no monitor	£430
Atari 1040STF with Mono Monitor, 1mb RAM, disk drive	£529
Atari 1040STF with Atari SC1224 Colour Monitor	£720
Atari 1040STF with Philips 8833 Colour Monitor	£670
Atari 1040STF with Philips 8552 Colour Monitor	£674
Atari SF314 1mb Floppy Disk Drive	£150
Atari SF354 512k Floppy Disk Drive	£118
Atari SH204 20mb Hard Disk Drive	£478
Cumana CS354 1mb Floppy Disk Drive	£116
Atari SM125 High Resolution Monochrome Monitor	£114
Atari SC1224 Colour Monitor	£296

**ATARI TOP SELLING SOFTWARE**

Flight Simulator II - Very Realistic Best Seller	£36
VP Professional (Lotus Clone Gem Version)	£149
Metacomco Lattice C Compiler	£71
Metacomco Macro Assembler	£37
First World War - Word Processor with Graphics	£62
Art Director - State of the Art Drawing Package	£35
Film Director - Powerful Animation Package	£45
Art + Film Director - Perfect Partners	£75
Easy Draw II - The Powerful Drawing Program	£57
Fast ST Basic (ROM) - The Fastest, Most Comprehensive	£66
Degas Elite - The Market Leader	£59
Mark Williams 'C' Compiler	£117
Superbase Personal - The Most Advanced Easy to Use Database	£84
ChessMaster 2000 - The Finest Chess Program with Speech	£33
Leaderboard - Realistic Golf Simulator	£18

**CATS 'N' MICE**

Mouse Systems Mouse with Pop-Up Menus & PC Paint	£145
Mouse Systems Mouse with Pop-Up Menus Only	£125
Microsoft Bus or Serial Mouse - Don't forget the cat!	£132
Logitech Logimouse Plus Package	£89

**DISKETTES**

Computer Express 5.25in DS/DD 48tpi disks	£1.00 each
Computer Express 5.25in DS/DD 96tpi disks	£1.40 each
Computer Express 5.25in DS/DD 96tpi Hi-Density	£1.85 each
Computer Express Branded 3.5in DS/DD diskettes	£1.99 each

**COMMUNICATIONS**

Miracle WS4000 V21-V23 Modem	£139
Miracle WS3000 V22 Professional Modem	£84
Sage Chitchat Comms Pack (Modem/Software/Cable)	£199
Crosstalk IV Comms Software	£93
Sage Chitchat Comms Software	£71
One-To-One Electronic Mail Subscription	£20
RS232 serial modem cable	£15

**HARD DISKS**

Dysan/Western Digital 20mb File Card	£289
Miniscribe 30mb Scribecard Hard Disk Card	£325
Seagate 20mb Hard Disk Kit with WD Controller & Cables	£235
Plus HardCard 20mb	£595

**ADD-ON BOARDS**

AST SixPack Plus 64k memory Multifunction Card	£169
Quibie SixShooter Multifunction Card 64k memory	£125
Intel AboveBoard with 0k installed	£225
Everex Mini Magic Ram Expansion Card (384k)	£117
Hercules Graphics/Graphics Plus Card	£179
Everex EverGraphics Plus (Clone Hercules Card)	£95
Eizo Auto-Switch EGA Card	£219
Paradise Auto-Switch EGA Card	£235
AST Rampage	£200
AST 3720 Terminal Emulation Card	£649
AST 5251 Model 12 Remote Emulation Card	£525
AST 5251 Model 11 Local Emulation Card	£600
AST SixPack Premium 256k Clock Parallel & Serial	£330
AST SixPack Premium 1mb EMS daughter board	£150
AST Advantage 128k Serial parallel Port	£400

**CHIPS, CO-PROCESSOR AND DRAM**

64k dRAM chips (nine to make 64k)	£1.15 each
256k dRAM Chips (nine to make 256k) 150 N.S.	£3.00 each
Intel 8087 5mhz Maths Co-Processor	£97
Intel 8087-2 8mhz Maths Co-Processor	£139
Intel 80287-8 Maths Co-Processor	£189

**TOP IBM-COMPATIBLE SOFTWARE**

WordStar 2000 release 2	£229
WordStar 3.4	£149
WordStar Professional Version 4	£193
WordStar 2000 Plus	£269
Wordcraft	£299
Word Perfect ver 4.2 - The Number 1 WP Package	£239
Microsoft Word ver 3 - Number 2 WP Package	£249
Multimate ver 3.31	£189
Multimate Advantage II	£290
Lotus Manuscript - Latest Blockbuster WP Package!	£236
PFS: First Choice	£110
Framework II Version 1.1	£312
Symphony version 1.2 (Latest Version)	£319
Lotus 1-2-3 ver 2.1 Top Selling Package In The World	£223
Supercalc ver 4 - The Celebrated Lotus-Beater!	£195
Graflok Logistix	£80
Javelin	£343
Smart System - The Best Integrated Package	£349
Executive Systems X-Tree (Super Friendly HD Organizer)	£40
Pegasus Accounts (per Module)	£199
Psion Chess - You too can play like Gary Kasparov	£25
Quad Software Copywrite (Back up Protected Software)	£35
Microsoft Flight Simulator - Don't crash!	£39
Funk Software Sideways	£40
Borland Turbo Lightening	£47
Microsoft Windows	£59
Norton Utilities 4	£52
Ventura Desk Top Publisher	£399
Freelance Plus	£269
Delta Professional	£325
Ansa Paradox II - Multi-User Database!	£299
Cardbox Plus	£225
Ashton-Tate Rapid File	£199
dBase III Plus - Best Selling Professional Database	£335
FoxBase Plus	£269

**LOW-COST SOFTWARE**

VP Planner by Paperback Software - Best Seller!	£61
VP Info (dBASE II Clone)	£62
VP Expert	£75
Borland Sidekick - The Original Co-Resident Process!	£49
Borland Turbo C - C How You Like This!	£65
Borland Turbo Pascal - The Classic Borland Product	£47
Sage Bookkeeper	£75
Sage PC Planner Spreadsheet (Lotus Clone)	£71
Sage PC-Write Word Processor	£71
Sage Accountant	£110
Sage Accountant Plus - Top Selling Cheap Accounts	£155
Sage Payroll	£85
Sage Financial Controller - Just reduced from 995!	£240
Personal Word Perfect	£149
Word Perfect Junior	£80
Microsoft Word Junior	£62
WordStar 1512	£60
Multiplan Junior	£62
Supercalc 3	£60
Amstrad Reflex	£60
Migent Ability - Top Integrated Package	£50
Migent Ability II - Spend a Little More, Matel	£135
Words & Figures - Lotus 123 v1 Clone with WP	£80
Gem WordChart	£89

**SPECIAL OFFERS**

Epson PC+ 20mb with Eizo 8042S EGA Monitor & Card	£1489
Epson PC+ 20mb with Mono Monitor	£989
Migent Ability	£50
LX-85 Auto Sheet Feed	£39

All prices exclude VAT and delivery. Prices are correct at the time of going to press although they are subject to change without notification. Official purchase orders welcome. Full back up and support. Open Monday to Friday 9am-6pm. Open Saturday 10am-4pm.

FOR FULL PRICE LIST PLEASE CALL  
 TELEPHONE ORDERS WELCOME



**0727 - 72790 / 37451**



**SINGLE AND MULTI-USERS  
 MICRO-COMPUTER  
 SOFTWARE SALES AND SUPPORT**

**SHOWROOM • 99 PARK STREET LANE • BRICKET WOOD • HERTFORDSHIRE • AL2 2JA • ST ALBANS (0727) 72790**  
 TELEX: 8950511 ONE ONE G (Quote Ref: 15412001)

**OFFICE AND WAREHOUSE • UNIT A • CAXTON CENTRE • PORTERS WOOD • ST ALBANS • HERTFORDSHIRE • AL3 6XT • (0727) 37451**

**COMPUTER EXPRESS HOLLAND • NIJVERHEIDSWEG • N60 • 3812 PM • AMERSFOORT • NETHERLANDS • (33) 630544**

**STOP!**

**STOP!**

**STOP!**

**WHEN YOU UPGRADE YOUR IBM AT,XT,PC OR COMPATIBLE  
CONSIDER OUR GOLD...™ FAMILY OF PRODUCTS**

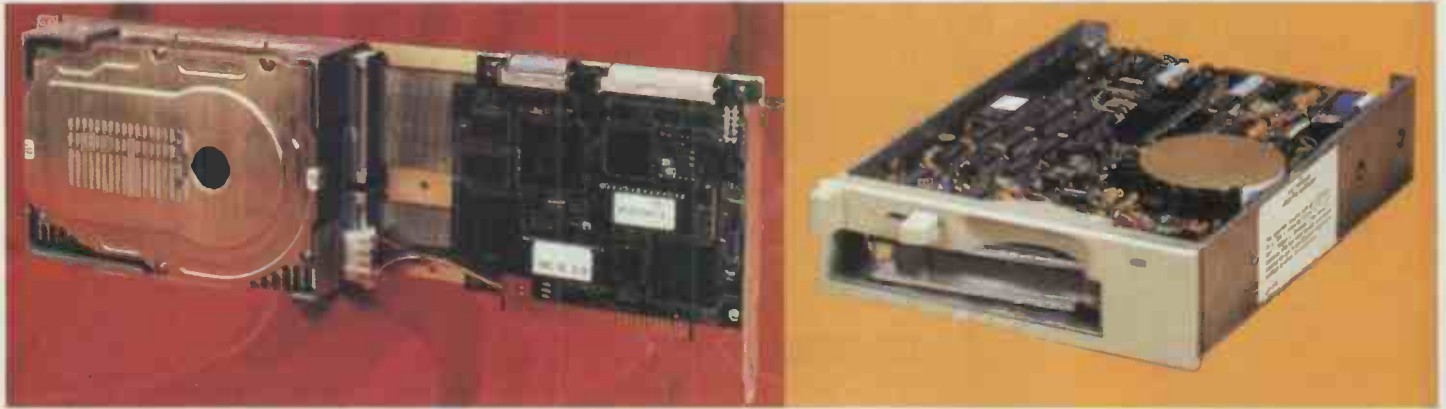

**GOLD-CARD™ PLUG-IN HARD DISKS**

**48MB 65MS GOLD-CARD™ FROM £425.00**

**32MB 65MS GOLD-CARD™ FROM £280.00**

**21MB 65MS GOLD-CARD™ FROM £265.00**

**ALL GOLD-CARD™ UNITS ARE SUPPLIED READY TO USE, PRE-TESTED, PRE-FORMATTED  
AND COMPLETE WITH ROM BASED UTILITIES AND OPERATIONS MANUAL.**

**GOLD-STORE™ TAPE BACK-UP SYSTEMS**

**125MB GOLD-STORE™ FROM £950.00**

**60MB GOLD-STORE™ FROM £625.00**

**42MB GOLD-STORE™ FROM £460.00**

**ALL GOLD-STORE™ UNITS ARE NETWORK COMPATIBLE AND ARE SUPPLIED WITH TAPE DRIVE,  
CONTROLLER (WHERE APPLICABLE), SOFTWARE, CABLE AND MANUAL, TAPE CARTRIDGE.**

**ALL PRODUCTS CARRY A FULL 1 YEAR WARRANTY.  
ALL PRICES EXCLUDE VAT AND CARRIAGE  
PERSONAL CALLERS WELCOME.**

**PERIPHERALS CONNECTION LTD.  
3 THE MALL  
LONDON W5 2PJ**

**TEL: 01-840-6262  
TELEX: 263083 OIL G  
FAX: 01-840-0462**

**PERIPHERALS CONNECTION LTD. ACKNOWLEDGE THE RESPECTIVE MANUFACTURERS TRADEMARKS.**

# SPRING RUNS FAST



**12 MHz ZERO WAIT STATE**

## SPRING "COMPACT 286"

1. INTRODUCING UP-TO-DATE TECHNOLOGY MAKES "SPRING" PRODUCTS AFFORDABLE AND FAST THAN EVER
2. COMPACT-286 80286-12 ADVANCED TECHNOLOGY MICROPROCESSOR INCORPORATING ZERO WAIT STATE TO PROVIDE ULTIMATE PERFORMANCE AND PROCESSING POWER

## SPRING MODEM 1200C

**CCITT V21/22/23 fully Hayes compatible**  
**OUR PERFORMANCE:**

- 1) New-AT command compatible 100% (include AT, at, aT & Data Format)
- 2) Sensitivity high: Even on worst line, SPRING MODEM still can go through
- 3) On dial command: SPRING MODEM increase "SWAP command", made user can do "Automatically dial repeat" easily
- 4) Voice/Data transfer automatically:  
 No need "push button" or "send AT command", SPRING MODEM change it automatically, on "Manual dial" SPRING MODEM can go to "Data" directly and also after dial you can break data go to voice directly, no need to power off Modem.

## COMPACT-88

SPRING TURBO-88 AND COMPACT-88 STATE-OF-THE-ART 8088-1 TURBO MICROPROCESSOR OF ZERO WAIT STATE FOR HIGH SPEED PROCESSING WITH RELIABILITY



MANUFACTURER AND EXPORTER  
**SPRING CIRCLE COMPUTER INC.**  
 3RD FL. NO. 126, ROOSEVELT RD. CABLE: "SPRINCLE" TAIPEI  
 SEC. 3, TAIPEI, TAIWAN, R.O.C. TEL: (02) 3517281/2  
 P.O. BOX 7-44 TAIPEI, TAIWAN 3413111/7  
 TELEX: 12925 SPRINCLE FAX NO: 3945587

U.S.A.  
**RESEARCH AND DEVELOP**  
**SPRING CIRCLE TECHNOLOGY INC.**  
 TEL: (208) 575-8088  
 FAX: (208) 575-6808

AGENT ON EUROPEAN  
 AUSTRIA  
 COPUTER TRADING  
 TEL: 07672-3494

ISRAEL  
 MLL COMPUTERS SYSTEMS LTD.  
 TEL: 03-7515511

PORTUGAL  
 REGINDUSTRIA SOCIEDADE DE EQUIPAMENTOS PARA  
 O COMERCIO E INDUSTRIA, LDA  
 TEL: 01-368157/367687

SWISS (SWITZERLAND)  
 SIL TRON AUTOMATION  
 TEL: 056-963370

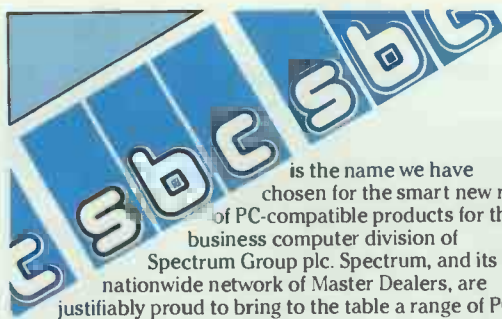

is the name we have chosen for the smart new range of PC-compatible products for the business computer division of Spectrum Group plc. Spectrum, and its nationwide network of Master Dealers, are justifiably proud to bring to the table a range of PC computers and peripherals, the quality and value of which is simply second to none.

From our compact twin drive sbc FD at £599, through to our top-of-the-range British developed and manufactured, 286 ATE (EGA) at £2399, we can offer you a 'stand alone' system, or multi-user/network system that's more efficient than anything in its class today. To compliment your system, choose from our range of monitors, printers, network systems and uninterrupted power supplies, which pound-for-pound beat anything on the market.

Finally we are so confident about our new product that we include a **12 month On-Site Maintenance Contract with every sbc computer.**

### FREE ON SITE MAINTENANCE

On site maintenance for PCs can be very expensive, in some cases costing hundreds of £££'s per annum. We are that confident of the quality of SBC PC compatible products that we now include a full 12 months Fast Call Out On Site Service Contract with every SBC computer FREE OF CHARGE.

## SBC PRINTERS

Sensational Value TP180-9 Dot Matrix Printer **£249.00**

## SBC MONITORS

12" green T.T.L. . . . . . Ex VAT **£79.95**  
 14" green or amber including swivel and tilt . . . . . Ex VAT **£99.95**  
 14" medium resolution colour . . . . . Ex VAT **£269.95**  
 14" EGA compatible colour . . . . . Ex VAT **£359.00**

## SBC Uninterruptable Power Supplies

No need to lose valuable data due to unexpected power failures, our system allows you up to 18 minutes of back-up time - a U.P.S. is invaluable in today's business environment

PWM 200 (200W) . . . . . Ex VAT **£199.00**  
 PWM 500 (500W) . . . . . Ex VAT **£299.00**  
 UPS 1000 (1KVA) . . . . . Ex VAT **£799.00**

# The SBC FD

## Priced...to beat you know who!

Now, from your sbc Master Dealer an enhanced range of superbly styled, second generation PC XT compatible computers that are faster and considerably more reliable than their predecessors.

Just check out the features listed below then add on our Free 12 month On-Site Maintenance Contract worth £54, then we think you'll agree.

**We know how too!**

**Undoubtedly the best value PC in Europe today**



The sbc FD Twin drive 360K

**£599.00** ex VAT  
 with Free 12 month On-Site Maintenance Contract

## SBC HD20



Features	1512 DDMM \$559 +VAT	SBC FD \$599 +VAT	Features	1512 DDMM \$559 +VAT	SBC FD \$599 +VAT
Microprocessor	8086-2	NECV-40	Basic language supplied	Locomotive Basic-2	Industry Std. CW Basic-3.2
8087-2 co-processor socket	✓	✓	Expansion slots	3	4
Parallel electronics port	✓	✓	CGA graphics option	No	✓
RS232 serial port	✓	✓	CGA graphics output	No	✓
Power supply rating	70W (approx)	135W	Mono colour changer switch	No	✓
Power supply location	In-rack	In Main Case	Dual speed processor	No	✓
Twin 360K floppy drives	✓	✓	640K RAM as standard	No	✓
Mouse and controller	✓	No	Full 12 months on-site warranty included in purchase price	No	✓
Gen and gem paint	✓	No			
MS-DOS 3.2	✓	✓			

Specifications as the FD but with one 20MB hard disk

ex VAT **£999**  
 with Free 12 month On-Site Maintenance Contract

**SBC FDC** as FD but with 11" colour monitor **£799** Ex VAT  
**SBC HD20C** as HD20 but with 11" colour monitor **£1199** Ex VAT

## SBC MASTER DEALER NETWORK · SBC MASTER DEALER NETWORK

**LONDON**  
 E11 Computer Junction, 475/477 High Road, Harrow Green, Leytonstone. Tel: 01 556 2266  
 EC2 9H Court Business Services Ltd, 4th Floor, Bell Court House, 11 Broomfield Street. Tel: 01 526 4825  
 N3 Mayflower Business Systems, 42 Hendon Lane, Finchley. Tel: 01 346 5300  
 NW2 Kay Jay Systems, 125 Coles Green Road. Tel: 01 208 0000  
 NW2 Delta Electronic Ltd, 665 Finchley Road. Tel: 01 794 3301  
 NW9 Business Technology Consultants Ltd, Masons House, 1 Valley Drive, Kingsbury. Tel: 01 206 6655  
 NW10 Microprinters, Park Royal Business Centre, 9-17 Park Royal Road. Tel: 01 961 8544  
 W18 Damson Computing, 6 Rays Road, Edmonston. Tel: 01 803 7074  
 SE 18 Computer Facilities, 2 Kings Highway, Plumstead. Tel: 01 654 5310  
 SE9 Alders Department Store, 145-159 High Street, Eitham. Tel: 01 850 9911  
 SW11 Arding & Hobbs, Clapham Junction. Tel: 01 228 8877  
 W1 Mico Avavia Ltd, 220A Tottenham Court Road. Tel: 01 580 6382  
 W2 Henry's Radio, 404/6 Edgware Road. Tel: 01 402 6822  
 W5 Magnesium Ltd, Thames Ward, Rainville Road. Tel: 01 385 3444  
 WC2E Relay Data Services, 33 Southampton Street. Tel: 01 240 5905

**AVON**  
 BATH Computer News, 9 Watcot Street. Tel: 0225 60541  
 NALSEA PAP Systems (UK) Ltd, The Lion, Crown Glass Place. Tel: 0272 686562  
 WESTON SUPER MARE K.K. Computers, 32 Alfred Street. Tel: 0934 493224

**BEDFORDSHIRE**  
 LEIGHTON BUZZARD Computa-Scene Ltd, 8 Hacklife Street. Tel: 0525 370790  
 LUTON Mill Computers, 18 Cardiff Street. Tel: 0582 458806

**BERKSHIRE**  
 BRACKNELL Miller Computing, Unit 10, Longshot Lane. Tel: 0344 419133  
 READING Computarc, 487 Oxford Road. Tel: 0734 508099  
 SLOUGH Slough Computers, 245 High Street. Tel: 0753 21954

**BUCKINGHAMSHIRE**  
 CHEESHAM D L, Chiddenden, 59-61 The Broadway. Tel: 0494 784441

**CHESHIRE**  
 ALTRINCHAM Regent Computers, 14 Regent Road. Tel: 061 928 0333  
 CREWE Microman, 128 Nantwich Road. Tel: 0270 216014  
 SALE Leigh Computer Systems, 75 Cross Street. Tel: 061 905 2144  
 WARRINGTON Pyramid Micros, Carlo Street. Tel: 0925 25713  
 WARRINGTON Sintek, 1 Tanning Court. Tel: 0925 762613

**CLEVELAND**  
 MIDDLESBOROUGH Briers Computer Services, 1 King Edwards Square. Tel: 0642 242017  
 MIDDLESBOROUGH Silicon Services, Room 308, Broadcasting House, Newport Road. Tel: 0642 226345

**CORNWALL**  
 PENZANCE S W Middlest, 17a Market Jew Street. Tel: 0736 66338  
 ST AUSTELL A & C Computers, 6 Lower Ajmer Square. Tel: 0736 67337

**CUMBRIA**  
 BARRON IN FURNESS C.A.V.E., 48 Cavendish Street. Tel: 0229 29209  
 PENRITH Penrith Communications, 14 Castlegate. Tel: 0768 67146

**DERBYSHIRE**  
 ALFRETON Gordon Harwood, 69-71 High Street. Tel: 0779 836781

**DEVON**  
 PLYMOUTH Daticat Ltd, Daticat House, 45 Weston Park Road, Peverell. Tel: 0752 674435  
 TAVISTOCK Cloud 9 Software, 4 Dolvin Road. Tel: 0822 5737

**DORSET**  
 BOURNEMOUTH Edoncor Ltd, 137 Stewart Road. Tel: 0202 21505  
 PORTLAND Daticat Ltd, 21 Reliance, Easton. Tel: 0305 826532  
 WEYMOUTH MSI, Micro Systems Ltd, 10 Queen Street. Tel: 0305 781878

**DURHAM**  
 CONSETT Deventerode ITEC Gate House Factory, Unit 4, Berridge Road. Tel: 0202 590186

**ESSEX**  
 BASILDON Alders Department Store, Eastgate Centre. Tel: 0268 27858  
 BASILDON Godfreys, 28-30 East Walk. Tel: 0268 289379  
 CHELMSFORD Maxton Hayman, 5 Broomfield Road. Tel: 0245 354599

**GREATER MANCHESTER**  
 MANCHESTER Executive Reprographics & Business Consultants, 2/4 Oxford Road. Tel: 061 228 1637  
 OLDHAM Professional Computer Services, 108-110 Yorkshire Street. Tel: 061 624 4165

**HAMPSHIRE**  
 PORTSMOUTH Linkline (Portsmouth) Ltd, 312 Victory House, Somers Road North. Tel: 0705 863736  
 SOUTHAMPTON Dalvend, 289 Salisbury Road, Totton. Tel: 0703 862425

**HERTFORDSHIRE**  
 BALDULOCK Threshold Electronics Ltd, Icknield Way. Tel: 0462 895994  
 KNEWORTH A P T International, Entech House, London Road, Woolmer Green. Tel: 0438 814827  
 ROYSTON Shep Associates, Long Barn, North End, Meldreth. Tel: 0763 69866  
 WATFORD S R S, Microsystems, 94 The Parade, High Street. Tel: 0923 226602

**HUMBERSIDE**  
 HULL M F Bertram & Sons, 308 Newland Avenue. Tel: 0482 41976  
 HULL P & C Cash Systems, 135 Beverley Road. Tel: 0482 226399

**KENT**  
 CANTERBURY Canterbury Computers, 56/57 Palace Street. Tel: 0227 462101  
 CHATHAM Alders Department Store, 220/240 High Street. Tel: 0634 407377  
 CHATHAM Arrow Computer Services, 42 New Road. Tel: 0634 815781  
 FAINHAM Broomway Computer Centre, 39 High Street. Tel: 0634 378702  
 SITTINGBOURNE Sefelone Ltd, Central House, Centre Avenue. Tel: 0795 776379  
 TENTERDEN MICA Micro Systems, 140 High Street. Tel: 0806 4278

**LANCASHIRE**  
 BLACKBURN Time Computers, Time House, 36 Granville Road. Tel: 0254 53414  
 BLACKPOOL Electronic Services, 176 Victoria Road, West Dingles. Tel: 0253 822708  
 BLACKPOOL Dakin Computers & Office Supplies, 131 Barton Road. Tel: 0253 301743  
 BOLTON ACE Computer Equipment, 27 Victoria Road, Norwich. Tel: 0204 69670  
 BURNLEY Burnley Computer Centre, 27 1/2 Halstead House, St James Road. Tel: 0282 34772  
 PRESTON 4-Mat Computing, 67 Priraigate. Tel: 0772 561952

**LEICESTERSHIRE**  
 HINCKLEY Leigh Computer Systems, 28 Bradgate Road. Tel: 0455 87915  
 LEICESTER Senal Computers, 105 Beigrave Road. Tel: 0533 660740  
 LEICESTER Dimension Computers, 27-29 High Street. Tel: 0533 517479  
 LEICESTER Cavendish CBM, 66 London Road. Tel: 0533 550993  
 OAKHAM Zebra Computer Services, Glaston Road, Uppingham. Tel: 0572 821234

**LINCOLNSHIRE**  
 STAMFORD Orange Business Systems Ltd, 46A High Street. Tel: 0780 57563

**MERSEYSIDE**  
 LIVERPOOL Bits & Bytes Computers, 18 Central Station, Ranelagh Street. Tel: 051 709 4036  
 NEWTON-LE-WILLOWS Source Computers, 4 Cross Lane. Tel: 09252 23049

**MIDDLESEX**  
 HARROW ASC Systems Ltd, Brent House, 214 Kenton Road. Tel: 01 907 8667  
 HARROW Burocar Computer Systems, 211 Kenton Road, Kenton. Tel: 01 907 3636  
 NORTHWOOD Screens Computers, 6 Main Avenue, Moor Park. Tel: 09274 02664  
 TWICKENHAM Productive Computers Ltd, 72 Heath Road. Tel: 01 891 4991  
 UXBROIDGE JMI Computers, 7 Windsor Street. Tel: 0895 51015

**NORFOLK**  
 KINGS LYNN Computer Plus, 40 New Conduit Street. Tel: 0533 774550  
 NORTHWOOD Young Computer Centre, Ashley Rise, Old Carlton Grove Road. Tel: 0663 41982  
 THETFORD Theford Micros, 21 Gaudhall Street. Tel: 0842 91645

**NORTHAMPTONSHIRE**  
 NORTHAMPTON Portasol Ltd, 2 Fulleburn Court, Lumberhubs. Tel: 0664 401765  
 NORTHAMPTON Consigold, 302 Wellington Road. Tel: 0604 230161

**NORTHUMBERLAND**  
 ALNWICK Alnwick Computerware, The Market Place. Tel: 0665 804816

**NOTTINGHAMSHIRE**  
 NOTTINGHAM Dal Computer Services, 2 Birdsall Avenue, Wollaton. Tel: 0602 282200

**sbc is the business computer division of Spectrum Group plc**  
 Hunting Gate, Hitchin, Herts, SG4 0TJ. Tel: 0462 37171.

Prices correct at time of going to press. E. & O.E.



# INTRODUCING The British Designed, British Built, SBC Mistral 286 AT40 WITH POWER TO SPARE

Yes! designed in Cambridge, motherboard built in Bristol, casing and power supply assembly produced in Stourbridge plus final assembly in London. It's as British as we can make it, and the best. The heart of the Mistral is the superb 12" x 12" motherboard running at an incredible 12MHz built at British Aerospace (BAe's) Filton plant using the latest surface mounting technology. It has already been acclaimed as "the 286 board by which others will be judged in the future". sbc is proud to bring you the finest quality and value AT-compatible in the world, and now includes a massive 40 MB hard disk.

Ex VAT  
**£ 1999**  
with Free  
12 month On-Site Maintenance Contract



## Main Features of Mistral 286 AT Series

1. PC AT-compatible
2. 80286 CPU running at 6, 8 or 12MHz
3. 1 MB RAM on board (max 4 MB)
4. 1.2 MB floppy drive
5. 40 MB hard disk
6. Maximum display resolution 1024 x 768
7. Battery back-up real time clock
8. RS232 serial and parallel port
9. 6 expansion slots
10. 80287 maths co-processor socket
11. Motherboard built in the UK by British Aerospace
12. 14" green or amber monitor including swivel and tilt stand
13. MS DOS 3.2 GW-BASIC 3.2
14. Full 12 months on-site warranty.
15. 84 key AT keyboard

### SBC MISTRAL 286 ATC



Featuring the 286 but with the SBC 14" medium resolution colour monitor and CGA compatible colour card.

**£2199.00 Ex VAT**

inc. MS DOS 3.2, GW Base 3.2  
Also available with 30MB Hard Disk  
MONO SYSTEM **£1799** COLOUR SYSTEM **£1999**

### SBC MISTRAL 286 ATE



Featuring the 286 but now coupled with the SBC 14" EGA colour monitor and EGA compatible colour card.

**£2399.00 Ex VAT**

inc. MS DOS 3.2, GW Base 3.2  
EGA SYSTEM **£2199**

## Sensational but True The SBC System M\* Multi-user/Network System

Just take a Mistral 286 AT. Add 3 sbc FD's. Network with our custom designed sbc - NET, and what have you got? The most incredible value, multi-user, intelligent terminal, computer system.



from just  
**£4699.00**

\*Available only from sbc System M authorised Dealers.

## SBC MASTER DEALER NETWORK

- |   |  |   |
|---|--|---|
| <b>OXFORDSHIRE</b><br>BANBURY Alphacore, Little Boulton House, Southam Road Tel: 0295 758202<br>BICESTER ITT Terryphone Ltd., Station Approach, London Road Tel: 0869 244664<br>CHIPPING HORTON Corswood Computers, 6 Middle Row Tel: 1608 4632<br>HEADINGTON Absolute Sound & Video, 18 Old High Street Tel: 0865 60990<br>KIDLINGTON Brookwood Computers, Brookwood House, 8 Banbury Road Tel: 08675 3408<br>TELFORD Business Computer Centre, Unit 2, Padlock Mount Office, Dawley Centre, Dawley Tel: 0952 501754 | <b>TYNE &amp; WEAR</b><br>HETTON-LE-MOLE Carrera Computing, Carrera House, 69 High Street, Eastington Lane Tel: 091 526 7816   | SHEFFIELD West Riding Graphic Supplies Ltd., WRG House, 49 Wellington Street Tel: 0742 701981<br>SHEFFIELD Keydata Systems & Supplies, 50 Portland Avenue, Aston Tel: 0742 872657<br>WHITBY Delta PI Software, 6 Ruswarp Lane Tel: 0947 600065<br>YORK Northern Computers Int. Ltd., Regent House, Lysander Close, North York Trading Estate Tel: 0904 692002   |
| <b>SHROPSHIRE</b><br>TELFORD Business Computer Centre, Unit 2, Padlock Mount Office, Dawley Centre, Dawley Tel: 0952 501754   | <b>WARWICKSHIRE</b><br>LEAMINGTON SPA Veritas Group Services, 38a Regent Street Tel: 0926 30209<br>NUNEATON Microcity, 1a Queens Road Tel: 0263 382049<br>RUGBY Rugby Micro Spares, 30 Oxford Street Tel: 0788 7643  | <b>WALES</b><br>CARMARTHEN Strong Computer Systems, Bryn Cottage Tel: 0262 231246<br>HAVERFORDNEST Business Informal Systems, Swan Square, Bridge Street Tel: 0437 58228<br>MOLD Mold Micro Systems, 8 Deylor Avenue, Bryn-y-Baal, Nr Mold, Clwyd Tel: 0352 56162<br>NEWPORT Gaert Computers, 92 Chestnut Road Tel: 0633 84760<br>WREKHAM Wretham Computers, 24 Abbot Street Tel: 0578 356832   |
| <b>STAFFORDSHIRE</b><br>BURTON ON TRENT Datafield Computers Ltd., 3 Herringbone Road Tel: 0283 44732<br>TAMWORTH Small Business Computer Services, 1st Floor, 81a Broderidge Street Tel: 0827 63549<br>TAMWORTH Micro-Tronics, 27a Market Street Tel: 0827 51480  | <b>WEST MIDLANDS</b><br>BIRMINGHAM Allen James, 831 Stratford Road, Sparkhill Tel: 021 778 5737<br>BIRMINGHAM Asmo Computers, 3 Elmwood Road, Marston Green, Tel: 021 779 6771<br>BIRMINGHAM Mentorium Systems Ltd., 168 Corporation Street Tel: 021 236 3349  | <b>NORTHERN IRELAND</b><br>BELFAST Chevron Computing, 32 Malone Park Tel: 0232 381335<br>LISBURN MKM Electric, 25 Antrim Street Tel: 08462 3184   |
| <b>SUFFOLK</b><br>BURY ST EDMUNDS Harram Computers, 11 Guildhall Street Tel: 0284 705808  | <b>WILTSHIRE</b><br>SWINDON Simcon Associates Ltd., Brunswick House, 38 Dover Street, Old Town, Tel: 0793 619969<br>SWINDON Codepoint Systems Ltd., Dammas House, Dammas Lane Tel: 0793 618130   | <b>SCOTLAND</b><br>ABERDEEN Knight TV & Computers, 108 Rosemount Place Tel: 0224 632626<br>CUMBERNAULD Megabyte Computers, 12 Elrick Square, Town Centre Tel: 0236 738398<br>DUNDEE J. Dave, (Business Computers) Ltd., 173 Brook Street, Broughty Ferry Tel: 0382 77029<br>ELGIN Huber Micros Ltd., 1 East Back Street, Bishopmill Tel: 0343 49944<br>GLASGOW Rufford Kyle, 18 Royal Terrace Tel: 041 332 2505<br>PEEBLES Peoples Micro Systems, 9 Eschiers Tel: 0721 24719<br>PERTH Wics Independent Supplies, 31-33 South Street Tel: 0738 36704 |
| <b>SURREY</b><br>CAMBERLEY Alders Department Store, High Street Tel: 0276 0221<br>CROYDON Alders Department Store, North End Tel: 01 681 2577<br>CROYDON Hi-Voltage, 53-59 High Street Tel: 01 681 3022<br>SUTTON Alders Department Store, High Street Tel: 01 642 8000<br>CATERHAM Wingo Computers Ltd., 22a High Street Tel: 1883 49321   | <b>WORCESTERSHIRE</b><br>MALVERN Wordscope, Coldwell House, Watkyn Road, Tel: 0684 40059<br>WORCESTER Computer Counters Ltd., Unit 95B Blackpole Trading Estate (West), Tel: 0905 58331  | <b>CHANNEL ISLANDS</b><br>GUERNSEY Channel Isle Computer Dist, PO Box 299, St. Peter's Port, Tel: 0481 47968  |
| <b>SUSSEX</b><br>BRIGHTON Games, 71 East Street, Tel: 0273 72681<br>HORSHAM Macmeslin Ltd., Unit 30 Lawson Hunt Ind Est., Broadbridge Heath, Tel: 0403 56276<br>HOVE Business Plan Ltd., 10 The Drive, Tel: 0273 72231  | <b>YORKSHIRE</b><br>BRADFORD Erricks Fotocopic House, Rawson Square Tel: 0274 309266<br>HARNOGATE & M.B. Group, 23 St. Marys Walk, Tel: 0423 63464<br>ROTHERHAM Rotherham Computer Centre, 135 Weigate Tel: 0709 369912<br>SCARBOROUGH Paperstall, Phonekiss, 181/183 Dean Road, Tel: 0723 360606<br>SHEFFIELD Computer Eng. & Support Services, Regency House, 75-77 St. Marys Road Tel: 0742 737303<br>SHEFFIELD Victoria Micros, 2-4 St. Josephs Road, Tel: 0742 540065 |   |

**Bondwell**

**BW-8**

Portable Wonder  
"Very few machines costing even twice as much offer so many facilities in such a small and attractive package - a portable wonder". Which Computer Feb '87.

**NOW FEATURES ADVANCED SUPERTWIST LCD SCREEN**

- True portability, approx 4.5 Kg (10lbs)
- Low-power CMOS components
- 512KB system RAM
- Built-in 3.5" disk drive, double-density 720KB formatted capacity

**£899.00**

Also available  
STANDARD LCD  
SCREEN VERSION  
**£799**

**sbc**

All prices shown are ex VAT

Not all dealers stock every advertised item, please phone before making your journey.

Continental Systems Inc. (CSI), has served one major mission-total dedication to the OEM mass manufacturing and advanced development of quality products for information industries. We are delivering products such as laser printers, personal computers, monitors, terminals and switching power supplies. We offer everything you need in quality, technology, performance, reliability, economy.

CSI presents the Steinic L-2060 laser printer which takes the advantage of the latest laser printer technology to provide you high resolution hardcopy for text and graphics applications. With state-of-the-art design and know-how, the Steinic L-2060 is designed to be compatible with HP LaserJet Plus, yet at a much lower cost to meet OEM customers' requirements. In addition to the full features of HP LaserJet Plus, the Steinic L-2060 laser printer also enhanced the function of HP LaserJet Plus.

# FOR OEM BUSINESS



**Continental**  
SYSTEMS INC.

10F, 604 MIN SHENG E. ROAD, TAIPEI, TAIWAN, R.O.C.  
TEL: (2)715 5300 FAX: (2)715-0722  
U.S.A. LIAISON OFFICE  
401 CHARCOT AVE. SAN JOSE, CA 95131 U.S.A.  
TEL: (408)922-0528 FAX: (408)922-0176

## Steinic L-2060 Laser Printer

### ■ Special features:

- HP LaserJet Plus emulation
- Light-weight laser engine
- 1.5 Mbyte RAM on controller board
- Advanced 300 dpi full page bit-map graphics
- Vector graphics capability
- Faster download raster graphics
- More user-friendly utility
- Face-up or Face-down Paper output
- Second paper tray option

# AppleCentre Chiswick

## Learn the Easy Way

If what you see isn't what you get . . . .  
The answer is training.

Course	Duration (In Days)	Cost	Dates for September
Intro. to The Macintosh	1	£99	7,14,21,28
Microsoft Word	1	£99	1,8,15,22
Excel	2	£198	2/3,16/17
Omnis	2	£198	9/10, 23/24
Pagemaker	1	£99	4,11
Illustrator	1	£99	9,18,
Professional D.T.P	2	£198	10/11, 29/30

### NOTE

For these courses more advanced training is not scheduled but is available by special arrangement.

Both Apple and IBM versions of Pagemaker are available on DTP courses.

All course are run in our specially equipped training rooms in the West of London

If you would like more details please write to James McVeigh at the address below.

All prices quoted are per person and VAT must be added.

Course fees cover tuition, course materials and light refreshments and are payable by cheque in advance.

Desktop Publishing Systems available to rent or buy

Authorised Education dealership

## AppleCentre Chiswick

Training Department

118-120 Chiswick High Rd, London W.4. 1PU

Telephone: 01-994 7424 Extn. 14

# TRAINING

**NOW AVAILABLE ON**  
 \* 3 1/2" disks \*  
 (please add 50%)

**ButtonWare, INC.**  
 AUTHORIZED DISTRIBUTOR  
 New Office Box 5786, Phoenix, AZ 85026

# SHAREWARE

★★★ A MARKETING REVOLUTION ★★★

Quality professional software for the Amstrad PC 1512 and other compatibles.  
 Price covers medium, VAT & postage. Documentation on disk where appropriate.



0732 358125

"SINGLE DISKS AS SHOWN. ANY 5 for £25; 10 for £39; 20 for £65"

★ PROGRAM OF THE MONTH ★  
**PC-TYPE+ £15 (counts as 3)**  
 The Ultimate Word Processor

- 100,000+ word **FAULT FINDER** that catches typos and double words
- Works hand-in-hand with PC File; allows you to pull in information from specific fields in PC-File
- Mail merge that works with PC-File databases, and comma delimited (Wordstar) formatted files. Also allows keyboard input.
- Works hand-in-hand with PC-Style, ButtonWare's style checking program. You can style check the document currently in RAM memory
- PC-Label included to simplify label processing
- Work with up to 10 files simultaneously
- Block and column moves and copy, including from one file to another
- Draw boxes and lines - Intersections automatically filled in
- Sort up to 8 levels by column or row; accepts ascending, descending, case sensitive and case insensitive requests
- Line width expandable to 240+ characters
- Whoops key to recover up to 10 "lost" or deleted lines

- Save up to 10 Smart Keys (macros) to eliminate repetitive keystrokes. Allows pausing for keyboard input
- Three levels of help including detailed step-by-step directions
- Search and replace includes optional case sensitivity
- Date and time stamps
- Add, align and sort columns of numbers
- Use any DOS command (like DIR or COPY) without leaving PC-TYPE+
- Up to 12 printer escape code sequences to work with your printer. This allows you to have bold, underlining, italics, etc.
- Column formatting/reformatting. Now includes the ability to have two or more columns per page (newsletter style)
- Customize PC-TYPE+ to fit your individual needs
- Cross hairs that allow you to visually line up columns and rows
- Ability to create backup files and check for duplicate file names
- Character Translation Table provided
- Ability to put a temporary place marker in a file

ACCOUNTS		
22	CashTrac	7.99 Personal finances organised.
26	Retail Point of Sale	7.99 PC-Shell handles stock/sales ledger/invoices at the counter.
21	Time & Money	7.99 The best of our personal finance programs. ok for small business. Does more than just accounts.
1A	<b>FREEWAY UK Sales/Purchases/Payroll</b>	15.00 This software is supported by registration by Freeway in UK. Counts as 3
48	<b>The Front Office V5.1</b>	15.00 Prospecting, Sales Management, Sales Order Processing, Job Costing & Profit Analysis. Needs Hard disk. Counts as 3

COMMUNICATIONS		
419	PC-Dial	5.75 Buttonware comms program
10	Procomm V2.42	7.99 Famous COMMS program
29	Q MODEM	7.99

DATABASES		
5	PC-File III V4.0	7.99 Easy to use database
700	U-Mind	6.99 Generates (GWBasic) programs. A bit like The Last One.
14	Genealogy	7.99 Graphical representation on screen & printer. Program runs alone tutorial needs Basic. Counts as 2.
701	Wampum/ Wampum docs.	11.50 Menu driven dBase III clone. Counts as 2
703	PC-File Plus	11.50 Paint screens, 5 times faster than PC-File. 175+ helps, on screen tutorial, imbed & nest calculations, sophisticated report writer. Works with PC-Type Plus. Easy. Supported by us. Counts as 2
24	Instant Recall	7.99 Unique memory resident free-form database

GAMES (Please note that you need a CGA card. All Amstrads ok)		
800	PC-Chess	7.99 2 games. Graphical simulation.
802	PINBALL	8.99 9 Pinball machines emulated. Fast!
803	Bushido	6.99 As good as most other Martial Arts games
804	Fun Music Programs	6.99 A jukebox of medleys. Needs Basic
807	Games III	8.99 Backgammon/Strategic US War Game (Maps etc.)/Big Rig
801	Games I	8.99 Frogger, Digger, Parotroo, Willy, Rogue, Sowpith
804	Games II	7.99 Golf, American Football, Blackjack, Archery & much more.
53	Adult Trivial/Poker	7.99
65	Games VIII	7.99 Backgammon, Hangman
61	Games VI	7.99 Casino Games; Bandit, Blackjack, Poker, Roulette, Sub-chase, Stock Exchange.
47	Sleuth	7.99 Great detective adventure with graphics.
44	Cavequest	7.99 Graphical adventure. Reminds me of Elite with castles!
52	Games IV	7.99 Mahjong, Backgammon, Spacewar, Flightmare, Dragons.
55	Games V	7.99 Monopoly, Kong, Golf, Striker.
60	Pianoman	7.99 Play music on keyboard, "record" it on disk, play it back!

GRAPHICS		
903	PC-Key-Draw	8.99 CAD/Animation/Graphics/Scale/Rotate/Slides/Text. More facilities than ProDesign & PC-Paint. Represented by us in UK.
900	Dancad 3D	7.99 Drawing, Animation, Wire Frame, Graphs. Needs 640k.
901	Draftsman	7.99 Produces pie, exploded pie, stacked bar, line & scatter charts.
19	PC-Demo	5.75 Produce graphics display screens for presentations

LANGUAGES		
408	Fig-Forth	7.99 Very good implementation
409	Small "C"	7.99 With primer
502	P-Basic / PC-Prof	8.99 GWBasic clone with hands-on Basic tutorial.
410	Xlisp	7.99 Lisp interpreter
501	Mini Asd	7.99 (Now compiled)
503	Pascal Compilers	7.99 One a subset of Turbo (everything but disk I/O); One Tiny Pascal; One Visible Pascal - built in editor/debugger.
63	Lisp	7.99
7	PD-Prolog V1.95c	7.99 Latest version with expert systems demo.
25	Macro Assembler (A86)	7.99 Probably the best 8086 assembler in the world. With debugger. We are the UK agents for this superb product. Version 3.07
59	Expert System	7.99 This one works well and is straightforward to set up. See also PD-Prolog.

WORDPROCESSING		
6	PC-Outline V3.15sw	7.99 Famous memory resident outline processor a la Brainstorm from Brown Bag Software.
16	PC-Style V1.2	5.75 Graphic reports on your writing readability, style, personal tone etc. Works hand-in-hand with PC-Type Plus even while working on a document. Supported by us
3	PC-Write V2.6	7.99 Maths/Foreign chrs. Edit two docs. Brilliant help screens. Memory residency. 300 printers supported (incl. Laserjet). Simple graphics. This is the version prior to that marketed by Sagesoft for £99
8	Galaxy V1.2	7.99 Perhaps the fastest WP in the world. Wordstar keys. Pull down menus.
31	Qwerty Wordprocessor	7.99 Probably the best one for novices. Includes comprehensive hands-on training course.
17	EZ-Spell	5.75 Spell-checker. Works with PC-Write.
18	Fogfin/Tally etc.	5.75 Various programs to analyse text, word counter, indexer etc.
62	Freeword	7.99
36	PC-Type Plus / PC-Label	15.00 Includes 100,000 word "Fault Finder". Checks for misspellings & repeated words on-line. Work on up to 10 files simultaneously. Easy to learn. Mailmerge. Works hand-in-hand with PC-Style & PC-File Plus. Support by us. Counts as 2

NEW PRODUCTS (Please note these include updates).		
20	Statistical Analysis	7.99 SPC-Professional. Beautifully complex graphic output.
68	MS-DOS Tutor	7.99 Tutorial for learning about MS-DOS!
69	DOS Shells	7.99 For those who don't like GEM. Still River, WFU, T-Shell.
70	Biblical Quotations	11.50 Huge database of Biblical quotes. Min. 2 drives.
72	Express Graph	7.99 Very easy to use colour business graphics. Pie, Exploded Pie, Segmented Lines, 3D bars etc. from typed data or imported.
73	Baker's Dozen	7.99 13 useful utilities from Buttonware incl. mini-spreadsheet, calendar, sideways print (large/small), sort text files, redirect printer to disk, snapshot, undelete & more.
74	PC-Board	11.99 Public Domain bulletin board system. Easier to set up than Fido or Opus.
76	Make My Day	7.99 Time Management + Programs suitable for financial calculations for loans, savings etc. Time management includes Appointment calendar, Job scheduler, Expense Accounts plus TIME LOG for solicitors, accountants etc.
78	Automotive Accounts	7.99 Maintain sales ledger & inventory system for car repair (or other small) business. Produce invoices. Twin floppy ONLY!!!
79	Portfolio Maintenance	7.99 PFRQI addresses the problem of "Return on Investment" of shares held.
80	Goal Seeker	7.99 Memory resident, works with Lotus, SuperCalc, Multiplan etc. to enable user to seek end result (goal).
81	Card Games I	7.99 Bridge, Canasta, etc.
82	Curvefit	7.99 Performs least squares curve fit on x, y data. Curves for 25 equations fitted. Equation co-efficients, Correlation co-efficient & Best fit are computed. Predictions for y can be calculated. Imports from Lotus possible.
83	"C" Tutorial	7.99
84	TASM	7.99 Table driven cross-assembler. Set up for 6502, 8048, 8051 but configurable for Z80 etc. (who's volunteering?)
85	Fastype	7.99 At last a decent touch typing course from beginner to advanced under ShareWare.
406	CHASM	7.99 Cheap Assembler. Compiled version of old standby. Retained mainly for the tutorial - otherwise use disk 25. (Now compiled)

Please note that we are authorised representatives for various authors so we get the latest versions first!

EDUCATIONAL		
54	Learn Japanese	7.99
808	South American Trek/Castaway	5.75 Educational adventures from Buttonware.
39	Foreign Languages I	7.99 French, German, Spanish, Italian. Needs Basic.
52	Educate I	8.99 High quality programs incl. Maths, Analogies etc. Needs Basic.
1026	Teachers Grades	7.99 Marking, analysis & reporting.
56	Learn Cantonese	7.99
51	Educate II	8.99 Quality young children's games.

SPREADSHEETS		
600	Turbo-Calc	7.99 20,000 cells, bar graphs (poor). Also features Galaxy-style text-editor.
601	AS-EASY-AS	7.99 Amazing Lotus feel-a-like spreadsheet with numerous facilities, including decent graphics, macros. Has it's own text-editor. No documentation but gives examples.
401	Sideways Print	5.75 Menu driven. Ok for Lotus/ASCII files.
4	PC-CALC V3.0	7.99 Relational spreadsheet. Take data from other spreadsheets or from PC-File Plus databases. Supported by us.
27	Critical Path Management	7.99 IPM Project Management
420	Hard Disk Utilis.	5.75 Includes disk space optimiser, diagnosis etc.
9	Deskmate	6.95 Memory resident clock, calendar, notepad etc.
415	Utilities I	6.99 Many useful utilities but including a super disc-doctor program.
11	Critical Path Management	7.99 PCPM, Gantt charts, 1000 tasks.
422	PC-Tickle	5.75 Reminds you of appointments, has simple maths which allow it to report on expenses or hours utilised at certain activities.
403	Screens Creation	5.75 Set up entry screens for Basic & other programs. This saves worrying about field names & screen editing. Handles data entry. Brilliant!
413	Utilities II	5.75 Undelete/unused/sector editor/partition
421	XD-Extended DOS	5.75 Utility tools from Buttonware.
34	Multi-tasking utilis.	7.99 Dosomatic enables up to 7 programs to run together. Other programs thrown in.
46	PC-Stock	7.99 Graphical analysis of Stocks & Shares.
30	Print Enhancers	7.99 3 programs to get NLQ fonts from non-NLQ printers.
28	File Encryptor	5.75 Secure your data. Prize if you can beat it!
423	Make Menus	5.75 Utilis. to make menus on hard disks.
35	Micro-Cache	5.75 Working copy of a commercial program. Limited features. UK product with full support.
57	Homebase	11.50 Brown Bag's famous competitor to Sidekick. Best with Hard-disk. Counts as 2.
44	Astronomy	11.50 Relational statistics of planets, sun & moons. Counts as 2.

VERTICAL		
418	Estibid	25.00 Estimating & Job Costing package. Counts as 5 disks.
33	Estate Agent	7.99 American but realistic. For residential agencies.
23	PDS*Quote	7.99 Quotation system
12	Surveysoft	7.99 Surveys measurement and calculation program.
66	PC-Till	5.75 Super Point-of-Sale program. Amongst other things it emulates an electronic cash register. Integrates with Sage accounts. British authors can customise. Used by large UK High Street store. US version available. Demo version (full documentation).
67	Supernews	7.99 Well proven newsagency software written by our associates. This version is complete but is limited to 50 customers. On registration this limit is removed.



(For brief reviews and full list send 75p stamps).

Please send cheque/postal order or Access/Visa to:-

Educational & Government orders welcome

**Shareware Marketing, Dept. PCW, 87 High Street, Tonbridge, Kent 0732 358125**

# COMPACT MONEYWARE

For all IBM, PC, XT, AT and Compatibles

## MONEYWARE

## MONEYVALUE

## MONEYMANAGEMENT

MONEYWARE Compacts low priced, high quality PC Business Accounting Software, is simply the best value Business Management System available in the U.K. today. With over 18,000 users, 8 years experience producing Business Software for Micro Computers, a Nationwide network of Dealers and Distributors, and 30 days after sales support – ABSOLUTELY FREE isn't it time your business had Compact Moneyware?



### MONEYWARE

<b>COMPACT DAYBOOK</b> Complete Small Business Book-keeping and Accounting	£89
<b>COMPACT ACCOUNTS</b> Fully Integrated Accounting and Invoicing	£199
<b>COMPACT ACCOUNTS PLUS</b> Integrated Accounts with Order Processing, Stock Control and Invoicing	£249
<b>COMPACT PAYROLL</b> Comprehensive Payroll System	£99
<b>COMPACT NUCLEUS</b> Award Winning Database, Report Writer and Program Generator	£99
<b>COMPACT INTERFACER</b> Transfers Information from Compact to Lotus 123, Wordstar, Supercalc etc.	£89

COMPACT MONEYWARE

# COMPACT

PC BUSINESS SOFTWARE

### FREE DEMONSTRATION DISC

For more information and a free 5¼" Demonstration disc or 16 page colour brochure with beginners guide to accounting, post the coupon today with your Company letterheading.

Name \_\_\_\_\_

Company \_\_\_\_\_

Position \_\_\_\_\_

Address \_\_\_\_\_

Post Code \_\_\_\_\_

Tel. No. \_\_\_\_\_

Computer \_\_\_\_\_

2  
Compact Software Ltd  
Woodside House, Woodside Road  
Eastleigh, Hants SO5 4ET Tel: (0703) 611214 (5 lines)

# MICRO MEDIA Computer Supplies Ltd.

Dept PCW  
 0707 50913 or 0707 52698 Freeport, Rydal Mount, Baker Street  
 Potters Bar, Herts EN6 3BR (NO STAMP REQUIRED)

## SUMMER SALE

Special Offer Prices valid until Sept 19th 1987

### 5 1/4 Micro Media Brand Discs

	10	20	30	50	100
SS/DD	6.99	13.10	18.70	29.50	55.80
DS/40T	8.50	16.00	22.75	35.90	67.60
DS/80T	9.99	18.70	26.35	41.05	76.35
DS/HD for PCAT	24.15	46.25	66.25	105.25	200.10

### 5 1/4 Reversible discs (Flippy's)

Have two write protect notches & index holes. Suitable for single sided drives.

	10.25	19.55	27.15	42.25	78.45
--	-------	-------	-------	-------	-------



All discs supplied are with labels, 5 1/4" write protects, envelopes & hub rings.

Discs purchased direct from one major manufacturer. 100% certified error free - lifetime guarantee.

### 5 1/4 Rainbow Discs come in five colours

	20	50	100	250	500
SS/DD	13.20	30.75	57.10	134.50	252.45
DS/40T	14.35	33.10	60.70	141.45	262.20
DS/80T	15.20	35.20	64.85	148.75	276.00

### 5 1/4 Unbranded Discs

SS/DD	9.65	22.45	41.40	97.10	181.13
DS/40T	10.95	25.00	45.55	105.25	193.20
DS/80T	11.85	26.73	49.55	116.45	216.20

### 3 1/2 Micro Media Brand

SS/DD	19.99	38.40	55.50	87.25	163.90
DS/DD	21.99	42.55	61.60	96.90	182.30

PRICES INCLUDE V.A.T.



### 3 1/2 Unbranded Discs

	10	30	50	100	150
SS/DD	14.95	42.95	61.50	111.65	164.50
DS/DD	16.70	48.30	78.20	147.20	212.20

## SUMMER SALE · SUMMER SALE · SUMMER SALE · SUMMER SALE · SUMMER SALE

### Monitor Swivel Bases



Pan tilt revolves around 360 degrees. 12.5 degrees tiltable up and down. Adjustable by front mechanism.

55 x 280 x 260mm for 12" Monitors		55 x 355 x 320mm for 14" Monitors	
1	13.25	1	16.70
3+	12.60 ea	3+	15.90 ea
6+	11.95 ea	6+	15.05 ea

### Adjustable Copy Holder

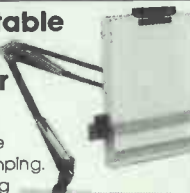

A4 adjustable desk clamping. Magnifying cursor line. Paper thickness adjustment. Paper height adjustable clip. 24.00

**A4 Version**  
Holds up to 300g

**Desk Top Version** 13.69  
Holds up to 1000g

**A3 Version** 42.45  
Holds up to 1400g

### Printer Stand

5mm perspex

**80 Column Version**  
400 x 310 x 100mm 22.80

**132 Column Version**  
600 x 310 x 100mm 28.60



### Mobile Printer Stand

Rugged steel frame. Height adjustable basket for output paper & base shelf for input paper. Self assembly - includes castors.

80 column	£50.00
132 column	£65.00

### The Space Saver



Paper feed and refeed positioned one above the other. Dial controlled paper feed with adjustable deflectors ensures smooth flow and automatic refolding.

80 column		132 column	
414x380x460mm	1	530x380x460mm	1
34.40	34.40	43.00	43.00
3+ 32.10ea	3+ 32.10ea	3+ 40.70ea	3+ 40.70ea
6+ 30.50ea	6+ 30.50ea	6+ 38.65ea	6+ 38.65ea

### Printer Ribbons

	3	6	12
<b>Amstrad 8512/8256</b>	10.35	20.00	37.95
Colours	15.50	31.00	62.10
DMP 2000	10.35	20.00	37.95
<b>Brother M1009</b>	8.10	15.50	28.95
Colours	12.30	24.60	49.20
HR15 MS	10.70	20.70	39.35
Fabric	11.05	21.40	40.70
<b>Canon FW1156/1080</b>	7.95	15.20	28.30
<b>Centronics GLP</b>	8.10	15.50	28.95
Colours	12.30	24.60	49.20
<b>Commodore MPS 802</b>	10.70	20.70	39.35
MPS 801	11.75	22.75	43.45
Colours	14.40	28.80	57.60
MPS 803	8.10	15.50	28.95
Colours	12.30	24.60	49.20
DPS1101 MS	7.25	13.80	25.55
<b>Epson FX/MX/RX 80/85</b>	7.25	13.80	25.55
Colours	13.20	26.40	52.80
LX/GX 80	6.90	13.10	24.15
Colours	12.60	25.20	50.40
MX/FX 105	8.80	16.90	31.75
LQ 800	10.00	19.30	36.60
Juki 6100 MS	7.25	13.80	25.55
<b>Kaga KP810/910</b>	7.95	15.20	28.30
Colours	13.20	26.40	52.80
<b>M/Tally MT80 MS</b>	10.70	20.70	39.35
<b>NEC PC8023</b>	11.75	22.75	43.45
Colours	15.30	30.60	61.20
<b>Panasonic KXP110/1080</b>	10.70	20.70	39.35
Colours	19.35	38.70	77.40
<b>Shinwa CP80 MS</b>	10.70	20.70	39.35

Colours available - Red/Brown/Blue/Green & Yellow

If the ribbon you require is not listed please let us quote

The above is a small selection of the 250 different ribbons we stock. We shall be pleased to find your ribbon, however old or obscure.

### MD 120

1	12.55	5 1/4" x 120
3+	11.90 each	
6+	11.35 each	



### Wire Printer Stand



stacks print-out in document tray automatically. Suitable for most standard printers. Made of safety coated steel wire. For 80 column £14.80 For 132 column £16.60

### MD 50

1	7.80	5 1/4" x 50
3+	7.40 each	
6+	7.10 each	



### MD 100

1	10.80	5 1/4" x 100
3+	10.30 each	
6+	9.80 each	

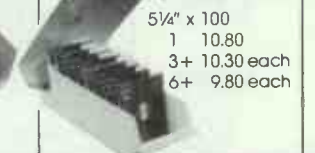

### MM 40

1	8.30	3 1/2" x 40
3+	7.90 each	
6+	7.50 each	

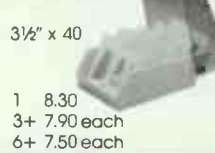

### MM 80

1	10.95	3 1/2" x 80
3+	10.40 each	
6+	9.90 each	



### Computer Labels

Continuous fanfold, sprocket fed. Price per 1,000 3,000

70 x 36	4.80	13.20
89 x 36	4.90	13.50
89 x 49	6.80	18.30
102 x 36	5.20	14.40

Please state no. of labels across the sheet (1, 2 or 3)

### Computer paper

Plain fanfold, micro perf edges

Size	Weight 1000s gm	per box	Price per box 1 box	3 boxes +
11x9 1/2	60	2	16.50	46.80
	80	2	20.40	56.10
Exact A4				
11 1/2 x 9 1/4	70	2	27.60	73.50
	90	1	17.40	43.80

A4 Fixed tractor paper available

ALL PRICES INCLUSIVE OF POSTAGE & PACKING AND V.A.T.

## MICRO MEDIA

Computer Supplies

Freeport, Rydal Mount, Baker Street, Potters Bar, Herts. EN6 3BR



Access & Visa



Out of Office Hours  
**0707 52698**

Orders despatched 24 hrs.

Please allow 5 days for delivery.

For next day delivery, please ring for details. Postage covers U.K. only.

A Catalogue is available with a more comprehensive range of products including - 3M & Verbatim discs - a wider choice of paper labels, ribbons and accessories.

Ring or write to obtain your copy now!

Educational and HMG orders accepted. For official orders/invoice/credit orders there is a minimum order value of £15.00 excluding V.A.T. Any order under £15.00 will be subject to £3.00 handling charge.

Personal callers welcome  
 Weekdays 8.30am - 5.30pm  
 Saturdays 10.00am - 4.00pm

## ATTENTION OVERSEAS COMPANIES!

WHERE ARE YOU IN THE WORLD?  
WE WOULD LIKE TO MEET YOU  
WE ARE AT STAND 1217



PST (TRADING) LTD, A SUBSIDIARY OF PST (HOLDINGS) PLC, IS AN INTERNATIONAL TRADING COMPANY OPERATING FROM A 22,000 SQUARE FEET OFFICE/WAREHOUSE COMPLEX STRATEGICALLY SITUATED NEAR THE M25 LONDON ORBITAL MOTORWAY.

PST (TRADING) LTD IS PROBABLY THE LARGEST EXPORT TRADING COMPANY IN EUROPE SPECIALISING IN THE EXPORT OF COMPUTER HARDWARE - WE REACH THE PARTS OTHER EXPORT COMPANIES CANNOT REACH.

WE HAVE AN EDGE OVER MOST OTHER COMPANIES BECAUSE OUR LARGE BUYING POWER ALLOWS US TO PURCHASE HUGE QUANTITIES OF SURPLUS AND DISCONTINUED COMPUTER HARDWARE AND TO DISTRIBUTE THESE STOCKS ON A WORLDWIDE BASIS.

DURING 1986 PST (TRADING) LTD SOLD OVER 100,000 SINCLAIR COMPUTERS AND AROUND 120,000 PRINTERS. NOW, AT THE PCW EXHIBITION, WE WILL BE OFFERING SOME "PCW SHOW SPECIALS" (COMPUTERS, PRINTERS, MONITORS AND OTHER COMPUTER HARDWARE) AT VERY LOW PRICES.



PCW  
Show

### INVITATION

To visit our spacious stand.  
Enjoy our Hospitality,  
talk to the experts  
and discuss your requirements.  
You are very welcome.



STAND No: 1217

## COME AND MEET US!

WE SPECIALISE AT PRESENT IN FOUR MARKET AREAS

- COMPUTER HARDWARE AND RELATED EQUIPMENT
- CONSUMER HARDWARE AND ELECTRONICS
- PHOTOGRAPHIC HARDWARE AND SOFTWARE
- PHOTOCOPIERS AND FAX MACHINES



TEL: 44 (0) 6284 6911 (25 LINES)

FAX: 44 (0) 6284 73451

TLX: 849898 PST-G

# Choose Walters and you're in business

## £990

### WALTERS AT

Standard model. Price includes:-

- CPU 80286/clock speed 6 MHz/8 MHz switchable
- 8-slot motherboard
- 640k memory on board
- 1.2 mbytes floppy disk
- floppy disk controller
- keyboard
- clock/calendar
- mono monitor
- high resolution mono and parallel printer card

Spec as above with 20 mbytes Winchester **£1375**

Spec as above with 40 mbytes Winchester **£1720**

Spec as above with 80 mbytes Winchester **£2190**



## £1060

### WALTERS BABY AT

Small footprint model. Price includes:-

- CPU 80286/clock speed 6 MHz/8 MHz switchable
- 8-slot motherboard
- 640k memory on board
  - 1.2 mbytes floppy disk
  - floppy disk controller
  - keyboard
  - clock/calendar
  - mono monitor
  - high resolution mono and parallel printer card

Processor casing measures 17" wide x 16" deep x 6" high

Spec as above with 20 mbytes Winchester **£1445**

Spec as above with 40 mbytes Winchester **£1790**

Spec as above with 80 mbytes Winchester **£2260**



## £1130

### WALTERS PORTABLE AT

Portable. Price includes:-

- CPU 80286/clock speed 6 MHz/8 MHz switchable
- 6-slot motherboard
- 640k memory on board
- 1.2 mbytes floppy disk
- floppy disk controller
- keyboard
- clock/calendar
- 9" integral mono monitor
- high resolution mono and parallel printer card

Spec as left with 20 mbytes Winchester **£1515**

Walters' machines have a 12-month warranty. An optional 2-year on-site maintenance contract is available. MS-DOS with GW-Basic is available for £60.

If you're in business and looking for an AT compatible, you'll want a machine that is not only very competitively priced, but also highly IBM compatible.

You'll be looking for something with the potential to expand and adapt - to add more storage for example, or a colour monitor and high resolution graphics card. Or perhaps you're looking for a machine to fit into a network.

And you'll want to buy from a reliable, well-established company that knows the marketplace.

Then you really should be looking at the Walters International AT range. Ring Walters for further information today or send off the coupon and you could be in business.



**WALTERS INTERNATIONAL**

*THESE ARE JUST SOME OF THE PRODUCTS IN THE WALTERS RANGE. OTHERS INCLUDE A SELECTION OF XT COMPATIBLES AND PORTABLES; A 386 MACHINE; NETWORKING AND MULTI-USER OPTIONS; A VARIETY OF PRINTERS; AND A WIDE CHOICE OF PERIPHERALS AND ADD-ONS.*



I would like to find out more about PC compatibles from Walters International

Name .....

Company .....

Job Title .....

Address .....

Please send to:  
Walters International Ltd., Matrix House, Lincoln Road,  
Cressex Industrial Estate, High Wycombe, Bucks HP12 3RD.  
Tel: (0494) 32751-9. Telex: 838882 MATRIX G. Fax: (0494) 33757 PCW 9/87



# Choose Walters and you're in business

## £399

### WALTERS PC/XT

Standard model. Price includes:-

- CPU 8088/clock speed 4.77 MHz
- 8-slot motherboard
- 256k memory expandable to 640k on board
- 360k floppy disk drive
- floppy disk controller
- keyboard
- mono monitor
- mono card

Spec as above with 20 mbytes Winchester

**£749**

Spec as above with 40 mbytes Winchester

**£1099**

Spec as above with 80 mbytes Winchester

**£1569**



## £505

### WALTERS TURBO

PC/XT WITH HIGH RESOLUTION GRAPHICS

Turbo model. Price includes:-

- CPU 8088/clock speed 4.77 MHz/8 MHz
- 8-slot motherboard
- 256k memory expandable to 640k
- 360k floppy disk drive
- floppy disk controller
- keyboard
- mono monitor
- high resolution mono and parallel printer card

Spec as above with 20 mbytes Winchester

**£855**

Spec as above with 40 mbytes Winchester

**£1205**

Spec as above with 80 mbytes Winchester

**£1675**



## £650

### WALTERS PC/XT PORTABLE

Portable. Price includes:-

- CPU 8088/clock speed 4.77/8 MHz
- 7-slot motherboard
- 256k memory
- 360k floppy disk drive
- floppy disk controller
- keyboard
- 9" integral mono monitor
- high resolution mono and parallel printer card

Spec as left with 20 mbytes Winchester

**£1000**

Walters' machines have a 12-month warranty. An optional 2-year on-site maintenance contract is available.

MS-DOS with GW-Basic is available for £60.

If you're in business and looking for an XT compatible, you'll want a machine that is not only very competitively priced, but also highly IBM compatible.

You'll be looking for something with the potential to expand and the ability to accommodate a wide range of add-ons. Perhaps you'll also be searching for a machine that will fit into a PC network.

And you'll want to buy from a reliable, well-established company that knows the marketplace.

Then you really should be looking at the Walters International PC/XT range. Walters was one of the first manufacturers to sell low-cost IBM clones and is now a market leader.

Ring Walters for further information today or send off the coupon and you could be in business.

THESE ARE JUST SOME OF THE PRODUCTS IN THE WALTERS' RANGE. OTHERS INCLUDE A SELECTION OF AT COMPATIBLES AND PORTABLES; A 386 MACHINE; NETWORKING AND MULTI-USER OPTIONS; A VARIETY OF PRINTERS; AND A WIDE CHOICE OF PERIPHERALS AND ADD-ONS.

## Lotus

1-2-3 Compatible PC



I would like to find out more about PC compatibles from Walters International

Name .....

Company .....

Job Title .....

Address .....

Please send to:

Walters International Ltd., Matrix House, Lincoln Road,  
Cressex Industrial Estate, High Wycombe, Bucks HP12 3RD.

Tel: (0494) 32751-9. Telex: 838882 MATRIX G. Fax: (0494) 33757 PCW 9/87



WALTERS  
INTERNATIONAL

All prices quoted are exclusive of VAT and correct at time of going to press. IBM is the registered trademark of International Business Machines.

Walters International reserve the right to alter specifications without prior notice.

# NEW

## 80386



£4050

Including EGA Monitor

£3625

Including Hi-Res Mono Monitor

- \* 80386 at 16Mhz
- \* 1Mb Ram Expandable 2Mb on board
- \* 40Mb Hard Disk Drive
- \* 1.2 Floppy Disk Drive
- \* Maths Co-processor Socket
- \* 8 Slots
- \* EGA Display Card or Hercules compatible
- \* 14" EGA Monitor or 14" mono monitor
- \* Parallel Printer Port
- \* RS232 Communications Port
- \* Calendar Clock
- \* 200 Watt Power Supply
- \* Enhanced Keyboard with 101 keys
- \* MS-Dos 3.x

## PC, XT, & AT.

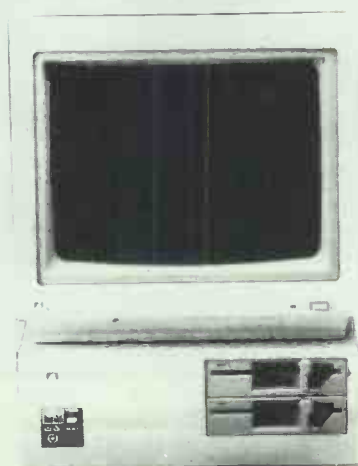

AT—6,8,10Mhz

£1325

2 x 1.2Mb Drives

£1495

20Mb & 1 x 1.2Mb Drives

PC & XT—4.77 & 8Mhz

£595

2 x 360Kb Drives

£995

20Mb & 1 x 360Kb Drives

- \* PC & XT 8088-2 at 4.77 or 8Mhz
- \* AT 80286 at 6,8 or 10Mhz
- \* 640Kb Ram (Expandable to 1Mb on AT)
- \* Maths Co-Processor Socket
- \* 8 Slots
- \* Hercules compatible Monographic Display Card
- \* Parallel Printer Port
- \* RS232 Communications Port
- \* Calendar Clock
- \* 150 watt Power Supply PC & XT
- \* 180 watt Power Supply AT
- \* 14" Tilt & Swivel Monochrome Monitor
- \* Turbo Switch, Activity LED's & Reset on Front Panel
- \* MS-Dos 3.x

## OURS 88

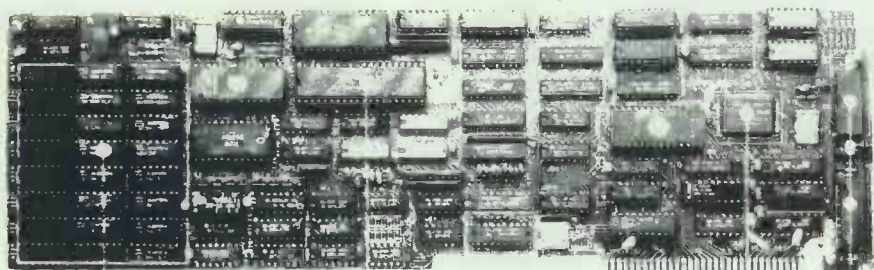

RAM: 256K expandable To 704K

VLSI: Color IC

CPU: CMOS v20 at 6.67MHz

15 PIN D-Type Connection

£616

Complete with Dual Frequency 14" Monitor. Cables & Keyboard.

- \* NEC V20 at 6.67 Mhz
- \* 256Kb Ram expandable to 740Kb
- \* Parallel Printer Port
- \* RS232 Communication's Port
- \* Disk and Peripheral Sharing
- \* File Lock Protection
- \* Cabling to Maximum Length of 200ft.
- \* NORTON SI 2.4
- \* Requires MS-Dos 3.x

The OURS88 Expansion Card is a breakthrough in PC/AT Technology, offering significant saving when compared with additional PC's or Networked Work Stations. Utilising a Single Slot to perform the Network function of a full Computer it provides convenient operation of both data and any combination of peripherals.

# Barbatan Limited

35-38 High Street, Bristol. BS1 2AW  
 Telephone: Bristol, (0272) 213928  
 Fax (0272) 213541

All prices quoted exclude VAT

**DEALER ENQUIRIES INVITED**

tra memory  
tra expandability  
tra flexibility

buffer

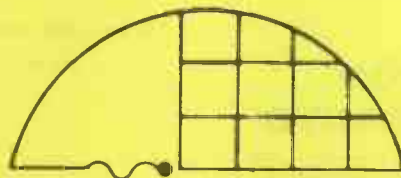

## control systems

USER UPGRADEABLE TO  
4096K MEMORY  
4 FULLY ACTIVE INTERFACES  
COMPATIBLE WITH ALL  
MICRO-COMPUTER SYSTEMS

SIMPLE TO USE BUT  
POWERFUL CAPABILITIES  
ERGONOMICAL DESIGN  
FOR DESK TOP  
CONVENIENCE

Micro Control Systems' X buffer allows users to connect previously incompatible hardware through its unique combination of 'crossover' Serial and Parallel switching interface and expandable memory capacity.

Thanks to its four interfaces – 2 input, 2 output – X buffer can be operated in several modes.

- 1 computer can use 2 printers/plotters.
- 2 computers share 1 printer/plotter.
- 2 independent 1-in/1-out buffers.
- 2-in/2-out crossover.

Data input can be redirected and can be used, for example, to send data to one output and a copy to another or, if a printer malfunctions, to direct output to the other. The COPY switch can be set to produce up to 255 copies, while the BYPASS switch

allows direct transmission to a printer or plotter, bypassing the buffer. Pressing the RESET button aborts any printout taking place but retains data held by the buffer. An added benefit is a 'Soft Mode' option which allows the computer to override the X buffer switch's instructions.

X buffer is user upgradeable to allow it to grow as an application demands. Simply by adding plug-in memory modules it is possible to equip the X buffer with a massive 4096K of usable memory at a fraction of the cost of other alternatives.

**FREEPOST SANDIACRE NOTTINGHAM NG10 5BR**  
0652 391 204

Name \_\_\_\_\_  
Position \_\_\_\_\_  
Company \_\_\_\_\_  
Address \_\_\_\_\_  
Phone \_\_\_\_\_

# DAMSON COMPUTING

## IBM COMPATIBLE ON SITE MAINTENANCE CONTRACT

**SANYO**

**SBC**

**AMSTRAD**

**BONDWELL**

## EPSON JUKI CANON CITIZEN PANASONIC SANYO

Please contact DAMSON for competitive prices on ribbons. Please do ask for the best possible price at any time. Please add £9.00+VAT per heavy item for parcel post (UK) delivery and £2.00+VAT per item for ribbon and disk boxes. DAMSON COMPUTING advise, supply, install, maintain complete systems tailor made to customer specifications. All prices exclude VAT, are rounded to the nearest pound and are subject to change without notice. Export and quantity enquiries welcome.  
DAMSON COMPUTING (MAIL ORDER), 6 RAYS ROAD, EDMONTON, LONDON N18 2NX. (CALLERS BY APPOINTMENT). EASY TO REMEMBER ADDRESS. P.O. BOX 100, LONDON N18, U.K. TELEPHONE: 01-803 7074 and 01-807 7577. TELEX 8950511 ONEONE G. PLEASE QUOTE TELEX BOX NO. 14514001.

IF YOU USE THIS  
YOU NEED  
FIRSTCADD FROM  
ROBOTECHNIC



FirstCADD at only £49,95 plus vat a full-featured 2-dimensional draughting and design package which runs on AMSTRAD, IBM and ATARI PC's

Create flow-charts, organisation charts, graphs, presentations, forms etc. We make it a snap to combine words and pictures

Draw floor plans elevations, product drawings and alterations. Change your mind without having to start a whole new drawing

Our manual is clear, concise and a joy to read

Draw your own conclusions call for a free fact sheet  
now .....01-499-9746



Robotechnic Limited, 19 Queen Street, Mayfair, London W1X 7PJ.  
Telephone No: 01-499-9746, Fax No: 01-499-0743, Telex No: 269914 ROBTEC

All Trade Marks Acknowledged

## MODEMS FOR THE PROFESSIONAL

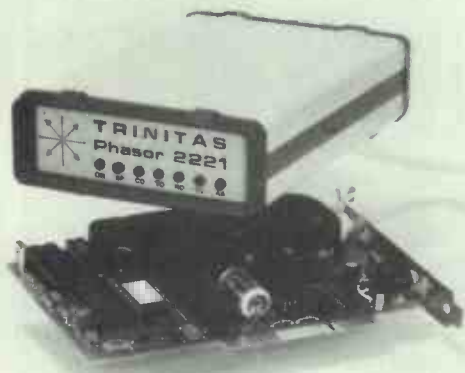

**BABT APPROVED**

Standard features of The Phasor 2221 and PCM 2221 Modems:

- ★ Speed Seeking (Answer and Dial)
- ★ Speed Buffering
- ★ Compact and Reliable
- ★ Built in logon macros
- ★ Low Power Requirement
- ★ Self Test Facility
- ★ Passworded Auto Answer
- ★ Battery Backup for Registers, Macros and Number Store
- ★ CCITT 1200 Full Duplex (V22)
- ★ CCITT 300 Full Duplex (V21)
- ★ BELL 103 (Originate only)
- ★ Intelligent
- ★ Truly HAYES Compatible
- ★ Auto Dial (Pulse and Tone)
- ★ Auto Answer (Multiple Modes)
- ★ Internal Phone Number Store with Dial by Name Feature

**PRICE: £295 + VAT**

Contact: TRINITAS LTD., 2-10 Camden Road,  
Ipswich, Suffolk IP3 8JW. Tel: (0473) 721006  
Gold Mailbox 72: MAG30969

Telex: 265871 MONREF G quoting 72: MAG3096

HAYES IS A TRADEMARK OF THE HAYES CORPORATION

## ★ MEMOTECH MTX 512 ★

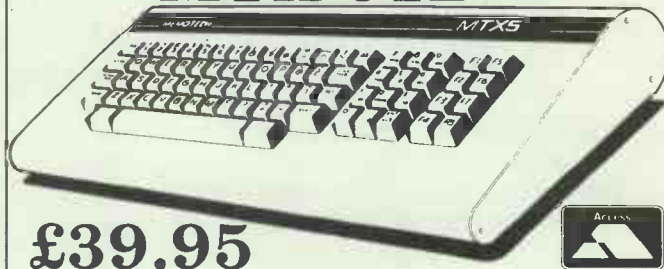

**£39.95**

Plus £3.05 postage (total £43)

- ★ 64K User Ram ★
- ★ Z80 Processor ★
- ★ 3 Channel Sound ★
- ★ 16 Colours ★
- ★ Extensive Software ★
- ★ CP/M 2.2 Adaptable ★
- ★ Fully Guaranteed ★

☆☆☆☆☆☆☆☆☆☆☆☆☆☆☆☆

Further details/orders to:

**UK HOME COMPUTERS**  
82 Churchward Avenue, Swindon, Wilts SN2 1NH  
Tel: 0793 695034

# J. & M. Computers

Eight Acres, Maldon Road, Wickham Bishops,  
Witham, Essex. Tel: Maldon (0621) 892701

**ITT EXTRA PC's** 256K (Exp to 640k)  
Single or twin half height floppy drives also available with half height 10Mb drive in place of one floppy green screen plus IBM style keyboard with software included IBM compatible **£400 to £500**

## PRINTERS

Centronics Print Station 351/DOT Matrix Used **£250**  
Centronics 700-701/Dot Matrix (new & used) **£250**  
Qume 57/45/Daisywheel (new & used) **£250**  
Epson series 900 dot matrix/serial **£120**

## MONITORS/WORD PROCESSORS

ITT Cifer 3214/Screen + Keyboard (new) **£50**  
Qume QVT 103/Screen + Keyboard/Full Edit RS232 **£120**  
Lee Data Colour Screen plus Keyboard, phone for details.

## SPECIAL OFFERS

ITT 3342/Swift ITT 3341/Swallow  
ITT 9420/Controller  
Rodime RO203 or RO204E/Hard drives/Good price  
Many floppy drives available.  
Calcomp 81 Flat Bed Plotter.  
LA Dec Writers  
Computer Tables **£30**

## HARD DISK DRIVERS PC XT & COMPATIBLES

Rose 201W2 half height 20Mb internal kit, Seagate ST225 complete with western digital control card and cables **£280**  
Rose 30HS full height, high speed 30Mb kit, Seagate ST4038 complete with W/D controller **£500**  
Rose 401WD half height 40MHz internal kit, Seagate ST251 complete with W/D **£420**

## KITS ATN COMPATIBLE

Rose 201WA2 half height 20Mb kit, Seagate ST225 **£320**  
Rose 30H WA2 full height high speed 30Mb kit, Seagate ST4038 **£550**  
Western digital Winchester and floppy controller included.  
Rose 401WA2 half height high speed 40Mb kit, Seagate ST251 software **£500**  
Many other disc drives available and IBM peripherals.

Much more in stock than advertised. Equipment bought and scrap purchased. All equipment add VAT & P&P

For any enquiries contact (0621) 892701

# CARDCHECK LIMITED

The Micro Centre

572 Wilmslow Road, Withington,  
Manchester, M20 9DB

## COMPUTERS

TANDON  
PCX20 ..... **£895.00**  
PCA20 ..... **£1345.00**  
PCA30 ..... **£1570.00**  
Target 20 and 30 ..... Call

## EGA OPTIONS

For all Tandons add ..... **£300.00**

## KAYPRO

PC Mono ..... **£875.00**  
PC Colour ..... **£995.00**  
PC30 Mono ..... **£1075.00**  
286i C Mono ..... **£1395.00**  
Kaypro 2000 ..... **£1194.00**

## AMSTRAD PC

Amstrad PC range ..... Call

## PC CLONES SUNTEK TURBO

PC Turbo DD ..... **£640.00**  
XT Turbo 20Mb ..... **£840.00**

## DOT-MATRIX PRINTERS

### CITIZEN

120D ..... **£160.00**  
MSP20 ..... **£335.00**  
HOP45 ..... **£660.00**

### EPSON

LX800 ..... **£235.00**  
LQ800 ..... **£475.00**  
LQ1000 ..... **£635.00**

### STAR

NL10 ..... **£245.00**  
SG 15 ..... **£325.00**

## DAISYWHEEL PRINTERS

Juki 6000 ..... **£165.00**  
Juki 6100 ..... **£286.00**  
Pan. PR 281 ..... **£287.00**  
GPR 2000 ..... **£189.00**

## LASER PRINTERS

Canon LBP-8 MkII ..... **£1795.00**  
Kyocera F-1010 (10PPM) ..... **£2345.00**  
HP Laserjet ..... **£1595.00**  
Centronics PP-8 ..... **£1395.00**  
Epson ..... **£1595.00**

## MONITORS

Philips Mono from ..... **£79.00**  
Call for full Microvitec, Eizo, Kaga and Casper mono colour and EGA range.

## VIDEO CARDS

Mono Hercules compatible ..... **£77.00**  
EGA multi-switches ..... **£225.00**  
Vega Video 7 ..... **£250.00**

## MOUSE DEVICES

Suma Mouse from ..... **£89.00**  
Manager Mouse ..... **£115.00**  
MI-KI Mouse ..... **£60.00**  
Modems ..... Call  
Disk Drives ..... Call

## SOFTWARE

Microsoft Word Junior ..... **£55.00**  
Microsoft Word ..... **£340.00**  
Sidekick (Borland) ..... **£59.00**  
dBASE III Plus ..... **£400.00**  
dBASE II (Amstrad PCW) ..... **£109.00**  
Wordstar 1512 ..... **£55.00**  
Wordstar 2000 Plus ..... **£375.00**  
Supercalc III (Amsoft) ..... **£55.00**  
Sage Accountant Plus ..... **£169.00**

## ACCESSORIES

5.25" DSDD £10 per Box of 10  
3.5" DSDD £25 per Box of 10  
DRAMS, Expansion and I/O Cards,  
Cables, Listing Paper and Ribbons in  
STOCK.

Our highly qualified Technical Staff will offer you full technical advice and support.

Export enquiries welcome  Visa and Access Welcome

All prices exclusive of VAT. Nominal P&P charge.

Prices subject to change without notice

Contact Sales Department (061) 448 1080

# PC MACRO ASSEMBLER

Why pay inflated prices for  
standard packages ?

PROGRAMMING  
ENVIRONMENT

**£30**

FULL 8086 IMPLEMENTATION  
BEGINNERS 8086 TUTORIAL!  
USES MSDOS LINKER  
SOURCE CODE ANIMATOR  
INTERACTIVE EDITOR  
SINGLE KEY EDIT ASSEMBLE  
LINK RUN

FOR IBM PC AND COMPATIBLES

Send SAE for details or order now

Name .....

Address .....

.....Postcode.....

**£30 all inclusive**

Description Quantity Amount

PC Macro Assembler

Total

COMMODITY SOFTWARE  
35 RUSHWORTH ST., LONDON SE1 0RD  
TEL: 01-221 3820



LOW COST DESKTOP PUBLISHER

**£57.50 inc. VAT**  
**+ £2.50 pp**

**ICAMS** GB LTD.  
**SOFTWARE**

Southbank Technopark, 90, London Road, London SE1 6LN

Telephone: 01-922 8834

Cheques or postal orders

# ARE YOU A SKINFLINT-RATBAG?

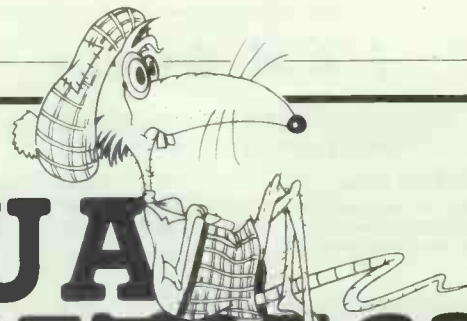

## Davis Transview

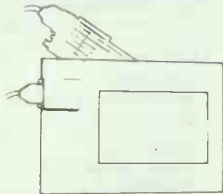

Penet for training and demonstrating environments. Fits onto an overhead projector with internal card for PC. Enables projection of software. Has good grey scale for translation of colour graphics. Norwegian product, built to military specification. Includes two annual service visits on BP&W price only.

SFRB-1499.00 BP&W-1699.00

## Graduate 'Shoebox'

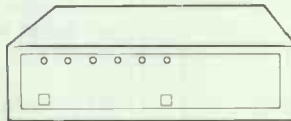

Easy to use 4 User Multi-user System. Ideal for upgrading your existing PCs to a Multi-user Network. No software knowledge required. Options: Tape back-up, Higher disk capacity. Includes Hot Line Support for one year. Further details on request.

SFRB-SORRY! BP&W-3750.00

## Diconix 150

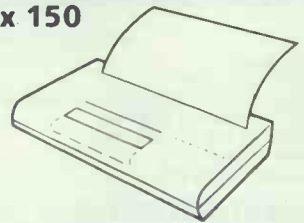

Portable, battery/mains printer - fits into a briefcase! IBM, Proprinter and Epson FX printer emulation. Centronics interface 150cps or NLQ, built-in italics. Enlarged, condensed and proportional print styles and user control switching between elite and script. Easy change ink jet cartridge.

SFRB-325.00 BP&W-380.00

## T3100



Toshiba 10mb Portable. 80286 processor 8Mhz turbo 640k ram (extendable to 2.6mb) 10mb H/D 720k 3.5 Drive 80 Chars 25 line Gas Plasma display IBM Compatible 81 keys Weighs 15lbs Dimensions = 12.2" by 31" by 14.8" MS DOS.

SFRB-2300.00 BP&W-2505.00

## T1100 plus

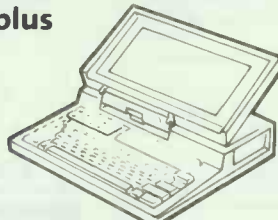

Portable Toshiba. 80C86 processor 716/4.77 turbo 256k ram. 2 by 720k 3.5" Drives 80 chars. 25 line LCD 81 keys. Up to 8 hour rechargeable battery (or mains) IBM compatible. Weighs 10lbs Dimensions = 12.2" by 2.6" by 12" MS DOS.

SFRB-1250.00 BP&W-1375.00

## Centronics PP8 Laser Printer

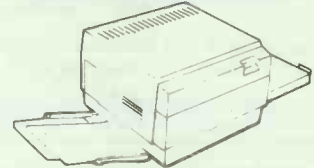

A4-B4 cut sheet. Can print envelopes, labels, transparencies and card stock. Switch selectable 8 pages per minute. True letter quality 256k up to 1.5mb for Bit Map graphics. Courier font as standard, optional font and character set cards. Automatic paper feed.

SFRB-1595.00 BP&W-1750.00

## PC

Small Footprint. Twin Floppy, 4.77/8Mhz turbo 512k ram. Hi-Res Mono Monitor. Hercules compatible card. Legal Bios. AT Style keyboard. (RS 232 port, real time clock).

SFRB-465.00 BP&W-525.00

## Hard Disks

20mb including controller and cables

40mb including controller and cables.

SFRB-295.00

SFRB-599.00

### SFRB = SKINFLINT-RATBAG PRICE

For 'know-alls' who just want the product sent mail order 'cause you know-it-all! No maintenance! Seven days to return to base for your product money back if you don't like it! Back to base at your cost for warranty.

### BP&W = BAG PIPES AND WHISTLES PRICE

Delivered to your door by our National maintenance company. One year on-site maintenance and warranty. 8 hour response to your call. Product is set up with manufacturer's test program to prove good working order. Seven days to return to base if you don't like it and your money back with no carriage charges.

ALL PRICES EXCLUSIVE OF VAT. CARRIAGE AND DELIVERY: Allow £20.00 for items 4, 5, 8, 1, 3 and 6. Allow £10.00 for item 7.

All order forms must be accompanied by a cheque made payable to Touché CLIENT ACCOUNT and must include VAT, and Carriage where applicable. Allow 28 days delivery.

Touché is a division of Microhire Ltd. IBM is the registered trademark of International Business Machines. MS DOS is the registered trademark of Microsoft. Epson is the registered trademark of Epson Corporation, Japan.

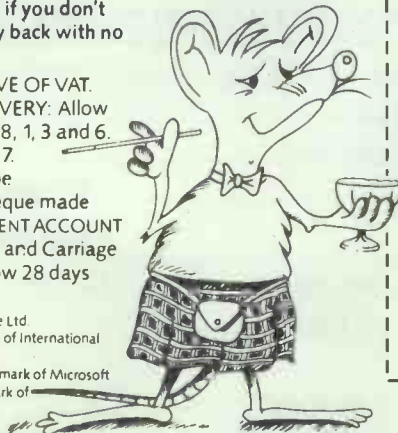

WM 9/87

To: **Touché** 1659 High Street, Knowle, Solihull, W. Midlands. Tel: (05645) 78818.

I enclose a cheque for \_\_\_\_\_ being product price plus carriage and VAT. The cheque is made payable to 'Touché Client Account' with my authority to transfer to Touché monies only for the purchase of product.

1) DAVIS TRANSVIEW SFRB <input type="checkbox"/> BP&W <input type="checkbox"/>	4) T3100 SFRB <input type="checkbox"/> BP&W <input type="checkbox"/>	7) HARD DISKS (Not illustrated) 20mb <input type="checkbox"/> 40mb <input type="checkbox"/>
2) GRADUATE/ SHOEBOX BP&W only <input type="checkbox"/>	5) T1100 PLUS SFRB <input type="checkbox"/> BP&W <input type="checkbox"/>	8) PC (Not illustrated) SFRB <input type="checkbox"/> BP&W <input type="checkbox"/>
3) DICONIX 150 SFRB <input type="checkbox"/> BP&W <input type="checkbox"/>	6) CENTRONICS PP-8 SFRB <input type="checkbox"/> BP&W <input type="checkbox"/>	<b>Touché</b>

Name \_\_\_\_\_

Company \_\_\_\_\_

Address \_\_\_\_\_

Post Code \_\_\_\_\_ Tel \_\_\_\_\_

I allow 28 days for delivery. I may return the goods in good order, at my own cost, within 7 days to the address above and receive my money back.

SIGNED \_\_\_\_\_

# SEGA

## THE ULTIMATE HOME VIDEO ARCADE MACHINE



This is SEGA – the powerful new video games system designed specially for the home and the whole family. It's compact and easy to assemble, and the high technology gives you sharp video images, vibrant colour and realistic sound!



**LOOK  
HOW MUCH  
SEGA GIVES YOU**

With Sega, you get a complete, ready-to-use system. All you need is a TV! The package includes

games console (to run a card or cartridge), a FREE copy of the hit arcade game "Hang On", 2 control pads, a TV aerial fixture to let you watch TV even when the console's still connected as well as a fitted 3-pin plug and a special mystery game built-in and ready for you to find!

**GAMES!  
GAMES! GAMES!**

Sports action, exciting thrillers and great arcade hits - there's a feast of fun covering

256k cards! And Sega has 1 megabyte and huge 2 megabyte cartridges to take the 40 new titles coming your way later this year including smash hits Out Run, Space Harrier and many more.

**SEGA GIVES YOU ALL  
THIS FOR JUST £99.95!**



**LIGHT PHASER**

Take aim and fire at your targets with ease – and stunning realism!

**3-D VISOR GLASSES**

Get more out of your game – More force, more action and more amazing 3-D realism!

# SEGA

*The Ultimate Games  
Machine For Your Home*



# MICRONIX MARVELS

**SMALL FOOTPRINT  
& MARVELOUS PRICES**

## 286 MARVEL – SUPERFAST 10 MHz 'AT' COMPATIBLE TURBO

**1.2 MB FLOPPY  
(READS & WRITES  
360K DISK) AND  
FAST 40MB  
(25mS) HARD DISK  
ONLY £1,599**

**WITH  
20MB HD  
£1,099**



14" MONITOR INCLUDED

MS DOS 3.2 AND GW BASIC 3.2 INCLUDED

■ 80286 – 10 6/10MHz SWITCHABLE ■ 640K RAM (EXPANDABLE TO 1MB ON BOARD) ■ HI-RES MONOGRAPHICS CARD ■ HI-RES 14" MONITOR ■ 'AT' TYPE KEYBOARD ■ 1.2MB HIGH DENSITY FLOPPY ■ SERIAL & PARALLEL PORTS ■ FAST 30MB HARD DISK ■ LEGAL LICENSED BIOS ■ 7 SLOTS ■ REAL TIME CLOCK/BATTERY ■ LICENSED MS DOS 3.2 GW BASIC RELEASE 3.2 AND MANUALS INCLUDED ■ SIZE: 390 x 362 x 153mm

## NEW NEC MULTISPEED LAPTOP PORTABLE

**SUPERFAST 9.5MHz V30**

**LCD SUPERTWIST**

**BATTERY BACKED RAMDISK**

**£1,295**



■ LCD SUPERTWIST SCREEN ENSURES LEGIBILITY IN AVERAGE LIGHT WITHOUT EXCESSIVE BATTERY DRAIN ■ RUNS UP TO SIX HOURS FROM BATTERY ■ SUPERFAST 9.5MHz (SWITCHABLE TO 4.77MHz) V30 SUPERPROCESSOR-NORTON RATING 4.6 ■ PHOENIX BIOS ■ 640K RAM ■ 126K BATTERY BACKED RAMDISK ■ CLOCK/CALENDAR ■ 240V AC ADAPTOR ■ RGB OUTPUT ■ SERIAL & PARALLEL PORTS ■ EXTERNAL FDC PORT ■ 2 x 720K 3.5" FLOPPY ■ MS DOS 3.2 ■ SIZE: 13.6 x 12.4 INCHES ■ 11.2LBS OPTIONS: CAR LIGHTER ADAPTOR, LINK CABLE TO DESKTOP FLOPPY (ALLOWS SOFTWARE TRANSFER BETWEEN 5.25/3.5 INCH FLOPPY), CARRY CASE

## PC MARVEL THE BEST OF 'XT' AND 'AT' IN ONE COMPACT SYSTEM

**PC MARVEL  
TWIN 1.2MB  
FLOPPY  
(READS & WRITES  
360K DISK) £749**

14" MONITOR INCLUDED

MS DOS 3.2 AND GW BASIC INCLUDED

NEC V20 SUPERCHIP INCLUDED



**PC MARVEL 1.2MB  
FLOPPY (READS &  
WRITES 360K DISK),  
20MB HARD DISK  
£999**

**30MB £1,099  
40MB (40mS)  
£1,399**

■ NEC V20 8/4.77MHz SWITCHABLE ■ 8 SLOTS ■ LEGAL LICENSED BIOS ■ CLOCK/CALENDAR & BATTERY ON BOARD ■ 1024K RAM – 640K RAM FOR DOS AND 384K RAMDISK ■ 2 x 1.2MB HIGH DENSITY 'AT' TYPE DRIVES (XT FLOPPY IS ONLY 360K!) OR 1 x 1.2MB FLOPPY AND HARD DISK ■ HI-RES MONO GRAPHICS CARD WITH PRINTER PORT ■ SERIAL RS232 PORT ■ COMPACT SIZE: 390 x 362 x 153mm ■ HI-RES 14" MONITOR ■ AT TYPE KEYBOARD ■ 360K DISKETTES CAN BE READ AND WRITTEN ONTO IN 1.2MB DRIVE AND FILES CAN BE COPIED BETWEEN 1.2MB & 360K DISKETTES AND VICE VERSA (EVEN IBM 'AT' CAN'T MANAGE THAT!) ■ LICENSED MS DOS 3.2 AND GWBASIC RELEASE 3.2 AND MANUALS INCLUDED

## NEW NEC APC IV POWERMATE I 'AT' COMPATIBLE

**20/40MB (40mS) EGA SYSTEM:**

**20MB (40mS) £1,995**

**40MB (40mS) £2,295**

**EGA CARD AS STANDARD  
MULTISYNC CGA/EGA/PGA  
MONITOR AS STANDARD  
40mS HIGH SPEED  
HARD DISK AS STANDARD  
INCLUDES PRINTER CABLE**



■ 80286 8MHz-NORTON RATING 7.7 ■ PHOENIX BIOS ■ 640K RAM ■ CLOCK/CALENDAR ■ EGA CARD: 650 x 350 RESOLUTION-16 COLOUR ■ 14" NEC MULTISYNC CGA/EGA/PGA COLOUR MONITOR ■ ENHANCED 102 KEY KEYBOARD ■ SERIAL & PARALLEL PORTS ■ PRINTER CABLE ■ MS DOS 3.2 ■ 1.2MB 5.25" FLOPPY ■ 20 OR 40MB HIGH SPEED (40mS) HARD DISK ■ 5 x 16BIT AND 1 x 8BIT SLOTS ■ 3.5 FLOPPY SLOT ■ SMALL FOOTPRINT: 16.5" x 16.5"

**micronix**  
computers Ltd

1 Grangeway,  
Kilburn,  
London NW6 2BW  
Tel: 01-625 0295/6/7/8/9 (5 lines)  
Telex: 295173 MICROX G

### Ordering Information:

Prices are exclusive of Carriage & VAT. Please add 15% to Total Cost. Carriage: Systems & Subsystems £20, Drives & Keyboards £8, Boards £5, RAM Chips £1. Monitor/Printer £15.

\* Visit our brand new Showroom – off-street parking, nearest tube Kilburn (Jubilee Line) OPEN MON-FRI: 9.30am-5.30pm. CLOSED FOR LUNCH 1-2pm. CLOSED SATURDAY.

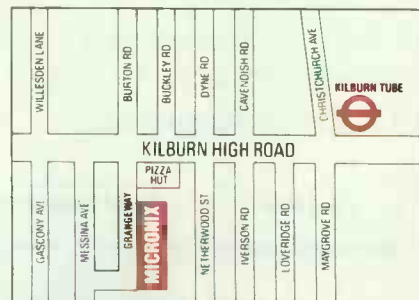



**AMSTRAD PC SPECIAL OFFER**

- 1512 DOUBLE DRIVE, COLOUR, 512K — RRP **£729** Our PRICE **£629**
- 1512 S/DIPE, 20MB NEC HD, COLOUR — **£1,069** **£949**
- RAM UPGRADE TO 640K C26
- NATIONWIDE ON-SITE MAINTENANCE AVAILABLE

**PACKARD BELL VX88 XT COMPATIBLE 30MB SYSTEM WITH 14" MONO MONITOR — £925**

- NEC V40 (MORTON 3.2) 8MHz CPU
- 640K RAM — SOCKET FOR CO-PROCESSOR
- REAL TIME CLOCK, BATTERY & MOTHERBOARD
- HI-RES MONOGRAPHS & COLOUR GRAPHICS (CGA) ON MOTHERBOARD — SWITCH SELECTABLE
- 1 x 360K FLOPPY-FD CONTROLLER ON MOTHERBOARD
- 30MB HARD DISK
- SERIAL & PARALLEL PORT ON MOTHERBOARD
- 84 KEY KEYBOARD
- 14" HI-RES MONO MONITOR
- 4 SLOTS (3 UNOCCUPIED)
- MS DOS 3.2 + GWBASIC 3.2 + MANUALS
- COMPREHENSIVE USER MANUAL

**HARD DISK UPGRADES PC/XT, AT & COMPATIBLES (INTERNAL)**

- 20MB/30MB & CONTROLLER — **£329/£449**
- 40MB & CONTROLLER (40MS ACCESS TIME) PC/XT — **£699**
- 20MB — AT (WITHOUT CONTROLLER) — **£299**
- 32MB — AT (40MS ACCESS TIME) WITHOUT CONTROLLER — **£550**
- **HARD CARDS PC/XT ONLY**
- 30MB BUSDRIVE — **£349**
- 65 MB (40MS) BUSDRIVE — **£899**

**FAST 20MB CASSETTE BACKUP PC/XT, AT & COMPATIBLES**

**£950**  
NOW ONLY **£599**  
LIMITED OFFER



WHY USE SLOW CARTRIDGE BACKUP? CASSETTE NEEDS NO TIME WASTING SERVOWRITING OR FORMATTING. BACKS UP 20MB IN 4 MINUTES! INTELLIGENT MENU DRIVEN SOFTWARE — ONE KEY COMMANDS: FILE BY FILE BACKUP/RESTORE, IMAGE BACKUP/RESTORE, FILE DIRECTORY AND DIAGNOSTICS. SUPPLIED WITH CONTROLLER, CABLE, SOFTWARE AND MANUAL.

**IBM PC/XT COMPATIBLE INTERFACE CARDS**

**MULTI I/O FLOPPY CARD: (SHORT SLOT) £79 PERFECT FOR THE 640K MOTHERBOARD**



- 2 DRIVE FLOPPY DISK CONTROLLER — CABLE SUPPLIED
- 1 x RS232 SERIAL PORT & OPTIONAL 2ND SERIAL PORT (E16)
- PARALLEL PRINTER PORT
- GAMES PORT
- CLOCK/CALENDAR BATTERY
- SOFTWARE SUPPLIED: CLOCK UTILITIES

**MULTI I/O CARD: (SHORT SLOT) £69 PERFECT FOR THE 640K MOTHERBOARD**



- CLOCK/CALENDAR BATTERY
- 1 RS232 SERIAL PORT; 2ND SERIAL PORT OPTION (E16)
- PARALLEL PRINTER PORT
- GAMES PORT — CABLE SUPPLIED
- SOFTWARE SUPPLIED: CLOCK UTILITIES

**MULTIFUNCTION CARD: CT 6050S WITH 8K RAM £99 WITH 384K RAM £149**



- COMPARE SPECS & PRICES BEFORE BUYING OTHER CARDS
- UP TO 512K RAM
- CLOCK/CALENDAR BATTERY
- 1 RS232 SERIAL PORT; 2ND SERIAL PORT OPTION (E16)
- PARALLEL PRINTER PORT
- GAMES PORT — CABLE SUPPLIED
- SOFTWARE SUPPLIED: CLOCK UTILITIES, RAMDISK, PRINTSPDLER

**COLOUR GRAPHICS ADAPTOR WITH PRINTER PORT — £79**

- FULLY COMPATIBLE WITH IBM COLOUR CARD
- 2 VIDEO INTERFACES: RGB COLOUR AND COMPOSITE MONOCHROME (NOT SUITABLE FOR IBM MONOCHROME MONITOR)
- COLOUR GRAPHICS MODE: 320 x 200
- MONOGRAPHS MODE: 640 x 200

**PARADISE ENHANCED GRAPHICS ADAPTOR (EGA) NEW! PARADISE EGA — 480 WITH AUTO SWITCH, UP TO 640x480, UP TO 132 COLUMN DISPLAY — SHORT SLOT**  
COMPATIBLE WITH IBM EGA, IBM COLOUR GRAPHIC ADAPTOR, IBM MONOCHROME ADAPTOR AND HERCULES CARD **£199**  
COMPATIBLE WITH PLANTRONICS COLOUR PLUS CARD  
SUPPORTS MONOCHROME AND COLOUR MODES  
640 x 350 MONO, 720 x 348 MONO, 640 x 350 COLOUR, 640 x 200 COLOUR.  
256K RAM ON BOARD AS STANDARD —

**GENIUS MOUSE (SERIAL) FOR PC/XT/AT £69**

BOTH MICROSOFT & MOUSE SYSTEMS COMPATIBLE



**MONOCHROME GRAPHICS CARD £79 FULLY COMPATIBLE WITH IBM MONOCHROME ADAPTOR & HERCULES GRAPHICS**



- LOTUS/SYMPHONY COMPATIBLE
- TEXT MODE: 80 x 25
- GRAPHICS MODE: 720 x 348
- PARALLEL PRINTER PORT

**UNIVERSAL MEMORY CARD: CT6280 WITH 8K RAM £49 WITH 384K RAM £99 WITH 512K RAM £109**



- UP TO 640K (YES 640K!) RAM ON BOARD
- USE 64K AND/OR 256K CHIPS
- USE 3 BANKS OF 256K CHIPS FOR TOTAL 640K RAM

**RAM CHIPS**

- 64K (9 CHIPS) 150NS **£10**
- 256K (9 CHIPS) 150NS **£20/£30 (120NS)**

**2MB EMS CARD FOR PC/XT/AT £349 FULLY POPULATED WITH 2MB RAM**

THIS CARD CAN GIVE YOUR PC/XT/AT BOTH EXPANDED MEMORY (LOTUS/INTEL/MICROSOFT EXPANDED MEMORY SPECIFICATION) AND THE EXTENDED MEMORY CAPABILITIES UP TO 2MB RAM. MEMORY CAN BE ALLOCATED AS CONVENTIONAL, EXPANDED OR EXTENDED MEMORY

**PC/XT ASYNCHRONOUS SERIAL CARD WITH 1 RS232 PORT — £29**

**PC/XT PARALLEL PRINTER CARD — £29**  
**FLOPPY DISK DRIVE ADAPTOR — £39**

**IBM PC/AT COMPATIBLE INTERFACE CARDS**

**3MB MULTIFUNCTION CARD: MF 3000 WITH 8K RAM £179 FULLY COMPATIBLE WITH IBM AT AND COMPATIBLES ADD £30 PER 256K RAM**



- UP TO 3MB RAM ON BOARD — 1.5MB ON MAIN BOARD AND FURTHER 1.5MB ON PIGGYBACK BOARD
- MEMORY STARTING ADDRESS CONFIGURABLE AT 256K, 512K OR ABOVE 1MB
- 1 RS232 PORT — 2ND PORT OPTION
- PARALLEL PORT • GAMES PORT

**SERIAL-PARALLEL CARD FOR AT: WITH 1 SERIAL/2 SERIAL PORTS: — £69/99**  
**FLOPPY/HARD DISK CONTROLLER FOR AT — £199**

**IBM COMPATIBLE ENHANCED KEYBOARDS — SWITCHABLE FOR PC OR AT £99**



- SEPARATE CURSOR PAD
- FULLY PC/XT & AT COMPATIBLE — SWITCH SELECTABLE
- LED STATUS INDICATORS FOR CAPS & NUMBER LOCK
- 101 KEY

**MONITORS**

**LATEST 14" FLATSCREEN PAPERWHITE MONITOR WITH TILT/SWIVEL £149**



**IBM COMPATIBLE • COMPOSITE MONOCHROME — CONNECTS TO COLOUR GRAPHICS CARD £99**

- IBM COMPATIBLE • 14" AMBER TTL MONITOR DUAL SCAN — **£149**
- IBM COMPATIBLE: 14" MITSUBISHI COLOUR MONITOR — **£249**
- NEC MULTISYNC CGA/EGA/PGA MONITOR — **£499**

**VISA, ACCESS WELCOME**



**Ordering Information:**  
Prices are exclusive of Carriage & VAT. Please add 15% to Total Cost. Carriage: Systems & Subsystems £20, Drives & Keyboards £8, Boards £5, RAM Chips £1, Monitor/Printer £15.  
\*Visit our brand new Showroom — off-street parking, nearest tube Kilburn (Jubilee Line)  
OPEN MON-FRI: 9.30am-5.30pm.  
CLOSED FOR LUNCH 1-2pm.  
CLOSED SATURDAY.



1 Grangeway, Kilburn, London NW6 2BW  
Tel: 01-625 0295/6/7/8/9 (5 lines)  
Telex: 295173 MICROX G



**LCS-8848: 3278/79 TERMINAL EMULATOR PC/XT/AT £549**



- IRMA COMPATIBLE • HOST INTERFACE: PC/XT/AT
- NATIVE MODE COAXIAL CONNECTION TO IBM 3274/76
- 3278 MONO OR 3279 COLOUR EMULATION
- UP TO 3440 CHARACTER DISPLAY, 80 CHARACTER STATUS
- FILE TRANSFER UNDER TSO OR CMS • EAB SUPPORT
- ON BOARD CPU HANDLES 3270 PROTOCOL INDEPENDENTLY
- EASILY SWITCHES BETWEEN PC & 3278 EMULATION MODES
- LIGHT PEN SUPPORT • ASYNCHRONOUS CHARACTER INPUT SUPPORT

**LCS-8261: ACCELERATOR CARD FOR PC/XT £299**



- 8MHz 80286 CPU • 80286/8088 MODE SWITCHABLE
- 8KB HIGH SPEED ZERO WAIT CACHE MEMORY
- SUPPORTS 5 OR 8MHz 80287 COPROCESSOR
- HARDWARE SWITCHABLE 8088 REMAINS IN SYSTEM
- FOR FULL COMPATIBILITY • HARDWARE CACHE DISABLE
- AUTOMATIC CACHE DISABLE DURING SELF TEST FOR COMPATIBILITY WITH MOST BIOSes • SOFTWARE CAN RUN UP TO SEVEN TIMES FASTER
- NO SOFTWARE PATCHES NEEDED • RUNS ALL XT/AT SOFTWARE

**THE BEST BUY PRINTER VP 1814 £199**



COMPARE SPECS AND PRICE OF THIS PRINTER BEFORE YOU BUY ANOTHER MAKE. IDEAL FOR AMSTRAD, IBM COMPATIBLES, BBC, ETC.

- EPSON/IBM COMPATIBLE — SWITCH SELECTABLE
- 180 CPS DRAFT/36 CPS NLQ (DIFFERENT FONTS AVAILABLE)
- BI DIRECTIONAL LOGIC SEEKING
- PROPORTIONAL SPACING
- ADJUSTABLE TRACTOR AND FRICTION FEED

**POWER SUPPLY**



150W FOR PC/XT **£89**



220W FOR AT **£149**

**PRINTERS OUTSTANDING VALUE**

**PANASONIC KXP 1081 PRINTER ONLY £175**  
80 COLUMN 100 CPS/20 CPS NLQ HARDWARE NLQ SWITCH



- PANASONIC KXP 1081: EPSON COMPATIBLE, 80 COLUMN, 100 CPS/20 CPS NLQ SPECIAL OFFER **£175**
- PANASONIC KXP 1092: IBM/EPSON COMPATIBLE, 80 COLUMN, 180 CPS/33 CPS NLQ **£350**
- PANASONIC KXP 1592: IBM/EPSON COMPATIBLE, 136 COLUMN, 180 CPS/36 CPS NLQ **£399**
- PANASONIC KXP 1595: IBM/EPSON COMPATIBLE, 136 COLUMN, 240 CPS/51 CPS NLQ DUAL LF **£549**
- PANASONIC KX3131 DAISY WHEEL — **£275**
- EPSON FX1000 136 COL. 200 CPS/40 NLQ F/T — **£450**
- EPSON SQ2500 INK JET — **£1,099**
- NEC P6: 24 PIN 80 COL. 216 CPS/72 LQ — **£399**
- NEC P7: 24 PIN 136 COL. 216 CPS/72 LQ — **£499**

**IBM PRINTER CABLE £13 (POSTAGE £2)**



• DB25 TO CENTRONICS • SHIELDED CABLE — 3 METRE

- FLOPPY DISK DRIVES 1/2 HEIGHT DS/DD 360K (PC/XT) — **£99**
- 360K FOR IBM AT — **£99**
- 1-2 MB FOR AT — **£129**



# WHAT

# MICRO?

## THE BUSINESS BUYERS GUIDE

### THE NEW AMSTRAD

### Full test of the PC 1640

Wordperfect Executive  
Ansa Paradox 2  
C compilers

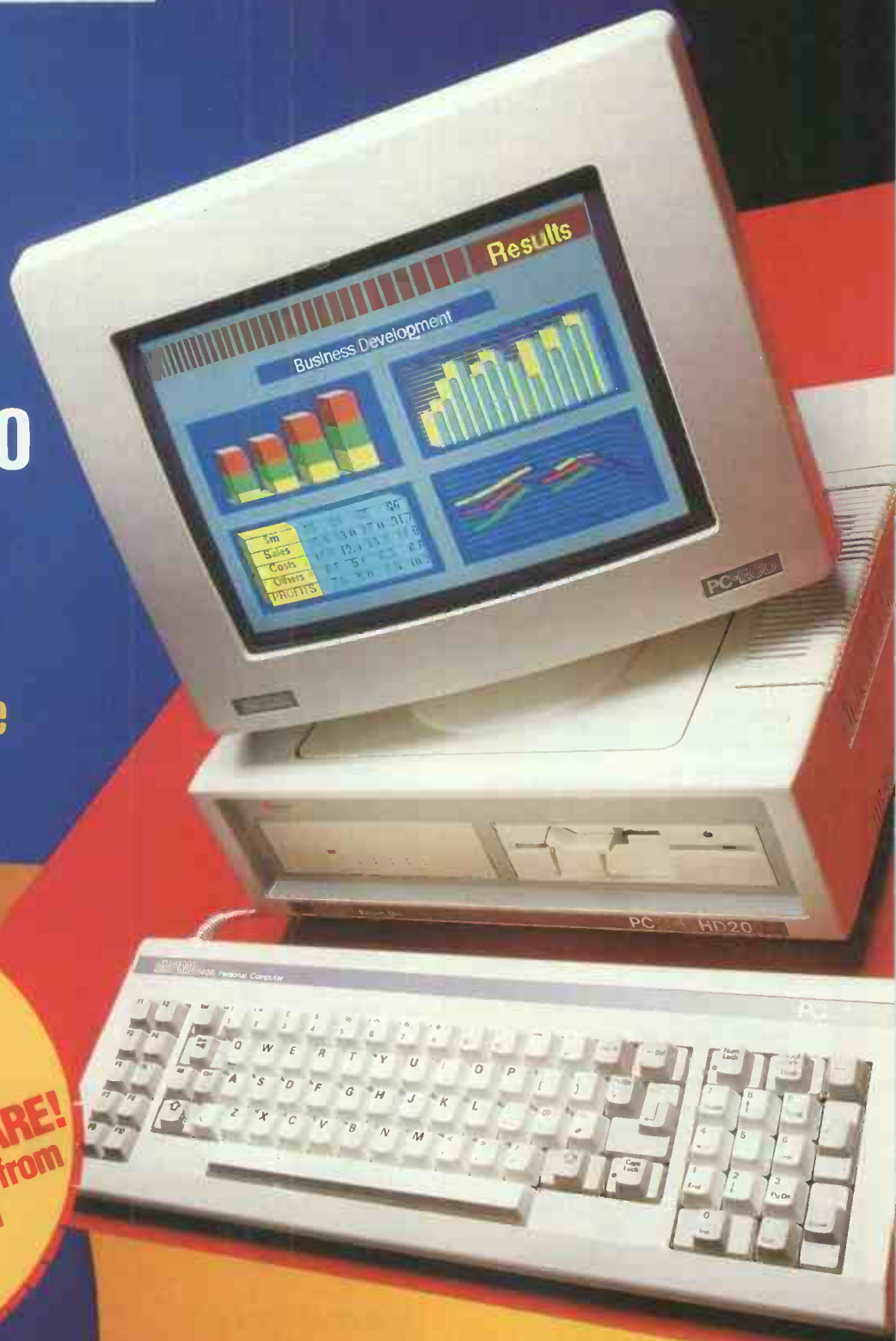

**OUT NOW**  
**WITH FREE SOFTWARE!**  
 The desk accessories from  
**OPEN ACCESS II**  
 and more!  
 At all leading  
 newsagents



## FOR ALL YOUR COMPUTER REQUIREMENTS

### Commodore Amiga 2000 Series

Amiga A 2000 C.P.U.	1095.00
Amiga A 1081 Colour MONITOR	299.00
Amiga A 2010 Internal 3.5in DRIVE	199.00
Amiga A 2052 2mg Ram Expansion	399.00
Amiga A 22860 AT BRIDGE BOARD + 5 1/4" DRIVE	699.00
Amiga A 2058 8mg Ram Expansion	
Amiga A 2090 Hard Disk + Controller	599.00
Amiga A 2092 PC 20mg M.D.A.	599.00

\* COMPLETE RANGE OF SOFTWARE & ACCESSORIES

### Commodore Amiga 500 Series

Amiga A 500 C.P.U	450.00
Amiga A 1081 Colour MONITOR	299.00
Amiga A 1010 EXTERNAL DISK DRIVE	249.00
Amiga A 501 512K Ram Expansion	99.00
Amiga A 521 T.V. Modulator	21.73

\* COMPLETE RANGE OF SOFTWARE & ACCESSORIES

### Commodore P.C. Series

Commodore PC10 CPU/Keyboard MONITOR	699.00
Commodore PC20 CPU/Keyboard MONITOR	999.00
Commodore PC40/20 CPU/Keyboard MONITOR	1599.00
Commodore PC40/40 CPU/Keyboard MONITOR	2541.00

### COMMODORE

Commodore 128D C.P.U/5 1/4 Disk Drive	346.00
Commodore 1901 Colour Monitor	239.00
Commodore MPS100 Dot Matrix Printer	215.00
Commodore 1541C Disk Drive	164.00
Commodore DPS 1101 Daisywheel Printer	170.00

**Commodore 64C + Cassette Recorder + Mouse + Six Games** **164.00 + VAT**

### Psion Organiser

Psion organiser II CM	86.00
Psion organiser II XP	120.00
Psion organiser 128K data pack	147.00
Psion organiser 64K Data pack	69.00
Psion organiser 16K Data pack	30.00
Psion organiser 8K Data pack	17.00
Psion organiser RS232 LINK	41.00
Psion organiser. FORMATTER	39.00

\* ALL ORGANISER SOFTWARE & ACCESSORIES IN STOCK

### Amstrad PC1512 Series

Amstrad PC1512 Single Drive Mono System	435.00
Amstrad PC1512 Single Drive Colour System	599.00
Amstrad PC1512 Dual Drive Mono System	542.00
Amstrad PC1512 Dual Drive Colour System	699.00
Amstrad PC1512 20mg Mono System	860.00
Amstrad PC1512 20mg Colour System	1035.00
Amstrad 8512 Word Processor	470.00
Amstrad 8256 Word Processor	373.00
Amstrad DMP4000 printer	349.00
Amstrad DMP3000 printer	169.00

\* COMPLETE RANGE OF SOFTWARE & ACCESSORIES

Amstrad PC1512 Dual Drive Mono + DMP3000 + Wordstar + Supercalc.

**699.00 + VAT**

### ATARI

Atari 1040ST 1mg Computer + Monitor	520.00
Atari 520ST 1mg computer	210.00
Atari 520ST 1mg computer + drive	260.00
Atari SF314 1mg Disk Drive	173.00
Atari SF354 1mg Disk Drive	129.00
Atari SM125 B/W Monitor	129.00
Atari SC1224 Colour Monitor	346.00
Atari SH204 Hard Drive 20mg	599.00
Mega ST2 with mono Monitor	860.00
Mega ST4 with Mono Monitor	1130.00

\* COMPLETE RANGE OF SOFTWARE & ACCESSORIES

### PRINTERS

Juki 6100 Daisywheel 18CPS	259.00
Micro P MP40 Daisywheel 40CPS	349.00
Micro P MP26 Daisywheel 26CPS	259.00
Micro P MP165 Dot Matrix NLQ. 165CPS	173.00
Citizen LSP10 Dot Matrix	155.00
Star NL10 Dot Matrix	207.00
Epson LX86 Dot Matrix	207.00
Canon PJ1080 Colour Printer	390.00
Canon PW 1080 Dot Matrix	230.00
Q.M.S Lazer Printer	1560.00
Zerox Colour Printer ink jet	1300.00
Panasonic KXP1081 Dot Matrix Printer	155.00

**We stock complete range of software, accessories, floppy disks, printer paper, storage boxes, cables, interfaces ribbons and much more!!!**

**Trade, Export, Educational Enquiries Welcome. All prices are excluding VAT.**

**G&B Computer**  
Electronics

13 Tottenham Court Road  
London W1P 9DP  
Tel: 01-636-9154

**G&B Computer**  
Electronics

At Galaxy  
London W1P 9AD  
Tel: 01-580 3702

**G&B Computer**  
Electronics

AT BUDGET SOUND SYSTEMS  
London W1P 9AD  
Tel: 01-636 6500

# Evesham Micros

All Prices Include VAT & Delivery  
Next Day Delivery £5.00 Extra

## AMSTRAD 1512/1640

ALL PRICES VAT & DELIVERY INCLUSIVE

1640  
IN STOCK  
NOW!

1640ECD single floppy	£ 889.00	STANDARD
1640ECD twin floppy	£ 989.00	AMSTRAD
1640ECD HD 20MEG	£ 1299.00	MODELS
1640ECD HD 32MEG (1 floppy)	£ 1229.00	EVESHAM
1640ECD HD 32MEG (2 floppy)	£ 1329.00	32 & 42
1640ECD HD 42MEG (1 floppy)	£ 1379.00	MEG

### FULL 1512 RANGE INCLUDING THE HIGHLY POPULAR EVESHAM 32/42 MEG 640K SPECIALS

MONO		COLOUR	
SD-MM	£ 479.00	STANDARD SD-CM	£ 649.00
DD-MM	£ 579.00	AMSTRAD DD-CM	£ 759.00
HD20MEG	£ 949.00	MODELS HD 20MEG	£ 1019.00
SD 32MEG	£ 829.00	EVESHAM SD 32MEG	£ 999.00
DD 32MEG	£ 949.00	32 & 42 MEG DD 32MEG	£ 1119.00
SD 42MEG	£ 1029.00	MODELS SD 42MEG	£ 1169.00

All 32 & 42 MEG models are upgraded to 640k (£20.00 extra on standard models). We use top quality MINISCRIBE hard disk units in our conversions (as used by you know who).

### THE AMSTRAD OFFICE

Exciting promotion from Amstrad includes 1512 twin drive mono, DMP 3000 printer, Wordstar and Supercalc.

OUR PRICE... ONLY  
**£729.00 inc**

### THE EVESHAM OFFICE

Includes the Amstrad office as above fitted with a 32MEG hardcard and 640k upgrade. A really useful bundle for only...

**£1089.00 inc**

Gold medal winner!  
Over 100,000 copies sold

## COPY II<sup>®</sup> PC

Protect your Software Investment...

For Amstrad PC and other compatibles

- Back up most protected software! (for personal use)
- Run many popular business programs from your hard disk!
- Verifies disk copies!
- Includes disk drive speed check!
- Fully automatic!

ONLY  
**£34.95**

NEW, "Version 4.01"

Central Point Software's best selling copy program.

Allows many popular programs to run from hard disk without reference to floppy eg.; DBASE LOTUS 123 SYMPHONY etc.

## COPY II Option Board

The 100% effective disk backup method. This half card fits in an expansion slot and will allow you to make backups of ANY, yes ANY disks (excluding protection by physical damage).

- Simple to fit
- Easy to use
- Success guaranteed
- Amstrad instructions
- Works with single or dual floppy systems

Only **£79.95**

PC Magazine "Editor's Choice" award

## PC TOOLS™

The most complete PC utilities program...

For Amstrad PC and other compatibles

- Powerful DOS interface! (will run resident)
- Fast hard disk backup & restore!
- Compress a hard disk!
- Undelete files!
- Unformat a hard disk!
- Over 20 utilities built in!

ONLY  
**£34.95**

Central Point Software's powerful new disk utility.

Combines the best features of Norton/Mace utilities, Fastback and Disk Optimizer into one incredibly powerful and ultra low priced package.

NEW, "Version 3.0"

## UPGRADE YOUR PC

### Miniscribe

32MEG hardcard (YES inc. VAT!)	£ 329.00
32MEG internal kit, Amstrad brackets & fascia FOC	£ 349.00
42MEG as above	£ 499.00

at best prices

Tandon 21MEG business card	£ 279.00
Zucker 2MEG EMS board, FULLY LOADED	£ 299.00
NEC V30	£ 24.95

8087-2 Maths co-processor	£ 159.00
Amstrad Modem Card	£ 158.00
PC1512 640K memory upgrade kit, detailed instructions	£ 19.95
Cipher 1525 tape streamer, for Amstrad PCs only	£ 469.00
Identica 60 MB ext. tape backup, 5MEG per minute, all PCs	£ 729.00
3M DC600 data cartridge suits either of the above	£ 27.50

## DISKS & BOXES

25 bulk packed DS/DD disks with tabs & labels...	£ 13.95
25 disks as above with 50 capacity storage box...	£ 22.95
25 disks as above with 100 capacity storage box...	£ 24.95
50 capacity lockable storage box as offered with disks...	£ 10.95
100 capacity lockable storage box	£ 13.95

Make the right decision  
with a

Star

ALL PRINTER PRICES  
INCLUDE

- VAT
- PRINTER CABLE
- INSURED DELIVERY

printer from Evesham Micros

If you would like a detailed print sample of any model please send S.A.E.

We use and recommend Star printers, they offer the best combination of features, print quality, reliability and value for money.

Star NL-10 New low price (state cartridge type)	£ 219.00
...2 extra ribbons (value £ 13.90) FREE with NL-10 orders...	
Star NX-15 Wide carriage version of NL-10	£ 319.00
Star ND-15 Faster version of NX-15	£ 419.00
Star NR-15 240cps, 60 NLQ wide carriage	£ 499.00
Star NB24-10 Brilliant 24 pin printer 216cps, 72cps NLQ	£ 479.00
Star NB24-15 Wide carriage 24 pin	£ 599.00
Star NB-15 Ultimate 24 pin, 100cps in NLQ!	£ 719.00
Star SF10-D Sheet feeder, all 10" models	£ 59.00
Star SF15-D Sheet feeder for NX, ND & NR15	£ 159.00
Star SF15-B Sheet feeder for NB15 & 24-15	£ 199.00
PANASONIC KXP-1081 Best sub £200.00 model	£ 179.00
Micro P. MP165 Fast & popular	£ 219.00
Micro P. MP200 Very fast printer for the money	£ 299.00
Micro P. MP26 Excellent 26cps d'wheel great value	£ 249.00
Micro P. MP40 Yes a 40cps d'wheel for this price	£ 349.00
Amstrad DMP3160 New version now 160cps	£ 179.00

Other models in stock at competitive prices

**SAVE £££**  
Save hundreds of pounds by buying  
PC Tools. Features the main functions of  
many higher priced programs.

All prices INCLUDE VAT/delivery. Next day delivery £ 5.00 extra

### How to order

# Evesham Micros

Send cheque P.O. or Access Visa details  
By phone with Access Visa no.  
Government, educational & PLC orders welcome  
Same day despatch whenever possible  
Callers welcome, open 5 days 9.30-5.30  
TELEX: 333294 EMICRO

Evesham Micros  
63 Bridge Street  
Evesham  
Worcs. WR11 4SF  
TEL: (0386) 765500



Also at: 1756 Pershore Rd., Cotteridge, Birmingham B30 3BH Tel: 021 458 4564

# CHECK OUR PRICES FIRST

UP TO 40% OFF

AMSTRAD	MONO	COLOUR
PC 1512 Twin Floppy	£515	£669
PC 1512 20mb Hard Disk	£829	£989
<b>LATEST MODELS</b>		
PC 1640 Twin Floppy		£789
PC 1640 20mb Hard Disk		£1059

## SOFTWARE

### AMSTRAD

- Reflex £47
- Wordstar £47
- Supercalc 3x £47
- PC Promise £45
- Sidekick £21
- D. Base II £69

### SAGE

- Accountant £105
- Accountant + £140
- Financial Controller £215
- Payroll £69
- PC Write £69
- PC Planner £69

### OTHERS

- Migent Ability + £115
- PSIAN PC4 £50
- Lifetree Volkswriter De Luxe £29
- Showerings Portex £69
- Minorsoft Fleet Street Editor £75
- ABC All in One £115

### COMPSOFT

- Delta 4 £55
- Delta Graph £45
- Bookworker £104
- Domino £59
- I Up £29

CHECK OUT THE PROFESSIONALS

### R.T.M. SYSTEMS

20-28 BOLD STREET, PRESTON PR1 7NX  
Tel (0772) 58099

Please add VAT—All prices subject to change without notice and goods subject to availability.

**FREE CARRIAGE ON ALL SOFTWARE NEXT DAY DELIVERY £2.50 PER PARCEL**

## OUR PRICES ADD MORE SELLING POWER TO YOUR COMPUTERS

COME WITH US, YOU WILL ALWAYS BE THE LEADER.



### P&C SHITEN ENTERPRISE CO., LTD.

RM 7, 8 FL., NO. 100 ROOSEVELT RD., SEC. 3, TAIPEI, TAIWAN, R.O.C.  
P.O. BOX 30-291 TAIPEI TAIWAN  
TLX: 19206 PC SHITEN  
TEL: (02) 395-1400 FAX: 886-2-3512073

## NORTHWEST COMPUTER SUPPLIES (PCC LTD)

82 School Lane, Didsbury, MANCHESTER M20 0RY  
Tel: 061-434 9747 MicroLink 72:MAG003

### BORLAND/PC DOS SOFTWARE

Turbo Pascal V3 with 8087 & BCD	49	Turbo Basic	49
Turbo Tutor NEW V2	23	Turbo Lightning/Word Wizard	49/37
Turbo Toolboxes		Turbo REFLEX/Reflex WORKSHOP	99/37
Numeric Methods/Database (Isam)	54/37	Prolog/Prolog Toolbox	49/49
Editor/GameWorks/Graphics	37/37	Eureka - The Solver	49
Special - TPas + Any Toolbox + Tutor	105	Sidekick/Trav Sidekick/Superkey	44/49/36
Special - TPas + Tbox + Tutor + Edit + Game + Graph	179	Sidekick and Travelling Sidekick	94
Turbo "C" (Now ex STOCK)	65	IBM format only	
Paradox 2.0 (Ansa)	395	Microsoft RBASE System V (NEW VERS)	412
Javelin	79	Lattice "C" Compiler	199
XEROX Ventura Publisher (IBM vers)	625	Norton Utilities/Commander	47/37
Q & A (512k vers)	245	ADVANCED Norton Utilities/Editor	99/56
DOS 3.1 (most compats)/Dos 3.2	57/72	VP-Planner/VP-Info	59/59
GEM Desktop/Draw plus	39/159	VP-Graphics/VP-Expert NEW	59/69
GEM Collection (Desktop + Write + Paint)	105	GW-Basic (with HERC & Col Graphics)	95
GEM Desktop Publishing	230	Wordstar (NEW vers 4) Professional	239
Microsoft Windows/Project	56/196	Flight Simulator/Jet	35/27
Microsoft Quick GW Basic Compiler	56	Hitchhikers Guide to the Galaxy	18
Microsoft "C" Comp/Macro Assem	239/89	BBC Basic for IBM Compts (SUPERB)	95
Ability/Flying Start	70/45	Other software prices - Call	

### WYSE 386/286 AT COMPUTERS

WYSE 286 AT - (WY-2108-01)		Wyse 20MB hard disc drive	350
Modular design, 8MHz, 80286, 512k		Wyse 40MB hard disc drive	875
1.2MB Flop, keyboard, ser, par	1219	NCS 40 MB hard disc drive	495
WYSE 286 AT - (WY-2112-01)		Wyse EGA display system	869
Modular design, 12.5MHz, 80286, 1MB		Wyse Mono display system (Herc)	369
1.2MB Flop, keyboard, ser, par	1749	PRINCEON EGA display system	595
WYSE 386 AT - (WY-3216-01)		NCS Mono display system (Herc)	195
Modular design, 16MHz, 80386, 1MB		Wyse 700 Hi-Res system (1280x800)	799
1.2MB Flop, keyboard, ser, par	3499	Wyse 30/Wyse 60 Terminals	349/525

### MODEMS etc/MEMORY/MICE/CO-PROCESSORS

Pace Linnet (V21/V23 Buff)	125	Amstrad package (Datatalk + innet)	145
Pace Series 4 1200s (V21/22/23)	289	Crosstalk 3.61	109
WS4000 V21/V23 (V21/23 Buff)	149	Mirror II	79
Siebek Quattro (Ext or Card)	695	DIAL UP Comms (EPAD/Prosteu/Kermit)	89
MEMORY UPGRADES (AMSTRAD/IBM's etc)		8087 5mb/8mb/10mb	125/175/289
128k Amstrad Upgrade (18x64k DRAMS)	29	80287 8mb/10mb	295/295
512k IBM/Olivetti (18x256k DRAMS)	59	MicroSoft Mouse (Serial or Bus)	149
256k Column Static/1MB DRAM	Call	Mouse Systems Mouse	135

### XENIX/UNIX for AT's

Santa Cruz Xenix (System V)		Op System/Dev/Text	166/132/132
Op System/Dev/Text	595/595/195	Complete set as above	399
(all of the above)	1295	Merge-OS (DOS as a UNIX job)	132
Informix SQL/SQL/4GL	1050/1050/1500	Other Unix Hardware	
SCO Lynx (WP system)	595	8 Port Wyse Intelligent Serial Card	695
SCO Professional (Notis lookalike)	795	4 Port Serial Card (AST)	450
MicroSoft Pascal	696	Cypher Tape Streamer Xenix or DOS	1250
MicroPort Unix (System V)			

### LASERS: LaserJet + emul 1745: Diablo/Epson emul 1395

Postage & Packing at COST). Manufacturer's Guarantees. All prices plus VAT at 15% (except EXPORT) Payment with all orders - Please. Mail order only

## WE ARE A HI-TECH OEM MANUFACTURER OF:

- Multi Turbo PC/XT (4.77/8 MHz)
- 80286 (6/10, 6/12MHz) Baby AT System
- 80286 (6/8/10, 12MHz) AT System
- 80386 (16 MHz) System
- Portable PC/XT, PC/AT
- 2.5MB Multifunction Card (25/1P/1Game)
- Serial/Parallel Card for AT
- MGP, CGP (Short Size) Card

CONTACT US TODAY

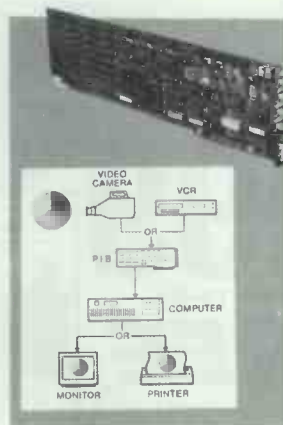

**NEW**

### PHI-EYE GRABBER BOARD

- Specs. ation:
- Resolution 512x256, 512x512 capable of 32K different colors
  - Mixing external picture with internal picture
  - In live mode
  - Real Picture by EGB can be displayed on EGA monitor
  - Grab picture in 1/60 second form standard-NTSC signal source (regular video camera, VCR, etc. or RGR camera)
  - Easy get picture on analog monitor or TV
  - Works on IBM PC/XT/AT/Compatible computer
  - Adapron available for European standard TV

### FON-WUN CO. PHO WEN ELECTRONICS IND. CO., LTD.

No. 41, Sec. 2, Chung Shen Road, Hsin Tien  
TEL: (02)918-3746 918-7873 Telex: 34573 FONWUN Fax: 886 2-915-5533

IBM PC/XT, PC/AT compatible, All kinds of add-on cards and peripherals.

# STRADCOM

The Dataflex Stradcom is a powerful modem and provides a wide range of communication facilities. Small in size but big in performance, this modem fits any IBM PC/AX/AT or compatible micro computers such as the Amstrad PC 1512

- Full Duplex at 1200/1200 and 300/300 baud — with automatic sense of the incoming modem.
- Very simple to install — slide into any spare expansion port.
- Full AT (Hayes compatibility) — guaranteed.
- Auto dial — hold up to 100 telephone numbers.
- Auto re-dial — press one key and Stradcom re-dials automatically.
- DOS gateway — stay on line but reference other systems at the same time.
- Six error detection protocols — communication with security.
- Powerful async software included — handle asynchronous communication services such as Prestel.
- Free registration to easylink — saves you £40 registration fee.

**£199** + VAT

**KKS Electronics**  
Eastern United Trading Estate  
Ruspidge  
Cinderford  
Gloucester  
GL14 3AW  
Telephone 0594 26435  
Reader enquiries welcome

# ASTRACOM + DIALUP

The perfect DATA COMBINATION  
Apart they're POWERFUL  
Together they're UNBEATABLE

## ASTRACOM

The Astracom 1000 is a multi-standard intelligent modem, providing auto-dial, auto-answer and centronics printer controller facilities. It has been designed to be low cost, high performance, and above all, easy to use.

## DIALUP

Dialup is a SIMPLE TO USE yet extremely powerful communications software package. It is designed for the computer enthusiast and the newcomer and can be used for many applications and interests in today's computer orientated world.

It can be used to access popular services such as PRESTEL, Microlink, Micronet or Telecom Gold and electronic mail, file transfer and downloading software.

**£199** + VAT

**Caves**  
77 Wilson Road  
Wyke  
Bradford

Telephone 0274 604230  
Reader enquiries  
welcome

LOOK!

## INTRODUCING THE NEW GPR-2000 DAISYWHEEL PRINTER

AMAZING  
VALUE!



The ideal letter quality printer  
for reports and general  
correspondence.  
Manufactured in Japan.  
Complements all modern PC's

- ★ 18cps printing speed
- ★ 10, 12 & 15 pitch
- ★ Variable line spacing
- ★ 96 char daisywheel
- ★ Interface - parallel standard
- ★ RS232 option
- ★ Qume compatible
- ★ Paper-max 13" wide
- ★ Front panel controls
- ★ Low noise 58dBA
- ★ Bi-directional logic seeking print system
- ★ Supports Wordstar commands
- ★ Tractors & S/Feeder option

THE  
VERY  
LATEST DESIGN  
WITH UP TO  
THE MINUTE  
STYLING

**1 1/2**  
THE  
PRICE  
OF  
SIMILAR  
MODELS

ONLY  
**£199**  
+VAT + P&P  
**Plus FREE**

- ★ 10 & 12 pitch daisywheels
- ★ Spare ribbon cassette
- ★ Dust cover
- ★ Detailed user manual & mains lead
- ★ Interface cable to your computer
- ★ £10 voucher for VOLKSWRITER de Luxe word processor

**NO QUIBBLE — FULL MONEY  
REFUND IF NOT DELIGHTED**

Internationally available ribbons and daisywheels guarantee low running costs.

The GPR - 2000 accepts Qume fabric or film ribbon cassettes

Wide choice of Qume compatible daisywheels

**DATAPLUS**

DATAPLUS (Sales) Ltd.  
PO Box 122, CHELTENHAM, GL51 8QL

TELEPHONE ORDERS **0242 573573** 24 HR

DATAPLUS (Sales) Ltd.  
PO Box 122, CHELTENHAM, GL51 8QL

Please supply \_\_\_\_\_ GPR 2000 Daisywheel printers at £228.85 each incl. VAT. plus £8.50 courier delivery and insurance.

cheque  Access  Visa

Expiry date \_\_\_\_\_

Name \_\_\_\_\_

Address \_\_\_\_\_

Post Code \_\_\_\_\_

Daytime Tel No. \_\_\_\_\_

Reg In England 2080289

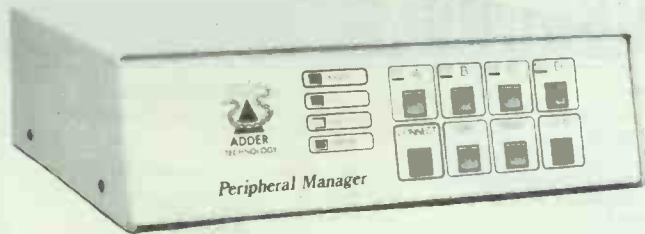

# SIMULTANEOUS Data Transfer Control Between Computers & Peripherals

The **Peripheral Manager** has a 256K Buffer, and will store data for fast transfer between all attached devices.

The unrivalled flexibility of the **Peripheral Manager** is fully programmable.

Ports inter-connect, with manual or software control.

Pause channel controls data into and out from the port.

Printer can give multi copies.

Centronic EPM1 Model  
Four Ports 36 pin female

**£395** + VAT  
carriage paid

Serial/Centronic EPM2 Model  
2 RS232 Serial Ports (25 way female)  
2 Centronics Ports (36 pin female)

**£395** + VAT  
carriage paid

Each **Peripheral Manager** has a comprehensive manual  
Ex-stock for immediate delivery

## HOMESTEAD DATA PRODUCTS LTD

145 EDINBURGH AVENUE, SLOUGH. SL1 4UA  
Fax (0753) 691037 Telex 846086 CABLIN-G

Tel: (0753) 691661

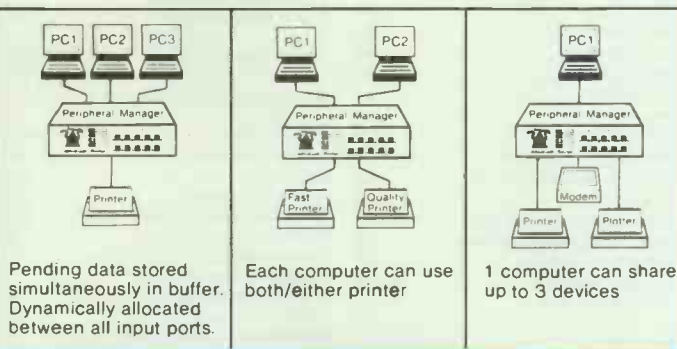

Pending data stored simultaneously in buffer. Dynamically allocated between all input ports.

Each computer can use both/either printer

1 computer can share up to 3 devices



©1987

## S&S £10 SOFTWARE

### SPECIAL OFFER - SEVEN OF OUR BESTSELLERS FOR ONLY £50

- UNDELETE** Lets you recover files that you have accidentally deleted from floppy or hard disc; also works in subdirectories. Works on all versions of DOS. £15 + VAT
- DOSMENU** A menu-driven front end for DOS, lets you choose any application (eg 123 or Word-Star) or DOS command with a single keystroke command from a menu
- FASTHELP\*** You can design your own help screens, which are just a keystroke away, even when running a program. Also has cut-and-paste from one program to another
- QPRINT\*** Lets your printer run while you use your PC for other jobs
- REDIRECT\*** Lets you redirect the printer to a file
- SIDELINE** Prints your wide spreadsheet printouts sideways. Needs IBM graphics printer or EPSON or compatible
- TYPEWRITER** Turns your computer into a typewriter. Works with all printers

Send your orders to:  
S&S Enterprises, Micro Division  
31 Holloway Lane, Amersham  
Bucks HP6 6DJ

PROGRAMS MARKED \* ARE FOR IBM'S AND COMPATIBLES ONLY

### THE DOS UTILITIES

- ALIAS\*** Lets you use short abbreviations for long DOS commands. eg 'zd' can stand for "dir".ind/w/p
- GRAFSHOT\*** Dump the contents of a graphics screen to a file
- DOSREDIR\*** Lets you redirect the 5 DOS devices (input, output, error, printer, comms) to a file. But it doesn't work if a program bypasses DOS
- SUPADU-PADIR** Used just like DIR, but keeps a master list of all your files on all your discs, and prints it out for reference
- BOOK\*** Lets you have an on-line pop-up manual of up to 36 pages of information

### DR SOLOMON'S DATA RECOVERY SERVICE

We recover deleted or corrupted files, corrupted, damaged or vanished disks, formatted hard disks. Its expensive but NO FIX-NO FEE. We can tackle ANYTHING

**172 PROGRAMS  
NOW AVAILABLE**  
PLEASE PHONE FOR FREE  
CATALOGUE

### THE PRINTER UTILITIES

- PRINTLOG\*** Logs all parallel printer output to a file as well as sending it to the printer
- SERIALOG\*** As above for serial printer
- REDSER\*** Lets you redirect the serial printer to a file
- POUNDLPT** Makes your parallel printer do a pound sign even if it doesn't have one, by doing L, backspace, dash
- POUNDCOM** As above for serial printer
- QUALIPRINT** Lets a cheap dot matrix printer do high quality printing. Works with IBM, Epson and compatible printers
- 4 FONT SETS** Available for use with QUALIPRINT for business and decorative use (£10 each) or all four for £30

ALL THESE PROGRAMS ARE NEW !!!

**CHOOSE ANY  
FIVE FOR £40!**

£10 & £15 Programs only

### THE WORD PROCESSING UTILITIES

- DWASCII** Converts DisplayWrite files to ASCII
- DIAGRAMMER** For designing diagrams on the screen, which can then be printed. Does not need a colour screen.
- EASYEDIT\*** A full-screen editor, but with many wordprocessor facilities and windowing



All programs cost £10.00 except where stated +VAT  
You can buy a package of any nine programs for £65 or any five for £40  
This offer only includes our £10 and £15 programs

PLEASE ADD VAT TO ALL ORDERS



**S&S ENTERPRISES (AMERSHAM) LTD. (02403) 4201 & 28095**

# ADVERTISERS INDEX

<b>A</b>		<b>E</b>		<b>M</b>			
A1 Computer Supplies Ltd	16	EFI Computers & Electronics (UK) Ltd	227	Mayfair Micros	74	Ramstrad Business Systems	209
AJP Business Computers	206		90	Megatech	54	Ringdale Engineering Company Ltd	222
AR Enterprises UK Ltd	111	Electrone	21	M-Tech Computer Services	55	Robotechnic	250
ATT Corporation Ltd	8/9	Elonex	21	Manor Court Supplies Ltd	232	Roland (UK) Ltd	87
Abbot Computer Products Ltd	233	Environmental Equipments (Northern)		Masteronic	253	Runnymede Computer Hardware	222
Acorn Computers Ltd	88/89		231	Matmos Ltd	224		
Advanced Microcomputer Applications	228	Epson (UK) Ltd	96/97	Micro Control Systems Ltd	249	<b>S</b>	
		Evesham MicroCentre Walltone	258	Micro General	18	S & S Enterprises	261
Almo Computer System	6			Micro Media	244	Samna International Ltd	162
Arch-Tech Computer Corporation	47	<b>F</b>		Micro Mindexx	60	Screens Microcomputers	105
Arkel Computer Services Ltd	66	Farnham Computers	35	Micro Peripherals	IBC	Seltec	76/77
Arnor Ltd	171	Fon Wun Co	259	Micro Rent	7	Sentinel Software Ltd	167
		Fortransoft	25	Microhire Ltd	252	Siama Ltd	23
		Fraser Associates Ltd	87	Micronet 800	177	Sierra Computer Consultants Ltd	207
<b>B</b>				Micronix Computers Ltd	254/255	Silica Shop Ltd	59
Barbatan Ltd	248	<b>G</b>		Microway Enterprises Co Ltd	209	Slough Computers	24/25
Borland International (UK) Ltd	72/73	G & B Computer Electronics	257	Mighty Micro	220	Softouch Computers	63
Bowthorpe EP	25	Good Software Co	55	Miracle Technology (UK) Ltd	141	Spectra Video	185
Brigden Technology	232	Goto Computer	27	Mitac International Corporation	16	Spectrum Group plc	238/239
Business Service Agency	209	Greymatter	1 & 263	Moor House Marketing	55	Spring Circle Computer Inc	237
		Bultronics	19	Morgan Computer Company	30 & 84	Star Micronics (UK) Ltd	79
				Mosaic Software Inc	163	Stem Computing	25
<b>C</b>		<b>H</b>				Stirling Microsystems	7
CAS	223	HM Systems	82	<b>N</b>		Surplus Computer Sales	12
CIS Technology Inc	208	Harvester Information Systems Ltd		National Software Library	211	Swanley Electronics	211
Calend	OBC		33, 35 & 37	Ness Industries Ltd	32	System Science (Systematika)	67
Card Device Ltd	225	Hi Spec Systems Ltd	42	North West Computer Supplies	259	System Zone Computers Ltd	207
Cardcheck Ltd	251	Hi Voltage	50/51	Northern Technology Systems Ltd	43		
Cherry Electrical Products	44/45	Hiisoft High Quality Microcomputers	20			<b>T</b>	
Cherry Electrical Products	62/63	Homestead Electronics	261	<b>O</b>		Tandon Computer (UK) Ltd	31
Commodity Software	251	Hua Chi Enterprises Co Ltd	222	Oemtek	26	Tasha Business Systems	241
Compact Selware International	243	Huntriump Industrial Co Ltd	208	Optimum Technology Ltd	13	Taxan (UK) Ltd	71
Compstand	24			Opus	113	Technomatic Ltd	38/39
Computacenter Ltd	11	<b>I</b>		Opus	160/161	Television Information Network Ltd	232
Computer Express Ltd	234/235	ISC Ltd	4/5	Osiris Computers	17	The Cotswold Press Ltd	43
Computer Manuals Ltd	47	Icams Software GB Ltd	251	Osprey	35	The Language Laboratory	221
Computer Precision Ltd	15	Intelligent Quotient	123			Thoughts & Crosses	61
Computers by Post	28	Iteo Ltd	23	<b>P</b>		Top Harvest International Corporation	60
Continanta Systems Inc	240			P & C Shiten Enterprise Co Ltd	259	Transform Ltd	220
Continuous xsting Paper	207	<b>J</b>		PST Ltd	245	Trinitas	250
		J & M Computers	251	Peripherals Connections	236	Trisoft Ltd	14
<b>D</b>		JBC Micro Services Ltd	37	Peripherals Enterprises	208	Trojan	37
De Vinci Computers Ltd	45	Juki (Europe) GMBH	IFC	Piccadilly Micros	29	<b>U</b>	
Damson Computing Ltd	250	KK Stationery Ltd	7	Plus 5 Engineering Ltd	226	UK Home Computers	250
Data Distributors Ltd	64 & 117	KKS Electronics Cinderford	260	Power Equipment Ltd	48	UK Software Ltd	209
Database Publications Ltd	65	Keele Codes Ltd	6	Precision Software Ltd	49	Unixitar Technology Inc	67
Dataplus Ltd	260	Keyzone Ltd	220	Puma Peripherals	67	Used Computer Sales	242
Dateline International Dating System	230	Kirklands Business Systems Ltd	58			<b>V</b>	
Dell Computer Corporation	52/53	Kudos Systems Ltd	93	<b>R</b>		Victor Technologies (UK) Ltd	149
Delta PI Software	43			R & D Technology Ltd	224		
Digitask Business Systems Ltd	210	Leigh Computer Systems	211	RP Direct Services	24	<b>W</b>	
Digitask Business Systems Ltd	34	Logitex Ltd	210	RPT Intergroup International Ltd	229	Walters International Ltd	246/247
Digitask Business Systems Ltd	36	Longman Group Ltd	177	RSC Ltd	10	West One Galaxy Business Systems Ltd	22
Digitask Business Systems Ltd	40/41			RTM Systems	259		
Digitask Business Systems Ltd	46			Ragley Data Systems Ltd	47	<b>Z</b>	
Digitask Business Systems Ltd	48					Zima Computing	20
Digitask Business Systems Ltd	80/81					Zorland	56/57

# MICROMART ADVERTISERS INDEX

<b>A</b>				<b>J</b>		<b>R</b>	
ACT Systems	196	Clydesoft	200	John Holmes Computers	205	RH Computer Consultants	201
AL Downloading Services	202	Computer Facilities	194	John Russell & Co	198	Ragley Data Systems Ltd	198
Abacom Computer Supplies	202						
Access Computers	199	<b>D</b>		<b>L</b>		<b>S</b>	
Altek Instruments	188	Datadisc	204	Lucy Parr		SP Electronics	204
Altra	191	Delostar	197			Sands Technology	201
Analogue Information Systems Ltd	199			<b>M</b>		Startex	203
Aptus Ltd	200	<b>E</b>		Micro Concepts	202	Suredata	195
Ashgate Ltd	196	Ekra Technology	192	Micro-Tech	200	Syntax Systems	197
Ashling UK	198			Microcom Systems	190		
Athene Consultants	201	<b>F</b>		Mr Bonthay	191	<b>T</b>	
		Four Party Services Ltd	196			T-Systems Ltd	206
<b>B</b>				<b>P</b>		Technical Media Services Ltd	192
BBD Computer Dust Covers	186	<b>G</b>		PB Electronics	191	Time Computers	188
Budget Typesetting Ltd	193	Gould Computer Services	186	Pace Electronics Ltd	186	Translatun International UK Ltd	203
				Pacific Computers (UK) Ltd	189	Tyepro Ltd	197
<b>C</b>		<b>I</b>		Polanka Video Ltd	195	<b>W</b>	
Carousel Tapes	199	International Software Distribution	187	Premier Software PM	205	Western Technology	193
Caspell Computer Services	203			Prospec Computer Systems	194	Wight Scientific	194
Central Media	204						
Chips Computer Centre (Direct Data)	195						



## BASIC LANGUAGE

New Quickbasic V3.0 uprates the competition with TURBO-BASIC.

### BASIC INTERPRETERS

BBC Basic (86)	PC-DOS	£ 95
BetterBASIC v2.1	PC-DOS	£150
Professional BASIC	PC-DOS	£ 70
TrueBasic v2.0	PC-DOS	£115
Microsoft MS-BASIC	MS-DOS	£210
MEGABASIC v5.2	MS-DOS	£235
Dig.Res. CBASIC	CP/M-86	£290
MEGABASIC	CP/M-86	£235
MEGABASIC	MP/M-86	£365
BBC BASIC	Z80+CP/M-80	£ 95
Dig.Res. CBASIC	CP/M-80	£130
Microsoft MBASIC	CP/M-80	£ 60
MEGABASIC	CP/M-80	£195

### BASIC COMPILERS

Microsoft QuickBASIC	PC-DOS	£ 60
Softaid MTBASIC	PC-DOS	£ 60
Turbo Basic	PC-DOS	£ 60
ZBASIC	PC-DOS	£ 75
Alcor Multi-Basic	MS-DOS	£ 85
Microsoft MS-BASIC	MS-DOS	£235
Dig.Res. CBASIC	MS-DOS	£390
Dig.Res. CBASIC	CP/M-86	£390
Dig.Res. CBASIC	CP/M-80	£435
ZBASIC	Z80+CP/M-80	£ 75
Softaid MTBASIC	Z80+CP/M-80	£ 60
Alcor Multi-Basic	Z80+CP/M-80	£ 85

## PROLOG LANGUAGE

Arity Standard	PC-DOS	£ 85
Arity Prolog v4.0	PC-DOS	£260
Arity Interpreter+Compil.	PC-DOS	£585
Chalcedony Prolog /I	MS-DOS	£ 90
PROLOG Professnl.	MS-DOS	£225
Micro-PROLOG v3.1	MS-DOS	£ 75
Prolog-86 v2.01	MS-DOS	£115
Prolog-1 v2.2	MS-DOS	£299
Prolog-2 Personal	PC-DOS	£145
Prolog-2 Programmer	PC-DOS	£495
Prolog-2 Professional	PC-DOS	£995
Turbo-Prolog v1.1	PC-DOS	£ 60

ADA Educ.Prolog	MS-DOS	£ 45
ADA FS Prolog	MS-DOS	£ 55
ADA VMI Prolog	MS-DOS	£ 85
ADA VML Prolog	MS-DOS	£165

Prolog-1 v2.2	CP/M-86	£299
Micro-Prolog v3.1	CP/M-86	£ 75
Micro-prolog v3.1	CP/M-80	£ 60
Prolog-1 v2.2	CP/M-80	£225

## MODULA-2 COMPILERS

New Farware compiler.

FTL is an excellent value learning tool.

Pecan P-Sys. w.Mod-2	PC-DOS	£ 80
Farware Modula-2	MS-DOS	£ 70
FTL Modula-2	MS-DOS	£ 45
Interface M2-SDS	PC-DOS	£ 75
Interface M2-SDS-XP	PC-DOS	£185
Modula-2/86 Apprentice	PC-DOS	£ 90
Modula-2/86 Wizard	PC-DOS	£200
Modula Corp.PC Mod.2	PC-DOS	£150
Modula 2/86	CP/M-86	£410
FTL Modula-2	Z80/CP/M-80	£ 45
Hochstrasser Mod.2	Z80/CP/M-80	£100
Turbo Modula-2	Z80/CP/M-80	£ 55
TDI Modula-2	ATARI 520ST	£ 75
MacModula-2	MACINTOSH	£100

Library source is available with some compilers.  
Please enquire about other utilities available.

## CROSS ASSEMBLERS

We supply cross-assemblers by Avocel, 2500AD,IAR Systems and Pecan hosted on MS-DOS, CP/M-86 and CP/M-80 with over 30 target processors. In total over 200 products with no space to list them here. We hold some stock but you should allow 10-14 days for delivery.  
Please call for information or advice.

### LIBRARIES & UTILITIES

#### Database

CADSAM (source code)	MS-DOS	£ 75
Btrieve	MS-BASIC + MS-DOS	£190
Btrieve/N	MS-BASIC + MS-DOS	£460
Multikey	MS-BASIC + MS-DOS	£145
CADSAM (source code)	CP/M-80	£ 70

#### Graphics

Multi-Halo	MS-BASIC + MS-DOS	£175
GSS CGI Graph.Dev.Tkt	PC-DOS	£330

#### Sundries

Finally Quickbasic +	PC-DOS	£ 75
PANEL Screen Manager	MS-DOS	£100
Wiley Scientific Lib.	PC-DOS	£110
Quickbasic 8087 Pack	PC-DOS	£ 50

#### Tuning & Debugging

Betatools Dev.System	PC-DOS	£100
----------------------	--------	------

## PROGRAMMING TOOLS

Ada Compilers	Algol Compilers
Assemblers	Assembler Libs.
Basic Compilers	Basic Interpreters
Basic Utilities	Basic Libraries
BCPL Compilers	C Compilers
C Interpreters	C Libraries
C Utilities	Cobol Compilers
Comms.Libraries	Cross Assemblers
Database Libs.	Debuggers
Dis-assemblers	Editors
Engineers Libs.	Expert Systems
Forth	Fortran Compilers
Fortran Libraries	Graphics Libraries
Icon	Linkers
Lisp	Modula-2
Nial Interpreters	OPS 5
Pascal Compilers	Pascal Libraries
Prolog	Rexx
Screen Libraries	Smalltalk
Snobol	

We stock many items for which there is no space in these advertisements.

## PASCAL LANGUAGE

Metaware excellence now on Concurrent Dos and on the 386.

ALICE Pascal Intrprtr.	PC-DOS	£ 80
Marshall Pascal	MS-DOS	£150
Metaware Prof.Pascal	MS-DOS	£420
Metaware Prof.Pas/386	MS-DOS	£595
Microsoft Pascal v3.32	MS-DOS	£180
Oregon Pascal-2	MS-DOS	£360
Prospero Pascal v2.225	MS-DOS	£220
Turbo-Pascal	MS-DOS & PC-DOS	£ 60
Pecan P-Sys w.UCSD Pas.	IBM-PC	£ 80
Pecan P-Sys Pascal Prof.	IBM-PC	£155
Metaware Prof.Pascal	C-DOS	£420
Pro-Pascal v2.14	CP/M-86	£220
Turbo-Pascal v3.01	CP/M-86	£ 60
Pascal MT+ v5.6	CP/M-80	£ 99
Pascal MT+ v5.6.1	CP/M-80	£290
Pro-Pascal v2.18	CP/M-80	£220
Turbo-Pascal v3.01	CP/M-80	£ 49
MCC Pascal	ATARI ST	£ 75
Pecan P-Sys w.UCSD Pas	ATARI ST	£ 80
Pecan P-Sys w.UCSD Pas	APPLE ][	£ 80

We have many Pascal Libraries. Enquire

## PRICES AND DELIVERY

Prices do not include VAT or other local taxes but do include delivery in UK and Europe. Please check prices at time of order, ads are prepared some weeks before publication. This page lists some of our products. Call us for a complete pricelist.

Order by phone with your credit card.

## PASCAL LIBRARIES

### TURBO PASCAL LIBRARIES

Blaise Power Tools Plus	PC-DOS	£ 75
Blaise Turbo Asyn.Plus	PC-DOS	£ 75
Mathpak 87 (TP)	MS-DOS	£ 60
Paragon Supertools	PC-DOS	£ 55
RM Graph Nimbus +	MS-DOS	£ 49
Science & Eng.Tools	MS-DOS	£ 50
Report Builder	MS-DOS	£ 70
System Builder	MS-DOS	£ 90
Turbo Halo Univ.Graph.	PC-DOS	£110
T-Debug Plus	PC-DOS	£ 35
Turbo Database	CP/M & MS-DOS	£ 49
Turbo Editor Toolbox	PC-DOS	£ 49
Turbo Extender	PC-DOS	£ 55
Turbo Gameworks	PC-DOS	£ 35
Turbo Graphix Toolbox	PC-DOS	£ 49
Turbo Advantage (Lader)	MS-DOS	£ 60
Turbo Link Plus	PC-DOS	£ 65
Turbopower Utilities	PC-DOS	£ 60
Turbo Optimiser	PC-DOS	£ 45
Turbo Professional	PC-DOS	£ 45
Turbo Screen	CP/M,MS,PC-DOS	£ 65
Turbo Tutor	CP/M & MS-DOS	£ 29
TurboWINDOWS	PC-DOS	£ 50

### GENERAL PASCAL LIBRARIES

Blaise Tools (s'ce) (MS)	PC-DOS	£ 95
Blaise Tools 2 (s'ce)	PC-DOS	£ 80
Blaise Asynch (s'ce) (MS)	PC-DOS	£125
Btrieve (MS)	PC-DOS	£190
MetaWINDOWS (MS)	PC-DOS	£100
Multi-Halo (MS)	PC-DOS	£175
Blaise View Mngr. (MS)	PC-DOS	£205
Shark database (Propas)	MS-DOS	£250
Prospect Graphics (Pro)	MS-DOS	£ 70
Panel (Screen) (MS)	MS-DOS	£205
Shark database (Propas)	CP/M-86	£250
Prospect Graphics (Pro)	CP/M-86	£ 70
Shark database (Propas)	CP/M-80	£150

## PROGRAM EDITORS

Kedit and Norton are new to us.  
So many good editors, spoilt for choice.

BRIEF v2	PC-DOS	£150
EC Editor v2.1	PC-DOS	£ 40
Epsilon v3.1	PC-DOS	£140
Lattice CVUE	PC-DOS	£ 95
FirstTime for Pascal	PC-DOS	£190
FirstTime for Turbo-P	PC-DOS	£ 60
Kedit v3.52	PC-DOS	£ 95
Norton Editor V1.3	PC-DOS	£ 80
Pmate PC v4	PC-DOS	£115
RED v6.6 (with C S'ce)	PC-DOS	£ 65
XTC (with Pascal source)	PC-DOS	£ 65
Vedit-Plus	PC-DOS	£120
CSE (with C source)	MS-DOS	£ 75
MIX Editor	MS-DOS	£ 35
Pmate 86 v4.00	MS-DOS	£115
Vedit-Plus	MS-DOS	£120
Vedit-Plus	CP/M-86	£120
CSE (with C source)	CP/M-80	£ 75
MIX Editor	Z80 + CP/M-80	£ 35
Nevada Edit	CP/M-80	£ 35
Vedit-Plus v2.33	CP/M-80	£120

For more information please call us.

## DISK COPYING SERVICE

We can copy files to and from 400 disk formats including CP/M, CP/M-86, MS-DOS, PC-DOS, ISIS, APPLE, SIRIUS, BBC, TORCH, APRICOT, HP150, TRSDOS, DEC RT-11, IBM BEF, ATARI520, AMSTRAD.  
Our charge is £10.00 + disk + VAT with discounts on small quantities and disks are normally despatched within 24hrs of receipt.

For more information call us.

**GREY MATTER**  
4 Prigg Meadow, Ashburton, Devon TQ13 7DF  
TEL. (0364) 53499

**GREY MATTER**  
4 Prigg Meadow, Ashburton, Devon TQ13 7DF  
TEL. (0364) 53499

**GREY MATTER**  
4 Prigg Meadow, Ashburton, Devon TQ13 7DF  
TEL. (0364) 53499

The view from Amstrad Towers must be interrupted by a mass of rose-tinted lenses. The press release announcing the launch of the PCW9512 in the US last month concludes: 'In Great Britain, it is difficult to find a journalist who has not bought and paid for an Amstrad word processor ...' From where I sit, I can count at least 20 ...

Still at Amstrad, another view of the company's self-perceived omnipotence comes from the apology which followed the above release: the company 'mistakenly stated that Locoscript and Locomail were registered trademarks of Amstrad plc.' Amstrad liked the names so much, it thought it had bought the company ...

Mind you, it's not just car aerial salesmen who want to succeed in the business (but not many will succeed as well as Alan Sugar). A reader from Skegness wrote in, saying that he was setting up as a dealer of hardware and software, including Commodore Amigas.

However, his knowledge of the computer business contained some gaps and could we help him with the phone numbers for Commodore's distributors. He also thinks that perhaps he will set up a bulletin board and could we tell him how to set one up. Perhaps he expects us to teach him how to sell as well ...

Another offer we've protected you from this month is a description of how to re-ink your own printer ribbons. It involves drilling holes into the top of the ribbon case and pouring in a mixture of stamp pad ink and glycerine. One month later you have a sticky mess ... No, sorry — it's supposed to be a nice, black ribbon. Try it at your

peril. We haven't ...

A rather distraught American Apple dealer phoned Apple, complaining that he could no longer 'wind back' the copy counter inside the new-model Apple Laserwriter like he used to be able to do on the old models. 'Why do you want to reset it?' Apple asked.

'Well, this is a demo model, and it's done 1400 copies so it's impossible to sell. But the warranty is about to run out so I have to reset the printer, and to do that I have to set the counter back to zero.'

The dealer in question was rather astounded that Apple wouldn't help him with this sleight of hand, according to the *Newsbytes* reporter who questioned him.

Can you imagine a car dealer phoning Ford and asking how to turn the clock back on his personal-use Sierra so he can sell it as brand new ...

Livingston Hire has the new IBM Model 30s available for hire, but the company has obviously had them upgraded as it has heard that these machines are a bit sluggish at times. How else can Livingston explain its announcement which describes the Model 30s as being based on the 80386 microprocessor ...

Another rental company, Microrent, has a new Microsprint service which offers two-hour replacement of faulty equipment, including laser printers. Microrent itself was clearly left in the lurch, as its announcement was printed on the faintest dot-matrix printer we've ever seen. Perhaps the cartridge was blocked up with glycerine ...

If you're still using Telecom Gold you might have received a message at some time, as succinct as this one from our Mailbox

columnist, Peter Tootill:

}i}\_{\_Xd}/ra{\_d li{e will call back ...

### Action Required

Cobonic has offered us a free digital clock/timer/alarm unit which normally sells for around £17.50. Handily, for the computer user, it comes with a magnetic clip for attaching to metallic surfaces — like disk drives and floppy disks ...

A combination of five lasers and realistic sound effects is being used inside a 'microdome' to train soldiers in ground-to-air combat. Four of these lasers draw the aircraft shapes onto the surface of the dome, superimposed on photographs of real settings; the fifth reproduces the flare of the laser. Scenarios such as Port Stanley in the Falklands are available.

It makes Starglider seem rather tame ...



*A new-technology showcase is being planned for Berkshire, including a permanent technology exhibition, countryside park and hotel. The 'Information Age' will be situated near Reading, on a site that looks like a refugee from MacPaint ...*

## This month

PC-compatible laptops are getting cheaper and smaller — those on our cover this month are certainly compact. But it does seem that screen design has some way to go before all machines have screens as legible as CRTs. How well current technology stands up can be seen on page 98.

The multi-tasking DOS utility, DESQview, was at the centre of a row between *PCW*'s technical editor, Owen Linderholm, and Microsoft founder, Bill Gates. On page 142 you can see why Owen became so heated in challenging Gates' belief that you couldn't multi-task properly without OS/2.

We all gave a sigh of relief when a full, working Cambridge Computer Z88 arrived in the *PCW* office. The warm, soapy cloth was kept busy cleaning up afterwards, as we all crowded round to get our eager paws on the rubbery keyboard and see whether



the internal software lived up to expectations. Page 108 gives our findings.

Finally, this issue sees a new member of staff joining our team. Chris Cain is our new editorial assistant, replacing Debbie Wallace who has moved on to the art studio. Chris is an Amiga owner and, as well as handling your general queries, will be looking after the Transaction File and Diary Data sections of End Zone. Our telephone is now answered with the mellow tones of Marble Madness in the background.

## Cheap PCW Show tickets!

As promised, here's how you can get £1 off the entry price to the PCW Show at Olympia, 23-27 September (see 'Showing off!', page 154). You should by now have in your possession two vouchers — marked '1' and '2' — cut from this and last month's subscriptions cards. (If you don't have our last wonderful issue, our Back Issues department will be happy to oblige.)

Send those two vouchers (photocopies are obviously not acceptable) along with a cheque or postal order for £2, to: Keith Prowse, PCW Show Ticket Office, PO Box 2, London W6 0LQ. Don't forget to enclose a stamped, self-addressed envelope, too, or Keith Prowse will be snowed in by unclaimed tickets.

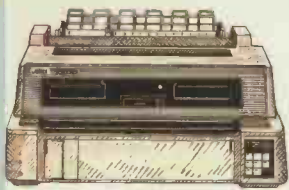

#### 7200 NLQ MATRIX

The world's first multi-function, multi-wire, flat-bed printer. It allows you to print virtually any kind of business form. It gives quality print as well as colour and plotting facilities.

**Speed:** 324cps (Draft). 108cps (LQ).  
**Columns:** 136. **Compatibility:** IBM, Epson, or Diablo 630.  
**Price:** £1625.



#### 5510/5520 NLQ MATRIX

High speed, NLQ with full graphics mode and 3K memory. 5520 is the colour version.

**Speed:** 180cps (Draft). 30cps (NLQ).  
**Columns:** 80. **Compatibility:** IBM & Epson.  
**Price:** 5510 £329. 5520 £449.



#### 6500 DAISYWHEEL

This new daisywheel is designed for heavy duty office use. It's very fast and includes parallel and serial interfaces.

**Speed:** 60cps. **Columns:** 132.  
**Compatibility:** IBM & Diablo 630.  
**Price:** £1299.



#### 6300 DAISYWHEEL

Our best selling general purpose daisywheel printer. It's fast speed and low noise level make it ideal for the office.

**Speed:** 40cps. **Columns:** 132.  
**Compatibility:** IBM & Diablo 630.  
**Price:** £899.



#### 6200 DAISYWHEEL

A popular wide bodied letter quality printer, perfect for the smaller office. Parallel or serial interface.

**Speed:** 30cps. **Columns:** 132.  
**Compatibility:** IBM & Diablo 630.  
**Price:** £579.



#### 6100 DAISYWHEEL

The U.K.'s best selling daisywheel printer. 30 character wheel. 2K memory expandable to 8K.

**Speed:** 20cps. **Columns:** 110.  
**Compatibility:** IBM & Diablo 630.  
**Price:** £399.



#### 6000 DAISYWHEEL

Letter quality printer designed for home use. 100 character wheel and either parallel or serial interface.

**Speed:** 10cps. **Columns:** 90.  
**Compatibility:** IBM graphics printer.  
**Price:** £199.



## The Juki 7200. The first printer in the world that can print anything.

Well, when we say anything we mean virtually any kind of business document. Everything from the usual cut sheets, labels and continuous paper to multi-part sets, envelopes, business cards, airline tickets, freight bills, cheques, statements and ledger leaves.

This is due to its revolutionary flat bed design and three way feed system. Combine this with print quality to rival a laser and the option of colour, you have something no other machine can match.

On top of that we offer a full 2 year warranty\* on all Juki printers. So, for more detailed information on any model call us now for free on 0800 521111.

Sole Distributor:

**JUKI**  
The Master Printers

**MP** **Micro Peripherals Ltd**

Intec 2, Unit 3, Wade Road, Basingstoke, Hampshire RG24 0NE.

Telephone: 0256 473232. Telex: 859669 MICRO P G. Facsimile: 0256 461570.

Unit 5/6, Newhallhey Works, Newhallhey Road, Rawtenstall, Rossendale, Lancashire, BB4 6HL.

Telephone: 0706 211526. Facsimile: 0706 228166.

\*Does not include printheads, ribbons and daisywheels.

All prices are RRP Ex VAT.

All trade marks are recognised.

# Why are PC users from New Zealand to Norway changing over to PCL?

**PCL** (Personal Computer Language) is the ideal language for beginners and experts alike. It is easy to learn and offers much greater practical programming power than either BASIC, Pascal or C.

**PCL** has a logical syntax and a clear structure which encourages the writing of very readable programs. Extensive debugging features and sensible error messages help you to track down errors quickly.

**PCL** is a major new high level language, implemented as the fastest interpreter on earth. **PCL** is not a scaled down adaptation of a mainframe language like Basic, Pascal or C – it was designed for the PC.

Calend\* developed **PCL** for the practical PC user. You will find that **PCL** is more powerful and easier to learn than any language you have come across.

**PCL** makes you more productive and it gets more performance out of your micro. It gives you the flexibility of an interpreter with an execution speed that puts most compilers to shame.

Join the fast growing number of **PCL** programmers. Get your applications running in record time. Why waste time wrestling with the quirks of the traditional languages. **PCL** has more useful built-in functions than the others:

- Sophisticated windowing, boxes frames and menus. Save and restore window settings and contents.
- Extremely fast screen displays.
- Array arithmetic.
- Sorting.
- Extended text manipulation and scientific functions. 16 digits precision. Date arithmetic. Automatic 8087/80287 support.
- Powerful file handling, directory and disk management.
- Dynamic record structures.
- DOS command interface.
- RS232 communications up to 19200 Baud handled by built-in background tasks.
- Supports the IBM graphics characters, but not pixel graphics which are incompatible with fast text display.
- Any **PCL** application can be made RAM-resident

...and much more.

**PCL** has over 330 built-in functions.

\*Calend is an independent UK software house.

Any **PCL** program can call on the interpreter itself at run time and pass source code for immediate execution. Useful for self-modifying, intelligent programs, spread-sheets, data dictionaries, AI applications etc.

Description	BASICA	MS-BASIC	C	PASCAL	PCL
Empty loop x 10000	4.6	23	.09	25	.04
BYTE Magazine decimal arithmetic benchmark:	252.5	17.32	39.4	31.88	14.82
With 8087:				6.29	6.09
Display 24 lines of 80 characters on standard colour display:	3.62	4.00	4.6	2.70	15
Mono or EGA display:	3.40	3.40	3.6	2.45	.04
Format & display 100 decimal numbers:	6.95	2.02	2.6	1.51	.42
With 8087:				1.35	.25
Convert 1000 decimals to character strings:	22.0	3.56	6.5	3.89	3.17
With 8087:				2.87	1.04
Convert 1000 character strings to decimals:	50.7	3.92	13.1	8.18	2.43
With 8087:				3.48	1.12
Catenate two 10 byte strings x 1000:	3.2	.65	.32	.58	.32
Sequential write, 1000 x 90 byte records	18.3	9.0	11.2	7.5	2.9
Sequential read, 1000 x 90 byte records	18.2	8.6	9.2	7.4	2.5

All timings are in seconds. They were taken on a standard IBM PC with PC DOS 3.1, a real-time clock and a 10MB hard disk. BASICA is the PC-DOS interpreter, MS-BASIC is Microsoft's compiler (version 2.0), C is the Digital Research version 1.1, PASCAL is Borland's Turbo Pascal 3.0

Minimum system requirements: IBM PC/XT/AT or compatible, 256k RAM, mono or colour monitor, PC DOS or MS DOS version 2.1 or later. **PCL** comes on a 5¼ diskette (not copy protected) with 16 sample programs. It is accompanied by a 255 page manual. The manual covers all aspects of **PCL** programming, is well structured and has a sensible index. 30 days money back guarantee for single copy prepaid UK orders.

Become more productive – order **PCL 2.0** from Calend for £100 (includes VAT and UK postage).

CALEND  
P.O. BOX 94  
TWICKENHAM TW2 6DD  
Telephone: 01 894 7409