

57 vll

Personal Computer

NEW
POCKET
SHARP
COMPUTER

Canada \$2.75/US \$2.50/FF 8.80/FL 4.00/SFr 7.20/IR £1.11/
BFr 83.00/SKr 12.80/DKr 21.00/Lire 4200/DM 5.50

World June 1982 75p

BRITAIN'S LARGEST SELLING MICRO MAGAZINE

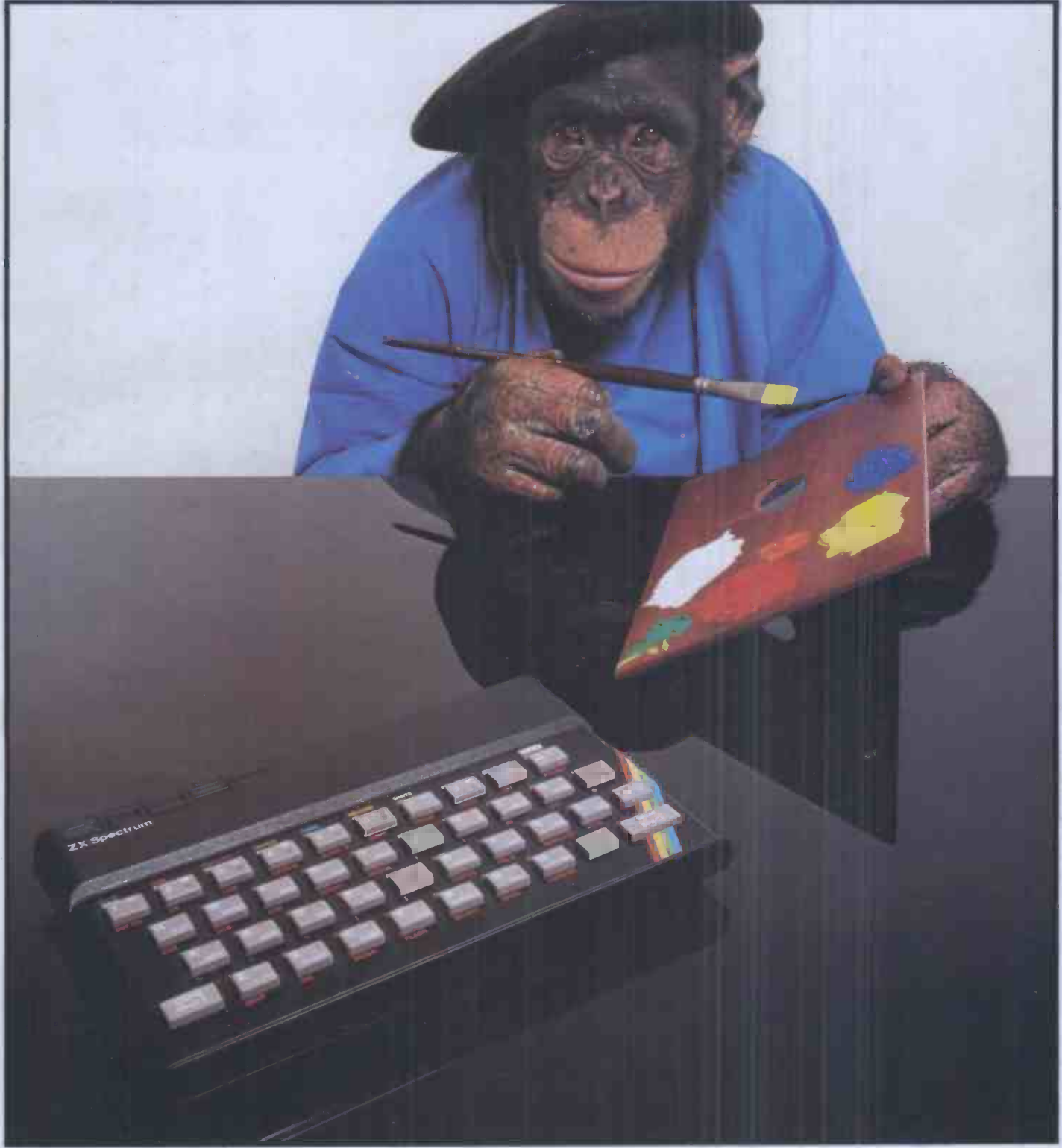

WORLD EXCLUSIVE: ZX SPECTRUM
We Benchtest Sinclair's new 16k colour micro

**NEW
MODEL**

**LOWER
COST**



Cromemco System One

MicroCentre introduce Cromemco's new System One computer, available with an integral 5 megabyte Winchester hard disk, at a new low price.

The System One supports the full range of Cromemco interface cards, including high resolution colour graphics, and software packages. The choice of operating systems includes CDOS, CP/M and CROMIX—Cromemco's answer to Unix.

Call MicroCentre for  Cromemco

MicroCentre Ltd
(Complete Micro Systems)

**Britain's independent
Cromemco importer**

**30 Dundas Street
Edinburgh EH3 6JN
Tel: 031-556 7354**

MICRO TRAINING FOR COMPUTER USERS

6 Micro courses



Which would you like to attend?

Digitus is running a number of courses to train users and potential users in the basic skills of micro-computing. Conducted at our Central London Workshop, the courses provide hands-on experience of microcomputers, demonstrations of working systems and tutorials on your particular needs.



One day's concentrated information on microcomputing aimed at the potential user in small and large organisations. A practical course which includes business applications of micros, guidelines on selecting microcomputer systems and an introduction to programming.

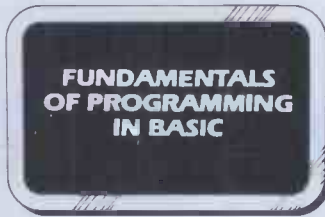

A two day course designed to teach the first principals of programming in BASIC. Aimed at those with some understanding of micros who want to learn how to instruct their computer to perform tasks.



A two day course for those who have learned Basic from hands-on experience and want to brush up their BASIC techniques and learn some timesaving software tools.



A one day course for people who want to learn the fundamentals of wordprocessing. Uses the popular Wordstar wordprocessing package available on most CP/M micros and teaches by hands-on use.



The DataStar data entry, retrieval and management system is a powerful aid which enables the educated user and computer professional to build information systems economically and rapidly.

Training for Computer Professionals
Course in: Micro Technology for Management • Local Area Networks • Micros for Computer Professionals.
Courses are run at the Workshop or on site. Telephone or write for details.

Micro Technology Workshop Set in 8,500 sq. ft in Central London, the Workshop is a few minutes from Covent Garden, Trafalgar Square, Charing Cross, Embankment and Waterloo stations. Specialist areas include: Personal Computers, Technical Systems, Business Systems, 16 bit and Local Network Systems, Bookstore and Training Rooms.

Booking and Fees The fee for all courses is £80 per day plus VAT, payable 14 days prior to starting date.



In addition to Wordstar, Micro-Pro Inc have produced a variety of aids to improve productivity in offices and systems departments. This one day course includes: Mail-Merge linked to Wordstar • Supersort sorting utility • CalcStar rows and columns manipulation • DataStar information manager • harnessing the 'Star' products together.

All courses provide access to an extensive range of micro hardware, software and expertise.

Note: Wordstar and DataStar are registered trademarks of Micro-Pro Inc.

Booking Form (Please complete in BLOCK capitals)
To Digitus Ltd, 10-14 Bedford Street, London WC2E 9HE. Tel 01-379 6968

Reserve places as follows:

Name of delegate Date

Name of delegate Date

Name of delegate Date

Courses/dates

Introduction to Microcomputers	<input type="checkbox"/> June 7	<input type="checkbox"/> Oct 11
Fundamentals of Programming in Basic	<input type="checkbox"/> June 8/9	<input type="checkbox"/> Oct 12/13
Improve your Basic	<input type="checkbox"/> June 10/11	<input type="checkbox"/> Oct 14/15
Wordstar Wordprocessing	<input type="checkbox"/> July 6	<input type="checkbox"/> Nov 9
DataStar Information Management	<input type="checkbox"/> July 7	<input type="checkbox"/> Nov 10
Micro-Pro Software Tools	<input type="checkbox"/> July 8	<input type="checkbox"/> Nov 11

Company/address

Name Position

Signature Tel.No.



PCW/6/82

INSIDE PCW

BENCHTESTS

102 SHARP MZ-80A
Peter Rodwell probes the innards of Sharp's latest personal computer.

118 ZX SPECTRUM
Sinclair's long-anticipated colour machine, Benchtested for the first time by David Tebbutt.

138 DATABASE BENCHTEST
DBMS2, another CP/M data management package.

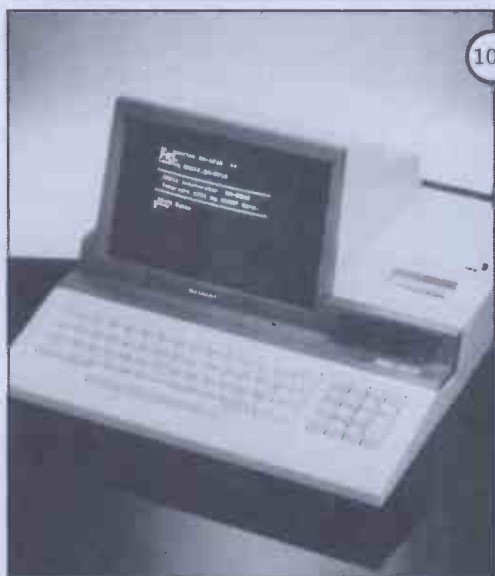
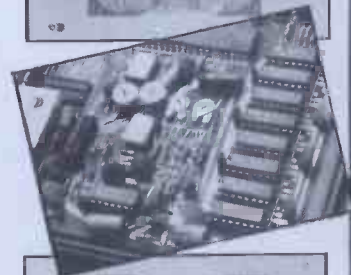

FEATURES AND SERIES



114 7th WEST COAST FAIRE
Our summary of goings-on at San Francisco's grand-scale expo.

125 SCREENPLAY
Dick Olney looks at games for the Apple II.

130 FRAMES OF REFERENCE
Alan Wood concludes his series on micros for the DP professional.

136 LISP
An artificial intelligence language, introduced by Mike Liardet.

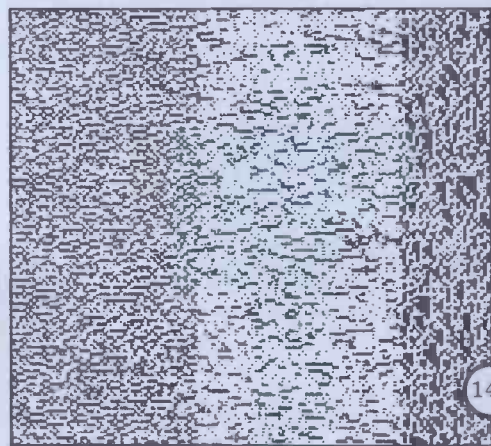

145 PATTERNS
More pretty pictures and the theory behind them from Alan Sutcliffe.

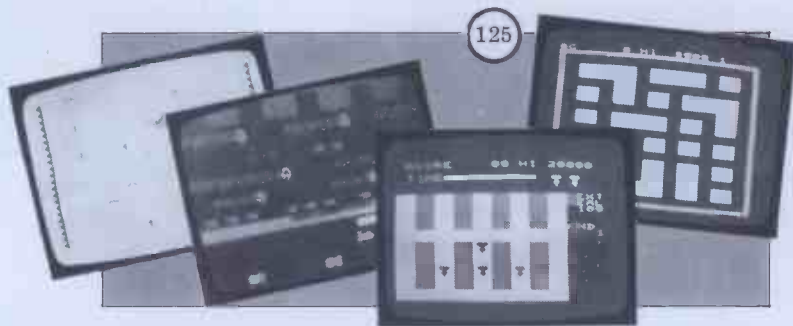



Cover photograph: Chris Stevens
Model: Louis, Twycross Zoo
Accessories: Winsor & Newton

REGULARS

80 NEWSPRINT
Roving reporter Guy Kewney keeps us informed in his own special way.

92 CTUK! NEWS
News and views from 'Towns nationwide.

93 BRAIN DUMP
Our chance to have our say (subject to as little discretion as possible!).

94 COMMUNICATIONS
Your chance to have your say — subject to editorial discretion!

96 SUBSCRIPTIONS
Save shoe leather — treat yourself to the shameful luxury of a subscription.

151 TJ'S WORKSHOP
Terminal junkies get their monthly hardware and software fixes here.

156 COMPUTER ANSWERS
Sheridan Williams and his crew peruse your problems.

158 NEWCOMERS START HERE
Our quick intro for new initiates to microcomputing.

159 DIRECT ACCESS
With In Store, Transaction File, User Groups Update, ACC News, CTUK! Centres, Network News and Diary Data.

172 LEISURE LINES
Another brain burster from JJ Clessa.

172 PROGRAMS
PCW's monthly selection of reader's offerings.

187 BLUNDERS
We confess!

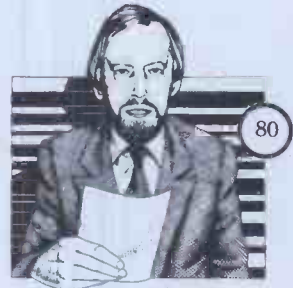

98 NOT CALCULATOR CORNER
The Sharp PC1500 and all its trimmings put through its paces by calculator supremo Dick Pountain.

100 BANKS' STATEMENT
Martin Banks presents his monthly monologue.



108 BOOKFARE
The pick of the new micro books sampled by Malcolm Peltu.

133 SUB SET
More useful assembler language subroutines.

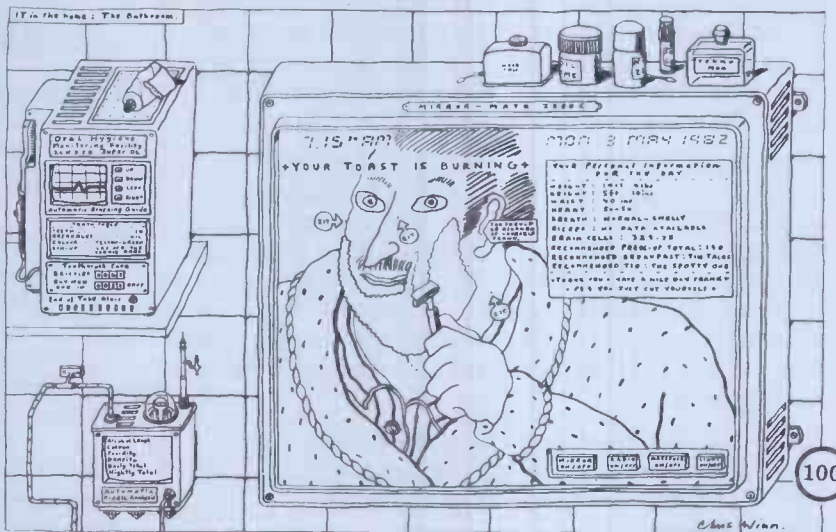

188 BACK ISSUES
Catch up with what you've missed — if you can remember what it was!

264 CHIP CHAT
More vicious, unfounded lies and gossip, among other snippets of morally rewarding information.

THE LARGEST MICROCOMPUTING SHOW IN BRITAIN



**Barbican Centre, City of London
9-12 September 1982**

Breaking all records!

By the first week in March, Exhibitors had already booked more space in the 5th Personal Computer World Show than the total on exhibition last year! It is absolutely certain now that the Show will be at least twice the size of last year's record breaking event. Possibly even three times the size or more.

Fortunately, the superb facilities at the Barbican offer us the opportunity to satisfy the staggering demands for space we are currently experiencing. The majority of Exhibitors have doubled their stand size in both sections of the Show which, like last year, will be divided into two floors. One floor will cater for professional and business microcomputing. The other will be devoted to home and hobbyist applications.

Massive stands have been booked or under offer from virtually all the big names in microcomputing. And a surprising proportion from foreign manufacturers!

Last year, the PCW Show brought more visitors to a microcomputing show than had ever been seen in the UK before. Sixteen thousand people in three days. This year the Show has been extended to four days and we are expecting record-breaking crowds.

Our promotional budget for the Show has been doubled and we are arranging the most exciting programme of features to attract the widest possible spectrum of visitors.

If your company is involved in microcomputing we strongly advise you to send off for details and reserve space now. The 5th Personal Computer World Show is already set to be a stunning success. Be a part of that success by calling Timothy Collins on 01-486 1951 today. Or use the coupon below to obtain a full information pack.

The 5th Personal Computer World Show is sponsored by Personal Computer World and organised by Montbuild Ltd.

Please rush me details of exhibition at the 5th Personal Computer World Show:

Name..... Position.....

Company.....

Address.....

..... Tel No.....

Send coupon to: Timothy Collins, Montbuild Ltd, 11 Manchester Square, London W1M 5AB



We'd love to market the game you've invented. If we can tear ourselves away from it.

If your program is compelling enough to glue us to our television sets, then it's just what we're looking for. And if we can leave it alone for long enough to produce it, we'll glue millions of other people to their sets as well.

THORN EMI is looking for video games and other general interest programs, which have been produced for home computers from the following:

Apple, Atari, B.B.C., Commodore, Sinclair or Texas Instruments.

Whether you're a professional programmer or competent amateur, if you have produced a program that you think we may be interested in, we'd love to hear from you.

Please don't send the program direct. Write to Home Computer Software Department, THORN EMI Video Programmes, Upper St. Martins Lane, London W.C.2. and we will send you an application form.

Leaders in home video entertainment.



At the Micro House we talk business as well as computers



When you come to us for a micro computer, we'll ask you a lot of questions. So that we know your needs before we install the system. And after that we'll still be available — to give you plenty of support.

It isn't the only possible way of buying a micro. But it is the way to maximise the return on your investment. Because there's one rule about computers which always holds good, no matter how much you've paid for the

hardware. Rubbish in equals rubbish out.

- We market the unique A.C.T. Sirius 1 - a breakthrough in high-performance business computing at low cost.

- Plus a big choice of packaged software. Plus tailor-made software. Plus a range of financial packages, including Supercalc and Micromodeller.

- We organise 'hands-on' training for your staff under experienced F.C.A. supervision.

Talk to:

RICHARD ALLISON B.Sc. F.C.A. STEPHEN COLTER B.Sc., (Hons.)



The Micro House,
49/50 Barton Arcade
Chambers,

Barton Square,
Manchester, M3 2BH.
Tel: 061-834 8815

TEXAS INSTRUMENTS HOME COMPUTER STOCKISTS

ABERDEEN Dixons **ALTRINCHAM** Boots **ASHFORD** Rumbelows **BARNET** Rumbelows **BASILDON** Rumbelows **BASINGSTOKE** Boots **BATH** Boots, Microstyle **BEDFORD** Carlow Radio, Rumbelows, Boots, Comserve **BILLERICAY** Rumbelows **BIRKENHEAD** Dixons **BIRMINGHAM** Dixons, Comet, Hewards Home Stores, Boots **BLACKPOOL** Boots **BLETCHLEY** Rumbelows **BOREHAMWOOD** Rumbelows **BRADFORD** Ackroyd Typewriters **BRAINTREE** Rumbelows **BRENTWOOD** Rumbelows **BRIGHTON** Gamer, Boots **BRISTOL** Dixons **BROMLEY** Rumbelows, Boots **BROMYARD** Acoutape Sound **CAMBRIDGE** Rumbelows, Dixons, Heffers **CANTERBURY** Rumbelows, Dixons **CARDIFF** Boots, Dixons, Computer Business Systems **CARLISLE** Dixons **CHELMSFORD** Dixons, Rumbelows **CHESTER** Boots **CHINGFORD** Rumbelows **COLCHESTER** Rumbelows **CORBY** Computer Supermarket **CREWE** Midshires **CROYDON** Boots, Dixons, Allders **DARTFORD** Rumbelows **DERBY** Datron Microcentre, Boots **DORRIDGE** Taylor Wilson **DUNSTABLE** Rumbelows **EASTBOURNE** Rumbelows **EDINBURGH** Robox, Esco, Texas Instruments, Dixons, B.E.M. **ENFIELD** Rumbelows **EXETER** Peter Scott, Boots, Dixons **GLASGOW** Boots, Esco, Robox, Dixons **GT. YARMOUTH** Rumbelows **HANLEY** Boots **HARLOW** Rumbelows **HATFIELD** Rumbelows **HEMEL HEMPSTEAD** Rumbelows, Dixons **HITCHIN** Rumbelows **HODDESDON** Rumbelows **HULL** Radius Computers, Boots, Dixons, Peter Tutty **ILFORD** Boots **IPSWICH** Rumbelows **KINGSTON** Dixons **LEEDS** Dixons, Boots, Comet **LEICESTER** Dixons, Boots **LEIGHTON BUZZARD** Computopia **LETCHWORTH** Rumbelows **LINCOLN** Dixons **LIVERPOOL** Dixons, B.E.C. Computerworld **LONDON: Balham** Argos **Bow** Rumbelows **Brent Cross** Dixons, Boots **Camden Town** Rumbelows **City Road** Sumlock Bondain **Clerkenwell** Star Business Machines **Curtain Road** Eurocalc **Ealing** Adda Computers **EC1** Argos **Edmonton** Rumbelows **Finchley Road** Star Business Machines **Fulham** Mondial **Goodge Street** Star Business Machines **Hackney** Rumbelows **Hammersmith** Dixons **Hendon** Futurtronic **Holborn** Dixons **Hounslow** Boots **Kensington High Street** Video Palace **Knightsbridge** Video Palace, Harrods **Loughton** Rumbelows **Marble Arch** Star Business Machines **Moorfield** Dixons **Moorgate** Star Business Machines **New Bond Street** Dixons **NW1** Mountaine **Oxford Street** Selfridges, H.M.V., Dixons **Regent Street** Star Business Machines **Tottenham Court Road** Landau, Eurocalc **Victoria Street** Army & Navy **Wandsworth** R.E.W. **Wood Green** Boots, Rumbelows **Woolwich** Rumbelows **LUTON** Dixons, Rumbelows **MAIDSTONE** Dixons, Boots, Rumbelows **MALDON** Rumbelows **MANCHESTER** Orbit, Boots, Dixons **MIDDLESBROUGH** Boots, Dixons **MILTON KEYNES** Rumbelows, Dixons **NEWBURY** Dixons **NEWCASTLE** Boots, Dixons **NORTHAMPTON** Dixons **NORWICH** Dixons, Rumbelows **NOTTINGHAM** Bestmoor, Dixons, Boots **ORPINGTON** Rumbelows **OXFORD** Science Studio **PETERBOROUGH** Boots **PLYMOUTH** J.A.D., Dixons **PORTSMOUTH** Boots, Dixons **POTTERS BAR** Rumbelows **PRESTON** Dixons **RAMSGATE** Dixons **RAYLEIGH** Rumbelows **READING** Dixons **RENFREW** Comet **ROMFORD** Rumbelows, Dixons **RUSHDEN** Computer Contact **SANDY** Electron Systems **SCARBOROUGH** Video+ **SHEFFIELD** Datron Microcentre, Dixons, Video+, Wigfalls **SITTINGBOURNE** Rumbelows **SLOUGH** Boots, Texas Instruments **SOUTHAMPTON** Dixons, The Maths Box **SOUTHEND** Rumbelows, Dixons **ST. ALBANS** Rumbelows **STEVENAGE** Dixons, Rumbelows **STRATFORD** Rumbelows **SUDBURY** Rumbelows **SWANSEA** Dixons **TONBRIDGE** Rumbelows **WALTHAM CROSS** Rumbelows **WALTHAMSTOW** Rumbelows **WARE** Rumbelows **WARRINGTON** Boots **WATFORD** Computer Plus, Computer Centre, **WELWYN GARDEN CITY** Rumbelows **WETHERBY** Bits & Pieces **WOLVERHAMPTON** Dixons **WOODFORD** Rumbelows

You can't get a Home Computer from Texas Instruments under 16 K RAM.



Make the right move into computing with the Home Computer from Texas Instruments. It gives you a large combined RAM/ROM capacity up to 110 K Byte and the ability to expand with a full range of peripherals and software. So as your knowledge of computers increases the TI Home Computer will grow with you.

Just compare the versatility of the TI Home Computer with its price—you'll find it real value for money that will prove to be a good long term investment.

The TI-99/4A is a sophisticated computer designed not only for the beginner with its ease of operation, but also for the professional with its vast computing power through a 16 bit microprocessor. And it simply plugs into an ordinary household TV set.



With its high resolution graphics with 32 characters over 24 lines in 16 colours (256 x 192 dots), 3 tones in five octaves plus noise, and BASIC as standard equipment and options such as other programming languages—UCSD-PASCAL, TI-LOGO and ASSEMBLER—and speech synthesis, you'll find that the TI 99/4A more than compares with the competition. Especially when the starting price is £340 or less. When you want to solve problems there are over 600 software programs available worldwide—including more than 40 on easy-to-use Solid State Software® Modules.

After all, from the inventors of the microprocessor, integrated circuit and microcomputer, it's only natural to expect high technology at a realistic price.



We'll help you do better.

TEXAS INSTRUMENTS

Hewlett-Packard's for Professionals.



Hewlett-Packard's HP-85 personal computer puts full professional computing power wherever you need it. On your desk, in the lab, at home—anywhere! With all the convenience of an easy-to-use, all-in-one computer system.

Not merely a *portable* computer, but a complete, super-reliable system.

The HP-85 is complete in itself. It incorporates a high-resolution video display with editing capability. A whisper-quiet thermal printer for hard copies of display graphics and alphanumerics. A magnetic tape unit with up to 217k bytes of storage

per cartridge. And a QWERTY keyboard, a separate numeric key pad, and eight keys you can define for yourself. Powerful, built-in features—yet HP's extended BASIC language puts them at anybody's fingertips.

Full computing power that tucks under your arm!

The HP-85 weighs only 18 lb (8 kg), and is about the same size as an electric typewriter. Where you go, it goes. When you get there, simply plug in, turn on, and start work.



Extend your capability.

The HP-85 is complete—but also expandable.

Extra memory

If you work with lengthy programs, or large data arrays, simply plug in an optional module to *double* your memory to 32k bytes. And if that's not enough, there's the HP 82900 series of 5¼" flexible disc drives.

Each with 270k bytes, giving fast, random-access, on-line storage.



Extra facilities

There's no shortage of peripherals to add!

With the range of four plug-in interface modules (HP-IB, RS-232C serial interface, GP-IO and BCD) you can connect your HP-85 to a full line of peripherals. There's a whole range of HP thermal and impact printers, as well as the quality HP 7225 graphics plotter, or the HP 9111A graphics tablet.

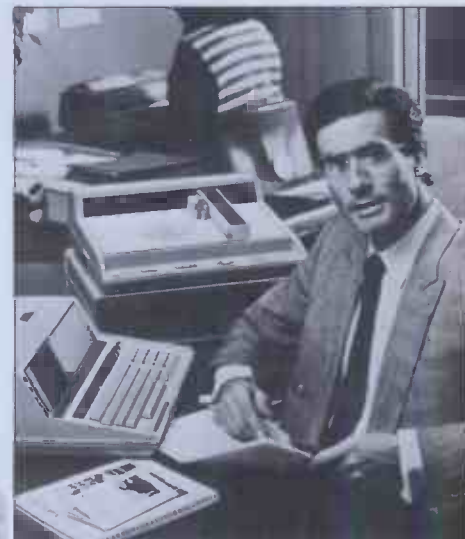

And with the HP-85 peripherals there's no need to write special operating programs—HP's peripheral ROMs do it for you.

Personal Computer The HP-85.

Advanced graphics – the easy way.

The HP-85 can turn the most complex data into easy-to-analyse graphs and plots. It copies anything from the display to the printer with a single command so you can generate an unlimited number of lines, curves, diagrams and designs. From plotting data to drawing and labelling graphs with ease.

And should you need multi-colour or presentation graphics, simply attach the HP 7225 Graphics Plotter to enhance your capability even further.



Get even more out of your HP-85 with Hewlett-Packard's unique software support.

As an HP-85 owner, you are provided with a comprehensive range of software support to make sure you can get the most out of your personal computer.

The Optional Application Pacs, for example, provide a variety of ready-tested programs. From the disciplines of Statistics to BASIC language training... from Mathematics and Finance to computer games. There are even facilities for circuit and waveform analysis, and linear programming. Another software service available to the HP-85 owner is Hewlett-Packard's unique Users Library (covering all Europe). At nominal cost it's designed specifically to encourage and facilitate the exchange of user-generated programs. Its resources cover the widest possible range of scientific and professional activity.

Extra user support

The HP-85 comes complete with the 80' manual. Its high-quality documentation

and easy-to-read style make up 340 comprehensive pages of instructions, programs and examples. Just as simple to follow whether you're the experienced pro. or the first-time user!



Super controller as well

The HP-85 is HP-IB compatible. This industry standard (IEEE-488) allows the connection of up to 14 instruments and peripherals per interface. And not only HP's instruments!

The micro-processor-based interface card handles the complex interfacing task. *So you can concentrate on how to use the instrument, instead of on how to hook it up.* Personal computer one minute – controller the next!



Hewlett-Packard: computers designed for professionals, with professional reliability guaranteed.

Behind the HP-85 computing system is the strength of Hewlett-Packard, one of the world's largest computer manufacturers. This means continuous commitment to quality – and single-source supply, service and support. When you build your personal system around an HP computer, you build in two important extras: first, the legendary Hewlett-Packard long-term reliability; second, the assurance that your entire system can be serviced and cared for on site by the same computer professionals who designed it. Think about a demo – today.



**HEWLETT
PACKARD**

See the HP-85 demonstrated today at

Aberdeen Tyseal Equipment Ltd, Tel: 29019.
Belfast Cardiac Services, Tel: 625566.
Birmingham John Mabon Assoc, Tel: 643 6351.
Microcomputers at Laskys, Tel: 632 6303.
Bournemouth South Coast Business Machines, Tel: Wimbourne 893040.
Brighton Office Machinery-Engineering, Tel: 689682.
Bristol Decimal Business Machines, Tel: 214093, Microcomputers at Laskys, Tel: 20421.
Cambridge Computer Store, Tel: 65334.
Hi-Tek Distribution Ltd, Tel: 81996.
Chester Microcomputers at Laskys, Tel: 317667.
Croydon Datalect Computers Ltd, Tel: 680 3581.
Dublin Abacus Systems, Tel: 951677.
Edinburgh Holdene Microsystems, Tel: 557 4060, Microcomputers at Laskys, Tel: 556 2914, Robox Office Equipment Ltd, Tel: 225 3871.
Glasgow Microcomputers at Laskys, Tel: 226 3349, Robox, Tel: 221 8413/4.
Harlow ITT Instruments Services, Tel: 29522.
High Wycombe Rapid Recall, Tel: 26271/35634.
Kingston Microcomputers at Laskys, Tel: 546 1271.
Leeds Holdene, Tel: 459459.
Leicester Sumlock Services, Tel: 29673.
Lichfield Anglo-American, Tel: 481042.
Liverpool Microcomputers at Laskys, Tel: 236 2828.
London Albata Ltd, Tel: 730 7928, Microcomputers at Laskys, Tel: 636 0845.
Sumlock-Bondain, Tel: 250 0505, 626 0487, 388 5702.
The Xerox Store, Tel: 405 5659, 629 0694, 588 1531.
Manchester Automatic Business Equipment, Tel: 432 0708. Holdene, Tel: Wilmslow 529486.
Microcomputers at Laskys, Tel: 832 6087.
Nantwich Rapid Recall, Tel: 627505.
Newcastle Thos Hill International, Tel: 739261.
Norwich Anglia Computer Centre, Tel: 29652.
Nottingham Microcomputers at Laskys, Tel: 415150.
Preston Microcomputers at Laskys, Tel: 59264.
Reading CSE Computers, Tel: 61492.
Royston (Herts) Electroplan, Tel: 41171.
Sheffield Microcomputers at Laskys, Tel: 750971.
Slough Crellon Microsystems, Tel: Burnham 4434, The Xerox Store, Tel: 176956.
Southampton Maths Box, Tel: 22958.
St. Albans Albata Ltd, Tel: 74361/2.
Sunderland Thos Hill International, Tel: 42447.
Tunbridge Wells D. J. Herriott, Tel: 22443/4.
Watford Automatic & Electronic Calcs, Tel: 31571.
Woking Datalect Computers Ltd, Tel: 69032.
Worthing Office Machinery Engineering, Tel: 207292.
CHANNEL ISLANDS:
The Processor Centre, Tel: Guernsey 28827, The Processor Centre, Tel: Jersey 77070.

Think ahead!

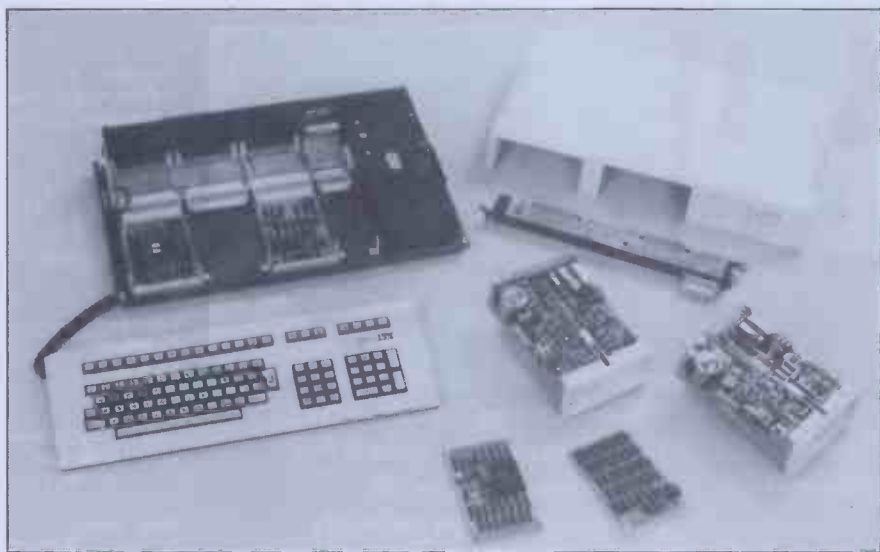

ITT 3030

programmed for growth

The ITT 3030 Microcomputer is the ultimate in modularity of design. Starting with a 64k, Z80A 4 MHz processor with twin 280k 5¼" Floppy disks, the ITT 3030 can be expanded to a 256k 16-bit Intel 8086 processor supporting twin 10 MB Winchester hard disks.

The keyboard features 15 programmable function keys, numeric keypad, and a 12 key Word Processing keypad. The keyboard is "soft" permitting simple customisation of control key functions for differing applications.

The display is 80 chs x 24 lines with an 8 x 12 matrix, upper and lower case with true descenders. The RS232 interface comes as standard.

Hardware Modules.

The ingenious hardware design permits the addition of the following:-

- RS232 adaptors (2 or 4 lines),
- IEEE - 488 Interface,
- Real Time Clock,
- Graphics/Colour Adaptor,
- Parallel Interface.
- S100 Interface,
- TV Adaptor - Colour,
- Monitor Adaptor - Colour.

Keeping Ahead.

By using this unique modular approach, the ITT 3030 is able to keep up with the day to day improvements in the fastest growing technology on earth.

Software.

The ITT 3030 applies the same principles of modularity to its software as it does to its hardware. There is a choice of three operating systems:-

- CP/M, MP/M®
- BOS/5,®
- UCSDpSystem (V.4)®

which support a wide variety of application programs. There is a complete range of Accounting and Business applications available from ITT running under BOS/5 plus a whole variety of business packages designed to run under CP/M. New software is continually being added under both CP/M and the BOS operating systems.

With the ITT 3030 you can confidently think ahead to Multi-user. Networking facilities, advanced operating systems knowing that the modular construction of the ITT 3030 will enable the hardware to keep pace with software innovation.

THINK AHEAD with the ITT 3030.

® CP/M and MP/M are registered trademarks of Digital Research Inc.
BOS is a registered trademark of MicroProducts Software Ltd.
UCSD p - system version 4 is a registered trademark of the Regents of University of California and Softech Inc.



Write or telephone: Ken Mace at ITT Consumer Products (UK) Ltd.,
Chester Hall Lane, Basildon, Essex
Telephone: Basildon 3040 (STD 0268) Telex: 99101

ITT
MICROCOMPUTER SYSTEMS

MicroValue

MONEY SAVERS

MicroValue Exclusive with the exclusive MicroValue 12 Months Warranty*

Software for the Gemini Multiboard System

COMAL 80—The extended BASIC with powerful PASCAL structures at **£100**

GEM PEN—A comprehensive text editor and text formatting package at **£45**

GEM ZAP—A very fast Z80 assembler with comprehensive screen editing at **£45**

ALL THE ABOVE AVAILABLE ON CASSETTE OR DISC.

MicroValue Exclusive

MicroValue's 'Nascom Special'

SAVE OVER £65

We've put together a microcomputer kit containing the Nascom 2, Nas-Sys 3, Graphics ROM, Bits & P.C.'s programmers aid, Gemini 3 16K RAM Board and mini motherboard. The result is a powerful micro using market proven boards and components.

RRP OVER £405 + VAT

MicroValue Exclusive

SHARP MZ80K with Super Graphics

SAVE £200!

The 48K RAM System is offered at a rock bottom price with the Quantum Micros HiRes Graphics which gives resolution down to a single dot and high res. plotting. Characters are user definable and the pixel characters actually join. Five free games packages are included too!

RRP £645 + VAT

MicroValue price

£445 + VAT

SHARP

48K MZ 80K

RRP £460 + VAT

MicroValue price **£345 + VAT**

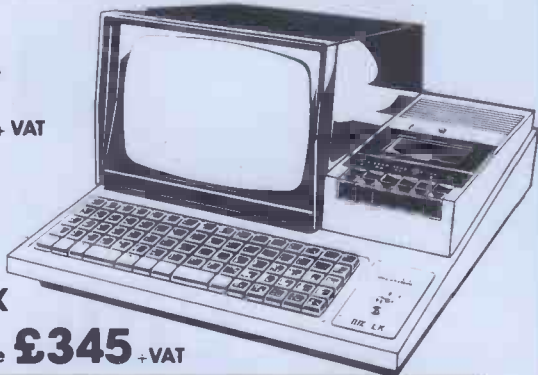

£20 worth of accessories FREE with every Epson Printer

MicroValue price

Epson MX80T	£359 + VAT
Epson MX80FT1	£399 + VAT
Epson MX80FT2	£465 + VAT
Epson MX100.....	£575 + VAT

Buy one of the above Epsoms from MicroValue and we'll give you a Pack of Fanfold paper, Interfacing Document and Connecting Cord for Multiboard or Nascom. The accessories are worth £20 but you can have them absolutely FREE.

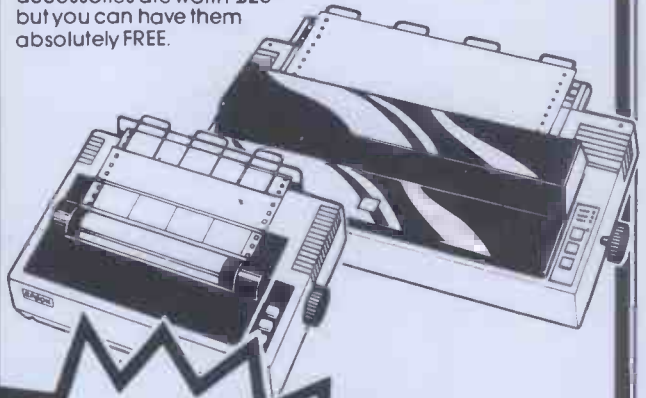

Cheapest Printer in the UK!

Nascom IMP + Graphics Only £199 + VAT

SAVE £156

MicroValue has slashed the price of the 80cps, 80 column IMP dot matrix printer. And added Imprint's high res. graphics and double width character option. IMP has bi-directional printing and friction/tractorfeed.

RRP **£355 + VAT**
MicroValue price **£199 + VAT**

NASBUS Compatible DOUBLE DENSITY Disk System - Available Ex Stock

With hundreds in daily use the Gemini Disk system is now the standard for Nascom and Gemini Multiboard systems. Single or twin drive configurations are available, giving 350K storage per drive. The CP/M 2.2 package available supports on-screen editing with either the normal Nascom or Gemini IVC screens, parallel or serial printers, and auto single-double density selection. An optional alternative to CP/M is available for Nascom owners wishing to support existing software. Called POLYDOS 2 it includes an editor and assembler and extends the Nascom BASIC to include disk commands.

Single drive system (G809, G815/1) **£450 + VAT**

Double drive system (G809, G815/2) **£675 + VAT**

CP/M 2.2 package (G513) **£100 + VAT**

Polydos 2 **£90 + VAT**

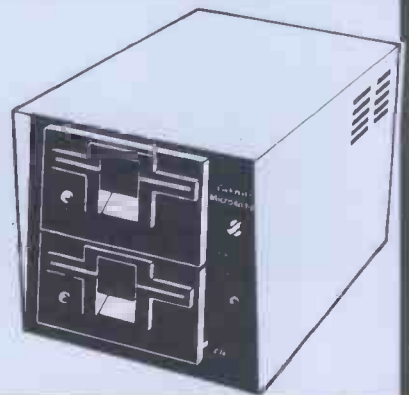

GEMINI GALAXY

A new CP/M system
based on Multiboard

HARDWARE

- * Twin Z80A CP/M System
- * 64K Dynamic RAM
- * 800K Disk Storage (Formatted)
- * 80 x 25 Screen Format
- * Inverse Video
- * Prog. Character Generator
- * 160 x 75 Pixel Graphics
- * Centronics Parallel I/O
- * RS232I/O
- * Light pen interface
- * 59-Key ASCII Keyboard

SOFTWARE

- * Full 64K CP/M 2.2 with screen edit facility
- * Comal-80 structured BASIC
- * GEM-ZAP Assembler/Editor
- * GEM-PEN Text editor
- * GEM-DE BUG debugging software

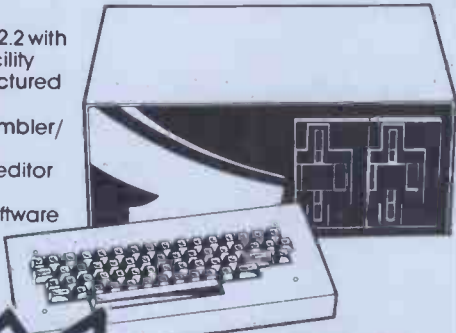

MicroValue Exclusive

MicroValue price
£1,450
+VAT

80 x 25 Video for Nascom

Nascom owners can now have a professional 80 x 25 Video display by using the Gemini G812 Intelligent Video Card with onboard Z80A. This card does not occupy system memory space and provides over 50 user controllable functions including prog character set, fully compatible with Gemini G805 and G815/809 Disk Systems. Built and tested.

MicroValue Exclusive

£140 +VAT

New Software for Nascom Systems

- POLYDOS 1A** disk operating system for use with Nascom 1 or 2 and Gemini G805 Disk Systems. An incomparable and extremely well presented DOS that includes an editor and assembler and adds disk commands to the Nascom BASIC. MicroValue price £90 + VAT
- MATHSPAK** Double precision maths package on tape. MicroValue price £13 + VAT
- MATHSPAK Handler** Used in conjunction with MATHSPAK. MicroValue price £9.95 + VAT
- Command Extender** For use with MATHSPAK it extends BASIC's reserve word list. MicroValue price £9.95 + VAT
- Logic Soft Relocater** An integrated assembler and disassembler package which allows disassembly and reassembly from anywhere on the memory map. MicroValue price £13 + VAT

SAVE MORE MONEY

Standard Firmware for Nascom at Reduced prices

NASPEN	RRP £30 + VAT	MicroValue price £20 + VAT
Nas-Sys 3	RRP £25 + VAT	MicroValue price £20 + VAT
NasDis - D-Bug (EPROM)	RRP £50 + VAT	MicroValue price £30 + VAT
NasDis - D-Bug (TAPE)	RRP £40 + VAT	MicroValue price £20 + VAT
Imprint	RRP £30 + VAT	MicroValue price £20 + VAT
Bits & PCs Prog. Aid	£28 + VAT	MicroValue price £20 + VAT

*MicroValue Warranty

All products, except kits and Nascom Imp, sold by MicroValue dealers are supplied with 12 months warranty and will be replaced or repaired by any dealer (even if you didn't buy it from him) in the group in the event of faulty manufacture.

YOUR LOCAL MICROVALUE DEALER

All the products on these two pages are available while stocks last from the MicroValue dealers listed on right (Mail order enquiries should telephone for delivery dates and post and packing costs.) Access and Barclaycard welcome.



MicroValue

MONEY SAVERS

with the exclusive
MicroValue 12 Months Warranty*

NEW

MicroValue Exclusive

I/O Board for Nascom & Gemini Multiboard Systems

GM816 Gemini I/O board

The new GM816 Gemini I/O board takes a unique approach to the problems of interfacng your Nascom or Gemini Multi-board to external devices. This 80 Bus and Nasbus compatible card is supplied fully built, populated and tested and includes three Z80 PIOs, a CTC and a RealTime Clock with battery back-up. In addition, a range of "daughter" boards that attach straight to the I/O board are under development catering for a wide variety of interfacng requirements.

GM 816 Gemini I/O board
MicroValue price—**£125 + VAT**

Prototyping daughter board
MicroValue price—**£20 + VAT**

IEEE-488

The EV Computers' IEEE-488 card is an 80 Bus and Nasbus compatible card designed to fully implement all IEEE-488 interface functions. This built and tested card gives the user a very cost effective and versatile method of controlling any equipment fitted with a standard IEEE-488 or GPIB interface.

MicroValue introductory price
£140 + VAT

Nascom 3

available from MicroValue

Based around the successful Nascom 2 computer, this new system can be built up into a complete disk based system. Supplied built and tested complete with PSU, Nas-Sys 3 and Nas-Gra.

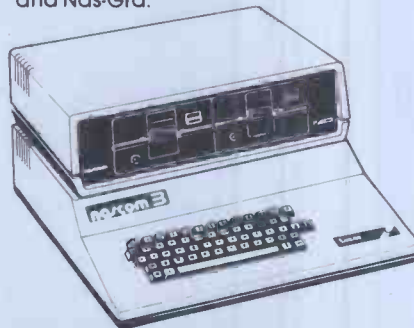

8K system
MicroValue price—
£416 + VAT

16K system
MicroValue price—
£476 + VAT

Dual floppy disk unit (0.7 MB storage)
MicroValue price—
£685 + VAT

CP/M 2.2
MicroValue price—
£100 + VAT

INTERFACE COMPONENTS LTD.
Oakfield Corner, Sycamore Road,
Amersham, Bucks.
Tel: (02403) 22307. Tlx: 837788.

COMPUTER INTERFACING & EQUIPMENT LTD.
The MICRO-SPARES Shop,
19 Roseburn Terrace,
Edinburgh EH12 5NG
Tel: (031) 337 5611

J. V. COMPUTING
700 Burnage Lane, Burnage,
Manchester M19 1NA.
Tel: (061) 431 4866.

ELECTROVALUE LTD.
28 St Judes, Englefield Green,
Egham, Surrey TW20 0HB.
Tel: (0784) 33603. Tlx: 264475.

SKYTRONICS,
2 North Road, The Park,
Nottingham.
Tel: (0602) 45053/45215

TARGET ELECTRONICS
16 Cherry Lane, Bristol BS1 3NG.
Tel: (0272) 421196.

BITS & PC'S
4 Westgate, Wetherby, W. Yorks.
Tel: (0937) 63774.

HENRY'S RADIO
404 Edgware Road, London W2.
Tel: (01) 402 6822.
Tlx: 262284 (quote ref. 1400).

LEEDS COMPUTER CENTRE,
62 The Balcony,
Merion Centre, Leeds.
Tel: (0532) 458877

BUG-BYTE

B.B.C. MICRO **VIC**
ZX81 **ATOM**

B.B.C. MICRO

SPACE WARP The ultimate Star-Trek game — High resolution colour graphics, sound, real time. Probably the most sophisticated Trek type game available. Supplied on cassette together with a 16 page manual, command reference chart and function key labels.

For model B BBC Micro — Price £11.50.

BACKGAMMON Standard Backgammon game for both model A & B. Fast computer responses. Playing instructions included. £8.00.

THE BEEBON A new magazine devoted exclusively to users of the BBC Micro, containing tested programs, features on programming, hardware etc., reviews and much more. At least three substantial programs in each issue, written by professional programmers. Published every two months starting in May. Annual subscription (6 issues) £7.50.

ATOM

Chess	12K	£9.00
747	12K FP	£8.00
Invaders	12K	£8.00
Galaxian	12K	£8.00
Breakout	4K	£4.00
Pinball	6K	£4.50
Star Trek	12K FP	£5.00
Labyrinth	12K FP	£7.00
Backgammon	8K	£7.00
Lunar Lander	12K	£5.50
Golf	6K FP	£5.00
Disassembler	4K	£4.00
Typist	6K	£4.00
Last run	7K	£3.00
2K programs 1,2&3	(each)	£4.50

FP = FLOATING POINT ROM NEEDED

ZX81

ADVENTURES

The Damsel and the Beast	£6.50
Dictator	£9.00
House of Gnomes	£7.00
Star Trek	£5.00

UTILITIES

ZXAS Assembler	£5.00
ZXDB Disassembler/Debugger	£6.50
RENUM Renumbering program	£4.00

GAMES PACKS

Program Pack 1 (1K)	£3.50
Program Pack 2	£3.50
Program Pack 3 (1K)	£4.50
Program Pack 4	£4.50
Program Pack 5	£4.50
Program Pack 6	£4.50
Program Pack 7	£5.00

OTHERS

Constellation	£8.00
Whist	£4.00
Multifile	£17.00
Invaders	£4.00
1K Breakout	£4.50

EDUCATIONAL

Videograph	£7.50
Tables teaching and testing	£6.00

VIC

VICMEN

(For the unexpanded Vic) £7.00

ANOTHER VIC IN THE WALL

(Breakout-unexpanded) £7.00

VICGAMMON

(3K expansion) £7.00

ACCESS/BARCLAYCARD ORDERS ACCEPTED
ON 24-HOUR SERVICE ON 051 227 2642



All prices inclusive. Dealer discounts available.

PLEASE SUPPLY:
NAME:
ADDRESS:

I ENCLOSE A CHEQUE/P.O. FOR:
OR, PLEASE DEBIT MY ACCESS/
BARCLAYCARD NUMBER:
SIGNATURE

**BUG-BYTE, 100 THE ALBANY, OLD HALL STREET,
LIVERPOOL L3 9EP.**

MAZOGS

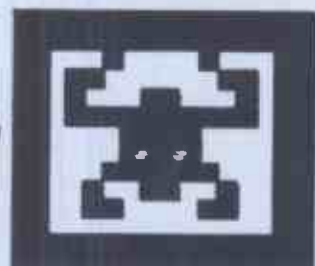

A MAZE ADVENTURE GAME FOR sinclair ZX81

MAZOGS is a brand new game for the 16K ZX81, unlike any other game you've seen on the ZX81. This is without doubt the best game available for this computer, and if you don't believe us, ask somebody who has seen it, or go down to your local computer shop and ask for a demonstration.

MAZOGS is a maze adventure game with very fast-moving animated graphics. A large proportion of the program is written in machine code to achieve the most amazing graphics you have ever seen on the ZX81.

You will be confronted by a large and complex Maze, which contains somewhere within it a glittering and fabulous Treasure. You not only have the problem of finding the treasure and bringing it out of the maze, you must also face the guardians of the maze in the form of a force of fearful Mazogs. Even if you survive their attacks you could still starve to death if you get hopelessly lost. Fortunately, there are various ways in which you can get help on this dangerous mission.

There are three levels of difficulty, and the game comes complete with comprehensive instructions. The cassette on which the game is supplied is of the highest quality, and loading is guaranteed.

Mazogs is available from Bug-Byte and most good computer shops at £10.00 inclusive.

BUG-BYTE SOFTWARE

100 The Albany, Old Hall Street, Liverpool L3 9EP

Please send me

Qty	Item	Price
	Bug-Byte "MAZOGS" Cassette For £10.00 inclusive	

I enclose cheque/P.O.

OR Please debit my:

Access 5224

Barclaycard 4929

Expiry Date _____

Name _____

Address _____

Code _____

Dealers Discounts Available.
ACCESS/BARCLAYCARD
ORDERS WELCOME ON
24-HOUR ANSA PHONE
051-227 2642

PCW-6-82

NEW

Introducing the

BRITISH MADE

ACCLAIM

A TRULY BUSINESS LIKE ALTERNATIVE TO THE **APPLE II**

● RUNS ALL APPLE SOFTWARE

● DOS 3.3

● CP/m

● Pascal

● 6/12 Mbyte Winchester



● 80/40 Column Format

● Apple II upgrades available

● Full Cursor Control

● 12 Programmable Function Keys

Country Computers Ltd

PIPERS ROAD,
PARK FARM INDUSTRIAL ESTATE,
REDDITCH, WORCS. B98 0HU
TEL: 0527 29826

London and Southern enquiries to:

G.B. Computer Products Ltd

14 GREENWOOD GROVE
WINNERSH, WOKINGHAM, BERKS. RG11 5LH
TEL: 0734 791678

ATLANTIC COMPUTER STORE

BUY... RENT... LEASE... BUY... RENT... LEASE...
LEASE... BUY... RENT... LEASE...

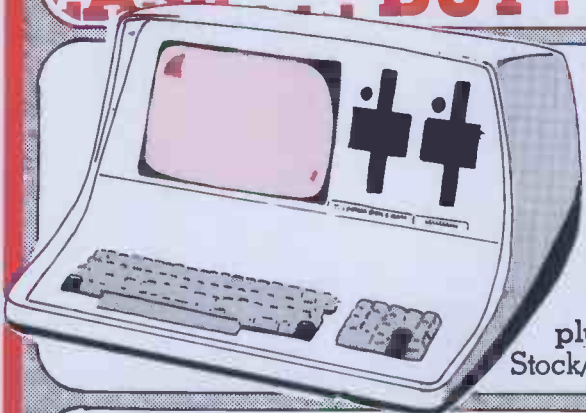

SUPERBRAIN from **£1750** Lease from **£12** per week

WORD PROCESSING offer **£2795**

Lease around **£17** per week
Letter quality word processing
includes 1 Days Training

**ASK FOR
TRADE DESK**

TAILORED BUSINESS SYSTEM from **£30** per week

Fully integrated accounts — Full training
plus maintenance 1 year

Stock/Invoices/Sales Ledger/Purchase/Nominal/Payroll



ACT SIRIUS 1 16 BIT MICRO

- With full accounts Software
- Wide range of application packages available
- CPM Compatible

£2395

TELEVIDEO

Multi-User Multi-Tasking From **£5130**

A MUST FOR
MULTI USERS
will run your
existing cp/m software.



Buy a typewriter which you can use with your computer.
Silver Reed/Olivetti RS232 — Centronics — IEEE interfaces now available.

SPECIAL OFFER

Olympia K.S.R.
£995.00
+VAT



SPECIAL PURCHASE
British micro
64k cpm

Dual Drives 350Kb
per drive

£1350 ex-stock

**THIS MONTH'S
SPECIAL OFFER
PRINTERS**

OKI MICROLINE 80

£269

RICOH 60 C.P.S.

£1295

Free delivery for cash with order

ATLANTIC SERVICE FACILITIES

The company provides full servicing cover throughout the entire country on a 24 hour call-out basis. Additionally, the company has its own hardware engineering team based at the main office in London.

ATLANTIC CONSULTANCY

The Company also retains the services of highly experienced computer consultants who are readily available to design a system to meet your special business requirements.

ATLANTIC TRAINING SERVICES

Atlantic Micro Systems provide a modern, 3,000 sq. ft. professional training centre capable of training up to 250 people a week using the latest teaching aids.
DEALER ENQUIRIES WELCOMED

APPLE II

48K Apples **£650.00**

Double Disk Drives
with Controller
Card **£550.00**

Monitors from **£99.00**

280 Soft Card **£195.00**

Serial/Parallel
Cards **£65.00**

Visicalc 3.3 **£100.00**

Full Range of software — too numerous to mention!



COMMODORE

Commodore 8032

CBM **£755.00**

Commodore 4032 PET

£595.00

Commodore Printer

4022 **£395.00**

Commodore 8050

£795.00

Bags of Software Special Offer

D.M.S. **£200.00**

Visicalc **£100.00**



ATLANTIC

ATLANTIC MICRO SYSTEMS

70-72 Honor Oak Park, London SE23 1DY. ask for Trade Desk.

Telex: 896691 IRG ATLANTIC

Overnight deliveries. Telephone orders

welcome on all credit cards. All prices

are exclusive of VAT and delivery.

ATLANTIC prices subject to dollar

fluctuation.

Tel: 01-699 2202



CP/M-MP/M PAYROLL

£125

INTRODUCTORY OFFER + VAT R.R.P £395

'PAYMASTER'

THE COMPREHENSIVE PAYROLL PACKAGE
FOR COMPANIES LARGE & SMALL
OPERATES ON FLOPPY OR HARD DISK.

Dealer Enquiries also invited

WARWICK COMPUTERS LTD.

MODEL/TYPE: _____

DISK DRIVES: _____

NO OF EMPS.: _____

CONTACT NAME: _____

ADDRESS: _____

BUSINESS SYSTEMS AND SERVICES

King's House, King Street, Bedworth CV12 8LL

Tel: (0208) 317746

Why take risks with accounting software?

Logic Computer Systems specialise in financial management systems on microcomputers.

We provide a comprehensive service which begins when we help you select the right system. But we don't stop there; we also install the computer and train your staff. Then we provide professional on going service and support.

We know that the choice of software is crucial. We recommend only the very best proven software. For instance . . .

Jarman accounting software, designed by Accountants to provide the right information to help you to control your business.

We offer programs for integrated sales purchase and nominal ledgers, payroll and stock control. They are all available for Apple II and Apple III computers.

For further information or a demonstration simply return the coupon or phone 01-222 1122/5492

Please send me details of Logic Computers accounting systems:

Name Title

Company

Address

.

Telephone No.

PCW6



COMPUTER SYSTEMS

31 PALMER STREET
LONDON SW1H 0PR

Great Memories Run In Our Family.

Making your personal IBM
even more valuable.

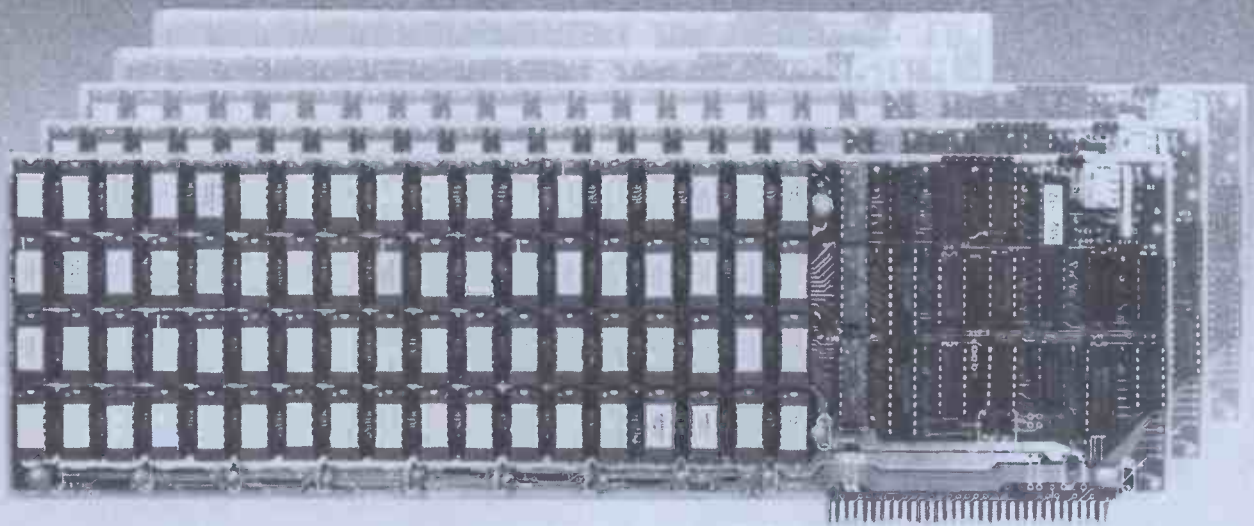

Now E.O.S. offers you and your IBM powerful memory-expansion PCBs with up to 512Kb storage per board.

With these versatile add-ons, you can increase your computer's memory to the highest, practical level of current technology

— and do it with minimal demands on space and power.

Because only the finest-quality materials and construction go into our multi-layer boards, you are assured of both the lowest signal distortion and the best RFI performance.

Mapping ROM makes set-up fast and easy, with a choice of flexible memory configurations.

An you don't wait for delivery. Our five PCB memories are available now—in 64, 128, 192, 256 and

512Kb. Each can be obtained in an expandable version.

Whatever your needs may be, you'll find that our "product-family" approach to memory design and manufacture backs you with total operating-system support—before and after sale.

For complete details on our family's great memories, don't forget to return our coupon.

Dealer inquiries are welcome.

**64K—£255-00 128K—£395-00 192K—£505-00
256K—£575-00 512K—£995-00**

All prices exclusive of V.A.T.

All prices include carriage.

I'd like to know more. Send information on:

- | | |
|--|---|
| <input type="checkbox"/> Memory-expansion boards | <input type="checkbox"/> Future IBM add-ons now in planning |
| <input type="checkbox"/> Disk drives—floppies & hard disks | <input type="checkbox"/> Dealer sales kits. |
| <input type="checkbox"/> Enclosed is my cheque for £ _____ Please rush me one _____ Kb memory board. (Plus VAT.) | |

Name _____ Title _____

Company _____

Address _____

Electronic Office Services (U.K.) Ltd.

29/31 Fleet Lane London E.C.4M 4YA Tel 01-248 6971 Telex 886750 UNIHOR G

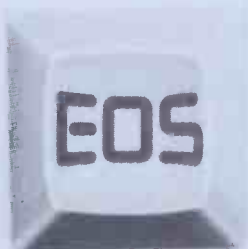

**Electronic Office
Services (U.K.) Ltd.**

29/31 Fleet Lane
London E.C.4M 4YA
Tel 01-248 6971
Telex 886750 UNIHOR G

UK101 — OHIO

BASIC 5 — for UK101 and OHIO

Adds 17 new BASIC words to your Interpreter which can be used in program lines and gives machine-code response speed

HLIN, VLIN, SCR, BLK, SET and TEST allow high speed generation and manipulation of graphics

PRINTUSING, PRINTAT, INAT allow total control of screen input/output

GET (key), RD (Read DATA), GS and GT (GOSUB and GOTO a variable), GO and GO\$ (GOTO a machine code routine), allow total program flexibility

WI and CWI allows CEGMON screen manipulation.

BASIC 5 is available for CEGMON, MONO2 and SYNMON/MONO1 only. State precisely your computer and monitor when ordering. Comes complete with comprehensive manual.

Available on DISK or in EPROM (9000 hex) £19.95

TOOLKIT 2 FOR UK101/OHIO

The most powerful TOOLKIT on the market, TOOLKIT 2 gives the following facilities in only ONE EPROM:

REPL exceptionally powerful Global Search and Replace of BASIC listings.

DUPL copy a line into a new line

LIST/ controlled listing of program

FIND anything in a BASIC listing

RENUM renumber from any start in any increment — full error messages, totally reliable

AUTO any start, any increment.

DELETE high-speed block line delete

VIEW cassette dump verification

TRACE superb trace feature — screen transparent MC enter the monitor quickly!

TOOLKIT 2 also lists on error and cures the warm start 'OM ERROR' bug.

Available in EPROM only (800hex), for CEGMON, MONO1 & 2, and SYNMON monitors (DISK soon),

Price £19.95. State machine & monitor

SPECIAL OFFERS

TOOLKIT 2 + MINI EPROM BOARD £29.95

BASIC 5 + MINI EPROM BOARD £29.95

CODEKIT + MINI EPROM BOARD £29.95

WORD WIZARD + MINI EPROM BOARD £29.95

SOUND/VIA — Base, Sound and VIA kits £43.95

FLOPPY DISK CARD

UK101/OHIO

The Premier F.D.C features:-

Integral Data Separator or

link-selectable for on-drive separator if required

Supports 4 x single-sided 5.25 or 8in drives or

2 x double-sided 5.25 or 8in drives

1 or 2mhz operation (DOS permitting)

Interrupt linkable if required

Padding for future options

Shugart Bus supplied

Linkable to other Bus requirements

providing signal compatibility is maintained

OSI SYSTEM COMPATIBLE (SOFTWARE and HARDWARE)

Drives available early March

PRICE £49.95 Delivery — March

SOUND/V.I.A BOARD

The TES II VIA/SOUND kit gives you up to 56 Input/Output lines and programmable sound generation. In order to allow total flexibility, we are offering the kit in low-cost packs.

The Base Kit consists of PCB, connector, address decoding and buffering, plus IC sockets.

The Sound Pack consists of AY-3-8910 sound chip, amplifier and components.

The VIA pack consists of VIA and support.

BASE KIT £24.95 SOUND £11.95 VIA £9.95

SCREEN ENHANCEMENT KIT

This kit offers 20 software selectable screen formats for the UK101/OHIO, including a true 32 x 64 format. It plugs directly into the main board (OHIOs need sockets inserting) and provides almost every available screen format for ultimate software compatibility.

PRICES KIT £55.95 BUILT £69.95 (+ 2.00 P&P)

Fitting service available.

PREMIER DISK SYSTEM

PREMIER PUBLICATIONS are proud to announce that we can now supply a complete disk system for any UK 101/OHIO machine. The system consists of Floppy disk card, single and double disk drive units, ROMDOS, cables, etc.

DISK DRIVES

Premier's disk drives come complete in an attractive box containing drive(s) and integral (240v) power supply. No additional PSU is required. Main features:-

- Ultra-reliable drives
- Capable of running in single or double density mode
- Storage Capacity — 80K (or 90K under PREMIER FORTH)
- Transfer rate — 125K bits per second
- Units are user address-selectable — up to four may be daisy-chained
- Shugart Standard Interconnections
- Integral power supply
- LED 'drive running' indicator
- DELIVERY Immediate

Prices (VAT inc)

Single Drives	£229.95
Dual Drives	£379.95
Floppy Disk Card (kit)	£49.95
(built & tested)	£67.95
Single Disk Cable	£9.95
Dual Disk Cable	£15.95
(cables free if FDC & Disk Unit(s) purchased together)	

NOTE!! P&P on the above drives is £10.00 extra per order.

LINK 65

This superb new suite of routines for the OS65D and ROMDOS disk system will simplify your disk operations enormously. The new commands are all called from BASIC, and being written in machine code, do not cause the loss of the resident BASIC program. No longer do you have to put your BASIC Program in a temporary store while you create the correct track length file for it — simply type DISK! DU PROG 1 and LINK65 will create a file for the program and then dump it onto disk.

Finding the contents of a disk has up to now required a BASIC program to be called — DISK!DD will almost instantly produce a neat, double column listing of your disk contents without disturbing resident programs.

Indirect files now become a Simple command — you can have two BASIC programs in workspace at once, use either one or merge them into one program.

In addition to the above features, LINK65 also produces FULL disk error messages, not simply a number which you have to look up!

All of LINK65's routines can be used either from BASIC, the Assembler or the kernel.

LINK65 comes complete with user-booklet, PRICE £17.95inc. State OS65D or ROMDOS when ordering, plus machine type.

ROMDOS

ROMDOS has been commissioned and written specifically for the PREMIER UK 101/OHIO Disk System. It is principally aimed at the user with a small capacity RAM machine, but is also extremely useful for the larger RAM machine user since it allows BASIC programs to run with disk with little or no alteration. ROMDOS links the standard BASIC-in-ROM with a disk controller program so no RAM memory is used for the BASIC interpreter AND UNDER 4K for ROMDOS, giving an 8K saving in memory over the normal OS-65D system. The BASIC IN ROM continues to work at its normal high speed and is enhanced by a wide range of disk commands. The system is compatible with ALL standard Premier EPROM upgrades such as BASIC 4, BASIC 5, and TOOLKIT2. ROMDOS comes as a two disk set with complete documentation. PRICE £19.95

POSTAGE & PACKING Software 75p per order, EPROMS/DISKS 95p per order, HARDWARE £POA.



Premier Publications

208 Croydon Road, Anerley, London SE20 7YX. Telephone 01-659-7131



INNOVATIVE TRS 80-GENIE SOFTWARE

from the professionals

MEMDISK

ADDITIONAL DISK TYPE STORAGE FOR UNDER £30!!

One of the most fantastic utilities to hit the market in many a day! MEMDISK literally creates a disk drive type storage in RAM. It uses many of the extensive sophisticated features of LDOS in order to achieve this miraculous effect! When the "drive" has been created it may, in general, be used as any other drive. Commands such as COPY, BACKUP, FREE, DIR, SAVE, LOAD and DUMP may all be utilised.

Memdisk is an absolute boon for the single drive user. Files may be copied from his single drive to the drive in memory, disks changed and then copied back. To coin a phrase — the applications are only limited by the imagination of the user whether you have one drive or more — after all, you always need another!

There are, of course, some limitations. Chiefly, that the maximum size of storage is 27K usable. The other side of the coin is that this space is user selectable from 1.5K to 27K. Tracks may be set up in 1.5K or 3K blocks.

Memdisk may be used with Double Density drives without any problem, although the memory drive itself, of course, cannot be double density. To assure reliability, Memdisk tests the RAM area which it is going to use before it installs itself.

Best of all, a Memdisk drive is faster than any floppy drive available and it is even faster than many hard disk drives. Memdisk involves no additional hardware of any sort. There is nothing to align, nothing to clean and nothing to break. It's all software.

Memdisk is available for all Genie machines and the Tandy Model 1 and Model 3. It requires a minimum of one drive 48K RAM and LDOS.

Memdisk £ **29.45** inclusive



MOLIMERX LTD

A J HARDING (MOLIMERX)



1 BUCKHURST ROAD, TOWN HALL SQUARE, BEXHILL-ON-SEA, EAST SUSSEX.

TEL: [0424] 220391/223636

TELEX 86736 SOTEX G

TRS-80 & VIDEO GENIE SOFTWARE CATALOGUE £1.00 [refundable] plus £1 postage.



INNOVATIVE TRS 80-GENIE SOFTWARE

from the professionals

LDOS

VERSION 5.1 THE TRS-80™ OPERATING SYSTEM MODEL I AND III

- * DOUBLE Sided & DOUBLE Density support.
 - * AUTOMATIC Density recognition.
 - * 35, 40, 77, 80 and any other track counts are supported.
 - * All available drive stepping rates are supported.
 - * Hard Drive support, can be HANDLED AS A SINGLE DRIVE.
 - * Hard drive partitioning, one drive can act as up to six.
 - * Intermix 5", 8" and Hard drives, up to a total of 8 drives.
 - Compatible with the Model I Radio Shack Expansion Interface.
 - Upward compatible with TRSDOS (2.3 & 1.2 as documented).
 - Fully supports Microsoft language products for the TRS-80.
 - Complete media compatibility Model I to Model III and back.
 - Full support for LOBO's LX-80 interface.
 - Full support for AEROCOMP LC double density controller (DDC).
 - Full support for PERCOM's DOUBLER II.
 - Complete documentation (well over 250 pages).
 - Complete technical information.
 - A Quarterly LDOS users magazine (The LDOS QUARTERLY).
 - A liberal update policy.
 - An enhanced BASIC (LBASIC) including:
 - > Upward compatible with Microsoft Basic.
 - > High speed LOAD and SAVE.
 - > Run multiple programs with common variables.
 - > BLOCKED (variable length) files are supported.
 - > DOS commands may be executed from LBASIC.
 - > Built in string array. SORT.
 - > Single stepper for debugging.
 - > Several new statements and file modes.
 - A compiled JOB CONTROL LANGUAGE (JCL).
 - CONVert utility to move files from Model III TRSDOS.
 - An Extended Debugging and Monitor program (with disk access).
 - CMDFILE for movement of disk and/or tape system (/CMD) files.
 - Device independent operation.
 - Full LINKing, ROUTEing, FILTERing and SETting are supported.
 - MiniDOS feature for constant access to certain DOS commands.
 - RS-232 DRIVER for serial support.
 - Sophisticated communications software included.
 - Wildcard characters and partial Filespecs are supported.
 - DATED FILES, show when a file was last written to.
 - Backup: Mirror, by Class, if Modified, by Date, by Extension, etc.
 - Selectable PURGE for fast disk "cleanup" of unwanted files.
 - Print formatter, for control of printer output.
 - Built in printer SPOOLER, to both disk and ram.
 - Joblog to record all system operations with time stamps.
 - UPPER and lower case support, throughout the system.
 - Blinking cursor with selectable cursor character.
 - 128 character TYPE AHEAD buffering for keyboard input.
 - Assign strings to individual keys with Key Stroke Multiply (KSM).
 - SUPER FAST operation with the SYSRES feature.
 - Extensive user control and system feedback.
 - Advanced PATCH utility for easy maintenance.
 - Complete transportability of software among all Z-80 LDOS systems through the use of the LDOS high ram supervisory call system (SVC).
- * Specific hardware is required to use these features.

LDOS for TRS-80 I/III and all current Genie machines
£85.00 + V.A.T. and P & P £3 Recepted Parcel Post



MOLIMERX LTD A J HARDING (MOLIMERX)

1 BUCKHURST ROAD, TOWN HALL SQUARE, BEXHILL-ON-SEA, EAST SUSSEX.

TEL: [0424] 220391/223636

TELEX 86736 SOTEX G

TRS-80 & VIDEO GENIE SOFTWARE CATALOGUE £1.00 [refundable] plus £1 postage.



Cards
Welcome



Buy it with Access

ANGLO AMERICAN SOFTWARE

UK DISTRIBUTORS FOR AUTOMATED SIMULATIONS

HELLFIRE WARRIOR

The sequel to the best-selling "Temple of Apshai," "Hellfire Warrior" gives you the challenge of more command options and more detail than you've ever imagined!

Four new levels with sixty rooms each will test the character of the most experienced, the most intuitive, the most intelligent adventurer. On Level 5, you'll have to outfit giant insects to stay alive. On Level 6, you'll discover that it's as much a puzzle to solve as a dunjon to explore — because the only exit is hidden somewhere within the complicated labyrinth. On Level 7, you're constantly trying to escape from skeletons, ghouls, mummies, and even invisible ghosts. But the culmination of your adventure is on Level 8, an underworld haunted by lost souls, guarded by dragons, riddled with bottomless pits and blasts of hellfire

The object of your journey is to rescue the warrior maid Brynhild, to bring her back to sun and air, to break the spell that binds her.

But all is not lost, because "Hellfire Warrior" includes an Armory where you'll bargain for 5 kinds of swords, 5 types of armour, shields in 2 sizes, for bows and arrows. You can visit the Apothecary and buy healing salves, 13 potions available by the vial or draught. You can enter the Magic Shoppe and turn ordinary weapons into enchanted ones.

To say that the challenges are great in "Hellfire Warrior" is the ultimate in understatement!

Price £19.50 cassette
£22.50 disk

CRUSH CRUMBLE AND CHOMP!

Just Released

Breathe fire, terrorize cities, snack on a horrified populace, and further develop your villainous personality, CRUSH, CRUMBLE, and CHOMP!

Is there a particular city against which you crave to wreak revenge? Do you have a grudge against the Golden Gate Bridge? Lunch on San Francisco, then. Can't control your burning desire to consume the Pentagon? Dine on Washington, D.C. Fed up with cheap imports? Tokyo, perhaps. Do you hunger for the Big' Apple? Munch on New York.

Be the deadly amphibian who longs to leave trails of poisonous nuclear pollution, simultaneously smash street cars with a single blow of your scaly tail, lunch on helpless humans, and radiate a ray of death from your malevolent eye.

Or would you like to be, perhaps, not even of the fallible flesh but, rather, of horrendously heartless steel? A lifeless, but life-like mechanical gizmo preprogrammed by zero population-growth professionals for the destruction of all things earthly.

If you were a giant winged creature, think of the aerial attacks you could make on the terrified but tasty titbits beneath you.

Take on the persona of any of six demonic beasties (even more for those who have a disk). Select from four mouth-watering metropolises and five different objectives, over 100 possible scenarios, complete with graphic mayhem and the resounding thunder of your monstrous presence, await your beastly appetite.

But wait! The National Guard is out to get you. The local police are sworn to your destruction. Even as you read this, a secret weapon is being readied against you by mad and skillful scientists. Are you truly prepared to face helicopters, tanks, artillery, and more, driven by those who are literally dying to get at you?

Sooner or later humanity will triumph. . . maybe. Or maybe vengeance will be yours.

Price £15.50 cassette
£17.75 Disk

TEMPLE OF APSHAI

Now, you can enter a universe in which quick wit, the strength of your sword arm and a talisman around your neck might be what separates you from a pharaoh's priceless treasure — or the death-grip mandibles of a giant mantis.

Enter the "Temple of Apshai," the first in our DUNJONQUEST series, the computer game that offers you the chance to undertake heroic acts in a labyrinth filled with treasures, traps and monsters.

"Temple . . ." is a role playing game (RPG) that catapults you into a world of magic and monsters doomed cities and damsels in distress.

More than a game, it's an alter ego experience. In an RPG, complex factors

that make up a human being are abstracted into a few basic characteristics: strength, constitution, dexterity, intelligence and ego. Via your role playing character, you'll venture into an essentially unknown world, and be at home with the likes of skeletons, zombies, spiders and wraiths.

When you play the "Temple of Apshai," you'll be both a character within and a reader of the epic you're actually helping to create. In this labyrinth, the choice is always yours. . . fight or flee, parry or thrust, slay the monsters or see if they'll listen to reason.

Price £19.50 cassette
£22.50 Disk

DEATH MAZE 5000

Price £14.75 cassette

A new breed of adventuring! Venture through a graphically represented 3-D maze, with halls that could dead end — or recede to infinity. Step through the doors or drop into the pits. Will you encounter monsters and mayhem, or will you be treated to useful objects and information? Will you ever get out alive?

LABYRINTH

Price £11.75 cassette

A nightmare of an adventure in graphically depicted three dimensions. Corridors stretch toward infinity right on your TRS-80 screen as you search this maze for treasures. If you get the feeling you're not alone, it's because you're not!

You use the arrow keys, plus two-word commands to move, manipulate objects and avoid the many pitfalls (pun intended) that await you in Labyrinth.

ASYLUM

Price £13.75 cassette

You are sitting alone at 2 am. Your eyes are bloodshot as you peer into your computer's screen and cry, "I must be CRAZY!" If this has never happened to you, you've never tried ASYLUM. It's Med Systems most ambitious 3-D graphics adventure yet!

ASYLUM places you on a cot in a small (padded?) room. Periodically the janitor lob a hand-grenade through the window. What you do next could mean escape — or disaster.

SEND 75p FOR FULL CATALOGUE

Refundable against purchase
Dealer Enquiries Welcome

ANGLO AMERICAN SOFTWARE CO.
138a Stratford Road
Sparkhill
BIRMINGHAM B11 1AG
021-771 2995



24 hour ansaphone

**the vic
centre**

Big savings for starters

If you're looking for a home computer, you'll already know that the VIC does it all. To help you get started, we have put together this attractive cost-saving package.



VIC-20 Colour computer

- + Cassette Deck
- + 10 Blank Cassettes
- + Introduction to Basic Part 1
- + User Manual

- + 12 months warranty
- + Fitted 13 amp plug

for only

£ 212

(price plus VAT £243.80)

NEW

Convert your VIC to a 40 Column 32k machine with this exciting new add-on
 32k RAM Expansion + 40 column screen format **£199.95 plus VAT**
 40 column screen format only **£99.95 plus VAT**

Dot Matrix Printer

Tractor feed, 80 characters per line at 30 characters/seconds.
£199.96 plus VAT

Memory Expansion Board

Multi-slot unit used to accept memory and/or game and program cartridges
£85.00 plus VAT

Plug-in Memory Expansion Cartridges

3k - **£26.04**, 8k - **£39.09**,
 16k - **£65.17 plus VAT**
Single Drive Floppy Disk Unit
£395.00 plus VAT

The standard features of the Vic are: ★ 5K RAM expandable to 32K ★ 16 screen colours ★ 8 character colours ★ 3 tone generators, each of 3 octaves - plus white noise generator ★ Screen display 22 characters x 23 lines deep ★ Full PET type graphics ★ High resolution graphics capability ★ 8 programmable special functions.

Goods required

Price

Add £4.00 post, packing and insurance for special deal and £1.00 post, packing and insurance for all other items. Add 15% to all prices for VAT

Total £

Name: _____

Address: _____

MAIL ORDER to: Adda Home Computers Ltd.
 FREEPOST, London W3 6BR or telephone your order (24 hours a day) to 01-992 9904 quoting your Visa, Access or American Express number.

* I enclose a cheque, made payable to Adda Home Computers Limited for
 £

* Please charge my Visa/Access/American Express account. My account number is

* Please add my name to your mailing list
 * Delete as applicable

Date

SHOP ADDRESS: Adda Home Computers Ltd.
 154 Victoria Road, Acton, London, W3.
 (near North Acton tube station)
 Tel 01-992 9904
 OPEN: 10am-6pm (Tuesday-Friday),
 10am-5pm (Saturday).

TERMS AND CONDITIONS: All goods sold subject to Adda terms and conditions of sale. Full details available on request, but include: 7 day money back guarantee, Adda 12-month hardware warranty. Please allow 21 days for delivery. Allow 7 days for personal cheques to be cleared. Quoted prices are exclusive of VAT.



WHAT'S the CATCH?

HOW COME THESE PRICES ARE SO LOW?
There is no catch except — you always catch a good deal at DEANS



SHARP

Apple II + 48K	£639.00	PC 1500	P.O.A.
Disk Drive + controller	£329.95	PC 1211 Pocket Computer	£59.95
Disk Drive	£289.00	CE121 cassette interface	£10.95
16K Ram Card	£60.00	CE122 printer	£54.95
Pascal System	£239.95	CSR700 paper roll (40)	P.O.A.
APPLE SOFTWARE			
Visicalc (3.3)	£99.00	MZ80K	
Visiplot	£95.00	MZ80A	P.O.A.
Visidex	£99.00	(New arrival)	
Visitrend/plot	£135.00	MZ80B	P.O.A.
Apple World	£29.95	MZ80K computer 48k	£329.00
Apple Writer	£34.95	MZ80 FD dual disk	£550.00
Desk Top plan II	£105.00	MZ80 P3 dot printer	£350.00
DOS plus	£19.95	MZ80 F1/0 disk interface	£49.95
Aplus	£19.95	MZ80 F15 disk cable	£8.00
Apple guard	£19.95	MZ80 1/0 expansion box	£94.00
		MZ80T20C machine language	£18.00

WORD PROCESSING

Apple writer (I)	£34.95
Apple writer II (80 col)	P.O.A.
Magic window	£59.95
Mailmerge (80 col)	£60.95
Wordstar	P.O.A.

MONITORS

12" green screen	£115.95
9" b/w monitor	
9" b/w Hi-Resul	£115.95

COLOUR MONITOR

14" JVC PAL/SECAM/MTSC	£299.95
------------------------	---------

Eurocolour Card	£69.00
Integer Card	£95.00
Language card	£97.50
Parallel Interface card	£87.00
Communication card	£99.00
Centronic card	£99.00
High speed serial card	£94.50

PRINTERS

Silentype	£190.00
Centronic 737	£345.00
Paper Tiger 445	£490.00
Epson	
MX80 T2	£399.00
MX80 FT/1	£395.00
EPSON/Sharp	£65.00
EPSON/Sharp Disk	P.O.A.

GAMES

Space Warrior, Alien Rain	All
Snoggle, Galaxy Wars,	at
Alien Typhoon, Cribbage	
Galactic Empire	£12.95
Star Mines, Apple Panic	All
Tarturian, Tawala's	at
Creature Venture	£14.95
Star Thief, Missile Defence	All
Epoch, Soft Porn Adven.	at
The Wizard & the Princess	
Threshold,	£17.95
Sneakers,	
Oldofo Revenge	
Pegasus II	

MZ80T Assembler	£35.00
VIDEO RECORDERS	
Sony SLC5	£390.95
Sony SLC7	£548.10
JVC HR7200	£451.53
JVC HR7300	£477.95
AKAI V55	
FLOPPY DISK	
5¼" Verbatim SS/DD	£2.30
5¼" Verbatim SS/DDX10	£19.95
5¼" Verbatim OS/DD	£2.60
BOOKS	
Apple	
Apple II Ref Manual	£11.00
6502 assembly language	£12.10
DOS 3.2 manual	£6.00
Apple II basic tutorial	
Pascal reference manual	£8.50
ZX81	
Getting Acquainted with your ZX81	£5.95
Mastering machine code on your ZX81 or 80	£5.95
The Gateway Guide to the ZX81 and ZX80	£5.95
49 Explosive Games for the ZX81	£5.25

Most of our prices are heavily discounted therefore please send cheques payable to DEANS Credit-card Sales add 3% Add 15% VAT Postage and Packing free on books + Software.

SPECIAL OFFER ON PRINTERS FROM PRESTON COMPUTER CENTRE

EPSON MX-80T/2 (Graphics) Tractor Printer

£319
List price £399

with high resolution graphics.

Features:- * 9 x 9 matrix with true desenders
* 80 CPS bidirectional logic seeking
* 80 Columns with condensed, emphasised and enlarged characters (40,66,80 & 132 chrs/line)

£359
List price £445

EPSON MX-80FT/2 (Graphics) Friction and Tractor printer

* All features of MX-80T
* Three way paper handling

PRINTER INTERFACE CARDS AVAILABLE NOW

IEEE 488 interface with cable	£55.00
Apple II with cable (graphics)	£69.00
TRS 80 Bus interface with cable	£49.00
RS232 with 2K FIFO (High res)	£85.00

ANADEX DP9501 with 2K buffer

£875
List price £1090

* 10,12.5,15 & 16.7 characters per inch
* 7 x 9 or 11 x 9 matrix printing bi-dir.
* 132,158,165,176,198 or 200 Columns
* 50 to 200 lines/Min - 120 to 200 Chrs per sec.
* High density graphics

Apple/Anadex graphics card **£99.00**
List price £140

All prices exclude VAT at 15% and carriage at £5 per unit.
Send all cheques and postal orders made payable to:

PRESTON COMPUTER CENTRE

6 Victoria Buildings, Fishergate, Preston PR1 2NJ.
Telephone: 0772 57684

DEANS of Kensington

191 KENSINGTON HIGH STREET, LONDON W8
Tel: 01-937 7896 ext 8.
Open MON to SAT (9.30am - 6.30pm)

Buy our
£475*

**Electronic Typewriter
and you have a
Daisy Wheel Printer
for your computer
absolutely FREE**



The T/Printer 35 is a superb portable typewriter that also doubles as a computer printer. It's the first electronic typewriter that's truly portable (it weighs only 17 pounds and is supplied with an ABS carrying case) and has all the features you'd expect of an electronic office typewriter. Except price.

Features include self-correction, dual function 100 character keyboard, triple pitch (10, 12 and 15 characters per inch), up to 12 in. wide paper—all with excellent print quality. And with Olivetti reliability.

Best of all, when you're finished using it as a typewriter, it's all set to go to work as a word processing quality computer output printer.

That makes the T/Printer 35 about the most versatile and cost effective piece of equipment you can buy. You get all the advantages of having a daisy wheel printer *and* electronic typewriter in a compact unit. And at one low price of £475*, including carrying case.

**The T/Printer 35 costs £475 with Centronics compatible parallel interface. With RS-232C interface it costs £535. Prices listed are exclusive of VAT.*

DATARITE

Datarite Terminals Ltd
Caldare House
144-146 High Road
Chadwell Heath, Essex RM6 6NT

Tel: 01-590 1155

Buy our
£475*

**Daisy Wheel Printer
for your computer
and you have an
Electronic Typewriter
absolutely FREE**



The T/Printer 35 is the lightest weight and lowest cost daisy wheel printer you can buy for your computer. So it will fit within your budget and you can carry it wherever you take your micro. Yet it is tough enough to give years of reliable service. Interchangeable typefaces (standard Olivetti 100 character daisy wheels), variable pitch, multiple copies—all the features you would expect of more expensive word processing printers.

Yet the T/Printer 35 costs only £475 with parallel interface. Operating speed under computer control is approximately 120 words per minute of letter perfect output. What typist can equal that?

Then when you're finished using it as a computer printer, the T/Printer 35 is ready to go right on working as an electronic typewriter.

That's the dual-purpose T/Printer 35—the versatile computer printer that fits your budget.

Orders are shipped within the UK carriage-free. To order or for more information about the T/Printer 35:

DATARITE

Datarite Terminals Ltd
Caldare House
144-146 High Road
Chadwell Heath, Essex RM6 6NT

Tel: 01-590 1155

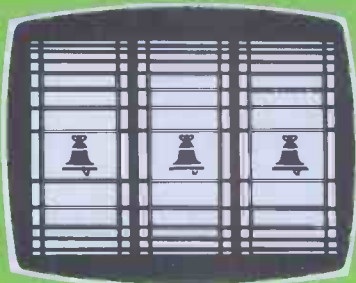

1. FRUIT MACHINE:

This is a computer version of the popular "one armed bandit", with three reels, Nudge reel, and Hold, Nudge and Gamble functions. Incorporating the VIC's normal graphics, colour and sound, it requires an expanded VIC (3/8/16K).

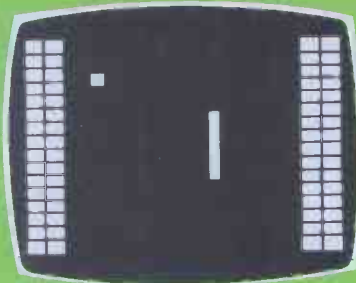

2. BRICKDOWN:

A variation on the game "BREAKOUT"; using the keyboard or a joystick controller manoeuvre the bat to try to break through the right hand wall, while protecting the left wall. Requires basic or 8K VIC.

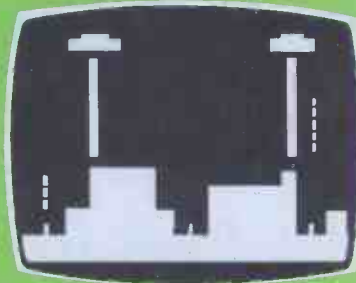

3. BLOCKADE:

Using joystick or keyboard, control your missile base to destroy incoming enemy missiles and protect your fuel dumps. Game ends when you are hit or all fuel dumps destroyed. Uses defined graphics, colour + sound. Runs in basic VIC only.

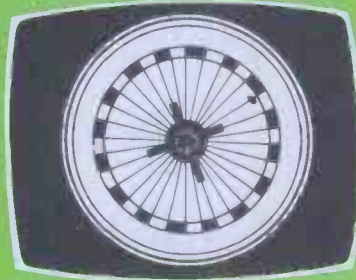

4. ROULETTE:

Complete with accurate full colour "MONTE CARLO" roulette table, you can break the bank without risk of personal loss! Complete with list of odds and allowed bets, you are given £5,000 to play with. Game ends when you lose your shirt. Runs in any VIC, with colour and sound.



5. HANGMAN:

Play the computer at this version of the popular pen + pencil game. The VIC has a built-in vocabulary of 50 words, to which you can Add, Delete or Replace your own words. Addictive, with colour + sound. Runs in any VIC.



6. TARKUS:

With the joystick or keyboard, control the stretcher bearers to pick up the wounded men, and return them safely to the red cross base. If you are hit by an enemy missile, however, you join the wounded, on the field! Challenging and addictive, with defined graphics, colour + sound. Runs in basic VIC only.

**'VIC 6' VOL 2.
PREVIEW AT
COMMODORE
SHOW!**

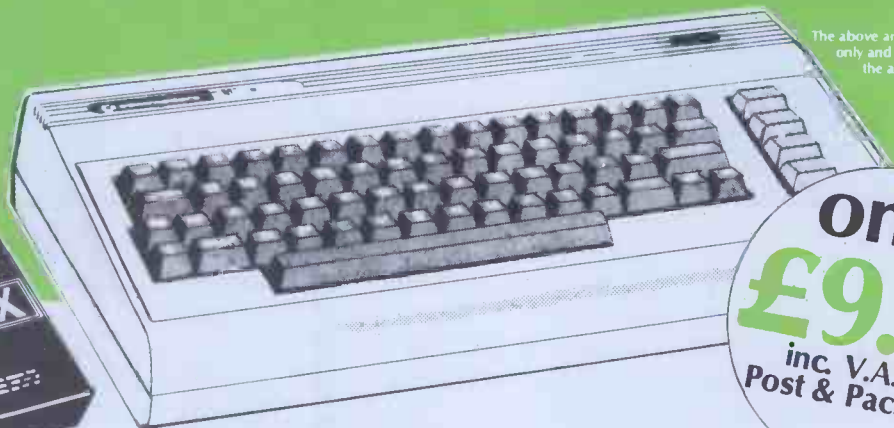

The above are artists impressions only and do not represent the actual displays.

**only
£9.95**
inc. V.A.T. &
Post & Packaging

BEELINES VIC 6 SIX VOL 1

The Games System in a Cassette!

At last! A really professionally produced piece of games software that will guarantee you hours of fascinating thrills on your VIC computer. The first volume of the 'Beelines VIC 6' gives you exciting colour, arcade quality games that make full use of the power and display quality of the VIC.

The 'VIC 6' is attractively priced so that no VIC user need be without it, and it is available exclusively from Beelines. Just send £9.95.

So fill in the coupon, or phone us with your credit card number, and the 'VIC 6' will be yours within days!



BEELINES (Bolton) LTD
FREEPOST (No stamp required) Bolton BL3 6YZ
Ansaphone (0204) 385299
Reg. office: 124 Newport St., Bolton BL3 6AB.
Dealer enquiries welcome.

Please send me:

Qty.	Item	Price
	Beelines 'VIC 6' Vol. 1 at £9.95	

I enclose cheque/P.O.

OR Please debit my:

Access 5224

Barclaycard 4929

Expiry Date _____

Name _____

Address _____

Code _____

Tel. (day) _____

Official orders welcome - we will ship to approved account holders on receipt of firm order. Delivery free within mainland UK. Access and Barclaycard welcome.

Telephone answering machine for 24hr/7 day credit card orders 0204 385299
Freepost: Beelines, FREEPOST, Bolton BL3 6YZ

PCW-6-82



CODE EXPANDS TO FIT THE SPACE AVAILABLE

When developing a system you know how one good idea follows another until CRUNCH, the system has run out of store. Then good ideas have to be sacrificed to make the system fit onto the available hardware, and your skills have to be diverted to finding compromises and making unsatisfactory choices.

IMAGINATION BECOMES PRACTICAL WITH BCPL CINTCODE

Imagine being able to compress your code effortlessly into half the space it now uses, the result would be a better, more comprehensive, and more competitive system - often developed in less time.

Imagine having the power and freedom of assembler in a high level language which is easily transferred to new computers.

Imagine using better development aids than those normally available on mainframe computers.

A WELL DESIGNED PRACTICAL LANGUAGE

BCPL is a modern well structured language, easy to learn, easy to write and easy to read. It is related to Algol and Pascal, but is particularly strong in solving the practical problems of real computer systems. Thus BCPL specifies input and output, provides for separate compilation, and supports very efficient implementations. Portability was an important part of the language design, and the availability of inexpensive and convenient conversion aids has led to compatible implementations on many different processors.

The language provides a basic framework of operations which can be adapted to any application by the declaration of procedures. The simplicity of the underlying structure ensures that BCPL requires little overhead. But in keeping with the practical nature of the language, a range of useful standard routines are defined, in particular for input and output.

RICHARDS COMPUTER PRODUCTS LTD, Brookside, Westbrook St., Blewbury, Didcot, Oxon. 0235-850218

BCPL CINTCODE is a new implementation of standard BCPL specifically for Microcomputers. It has been carefully designed to hold the logic of a program in a minimum number of bytes. This releases store and disk for more code and data. Tests show that CINTCODE requires only a third the space of fully compiled code, and that it is significantly more compact than other language systems.

CINTCODE is freely relocatable and links at runtime. This means that common procedures used by several tasks need only be stored once. It is distributed with 94 useful procedures, which include all those normally provided in BCPL implementations.

The debugging aids provide breakpoints, symbolic traces, displays of the sequence of calls leading to an error, etc. in a way which is easily related to the high level source code.

BCPL CINTCODE supports multitasking and overlays under CP/M in a simple and effective way.

The full BCPL CINTCODE development system on CP/M is £250, the User Manual is also available separately for £35. Licences for the interpreter and libraries on target systems are only £20. Products developed in CINTCODE under CP/M can also be run on Apples and other 6502 processors.

RCP

THE TRANSTEC 1200 VIDEO MONITOR.



At last, a top quality green screen 12" video monitor at a really competitive price.

The Transtec 1200 has a composite video input, compatible with all micro computers and the screen gives a crisp read-out of a full 80 columns.

The unit is housed in a durable plastic cabinet with controls neatly concealed behind a hinged front-access panel.

Why pay more? Send the coupon today for full specification or better still, call us direct in Bristol.

transtec

13A Small Street, Bristol W.1.
Tel. 0272-277462.

35 Lisburn Road, Belfast.
Tel. 24009.

IDA Complex,
22 Macken Street
Dublin-2
Tel. 713049.

SEND
£115 (VAT
CARRIAGE
INCL.) FOR
IMMED.
DELIVERY.

I like the Transtec 1200 price - send me more data - fast.

Name _____
Company _____
Position _____

DEALER ENQUIRES WELCOME
PRIVATE LABELLING AVAILABLE
ALSO AVAILABLE UNCASED

JUST £99 COMPLETE.*

* Vat. postage and packing not included.

*Dear
Computer Dealer,
We may well have
obsoleted your present
micro computer dealership.*

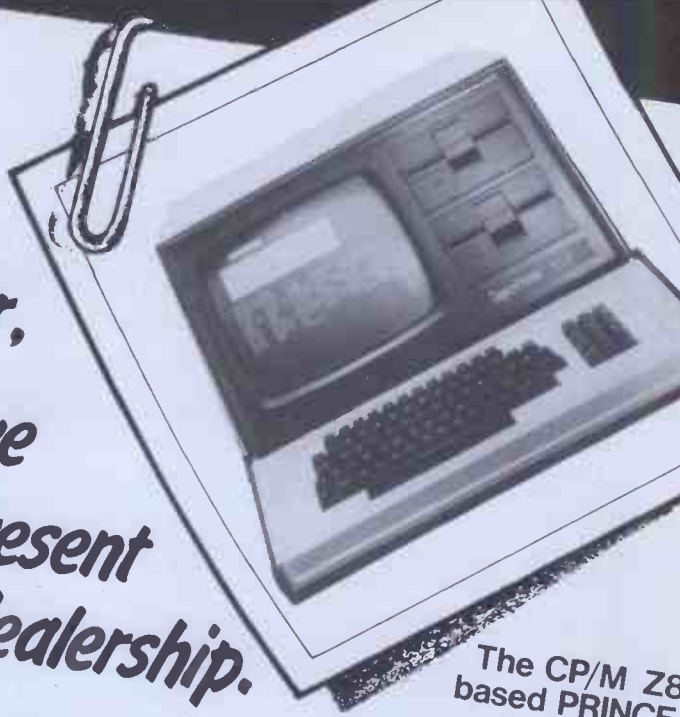

The CP/M Z8 based PRINCE

If your present micro supplier:

1. Does not carry a seven year maintenance guarantee.
 2. Is not supported by an established British manufacturer with over 16 years computing experience.
 3. Does not offer your users a growth capability.
 4. Does not offer a minimum interruption plan during breakdown.
 5. Does not provide comprehensive support for its dealers.
- then you could well be dealing with the wrong supplier.

We are looking for professional distributors of our latest micro computer system - THE PRINCE.

Your micro checklist

- **First class dealer support.**
We provide comprehensive sales support - sales expertise, local seminars, exhibitions, publicity, sales aids, training and consultancy.
- **Provides for growth**
By linking you to powerful mini systems and permit you to develop a real big system capability.
- **Maintenance for seven years**
Offering a seven year maintenance guarantee* the Digico Prince provides the 'coming of age' seal to the micro industry.
- **Backed in Britain**
Digico Computers have been in the business of computer hardware design, manufacture and maintenance for over sixteen years. With factories in Leeds and Stevenage, the Prince is fully supported in the United Kingdom.
- **Excellent value rental scheme**
For complete turnkey systems which include maintenance. (Dealer commission paid up front in full)
- **Minimum Interruption Plan (MIP)**
If your Prince goes down, we'll exchange it for a replacement to keep you running - all in the rental price!
- **Keep up with technology**
Digico Computers have enabled their users to keep pace with technology since 1966.
- **Ready made accounting**
No development cost - just buy proven packages covering sales, purchase and nominal ledgers plus stock control, order entry, payroll, word processing, full graphics and supercalc.
- **Ideal for new computer users**
Maximise their learning on a minimum investment and then link them up to larger systems when they're fully familiar and ready to grow.

We're looking for the sort of distributor that can sell a real business machine and not leave the user to the mercy of a plaything.

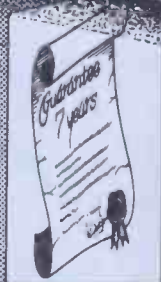

**MAINTENANCE
FOR
SEVEN
YEARS**

REAL SUPPORT

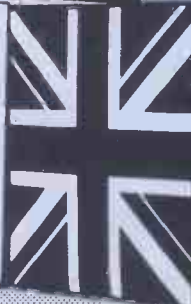

**BACKED
IN
BRITAIN**



**IDEAL
FOR NEW
COMPUTER
USERS**

digico
MICRO DIVISION
Arena House
46 Broadway
Letchworth
Herts. SG6 3BX
Tel: (04626) 781

* Providing there is a maintenance contract continuously from new

AS THINGS GET TOUGH

As a man thinketh, so he will be
This is a major breakthrough programme in human development disciplines which is destined to effect the lives of thousands of thinking men and women. It engages a remarkable new concept — A MULTI-DIMENSIONAL APPROACH TO HUMAN SUCCESS AND TOTAL ACHIEVEMENT

WHAT DO YOU DESIRE? UNFORTUNATELY, THIS PROGRAMME CAN ONLY OFFER TOTAL WINNING KNOWLEDGE, THE BASIC ELEMENT SO ABSOLUTELY NECESSARY FOR POSITIVE HUMAN DEVELOPMENT.

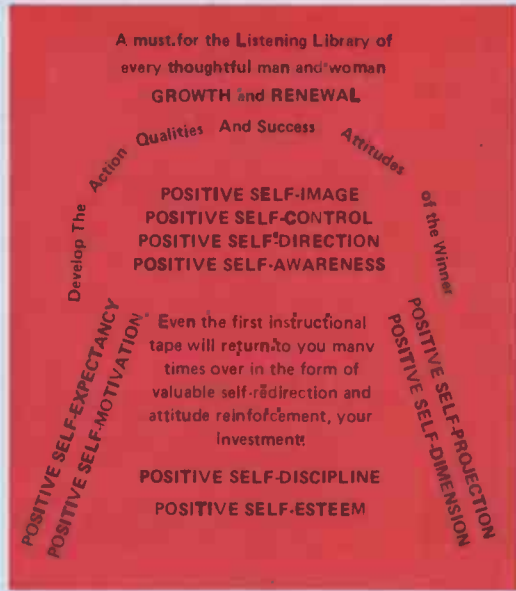
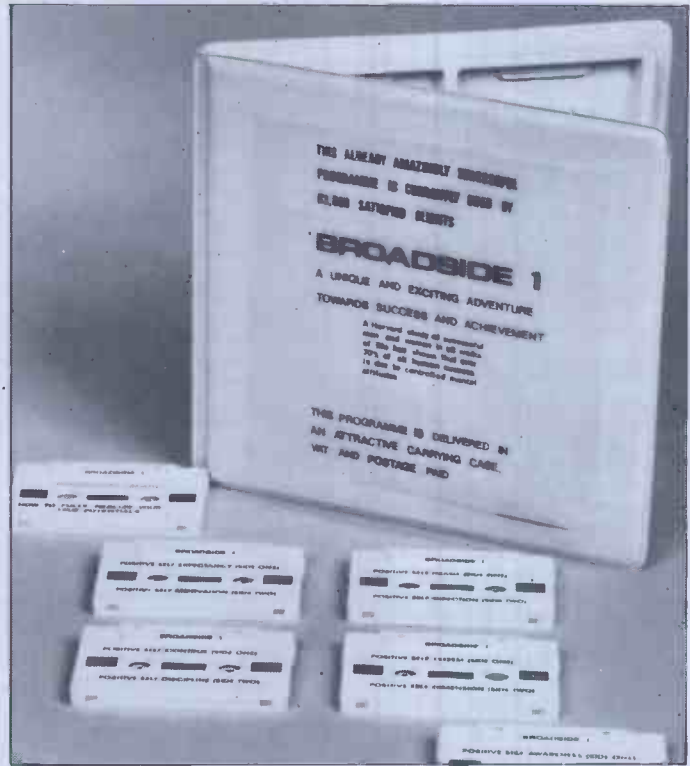

SELF-REALIZATION

A lesson in winning — Broadside 1 is not a psychological gimmick but a profound professional in-depth study into the attitudes and the qualities that go into the formation of the total winner. It is a programme based upon years of exhaustive research, using clinically controlled feedback studies, into the ever present human desire for success and achievement as the basic motivating winning force that brings men and women alike to the forefront of our society. It is a unique and masterful attempt to define and to formulate into a controlled audio pack, the exact guide lines for creating the winner.

The motivated need

Have you ever given thought as to why some people are more successful than others? The secret of the successful lies in direct relation to their positive attitudes and their defined purpose control.

ACTION

Each unit of human life is composed greatly from dreams derived from the unconscious. He who has the ability and know-how to translate them into positive reality, will truly be placed amongst the great. Anais Nin

BROADSIDE 1 — THE INSTRUMENT OF HUMAN DEVELOPMENT

To: Broadside Associates
2 The Spinney
North Cray
Kent

GUARANTEE
I understand that if I am not fully satisfied, I can, within 15 days after despatch, return the complete programme and obtain a full refund.

Please send me the full Broadside 1 programme for which I enclose a cheque/postal order (crossed) for the sum of £25 (inc VAT and Postage) made payable to BROADSIDE (allow a maximum 28 days for delivery)

PLEASE PRINT

Name

Address

Postcode County

THE HUMAN RESOURCES ORGANISATION

BROADSIDE ASSOCIATES
2 THE SPINNEY, NORTH CRAY, KENT
Tel: 01-302 9119

BB

ANGLO AMERICAN SOFTWARE CO

BBC — TRS-80 — ATARI — PET — APPLE — VIC — ZX81

We know what it is like out there, because that's where we came from. Before we decided to become software entrepreneurs, we were just like you enthusiasts searching through magazines for the ideal mail order software source. What we hoped to find was a single entity that offered an ultra-wide selection for our micro-computer. That pre-selected only the best of many similar sounding programs that reached the market every month. That could give us personal assistance with the purchase-decision process, and that stood behind its products. When we couldn't find it we decided to become it. So ANGLO-AMERICAN SOFTWARE CO WAS BORN.

COSMIC PATROL

Skilled players soon master many difficult computer games, but COSMIC PATROL is in a world all its own. The challenge intensifies! Supporting graphics and sound (optional) make each encounter an exciting new experience. It all adds up to a Super 3-S package ... Skill, sight and Sound.

The Cosmic Patrol program is not just another search and destroy game. With its fast, real-time action, impressive sound option and superb graphics, this machine-language program is the best of its genre.

PRICE £12.50

CASSETTE

DISK £16.25

BATTLEGROUND

Here is a program that should interest you war-gamers:

It is late 1944, and the Allied Forces are sweeping towards Berlin. As General of your sector, you have at your command tanks, planes, artillery, infantry, engineers and vehicles — an awesome array of fighting men and the machines of war. From intelligence reports you know that the enemy General is a shrewd tactician, not to be underestimated. It will take planning and strategy to outwit this wily old campaigner.

The battle map of your sector will fill with markers, each showing the deployment of your forces. You and another player will slip into the roles of opposing German and American commanders as yet another battle unfolds. Battleground allows you to experience the total responsibility of a battle-area command. It will be up to you to deploy your forces. On your shoulders rests the decision whether to call for direct artillery gunfire or to order your planes into the air. You will constantly be watching for an enemy airdrop, always carefully manoeuvring your forces.

The stark reality of World War II comes alive in BATTLEGROUND.

PRICE £8.00

CASSETTE

PROGRAM OF THE MONTH

TLDIS & DLDIS

You've bought a super machine-code program but now wonder how it works. Maybe you even used a quick PEEK routine to glance through it when it was in memory. If so, you definitely noticed the complete lack of comments in the code, making it almost impossible for you to decipher and understand it.

Well Instant Software's Labelling Disassemblers are the answer to your problem.

TLDIS (Tape-based Labelling DIS-assembler) make three passes to assign labels (where appropriate) to the routines in a machine-language program. Their output is almost identical in that of a hand-assembled source code.

You can send the disassembly to a line-printer (Radio Shack parallel port) for either TLDIS or DLDIS. (The difference between these utilities is the storage mode of the disassembly).

TLDIS can send the disassembly to cassette tape. DLDIS can send it to disk: both send it to the video monitor. The stored disassembly from TLDIS may be reassembled with Radio Shack's EDTASM™ — the disassembly from DLDIS with Apparat's extension of EDTASM™. Because of the use of labels it is a simple matter to change any object code program by disassembling it and then making changes to the resultant source code, without losing track of jump/load addresses. Labels start with "AA00" and increment up in even numbered steps (AA02, AA04, etc). The odd numbers (AA01, AA03, etc.) are left for you to use for the source code during reassembly.

The printing of the disassembly may be temporarily halted by using (SHIFT) @ (just as in BASIC) or it may be ended by pressing the (BREAK) key. It also has a comments column to display ASCII characters used in a LD or CP opcode.

TLDIS and DLDIS may be relocated in memory to avoid conflict with the program you disassemble.

The next time you need to "climb inside" a machine-code program, take DLDIS or TLDIS with you. We promise that it will be an easier journey.

TLDIS £11.50 Cassette

DLDIS £15.50 Disk

THE ALL STARS

Here's a collection of our best selling games . . . the ones you'll want to play again and again. It includes: SANTA PARAVIA AND FIUMACCIO — Become the ruler of a medieval city state as you struggle to create a kingdom. Up to six players can compete to see who will become the King or Queen.

OIL TYCOON — Avoid oil spills, blowouts and dry wells as you battle to become the world's richest oil tycoon. Two players become the owners of competing oil companies . . . and there's room for only ONE at the top!

PARADISE TRADER — You're the captain of a trading schooner, sailing the Caribbean in search of profits. As you sail from island to island beware the dangers of the deep: pirates, ghost ships and hurricanes. Good sailing, skipper!

MILLIONAIRE — Here's \$1000. Can you turn it into a million dollars in fifteen (simulated) years? It depends on your strategy as you buy and sell properties, negotiate bank loans, collect rentals and accept sealed bids.

TIMBER BARON — An in-depth experience of the timber business, from dropping trees, until the milled lumber reaches the market. Your transactions are affected by those unexpected eventualities that can upset even the most careful plans.

BATTLEGROUND — European Theatre, 1944: Your forces command are tanks, planes, artillery, infantry, engineers and vehicles. The battle map will fill with markers showing the development of your forces and the location of the enemy in one day of fighting. This two-player game will provide hours of entertainment.

Price £26.50 Disk

DOCTOR CHIPS

DR. CHIPS is a great icebreaker at cocktail parties. And if the need arose, he could entertain your early arriving guests while you finished dressing! Your friends will be asking you how the guy got into the computer.

Why shoulder the burdens of modern life in silence? Put your DR CHIPS to work today and get it all off your chest!

£12.50 cassette £14.75 Disk

SEND 75p FOR FULL CATALOGUE

Refundable against purchase

Dealer Enquiries Welcome

ANGLO AMERICAN SOFTWARE CO.

**138a Stratford Road
Sparkhill
BIRMINGHAM B11 1AG
021-771 2995**



24 hour ansaphone

Please state clearly the program(s) you require. Include your name, address & machine type + memory size. Prices include VAT, postage & packing.

ALL PRICES INCLUDE VAT & POSTAGE
24 Hour answering service on 021-771 2995



for Access orders

PLEASE SUPPLY:

I enclose a cheque/PO for £..... made payable to

ANGLO AMERICAN or Debit my

Access card number

Signature

NAME

ADDRESS

.....PCW1

SEE VIC AT THE INTERNATIONAL
COMMODORE COMPUTER SHOW,
CUNARD HOTEL, HAMMERSMITH,
3rd-5th JUNE.
3rd June 12 noon-6pm. 4th June 10am-6pm.
5th June 10am-5pm.



“Give me one good reason why I should choose a VIC 20 home computer.”

1. VIC is outstanding value for money. No other colour home computer can give so much for under £200.
2. Total standard memory 25K made up of 20K ROM and 5K RAM.
3. Fully expandable to 27½K user RAM.
4. Microsoft Basic interpreter as standard.
5. Accessible machine language via plug-in cartridges.
6. Connects direct to monitor or standard television.
7. Full size typewriter style keyboard.
8. Full colour and sound.
9. All colours easily accessible.
10. 62 predefined graphic characters direct from the keyboard.
11. Full set of upper and lower case characters.
12. 256 displayable characters direct from the keyboard.
13. High resolution graphics capability via plug-in cartridges.
14. Programmable function keys can be used with plug-in cartridges.
15. Automatic repeat on cursor function keys.
16. User-definable input/output port.
17. Machine bus port for memory expansion and ROM software.
18. Standard interfaces for hardware peripherals.
19. VIC 20 is truly expandable into a highly sophisticated computer system with a comprehensive list of accessories (see panel below).
20. Full range of software for home, education, business and entertainment on disk, cassette and cartridge.
21. Books, manuals and learning aids from Teach Yourself Basic to the VIC programmers' reference guide (a must for advanced programmers).
22. Full support for VIC owners – their own magazine 'VIC Computing' as well as a national network of VIC user groups.
23. National dealer network providing full service and support to VIC owners.
24. Expertise and experience – Commodore are world leaders in microcomputer and silicon chip technology.
25. Commodore is the leading supplier of micro computers in the UK to business, schools, industry and the home.
26. VIC 20 is the best-selling colour home computer in the UK.

How many reasons was it you wanted?

Accessories include:

- Cassette tape unit.
- Single drive 5¼" floppy disk unit (170 K bytes capacity).
- 80-column dot matrix printer.
- 3K, 8K and 16K RAM expansion cartridges.
- Programming aid packs; machine code monitor cartridge, programmers' aid cartridge, high resolution graphics cartridge.
- Plug-in conversion box for a full 32K, 40-column x 24 lines VIC including Prestel compatibility.
- RS 232C communication cartridge.
- Memory expansion board.
- IEEE/488 interface cartridge.
- Joysticks, light pens, paddles and motor controllers.

commodore
VIC 20
The best home computer in the world.

EPSON'S NEW TYPE III simply out of this world



Epson's new Type III series brings quality graphic printing within the price range of alphanumeric users for the first time.

The MX-80, MX80F/T and the MX-100 offer high reliability, improved performance and greater flexibility.

Performance of the MX-100 has been boosted to 100 cps, and the MX-80 and MX-80F/T each give 80 cps. New features include super and subscript, underlining, deletion and italics. Users can select a unidirectional print mode and system reset.

High resolution printing quality is from a 9 x 9 dot matrix head, and a wide range of type sizes is available. Other user benefits include an easy-change cartridge ribbon, and quiet operation.

All three are equipped with a full 96-character ASCII set, with descenders. The standard interface is Centronics-style 8-bit parallel, with optional RS 232 or IEEE 488 ports.

Epson ...Simply out of this world.

MICROCOMPUTER PRODUCTS

MPI

INTERNATIONAL LTD.

ROOM PCW, 8 CAMBRIDGE HOUSE, CAMBRIDGE ROAD, BARKING, ESSEX IG11 8NT, ENGLAND
 Telephone: 01-591 6511 Telex: 892395

SOFTWARE FOR CP/M COMPUTERS

BYROM SOFTWARE

BSTAM—Utility to link one micro-computer to another also using BSTAM	£95	£6
BSTMS—Utility to link a micro to a mini or mainframe	£95	£11

DIGITAL RESEARCH

CBASIC v 2.08	£65	£15
MPM 1.1	£195	£20
MPM 2.0	£250	£30
CP/M86	£160	£27
CP/M 2.2	£95	£20
CP/NET	£120	£14
SID	£50	£14
ZSID	£55	£14
MAC	£60	£14
TEX	£50	£14
DESPPOOL	£33	£6
PL/1	£300	£27
BT-80	£140	£20

FOX & GELLER

QUICKSCREEN	£87	£12
-------------	-----	-----

KLH SYSTEMS

Spooler for CPM systems v3.0	£70	£6
------------------------------	-----	----

MPI LTD.

FORTH	£72	£20
PAYROLL	£500	£15
SALES LEDGER	£200	£15
PURCHASE LEDGER	£200	£15
NOMINAL LEDGER	£200	£15
INCOMPLETE RECORDS	£1200	£20

MICRO-AP

SELECTOR V	£275	£25
------------	------	-----

MICROFOCUS

CIS COBOL version 4.4	£425	£25
FORMS 2 v11	£100	£10

MICROPRO INC.

WORD-MASTER 1.7A	£75	£22
TEX-WRITER 2.6	£37	£17
WORDSTAR 3.0	£250	£38
MAIL MERGE 3.0 (requires Wordstar)	£75	£10
SPELLSTAR 1.0 (requires Wordstar)	£125	£10
WORDSTAR TRAINING MANUAL		£18
WORDSTAR CUSTOMIZATION NOTES	£50	
SUPER-SORT 1.6	£125	£22
DATASTAR 1.101	£175	£25
DATASTAR CUSTOMIZATION NOTES	£50	
CALCSTAR	£150	£25

APPLE VERSIONS

WORDSTAR 3.0	£188	£38
MAILMERGE 3.0 (requires Wordstar)	£63	£10
SPELLSTAR 1.0 (requires Wordstar)	£98	£10
DATASTAR 1.101	£148	£25
SUPERSORT 1.6	£100	£22
CALCSTAR	£98	£25

PAYROLL

Comprehensive Master File
 All Employees details stored on disc
 Six Pay Rates, standard payments/deductions and pension scales
 Employee Details screened for easy updating
 Leavers stored until Year End

Manual Data Input for Payroll
 Applicable for hourly paid employees working overtime etc
 Screen displays standard payments and deductions per employee
 Cursor addressing used to input hours worked
 Variable payment input with description e.g. Sick £20.00
 Manual override for all standards screened
 Automatic calculation of Tax and N.I. for all rates and levels
 Completed Payslip to NETT PAY screened for checking
 Tax Refunds flagged for operators acceptance or override
 Totals updated only on acceptance of screened details

Exceptions Payroll
 Operated when paying weekly/salaried staff input only for employees with variances to standards
 Exceptions List printed for checking prior to payroll automatic or Manual acceptance of payslips

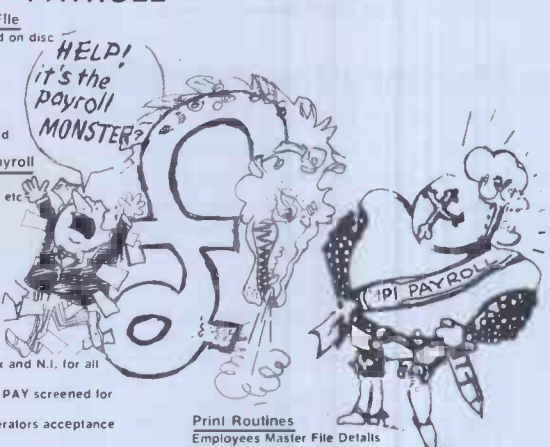

Print Routines
 Employees Master File Details
 Comprehensive Payslips
 Coinage Analysis by Department
 Credit Transfers and Cheques
 Summary of Totals and Cost Centre Analysis
 N.I. and Tax Payment Details
 P35 for Weekly Reconciliation
 Year End P60's prepared automatically
 Pro-Forma for all current employees

MICROSOFT INC.

BASIC-80 5.21	£185	
BASIC Compiler 5.3	£205	
FORTRAN-80 3.43	£260	
COBOL-80 4.01	£380	
M/SORT 1.01	£75	
EDIT-80 2.02	£65	
MACRO-80 3.43	£105	
MULISP 2.10	£105	
MUMATH 2.10	£130	

MICROTECH EXPORTS

REFORMATTER		
CPM ↔ IBM	£98	£17
CPM ↔ DEC	£98	£17

MT MICROSYSTEMS

PASCAL MT 5.5	£150	£25
PASCAL MT 5.5 with SPP	£265	£50
Library Sources	£110	
Speed Programming Pkge. (Softbus)	£125	£25

PHOENIX SOFTWARE ASSOCIATES (For Z80 only)

PLINK—Disc to disc link loader	£72	£15
PASM—Macro Assembler	£72	£15
PEDIT—Line editor with Macros	£72	£15
BUG—Very powerful debug	£72	£15
PDEVELOP Package with all the above	£193	£33
PLINK—2 Overlay Link Loader	£185	£15

NEW PRODUCTS

DIGITAL RESEARCH
 CB-80
 XLT-86

TBA
 TBA

MAGIC CIRCLE SOFTWARE
 CPMSIM
 £120

MICROPRO
 INFOSTAR
 TBA

ORDER INFORMATION

When ordering CP/M software please specify the format you require. All software items are subject to VAT. Manuals, when purchased separately, are not subject to VAT. Please add £4.00 for postage, packing and insurance on each item purchased. For overseas please add £6.50 per item. Most software in this advertisement is available from stock and a 72 hour return service is thereby offered on most prepaid orders. These details and prices are all current as of March 1982. Our prices reflect an exchange rate of U.S.\$2.00 to £1.00. Should the exchange rate vary by more than 5 cents, a surcharge may be added or a discount given. All payments must be in Sterling and drawn against a U.K. bank.

MAIL ORDER TELEPHONE ORDER VISIT Send Cash, Cheque, Postal Order, IMO, Access or Barclaycard/Visa number to Microcomputer Products International Ltd., Room PCW, 8 Cambridge House, Cambridge Road, Barking, Essex IG11 8NT.

Retailer and OEM terms

MAIL ORDER
 TELEPHONE
 CREDIT CARD ORDER

* VISIT *

Full descriptive Catalogue: available £1 — deductible from first purchase

Trade Enquiries Welcome

MEDIA AND FORMATS

Altos
 APPLE CP/M-80 13 Sector
 APPLE CP/M-80 16 Sector
 Blackhawk Micropolis Mod II
 California Computer Sys 8 in
 CDS Versatile 4
 Columbia Data Products 8 in
 Comart Communicator CP50
 Comart Communicator CP100
 Comart Communicator CP200
 Comart Communicator CP500
 Compal-80

A1 CSSN Backup
 RG Datapoint 1550/2150
 RR Delta Systems
 Q2 Dynabyte DB8/4
 A1 Exidy Sorcerer + CP/M-80
 Q2 Exidy Sorcerer + Exidy CP/M-80 8"
 A1 EXO
 Q1 Heath H8 + H47
 P2 Hewlett-Packard 125.8in
 P2 ICOM 3712
 P2 IMSAI VDP-80
 P2 Industrial Microsystems 5000
 Q2 Industrial Microsystems 8000

A1 Intel MDS SD
 A1 Intertec Superbrain SSDD
 R6 Intertec Superbrain QD
 RX ISC Intercolor 8063/8360/8963
 T1 ITT 3030 DSDD
 A1 Micromation
 A1 Micropolis Mod II
 A1 Morrow Discus
 Q2 Mostek
 A1 Multi-Tech 1
 A1 Multi-Tech 2
 A1 Micromation
 A1 Micropolis Mod II
 A1 Morrow Discus
 A1 Mostek
 RA Nascom (Gemini Drives SSDD)
 A1 Nascom (Gemini Drives DSDD)

A1 Nascom/Lucas
 RK NCR 8140/9010
 RS NNC-80
 A1 NNC-80W
 R1 North Star Advantage
 A1 North Star Horizon SSDD
 Q2 North Star Horizon SSDD
 A1 North Star Horizon QD (MPI CP/M)P3
 A1 North Star Horizon QD
 Q2 (Other CP/M)
 Q2 Nylac Micropolis Mod II
 A1 Pertec PCC 2000
 Q2 Rade 1000 SSDD
 A1 Rade 1000 DSDD
 A1 Rair Black Box
 R3 Research Machines 5.25in
 R7 Research Machines 8in

N1 SD Systems 5.25in
 A1 SD Systems 8in
 A1 Spacebyte
 A1 Tarbell 8in
 P2 TEI 8in
 P1 Televideo DSDD
 P2 Toshiba T200 DSDD
 TRS-80 Modell + Shuffle-board 8in
 P2 TRS-80 Modell II
 Q2 Vector MZ
 A1 Vector Systems 2800
 RL Vector System B
 RM Vector VIP
 RE Xerox 820 5.25in
 RN Xerox 820 8in
 A1

R3
 A1
 A1
 A1
 A1
 S5
 SF
 A1
 A1
 Q2
 Q2
 S6
 A1

Support for ATOM and ZX

The Atom Magic Book

A wealth of games and other programs: storing speech in your ATOM, converting programs written in other BASICS: tape recording hints, and many more useful software and hardware tips. £5.50

Getting Acquainted with your Acorn Atom

By Tim Hartnell and Trevor Sharples. 80 programs including Draughts! £7.95

The Memory for your ATOM

16 or 32K! BYTE VERSIONS Expand your ATOM to 28 or 38K RAM Ideal for Word Processing, Chess programs and Business Software.

Fully Compatible with other Acorn ATOM software and hardware Versions available to fit inside the ATOM while still leaving room for other extensions such as the Acorn ATOM colour encoder board. Eurocard rack mounting types also available

PRICES: INCLUDING U.K. P&P & 15% VAT

MZ163A 16K Built & tested to fit inside ATOM'S case	£59.50
MZ163B 32K " " " " " " " "	£74.00
MZ163C 16K Built & tested, Eurocard rack mounting	£62.00
MZ163D 32K " " " " " " " "	£76.50
MZ163E Bare PCB to build any of above with data	£23.00
MP100 DC/DC converter; powers any MZ163 board from unregulated 8V supply such as the ATOM mains adaptor	£8.50

S.A.E. for further details.



ALL PRICES INCLUDE U.K. P&P + 15% VAT WHERE APPLICABLE. OVERSEAS CUSTOMERS ADD £1.50 CARRIAGE PER ORDER PAYMENT WITH ORDER PLEASE.

TIMEDATA LTD Dept C 57 Swallowdale, Basildon, Essex. SS16 5JG Tel: (0268) 411125 (MON-FRI)

The Explorer's Guide to the ZX81

IF YOU'VE GOT A ZX81 THEN YOU NEED THIS BOOK!

Programs for 1K RAM, and programs for 16K RAM. Games, Business and Engineering Applications. RAM & I/O Circuits. Useful ROM Routines. Hints and Tips. 120 pages £4.95

What Can I Do with 1K?

By Roger Valentine. A fresh and original book containing 40 programs and routines for the unexpanded ZX81. £4.95



34 Amazing Games for the 1K ZX81

by Alastair Gourlay. £3.95

The ZX80 Magic Book

With 8K ROM/ZX81 Supplement

Games programs, computer music, converting programs written in other BASICS, improving the picture RAM & I/O circuits, and much more. £4.75

Getting Acquainted with your ZX81

75 + programs including Draughts; by Tim Hartnell £4.95

Mastering Machine Code on your ZX81

by Toni Baker. 180 pages of immense value to beginner and expert alike. £5.95

TIMEDATA



FLOPPY DISKS (BASF)

SS/DD Soft Sector 5 1/4" - £19.20 / 8" - £19.50 (box of 10)

DS/DD Soft Sector 5 1/4" - £24.45 / 8" - £24.75 (box of 10)

Plastic Library Case 5 1/4" - £1.95 / 8" - £2.25 extra per box

*Add 15% VAT

*Free Postage

We also supply:
LISTING PAPER
LABELS
MAGNETIC MEDIA
PRINTER RIBBONS
PRINT WHEELS

Please rush me the following goods. I am paying by Cheque/Postal Order

..... boxes 5 1/4" SS/DD @ £22.08

..... boxes 8" SS/DD @ £22.43

..... boxes 5 1/4" DS/DD @ £28.12

..... boxes 8" DS/DD @ £28.46

..... plastic cases @ £2.24 extra

..... plastic cases @ £2.58 extra

Please send me your full price list

Total Order Value £

Name

Address

Post Code

Send to:

Geest
Computer Services
 Supplies Division
 Carr Road Industrial Estate
 Peterborough PE1 57B

Telephone
 Peterborough (0733) 51231

MAPLIN the people for Atari



3 Consoles available:

Atari 400 with 16K RAM (AF36P) £299

Atari 400 with 32K RAM (AF37S) £395

Atari 800 with 16K RAM (AF02C) £599

Lots of other hardware:

Cassette Recorder	(AF28F)	£50.00
Disk Drive	(AF06G)	£345.00
Thermal Printer	(AF04E)	£265.00
Printer Interface for 400	(AF41U)	£49.95
Printer Interface for 800	(AF42V)	£49.95
Interface Module	(AF29G)	£135.00
Versawriter	(AF43W)	£169.00

16K RAM Module	(AF08J)	£64.00
32K RAM Module	(AF44X)	£125.35
32K Upgrade for 400	(AF45Y)	£75.00
Floppy Disk	(YX87U)	£2.75
Le Stick	(AC45Y)	£24.95
Joystick Controllers	(AC37S)	£13.95

For full details ask for our hardware leaflet (XH54J) SAE appreciated



NOW YOU CAN JOIN THE U.K. ATARI COMPUTER OWNER'S CLUB. An independent user's group. Four issues of the club magazine for only £1.60! Address your subscription to Graham.

THE CHOICEST GEMS OF ATARI SOFTWARE FROM MAPLIN

Adventure Games

Star Warrior	-C-32K-(BQ24B)	£28.95
Rescue At Rigel	-C-32K-(BQ21X)	£22.45
Invasion Orion	-C-32K-(BQ23A)	£18.95
Dalestones of Ryn	-C-32K-(BQ22Y)	£14.95
Galactic Empire	-C-24K-(BQ14Q)	£14.95
Hi-Res Adventure #1/2	-D-48K-(BQ25C)	£24.95
Analog Adventure	-D-32K-(BQ33L)	£24.95
Adventure Land	-C-24K-(BQ00A)	£14.95
Pirates Adventure	-C-24K-(BQ01B)	£14.95
Mission Impossible	-C-24K-(BQ02C)	£14.95
Voodoo Castle	-C-24K-(BQ03D)	£14.95
The Count	-C-24K-(BQ04E)	£14.95
Strange Odyssey	-C-24K-(BQ05F)	£14.95
Mystery Fun House	-C-24K-(BQ06G)	£14.95
Pyramid of Doom	-C-24K-(BQ07H)	£14.95
Ghost Town	-C-24K-(BQ08J)	£14.95
Savage Island I	-C-24K-(BQ09K)	£14.95
Savage Island II	-C-24K-(BQ10L)	£14.95
Golden Voyage	-C-24K-(BQ11M)	£14.95
Energy Czar	-C-16K-(YG53H)	£8.95
Kingdom	-C-8K-(YG55K)	£8.95

Teach-Yourself Programs

Conversational French	-5C-16K-(YG44X)	£32.50
Conversational German	-5C-16K-(YG45Y)	£32.50
Conversational Spanish	-5C-16K-(YG46A)	£32.50
Conversational Italian	-5C-16K-(YG47B)	£32.50
Touch Typing	-2C-16K-(YG49D)	£14.95
States & Capitals	-C-24K-(YG56L)	£8.95
European Countries & Capitals	-C-16K-(YG57M)	£8.95

Learn Programming

Invitation to Programming	-C-8K-(YG43W)	£11.95
Basics of Animation	-C-32K-(BQ57M)	£9.95
Basics of Animation	-D-32K-(BQ58N)	£10.95
Player Missile Graphics	-C-16K-(BQ59P)	£18.95
Player Missile Graphics	-D-24K-(BQ60Q)	£19.95
Display Lists	-C-16K-(BQ51F)	£9.95
Display Lists	-D-24K-(BQ52G)	£10.95
Horiz/Vertical Scroll	-C-16K-(BQ53H)	£9.95
Horiz/Vertical Scroll	-D-24K-(BQ54J)	£10.95

Page Flipping	-C-16K-(BQ55K)	£9.95
Page Flipping	-D-24K-(BQ56L)	£10.95
Master Memory Map	-Walchart-(XH57M)	£4.00

Business Programs

Visicalc	-D-32K-(YL39N)	£119.95
Word Processor	-D-32K-(YG42V)	£85.00
Calculator	-D-24K-(YG50E)	£16.95
Graph—It	-C-16K-(YG51F)	£11.95
Statistics	-C-16K-(YG52G)	£11.95

Arcade Games

Star Raiders	-E-8K-(YG66W)	£29.95
Asteroids	-E-8K-(YG60O)	£29.95
Space Invaders	-E-8K-(YG70M)	£24.50
Missile Command	-E-8K-(YG64U)	£29.95
Super Breakout	-E-8K-(YG67X)	£29.95
Tari Trek	-C-24K-(YL36P)	£8.95
Tari Trek	-D-32K-(YL37S)	£11.95
Star Trek 3.5	-C-32K-(BQ15R)	£14.95
Race In Space	-C-16K-(BQ35Q)	£14.95
Shooting Gallery	-C-16K-(BQ36P)	£14.95
Mountain Shoot	-C-16K-(BQ12N)	£10.95
Jawbreaker	-D-48K-(BQ26D)	£22.95
Basketball	-E-8K-(YG61R)	£29.95
Tank Trap	-C-16K-(YL34M)	£8.95
Tank Trap	-D-32K-(YL35O)	£11.95

Home Game Programs

Scram	-C-16/24K-(YG58N)	£12.95
Cypher Bowl	-C-32K-(BQ20W)	£22.45
Thunder Island	-C-16K-(BQ37S)	£10.95
Rotating Tilt	-C-16K-(BQ48C)	£14.95
Lunar Lander	-C-16K-(BQ16S)	£10.95
Jumbo Jet Lander	-C-16K-(BQ46A)	£29.95
Submarine Commander	-C-16K-(BQ47B)	£24.50
Sunday Golf	-C-16K-(BQ13P)	£10.95
Darts	-C-16K-(BQ42V)	£19.95
Tournament Pool	-C-16K-(BQ45Y)	£19.95
Snooker & Billiards	-C-16K-(BQ44X)	£19.95
Chess	-E-8K-(YG63T)	£29.95
Microchess	-C-16K-(YL40T)	£15.95
Checker King	-C-16K-(YL41U)	£15.95
Cribbage & Dominoes	-C-16K-(BQ43W)	£14.95

Poker Solitaire	-C-16K-(BQ17T)	£10.95
Blackjack	-C-8K-(YG62S)	£8.95
Fast Gammon	-C-8K-(YL33L)	£9.95
Reversi (Othello-type)	-C-16K-(BQ19V)	£14.95
Gomoko	-C-16K-(BQ18U)	£14.95
Hangman	-C-8K-(YG54J)	£8.95
Humpty Dumpty & Jack & Jill	-C-16K-(BQ38R)	£19.95
Hickory Dickory Dock	-C-16K-(BQ39N)	£19.95
British Heritage		
Jig-Saw Puzzles	-C-16K-(BQ40T)	£19.95
European Scene		
Jig-Saw Puzzles	-C-16K-(BQ41U)	£19.95
Atari Safari (25 Programs)	-C-16K-(BQ49D)	£18.95
Atari Safari (25 Programs)	-D-16K-(BQ50E)	£24.95
Mind Bogglers (3 Programs)	-C-16K-(YL38R)	£8.95

Music Programs

Music Composer	-E-8K-(YG48C)	£32.50
Movie Themes (use with Music Composer)	-C-16K-(BQ34M)	£9.95

Computer Languages

Basic A +	-D-48K-(BQ31J)	£52.50
Operating System A +	-D-48K-(BQ30H)	£52.50
Basic A + & Operating System A +	-D-48K-(BQ32K)	£99.50
QS Forth	-D-24K-(YL29G)	£44.90
Pilot	-E&2C-8K-(YG69A)	£49.50

Utilities

3D-Super Graphics	-D-48K-(BQ28F)	£29.95
3D-Super Graphics	-C-48K-(BQ29G)	£29.95
Atari World (Graphics)	-D-48K-(BQ27E)	£43.95
Assembler Editor	-E-8K-(YG68Y)	£34.50
Assembler	-C-16K-(YL32K)	£14.95
6502 Disassembler	-C-8K-(YL30H)	£8.95
6502 Disassembler	-D-8K-(YL31J)	£11.95
Character Generator	-C-16K-(YL27E)	£9.97
Character Generator	-D-16K-(YL28F)	£12.50
Teletink	-E-8K-(YG59P)	£14.95

Key: C = Cassette, D = Disk, E = Cartridge, 2C = 2 Cassettes etc. 8K, 16K etc. shows minimum memory requirement.

Send sae now for our new software leaflet with details of all the above programs. Order As XH52G — Issue 2.

Lots of exciting new software titles available soon. Keep in touch with Maplin!

Subscribe now to America's leading Atari-only magazine — Analog — 6 Issues per year for just £9.00. Order as GG24B.

MAPLIN

Maplin Electronic Supplies Ltd
P.O. Box 3, Rayleigh, Essex.
Tel: Southend (0702)
552911/554155.

Demonstrations at our shops NOW
See the amazing Atari's in action at
159-161 King St., Hammersmith W6
Tel: 01-748 0926
or at 284 London Road,
Westcliff-on-Sea, Essex.
Tel: (0702) 554000

Note: Order codes shown in brackets. Prices correct at time of going to press.



Pete & Pam Computers

SATURN SYSTEMS

128K and 32K boards and VC— Expand
The 32K BOARD

Comes with utilities to allow the movement of DOS and the use of Integer together with the ability to store subroutines on the board to be called from a main program. The final utility allows the board or multiple of boards to be used as a fast disk drive

£149.00

128K BOARD

Can be used as above with the additional facility to use the card as a fast disk drive in C/PM and PASCAL in addition to BASIC

£359.00

VC EXPAND

Is a utility that can be used with either the above two boards to give additional memory for VISICALC models, up to 146K with the 128 board—and more with additional boards

£55.00

COMING SOON

A version of VC EXPAND to allow use of VISICALC with the VIDEX 80 column board (VIDEX 80 column board—£185.00) (VISICALC—£105.00)

MICROSOFT PRODUCTS

MICROSOFT have written most of the BASICS for the World's Micros. As MICROSOFT'S biggest UK distributor we carry a wide range of MICROSOFT products for APPLE

TASC the Applesoft computer

True machine code programs for your APPLESOFT BASIC

£109.00

Z-80 SOFTCARD

THE C/PM System for APPLE. Over 35,000 sold to Apple users world-wide, making APPLE the most popular C/PM system

£189.00

A.L.D.S.—Assembly Language Development

System can handle 6502, Z-80 or 8080

£79.00

FORTRAN 80 £109.00

COBOL 80 £359.00

THE ENHANCER II

The dawn of a new era for the APPLE II Introducing the ENHANCER II—a new standard which is improving the relationship between Humans and Apples. The Enhancer II can help your Apple II's keyboard become more sociable by remembering words or phrases which can be entered into the Apple by the mere touch of a key. Life can become even easier because the Enhancer II can remember what you typed while your Apple was busy talking to your disk (or doing other things). Naturally, it knows the difference between upper and lower case letters and what shift keys are supposed to do. It even knows to auto repeat any key held down. The Enhancer II replaces the encoder board making installation simple.

£99.00



The APPLE Computer Specialists

Hardware & software distribution is our business — WORLDWIDE

Payment in sterling or dollars
other currencies by arrangement

Over 600 items for APPLE

From business to scientific, from education to pleasure. It's here NOW, make sure you get YOUR Copy—write or telex either of our offices now. If you're interested in Apple computers, you can't afford to be without it.



D BASE II—from Ashton Tate

For Apple II with Z-80 softcard
A true relational database able to work on multiple files—gives you the power to use your Apple for jobs that were previously reserved for main frames.

£395.00

MICROSOFT Z-80 SOFTCARD £189.00

WORD PROCESSING

The Wordstar Family (requires Z-80)

WORDSTAR £145.00

MAILMERGE £69.00

SUPERSOFT £85.00

DATASTAR £140.00

SPELLSTAR £89.00

WORDSTAR Training Manual £19.00

MACHINE COVERS—only the best material used

Apple only	£5.95
Single Disk	£2.95
2 stacked disks	£4.45
Apple, 2 disks and 9" monitor or Apple and 12" monitor	£8.95
Apple and 2 disk	£7.95
Epson MX 70/80	£5.45
Paper Tiger 445—460	£5.45

NEW ADDITIONS

KEYPLUS from Aids Data

A Visicalc compatible keypad with left and right arrows, space bar and escape key in addition to numbers

£99.00

CLIP-ON APPLE FAN

With forward facing Apple power switch neon lit

£49.00

COOL-STACK

A colour compatible shelf arrangement with integral fan to sit over Apple to accommodate disk drives, act as a stand for a monitor plus allow easy access to the inside of your Apple

£69.00

NEW VISISCHEDULE

from the publishers of Visicalc
A powerful project planner. Allocates all costs, specifies earliest and latest start dates prerequisites and deadlines for each task, automatic calculation and display of critical path. Can link with other Visi programs

£189.00

MATHSMAGIC

A unique number processing system designed for linear sequential calculations using a threaded interpretive language. Make your Apple a very powerful programmable calculator

£59.00

Authorised Apple Sales and Service

LONDON RETAIL

98 Moyser Road, London SW16 6SH
Telephone 01-677 2052/7341

MAIL ORDER AND DISTRIBUTION

Waingate Lodge, Waingate Close,
Rossendale, Lanc. BB4 7SQ
Telephone (0706) 227011

Prices do not include VAT please add 15% to your remittance
Postage and packing FREE

Telex No. 635740
Orders welcome by phone or telex
PETPAM G



When you outgrow your personal computer that's the time you'll wish you'd bought a DAI.

Very low priced personal computers can leave you feeling very low, after the initial novelty has worn off. Having learned what the computer can do, you then find out what it can't do. Unless you expand the system. And that can set you back a few hundred pounds for items such as extra RAM and serial interface. In fact, more than you paid in the first place! So when you've done all the sums, you'll realise that the DAI personal computer offers incredibly good value for money. Just look what you get for the all-in price.

1. 48K RAM.
2. 24K ROM-based software that includes a fast BASIC interpreter, scrolling screen editor, machine code utility program, twin cassette tile handling, and disc support.
3. A full duplex RS232 serial interface allowing direct connection of a printer (with resident software support) and other peripherals.
4. A parallel interface for connection of the CP/M compatible DAI disc unit and other user devices.
5. Superb 16-colour high resolution graphics (256 x 336).

6. Sound commands for music generation.
7. Standard TV interface via aerial socket.

These standard features pave the way for a whole new vista of personal computing possibilities. Find out more by completing the coupon today. Large range of "Dainasoft" software available, e.g. viewdata, word processing, educational, games . . .



only
£595.00
+ VAT
Disc unit extra

a DAI sets you up for life

DAI

Data Applications
(UK) Ltd.

16B DYER STREET, CIRENCESTER,
GLOUCESTERSHIRE GL7 2PF
TELEPHONE:
CIRENCESTER (0285) 61828 or 2588
TELEX: 43605 BECHAM G

Please send me further details about the DAI Personal Computer.
My interest areas are

Please send me a list of dealers

NAME:

ADDRESS:

TEL. NO.:

Send to DAI, 16B Dyer Street, Cirencester, Glos. GL7 2PF

SEEING IS BELIEVING

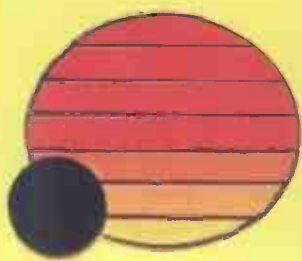
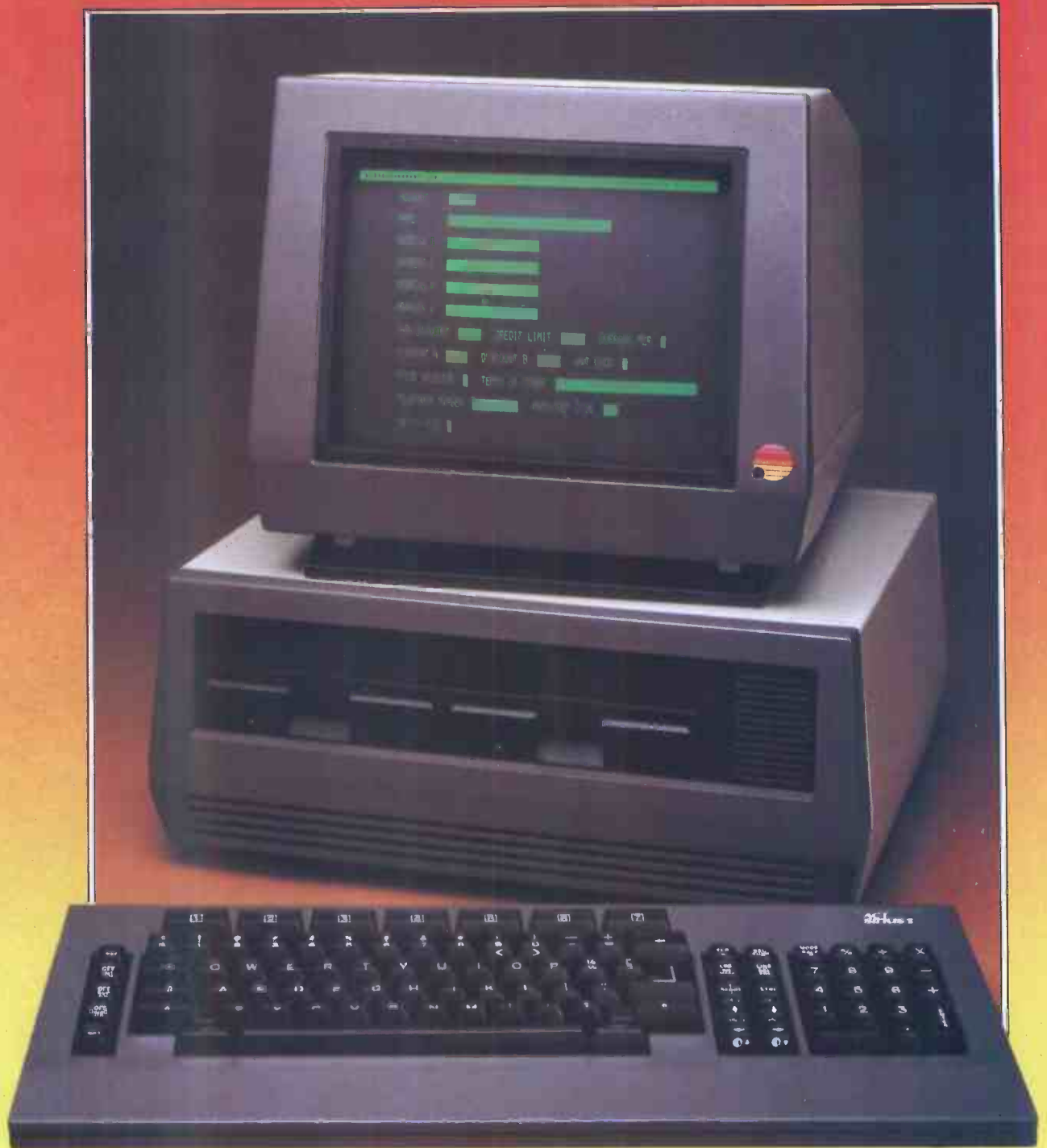

**ACT
SIRIUS 1**

NEW ACT SIRIUS 1

Minicomputer Performance. Personal Computer Price.

16 bit processor: £2,395

The best price/performance ratio you've ever seen on a personal computer.

	ACT Sirius 1	Typical Personal Computers	Typical Business Systems
Memory	128K-1024K	32K-64K	48K-256K
Disk Capacity	1.2Mb-10 Mb	140K-1Mb	1.2Mb-10 Mb
Processor	16 bit	8 bit	8 bit
Operating Systems	CP/M-86, MSDOS	CP/M or Machine Specific	Usually Machine Specific
Languages	Microsoft BASIC Compiled BASIC COBOL PASCAL FORTRAN	Microsoft BASIC perhaps one or two others, eg PASCAL	BASIC and perhaps one or two others
Price	£2395	£1800-£3000	£4500-£8500

ACT Sirius 1 is a new generation personal computer. Quite simply, it has no competition at the price.

It's the first personal computer developed from the outset for business and professional use.

It's launched with more software than anything before it.

It's supported and distributed solely by ACT — the biggest name in personal computer software.

And it's developed by Chuck Peddle, formerly of Commodore and generally regarded as the father of personal computing.

SOFTWARE SPELLS SUCCESS

ACT Sirius 1 has more software than any other new personal computer:

A choice of two operating systems — CP/M-86 or MSDOS, from Microsoft.

For Software Houses

The ACT Sirius 1 has a language for you. Microsoft BASIC 80, two BASIC Compilers, two COBOLS, PASCAL and FORTRAN.

For Applications

Wordstar, Mailmerge, Pulsar, SuperCalc and MicroModeller — all the best sellers.

And the ACT Sirius 1 can run any software written for CP/M — that means hundreds of specialised packages.

THE BODY IN QUESTION

Ergonomics play a vital part in the design of ACT's Sirius 1.

The screen tilts and swivels to suit the user and glare is eliminated.

The display is razor sharp; and the brilliance and contrast can be adjusted using keys on the low-profile detachable keyboard.

STAYING OUT IN FRONT

The ACT Sirius 1 is designed to keep you out in front. Winchester, networks, multi-user facilities and colour graphics are all scheduled during the next twelve months. And all at the same record-breaking price levels of the ACT Sirius 1.

SEEING IS BELIEVING

The ACT Sirius 1 goes through the most exhaustive quality control process of any microcomputer — including the much vaunted Japanese products.

ACT Sirius 1 has been successfully operating in testing field trials for over 6 months already. And now it's at your nearest ACT Dealer — ready to revolutionise your ideas on personal computers.

Clip the coupon for literature. Better still, call David Low now on the hot line 021-454 8585, get the name of your nearest dealer and see a demonstration as soon as you can — because seeing is believing.

To: ACT (Microsoft) Ltd, FREEPOST,
Birmingham B16 8BR.

Please send a brochure and name of my nearest dealer

I am interested in dealership — send the dealer pack and ask your sales director to contact me.

Name _____

Position _____

Company _____

Address _____

Telephone _____ PCW6

ACT No.1 in Total Computing.

Two flexible multi-user systems

The Vector Graphic 5005

and 5032

with 5 megabyte and 32 megabyte Winchester hard discs

The Vector Graphic 5005 & 5032 are multiple-user, multi-tasking hard disc systems for general business and word processing applications.

Supporting up to a maximum of 5 users and giving up to 32 megabytes of high-speed totally reliable Winchester disc technology with Vector's automatic error correction feature.

Total flexibility means that the systems terminals can work independently which permits the widest possible range of usage.

One user could use Execuplan for financial planning whilst the second user is entering sales information with accounting software and the third may run correspondence simultaneously with Vector's Memorite III word processing software.

Most other standard CP/M

compatible applications software will run on the system e.g. COBOL, FORTRAN, PASCAL, BASIC COMPILER, ALGOL, PL/I and other statistical and data based management packages.

The Vector Graphic 5005 & 5032 are ideal for application packages, such as accounts, stock control, payroll, word processing, financial modelling and solicitors packages, all available from Almarc.

For further information write or telephone Almarc. Complete sales and servicing facilities are available throughout the U.K.

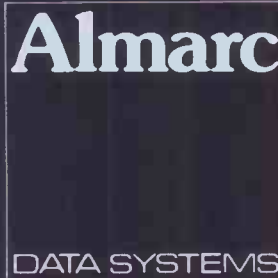

Almarc Data Systems Ltd.,
Great Freeman Street,
Nottingham NG3 1FR
Tel: (0602) 52657/8/9
Telex: 37407 Almarc/G

Also at:
Green Street,
High Wycombe,
Bucks. HP11 2RF.
Tel: (0494) 23804



APPROVED ALMARC DEALERS

BALDOCK
BIRMINGHAM
BRISTOL
CAMBERLEY
DONCASTER
HIGH WYCOMBE
HARROGATE

Modus Systems
Taylor Micro Systems Ltd.
Johnson Micro Computers
Johnson Micro Computers
Reed Computing
Common Sense Business Systems
Business Microsystems

(0462) 894848
(0211) 358 2436
(0272) 422061
(0276) 20446
(0703) 67087
(0494) 40116
(0423) 68224

KETTERING
LONDON
LOUTH
NOTTINGHAM
OXFORD
SWANSEA
TYNE & WEAR
YEOVIL

Shuttleworth Business Systems (0536) 511357
Micro Systems Consultants (01) 979 4098
Compu-Crop (0507) 604271/2
Almarc Business Systems (0602) 622501
Johnson Micro Computers (0865) 721461
Business Microsystems (0792) 474082
H.P. Micros (0632) 859923
Dale Computers (0935) 23097

PERSONAL PEARL

PURPOSE

To provide a natural, easy way for people to create custom application programs through an English language interaction with a personal computer.

DESCRIPTION

Personal Pearl is the natural, human way to create new computer solutions. Computers are designed to solve general problems at incredible speeds. Application programs are required to operate the computer in order to quickly solve specific human problems. Personal Pearl unlocks the power of the computer so you can resolve your unique business problems.

Personal Pearl asks you for examples of the results you require from the computer. Personal Pearl then produces the application program. Personal Pearl is for the individual who requires custom computer solutions without the cost and time delay of hiring a programmer.

With Personal Pearl, you can create a library of personal programs, each tailored to your individual requirements. Accounting, mailing lists, data files, data management, calculations and reporting. Personal Programmer builds the program library of your choice, for one price.

Why buy several programs designed for the average computer use? Buy Personal Pearl to create an entire library of the highest quality programs designed by you, for your Personal Pearl leads you through the program design. Your answers are used by Personal Pearl to create the new program.

HIGHLIGHTS

- Interactive English program development. Menu-oriented application description speeds development via formatted screens, input error checking.
- Built in HELP facility.
- Display handling is defined by using Personal Pearl convenient full-screen facilities to simply type in the display screens exactly the way they are to appear in the new program.
- Report handling is defined in the same way; by simply formatting the display screen to show the layout of the reports required by the new program.
- The application program display screens or reports may be modified at any time, or new displays or reports may be added.
- Calculation edit: arithmetic operations, editing, translation, table look up, and data validation are included.
- Data routine: display-to-display, display-to-printer, and display-to-file facilities are provided.
- Files may be quickly and easily sorted, printed, searched for selected records, reorganised or analysed.
- Display screens, files or reports may be modified to reflect changing program requirements.
- Display screens may be custom designed in any form.
- Reports may be custom designed in any form. Several report formats may be stored for later use.
- Data may be sent to SuperCalc* or Multiplan* for forecasting.
- No limitation on number of application programs.
- Maximum file sizes determined only by the maximum capacity of the disk storage medium on the computer.
- Records may be up to several thousand characters long, if needed.
- The number of records that may be stored in a file is determined by the total file size. Records are variable length with record packing, eliminating the wasted space incurred by fixed length schemes.
- Data base support is provided by an independent data base manager.
- File support is provided through indexing and sequential data access.
- Security and Integrity of Data:
 - Data input can be validated against previously defined edit criteria before changes are made to data files.
 - Edit criteria can be modified dynamically.
- Automatic Screen Entry Message:
 - Users of Personal Pearl can establish messages to the program operator in order to direct correct data entry.
- Data File Independence:
 - The descriptions of data files are maintained in an independent description file — the dictionary.
- Multiple Program Integration
 - Several generic programs such as word processing and spread sheet analysis may be integrated through Personal Pearl.

PEARL
software

Manufacture, OEM and dealer enquiries welcome.

Suggested retail price: under £200* *excluding VAT

PREREQUISITE PRODUCTS

CP/M Operating System
48K RAM Microcomputer.

To: PEARL INTERNATIONAL (UK) LTD, PO BOX 34, POOLE, DORSET, BH14 8AR

Please send me details of Personal Pearl

Name.....Firm.....

Address.....

.....Postcode.....

Type of equipment.....Disc size and format.....

Type of VDU.....



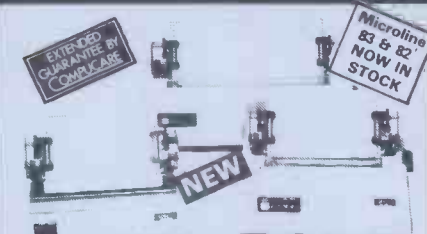

MICROLINE 80 £289 + VAT

● 80 cps Uni-directional ● Small size: 342 (W) x 254 (D) x 108 (H) mm. ● 160 Characters, 96 ASCII and 64 graphics ● 3 Character sizes: 40, 80 or 132 chars/line ● Friction and Pin Feed ● Low noise: 65 dB ● Low weight: 6.5 kg

MICROLINE 82 £449 + VAT

● 80 cps Bi-directional logic seeking ● Small size: 360 (W) x 328 (D) x 130 (H) mm. ● 160 characters, 96 ASCII and 64 graphics, with 10 National character-set Variants. ● 4 Character sizes: 40, 66, 80 or 132 chars/line. ● Built-in parallel and serial interfaces. ● Friction and Pin Feed ● Low noise: 65dB ● Low weight: 8kg

MICROLINE 83 £649 + VAT

● 120 cps bi-directional logic seeking ● 136 column printing on up to 15in forms ● Small size: 512 (W) x 328 (D) x 130 (H) mm. ● 160 characters, 96 ASCII and 64 graphics with 10 National character-set variants ● 3 Character spacings: 5, 10 and 16.5 Chars/in. ● Built-in parallel and serial interfaces ● Friction and Pin Feed ● Low noise 65dB ● Low weight: 13 kg

THE ANADEX DP9500 and DP9501 A PROFESSIONAL PRINTER



● Bi-directional printing ● Up to 220 chars/line with 4 print densities ● 500 char buffer ● RS232C and Centronics Parallel interface built in ● Full software control of matrix needles allowing graphics capability ● 200 chars/sec ● Adjustable width tractor feed.

DP9500 — ONLY £845 + VAT
DP9501 — ONLY £895 + VAT

WE ARE NOW STOCKING THE APPLE II AT REDUCED PRICES



AUTOSTART EURO PLUS
48K £649 + VAT

Getting Started APPLE II is faster, smaller, and more powerful than its predecessors. And it's more fun to use too because of built-in features like:
● **BASIC** — The Language that Makes Programming Fun.
● **High-Resolution Graphics** (in a 54,000-Point Array) for Finely-Detailed Displays. ● **Sound Capability** that Brings Programs to Life. ● **Hand Controls** for Games and Other Human-Input Applications. ● **Internal Memory Capacity** of 48K Bytes of RAM, 12K Bytes of ROM; for Big-System Performance in a Small Package. ● **Eight Accessory Expansion Slots** to let the System Grow With Your Needs.
You don't need to be an expert to enjoy APPLE II. It is a complete, ready-to-run computer. Just connect it to a video display and start using programs (or writing your own) the first day. You'll find that its tutorial manuals help you make it your own personal problem solver.

APPLE DISC II 3.3 Dos

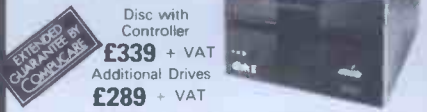

Disc with Controller £339 + VAT
Additional Drives £289 + VAT
● Powerful Disk Operating Software Supports up to 6 drives ● Name Access to Files for Ease of Use ● BASIC Program Chaining to Link Software Together ● Random or Sequential File Access to Simplify Programming ● Dynamic Disk Space Allocation for Efficient Storage ● Individual File Write-Protection Eliminates Accidental File Alterations ● Loads an 8K Byte Binary Image in 6.5 sec. (1.2 sec. in Pascal) ● Storage Capacity of 116 KiloBytes (143K Bytes with Pascal) on Standard 5¼" Diskettes ● Powered Directly From the APPLE (Up to 6 Drives) for Convenience and High Reliability ● Packaged in Heavy-Duty, Colour-Coordinated Steel Cabinet
Colour Monitors for Apple — £295 + VAT

LUXOR 14" COLOUR MONITOR FOR THE APPLE £295 + VAT

THE EPSON MX SERIES

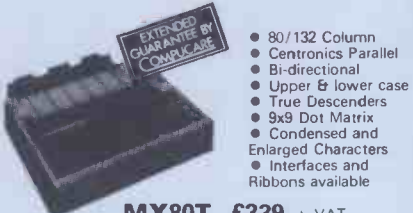

MX80T £339 + VAT
MX80F/T £389 + VAT

- 80/132 Column
- Centronics Parallel
- Bi-directional
- Upper & lower case
- True Descenders
- 9x9 Dot Matrix
- Condensed and Enlarged Characters
- Interfaces and Ribbons available

CENTRONICS DOT MATRIX PRINTERS



737 £369 + VAT
739 £469 + VAT
Standard Features
● Proportional Spacing ● Right Margin Justification ● 3 way paper handling ● Upper and lower case ● True Descenders ● Bi-directional Paper Mode ● Underlining capability ● Condensed/Expanded Print ● Sub-Scripts and Super Scripts ● Pin and Friction Feed ● 80/132 Column
739 as above with special feature of Dot Resolution Graphics.

NEC SPINWRITER



only £1490 + VAT
NEC's high quality printer uses a print "thimble" that has less diameter and inertia than a daisy wheel, giving a quieter, faster, more reliable printer that can cope with plotting and printing (128 ASCII characters) with up to five copies, friction or tractor fed. The ribbon and thimble can be changed in seconds. 55 characters per second bidirectional printing — with red/black, bold, subscript, superscript, proportional spacing, tabbing, and much, much more.

HITACHI PROFESSIONAL MONITORS

11" — £129 £99.95 + VAT
12" — £199 £149 + VAT

- **Reliability** Solid state circuitry using an IC and silicon transistors ensures high reliability. ● **500 lines horizontal resolution** Horizontal resolution in excess of 500 lines is achieved in picture center. ● **Stable picture** Even played back pictures of VTR can be displayed without jittering. ● **Looping video input** Video input can be looped through with built-in termination switch. ● **External sync operation** (available as option for U and C types) ● **Compact construction** Two monitors are mountable side by side in a standard 19-inch rack.

ACORN ATOM



UNIQUE IN CONCEPT — THE HOME COMPUTER THAT GROWS AS YOU DO
Fully Assembled £157.50 + VAT inc. PSU

Special features include ● Full Sized Keyboard ● Assembler and Basic ● Top Quality Moulded Case ● Optional High Resolution Colour Graphics ● 6502 Microprocessor

4K FLOATING POINT ROOM £19.50 + VAT
COLOUR ENCODER £19.00 + VAT
We give a full one year's guarantee on all our products, which normally only carry 3 months guarantee.
A SELECTION OF APPLE INTERFACES ARE NOW AVAILABLE AT OUR EDGWARE ROAD SHOWROOM

INTRODUCING THE NEW GENIE

Ideal for small businesses, schools, colleges, homes, etc. Suitable for the experienced, inexperienced, hobbyist, teacher, etc.



GENIE I
NOW INCLUDED: Sound, Upper and lower case, Extended BASIC and Machine Code enabling the Writing and Execution of Machine Codes Programming direct from Keyboard. 16K RAM. 12K Microsoft BASIC Extensive Software Range. Self-Contained PSU UHF Modulator Cassette. External Cassette Interface. Simply plugs into TV or Monitor. Complete and Ready to Go. Display is 6 lines by 32 or 64 Characters Switchable. 3 Manuals included, Users Guide, Beginners Programming and BASIC Reference Manual. BASIC Program Tape Supplied. Pixel Graphics.



GENIE II
£299 + VAT
The NEW GENIE II an ideal Business Machine. 13K Microsoft BASIC in ROM. 71 Keyboard. Numeric Keypad. Upper & Lower Case. Standard Flashing Cursor. Cassette Interface 16K RAM Expanded externally to 48K.

GENIE I & II EXPANSION UNIT WITH 32K RAM £199 + VAT
PARALLEL PRINTER INTERFACE CARD £35.00 + VAT



TEAC DISK DRIVES
● TEAC FD-50A has 40 tracks giving 125K Bytes unformatted single density capacity. ● The FD-50A can be used in double density recording mode. ● The FD-50A is Shugart SA400 interface compatible. ● Directly compatible with Tandy TRS80 expansion interface. ● Also interfaces with Video Genie, SWTP, TRS80, North Star Horizon, Superbrain, Nascom, etc, etc. ● Address selection for Daisy chaining up to 4 Disks. ● Disks plus power supply housed in an attractive grey case.

40 TRACK
Single Disk Drive £225 + VAT Double Disk Drive £389 + VAT
77 TRACK
Single Disk Drive £299 + VAT Double Disk Drive £499 + VAT

SALE MEMORY UPGRADES
16K (8 x 4116) £12.90 + VAT
4K Compukit (8 x 2114) £12.90 + VAT

WE HAVE ONE OF THE LARGEST COLLECTIONS OF COMPUTER BOOKS UNDER ONE ROOF, ALONG WITH SOFTWARE FOR THE GENIE, TRS80 AND APPLE.

NOW IN STOCK

THE NEW & EXCITING TRS80 MODEL III

EXTENDED GUARANTEE BY COMPUKARE



48K £599 + VAT

The Radio Shack TRS-80™ Model III is a ROM-based computer system consisting of:

- A 12-inch screen to display results and other information
 - A 65-key console keyboard for inputting programs and data to the Computer
 - A Z-80 Microprocessor, the "brains" of the system
 - A Real-Time Clock
 - Read Only Memory (ROM) containing the Model III BASIC Language (fully compatible with most Model I BASIC programs)
 - Random Access Memory (RAM) for storage of programs and data while the Computer is on (amount is expandable from "16K" to "48K", optional extra)
 - A Cassette Interface for long-term storage of programs and data (requires a separate cassette recorder, optional/extra)
 - A Printer Interface for hard-copy output of programs and data (requires a separate line printer, optional/extra)
 - Expansion area for upgrading to a disk-based system (optional/extra)
 - Expansion area for an RS-232-C serial communications interface (optional/extra)
- All these components are contained in a single moulded case, and all are powered via one power cord.

- Disc Drives Kit with 2x40 Track Drives — £599 + VAT
- Disc Drives Kit with 2x80 Track Drives — £729 + VAT

DUE TO IMMENSE POPULARITY SALE CONTINUED

UNTIL STOCKS LAST

★ 6502 based system — best value for money on the market. ★ Powerful 8K Basic — Fastest around ★ Full Qwerty Keyboard ★ 1K RAM Expandable to 8K on board. ★ Power supply and RF Modulator on board. ★ No Extras needed — Plug-in and go ★ Kansas City Tape Interface on board. ★ Free Sampler Tape including powerful Disassembler and Monitor with each Kit. ★ If you want to learn about Micros, but didn't know which machine to buy then this is the machine for you.

Build, Understand and Program your own Computer for only a small outlay

KIT ONLY £99.95 + VAT

Fully Assembled — £149 + VAT

PLUS £4.80 Post & Packing

COMPUKIT WITH ALL THE FEATURES THAT MADE IT THE MOST PROFESSIONAL COMPUTER KIT ON THE MARKET. NOW WITH FREE NEW MONITOR (a saving), which includes Flashing Cursor, Screen Editing, & Save Data on Tape.

NEW MONITOR IN ROM — available separately at **£7.90 + VAT.**

Improved BASIC 3 ROM — revised GARBAGE routine allows correct use of STRING ARRAYS **£4.90 + VAT**
This chip can be sold separately to existing CompuKit and Super board users.

FOR THE COMPUKIT — Assembler Editor **£14.90** Case for UK101 **£29.50**

GAME PACKS — 1). Four Games **£5.00** 2). Four Games **£5.00**

Super Space Invaders (8K) **£6.50** Chequers **£3.00** Realtime Clock **£3.00**

10 x C12 Cassettes **£4.00**

40 pin Expansion Jumper Cable **£8.50**

All Prices exclusive VAT

AK Upgrade Kit £12.90 + VAT

YOUR ZX80 IS NOW NO LONGER REDUNDANT

Upgrade your ZX80 to the full animated graphics of the ZX81. (No screen flicker).

FOR ONLY £12.95 + VAT IN KIT FORM

Works only in conjunction with **NEW 8K ROM** from Sinclair (Not Included).

CASIO VL TONE NEW £31.25 + VAT

EXTENDED GUARANTEE BY COMPUKARE



It's a new kind of musical instrument. A computer controlled synthesiser that helps you create, play and arrange compositions that normally take years of music training. Also a calculator.



SHARP PC1211 £69.95 + VAT

COMPUTER POWER THAT ONCE FILLED A ROOM CAN NOW BE CARRIED IN YOUR POCKET!

- Programs in BASIC
- "QWERTY" Alphabetic Keyboard
- 1.9K Random Access Memory
- Long Battery Life.

SHARP CE122 PRINTER & CASSETTE INTERFACE £75 + VAT
CASSETTE INTERFACE ONLY £14.90 + VAT

INTRODUCING THE NEW SHARP MZ-80B



£999 + VAT.

- 4 Mhz Z-80CPU
- Dynamic RAM
- 2K ROM
- BASIC is provided
- High Resolution Graphics
- 9" High Focus Green Display
- Upper and Lower Case
- 80/40 Characters x 25 line display
- Electro Magnetic Cassette Deck included
- ASC11 Keyboard
- Numeric Keypad
- Sound Output
- Built-in Clock and Music.

Available Soon—Discs, Printers and other Accessories.

OUR NEW SUPER LOCATION IN IRELAND

19 Herbert Street, Dublin 2. Telephone: Dublin 604165

HEAR OUR ADS ON RADIO NOVA 88.1 VHF Stereo

NEW The PEDIGREE PETS

RRP £795 for 32K



32K ONLY £569 + VAT

Very popular for home & business use. 8K Microsoft Basic in ROM. 32K with new improved keyboard. 12" screen. Cassette Deck £55 extra



8032 80 COLUMN PET

ONLY £825 + VAT

The reliable value for money system with after sales support, instruction and training facilities and a wide range of programmes.

SECK 62 MIXER

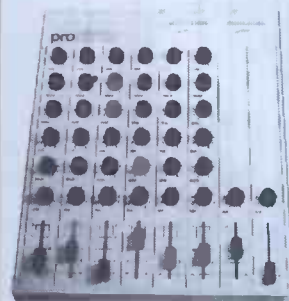

Professional audio mixer that you can build yourself and save over £100.

Only **£99.90**

plus VAT for complete kit. Plus **FREE** power supply valued at **£25.00**

COMMODORE VIC-20

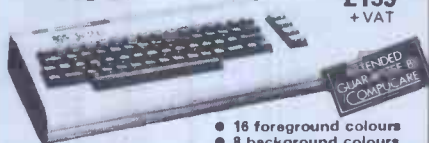

ONLY £159 + VAT

- 16 foreground colours
- 8 background colours
- Real typewriter keyboard with full graphics
- Music in three voices and three octaves
- Language and sound effects

BBC COMPUTER

Please phone for availability and price



"Europe's Largest Discount Personal Computer Stores"

Delivery is added at cost. Please make cheques and postal orders payable to **COMP SHOP LTD.**, or phone your order quoting **BARCLAYCARD, ACCESS, DINERS CLUB** or **AMERICAN EXPRESS** number.

MAIL ORDER AND SHOP:

14 Station Road, New Barnet, Hertfordshire, EN5 1QW (Close to New Barnet BR Station — Moorgate Line). Telephone: 01-441 2922 (Sales) 01-449 6596 Telex: 298755 TELCOM G

OPEN (BARNET) — 10am - 7pm — Monday to Saturday

NEW WEST END SHOWROOM:

311 Edgware Road, London W2. Telephone: 01-262 0387

OPEN (LONDON) — 10am - 6pm — Monday to Saturday

● **IRELAND:** 19 Herbert Street, Dublin 2. Telephone Dublin 604165

● **COMP SHOP USA,** 1348 East Edinger, Santa Ana, California, Zip Code 92705. Telephone: 0101 714 5472526

EUROPE'S FASTEST SELLING ONE BOARD COMPUTER
COMPUKIT UK101



Sumlock

Manchester

microcomputer world



A Pocket Computer with Personal Computer Capabilities.

Into pocket computer dimensions, Sharp packs real personal computer-like capabilities—speed, memory capacity and peripheral connectivity. Ideal for beginners, a versatile tool for experts.

All items are ex stock
Carriage free U.K. mainland

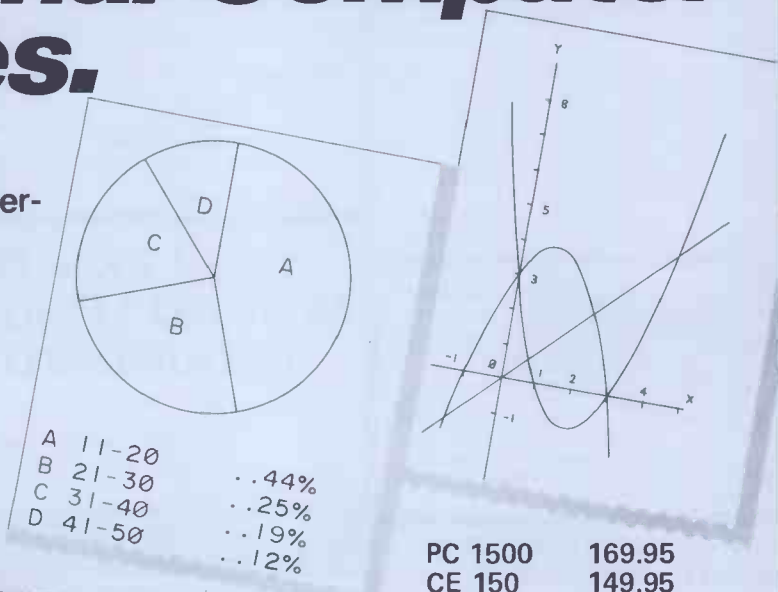

PC 1500	169.95
CE 150	149.95
CE 151	49.95
Inc. VAT	

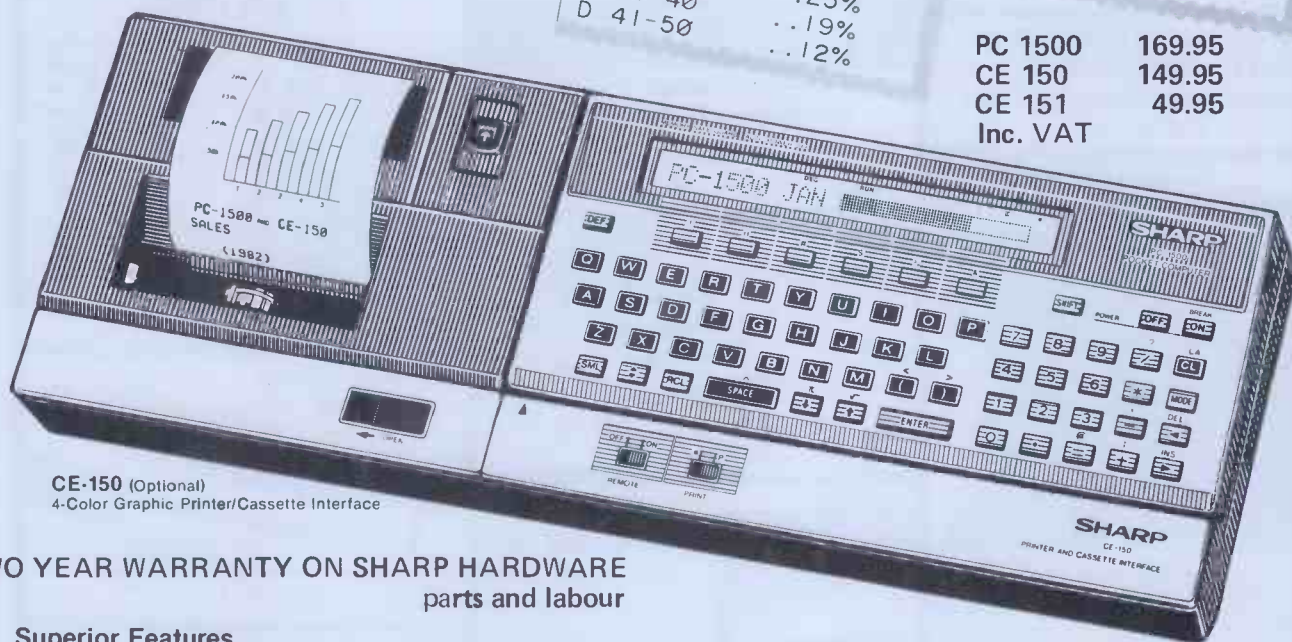

CE-150 (Optional)
4-Color Graphic Printer/Cassette Interface

TWO YEAR WARRANTY ON SHARP HARDWARE
parts and labour

Superior Features

- 8-bit C-MOS CPU for high-speed processing with reduced power consumption
- Powerful BASIC with versatile commands and statements
- Huge memory capacity with 16k-byte ROM and 3.5k-byte RAM, expandable to 7.5k-bytes with Memory Module CE-151 or to 11.5k-bytes with CE-155.
- 4-color data/graphic print-out capability with Graphic Printer/Cassette Interface CE-150
- 7 x 156 dot display with graphics
- Typewriter key arrangement
- Six user-programmable keys
- Wide range of applications for business, engineering and hobbies

Sumlock Manchester
Dept PCW
Royal London House
198 Deansgate Manchester M3 3NE



Telephone/mail order

PC-1500
Pocket Computer

061 834 4233



One Expander Card for apple leads to another....

In fact it leads to many others! Joining the amazing success of our PAL Encoder Card, these four new expander cards all featuring the unique 'Digitek Safety Tab' are ready to plug straight into your Apple Computer.

PAL Colour Encoder Card £105 This amazing card with it's on-board modulator, displays exceptional colour graphics to your TV.

16k Ramcard £91 Insert the card straight into slot 0, and increase the memory capability of your Apple without having to remove any memory chips.

Z80 Expansion Card £110 Installing the Z80 Into your Apple gives you two systems in one, which enables you to run the popular CP/M operating system.

RS232 High Speed Serial Interface £72 The RS232 Interface Card incorporates 13 selectable Baud rates from 75 to 19,200.

Print-master Interface £79 The ultimate parallel interface for Apple to all popular dot matrix printers.

The PRINT-MASTER accepts Apple protocols, 15+ software commands and has on-board graphics dump capability to all popular graphics printers. No need to load clumsy software routines - it's all at your fingertips on the PRINT-MASTER - choice of Inverse printing, double size picture, 90° picture rotation, many word processor type text commands, plus many more.

Apple is the trademark of Apple Computers Inc. Digitek and Print-master are the trademarks of Digitek (International) Ltd.



The people who are really into Apples.

DIGITEK

EXPANDER CARD SERIES

Please send me
 Colour Encoder £105
 Ramcard £91 Z80 £110
 RS232 £72 Print-master £79
 Further Information

I enclose my cheque for £
 payable to Digitek International Ltd.
 Add 15% VAT to all prices quoted.
 Post and packaging FREE.
 Telephone orders **0403 66550**

Name.....

My card.....

Address.....

Number is.....

Post Code.....

Number is.....

DIGITEK (INTERNATIONAL) LTD. 37C WEST STREET, HORSHAM, WEST SUSSEX RH12 1PP.



PCW

Dealer enquiries welcome



Genie III... your third and greatest wish!

The new Genie III surpasses even its predecessors by harnessing all the benefits of modern, professional microcomputing in one unit.

Versatility.

Software availability is exceptionally good - in fact the Genie III has more software available than any of its competitors. And even if you don't want to use a ready made business package, with the Genie III you can write your own! The Genie III is fully operational in either CP/M, or level II basic. It has a built-in screen, 64K RAM, and dual disk drive with 730K storage capacity, all incorporated in its compact and attractive casing.

Speed.

The new Genie III is an obedient slave in the office, quickly and quietly taking care of all your routine work, from printed invoices, mailing lists and letters to stock control.

Economy and simplicity.

It all costs less than a new office junior, yet it's simple enough to operate, and comes complete with a teaching programme to show you how.

Reliability.

Your Genie III is reliable too, manufactured to the most stringent standards with top quality

components. And even in the unlikely event that your Genie should ever temporarily fail to please you are assured of very fast, competent service because the Genie III is only available from our specially selected **SUPERDEALERS**. Dealers whose technical expertise and experience in the fields of installation, software availability and repair is proven.

Software.

Finally, it's compatibility with CP/M or Level II BASIC means there is more Software available for Genie III than any other comparable system!

Please send me FREE, 16 page colour brochure on the Genie Computer System. I enclose 25p postage.

Name

Address

Telephone PCW-82

IOWE
electronics Chesterfield Road,
Matlock,
Derbyshire DE4 5LE.
Telephone: 0629 4995.
Telex: 377482 Lowlec G.

TEC Daisy Wheel Printers reflect the best in Japanese letter quality printing

Features include:

- ★ 40 & 55 CPS Models
- ★ Serial RS232C or 8 bit parallel (Centronics)
- ★ Automatic proportional spacing
- ★ ½ line feed forward & reverse
- ★ Horizontal Tabulation, reverse platen feed, graphics
- ★ 2k buffer and Word Processing function ROM fitted standard
- ★ Logic seeking and space skipping
- ★ Black and Red ribbons (55 CPS only)
- ★ Double print, bold print automatic underlining
- ★ Standard 96 character set, Diablo or Qume print wheels
- ★ Full 12 month guarantee



**Micro
Peripherals Ltd.**

61 NEW MARKET SQUARE, BASINGSTOKE, HAMPSHIRE
Telephone: BASINGSTOKE (0256) 56468 (4 lines)
Telex: 859669 (MICROP G)

Japanese Office: 101 Abe Bldg, 4F, 2-42 Kanda Jinbocho, Chiyado-ku, Tokyo

IMPORTERS AND DISTRIBUTORS OF QUALITY MICRO COMPUTER PRODUCTS TO THE TRADE

The amazing new Altos Series-5. A professional multi-user micro for an incredible £2200.

suggested end-user price including MP/M¹ and on-site warranty



Check these Series-5 features...

- 2x1 Mb² of super-fast floppy disk storage (at least the capacity for true integrated accounting).
- Alternative 5Mb³ hard-disk-based system at £4,400*.
- Optional hard-disk expansion.
- 192K memory, high speed DMA.
- Multi-user, multi-tasking (3 users can share the system at once).
- MP/M included (CP/M⁴ standard for access to a world of software).
- Professional, fully integrated accounting for around £1000*.
- Full range of popular software, printers and video terminals.

On-site warranty, nationwide field service and friendly support.

Superb build quality and fast-access, fast-service design.

All this adds up to the best value-for-money micro we know. So at last, you have an inexpensive and fast way out of the microcomputer jungle. Telephone us right now (07535 55211) for the full story.

*Registered trademarks of Digital Research, Inc. ²Unformatted disk capacity

We'll help you out of the microcomputer jungle.

Microtex

119/120 High Street Eton
Windsor Berkshire SL4 5AN
07535 55211 Tel x 848945



NASCOM MEANS SOLUTIONS NASCOM MEANS PERFORMANCE

Nascom have come a long way since their acquisition by Lucas. With the knowledge of over 30,000 units already in the field you can buy with confidence from NASCOM.

PRODUCTS:

We have kits, built and tested boards, and our fully assembled and tested NASCOM 3 system with a full choice of configuration either cassette or disc based. Alternative operating systems include NAS DOS and CP/M.

SOFTWARE:

We have a team of programmers who are writing software and courseware especially for UK educational business and domestic users.

FREE ADVICE:

We have appointed experts to advise on the specialist use of micro computers in U.K. schools, homes or businesses.

BACK-UP:

We have a nationwide dealer network giving full sales back-up and after sales service. From our head office we have a service line to sort out any problems.

SYSTEM EXPANSION:

NASCOM machines are designed to grow with users. Easily and simply NASCOM systems can be expanded by adding extra modules to the basic system.



Learn more about NASCOM now. Complete the coupon for further information and a full list of dealers.

LUCAS LOGIC LIMITED
NASCOM MICROCOMPUTERS DIVISION,
 Welton Road, Wedgcock Industrial Estate,
 Warwick CV34 5PZ, England.

Have you a NASCOM programme? If so send for an application form for inclusion in our programme book

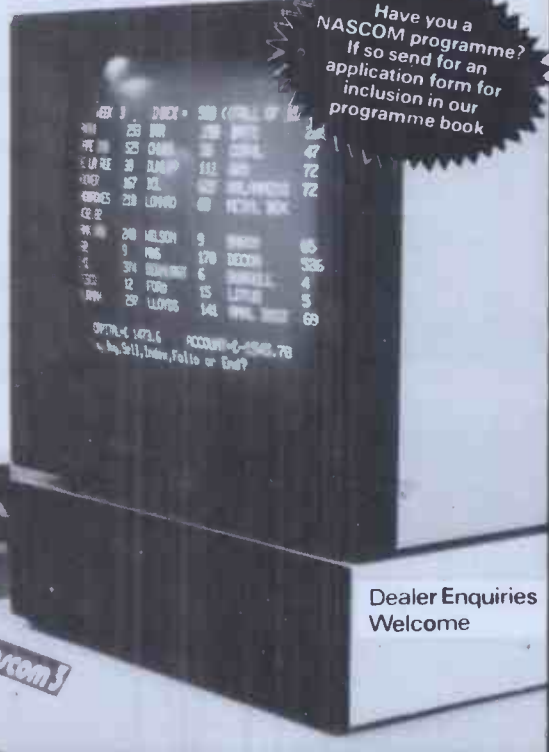

Dealer Enquiries Welcome

£1,548 + VAT
 A typical system as shown consisting of a Nascom 3 (48K), dual disks, monitor, and printer is available from your dealer now.

To Lucas Logic Ltd., Nascom Microcomputers Division, Welton Road, Wedgcock Industrial Estate, Warwick CV34 5PZ, England

Please send:

Literature Dealer List Prog. Book Form

Name

Position

Establishment

Address

Tel. No

PCW 3

Lucas Logic

GW Computers Ltd

TeleVideo

TS 802 Series



TeleVideo's TS 802 and TS 802H microcomputers are low-cost, powerful single-user integrated computer systems. TeleVideo has combined its top of the line CRT display with an advanced design single board computer (Z80, 64K RAM) with 5 1/4 floppy disks and Winchester hard disk all in one attractive tabletop enclosure. A detached typewriter-style keyboard is also included. The TS 802 computer features two 5 1/4-inch Winchester disk drive for 10 Mbytes of data storage, and a single 500 Kbyte minifloppy disk unit.

Both the TS 802 and 802H use the industry standard CP/M 2.2 operating system. This lets the user fulfill a wide variety of information and word processing needs using a multitude of commonly available application programs.

The TS 802 and TS 802H can accommodate serial printers and modems through the RS-232C serial ports.

When it comes time to expand to a multi-user system, you can utilize either your TS 802 or 802H as a satellite user station in the overall system without modification.

TS 802 & 802H Features:

- Z80A 4 MHz processor with direct memory access
- 64 Kbytes of RAM main memory
- 4 Kbytes of EPROM for system diagnostics and boot loading
- Dual floppy disk controller (TS 802), and hard disk controller (TS 802H)
- Dual minifloppy disks: 1 Mbyte capacity (TS 802) Single minifloppy disk (.5 Mbyte capacity), plus 10
- Mbyte Winchester 5 1/4-inch hard disk (TS 802H)
- Green phosphor CRT (25 rows by 80 columns)
- Typewriter-style detached keyboard
- Full-screen attributes, editing, smooth scroll, 25th status line, 11 function keys, numeric key pad

COMPUSTAR™ /CORVUS



Functional characteristics

The CompuStar 10 megabyte Disk Storage System (DSS) consists of read/write and control electronics, read/write heads, a track positioning mechanism, a spindle drive mechanism, dual disks, an air filtration system, and our exclusive 255 user controller — all packaged in a compact desktop enclosure. Although designed primarily to accommodate multiple CompuStar Video Processing Units (described at left), the unit can easily be connected to a single SuperBrain Video Computer System to facilitate additional disk storage. When used with CompuStar VDU's, however, the integral Z80 based controller will permit up to 255 users to 'share' the resources of the disk with minimal CPU response degradation.

Read/Write Heads and Disks

The recording media consists of a lubricated thin magnetic oxide coating on a 200mm diameter aluminium substrate. This coating for mulation, together with the low load force/low mass Winchester type flying heads, permits reliable contact start/stop operation. Data on each disk surface is read by one read/write head, each of which accesses 256 tracks.

- 2 RS-232C serial ports. These are jumper selectable for any combination of modems or printers
- CP/M 2.2 operating system
- Attractive tabletop enclosure, fully integrated with CRT, CPU, RAM and disk drives
- 1 RS-422 high-speed port

24 HOUR ANSWER PHONE — LEAVE ADDRESS FOR STANDARD INFORMATION PACK

ALL YOU NEED FROM A COMPUTER SYSTEM

DATABASE MANAGEMENT+WORD-PROCESSING+MODELLING+DIY INTERPRETER+SERVICE

TWO TYPICAL PACKAGE DEALS	NORMALLY	NORMALLY
01-SUPERBRAIN 64K RAM 320 K	1695.00	01-SUPERBRAIN 64K RAM 700K
02-OKI 80 + INTFCE OR SIMILAR	475.00	02-QUEM SPRINT 9/45
03-CABLE	25.00	03-CABLE ADAPTER
04-12 MONTH WARRANTY	235.00	04-12 MONTH WARRANTY
05-DELIVERY IN U.K.	40.00	05-DELIVERY IN U.K.
06-TRAINING SESSION	50.00	06-TRAINING SESSION
07-CPM HANDBOOK	8.75	07-CPM HANDBOOK
08-50 BASIC EXERCISES	8.75	08-50 BASIC EXERCISES
09-BOX PAPER (2000 SHEETS)	20.00	09-BOX PAPER (2000 SHEETS)
10-DBMS2 (DATABASE)	575.00	10-DBMS2 (DATABASE)
11-MAGIC WAND	190.00	11-MAGIC WAND
12-MBASIC-80	150.00	12-MBASIC-80
13-SUPER CALC	150.00	13-SUPER CALC
14-50 MEMOREX DISKETTES	150.00	14-25 DYSAN D/SIDE DISKETTES
15-DOS+ AND DIAGNOSTICS	125.00	15-DOS+ AND DIAGNOSTICS
16-MSORT & DSORT	75.00	16-MSORT & DSORT
17-RECEIVER + AUTOLOAD	25.00	17-RECEIVER + AUTOLOAD
18-INSTANT BASIC	9.00	18-INSTANT BASIC
19-FIFTY GAMES (ON DISK)	100.00	19-FIFTY GAMES (ON DISK)
20-COVERS/DSK CASES/RIBBONS	50.00	20-COVERS/DSK CASES/RIBBONS
(NOT INC. VAT)	4161.50	(NOT INC. VAT)
	OUR PRICE****2995.00****	OUR PRICE****4995.00****

(Note: The principle of this deal is that you pay (approximately) for item numbers: 01-02-03-04-05-11-14 and the rest is *** FREE ***. You could make up your own package from our price list similarly.)

THREE OTHER PROPOSITIONS

DBMS2 + SORTS + MAGIC WAND + MBASIC 80 + SUPER CALC normally 1140 pounds. Our price 495.00 plus V.A.T.

Also special deal on SUPERBRAIN 64K 320K Disk & OKI 80 Printer as a system with Magic Calc at 2250 plus V.A.T. (90 day warranty).

or SUPERBRAIN 64K 320K Disk & NEC 5510 word-processing printer as a system with magic wand at 2995.00 plus VAT (90 days warranty).

Warranty note: We handle all repairs ourselves. Warranty covers free replacement equipment if defective in first three weeks. Thereafter up to 12 months the cover provides insurance on all spare parts and labour costs (excluding carriage). Call out maintenance is also available at 30.00 minimum (London) 60.00 minimum elsewhere in U.K. plus mileage.

**CALL ONLY BY APPOINTMENT AT 55 BEDFORD COURT MANSIONS,
BEDFORD AVENUE, LONDON W.C.1. TELEX 892031 TWC G.**

GW Computers Ltd

SUPERBRAIN™



SuperBrain users get exceptional performance for just a fraction of what they'd expect to pay. Standard SuperBrain features include: two double density mini-floppies with 350k bytes of disk storage, 32k of RAM memory (expandable to 64k) to handle even the most sophisticated programs, a CP/M® Disk Operating System with a high powered text editor, assembler, debugger and a disk formatter. And, with SuperBrain's S-100 bus adaptor, you can add all the programming power you will ever need... almost any type of S-100 compatible bus accessory.

SuperBrain's CP/M operating system boasts an overwhelming amount of available software in BASIC, FORTRAN, COBOL, and APL. Whatever your application... General Ledger, Accounts Receivable, Payroll, Inventory of Word Processing, SuperBrain is tops in its class. And the SuperBrain OD boasts the same powerful performance but also features a double-sided drive system to render more than 700k bytes of disk storage and a full 64k of RAM. All standard!

Whatever model you choose, you'll appreciate the careful attention given to every engineering detail. A full ASCII keyboard with numeric pad and user-programmable function keys. A non-glare, specially focused 12-inch CRT for sharp images everywhere on the screen. Twin Z-80 microprocessors to insure efficient data transfer to auxiliary peripheral devices. Dual universal RS-232 communications ports for serial data transmission. And, a single board design to make servicing a snap!

ADVANTAGE

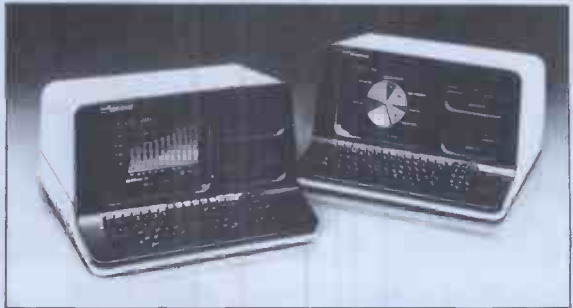

Integrated Desk Top Computer with 12 Inch Bit-Mapped Graphics or Character Display, 64Kb RAM, 4 MHz Z80A, Two Quad Capacity Floppy Disk Drives, Selectric® Style 87 Key Keyboard, Business Graphics Software.

The North Star ADVANTAGE™ is an interactive integrated graphics computer supplying the single user with a balanced set of Business-Data, Word, or Scientific-Data processing capabilities along with both character and graphics output. ADVANTAGE is fully supported by North Star's wide range of System and Application Software.

The ADVANTAGE contains a 4 MHz Z80A® CPU with 64Kb of 200 nsec Dynamic RAM (with parity) for program storage, a separate 20Kb 200 nsec RAM to drive the bit-mapped display, a 2Kb bootstrap PROM and an auxiliary Intel 8035 microprocessor to control the keyboard and floppy disks. The display can be operated as a 1920 (24 lines by 80 characters) character display or as a bit-mapped display (240x640 pixels), where each pixel is controlled by one bit in the 20Kb display RAM. The two integrated 5 1/4 inch floppy disks are double-sided, double-density providing storage of 3600Kb per drive for a total of 7200Kb. The n-key rollover Selectric style keyboard contains 49 standard typewriter keys, 9 symbol or control keys, a 14 key numeric/cursor control pad and 15 user programmable function keys.

G.W. COMPUTERS LTD. 01-636-8210, 01-631-4818, TELEX 892031 TWCG

***** BUS *** WIDELY USED IN UK/France/USA AND ENGLISH SPEAKING COUNTRIES FOR ITS (BUSINESS EFFICIENCY) OVERALL FLEXIBILITY AS A COMPLETE BUSINESS PACKAGE.**

Includes Inventory, Database, Management, Invoicing, Mailing Addresses, Statements, Sales/Purchase Ledger with or without Auto Stock Update and Double Entry Journals including Nominal Ledger; plus A/C Receivable and Payable making Auto Bank entries.

01 = Address section	07 = Bank update	13 = Print customer statements	19 = Nominal analysis
02 = Stock control	08 = User database area	14 = Print supplier statements	20 = Aged debtor analysis
03 = A/C receivables	09 = Invoice creation	15 = Print agent statements	21 = Disk directories
04 = Sales ledger	10 = Order files	16 = Print tax statements	22 = File management
05 = A/C payables	11 = 30/60/90 day age analysis	17 = Run separate programs	23 = Sorts
06 = Purchase ledgers	12 = Arithmetic section	18 = Change vocabulary	24 = Disk swap/exit system

WHICH OPTION . . .

(LEVEL 8.00 @ 575.00)

+++++ SUPER - BUS +++++ A NEW HIGHER LEVEL OF THE ABOVE PACKAGE. . . HAS BEEN REDUCED IN SIZE BY 50 PER CENT TO A SINGLE 15K BASIC PROGRAM, MAKING ALL FILE RETRIEVALS A MATTER OF NANoseconds. WORKS UNDER M/PM AND COMPUSSTAR FOR COMMON DATA RETRIEVAL LEVEL 10.00 . . . ***** 975.00 *****

DBMS (DATABASE) HAS 01=,02=,04=,06=,07=,08=,17=,18=,21=,24=. PRICE 475.00

DATABASE FEATURES ARE . . . FOR ANY SIZE RECORD UP TO TWENTY FOUR FIELDS FILE ARCHITECTURES CAN BE DESIGNED WITH COMPLETE FREEDOM OVER THE LINGUISTIC CONVENTIONS ASSIGNED TO EACH FIELD. THE FILE THEN CAN STORE 32000 RECORDS WHICH CAN BE SEARCHED BY THE RANDOM ACCESS NUMBER (RETRIEVED IN LESS THAN ONE SECOND) OR 'KEY' RANDOM ACCESS ON SPECIFIED FIELD OR SEQUENTIALLY COMPARING FOR LEFT FIELD PARTS, FIELD-KEYS OR PARTS OF RECORD, AND THEN CHANGED, PRINTED, DELETED, SKIPPED.

GRAMA (WINTER) LTD; G.W. COMPUTERS LTD. ARE THE PRODUCERS OF THIS PACKAGE WHICH IS UNEQUALLED FOR ITS LEVEL OF TOTAL INTEGRATION, LINGUISTIC FLEXIBILITY AND MAXIMISED DISK MEMORY CONSERVATION. AUTHOR TONY WINTER (M.D., B.A. LIT-R.A. HON PHIL. AND LECTURER)

24 HOUR ANSWER PHONE — LEAVE ADDRESS FOR STANDARD INFORMATION PACK

Superbrain * Corvus DSK /	North Star *	Televideo / NEC/OKI	* Printer
SUPERBRAIN 320K 1695.00	NORTH STAR 700K 2495.00	OKI MICRO-82A 575.00	
SUPERBRAIN 700K 2195.00	NORTH STAR 5.3M 3495.00	OKI MICRO-83 795.00	
SUPERBRAIN 1500K 2595.00	TELEVIDEO 10.3M 4594.00	OKI MICRO-83A 850.00	
COMPUSTAR 10 OK 1695.00	TELEVIDEO T'MNL 1195.00	EPSON MX80FT 475.00	
COMPUSTAR 20 320K 2495.00	TELEVIDEO 700K 2395.00	EPSON MX100 675.00	
COMPUSTAR 30 700K 2695.00	VTR MIRROR DUMP 695.00	TEXAS 810 1395.00	
COMPUSTAR 40 1.5M 2995.00	7 STATION M'PLEX 695.00	SCRIPTA KSR 975.00	
COMPUSTAR 10M DSK 3250.00	BUS ACCOUNTS 8.0 575.00	NEC 3350 1395.00	
CORVUS 5.6M H'DSK 2250.00	NEC 8001/12/31 1850.00	nec 5510 1795.00	
CORVUS 10M H'DSK 3250.00	QUME S/S FEEDER 675.00	NEC 5525 2095.00	
CORVUS 20M H'DSK 4250.00		QUME 9/45 1695.00	
MBASIC 80 150.00	FORTRAN-80 200.00		
CIS COBOL 420.00	PASCAL (VARIOUS) 175.00	COBOL-80 320.00	
MAIL MERGE 55.00	SUPER SORT 120.00	WORD-STAR 250.00	
DATASAR 190.00	BASCOMPILER 190.00	CBASIC 75.00	
DBMS & BUS 8.00 675.00	MAGIC CALC (CPM) 155.00	MAGIC WAND 190.00	
DBMS (EXTENDED) 575.00	BUS VER 8.00 575.00	T/MAKER 150.00	
MSORT & DSORT 75.00	LETTERIGHT 100.00	DBMS & BUS 675.00	
		UTILITIES 75.00	

FORMATS: (FOR BASIC, DBMS II, = N*STAR & SUPERBRAIN 5"1/4) (FOR SUPER-CALC = 8"); ZENITH; XEROX; APPLE; VECTOR. (FOR MAGIC WAND/CALC = N*STAR & SUPERBRAIN)

ANY OF OUR COMPUTER TERMINALS AUTOMATICALLY INCLUDE *****FREE*****

***** MAGIC WAND WORD PROCESSING SOFTWARE *****
***** TESTING AND DELIVERY *****
***** 90 DAY WARRANTY *****

Due to long term contractual commitments, we are only giving restricted demonstrations by appointment at one of our London offices. We export to all countries. Contact Tony Winter on 01-636-8210 or 01-631-4818 and if unavailable then leave a call-back message (clearly stating your telephone number and name) on the 24 hour answer phone, we call back anywhere in the world.

IMPORTANT!!! NO HARDWARE IS ANY VALUE WITHOUT THE SOFTWARE, AND OUR SOFTWARE IS UNEQUALLED. BUY A COMPLETE SYSTEM AND GET 10% OF THE HARDWARE COST IN FREE SOFTWARE.

FOR 1 YEARS WARRANTY ADD 10% HARDWARE COST. MAINTENANCE PRICES PLEASE CALL
MAIL ADDRESS G.W. COMPUTERS LTD. 55 BEDFORD COURT MANS. BEDFORD AVENUE W.C.1, LONDON.
TELEX 892031 TWCG BOSTON OFFICE TELEX 94 0890
CONTACT 01-636-8210 OR 01-631-4818 AND IF UNAVAILABLE THEN LEAVE A CALL-BACK MESSAGE (CLEARLY
STATING YOUR TELEPHONE NUMBER AND NAME) ON THE 24 HOUR ANSWER PHONE OR SIMPLY LEAVE YOUR
ADDRESS AND WE'LL MAIL YOU A STANDARD INFORMATION PACK. WE REGRET WE DO NOT OPERATE A
READER'S REPLY CARD SERVICE. TERMS: C.W.O. OR C.O.D. (PRICES EXCLUDE V.A.T.) SOFTWARE SALES ARE
"MAIL ORDER ONLY". NO DEALERS.

OUR APPLE PRICES TURN OTHERS GREEN.

C/WP Computer prices are so low, we reckon they're the most competitive you will find for a standard factory-fresh Apple with a full 12-month warranty.

And we're not just clever at keeping prices down: C/WP are experts in CP/M and its software. If you already have a 48K Apple II with two disc drives it could cost you only £125 to make it a CP/M APPLE.

If you are starting from scratch, you can buy a complete CP/M APPLE for under £2,000.

Write or 'phone for our full CP/M hardware and software list.

If you're hungry for an Apple at these prices, contact C/WP Computers on 01-828 3127.

C/WP

C/WP Computers
108 Rochester Row, London SW1P 1JP
Telephone: 01-828 3127

APPLE-CP/M OFFER

	EX-VAT PRICES	
	C/WP PRICE £	TYPICAL PRICE £
Apple 48K Europlus	579	812
2 Siemens disc drives with controller	500	650
Microsoft CP/M system with Z80A processor	180	200
16 K RAM card	70	106
Green screen monitor 24MHz	110	159
80 column card	170	200
Epson MX 80T printer	290	360
Printer interface	80	92
10 Floppy discs	20	31
	<u>1999</u>	<u>2580</u>

Items available separately at same price.

SOFTWARE FOR CP/M

	C/WP PRICE £ EX. VAT
Wordstar 3.0	200
Wordstar training pack	40
Calcstar	140
dBase II	375
M Fortran	110
CIS COBOL + Forms-2	475
M Basic Compiler	210

GUESTELCARE

more than just hardware and software at good prices.

We supply  **apple** hardware and software to care for your financial modelling, accounting, word processing etc.

But at Guestel that's not the end of the story. We supply GUESTELCARE - care to ensure that the system you chose is tailored to meet your specific requirements. We also train all operators to achieve maximum efficiency from the system.

After you have purchased your system Guestel care continues with night and day technical and operational support.

Our care also extends to our prices, we take care to keep them as competitive as we can.

Clip the coupon or call into our showrooms and let Guestel care for you and your micro.



8/12 NEW BRIDGE STREET LONDON EC4V 6AL.
TELEPHONE 01 583 2255.

41/43 BALDWIN STREET BRISTOL BS1 1RB.
TELEPHONE 0272 277461

15 GRAND PARADE BRIGHTON SUSSEX BN2 2QB.
TELEPHONE 0273 695264.

 **apple**[®]
DEALERS AND LEVEL ONE SERVICE CENTRES
Guestel Limited is a PLANET company.

- Please send me the current Guestel  **apple** systems and software price list.
- Please ask your sales staff to contact me.

NAME _____

COMPANY _____

ADDRESS _____

TELEPHONE _____

TO GUESTEL LIMITED 8/12 NEW BRIDGE STREET LONDON EC4V 6AL.

PCW1

And now...

THE \$100 DATA SHOW

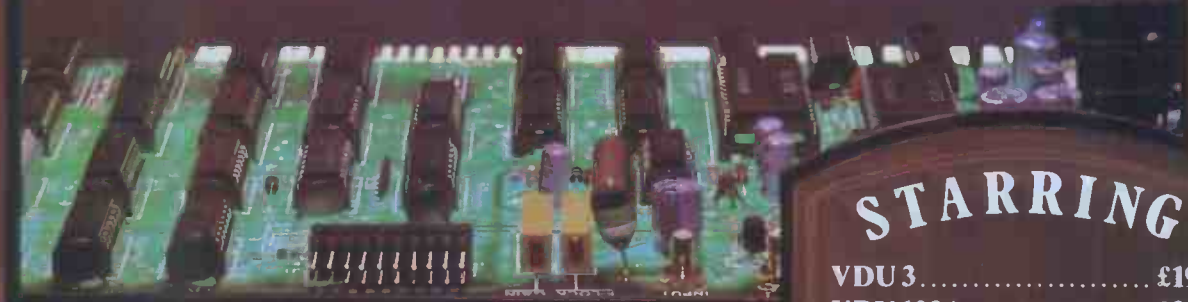

STARRING

VDU 3	£195
VDU 1234	£349
VDU 5	£430

N.B. Prices quoted exclude VAT

To order your VDU card *now*,
phone or write to:

From their range of professional S100 cards, Hi-tech Electronics proudly present:

VDU 3, now in its fourth year of production, providing a Prestel- and viewdata-compatible PAL UHF colour output

VDU 1234, with all the features of VDU 3, plus a choice of PAL UHF, RGB (TTL) and RGB (CCIR) outputs

VDU 5, with synchronization to an external video signal for subtitling, caption generation, etc.

HI-TECH ELECTRONICS

54 HIGH ROAD, SWAYTHLING, SOUTHAMPTON SO2 2JF
TEL 0703 581555 TELEX NO. 47388 HTEL

A Grand Metropolitan Electronics Company

The DAI Personal Computer is

High Performance
High Value

Cash price
ONLY £595 + VAT
BEAT THAT FOR VALUE

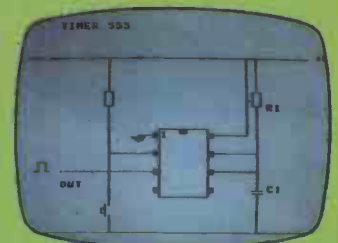
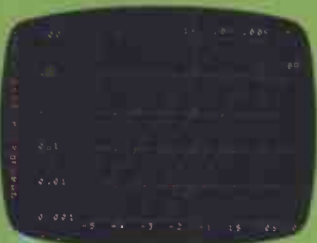
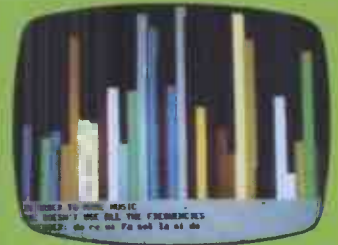

Standard Features

- * 24k Resident High-Speed Basic
- * 16 Colour High-Resolution Graphics (255 x 335)
- * Scrolling Screen Editor
- * Sound Commands for Music Generation
- * Very High Speed Hardware Maths Option
- * Resident Monitor for Machine Language Programming
- * 3 Programmable Parallel Ports
- * Standard TV Interface via Aerial Socket
- * RS232 Serial Port and Dual Cassette Interfaces

Manufactured by:

DAI

THE
MICROCOMPUTER
ENGINEERING
COMPANY
Brussels, Belgium.

Available from:

Data Applications (UK) Ltd.

Personal Computer Division
16b Dyer Street
Cirencester
Gloucestershire
GL7 2PF
Tel: Cirencester
(0285) 66798

For further information please complete and post to:
Data Applications (UK) Ltd, 16b Dyer Street, Cirencester, Glos GL7 2PF

NAME _____

ADDRESS _____

MY INTEREST IS: _____

ADVERTISEMENT

THIS IS THE MONITOR FOR ZX81,
MADE IN DENMARK BY B+H.

JUST PLUG IN YOUR STANDARD ZX81
AND YOU GET A CRISP, CLEAR PIC-
TURE, VIEWABLE EVEN IN BRIGHT
SUNLIGHT. YOU ALSO GET A 3 AMP.
POWER SUPPLY TO DRIVE A PRINTER
AND OTHER ACCESSORIES.

THE SCREEN IS A CUSTOM DESIGNED
7.5 INCH GREEN TUBE WITH A RESO-
LUTION HIGHER THAN 20 MHZ.
YOU CAN STILL USE ALL SINCLAIR
PERIPHERALS, BUT INSIDE THE CASE
WE MADE ROOM FOR THE FUTURE...

AVAILABLE SOON... EXCL. VAT
AT £79.50

ASK YOUR DEALER FOR DETAILS...
THIS IS AN UNRETOUCHED PHOTO

●/830

display monitor

ZX81



BERGQVIST
& HOBBERSTAD
ENG. A/S

20-21 Herluf Trolles Gade,
1052 Copenhagen K., Denmark.
Telephone 45 17 93 1146
Telex 16031 berhob dk.
Trade enquiries welcome.

B+H

ANNOUNCING

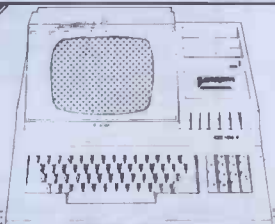

THE MZ80 - A

A SHARPER SHARP

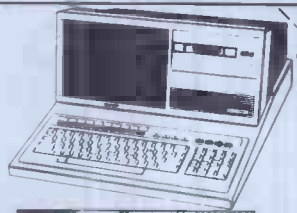

ADDRESS NAME

NEW Account VAT & Non VAT

NEW Database

NEW Forth

NEW Pilot

NEW WDPRO

MZ80 - A
Featuring:

- ★ Professional key board & Numeric pad
- ★ Green Screen, with fast display.
- ★ Scrolling up or down.
- ★ Reverse video.
- ★ Reset switch.
- ★ External volume and Brightness control.
- ★ Auto repeat on all keys.
- ★ Improved Basic printer command and error codes

£549 including V.A.T.

PHONE FOR OUR DEALS

SEND FOR CATALOGUE

MUSIC COMPOSER-EDITOR	£10.50
CHILDRENS MATHS	£5.50
BROWNIAN MOTION	£10.50
BUSINESS PACKAGES					
CASSETTE DATABASE V2.1	£29.50
SOLID STATE V.A.T. ACCOUNTS	£29.50
SOLID STATE ACCOUNTS (non-VAT)	£29.50
BUSINESS PACKAGES					
STOCK CONTROL (disc)	£95.00
MAILING LIST (disc)	£19.50
MAILING LIST (cassette)	£14.50

NEW

GAMES	£5.50
ALLADDIN'S CAVE	£5.50
ASTRODODGE	£5.50
CASINO	£5.50
CRICKET	£5.50
KENTUCKY DERBY	£5.50
HISSING SID	£5.50
MINEFIELD	£5.50
M-CHECKERS (DRAUGHTS)	£10.50
MZ-OTHELLO	£10.50
ROCKET	£5.50
SHUDO	£5.50
SIMON	£5.50
SUPER MOUSE	£5.50
TOWERS OF HANOI	£5.50
TRACK-LAYER	£5.50

KUMA specialise is professional application for the MZ 80-B.

POKER	£5.50
PONTOON	£5.50
PRINCESS & MONSTER MAZE	£5.50
QUADRAX	£5.50
RACING	£5.50
RACETRACK	£5.50
RAIDER	£5.50
REACTOR	£5.50
ROAD HUNTER	£8.00
RHYMES	£5.50
SHAPEMATCH	£5.50
SHARP DEMO (GRAPHICS)	£5.50
SHOWJUMPING	£5.50
SHUDO	£5.50
SNAKES & LADDERS	£5.50
SPACE BATTLE	£5.50
SPACE INVADERS	£5.50
SPACE PURSUIT	£5.50
STARTREK	£5.50
STOMPER	£5.50
SUBMARINE	£5.50
SUPER FIRE	£5.50
SUPER SIMON	£5.50
WORDSMAN	£8.00
TANKWARP/WALL	£5.50
TEN PIN BOWLING	£5.50
TRADER SMITH	£8.00
TYCOON	£5.50
3D	£5.50
U.F.O.	£5.50

APPLICATION AND UTILITY PACKAGES

CASSETTE DATABASE V2.1	£29.50
BASIC PLUS	£12.00
DYBUG	£14.50
SLAVE INTERPRETER	£14.50
WDPRO PROFESSIONAL WORD PROCESSOR (cassette based)	£39.50
WDPRO PROFESSIONAL WORD PROCESSOR (disc based)	£79.95
APOLLO WORD PROCESSOR v1.9 (cassette based)	£24.95
APOLLO WORD PROCESSOR/DOS (disc based)	£55.00
MEMORY TEST	£5.50
BASIC EXTENSIONS	£13.00
ARDENSOFT TOOLKIT	£35.00
CP/M	£150.00
ZEN EDITOR/ASSEMBLER	£19.50
ZEN MOD	£10.50
ZEN-DOS (disc based)	£37.50
DISASSEMBLER (ZEN COMPATIBLE)	£10.50
SHARP EDITOR/ASSEMBLER	£45.00
SHARP MACHINE CODE TAPE & MANUAL	£22.50
CRYSTAL BASIC	£40.00
SUPER COPY	£10.50
PROGRAM FILING INDEX	£5.50
SPEED BASIC	£10.00
CALC II	£34.50
APOLLO FRONT PANEL (48K)	£12.50
LANGUAGES	
FORTH	£34.95
PILOT	£15.00
PASCAL SP4015 (cassette)	£50.00
DOUBLE PRECISION BASIC FOR THE MZ-80K DISC SYSTEM	£40.00
EDUCATIONAL PACKAGES					
ELECTRONS 1 & 2	£10.50
WAVES 1 & 2	£10.50
SEMICONDUCTORS 1 & 2	£10.50
NEWTON CONSERVATION	£10.50
NAVEX 1.0	£24.95
PILOT	£15.00
SLAVE INTERPRETER	£14.50
ROCKET	£5.50
J MATHS add/sub & STEPPING STONES	£5.50
INFANT ADDITION & FOUR RULES	£5.50
CEBIL III	£4.95
TIMETABLING AID	£19.50

ANIMATE	£8.00
BLOCKADE	£5.50
BOMBER	£5.50
BREAKOUT	£5.50
CAMELOT	£5.50
CAROLS	£5.50
CATCH 2000/INVADER	£5.50
CHESS	£10.50
COMBAT	£5.50
CONCENTRATION	£5.50
COSMIAD 12K	£8.00
CRIBBAGE	£10.50
DONKEY DERBY	£5.50
ELECTRONIC ORGAN	£5.50
ENIGMA	£5.50
EVASION	£5.50
EXECUTIVE	£8.00
EXPLORING AFRICA	£5.50
FALL OUT	£5.50
FIREBALLS	£5.50
4 IN A ROW	£5.50
FRUIT MACHINE	£5.50
GUESS WORD	£5.50
GUN	£5.50
HANGMAN	£5.50
HEAD ON	£5.50
HOME BUDGET Ver. 2	£5.50
HUNTER KILLER	£5.50
INTRUDER	£5.50
J.S. LINE 4	£5.50
LARGE DISPLAY	£5.50
LIFE	£8.00
LUNAR	£5.50
LUNAR LANDING	£5.50
MAP OF ENGLAND	£10.50
MASTERMIND	£5.50
MELODY	£5.50
MIZ MAZE	£8.90
MONKEY CLIMB	£5.50
MORTAR ATTACK	£5.50
PATIENCE	£5.50

HARDWARE ACCESSORIES

I/O Box card extender	£34.50
D-I-P Prototyping board	£37.50
Printer Interface Centronics parallel	£110.00
High Resolunon Graphics board	£110.00
Green Screen	£5.50
MZ 80-K MANUALS AND ACCESSORIES					
BASIC 5025 MANUAL	£7.00
MZ 80-K SERVICE MANUAL	£7.50
MZ 80-10 SERVICE MANUAL	£7.50
MZ-80P3 SERVICE MANUAL	£7.50
MZ-80FD SERVICE MANUAL	£10.00
MZ 80-K DUSTCOVER	£9.95
MANUALS					
MONITOR LISTING	£15.00
BOOKS					
A Beginners guide to using the MZ 80-K	
R.G. Meadows	£3.95
MZ 80-K Software Secrets Graham Beech	£5.95
Sharp Software Techniques Trowsdale	£5.95
Peeking and Poking into the MZ 80-K	£4.30

STATIONARY

*Lining paper for P3 or Epson printers (9.5x11inch (inkjet))	£14.00
*Sticky labels by the 1000 tractor feed (3.5x1.5 in)	£5.50
*Ribbons for P3 printer	£2.50
*Ribbons for Epson printer	£7.50
*Ribbons for Tec Starwriter printer (fabric or carbon)	£2.95
*Daisy wheel for Tec Starwriter	£4.45
*Cassettes C12	£0.44
*Cassette cases	£1.10
*M-Lining Paper	£32.50
*Double sided single/dh density Diskettes (including storage box)	£28.00

*Just ask for other requirements.

TRADE INQUIRIES FOR SHARP SOFTWARE WELCOME

Kuma major in, Sharp Software, Matrix and Daisy wheel printers. ZX81 Software + Books & computer Books

Software authors for Sharp Please contact Kuma
 Please add V.A.T. to all prices

Kuma Computers

11 York Road, Maidenhead, Berks. SL6 15Q
 Tel: (0628) 71778/9 Telex: 849462 TELFAC.KUM



ConSup

COMPLETE COMPUTER SUPPLIES

DISCS

All our discs come with no-quibble guarantee for one year!
If you have any problems with a disc we will cheerfully
replace it free of charge. Prices are per a box of ten discs.

	BASF	ACCUTRACK	VERBATIM
SSSD	15.00	18.10	18.50
SSDD	20.00	18.10	23.80
DSDD	23.35	27.00	35.00
SSSD	16.00	21.00	23.00
SSDD	20.10	21.00	26.20
DSDD	23.35	27.00	35.00

RIGID PLASTIC LIBRARY CASES

5 Discs (Blue/Black/Grey/Beige)	2.25
8 Discs (" " " ")	2.35

DISC DRIVE HEAD CLEANING KITS

5 Disc Head Cleaner	13.70
8 " " "	13.70
Complete computer Cleaning Kit	22.90

LISTING PAPER

11 x 9 Perforated, Plain	9.28 per box
12 x 9 " "	10.00 per box
11 x 14 Plain or Music ruled	11.00 per box

(Box contains 2000 sheets)

MAILING LABELS

3 x 1 1 across	7.50 per 1000 labels
3 x 1 2 across	7.00 per 1000 labels

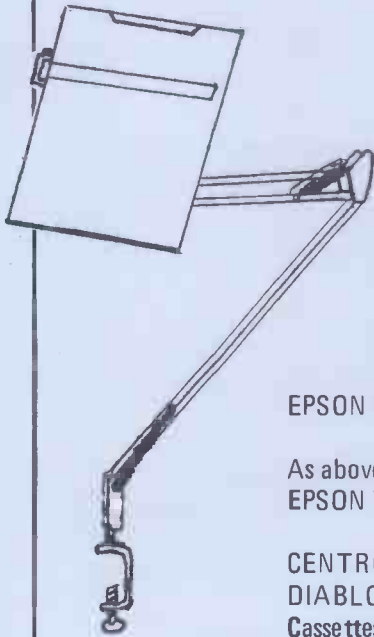

LUXURY DATA READER

Adjustable arm and 'G' clamp
22.50

DUSTCOVERS FOR PRINTERS AND COMPUTERS

eg Cover for PET only 5.00

DAISY WHEELS

QUME or DIABLO	3.49 each
RICOH	15.00
NEC Thimbles	10.00

PRINTER RIBBONS

EPSON MX80/Commodore 4022	5.85 each
As above REFILLS	3.00 each
EPSON TX80/Commodore 3022	2.00 each
CENTRONICS ZIP-PACK	4.20 each
DIABLO Multistrike	3.00 each
Cassettes C15	50p each

ORDERING INFORMATION

Prices are exclusive of VAT or delivery.

Postage & Packing as follows if you live outside our delivery area (London)

Discs	0.75 per box	Library Boxes	0.30 per box
Ribbons	0.30 per box	Listing paper	3.50 " "
Cleaning Kits	1.30 each	Mailing Labels	1.20 " "
Cassettes	0.15 each	Data Reader	1.25 each

Add 15% of total for VAT and make cheques payable to
ConSup - 62 Tritton Road, London SE21 8DE
01-670 4411

Send now for our complete price list!

Visit the Prentice-Hall
computer books displays to
see a wide range of up-to-date
titles at these shops:

LONDON & HOME COUNTIES

Appleby, Myers & Clarke, Watford
Barbican Business Book Centre, Moorfields
Stanley Botes, Kingston
Brunel University, Uxbridge
Carter & Wheeler, Slough
Dillons, Malet Street
Foyles, Charing Cross Road
H K Lewis, Gower Street
John Menzies, Old Broad Street
Modern Book Company, Praed Street
Wm Smith, University of Reading
Wm Smith, Reading
University Bookshop, Surrey
University Bookshop, Sussex
Websters, Croydon

SOUTH-EAST

Albion, Canterbury
Bowes & Bowes, Southampton
Bowes & Bowes, University of Southampton
Dillons, University of Kent at Canterbury
Robinsons, Brighton

SOUTH-WEST & WALES

Bilbo's Bookshop, Bath
Bowes & Bowes, University of Bath
Bowes & Bowes, Cardiff
Galloway Bookseller, Aberystwyth
Georges, Bristol
Lears, Cardiff
Polytechnic Bookshop, Plymouth
Singleton Bookshop, University of Swansea
Swindon Bookshop, Swindon
Uplands Bookshop, Swansea
University Bookshop, Cardiff
University Bookshop, Exeter

MIDLANDS & EAST

Blackwells, Oxford
Bookland, Stafford
Bowes & Bowes, Cambridge
Bowes & Bowes, Leicester
Cambridge Computer Store
Dillons, University Bookshop, Nottingham
Heffers, Cambridge
Hudsons, New Street, Birmingham
Hudsons, University of Birmingham
Hudsons, Earl Street, Coventry
Hudsons, Hertford Precinct, Coventry
Hudsons, Leicester
Hudsons, University of Loughborough
Jarrolds, Norwich
Sisson & Parker, Milton Street, Nottingham
Sisson & Parker, Wheelergate, Nottingham

NORTH

Austicks Polytechnic Bookshop, Leeds
Bowes & Bowes, University of Bradford
Bowes & Bowes, University of Hull
Bowes & Bowes, Liverpool
Bowes & Bowes, Sheffield University
Briers, Middlesbrough
Browns, Hull
Godfreys, University of York
Godfreys, York
Haigh & Hochland, University of Manchester
Hudsons, Liverpool
Hudsons, Newcastle
Phillip Son & Nephew, Liverpool
Salford University Bookshop
Students Bookshop, Lancaster
Thornes, Newcastle
W H Willshaw, Manchester

SCOTLAND

Bauermeister, Edinburgh
James G Bisset, High Street, Old Aberdeen
James G Bisset, Upper Kirkgate, Aberdeen
John Smith, St Vincent Street, Glasgow
John Smith, University of Glasgow
John Smith, Stirling University Bookshop
James Thin, South Bridge, Edinburgh
University Bookshop, Dundee

May-June Prentice-Hall computer books event

During May and June new and bestselling computer books published by Prentice-Hall and its associated imprints—Reston, Reward and Spectrum—will be on display in bookshops throughout the country.

Featuring—the book you've been waiting for . . .

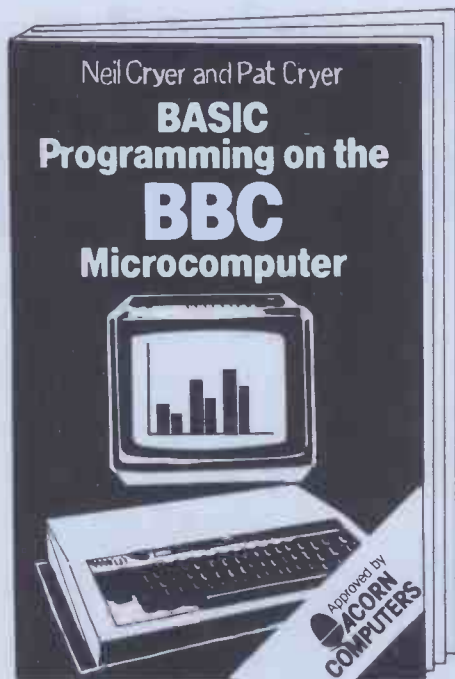

BASIC Programming on the BBC Microcomputer

Neil Cryer and Pat Cryer

For beginners with no experience of computers, this comprehensive book has been written with particular reference to the BBC Microcomputer. It provides a step-by-step course on BASIC and teaches you how to write programs using the BBC's enhanced version of BASIC. Every program included has been tested on a production model of the BBC micro.

£5.95 paperback 208 pages 13-066407-3 March 29th



. . . and many other outstanding titles, such as



Apple BASIC for Business For the Apple II

£13.45 hardback 400 pages 8359-0228-5
£11.20 paperback 8359-0226-9 1981

The ATARI Assembler

Don Inman and Kurt Inman
£9.70 paperback 270 pages 8359-0236-6
1981

Microcomputer Data Communication Systems

A Guide to Modems, Terminals, Electronic
Bulletin Boards . . . for Users of TRS-80,
Apple II, Heath-89 and Other Systems
Frank J. Derfler
£9.70 paperback 128 pages 13-580712-3
April 1982

The PET Personal Computer for Beginners

Seamus Dunn and Valerie Morgan
£7.50 hardback 240 pages 13-661835-9
£4.95 paperback 13-661827-8 1981

Starting FORTH

Leo Brodie
£14.95 hardback 384 pages 13-842930-8
£11.95 paperback 13-842922-7 1981

Prices and publication dates are correct at the time of going to press
but may be subject to change.

Prentice/Hall  International

66 Wood Lane End, Hemel Hempstead, Hertfordshire HP2 4RG, England

Better buy Cumana strictly dependable top Quality Products like TEAC... like no one else for price!



Cumana Ltd. offer you a dependable flow of exceptionally high quality **DISK DRIVES** from **TEAC of Tokyo** featuring high reliability and compatibility. Cumana have an enviable reputation and aim to continue giving you the best service in the business. These mains powered Disk Drive units are designed to interface to a wide range of computers such as **TRS 80 models I and III, Genie I and II, SWTP, Heathkit, Superbrain, Nascom** and the **BBC Micro, Model B.**

Floppy Disk Drives 40 and 80 Track Cased Units

Single Disk Units

1x40 Track single sided Drive	£199
1x80 Track single sided Drive	£265
1x80 Track double sided Drive	£429

Dual Disk Units

2x40 Track single sided Drives	£369
2x80 Track single sided Drives	£495
2x80 Track double sided Drives	£799

Disk Drive Cables

2 Drive Cable	£15.00
4 Drive Cable	£25.00

Please add VAT to all prices. Delivery at cost will be advised at time of order.

CUMANA LTD

35 Walnut Tree Close, Guildford, Surrey GU1 4UN. Telephone: (0483) 503121. Telex: 858306.

Call your nearest dealer for a demonstration: Write or 'phone for Data Sheets - Dealer and O.E.M. enquiries welcome.

RADIO SHACK LTD.,
London NW6. Tel: 01-624-7174

COMP SHOP LTD.,
New Barnet, Herts.
Tel: 01-441-2922

COMP SHOP LTD.,
London W2. Tel: 01-262-0387

COMP SHOP LTD.,
Dublin 2. Tel: 604165

LONDON COMPUTER CENTRE,
London W1. Tel: 01-388-5721

N.I.C.
London N15. Tel: 01-808-0377

CROYDON COMPUTER CENTRE,
Thornton Heath, Surrey.
Tel: 01-689-1280

P J EQUIPMENT LTD.,
Guildford. Tel: 0483-504801

R.D.S. ELECTRICAL LTD.,
Portsmouth. Tel: 0705-812478

TANDY HASTINGS LTD.,
Hastings. Tel: 0424-431849

MICROWARE COMPUTING SERVICES,
Bristol. Tel: 0272-279560

BLANDFORD COMPUTERS,
Blandford Forum.
Tel: 0258-53737

TAPE SHOP
Brighton. Tel: 0273-609099

PARWEST LTD.,
Chippenham. Tel: Q249-2131

COMPUTER SHACK
Cheltenham. Tel: 0242-584343

TANDY GLOUCESTER,
Gloucester. Tel: 0452-31323

COMSERVE,
Bedford. Tel: 0234-216749

CLEARTONE COMPUTERS,
Abercarn, Gwent.
Tel: 0495-244555

EMPRISE LTD.,
Colchester. Tel: 0206-865926

MAGNUS MICRO-COMPUTERS,
Kidlington, Oxford.
Tel: 08675-6703

CAMBRIDGE COMPUTER STORE,
Cambridge. Tel: 0223-65334

I.C. ELECTRONICS,
Biddenden, Kent.
Tel: 0580-291816

MICRO CHIP SHOP,
Fleetwood, Lancs.
Tel: 03917-79511

HARDEN MICRO-SYSTEMS,
Blackpool. Tel: 0253-27590

AMBASSADOR BUSINESS COMPUTERS LTD.,
Shipley, W. Yorks.
Tel: 0274-595941

Q-TEK SYSTEMS LTD.,
Stevenage, Herts.
Tel: 0438-65385

COMPUTER & CHIPS,
St. Andrews, Fife, Scotland.
Tel: 0334-72569

HEWART MICRO-ELECTRONICS,
Macclesfield. Tel: 0625-22030

KARADAWN LTD.,
Great Sankey, Warrington.
Tel: 0925-572668

PHOTO-ELECTRICS,
Sheffield. Tel: 0742 53865

ARC ELECTRONICS,
Nr. Wakefield, W. Yorks
WF2 6SL. Tel: 0924-253145

VICTOR MORRIS LTD.,
Glasgow, G2 8LY.
Tel: 041-221 8958

COMPRITE LTD.,
Laisterdyke, Bradford.
Tel: 0274-663471

GNOMIC LTD.,
Blackhall, Hartlepool.
Tel: 0783-863871

BRIERS COMPUTER SERVICES,
Middlesbrough, Cleveland. Tel: 0642-242017

3 LINE COMPUTING
Hull. Tel: 0482-445496

H.C. COMPUTER SALES LTD.,
Gateshead. Tel: 0632-874811

EWL COMPUTERS LTD.,
Glasgow. Tel: 041-332-7642

EVERYMAN COMPUTING,
Westbury, Wilts.
Tel: 0373-864644



The choice is yours...

Xitan Systems, the South Coast's leading centre for microcomputer hardware and software, offer a choice of over twenty systems from seven major manufacturers.

apple Popular desktop computers for personal and small business use.

comart Communicator range of sophisticated British S100 business systems.

commodore VIC-20, the ideal introduction to computing.

Cromemco Computer range for professional use, with numerous options.

XITAN SYSTEMS

Xitan Systems Limited
23 Cumberland Place
Southampton SO1 2BB
Telephone 0703 38740
Telex 47388 CHACOM G.

NorthStar The Advantage desktop computer with business graphics.

OSBORNE The briefcase-sized system that took America by storm: a complete business system in a compact, portable package.

SHARP The elegant MZ80B desktop computer, with a range of options.

XITAN The essential back-up for every system, Xitan offer unrivalled knowhow in commercial, industrial, educational and scientific microcomputer applications. Xitan's services include system development, hardware and software support, and fast and effective service in the field.

Make the most of your Sinclair ZX Computer...

Sinclair ZX software on cassette.

£3.⁹⁵ per cassette.



The unprecedented popularity of the ZX Series of Sinclair Personal Computers has generated a large volume of programs written by users.

Sinclair has undertaken to publish the most elegant of these on pre-recorded cassettes. Each program is carefully vetted for interest and quality, and then grouped with other programs to form a single-subject cassette.

Each cassette costs £3.95 (including VAT and p&p) and comes complete with full instructions.

Although primarily designed for the Sinclair ZX81, many of the cassettes are suitable for running on a Sinclair ZX80 – if fitted with a replacement 8K BASIC ROM.

Some of the more elaborate programs can be run only on a Sinclair ZX Personal Computer augmented by a 16K-byte add-on RAM pack.

This RAM pack is described below. And the description of each cassette makes it clear what hardware is required.

16K-BYTE RAM pack

The 16K-byte RAM pack provides 16-times more memory in one complete module. Compatible with the ZX81 and the ZX80, it can be used for program storage or as a database.

The RAM pack simply plugs into the existing expansion port on the rear of a Sinclair ZX Personal Computer.

Cassette 1 – Games

For ZX81 (and ZX80 with 8K BASIC ROM)

ORBIT – your space craft's mission is to pick up a very valuable cargo that's in orbit around a star.

SNIPER – you're surrounded by 40 of the enemy. How quickly can you spot and shoot them when they appear?

METEORS – your starship is cruising through space when you meet a meteor storm. How long can you dodge the deadly danger?

LIFE – J.H. Conway's 'Game of Life' has achieved tremendous popularity in the computing world. Study the life, death and evolution patterns of cells.

WOLFPACK – your naval destroyer is on a submarine hunt. The depth charges are armed, but must be fired with precision.

GOLF – what's your handicap? It's a tricky course but you control the strength of your shots.

Cassette 2 – Junior

For ZX81 with 16K RAM pack

CRASH – simple addition – with the added attraction of a car crash if you get it wrong.

MULTIPLY – long multiplication with five levels of difficulty. If the answer's wrong – the solution is explained.

TRAIN – multiplication tests against the computer. The winner's train reaches the station first.

FRACTIONS – fractions explained at three levels of difficulty. A ten-question test completes the program.

ADDSUB – addition and subtraction with three levels of difficulty. Again, wrong answers are followed by an explanation.

DIVISION – with five levels of difficulty. Mistakes are explained graphically, and a running score is displayed.

SPELLING – up to 500 words over five levels of difficulty. You can even change the words yourself.

Cassette 3 – Business and Household

For ZX81 (and ZX80 with 8K BASIC ROM) with 16K RAM pack

TELEPHONE – set up your own computerised telephone directory and address book. Changes, additions and deletions of up to 50 entries are easy.

NOTE PAD – a powerful, easy-to-run system for storing and retrieving everyday information. Use it as a diary, a catalogue, a reminder system, or a directory.

BANK ACCOUNT – a sophisticated financial recording system with comprehensive documentation. Use it at home to keep track of 'where the money goes,' and at work for expenses, departmental budgets, etc.

Cassette 4 – Games

For ZX81 (and ZX80 with 8K BASIC ROM) and 16K RAM pack

LUNAR LANDING – bring the lunar module down from orbit to a soft landing. You control attitude and orbital direction – but watch the fuel gauge! The screen displays your flight status – digitally and graphically.

TWENTYONE – a dice version of Blackjack.

COMBAT – you're on a suicide space mission. You have only 12

missiles but the aliens have unlimited strength. Can you take 12 of them with you?

SUBSTRIKE – on patrol, your frigate detects a pack of 10 enemy subs. Can you depth-charge them before they torpedo you?

CODEBREAKER – the computer thinks of a 4-digit number which you have to guess in up to 10 tries. The logical approach is best!

MAYDAY – in answer to a distress call, you've narrowed down the search area to 343 cubic kilometers of deep space. Can you find the astronaut before his life-support system fails in 10 hours time?

Cassette 5 – Junior Education: 9-11-year-olds

For ZX81 (and ZX80 with 8K BASIC ROM)

MATHS – tests arithmetic with three levels of difficulty, and gives your score out of 10.

BALANCE – tests understanding of levers/fulcrum theory with a series of graphic examples.

VOLUMES – 'yes' or 'no' answers from the computer to a series of cube volume calculations.

AVERAGES – what's the average height of your class? The average shoe size of your family? The average pocket money of your friends? The computer plots a bar chart, and distinguishes MEAN from MEDIAN.

BASES – convert from decimal (base 10) to other bases of your choice in the range 2 to 9.

TEMP – Volumes, temperatures – and their combinations.

Cassette 6 – Family Quiz

For ZX81 (and ZX80 with 8K BASIC ROM) with 16K RAM pack.

Four different quizzes, each consisting of 10 questions suitable for the whole family. There's a target time for each quiz, and at the end you're told how long you took to answer the questions – and how many you got right. The quizzes cover a range of topics – including maths, English grammar, and general knowledge.

How to order

Simply use the order form below, and either enclose a cheque or give us the number of your Access, Barclaycard or Trustcard account. Please allow 28 days for delivery. 14-day money-back option.

sinclair ZX SOFTWARE

Sinclair Research Ltd,
6 Kings Parade, Cambridge,
Cambs., CB2 1SN. Tel: 0276 66104.

To: Sinclair Research FREEPOST, Camberley, Surrey, GU15 3BR.

Please send me the items I have indicated below.

Please print

Qty	Code	Item	Item price	Total
	21	Cassette 1 – Games	£3.95	
	22	Cassette 2 – Junior Education	£3.95	
	23	Cassette 3 – Business and Household	£3.95	
	24	Cassette 4 – Games	£3.95	
	25	Cassette 5 – Junior Education	£3.95	
	26	Cassette 6 – Family Quiz	£3.95	
	17	*8K BASIC ROM for ZX80	£19.95	
	18	*16K RAM pack for ZX81 and ZX80	£29.95	
		*Post and packing (if applicable)	£2.95	
Total £				

*Please add £2.95 to total order value only if ordering ROM and/or RAM.

I enclose a cheque/PO to Sinclair Research Ltd for £ _____

Please charge by Access*/Barclaycard/Trustcard no. _____

*Please delete as applicable.

Name: Mr/Mrs/Miss _____

Address: _____

SOF08

SHARP COLOUR SENSATION

for only
£278 +VAT

SHARP CE-150
4-colour Graphic
Printer
£130.39 + VAT;
Total £149.95



SHARP PC-1500
'Basic' Pocket
Computer
£147.78 + VAT;
Total £169.95

Price includes
SECURICOR 24
HOUR DELIVERY*.

Same day despatch,
subject to availability.

SHARP 1500 COMPUTER SYSTEM FULL REVIEW IN THIS ISSUE!

Up to **11.5K** user memory (3.5K PC-1500 + 4K CE-151/8K CE-155)
maintained during power-off and battery change
16K Extended BASIC language for powerful programming (PLUS CE-150
8K Graphics BASIC)
Four Colour high resolution (500 x 200) printer/plotter with 9 type sizes and
4 print directions (CE-150)

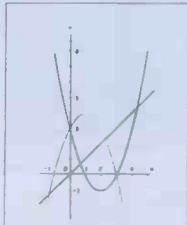
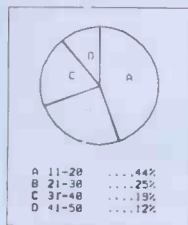

TWO cassette control for bulk data & program storage with remote control
(CE-150)

Full range of science and math functions (statistics with MiCROL software)

Up to **thirty-six** separate programs immediately accessible

Twenty-six character LCD display doubles as **1092 point** mini-graphic display
with BASIC program control

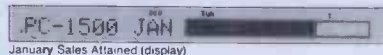

256 frequency tone generator with BASIC repetition, frequency and duration
control

Built-in month, date, hours, minutes and seconds clock, usable in BASIC
programs

One and two dimensional arrays (numeric and text)

Full range of text manipulation functions (LEFT, RIGHT, LEN, VAL, MID,
CHR, ASC etc)

Ergonomic QWERTY typewriter-style keyboard with separate numeric keypad
'Advanced' programming capabilities with PEEK, POKE, CALL etc

Sixty-way system expansion socket for optional add-ons (see below)

Three-way power option (with CE-150) — standard HP7 batteries for
PC1500/EA-150 mains adaptor, CE-150 contains rechargeable batteries and is
supplied with EZ-150 adaptor

350+ page User Manuals

Optional add-ons include: CE-150 printer/plotter/cassette adaptor, CE-151 4K
memory module, CE-155 8K memory module, CE-153 140-key custom
keyboard (Summer 82), RS232C communications interface (Autumn 82),
custom cassette recorder (Autumn 82), custom system carry-case (Autumn
82). Further system add-ons will be available first from TEMPUS.

DIMENSIONS

PC-1500: 195Wx25.5Hx86Dmm (7.11/16x3.3/8") Wt 375g
(0.83lb)

CE-150: 330Wx50hx115Dmm (13x2x4inches) Wt 900g
(1.98lb).

Full **12 MONTHS** guarantee, with **EQUIPMENT LOAN**
SERVICE during downtime.

***SAME DAY DESPATCH** of orders — Systems by
SECURICOR 24 hour service, (to attended premises only) or
by first class registered post. **AT NO EXTRA COST.**

TEMPUS

THE PORTABLE COMPUTER PEOPLE

DEPT PCW 38 Burleigh Street, Cambridge CB1 1DG.

Tel: 0223 312866

MiCROL 1500 Software Series THE PORTABLE COMPUTER COMES OF AGE

Powerful, ready-to-run applications software on cassette, for
business, science, engineering and the professions.

All 1500 Software Series programs feature:

- * 100% reliable performance for total dependability
- * User-friendly operating style
- * Comprehensive reference manuals, user tutorials and quick-check reference cards
- * Designed to the highest standards in conjunction with qualified consultants.

MiCROL 1500 Software Series products available now and
under development include:

1500 PROCOS — the most powerful, practical, yet easy-to-
learn software package ever developed for a portable
computer.

Using PROCOS, you will be able to create powerful, reliable
programs in just minutes — even if you have never pro-
grammed A computer before.

Designed for all applications involving calculations, PROCOS
cuts program development time by as much as **80-90%**, whilst
offering user features normally only found on 'Visicalc'-type
systems, helping you answer 'what if' questions and analyse
trends.

Fully menu-driven for easy operation, with over forty
touch commands for complete, flexible data management.
The detailed tutorial manual includes examples illustrating
how PROCOS can be used to create a powerful financial
accounting package, a business management aid, and general
purpose 'super-calculator', but the full range of applications
is as wide as your imagination.

PROCOS is an expandable professional computing system.
The first expansion modules (available June) include:
GRAPHIX adds the easy-read clarity of graphic presentation to
PROCOS. Data may be presented as displayed barcharts,
printed pie and bar charts, with Autocolour options and
'note-printing' feature.

STATIX brings the benefits of statistical analysis to
PROCOS. Designed for the non-technical user, STATIX helps
you determine trends and predict future developments.
MiCROL 1500 Software Series products require the fol-
lowing hardware:

PC-1500, CE-150 and compatible standard cassette recorder,
CE-151/CE-155 memory modules (CE-155 recommended)

1500 PROCOS	£49.95	inc VAT & UK delivery
1500 GRAPHIX	£19.95	
1500 STATIX	£19.95	

To: Tempus, FREEPOST, 38 Burleigh St, Cambridge CB1 1BR.

QTY	ITEM	INFO	PRICE	TOTAL
	PC-1500 Pocket Calculator		£169.95	
	CE-150 Four Colour Printer		£149.95	
	CE-151 4K Byte RAM Module		£ 49.95	
	CE-155 8K Byte RAM Module		£ 79.95	

Sharp 1500 information MiCROL 1500 information

I herewith enclose a cheque or Postal Orders value £ _____
or I wish to pay by Access/B'card/Visa.

My name is:

Name:

Address:

PCW 6

Hardware and software costs may be a deductible business expense.

WE PUT CP/M TO WORK ON SHARP

Micro Technology, the people who put CP/M on the Sharp MZ-80B, and on the all-new MZ-80A, have achieved the near impossible and produced CP/M on the PC 3201; plug our board into the back of your PC 3201 and you can run standard 64k CP/M and use the vast library of CP/M software that Micro Technology can supply.

Now look at Sharp equipment, with all machines offering CP/M and integration using CP/NET and MP/M, you can network together the economy of the MZ-80A, the speed and graphics capability of the MZ-80B and the superbly attractive business presentation of the PC 3201.

**SHARP
MZ80B** Highly flexible micro computer with 64k RAM, disks or tape; high resolution graphics and CP/M.



**SHARP
PC3201** And newly available from Micro Technology, a plug-in board that allows you to run your PC 3201 with standard 64k CP/M. All CP/M products on our list are now available, including the superb new Padmede/Micro Technology business packages, all making the PC 3201 an excellent business machine.

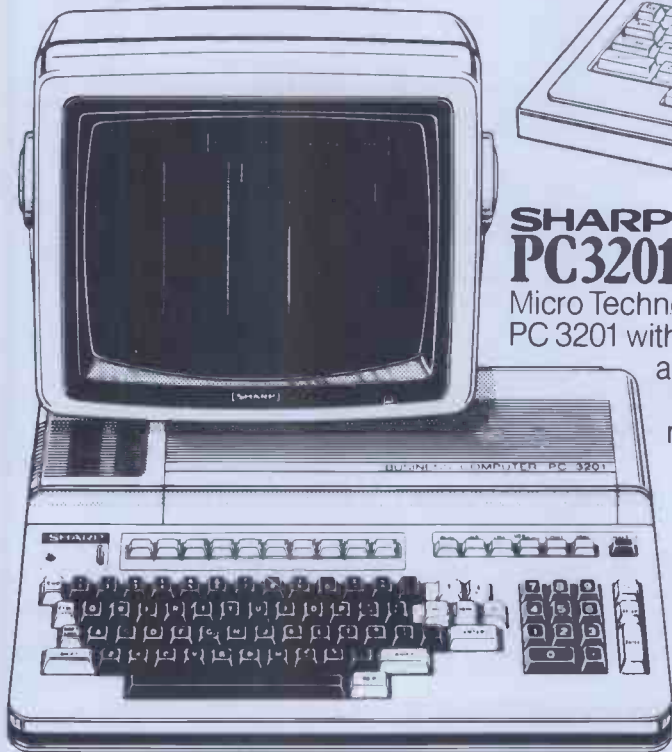

**SHARP
MZ80A** The newest Sharp machine, bristling with features, equally at home in a domestic or a business environment. Now with CP/M.



If you're interested in the hardware as well - then please call us.

Just check through our list of software

WORDSTAR Powerful word-processing package, made easy to use by full function key support on the MZ-80B. **£242**

MAILMERGE Add on to WORDSTAR, provides mail-shot and text inclusion. **£73**

SPELLSTAR Add on to WORDSTAR, for spelling checking. **£121**

DATASCREEN Screen oriented form definition and data entry tool. **£171**

SUPERSORT I Powerful disk based sort package. Stand alone program and MICROSOFT compatible CALLING SEQUENCE RELOCATABLE ROUTINES. **£122**

SUPERSORT II As SUPERSORT I, but only the stand alone program. **£97**

WORDMASTER Superb screen based text editor, all functions driven by MZ-80B function keys. **£73**

CALCSTAR The new financial planning package from the MICROPRO stable. **£144**

EASYFILER Flexible data definition, data entry, data update and report generator. **£150**

GENSYS General insurance system for office admin and accounting of general insurance broker. **£1000**

EMIS Estate agent management information system. Designed by estate agents for estate agents. **£795**

COMAL-80 The revolutionary structured programming language, easy to use as BASIC. Recommended for education and teaching environment. **£130**

BASIC-80 Accepted standard Microprocessor based BASIC interpreter. **£209**

BASIC COMPILER BASIC-80 compatible compiler, makes BASIC programs run many times faster. **£236**

FORTTRAN-80 ANSI standard FORTRAN, except for COMPLEX numbers. **£298**

COBOL-80 1974 ANSI standard COBOL, with large program chaining and screen DISPLAY/ACCEPT. **£448**

M/SORT Powerful sorting facility for use primarily with COBOL-80. **£75**

Mu-MATH & MuSIMP Symbolic math package, allows computation on to 611 arithmetic digits. Superb for scientific and engineering applications. **£149**

Mu-LISP & Mu-STAR Extended LISP 1.5. Includes screen based LISP environment editor. **£119**

EDIT-80 & FILCOM Line oriented random access text editor. Includes source and binary file compare program. **£71**

MACRO-80 Assembler with Z80 mnemonics. Includes linking loader, library manager and cross referencer. **£119**

CIS COBOL ANSI 74 standard COBOL to full level 1 standard. **£425**

FORMS-2 For use with CIS COBOL, provides superb screen handling capability for CIS COBOL programs. **£100**

PROSPERO PRO PASCAL Fastest Z80 PASCAL we know. **£190**

PL/1-80 ANSI standard subset G based PL/1 producing direct object code for fast execution. **£298**

BT-80 Record retrieval system or use with PL/1-80, to give data base management facilities. **£119**

MAC Upward compatible assembler from ASM, provides MACROs and Z80 assembly support. **£53**

ZSID Super symbolic debugger, with full Z80 mnemonic support. Works well with MACRO-80. **£59**

TEX Text for matter ideal for producing manuals and similar documents. Note this is not screen based. **£59**

DESPOOL Allows listing of files at same time as other processing. **£29**

CBASIC Commercial BASIC, used extensively for business packages. **£65**

CB80 Full compiler for CBASIC. **£298**

MINI MODEL Very powerful professional financial modelling package. **£399**

MAGSAM Indexed sequential access routines, for use with CBASIC. **£110**

BASKAM Basic keyed access routines for use with BASIC-80. **£95**

DATAFLOW Easy use data file entry tool. For reports, labels or MICROPRO MAILMERGE compatible files. **£99**

PADMEDE/MICRO TECHNOLOGY A full range of business software converted by us from the highly reliable PADMEDE originals to run under CP/M. **£249**

SALES LEDGER SYSTEM Fully integrated, secure, parameterisable with full report facilities. **£249**

PURCHASE LEDGER SYSTEM All the same flexibility as the sales ledger system. **£249**

SALES INVOICING SYSTEM Automatic product description access, audit trail,

instantly updatable product file (even while creating an invoice). Integrates with sales ledger system if required. **£249**

NOMINAL LEDGER SYSTEM Integrates all the sales and purchase side of your business. Trial balances can be produced for incomplete records accounting. **£249**

STOCK CONTROL SYSTEM Full stock control system with minimum stock levels and re-order levels. Integration to sales invoicing system provided. **£249**

MICRO TECHNOLOGY MICROTTEXT Easy to learn and easy to use text processor with far more friendly user interface than WORDSTAR. If you wish to use it, then far more power is available to you, including calculator, column and row totalling and macro-text functions. **£270**

MICROMERGE Integrate and merge facility for use with MICROTTEXT. Use for mailshots and simple database retrieval and reporting. **£70**

EXPAND Library routines for use with MICROSOFT calling sequence products. Gives MZ-80B graphics, cassette and music handling. **£65**

Free with any MICROSOFT product purchased at the same time from us.

Please state for which machine /version of CP/M the product is intended.

CASH WITH ORDER for goods by return. Post & packing at £2 per item + VAT @15%. All orders sent 1st class post.

NOW WE HAVE ADDED 6 TO 24 Mb WINCHESTER DISKS, MP/M AND NETWORKING ON SHARP AS WELL!

6 Mb Winchester hard disk – £1930
12 Mb Winchester hard disk – £2475
18 Mb Winchester hard disk – £3020
24 Mb Winchester hard disk – £3565
* Integral floppy back-up unit – £400
* Clock option
(improves MP/M performance) – £25
RS232C card for MZ-80A or MZ-80B
fully program controlled up to 19,200
baud, dual RS232 or EIA – £150

* Must be ordered with disk unit.

Totally flexible networks of any mix of up to 4 MZ-80As, MZ-80Bs and PC 3201s on an active network, communicating at speeds of up to 19,200 baud or miles apart.

MP/M – £350 CP/NET – £250

Dealer enquiries welcomed.

CP/M, MP/M & CP/NET are trade marks of Digital Research.

Ask your dealer for details or call us on Tunbridge Wells (0892) 45344.

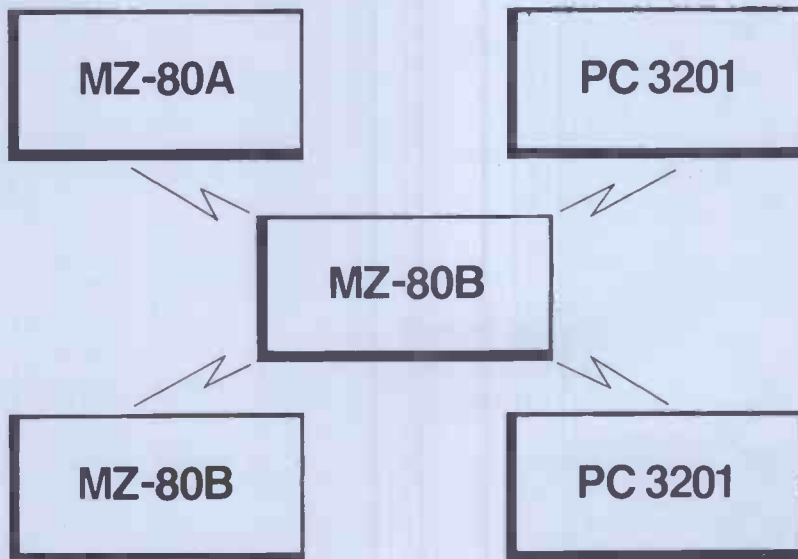

Micro Technology LIMITED

51/53 The Pantiles, Tunbridge Wells, Kent TN2 5TH.

Telex 95441 MICRO-G





Apple, Atari and NEC at hard-checked prices*

*Hardware or software, you don't have to shop around. We continually check all our prices and we're certain they are as competitive as you will find anywhere.



Apple VDU Disk Drives and Processor



Atari 800.

	NET	VAT	TOTAL
PACKAGE SYSTEMS			
Apple Executive System	1950.00	292.50	2242.50
Apple Top Secretary System	2150.00	322.00	2472.50
Apple Education System	1425.00	213.75	1638.75
APPLE HARDWARE			
Apple 48K Video Output only	625.00	93.75	718.75
16K Add on	45.00	6.75	51.75
Disk Drive with Controller (16 sec)	345.00	51.75	396.75
Disk Drive without Controller	275.00	41.25	316.25
ACCESSORIES			
Programmers Aid 1	25.00	3.90	29.90
Auto Start ROM Pack	33.00	4.95	37.95
Graphics Tablet	399.00	59.85	458.85
Appletel System	525.00	78.75	603.75
TV Modulator	14.00	2.10	16.10
INTERFACE CARDS			
Prototype/Hobby Card	12.00	1.80	13.80
Parallel Printer Card	79.00	11.85	90.85
Communications Card	100.00	15.00	115.00
High Speed Serial Card	90.00	13.50	103.50
Centronics Card	100.00	15.00	115.00
Integer Card	90.00	13.50	103.50
Language Card	95.00	14.25	109.25
Controller Card	95.00	14.25	109.25
Eurocolour Card	65.00	9.75	74.75
IEEE-48 Card	200.00	30.00	230.00
16K RAM Card (48K to 64K)	60.00	9.00	69.00
SOFTWARE			
Disk Utility Pack	12.00	1.80	13.80
Apple Post Program	27.00	4.05	31.05
The Shell Games	15.00	2.25	17.25
Elementary My Dear Apple	16.00	2.40	18.40
Apple Bowl Diskette	13.00	1.95	14.95
3.3 Operating System	34.00	5.10	39.10
DOS 3.3 Tool Kit	41.00	6.15	47.15
Apple Writer 1.1	34.00	5.10	39.10
Stellar Invader	13.00	1.95	14.95
Apple Plot	34.00	5.10	39.10
Apple Adventure	19.00	2.85	21.85
APPLE DISTRIBUTED SOFTWARE			
The Go Between (Centronics)	26.50	3.98	30.48
Micro Modeller	375.00	56.25	431.25
Visicalc 3.3	105.00	15.75	120.75
VisiFile	135.00	20.25	155.25
VisiPlot	95.00	14.25	109.25
VisiTrend/VisiPilot	135.00	20.25	155.25
VisiTerm	80.00	12.00	92.00
VisiDex	105.00	15.75	120.75
Desktop Plan II	105.00	15.75	120.75
LANGUAGES			
Pascal Language System	225.00	33.75	258.75
Apple Pilot	75.00	11.25	86.25
Apple Fortran	95.00	14.25	109.25
CIS Cobol with Forms -2	410.00	61.50	471.50

PRINTER & ACCESSORIES

	NET	VAT	TOTAL
Silentype Printer	170.00	25.50	195.50
10 Rolls Thermal Paper	28.00	4.20	32.20

VIDEO MONITORS

	NET	VAT	TOTAL
BMC 12" Green Screen	120.00	18.00	138.00
9" Black & White Monitor	100.00	15.00	115.00
Cables	5.00	0.75	5.75

OTHER ITEMS

	NET	VAT	TOTAL
Z80 Softcard	170.00	25.50	195.50

ATARI

	NET	VAT	TOTAL
400 16K Computer	250.00	37.50	287.50
800 16K Computer	500.00	75.00	575.00
410 Tape Recorder	42.61	6.39	49.00
810 Disk Drive	260.00	39.00	299.00
822 Thermal Printer	200.00	30.00	230.00
825 80 Column Printer	400.00	60.00	460.00
850 RS 232 Interface	110.00	16.50	126.50
16K Ram Upgrade	52.13	7.82	59.95
Conversational French	28.26	4.24	32.50
Conversational German	28.26	4.24	32.50
Conversational Spanish	28.26	4.24	32.50
Conversational Italian	28.26	4.24	32.50
Assembler Editor Rom	30.39	4.56	34.95
Visicalc	105.00	15.75	120.75
Word Processor	78.22	11.73	89.95
Video Computer System	69.56	10.43	79.99

NEW - N.E.C. PC 8000 SERIES

	NET	VAT	TOTAL
PC 8001 Keyboard	500.00	75.00	575.00
PC 8011 Expansion Unit	407.83	61.17	469.00
PC 8012 I/O Unit	346.96	52.04	399.00
PC 8023 Dot Matrix Printer	326.08	48.91	375.00
PC 8031 Floppy Disc Drive	543.48	81.52	625.00
PC 8041 12" Green or Amber Monitor	129.57	19.43	149.00
PC 8043 12" High Resolution CRT Colour Monitor	477.39	71.61	549.00

HARDWARE GUARANTEE

All advertised products are guaranteed one year from date of purchase against defects in materials and workmanship.

During the guarantee period, Metrotech will repair or replace, at no extra charge, components that prove defective - providing that the product is returned, shipping or postage prepaid, stating when bought and enclosing proof of purchase.

This guarantee does not apply if, in the opinion of the Company, the product has been damaged by accident, misuse or misapplication.

CONDITIONS OF BUSINESS.

We accept cheques or Access, Barclaycard, American Express and Diners Club Cards. All prices, specifications and terms are subject to change without notice at the discretion of the management. All offers subject to availability.

Prices correct at time of going to press. E. & O.E.

Hardware Post and packaging subject to confirmation.



New CP/M software at hard to beat prices



NEW WORDSTAR 3

WORDSTARtm Version 3.xx has now been released. New features include: column move capabilities, horizontal scrolling—up to 240 columns and even clearer menus. Also released is MicroPro's own spelling checker—SPELLSTAR.

WORD-STAR 3.xx **£195/£30**
MAILMERGE 3.xx (optional) **£55/£10**
SPELLSTAR (optional) **£105/£10**

IN ADDITION METROTECH SUPPLIES A TRUE ENGLISH DICTIONARY, REPLACING U.S. WORDS WITH ENGLISH.

NEW * RECORDS MANAGEMENT

Ideal for office records including personnel, stock, clients and accounts. Features include:

- Comprehensive calculation
- Record selection on updates and reports
- Full sorting facilities
- WORDSTAR INTERFACE—for selective mailing.

COMPSOFT DMS **£345/£25**

NEW * MICROPLAN

If you have any problem that you would normally solve with a pen, paper and a calculator, then MicroPlan will help you. MicroPlan will perform most types of calculations working on rows and columns, as well as advanced financial analysis.

MICROPLAN **£245/£20**

NEW CALCSTAR

CalcStar is MicroPro's new electronic Spread sheet and financial modelling Program—a sophisticated, yet easy to use calculating and planning tool. CalcStar also links with WordStar, so you can easily include your final calculations within your report.

CALCSTAR **£120/£30**

POINTS TO REMEMBER

- All software is Ex-Stock except MDBS and available on standard 8" disks or 5" disks for Vector MZ, Superbrain, Dynabyte and NEC PC 8000.
- Prices shown as Software with manual/Manual only.
- tm WORD-STAR is a trademark of Micropro.
- METROTECH are sole U.K. distributors for DYNABYTE micro-computer systems.



LANGUAGES/UTILITIES

SUPERSORT I **£105/£20**

WORD-MASTER SUPERIOR TEXT EDITOR **£60/£20**

MET/TWAM INDEX SEQUENTIAL FILE ACCESS IN CBASIC II **£55/£20**

CBASIC II COMMERCIAL DISK EXTENDED BASIC **£75/£30**

SBASIC COMPILER STRUCTURED BASIC **£175/£30**

MICROSOFT BASIC 80 INTERPRETER **£155/£25**

MICROSOFT BASIC COMPILER **£195/£25**

MICROSOFT FORTRAN 80 **£215/£25**

MICROSOFT COBOL 80 **£315/£25**

NEW SUPERCALC BY SORCIM—SUPER FEATURES OF SUPERCALC

Accountants, Planners, Engineers, and Business owners have found Supercalc invaluable for day-to-day "What if?" as well as "Now what?" Questions for the times when the unexpected occurs. And you certainly don't need a programmer—Supercalc is easy to use; it's been designed to use the minimum number of commands to get the maximum power. It's self explanatory.

£190

NEW BCPL *

BCPL CINTCODE is a full and extended implementation of the popular Systems programming language BCPL CINTCODE gives a dramatic reduction in the space required for programs, requiring about a third of the store of fully compiled Z80 code.

BCPL **£250/£35**

DATA MANAGEMENT

SELECTOR III-C2
An easy to use Information Management System requires CBASIC II **£185/£30**

SELECTOR IV
An advanced Information Management System, requires CBASIC II **£275/£35**

DATASTAR
Powerful data entry, retrieval and update system **£150/£30**

COMMUNICATIONS

BISYNC-80/3780 and BISYNC-80/3270 are full function IBM 2780, 3780 and 3270 emulators for micro computers. BISYNC-80/3780 gives you a Remote Job Entry terminal for the price of a micro! BISYNC-80/3270 combines the local processing power of a micro with a sophisticated screen capability. Make your dumb terminal smart!

MET/TTY will connect your micro to a Timesharing service in simple teletype emulation.

BISYNC-80/3780 **£445/£20**

BISYNC-80/3270 **£445/£20**

MET/TTY **£145/£20**

FINANCIAL REPORTING

REPORT WRITER You input the values. Report Writer will perform your calculations and produce a report with your headings, totals and summaries.

£70/£10

GLECTOR General ledger option in Selector III, requires Selector III and CBASIC II

£125/£30

Newly released software

CB 80 **£295/£35**

INFOSTAR from MICROPRO **TBA**

PL/1-80 **TBA**

HOW TO ORDER

- State disk type and size • Add 15% VAT
- Include £2 per Software Item for Postage and Packing
- Enclose cheque/PO's payable to METROTECH

Mail to METROTECH MAIL ORDER, WATERLOO ROAD, UXBRIDGE, MIDDLESEX UB8 2YW

CREDIT CARDS Telephone orders welcome Tel: 0895 58111 Ext 265 or 206

TRADE ENQUIRIES WELCOMED

METROTECH

A MEMBER OF THE GRAND METROPOLITAN GROUP

DISK-DRIVE-DEALS

From KRAM electronics, Victoria House, 17 Highcross Street, Leicester LE1 4PF Telephone (0533) 27556

40 TRACK DISK DRIVES

COMPATIBLE WITH TANDY, GENIE, NASCOM, GEMINI, SUPER BRAIN, ETC.

The latest
OLIVETTI
Disk Drives
fully cased and
complete with
Toroidal power supply

(Perhaps not
the cheapest but
we think these
are the
BEST)

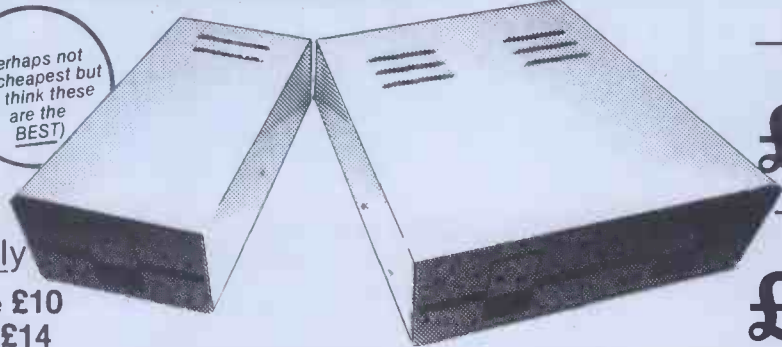

— SINGLE —

£179

— DUAL —

£349

DISK DRIVE Single drive **£10**
CABLES Dual drive **£14**

GENIE I & II
EXPANSION BOX
INCLUDING DISK
CONTROLLER
AND LINE PRINTER
INTERFACE AND
32 K RAM

£199



FREE
EXTRA
16K RAM

GENIE I & II

BOTH INCLUDING *SOUND
*LOWER CASE *MODULATOR
*MACHINE CODE MONITOR

Choose either for only

£299

PARALLEL PRINTER INTERFACE CARD **£33**

FREE INTERFACES WITH EPSON PRINTERS*



*for RS232,
PET, GENIE
or ATOM

MX 80T	MX 80FT	MX 100
£349	£399	£569

SEIKOSHA GP 100A



£199

NEW

CONTINUOUS PAPER

8" for GP80A 2000 sheets	£12
9½" for EPSON & GP100A 2000 sheets	£12
5¼" floppy disks	£1.70
4116 RAM CHIPS	-69p
2114 RAM CHIPS	-89p

CARRIAGE: Orders over £100 ADD £6. Orders over £10 ADD £3.
Orders under £10 ADD .50p

ACCESS: Access orders may be telephoned day or night, give full
description of items, card number, name and address.

TERMS: Terms available for suitable applicants.
Please write for details.

Name:
Address:

PLEASE SEND:				
QTY	ITEM	PRICE	VAT @ 15%	TOTAL

KRAM ELECTRONICS

TOTAL INC. VAT £
PLUS CARRIAGE £
I ENCLOSE CHEQUE FOR TOTAL £

Access Number:
Post to: (or Tel: (0533) 27556) KRAM Electronics, FREEPOST, Leicester.

RABBIT SOFTWARE



380 STATION ROAD,
HARROW, MIDDX.
HA1 2DE.

Tel: 01-863-0833

ALL THE LATEST TOP QUALITY SOFTWARE AND PROGRAMMING AIDS AND ACCESSORIES FOR YOUR VIC 20 TO NIBBLE ON. ALL ON DEMONSTRATION AT OUR VIC SOFTWARE CENTRE OR LARGER VIC DEALERS AND NOW AT SELECTED CURRY MICROCENTRES

WANTED

International Distributors and dealers WANTED NOW! phone Heather on 01-863 0833 for details

VIC owners do you have programmes that come up to Rabbit standard that you would like to sell. Send them to Heather at Rabbit Exchange.

A DIVISION OF CREAM COMPUTER SHOP



VIC-20

Software and Hardware at Super Discount Prices

* TOP TEN *

1. **SPACE DEFENCE** - (see below for details) £12
 2. **FROGGER** - Try to cross the motorway without getting run over! £10
 3. **SKI-RUN** - Super exciting game (see below for details) £5
 4. **DUNE BUGGY** - How far can you travel in three minutes? With acceleration and control keys. Drive and buggy across the shores avoiding many hazards. Has 9 skill levels. £5
 5. **CAR RACE** - Again an up-to-date arcade favourite. Drive around a figure of eight dodging the other lunatic drivers and hazards. Beware of head-on and cross-over collisions. Not for 'L' drivers or the faint-hearted. £10
 6. **SUPER WORM** - An enhanced version of THE WORM with many options including disjointed and invisible tails. £5
 7. **CHARSET-20** - Design your own graphic characters to use in your own programs. Contains full instructions for implementing a character set in RAM. £5
 8. **CODE BREAKER** - A variation of the old favourite. Break the code of colours in as few moves as possible. Beats all other versions with colour and sound effects. £5
 9. **COSMIC BATTLE** - Pilot a space ship through the Cosmos destroying enemy fighters with lasers and photons torpedoes whilst fending off their counter attacks with your shields. £5
 10. **JUNGLE** - Hack your way through a jungle but beware Lions and Snakes are out to get you! Lure them into marshes and pits. 9 skill levels. £5
- All these top selling games are run on Basic Machine and all prices are inclusive of VAT.

NEW VIC SUPERMARKET STOP PRESS

We have opened our VIC-SUPERMARKET in our spacious showrooms above our established CREAM COMPUTER SHOP in Central Harrow.

The Centre has 12 plus VIC's permanently on display with all the latest hardware and software from RABBIT and other VIC suppliers for you to peruse and choose at your leisure.

Trained staff will be able to offer you advice on software, hardware and all accessories.

TURBO-TAPE

£29

(PET-RABBIT VICchip No.1)

Turbocharge your cassette deck, well almost! If your budget will not run to a Floppy-disk unit just yet, why not buy the next best thing. Dramatically reduces loading and saving on cassette by 5 to 6 times. The programme was originally written for a client who wished to protect original programmes, an additional benefit. Can be turned off and on to load standard C.B.M. format tapes as normal.

Other powerful Toolkit commands and extra programming aid features incorporated together with easy function key control.

new

SKI-RUN

Our superselling game. This fast exciting game, has skill levels 1-9 with fantastic colour and sound and three super games incorporated into it, Slalom Downhill and Giant Slalom. Become an expert skiing down the dangerous slopes.

FROGGER

Variation of a famous pub game, Try to cross the motorway without getting run over. Full colour, Hi-Res, optional joy stick control.

£10

SPACE DEFENCE

Yes its here, our version of the all time popular exciting and fast arcade game. You have to be fast, accurate and alert to defend your men on the moons surface against alien craft. But watch out for the mutants and baiters who are always after you.

Please put me on your mailing list for lots of new information on the VIC-20

Name _____

Address _____

and please send me

QUANTITY	DESCRIPTION	PRICE

I enclose my *cheque/charge my Access/Trustcard/
Barclaycard/Visa No.

Signature _____ TOTAL

All prices are inclusive of VAT and packing.



CARD HOLDERS 'PHONE YOUR ORDER
01-863 0833 *Delete as applicable

ADVANCED SOFTWARE FOR ADVANCED COMPUTERS

MICROL/ZX SPECTRUM SOFTWARE

IF YOU'RE wanting to get the very best from your powerful new Sinclair ZX Spectrum, then look no further than **MICROL**.

MICROL sets the performance and price standard in personal computer software in the same way Sinclair does in personal computer hardware. Bringing you totally professional quality at a remarkably low price.

With MICROL Spectrum software you will be able to unleash the full power and versatility of your Spectrum computer. Not just in the home and leisure fields but in a wide range of important Business and Professional applications.

Find out NOW how MICROL will enable you to get the very best out of your Sinclair ZX Spectrum by sending off the coupon TODAY.

Micro! puts all this at your fingertips



MICROL

38 Burleigh Street, Cambridge CB1 1BR.

(0223) 312866

Distributed Worldwide Exclusively by Tempus of Cambridge.

Designed by Sesames(UK)Ltd

CITY FROM MICROL COMPLEXITY BY SINCLAIR

SOFTWARE PUBLISHING

MICROL FOR BUSINESS AND THE PROFESSIONS

Programs for all standard business applications; accounts, stock control, payroll, and word-processing — plus much more:

Financial modelling
Project management
Resource allocation and optimisation
Decision support and forecasting

All at prices that put complete professional computing power within the reach of every business (and all in a language you can understand.)



MICROL FOR BETTER QUALITY, BETTER PRICES, BETTER CHOICE IN HOME AND LEISURE PROGRAMS.

The most exciting, entertaining and original video games, bringing a new era of in-home entertainment to your television screen. MiCROL has this and much more lined up for you. Find out about Advanced Simplicity from MiCROL. Complete and freepost the coupon today — and we'll keep you posted in good time for when you get your Advanced Complexity from Sinclair.

SPECTRUM SOFTWARE

Freepost to:
MiCROL, Freepost, 38 Burleigh Street, Cambridge CB1 1BR.

Please put me on your mailing list for 16k RAM
MiCROL Spectrum Software. 48k RAM

My interests are:
 Business Professional (please specify).....
 Home & Leisure
 Personal Programming Aids Other.....

Name.....

Address.....

.....

.....

..... P.C.W.1

C.O.R.P.TM makes Apples more tempting

Apple, the most popular micro-computer,
now has a Software accessory which
enables the system to be
programmed by beginners!



the Software that writes programs

C.O.R.P. II is the most advanced and comprehensive collection of program generators which writes Applesoft programs. It enables a beginner to program quickly, simply, and error free by himself in everyday language with no programming knowledge. It's the first usable, educational package!

Handbooks and demodisk tutorial are supplied with every system. C.O.R.P. II £249.

C.O.R.P. I: Database/Print Generator only: £149.
Demodisk & Free Basic Language Tutorial £29.

48K Apple II, DOS 3.3 & 2 disk drives required.

Details of C.O.R.P. 'Turnkey' systems and Training Courses from:

MICROSYSTEMS LIMITED

SUMMERFIELD HOUSE, VALE, GUERNSEY, CHANNEL ISLANDS.

Telephone: 0481 47377, Telex: 4191130 (DYN MIC G)

*C.O.R.P. is a registered trademark of the MAROMATY & SCOTTO SOFTWARE CORP.

*APPLE is a registered trademark of APPLE COMPUTER INC.

a Dynatech company

Program generators for other micro-computer systems available on application.



AUTHORISED DEALERS

SPOT COMPUTER SYSTEMS LTD.,
New Street, Kelham Street Ind. Estate,
Doncaster. Tel. (0302) 25159

AMPAL (COMPUTER SERVICES) LTD.,
PO Box 19, Knutsford, Cheshire WA16 0HE.
Tel. (056 589) 3563

AMPAL (COMPUTER SERVICES) LTD.,
31 Woodbridge Road, Darby Green,
Blackwater, Camberley, Surrey.
Tel. (0252) 876677

Memotech's New Memory System for the ZX81

It grows as you progress



Memopak 16K Memory Extension

- £39.95 incl.VAT

It is a fact that the ZX81 has revolutionised home computing, and coupled with the new Memopak 16K it gives you a massive 16K of Directly Addressable RAM, which is neither switched nor paged. With the addition of the Memopak 16K your ZX81's enlarged memory capacity will enable it to execute longer and more sophisticated programs, and to hold an extended database.

The 16K and 64K Memopaks come in attractive, custom-designed and engineered cases which fit snugly on to the back of the ZX81, giving firm, wobble-free connections. See below for ordering information.

Coming Soon...

A complete range of ZX81 plug-in peripherals:
 Memotech Hi-Res Graphics
 Centronics Interface and Software Drivers
 Memotech Digitising Tablet RS232 Interface

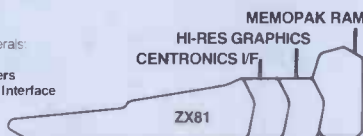

All these products are designed to fit 'piggy-back' fashion on to each other, and use the Sinclair power supply. WATCH THIS SPACE for further details. We regret we are as yet unable to accept orders or enquiries concerning these products – but we'll let you know as soon as they become available.

How to order your Memopak.

By Post: Fill in the coupon below and enclose your cheque/P.O./Access or Barclaycard number.

By Phone: Access/Barclaycard holders please ring Oxford (0865) 722102 (24-hour answering service).

Please make cheques payable to Memotech Limited
 Please debit my Access/Barclaycard* account number

*Please delete whichever does not apply.

SIGNATURE _____ DATE _____

NAME _____ ADDRESS _____

We want to be sure you are satisfied with your Memopak – so we offer a 14-day money back Guarantee on all our products.
 Memotech Limited, 3 Collins Street, Oxford OX4 1XL, England Telephone: Oxford (0865) 722102/3/4/5



Memopak 64K Memory Extension

- £79.00 incl.VAT

The 64K Memopak is a pack which extends the memory of the ZX81 by a further 56K, and together with the ZX81 gives a full 64K, which is neither switched nor paged, and is directly addressable. The unit is user transparent and accepts basic commands such as 10 DIM A(9000).

BREAKDOWN OF MEMORY AREAS

0–8K ... Sinclair ROM

8–16K ... This section of memory switches in or out in 4K blocks to leave space for memory mapping, holds its contents during cassette loads, allows communication between programmes, and can be used to run assembly language routines.

16–32K ... This area can be used for basic programmes and assembly language routines.

32–64K ... 32K of RAM memory for basic variables and large arrays.

With the Memopak 64K extension the ZX81 is transformed into a powerful computer, suitable for business, leisure and educational use, at a fraction of the cost of comparable systems.

Unique 3 month trade-in offer!

When your programming needs have outgrown the capacity provided by 16K RAM, and you find it necessary to further extend your ZX81's capacity, we will take back your 16K Memopak and allow a discount of £15.00 against your purchase of our 64K model.*

*We reserve the right to reject, for discounting purposes, units which have been either opened or damaged in any way.

Please send me:

	Quantity	Price	Total
16K RAM, Assembled		£39.95	
64K RAM, Assembled		£79.00	
		Postage	£2.00
		Total Enclosed	

PEC6

© R. Branton & G. A. C. Boyd 1982.

Wherever you are in the UK there's a Genie dealer nearby



Genie I & II Approved Dealers

AVON Microstyle, Bath, 0225 334659/319705. **BEDFORD** Comserve, Bedford, 0234 216749. **BERKSHIRE** P.C.P., Reading, 0743 589249. Castle Computers (Windsor), 07535 58115. **BIRMINGHAM** Ward Electronics, Birmingham, 021 554 0708. Consultant Electronics, Birmingham, 021 382 7247. A. E. Chapman and Co., Cradeley Heath, 0384 66497/8. **BUCKINGHAMSHIRE** Photo Acoustics, Newport Pagnell, 0908 610625. **CAMBRIDGESHIRE** Cambridge Micro Computers, Cambridge, 0223 314666. **CHESHIRE** Hewart Electronics, Macclesfield, 0625 22030. Mid Shires Computer Centre, Crew, 0270 211086. **CUMBRIA** Kendal Computer Centre, Kendal, 0539 22559. **DORSET** Blandford Computers, Blandford Forum, 0258 53737. Parkstone Electrics, Poole, 0202 746555. **ESSEX** Emprise, Colchester, 0206 865926. **GLOUCESTERSHIRE** Computer Shack, Cheltenham, 0242 584343. **HERTFORDSHIRE** Photo Acoustics, Watford, 0923 40698. Q Tek Systems, Stevenage, 0438 65385. Chrisalid Systems and Software, Berkhamsted, 044 27 74969. **KENT** Swanley Electronics, Swanley, 0322 64851. **LANCASHIRE** Harden Microsystems, Blackpool, 0253 27590. Sound Service, Burnley, 0282 38481. Computercat, Leigh, 0942 605730. **BEC** Computerworld (Liverpool) 051-708 7100. **LEICESTERSHIRE** Kram Electronics, Leicester, 0533 27556. **LONDON** City Microsystems, EC2, 01 588 7272/4. Wason Microchip, N 18, 01 807 1757/2230. Premier Publications, Anerley SE20, 01 659 7131. **NORTH EAST** Briers Computer Services, Middlesborough, 0642 242017. General Northern Microcomputers, Hartlepool, 0783 863871. HCCS Associates, Gateshead, 0632 821924. **NOTTINGHAMSHIRE** Midland Microcomputers, Nottingham, 0602 298281. Mansfield Computers, Mansfield, 0623 31202. East Midland Computer Services, Arnold, 0602 267079. Electronic Servicing Co., Lenton, 0602 783938. **NORFOLK** Anglia Computer Centre, Norwich, 0603 29652. Bennetts, Dereham, 0362 2488/9. **OXFORDSHIRE** Micro Business Systems, Whitney, 0993 73145. Pebbleglow Ltd. (Thame) 084421 5368. **SCOTLAND** Esco Computing, Glasgow 041 427 5497. Edinburgh: 031 557 3937. Computer and Chips, St. Andrews, 0334 72569. Scothbyte Computers, Edinburgh, 031 343 1055. Victor Morris and Co., Glasgow, 041 221 8958. **SHROPSHIRE** Tarrant Electronics, Newport, 0952 814275. **SOUTH WEST** Diskwise, Plymouth (0752) 267000. West Devon Electronics, Yelverton, 082 285 3434. Bits and Bytes, Barnstaple, 0271 72789. **SUFFOLK** Elgelec Ltd., Ipswich, 0473 711164. **SURREY** Croydon Computer Centre, Thornton Heath, 01 689 1280. **WALES** Tryfan Computers, Bangor, 0248 52042. **WEST MIDLANDS** Allen TV Services, Stoke on Trent, 0782 616929. **WILTSHIRE** Everyman Computers, Westbury, 0373 823764. B & D Computing (Swindon), 0793 762449. **YORKSHIRE** Media 5 Ltd, Sowerby Bridge 0422 33580. Advance TV Services, Bradford, 0274 585333. Huddersfield Computer Centre, Huddersfield, 0484 20774. Comprite, Bradford, 0274 668890. Superior Systems Ltd., Sheffield, 0742 755005. Photo Electronics, Sheffield, 0742 53865. Ebor Computer Services (York) 0904 791595. **NORTHERN IRELAND** Business Electronic Equipment, Belfast, 0232 46161. Britain Laboratories, Belfast 0232 28374.



Sole Importers:

LOWE electronics

Chesterfield Road, Matlock, Derbyshire DE4 5LE.
Telephone: 0629 4995. Telex: 377482 Lowlec G.



See Adda for Osborne

Osborne – the business computer that's a personal, portable productivity package! You can confidently tackle tougher jobs, with a vast increase in **personal effectiveness** wherever you are – plane, train, car, office or home. And at Adda you get advice and service from professionals who know what business users need.

For only

£ 1250

for a complete system excluding VAT

THE ADDA-OSBORNE SUPER DEAL INCLUDES: 12 months parts and labour warranty
Free delivery London and Home Counties · Full set manuals · Comprehensive software including: **Wordstar/ Mailmerge** word processing
· **Supercalc** financial package · **CBasic** · **MBasic** · **CP/M** operating system · **10 diskettes.**

For further information or to place an order telephone 01-997 6666

Dot matrix and Daisy Wheel printers available from £399 excl. VAT.

adda

Adda Computers Ltd.

Mercury House
Hanger Green
Ealing London W5 3BA
Tel: 01-997 6666

Only 20 minutes by car or tube from the West End.



**Now you can do all
accounting with...**



without...

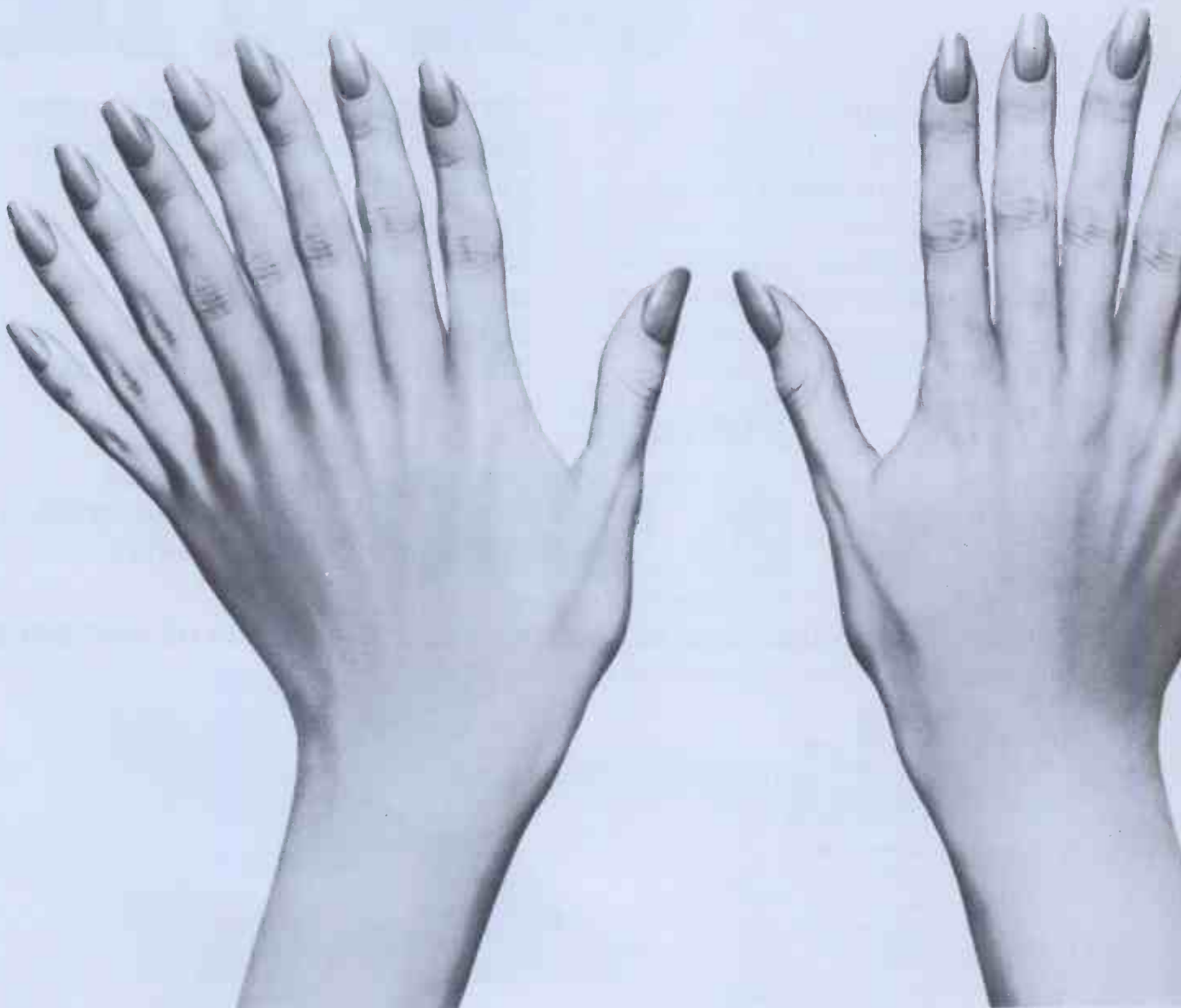

the filing, typing and

Silicon Office is the latest microcomputer software program from the Bristol Software Factory.

Designed specifically for use with the Commodore PET 8096, it'll help you run your office with the minimum amount of effort and maximum efficiency.

Think of it like three normal software packages in one, each separate package totally interactive with the other.

For around £4,500, you can have the complete electronic office, the solution to practically all your business problems. The price includes Commodore hardware, a high quality daisy wheel printer and Silicon Office software.

Silicon Office is made up from a flexible information management system which lets you create and maintain an extensive filing arrangement. Allowing you to search quickly through your records, making cross references between files in order to gain the facts you require.

A highly sophisticated word processing program allows you to generate letters, documents and reports. Letting secretaries get on with the more important tasks.

And a fully comprehensive calculator means you can handle all the number crunching you're ever likely to do in a business situation.

Leaving the accounts department to concentrate on more profitable things.

But that's not all by any means.

Silicon Office also has a special programmability feature which means you or your dealer can expand and tailor the Silicon Office program to your business.

When Silicon Office is used in an everyday business situation, certain command sequences are inevitably repeated. By writing short, very simple programs which are entered into the computer's memory, Silicon Office can perform the necessary tasks, automatically.

And last, but by no means least is an optional communications facility.

It doesn't take much imagination to see the potential of Silicon Office in virtually any line of business.

So to get a better grasp, send away for our brochure. It'll only cost you a stamp. And it could save you a fortune. Or talk to your local Commodore dealer who has all the facts at his fingertips.

You'll soon see how you're much better off with Silicon Office. Than without.

 **commodore**
COMPUTER



I can't wait to get my hands on a free copy of the Silicon Office brochure.

Name _____

Position _____

Company _____

Address _____

B/PW2

I own a Commodore PET (Please tick box) YES NO



Send to: Bristol Software Factory, PO Box 14, Horley, Surrey.

SILICON OFFICE



Guy Kewney delivers his monthly package of micronews.

Prestel spreads its wings

The time has come to choose a good Prestel computer, or to suffer that 'left out' feeling. In a nutshell, things are starting to happen on Prestel — and the only way to find out what they are is to be plugged in.

A Prestel computer nowadays is one that can connect you to other people with Prestel computers — one of the things that it most conspicuously could not do, originally. More: these days it is getting cheaper to use a Prestel machine for sending messages like this, because the Prestel authorities have reduced the price of doing so.

And, on top of that, there are more and more machines around that can be connected to the Prestel network. Not just expensive TV sets with a funny little pocket calculator but real computer terminals, for rather less money.

Latest of the new machines is one from Tandata Marketing, using the most popular 'Viewdata adaptor' — a device

for turning an ordinary TV set into a Prestel terminal — the AlphaTantel. This new machine comes in a briefcase, at just over £500 including VAT.

The unusual thing about the briefcase Viewdata machine is that it doesn't plug into the telephone socket. Normal Prestel receivers do, but the fact of the matter is that most telephones still don't have sockets, and so normal Prestel receivers can't be plugged into any phone. Briefcase Viewdata can, because it can make the necessary Prestel tones audibly and sing them into an ordinary telephone receiver — and can pick up the sound of the returning notes.

'Prestel or private Viewdata users can therefore make use of the system wherever they can find an ordinary telephone and television — for example, in a hotel room,' notes Tandata.

The acoustic coupler is

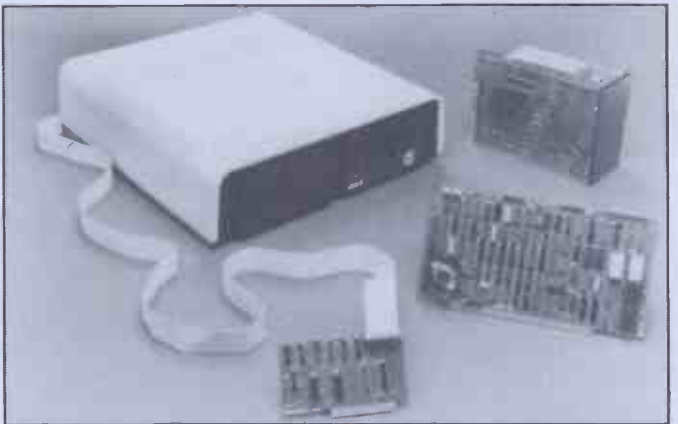

Independent Computer Engineering can supply this Scottish-built hard disk system for Apple, Superbrain or any S100 bus micro. It provides up to 10 megabytes of storage, and has the advantage of being locally repairable, they say. They don't say it has the advantage of being cheap, however. Details on Ashford (07842) 47271.

built into the system. The machine otherwise has all the features of the AlphaTantel — it can be connected to a printer with the cheap Centronics interface, and it can store pages on a tape recorder.

To use the 'mailbox' facility on Prestel, you have to belong to a sort of club called a 'closed user group', with your own licensed storage inside the Prestel computer. Until recently, this was a bit of a joke: the cost of belonging was high and the number of closed user groups was restricted to 50 in the UK.

Prestel authorities have now stopped discouraging customers. The cost of setting up a private Prestel group used to be £2500 — it is now a tenth of that at £250. And Prestel can accept 32,000 groups instead of only 50.

Even more significantly, anybody with their own database of information (or group of connected computers) can link it up to Prestel. That is, anybody within easy reach of Croydon phone exchange.

Prestel has set up a 'Gateway' service to connect outside computers to its own storage and switching machines. Instead of dialling into the normal pages of information, you can dial into the gateway. And if the gateway is a computer with a whole new set of Prestel-type pages, somewhere else in the country, this is very useful — or at least it will be.

At the moment, however, it is only very useful to

'nearly one quarter of Britain's telephone users', as Prestel people refer to the people who can dial 01- numbers as a local call. All the rest have to make a trunk call (or STD call, if you like the acronym better).

One of the things that can now be dialled into is a newspaper about micros. It's called *Viewfax 258*, which has something of the appeal of a pirate radio station about it.

'Unlike other bulletin boards, *Viewfax 258* is available to the majority of UK telephone subscribers at local call rates, 24 hours a day, seven days a week,' announces the company.

'Another advantage of using Prestel is that information is sent at four times the speed of most bulletin board systems; furthermore, every retrieval computer can handle around 200 simultaneous users. There is even a computer in Boston which can be accessed throughout North America via Telenet,' they add.

The reference to speed has to do with the fact that Prestel transmits 120 (or so) characters per second, while most systems only manage 30 (or so).

This brings one naturally to the only real drawback of Prestel: you still can't transmit faster than seven (or so) characters per second. This may be about as fast as you could hope to type, but with a computer you tend to prepare your message first (while



This thrilling example of the photographer's art is the PCW cover that never was. It should have graced this very issue but was displaced by the sudden arrival of Uncle Clive's latest blockbuster, to the eternal chagrin of DP who has fought for years to get a handhold on the cover. Flowers, letters of condolence or small gifts of alcoholic beverages should be sent to the usual editorial address.

the phone isn't working up a big charge) and then transmit it later as fast as possible.

The reason users are stuck with seven (or so) characters per second is not, however, so that you are forced to run up huge charges on your phone if ever you use the service. Naturally, this consideration doesn't actually bother the people at Telephone House, but it isn't why it happens.

No, the reason is that the modem which Prestel sets use was originally designed to receive data fast but to transmit slowly — because it would be cheap (they said at the time). And when they found that it could work fast in both directions, and still be cheap, they refused to allow people to do it. They refused because the service provided that way would be vastly superior to the antiquated, clumsy service provided by Telecom's Datel modems, which can't even tell if the phone line is working or disconnected.

And we can't have technology putting our valuable antiques onto the scrap-heap, can we?

Anyway, the daily micro magazine is subsidised by advertisers who pay £15 for a page on Viewfax, and it sounds interesting. I shall just have to get a Prestel set and try it — use Prestel mailbox 021-704 115 for information. Or call 021-705 0258.

For details of how to set up a closed user group of your own, contact Prestel HQ on 01-583 9811.

ZX chess

Turn your ZX81 into a nice chess-playing computer with excellent graphics, by getting a £45 ZXChess program plus QS Characters board. This offer from Artic Computing comes as a taster before its rather more important, though more esoteric, announcement of Forth for the Sinclair.

Forth is a programming language where you define what you want to do in terms

of instructions which you build up yourself. It may be hell for someone else to find out what you have actually done, but it is very fast as a method of actually doing it in the first place.

Forth from Artic (as in lorry, not as in North Pole) will cost £60 on a ROM. Details from Artic at 396 James Reckitt Avenue, Hull, North Humberside.

Video course

For a fee of £275, you can get into a course on computer-controlled video where you will be able to operate a video disk player by programming an Apple. The course is the first workshop by Roy Goodman's new company, Office Of The Future Ltd. Goodman originally was famous as the founder of Infotech.

The two-day course runs on 18-19 May and 17-18 June, and details are available from 108 Kew Road, Richmond, Surrey TW9 2PD.

Soft rent

On 1 July, the Software Rental Bank will begin a superb notion of renting software to people so that they can see if they like it before buying. If you buy, you get the rent paid deducted from the price.

The idea will terrify many suppliers of software, who are bound to shriek 'but they'll just copy it and keep it'.

It won't happen like that. Most people copy software either because they just can't afford to buy it, or because they don't know whether it's worth buying or not, so they borrow it first from a friend.

This scheme will let people try software out, legitimately. Do you think that The Last One, for instance, is all razzmatazz and nothing more? Find out if WordStar really is too complicated to use. Find out if you prefer Visicalc to the more costly



The closest thing to a real working Ethernet network is the Ungermann-Bass system Net One (available exclusively through Case and exclusively through Thame Systems, and exclusively through British Telecom) which now has this little white box. It is a Network Configuration Facility.

That, my children, is something on which you can develop extra software, using a Whitesmith C Compiler, to improve your network. It has a five-megabyte hard disk, a one-megabyte floppy disk and an intelligent controller with a general purpose bus interface (IEEE 488). Details from Thame on (084 421) 5471.

Micromodeller, or whether you need the extra features. All for the cost of your membership, plus the safeguard of a deposit.

Membership costs £30 for 'associate' status; £70 for 'full' membership, and £500 for 'corporate' membership.

Rental normally costs 20 percent of the list price of a program, down to a minimum of £8.00. Associates get one week's rental and have to pay a deposit of the full value of the program. Full members get two weeks' rental (up to £500 at any one time, they say — so presumably full members can't rent expensive software) while corporate members pay only 10 percent and get up to £1000 worth at any time.

It sounds a bit complex, but apart from that I can't see anything wrong with the scheme. Details from 58 North Street, Leighton Buzzard, Beds LU7 7EN or phone (0908) 53491.

16-bit TABS

Until something new evolves, traditional computerised methods of keeping track of accounts are necessary — and surprisingly few traditional accounting methods have been transferred from old computers to the new micros.

The TABS accounting system has been described as having all the traditional computer accounting virtues, with a few nice trends in working towards tomorrow's systems — and it is possibly this traditional stability that has led Terry Poole to transfer it all to two new machines, the IBM Personal Computer and the similar ACT Sirius 1.

The system 'covers a suite of 14 application program modules, which include sales, purchase and nominal ledgers, stock control, payroll, job

costing, word processing management accounting, and so on,' says TABS, announcing the availability of its software on these two machines.

There isn't a lot else to say: contact TABS on Andover (0264) 58933 for more details.

Would you credit it?

Don't use your Access card to buy a BBC Computer for a friend because Access will bounce the payment. Yes, it will, and it won't warn you either — and goodness only knows what happens to your place in the queue.

It turns out that Access credit card holders can order goods to be delivered only to their home addresses. As soon as you buy something for a friend, of course, Access will write to you and tell you they've bounced it, adding a terse note to the effect that they are 'sorry for the inconvenience'.

Inconvenience! You don't know the half of it, Access. The thing is that the BBC micro is supplied under the most honourable terms, whereby Acorn is not allowed to collect the money until it gets word from its mail order subcontractor that the product is in the warehouse, ready to ship.

The way the deliveries have been going, that can be five or six or more months after you placed the order. Your place in the long queue has finally come up... and what do you know? Access has bounced the payment. Access expects you to be grateful, because Access has saved you from being ripped off by somebody who knew your Access number. It's a pity you moved house in the meanwhile... At that point,



If you buy a Xerox 820 and you want a five-megabyte hard disk drive, Rair will sell you this one for around £2000, including adaptor and software to operate it. Details on 01-836 6921.

WHEN YOU HAVE 637 PROSPECTS TO REMEMBER YOU NEED OUR ELECTRONIC CARD-INDEXING AND RETRIEVAL SYSTEM



Many people know Henry VIII had six wives. But few are aware of his 637 girlfriends. Poor Henry! Is it any wonder he laid about them with an axe. Just imagine trying to remember all those first names, addresses, birthdays, pigeon hole numbers and personal details.

With CARDBOX, Caxton's new electronic card indexing system, keeping and retrieving information is simplicity itself. Not only could Henry have found his ladies but he could have kept tabs on all those barons, bishops and bowmen. (Rent demands would have gone on time, confiscations would have been orderly and executioners would have been selected to suit every occasion.)

And he wouldn't have had to understand a thing about computers. CARDBOX looks like your favourite card index on the screen. You draw the card yourself. You decide where you want lines. You make up your own headings. And you fill in the details.

At this point CARDBOX stops behaving

like a flat inflexible card. It becomes multi-dimensional electronic paper. You can change any information you want. You can retrieve portions of information. You can print out all or selected information from your cards.

You talk to CARDBOX in plain English. You search your records on key words or on selected criteria. CARDBOX acts like a sieve, sifting through the records reducing the number until it finds only those that meet your needs. You display records on your screen or print them out in a format of your own design. Label production for mailing is simple. You can also use CARDBOX with some of your favourite wordprocessing packages, eg Wordstar.

CARDBOX works on most popular CP/M machines including those with special screens, eg Osborne. Use the CARDBOX Tutorial to learn all about this simple, fast aid to better record management. Study the detailed Reference Manual to take full advantage of its sophisticated features.

See CARDBOX at your local computer dealer. Or we'll send it to you with a dealer list. Call or return the coupon to us.



CP/M, Wordstar and Osborne are registered trademarks of Digital Research, MicroPro and Osborne Computer Corporation respectively.

Caxton Software Publishing Company 10-14 Bedford Street Covent Garden London WC2E 9HE Telephone (01) 379 6502

I am a User Dealer Please send me Leaflet Cardbox, I enclose a cheque for £155 (+ VAT at 15% and £2 p & p.)

Name _____ Position _____ Company _____

Address _____

Computer _____ Disk Format _____





The really interesting thing about this picture of a Digico Prince micro being delivered to the Liberal Party at the National Liberal Club is the question: what is Lord Avebury doing there?

Lord Avebury used to kiss babies (or whatever you do to become Orpington's MP) under the name of Eric Lubbock, and he remains a prominent Liberal. The Liberal Party is going to use two Digico Prince micros — but Eric isn't in the picture because he represents the Liberal Party. That task falls to the Party's Secretary General, Hugh Jones (in the middle).

Digico's announcement mentions that the Liberals will use the micro for 'general accounting, subscriptions for the party's newspaper Liberal News, and for the large mailing lists of subscribers to fund raising appeals (at present 10,000 names and addresses)'. And it mentions the nice Digico sales director (with the beard), Steve Moyle.

I imagine it doesn't explain what Avebury is doing there, because the publicists at Digico felt that some of the glory of the announcement would be lost if they pointed out that he was also chairman of Digico.

Oh well, heck: at least it provided seven paragraphs of publicity to lead into the announcement that the Prince can now be bought for £6000 with a daisywheel printer and a big five-megabyte hard disk data storage device built in. Details on (04626) 78172.

you have the choice of starting a long explanation to Acorn and its mail-order group, and hoping they have records which show it all — or of going off and buying Uncle Clive's new Spectrum.

Oh, come on. Surely you're not going to quit now? After waiting so long?

Dr Micro

What is wrong with computers in medicine? Apparently quite a lot, and the British Medical Association (BMA) is out to give the computer people a good push in the right direction, by running a seminar on this subject in the beginning of June.

The seminar, 'What's Wrong With Computers In Medicine', will feature one talk on all the shortcomings, in the hope of encouraging

them to be put right. It will be given by Dr John Dawson, the BMA Under-Secretary, 'who will highlight ways of overcoming poor ergonomic design, and encourage doctors and manufacturers to understand how currently inadequate systems could be improved to exploit fully the potential of available computers.'

It looks like a high-power seminar, opened by that ubiquitous MP and Minister. Kenneth Baker (Information Technology chief in the Cabinet) and with a second minister, Kenneth Clark of the Health Department, speaking on the second day. The BMA is organising it jointly with the Institution of Electrical Engineers.

If you feel you need more guarantees of its likely importance, then I can tell you that other speakers in-

clude somebody specialising in aids for the disabled, somebody from the Health Department in charge of information handling, somebody from the Royal Free Hospital (Professor Neil McIntyre), and somebody from the Royal College of Surgeons (Professor James Payne).

The only snag: IBM is giving a presentation on its 'Patient Care System'. I'm sure that will be inspiring, but what about micros? A bit beneath our august medical dignity, are they? Not a mention of them in the whole announcement.

I expect if we ignore them, they might still go away.

Details from the BMA at Tavistock Square, London WC1, phone 01-387 4499.

Atom add

There are so many ways of improving the Acorn Atom, mostly by plugging in a ROM chip, that users normally have a terrible time deciding which chip to buy. You can't normally plug them all in.

Aha, you say — 'normally'. That means that something new has arrived doesn't it?

Yes, indeed: a Four Outlet ROM adaptor. You get it from CMT Computer Technology of 6 Turf Park Road, Royton, Oldham, Lancs OL2 6EP, for a mere £22. You can then plug in four different ROM chips — for example, a Word Pack text editor, a Prog Power Tool Box, an Acorn Data Base, and a fast cassette controller from CMT. The only snag is that you have to use a Poke command (a '?' in Atom Basic) to select which ROM you use.

Phones 'freed'

I foresee tears as a result of the Department of Industry's attempt to 'liberalise' the Telecom authority.

The idea is that you and I, should we be brave enough, can now compete with Telecom even if we use its own copper wire, by doing extra

clever things to any messages that get transmitted. For example, you can store messages and forward them later when the recipient is there. Or you can change the protocols, so that a message from an IBM computer will make sense to an ICL or Apple computer.

The trouble is that it isn't clear (to me) that you can provide a protocol conversion service. Inevitably, some of your users are going to have the same protocol (they may not know it) and your service is going to output exactly the same thing as it received.

But, according to the Department of Industry, these 'value added' services must first 'process in such a way that when delivered, the messages have been clearly altered as to format, protocol or content'.

And, of course, Telecom would never oppose a licence on such obviously *bona fide* grounds, because Telecom welcomes competition. Doesn't it? And anyway, the message will have been stored and forwarded.

Fortunately, there is an Advisory Panel which can be appealed to if you disagree. It can 'recommend action' to the Secretary of State.

But I still think it'll end in tears.

Run with Clive

Here's your own chance to beat Sinclair on Sunday 18 July. After all the excitement of Clive Sinclair's new machine, get ready for his new marathon. Or, more precisely, his new half-marathon.

The half-marathon is costing Sinclair £5000 as part of his sponsorship of the 1982 Cambridge Festival. But he's going a step further than merely sponsoring it — he's running in it, too.

The race starts near his Kings Parade offices, 'includes a riverside stretch along Chesterton Lane, the "Backs", and finishes in the Market



Costing around £200, this is a Centronics-interface version of the Star printer supplied by Stotron of Hastings. Details on (0424) 442160.

Vic 20	Colour Computer	£199.99*
C2N	Cassette Unit	£44.95*
4016	16K Computer	£550
4032	32K Computer	£695
2031	171K Single Drive Floppy Disk	£395
4040	343K Dual Drive Floppy Disk	£695
4022	Tractor Feed Printer	£395
8032	32K Computer	£895
8096	96K Computer	£1195
8050	950K Dual Drive Floppy Disk	£895
8023	Tractor Feed Printer	£895
8422	22 Megabyte Winchester Disk	£3495
9000	SuperPet 134K Multilanguage Computer	£1495

*Price inclusive of VAT. All other prices VAT extra.
All prices are correct at time of going to press.

At Commodore we leave you no choice



10PC4



Send to: Commodore Information Centre, 675 Ajax Avenue, Slough, Berks., Tel. Slough 79292.
I'd like to know more about how Commodore can help me make the right choice.

Name _____ Position _____
Nature of Business _____ Company _____
Address _____
_____ Tel. _____



commodore
COMPUTER

Quite simply, you benefit from our experience

Come and see us at the Third International Commodore Computer Show. 3rd - 5th June, Cunard Hotel, Hammersmith

Commodore Official Dealer List

London
 Adaa W13
 01-579 5845
 Capital Computer Systems W1
 01-636 3863
 Logic Computer Systems SW1
 01-222 1122/5492
 Merchant Systems Ltd EC4
 01-583 6774
 Micro Computation N14
 01-882 5104
 Microcomputer Centre SW14
 01-878 7044/7
 Sumlock Bondain Ltd EC1
 01-250 0505
 Informex-London Ltd SE13
 01-318 4213/7
 CSS (Systems) Ltd E8
 01-254 9293
 Meares Consultants Ltd NW3
 01-431 3410
 Data Base NW2
 01-450 1388

Surrey & Middlesex
 Douglas Moore Ltd Kingston-Upon-Thames
 01-549 2121
 Micro Facilities Ltd Hampton Hill
 01-975 4546/941 1197
 PPM Ltd Woking
 04867-80111
 Datalect Computers Ltd Croydon
 01-680 3581
 Datalect Computers Ltd Woking
 04862-25995
 Johnson Microcomputers Camberley
 0276-20446
 Wego Computers Ltd Caterham
 0883-49235
 Cream Computer Shop Harrow
 01-863 0833
 Da Vinci Computer Shop Edgware
 01-952 0526
 L & J Computers Stanmore
 01-204 7525/206 0440

Kent, Sussex & Hampshire
 Amplicon Micro Systems Brighton
 0273-562163/608331
 Business Electronics Southampton
 0703-738248
 HSV (Microcomputers) Ltd Hants
 0256-62444/0703-331422
 Millhouse Designs Ltd Alton
 042-084517
 The Computer Room Tonbridge
 0732-355962
 Scan Computers Storrington
 09066-5432

Essex
 Dataview Colchester
 0206-865835
 CSSC Ltd Ilford
 01-554 3344
 DDM Brentwood
 0277-229379
 Stuart R Dean Ltd Southend-on-Sea
 0702-62707

Berkshire, Buckinghamshire, Oxfordshire & Wiltshire
 Commonsense Business Systems Ltd High Wycombe
 0494-40116
 Orchard Computer Services Wallingford
 0491-35529
 Wymark Micro-Computer Centre Salisbury
 04254-77012
 Alphascan Ltd Banbury
 029575-8202
 J R Ward Computers Ltd Milton Keynes
 0908-562850
 The Computer Shop Oxford
 0865-722872
 Kingsley Computers High Wycombe
 0494-449749

Hertfordshire & Bedfordshire
 Alpha Business Systems Ware
 0920-68926
 Bromwall Data Services Old Hatfield
 07072-60980/63295
 Computer Plus Watford
 0923-33927
 HB Computers (Luton) Ltd Luton
 0582-454466
 Photo Acoustics Watford
 0923-40698/32006
 MMS Ltd Bedford
 0234-40601
 Brent Computer Systems Rickmansworth
 87-71306/70329

East Midlands, South Humberside & Derbyshire
 Davidson Richards Ltd Derby
 0332-3689034
 Roger Clark (Business Systems) Ltd Leicester
 0533-20455
 Arden Data Processing Leicester
 0533-22255
 Belos Systems Ltd Nottingham
 0602-48108
 Caddis Computer Systems Ltd Hinckley
 0455-613544
 AJR Ltd Arnold Nottingham
 0602-206647

East Anglia, Lincolnshire & Northamptonshire
 Arden Data Processing Peterborough
 0733-47767
 HB Computers Ltd Kettering
 0536-520910
 Sumlock Bondain Ltd Norwich
 0603-26259/614302
 Dataview Norwich
 0603-616221

West Midlands, Staffordshire & Warwickshire
 Joseph Ware Associates Birmingham
 021-643 8033
 Camden Electronics Ltd Birmingham
 021-773 8240
 Micro Associates Birmingham
 021-328 4574
 Taylor Wilson Systems Dorridge, Solihull
 05645-6192
 Walters Computer Systems Ltd Stourbridge
 03843-70811
 CBS Consultants Ltd Birmingham
 021-772 8181
 Peach Data Services Burton-on-Trent
 0283-44968
 Computer Services Midlands Ltd Birmingham
 021-382 4171
 Business Equipment Rentals Ltd Rugby
 0788-65756

Business Equipment Rentals Ltd Coventry
 0203-20246

North Wales, Cheshire & Merseyside
 Rockliff Micro Computers Mold
 0352-59629
 North Wales Computer Services Colwyn Bay
 0492-33151
 Office & Business Equipment (Chester) Ltd Queensferry
 0244-816803
 Cattlands Information Systems Wilslow
 0625-527166
 Rockliff Micro Computers Liverpool
 051-521 5830
 Stack Computer Services Bootle
 051-933 5511

Manchester
 Cytek (UK) Ltd Old Trafford
 061-872 4682
 Executive Reprographic Manchester
 061-228 1657
 Sumlock (Manchester) Ltd Manchester
 051-834 4233
 D Kipping Salford
 061-834 6367/9
 Computastore Ltd Manchester
 061-832 4761

Lancashire
 Preston Computer Centre Preston
 0772-57684
 Tharstern Ltd Burnley
 0282-813299

Yorkshire & Humberside
 Acroyd Typewriter Co Ltd Bradford
 0274-31835
 Alcor Computer Systems Ltd Huddersfield
 0484-512352
 Deans Computer Services Leeds
 0532-452966
 Holbrook Business Systems Sheffield
 0742-484466
 Holdene Ltd Leeds
 0532-459459
 Microware Computers Hull
 0482-962107
 Milre Finch Fishergate
 0904-52995
 Yorkshire Electronics Morley
 0532-522181
 Computer Centre (Sheffield) Ltd Sheffield
 0742-53519/588731
 Microprocessor Services Hull
 0482-23146
 Ram Computer Services Ltd Bradford
 0274-391166

North East
 Currie & Maughan Gateshead
 0632-774540
 Dysons Instruments Houghton-Le-Spring
 0783-260452
 Intex Datalog Ltd Eaglescliffe
 0642-781193
 Key Computer Services Ltd Jesmond
 0632-815157

Avon, Wales & West Country
 Calculator Services & Sales (Bristol) Ltd Bristol
 0272-779452/3
 Computer Supplies (Swansea) Sketty
 0792-290047
 McDowell Knaggs & Associates Worcester
 0905-28456
 Somerset Business Computers Taunton
 0823-52149
 Milequip Ltd Gloucester
 0452-411010
 Reeves Computers Ltd Carmarthen
 0267-32441/2
 Welsh Computer Centre Bridgend
 0656-2757
 Sigma Systems Ltd Cardiff
 0222-21515/34869
 Reeves Computers Newport
 0633-212331/2
 Computer Shack Ltd Cheltenham
 0242-584343
 Midland Micro Stourport-on-Severn
 02993-77098/6706
 Sumlock Tabdown Ltd Bristol
 0272-276685/6
 Radan Computational Ltd Bath
 0225-318483

Devon & Cornwall
 AC Systems Exeter
 0392-71718
 Devon Computers Paignton
 0803-526303
 Jeffrey Martin Computer Services Ltd Turo
 0872-71626
 AC Systems Plymouth
 0752-260861
 JAD Integrated Services (Plymouth) Ltd Plymouth
 0752-662616/29038

Scotland
 Ayrshire Office Services Ltd Kilmarnock
 0563-24255/20551
 Holdene Microsystems Ltd Edinburgh
 031-557 4060
 Robox Office Equipment Ltd Glasgow
 041-221 8413/4
 Gate Microsystems Ltd Dundee
 0382-28194
 Gate Microsystems Ltd Glasgow
 041-221 9372
 Mac Micro Ltd Inverness
 0463-712774

Eire & Northern Ireland
 Northern Ireland Computer Centre Co. Down
 02317-6548/9
 Crowley Computers Ltd Dublin 2
 0001-600681
 Cork Microcomputer Systems Cork
 Cork 20252/20259
 CDS Computing Ltd Cork
 Cork 23922
 QTH Electronics Dunlaoire
 Dunlaoire 803358
 Microcomputer Systems Ltd Limerick
 Limerick 46755
 Software Development Services Ltd Dublin 4
 Dublin 685 755
 Declan Computers Galway
 Galway 67156/67157
 Microsolve Dublin 14
 Dublin 894598
 Computer Science Ltd Dublin 6
 Dublin 966204

Isle of Man
 Resource Planning Ltd Douglas
 0624-4247/8

Square at the Guildhall Steps', says the announcement. That's very near rival Acorn Computer's original office and where Acornsoft is now based.

Details from the organiser, Brian Allinson of the Amenities and Recreation Department, Cambridge City Council, which is at Kett House, Station Road, Cambridge CB1 2JX.

Moving in...

People describe Japanese machines in Japan as very cheap but lacking software. Over here, they still aren't even cheap — but with Mitsubishi's latest idea, maybe they are starting to get some software, because the thing comes complete with a robot.

The robot is the 'Move Master', a robot arm which can move all over the place, under control of a CP/M microcomputer.

Apart from having the CP/M software, the micro also has to have something called a 'semiCentronics interface' which is a little less than the normal parallel wires that control Centronics-type printers but can be connected to a normal Centronics 'outlet' on a micro. So, to make the robot work you need the half-Centronics software to send the right signals down the right half of the wires.

Cost of Move Master and control processor is \$5000. Mitsubishi hopes the thing will be used 'for training operators, as a teaching aid, or as a point of sale display' (a shop window gimmick, I suppose).

With a little luck, it will also prod lethargic UK micro builders into realising what they will be up against in a year or so, when Japanese machines do start spilling over into the West. But I doubt it: they will carry on making 'hand-crafted quality machines' which will go the way of the Norton motor-bike and the Dodo.

Details of Move Master from the company's Tokyo offices at 2-3, Marunouchi

2-chome Chiyoda-ku, Tokyo 100, Japan — or wake up in the night and phone (218) 2173.

Auto office

An office automation conference, backed by the Institute of Directors and supposed to be 'part of Information Technology Year', is running from 15-17 June at the Barbican Centre in London. It is organised by the organisers of the *Which Computer?* Show, Clapp and Poliak Europe. That's all the details I have at press time: further information on 01-747 3131.

PET show

The PET Show, still a bit bigger and more important than any other specialist micro show in Britain, runs from 3 to 5 June at the Cunard Hotel, Hammersmith. Over 100 exhibitors will be there, and while the hardware will be mainly the same from one stand to another, there will be lots of different (and competing) add-ons, software, and other ideas to compare.

If for nothing else, get there to see Jim Butterfield, the world's greatest PET expert. I think he actually knows more about the PET than there is to know. And he will be meeting the worried, curious or otherwise fascinated, courtesy of Commodore. Details on Slough 79292

Apple Logo

Just because a language is easy to learn doesn't make it easy to write programs in that language — as a great many Basic programmers are starting to find out. Which accounts for the number of people who are getting enthusiastic about Logo, a teaching language which actually encourages people to write good programs, and to learn good programming habits.

Latest to get enthusiastic about Logo is Apple itself, which has announced an official Apple Logo. Hope-



The Move Master — see 'Moving in ...'

DEALER
ENQUIRIES
WELCOME

EPISODE

The NEW compact 1.5MB
Standalone Computer

£1995 + VAT



EPISODE – A high performance standalone computer at a down to earth price. Capable of sharing data bases.

■ **FLEXIBLE – COMPACT – ADAPTABLE.** The Episode allows user choice of VDU's and printers, takes up the desk space of a legal document and under its CP/M operating system ensures availability of technical and business software for both technical and non-technical user.

■ **Word processing/ mailing** ■ **Financial planning**
■ **Integrated accounts** ■ **Stock control**
■ **Payroll** ■ **Information management**

■ A wide range of languages and utilities is available under CP/M to the technical user. BASIC, FORTRAN, COBOL, PASCAL, etc.

■ Can be used with existing mainframe terminals.

Standard features

Z80A Processor, 64K RAM, Diagnostic PROM, Dual 5" double sided double tracked drives (1.5 MB total), Dual RS232c ports, Centronics parallel port, battery calendar clock.

REGISTERED
TRADEMARKS:
CP/M – Digital
Research

All prices
exclusive
of VAT and
carriage

EQUINOX
Systems for Business
Kleeman House, 16 Anning Street, New Inn Yard,
London EC2A 3HB. Tel: 01-739 2387 & 01-729 4460
Telex: 27341

NEWSPRINT

fully it is a good version because there are so many different people around, all offering their own versions, that it is going to be very difficult to know which one to recommend – but the Apple version is almost certain to become the standard. Just because Apple is behind it, probably.

Available from Apple dealers.

Single-handed WP

Our lovable Editor has a thing about a one-handed typing device called a Microwriter, which requires you to press five keys in many different combinations to create the whole printable typewriter character set.

He has learned to type with one hand and therefore wishes everyone to know that you've just missed the chance to see the thing at the Word Processing exhibition on 25-28 May. Oh, maybe you've just got time to see it if you run or the issue got printed early. It's at the Wembley Conference Centre in London.

The company was also planning to launch a new product just before the show but didn't tell us what it was (please see 'The Line Is Dead') in time for this report.

68k chips

Motorola's partner in the development of its giant 16-bit processor, the 68000, is semiconductor firm Mostek – which has now announced a few enormous chips of its own to add to the 68000's potential.

The company has published

details of four new chips in the 68000 family, including a 'single-chip computer' with a few extra functions included that would normally require extra chips and complicated interfaces to the central processor.

It isn't meant for computing work but for using as a controller chip inside some automatic machine. That chip won't be available for at least a year, however.

More significantly for us computing types, there is a serial input and output controller, which will make it simple to take the 16-bit parallel codes inside the central processor and queue them up into a serial stream of pulses for transmitting or receiving – in quite complex manners such as ordinary asynchronous communications; or IBM's favourite bisynch (binary synchronous) and even including IBM's complete SDLC (synchronous data link control) protocol. That is all on a chip due to be tried out by the end of this year, and possibly available to builders within 12 months.

There is also a multi-function peripheral chip, to provide 'the three most popular peripheral functions, of serial input and output, timers, and parallel input and output, into one device,' says Mostek. By input and output, Mostek doesn't just mean a string of serial information but complex tasks such as feeding data streams directly into specified parts of the computer's memory without having to interrupt the processor – direct memory access or DMA. That chip too will appear towards the end of this year and will be available in around 12 months in high volume (perhaps).

Finally, Mostek has decided to follow Intel, Digital



The little white box inset, looking like a one-ring electric cooker on its side, is actually a power supply and fan which can reduce the temperature inside your Apple from 47 deg C to 23 deg C, and can also power the machine, a printer (or hard disk) and the fan, while cutting out several of the electrical interruptions that can come down the mains and screw up your Apple. It costs £150 including VAT, and details are available from Avitek near Reading, on (049 162) 765.

NEWSPRINT



Should you ever notice that your office is always cold for the first five minutes or so that you are in it, look round for one of these little blind TV sets — because what it actually is, is a Sensatemp, which can tell if there's somebody in the room. If there isn't, it can tell the central computer which controls the building's heating and lighting, to save the electricity for the heating (or air conditioning) and lighting in that room. It costs £97. Details from Alternative Marketing Services in Sharpthorne, West Sussex, on (0342) 810771.

Equipment and Xerox by adopting the Ethernet idea for local networks of processors and other equipment.

By putting the whole electronics of Ethernet on one chip, the company will make it possible to have lots of 68000 processors all sharing printers, disks and other expensive items for only a couple of hundred pounds, rather than a few thousand extra. But this chip is really only in the early stages of a long design process: don't expect to see even one sample much before the end of 1983, says Mostek. It's a very big chip.

In the meantime, don't believe anybody who says he has a cheap Ethernet system. Details of the Mostek chip on 01-204 9322.

The line is dead

Deadlines are strange things. A deadline can be 'put back' sometimes, if it has first been 'put forward' to make this possible. A deadline can be 'stretched' if it is broad enough, by taking the four things that have to be done in a different order. A deadline can be rescheduled, sometimes, if you can see the new schedule coming.

The One Thing a Deadline Cannot Do is be revived. Once 'Newsprint' has been written and printed, it is dead and gone. The line is dead; long live next month's deadline.

In this issue are one or two items of some importance,

which actually happened in February. The people who made these things (for example, Prestel's new price for closed user groups) happen kept it all secret until they were ready. Then they sent us an announcement which got here just after we put the May issue to bed — so it got printed in the June issue.

For the sake of professional (!) publicists, let me point out that it takes a long time to prepare and print a paper as big as PCW.

This item, for instance, was written over the Easter weekend, finishing on Monday 12 April. Just because you did something in March and posted the announcement in the first week of April, don't expect to see it here, because it missed the deadline.

If you want to know why it missed the deadline, think of this: in any week, PCW gets between 200 and 300 serious press announcements. Just sorting out this month's 600-plus news possibilities into a rough priority order took me three full days' work.

During those three days, I don't open the post — I don't have time. At the end of those three days, I have to writelike-hell for the rest of the week, including the weekend.

At that stage, anybody who suggested that I start opening the extra 200-odd announcements that have come in since I started work, and sorted them into some priority, and wrote them up, would get his trousers kicked, even by phone if necessary.

If you want to tell me

OSBORNE 1

The portable business computer with a difference

£1250

+ VAT

INCLUDES SOFTWARE VALUE £800+



Osborne 1 — The personal business computer for small businesses and busy executives on the move.

- Compact and mobile — The Osborne 1 simply packs into its own carrying case. Take it wherever your work takes you.
- Comes complete — Z80A 64K computer, dual 100KB disc drives, typewriter keyboard with numeric keypad and 5" screen.
- Capabilities include word processing, data processing and financial planning.
- CP/M operating system allows user choice from a wide range of existing written programs.
- Connects to a variety of printers.

Included in the amazing price of just £1250 is over £800 worth of FREE software:—

WORDSTAR for word processing.
MAILMERGE for name/address database.
SUPERCALC for financial planning.
MBASIC & CBASIC for programming.

REGISTERED TRADEMARKS:

CP/M: Digital Research
WORDSTAR, MAILMERGE: MicroPro International
MBASIC: Microsoft
CBASIC: Compiler Systems, Inc.

All prices exclusive of VAT and carriage

EQUINOX

Systems for Business
Kleeman House, 16 Amning Street, New Inn Yard,
London EC2A 3HB Tel: 01-739 2387 & 01-729 4460
Telex: 27341

The Printer People

MANNESMANN TALLY

120 & 140

The high speed machine with high quality features, utter reliability and reasonable price — and all the features you ever wanted including:-
80 cols. (120 version) or 132 cols. (140 version), 160 CPS, 10 character sets - 96 characters each, double width characters, four different pitches, (2 colour printing - option)

The small, quiet, robust, business printers, ideally matching today's requirements for —
QUALITY + SPEED + VERSATILITY AND PRICE



QUME

SPRINT 9 & 9/35 KSR



The Daisywheel Printing Terminal series that sets a new standard for print quality, reliability and serviceability. Unbeatable performance at a realistic price.

NEC

SPINWRITER Plus '83



Up to 55 CPS
Impeccable print quality
printers utilising the NEC print "thimble".

OKI

82A 83A

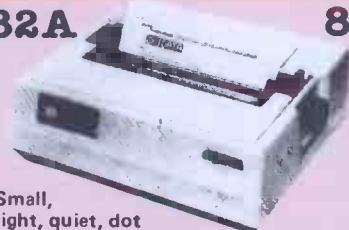

Small, light, quiet, dot matrix printer. 40, 80 or 132 columns, 6 or 8 lines per inch, 96 ASCII characters plus 64 graphics characters, Centronics int.

EPSON

MX80 RANGE



The unbelievable quality printer from the world's largest print head manufacturer. A whole stable of machines to suit a wide variety of applications: MX80, MX82, MX 80FT/1 & MX80 FT/New Type 2. MX100

NEC

8023A



100CPS Dot Matrix Printer —First in a new generation of machines embodying the quality and features you have come to expect from one of the worlds leading manufacturers.

BDT

ASF 160/560



BDT automatic sheet feeders automate the only thing left in word processing that needs automation. No word processing system is truly automatic if an operator is required to hand feed sheets into the printer, or resort to perforated continuous stock. This handling individual sheets can now be a thing of the past.

TEC

STARWRITER



Low cost, reliable, bidirectional daisy wheel printer—professional quality printout with Diablo or Qume print wheels. Suitable for most micros with RS232C or 8 bit parallel.

PRINCE

24 MHz

12" Green Screen, the monitor with features normally found on screens costing far more. It has a sensitivity adjustment from 0.5V to 4.0V thus allowing ample drive capabilities even with the most meagre of video signals.



WORTHAMBER LIMITED

3 & 4 DAWES COURT,
ESHER, SURREY.

Tel: Esher (0372) 66397 or
62071 (from 01 nos dial
78-66397 or 78-62071

Importers, Distributors
& Wholesalers
of quality Computer
products.

0372 66397 / 62071

If you want a Printer
tomorrow—
call us today



I think the Baroness, a well-known publicity consultant, deserves some kind of extra points for this valiant attempt to take a picture of software.

She did it on behalf of Alphatronic: the picture of the blonde lady is one showing a 'very popular German database program, Minigeni, now translated and adapted for this country by Dantedale Ltd'.

The picture of the dark-haired lady shows a telex preparation system (the black box punches telex paper tape), 'which significantly reduces the bottlenecks that occur at a company's telex machine during preparation and editing of telex messages.' Details of these Alphachronic (as it is affectionately known) systems from Triumph Adler, on 01-734 2907.

something, tell me before the deadline dies. Especially courses. This month, I threw away announcements of 17 different training courses, because they happened before PCW could be printed.

What really makes it fun is that, two weeks later, the Editor will get a letter from the outraged course organiser, complaining that 'Guy Kewney never seems interested in our courses.'

Moderate cheers

It is very useful to have computers in schools and providing 100 as prizes should give a lot of people who don't win a powerful incentive to go out and buy one. So two moderate cheers for the Department of Industry, which has awarded the prizes.

Why the restraint (you ask)? Easy: the prizes were Research Machines RML 380Z computers, which no school in my neck of the woods can afford to spread

thickly round the pupils. The machine may be lovely but one computer in a school is about as significant a step towards computer literacy as having a woman Prime Minister is a step to female equality — that is to say, almost irrelevant. And more than one 380Z is on its way to being expensive: a classroom full is out of the question.

All of which is not to say that the prizes are a bad idea — far from it. It's just not too hard to think of a better one, even if it does mean casting some slight doubt on the RML range's status as Official Educational Micro. But then, that might do Research Machines a bit of good in the long run (perhaps).

Blatant plug

An exciting plan to publish a book on computer and video games in time for this Xmas rush has just fallen through.

A pity: not only would the book have been valuable to the market and the readers, but the two authors (a lady called Elsbeth Joiner and myself) would have made some money out of it. But, apparently, the publishers wouldn't have.

Not to worry: we're going ahead anyway. The result of our efforts will be published — somehow — before the program-buying season in November. All we need is information.

Anybody with game products, please make sure I get details in plenty of time — send information to my own office at 38 Digby Crescent, London N4 2HR.

New Commodores

After sitting quietly letting the world speculate and shake its collective head in wonderment, Commodore has suddenly leapt in with a new range of computers, both up- and down-market from its existing machines.

Most spectacular is the 720, a smart new business machine which not only

looks radically different from anything else on the market but has some very exciting features. Like: 256k of RAM (a 128k model is on its way), 20k of ROM, an integral 80 x 25 display, a full qwerty keyboard with 10 programmable function keys, four cursor controls (at last!) and a numeric pad, twin built-in floppy disk drives (also at last), cassette, RS232, IEEE 488 and user ports and — most interesting of all — a slot for a second processor; 8088 and Z80 add-ons are also promised.

Slightly down-range is the 500 series, which looks quite similar except that there's no integral screen or disk drives. The unit plugs into a TV to give a 40 x 25 colour text display or 320 x 200 hi-res colour graphics, there's a music synthesiser with a 9-octave range and three voices, 20k of ROM and 64k RAM (expandable to 256k) and the unit also has a second processor slot.

Both machines come with Basic in ROM and, with the addition of a Z80, both will run CP/M software, with the main processor, a 6509 (a 6502 with memory paging) handling I/O.



Severely disabled people can do amazing things with computers, if they are trained to program them, but severely disabled people often have trouble raising the money needed to get trained.

So lots of marks to Olivetti for donating this P6060 (a sort of costly micro) to Queen Elizabeth's College in Leatherhead, Surrey. Until now, students have had to do their studies without a computer to transfer theory to practice, which is an absolute scandal and every micro supplier who hasn't responded to this sort of problem is not only unaware but thick — because training people on your own machine is very much a two-way benefit. It grows friendly users who are likely to do a lot to enhance the abilities of the machine.

The 5th Personal Computer World Show

By the middle of April we knew that this year's Show would break all records — for number of exhibitors, size of show and attendance. Over 1500 square metres of space are already allocated to the 70-odd companies who have so far returned their contracts. A full list of all the companies that are coming will appear in each issue of *PCW* from now until the preview issue itself comes out in the middle of August. Here's the first list.

If you're looking for business systems the big news is that Digital Equipment (DEC to its friends) has booked a massive 100-square-metre stand. When a big mini manufacturer starts up in the micro market a few sparks should fly. IBM machines will be on show on the Microcomputerland Stand — with a new add-on coming out every twenty minutes for IBM's Personal Computer in the States who knows what will filter through by September? And it's a little more than coincidence that Peachtree (the company IBM picked as official business software suppliers in the US) is also booked into the show. Other news is that the Newbrain (mooted two years ago and now finally being built by Grundy) will be there, as will the entire product range from Sharp Commodore, Tandy and NEC.

Upstairs in the home and hobbyist section we know that if all goes well the colour Genie will be launched at the Show. Commodore, NEC and Acorn will be in both parts of the show this year, which will mean even more demonstration machines for visitors to get their hands on.

There will also be the usual profusion of add-ons, dongles and gizmos from people like Supersoft, Vero and Audio Computers. It is not beyond the bounds of possibility that this will be the first place to see BBC software in decent quantity and variety — from Acorn/Aunty and from independents like Bugbyte.

Our own features will include the World Microcomputer Chess Championship, Computertown, and almost certainly a chance to challenge micros to a very well known board game.

If you are one of the 14 people who haven't already got the *PCW* Show in their diary you should by now have realised the error of your ways. And, if you need more convincing, over the next couple of issues we will be giving details of cheap travel and hotel deals, reduced entry vouchers and more news about the features.

Lower level
Acorn
Adda
AICS
AM Electronics
Apple
Atari
BFI Electronics
Biodata
BMIS
British Computer Society
Caxton Software
Commodore
Community Computers
Computer Bookshop
Data Applications
Digital Equipment (DEC)
Decom Computer Supplies
East Central Business Machines
Electrohome
Electronic Aids
Environmental Equipment
Gemini Microsystems
Grundy (Newbrain)
GW Design
Humac
Interval Advertising
IO Systems
Icarus
John Wiley Zenithplan
KGB Micros
Little Genius
Lowe Electronics (Video Genie)
McGraw Hill Book Co
MC Computers
Microcomputerland (IBM)
Molimerx
MPI
NEC
Peachtree Software
Personal Computers
Pete & Pam

Rediffusion
Research Machines
Riva
Roadrunner
Sharp Electronics
Stotron
Systematics
Tandy
Thame Systems
Tomorrow Microsystems
Transam
Vero
VNU Publishing
Wadsworth Electronics

Upper Level
Acorn
Adda
Audio Computers
BugByte
Camtronic Circuits
Chromasonic
Commodore
Computer User Aids
Creative Computing
Elcomp
Ikon
Kansas City Systems
Macronics
Maplin
Microtanic
Mine of Information
MPI
NEC
OK Machine Tool Co
Personal Computers
SBD Software
Southern Software
Supersoft
Sinclair
Time Data

Three new home machines have been announced: the VIC 10, VIC 30 and the long-rumoured Commodore 64.

The two VIC models feature similar basic specs (40 x 25 colour text or 320 x 200 graphics, ROM Basic, and sound), but the Basics differ in that the 10 has a plug-in ROM pack Basic which can be replaced with games or music cartridges while the 30 has an 8k Basic buried in 20k of ROM, which includes the operating system and character generator. They have different RAM sizes, too: 2k for the 10 and 16k for the 30.

The Commodore 64 has the same graphics and sound capabilities of the VICs but has a full 64k of RAM in addition to the 20k Basic and operating system in ROM and also has a second processor slot. In addition, it can be persuaded to run software written for other 40-column Commodore machines.

With the new machines, Commodore now has a very large product range. The 3000 series is dropped but the 4000 and 8000 series remain — for the time being. Although there's no official word from CBM at the moment, it rather looks as though the ageing remnants of the PET line will fade in the near future (ie, as soon as the existing stocks have been sold), to be replaced by the 500 and 700 series.

Prices: VIC 10: £100; VIC 20: £200; VIC 30: £250; 64: £400; 4000 series: £550-£1430; 510: £695; 8000 series: £895-£3500; 710 (like the 720 but without a screen): £995; and 720: £1595. Note that the VIC and 64 prices include VAT — the other prices don't.

Peter Rodwell.

Any clubs who want to get in on the scene should contact Dr David Annals at 142 Windermere Road, London SW16 5HE immediately!

Three new 16-biters

Three 16-bit micros were launched in Europe in the last month, one of which looks as though it could ally with the Sirius 1 to give IBM a tough time when the Jolly Giant finally gets round to launching this side of the Atlantic (and the latest estimate for that is a September launch for end-of-year delivery).

Office equipment giant Olivetti finally launched its personal computer, the M20, at a lavish press conference near Turin.

Instead of first testing the water with a conventional 8-bit machine, Olivetti has produced a 16-bit micro with 128k of RAM and its very own operating system. Estimated selling price in the UK is around £2500.

The M20 is virtually unique in the micro world in being based around Zilog's Z8000 processor, a decision made back in the early days of 16-bit chips when the Z8000 was the only real product available and looked all set to win the race.

As well as the Z8000 and the 128k RAM, the M20 has as standard Centronics and RS232 interfaces and an 80x25 display (software switchable to 64x16) with 512x256 graphics, and twin 5 1/4in floppy drives holding a total of 286k (formatted) each.

Upgrades and expansions include memory expansion to 224k by three plug-in 32k cards, IEEE 488 and twin serial port boards, and very nice colour graphics.

Olivetti's operating system, called PCOS, is a single-task, single-user set-up which, from the documentation, appears rather similar

Calling all clubs

Once again free stand space is being made available to computer clubs at this year's *PCW* Show (9-12 September at the Barbican in London).



Commodore's smooth 720

in concept to CP/M but is more flexible and friendlier — it incorporates a 'help' command, for example — and includes password protection facilities for files. The Basic used is more-or-less standard Microsoft, with commands to handle the quite sophisticated display, which includes windows and full graphics control.

A set of diagnostic routines is contained in ROM and is automatically executed on power-up, with any malfunctions being reported on the screen or printer. A disk containing more sophisticated diagnostics is also available.

All this is, of course, useless without some good applications software. The deviation from the now almost-standard CP/M family means that the fast-growing pool of 16-bit software won't run on the M20. Recognising this, Olivetti has produced a number of its own packages, including a word processor called Oliword, a 'data entry, retrieval and update package' called Olientry and a spreadsheet packages called — no, not Olicale but Multiplan. A number of utilities are also available, including a scientific subroutines library and a system self-instruction guide. A choice of three printers is available, one thermal and two dot matrix, and, of course, you can hook up one of those stylish Olivetti daisywheel units too.

Rather more up-market is the Fortune 32:16. As the name suggests, it's based on the Motorola 68000 chip, which looks like a 16-bit machine on the outside but has 32-bit internal architecture. For £3510 you get 128k internal RAM plus a single 800k floppy and a single-user operating system based on Unix but with a rather neat and considerably more user-friendly shell around it which sensibly keeps the user isolated from the nasties of Unix itself. A twin floppy unit costs £4209 while a machine with a single floppy and an integral hard disk costs £6145 (for a 5 Mbyte disk) or £6848 (10 Mbyte). Upgrade to a multi-user operating system (£348) and you can share the system with other users by adding work stations at £770 apiece.

Surprisingly (especially as the basic machine sells in the US for \$4995), no applications software is included in the price. So you'll pay £348 for what looked at the demo to be a rather nice word processing package, £208 for a spreadsheet and £418 for a database system called IDOL.

Another 68k-based micro launched recently also caters for more than one user, but does it with a network rather than splitting the CPU between users. The Corvus Concept is in fact a very upmarket workstation



A Fortune at your fingertips

designed to hook in to the Corvus Omnet local area networking system, giving communications with other machines and with printers and hard disks. 'Workstation' isn't really doing the machine justice, actually — it's a fully-blown Unix machine just bursting with really interesting features, the most immediately obvious of which is the rotating screen. Well 'rotating' isn't quite the word — it's a two-person job — but in essence, you use the machine with the screen in an upright position (see photo) to give a full A4 display (72 lines of 80 characters) for word processing; if you want to do accounts-type work, for which a very wide display is usually a great help, you simply lift the screen unit up, turn it on its side and put it back after flicking a switch on the back to tell the computer what you've done — the machine then reconfigures itself to the new screen format — 56 lines of 120 chars.

A close look at the photo will show that the Concept has no disk drives. As it's a network-oriented machine, you need to interface it to a Corvus disk drive — £2300 for 6 Mbytes on top of the 'under £4000' for the computer, making it rather expensive for a single-user set-up. Putting more computers onto the network is easy, though, and — impressively — you're not just confined to adding more Concepts; the Apple II can interface to Omnet to give a low-cost terminal where you don't need the full power of the M68000, and Chuck Peddle recently announced that the Sirius 1 will have an Omnet capability soon.

Software for the concept will include Pascal (ISO with full UCSD extensions), Fortran 77, the obligatory word processor and spreadsheet and a CP/M emulator to allow you to run Basic and Cobol.

And there's a very interesting hardware feature inside the Concept — a bus into which a large range of Apple II cards can be plugged, although you will have to re-write the ROM drivers on the cards. . .

Peter Rodwell



Olivetti's 16-bit contender



Corvus with full page screen.

by David Tebbutt

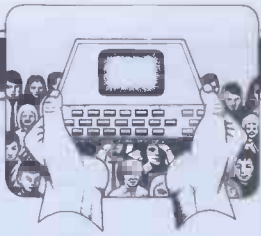

Still going strong

First of all my apologies to those who had to wait for a little while for a response to their letters. The fact is I trotted off on my annual pilgrimage to the West Coast Computer Faire and this knocked a fair sized hole in the month of March as far as ComputerTown was concerned.

Let's have a look at this month's mailbag. First of all, a real livewire by the name of Chris Woodford wrote from Burton-on-Trent with a copy of ComputerTown Burton's first newsletter. It made very interesting reading and, although CT Burton is not yet off the ground, I'm sure it will be soon. If you'd like to help Chris start up in Burton please write to him at 31 Hopley Road, Anslow, Burton-on-Trent, Staffordshire.

John Stafford has a lot to answer for: he kindly wrote an article about ComputerTown Worcester in the magazine *Assistant Librarian*. The result has been a deluge of enquiries from libraries all over the country. Well done John, and thanks.

John Bone of CT Gateshead is coordinating the ComputerTown stand at this year's PCW Show. If you'd like to pitch in for a few hours or more, then please contact John as soon as possible. His address is at the back of the magazine (CT centres). John has just sent me a 'shopping list' of machines he would like loaned for the duration of the show. If anyone would like to help out, will they once again contact John as soon as possible. Here is the shopping list: two BBC model Bs with disks, Paper Tiger printer and colour televisions; two BBC model As with TVs; two Atari 800s with disk drives, joysticks and colour TVs; two ZX81s with 16k, large keyboard, printer and flat TVs; two ZX82s(!); one 48k Apple with Softcard and printer; a telephone line and modem; and someone willing to telephone the show from a US network. Phew!! If you're willing to help out but you can't reach John, please leave appropriate messages for me with PCW unless, of course, you happen to know my own telephone numbers. Thanks in anticipation.

A phone call from Peter Kiff updated me on what's happening at CT Broadstairs. Peter and his merry men have been running a 10 week Basic course very successfully. It starts with a re-run of the BBC programme followed by 20 minutes' teaching and 40 minutes' practice. Homework is available for those who want it. At the moment the structure of the course is fairly flexible but, when the first one is complete and they've had a chance to reflect a little, Peter has promised to send me a note of the teaching sequence which they find works for them. I'll let you know when it's available. Incidentally, CT Broadstairs has received a

lot of support from local traders. Rediffusion has loaned a television and video recorder for the course, WH Smith in Ramsgate has lent ZX81s and cassettes - Computer Town acts as a useful testbed for the programs. Apparently, people are turning up on Friday night for ComputerTown then rushing into Smiths on Saturday to buy their own machines! Radio Rentals, too, are offering televisions and a local software house is seriously considering the loan of a computer. It sounds as if Peter and company have got a nice little community thing going there. If you want to join in, help or whatever, Peter's phone number is 0843 67368.

Here are the addresses of the serious looking enquiries this month: Steven Donoghue, Services Development Librarian, Central Library, George IV Bridge, Edinburgh EH1 1EG; Miss P Crabb, Children's Librarian, Warrington Library or 40 Lander Close, Old Hall, Great Sankey, Cheshire WA5 5PJ; Mrs Heather Arnold, 88a Pontway, Warminster, Wiltshire; J Hamilton, Whithorn Computer Group, c/o South Machars Community Education Centre, Whithorn, Newton Stewart DG8 8PN; C W Franklin, Wiltshire County Council, Library & Museum Service, Bythesea Road, Trowbridge, Wiltshire BA14 8BS; John G Batch, Assistant Lending Librarian, Lowestoft, Central Library, Clapham Road, Lowestoft NR32 1DR; Colin Glover, 116 Whitecross, Abingdon, Oxon OX13 6BU; AJ Reese, 94 Coombe Lane, Bristol, BS9 2NP; Frank Richardson, 65 Norwich Road, Fakenham, Norfolk, N21 8BA; Stephen Robinson, Divisional Librarian, Gillingham, Kent; Philip Colner (or is it Colmer?), 43 Victoria Road, Fordingbridge, Hants SP4 1DD; Tricia Raper, 155 Grace Dieu Road, Thringstone, Leicestershire.

I'm sure that all the above are just

waiting to hear from like-minded souls who'd like to help them get a local Town going.

Other letters this month came from London (SW18 and W1), Bordon, Kenton, Holmfirth, St. Louis Grammar School (I didn't note the town), Leicester, Nottingham, Edinburgh, Lympne, Brighton, Paisley, Bootle, Lowestoft, Rotherham, Windlesham.

Finally, my thanks to all of you who wrote and expressed interest in ComputerTown. If you've got half a mind to start one then write for guidelines: appropriate details are in the box somewhere on this page. Thanks too to *Technology Week* magazine who kindly gave us a write-up. Keep those letters rolling in and, if you've a mind to, why not write articles about ComputerTown for your other favourite magazines and papers?

ComputerTown UK! is an ever-growing network of computer literacy centres, where members of the public are given free access to micro-computers, courtesy of those willing to volunteer their time and equipment. ComputerTowns might be found anywhere: in a church hall, a library or maybe in a school after hours. The emphasis is on making computing enjoyable and non-threatening and, because Computer Town is entirely non-commercial, overt axe-grinding of any sort is banned. Guidelines are available for those interested in setting up their own 'Towns: Write to CTUK!, 7 Collins Drive, Eastcote, Middlesex HA4 9EL and remember to enclose a large SAE (A4 would be fine) for your reply. Please don't try to telephone PCW for information because this project is entirely a spare-time activity.



ComputerTown Enfield was formed in April 1981 as a result of a meeting between Alan Waring, Dave Clark and Lesley Blundell, the Deputy Borough Librarian. With the help of Southgate Technical College Computer Club CT Enfield swiftly got off the ground. This ComputerTown has attracted a loyal following of some 30 people and it runs at both Palmers Green and Ridge Avenue libraries. A ZX81 has been permanently installed at Ridge Avenue for use by validated users outside normal CT hours. CT Enfield exists mainly for beginners so as people become skilled they are invited to help out with ComputerTown or to join the Southgate club. Here's a quick list of the people who make CT Enfield happen: Dave Clark, Lesley Blundell, Alan Willis, Dave Howell, David Sharp, Piers Bishop, Nigel Craig, Keith Laurence, Ron Fellows, Brendan Grehan, Sheila Barford, Tony Terry, Anne Semphins, Andy Scott, Alan Tootill, Terry Gerrish, Max Granger, Andrew Lack, Alan Gregory, Kev Pretorius, Ron Green, Derek Bailey and Alan Waring.



Dick Pountain burrows through the letters in our massive 'in-tray' and gets to grips with digital electronics.

READER'S WRITINGS

Over the last few months it has often fallen to my lot to select the readers' letters which are to be published in 'Communications' and the experience prompts me to offer a few observations gleaned therefrom. Some trends are visible which might shed a little light on the way that the microcomputing scene is developing.

Once upon a time (that is, a year or so ago), the letters *PCW* received fell into four main groups: people reporting tips and discoveries or requesting info from other readers; people making points of general interest about microcomputing, eg, about languages or operating systems; people complaining (usually with justification) about mistakes we had made in the mag or slanders about their product; and gossip and/or in-jokes from pople in the trade. All of which is fine and healthy stuff and the clay from which letters pages are wrought.

In the intervening time two or three new categories have started to be seen, however.

First is the complaint about the trade. We could easily fill a special issue of *PCW* with complaints about the ZX81 RAM pack, the BBC waiting list and various manufacturers' service arrangements or lack thereof (don't worry, we're not going to!). The problem is that we can do very little to help such readers; we can't investigate each case individually, and it is a very dodgy business to make representations to a manufacturer or publicise the complaint without such investigation. We do of course document elsewhere in the magazine the progress on the larger scale bugs delays and foul-ups which beset the industry. But the other problem is that we see both sides of the story from where we're sitting. Without manufacturers there are no computers, hence no *PCW*, hence no *PCW* readers; what's more we have some idea of the immense complexities involved in getting a microcomputer to work at all, let alone into a carnivorously competitive market-place, and we have developed a rather worldweary acceptance of the inevitability of cock-up, catastrophe and crisis (usually followed eventually by triumph). It's a young industry, an immature industry in marketing terms, and also a highly exciting one. One day it may grow up so that you can get the same standard of service as when you buy a toaster. I doubt it myself — there'll always be some crazy who wants to push the technology further than it will stand and three more who want to buy it (he will have budgeted for two).

Never forget that the little box which you paid merely the price of a holiday for (the holiday you now need to get rid of the nervous tension) would once have cost £3,000,000,000 and filled 17 ward-robres, etc, etc.



The next category is altogether more tedious; the diatribes, vitriolic attacks and partisan defences of 'my machine' or 'my language' or whatever. I find it really hard to understand how anyone can get emotionally involved with a computer. To me they are still tools, albeit satisfyingly complex ones. I got interested in them in order to learn things and to do that one must always accept that what you're working with now is not the end of the road; it has imperfections and omissions (regardless of whether or not you can afford to rectify them right now) and that recognising and coping with limitations is as important to learning as bragging about strengths. One subject guaranteed to bring a crop of these letters is structured programming and any article (like Borge Christensen's recent ones) that suggests that Basic is in any way less than the perfect programming language. Within the next year or so I predict that Pascal, Comal, Forth or some such will become cheaply available for every popular micro; then, perhaps, it will be possible to give one of them a try before digging in to entrenched positions.

In general I don't think it's necessary or wise to invest ego in anything to do with computers; so many computer disputes are in the end reducible as much to personal style as to any real superiority of one device or system over another. Save partisanship for the soccer season.

The last new category is that of people who write to say that *PCW* is too difficult and can't we run more stuff for beginners. Apart from the fact that we do run the 'Newcomers' page every month, the point is that beginners don't stay beginners very long in this game and reading articles which go over the same basic ground continually becomes very boring after a while. When you first opened your Basic manual it probably seemed difficult; three months later it's hard to remember what the fuss was about. Now you want to stretch out a little. We can help you there; think of us as a nasty gym teacher or a red-faced sergeant-major or something keeping

you on your toes and egging you on to deeds of glory.

The moral of all this is that if you have a burning desire to see your name on *PCW*'s letters page, your chances are good if you're saying something of general interest, relevance or importance to the mass of microcomputer users rather than making a narrower point, however justified.

But above all, keep the letters coming.

Digital Didactics

Digital hardware has never been my strong point; Rodwell wields the soldering iron around these offices. My last real involvement in hardware was when, at school in the embarrassingly early 60's, we built an analogue computer out of ex-RAF radar parts. It was, of course, the size of a wardrobe, like everything else in those days (the wardrobes were the size of a house) and could solve a seventh order differential equation while delivering a 9000-volt electric shock — I know because I received one. Anyway, to get to the point, we recently received the Superkit from Cambridge Learning, containing a beginner's course in digital electronics which I decided I was in need of and duly tried out.

The kit, which comes in a neat pocket-sized plastic wallet, consists of a small Eurobreadboard, seven ICs, a four-pole DIL switch and an assortment of discrete components: resistors, capacitors and LEDs. The manual is a 170-page document organised as a graded series of experiments with problems set at the end of each chapter (answers are given). The experiments are extremely well worked out, starting from the use of a single AND gate and ending up some evenings later with shift-registers and twisted-ring counters. The explanations and the system of notation for describing circuits are clear and concise and should not prove frightening to anyone who can wire a plug or change a fuse. Two entry points are provided, one for those totally new to electronics and one for those with experience of non-digital electronics. I found the whole business very rewarding, particularly proving De Morgans Theorems by experiment and finding out how a J-K flipflop works — which made me realise that until then I hadn't really understood what makes RAM remember.

The kit costs £20, which we figured to be good value since there is about £10 of hardware in it, before you consider the manual and the instructional expertise you're getting. Recommended for all budding Tom Wests.

Cambridge Learning is at Rivermill Lodge, St Ives, Huntingdon, Cambs. **END**



PCW welcomes correspondence from its readers but we must warn that it tends to be one way! Please be as brief as possible and add 'not for publication' if your letter is to be kept private. Please note that we are unable to give advice about the purchase of computers or other hardware/software — these questions must be addressed to Sheridan Williams (see 'Computer Answers' page). Address letters to: 'Communications', *Personal Computer World*, 14 Rathbone Place, London W1P 1DE.

Soft sell

Why oh why don't you include reviews of the vast number of programs that are available to the micro owner? You review some of the more sophisticated software and under Bookfare give us a round-up of the latest computer books, but in the area of much of the software advertised in your magazine, nothing.

I have bought a number of programs ranging in cost from £5 to £35 and each time have ordered them cold, unseen and untried, as the facilities did not exist to try them out. In most instances I have been satisfied with the product but there have been disappointments and, at a minimum cost of £5, a point of reference such as a software review would have been very useful.

When purchasing a book we not only have, very often, the benefit of a review but we can look at the book in the bookshop. A software review would help to bridge the gap that exists between what the vendor claims and how the software actually performs. The restriction of machine dependability will place a limitation on the number of reviews that can be undertaken but a panel of reviewers operating various machines could provide a very useful service to the micro user through the pages of your excellent magazine.
A R J Stevens, Orpington

We intend to start in-depth software reviews very soon (we already do Databases). Unfortunately the business of testing is even more time-consuming than hardware Benchtests which is why so few periodicals do them properly — Ed

Beebs's boobs

I believe Malcolm Peltu has missed some important points in his review of the NEC 30 Hour Basic book. I bought the book primarily for my computer-naive wife, but have found a number of errors in the text. While I agree that the book is a reasonable introduction to Basic, I think the errors should be mentioned, especially those directly concerned with the BBC machine.

For example: throughout Unit 3, BBCers are told to omit the semi-colon in INPUT statements — they should, in fact, replace the semi-colon with a comma; some of the alternative PRINT statements for BBCers are incorrect; in Unit 9, IF

EOF #B=-1 is used as the BBC equivalent of IF EOF(1), when IF EOF #B works perfectly well.

There are other errors (even in the errata!) not directly concerning BBC Basic and, although anyone familiar with computers will spot them quite easily, some people will be awfully confused — I understand around 50,000 copies have been sold.

For a course that is being sold on the back of the BBC machine, the constant marginal notes for BBCers are a pain. A separate edition should have been produced — and perhaps your review should have been written by a BBC user (I don't charge much!).
David Budd, Manchester

Unfair to expatriate

I recently became rather excited about the BBC micro-computer, having heard a lot in its favour from fellow expatriates here in Stuttgart. And so I dutifully sent off a letter to Aspen House, Kettering requesting a price list for the BBC microsystem along with a query as to whether a system could be sent to me directly in Stuttgart. I was rather surprised at their response. When I opened their letter I found my original letter (very useful!) and a xeroxed reply-sheet obviously used to shake off the more troublesome customers. A small tick in the box against the line saying orders could not be accepted outside the UK was the only information. No price list or other information was sent. I must comment that such an unprofessional response was not expected and does not really enhance the image of British firms here on the continent.

However I would still like to buy a BBC micro, so can anyone tell me what the latest price of a BBC micro model B is and how I can order one from Stuttgart (W. Germany)?
R W Lewis, Ditzingen, Germany

Atomic radiation

I have discovered a useful, and rather unexpected, use for a radio. It may be used to discover whether a computer is processing, without interfering with its operation.

The radio needs simply to be tuned to the FM band (though LW will also work

well) and sat on, or near to the machine. Assorted noises will come through the radio loudspeaker, the volume and tone of noise depending on what the machine is doing — eg, if you press a few keys when the machine is inputting something, you will get a different tone for each key (on an Atom at any rate!).

Perhaps a more sensible use is as follows: On the Atom, the cassette operating system messages are decidedly unhelpful in telling one whether the machine is still loading (or saving) a program, or if it has 'crashed'. The only way to find out, without stopping the load, is to sit said radio on the Atom and listen to the squeaks and gibbers that issue forth. With a little practice, one becomes quite adept at identifying what the machine is doing, just by listening to the radio!
J R Chapman, Dulwich

Thanks for the tip Mr Chapman — I do hope you realise though that the micro industry is spending thousands to eradicate RF emissions! Let's hope the Home Office isn't reading this — Ed.

Apple not outdated

In your March issue Guy Kewney, in his 'Newsprint' compilation, is in many ways inaccurate and in several others at least unfair in what he says about the Apple system.

I would argue strongly that, far from being out-of-date design, this computer has kept abreast of current developments and has in some cases led them. Why does he think it is that there are so many manufacturers who still consider it well worth their while to mount new design and marketing exercises for Apple-compatible products and software if the future of the machine is as short as he thinks? The existing and potential user base for this most versatile of computers is still enormous. The 'competition' comes nowhere near in terms of availability of professional software in almost every major computer language; choice of professional printers, floppy and hard disk systems as well as most other kind of peripheral.

I would feel some sympathy for Guy when he says that the prospect of experimenting with other interfaces gets a bit frightening, if it were not for the excellent quality of the instruction books. The friendly way in which they

are written dispels any qualms one may have had. No other computer of any make or size, within my experience, has such helpful and complete manuals. In particular, the tutorial is second to none for the absolute tyro. Every Apple peripheral and interface card has the same standard of helpful instruction book. Many have photographs to assist with installation and they all take you through the relevant instructions for the product.

Does he not know that, in addition to the standard Apple 5¼-inch floppies, there have been several 8-inch floppies and several hard disk systems, including removable platter types for the Apple II, for over 2 years?

It would seem that he has not read his manuals (Tutorial p 52; also see index for editing), or he would know that on-screen editing is available on the Apple II with complete cursor control. Insertion, deletion (character and end of line), and program line copying are all provided in firmware. During program writing, the Apple Toolkit provides many useful programming aids. Since it is RAM-resident it need not occupy run-time memory when it is not needed. A ROM resident toolkit normally occupies valuable address space whether you want it or not.

One final word, the Apple is aimed mainly at the serious commercial user. This being so, it is the Apple dealer, not the user, who sets the equipment up and plugs together the particular configuration for that customer. This major class of user is therefore not involved in the 'nuts and bolts' of installation, nor should he be. This reliance on the Apple dealer is all part of the Apple system and is built into the pricing structure. The cut-price cowboys (and there are unfortunately quite a few in London) cannot provide professional standards of support without charging heavily for it. On the other hand, the properly organised Authorised Apple Dealer/Service Centre provides not only the full installation service, but very often at least a day or two's assistance with the familiarisation, operator training and help with the use of various programs. Such high standards of service are normally required by the non-technical commercial client and are to my knowledge only provided by the serious Apple dealer, not the cheap mail-order operator out for a fast buck.

I hope that the above will assist Guy in coming to terms with a machine which can outshine all others in this field. The longevity of the Apple II as a design concept has enabled it to gather all the accoutrements required of a business-oriented machine. It is worth noting that it is those aspects which have been developed and fine-tuned for this most unforbearing of markets, rather than the more trivial games facilities. It remains to be seen whether Apple can get it as right again with another machine.

Hugh S O'Neill, Selsey

Depreciate, skip on zero

The enclosed cutting from today's *Edinburgh Evening News* causes me to wonder how successful I'd be trying to sell my UK101 complete with numerous modes and add-ons. I can't help but feel that many advertisers in 'Transaction File' are very optimistic! I'd like to sell my machine with colour, sound, etc, but I think I'd be lucky to get a quarter of what I paid for it. (I ordered a BBC computer early in January.)

Dave Henniker, Edinburgh

common; they are not perfect. When the price tag reaches £1000 and over they should be given less than four pages of review. A writer like A F T Winfield gives more of interest in just two pages, but you haven't even looked at his Hullforth.

Olaf Baaken, Norway

I shall be looking at Hullforth as soon as I can get hold of a Nascom. And incidentally PCW is a magazine for all microcomputer users, not only hobbyists, common or otherwise — DP.

Agora-phobia

MP Ian Lloyd's concern (Commons Report — *PCW* March 1982) with the imminence of 'electronic democracy' is both understandable and laudable. It would be an absolute disaster! The childish idea that a complicated modern society comprising individuals up to multi-nationals could be managed by millions taking time off from *Coronation Street* or their TV games to press a few buttons is as ludicrous as it is terrifying.

The concept rests upon the assumption of an 'informed community'. This assumption, no doubt expressing the aspirations of the 'informers', is biological rubbish. There has never been an informed community and there never will be. The human mind is like a computer in many respects. It will deal with all data fed to it according to its program. Unfortunately for the 'informers', every human mind has a different program. Information technology can disseminate information but it cannot ensure its absorption. Even if it could, TV-watching pollsters totally isolated from the realities under discussion at best would merely be ineffectual or at worst totally anarchistic.

Electronic AGORA is a juvenile nonsense born of

technological enthusiasm rather than political maturity. If it seems to be on its way in the US, we should be warned rather than enthused. Political acumen, except on the part of career politicians, has never been very high over there. But this apart, the whole idea is theoretically indefensible as a democratic mechanism.

The populist view, 'All the people, every issue, every time', is philosophically unsound. Populist democracy, or any other sort, only makes political sense if the communication traffic is in both directions. That is, when all who have power to vote also have power to participate in the debate. In the present, and foreseeable future state of the art this electronic Tower of Babel is just not on. That being the case, government by electronic referenda, far from being the extension of democracy its proponents claim, would be a move towards totalitarianism with real power resting with those with access to the media. Shades of the EEC debate and 1984!

Information dissemination is not the same as information provision. Information arbitrarily directed at people as envisaged in 'electronic democracy' suffers an altogether different fate to the information consciously sought from such as Prestel, Ceefax and Viewdata. Electronics cannot overcome psychology. Viewers unconsciously regretting missing *Crossroads* offer decidedly less receptivity than conscious applicants to an information service.

And this is the crux of the matter. Democracy, electronic or otherwise, can only be effectively run by those who wish to participate in its running. If this means, in practice, too few people involved or that too many partisan views get expressed, this is a fact of life that has to be faced. The fundamental

realities of political parties, trade unions, pressure groups, vested interests and the like will not go away. Neither can they be circumvented by introducing a spurious wider suffrage of relatively disinterested button-bushers. These latter could swamp the political activists and probably would. But what would these traditional elements do? Give up the struggle in the face of an electronic smothering of their hopes and aspirations? Not likely! They would go further underground than they are already and carry on the fight.

Thus more fights, squabbles and eruptions of discontent. More grist to media sensationalism and more and more 'inexplicable' events for our electronic pollsters to pronounce upon. And deeper and deeper into the mire of unresolved conflicts would we sink. No, let us have interactive cable television by all means. All ways in which views may be expressed should be encouraged. But let us treat it as a discussion medium because it can never effectively be more, not as a form of government.

E. A. Hawkins, Ipswich

Hey doobrie

This word was in common usage in the Middle East over 30 years ago, I know, I was there. It may be Arabic.

Don't ever be conned into printing zoobrie or similar sounding word which is Arabic!

For an old man of 55 I find *PCW* very helpful and read it cover to cover. The ZX81 tips are interesting but the programs seem a long time coming.

Ray Mullard, Guildford

Thanks for your doobrie, Ray, this whatdoyoucallit is now closed — Ed.

GOING CHEAP—A COMPUTER WORTH £50,000

A Midlothian college are to get a £50,000 computer — for next to nothing. Midlothian District Council, trying to dispose of a five-year-old ICL 2903 machine, found there was a lack of interest from the trade. One offer was free removal, and another was to pay £1 for each disc cartridge. Yesterday the council's finance committee declared that the computer, worth £50,000 when new, should go to Esk Valley College — on the above terms.

Norse Nascom

I have a complaint. Why haven't you presented the promised test report on Hisoft Pascal-3 for Nascom (now also for MZ-80K)? You said (was it last November?) that you had asked for a tape and the manual. Now, if a rather comprehensive report appears next month I shall forgive you, otherwise not!

Generally you should watch your own ads and give new British firm- and software more and better attention.

Your magazine grows fatter every month, but I wish you would be slightly less trendy and keep more to the practical side of personal computing. That is what the common hobbyist has to do. All these shining new computers have just one thing in



'We feed the geological data for the area, the computer produces a schematic topological overview designating high probability key points, then we stick the printout on the wall and Johnson here throws a dart at it.'

Accounting
Business Systems

TABS

The UK's largest selling accounting business software already on the latest generation 16 bit micro...



ACT SIRIUS 1

At last! A 16 bit micro computer to put the UK's largest selling accounting business software on.

TABS highly successful modular accounting business software is already running on the first new generation micro-ACT SIRIUS 1.

Together, TABS proven software and this 16 bit personal computer combine to give the end user a much

faster and more powerful system never before available at the micro end of the computer market.

We think you'll find it an unbeatable combination.

If you'd like a demonstration in London we'll be at the National Microprocessor and Electronics Centre, within a few minutes walk from Tower Hill tube station, every Thursday

10.00a.m. to 5.00p.m., or visit our resources centre in Andover.

Why not send for our 32 page booklet which outlines the capabilities of each module, our comprehensive training facilities, video training tapes, installation and hot line support services.

Financial Flow In the TABS Accounting System

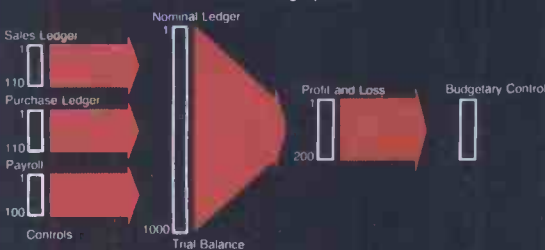

THE NATIONAL MICROPROCESSOR & ELECTRONICS CENTRE At the London World Trade Centre

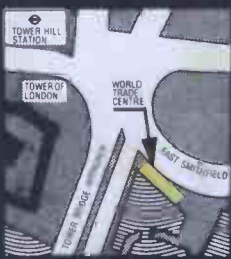

For more information about TABS accounting business software and hardware fill in and return this coupon to us. Please tick box(es)

- Please send me your 32 page booklet
 - Please send me more information about TABS Hardware
 - Please send me details about seminars and free demonstrations
 - Please send me the TABS User Manual
- I enclose £5 (postage and packing included)

Name _____
Address _____

Tel. No: _____ PCW
TABS Ltd, Sopers House, Chantry Way, Andover,
Hants. SP10 1LS. Telephone: Andover (0264) 58933.



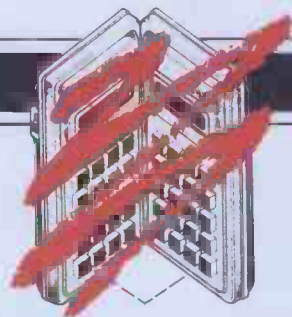

NOT CALCULATOR CORNER

SHARP PC1500

By Dick Pountain

It has been quite fascinating to watch at close quarters the battle for supremacy in the hand-held computer market over the last two years. Sharp got in the first blow with the PC1211, which was the first hand-held with Basic; Casio retaliated with the 702p which is faster and has more memory. Meanwhile, Hewlett-Packard strapped on quadruple memory and an interface loop to its established HP-41C calculator. Now Sharp has come back with a blockbuster, the PC1500. Though it is clearly related to the 1211, it's an all-new machine which builds on the good features of the old but is very much more powerful. And it features a truly remarkable four-colour plotter/printer which has no rival at present.

Hardware

The PC1500 computer unit is enclosed in an alloy-faced ABS case of considerably larger size than the 1211 (195x86x25.5mm), which reflects the use of four AA size batteries to power the expanded memory instead of the normal silver oxide or lithium 'button' cells. These give around 50 hours of use; a 6V mains unit is available for desk use. Opening up the case reveals a two-board computer with 14 ICs including the processor, a full 8-bit CMOS unit of Sharp's own manufacture, 16k of ROM and 3.5K of on-board RAM. A compartment on the back of the case next to the batteries has an edge connector for an expansion RAM module (4k on the test machine; 8k is due this month). All of the RAM is, of course, non-volatile CMOS memory.

The keyboard is of qwerty layout; similar to the 1211's but with rather larger keys which greatly improves its ease of use. The most noticeable difference is the row of six function keys under the display, of which more later. Upper and lower case letters are obtainable either by the SHIFT or by a key called SML (for small) which toggles a caps-lock. The display is a 26-character LCD job with annunciators for operation and angular mode and BUSY to show a program is running.

Calculations are performed to 10 figures (dynamic range of $10^{\pm 99}$) plus a two-digit exponent when in scientific notation. The speed of calculation is very greatly improved by the 8-bit processor; the 1500 ran my calculator Benchmark (see 'Calc Corner' Jan 82) in 13 seconds, which beats the previous best Casio 702 (20 secs) quite comfortably. I also ran the PCW Benchmarks out of interest; to put things in perspective, even this is an order of magnitude slower than a typical 2MHz, 6502-based machine.

The 1500 has, like the 1211, four modes of operation, but the ergonomics have been considerably improved. The MODE key toggles between RUN and PRO mode. The DEF mode now has its own key and the top keyboard

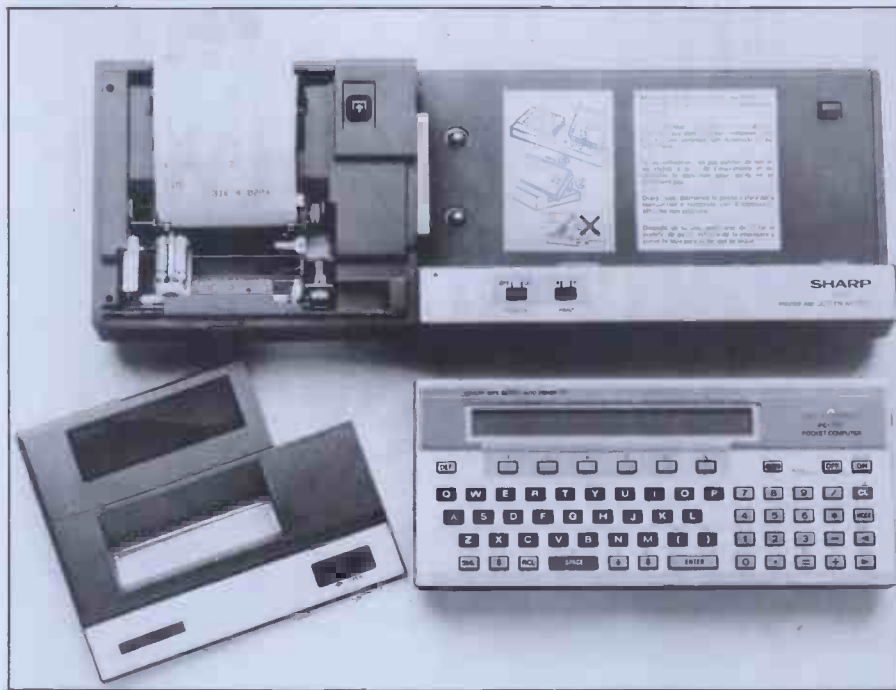

row has Basic reserved words permanently assigned; 18 of the other keys are available to have user programs assigned. The RESERVE mode now operates on the six function keys under the display and allows 18 commands (including carriage returns) to be assigned to them and used in RUN or PRO mode. This is achieved by a key \uparrow which selects one of the three definition sets flagged as I, II and III in the display. Each command may be labelled with a string, and the RCL key displays the six labels over their respective keys. Reserve assignments are stored in 198 bytes of protected memory just below the Basic program area and can be saved to tape. The arrangement works very well, unlike that on the 1211 which was too fiddly to bother with. The editor is

the same as the 1211's with full four-way movement through the program and insertion and deletion.

Basic

The interpreter on the 1500 is a full implementation of a Microsoft-style Basic and includes PC1211 Basic as a subset, together with 62 extra instructions. In particular, a full set of string functions is provided, including CHR\$, and ASC, STR\$ and VAL. Variable handling is orthodox, unlike that of the 1211 which configured the memory as an array. Names can be of any length, though only the first two characters are significant, and two-dimensional arrays are permitted. Strings are limited by default to 16 characters but may be

NOT CALCULATOR CORNER

DIMensioned to up to 80. A nice touch is that variables with names A-Z are stored in a separate protected area which is not cleared by RUN, thus allowing values to be accumulated between runs. This area can also be used as an array called ∂ or $\partial\$.$

number] to incorporate data into programs.

A real time clock-calendar is built in which displays in the rather unwieldy [monthdayhour.minutesecond] format when summoned by TIME. Together with the built-in beeper (programmable

words and ASCII for the rest). A command called STATUS returns the number of bytes remaining (STATUS 0) and used (STATUS 1) as well as the address of the top of program and the bottom of variables (2 and 3). Basic begins at 16582, immediately above the reserve area, and variables are stored from 22528 down.

The basic interpreter/monitor sits between 49152 and the top at 65536. By CALLing into the right location in the latter area you can dump the contents in character-encoded form but until Sharp issues both the processor instruction set and a monitor listing nothing very useful can be done in this way.

To summarise, this Basic is far superior to that on any previous handheld computer and even to that on some home computers. The only things I can find to bitch about (one has one's credibility to consider...) are the absence of DELete and RENumber and the unwieldy format of the DMS conversion routine which uses a single packed decimal number instead of having proper 01 11 separators. It would also be nice to see some built in statistics routines on a machine of this type, but that is perhaps stretching a ROM too far.

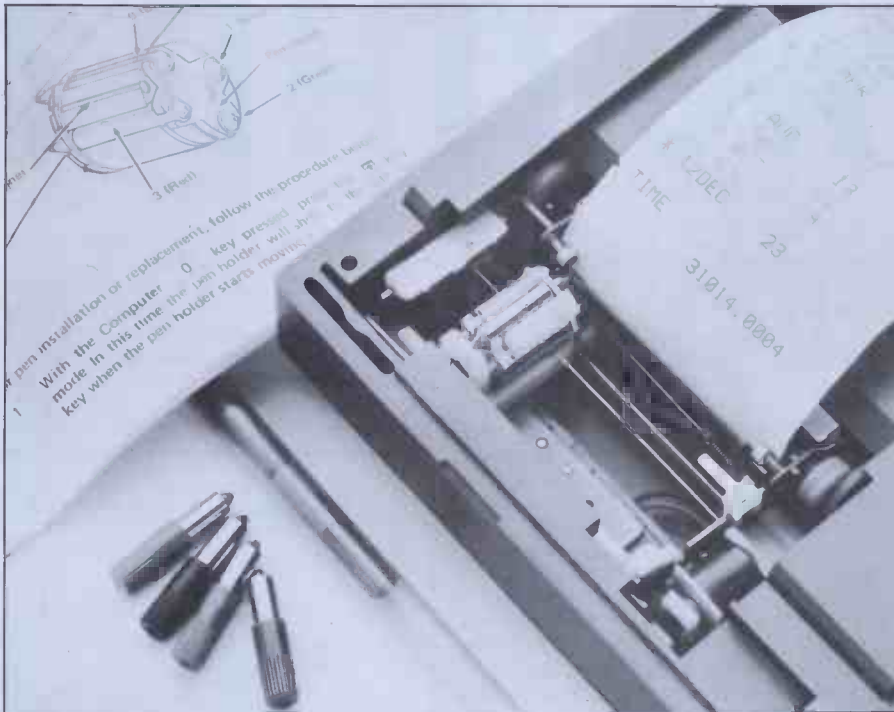

Printer & Cassette Interface

The CE-150 is one of those bits of machinery that must elicit a cry of admiration from anyone who has any respect for human ingenuity.

The unit combines a cassette interface to control two recorders with a miniature four-colour plotter and comes with a neat travelling case which has room for extra paper rolls, leads, pens and a micro cassette recorder. It is powered by built-in rechargeable batteries which provide juice for 1½ hours of continuous printing and require 15 hours' charging from the mains unit. The unit is usable under mains power at all times. When mounted, the PC1500 takes its power from the CE-150, thus saving its own internal batteries.

The plotter is a marvel of miniature engineering. A rotating drum like a gatling-gun contains four inch-long felt tip pens in black, red, green and blue; the required colour being swung into the firing position on request. Removing and loading the pens is quite easy for those with average motor control; it is recommended that they be removed and capped to avoid drying up when not in use.

The device is a true plotter in that it draws continuous lines, not dots; and the paper is moved in both directions. The set of plotting commands provided would shame machines at ten times its price. In text mode it acts as a printer, using the PC1500 character set with a choice of print sizes from 1.2 to 10.8 mm cap height selected by the CSIZE command. ROTATE [0-3] determines the orientation of the printed text according to the points of the compass; it can be vertical or even upside-down. COLOR [0-3] selects the colour printed. LCURSOR positions the pen on the 58mm wide paper in one

MEMORY MAP

FFFFH	ROM BASIC INTERPRETER	65535
C000H	ROM EXPANSION	49152
8000H	PROTECTED	32768
7C00H	SYSTEM WORKSPACE	31744
7800H	DISPLAY BUFFERS	30720
7600H	PROTECTED	30208
7000H	EXPANSION RAM	28672
5800H	BASIC VARIABLES	22528
	WORKSPACE	
	BASIC PROGS	
40C6H	RESERVE DEFINITIONS	16582
3FFFH	NOT USED	16388
0000H		0

RND n generates a random number between 1 and its argument n and is repeatable unless initialised by RANDOM. In addition to PAUSE for output, there is a programmable WAIT [nnnn] which holds a display for nnnn units of 1/60th of a second. The PRINT USING has facilities to provide asterisk fill, commas, signs and the inclusion of characters in numeric formats. ON ERROR GOTO is provided for error trapping and TRON/TROFF for debugging. Another welcome 'big' Basic feature is the inclusion of READ... DATA... RESTORE [line

for pitch, volume and duration), this can be used as an alarm or to date-stamp printouts.

LOCK/UNLOCK is a clever feature which allows the programmer to lock the machine in its current operating mode; this stops a ham-fisted user accidentally corrupting programs or otherwise wreaking havoc.

Proper file handling is enabled by PRINT# and INPUT#, which allows multiple field records; CHAIN and MERGE can be used to segment and overlay programs from tape.

As if all this 'real computer' stuff was not enough, there is even a facility for dot graphics! The display is treated as a 7x156 dot matrix and the GCURSOR statement selects any column of 7 dots; the GPRINT statement then allows these dots to be set or unset by specifying a decimal or hex number whose binary representation is the required pattern. GCURSOR can take a string of arguments to define a whole shape in a single statement. POINT reads a column-value from the display.

No, your eyes are not deceiving you, I said hex. Not only does the 1500 allow hex (prefixed by an &) to be used in any expression but it has PEEK, POKE and CALL as well! You will look in vain for any reference to these in the manual (a Sharp spokesman tells me that a new manual, which covers machine code operation, will follow in time) but they work. With the help of PEEK I was able to uncover some of the labyrinthine twists of the 1500's memory map (also not in the manual) and to dump Basic programs and hence discover the system of tokens used for storage (two-byte codes beginning with 240 or 241 decimal are used for key-

Banks Statement.

IS IT WORTH IT?

Martin Banks questions the relevance of Information Technology Year.

All this stuff going around about Information Technology year makes one wonder where it is all likely to lead. What exactly does the future hold in the brave new world that we are constructing — or appear to be constructing (I sometimes get the feeling that it is in fact constructing us)?

The question is an interesting and important one, for, while there seems to be overall agreement that we need to exploit Information Technology, there seems less clarity about what bits of the stuff are, or may be, needed, and exactly why they may be needed. These are important aspects because there is the considerable danger of a variety of boats being missed, either because the technology has been adopted far too keenly for its own sake, or has been adopted not at all because people have been frightened off.

Such topics very often form the subject for debate at lunches or dinners populated by the cognoscenti of the computer and 'Information Technology' industry. The arguments are usually pretty erudite, and fully consider the subtleties that are inevitably involved.

For the average person in the street, however, such debates might just as well be in Swahili. It is an observable fact that among the non-computer-oriented populations of the world, the concepts and applications of computers are very poorly understood. Not only that, they remain poorly understood, no matter how much verbiage those 'in the know' try to lay on them. It is only when something specific happens to one individual — often an inconsequential event of no particular value to others — then suddenly that individual makes the transition from 'non-understander' to the state of enlightenment. It's all rather like Zen Buddhism.

Information Technology is now suffering from this encumbrance. IT (if you'll pardon the word) is important for a wide range of strategic, productive and life-enhancing reasons that are too complex to fully enter into here. But any coherent use of it will come from its natural adoption by users, rather than its imposition by a necessarily small body of planners, no matter how 'correct' they may be. To be effective as an integrated part of our future, Information Technology should have the natural feel, the 'oneness', of a place like Castle Coombe, not the sterile 'correctness' of a high-rise building estate.

But to get to the former, as wide a cross-section of the population as possible has to participate in the design and implementation of the Information Technology infrastructure, and if they don't understand the subject that becomes very difficult. Hence, of course, Information Technology Year, 1982.

This aims to publicise and support Information Technology in a wide range of applications and areas. In some it has already done well, especially where there is an existing and definable user interest — for example in business-oriented applications.

It has also been involved in pushing the subject in other areas where the acceptance has been somewhat slower, but where its long term impact is liable to be far more significant. One such area is the use of IT in the home.

It is now necessary that, for a short paragraph, I come clean. I have had some involvement with this myself,

having done some work on the showing of 'IT in the Home' at the Ideal Home Exhibition. This was a project to try and demonstrate some of the ways Information Technology may change the way we live. It was designed to promote interest, and maybe pose some questions, for only through lodging questions in people's minds firmly enough that they wish to seek an answer will there come any understanding of what IT is all about.

I would not dare attempt to assess the success of the project, certainly objectively, for as one of the team involved in its development I am, for better or worse, too close to be objective. There are some aspects which bear some consideration, however, even from a subjective viewpoint.

The main ones are those already stated: getting people sufficiently knowledgeable to contribute to the design of the IT system, and what actual products they are likely to come up with.

The application of IT in the home is a nebulous area at the best of times, where only one or two specific applications come readily to mind. At the Ideal Home, where the IT project was given extensive bed and board in the show homes of Barratt Developments, these areas were satellite communications, the office in the home, and energy management. Even then, it was only the Office in the Home concept — in this case based around a brand new ICL Personal Computer (*nee* Rair Black Box) coupled to a Prestel interface developed jointly by Johnson Microcomputers and B&B Computers — where the issues were fairly clearcut.

The technology does and will allow more people to work either part-time or full-time at home. The demo at the Ideal Home simply showed how.

But even satellite communications, a subject which at first sight is fairly understandable, has some extensive grey areas, both in terms of telecommunications and telephones, and broadcasting. The same can be said for energy management, where the enhancements that are now possible to the simple control systems of today often require great gobs of lateral thinking for their implications to be fully appreciated.

And appreciation is the problem. There is an ancient law (or if there isn't there should be) that says that people will not accept a new technology any faster than they can see a good reason for having it. Once people see the reason, then they usually become very adept at thinking up entirely new uses for the

technology, whatever it is.

To achieve this, however, poses considerable problems for, though publicity helps, it also hinders many people. It just creates an awareness of something 'out there' that they do not, and firmly believe they cannot, understand. In the long term the solution would appear to be the provision of ways in which people

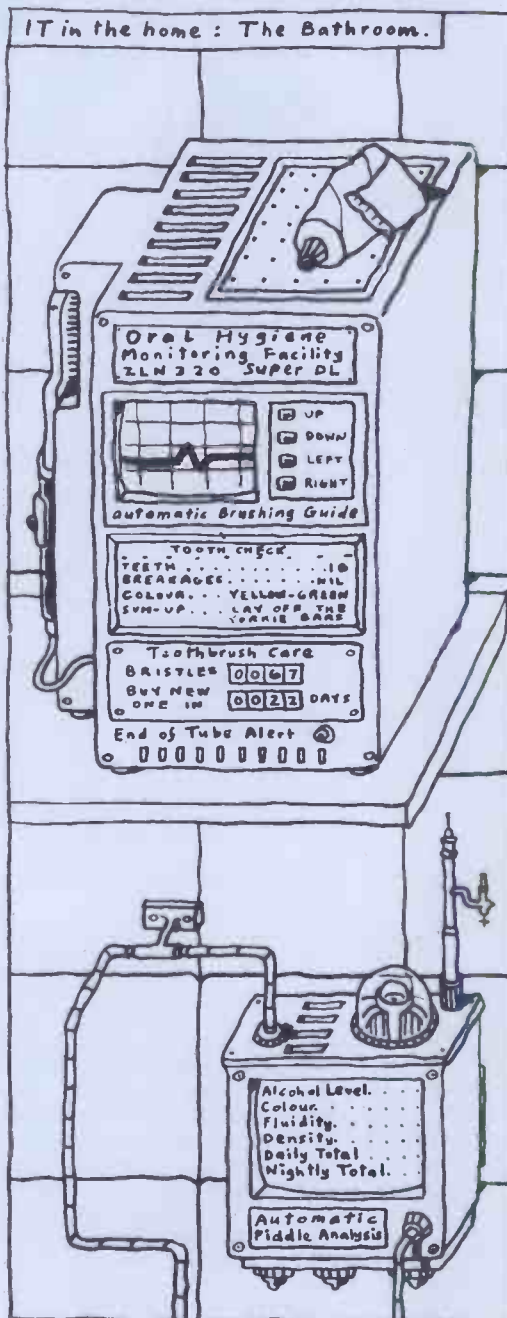

can see IT in action and make use of it themselves. In days of yore there must have been considerable doubt about the railway or electric light until their uses were appreciated. Our trouble, in terms of some of the obvious strategic requirements of exploiting IT, is that we do not have the time to wait for that appreciation to grow. Unfortunately, there seems no way in which the process can be speeded up.

As that appreciation eventually grows, however, the home will become a goldmine of potential applications of IT-oriented products — from the banal to the truly ingenious. There is so much scope for the lateral thinker in this area, for that classic phrase 'we have the technology' is to all intents and purposes now true. This means that at last the technology actually becomes secondary to the application, that the end makes use of the most appropriate means rather than the means dictating what end is achievable.

For the Ideal Home Exhibition we tried to produce such an application. Whether we succeed is arguable, but the end result created some interest if no-

thing else. That result was the 'Talking House', a system whereby the home owner would be able to interrogate the home using a telephone.

One thing this exercise demonstrated above all else is that, despite the propaganda, things can be achieved very quickly in the UK. The idea was simple enough (a classic 'back of a fag packet' design). Build a computer system that would respond with speech to the sensed input from a telephone keypad. In that way, the house could be interrogated about itself. A typical Q and A would be, for example, about the current temperature. 'The temperature is one-eight degrees', the house might say. To change that, key in the numbers — a simple and direct 'communication'.

From that simple concept to the finished article on the stand at the show took just under three weeks. A Comart Communicator became the basis of the system, which was connected, with some burned midnight oil and the odd oath by Ross Electronics and Millenium (the engineering team), to a Texas Instruments Superspeaker speech synthesis board. All that was missing to make

it a real product rather than a demonstration was the interfacing to such items as the central heating controller.

In the end, the most interesting aspect of the exercise was to observe the reactions of the public, especially after the media (and in particular the radio) latched on to the obvious gimmick aspects.

Some just thought it silly (and maybe they were right). Some thought it sounded extremely odd for 'a tape recorder' and failed to comprehend the idea of speech synthesis. Some could see how it could be used — extended even — but then they tended to come from the electronics industry so understood anyway. Some just came to listen because it had been on the radio. Some, like a blind lady who came especially to hear it, could obviously visualise much greater scope for its application in the home.

This was just one potential product for the home. It created interest and in some cases real appreciation not only of its specific details but also of what it represented conceptually. It is highly unlikely that it will ever become a real product. It is to be hoped however that the appreciation does become real. **END**

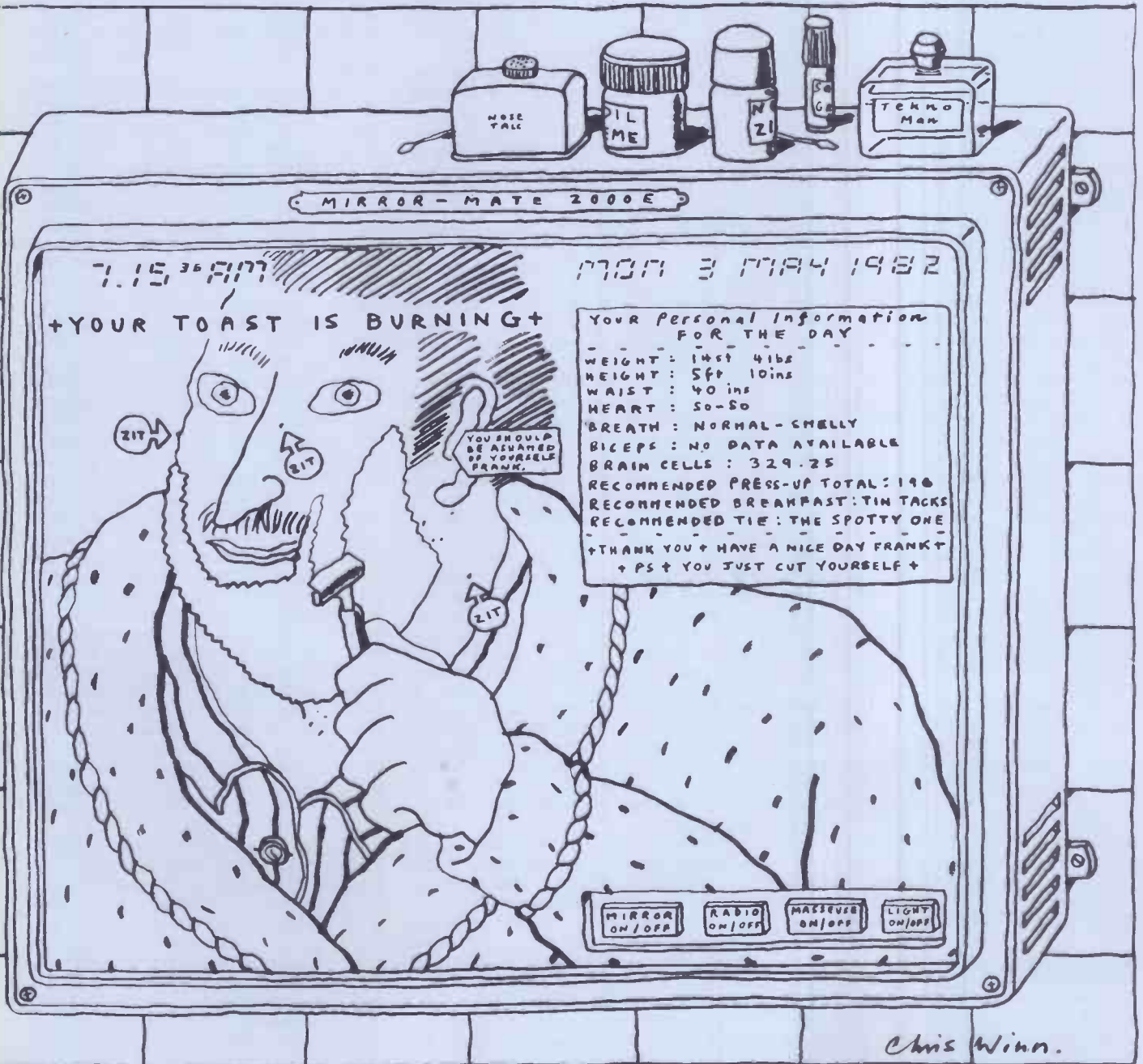

Peter Rodwell takes the lid off Sharp's latest model, the replacement for the popular but ageing MZ-80K.

Considering their track record in the car, camera and domestic electronics markets, the Japanese have been remarkably slow to flood us with their microcomputers. Way back in '79, the first Japanese micro company to sell in the UK, Sharp, launched its MZ-80k with not so much a bang as a murmur: the machine was aimed at the Commodore PET market and offered a fairly similar concept in that it was an all-in-one unit combining screen, keyboard, cassette player and electronics in a single box.

Although other Japanese manufacturers have since launched in the UK, and the long-expected invasion now appears to be gearing up, Sharp's early entry has stood it in good stead and it now has a commanding lead over other Japanese companies.

Yet Sharp appears not to have learned much from its American rivals: the '80K was launched with virtually no software to support it (apart from its cassette Basic) and no add-ons at all at a time when the PET and TRS-80 had built up respectable user, software and add-on bases. Its Basic had to be loaded from cassette when other machines had it in ROM for instant use on power-up and it had a bizarre keyboard, only marginally better than the original PET keyboard which Commodore dropped fairly quickly in favour of a proper unit.

While Sharp built up its model range with the PC-3201 and the MZ-80B, both aimed primarily at the business market, and added an interesting pocket computer programmable in Basic, not a great deal was done with the '80K apart from the introduction of a printer and disk drives — the 'funny' keyboard was kept and Sharp did not introduce any other programming languages, which would have made the cassette-based Basic a reasonably logical idea.

Now, though, after three years and 10,000 models sold in the UK (about 100,000 worldwide) — and with pre-death price cutting giving the machine a sudden sales surge in the last six months — Sharp has killed off the K and replaced it with the MZ-80A. (And before you ask, no, I can't figure out the logic of starting with 'K', progressing to 'B' and then bringing out an 'A' either.)

By the time you read this, there should be no more 'Ks on sale anywhere — certainly Sharp had sold out by early April — and you'll have missed your chance to pick up a 48k home computer for £350 or so. For the MZ-80A you'll pay more — £549 including VAT, for the basic unit — and naturally one of my main objects with this Benchtest was to discover whether you ought to be kicking yourself for not grabbing an '80K when you could.

Hardware

Physically, the MZ-80A looks quite different to the '80K: yes, it has the same basic layout, with the screen taking up the left part of the box and a cassette

deck on its right side, but the cabinet is more pleasantly styled, although it's in plastic instead of the '80K's metal construction.

The MZ-80K's odd keyboard, on which it was impossible for any ordinary person to touch-type, has gone and is replaced by a proper typewriter quality unit with a very professional feel to it; there's also a conventional numeric pad to the right of the main keyboard.

The K's black and white screen has been replaced with a slightly smaller (21cm) green model, but this has the same 40 characters on 25 lines display as the 'K; earlier rumours that the 'A would have the same display as the MZ-80B (ie, proper 80x24 text and good graphics) can now be ignored, which is a pity. The 'A's graphics are those of the 'K — what the manual describes as 'pseudo-graphics', which means a chunky 80x50; rather poor by today's micro standards.

As with the MZ-80K, access to the machine's interior is gained by undoing a couple of screws and hinging back the whole upper half of the casing — there's even a 'bonnet prop' inside to keep it open, too. Sensibly, the 'A's display tube and video electronics have been mounted on their own sub-frame connected to the lower half of the case (on the 'K these hinged upwards with the lid), although the cassette deck is still mounted in the lid. As one has grown to expect, the interior is a model of Japanese neatness and thoroughness, with no flapping wires or exposed mains connectors.

One large PCB houses all the computing electronics. At the machine's heart is a 2 MHz Z80, as in the 'K, a surprise since an easy and obvious upgrade would have been to uprate the processor to at least 4 MHz. At the front left-hand side of the board is a block of 16k dynamic RAM chips forming the 48k of user RAM — there are no empty sockets for a further 16k to expand to the processor's full 64k capacity but a glance at the memory map shows why — a 4k block is taken up by the monitor ROM and another 2k is used for the video display. Next to the monitor ROM chip is an empty ROM socket intriguingly labelled 'user'; this is undocumented in the manual and is presumably for your own monitor ROM or Toolkit or whatever, although how this would be activated remains a mystery — it can only be a matter of months before we read how in 'TJ's Workshop'!

Nearly all of the important chips, including the CPU and the RAM chips, are socketed, by the way. This is usually a good sign as it makes servicing easier but Sharp has built up a formidable reputation for reliability so unless you're very unlucky you won't need this particular feature.

The '80A has a sound generator, with a loudspeaker mounted pointing downwards under the numeric keypad. All other I/O connections are brought out

at the rear of the main board and to interface peripherals, such as a printer or disk drives, an expansion unit is required; this bolts onto the back and houses up to four plug-in interface cards, a neater arrangement than the separate expansion unit of the '80K.

Also at the back are the on/off switch, a reset button, the display brightness control and the sound volume control; on the '80K, this last was inconveniently sited *inside* the cabinet!

Cassette Basic

At power-on, the system enters the ROM-based monitor. This provides only minimal facilities — loading Basic or a machine-code program from cassette, booting an operating system and/or language from disk, jumping to an address in memory and executing the program there and toggling on or off a beeper which sounds whenever a key is pressed.

The monitor also handles I/O for the screen, keyboard, music system and tape, and recognises a limited group of control codes which roll the display up or down (the screen acts as a 1 kbyte 'window' in the 2 kbytes video memory), generate a '→' sign used as a delimiter under Sharp's FDOS, toggle between reverse and normal video, and alter certain system parameters to enable the '80A to run '80K Basic programs — more on this later. Additionally, there's the facility to change the way the shift key works; normally this functions in the *opposite* sense to a normal typewriter in that the unshifted keys provide upper case characters and lower case is obtained by shifting; this makes Basic programming easier. Hitting CTRL-A reverses this, putting keyboard into normal typewriter action.

The basic MZ-80A comes with Sharp's SA-5510 Basic on cassette; this takes just over 1½ minutes to load, although while you're sitting waiting for it to happen it feels like much longer. As far as I could make out, this Basic is functionally the same as the MZ-80K's Basic and is virtually to Microsoft standard. Its few oddities centre around machine-specific items such as the sound generator, for which there are MUSIC and TEMPO commands and extensions to some commands to send stuff to the printer or cassette: LIST, for example, LISTs on the screen while LIST/P lists to the printer; similarly with PRINT and PRINT/P, while PRINT/T prints to tape.

The cassette handling is very easy. Programs can be loaded simply by positioning the tape at the correct spot, using the tape counter, and typing 'LOAD', upon which the system prompts you to press the play key on the cassette unit. As soon as the system finds a program it tells you so, displays its name and gives a message to say when loading has started. Once the program is loaded, the computer switches off the tape drive. If you don't know the

MZ-80A

BENCHTEST
PERSONAL COMPUTER



position of the program you want, you can instead specify the file name with 'LOAD "Program"', and the system reads through the tape until it finds it. LOADING can be aborted at any time with the break key. It's just as easy to SAVE a program and there's also a VERIFY command which allows you to check that the SAVE has been successful. Data can be written to and read from tape under program control using PRINT/T and INPUT/T.



If you want to feel at home in the world of computers, you'll want the best home computer in the world.

We live in the age of computers.

Coming to terms with them and enjoying them is part of coming to terms with the twentieth century.

A few years ago, a computer would have filled a fair-sized room. Now microtechnology has allowed Commodore to produce a home computer, the VIC 20, that's no bigger than a typewriter yet performs miracles.

FOR BUSINESS. OR PLEASURE.

VIC can keep your diary up to date. Teach you mathematics. Play an enormous range of video games. Even play a piece of music to soothe your worried brow.

In fact, you and VIC can do almost anything better. Keeping records of family finances, sorting out and working out household accounts, being one step ahead of the bank manager or helping your own business be more businesslike.

VIC'S THE BEST. BY FAR.

Contrary to popular belief, computers are really rather friendly. VIC is particularly easy to understand. It's what the computer people call 'user friendly'. The typewriter-type keyboard is easy to use. It even tells you about mistakes you might make.

If you're technically minded, here's a reminder. VIC has a 5k memory expandable to 27½k. (That means you can put in a great deal of information.)

But what makes the VIC the best home computer by far are features that are just not available in most other home computers. Features like colour, computer graphics and sound.

PLUG IN AND YOU'RE OFF.

VIC plugs in to any television set, colour or black and white. (We even fit a 13 amp

plug, so you can play with VIC right away.) You don't have to learn a special language. VIC speaks English, just like you. With the help of our handbook, you will begin to feel at home to the world of computers in no time at all.

COMPUTER SUPERMARKET'S GUARANTEE.

Buy through Computer Supermarket and you get exactly what's promised. We guarantee you that.

Every machine is thoroughly tested before it's despatched. And every machine is guaranteed for twelve months on parts and labour. (Not that you'll need it, of course.)

In the unlikely event that you don't want to keep your VIC, just return it, in its original packaging, within 30 days and your money will be completely refunded - in addition to your statutory rights.

FREE PROGRAMS.

Apart from the more practical things like accounting, and the more pleasurable

things like video games, you can put VIC to literally hundreds of uses.

There are pre-recorded programs on many different subjects. You can develop your own programs and store them by using ordinary cassette tape.

The special Commodore cassette deck is on offer at only £39.50. If you buy VIC and the deck together we'll send you a 6 program pack to start you off that's absolutely free.

YOUR FUTURE WITH VIC.

It's a big step into the future. Understanding the future. Having fun in the future. Even saving money in the future. Every member of the family, especially the young, will feel at home with VIC right away. So send in the coupon. We're sure you'll find the best home computer in the world will make the world of difference to you and your family.

Computer Supermarket Ltd., Douglas House, Queen's Square, Corby, Northants. Tel: (05363) 61587/8. Reg. No. 2646589. Prestel No. 400400.



Computer Supermarket Ltd., Douglas House, Queen's Square, Corby, Northants.

Please accept my order for _____ VIC 20's at £199.99 each inclusive of packing, carriage and insurance.

Please send me _____ Cassette Decks at £39.50 incl. Free 6 program cassette if VIC 20 and Cassette Deck ordered together.

I enclose Cheque/P.O. for _____

*Please debit my Access/Barclaycard/American Express/Diners Card. Account no. _____

Please allow twenty-one days for delivery. *Credit Card orders can be telephoned to (05363) 61587/8.

Name: Mr/Mrs/Miss _____

Address: _____

Signature _____

PCW2

COMPUTER SUPERMARKET

A Commodore Appointed VIC Dealer. Please make remittances payable to Computer Supermarket Readers Account.



THE GALAXY 1 COMPUTER

The cost effective solution to your computer needs for only

£1,450*

The Galaxy 1 desk top computer system can be used in education, small business applications, word processing, stock control and a host of other environments. Our choice of CP/M as the operating system means that our customers can select a suitable application package from the widest possible range.

However, unlike our competitors, we supply not only the hardware but all the essential system software needed to start using the Galaxy 1 as soon as it is installed. We have adopted COMAL-80 as our standard language. This structured basic is rapidly gaining widespread acceptance and popularity especially in the education market, offering much greater flexibility and ease of use than existing Basics. We also supply a very powerful Z80 assembler/editor called GEM ZAP with GEM PEN, a compact but very powerful word processing package. The system software suite is completed with GEM DEBUG, a useful machine code program de-bugging utility.

Modular design means reliability and ease of maintenance. Unlike many other manufacturers Gemini offer a full one year warranty (except Disc heads which are guaranteed for 3 months). Our distributors carry a full range of replacement boards thereby facilitating a quick, efficient and cost effective back up customer service.

Features include:

- Twin Z80 Processors
- 64K Dynamic RAM
- 800 K Disc Based Storage
- 80x25 Screen Format
- Dual Printer Interfaces
- Modular Design
- CP/M 2.2 Operating system
- COMAL-80 - Structured Basic
- Z80 Editor/Assembler
- Text Editor & Formatter
- Program De-Bugging Utility

STOP PRESS
COMPLETE CASSETTE
PAYROLL SYSTEM
£29.95

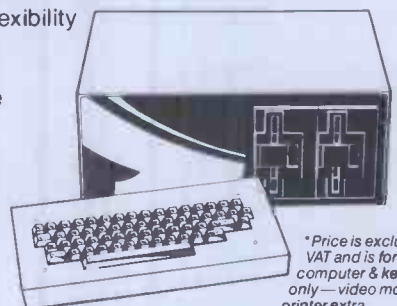

*Price is exclusive of VAT and is for computer & keyboard only—video monitor & printer extra.

BRITISH MADE



Telephone Amersham 28321 for the name and address of your nearest distributor.

* Dealer enquiries invited.

Gemini Microcomputers

Oakfield Corner, Sycamore Road, Amersham, Bucks HP6 5EQ.

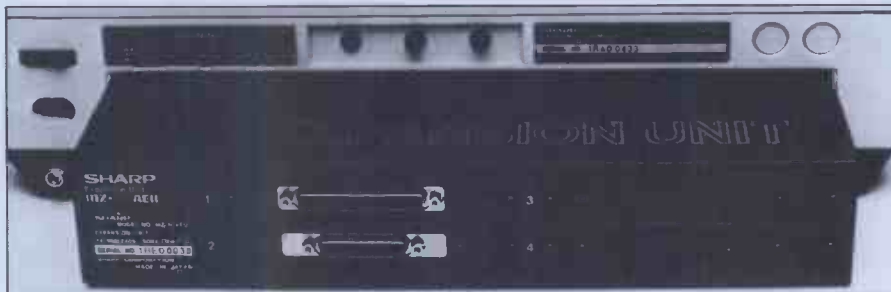
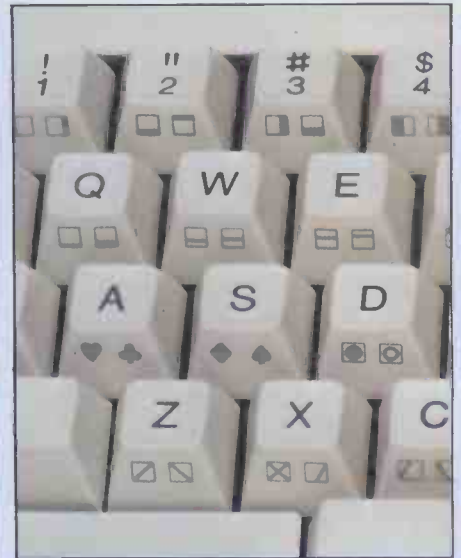
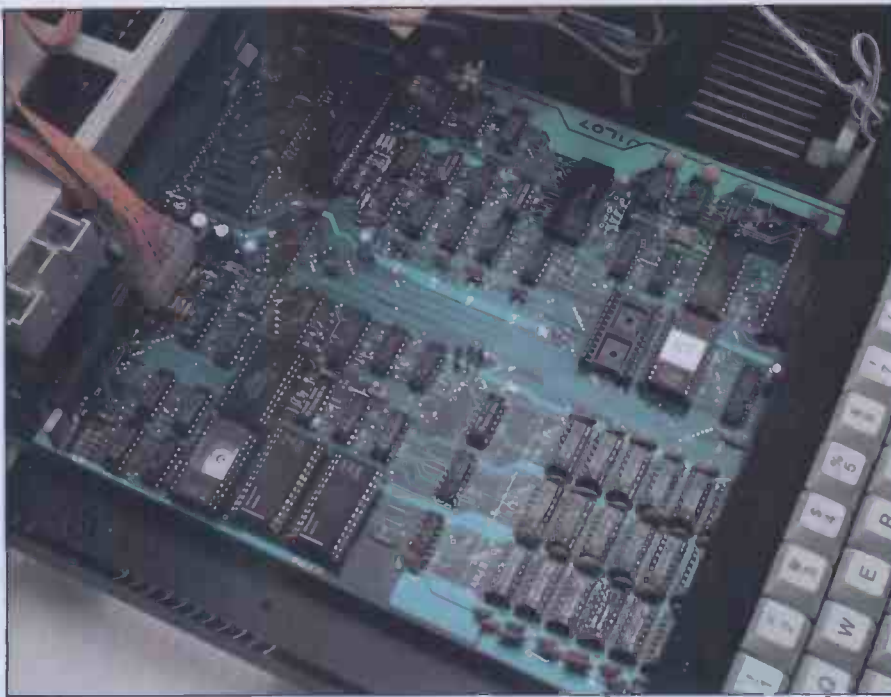

Above left: Japanese neatness inside. Above right: graphics symbols on front edges of keys. Below: controls and I/O ports at rear.

Long variable names are allowed — the manual doesn't specify an upper limit on their length — but only the first two characters are significant. Apart from Basic reserved words, one other variable name is reserved for system use, `TI$`, which references the internal clock: `TI$="123000"` sets the clock to 12 h 30 m 00 sec and the clock runs until power-off or reset. You can convert the MZ-80A into a very expensive digital clock by setting `TI$` and then running a small Basic program to print the time on the screen. Like the '80K, the MZ-80A has a set of 136 graphics characters available from the keyboard. A graphics key toggles the keyboard between alpha-numerics and graphics modes and the cursor changes to reflect the mode chosen. Sharp has reduced the clutter of the '80K's keyboard by placing the shifted and unshifted graphics symbols on the front edges of the keys and this works reasonably well, although I did find myself peering around for the symbols I wanted as they're printed in an only slightly darker shade of beige than the colour of the keys themselves.

The graphics characters (plus cursor movement, home and screen clear) are incorporated in `PRINT` statements simply by entering "`PRINT`", hitting the graphics key, typing the required symbols and then getting back into alpha mode for the closing '"' at the end of the statement. As well as lines, hatchings and curves, the graphics symbols include little faces, a spaceship and electronics symbols. The MZ-80PG printer, an Epson in a smarter case, prints all the graphics symbols as well as the alphanumerics.

Pressing the reset button at the back of the case puts you back to the monitor. At first sight this seems a pretty disastrous move, implying that you have to re-load Basic — particularly frustrating if you had been debugging a program which you hadn't yet saved to cassette. However, as mentioned earlier, the monitor has a jump instruction; typing '`J1250`' warm-starts the Basic and you'll find your program still intact. The Basic can be cold-started by typing '`J1200`', but of course this wipes out your program.

Because the MZ-80A's hardware is virtually identical to that of the '80K, the machines are almost completely software compatible too. I say almost, because, although the Basics are virtually the same, there are minor differences: `POKEs` to the screen are the most irksome — the '80A's screen address is different and the `POKEs` need to be altered accordingly. I tried `LOADing` an MZ-80K tape to see what happened: it `LOADed` OK and I could even `LIST` it but it wouldn't run. The reason is that internally, the Basics are different — specifically, they use different 'tokens' (the internal representation of Basic reserved words) so that `PRINT` in the '80K program came out as '=' when `LISTed` on the 'A. This can be overcome with a translation tape, which turns 'K software into 'A software, or you can buy a copy of the MZ-80K's Basic and use this with your 'K programs on the 'A.

Disk Basic

The MZ-80A can be expanded with a single or twin 5¼in floppy disk, using the same units as the MZ-80B, which

hold 280 kbytes per disk.

Adding the disk drives turns the MZ-80A into a medium-cost, lower-end business machine and Sharp's disk Basic reflects this — it incorporates all the features of cassette Basic with additional facilities to operate the disks, including random access file handling. Interesting features here include `LOCK` and `UNLOCK` commands which protect specified files against writing, deletion and renaming. There's a `CHAIN` command to allow one program to call another and pass values to it through variables, and comprehensive error trapping which includes not only `ON ERROR GOTO`... but facilities for trapping both the error number and the line number on which the error occurred.

Facilities exist for `LOADing` and `SAVEing` from and to tape from disk Basic as well as reading and writing tape files; this is handy not only for transferring cassette Basic programs and files but also for making security copies if, like me, you have a vague unease about the reliability of floppy disks and therefore have backup paranoia in a big way. It is even possible to transfer the cassette Basic to disk.

I ran our standard Benchmarks on both cassette and disk Basics and recorded identical timings for both.

Documentation

The basic MZ-80K comes with a 225-page A4 manual which assumes you know nothing about Basic and proceeds to teach you, with plentiful demonstration programs and examples throughout. It also assumes you have a Japanese sense of humour — the text is for the most part well translated, clear and concise, but it is liberally sprinkled with all sorts of unusual cartoons, including one showing decidedly slant-eyed rabbits and foxes.

As far as I can remember, large sections of the manual are in fact identical to the MZ-80K's. Extra information has been added, however: there's a full source-code listing of the monitor, together with detailed notes on all its routines, and a long section on machine-code programming which positively encourages you to get to grips with the Z80 on its own ground. Unusually, Sharp also includes full circuit diagrams of the machine so the soldering-iron freaks will have equal ease in finding their way about the system.

You also get a box of tapes with the MZ-80A. Apart from the Basic tape, the set comprises a Basic tutorial, games, 'home finance' and 'education'. All, with the exception of a Space Invaders game, are in Basic and all seemed reasonable without being particularly exciting. One or two of the games were somewhat bizarre and the geography program on the education tape had a distinct leaning towards asking the capitals of obscure countries (can you name the capital of Togo?). But, generally speaking, all should prove entertaining and useful to the novice home owner, at whom they're clearly aimed, and examining the listings could prove instructive.

Documentation for the disk Basic is rather slimmer as it deals only with the features which aren't found in cassette Basic. The explanations are altogether more business-like and serious, with no cartoons, and there's a very long listing of a stock control program with detailed explanations (including flowcharts) to show how it works. Time didn't allow me to 'play' with this but it seemed a fairly good implementation and, as Sharp hopes to sell the disk-based system as a low-cost business machine, it will probably prove both useful and instructive to small businessmen who have the time, inclination and determination to write their own programs.

The printer and disk drives each have their own manuals, which simply cover all a user needs to know about the operation and care of these peripherals. The printer manual is a damn sight better than the manual which came with my (standard) Epson and even includes an assembler source code listing for driving the printer from a machine-code program.

Expansion

As I've already stated, there's nothing you can do to expand the system's RAM — 48k is what you get and 48k is what you'll have to live with.

With the expansion unit fitted, you can add a printer and disk drives by slotting in the appropriate interface cards. Sharp sells a single disk drive unit, but this is a relatively expensive way to go — the extra cost of the twin unit is low enough to make the single unit appeal only to the very hard-up and, in any case, juggling floppies with a single drive can be a most annoying process. Neither printer or disk drives match the MZ-80A's styling — both are painted silver and the twin disk unit is in fact the same as that used on the MZ-80B; the printer, while similar to the '80B's, is slightly different, I'm told.

On the software side, Pascal is promised and CP/M will probably be with us by the time you read this; this latter will give users access to a much

wider software base, provided they can find somebody who supplies CP/M software on Sharp format disks: my colleague Dick Pountain certainly has very great difficulty in obtaining software for his MZ80B. Given the high degree of software compatibility, it's likely that many software houses will quickly translate their MZ-80K software — applications as well as languages — to the '80A, so the '80A buyer will be in a much better position than the early MZ-80K owners, who really were on their own to start with.

Conclusions

I must state now that I was in some ways disappointed with the MZ-80A. I had expected a considerable upgrade from the '80K — goodness knows Sharp has certainly had enough time to do this — but what we have is, in essence, just a 're-skinned' machine with improvements which, although undoubtedly in the right direction, are really the sort of things which should have been done 18 months or so back as a half-way stage to bringing out a model with a much higher spec. We're now at the stage where it's possible to mass-produce a 64k, twin-disk CP/M micro with a good display and medium-resolution graphics for an end-user price of around £1000, including a useful selection of software, which means that machines such as the MZ-80A, sitting pricewise at the top of the home range and the bottom of the business range, should offer not only the full 64k of RAM but good quality graphics and colour too, at least as an option.

My feelings are that, provided you could have lived with its nasty keyboard, then yes, you should be kicking yourself for not buying one of the last MZ-80Ks — price is important in the UK and the MZ-80A, at its present price, does not offer particularly good value for money. In six months' time, though, the price will almost certainly have fallen.

With machines such as the BBC Computer and the new Sinclair appearing,

BASIC BENCHMARKS

BM1	1.5
BM2	9.2
BM3	16.4
BM4	22.8
BM5	25.6
BM6	37.7
BM7	55.0
BM8	10.1

All timings in seconds. For an explanation and listings of the Benchmark tests, see PCW Vol 4 No 11, Nov 1981.

TECHNICAL SPECIFICATIONS

Processor:	Z80, 2 MHz
Memory:	48k dynamic RAM, 4k monitor ROM, 2k video RAM
Cassette:	Integral, 1200 baud
Disks:	Single or twin 5¼in, 280k per disk (requires expansion unit)
Screen:	21 cm, 40 x 25, green on black, 80 x 50 graphics
I/O:	Optional parallel printer, RS232 (requires expansion unit)
Keyboard:	73 keys inc. numeric pad, cursor controls, insert & delete; alpha & graphics modes
System Software:	4k ROM-based monitor
Languages:	Basic (cassette & disk)

offering good graphics, colour, sound, etc, for much less money, it's difficult to see the MZ-80A appealing to many home/hobby computerists. At the lower end of the business market, a twin-disk system could appeal to the cost-conscious buyer; the 40-column screen is a decided limitation in some applications, particularly word processing, but would be sufficient for most general business use, as a demonstration stock control program shows.

Through this Benchtest I repeatedly found myself saying, 'If only . . .': If only Sharp had given it the graphics from the MZ-80B (and this should be possible while retaining MZ-80K compatibility); if only the screen had 80-column capacity; if only there was a colour option; if only the processor had been updated to 4 MHz . . . any one — and preferably all — of these would have made me a great deal more enthusiastic about the machine. As it is, I'm left wondering what Sharp's development people have been doing all this time . . .

Prices

MZ-80A	£549 (inc VAT)
Expansion unit	£100 (exc VAT)
Disk drives (inc. Interface)	
Single	£400 (exc VAT)
Twin	£590 (exc VAT)
Printer	
Tractor feed	£349 (exc VAT)
Friction/tractor feed	£409 (exc VAT)
Interface	£30 (exc VAT)
Cable	£23 (exc VAT)
Character generator	£13 (exc VAT)

END

BASIC RESERVED WORDS

ABS	INT	RETURN
ASC	LEFT\$	RIGHT\$
ATN	LEN	RND
AUTO	LET	ROPEN/T
CHARACTER\$	LIMIT	RUN
CHR\$	LIST	SAVE
CLOSE/T	LIST/P	SET
CLR	LN	SGN
CONT	LOAD	SIN
COPY/P	LOG	SIZE
COS	MID\$	SPACE\$
CSRH	MON	SQR
CSRV	MUSIC	STEP
CURSOR	NEW	STOP
DATA	NEXT	STR\$
DEF FN	ON	STRINGS\$
DIM	OUT	TAB
END	PAGE/P	TAN
EXP	PEEK	TEMPO
FOR	POKE	THEN
GET	PRINT	TI\$
GOSUB	PRINT/P	TO
GOTO	PRINT/T	USR
IF	READ	VAL
INP	REM	VERIFY
INPUT	RESET	WOPEN/T
INPUT/T	RESTORE	

The above are all in cassette Basic. Disk Basic includes all of these plus the following:

CHAIN	ERROR	RESUME
CLOSE	INPUT#	ROPEN #
CLOSE#	KILL	SAVE/T
DELETE	LOAD/T	SWAP
DIR	LOCK	UNLOCK
DIR/P	PRINT#	WOPEN#
ERL	RENAME	XOPEN#
ERN	RESET	

Matchstick Basic

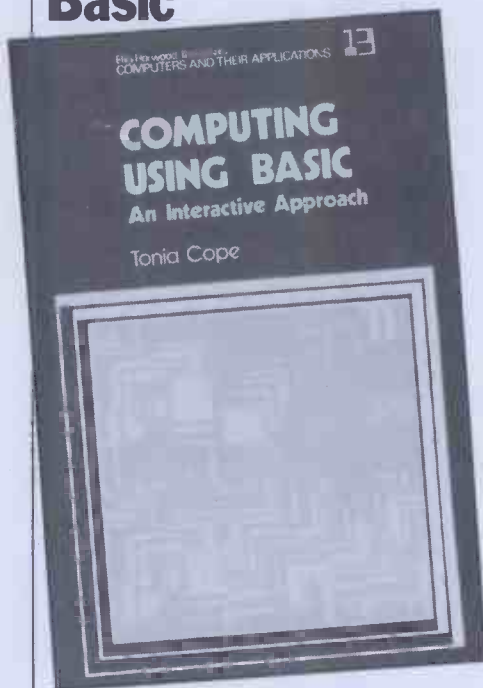

Computing Using Basic — An Interactive Approach by Tonia Cope (Ellis H Horwood/John Wiley & Sons, £15.00 hardback, £5.90 paperback)

Matchstick men and women provide a humorous and useful guiding hand through *Computing Using Basic — An Interactive Approach* by Tonia Cope. There are many introductions to Basic; this is a good one, which is lifted out of the ordinary by Charles Beesley's matchstick people.

They are useful little creatures because they make comments that a teacher might make in prompting a student or answering a question. The drawings are liberally sprinkled through the text, which also provides a lively flavour to the whole concoction. The matchstick tutors overcome a common problem in language books, where chunks of coding following text can be a forbidding prospect for a reader. The drawings provide a helping hand.

Programs in the book were developed and tested on a Research Machine S380Z, using BASICSG Version 5.0. An appendix compares command formats for this Basic with ANSI Minimal Basic and other Basics (which says in places 'check your manual'). Like all books on Basic, the problem with dialectics tends to make it more appropriate for readers with access to the Basic used in the examples. Cope's clarity of writing and the attractive presentation of the material, however, makes this book of value to a wider audience than RML users, provided the reader has guidance on the variations of the Basic dialectic theme.

There are two sections in the book. The first describes the Basic language and the second looks at some applications. The language description follows a functional course, starting

with general introductory material. The functions covered follow the sequence: arrays and FOR loops; strings and things; printing; reading data; program control; functions and subroutines; graphics; filing; editing and miscellaneous commands. The applications looked at include random numbers; sorting; simulation and modelling; statistics; computer aided design; and controlling a mass spectrometer. Although matrices are not a part of the RML Basic used by Cope, an appendix on matrices is provided, using examples run on a Computer Technology Mod One mini.

All in all, this is a practical and attractive introduction which reflects the fact that Cope developed it after testing an earlier version by over 1000 people, from schoolchildren and students to businessmen and university professors. It is particularly recommended for classroom teaching where there is access to an RML 380Z.

Complex comms

Network Systems by Roshan Lal Sharma, Paulo J T de Sousa and Asok D Ingle (Van Nostrand Rheinhold, £25.45)

The spread of computing is inexorably linked with the development of the new telecommunications networks. Whether it is a local area network of micros or national and international networks involving satellites, optical fibres and

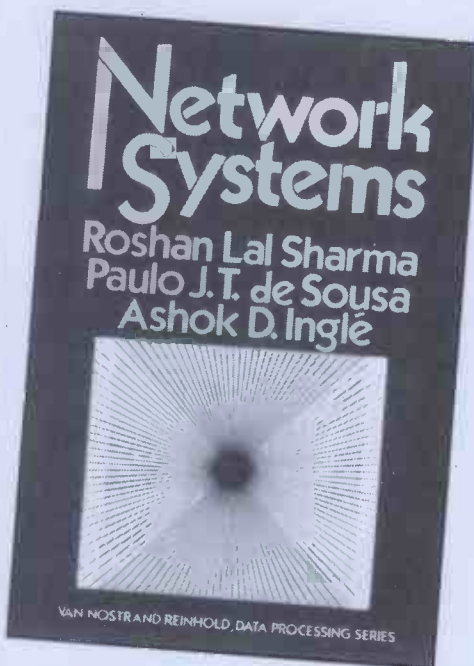

microwaves, computers are being hooked together.

Understanding the concept of networks is easy but the details of networking and the jargon surrounding it is a whole technology of its own. If you want or need more than just a superficial knowledge of these nets, then *Network Systems* by three senior technologists from Rockwell International provides a good round-up of the main factors.

There are three sections dealing with modelling, analysis and design. The first section on modelling will probably be of most interest to someone wanting to find out more about networking without having to actually get involved in detailed analysis and design. In this context, 'modelling' is concerned with the structure of the network, how traffic flows within it and how to evaluate system performance. There are seven chapters in this section.

The first chapter provides a brief introduction to the concept of networks. The next discusses the various network topologies that have been used. A topology is the way in which various nodes in the network are interlinked — for example, as a ring or as a hierarchical organisation.

The next four chapters examine the concepts of traffic flow and network control; transmission and signalling; modelling, analysis and design; and system performance. The last chapter of the section provides a detailed look at some existing networks, including the gigantic 'Ma Bell' national telephone network in the US; computer services like the US Department of Defence Arpanet and the commercial Telenet and Tymnet services; and local networks like Ethernet.

The sections on network analysis and design are much more suitable for practitioners and get involved in a considerable amount of detail.

This book is not an easy read, although it is written clearly. It is a useful reference work and an aid in educational courses.

Taking a global view

World Challenge by Jean Jacques Servan-Schreiber (William Collins, £9.95)

The World Challenge is a book to reckon with. It influenced French President Mitterand to establish centres for developing computer technology to meet human and social as well as commercial objectives. Its aim is nothing less than to show how Information Technology can transform world politics and economics. And the publicity hype is even greater than for *The Soul Of A New Machine* (reviewed above).

'Jean Jacques Servan-Schreiber has written the most important book of this decade,' says the publisher's puff. 'He confronts the most important crisis of our generation, analysing its roots and offering a challenging blueprint for our survival. . . ' proclaims the cover.

Whereas Tracy Kidder set out with modest aims which were subsequently overblown by the publicity machine, Servan-Schreiber started with an ambitious concept. For his global perspective and his writing style (at least in the English translation) he deserves unstinting praise. But he fails to fulfil the promise of his own ambition.

The oil crisis and the microelec-

BOOK FARE

tronics revolution are the twin pillars of Servan-Schreiber's argument that a fairer distribution of resources can take place between developed countries and the Third World.

Recent events have thrown into doubt his analysis of how the OPEC oil-producing countries will be able to use their power and wealth to force the West to make a massive transfer of technological knowhow, equipment and services to the Third World. The fall in the price of oil and OPEC's loss of prestige — even if it is only temporary — undermine the certainty of future events which Servan-Schreiber assumes. He writes as if OPEC's stranglehold on oil is invincible and does not even hint at the sudden turnaround this year.

Nevertheless, there is much to be learned from his analysis of why and how the Arabs first seized control of oil and now want to use oil as a bargaining counter to achieve wider ambitions.

Jean-Jacques Servan-Schreiber confronts the most important crisis of our generation, analysing its roots and offering a challenging blueprint for our survival...



THE WORLD CHALLENGE

Servan-Schreiber is a journalist and politician and he writes about politics like a journalist. Most of *The World Challenge* is written in compelling narrative form, like a romantic adventure novel of intrigue, power play, international diplomacy and the 'making of great events before your very eyes'.

He starts with a meeting of Arab oil ministers in Taif, Saudi Arabia, in 1980. Taif is near Mecca and is the place where Prophet Mohammed gathered a small group of followers which lead the advance of Islam. It was in Taif in 1980 that a report was prepared which Servan-Schreiber says marks a turning point in world affairs.

The Taif Report, he says, 'aims for a new alliance between the Arabs and the Third World against their traditional exploiters, the industrialised West. It is conceived as a warning, a challenge and finally a demand for a massive transfer of technology from the United States, Europe and Japan to the poor and needy. It is not just another wishful plea — for it is backed up by the most powerful of all new weapons: oil.'

The first 100 pages of this 300-page book are concerned with describing the events that led to Taif in terms of the Arabs' increasing control of oil prices and the shocks to the Western industrialised systems of sudden oil price rises.

He also looks at other developments in Third World countries, at the Suez crisis, the traumatic events following independence of the Belgian Congo in 1960 and attempts by the Third World to get a bigger share of world economic and industrial activity.

The spotlight is then turned on Japan. He graphically describes the Japanese attack on Pearl Harbour and the dropping of atomic bombs on Hiroshima and Nagasaki; key events of the Second World War which resulted in Japanese humiliation.

From the ruins of war, Japan rapidly grew from a poor Third World country to one of the leading industrial powers. Much of Japan's industrial success has been built on high technology developments, and Servan-Schreiber shows how Japan is now opening its technological knowhow to the Third World, while the West carries on regardless. I found this section particularly illuminating. Although he glosses over problems in Japanese society, Servan-Schreiber provides a sympathetic insight into the Japanese collective and individual psyche. He provides interesting — and rarely reported — background on recent Japanese moves to share its technological and industrial knowhow with other countries. Led by men like Toshiwa Doki, president of the Japanese Federation of industrialists, and backed by the government and a number of research reports, Japan is planning a new strategy. 'The Japanese industrial giants can no longer concentrate simply on expanding overseas and conquering foreign markets. They must become more closely integrated with the world,' explains Servan-Schreiber. In particular, Japan has started training programmes in countries like Singapore, Hong Kong, Korea and China.

The weakest part of *The World Challenge* is Servan-Schreiber's superficial and uncritical approach to the technology. He makes sweeping statements like 'Computerised systems will be capable of performing all nonhuman tasks on a planetary scale, and thus permitting, in fact demanding, the creative fulfilment of what is and always will be peculiar to man.'

He dismisses all fears that computerisation may cause unemployment: 'The larger the number of microprocessors, the greater the need for vast human contribution,' he comments. All doubts are cast to the wind: 'Computerisation is inevitable, irreversible and desirable. That is the only way for a society, a factory or a bank to survive.'

For a book that is supposed to be concerned about human and social values and the quality of life throughout the world, such an uncritical approach to the impact of information technology is disappointing, to say the least. There are enough books extolling the marvels of the technology. With the breadth of vision he displays elsewhere in the book, Servan-Schreiber should have been more concerned about the impact that the technology might make

on the nature of the societies around the world.

Nevertheless, *The World Challenge* is an important book because it provides perspective on the well-known theme of the microelectronics revolution. It places the chip in an international perspective and shows how oil and chips may make a potent mix.

Juice extraction

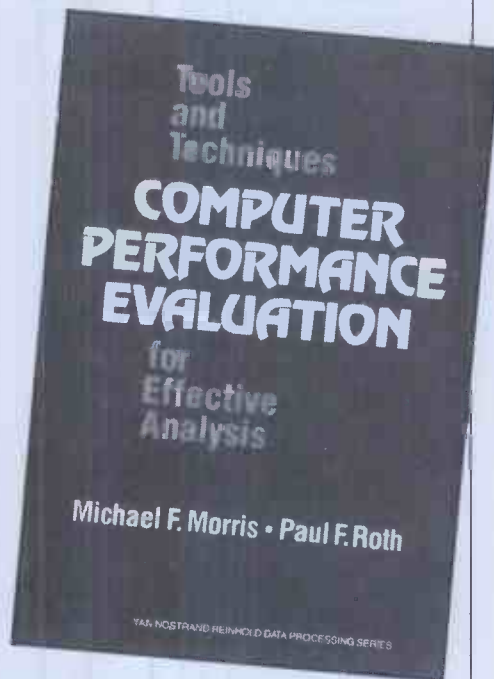

Computing Performance Evaluation — Tools and techniques for effective analysis (Van Nostrand Reinhold, £21.20)

Despite the falling price of computing, users must be concerned about squeezing as much juice as possible out of their investment. Over the years, a wide range of aids to determine exactly how a computer is performing have been developed. Once the data is available on performance, it becomes possible to determine a plan of how to tune the computing engine to get more mileage out of the system.

These tools and techniques, however, do not come free. Software and hardware tools and techniques that can best be exploited by skilled performance specialists can cost a lot of money. This probably places many of the tools and techniques discussed by Michael F. Morris and Paul F. Roth in *Computer Performance Evaluation* beyond the scope of most micro users.

Their book, however, is a practical introduction to a subject that should be of interest to anyone seriously involved in computing. It is written primarily for data processing managers of largish mini/mainframe installations. But small systems have a habit of growing into bigger ones and today's ZX81 freak might be tomorrow's top computer whizzkid.

Performance evaluation is a subject that can be easily shrouded in equations. Morris and Roth avoid this danger admirably, except in a couple of places where mathematics is inevitable. All examples are based on actual experiences.

They provide introductory material

to all the main methods of performance evaluation starting with the collection of basic 'accounting data' on how the system has operated, through software monitors and program optimisers to hardware monitor benchmarking, simulation and modelling.

In addition, this book supplies guidelines on how to manage evaluation projects, the type of staff to be used and exactly where and when particular techniques are most useful. It could well be valuable to students of computer sciences as an introduction to and overview of this important subject.

The magnificent 32-bit



The Soul of a New Machine by Tracy Kidder (Allen Lane £7.50)

'The First Great Classic of the Computer Age.' That's how the publisher immodestly advertises Tracy Kidder's *The Soul of a New Machine*, a fast-moving and valuable description of the human effort that went into making Data General's 32-bit mini.

Kidder's book may be a best seller (its unexpected success in the States provided the resources which fuelled a razzmatazz launch in the UK). It may be an excellent piece of fly-on-the-wall journalism. It may even be a brilliant attempt to explain computer engineering in lay language — but to call it a 'classic' is to devalue the word. A literary classic should be multi-dimensional. It should be subtle. It should explore hidden depths beneath the superficial skin.

Kidder is too busy reporting events in a way that rams home his own thesis to explore more than one dimension. His thesis is that computer engineering can be equated with the craftsmanship and achievement of architects and builders of cathedrals and bridges, furniture and steam engines.

He reports on Data General's Eagle team, lead by Tom West. (Eagle was

Data General's belated response to mini giant DEC's 32-bit VAX system.) The one dimension he describes brilliantly is the way in which West's team were motivated to complete their work. What he fails to do is to examine fully the context in which the Eagle team were working and those aspects which contradict his thesis. He also became too committed to West himself to explain fully the problems which his management style created.

These criticisms may seem unfair in view of Kidder's original aim. He is a journalist, who was given a unique opportunity to sit in through the design of a new computer. As a piece of journalistic reporting, *The Soul of a New Machine* cannot be faulted. Kidder is particularly impressive in the way he explains the technological jargon sufficiently to enable a non-computing expert to understand the essence of the creative design and exhausting bug searching. Having cracked the jargon problem decisively, he reveals the kernel of Eagle's development effort with the skill of a thriller writer. He turns it into a something like a *Magnificent Seven* or *Dirty Dozen*. Tom West is the leader who gathered the gang together.

The book starts with a chapter about West on a yacht in stormy seas entitled (surprise, surprise!) 'A Good Man In A Storm'. It sketches in the corporate background in which the Eagle project was initiated. Basically, Data General had made a cock-up in the 32-bit mini market, had rival teams working on similar projects and ended up by trying to make a 32-bit version of its old Eclipse range, although other more appealing designs had been worked on.

West then gets the gang together. Those working on the hardware were called the Hardy Boys and, with equal obviousness, those doing the microcode were called the Microkids. The book then follows the roller-coaster ups and downs that led, 18 months later, to the emergence of Eagle in its marketing garb, called the Eclipse MV/8000.

In addition to describing the work, Kidder provides sharp characterisations of some of the key figures, like West's right-hand man, Carl Alsing. At first sight, writes Kidder, Alsing looked like a 'typical engineer' who 'wears a white undershirt and a plastic pouch (known to some as "nerd pack") in his breast pocket, in order to keep his pens from soiling his clothes. An electronic calculator — used to be a slide rule — hangs like a ring of janitor's keys from his belt.'

Then, in a typical passage which combines sharp observation with a quick dip into a psychological nerd pack, Kidder says that Alsing is different from that first impression. 'About his hands, the way he folds them in his lap or puts them together under his chin, there is something delicate. . . I thought that I could see in him the lonely childhood behind him — he would have been the last boy picked in every school yard game, the one who threw out a ball like a girl. But Alsing is gregarious,' observes Kidder. Most of the Eagle team have a characteristic psychological nerd pack provided by Kidder — a liking for finding out how things work, some private hobbies and

pursuits, a desire to work on interesting projects and a frustration at the commercial and management constraints which they feel generally hamper their creative work.

Taken at its face value, Kidder's book is a success. It captures the atmosphere of the team's work and gets over the excitement of computing to a lay audience. Yet, because of its commercial success, much more is being claimed for it. That is why I think criticism should extend into the areas which Kidder failed to cover adequately.

Firstly, there is the problem of why West and his team were forced to work on a project which arose almost as an afterthought following failures of other attempts to catch up with DEC's VAX.

Data General was formed in 1968 by three engineers from DEC, including Edson de Castro, now the President. Like many other similar ventures in the States (such as Apple), the entrepreneurial spirit worked well in a small team. But as it grew, the entrepreneurs found it difficult to keep the same spirit going.

As Kidder explains, de Castro runs the company with charisma but a great deal of inconsistency. For such a good journalist, Kidder surprisingly fails to investigate how much of the problems hit by Data General at the time of Eagle (late 1970s) were caused by de Castro. He tends to explain it all away by saying that perhaps de Castro deliberately created rivalries between different teams and failed to give Eagle adequate resources as a deliberate ploy to get the best out of West and his team, in a shoot-out with their backs to the wall. Something more incisive would have been more illuminating on the nature of the computer industry.

The second main criticism is that he mentions but fails to develop a central issue when discussing computer engineering as a craft. At one point West says that the excitement of being an engineer is that it 'provides some notion of control that you can derive in a world full of confusion'. He also says he always wanted to build something 'larger than' himself. Kidder relates these feelings to those of architects who created cathedrals.

But cathedrals were built to last. Before Eagle was started it was out of date because VAX was already established in the market. Even if they had begun in sufficient time, there is an in-built knowledge that any particular computer is likely to become redundant soon.

At one point in the Eagle project, West comments, 'We're way beyond what any one person can do. It's too complex.' And in a private moment, he confesses that 'computers are irrelevant', because they are replaced by new models so quickly.

Kidder is really describing a dying breed, rather than the career of the future as some critics have claimed. As computer design becomes more complex, more automated and more quickly replaced, the craft engineer will be replaced by cogs in a design machine. It is this contradiction at the core of the process described by Kidder — the creative motivation of the engineer

GOTO 187

The RP1600

FLOWWRITER™

A Daisywheel Printer that thinks it's a computer !

The RICOH FLOWWRITER is the most intelligent Daisy Wheel printer on the world market. Equipped with an internal micro computer and a large memory it will intelligently handle all printing and word processing operations; hence relieving the host computer for simultaneous use.

The Flowwriter is fully compatible with software written for any intelligent printer and is plug compatible with all popular hardware.



Standard Features

- Prints up to 60 characters in 1 second.
- Compatible with QUME SPRINT, DIABLO and NEC Spinwriter standard and enhanced word processing commands including graphics.
- Proportional spacing tables programmed internally.
- Automatic margin justification even with proportional spacing.
- 8K buffer under full program control.
- Auto bidirectional printing.
- Optimised auto logic seeking in both vertical and horizontal directions.
- Graphics capability down to 1/120".
- Three interfaces included internally: Centronics -IEEE 488 - RS232C.
- Detached keyboard option.
- External program mode, allows use of many more printwheels.
- Selectable international languages.



.....and ITS CHEAP!!

APT APPROPRIATE TECHNOLOGY LIMITED

2-4 Canfield Place London NW6 3BT Tel: 01 625 5575/5134 Telex 264538 SSE G

The RP1600 FLOWWRITER is only supplied by APTEC and their authorised dealers, backed by national and international service networks.

The FLOWWRITER is a registered trademark of APTEC, UK.



S

B

C

Dual floppy disk drives. Two 5¼" floppy disk drives provide 100,000 characters each of data storage, or about 60 pages of typed, doublespaced text.

Diskette storage. The floppy diskettes can be removed, providing infinite permanent information storage. Two compartments provide storage for up to 25 diskettes.

RS-232C Interface. Enables the OSBORNE 1 to connect with serial printers, or other devices using this popular industry-standard interface.

IEEE 488 Interface. Connects the OSBORNE 1 to the standard instrumentation bus, for data communication with test instruments.



Osborne 1.
It doesn't need a room of its own.
Or even a desk of its own.
With its optional battery pack, in fact, it doesn't need mains electricity for up to two hours.
It's - as you can see - portable.
Weighing under 24lb in its weatherproof case, it can be carried in one hand. Or in your car. Or tucked under an airline seat.
But its performance is equal to, often better than, small business computers several times as big and twice as expensive.
The Osborne 1 will achieve in seconds commercial, engineering or scientific calculations which, without a computer, would take days.
And store a whole library of data for instant retrieval and use any time.

Connected to a printer, it will operate as a word processor and produce letters, documents, reports - anything you want word-(and figure-) perfect.
And carry out financial planning, too, using an electronic spreadsheet, providing fast, accurate cash flow forecasts and instant answers to those important 'what if' questions.
You can see an Osborne 1 - and try it out - at any of the dealers listed below.
And then happily walk away with it.

For £1,250* the only personal business computer

See the Osborne 1 at any of these authorised dealers:

LONDON
Adda Computers Ltd, Mercury House, Hangar Green, Ealing, London W5 3BA. Tel: (01) 997 6666

Business Computers (Systems) PLC, The Pagoda, Theobald Street, Bournemouth, Herts WD6 4RT. Tel: (01) 207 3344

Byteshop Computerland, 324 Euston Road, London NW1. Tel: (01) 387 0505

Digitus Limited, 10/14 Bedford Street, Covent Garden, London WC2E 9HE. Tel: (01) 379 6966

Equinox Computer Systems Ltd, Kleeman House, 16 Anning Street, New Inn Yard, London EC2A 3HB. Tel: (01) 739 2387/729 4460

Lion Microcomputers, Lion House, 227 Tottenham Court Road, London W1. Tel: (01) 637 8760

Microcomputers at Laskys, 42 Tottenham Court Road, London W1 9HD. Tel: (01) 636 0845

O Computers, 108 Rochester Row, London SW1P 1JP. Tel: (01) 630 5449

Star Computer Group PLC, 64 Great Eastern Street, London EC2A 3QR. Tel: (01) 739 7633

Subscription Services, 70 Warren Street, London W1P 5PA. Tel: (01) 388 2663

The Xerox Store, 84 Piccadilly, London W1V 9HE. Tel: (01) 629 0694

77 High Holborn, London WC1V 6LS. Tel: (01) 242 9596

110 Moorgate, London EC2M 6SU. Tel: (01) 588 1531

BELFAST
Northern Ireland Business Systems Ltd, 7/9 Botanic Avenue, Belfast BT7 1JH. Tel: (0232) 48340

BIRMINGHAM
Byteshop Computerland, 94/96 Hurst Street, Birmingham B5 4TD. Tel: (021) 622 7149

Microcomputers at Laskys, 19/21 Corporation Street, Birmingham B2 4LP. Tel: (021) 632 6303

BRISTOL
*Microcomputers at Laskys, 16/20 Penn Street, Bristol BS1 3AN. Tel: (0272) 20421

CAMBRIDGE
Cambridge Computer Store, 1 Emmanuel Street, Cambridge CB1 1NE. Tel: (0233) 65334/5

CHESTER
Microcomputers at Laskys, The Forum, Northgate Street, Chester CH1 2BZ. Tel: (0244) 317667

DERBY
Daltron Micro Centre, Duckworth Square, Derby DE1 1JZ. Tel: (0322) 380085

EDINBURGH
Microcomputers at Laskys, 4 St James Centre, Edinburgh EH1 3SR. Tel: (031) 556 2914

GLASGOW
Byteshop Computerland, Magnet House, 61 Waterloo Street, Glasgow G2 7BP. Tel: (041) 221 7409
Microcomputers at Laskys, 22/24 West Nile Street, Glasgow G7 2PF. Tel: (041) 226 3349

GUILDFORD
Systematic Business Computers, Braboeuf House, 64 Portsmouth Road, Guildford, Surrey GU2 5DU. Tel: (0483) 32666

LIVERPOOL
Microcomputers at Laskys, 14 Castle Street, Liverpool L2 0TA. Tel: (051) 227 2535

MANCHESTER
Byteshop Computerland, 11 Gateway House, Station Approach, Piccadilly, Manchester 1. Tel: (061) 236 4737
Microcomputers at Laskys, 12/14 St Mary's Gate, Market Street, Manchester M1 1PX. Tel: (061) 832 6087

NEWCASTLE
Sage Systems, Hawick Crescent, Newcastle upon Tyne NE6 1AS. Tel: (0632) 761669

NOTTINGHAM
Byteshop Computerland, 92A Upper Parliament Street, Nottingham NG1 6LF. Tel: (0602) 40576
*Microcomputers at Laskys, 1/4 Smithy Row, Nottingham NG1 2DU. Tel: (0602) 415150

PRESTON
Microcomputers at Laskys, 1/4 Guildhall Arcade, Preston PR1 1HR. Tel: (0772) 59264

OSBORNE 1

TM



Internal electronics. Z80A™ CPU, 64K bytes RAM memory (60K available to the programmer, 4K used to run the screen.) System software is held in ROM in a separate address space.

Screen. Clear, 5", 24-row screen displays a 52-character window on a 128-character line with automatic horizontal scrolling.

Monitor Interface. Connects the OSBORNE 1 to any monitor screen.

Keyboard. A standard typewriter keyboard plus numeric, adding-machine keypad for fast entry, and cursor control keys for easy cursor movement.

Case. The plastic case snaps together to form a weatherproof, 24-pound package that fits underneath the standard airline seat.

Standard software
Five outstanding software packages, with a retail value of over £800 are included:
● CP/M® Operating System
● WORDSTAR® with MAIL MERGE®
● SUPERCALC™ ● MBASIC®
● CBASIC®

Optional extras
● Modem cable for use with acoustic couplers for telephone transmission of data
● Battery pack
● Double density disk drives with 200K bytes of storage per drive

Trademarks: SUPERCALC: Sorcim Corporation; Z80A: Zilog Corporation.
Registered Trademarks: OSBORNE 1: Osborne Computer Corporation; CP/M Digital Research; WORDSTAR, MAILMERGE: MicroPro International; MBASIC: Microsoft; CBASIC: Compiler Systems, Inc.

Computer you can take anywhere.

SHEFFIELD
Datron Micro Centre, 2 Abbeydale Road, Sheffield S7 1FD.
Tel: (0742) 585490
Microcomputers at Laskys, 58 Leopold Street, Sheffield
SL1 2GZ. Tel: (0742) 750971

SLOUGH
The Xerox Store, 3/4 William Street, Slough, Berkshire
SL1 1XY. Tel: (0753) 76957

SOUTHAMPTON
Xitan Systems Limited, 23 Cumberland Place,
Southampton SO1 2BB. Tel: (0703) 38740

TORQUAY
Crystal Electronics, 40 Magdalene Road, Torquay, Devon.
Tel: (0805) 22699

For further information and full specification, return the coupon to The Marketing Manager, Osborne Computer Corporation (UK) Ltd, 38 Tanners Drive, Blakelands North, Milton Keynes, Buckinghamshire MK14 5BW. Telephone: 0908 615274. Telex 825220

More information on Osborne 1, please.

Name _____

Address _____

PCW 6 _____

Tel _____

OSBORNE
COMPUTER CORPORATION (UK) LTD.

7th West Coast Computer Faire

Several British companies took stands at the Faire. Manning one of them was David Tebbutt, who presents this exhibitor's eye view.

Something like 40,000 souls risked the spring sunshine and the possibility of an earthquake to attend this year's West Coast Faire in San Francisco.

Compared to previous shows, there was less of a revolutionary air about the event — it reflected more of an evolution from what had gone before. Fortune systems weighed in with its 32-bit machine, Osborne clones appeared and four British companies bagged themselves (or 'booths' as the Americans call them). The IBM machine has spawned a whole sub-industry of magazines, hardware add-ons and software products since the last show when the IBM Personal Computer was only a very faint rumour.

In previous years I have visited the show as a reporter and have managed to visit every square inch, as well as getting to one or two conference sessions. This year my viewpoint has been that of an exhibitor tethered to his stand about 80 percent of the time. Of course, outside show hours there was the usual round of 'receptions' (ie, booze-ups) and visits to local companies. From this I offer my impressions. I leave it to my colleagues, Guy Kewney and Chris Horseman, to fill in the details.

Let's start off with the British contingent — The Last One, Supersoft, Microfocus and Caxton. The TLO booth was full of posters containing quotes from its extensive press coverage. In the corner of the booth was a large screen projector which wasn't working when I passed by. I assume it was demonstrating The Last One in operation. The booth was organised and manned by the American end of the TLO Organisation, Krown Enterprises.

Supersoft from Eastcote was there, too, showing off its excellent, low cost high resolution graphics board for the Commodore PET. It was also showing its Microscript word processor, again for the PET.

MicroFocus was there again this year with its well entrenched CIS Cobol, FORMS-2 and the Animator, which displays lines of Cobol code as they are being executed.

Finally my own company, Caxton, attended with its first two products, Optimiser and Cardbox. Optimiser is an easy to use planning aid which uses linear programming techniques, while Cardbox looks like an enormous electronic card index filing system.

As well as the four booths, two Brits also gave forth at the conference. David Ferris chaired a session on packaged



Crowds queue to see the Faire



Otrona's neat portable

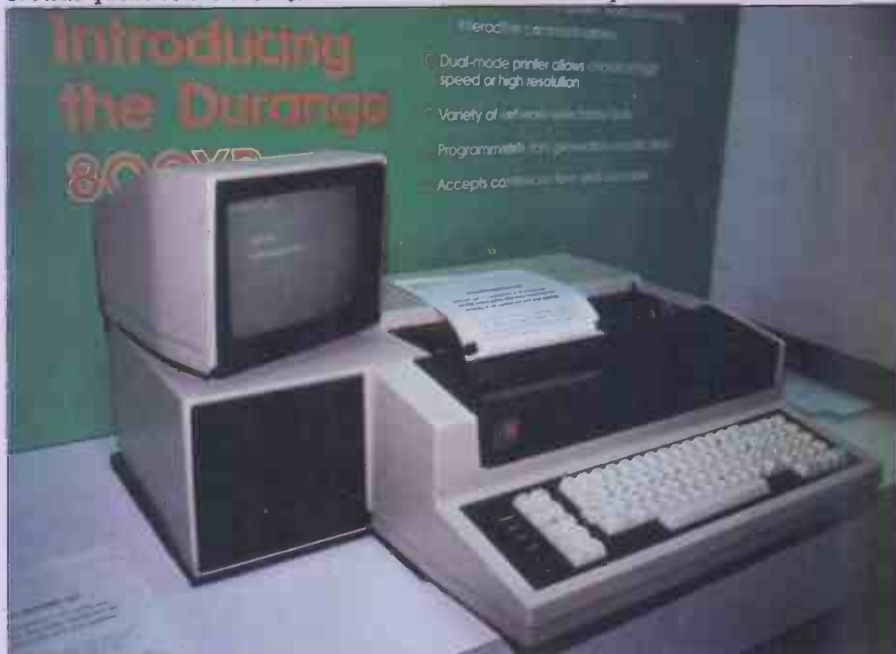

Durango's desk-top micro

software, while Metrotech's Graham Hawker gave a session on Prestel. Incidentally, Metrotech can supply a very nice line in private viewdata networks. Contact Graham on Uxbridge 58111.

Just after Graham finished his talk he was approached by an American woman who described herself as a 'microcomputer consultant'. She asked Graham who in the UK might be prepared to pay her fare to come over to give a talk. Graham hummed and hahed and in the end he had to confess he couldn't help. Out of curiosity Graham asked her how deeply into CP/M she was. 'What's CP/M?' was the reply!

For me the star of the show (apart from Caxton, of course) was the Otrona Attache. It occupies less than a cubic foot of space and into this manages to pack two high capacity (380k each) disk drives, a full 80-column screen with graphics and all the necessary workings to make it go. The machine is pretty as a picture and would look good on anyone's desk. It comes with some software packages included in the price — CP/M, Wordstar Plus, Basic-80, Valet and Charton. Valet allows you to inter-

rupt whatever you're doing while you perform another task. Charton is a plotting package which takes advantage of the 320 x 240 point display. The reason it won't wipe the floor with Osborne is because the price is more than twice that of the Osborne 1. Further details can be obtained from the Otrona Corporation at 4755 Walnut Street, Boulder, Colorado 80311; tel (303) 444 8100.

Somebody whispered that an Osborne clone was lurking down by the concession area. Further investigation uncovered the Kaycomp II, which looked remarkably similar to the Osborne prototype shown at last year's Faire. Unlike the Osborne, this machine boasts a 9in 80-column screen and vertically mounted disk drives. It is on sale at exactly the same price as the Osborne, and includes CP/M, a word processor, a high level language (Basic, presumably), a spreadsheet program and a mathematical program. All these descriptions are fairly vague in the supplied literature. Further details are available from meter manufacturers Non Linear Systems Inc, 533 Stevens

O FOR AN OSBORNE!

THE INCREDIBLE
OSBORNE I - A BEST BUY
FROM O COMPUTERS.



LOOK WHAT YOU GET FOR £1,250+VAT

THE HARDWARE

- * 4MHz Z80A Processor, 64K RAM
- * 2 floppy disc drives (90K)
- * 5 inch 52 column 24 line monitor
- * Professional keyboard plus numeric keypad
- * RS232C serial interface
- * IEEE 488 interface
- * Modem connection for communications
- * Plugs for external monitor or battery

THE SOFTWARE

- * CP/M Operating System and utilities
- * M BASIC interpreter for program-writing
- * C BASIC quasi compiled language with compiler & interpreter
- * WORDSTAR the best microcomputer word processing program
- * MAILMERGE for combining data files with word processed text
- * SUPERCALC an electronic spreadsheet for financial planning

AND A SPECIAL INTRODUCTORY FREE OFFER FROM
O COMPUTERS A SUPERB 12" GREEN MONITOR WORTH £165.

PRINTERS

Seikosha GP100A	£219
Epson MX80T	£320
Epson MX100FT	£510
Microline 82A	£370
Microline 83A	£610
TEC 40cps daisy wheel.....	£1090
TEC 55cps daisy wheel.....	£1420
Qume 45cps daisy wheel.....	£1520

Printer prices include cables. All prices exclude VAT

MORE SOFTWARE

PASCAL M compiler.....	£195
FORTRAN 80 compiler.....	£220
CIS COBOL version 4.3.....	£425
FORMS 2 (used with COBOL).....	£100
BSTAM (links micros).....	£ 95
DBASE II (relational db).....	£380
MILESTONE (project mngmt).....	£160
MICROSTAT (statistics).....	£150
SUPERSORT I.....	£120

O COMPUTERS

A company in the C/WP Group, 104-106 Rochester Row, London SW1.
To reserve your free monitor and get details of the OSBORNE I Call 01-630 7447.

Avenue, Solana Beach, CA 92075; tel (714) 755 1134.

Durango had some nice looking desktop machines on show. The most amazing thing about them was the quality of the dot matrix printer which could produce a wide range of fonts. With a bit of luck, PCW will have reproduced a sample somewhere in this report.

Adam Osborne was much in evidence at the show. He no longer makes awards, he collects them. *Infoworld* presented him with the world's first 'Floppy' award for the Osborne 1. The reasoning behind the name was if other professions can have Oscars and Grammys, why shouldn't we have Floppies? Why not indeed?

Adam took advantage of the show to pre-announce a couple of upcoming Osborne add-ons. An intelligent double-density disk drive option will be available at the end of April. As well as doubling the Osborne disk capacity, it will also be able to handle a number of other formats including the Xerox 820. The option will cost around \$185 in the US and will take a dealer about half an hour to install. The battery option will be available from mid-May. This will give up to an hour of power, sounding an alarm five minutes before the power runs out. This 'Portable Power' unit can be used when running off the mains or a car battery to give continuous power in the event of an interruption of the main supply. A charger is supplied with the unit and it takes something like 16 hours to recharge the batteries inside. Portable Power comes in a leather case and costs \$390 in the US.

The IBM machine has spawned a host of add-ons, magazines and software. The only surprising thing about this is the speed with which it has been done. There is a rumour, very faint and very distant, that IBM will launch in the UK at the end of the year. It is a rumour, I hasten to add.

An outfit called Xedex has come up with a Z-80 based peripheral card which allows IBM's Personal Computer to run normal CP/M programs. When not being used for this, it acts as an extra 64k of RAM. With the lovely name of Baby Blue CPU Plus, the card plugs directly into one of the PC's expansion slots. The software which drives Baby Blue is supplied on disk. It allows you to read several different format 5¼in soft sectored disks and to write the CP/M program files in PC DOS disk format. While doing this, Baby Blue tricks a header into the program so that whenever it is loaded it wakes up Baby Blue's own Z80 processor, pops a small translator into BB's memory then transfers the CP/M program to BB. The program is then executed by BB for I/O calls which are passed back via the translator to PC DOS. When the program terminates, BB goes back to sleep and appears to be just another common or garden 64k RAM board.

BB costs \$600, unless you'd like Wordstar and MailMerge too, in which case it'll cost you \$980.

Further information can be obtained from Xedex Corporation, 645 Madison Avenue, New York, NY 10022; tel (212) 247 1400.

I mentioned Fortune Systems' 32-bitter. It's built around the Motorola MC 68000 and comes with between 128k and 1Mb of RAM plus 4-16k of

ROM. It can drive up to four 5¼in floppy disk drives (800k each, formatted) and up to four hard disks, either 5¼in or 8in.

Bell Labs' UNIX system is what makes this thing tick, so not surprisingly, you'll find it allows multi-user, multi-function operation. Plus, it offers a wide range of communications options.

The main languages offered are Basic, Cobol, Fortran, Pascal and C. The 32:16 allows local networking through the Ethernet system.

I could go on and tell you about the hi res (640x480) colour graphics or the business software available, but I won't. If you're interested, write to Fortune Systems Corporation, 150 Industrial Road, San Carlos, California 94070; tel (415) 595 8444.

Another hardware development which caught my eye was the 'modem on a chip'. Perhaps the rumours I have been hearing of a one-dollar built-in modem will come true. I suspect the dollar is the cost per unit in bulk manufacture rather than a retail figure.

Someone told me there is an 8088 add-on for the Apple which sounds mighty interesting. Graham Hawker also told me about a product which is a dealer's dream. It is called Teach/M and it is a software package which answers all the user's questions about CP/M.

The day following the Faire I found myself at the Machine Intelligence Corporation. This is a company set up a few years ago by some people from Stanford Research Institute. While I was there I was shown some interesting vision systems connected to robots which enabled them to 'see' silhouettes of objects and handle them appropriately. A new subsidiary of MIC, Symantek, is about to be created specifically to implement artificial intelligence applications on microcomputers. If the Editor will let me, I shall write an article about their work later on this year. For the moment the details of this work are a secret.

While 'Tebbo' was selling hard, newshound Guy Kewney was sniffing out new products.

All right, all you clever swots who know what software publishing is: answer this one. What is the largest software publishing organisation in the micro business?

Those who know their onions will start with a list of people such as Quality Software, Visicorp, Online Systems, Broderbund, and so on — all people who get programs submitted from ordinary users, and who then sell copies and pay the author a royalty.

Those who really know their onions will say that Visicorp, the company which used to be called Personal Software until its product Visicalc got more famous than the company itself since it turns over upwards of \$20 million a year, is the largest.

At the Faire, I made the interesting discovery that Apple itself now claims to have around \$40 million worth of software publishing business this year.

Certainly, on a subsequent visit to Cupertino, I found the offices absolutely crawling with outsiders who were claiming to be freelance programmers, and who were working in the Apple offices on their own products, turning them into Apple products.

It would, said one of these programmers in his laconic Californian drawl, be a much more impressive figure if one didn't have to contrast it with the number of programs that it could publish, actually owns rights to publish, but hasn't yet quite managed to organise.

'The only bigger collection of freelance programmers than the bunch inside the Apple buildings', he said, 'is the bunch who used to be in, but who have stormed out in a rage because Apple can't organise their products onto the market — they don't even seem to know they've got them.'

A lot of people have been very sceptical (except they were Americans, so



they were skeptical) about the latest offspring of CP/M — something called 'concurrent' CP/M-86. This annoys me, because I thought it was the star of the Faire.

What it is to the user is the answer to all his prayers, if it works. It allows you to run several programs at once.

For example, you are typing away at your word processor and you find that you have to include a quotation for a customer. He has ordered 235 units at \$4.50 each, plus 345 units at \$2.99 each, plus two dozen at 14 Dmarks, half of each to be discounted at 24 percent and the rest to be discounted at 15 percent which makes them free of tax... in short, you need a calculator.

It just happens that your computer, if it were running Basic rather than your

word processor, could let you calculate all these things instantly. If you were running your invoicing program, you could not only use it to calculate all these numbers, but could create an invoice, and store it as a file.

At this point, the phone goes. It's the *Daily Snoot*, wanting to know turnover in Afghanistan this year compared with before the Russians moved in. You know the figures are somewhere in your CMS files, or maybe they were in dBase II. If only you could be sure — a DIR command would tell you what the filename was, but your wretched system won't do DIR while running the word processor... Under concurrent operating



and it has amply vindicated those sceptics who forecast that it would never work properly (they said nothing that sophisticated would ever work on an eight-bit Z80 or 8085 type micro). It had burned fingers — not just the users' but also Digital Research's fingers, in trying to improve it and make it work.

One day, maybe it will. In the meantime, however, people are nervous about anything that has the smell of MP/M about it. So naturally, they are wary of concurrent CP/M-86.

As I see it, the problems that bedevilled MP/M don't apply to this new system. Mainly, because although it may have four or five or whatever different programs 'running' at one time, they are in fact not running, but waiting. There is no chance that one program will try to read a record which another program is actively updating, because they can't work together — they take it in turns.

I hope I'm right! If I am, it will be a tremendous boon for the IBM Personal Computer — IBM was due to announce its availability as this piece went to press — and the Sirius One, where Chuck Peddle's company is negotiating to get the system from Digital Research.

On another stand a weird collection of rods was being waved around, pointing at an apple. Not an

more for hard disk drives in Britain, it comes as a bit of a shock to walk past something called 'Davong Systems' and see a hard disk for the IBM Personal Computer, costing \$2,000.

That was the price for the disk system installed in one of the holes where you normally find a floppy, with an interface, a controller, and software to let the system boot up from MSDOS, the new IBM operating system from Microsoft.

'We placed a \$2 million order with Tandon, the disk maker,' explained the company boss. It turns out that the price frightens even the Americans, but not because they think it's impossible — just that they think all hard disk prices will be down to that level soon. Tandon, Seagate and Shugart are fighting the price down, in the hope of encouraging a big market, it seems.

Davong says it is happy to supply to the UK, and is looking for a distributor. Details: 1061 Terra Bella Avenue, Mountain View, CA 94043 or phone (415) 965 7130.

If you were looking for help in choosing the best way of organising vast amounts of data on a micro, you would have done well to stay away from the most obvious source of help at the Faire — the seminar session on database.

All the big ones were there — dBase II, now best-seller outside the Apple world, MDBS, Access 80 (a new one, but impressive to experts), Selector V, Condor, and FM-80.

One by one, each product was 'described' by a senior executive from the company which either sold it or produced it. And, one by one, the audience either fought off sleep long enough to get out of the room, or yielded and went into a dull doze.

My conclusion at the end of the session was that none of the people who were speaking had the faintest idea of what their rivals could or couldn't do. They made little attempt to compare and contrast the abilities of their own database manager with others — instead, they recited a list of 'features'.

The trouble with a list of features is that it conveys nothing about whether the features are useful or not. Is a system with the ability to use five files better or worse than one with one file of infinity size and no restriction on record length? Why?

At the end, I came to the following tentative conclusions:

1. GBS from Quality Software is not available yet.
2. MDBS from Micro DataBase Systems is very powerful, but should be restricted only to programmers of considerable skill. The company says so, and I don't think they say so just to impress customers.
3. Access 80 may be very powerful at storing, and recalling, data you put into it. On the other hand, it may not be suitable for what you have in mind, and the literature, or the program itself, will never tell you anything to help you make up your mind.
4. dBase II is market leader. Some people like it.
5. If Condor is a good product, somebody ought to tell the people who sell it.
6. FMS-80 isn't a database manager, though it may well do more for you than a database manager can.

GOTO Page 185



Fortune's micro (above) and a general view of the Faire (below)

systems, you can run all these programs at once. Under concurrent CP/M-86, you press control and a number, and you get a fresh screen. On that screen, you can load and run a program. On the next empty screen, you load and run a third. You create your invoice, then switch back to Basic to check the arithmetic. It's okay, so you switch instantly back to the word processor, and call up the new invoice file. You read the figures right out of the invoice file, and merge the invoice and the standard 'pay in 30 days' letter.

The reason people haven't been jumping up and down enthusiastically is simple enough: concurrent CP/M-86 is based, mainly, on a program which is called MP/M.

That is a multi-user version of CP/M,

Apple, but an apple — green, crunchy, nourishing-looking.

The man behind it was pointing the end of his rods at the apple, and pressing buttons on his computer — and eventually it dawned on me that he was producing a three-dimensional picture of the fruit.

Each point where his apparatus touched the skin was connected to the nearest ones until a 'wire cage' around the surface was built up.

This magic trick, by Penguin Software, works for anything you can put on the plotter table. Mark Pelczarski, president, assured me he'd be delighted to have a UK distributor: contact him in Illinois at 830 Fourth Avenue, Geneva, Ill 60134.

When people are asking \$2,000 and

SINCLAIR ZX SPECTRUM

*Once again Sinclair offers value for money with a vengeance — colour, sound and graphics for £125!
David Tebbutt reports.*

Well, he's done it again, hasn't he? Uncle Clive has gone and shown the world how to produce a decent colour personal computer at the sort of price only he can conceive. Two versions of the Spectrum are available — 16k and 48k at £125 and £175 respectively, including VAT. If you want to upgrade your 16k machine to 48k later on, it will cost you £60. At the moment, the machines are available only by mail order. The Spectrum (ZX Spectrum to be precise) offers colour, high resolution graphics and sound and, at the price, it has just got to be the best value for money around.

Like most computers at this level, the Spectrum plugs into the domestic television and uses a normal cassette recorder. The ZX printer can be attached and, with a little modification, ZX81 programs will run happily on the Spectrum. A £50 miniature disk drive (the ZX Microdrive), communications facilities and an RS232 interface will be announced later on.

Hardware

The Spectrum measures just 233x144x30mm and weighs in at 520 grams excluding the separate power supply and cables. It looks extremely elegant and, unlike its predecessors, it has keys that actually press down.

You'll not be surprised to learn that there are hardly any components inside the machine: 14 chips, a UHF modulator, a piezo-electric 'speaker' and an assortment of capacitors, resistors, diodes, crystals and a coil make up the complement. I swear that some of my crystal sets had more in them. All this is mounted on a single board and, looking underneath this production prototype, I notice that there's not a single patch. The only odd thing about it is that there's a big blob of green plastic stuck around the coil. The coil on the review machine does whistle a bit but I understand that production machines come with suitably lacquered coils to eliminate this problem.

A hefty edge connector at the back brings out just about every signal you could wish to have. This is used for printers, communications and disk drive connections. Inside there are two spare sockets which accommodate each end

of the 32k memory expansion board. This is a great improvement on the ZX81 memory expansion which tended to drop off the back of the machine at the least provocation. Talking of sockets (well I was, just now), every chip except the ULA is socketed. The reason the ULA isn't is because it gets darned hot — putting it on the PCB allows the heat to dissipate better.

The keyboard comprises a one-piece grey rubber moulding mounted over a pressure-sensitive membrane. The keys poke up through holes in a black metal plate and I must confess the feel is more that of a calculator than a typewriter. Most keytops have three symbols on them and, in addition, most of them have another two associated inscriptions printed on the metal surround. If you're anything like me you'll find yourself reading the whole keyboard each time you want to find a function. You do get used to it after a while: in my case it took a couple of days. I found that red symbols on grey keytops are quite difficult to read and, thinking my eyesight might be going, I showed the machine to a number of friends, all of whom had the same difficulty. I showed it to my 11-year-old and he thought it was just fine, though.

A power supply is included in the price, so there's not a lot of point risking one of your own and blowing the Spectrum up. The two cassette leads terminate in 3.5mm jack plugs so be sure that they work with your recorder before you embark on any major programs. It took me four or five tries before I found the right volume setting on my tape recorder. Once this was found, though, program loading presented no problems.

I tried the Spectrum on three televisions and the results matched the quality of the sets used. The display comprises 24 lines of 32 characters with the bottom two lines reserved for messages and entries. The display can also be regarded as 176 x 256 resolution for graphics work. High resolution graphics work is best done in two colours as you will see in the Firmware section of this review. The screen, border and individual characters can each take on one of eight colours and, in addition to this, characters can be bright or flashing. Other screen attributes

like inverse and overprinting relate to the whole screen. More on these later.

The single channel BEEP facility is about what you'd expect from a piezo-electric speaker. It does sound slightly better amplified from the cassette port but it's still pretty awful. A couple of octaves around middle C aren't bad; but the other eight are best used for sound effects. At the high end they warble and at the low end they grate — BEEP is a refreshingly honest description.

Really, there's not a lot more to say about the hardware. It is a very professional job; looks smart, works well and manages to squeeze 191 legends on to just 40 keys!

Firmware

Here's a new section for PCW Benchtests. All the software on the review machine was in the ROM chip which also contained the character set. This time Sinclair has gone for a basic ASCII set (upper and lower case) with the addition of both built-in and user-defined graphics characters. Outside of the range SPACE to QUOTES (32 to 126), many of the codes have special values relating to Spectrum keys and functions. For example, you'll find a copyright symbol key. (Now why didn't anyone else think of that?) You can define up to 21 characters of your own.

Two screen tables are maintained in memory — one for the displayed characters themselves and the other for the attributes which describe how they're to be displayed. These attributes can be tested from within a Basic program. The character colour is referred to as INK while the background colour is called PAPER. Isn't that sensible? Each character can have its own value for INK, PAPER, FLASHING, BRIGHTNESS, INVERSE and OVER. The last two should be explained: INVERSE simply means that the dots which form the character are printed in the PAPER colour while the PAPER is printed in the INK colour. OVER is special: it allows you to merge a new character with the one already at the screen position. The rules are that two INKs or two PAPERs print PAPER otherwise it prints INK. This means that you have a neat way of removing the last thing

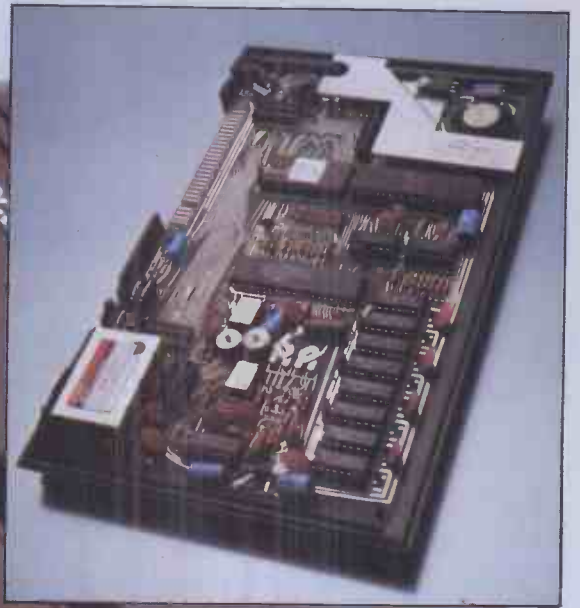

Sinclair ZX81 Personal Computer the heart of a system that grows with you.

1980 saw a genuine breakthrough – the Sinclair ZX80, world's first complete personal computer for under £100. Not surprisingly, over 50,000 were sold.

In March 1981, the Sinclair lead increased dramatically. For just £69.95 the Sinclair ZX81 offers even more advanced facilities at an even lower price. Initially, even we were surprised by the demand – over 50,000 in the first 3 months!

Today, the Sinclair ZX81 is the heart of a computer system. You can add 16-times more memory with the ZX RAM pack. The ZX Printer offers an unbeatable combination of performance and price. And the ZX Software library is growing every day.

Lower price: higher capability

With the ZX81, it's still very simple to teach yourself computing, but the ZX81 packs even greater working capability than the ZX80.

It uses the same micro-processor, but incorporates a new, more powerful 8K BASIC ROM – the 'trained intelligence' of the computer. This chip works in decimals, handles logs and trig, allows you to plot graphs, and builds up animated displays.

And the ZX81 incorporates other operation refinements – the facility to load and save named programs on cassette, for example, and to drive the new ZX Printer.



New BASIC manual

Every ZX81 comes with a comprehensive, specially-written manual – a complete course in BASIC programming, from first principles to complex programs.

Kit: £49.⁹⁵

Higher specification, lower price – how's it done?

Quite simply, by design. The ZX80 reduced the chips in a working computer from 40 or so, to 21. The ZX81 reduces the 21 to 4!

The secret lies in a totally new master chip. Designed by Sinclair and custom-built in Britain, this unique chip replaces 18 chips from the ZX80!

New, improved specification

- Z80A micro-processor – new faster version of the famous Z80 chip, widely recognised as the best ever made.
- Unique 'one-touch' key word entry: the ZX81 eliminates a great deal of tiresome typing. Key words (RUN, LIST, PRINT, etc.) have their own single-key entry.
- Unique syntax-check and report codes identify programming errors immediately.
- Full range of mathematical and scientific functions accurate to eight decimal places.
- Graph-drawing and animated-display facilities.
- Multi-dimensional string and numerical arrays.
- Up to 26 FOR/NEXT loops.
- Randomise function – useful for games as well as serious applications.
- Cassette LOAD and SAVE with named programs.
- 1K-byte RAM expandable to 16K bytes with Sinclair RAM pack.
- Able to drive the new Sinclair printer.
- Advanced 4-chip design: micro-processor, ROM, RAM, plus master chip – unique, custom-built chip replacing 18 ZX80 chips.



Built: £69.⁹⁵

Kit or built – it's up to you!

You'll be surprised how easy the ZX81 kit is to build: just four chips to assemble (plus, of course the other discrete components) – a few hours' work with a fine-tipped soldering iron. And you may already have a suitable mains adaptor – 700 mA at 9V DC nominal unregulated (supplied with built version).

Kit and built versions come complete with all leads to connect to your TV (colour or black and white) and cassette recorder.



ter-



Available now - the ZX Printer for only £59.⁹⁵

Designed exclusively for use with the ZX81 (and ZX80 with 8K BASIC ROM), the printer offers full alpha- numerics and highly sophisticated graphics.

A special feature is COPY, which prints out exactly what is on the whole TV screen without the need for further instructions.

How to order your ZX81

BY PHONE - Access, Barclaycard or Trustcard holders can call 01-200 0200 for personal attention 24 hours a day, every day.
BY FREEPOST - use the no-stamp-needed coupon below. You can pay

At last you can have a hard copy of your program listings - particularly useful when writing or editing programs.

And of course you can print out your results for permanent records or sending to a friend.

Printing speed is 50 characters per second, with 32 characters per line and 9 lines per vertical inch.

The ZX Printer connects to the rear of your computer - using a stackable connector so you can plug in a RAM pack as well. A roll of paper (65 ft long x 4 in wide) is supplied, along with full instructions.

by cheque, postal order, Access, Barclaycard or Trustcard.
EITHER WAY - please allow up to 28 days for delivery. And there's a 14-day money-back option. We want you to be satisfied beyond doubt - and we have no doubt that you will be.

16K-byte RAM pack for massive add-on memory.

Designed as a complete module to fit your Sinclair ZX80 or ZX81, the RAM pack simply plugs into the existing expansion port at the rear of the computer to multiply your data/program storage by 16!

Use it for long and complex programs or as a personal database. Yet it costs as little as half the price of competitive additional memory.

With the RAM pack, you can also run some of the more sophisticated ZX Software - the Business & Household management systems for example.

To: Sinclair Research, FREEPOST, Camberley, Surrey, GU15 3BR.

Qty	Item	Code	Item price £	Total £
	Sinclair ZX81 Personal Computer kit(s). Price includes ZX81 BASIC manual, excludes mains adaptor.	12	49.95	
	Ready-assembled Sinclair ZX81 Personal Computer(s). Price includes ZX81 BASIC manual and mains adaptor.	11	69.95	
	Mains Adaptor(s) (700 mA at 9V DC nominal unregulated).	10	8.95	
	16K-BYTE RAM pack.	18	29.95	
	Sinclair ZX Printer.	27	59.95	
	8K BASIC ROM to fit ZX80.	17	19.95	
	Post and Packing.			2.95

Please tick if you require a VAT receipt

TOTAL £ _____

*I enclose a cheque/postal order payable to Sinclair Research Ltd, for £ _____

*Please charge to my Access/Barclaycard/Trustcard account no. _____

*Please delete/complete as applicable. _____

Please print.

Name: Mr/Mrs/Miss _____

Address: _____

FREEPOST - no stamp needed.

PCW 06

sinclair ZX81

6 Kings Parade, Cambridge, Cambs., CB2 1SN.
Tel: (0276) 66104 & 21282.

North Star's ADVANTAGE is easy to see.

The best value in microcomputing.

The North Star ADVANTAGE is the perfect low cost micro-computer for business or personal use. With 720Kb of floppy disk storage, or an optional 5Mb Winchester disk, the North Star ADVANTAGE offers the most memory in its price/performance class. And it comes with advanced business graphics software at no extra cost. You can look everywhere, but you won't find a better micro-computer for the money.

High performance computing and high performance software.

The North Star ADVANTAGE system offers high speed computing based on the Zilog Z80A® microprocessor, the most accepted 8-bit microprocessor in the world, plus an Intel 8035 auxiliary processor. 64Kb of RAM main memory delivers fast program execution, with an additional 20Kb of RAM for the graphic display. North Star provides graphics software com-

patible with CP/M® and HDOS operating systems and application packages, and most standard languages. There are thousands of CP/M compatible software programs available throughout the world. Or you can choose any of the North Star application



packages available for word processing, financial analysis, accounting and data base management.

Graphic displays for every need.

The free North Star ADVANTAGE BUSIGRAPH™ package makes it possible to generate line, bar, pie, and 3-dimensional charts, plus complex 3-dimensional forms. Reports can be transformed into impressive hard copy graphic displays in a matter of seconds.

Build a network of ADVANTAGES.

One North Star ADVANTAGE computer can be linked to other North Star ADVANTAGES by twisted pair cable using North Star's new network interface and software package. This allows you to have a low cost network of individual systems sharing the more expensive peripherals. This can be the first step toward fully automating an entire office or department.

Convenient design and service.

The North Star ADVANTAGE is a fully integrated micro-computer in an attractive, integrated enclosure. It provides high reliability and excellent operator comfort, plus straightforward servicing. For more information about the North Star ADVANTAGE, contact... North Star Computers Inc. Arabellastrasse 5/133 c, Postfach 810623, D-8000, Munich 81, Telephone (089) 91 83 58, Telex 521 5772 ibs

FOLLOW THE STAR
NorthStar™

CP/M is a registered trademark of Digital Research, Inc.

North Star Computers Inc.

14440 Catalina Street, San Leandro, CA 94577 USA (415) 357-8500, TWX/Telex (910) 366-7001

SINCLAIR ZX SPECTRUM

printed and restoring what was there before it.

By now you have probably realised why it is best to stick to two colours when doing graphics work. Since the colour of the INK and PAPER relates to a whole character position, then each time a new colour graphics point is set, all other set points within the boundary of that character are set to the new colour. This makes for a very curious effect to say the least.

Mathematical accuracy is to 9½ decimal digits and a fairly full range of mathematical functions is accessible from the keyboard. While on the subject of keyboards, this one has a built-in software 'click', an upper-case lock key and automatically repeating keys. Like the ZX80 and ZX81 before it, the Spectrum makes great use of single stroke keyword entries. In fact, I think every standard function and command is obtainable in this way. You'll even find things like >= and <= occupying their own pieces of grey rubber.

Basic

The Spectrum comes with a very useful version of Basic. It will be quite familiar to anyone who is used to the Microsoft types of Basic and a doddle to learn for those new to the language.

Rather than go through all the features and functions of the language, I have summarised them in a separate box. Here, I'll just comment on the unusual and interesting aspects of this particular implementation. Unlike some Basics, it is a teeny bit strict about things like using LET before assigning a value to a variable name or putting GOTO after a THEN. My view is that this is all jolly good discipline and it is more than compensated for by the fact that Spectrum pops in all those spaces which make programs so much easier to read. Of course, once you've found your way round the keyboard, the single stroke keyword entry is a joy. (I've got a feeling I said that in my last two ZX reviews.)

SAVEing and LOADing cassette tapes gives plenty of scope on this machine. You can save a program normally, you can save it so that execution starts automatically when it is reloaded, you can save arrays, you can save particular chunks of memory and if you want to keep a pretty picture you've created then you can use the SCREEN\$ option to save that too. All saved programs can be verified after saving. The screen save can't be verified because the display is changed during the verify program and it would not then match that held on tape. The LOAD command can, of course, handle any tape created by SAVE. The MERGE command allows you to merge a program on tape with one already in memory. Program lines which are duplicated are overwritten while all others are suitably interleaved.

The graphics facilities are great fun. You can draw straight lines, curves and circles on the 176x256 pixel (PICTure ELeMent, or dot) window. Position 0,0

What about the '81?

It was no secret that 'Uncle' Clive was going to launch a knockout micro — he's put a bomb under the industry twice already, producing machines which brought computing power within everybody's reach at prices which drastically undercut the competition.



A slightly upmarket (by Sinclair standards) machine offering colour and sound and reasonable graphics at a price far, far below that of any equivalent machine was a logical step to take, especially in view of Sinclair's obvious annoyance at being left out of the BBC deal.

What is interesting, though, is that the Spectrum does not replace the ZX81, as the 81 did the 80 — it's an addition to the range and the ZX81 will continue in production. In fact, production of the 81 is to be increased to a target of 150,000 a month by the end of the year.

'The ZX81 will continue to be ideal for the person who wants the lowest possible entry cost into computing,' says Sinclair. And to prove the point, he's knocked £20 off the price of the 16k RAM pack.

At the moment Spectrum is available only by mail order and is only on sale in the UK — there are no plans yet to market it through retail outlets, as is done with the ZX81 through W H Smith, and export versions are not planned until the end of the year, with the USA being the first (and largest) market to get the new machine.

Peter Rodwell

is at the bottom left-hand corner of the screen. You can define up to 21 graphics characters of your own which is a superb feature if you're into writing your own Space Invader or Pack-Man games. I had a lot of fun drawing and animating little people on the screen. The nice thing is that you can do all this sort of thing without leaving Basic. A BIN (binary) notation has been introduced which allows you to define numbers as a series of 0s and 1s — just the ticket for designing funny characters. Each character comprises eight lines of eight points, so a succession of eight BIN numbers is all you need to define such a character. Another use for user-defined graphics is to squeeze some extra colours out of the machine. If you lay out the 64 pixels like a chess board and choose suitable INK and PAPER colours then you can get some interesting effects. Most of them will be awful but persevere — some will be good.

You won't be surprised to learn that line drawing and circle plotting are achieved using the DRAW and CIRCLE commands. A PLOT command allows you to plot single points. POINT enables you to find out whether a parti-

cular pixel is set. You always DRAW from where Spectrum thinks you are on the screen. For example, a command DRAW 10,10,pi would draw a semi-circle ending up 10 places to the right and 10 above the current position. A fraction of pi would provide a different arc while zero, or no third argument (DRAW 10, 10) would draw a straight line. The curve can be drawn on either side of the centre line by making the third argument a positive or negative number.

The CIRCLE command uses three arguments: x-axis, y-axis and radius. Remember, the OVER command can be used to erase something already drawn. I used this feature in conjunction with DRAW, PLOT and CIRCLE to create cartoon effects. OVER is also useful for embedding text in a drawing. When set on, the text merges with the existing lines in the drawing. When set off it prints the full 8x8 character, completely replacing anything already displayed at that position. Incidentally, SCREEN\$ can be used to return details of the contents of a character position. Used in conjunction with the PRINT AT command, this could be a good way of

Spectrum Basic

Functions

ABS	ACS	AND	ASN	ATN	ATTR	BIN	CHRS	CODE
COS	EXP	FN	IN	INKEY\$	INT	LEN	LN	NOT
OR	PEEK	PI	POINT	RND	SCREEN\$	SGN	SIN	SQR
STR\$	TAN	USR	VAL	VAL\$				

Operations

+ - * / = > < <= >= <>

Statements

BEEP	DATA	GO TO	LOAD .DATA	OVER	RETURN
BORDER	DEF FN	IF .THEN	LOAD .CODE	PAPER	RUN
BRIGHT	DELETE	INK	LOAD .SCREEN\$	PAUSE	SAVE
CAT	DIM	INPUT	LPRINT	PLOT	SAVE .LINE
CIRCLE	DRAW	INVERSE	MERGE	POKE	SAVE .DATA
CLEAR	ERASE	LET	MOVE	PRINT	SAVE .CODE
CLOSE	FLASH	LIST	NEW	RANDOMIZE	SAVE .SCREEN\$
CLS	FOR .TO .STEP	NEXT	NEW	READ	STOP
CONTINUE	FORMAT	LLIST	OPEN #	REM	VERIFY
COPY	GOSUB	LOAD	OUT	RESTORE	

SINCLAIR ZX SPECTRUM

making your program find a suitable place to print a sort of 'label' on a drawing. The AT allows you to define the row and column at which printing should start.

A few instructions I particularly noticed as I went through the manual were READ, DATA, RESTORE and VAL\$. READ and DATA are old friends although I can't remember them being on previous ZX machines. Using the DATA command you can provide lists of information at the beginning of a program. Each READ instruction takes the next word from this list. RESTORE can be used to set the DATA pointer to any DATA statement. VAL\$ baffles me — it strips the outside quotes from string expressions and returns the string value of the result. Perhaps some kind reader would care to suggest a worthwhile application for this feature.

Now let's have a look at our honestly named friend, BEEP. There's not a lot to tell, really, except that you can control both pitch and duration. Notes below middle C are represented by negative numbers, those above by positive. Twelve numbers make an octave. (If you look at a piano keyboard you'll find that there are seven white notes and five black notes per octave.) Middle C is zero. The duration is expressed in seconds or fractions of a second. As I mentioned earlier, the sound isn't brilliant but it has the saving grace of being fairly quiet (ComputerTowns please note). You can pick this sound up from the cassette ports if you so wish. I'd say these facilities are more likely to be used for sound effects than composing symphonies.

That's really all I have to say about the Basic. It is a very good implementation for a machine of this size. A PAINT instruction would have been nice to fill in graphics shapes, but I think it would look a bit weird in multi-colour mode with the colours changing at each character boundary. A routine to do this should be simple enough. I think the screen resolution is quite adequate for most personal users of the machine. In fact you can churn out some quite stunning effects using DRAW, PLOT, CIRCLE and the user-defined characters.

Before moving on to documentation, here's a list of the disk commands just to whet your appetite: CAT, CLOSE, DELETE, ERASE, FORMAT, MOVE, OPEN. CAT is probably short for Catalogue which lists the files on a disk. MOVE probably copies a file from one place to another. The others are self-explanatory.

Documentation

Two manuals come with the Spectrum — a thin but useful introduction for the complete novice and a thicker one which explains things in depth. A lot of effort has been put into this latter manual. It is professionally presented and easy to read. Unfortunately, I was given a photocopy of the final proofs and it contained no index and no table

of contents. I read the whole manual a couple of times before starting the review and I found it a real problem to find things that I knew were there somewhere. I must admit that the style wasn't to my liking; it's a little verbose and the individual chapters seem to lack structure. I also found the inevitable errors which might cause a beginner problems — things like a minus sign being printed instead of equals, for example. The manual certainly seems to cover everything, so if a table of contents and a comprehensive index are added you'll probably find it adequate. It's certainly an improvement on many manuals on the market.

Potential use

This is the first machine that I've reviewed since the Atari two summers ago that I would actually buy — in fact I will have probably ordered one by the time you read this. I would use it for fun, for fooling around with graphics and for programming in Z80 code. I would treat it as a hobby machine, a way of relaxing. My children have already become very interested in the graphics capability and I see this as a way of giving them a real understanding of mathematics. A Logo system on this at the right price would go down an absolute treat — if anyone out there thinks of doing it, I'd love to review it. Of course, there are those who want to learn to write programs. Once again, this is an excellent machine to cut your teeth on. I think that schools and homes have got to be the prime targets for Spectrum at the moment.

Later on when the disk drives appear, this may change. At a predicted £50 for a 100k drive, a lot of people who will have written the Spectrum off as a hobby machine will have to think again. Add to that a £20 combined RS232 and communications facility, and you could be talking about some very interesting and fairly sophisticated networks. At that stage, it becomes a very real prospect for schools looking for a fairly grown-up system, but one which can involve as many pupils as possible. At Sinclair's prices could we possibly be heading for the 'one on every desk' scenario painted by so many futurologists?

Until those disks arrive there is no great office potential for the Spectrum. Once they're on stream then it's probably just a question of appropriate software. Information management and Visicalc-type applications would seem to be the most likely and, because of the price of the television, they will probably be used with portable black and white machines. No doubt the dedicated will take their Spectrums (or is it Spectri?) home to plug into the colour TV. Most people will probably wait until Sinclair announces a flat screen colour television. The network

idea could then be useful in offices for things like telephone directories, noticeboards and memos.

Prices (inc VAT)

16k Spectrum	£125
48k Spectrum	£175
32k Memory	£60
Microdrive disk	(estimated) £50
RS232 + Comms	(estimated) £20
ZX Printer	£59.95

Conclusions

Well, for the benefit of those who only read the first and last paragraphs of these reviews here are my conclusions: Clive Sinclair has produced a very good 16k personal computer which offers colour, high resolution graphics and limited sound for just £125. That represents very good value for money provided that this is the sort of machine you want. It is ideal for people who want to learn about computing and have a lot of fun while they're doing it. Given the right sort of graphics-based educational software, it can bring people very pleasurable ways of learning subjects such as mathematics and geography. Once the games programs start to appear, a lot of people will use it just for that, although it does seem a bit of a waste.

Later on, the provision of disk drives and communications facilities will make it an even more serious contender for the school markets and it will begin to creep into businesses. When the flat screen television appears then I suspect that the business interest will rise because the price will be far more appropriate. Bulletin boards, memos, telephone directories, spreadsheet calculation and information management seem to be the most likely applications.

The 'proper' keyboard is a distinct improvement on its predecessors, but it still doesn't achieve — or try to achieve — the quality of an IBM. All the old regular Sinclair features are included — the single keyword entry and the automatic syntax checking as you enter each command, for example.

My verdict? The best value for money you can find today! **END**

I would like to thank John Mathieson of Sinclair Research for so patiently answering my questions.

Benchmark timings

BM1	4.8
BM2	8.7
BM3	21.1
BM4	20.4
BM5	24.0
BM6	55.3
BM7	80.7
BM8	25.3

All timings in seconds.

Technical data

CPU:	3.5 MHz Z80A
Memory:	16k Dynamic RAM, 16k ROM, 32k expansion option
Keyboard:	40 keys rubber moulding. 183 functions + 8 colour labels. Auto-repeat
Screen:	Domestic colour television. 8 Colours or 6 grey shades.
Cassette:	Domestic recorder.
Disk drives:	To be announced. 100k per drive.
Ports:	To be announced. RS232 & comms.
Language:	Basic in ROM

SCREENPLAY

This month Dick Olney reviews

games for Commodore's VIC-20

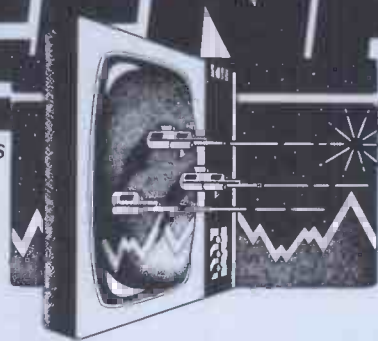

Hardware

The VIC-20 is part of Commodore's marketing strategy of gearing its products to more specific markets and attempting to exorcise the spectre of the PET (CBM is, it seems, upset that this rather endearing brand name has become so integral to its 'corporate image'). It is very much a home machine, offering colour graphics and sound through a domestic TV (see Benchtest in September '81 PCW). To keep the price as low as possible, however, the basic machine carries only 3k of user RAM. This means that for most of the cassette-based games (ie, those not supplied by Commodore), you'll

need a 3k RAM expansion and even then the complexity and presentation (though not necessarily quality) of these programs is rather inhibited by the lack of space.

The configuration I used would cost £165 for the CPU unit, with an extra £40 for the cassette and £26 for the 3k RAM (ex VAT), making a total of £231 — though the same set-up with 16k RAM (as offered by most machines in this range) would cost you £270. Some of the games use a joystick costing £7.50 and the Pinball uses a pair of paddles.

The operating system on the VIC is refreshingly friendly, giving clear messages as to what it is doing when

loading in from cassette, which makes the machine very easy to use. Overall I have only two complaints regarding the hardware. Firstly, the lead going to the television could be a bit longer, though of course it would be easy to extend it yourself. The second criticism is rather more important and regards the ROM packs on which nearly all the Commodore games are supplied. The edge connector on these is very exposed and quite difficult to guide into the socket on the back of the CPU unit. This makes them highly susceptible to damage, particularly if they are to be handled by impatient children.

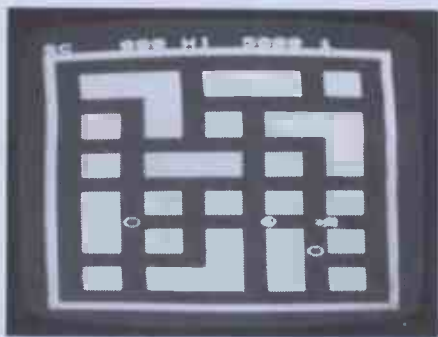

Game: Alien
Supplier: Commodore
Price: £19.95

Another descendent from the arcades, this game takes its general principles from a machine called 'Space Panic'

which I have always felt was rather understated. You are being hunted by aliens in a maze and the only way to destroy them is to dig a hole, wait until one falls in and then bury him. Space Panic showed a vertical section with several floors and the creatures would actually drop through the holes but in Alien you are given an aerial view and thus there is only one level. The enemy are quite fast but very dumb so they won't necessarily find you — but if your time runs out all hell breaks loose with hordes of super-fast aliens appearing from nowhere.

Movement can be controlled by either the keyboard or the joystick. Digging and filling, however, are initiated only through the keyboard (the 'A' and 'D' keys) so if you use the joystick you will find you need three

hands to operate the game properly (can this mean that Commodore plans to bring out an add-on limb interface?). I overcame the problem by grasping the joystick between my knees and I'm sure there are other possibilities! Despite a good response time and reasonable graphics Allen is not nearly as good as its predecessor but it still has a certain unique quality that makes it attractive.

Value for money: ***
Use of graphics: ****
Addictive quality: ****
Response speed: *****

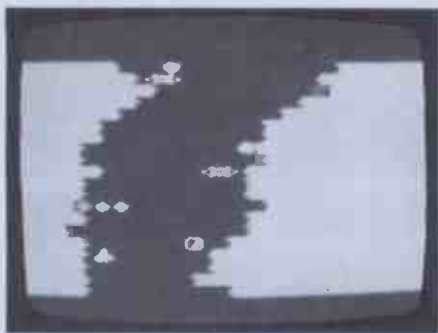

Game: Canyon Fighter
Supplier: The VIC Centre
Price: £5.95

Another program loaded in two parts with the first setting up the graphics. This one seems to be widely based on the arcade game Scramble (last month's Arcade Ace). There is a slightly

different version on each side of the cassette, one using the joysticks and the other the keyboard. You guide a space-ship through a jagged (and in some places very narrow) ravine. The game has a vertical orientation so in fact you just move the ship left and right as it moves downwards at a steady rate. Your aim is to avoid crashing into the walls or asteroids and, if possible, to destroy enemy ships and fuel bases. As in Scramble, you have limited energy which is replenished only when you hit a fuel base. At the end of the game (when you are destroyed) your score and the amount of remaining energy are displayed. It is one player only with nine skill levels.

Unfortunately there are a number of design faults in this game which ruin what might otherwise be a lot of fun. Fairly frequently the game starts, only to be immediately terminated as your

ship materialises right next to the wall. Considering the rather poor control you have, the game gets far too difficult at higher skill levels and there is occasionally an impenetrable line of asteroids blocking your path. The only sound is when you fire or crash and the graphics are less than inspired. Having said all this I should hastily add that the game is fairly addictive — it just needs a bit of polishing up.

Value for money: ****
Use of graphics: **
Addictive quality: *****
Response speed: ***

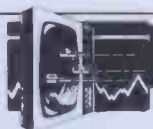

SCREENPLAY

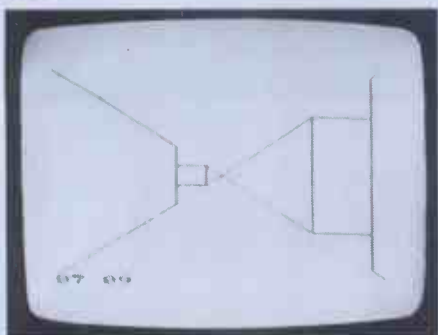

Game: 3D Maze
Supplier: Hi-Tech
Price: £8.63

The name of this game is perhaps slightly misleading. One might be led to think that your task was to find your way around a three-dimensional maze but in fact — from a playing point of view — the maze in question quite definitely has a mere two dimensions. The 3D refers to the line perspective representations of the walls and entrances displayed while you are inside it. You can look at an overall map at any time, so the trick is to find a position compatible with the short range view you are given of the corridor. Movement and mapping are controlled by either the joystick or the keyboard. This must have been an interesting

graphics project but as a mind teaser it has severe limitations. I'm afraid the distributor's proud proclamation that 3D Maze provides 'hours of endless frustration' is highly exaggerated (though I'm not sure how inviting that sounds anyway!).

Value for money: **
Presentation: **
Use of graphics: *****
Addictive quality: **



Game: Rat Race
Supplier: Commodore
Price £19.95

Using either the joystick or the keyboard, your task in this game is to navi-

gate a mouse through a maze; it is running from a group of deadly rats while attempting to eat 10 pieces of cheese. It is in most respects identical to an arcade game (whose name escapes me) which is based on racing cars and flags. In the latter there is an extra hazard of oil slicks, here replaced by stationary black cats. You are given a short-range view of the maze and also a small-scale plan showing just the relative positions of rats, cheese and your mouse. Your only defence against the rats is to lay a 'star screen' in their path which temporarily confuses them. This, however, uses up your time units and so must be used sparingly. The score value of the cheeses increments as you eat them and one of them doubles the value of any subsequent meals.

After completing a couple of runs you play one frame against the clock in which the rats remain stationary; after this the number of rats increases. You lose a life (you are given three) each time a rat catches you, you run out of time or if you run into a black cat. I used to thoroughly enjoy playing the original version of this game and Rat Race is no less attractive. It should particularly appeal to those afflicted with the recently isolated disease 'Puckman fever', now apparently reaching epidemic proportions in the USA.

Value for money: ****
Use of graphics: ****
Addictive quality: *****
Response speed ***

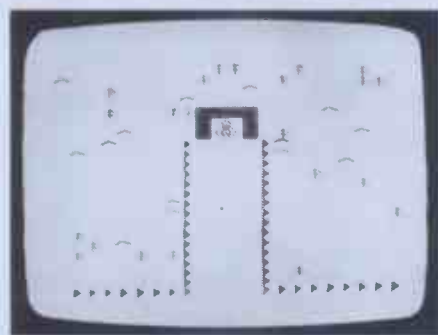

Game: Ski Run
Supplier: Rabbit Software
Price: £10

One way to improve on the memory limitations posed by the VIC is to load

the program in two parts, and Ski Run is one of the many games which use this technique. The first part displays the playing instructions and sets up the graphics, while the second actually runs the game, of which there are three variations. It basically involves guiding a cleverly depicted skier down a mountain, avoiding snowdrifts, trees and flags. In Slalom and Giant Slalom, the idea is to ski between evenly spaced pairs of marker flags (in Giant Slalom the flags are more widely spaced) while downhill involves following a narrow fenced track. A skill level of one to nine determines the quantity and complexity of the hazards. The skier moves quite fast at a steady speed and you move it left or right using the 'A' and 'D' keys (there is one joystick option). If you manage

to complete the course, you are given a time for the run.

The graphics, though hardly complex, are remarkably effective — especially the sideways movement of the skier — as is the steady whooshing sound. Although Ski Run may not be particularly sophisticated, it is well designed and executed and is certainly worth looking at.

Value for money: ***
Use of graphics: *****
Addictive quality: ****
Response speed: ****



Game: Blitz (cassette)
Supplier: Commodore
Price £4.99

There are a number of versions of this game around for various machines. The basic principles are extremely simple. The program builds a city (looking rather like New York) with 18 skyscrapers of various sizes (it changes in each game) and you use the space bar to bomb it from an airplane travelling across the top of the screen. The latter is gradually getting lower so you must destroy the buildings before you crash into the side of one. You can only have one bomb at a time on the screen and they drop quite slowly so you must be extremely selective about your targets. This game is much more difficult than one might think and demands

quite a high degree of skill. The presentation, graphics and sound effects are all impeccable and the give-away price makes Blitz a must for all VIC owners.

Value for money: *****
Use of graphics: *****
Addictive quality: *****

PERSONAL COM

age
nd
way
an,
ian,
ese,
r a
age.
s, Se

nt
DIY
or a
Way,

nop
on

LONELY Genie I Microcomputer, early eighties, with large peripheral family but currently unattached, would like to meet interesting, attractively packaged software, Genie or Tandy specification, for programming, problem solving, entertainment and long-lasting friendship. Reply in confidence. Box No RS232.

LON
intel
vated

ATTI
wish
may
mar

SO
me
(mu
tion.
hum

MAI
to
war
wis
C

ANSWERING MACHINES
Office certified



**ingenious
...but lonely!**

Buying your first Genie I microcomputer is just the start of a long and enthralling adventure, for it won't be long before you will want to expand your system with some of the wide range of peripherals which make up the complete Genie System.



Firstly there is the **Expansion Box**, which immediately expands your Genie's capacity to 32K RAM, and up to 48K RAM if required. It can be connected to 4 disk drives, a printer, RS232 interface or S100 cards.

The supreme advantage of the Genie I system is its compatibility with the TRS 80, which means that literally 1000's of pre-recorded programs are already available, just waiting to be plugged into your Genie!

The recent improvements in the Genie system, including Extended Basic, sound unit and machine language monitor, make it the ideal system for the committed hobbyist, and an excellent and easy-to-use educational tool.

Then there is the **Printer**,

a compact unit with 80 column, 5 x 7 matrix print-out, which connects to your Genie through the Expander, or via the Parallel Printer Interface.



**SPECIAL TECHNICAL GENIE
HOT - LINE ON 0629 4995**
for all your technical advice and service back-up on any aspect of the Genie system direct from the experts!



The **Disk Drive** gives you greater storage capacity and full random access file handling, with the option of double-density through a special adapter. New Dual Disk Drive now available!

Please send me FREE, 16 page colour brochure on the Genie Computer System. I enclose 25p postage.

Name _____

Address _____

Telephone _____ PCW-82

Finally, there is Genie's very own **12" Monitor**, a must if you want to let the rest of the family watch their T.V. in peace!
Available in B & W or green tube.



LOWE electronics Chesterfield Road, Matlock, Derbyshire DE4 5LE.
Telephone: 0629 4995.
Telex: 377482 Lowlec G.

First things first. Small business computer hardware or software - which comes first? At Peachtree we know that software has to come first.

It's all a very confusing business at the moment. The microcomputer is growing up, making computer power accessible to thousands of smaller businesses and to departments of larger organisations who couldn't justify it before. The trouble is, you are forced to choose a computer first (the hardware, like the tape recorder) and then find the programs (the software, like the music) to make it do what you want.

Peachtree has changed all that. There is no question now which comes first. It must be the software.

For the first time ever, the small computer user (like the large computer user) has the option of choosing a coherent, complete and comprehensive set of *business software products*, all from the same company, all designed to work together.



Peachtree Financial Management Tools Nominal Ledger and Budgeting, Financial

Forecasting, Purchase Ledger, Sales Ledger, Inventory Management.



Peachtree Business Management Tools Sales Order

Processing, Payroll Accounting, Name and Address Management.



Peachtree Office Management Tools Word Processing,

Automatic Spelling Dictionary, Communications to other computers.

Until now either you, the user, or your computer supplier have had to cobble together a collection of products from different sources to meet some or all of these requirements.

Now - for the first time - your computer supplier can offer you the full set, (or the parts you need to start with) plus all the service you need, from one source.

This means that your software systems are easier to install and you get a quicker return on the investment you make in your computer.

It means that the systems all work

First things first.



together, enabling you to get more out of your computer.

Because Peachtree software works on so many different types of computers it also means you're more likely to be able to take your application systems with you as you expand your use of computers in the future. You will be able to protect your investment in computer systems as you grow.

Until now microcomputer software has been a jungle. Now MSA, the world's largest company specialising entirely in business computer software products for large computers (nearly £40 million worldwide sales in 1981), has joined forces with PEACHTREE SOFTWARE, the world leader in these products for microcomputers.

Together we make an unbeatable combination. As a public company, MSA has the resources to *guarantee* you and your computer supplier support, both now and in the future. Peachtree software is supplied by computer manufacturers themselves, on a whole range of small computers - including the new IBM personal computer.

Now you can go and buy your computer. Ask for Peachtree business

software products in the confidence that

you will receive skilled and professional advice in their use from your computer supplier, backed up by Peachtree

We work through local computer service companies because they are close to your office and your needs.

So, first things first: Send us the coupon or your business card or letterhead. We'll send you the name of your nearest supplier, along with a detailed description of Peachtree business software products and a full explanation of the importance of software. Or telephone Miss Susan Jane at Maidenhead (0628) 71011. Peachtree Software International, MSA House, 99 King Street, Maidenhead, Berkshire SL6 1YF.

I'd like to know more about PEACHTREE business software products.

NAME..... TITLE.....

COMPANY.....

ADDRESS.....

TELEPHONE NUMBER.....

PCW/6/82



AN MSA COMPANY

Please return to Susan Jane, Peachtree Software International, MSA House, 99 King Street, Maidenhead, Berkshire SL6 1YF Telephone Maidenhead (0628) 71011 Telex: 847400 MSAUK G MSA (Management Science America) Ltd is a subsidiary of Management Science America Inc.

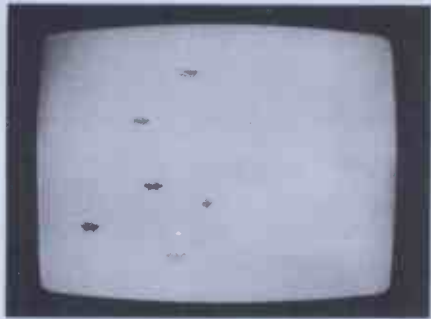

Game: Invader Fall
Supplier: Hi-Tech Ltd
Price: £8.63

Based on Space Invaders, this is a simple, one-player game which

uses a joystick or the keyboard to move a traditional firing platform around the bottom of the screen. Instead of the usual marching formation, the invaders appear randomly at the top of the screen and move directly downwards. As might be expected, you are destroyed if any of them reach the bottom. The invaders themselves do not fire any missiles at you, although the occasional flying saucer makes up for this with highly accurate and rapid artillery.

One of the best features of this game is the series of bright colours which the invaders take on during their descent (the screen background is white). As with many of the VIC cassette-based games, the program is kept down to size by excluding common features of

presentation such as a running score or players' initials; you simply play the game and are told your score and how many shots you fired at the end of it. Despite this, Invader Fall combines traditional Space Invader playing concepts with its own unique qualities and a very reasonable price to create a fast moving and addictive game which is well worth the money.

Value for money: *****
Use of graphics: *****
Addictive quality: *****
Response Speed: *****

Game: Adventure Island, Pirate Cove, Mission Impossible, The Count, Voodoo Castle
Supplier: Commodore
Price: £19.95 each

This set of Scott Adams Adventure games is due out soon on Commodore's own ROM packs. The ones I was sent had apparently only just arrived in this country and were each held on a pair of

EPROMs (TI264s in fact) poking from the standard packaging. I can't claim to have fully completed any of them but I did have a good look at them all. Their format is completely standard with no concessions to the VIC's graphics capabilities except coloured text. All of them are imaginative and complex and should certainly provide hours of entertainment even for the most cunning adventurer. The price is a little high,

unfortunately, considering the single completion redundancy of such games; but if you can afford it, you'll not be disappointed.

Value for money: *****
Presentation: *****
Complexity: *****

Conclusion

Except for the memory restrictions I mentioned at the beginning, the Commodore VIC-20 has all the makings of a superb games-orientated home computer and this has been reflected in its popularity. The general quality of

the games is quite high and I was particularly impressed by the way some of the cassette software overcomes the lack of space. Commodore seems to be developing a very good selection of ROM packs, which is greatly enhanced by the introduction of the Adventure games. The graphics could be better,

but used properly they yield some good results. The price of this machine makes the VIC not only a strong contender in the home market but also a viable alternative to a non-programmable games console.

ARCADE ACE



Having so far concentrated on well-established classics the game I have chosen this month is rather more recent, although it already has a good following. It is called Frogger and is definitely in the Puckman rather than the Space Invaders genre. You control a small green frog using a joystick to move and a button to jump. It has to cross a road followed by a river in order to reach its home on the other side of the screen. The road is crowded with vehicles of various types which speed up as you work through the frames and must be negotiated using the joystick. Since the frog is unable to swim the river due to a stream of logs (and the odd crocodile), he must jump from log to log, taking care not to be swept away. As you progress other creatures appear presen-

ting further hazards.

I can't claim to be an expert at this, though the small boy who was playing when we took the photograph most certainly is. The graphics on Frogger are extremely good, however, with all sorts of nice touches which make it an interesting spectator sport. Timing is the essence of this game, which requires quick and careful planning if you're to avoid getting squashed. It may not be as hectic as a space battle but it demands just as much concentration. The concept behind Frogger is pretty sick in a harmless sort of way but the game itself is amusing and challenging.

END

FRAMES OF REFERENCE

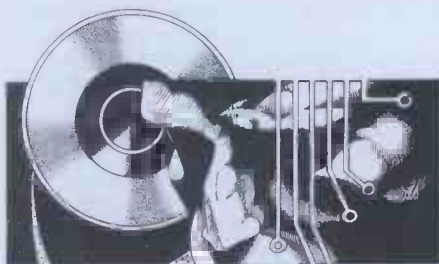

A DP MANAGER'S GUIDE TO MICROS

By Alan Wood of Digitus Ltd.

It is easier to determine what micro-computers are not good for than it is to describe the numerous applications for which they are suited. Micros are not good for handling vast files of data, for handling many users simultaneously, or for handling huge number-crunching tasks. The practical hardware limits of today's micros are: 1 megabyte of RAM, 100 megabytes of disk store, eight users on a multi-user system or about 24 single users on a network.

The software limitations of micros are more significant than the hardware limits. The development of a multi-user or network operating system is not a trivial task; such software takes many years of talented design and programming to produce and many more years before it is largely debugged. Some of the offerings in the micro market are simply not credible, although there are excellent examples of software, eg, the Unix implementations and Xionics Xibus/Xinet. The software available on micros is lacking when it comes to organising and getting rapid access to data in large files. There are few languages and operating systems with even ISAM facilities and there are fewer database management systems.

It is important to get the limitations of microcomputers in perspective before you consider their application and place in your company. It is also helpful to start with a working definition of the operational differences between computers:

A mainframe is a computer which requires an operational department to run it.

A mini is a computer which requires an operations manager to look after it.

A micro is a computer which is operated by its user.

Microcomputers offer a number of benefits compared to their computing antecedents: rapid delivery... from one to four weeks; low entry cost... £6000 for a complete single user system that could grow to a 24-user network; fast implementation... complete small systems installed three months from order and no system installed in longer than six months; package abundance... low cost implementation and maintenance; physical size... micros pack more and more power into desktop units — yesterday's mini literally fits into today's desk.

The disadvantages of micro-computers in the hands of users can be described as:

1. Publicity greater than performance... microcomputers do not equal mainframe computers; the cost of a system does not equal the cost of the hardware — personal computers are good as super-calculators but not as file processors.

2. Users are not disciplined enough to have own computers... floppy disks get lost/disorganised, data backup is not taken regularly if at all, hardware is abused with dust, coffee and crumbs.
3. Hardware and software limitations not understood... a little knowledge leads to doing dangerous things, DP departments adopt a 'not invented here' attitude and refuse to get involved/help until the user is humbled by mistakes.

PART 6: PUTTING YOUR MICRO TO WORK

4. Surreptitious microcomputing... micros sneaked in by users, little, no or fallacious justification, self-indulgence in doing interesting things in computing (previously the prerogative of DP people only!).

Applications

In addition to familiar data processing tasks, the cost of micros justifies new applications which were previously uneconomic, impractical, or low on the priority list. Data processing departments have seriously underestimated the role of micros, associating them with game playing and trivial tasks. Microcomputers are extensively displacing and supplementing timesharing services with significant cost savings; they are replacing tasks previously undertaken on minis, much as minis usurped the position of the low-end mainframes; and they are pushing computing facilities further up and down organisation hierarchies... the first computer on the director's desk is often a micro.

The computer manufacturers of the '50s and '60s found an eager market in the commercial and industrial companies whose operation and expansion was inhibited by manual systems. The first systems they installed were a computer replication of what was there already. Then the systems became more

sophisticated, reflecting new services companies could offer, such as credit card facilities and airline reservations. The increasing complexity of those systems led in turn to bigger computers. At the same time, the individual manager's job grew in complexity to a point where computers were needed to aid decisions. The data needed for those decisions is not easily abstracted from traditional data processing systems in the format the manager needs. Consequently, the microcomputer manufacturers have found an eager market among professionals in large companies hungry for computer assistance. The microcomputer is excellent at handling the top layer of management information. It can be applied to taking a lateral view of data in a hierarchical data processing system. It can be applied to calculating and assembling data in a digestible form. In the hands of an intelligent user it functions as a brain-extender to help reduce costs, make better returns on investments, sharpen negotiations and provide 'considered' responses more quickly.

Personal and company systems

It is important to distinguish between the personal and the company system, between personal data and company data. Personal data can be defined as 'unique to an individual'; company data is 'integral to the company'. An engineer working on a project will have data unique to him on which calculations need to be performed. Similarly, scientists, managers, accountants and executives have unique data requirements. The needs of this group can be partially satisfied by a personal system which has some of the following characteristics: uses unique data; is applied as a super-calculator or electronic file index; encourages computer literacy; supplements/replaces time-sharing service; prepares for future electronic office; uses programs and packages which do not require central support.

One danger associated with personal systems is that managers will spend more time learning programming and playing with computers than managing. In practice, what is tending to happen is they put in extra hours in the evening and weekends and also encourage junior office personnel to become computer literate. A more significant danger is the creeping system: the simple personal system which creeps into a company system with all the dependencies that this implies but none of the essential standards or controls.

Company systems are, by definition not unique to an individual but integral

to a company. They develop as the company develops and they require control and support. If the company system's operator, manager or user leaves it is essential that the system can be passed on, understood and operated by his or her successor. Micro-based company systems are similar to traditional data processing systems, even if they are used like 'link-less' terminals. There are many examples of such systems. They lend themselves to company-developed packages which can be used at a number of sites: warehouse stock location, local stock recording, stock taking; 'specials' purchasing, goods receipt; personnel records, career/salary administration, graduate recruitment; depot, division, department, and branch record keeping; quotations, contracts, proposals and project administration.

Fertile areas for micros

The 'no-man's land' for microcomputers is between what users want and the border with existing mainframe systems. If you leave aside that territory, there are still acres of applications untouched by existing company systems. Two of the most rewarding areas are office systems and timesharing replacement, sometimes in combination.

The functions performed in offices up and down the country are basically similar. The typically comprise calculating, record keeping, typing and communicating via telephones and mail. These functions suit standard systems and packages because they are so alike.

The off-the-shelf microcomputer can perform most office functions using packages, with a few tailored programs to meet justified special needs. There is a variety of standard calculation aids, such as Visicalc and Supercalc. There is a choice of information managers from the simple electronic index, Visidex and Cardbox to the more detailed electronic file cabinet, Auto-Index, DataStar and DMS. Word processing packages abound, often in combination with record keeping (eg, WordStar/DataStar, Silicon Office) and with other facilities like spelling dictionaries (Spellguard, Spellstan). A feature of networked micros is the ability to send messages to other users of the network, such as Nestar and Xinet. Micros can also be used with acoustic couplers and modems to communicate messages over the public telephone system, so authors creating text on a home computer can send it down the line to the publishing house central machine.

The point has already been made about the limitation of the micro as a super number-cruncher. Timesharing services thrive on the software and databases they offer; they will continue but cursory analysis reveals that many of the smaller programs can be run on micros and many of the new micro packages offer a top cut off the timesharing service at a fraction of the cost.

The trend began with tools like Visicalc, a rows-and-columns program providing a matrix of 64 columns by 200 rows, automatic re-calculation facilities and a variety of mathematical formulae. Visicalc is much friendlier than timesharing programs which do not provide screen interaction. It has been followed

by a variety of other aids — Micro Modeller and Micro Finesse for financial modelling, Micro Pert and Micro-Planner for critical path applications, Optimiser for linear programming. More management aids and personal productivity programs will follow. The 16-bit desktop micros with these programs will eat further into timesharing spend. Using micros for front-end data entry is also an economic extension of your timesharing service, so that you keep connect costs and phone bills down. The added facilities that the micro provides off-line combined with use as a terminal are valid justification.

In some departments dedicated word processors are required, eg, updating from a typing to a word processing pool. In others, the general-purpose microcomputer with word processing software provides an economic and versatile solution. At today's prices, £5000 buys a high-quality micro with a daisywheel printer and word processing software. The software is not as friendly or as feature full as the specialist word-processors, but the fancy features for which those machines are bought are seldom used. Applications combining data processing, word processing, information processing and number processing are ideally satisfied by microcomputers. A small bonus (or hazard, depending on your point of view) is the extension of keyboard skills in the organisation and the dispersal of some typing to two-fingered word processing users.

Data processing on micros

It is in their application in data processing that microcomputers cause most agony, antipathy and indecision in larger companies. Just how far should you let them go or grow? The hardware and, particularly, the software limitations of micros automatically exclude them from many applications, although the boundaries are being pushed steadily outwards. The cost of converting software on existing systems is another natural boundary to micro encroachment. Then there is the preservation of computing skills and all those hard-learned standards and controls built up over the years. And superimposed on the top is the company organisation and computing policies. Is yours a heavily centralised organisation, with controls flowing outward from the centre? Or does your management favour operating in relatively autonomous groups with just top-level financial controls?

In the Big Brother company, the best micros to use are the first level personal computers, perhaps with mainframe communication. In the Little Brother company, there is a lot of scope for more powerful micros. The network of micros has a place in both centralised head offices and in dispersed organisations.

For the most part, ledger applications will be well taken care of and will be much too big for micros. However, some of the small business subsidiaries of big companies can fit quite nicely and quickly on to a microcomputer. Examples are overseas or remote small companies, companies acquired in a takeover, companies set up to market a new product of service. Another common application for micros in large

companies is executive payroll — often a tedious job for the company secretary or financial controller.

There's a whole variety of standard application packages for ledger applications so it should not be necessary to develop special software, other than a small number of tailored programs. Reputable suppliers include MicroProducts Software and Omicron.

The minicomputer made great headway as a machine dedicated to regional and branch order processing and stock control. The micro is equally successful for smaller order processing systems, as a single-user, or networked configuration. A number of big companies use micros for local stock control and repeat the same system in lots of locations, eg, Shell. There are a variety of order processing and stock control packages, eg, Omicron, MicroProducts, Paxton, Peachtree. Purchase order processing, particularly specials as opposed to bulk purchasing, is a common micro application in the larger company.

Teletype communications and 2780 and 3270 emulators provide the means of connecting microcomputers to mainframes. The other popular protocols are gradually appearing from computer manufacturers and from independent vendors. The availability of such software removes one of the main deterrents to DP applications on micros; the micro becomes simply an extension of the existing facilities. A microcomputer used locally for a variety of tasks can be switched to an intelligent terminal to talk to, and receive data from, the mainframe computer. As more protocol software becomes available, micros will be used to replace expensive emulation terminals. Suppliers of communication software include: Micro Integration with Bysync 2780, 3270, Lifeboat with RBTE, Winterhalter Associates also with 2780/3780 and 3270 emulators.

Multi-function applications

The microprocessor is overturning the traditional approach to multi-user, multi-tasking computers in a number of ways and providing new options in multi-function computing.

The mainframe and minicomputer solution to providing access for many users to an information facility has been to share central memory and store. A sophisticated operating system handles the management of many users and tasks, apportioning part of the memory and store to each task, handling queues of users and protecting files from corruption through simultaneous access by more than one user. Advanced multi-user computers partition and use virtual memory, allocate priorities and have extensive security and data management features, all of these house-keeping tasks consuming an increasing proportion of the power of the computer — for example, if you have an IBM environment you virtually need one machine to manage CICS and IMS and another machine to run your applications.

Multi-user and multi-tasking

There are two solid justifications for large computers for multi-user work.

FRAMES OF REFERENCE

The first is where a vast amount of data has to be stored and manipulated. The second is where many people must share data and have access to it at the same time; the classic example is airline reservation systems.

The justification of multi-tasking — the performance of many jobs simultaneously by one computer — is based more on economics than the need for big computers *per se*. Multi-tasking can still be justified where it is more economic to fulfil applications on one big machine, rather than on a series of small ones. If the applications are up and running, it may also be cheaper to keep them there because of software conversion costs. However, if the applications have not yet been implemented, or have to be updated, or the computer has to be changed, a series of machines performing one or more different tasks can provide a highly resilient, economic and responsive solution.

There are two simple examples of multiples of microcomputers being used to satisfy requirements economically and securely. Firstly, when the tasks become too many for one machine in an office, a second machine can be installed to meet the expanded requirement. Secondly, when the same jobs have to be repeated in different locations, the distributed microcomputer can be the ideal solution. Set up to produce quotations, keep stock, run an estate or personnel agent's office in one location, the microcomputer can be cloned for as many sites as is economically justified.

The essential characteristic of distributed micro systems is that users do not need simultaneous access to the same files. Transfer of floppy disks from one machine to another or telecommunications to a central point is sufficient to satisfy occasional sharing of information. Because we are used to thinking of traditional multi-user file sharing, we too often jump in that direction without examining the options sufficiently. Even micros stacked one on top of the other can provide more resilience and take up less space than one multi-tasking computer.

Where it is vital for a small number of users to share the same files, a multi-user microcomputer can be employed. On 8-bit single processor machines, the practical limit is about four terminals. The multi-user features are achieved in differing ways; for example, by switching from one bank of memory to another, dedicating memory to each attached terminal. On a bank-switching system, the users share disks and operating system. Speed of response depends on disk speeds, sophistication of operating system and the cleverness of the programmer. Hard disks are essential to provide adequate data storage and response and backup should be available by tape or exchangeable disk. More advanced 8-bit multi-user microcomputers provide several processors to support multiple users.

On 16-bit micros with Unix derivatives or own operating systems, the limit is 16 users and the typical load is 6-12. On these machines input/output is a greater limitation than processor

capacity since most typically operate with only one disk channel. They are well suited to multi-user information management and word processing tasks where all operators must share the same files but where transaction levels on individual records are not very high.

Where a lot of workstations, data storage and peripherals are needed, the trend is to go to local micro networks. There's a variety of systems available, of ascending capability, which at one end of the scale simply share storage media and at the other end enable users to connect micros-to-minis-to-word-processors-to-mainframes.

The Nestar shared resource system enables connection of a series of Apple computers to a central store of data or programs, thus extending store capacity whilst retaining a computer for each individual user. For example, in an accountant's office, each Apple user could be dedicated to his client's incomplete records processing. When the job was finished the accountant could call the 'group' time recording system on the 'shared' resource and log in the time taken on the job for central charging.

The DSC Hi-Net enables its users to connect 30 intelligent workstations at a series of nodes on the network. Attached devices can be microcomputers, 64k terminals or shared resources — eg, winchester disks and printers. Different activities can be conducted at different nodes on the network — eg, word processing, order processing, stock control. The operation is rather comparable to a multi-tasking computer, except that if one microcomputer on the network goes down the others continue to operate.

Xionics Xibus data management and Xinet networking systems come in the most powerful category of networking systems: those providing a highly resilient, general purpose resource to enable unification of the various computing and digital devices in a large organisation. For example, a Xibus/Xinet user in a company with IBM mainframes, DEC minis, Vydec word processors, Zilog microcomputers and Prestel Viewdata can call down on his workstation a mainframe or mini file, or send data to the micro and word processors and later read pages of Prestel — always provided he has the necessary security clearance and access code for those transactions.

Finally, there are both general-purpose and special-purpose computers being built around multiple micro processors, rather than on one processor, eg, the Triton 4 microcomputer with four processors and Xibus/Xinet with multiple processors. To improve resilience and efficiency and to capitalise on microprocessor costs, tomorrow's special and general-purpose machines are being built on a honeycomb of microprocessors, with each cell performing or duplicating a function, all intricately interconnected.

Existing computer users have a wide variety of options and constraints with regard to microcomputing. Should they: connect micros to mainframes?/use micros as 'linkless' terminals for remote tasks?/use micro networks?/or intercon-

nect micros with word processors, minis, mainframes? The new users also have many options; should they choose multiples of micros, a multi-user micro or a micro network to satisfy their needs? There is no absolute answer for either the existing or new user, other than selecting a reliable system at the bottom end of its capability so that it will grow with your needs. The key words are 'reliable' or 'proven' at the 'lower end' rather than at the extremities of what suppliers claim. These requirements limit choices and ease the process of selection, once the more difficult decision is made about what conceptually will suit present and future needs.

More radical thinking

So far we have taken a traditional approach to the new computing, carefully matching capabilities and limitations with possibilities and constraints. Some managers are more radical in their approach to take full advantage of powerful low-cost micros. Forget for the moment that you are constrained by years in DP and by all the computing paraphernalia your organisation has accumulated. Without those trappings, how would you proceed?

Starting at the baseline in your organisation, you could equip every worker from director to office administrator with a computer which would occasionally connect or feed into a central hub. Everywhere you see a typewriter or find a calculator, install a dumb terminal; everywhere there is a telephone, and a few more places besides, you could put in a micro. Connect them by cables and you have a computer utility. Connect your cable to existing minis, word processors and mainframes and you have closed the loop on existing computing. The technology, products and costs are such that radical-thinking managements are achieving or planning this computing scenario now.

The costs of personal computers are comparable to the costs of quality electric typewriters. A network of microcomputers providing calculating power also facilitates inter-office communication. An 'incompatibles' networking facility of the Xinet class enables you to connect your micros and liquorice assortments of mainframes, minis, word processors and information services. The choice for the larger organisations lies between allowing a piecemeal approach or developing a rational architecture for the 80s which will fully employ new technologies linked to existing computing.

The sixth commandment of microcomputing

Thou shalt not treat micros as transaction processing machines. Micros are at their best as single-user or multi-function computers on which each user is processing a discrete task. Micros are ideally suited to office systems, time sharing replacement and intelligent workstation tasks. They are not suited to transaction processing where many users want to simultaneously access and update the same files and records — eg, order processing.

END

PCW SUBSET

Alan Tootill presents more useful assembler-language subroutines. This is your chance to help build a library of general-purpose routines, documented to the standards we have developed together in this series. You can contribute a Datasheet, improve or develop one already printed or translate the implementation of a good idea from one processor to another. PCW will pay for those contributions that achieve Datasheet status. Contributions (for any of the popular processors) should be sent to: Sub Set, PCW, 14 Rathbone Place, London W1P 1DE

Random numbers

There was a misprint in February's RANDM routine, leaving both the mnemonics and hex code incorrect. As luck would have it, J A Lewis of East Grinstead chose

this particular routine to try out on his home-made computer as his introduction to 'Sub Set'. He sent some suitable comments. Sorry J A! The code should have been:

```
RANDM: PUSH AF      ;save          F5
        PUSH BC     ;registers      C5
        PUSH HL     ;save original HL E5
        LD  H,L      ;              65
        LD  L,+10    ;HL<=256*HL+10 2E OA
        POP BC      ;BC<=original HL C1
        OR   A       ;clear carry    B7
        SBC HL,BC   ;HL<=255*HL+10  ED 42
        ADD HL,HL   ;HL<=510*HL+20   29
        ADD HL,HL   ;HL<=1020*HL+40  29
        SCF        ;prepare to add 1  37
        ADC HL,BC   ;HL<=1021*HL+41  ED 4A
        POP BC     ;restore          C1
        POP AF     ;registers       F1
        RET        ;return          C9
```

Another reader more charitably recognised the misprint and sent this improved version of the code, two bytes shorter and 19 T-states quicker:

```
RANDM: PUSH AF      ;save          F5
        PUSH DE     ;registers      D5
        EX  DE,HL   ;save HL        EB
        LD  H,E     ;              63
        LD  L,+10    ;HL<=256*HL+10 2E OA
        OR   A       ;clear carry    B7
        SBC HL,DE   ;HL<=255*HL+10  ED 52
        ADD HL,HL   ;HL<=510*HL+20   29
        ADD HL,HL   ;HL<=1020*HL+40  29
        ADD HL,DE   ;HL<=1021*HL+40  19
        INC HL     ;HL<=1021*HL+41  23
        POP DE     ;restore          D1
        POP AF     ;registers       F1
        RET        ;return          C9
```

This would have made a respectable seeming Datasheet if Dr Brian Ripley of Imperial College of Science and Technology had not written:

'You ask if there are better multipliers: there are! The best reference is indeed Knuth, but the second (1981) edition is needed. He stresses the importance of the spectral test which identifies the problems with all generators known to be bad for other reasons. None of a = 257, 765, 889, 989, 1021 or 2009 passes acceptably. High potency is a necessary but not sufficient condition for a good generator. The choice of a = 257 is dreadful, and a = 765 and 1021 are bad. A search through multipliers from 1 to 2001 with a = 1 mod 4 (so the period is M = 2**16) suggests the

following, in roughly decreasing order of merit: 293, 389, 1509, 249, 1785, 685.

'Little seems known about the choice of c except that it should be odd. All the more powerful tests look at the whole sequence, which doesn't depend on c. The choice of c = 41 seems as good as any.

'A more serious point is whether 16 bits are good enough. It seems that for serious work they are not. The spectral test looks at the lattice of successive k-tuples (X_i/M, X_{i+1}/M, ... X_{i+k}/M). In four dimensions the points of the lattice are at least 1/16 apart, which is very different from the uniform scatter they should have. It would be worth the effort of producing a 32-bit generator. Try a = 69069, 71365 or 100485. 'Unfortunately this is a

rather technical subject area in which many mistakes have been made. (See, eg, P J Brown's comments in 'Writing Interactive Compilers and Interpreters'.) All I can say is that it is one of my research interests and the algorithm used is an improvement on Knuth's.'

So, if we are sticking with our algorithm $X_{i+1} = aX_i + C \text{ mod } 65536$ and 16 bits, we need a routine with 'a' = 1509 (potency of 5, > 655 and < 64880) in order to satisfy all our correspondents. But what about a 32-bit routine with an 'a' of 69069, 71365 or 100485!

This is where W E Thomson of Aldeburgh comes in. For some 20 years he has been unhappy with numbers using a modulus which is a power of 2, because of their non-random nature when you look at the individual bits.

For 16-bit numbers and M = 2**16 = 65536, the leading binary digit, bit 15, has a period of 2**16, but bit 14 has a period of only 2**15, bit 13, 2**14 and so on; the 2nd least significant byte repeats every 256 numbers and the numbers are alternatively odd and even.

W E Thomson prefers the well-known $r(i+1) = u*r(i) \text{ mod } M$, where M is a large prime and u one of its primitive roots, with u and M chosen to avoid full-length multiplication and division. For 16-bit numbers the obvious choice to him is the Fermat prime 65537 = 2**16 + 1 and he sends a routine using this for our first Datasheet this month.

He tells us Sinclair uses this modulus in the ZX80/81 with a primitive root of 75. W E's primitive root, 254, lends itself to simplifying the multiplication.

Datasheet

```
=RANDM-16-bit pseudo-random number generator

;CLASS:2 (not position independant)
;TIME CRITICAL?: no
;DESCRIPTION: generates a 16-bit number from
;              the series r(i+1)=(254*(r(i)+1)
;              mod 65537-1
;ACTION: The 24-bit number p=254*(r(i)+1)-1 is
;         built up in A & HL thus: Let r(i)=256*
;         r1+r0; Then since 254=246-2, p=65536*r1
;         +(256*r0+253)-2*(256*r1+r0)=65536*A+HL
;         =65537*A+(HL-A)
;         If HL-A>=0 then r(i+1)=HL-A
;         If HL-A<0 then r(i+1)=HL-A+65537
;SUBR DEPENDANCE:none
;INTERFACES:two bytes of directly addressed RAM,
;            used to store the previous random
;            number, r(i), or an arbitrary seed.
;INPUT:a seed or the previous random number in
;       store addresses RN,RN+1
;OUTPUT:the new random number r(i+1) appears in
;        HL and is also transferred to RN,RN+1
;REGS USED:A,DE,HL
;STACK USE:none
;LENGTH:29
;TIME STATES:148
;PROCESSOR:Z80
RANDM: LD  DE,(RN) ;DE:=r(i)=256*r1+r0      ED 5B XX XX
        LD  H,E   ;
        LD  L,FDH ;HL=256*r0=253          2E FD
        LD  A,D   ;A:=r1                  7A
        OR  A     ;this & next 4 instrs    B7
        SBC HL,DE ;set 65536*A+HL=254*   ED 52
        ;(r(i)+1)-1
        SBC A,O   ;it can be shown that   DE 00
        SBC HL,DE ;SBC A,O always         ED 52
        SBC A,O   ;leaves carry clear     DE 00
        LD  E,A   ;
        LD  D,O   ;HL:=HL-A (no carry)    16 00
        SBC HL,DE ; =HL-A+65536 (carry)  ED 52
        JR  NC,+1 ;
        INC HL   ;
        LD  (RN),HL ;(RN):=HL=r(i+1)      22 XX XX
        RET      ;
        C9
```

Sharp MZ-80A
The compact Personal Computer — designed for any environment.



Package includes the following Software (worth £75)

Home Finance Home Budget, Bank Reconciliation, Bank Loan Calculation, Mortgage Calculation.
Basic Tutorial In Four Parts
Education Simple Maths, Spelling (Hangman), Geography (Countries & Capitals)
Games Clever Cribber, Identi-Kit, Scramble, D-Day, Ten-Pin Bowling, Spacefighter, Star-Trek, Space Invaders, Paper-Stone-Scissors, Jumping Balls.

£477.39 + V.A.T.

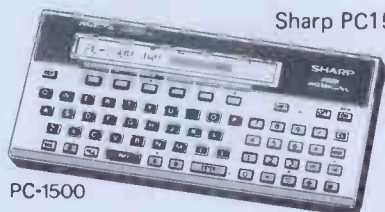

Sharp PC1500

PC-1500

A Pocket Computer with personal computer capabilities.

- * Power BASIC
- * 4 colour data/graphic printer.
- * 16K ROM — up to 11.5K RAM

PC1500 Computer £169.95 inc. V.A.T.
CE150 Colour Printer £149.95 inc. V.A.T.
CE151 4K RAM £49.95 inc. V.A.T.

Apple III — for the businessman, manager, scientist or student.

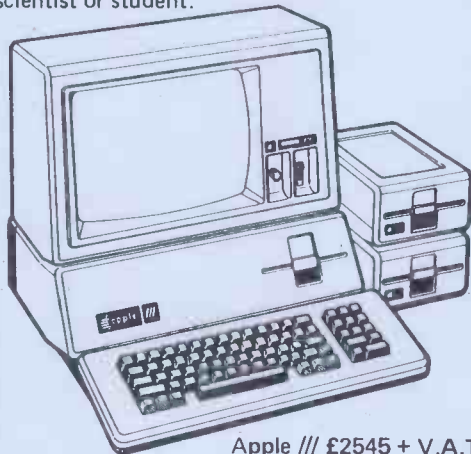

Apple III £2545 + V.A.T.

Level 1 Apple Authorised Service
Sharp registered dealer

LEICESTER
computer centre limited

67 Regent Road, Leicester LE1 6YF. Tel: 0533 556268

SHARP
First, and foremost

LEICESTER
computer centre limited

apple computer
Sales and Service



★ NEW BROOM FOR EPROMS ★
TEX ERASER SWEEPS CLEAN!

EPROMPT is Prompt Enough!



Eproms need careful treatment to survive their expected lifetime. Rushing it could burn their brains out. So cop-out of this helter-skelter world; take it easy the TEX way and give your chips a well-earned break. Cool, gentle and affordable; EPROMPT does it properly.

- ★ 16-chip basic economy EPROMPT EB: £32 nett; £39 c.w.o. ★
- ★ 32-chip interlocked de-luxe EPROMPT GT: £40 nett; £49 c.w.o. ★



TEXTIME
is
Tea-Break Time!

Our EPROMPT needs just half-an-hour to finish its job; this is the proper erase time for all Eproms. While it's busy you may as well take a break yourself, but don't take too long without a timer on the job; over-erasing can shorten data storage time. So our TEXTIME will remember to turn out the light and your chips will forget nothing new.

- ★ 30-minute solid-state TEXTIME M30: £15 nett; £19 c.w.o. ★
- ★★★ Special Offer EB + M30: £45 nett; £55 c.w.o. ★★★
- ★★★ Special Offer GT + M30: £53 nett; £66 c.w.o. ★★★

TEX: Reliable quality at affordable prices. We manufacture in the U.K. and sell direct. All items ex-stock from St. Albans or Watford Electronics.
C.W.O. Prices include Carriage & VAT. Write post-free: **BOX 11;**

TEX MICROSYSTEMS LTD. FREEPOST
ST. ALBANS, HERTS. AL1 1BR ST. ALBANS 64077/TRING 4797 ANYTIME

Programming the
PET/CBM

NEW

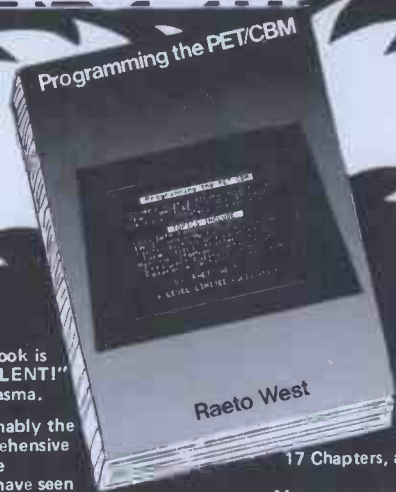

"This book is EXCELLENT!"
Jim Strasma.

"Unquestionably the most comprehensive and accurate reference I have seen to date" — Jim Butterfield.

17 Chapters, appendices and index.
Many programs, diagrams and charts.

The only comprehensive teaching and reference book on all software aspects of Commodore's 2000, 3000, 4000 and 8000 series of microcomputers and peripherals.

viii + 504 pages.
ISBN 0 9507650 0 7
£14.90 each (incs. p&p)
from LEVEL LIMITED,
PO Box 438, HAMPSTEAD,
LONDON NW3 1BH
Tel: (01) 794-9848

CLIP OR COPY COUPON, OR WRITE TO:
LEVEL LTD, PO BOX 438. HAMPSTEAD, LONDON NW3 1BH
SEND COPIES, 'PROGRAMMING THE PET/CBM' AT £14.90
U.K. & Europe Price £14.90 (includes postage, packing) — same day dispatch
NAME: _____
ADDRESS: _____

5 OR MORE: £13.99 EACH PCW/5 82
Send s.a.e. for sample pages

PCW SUBSET

6502/Z80 check digit

To reduce the chances of miskeying important numbers (say a product number when asking for its price or availability or an account number when asking for its balance) it is common, in business applications, for such numbers to have a check digit added on the end. The check digit is calculated by multiplying each digit of the basic number by a weighting digit from a fixed sequence, adding all the results together, dividing the final result by 10 and taking the one-digit remainder as the check digit.

If, for example, the weighting digits are 1, 3 and 7, a basic number of 2784 becomes 27843 with the check digit, 3, calculated:

```
2 x 1 = 2
7 x 3 = 21
8 x 7 = 56
4 x 1 = 4
-----
10) 83
```

8 remainder 3

If any digit in the number 27843 is entered incorrectly, it is probable that the number will fail the check digit test and the user can be asked to re-enter the number correctly.

At the end of Chapter 8 of his book *Z80 Assembly Language Programming*, Lance A Leventhal sets an exercise to write a routine to calculate a check digit from a string of BCD digits with this weighting 1, 3, 7 mod 10. Our next Datasheet, CADIDZ, from Dave Barrow of Hemsworth, gives the routine to do this in both Z80 and 6502 code.

Datasheet

;=CADID-BCD Checksum

```
;/CLASS: 1
;/TIME CRITICAL?: no
;/DESCRIPTION: calculates checksum (weighted 1,3,7,
;/ mod 10) on packed BCD string
;/ACTION: initialise checksum & multiplication factor
;/ (m) to zero. Iterate for each byte.
;/ Iterate for each digit
;/ Get digit in low-nibble storage
;/ m ← m*2+1
;/ m.l.c. ← m
;/ if m=7 then m ← 0
;/ iterate for m.l.c.
;/ checksum ← checksum+digit
;/ checksum ← checksum mod 10
;/SUBR DEPENDANCE: none
;/INTERFACES: none
;/INPUT: Z80:HL points 1st byte of string, B=no of bytes
;/ 6502: M1,0 points 1st byte, M2= no of bytes
;/OUTPUT: Z80: HL points at string+1, B=checksum
;/ 6502: M1,0 points at string+1, M2=checksum
;/REGS USED: Z80: B,HL 6502:M0,1,2
;/STACK USE: Z80: 8 6502: 5
;/LENGTH: Z80: 41 6502: 77
;/TIME STATES: Z80: 87+Av 180 per digit
;/ 6502: 134+Av 83 per digit (ignoring page
;/ boundaries)
;/PROCESSOR: Z80 6502
```

;=CADIDZ- Z80 version

```
CADIDZ PUSH AF ; F5
PUSH BC ; C5
PUSH DE ; D5
XOR A ; initialise checksum and
LD D,A ;mult factor to 0 AF
NXTBZ: LD E,(HL) ;save byte 5E
LD C,+2 ;set digit counter 0E 02
NXTDZ: PUSH BC ;save byte & digit counts C5
LD B,A ;get next digit in 47
RLD ;low-nibble C ED 6F
LD C,A ;and 4F
LD A,B ;checksum in A 78
SLI D ;m ← m*2+1 CB 32
LD B,D ;additive loop count 42
MADDZ: ADD A,C ;checksum ← checksum+ 81
DAA ;(digit*m) 27
DJNZ MADDZ ; 10 FC
BIT 2,D ;if m=7 then m ← 0 CB 52
JR Z,TDIG ; 28 01
LD D,B ; 50
TDIG: POP BC ;restore bytes&digit counts C1
DEC C ; 0D
JR NZ,NXTDZ ; 20 EA
LD (HL),E ;restore byte and 73
INC HL ;point to next 23
```

```
DJNZ NXTBZ ; 10 E3
AND OFH ;mod 10 E6 0F
POP DE ; D1
POP BC ; C1

LD B,A ;return checksum in B 47
POP AF ; F1
RET ; C9
```

;=CADIDZ-6502 version

```
CADIDZ:PHP ; 08
LDX E4 ;save accumulator A2 04
PHLP: PHA ;and 48
LDA M1,X ;M5,4,3 B5 ZZ
DEX ; CA
BNE PHLP ; D0 FA
STA M3 ;byte count 85 ZZ
TXA ;initialise checksum and 8A
TAY ;pointer index and A8
STA M4 ;mult factor to 0 85 ZZ
SED ;decimal mode F8
NXTBS: LDX E2 ;set digit counter A2 02
NXTDS: STA M2 ;save checksum 85 ZZ
LDA (MO),Y ;get byte B1 ZZ
CPX E2 ;and if EO 02
BNE NEWDIG ;high nibble digit D0 04
LSR A ;shift it 4A
LSR A ;down 4A
LSR A ;into 4A
LSR A ;low-nibble A 4A
NEWDIG: STA M5 ; 85 ZZ
LDA M4 ;m A5 ZZ
CMP E7 ; C9 07
BNE NEWFAC ;if m=7 then m ← 0 D0 01
TYA ; 98
NEWFAC: SEC ;m ← m*2+1 38
ROL A ; 2A
STA M4 ; 85 ZZ
TAY ;m.l.c. A8
LDA M2 ; A5 ZZ
MADDZ: CLC ;checksum ← checksum + 18
ADC M5 ; (digit*m.l.c.) 65 ZZ
DEY ; 88
BNE MADDZ ; D0 FA
DEX ; CA
BNE NXTDS ; D0 DB
INC MO ;point to next byte E6 ZZ
BNE TEND ; D0 02
INC M1 ; E6 ZZ
TEND: DEC M3 ; C6 ZZ
BNE NXTBS ; D0 CF
AND EOF ;mod 10 29 0F
PLLP: STA M2,X ;return checksum in M2 95 ZZ
PLA ;and restore M3,4,5 68
INX ;and accumulator E8
CPX E4 ; E0 04
BNE PLLP ; D0 F8
PLP ; 28
RTS ; 60
```

I hardly dare draw your attention to the sly use in CADIDZ of the non-existent SLI (shift left and increment) instruction. But what more perfect application of it could there be than to implement $m \leftarrow m * 2 + 1$ in calculating check digits with a 1, 3, 7 weighting specified by

Levanthal?

Nobody reported non-execution of the mystery op codes CB 30 to CB 37, when we asked in Feb 81. But if any reader has a Z80 processor which doesn't execute SLI D, let us know and we will apologise.

Extra instructions-Z80

The code printed in April for LD HL,(HL) is improved by Roger Hargrave of Crawley to:

```
PUSH DE ;D5
LD E,(HL) ;5E
INC HL ;23
LD H,(HL) ;66
LD L,E ;6B
POP DE ;D1
RET ;C9
```

Roger asks why not a LD DE,(DE) and gives:

```
PUSH AF ;F5
EX DE,HL ;EB
```

```
LD A,(HL) ;7E
INC HL ;23
LD H,(HL) ;66
LD L,A ;6F
EX DE,HL ;EB
POP AF ;F1
RET ;C9
```

or a LD BC,(BC) not so conveniently coded as follows:

```
PUSH AF ;F5
LD A,(BC) ;0A
PUSH AF ;F5
INC BC ;03
LD A,(BC) ;0A
LD B,A ;47
POP AF ;F1
LD C,A ;4F
POP AF ;F1
RET ;C9
```

LISP

Michael Liardet spent several years as a research worker in artificial intelligence and computer aided design and has worked for the last two years as a systems consultant for a well-known microcomputer systems house. Here he presents an overview of one of the most fascinating of computer languages.

In this article I shall present the background and a basic introduction to the programming language Lisp. As a motivation for the readers who doubt that Lisp can hold any advantages over their own favourite language, I shall wind up with an almost trivial Lisp program that would be a fairly daunting project in most other programming languages: the symbolic differentiation of an arbitrarily complex mathematical expression.

Lisp is a programming language widely used in artificial intelligence research but now available to the more general public through various implementations on micros. Lisp is an acronym for LISt Processing and, although not quite the earliest list processing language, it is certainly the earliest one that is still with us. Designed by John McCarthy and implemented by him and his students at Massachusetts Institute of Technology, the language has been around for over 20 years now, which certainly pre-dates the more familiar Basic and Pascal (both from the late '60s).

In these last 20 years, Lisp has been used on a wide variety of fascinating research projects such as computer chess, natural language understanding, automatic theorem-proving and even program correctness verification. In addition, it has spawned a number of other languages, most of them not widely known outside the AI community, including languages like Prolog and Pop-2.

The language has not been greatly used outside academic circles but this is due more to general unawareness of it rather than some intrinsic flaw. Certainly the language could be extremely useful in, for example, the implementation of a database system where complex relationships and interrogations need to be handled. It could be a highly relevant language in other applications, too, but it does not look as though the great mass of Fortran/Cobol/Basic programmers are going to be reaching for their Lisp manuals just yet!

Lisp completely outclasses the better-known languages when symbol processing and complex data structures are required. It's ideal when ideas need to be quickly coded up, tested and re-evaluated, etc. (Once the ideas have been shown to work, the solution can, if necessary, be re-coded in some other language which can execute them more efficiently — most of the super-fast machine-code chess programs are based on principles first explored by Lisp programmers.) Most Lisp systems, mainframe and micro alike, are fully

interactive and generally interpretive rather than compiled, just like Basic in that respect at least! An interesting historical note: a lot of the pioneering work in interactive multi-user mainframes was based around Lisp systems.

Following its strong emphasis on symbol processing, Lisp tends to pay lip-service (Lisp service?) only to number-crunching facilities. So if you want to have some fun with matrix inversion (does anybody?) then you had better stick to Fortran and friends. If, however, you want to experiment and possibly break new ground with some AI project, or even if you are just interested in learning some new programming techniques and concepts, then there's a whole new world awaiting you!

Before embarking on a quick run-through of the Lisp features, a word of warning to the experienced programmer: Lisp is likely to have next to nothing in common with any previous language of your experience. Thus learning Lisp is almost like learning to program all over again! This is not going to be particularly discouraging to someone who cannot yet program anyway but does place a higher than expected learning curve in front of someone who is expecting it to be as easy as, say, a transfer from Fortran to Basic.

So much for the background; but what is the language like to use? The first sight of a Lisp program is, to put it mildly, likely to be slightly discouraging. With its vast numbers of parentheses and curious terminology, the language looks almost as unreadable as APL. (Incidentally, it has at least one other feature in common with APL — the fanaticism of its converts!) Anyway, bear in mind that beauty is only skin-deep and try not to be put off by superficialities. The language has great beauty and elegance underneath all those parentheses! For example: just about everything, from a simple arithmetic expression through to conditional expressions or even complex function definitions, is based on the same underlying structure: the list! As the data is also generally represented in lists, some very useful possibilities start to emerge — for example a program to modify a program can be written as simply as a program to modify a data structure. (If you are wondering why you should need to do that then ask yourself what a program (as opposed to PCW!) editor is? (By the way the Lisp lesson has started (basic training in the use of '(s (and ""s too!))))))

To get some sort of feel for the language let's see how you might translate a relatively simple Basic statement

into Lisp. We will break down the translation into simple stages. Of course the intermediate stages are for explanatory purposes only and don't resemble any programming language yet devised! Let's try:

```
IF A+B=2 OR C*D< 5 THEN E=C-D
```

If we now introduce brackets everywhere, to make the order evaluation absolutely explicit (in Basic, order of evaluation in expressions is implicitly determined by operator precedences):

```
(IF (((A+B)=2)OR((C*D)<5)) THEN (E=(C-D)))
```

Next we re-name most of the functions with rather more lengthy names. Note that IF... THEN translates as COND, '<' as LESSP and the assignment '=' as SETQ. We won't bother if we now have to write the expression on several lines, as Lisp always ignores the way a program is laid out, and just relies on the parentheses to determine when expressions begin and end:

```
((((A PLUS B) EQ 2) OR ((C TIMES D) LESSP 5)) COND (E SETQ (C MINUS D)))
```

Now there is only one step left to reach Lisp. All the functions, currently lying between their arguments, are moved in front of their arguments and one extra pair of brackets (just after COND) is introduced.

Lisp uses 'prefix' notation; to add 2 and 2 we say PLUS 2 2. So the actual Lisp translation looks like this:

```
(COND ((OR (EQ (PLUS A B) 2) (LESSP (TIMES C D) 5) (SETQ E (MINUS C D))))
```

The extra brackets (mentioned above) must be introduced to allow for the fact that the Lisp COND is more general than Basic's IF... THEN. Most Lisps support:

```
(COND (test1 do this) (test 2 do this) etc)
```

This is the IF... THEN... ELSEIF structure and thus (COND test1 do this) would be a correct translation.

Having seen what a fragment of Lisp code looks like, now let's look at a fragment of Lisp data. Let's suppose we need to represent details of various people's names, ages and sex. (Imagine we have written a program to organise the seating at a dinner party or some similar style of problem uncomplicated by disk accesses or validations, etc.) Under these circumstances, in Basic we would probably choose to set up the details in DATA statements and then initialise pre-dimensioned arrays with these details. The Lisp way of doing this would be:

```
(SETQ PEOPLE '(BASIL 32 M) (CYNTHIA 30 F) (JOHN 28 M))
```

The variable PEOPLE is assigned (SETQd) a list of length three (it could easily be much longer), each element in the list itself being a list of length three. A list is defined by enclosing its elements ('atoms') in parentheses. Notice the small quote "" just before the start of the list. This single character is really all that is needed to distinguish between program and data. It means that the list following is to be treated literally and not 'evaluated' — to use the Lisp jargon. In contrast, a list like (PLUS 2 NUM) would not generally be quoted as normally we would be expecting Lisp to evaluate it to the number two greater than NUM. Notice also that there is no closing quote — the parentheses determine the extent of the quotation.

Now, suppose we need to access details of the first of the PEOPLE. What is required is the front or head of the list held by the variable PEOPLE. The Lisp function CAR returns the head of a list and so (CAR PEOPLE) will return (BASIL 32 M). The sister function to CAR is CDR which will return the rest of a list without its head. These two functions used in combination allow any part or sub-part of a list to be accessed — eg, CAR (CAR (CDR PEOPLE))) returns CYNTHIA. The terminology CAR and CDR by the way, is a hang-over from the original terminology where these functions were encoded using Contents Address Register and Contents Decrement Register machine instructions. The probable reason for them still being in use today is that it is absolutely trivial to set up alternate names — just SETQ CAR or CDR to name of your choice and use that instead!

Before moving on from the data structuring, there is only one other major Lisp list function to cover, CONS, which constructs lists. Thus if we want to add another person, say (JEAN 21 F, to PEOPLE then we use CONS to construct a new list whose CAR (ie, head) is (JEAN 21 F) and whose CDR (ie, tail) is the old list PEOPLE. The new list is simply SETQd (ie, assigned) to PEOPLE which will henceforth have a list of

since conditionals, loops and so on are not counted as being expressions, but in Lisp things like COND, as we have already seen are not greatly distinguished from things like PLUS and so function definitions are not really limited in Lisp at all.

It is possible to determine the length of a list by setting a counter to zero and then repeatedly CDRing the list and incrementing the counter until there is no list left to CDR (Lisp calls such a list

```
(DE DIFF (X)
(COND
  ((EQ 'X X) 1)
  ((ATOM X) 0)
  ((EQ (CAR X) 'PLUS)
   (CONS 'PLUS (CONS (DIFF (CADR X)) (CONS (DIFF (CADDR X)) NIL))))
  ((EQ (CAR X) 'MINUS)
   (CONS 'MINUS (CONS (DIFF (CADR X)) (CONS (DIFF (CADDR X)) NIL))))
  ....
  (T 'UNKNOWN)))
```

Fig 2

NIL — equivalent to a pair of parentheses with nothing between them). This sort of approach is an iterative solution but we shall consider an alternative recursive solution: to find the length of a list, find the length of its tail and add one. If it doesn't have a tail, (ie, it's NIL) then its length is zero. The essence of a recursive solution is that it doesn't 'try very hard' to solve the problem but just simplifies it enough to call upon itself again to solve the simpler problem and so on until the solution is transparently obvious (when the list is NIL the answer is 0). Without further ado, here is the code for LENGTH (DE is the function defining Function, called DEFUN in some dialects):

```
(DE LENGTH (LIST)
(COND ((EQ LIST NIL) 0)
      (T (PLUS 1 (LENGTH
(CDR LIST))))))
```

You may wonder how a Lisp function returns a value. Well, in this particular instance, LENGTH will return either 0 (if (EQ LIST NIL)) or (PLUS 1 (LENGTH (CDR LIST))) (if it isn't, T means 'true' and will always satisfy a conditional).

```
DIFF (A+B) = DIFF (A) + DIFF (B)
DIFF (A-B) = DIFF (A) - DIFF (B)
DIFF (A*B) = A*DIFF (B) + B*DIFF (A)
DIFF (A/B) = (B*DIFF (A) - A*DIFF (B))/B2
DIFF (An) = n*(An-1)*DIFF (A)
DIFF (n) = 0
DIFF (X) = 1
```

where A and B are expressions in X and n is a constant

Fig 1

length four rather than three. In case you can't work this out for yourself the code to do this is:

```
(SETQ PEOPLE (CONS '
(JEAN 21 F) PEOPLE))
```

At this point we have covered enough ground to start on a simple Lisp function — a function to determine the length of a list. A Lisp function, by the way, is almost directly analogous to a Basic function, which is usually restricted to being an expression. In Basic this amounts to a very severe limitation,

Basic programmers who may not be familiar with recursion should try and master it. Most interesting applications of Lisp rely heavily on recursion and an iterative technique very rarely works as well. For example, many games programs use a variant of the recursive algorithm — to evaluate the current position generate, in turn, every possible move to modify this position and evaluate the new position (recursively). The value of the position is the value of the best possible continuation.

Well at this point we have really come far enough to demonstrate the promised program to differentiate symbolically an arbitrarily complex mathematical expression. First a quick refresher course for those whose O-level maths has got a bit rusty (using DIFF to mean 'differential with respect to x' — see Figure 1).

The Lisp implementation of differentiation is almost solely a syntactic translation of the above, substituting

Lisp symbols for mathematical ones and using the standard Lisp 'grammar' of prefix function operators, rather than the infix — see Figure 2.

Not all of the definition of DIFF has been included here. The rules for *, / and powers should be inserted as '....'. Briefly the definition can be read as: To define differential of x:

```
If
1 x is in fact 'x' then return 1.
2 x is not a list (and it can't now be 'x') then return 0.
3 x's head is 'plus' (and it must now be a list) then return a list of the form (plus (diff of 2nd element of list) (diff of 3rd element of list)). NB:CADR, etc, is the abbreviation of CAR(CDR).
4 x's head is minus then return a list of the form (minus (diff of 2nd element of list) (diff of third element of list)).
5, 6 & 7. An exercise for the reader!
8. If all else fails then return 'unknown'.
To use this function (assuming by now you have (a) rushed out to buy a Lisp system and (b) typed it in), just enter:
(DIFF '(PLUS (TIMES X 3)
(quotient 4 X)))
```

If everything is okay the system should immediately respond with the answer. Notice how, although the answer is mathematically correct, it is not in its simplest form, containing sub-expressions like (TIMES 1 3) where 3 would do just as well, etc. Well, I didn't promise a simplification of a symbolic differentiation, did I? In any case it leaves you with a nice little follow-up exercise! Or alternatively (if your version of Lisp supports floating point arithmetic), you can use this routine without simplification in, for example, a numerical analysis program which would otherwise expect the differentiation to be done by the user (eg, Newton's method to find the roots of an equation) — a touch of irony for Lisp to be useful in numerical analysis!

Finally, for any reader who has been stimulated to the point of buying a Lisp system, here are the best known currently available (but not reviewed!): Owl Lisp — for Apple II. (My thanks to Owl for lending me a copy — the system worked very reliably and the examples above use the Owl dialect.) Mu-Lisp — a Microsoft product for CP/M systems. Mu-Simp — Ditto with simplification facilities.

END

DBMS2

DBMS2 is a set of programs written in Basic to run under the CP/M operating system. It provides facilities to store and access data in individual files and also some linkage among data fields in different files. It is produced and supported by GW Computers of London, who supplied my review copy. GW also markets an accounting suite based on the same approach, with a similar user image.

DBMS2 uses a 'driver' file, called VOCAB file, to keep track of the characteristics of all the data files it currently knows about. So, to use a data file, you must have appropriate entries in a VOCAB file on the program disk. This file contains the names of all the files currently available, and information about their structure. When the main DBMS2 program is first loaded, it displays a menu on the screen; the first 12 items show the names of data files held in the current VOCAB file. The menu also contains a list of functions which are available before a particular data file has been selected for processing: a typical main menu is shown in Figure 1.

The main DBMS2 program carries out functions such as data input, editing, retrieval and update. Special functions, like sorting, are carried out by separate programs. Once the particular program you need has been loaded, you can dispense with the program disk until you need to change programs — the only necessity is to have a valid VOCAB file available for the program to use. Once you have selected the current data file, each program prompts the user to choose among processing options for the required responses in sequence, requesting a single character response — Q for Quit, R for Random access (by record number) and so on. This prompting is hierarchical, so that once you have, for instance, selected a type of access, your only alternatives are either to continue responding to each prompt in turn or to Quit to the main menu. (A diagram showing part of the prompt system as it looked to me is shown as Figure 2.) There is no provision to allow the experienced user to override the prompting mechanism.

DBMS2 stores information in fixed length records; each record in a single file must have the same structure. The basic unit of data display for both input and retrieval is the screen. Each record is displayed on a single screen, one field per line and one record per screen.

A SCREEN-BASED DATA MANAGEMENT SYSTEM

Kathy Lang continues her series of database reviews

Records are stored using Basic random access files, so that access to records by record number is extremely fast, but is less quick when retrieving by other fields, unless the data file has previously been sorted.

Constraints

Records in DBMS2 may contain up to 1400 characters, and files may have up to 32,000 records; within those limits, the total size of any one data file can be as large as the physical disk or the operating system permits, whichever limit you hit first, provided you leave enough space for the VOCAB file. Subfiles, that is files containing subsets of the main data file created by running a selection option on the main file, may contain records not more than 250 characters long. Because data file names are stored in special locations in the VOCAB file, and displayed in the main menu, you are limited to a maximum of 12 types of files on any one disk. Names of data files may not be more than eight characters long, including the two character drive prefix where the file is on drive B (which is of course a greater limitation than that imposed by CP/M, where file names may be eight characters long excluding the drive prefix).

In the current version of the package, a record may contain up to 20 fields, and the total length of each field and the 'label' used to describe it must not exceed 70 characters. A subsequent release of the package, due out in the late summer of this year, is likely to permit at least 100 fields per record.

Input and updating

Data file creation involves providing the VOCAB file with the necessary entries describing the structure of the records

in the file. DBMS2 provides a program which prompts for the appropriate responses, or you can edit the VOCAB file directly — not a process I'd recommend, even for the experienced user, as it is very easy to get it wrong. For each field, you can specify whether it is to be text or numeric and, if the latter, whether its validity is to be checked on input. You must also specify the field length. There is no specific date format, so dates have to be entered in year/month/day order as ordinary numbers if you are likely to need the records sorted in date order.

Records are stored in order by the record number, which must be included as one of the fields in the record. Record numbers need not be consecutive or start from 1, so you can use an existing numbering scheme provided the numbers don't exceed the limit of 32767 imposed by MBasic. However, if you do want to use consecutive numbers, you can make use of the prompt that DBMS2 gives you, displaying the next 'free' record number. To put records in the file, you respond to the main menu with the number of the file you want to access, request random access and then give the number for the record you want to insert. A blank record is displayed on the screen, one line per field, using the labels specified in VOCAB. Amending is carried out in a similar way — you specify the record you want to amend, using one of the access methods outlined in the next section, the record is displayed, and you can then edit any fields which need changing by retyping them. When creating a sequence of records which have a few common entries, you can cause the common fields to be carried over without having to type them again. If two records are very similar, you can call up the existing record by number, overtyping the number and make the necessary changes and store the record, whereupon the new version will be saved without affecting the original record.

So much for inserting and amending records from the keyboard. To get data into DBMS2 from other programs — for instance, to import straight ASCII data files — you have to write your own Basic program to rewrite the data to a Basic random access file. I wrote a program to do this quite quickly for my benchtest data, but you do need the necessary understanding of Basic programming. Having converted the data, you simply amend the VOCAB file to

reflect the new file's name and record structure in the usual way.

However, utilities are provided to get data out of DBMS2 into sequential format, and to reconfigure DBMS2 files to have a different record structure, although I didn't get a chance to try these out.

Displaying data

Data records are always displayed in the same format, with the name of each field down the screen and the value alongside it (sometimes accompanied by totals — see the Calculations section later). You can get access to particular records in four ways. If you give the record number, DBMS2 will go directly to the record in question. If the file has been sorted on a particular field, then you can request keyed access via that field; this just means that the program utilises the fact that the data has been sorted on the field in question to use a binary search technique to find the right record with a small number of reads — for instance about 10 reads for a file of 1000 records.

Where you need to access records on the basis of other fields, sequential access is necessary, that is each record is read in turn in the order in which it is stored. In this case, all the records may be read, or a subset selected. Whichever access method is used, after displaying the requested record you can then scroll forward or backward from that point in the data file, for instance, displaying the records with record numbers immediately next to that of the current record, but to access another record directly by number or key involves quitting the current search, reselecting the file from the main menu and requesting the access method all over again.

In addition to the methods of accessing records by field values, it is also possible to make an explicit relationship between one record and another in the same file, or between a single record in one file and a corresponding record in another. This is achieved by having at the beginning of a data field a pointer consisting of the number of the file and of the record to which the linkage is to be made. This could be a quite useful and powerful facility; for instance, if you had two files of information about the same people — say one containing their accounts information and another their names and addresses — you could use the same record number for someone in each file, and have a field in each record referring to the equivalent record in the other file. This would enable you to make connections between related records in different files without going back to the main menu.

However, since the relationship must be set up individually, the facility would be much less useful if you wanted, say, to link two dissimilar files with one common field, for instance a product file and a supplier file where only the supplier identifier was common to the two files. The other constraint is that while you may use an ordinary data field for this purpose, and have it contain raw data too, by delimiting the pointer with the special characters '!C' (which does of course prevent you having this combination in your data if you use cross-referencing) the manual advises against doing this. But to use a field or fields specifically for this purpose would limit

the user even more in terms of the number of data fields available.

All these methods of displaying your data are exclusive, in the sense that once you have opted for a particular form of access — random, keyed, sequential or cross-reference — to change the mode of access involves quitting and selecting the data file again from the main menu.

Reporting

Reporting on complete files is achieved by creating a print mask which dictates the layout of the printed report. Two types of mask are available: for the simpler version, you specify the number of fields you want to print and the width of the printed page. The program divides that width by the number of variables, allows that figure as the width for each column of printing, and prints each value centred within the column. The second type of mask enables you to specify the column number to which a value is to be right-justified when printed. In either case, you can set up headings, and ask for actual field values (referring to fields by number), for computed values, and for accumulated totals to be printed. Where computations or totals are required, the rules by which the values are to be calculated must have been set up in advance, using the 'compute functions' call from the main menu. There are no facilities for sub-totals when field values change.

In addition to printing all or parts of a file using a mask, you can request a printout of a record as you run through the file using any of the permitted display access methods.

Selecting sets of records

When using sequential access, you can define one or more criteria by which to select particular records for display or printing. Selection can operate over all the records in a file, or a subset specified can be specified by record number. The criteria can be defined when you select from the file, or in advance and saved in a text file and recalled when needed. If you just want to select a record where one field has a particular value, you can specify exactly that. If you want something more extensive, you are presented with a screen display of the record structure, and must specify selection criteria for each field in turn (carriage return allows matching any value) — ie, you must specify whether or not you want to select on each field, rather than just specifying those fields on which you *do* want to select. With a maximum of 20 fields per record, this is not a serious problem, but when that maximum is increased it could become a great nuisance.

The process of specifying selection criteria has some highly esoteric features. One of the options available allows you to specify identity with one or more constants within a field (eg, to ask if a name is equal to SMITH or JONES or BROWN). You request this by typing a question mark followed by the first value you want to match, then another question mark followed by the second value and so on. When you type the second question mark, the cursor moves back to the beginning of the test field,

01= CUSTOMER FILE	13=-----
02=STOCK LIST	14=-----
03=PARTS LIST	15=-----
04=OUTSTANDING ORDERS FILE	16=-----
05=JOB COSTS FILE	17=-----
06=CUTTING LIST FILE	18=PARAMETER SECTIONS
07=PERSONNEL FILE	19=-----
08=PENSIONS LIST	20=COMPUTE FUNCTIONS
09=SUPPLIERS FILE	21=FILE MAINTENANCE
10=SCHEDULING DATA FILE	22=CALL OTHER PROGRAMS
11=FILE TYPE '11'	23=AUTOMATIC DRIVE
12=FILE TYPE '12'	24=EXIT SYSTEM

Fig 1

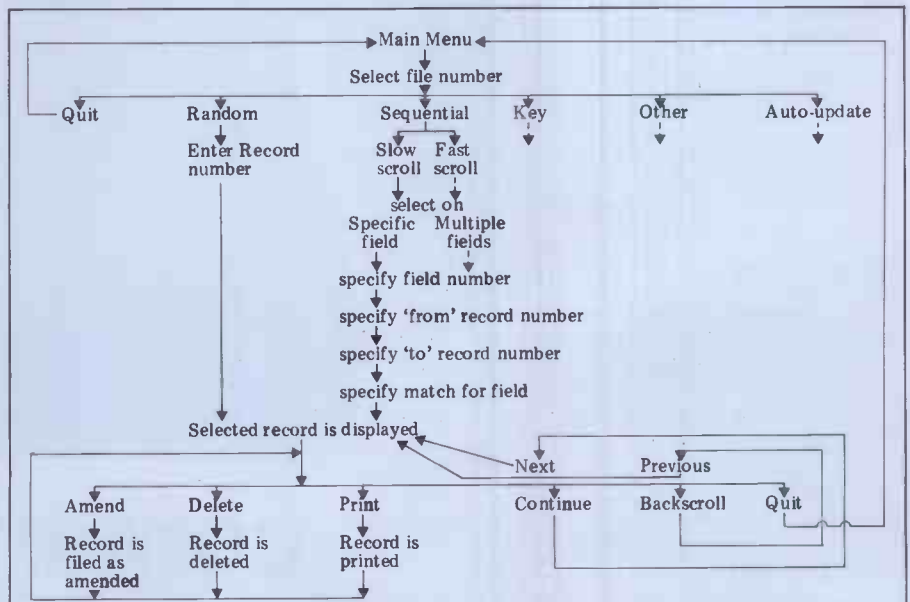

Fig 2 Dotted lines indicate further options not included on this diagram.

Main Dealers

Birmingham
Byteshop Computerland
94/96 Hurst Street
Tel 021 622 7149

Dublin
Lendac Data Systems
8 Dawson Street
Tel 0001 372052

Glasgow
Byteshop Computerland
Magnet House
61 Waterloo Street
Tel 041 221 7409

Leeds
Holdene
Manchester Unity House
11-12 Rampart Road
Tel 0532 459459

London
Byteshop Computerland
324 Euston Road NW1
Tel 01 387 0505

Digitus
Lading House
10/14 Bedford Street
Covent Garden WC2
Tel 01 379 6968

Jarogate
197-213 Lyham Road
Brixton SW2
Tel 01 671 6321

Manchester
Byteshop Computerland
11 Gateway House
Piccadilly Station Approach
Tel 061 236 4737

Nottingham
Byteshop Computerland
92a Upper Parliament Street
Tel 0602 40576

Southampton
Xitan Systems
23 Cumberland Place
Tel 0703 38740



into a major benefit.

Dealers

Bristol
Senton
27 St Nicholas Street
Tel 0272 276132

Cambridge
Cambridge Computer Store
1 Emmanuel Street
Tel 0223 65334

Cheshire
Holdene
82a Water Lane
Wilmslow
Tel 0625 529486

Edinburgh
Holdene Microsystems
48 Great King Street
Tel 031 557 4060

Luton
Remdex Bradley Systems
31-33 Wellington Street
Tel 0582 23682

Manchester
NSC Computers
29 Hanging Ditch
Tel 061 832 2269

Norwich
Anglia Computer Centre
88 St Benedict's Street
Tel 0603 29652

Sheffield
Hallam Computer Systems
1 Berkeley Precinct
451 Ecclesall Road
Tel 0742 663125

Watford
Lux Computer Services
108 The Parade
High Street
Tel 0923 29513

ADVANTAGE™ is the exciting new, packaged high performance desk top computer with integral video screen. It brings the proven reliability, so long the hallmark of NorthStar★ products, into new and broader fields of application.

Add the established Comart technical, software, and service support and the ADVANTAGE becomes a major benefit to users looking for a low cost, yet versatile, dedicated system. NOW!

Just look at the benefits.

ADVANTAGE is economical: A complete integrated accounting system and word processing system will cost around £4500 depending on the printer and software used.

ADVANTAGE is versatile: You have the benefit of application software that is already available and proven on NORTH STAR Systems.

ADVANTAGE is new: It's Business Graphics can convert data into bar charts, pie charts, graphs, and 3D representations instantly. And, what you can see on the screen, you can print.

For the technically minded, ADVANTAGE is a 4MHz, Z80A™ based microcomputer with 64K dynamic RAM, a 20K Byte display dedicated RAM, plus 2K Boot PROM.

An auxiliary 8035 processor provides keyboard and disk control. It has a 12" green screen, and integrated twin quad capacity 5" disk drives providing 720K Bytes of data storage. It has an 87 key Selectric™ style keyboard with 9 control keys, 14 key numeric/cursor control pad, 15 programmable function keys, and 49 conventional character keys.

ADVANTAGE comes complete with Business graphics, self diagnostic software and graphics demo software. Its G-Basic/G-DOS, and Graphics CP/M™ are supersets of the industry standards. They enhance ADVANTAGE'S Graphic and Character Mode capabilities, and provide a consistent operating environment for development and application programs written in any other CP/M compatible language.

To see more of the benefits of the ADVANTAGE ask your Comart Dealer, or send now for further information.



TM Advantage is a trade mark of North Star Computers Inc.
Z80A is a trade mark of Zilog Inc.
Selectric is a trade mark of IBM.
CP/M is a trade mark of Digital Research Inc.

Comart Limited

St Neots Cambs PE19 3JG
Tel (0480) 215005
Telex 32514 Comart G

comart

SPECIALISTS IN MICROCOMPUTERS

A member of the  Comart Group of Companies

DBMS2

so that the second value overtypes the first. Thus you don't see all the possible matches you've selected for that field, only the match most recently entered.

'Identity' in this context means 'identical with or contained within'; for example, a request to match 'SMITH' would also match 'SMITHSON' and 'ARROWSMITH'. This means that if this test were used in an attempt to select all records with a numeric field identical with '1' the program would match values of that field such as '12', '212' and so on, as well as just '1'. There is a different test for matching a number exactly, but no equivalent is available for text fields. Fields may also be tested for being greater than or less than a numeric value (these comparisons don't seem to work with text fields; the program doesn't complain, but it doesn't find the records with matching fields either) and for being not identical with a value. Apart from the special case of textual identity, you can make only one test on each field, so that I could not, for instance, find a way to test for a numeric field having a value within a range. The results of the tests on each field are ANDed together, except that it is possible to OR a pair of results where the test for each is identity with a constant.

It is also possible to store in another file the records which a set of tests select, provided the subset which results

does not contain more than 250 records.

Sets of selection criteria are stored in ordinary text files, so if you understand their format you can edit them as you might any CP/M text file.

Sorting records

DBMS2 has two sort programs available — a memory sort and a disk sort. They can be invoked via the 'call other programs' option on the main menu. The memory sort is restricted to quite small files but the disk sort, though much slower, allows you to sort a file as large as the disk can hold. This is because if you specify the same file name for source and destination files DBMS2 uses an interleaving technique so that the sorted file overwrites the source file. Sorting is allowed on only one field at a time, so that to sort on several fields you would have to do one sort for each field starting with the least significant. Of course, you may have as many sorted versions of the raw data file as you like, one for each field on which you might want keyed access. You can specify all or part of the field to be used as a sort key, but as far as I could tell sorting was always in ascending order.

Once sorted, a file can be used through the keyed access method by matching against the field on which the file was sorted. However, the program takes no steps to ensure that if the parent file is changed the sorted versions keep in step — you just have to re-sort the data file, which is a slow process for a file of any size. This, of course, is a criticism which applies to all the packages I have reviewed so far. But it is of

greater significance with DBMS2, as it is only by sorting the whole data file that you can have keyed access to fields other than that containing the record number. Without any facility for creating indexes which relate field values to record numbers, the user must rely heavily on full sorts to permit direct access to individual records.

Calculations

DBMS2 provides the means to do three kinds of calculation. You can carry out simple calculations on the values of particular fields and display the results when the record is displayed, or store the results in another field — for instance, you can update the old price of stock by 5 percent and place the old price in another field in the record. You can also accumulate values across records. These calculations can be displayed when you show records on the screen, or when printed out. The ability to display fields, calculations derived from them and accumulated totals all at the same time reflects the accounting background of the parent package.

The kinds of calculation you can do contrast curiously with the selection criteria you can set up for sequential record access. With selection, you can test values only against constants and not against the values of other fields. With calculations the opposite is true: you can perform calculations only with respect to field values and cannot, for example, add a constant to a field. Calculations allowed include the ability to add, subtract, multiply and

Tower Hill

Trafalgar Sq

Fenchurch St

Whitehall

Big Ben

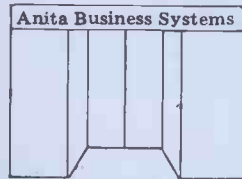

VISIT LONDONS NEW ATTRACTION

(ENTRANCE FREE)

ANITA BUSINESS SYSTEMS HAS OPENED ITS NEW RETAIL SHOP AND WE CAN NOW OFFER:-

- * COMMODORE, APPLE ADLER MICRO COMPUTERS
- * ASSOCIATED PRINTERS * DISK DRIVES
- * FULL SOFTWARE SUPPORT * DEMONSTRATION FACILITIES
- * CALCULATORS * TYPEWRITERS * DICTAPHONES
- * OFFICE FURNITURE
- * EXPERIENCED SERVICE BACK UP ON ALL EQUIPMENT
- * VIDEO DEPARTMENT

FOR ALL YOUR BUSINESS EQUIPMENT REQUIREMENTS COME TO:-



Anita Business Systems

50, FENCHURCH STREET, LONDON EC3
15, CLERKENWELL CLOSE, LONDON EC1 01-253 2444

GW Computers Ltd

*** THE NEW DBMS (DATABASE) ***

DBMS2 is a record relational as well as a file relational database management tool that is capable of being at different times, many different things. The one core program can be set up to perform tasks normally associated with the following list.

Accounting	Budgetting	Cashflow
Stock control	Address mailing	Letter writing
Simulations	Time recording	Filing
Calc-type predictions	Hospital indexing	Profit analysis
Bureaux services	General analysis	Mathematics
Answer what-if's	Employees records	Tabulate values
Print reports	Sort files	Edit records

Within hours perform all the above in **French** or **German**. The list is as endless as that which meets the requirements of your own imagination. **Within the appropriate** frames of reference you could ask questions like the following:

Find someone whose name contains a W or X or Y or Z, who is either in London or Birmingham, and available for work at a salary of less than 10,000.000; and is under 40 years of age, not married, of credit worthiness grade 1, with a car, prepared to travel, and who likes horses, does not mind the hours he works, is congenial and has good references. When you find such persons produce a printed list of them showing their names, telephone numbers, and what their salaries are as well as their salary if increased by 10% and show their availability for work. At the end of the list enumerate the total of such persons.

Find all stock items that are codes **micro-computers** that are either in warehouse 1 or warehouse 2, where the quantity on hand is more than 50 units, the cost is less than 1000.00, the selling price higher than 2000.00; that are not in cartons, bought from supplier 52, allocated more than 20, rated for tax at .15% and weigh less than 50lbs. When you find such categories then print a report showing the description, cost price, quantity on hand, lead time for refills, what the selling price should be if raised by 12.3% as well as the profit in either per-cent or round figures of that projected selling price.

Find all patients who suffered from cold, that are either girls or women younger than 23 years old, and who live in London at a socio-economic grade higher than 3; do not smoke; have more than 3 children, are currently at work and where treatment failed to effect a cure in under 6 days. When you find such persons then print a list showing their age, marital status, income, and frequency of illness in the past 2 years.

Currently you can ask 7 types of questions 20 times for a single selection criterion, and then you can compute 10 mathematical relationships between the questions for the individual as well as for the total number of matches. In all some 60 bits of information relating to one record or a group of records on simply one permutation of the selection criterion, with a cross referencing facility as well.

Every word in the system, as well as the file architectures, print masks, and field attributes, is capable of alteration by you without programming expertise (but with some thought).

ALL IN ONE PROGRAM FROM G W COMPUTERS. THE DBMS2!!

THE NEW RELEASE DBMS 2a

In the time with the bechtest article in Personal Computer World on pages 138-143, we append our notes regarding some subsequent implementations arising from constraints referred to by Dr Lang.

Version 2a has now the following new features:

- All fast output to screen or printer has a pause sequence that stops output at a prompt that enables the user to either continue, amend, jump, or quit.
- A default to all records option exists now which precludes the need to specify a record range when searching files.
- The runtime module BRUN.COM is now no longer needed on the master disk.
- It is estimated that by the time this article comes to press, the program will have the ability to create records of up to 100 fields, and that a full screen form generating module will be implemented to simplify the creation of file architectures.

CALLERS BY APPOINTMENT ONLY AT 55 BEDFORD COURT MANSIONS, BEDFORD AVENUE, LONDON WC1
PHONE: 01-636 8210, 01-631 4818 TELEX 892031 TWCG

DBMS2

divide one field by another, to add or subtract from a field a percentage of that field, and carry out some standard functions such as squaring the value of a field.

Security

The package provides a facility for copying to the printer every record as it is input or updated. Apart from this transaction logging, DBMS2 does not provide any security facilities such as password protection of files or masking of record display so that only some fields are seen.

Tailoring

Because the program keeps all its prompts in the VOCAB file along with the record structure information, they can be easily changed if the user wants to make them more appropriate to his environment, for instance by translating them into another (human) language. Otherwise, tailoring depends on the user's ability to write Basic programs.

Stability and reliability

The package is regularly updated, and users who keep in touch with GW get updates, at present free of charge. The version of the package I had seemed reliable; I managed to produce its catch-all error message several times (you are asked to record the Basic error message number given and reload the program) but never in situations which caused me to lose data.

User image

As usual with these reviews, I shall try to distinguish comments on the appearance of the package itself from the way the package is described in the manual. I should also emphasise that GW says it is not aiming at the naive user but at people who are already reasonably knowledgeable about computing. However, I think that even experienced people will have some difficulty with the inconsistencies of the user image and the lack of any coherent model, either explicit or implicit, by which to deduce the way instructions are formed. A good example is the contrast I noted between expressions for calculation and for selection. On the other hand, the programs don't provide short-cuts for experienced users, for instance to enable the user to specify all parameters required by a routine at once, instead of having to respond to prompts one at a time.

I eventually learned to avoid the dangers of trying to build on experience in one part of the package to work out how to use another, and an experienced user should be able to cope. I found the package much easier to use when I'd drawn a diagram of the routes the prompt mechanisms appear to take, part of which is shown as Figure 2.

However, the user image also has some merely irritating features. Those I

encountered included not always being able to 'quit' (ie, get back to main menu level) from every prompt level, having to type the prompt characters in upper case (lower case letters are met with a bleep), and the vagaries of the selection process. These included the over-typing of the 'OR' responses I've already mentioned, and the fact that one does not have the option of editing the selection before it is stored. Another great nuisance is the necessity to specify the range of records over which you wish a selection to operate—the package doesn't let you default this to 'all records' but requires you to specify the lowest and highest numbers each time. Just as irksome is the inability to terminate a selection once you've started it—if, for instance, you realise too late that you've mistyped a value, and no match of the selection will be found. Since CTRL-C is (sensibly) disabled and no alternative mechanism provided, you just have to let the package find out by reading every record—and that's a long time to hang about for a large file...

I got away to a bad start with the documentation, as the page numbering, though ordered, followed no obvious pattern. In one chapter, for instance, the pages run 040, 050, 051 to 057, 060, 070... I worked out how to cope with that in the end by making my own table of contents, which also helped me to live with the fact that the lack of a coherent user image for the package itself is more than reflected in the manual. Rather than comment on the documentation in detail, I've included a couple of quotes so that readers can judge it for themselves. The first relates to the thought processes the user is expected to go through when considering altering file structures: 'The probative exercise will pass you through the stages of conjecture, as you learn by error; until you reach a true epistemological contact with your object. That will be the stage when you are in effective control, knowing and understanding the nature of the medium you are involved with.'

The other quote is from a section telling the user how to set up file structures: 'Having decided upon a system of limited lengths and restricted inputs, you will insert a number of such

records into the file and they will actually be recorded as a continuous set of characters seated side by side in one long string, separated by a "FIELD" statement after each line finish. When the file is subsequently read, it is in a manner that accounts for the field statements and understands that each is a field separator. When reading twelve such fields it is clear that the next read will be at the commencement of field 1 of the next record.'

I've tried to choose representative quotations, but they are of necessity out of context and readers should of course make allowances for that. GW is in the process of adding to the manual a set of nine 'lessons' to help new users; the first three were available when I tested the package and they are an improvement.

Costs

The latest version of DBMS2 costs £575 including MBasic (some features, such as the program which allows you to set up new file structures, require Basic to run). Even allowing for the inclusion of Basic, this makes the package as expensive as most of those I've reviewed so far.

Conclusions

DBMS2 provides facilities for creating, updating and accessing files in a limited way. At present, the user may have only 20 fields per record. File access is restricted to direct access by record number, keyed access by sorting on a single key field, sequential access, and cross-reference between fields and among fields by explicit, individual linkage. Its selection and sorting capabilities are also rather limited. But it does give the user access to almost the whole of both disk drives for data storage, since the whole main program lives in core. It would also have particular application where the types of processing required are close to those used in the accounting suite from which it derives. The package is supplied and supported from London by its originator, GW, and whenever I had queries I found the company extremely helpful. **END**

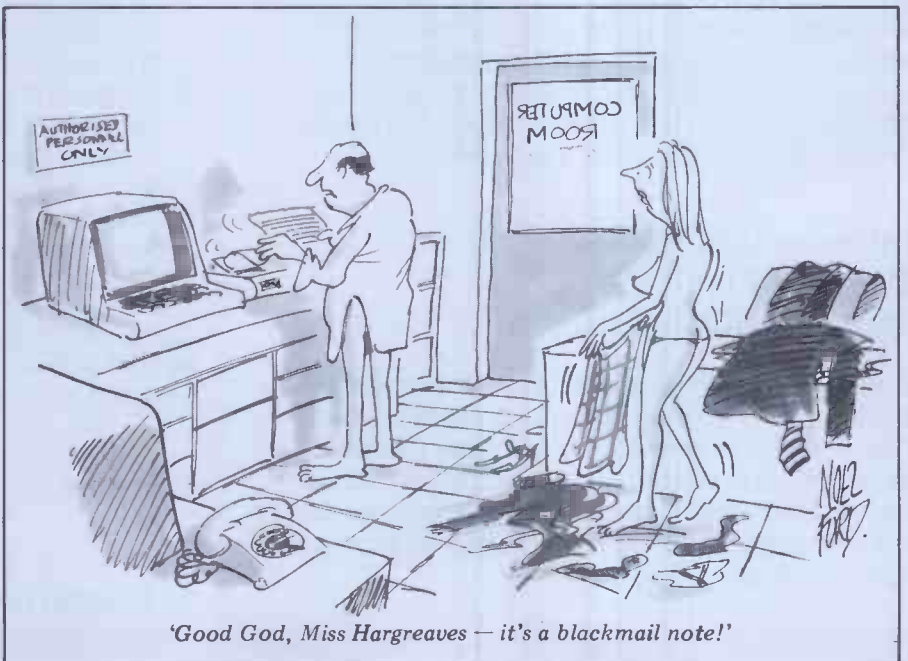

3 NEW BOOKS FROM SYBEX

To increase your technical knowledge!

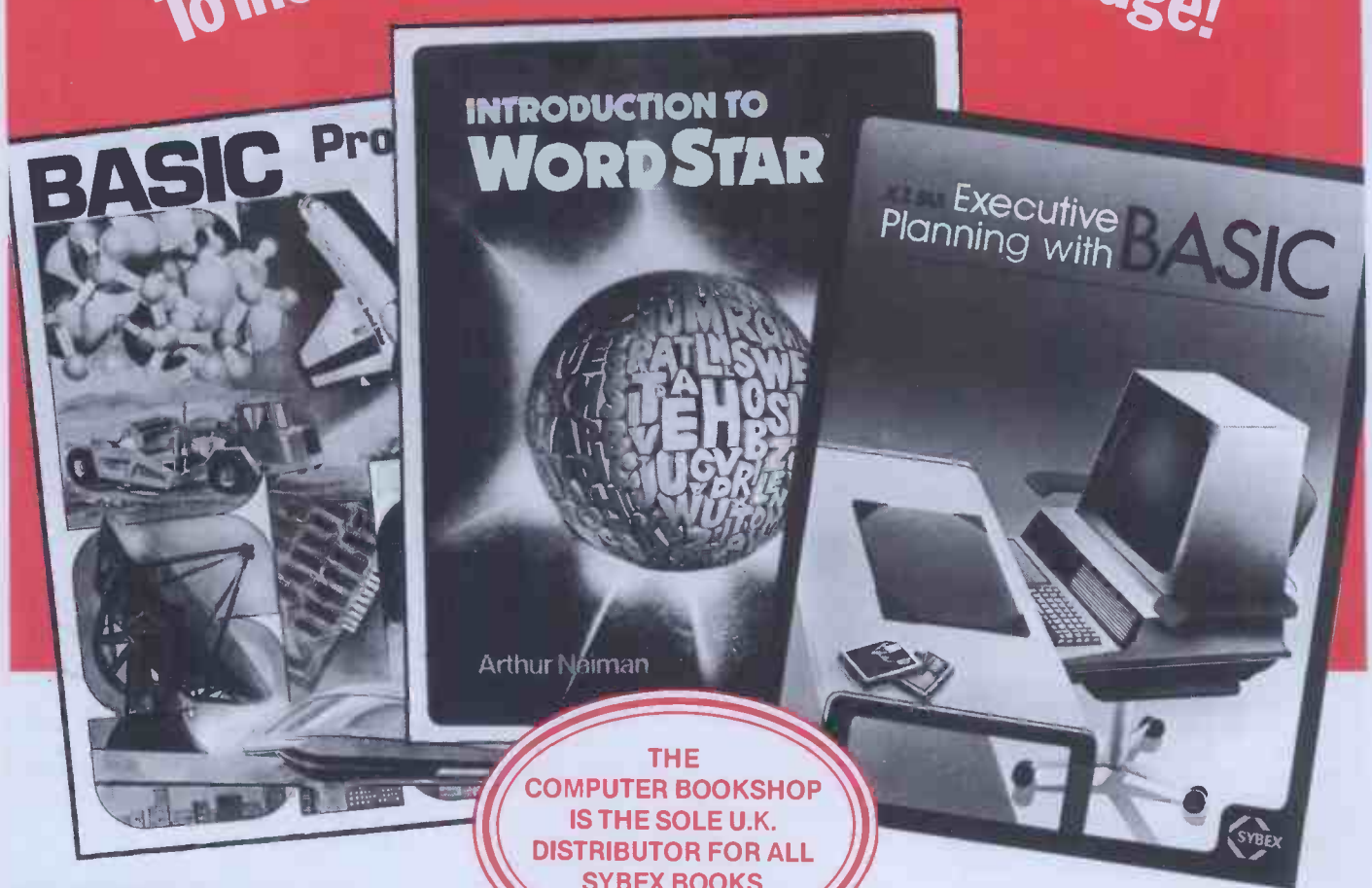

Basic Programs for Scientists & Engineers

By Alan R Miller
345 Pages Only £11.50

This vital book provides a comprehensive Library of Programs designed to solve problems commonly encountered in Science and Engineering. It's designed to teach BASIC programming and each program is explained in detail to help the reader develop proficiency in the use of BASIC.

Introduction to Word Star

By Arthur Naiman
200 Pages Only £10.95

For anyone who owns Word Star, or is considering buying it, this book will quickly and easily teach how it works while presenting a clear picture of what a word processing program can do. The clearly written and well organised guide clarifies the process of learning how to use a high-powered word processing program.

Executive Planning with BASIC

By X T Bui
197 Pages Only £11.50

This invaluable book has 3 goals.

1. To explain the quantitative methods of management decision making in clear and practical terms.
2. To dispel the idea that programming is only for specialists and that it is practical for management to have direct access to computers for analysis, planning and control.
3. To provide an efficient and time-saving set of computer implementations for quantitative analysis.

Get these invaluable books from your Local Computer Store or Book Shop. In case of difficulty send S.A.E. and we will supply the name and address of your nearest stockist by return.

Dept. PCW **The Computer Bookshop** 
30 Lincoln Road, Olton, Birmingham B27 6PA

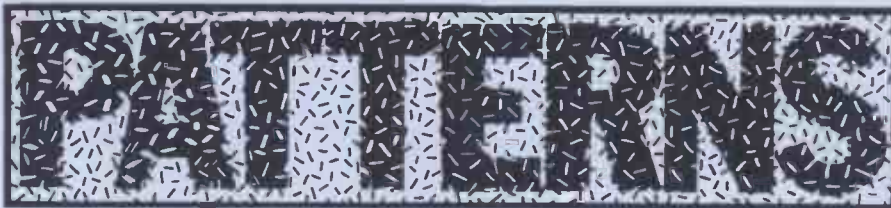

Alan Sutcliffe continues his series with a look at generating textures.

Misunderstanding is among the mothers of invention. As a for instance, I recently read a fascinating article in *Computer Graphics and Image Processing* about programs to analyse and then synthesise textures. Reading it again later and more carefully, I found that I had not followed it at all — but in the meantime I had written my own program based on what I thought was proposed. And it worked: at least it is capable of producing many kinds of texture. I have not used it for analysis but that seems straightforward once a texture has been digitised and stored in the computer.

For the purpose of explanation, I present a more limited program and before that a few words on the use of the textures that can be produced.

Suppose you want to simulate flying over an area of the moon. If it is possible to characterise the appearance of the surface using just a few numbers, then suitable-looking fine detail of the terrain can be invented. This will cost a little more in processor power than keeping precise data on a vast area but there will be a great saving in the storage needed and, probably more important, in the time needed to enter the data. Major known features could be imposed on such statistically correct texture.

At the level of personal computing, there are many games and simulations that would be much improved by the

addition of appropriate textures to otherwise bald and unconvincing super-fices.

The method (this much I did get right at the first reading) can be applied to any kind of display that uses a cellular array of picture elements or pixels. It is easily adapted for whatever number of colours or grey levels the system has, from simple black and white upwards.

Here is the simplest possible version of the method. Each pixel is black or white and its colour is controlled by the one immediately to the left of it and the one immediately below it. Thus there are four cases, as shown in Figure 1. The value of N , representing the colour of the current pixel, is not fully determined by its two neighbours. What is fixed is the probability of its being black or white in each case. This requires just one number between 0 and 1 in each case, the probability of being black, say. The difference between this number and 1 is then the probability of being white, since a probability of 1 represents certainty; in this case, the certainty of being black or white. Figure 1 shows some possible values.

The implementation of this version is given in Program A. The probabilities are stored in the array T . There is clearly a problem in getting the process started, since the pixel at the bottom

left of the display does not have the neighbours it needs to determine which probability applies, so these extra cells must be provided. $X(XMAX)$ is a row of cells, not displayed on the screen, to provide neighbours below for the bottom row proper. $XMAX$ is the width of the display. Similarly, $Y(YMAX)$ is an extra column of cells to the left of the main array. These are first of all filled with values 0 or 1 for black or white at random.

It may be thought preferable to fill these two starter arrays with values distributed like the values in the resulting display — but we do not know yet what will be. I have found that this edge effect from starting with a row and column not typical of the main texture is small and when some effect can be seen it affects only the bottom few rows and a few columns at the left. Each texture seems to settle down quickly to a more or less characteristic pattern,

Pixel to the left	1	$T(1,0)=0.2$	$T(1,1)=0.7$
	0	$T(0,0)=0.7$	$T(0,1)=0.5$
		0	1

Pixel below

Fig 1 Probabilities for this pixel based on two neighbours.

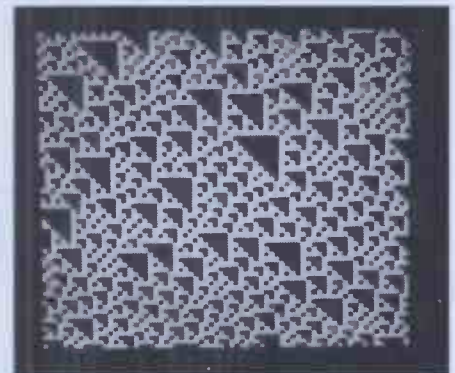

Fig 2 Output with certainties.

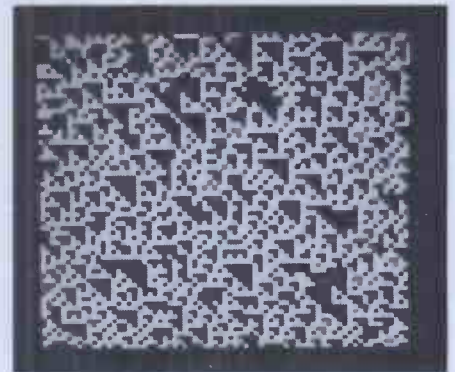

Fig 3 Output with near certainties.

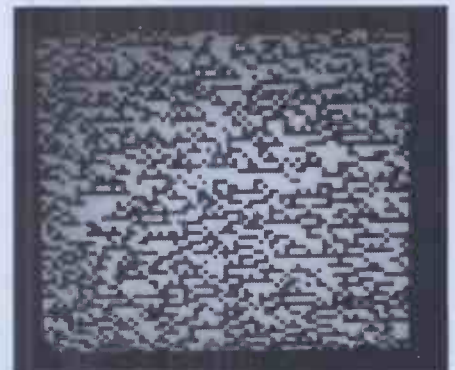

Fig 4 Output with random probabilities.

```

IMP INT          Variables are integer
IMP FPT P-T     except those starting P to T
CLEAR 1000
100 MODE 2      Low resolution
110 COLORG 0 1 2 3 Set colours - only 1 is used
120 DIM X(XMAX),Y(YMAX) Boundary values
130 DIM T(1,1) Probabilities
140 T(0,0)=1.0 Set probabilities
150 T(0,1)=0.0
160 T(1,0)=0.0
170 T(1,1)=1.0
180 FOR I=1 TO XMAX Set up X boundary
190 X(I)=RND(2) 50/50 0 or 1
200 NEXT I
210 FOR J=0 TO YMAX Set up Y boundary
220 Y(J)=RND(2) 50/50 0 or 1
230 NEXT J
240 FOR J=0 TO YMAX Main loop for each line
250 C=Y(J) Set left cell effect
260 FOR I=0 TO XMAX For each cell on a line
270 D=X(I) set effect of cell below
280 S=RND(1.0) Random selector
290 N=0 If S>T(D,C)
300 IF S<T(D,C) THEN 330 select case
310 N=1
320 DOT I,J N Draw dot
330 X(I)=N Save value for next line
340 C=N Set effect for next cell
350 NEXT I
360 NEXT J
370 COLORG 0 15 00 Set col to black & white
380 GOTO 380 Keep display on screen

```

Program A Simple DAI Basic program for textures

THE PRINTER YOU WANT IS HERE



PERTEC P80

* Heavy duty matrix printer at a sensible price. * 80cps.
* 80/120 character lines.
* Optional character sets, with true descenders. * Centronics and RS232 serial interfaces.
£439 + VAT



RICOH RP 1600

* Advanced daisywheel printer for word processing, mini and micro applications. * 60cps.
* Intelligent option includes Qume/Diablo compatible commands and auto bidirectional operation.
£1395 + VAT



TRIUMPH-ADLER STYLIST

* Low cost daisywheel printer for most popular micros and minis. * 14.5cps. * Proportional spacing. * Bidirectional / logic seeking. * Range of type styles and languages.
£695 + VAT

Trade and OEM discounts available.

Write or call for further information.
Butel-Comco Limited
Garrick Industrial Centre,
Garrick Road, London NW9 6AQ.
Telephone: 01-202 2277

BUTEL ✓
Technology for business



L&J COMPUTERS

192 HONEYPOT LANE, QUEENSBURY, STANMORE, MIDDX HA7 1EE. 01-204 7525

THE "PET" SPECIALISTS



GET THE BEST OF BOTH WORLDS!

WE CAN SUPPLY ALL YOUR 'PET' NEEDS AT CASH & CARRY PRICES

8096	80 Col 96K	£1050	8250	2 Mb Disk	£1095
8032	80 Col 32K	£ 755	8050	1 Mb Disk	£ 755
4032	40 Col 32K	£ 585	4040	340K Disk	£ 585
9000	SuperPET	£1295	2130	170K Disk	£ 360
8023	Printer	£ 755	4022	Printer	£ 357

OR WE CAN SUPPLY INSTALL AND TRAIN YOUR STAFF AT THE NORMAL PRICE WITHOUT ANY EXTRAS!!

TRY US!
YOU WILL NOT BE DISAPPOINTED

ALL IN STOCK NOW!

EXT CASSETTE DECKS (INC COUNTER & SOUNDBOX) £65-£55*

Printers	Disk Drives	Sundries	
CBM 4022 & 8024	CBM 8050	Interfaces:	C12 Cassettes
Centronic 779	CBM 4040	Disks:	Library Cases
Centronic 737	CBM 3040	Paper:	(roll & tractor feed)
Spinwriter 5510		Labels:	Dust covers
CBM 8026 & 8027			

Now in stock: 23 Mb HARD DISK: £3500

For those with 3032's who want 4032's and those with 4032's who sigh for 3032's, all is not lost! HAVE BOTH, at the flick of a switch - CHIPSWITCH for £57 + ROMs for £38 (with de-glitching facility built-in).

TOOL KITS (BASIC 2 & 4), SUPERCHIPS,
..... AND ALL SORTS OF OTHER CHIPS.....
UPGRADE YOUR PET EVEN MORE!!

* PRICES DO NOT INCLUDE VAT

SOFTWARE

As well as a full range of programs listed below, we have some highly reliable "Home-Brewed" programs available.

STOCK CONTROL & INVOICING £60
(Handles up to 500 items - 32K) (180 on 16K). Stock depleted on invoicing, search etc. Cassette, disk (& print option).

CASH BOOK

Enter daily/weekly amounts - printout and totals, weekly/monthly analysis, totals and balances.

3032, 4032 & 8032 versions from £90 to £150

STOCK TAKING for the licensing trade £240
Superb new program for 8032 £420

OUTSIDE SERVICES (For Mini-Cabs etc.) £220

New 8032 Version at 3032 price

Sae for free software booklet

**SILICON OFFICE : WORDCRAFT : WORDPRO
D.M.S.V. : ADMINISTRATOR : DATALEX
BASIC & SUPERPAY : ACCOUNTS : VISICALC**

COME AND SEE THE NEW

VIC-20 at £160

FULLY WORKING AND OPERATIONAL
ASK US ABOUT ALL THE ADD-ON-GOODIES
THAT GO WITH THE VIC ...!

PERSONAL SHOPPERS WELCOME
Phone & Mail Orders accepted

ALL GOODS SENT SAME DAY WHEREVER POSSIBLE
LARGE S.A.E. FOR LISTS ETC.

MADE IN U.K.

VNA



PATTERNS

which remains stable across the display.

Figure 2 shows the result when the probabilities have been turned into the certainties of 0 and 1, as in lines 140 to 170 of Program A. In this case, the value of each pixel is fully determined by its two neighbours. Looking at the pattern you can see that each pixel that has black pixels below and to the left of it is white, with a probability of 1 = certainty. The whole pattern depends entirely on the values in the two random starter arrays, X and Y.

Figure 3 shows what happens when the probabilities are changed slightly to 0.9, 0.1, 0.1, 0.9. This is very like Figure 2, but with 10 percent noise added. But if the probabilities are changed completely then quite different textures result: Figure 4 shows an example with probabilities set at random.

This simple system is not complex enough to produce a very rich variety of textures. There are at least two ways to think of this intuitively. First, four variables, the four probabilities, are not enough to represent or characterise the many different dimensions of texture. Second, working at the level of single pixels is too low: there is in most textures a lowest level of detail that is more or less random and the texture itself is somehow operating at a slightly less microscopic level.

A move that copes with both these points is to use small groups of pixels. In the example presented here a simple array, two pixels by two pixels, is used, and I call this unit a cell. With just black and white there are now five possible values for a cell, ranging from all four pixels black, three black and one white, to all white. When, say, one pixel in a cell is black, it is not considered important which one it is. In Program B the setting of pixels within a cell is fixed, and is set in the array A. For a little more computer time the one to be set could be chosen at random.

Program B implements this scheme in Pascal and Figure 5 shows five textures produced by this program, where the probabilities stored in T are themselves set by calls to the random function. The function RAND takes an integer in the range -32768 to +32767, which is what the system function Random produces, and converts it to a floating point value in the range 0.0 to RANGE. Most of the variables have the same uses as in the Basic program. It is necessary to have U and V as the coordinates for plotting pixels as twice X and Y which are coordinates of the cells. The array of probabilities T now has three dimensions, there are 5 x 5 = 25 different cases for the values of the two neighbours, and for each case there are now four probabilities. The multiple calls to RAND in setting the values in T ensure more variety in these settings.

Reference: Monne, Schmitt and Massaloux, 'Bidimensional texture synthesis by Markov chains', *Computer Graphics and Image Processing*, September 1981. (Academic Press).

```

Program TEXTURE;
Const
  XM=100;
  YM=100;
Var
  C,D:Integer;
  I,J:Integer;
  N:Integer;
  U,V:Integer;
  S:Real;
  X:Array[0..XM] of Integer;
  Y:Array[0..YM] of Integer;
  A:Array[0..4,0..3] of Boolean;
  T:Array[0..3,0..4,0..4] of Real;
Function RAND(RANGE:Real):Real;
Begin
  RAND:=-RANGE*(Float(Random)+32770.0/65540.0); Scale Random to range
End;
Begin
  InitRandom;
  Readln(I);
  For J=1 to I do
    N:=Random;
  For I=0 to 4 do
    Begin
      For J:=0 to 3 do
        Begin
          A[I,J]:=false;
          If I>J then A[I,J]:=true
        End;
      End;
    End;
  For I:=0 to 4 do
    Begin
      For J:=0 to 4 do
        Begin
          T[0,I,J]:=RAND(RAND(RAND(3.0)));
          T[1,I,J]:=RAND(RAND(RAND(1.0)))+T[0,I,J];
          T[2,I,J]:=RAND(RAND(RAND(1.0)))+T[1,I,J];
          T[3,I,J]:=RAND(RAND(RAND(1.0)))+T[2,I,J];
        End;
      End;
    End;
  For I:=0 to XM do
    X[I]:=Trunc(RAND(5.0));
  For J:=0 to YM do
    Y[J]:=Trunc(RAND(5.0));
  For J:=0 to YM do
    Begin
      C:=Y[J];
      V:=J+J;
      For I:=0 to XM do
        Begin
          D:=X[X];
          U:=I+I;
          S:=RAND(1.0);
          N:=4;
          If S<T[3,C,D] then N:=3;
          If S<T[2,C,D] then N:=2;
          If S<T[1,C,D] then N:=1;
          If S<T[0,C,D] then N:=0;
          If A[N,0]=true then Dot(U,V,U,V);
          If A[N,1]=true then Dot(U+1,V,U+1,V);
          If A[N,2]=true then Dot(U,V+1,U,V+1);
          If A[N,3]=true then Dot(U+1,V+1,U+1,V+1);
          X[I]:=N;
          C:=N;
        End;
      End;
    End;
End.

```

Prog to plot textures
Screen width
Screen height
Val of cells left & below
Loop ctrl, cell co-ords
Current cell value
Pixel co-ords
Random selector value
Start values along X
Start values along Y
Cell definitions
Main table of probabilities

Random function 0 to RANGE

Main program
Initialise Random
Read in seed
Ignore 1st I random values

Set up array for cell values
0 to 4 pixels set
1 3 4 pixels
0 2 in each cell

Set up main array of probabilities
5 values at left
by 5 values below
1st case quite likely
2nd 3rd & 4th no so
likely
Rest is 5th case

Set up X boundary
Random integer 0 to 4
Set up Y boundary
Random integer 0 to 4

Main loop for each line
Effect of cell to left
Double the Y co-ord
For each cell on a line

Effect of cell below
Double the X co-ord
Random selector
If S>T[3,C,D]
Select case according to S

Plot points
Save value for next line
Set effect for next cell

Program B Pascal program for 2 x 2 cells in black and white.

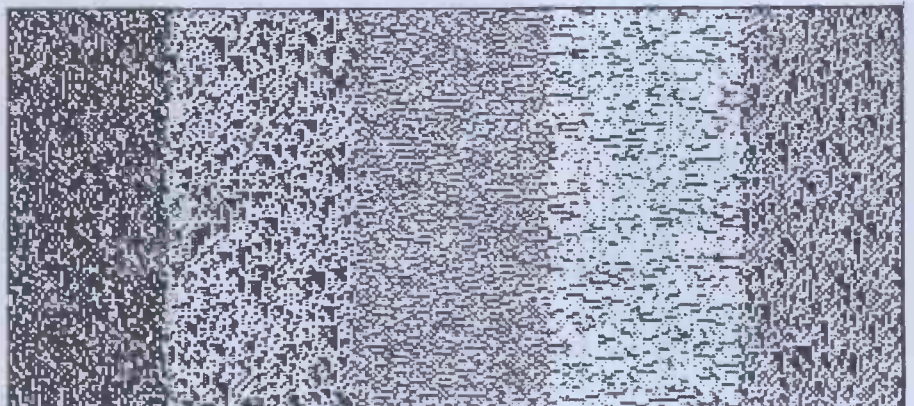

Fig 5 Sample textures from the Pascal program

END

THE PROFESSIONAL'S CHOICE

Act Sirius 1

16 Bit Stand Alone micro with superb features. 128K, 1.2MB Floppies, CPM86 as standard - £2395.



Altos

Up to 4 terminals and 40MB of Winchester Disc. One of the biggest selling small business systems starting at £2350.

16 Bit system with 8 terminals available soon.

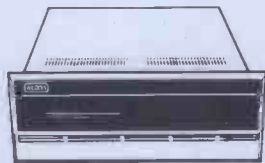

OKI 1F800

Quality graphics micro with full colour screen and integral printer. 64K and Basic are standard - £4750. Wide range of peripherals available.

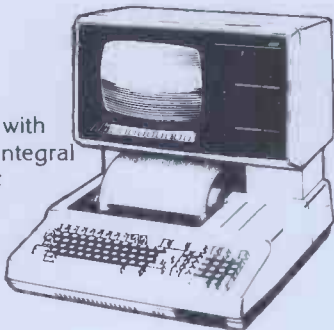

LSI M3

High specification Stand Alone micro. CPM, 64K and up to 10MB of Winchester in one package. Very easy to use. Detachable keyboard. User programmable function keys. From £2250.

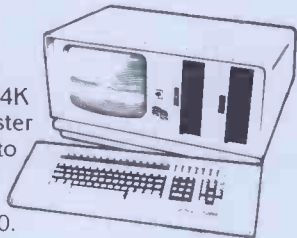

Superbrain

Still a leader in 8 bit price performance. KGB having sold over 400 Superbrains has unbeatable experience on them. From £1875.



Word Processing - Wordstar £250, Mailmerge £75.

Full on-screen facilities enabling the printing of standard letters and preparation of mail shots.



Accounting - From £300 per module.

Integrated accounting systems with Invoicing, Sales, Purchase and Nominal Ledgers.



Financial Modelling - Micromodeller £645.

Budgets, forecasts and accounting data become easy to prepare. Allows "what if" projections.



Calculation - Supercalc £175.

Electronic worksheet for preparation of budgets and tables of data.



Record Keeping - DMS £400.

Personnel, stock or any other records with quick retrieval, sorting and reporting.



Sales Office Management - Sales Desk £300.

For the busy sales office to manage sales leads and marketing lists.



Accounts - IRIS £750.

Incomplete records and time recording systems.



Payroll - Graffcom £500.

Up to 500 employees both weekly and monthly paid. Automatic deduction for items like company pensions.



Graphics - Price depends on application.

Full on-screen graphics both colour and black and white.



Engineering - SPERT £450.

Suite of programmes for PERT analysis and civil engineering applications.



Communications - Liberator £250.

Enables a micro-computer to act like a mainframe terminal and transfer data from Floppy disc to another computer.



Languages - From £175.

Most major computer languages are available: Basic, Cobol, Fortran, Pascal and Assembler.



Solicitors - Solace £1600.

Solicitors accounting, client accounting and time recording.



Multi-terminals - MP/M and Oasis from £350.

Multi-user systems available.

KGB

MICROS LIMITED

14 Windsor Road, Slough SL1 2EJ Tel: Slough (0753) 38581/38319 Telex: 847777

TO: THE MICROCOMPUTER MARKET · STOP.
 KGB SUPERBRAIN SALES SUCCESS MEANS
 PRICE REDUCTIONS ON SUPERBRAIN · STOP.
 NOW FROM ONLY £1495 · STOP.
 CALL KGB NOW!

POURING QUARTS INTO PINT POTS

When you plan to buy your computer equipment you normally look very carefully at the things that cost most money. You tend to think very hard about, for instance, what printer you need and can afford. People usually regard the purchase of disk units as inevitable, with no scope for savings. That is not necessarily so: this article discusses a technique which could save you money.

Have you thought carefully about how data is stored on your disk? For example, when you investigate the way numeric data is stored on the Apple Disk II using the normal facilities of Applesoft and DOS 3.3 you will discover it is rather like a sieve. Each numeric digit is put into a separate byte. This is very wasteful since each byte can hold numbers up to 255 and we can normally only put in values up to 9.

Figure 1 shows how the value 12,345,678 is stored in 9 bytes, using conventional methods. Although the number is held in binary form in memory, it gets expanded to base 10 on the disk. The accompanying program shows how the number can be compacted to three bytes expressed to base 256, as in Figure 2. This technique can make all the difference between needing bigger, or more disks, and being able to manage with what you've already got.

The example in the program is based on an imaginary requirement, in which an organisation needs to store information (sales figures perhaps) for 99 products and 29 areas over a period of 12 months. The program enables us to store numbers for all these combinations (34,452 in all), each with a value up to over 16 million. Using conventional methods this requires over 310,000 bytes. Using this method it requires only about 195,000 bytes, and can therefore be stored on a 5¼in disk II.

You can store numbers (option 1), add to them (option 2) and display them (option 3). Option 0 allows you to set the file up in the first place. Although this takes about 20 minutes it is necessary in order to avoid problems on reading fields which have not previously been addressed. Option 4 is required to close the file down, and to clear whatever happens to be in the buffer. Each option returns you straight to the Menu except option 3, which lets you read the value displayed and waits until you press any key before returning to the Menu.

The method used is by successive division to reduce numbers into three one-byte portions of values up to 255. The three byte fields are joined together in the buffer area and written to disk using the facilities of DOS Random Access storage. They are subsequently read from disk, unpacked and converted back to their original form. This process inevitably requires the use of PEEK and

POKE, since Basic by itself does not allow us to address individual bytes.

Record length is given as 256 bytes — that is the whole of the buffer area. Bytes 0 and 1 contain 1 and Return respectively. Bytes 2 to 253 contain 84 fields of 3 bytes packed together with no separating characters between fields. Bytes 0 and 1 contain the values stated because a DOS "WRITE" needs a PRINT, and a DOS "READ" needs an INPUT. The 1 in byte 0 has no data significance, of course, but is there in order to take the 84 packed binary fields on to the disk by POKE and from the buffer by PEEK. Bytes 254 and 255 are wasted because there is no more room in the sector for a 3-byte field. (The loss of the first two and last two bytes in each sector is a minor but unavoidable loss of efficiency.)

A Write Indicator (WR) is used to keep the Buffer READs and WRITEs under control in subroutines 600 and 700. Without this additional check DOS will use other buffer areas some of the time, which would prevent this method from working correctly.

Extensions

The method can be extended in four different ways.

Firstly, although the program illustrates the method with a three-byte field, the number of bytes can be changed by altering the value of 1 in subroutines 400, 600, 800 and 900, and expanding the range of values for Z. The more bytes you pack together into one field, the bigger the saving of space.

Secondly, it is possible to add to the code by recording negative numbers. This can be done by allocating one binary position for negative numbers prior to coding and POKing them and later PEEKing and de-coding them.

Thirdly, decimals can be coded by moving the decimal point before coding and after de-coding.

Fourthly, alphabetical characters can also be coded — although the saving is not as great. Since the range of alphanumeric characters can be accommodated within six bits (0-63) it will be possible to store four alphabetical characters in three bytes by using an extension of this method. **END**

Contents	188	97	78
Byte No	0	1	2
	188 x 65536 =	12,320,768	
	97 x 256 =	24,832	
	78 x 1 =	78	
		12,345,678	

Figure 2

Contents	1	2	3	4	5	6	7	8	R
Byte No	0	1	2	3	4	5	6	7	8

Figure 1

```

5  REM COMPACT
6  REM AUTHOR ERWIN SCHNEIDER
7  REM TRIAD COMPUTING SYSTEMS
8  REM TEL 01-831-7211
15  REM
16  REM THE PURPOSE OF THIS
17  REM PROGRAM IS TO COMPRESS
18  REM NUMERIC DATA ON DISK.
19  REM
21  REM THIS IS ACHIEVED BY
22  REM DIVIDING NUMBERS INTO
23  REM SUCCESSIVE BYTES ON DISK
24  REM EACH BYTE REPRESENTS AN
25  REM ELEMENT TO BASE 256.
26  REM THIS IS DONE WITH PEEKS
27  REM AND POKES IN THE BUFFER
28  REM AREA.
29  REM
30  Z(1) = 65536
31  Z(2) = 256
32  Z(3) = 1
70  GOTO 1000
100  REM ## INPUT ##
110  HOME : VTAB 5 : HTAB 10
120  PRINT "INPUT DATA"
140  VTAB 7
150  INPUT "AREA (1- 29) " :JA
160  IF A < 1 OR A > 29 THEN 140
170  VTAB 9
180  INPUT "PRODUCT (1 - 99) " :JP
190  IF P < 1 OR P > 99 THEN 170
155  VTAB 11
200  INPUT "MONTH (1 - 12) " :JH
210  IF H < 1 OR H > 12 THEN 195
220  RETURN
250  REM ## GET VALUE ##
260  VTAB 15 : HTAB 5
270  PRINT "DATA INPUT"
280  INPUT "VALUE (1 TO 16777215)
      " :V
290  IF V < 0 OR V > 16777215 THEN
      260
295  RETURN
300  REM ## FORM KEY ##
305  KE = K1 : REM PREV REC NO
310  K = (1180 + (K + 1) * 12)
      (P - 1) * H - 1
320  K1 = INT (K / 84) : REM REC
      NO
      = 3 + (K - (K1 * 84)) : REM
      REMAINDER
340  K1 = K1 + 1
350  RETURN
400  REM ## TO BINARY ##
410  FOR I = 1 TO 3
420  V(I) = INT (V / Z(I))
430  V = V - V(I) * Z(I)
440  NEXT I
450  RETURN
500  REM ## BUFFER CONTROL ##
510  IF K1 = K2 THEN 540
520  GOSUB 700 : REM OUTPUT
530  GOSUB 750 : REM INPUT
540  RETURN
600  REM ## NEW ITEM IN ##
610  FOR I = 1 TO 3
620  POKE (38401 + K + I) * V(I)
630  NEXT I
650  WR = 1 : REM WRITE INDIC
660  RETURN
700  REM ## OUTPUT ##
705  REM ## OUTPUT ##
707  IF WR = 0 THEN 740
710  PRINT D$ : "WRITE COMPACT-B DA
      TA,R"K2
720  PRINT I
730  WR = 0
740  RETURN
750  REM ## INPUT ##
760  PRINT D$ : "READ COMPACT-B DAT
      A,R"K1
770  INPUT A
780  RETURN
800  REM ## FROM BINARY ##
810  A = 0
820  FOR I = 1 TO 3
830  A = (A * 256) + V(I)
840  NEXT I
850  RETURN
900  REM ## GET ITEM ##
910  FOR I = 1 TO 3
920  V(I) = PEEK (38401 + K + I)
930  NEXT I
940  RETURN
1000  REM ##INITIALISATION##
1010  D$ = CHR$(4) : "OPEN COMPACT-B DA
      TA,L256"
1100  PRINT D$
1105  HOME : VTAB 5 : HTAB 10
1110  PRINT "MAIN MENU"
1120  VTAB 7 : HTAB 5
1130  PRINT "0. INITIAL FILE SET-
      UP"
1140  PRINT "      (TO BE USED ONL
      Y DICE)"
1150  VTAB 10 : HTAB 5
1160  PRINT "1. REPLACE A FIELD"
1170  VTAB 12 : HTAB 5
1180  PRINT "2. ADD TO A FIELD"
1190  VTAB 14 : HTAB 5
1200  PRINT "3. DISPLAY A FIELD"
1210  VTAB 16 : HTAB 5
1220  PRINT "4. STOP"
1230  VTAB 18 : HTAB 6
1250  INPUT " :H
1260  IF H < 0 OR H > 4 THEN 1230
1270  ON H + 1 GOTO 1300,1400,1500
      6,1600,1700
1300  REM ## FORMAT SECTORS ##
1310  FOR K2 = 1 TO 411
1320  FOR I = 2 TO 255
1330  POKE (38400 + I),0
1340  NEXT I
1350  GOSUB 710 : REM OUTPUT
1360  NEXT K2
1370  GOTO 1100
1400  REM ##REPLACE ##
1410  GOSUB 100 : REM INPUT
1420  GOSUB 250 : REM GET VALUE
1430  GOSUB 300 : REM FORM KEY
1435  GOSUB 500 : REM BUFFER CTRL
1440  GOSUB 400 : REM TO BINARY
1450  GOSUB 600 : REM NEW ITEM IN
1460  GOTO 1100
1500  REM ## ADD TO FIELD ##
1510  GOSUB 100 : REM INPUT
1520  GOSUB 250 : REM GET VALUE
1530  GOSUB 300 : REM FORM KEY
1540  GOSUB 500 : REM BUFFER CTRL
1550  GOSUB 900 : REM GET ITEM
1560  GOSUB 800 : REM FROM BINARY
1570  V = V + A
1580  GOSUB 400 : REM TO BINARY
1590  GOSUB 600 : REM NEW ITEM IN
1595  GOTO 1100
1600  REM ## DISPLAY FIELD ##
1610  GOSUB 100 : REM INPUT
1620  GOSUB 300 : REM FORM KEY
1630  GOSUB 500 : REM BUFFER CTRL
1640  GOSUB 900 : REM GET ITEM
1650  GOSUB 800 : REM FROM BINARY
1660  VTAB 15 : HTAB 5 : PRINT D$
1670  PRINT "VALUE IS " : A
1680  GET AS : REM TIME TO READ
1690  GOTO 1100
1700  REM ##END ##
1710  KE = K1
1720  GOSUB 700 : REM OUTPUT
1730  PRINT D$ : "CLOSE"
1740  END

```



THE COMPLETE SINCLAIR ZX81 BASIC COURSE

At last, a comprehensive text for your Sinclair ZX81! The complete BASIC Course is a manual which will immediately become an indispensable work of reference for all your ZX81 programming.

Whether you have never done any programming or whether you are an experienced microcomputer user, the Complete BASIC Course will provide an invaluable aid.

The complete BASIC Course is designed to teach you to write and develop BASIC programs for the Sinclair ZX81 - no other books or aids are necessary. All is revealed in our easy step-by-step guide with programs and "test yourself" exercises all the way through.

As you become more proficient with computing, the Complete BASIC Course will continue to be an essential guide, giving you finger tip references, numerous advanced programming techniques and memory saving devices specifically for the Sinclair ZX81.

HOW TO WRITE PROGRAMS

Even if the idea of writing programs is completely mystifying to you, the Complete BASIC Course will show you just how easy it is. In no time you will be able to write and enjoy complex programs for whatever you desire.

Using the proven "TOP-DOWN" approach, the Complete BASIC Course will show you systematic and simple ways to write programs. Even experienced programmers will benefit from this Course, making programs easier to write and less prone to error!

NUMEROUS EXAMPLES

Every concept, every function is fully described by simple programs that you can enter on your Sinclair ZX81 in minutes.

The Complete BASIC Course contains over 100 programs and examples! These programs illustrate the use and possibilities of the Sinclair ZX81:

- Home use
- Financial analysis and planning
- Educational applications
- Games
- Mathematical applications
- Displays of 'Artificial Intelligence'

EVERY FUNCTION COVERED

No matter what your application, what your confusion about any function, you will find it covered in the Complete BASIC Course.

A full and detailed discussion is included of even traditionally taboo topics such as USR, PEEK and POKE.

A handy alphabetical summary section lists all functions, and provides a short description and example programs of all topics.

A PERMANENT WORK OF REFERENCE

The complete BASIC Course is an excellent reference work for experienced programmers (including tips on using special techniques) as well as a comprehensive step-by-step guide for complete beginners.



Melbourne House is the world's leading publisher of books and software for the Sinclair ZX81.

The following titles are also available if you wish to expand your horizons:

ZX81 ROM Disassembly Part A

This book is for the programmer that needs complete answers about the ZX81. Dr. Logan has examined all routines in the ROM and here he comments on each one. It covers all ROM locations from 0000H to 0F54H, and includes all functions except for the routines used in the floating point calculator.

ZX81 ROM Disassembly Part B

In this companion volume to Part A Dr. Logan covers locations 0F55H to IDFFH and includes all routines used in the ZX81 floating point calculator. These two books are a must for the experienced programmer.

Not Only 30 Programs for the Sinclair ZX81: 1K —

Not only over 30 programs, from arcade games to the final challenging Draughts playing program, which all fit into the unexpanded 1K Sinclair ZX81 but also notes on how these programs were written and special tips! Great value!

Machine Language Programming Made Simple for the Sinclair —

A complete beginner's guide to the computer's own language - Z80 machine language. Machine language programs enable you to save on memory and typically give you programs that run 10-30 times faster than BASIC programs.

BASIC Course Programs on Cassette —

All major programs in the BASIC Course are available pre-recorded in this set of cassettes.

Understanding Your ZX81 ROM —

A brilliant guide for more experienced programmers by Dr. Ian Logan, this book illustrates the Sinclair's own operating system and how you can use it.

Orders to Melbourne House Publishers
131 Trafalgar Road, Greenwich London
SE10
(Correspondence to
Glebe Cottage, Station Road,
Cheddington, Leighton Buzzard, BEDS LU7
7NA)

NAME

ADDRESS

Postcode

The Complete Sinclair ZX81 BASIC Course	£17.50	<input type="checkbox"/>
Basic Course Programs on Cassette	£2.50	<input type="checkbox"/>
Not Only 30 Programs/ Sinclair ZX81:1K	£6.95	<input type="checkbox"/>
Machine Language Programming Made Simple	£8.95	<input type="checkbox"/>
ZX81 ROM Disassembly Part A	£7.00	<input type="checkbox"/>
ZX81 ROM Disassembly Part B	£8.00	<input type="checkbox"/>
Understanding Your ZX81 ROM	£8.95	<input type="checkbox"/>

Postage and Packing £0.80

Remittance enclosed £.....

TJ's WORKSHOP

Our monthly pot-pourri of hardware and software tips for the popular micros. If you have a favourite tip to pass on, send it to: 'TJ's Workshop', PCW, 14 Rathbone Place, London W1P 1DE. Please keep your contributions as concise as possible. We will pay £10 for any tips we publish (think how much solder and/or Elastoplast that would buy).

UK101 OUTPUT

This modification allows the ACIA chip on a Superboard/UK101 machine to be used as a single bit Input/Output port.

On the ACIA, pin 5 is the ready to send enable pin. By POKEing location 61440 with 81 and 51, logic at this pin goes high and low respectively. This output facility allows use of the ACIA as an output port without the need for a PIA. It should be noted that the current available is low, and the circuit below ought to be used when driving relays, etc.

The Input side of this arrangement is a little more complex. Cut the track on the board that is connected to pin 5; it runs under the socket, so either remove the

IC and cut there or trace the track until it emerges from the socket. Connect a 4.7k resistor to the pin 5 side of the cut, and a positive +5v power line to the other side of the resistor. Then connect the input line to pin 5. Logic high or low is detected by PEEKing 61440, and bit four of this location goes 1 or 0 depending on the state of input at pin 5. If the input side of the above does not function, swap the 4.7k for a 2.7k. There should be no difficulties with the output side, as it is very straight forward.

Below is the circuit for the enhanced output port. This will drive a small relay, tape recorder, light, etc.

R Wells

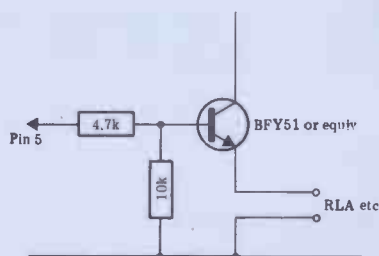

MBASIC TIP

In your February issue P H Elliott points out how to duplicate MBasic lines with control-A. There is another very useful technique akin to this. When testing a program, a syntax error can be corrected and the program continued without restarting, as follows:

1. The program is run and halts with an error in, say, line 550.
2. Edit mode is entered automatically.
3. Enter Q. Edit mode is exited, without altering the statement in error or losing variable values.
4. Enter control-A. State-

ment 550 will appear in direct mode, without a line number.
5. Edit the line to correct it, without re-entering a line number.
6. Press RETURN, and the statement will execute in direct mode.
7. Enter GOTO 560 (assuming this is the next statement in sequence), and the program will continue.

Note that it will still be necessary to correct the statement in error before saving the program, but this technique can save debugging time.

Brian Hebbes

MICROTAN EPROMS

If you own a Microtan 65 with Tanex the following modification will allow you to run several EPROMs from one of the EPROM extension sockets. You will be able to switch between these using a software or hardware switch. I am currently running three EPROMs in this expansion board and I have found no problems whatsoever.

As can be seen from the circuit diagram the EPROMs are connected in parallel except for CE and OE. To enable any one chip at a time these two lines are taken low. If any other EPROM has its outputs enabled at this stage you will fry these instantly. To make sure that this does not happen I used a 74LS139 which is a 2-4 line decoder. This ensures that only one EPROM is selected at any one time. This 2-4 line decoder is connected to one of the spare ports on Tanex, allowing software control of which EPROM is being selected. The useful thing about this is that on reset EPROM 0 is selected. I have used this modification to allow me to use two different versions of Toolkit (one high-res, the other sound).

The following circuit assumes that 2716 EPROMs are used and that you are not

using more than three in parallel. If you wish to use more I suggest that you buffer the address bus to avoid loading it too much.

The circuit was built on veroboard and connected to EPROM socket E2 and bits 0 & 1 of port 1 B.

The following pins of the EPROMs are simply connected in parallel.

pin	function	pin	function
1	A7	24	Vcc
2	A6	23	A8
3	A5	22	A9
4	A4	21	Vcc
5	A3	20	see text
6	A2	19	A10
7	A1	18	see text
8	A0	17	D7
9	D0	16	D6
10	D1	15	D5
11	D2	14	D4
12	Vss	13	D3

All the address and data lines are connected together in parallel. Pins 20 and 18 are connected together. When these lines are taken low the chip is selected. From every EPROM these lines are taken to one of the outputs of the 74LS139. The enable pin on the 74LS139 is connected to the CE signal that comes from Tanex. I used a 24 pin connector cable which was plugged into socket E2.

R Lienfellner

6k ROMboard circuit diagram

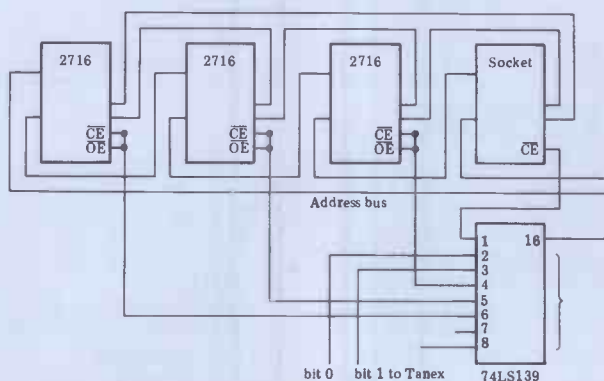

UK101 NEGATIVE SUPPLY

Most RS232 interface devices require that the signals from the computer can swing negative with respect to ground. This often means that an extra negative supply must be provided.

To save the expense of an additional transformer and the need to find space for it inside the case of my Compukit I have used a negative supply generator which operates off the 5 volt supply of the Compukit. This can be built on a small piece of veroboard and will fit into any small available space.

The circuit used was as shown in Figure 1. This consists of a transistor switched on and off by the TXCLK signal available at IC68 pin 11. When this transistor is off, capacitor C1 charges to about 4.5 volts through resistor R3 and diode D1. When the transistor turns on, the positive end of C1 is taken to 0 volts while the negative end is at -4.5 v.

If the voltage on C1 is more negative than the voltage on C2, diode D2 will conduct to allow capacitor C2 to charge up and C2 will end up with a voltage of about -4 volts on it.

If the link at W10 on the Compukit is broken and the supply now available from the junction of C2 and D2 is connected to J3 pin 7, a check with an oscilloscope connected between J3 pin 2 and J3 pin 1 will show that when data is being output from the serial port J3 pin 2 will go from about +4 to -4 volts.

I have used this modification on my Compukit to allow me to drive a TI Silent 700 terminal and a TRS-80 Line Printer VII. With neither of these has there been any problem of corruption of data during transfer.

A parts list indicating typical component values is included as Figure 2.
R A Shackelford

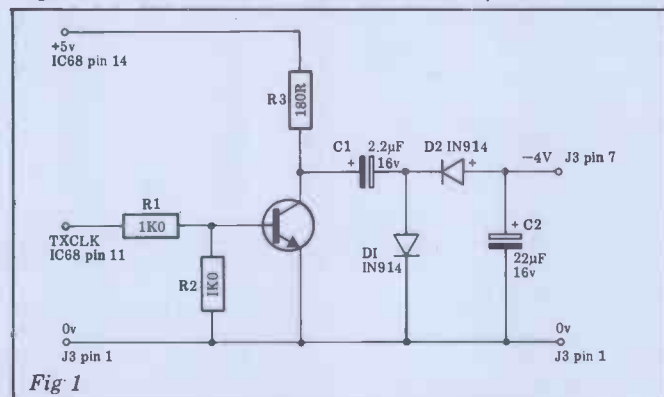

Fig 1

Item	Description	Value
R1	Resistor, carbon film	1K0, 5%, 1/4W
R2	Resistor, carbon film	1K0, 5%, 1/4W
R3	Resistor, carbon film	180R, 5%, 1/4W
C1	Capacitor, tantalum	2.2uF, 16Vdc.
C2	Capacitor, tantalum	2.2uF, 16Vdc.
D1	Diode, silicon, small signal	1N914
D2	Diode, silicon, small signal	1N914
TR1	Transistor, small signal, npn	BC182

Fig 2

ZX81 POKE

While PEEKing and POKEing on my ZX81 recently I discovered an easy way to obtain a 34 column display (as opposed to the usual 32). The effect is obtained by POKEing 16441 and 16442 with the values 20. The following program illustrates this. When the program

ends or is interrupted by BREAK, to return to normal mode press NEWLINE.
10 POKE 16441, 20
20 POKE 16442, 20
30 GOTO 10

Other interesting effects can be obtained by POKEing the two addresses.

Richard Gosling

MZ80K BACKUP

It is unfortunate that Sharp does not provide information to aid making a back-up copy of its tape Basic interpreter, SP5025. This is, however, quite simple, using the enclosed program.

The procedure is as follows:

1. Load Sharp Basic SP5025 in the normal way.
2. If you have Knights Commander, load that too.
3. Load the copy program,

as a normal Basic program.
4. Run the program and, at the prompt, insert a blank cassette, positioned to record.

5. Press any key on the keyboard to continue and, at the next prompt, press RECORD & PLAY.

The interpreter will now record, and this recording can now be loaded from the monitor in the normal way.

Clinton Evans

```

100 REM *****
110 REM * BASIC TAPE BACK-UP PROGRAM *
120 REM *****
130 REM
140 POKE 4336,1
150 REM READ TITLE IN A$
160 READ A$
170 J=4336+LEN(A$)
180 FOR I=4337 TO J
190 POKE I,ASC(MID$(A$,I-4336,1))
200 NEXT
210 POKE J+1,13
220 REM READ LENGTH OF PROGRAM
230 READ L
240 GOSUB 430
250 POKE 4354,J
260 POKE 4355,I
270 REM READ PROGRAM START ADDRESS
280 READ L
290 GOSUB 430
300 POKE 4356,J
310 POKE 4357,I
320 REM READ PROGRAM EXECUTE ADDRESS
330 READ L
340 GOSUB 430
350 POKE 4358,J
360 POKE 4359,I
370 PRINT"*****POSITION TAPE TO RECORD PROGRAM
380 PRINT"*****ANY KEY TO CONTINUE*****"
390 GET Z$:IF Z$="" THEN 390
400USR(33)
410USR(36)
420STOP
430I=INT(L/256)
440J=L-I*256
450RETURN
460DATA "SHARP BASIC SP5025"
470DATA 12900,4608,4608

```

PRINTING TO 3 DECIMAL PLACES

Basic normally prints numerical values less than 0.01 in the exponent form 1.23E-03. This can be annoying and untidy if you are listing a table of figures where the third decimal place is needed (eg, dimensions in mm or thou or prices).

To overcome this I developed the short subroutine below, which can be inserted into the program where the number is to be printed. A sample run is shown to demonstrate the improvement to the format.

Sample program
(Line 20 is for print enhancement)

```

10 INPUTN
20 IFN<.01THENPRINT
  ".00";CHR$(48+INT
  (N*1000+.5)):GOTO 40
30 PRINTN
40 GOTO10

```

Example of formats

Normal	Improved
.123	.123
.012	.012
1E-03	.001
5E-03	.005
.054	.054
.543	.543

D Gayler

APPLE SCREEN BUG

With most TV/monitors the Apple produces half-intensity dots at certain points on the screen. This occurs with colours 5, 6 and 7 and is apparent in both b/w and colour. The only system, known to the author, in which this doesn't occur is an Apple with Sony TV and special Sony colour card. To assess whether this problem occurs with your system try program 1 which produces three half-intensity dots and then changes them to full intensity. If the dots remain unchanged then your system has no problems and you need read no further. To see how annoying this problem is run programs 2 and 3. The problem in plotting the point X, Y only occurs in a limited number of situations. Namely:

1. HCOLOR = 5, X odd and X+1 divisible by 7.
2. HCOLOR = 6, X even and

```

10 HOME : TEXT : HGR
20 HCOLOR= 5
30 H PLOT 13,1 TO 13,150
40 H PLOT 17,50 TO 17,150
50 HCOLOR= 6
60 H PLOT 48,1 TO 48,150
70 H PLOT 52,50 TO 52,150
80 HCOLOR= 7
90 H PLOT 96,1 TO 96,150
100 H PLOT 97,1 TO 97,150
110 H PLOT 101,50 TO 101,150
120 H PLOT 102,50 TO 102,150
130 END

```

Program 2

```

10 HOME : TEXT : HGR
20 HCOLOR= 5
30 H PLOT 13,100
40 HCOLOR= 6
50 H PLOT 48,100
60 HCOLOR= 7
70 H PLOT 96,100 TO 97,100
80 V TAB 21: PRINT "WATCH THE LEFT HAND DOT"
90 PRINT "AND PRESS THE 'SPACE BAR'": GET A$
100 HCOLOR= 4: REM BLACK
110 H PLOT 16,100: REM SHOULD BE NO CHANGE
115 HOME
120 V TAB 21: PRINT "NOW WATCH THE NEXT DOT"
130 PRINT "AND PRESS THE 'SPACE BAR'": GET A$
140 H PLOT 52,100: REM AGAIN THERE SHOULD BE
NO CHANGE SINCE PLOTTING IN BLACK
145 HOME
150 V TAB 21: PRINT "NOW WATCH THE LAST DOT"
160 PRINT "AND PRESS THE 'SPACE BAR'": GET A$
170 H PLOT 100,100: REM THERE SHOULD BE NO
CHANGE SINCE PLOTTING IN BLACK"
180 END

```

Program 1

```

10 HOME : TEXT : HGR
20 HCOLOR= 6
30 H PLOT 48,0 TO 244,0 TO 244,100 TO 48,100 TO 48,0
40 H PLOT 52,20 TO 230,20 TO 230,80 TO 52,80 TO 52,20
50 END

```

Program 3

- X+1 divisible by 7.
3. HCOLOR = 7 and X+1 divisible by 7.

Normally the remedy is to set HCOLOR = 4 (ie, black) and then to plot the point X+1, Y in black. Thus program 2 can be corrected by adding the lines:

```

35 HCOLOR= 4: H PLOT
14,1 TO 14,150: HCOLOR= 5
65 HCOLOR= 4: H PLOT
49,1 TO 49,150: HCOLOR= 6
105 HCOLOR= 4: H PLOT
98,1 TO 98,150: HCOLOR= 7

```

The remedy for program 3 is similar. Add the lines

```

42 HCOLOR= 4: H PLOT
245,0 TO 245,100
44 H PLOT 49,0 TO 49,100
46 H PLOT 231,20 TO
231,80.

```

Note that if HCOLOR = 7 is used in program 3 instead of HCOLOR = 6 then the given correction produces two small black dots at 49,0 and 49,100. This can be corrected by changing line 44 to:

```

44 H PLOT 49,1 TO 49,99.

```

This problem is caused by a fault in the Apple's plotting routines. Since this can be corrected in Basic then the machine code routines could also be corrected. Let's hope that Apple will correct this most annoying fault.

Dr G A Manson

VIDEO GENIE SEARCH

This program allows the user to determine which lines of his program contain any Basic keyword or any other form of text string. Also an indication will be given (by line number repetition) of how many times the search key was found on each line.

```

2 CLS: DEFINTI-L:
L=PEEK(16634)*256+PEEK
(16633)-4: K=17133:
FORI=K-5 TOL: IFPEEK
(I)=0: N=PEEK(I+4)*256+
PEEK(I+3): I=I+4: NEXTI:
ELSEFORJ=K TOK+20:
IFPEEK(J)=38: NEXTJ:
ELSEIFPEEK(J)=0:
PRINTN; : NEXTI:
ENDELSE IF PEEK(J)<>
PEEK(I+J-K): NEXTI:
ELSELSENEXTJ: NEXTI:
END

```

When typing the program use ? instead of PRINT otherwise the ND of the final END will have to be inserted using the Edit mode. This is because the keywords are not tokenised until after the line has been entered and the line is too long until this has taken place. Using the ? means that less initial text is entered.

Line number 1 is also required by this program to create the search key. This is used in the following manner:

The search key may be any basic keyword or any text not including a keyword, eg, 1 PRINT 1 SPIDERS IPRINT"SPIDERS.

But note the problem if the search key is 1 TARGET - GET is a Basic keyword, hence the word TARGET will not be found. To overcome this problem the text may be shortened or the special character (&) used, eg, 1 TARGE or 1 TARG&T. Keywords split by blanks are the same as those not, eg, GO TO is the same as GOTO but GOTO24 is not the same as GOTO 24.

Note: & is reserved for use as follows:

1. Immediately after the line number of line 1, to separate a numeric search key from the line number. This *must* be used for a numeric search key to avoid accidental deletion of a line in the user program - eg, 1&24 will create a search key for 24, while 1 24 will delete line 124 if it exists.
2. Following an extra blank after the line number 1 to

enable a blank to be used as the search key - eg, 1 &.

3. In any other position the character in a search key occupied by the & will not be checked. Therefore, & can be used in place of any character to disallow a keyword or if the spelling of a word is not known exactly.

Line 1 may contain any data for the search key and does not have to be in correct Basic syntax. This line is not intended to be run.

There are some restrictions with this routine:

1. The user program must start at a line number greater than 2.
2. The search key must not exceed 20 characters (although keywords may be counted as only 1).
3. The search program and search key line will occupy up to 190 bytes.

After the search key line is entered simply enter RUN 2. To run the user program enter RUN number, where number is the first line number of the user program. Alternatively, replace line 1 by 1 GOTO number then RUN will access the user program directly.

Each time the search key is found, the line number of the line containing the search key will be printed starting at the top left corner of the screen. The line number will be printed each time the search key is found, therefore the number of times the line number appears indicates how many times the search key occurred on this line. Approximately 12 line numbers are printed for each line of display.

M S Hale

COMPUTER PLUS

WATFORD

HOME COMPUTERS

ACORN ATOM The mighty Atom continues to smash records. Come and talk to us about Atom extras like Atom colour, Atom expansion, Atom printers, Atom Invaders (from Computer Concepts). And our prices are low – how about £239 for a fully expanded Atom with PSU!

BBC MICRO We're a support centre for the new BBC machines. So we have software, spares, upgrade kits – and plenty of advice!

SHARP MZ-80K For around £400, what other machine offers a 48K Z80-based computer with an integral 1000 ch. high definition screen and cassette unit – and is expandable with dual disc units, printers, etc? Fantastic value!

TEXAS TI-99/4A THE computer for the home if you really want a big range of plug-in cartridges for early-learning, education and games. AND you get a 16-bit micro with 5 octaves of music, 16 colours, etc.

VIC-20 You've read all about it, now come and see the famous VIC in action! Full and expanding range of accessories from Commodore, Arfon, Audiogenics, Hi-tech, Rabbit, Stack, etc. **SPECIAL OFFERS:**

VIC-20 & C2N cassette. . . £235

8K VIC & C2N. . . £265

21K VIC & C2N. . . £299

BUSINESS COMPUTERS

If you've got a business problem that needs a computer solution, come and talk to us. Mention stock control, accounting, file/record management or word-processing and – since we're dealers for **APPLE** ● **COMMODORE** ● **SHARP** – we'll probably mention names like:

● **SILICON OFFICE** ● **ANAGRAM** ● **MICROFACTS** ● **CP/M** ● **WORDCRAFT** ● **VISICALC**

– but only as a way of solving your problem. We try to keep it simple!

AND we stock – books – magazines – games – peripherals – diskettes – tapes – paper – labels, etc

COMPUTER PLUS

47 Queens Road, Watford, Herts WD1 2LH

Telephone: 0923 33927

Complete Sinclair ZX81 BASIC Course

At last, a comprehensive text for your Sinclair ZX81! The complete BASIC Course is a manual which will immediately become an indispensable work of reference for all your ZX81 programming.

Whether you have never done any programming or whether you are an experienced microcomputer user, the Complete BASIC Course will provide an invaluable aid.

Not Only 30 Programs for the Sinclair ZX81: 1K –

Not only over 30 programs, from arcade games to the final challenging Draughts playing program, which all fit into the unexpanded 1K Sinclair ZX81 but also notes on how these programs were written and special tips! Great value!

Machine Language Programming Made Simple for the Sinclair –

A complete beginner's guide to the computer's own language – Z80 machine language. Machine language programs enable you to save on memory and typically give you programs that run 10-30 times faster than BASIC programs.

ZX81 ROM Disassembly Part A

This book is for the programmer that needs complete answers about the ZX81. Dr. Logan has examined all routines in the ROM and here he comments on each one. It covers all ROM locations from 0000H to 0F54H, and includes all functions except for the routines used in the floating point calculator.

Understanding Your ZX81 ROM

A brilliant guide for more experienced programmers by Dr. Ian Logan, this book illustrates the Sinclair's own operating system and how you can use it

SPECIAL OFFER!

FREE BLANK CASSETTE WITH EVERY BOOK

OFFER EXTENDED TO 30 JUNE 1982

The Essential Software Company

We are pleased to announce the opening of our new shop at the **TECHNICAL LEISURE CENTRE**, 1, GRANGEWAY, KILBURN, LONDON, NW6.

GRAND OPENING -
29th 30th &
31st MAY.

Come and see our exciting range for ZX81, TRS80 VIDEO GENIE



Order Form:

Orders to
The Essential Software Company, Dept BT
(Visconti Ltd.) 01 866 5445
47 Brunswick Centre, London WC1N 1AF

NAME:

ADDRESS:

Postcode

The Complete Sinclair ZX 81 BASIC Course	£17.50	<input type="checkbox"/>
Basic Course		
Programs on Cassette	£ 2.50	<input type="checkbox"/>
Sinclair ZX 81 ROM Disassembly		
Part A - 0000H-0F54H	£ 7.00	<input type="checkbox"/>
Not Only 30 Programs/Sinclair ZX 81:1K	£ 6.95	<input type="checkbox"/>
Machine Language		
Programming Made Simple	£ 8.95	<input type="checkbox"/>
Understanding Your ZX 81 ROM	£ 8.95	<input type="checkbox"/>
Postage and Packing	£ 0.70	
Remittance enclosed		<input type="checkbox"/>

OUR GREAT NEW CATALOGUE IS NOW AVAILABLE

SEND S.A.E.

BBC BASIC APPEND

BBC Basic has no explicit APPEND statement to allow selected procedures to be added to a program from a library.

Here is a routine which allows repeated appending of Basic statements (complete programs or library sets of procedures) by loading the programmable function keys, f0 to f8, with a sequence of instructions and messages. You work through the keys from left to right and repeat the sequence as often as required for multiple appending. Step-by-step instructions are designed to give the user, at all times, a screen display containing the next action to be taken and a reminder of which key to press next.

Before using the program, a little thought regarding the line numbers of the statements to be appended will prevent ambiguities in the resulting programs. The highest line number of the first set of statements must be lower than the first line number of the second set, since the program does not merge but only appends. However, the first step in appending, loaded on key f0, can force a renumbering of the first set (from 1 in steps of 1). Similarly, key f3 is loaded with an instruction to renumber the second set from 10000 in steps of 1, and, to repair the odd appearance that this would give in the final version, the appended statements can be collectively renumbered, using key f8, from 10 in steps of 10. After the APPEND program is run to load the keys, and before any of the keys have been pressed (or subsequently between key presses if required), keys f0, f3 and f8 can be reloaded to any convenient renumbering system desired by the user. The chosen renumberings are designed merely as default values.

The APPEND program is loaded and run, setting LOMEM to the high end of memory in order to protect a small section of RAM, for the instruction strings to be called down later by the function keys — the only variables used by the program are the static variables in the range A% to Z%. The orange function keys are left loaded for subsequent use and the

first set of instructions is displayed on the screen. These tell the user to load the first set of statements (referred to as Program 1, but not necessarily a complete and executable program), to renumber using f0 if required, and to press f1 for the next set of instructions.

Loading the first set of statements is done by the user with the usual LOAD "" or LOAD "name"; this statement can not be put on a function key since the quote symbols terminate the *KEY statement. However, leaving this step to the user has the advantage that the correct name of Program 1 can be incorporated in the LOADing. Note that this action also deletes the APPEND program, but by now the subsequent actions are all stored on the function keys and the APPEND program has no other part to play. The ESCAPE and BREAK keys don't actually clear the keys if one of these is pressed by accident.

If Program 1 is to be renumbered, f0 is pressed when loading is complete.

When key f1 is pressed and immediately before the next set of instructions is displayed, PAGE is set to TOP+256 to move 'user memory' above program 1. (The BBC manual is misleading here since it gives a programming example of PAGE = TOP + 1. This is highly unlikely to move PAGE above TOP, since the Basic interpreter strips the lowest two bytes from PAGE to force it to a 'hexadecimal hundreds' boundary.)

The instructions now displayed tell the user to load Program 2 (again, it may be an executable program or just a set of procedures or statements) which is done by a LOAD "" or LOAD "name" as before. Since BBC Basic programs are stored in a fully relocatable format, the statements will be positioned in memory from the new value of PAGE, even though they were saved from the normal program location (starting at &OE00 in a tape-based Model B).

Key f2 is now pressed for further instructions.

Key f3 may be pressed for an optional renumbering of Program 2.

Key f4 brings up the next set of instructions, but before they are displayed the length of Program 2 is stored in L% for use in the appending stage, and PAGE is reset to its original value (stored by the APPEND program in P%).

Key f5 resets TOP for Program 1 by executing an 'OLD' command — TOP is not a variable but a function, and cannot be directly reset by storing its old value, as PAGE can.

Key f6 brings up the final set of instructions and executes the FOR...NEXT loop which successively PEEKs the values from Program 2 and rePOKEs them at the end of Program 1, resulting in what, on the Nascom2, would be an 'intelligent copy'. That means that, unless Program 2 is very short, the appended programs will eventually overwrite Program 2, but, by the time they do, the overwritten part of Program 2 has already been safely transferred.

For those who like to know how their Basic programs are stored, the BBC interpreter uses the following format (all in hex, of course): 0D AA BB NN (statements with reserved words tokenised) 0D (where AA BB is the hex representation of the line number, and NN is the number of bytes in the line, expressed in hex, the whole program being termi-

nated with one hex byte, &FF, following the last &0D).

Key f7, which must not be pressed until the command prompt > reappears, resets TOP for the appended program. If this step is omitted, TOP still refers to Program 1 and any attempt to list or run the appended program will result in the obdurate message 'Bad program'.

Pressing f8, the final key in the sequence, renumbers the appended program from 10 in steps of 10. This may be necessary even if the earlier renumbering options were not exercised.

Finally, if further programs or sets of statements are to be appended, the APPEND program itself need not be reloaded, as the function keys still retain the necessary information and the instruction strings remain at the high end of memory. The final instructions will have reminded the user to commence the sequence again from f1 (or f0 to renumber the appended program from 1 in steps of 1), the appended program now being 'Program 1' and the new material to be appended, 'Program 2'.

Gwyneth Pettit

```

10 REM BBC BASIC APPEND MARCH 1982
20 REM Authors - Leslie & Gwyn Pettit
30 REM (C) PETTIT 1982
40 REM
50 LOMEM=HIMEM-500
60 DIM O%60,R%70,S%80,T%160
70 CLS:VDU15
80 PRINT:"APPEND routine for programs in BBC BASIC"
90 PRINT:" This program uses the function keys in order (f0 to
f8). Instructions will be given in detail as you go along."
100 PRINT:" Note that PROCEDURES at the end of the 1st program may
need to be moved to the end of the merged program."
110 PRINT:" You need not renumber either part, but MAKE SURE line
numbers are in sequence and DO NOT OVERLAP in this case."
120 PRINT:" If you choose to renumber either part, the APPEND program
will renumber the 1st program from 1 (steps of 1) and the 2nd
from 10000."
130 PRINT:" Further programs may be APPENDED by pressing f1 (or
f0 to renumber) and following instructions."
140 PRINT:"Press the space bar to continue -"
150 REPEAT UNTIL GET=32:CLS
160 PRINT:" Load program 1."
170 PRINT:"Press f0 if you want to renumber and f1 for next instructions"
180 P%=PAGE
190 O%=" Now load Program 2 and then f2 for next instructions"
200 R%=" Press f3 if you wish to renumber and f4 for next instructions"
210 S%="Press f5, then f6 to append the programs. Then press f7
to reset parameters."
220 T%="DELAY Press f7 when > reappears. Key f8 may be used to
renumber resulting program. To append again repeat the sequence f
rom f1 (or f0 to RENUMBER 1,1)"
230 #KEY0"REN.1,1:M"
240 #KEY1"PAGE=TOP+256;N%=PAGE;CLS:P.%"O%IM"
250 #KEY2"CLS:P.%"R%IM"
260 #KEY3"REN.10000,1:M"
270 #KEY4"L%=TOP-N%;PAGE=P%;CLS:P.%"S%IM"
280 #KEY5"OLD:M"
290 #KEY6"P.%"T%:FORI%=0TOLX:!(TOP+I%-2)=?(N%+I%):N.1:M"
300 #KEY7"OLDIM"
310 #KEY8"REN.1:M"

```

COMPUTER ANSWERS

Send your queries to: Sheridan Williams, 35 St Julian's Road, St Albans, Herts.
Please note that Sheridan can no longer answer questions on an individual basis, so please don't send an SAE with your query.



PET GET

I have been writing some games programs on my PET and have been having some trouble with the keyboard input. The GET function cannot detect a key that is being held down. How can I get the PET to recognise this?

D Harrison, St Helier, Jersey

Fortunately for games writers, the keyboard on Commodore computers is controlled by the operating system. It is possible to bypass these functions and directly find out the state of the keys. This is best done in machine code programs but the Basic operating system has some useful locations which may be examined. As an example look at location 152; this will normally be 0, but while the shift key is pressed it will be 1. If this is not enough, then location 151 shows which key is being pressed down. You can use GET to detect a key being held down. Try including in your GET loop the statement: POKE 151,255. This will confuse the machine into thinking that the key was previously released. This can be used to construct a simple screen editor with auto-repeat keys in Basic. I'll leave you to work out how to start the repeat after a preset time, at a defined rate.

Mark Wratten

BBC monitor

I am due to take delivery of a BBC Computer any day now. Would you recommend that I purchase a monitor rather than use a TV?

D O'Brien, Whitstable

The answer depends entirely on what you want to use it for, how good quality your present TV set is, and whether you wish to use colour or black and white. The BBC Computer will be unsuitable in its 80-column mode with an ordinary TV set. Also, some black and white sets have difficulty when the BBC displays are in colour. I have had reasonably satisfactory results using my home Sony colour TV, whereas many other people using other sets find the picture very bad. The answer is also dependent on your finances, because colour monitors are still rather expensive. Two sources that you might like to try for a colour set are Gadney Electronics 179 Torridon Rd, Catford,

London SE6 (01-697 0079) and MicroVitec Ltd, Futures Way, Bolling Rd, Bradford, BD4 7TU (0274 390011). Black and white monitors are very easy to come by and are getting cheaper by the month — just look through PCW for ads. A good monitor is a joy to use, mainly because it reduces eyestrain. BEEBUG (National Independent BBC Micro user group, PO BOX 50, St Albans, Herts, AL1 2AR) is currently negotiating discounts for members on monitor sets.

Sheridan Williams

Beeb delay

I ordered a model A BBC Computer two months ago and have not received it yet. What is causing the delay, and when should I expect my machine? Can you tell me if it is possible to increase the memory to 32k without upgrading the machine fully, which I will not be able to afford?

K Jackson, Catford

As you may have read in the computer press some time ago, there have been production problems with the BBC Computer. The biggest problem has been caused by the ULA chips made by Ferranti Ltd. These are custom-made integrated circuits that replace a vast number of logic gates and reduce production costs and machine size considerably. The problem arose because, while the prototypes worked okay, only a small fraction of the production-run ULAs functioned at the required speed (16 MHz for the model B!). The problem is apparently not totally resolved, and Acorn has told us that when ULAs are tested many are still rejected, and the remainder are sorted for A and B machines; with model As getting lower grade ULAs. This has implications for the last part of your question.

Before we get on to that, one or two more points about supply. We talked to a spokesman for Acorn today asking about supply rates, and it would seem that the backlog of model A orders has now been largely cleared, so that a model A machine ordered on 31 March 1982 could reasonably be expected to be despatched by 8 May. The backlog on the model B is somewhat greater, since model Bs have only just begun to emerge (at the time of writing), and model Bs were in the majority among the first 12,000 orders for the BBC machine. Acorn's

prediction for a model B ordered on 31 March gives a despatch date of 12 June. So the supply problems are clearly not yet resolved. Production rates are currently 800 model As per week, and 1000 model Bs, according to our information.

Upgrading the model A to 32k can be done by purchasing a set of eight 4816 dynamic RAMs (100ns) and making an appropriate link change on the main board, but there are two catches for the unwary. Firstly the cost of 4816s varies considerably. One retailer is advertising a BBC Computer upgrade for £55. In our view you should aim for around £25, and there are one or two retailers with suitable 4816s at this price. But there is a further problem to the would-be upgrader — the ULA in the A machine may not be fast enough to run the higher graphics modes with the memory upgrade and Acorn has said it will only release the higher grade ULAs in full upgrade kits to dealers. There is not space here to go into this issue fully, but it is treated in the April issue of the BEEBUG newsletter, along with full notes on memory and printer upgrading. Moreover, BEEBUG is pressing Acorn to change its stance on this question.

D E Graham, National User Group for the BBC Computer

Loading problems

I have had three ZX81s that have given me tape loading problems. I want a more reliable micro and have used a CBM PET that has a VERIFY command which seems a very useful feature because it reduces the risk of tape load errors. Is it available on other micros and what are the problems with cassette loading?

B W Moore, Stockton, Co Cleveland

You are quite right that tape loading problems are both common and annoying. Most of the problems can be traced back to a mismatch between the signal from the micro or back to it, or to what is called the 'azimuth' adjustment of the recording head in the tape deck. The read and record heads each have a very narrow gap between the poles of the magnet that records or the soft iron core that senses the recording on playback. If these gaps are not exactly at right angles to the line of movement of the tape, the signal is blurred

unless the recording machine was similarly out of adjustment. This blurring may be bad enough to cause errors on reading the tape even if the signal levels are perfect. I have sometimes only been able to read tapes produced on other machines by forcing down one corner of the cassette or putting a cardboard wedge under one side (a procedure to adopt with caution). Your suggestion that there should be a VERIFY instruction at first surprised me, as I am used to the Nascom machine which has one. It works exactly the same way as the READ routine, except that the characters when read and added into the parity check are not then put into memory. Furthermore, there is also available an intelligent read routine for the Nascom which only transfers a block of data to store if read correctly (on most machines an error in a previously correctly read block will be put into store and will spoil the good data). This intelligent read is in issue three of the Nascom magazine produced by Program Power, of 5 Wensleydale Road, Leeds. (But beware — there is a correction to it announced in issue four.) To return to signal levels — there is nothing I can do to help you to tell the difference between a satisfactory recording and a duff one, except to advise you to find a friendly computer club where you can listen to good recordings that sound clean and undistorted. Another approach is simply to try every recorder you can beg or borrow. It is not usually necessary to use anything of high quality. A micro club may also have someone with a meter who will help adjust any circuits if your machine has adjustments.

Anthony Camacho

Micro shares

I am looking for a package on a microcomputer that will enable me to produce portfolios for clients whose stocks and shares I manage. I am aware that there are packages on mini and large computers but these cost in excess of £20,000. (Name and address withheld by request)

I only know of one such package. This runs on a Hewlett-Packard HP125, which is not the cheapest micro on the market. It runs under CP/M so should be convertible to other micros without too much problem. You do not say how many clients, or how many stocks and shares you wish to handle, as

the limiting factor for most micros is the disk capacity. The package mentioned will handle up to 1500 stocks and shares held by up to 300 clients, although if you reduce the number of clients you can increase the number of stocks held, and vice versa. If a hard disk was used this would increase the capacity tenfold. It handles purchases, sales, adjustments, bonus and rights issues, performs stock analysis, and produces portfolios. The only supplier is Sumlock Bondain Ltd, 263-269 City Road, London N1 (01-250 0505).
Sheridan Williams

All change

I have an extender board for my UK101 which has sockets for four EPROMs. I have configured these sockets for the single-rail 2716. I would like to be able to plug 6116 RAM into these sockets but find that I cannot write data to the 6116.

I have full manufacturer's sheets on the 2716 but the only data I have on the 6116 is a pin-out diagram, which appears to be pin compatible with the 2716 with the exception of pin 21 which needs to be a R/W line. I have coupled pin 21 to a R/W line which is working sixteen 2114s and up to four 2716s without problems, but I thought that it may be overloaded and fitted a 4.7k pull-down resistor. I have tried two 6116s in the socket with exactly similar results, and the 2716 in the same sockets reads out perfectly.

Even more peculiar is the fact that because the 6116s are addressed continuous with the top of RAM, the Basic thinks it has the extra RAM, and shows a free area showing 19000 bytes free, when there are only 16k of 2114s in the machine.

I get the same results whether I run the processor at 1 or 2 MHz. Can you assist?
K P Wood, Wakefield, W. Yorks

The add-on board that you describe sounds like the Elektor 8k RAM plus EPROM board, which I myself have used and I ran into exactly the same problem as you did. The 6116 is certainly static rather than dynamic RAM and, moreover, it is a CMOS device, so its current loading will be minimal, much less than that of a 2716.

The major difficulty is simply a question of pin incompatibility between the 2716 (for which link connections are given with the

particular memory board that you have) and the 6116 (for which no details are given). In fact you have dealt correctly with pin 21, but there is a little track cutting that needs to be done before the switch can be made.

First, isolate each of the pin 18s of the four 2716 sockets, and then simply link pin 18 of each socket to pin 20 of the same socket. The reason for these alterations is that pin 18 of each socket has been earthed, which is okay for a 2716 but not so good for a 6116 or a 4118, where pin 18 is in fact the chip select! It is pin 20 of the 2716 that carries the chip select — hence the need to link 18 and 20. Note that leaving pin 20 of the 6116 connected to the chip select causes no problems.

There is one further catch with this particular board that could try your patience, though you have probably already discovered this. The addressing order of the two EPROM sockets is altered when you go from using four 1k devices (eg, 2708) to four 2k devices (eg, 2716 or 6116). The result is that the addressing order for the 2k configuration is IC 26, 28, 25, 27.

If by any chance you are in fact using a different memory board, there should still be enough here for you to work out a fix for your particular board.

D E Graham

Disk control

After reading the letter 'Corrupted Commodore' in the March issue I thought you might be interested in the disk controller developed at Merchant Taylors' School in Crosby.

Mark Atherton

Mark has sent documentation on a system that allows multi-access to the IEEE bus for a number of PETs, so they may communicate, without interference, with a disk. If the documentation is to be believed, then the system is far superior to the MUPET mentioned in my reply referred to in March. It overcomes many of the MUPET's weak points. It should also be a lot cheaper. If you require further details write to: Mark Atherton, Merchant Taylors' School, Crosby, Liverpool L23 0QP. I would have thought it worth marketing, and it should bring the originator a fair return for his development.

Sheridan Williams

Dates

I was interested to read your comments on a question from Barbara Sanders in the March issue of PCW. She asks how to create a file called DATES.COM which will, when executed cause the Basic program DATES.BAS to be run. I have the following program which

can be assembled using the CP/M assembler and it creates a file identical to the SUBMIT command's temporary work file. Thus when a warm-boot is performed the system is tricked into thinking that it is in the middle of a SUBMIT. To change the follow-on program change the line labelled COM: appropriately.

```
SYS EQU 0005H
BOOT EQU 0000H
OPEN EQU 15
CLOSE EQU 16
DELETE EQU 19
WRITE EQU 21
MAKE EQU 22
SETDMA EQU 26
BUFF EQU 0080H

ORG 100H

MVI C,MAKE ;) Make
LXI D,FCB ;) Scratch
CALL SYS ;) File

MVI C,OPEN ;) Open
LXI D,FCB ;) Scratch
CALL! SYS ;) File

MVI C,SETDMA ;) DMA
LXI D,COM ;) Set to
CALL SYS ;) COM

MVI C,WRITE ;)
LXI D,FCB ;) Write
CALL SYS

MVI C,CLOSE ;)
LXI D,FCB ;) Close
CALL SYS

MVI C,SETDMA ;) Restore
LXI D,BUFF ;) Default
CALL SYS ;) DMA

JMP BOOT

FCB: DB 0,'$$$' , 'SUB',0,0,0
DS 16
DB 0

COM: DB 12, 'MBASIC DATES',0 ; Initial number
; is length of
; command string
; including the
; space but
; excluding the
; final 0
```

END

J S Linfoot, Oxford



'Isn't that nice, Grandad — a telegram from the Queen's microcomputer.'

NEWCOMERS START HERE

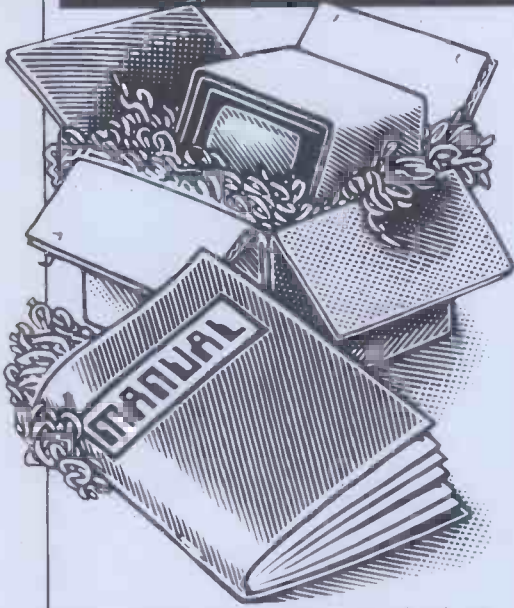

This is our unique quick-reference guide, reprinted every month to help our readers pick their way through the most important pieces of (necessary) jargon found in PCW. While it's in no way totally comprehensive, we trust you'll find it a useful introduction. Happy microcomputing!

Welcome to the confusing world of the microcomputer. First of all, don't be fooled; there's nothing complicated about this business, it's just that we're surrounded by an immense amount of necessary jargon. Imagine if we had to continually say 'numbering system with a radix of 16 in which the letters A to F represent the values ten to 15' when instead we can simply say 'hex'. No doubt soon many of the words and phrases we are about to explain will eventually fall into common English usage. Until that time, PCW will be publishing this guide — every month.

We'll start by considering a microcomputer's functions and then examine the physical components necessary to implement these functions.

The microcomputer is capable of receiving information, **processing** it, storing the results or sending them somewhere else. All this information is called **data** and it comprises numbers, letters and special symbols which can be read by humans. Although the data is accepted and output by the computer in 'human' form, inside it's a different story — it must be held in the form of an electronic code. This code is called **binary** — a system of numbering which uses only 0s and 1s. Thus in most micros each character, number or symbol is represented by eight binary digits or **bits** as they are called, ranging from 00000000 to 11111111.

To simplify communication between computers, several standard coding systems exist, the most common being **ASCII** (American Standard Code for Information Interchange). As an example of this standard, the number five is represented as 00110101 — complicated for humans, but easy for the computer! This collection of eight bits is called a **byte** and computer freaks who spend a lot of time messing around with bits and bytes use a half-way human representation called **hex**. The hex equivalent of a byte is obtained by giving each half a single character code (0—9, A—F): 0=0000, 1=0001, 2=0010, 3=0011, 4=0100, 5=0101 E=1110 and F=1111. Our example of 5 is therefore 35 in hex. This makes it easier for humans to handle complicated collections of 0s and 1s. The machine detects these 0s and 1s by recognising different voltage levels.

The computer processes data by reshuffling, performing arithmetic on, or by comparing it with other data. It's the latter function that gives a computer its apparent 'intelligence' — the ability to make decisions and to act upon them. It has to be given a set of rules in order to do this and, once again, these rules are stored in **memory** as bytes. The rules are called **programs** and while they can be input in binary

or hex (**machine code programming**), the usual method is to have a special program which translates English or near-English into machine code. This speeds programming considerably; the nearer the **programming language** is to English, the faster the programming time. On the other hand, program execution speed tends to be slower.

The most common microcomputer language is **Basic**. Program instructions are typed in at the keyboard, to be coded and stored in the computer's memory. To run such a program the computer uses an **interpreter** which picks up each English-type instruction, translates it into machine code and then feeds it into the **processor** for execution. It has to do this each time the same instruction has to be executed.

Two strange words you will hear in connection with Basic are **PEEK** and **POKE**. They give the programmer access to the memory of the machine. It's possible to read (PEEK) the contents of a byte in the computer and to modify a byte (POKE).

Moving on to **hardware**, this means the physical components of a computer system as opposed to **software** — the programs needed to make the system work.

At the heart of a microcomputer system is the central processing unit (**CPU**), a single microprocessor chip with supporting devices such as **buffers**, which 'amplify' the CPU's signals for use by other components in the system. The packaged chips are either soldered directly to a printed circuit board (**PCB**) or are mounted in sockets.

In some microcomputers, the entire system is mounted on a single, large, PCB; in others a **bus system** is used, comprising a long PCB holding a number of interconnected sockets. Plugged into these are several smaller PCBs, each with a specific function — for instance, one card would hold the CPU and its support chips. The most widely-used bus system is called the **S100**.

The CPU needs memory in which to keep programs and data. Microcomputers generally have two types of memory, **RAM** (Random Access Memory) and **ROM** (Read Only Memory). The CPU can read information stored in RAM — and also put information into RAM. Two types of RAM exist — **static** and **dynamic**; all you really need know is that dynamic RAM uses less power and is less expensive than static, but it requires additional, complex, circuitry to make it work. Both types of RAM lose their contents when power is switched off, whereas ROM retains its contents permanently. Not surprisingly, manufacturers often store interpreters and the like in ROM. The CPU can only read the ROM's contents and cannot alter them in any way. You can buy special ROMs called **PROMs** (Programmable ROMs) and **EPROMs** (Erasable PROMs) which can be programmed using a special device; EPROMs can be erased using ultra-violet light.

Because RAM loses its contents when power is switched off, **cassettes** and **floppy disks** are used to save programs and data for later use. Audio-type tape recorders are often used by converting data to a series of audio tones and recording them; later the computer can listen to these same tones and re-convert them into data. Various methods are used for this, so a cassette recorded by one make of computer

won't necessarily work on another make. It takes a long time to record and play back information and it's difficult to locate one specific item among a whole mass of information on a cassette; therefore, to overcome these problems, **floppy disks** are used on more sophisticated systems.

A floppy disk is made of thin plastic, coated with a magnetic recording surface rather like that used on tape. The disk, in its protective envelope, is placed in a disk drive which rotates it and moves a **read/write head** across the disk's surface. The disk is divided into concentric rings called **tracks**, each of which is in turn subdivided into **sectors**. Using a program called a **disk operating system**, the computer keeps track of exactly where information is on the disk and it can get to any item of data by moving the head to the appropriate track and then waiting for the right sector to come round. Two methods are used to tell the computer where on a track each sector starts: **soft sectoring** where special signals are recorded on the surface and **hard sectoring** where holes are punched through the disk around the central hole, one per sector.

Half-way between cassettes and disks is the **stringy floppy** — a miniature continuous loop tape cartridge, faster than a cassette but cheaper than a disk system. **Hard disk** systems are also available for micro-computers; they store more information than floppy disks, are more reliable and information can be transferred to and from them much more quickly.

You, the user, must be able to communicate with the computer and the generally accepted minimum for this is the visual display unit (**VDU**), which looks like a TV screen with a typewriter-style **keyboard**; sometimes these are built into the system, sometimes they're separate. If you want a written record (**hard copy**) of the computer's output, you'll need a **printer**.

The computer can send out and receive information in two forms — **parallel** and **serial**. Parallel input/output (**I/O**) requires a series of wires to connect the computer to another device, such as a printer, and it sends out data a byte at a time, with a separate wire carrying each bit. Serial I/O involves sending data one bit at a time along a single piece of wire, with extra bits added to tell the receiving device when a byte is about to start and when it has finished. The speed that data is transmitted is referred to as the **baud rate** and, very roughly, the baud rate divided by ten equals the number of bytes being sent per second.

To ensure that both receiver and transmitter link up without any electrical horrors, standards exist for serial interfaces; the most common is **RS232** (or **V24**) while, for parallel interfaces to printers, the Centronics standard is popular.

Finally, a **modem** connects a computer, via a serial interface, to the telephone system allowing two computers with modems to exchange information. A modem must be wired into the telephone system and you need British Telecom's permission; instead you could use an **acoustic coupler**, which has two obscene-looking rubber cups into which the handset fits, and which has no electrical connection with the phone system — British Telecom isn't so uppity about the use of these.



IN STORE

I'm afraid that, due to pressure of work, I have been unable to fully update 'In Store' this month. I have however corrected the telephone number of Sinclair — I hope that, in the fullness of time, the lady who has been taking their calls will forgive me!

Machine (Price from)	Main Distributor/s (No. of Dealers)	Hardware	Software	Miscellaneous (Documentation)
ABC 24 (£3195)	AI 09237-77139	64k RAM; Z80A: dual 5¼" F/D (640k); 12", 24 x 80 VDU; 2 x S/P; 2 x P/P	CP/M: <i>Basic: Cobol; Fortran: Pascal.</i>	BT 4/81 (S)
ABC 80 (£738)	Datormark Ltd: 97 44896	16-40k RAM; Z80A: C: 12", 16 x 40 b&w VDU; 4680 bus; IEE 488; RS232 port.	DOS Basic (16k ROM); <i>Fortran: Pascal: A: Multi user Basic.</i>	Colour video graphics with UHF output. Viewdata compatible. Loudspeaker. Numeric keypad. Options: dual 5¼" F/D (320k) £895; dual 8" F/D (2 Mb). BT 1/80. (1)
ACT Series 800 (£3495)	ACT: 021-501 2284 (50)	48k RAM; 6502: dual 5¼" F/D (800k); 12", 30 x 64 VDU; 1 S/P; 1 P/P; Multi-screen int. Option: 10-20 Mb H/D	MDOS: <i>Basic; A: CBasic: PL/M: Forth: Fifth: Cesil: Pilot: Fortran.</i>	IBM compatible K/B High resolution graphics. Available with dual 8" F/D (2.4 Mb) £4950 — 4.8 Mb maximum. BT 2/80(E).
ACT Sirius 1 (£2349)	As above	128-512k RAM; 8088: dual 5¼" F/D (1.2M); 12", 25 x 80 VDU; 2 x RS232 ports; 2 x P/P	CP/M 86: <i>U: Basic: Cobol: Fortran: Pascal</i>	High res graphics. Options: 10 Mb H/D; dual 5¼" F/D (2.4 M).(S)
Adler Alphatronic (£1600)	Adler 01-250 1717	48k RAM; 8085 A single 5¼" F/D (160k); 12", 24 x 80 VDU; S/P; P/P	CP/M: <i>Basic: CBasic: Fortran: Cobol</i>	With 80 cps printer and dual F/D £2345 (inc CP/M). (S)
Alpha Micro (£5650)	Alpha Micro (UK) Ltd: 01-250 1616 (TBA)	64k — 1 Mb RAM; 16 bit; dual 8" F/D (2.4 Mb); 6 S/P.	Multi-user OS: <i>Basic: M/A: Pascal: U. Fortran: Cobol</i>	Modular. Expands to 1200 Mb, 24 terminals or multiprocessor system. (E)
Altos ACS 800-2 (£2995)	logitek: 02572 66803 (33)	64k RAM; Z80A; dual 8" F/D (1 Mb); 2 x RS232 ports; 2 P/P.	CP/M: <i>Basic: CBasic: Cobol.</i>	Single user. Options: DMA. Floating point processor. Phototyping board.
Altos ACS 800-10 (£6675)	As above.	280k RAM; Z80A: single 8" F/D (500k); 10 Mb H/D; 6 x RS232 ports; P/P; network RS422 port; DMA	CP/M: <i>MP/M: Basic: Cobol: Fortran: APL: Pascal.</i>	Multi-user/multi tasking. Up to 4 users. Options: 10 Mb; mag tape backup (S + H).
APL Signet (£1750 or £130pm)	Micro APL: 01-834 2687	64k RAM; Z80A: dual 5¼" F/D (380k); 2 x RS232 ports.	CP/M: <i>APL: Basic: U: Fortran: Cobol: Algol: Forth</i>	Desktop APL computer with self teaching course. (S)
Apple II (£695)	Microsense: 0442 41191 (190)	16-48k, RAM; 6502: 8 I/O slots.	OS: <i>Basic: Pascal: Fortran: Cobol: Pilot</i>	280 x 192 high resolution graphics; Option: single 5¼" F/D (116k) £349.
Atari 400 (£345-16k)	Ingersoll: 01-226 1200 (40)	16k RAM; 6502; C int; cartridge slot; 12 x 20 TV int; RS232C port; touchpad k/b; Opt: C £40	OS (10k ROM); <i>Basic (8k ROM). Pilot: Forth.</i>	High resolution colour graphics. 4-channel sound. Four games controller/light pen sockets. BT 10/80. (1/B).
Atari 800 (£645-16k)	As above.	16-48k RAM; 6502; C int; 4 x cartridge slots; 12 x 20 TV int; RS232C port. Opt: single 5¼" F/D (90k) £345; 16k RAM £65.	As above.	As above. Software & RAM on cartridge modules. Up to 4 disk drives. BT 10/80. (1/B).
Athena 8285 (£5694)	Burel-Comco Ltd: 0703 39890 or 01-202 0262 (TBA)	64k RAM; 8085A: dual 5¼" F/D (644k); 12" 25 x 80 VDU; 150 cps printer; RS232 port.	AMOS: T/E: <i>Basic: Cobol: Fortran: Pascal: APL: M/A.</i>	Extended ASCII K/B with numeric pad; graphics. Options: dual 8" F/D (2 Mb); up to 1200 Mb H/D.
Atom (£120)	Acorn: 0223 312772 (35)	2-12k RAM; 8-16k ROM 6502; Full K/B; C int; TV int; 20 I/O lines; 1 P/P. Options: 80 col printer £199, Prestel adaptor £120.	Basic in 8k ROM; A Cass O/S.	High resolution graphics on bigger model; colour monitor O/P. Loudspeaker. Note also, systems based on Acorn SBC. BT 7/80(B).
Attache 201 (£8000)	COLT 01-572 3784 (10)	64k RAM; Z80: dual 8" F/D (2.4 Mb); 12" 24 x 80 VDU; 180 cps printer.	Basic: <i>Fortran: Cobol.</i>	Upgradable to multiuser system with 18 Mb H/D. Full range of business packages included software dealers TBA. (S)
BASF 7120 (£3600)	BASF: 01-388 4200 (12)	64k RAM; Z80A: 3 x 5¼" F/D (480k); 12", 24 x 80 VDU; RS232 port; P/P	DOS: (OASIS) <i>Ex Basic: Cobol U. A: CP/M</i>	H/D available soon. Also 7125 with 930k F/D £4280 and 7130 with single F/D (430k) & 5Mb H/D £4950. Disk controller has own Z80A. BT 9/80
BBC Micro (£205)	BBC Micro Systems 14 Station Road Kettering Northants (no tel)	16-32k RAM; 6502; C int; TV int; RS423 port; P/P; Option: single 5¼" F/D (100k) £230	MOS: <i>Basic A</i>	Video text & second processor int. 32k model with Econet and disk interface £3.95. BT 1/82 (I)
Billings BC-12 FD: (£3995)	Mitech: 04862 23131 (TBA)	64k RAM; Z80A: dual 5¼" F/D (640k); 12", 24 x 80 b&w (or b&g) VDU.	DOS: <i>Basic: Fortran: Cobol: A</i>	With dual 8" F/D (2 Mb) £5995. Additional dual 8" F/D £300 option: 50Mb H/D. (S).

List of Abbreviations

A Assembler	G/C Graphics card	M/A Macro assembler	S Software
BT Bench Tested	H Hardware	N/A Not available	S/P Serial port
C Cassette	H/D Hard disk	N/P Numeric pad	T/E Text editor
E Extensive	I Introductory	O/S Operating system	TBA To be announced
F/D Floppy disk	Int Interface	P/P Parallel port	U Utility

Please note: Software items listed in *italic* are not included in the basic price of the equipment. All prices are exclusive of VAT.

WHEN IT COMES TO MICROCOMPUTER SOFTWARE WE WROTE THE BOOK

How do you stay up-to-the-minute with the rapidly changing world of microcomputer software? Get the Lifeboat Catalogue.

The latest innovations The new Lifeboat Catalogue is packed with the latest state-of-the-art software. And if we publish a new program after the latest catalogue has gone to press, we enclose a flash bulletin in your copy.

The greatest selection

Because Lifeboat is the world's largest publisher of microcomputer software, our catalogue offers you the greatest selection of programs for business, professional and personal use. Our more than 200 programs range from the integrated accounting and professional practice systems to office tools for book-keepers and secretaries to sophisticated tools for programmers. Included are business systems, word processors, programming languages, database management systems, application tools and advanced system utilities.

We specialise in software that runs on most small business computers. Our more than 60 media formats, including floppy disks, data cartridges, magnetic tape and disk cartridges, support well over 100 different types of computer.

Get full service We give the crucial dimension of after-sales service and full support to everything we sell.

That includes:

- An update service for software and documentation.
- Telephone, telex and mail-order services in the London office and at overseas offices in the United States, France, Switzerland, West Germany and Japan.
- Subscriptions to Lifelines™, the monthly magazine that offers comparative reviews, tips, techniques, identified bugs and updates that keep you abreast of change.

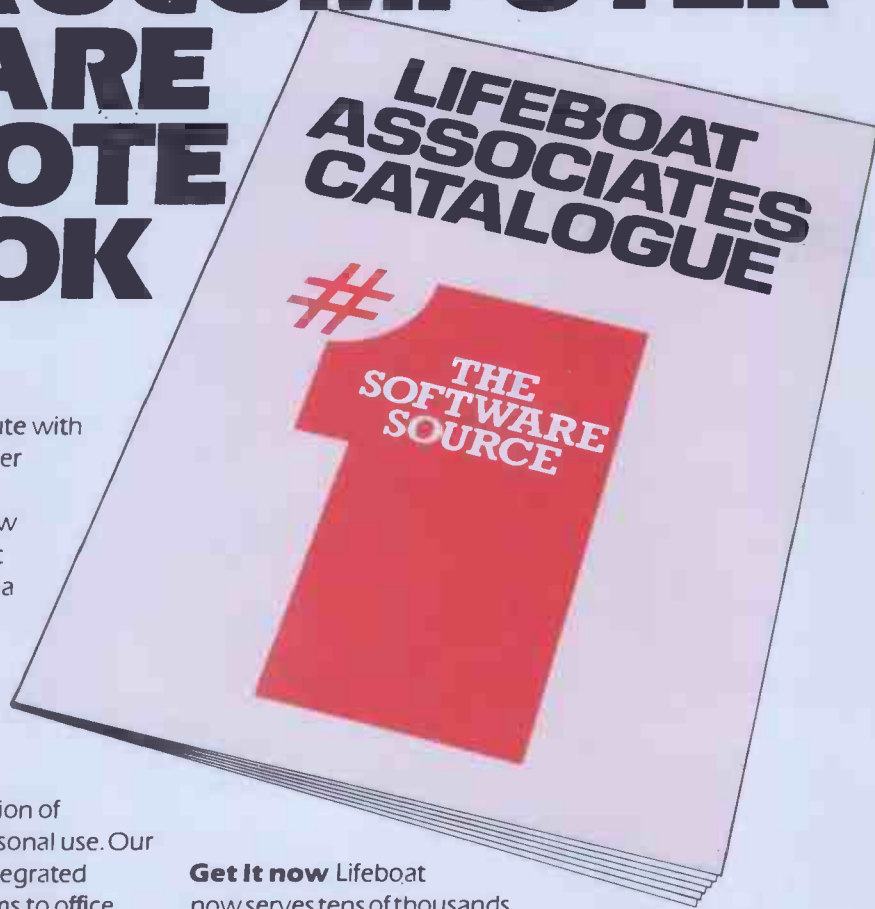

Get It now Lifeboat now serves tens of thousands of satisfied customers with our breadth of up-to-date, fully tested, fully supported and competitively priced software.

You may not need all we offer, but we offer just what you need. After all, we wrote the book.

#1 Lifeboat Associates
World's foremost software source

Mail coupon to: Lifeboat Associates
PO Box 125, London WC2H 9LU or call 01-836 9028

Please send me a free lifeboat catalogue.

Name _____

Title _____

Company _____

Address _____

Postcode _____

PCW/6/82

Copyright © 1981, by Lifeboat Associates.

Lifeboat Worldwide offers you the world's largest library of software. Contact your nearest dealer of Lifeboat.

USA Lifeboat Associates 1651 Third Ave. New York NY 10028 Tel (212) 860-0300 Telex 640693 [LBSOFT.NYK] TWX 710 581-2524 **JAPAN** Lifeboat Inc. OK Bldg. 5F 1-2-8 Shiba-Daimon Minato-ku Tokyo 105 Japan Tel 03-437-3901 Telex 2423296 [LBJTYO] **ENGLAND** Lifeboat Associates Ltd PO Box 125 London WC2H 9LU England Tel 01-836 9028 Telex 893709 [LBSOFTG] **SWITZERLAND** Lifeboat Associates GmbH Hinterbergstrasse Postfach 251 6330 Cham Switzerland Tel 042-36-8686 Telex 865265 [MICO CH] **WEST GERMANY** Intersoft GmbH Schlossgartenweg 5 D-8045 Ismaning W. Germany Tel 089-966-444 Telex 5213643 [ISOFD] **FRANCE** Lifeboat Associates SARL 10 Grande Rue Charles de Gaulle 92600 Asnieres France Tel 1-733-08-04 Telex 250303 [PUBLIC X PARIS]

IN STORE

Machine (Price from)	Main Distributor/s (No. of Dealers)	Hardware	Software	Miscellaneous (Documentation)
C/09 (£3500)	SWTP Ltd: 01-491 7507 7507 (16)	64k RAM: 6809: dual 5 1/4" F/D (700k) 9", 24 x 80 VDU: 2 S/P: 1 P/P.	TSC FLEX: <i>Basic: Fortran</i> <i>Pascal: A: Dis A:</i> <i>T/E: U.</i>	Expandable to S/09 UniFLEX 32 user system. (H)
Canon BX-3 (£4250)	Canon 01-680-7700.	32k RAM: 6809: dual 5 1/4" F/D (640k): 28 char display: 80 cps printer: 3 x RS232 port: P/P.	OS: Basic: A. <i>Cobol: Pascal</i>	Fully integral unit. Extensive applications support offered on all Cannon Machines. Options: dual dual 5 1/4" F/D (640k) £1500.
Canon CX-1 (£6000)	As above.	128k RAM: 6809: dual 5 1/4" F/D (640k): 12", 24 x 80 VDU: 180 cps printer: 3 x V24 ports: P/P: light pen.	OS: Basic: A: <i>Cobol: Pascal.</i>	Price includes installation & training. Extensive application support offered. Options: dual 8" F/D (1Mb) £3300. (S)
Canon TX-25 (£1600)	As above.	16-32k RAM: 6809: C: 20 char display: 26 col, 2.4 lps printer. Option: 2 x RS232 port.	Basic: A	Fully integral unit. Cassette is Cannon's own design (8k). Can be used with communications. (S).
Challenger IP & C4P (£220 & £395)	CTS: 0706 79332 Millbank Computing: 01-549 7262. Mutek: 0225 743289. U- Microcomputers: 0925 54117 Watford Elec: Watford 40588 (18)	4.32k RAM: 6502: C int: RS232 port. Options: dual 5 1/4" F/D (160k) £550: for C4P dual 8" F/D (1.15 Mb) and 20MB H/D	O/S: Basic (8k ROM) <i>Ex Basic: A.</i>	D/A conv: colour capability. Runs OSI business software on 8" F/D Plato educational software avail soon. BT 4/80. (S).
Challenger 2 (£150)	As above	48k RAM: 6502: dual 8" F/D (0.5 Mb): RS232 port.	OS65U: Ex Basic: A.	Designed as low cost business system (S).
Challenger C3 (£2334)	As above	32-56k RAM: 6502: 6800: Z80: dual 8" F/D (1.15 Mb): 2-16 S/P.	OS65U: Basic: <i>CP/M: Fortran: Cobol</i>	Expandable to multi-user (8) system. Options: C3B & C3C H/D units, 74 Mb for about £8500. (S&H).
Clenlo Conqueror (£2475)	Clenlo Computing Systems Ltd: 01-670 4202 (TBA)	64k RAM: Z80: dual 8" F/D (1 Mb): 3 S/P: 2 P/P.	CP/M: CBasic-2: Pearl I: <i>U Fortran: Cobol: Pascal</i>	With 2.4Mb F/D £2950. Also H/D systems with 10 Mb H/D & tape drive £5430.
Comart Communicator (£1995)	Comart 0480 215005 (25)	64k RAM: Z80A: dual 5 1/4" F/D (780k): 2 S/P: P/P.	CP/M: <i>Basic: Cobol: Pascal</i>	With 1.5 Mb F/D £2295. With 4.8 Mb H/D & 790k F/D £3795. Option: 18 Mb H/D. £3395 (S).
Compucolor II (£1175)	Dyad Developments: 08446 729 (TBA)	16-32k RAM: 8080: 13" 32x64 8-colour VDU: single 5 1/4" F/D (51k): RS232 port.	DOS (ROM): Ex-Basic (ROM): A. <i>M/A: T/E: Fortran: U</i>	32k version £1295. High resolution graphics. 6-month subscription to user magazine inclusive BT 9/79. (S).
Compucorp 625 (£6000)	Compucorp: 01-952 7860 (17)	48-60k RAM: Z80: dual 5 1/4" F/D (630k): 9", 16x80 VDU: 40 col printer: RS232 port, P/P.	Basic: A: <i>Fortran: Pascal: U</i>	IEEE-488 Controller and S100 int. Many applications packages avail. (E).
Compucorp 655/665/675/685 (from £5050)	As above	60k RAM: Z80: Up to 4x5 1/4" F/D (160k-2.4 Mb): 9", 20x80 or 12" 20x80 or 20" 60x80 VDU: 40-col printer: RS232 port.	As above	Prices incl installation and training. Opt: 10-20 Mb H/D
Computermart 2000 DS (£1500)	Computermart: 0603 615089	32-256k RAM: 8085: dual 8" F/D (1-2 Mb): S/P: P/P	CP/M: <i>Cis Cobol: Basic: Fortran</i>	Expandable to multi-user, multi-tasking,, multi-processor 96 Mb H/D system (around £15000).
Cromemco System Zero/DDF, System 2, System 3, System Z2H. (£2627/£2873/£4893/£6118).	Datron: 0742 515490. Comart 0480 215005 MicroCentre: 0314 556 7354 (18)	64k RAM: Z80: dual 5 1/4" F/D (346k) on System Zero, System 2 & Z2H: dual 8" F/D (1.2 Mb) on Sys 3: 10 Mb H/D on Z2H: S/P: P/P.	CDOS: <i>Basic: Cobol: Fortran: RPG II: Lisp: A: W/P: Multi-user Basic. Cromix.</i>	System 2 & 3 expandable to Multi-user (max 7): £8373 System 2- £10252 System 3. Options: dual 8" F/D (996k): 11.2Mb H/D. BT 10/79 (E).
DAI (£595)	Data Applications (UK): 0285 2588 (7)	48k RAM: 8080: C int: 24x60 VDU int: RS232 port: over 20 industrial ints. option: dual 5 1/4" F/D £5.95	Basic (ROM): U	Colour graphics up to 255 x 335: 3 notes & noise generator: PAL O/P to TV: Paddle int: H maths option. (1). BT 10/80.
Diablo 3000 (£6950) (TBA)	Business Computers Ltd: 01-207 3344	32k RAM: 8085: dual 8" F/D (1.3 Mb): 12", 24x80 b&w VDU: 45 cps printer.	DOS: Basic: <i>DACL: A: U.</i>	Selection of business packages included (S).
Digital Micro-systems DSC-3 (£3530)	Modata: 0892 41555 (14)	64k RAM: Z80A: dual 8" F/D (1.14Mb): 4xRS232 ports: EIA port.	CP/M: CBasic: <i>Cobol: Fortran: Pascal: PL/I</i>	Expandable to multi-user system with 10-28 Mb H/D. Extensive software avail. (S).
Digital Micro-systems DSC-4 (£4395)	As above	128k RAM: Z80A: single 8" F/D (500k): 11 Mb H/D: 4x RS232 ports: 2 P/P.	CP/M: Basic-E: CBasic: <i>Cobol: Fortran: Pascal.</i>	Also DSC-3 with 64k RAM. Options: 128k RAM £1295: up to 4 Mb F/D and 20 Mb. H/D. (H).
Durango F-85 (£4995)	Comp Ancillaries: 0784 36455 (12)	64k RAM: 8085: dual 5 1/4" F/D (1 Mb): 9", 16x64 green VDU: 132 col 165 cps printer: N/P	O/S: D Basic: <i>CP/M: CBasic: Micro Cobol.</i>	Up to 5 work stations: fully integrated system. Options: additional dual 5 1/4" F/D (1 Mb): 12-24 Mb H/D. (S).
Dynabyte 5200 5900 (£2600)	Metrotech 0895 57780 (15)	64k RAM: Z80: S100 bus: 2 ser ports: 1 par port: any com of 5 1/4" F/D (630k), dual 8" F/D (1Mb), 9/27/45 Mb H/D, 32/64/96 Mb Cart Module Disk.	CP/M: MP/M: CP/Net, CBasic, MBasic Cobol, Fortran, Pascal, PL/1-80	All systems expandable to multi-user and net working: CP/M inc in base price for F/D system, MP/M for H/D systems.
Equinox 200 (£7500)	Equinox: 01-739 2387 (N/A)	64-512k RAM: Z80: 10 Mb-1200 Mb H/D: 6xS/P: 1 P/P.	CP/M: CBasic: <i>Cobol: Fortran.</i>	Multi-user MVT/FAMOS available in place of CP/M. 16-bit version (Equinox 300) £10,000. (S&H).

List of Abbreviations

A Assembler	G/C Graphics card	M/A Macro assembler	S Software
BT Bench Tested	H Hardware	N/A Not available	S/P Serial port
C Cassette	H/D Hard disk	N/P Numeric pad	T/E Text editor
E Extensive	I Introductory	O/S Operating system	TBA To be announced
F/D Floppy disk	Int Interface	P/P Parallel port	U Utility

Please note: Software items listed in *italic* are not included in the basic price of the equipment. All prices are *exclusive* of VAT.

IN STORE

Machine (Price from)	Main Distributor/s (No. of Dealers)	Hardware	Software	Miscellaneous (Documentation)
Exidy Sorcerer (£695)	Liveport Data Products: 0736 798157 (27)	48k RAM: Z80: RS232 port: 1 P/P: S100 connector: 30x64 VDU int. N/P.	O/S: Basic (ROM): T/E: A: CP/M: Algol: Fortran: Basic: 80. Pascal: W/P.	High-resolution graphics capability: user programmable character set, Option: single 5 1/4" F/D (316k) £600
Gemini 801 (£1075)	Gemini: 02403 22307 (7).	64k RAM: Z80A: Single 5 1/4" F/D (315k): 25x80 VDU int: RS232 port. P/P.	CP/M Basic: Cobol: Fortran: Pascal: A: T/E.	Up to two integral & two external F/D. Graphics. With no F/D and C int. £750. (S).
Gemini Multiboard (£602)	As above	64k RAM: Z80: 25 x 80 VDU int (with Z80): Option: dual 5 1/4" F/D £550.	CP/M: Basic Cobol: Pascal Fortran	Modular system. Other options inc ROM board & EPROM programmer. Complete cased disk system £1450 BT 2/82 (H&S).
Gimix System 68 (£2000)	SEED: 05433 78151: Windrush 0692 505189	16-64k RAM: 6800/6809: dual 5 1/4" F/D (500k): 2xRS232 ports.	OS-9: Flex Basic: Pascal: A: Dis A: T/E:U	With dual 8" F/D (2 Mb) £2900. Designed as development system for industrial control. (H).
Haywood 3000 (£1925)	Haywood: 01- 428 0111. (TBA)	32-64k RAM: Z80A: dual 5 1/4" F/D (800k): RS232 port: P/P. Opt: 15" 28x80 VDU £799.	CP/M: Basic: Cobol: Fortran: Pascal: W/P.	Also system 7000 with 48-65k RAM and 8" F/D (2.5 Mb) £2999. (S).
HP 85 (£1830)	Hewlett Packard Ltd: 0734 784774 (16)	16-32k RAM: C.P.U.: 5", 16x32 VDU: C(200k): 64 cps printer: 4 P/P. Options: dual 5 1/4" F/D (540k) £1408: fusi 8" F/D (2.4 Mb) £3744.	Basic (ROM)	Full dot matrix graphics. Complete range of interfaces, peripherals and application packages avail. 16k RAM £222. (S).
IMS 5000 (£1500)	Equinox: 01-739 2387 (20)	16-56k RAM: Z80: dual 5 1/4" F/D (320k): 2xS/P: 1 P/P:	CP/M: C/Basic: Cobol, Fortran.	3 drives option: (S&H).
IMS 8000 (£2500)	As above	64-256k RAM: Z80: dual 8" F/D (1 Mb): 2xS/P: 1 P/P	CP/M: CBasic: Cobol: Fortran: MicroCobol.	Multi-user MVT/FAMOS available in place of CP/M. (S&H).
Intecolor 8000 (£2999)	Dyad Developments: 08446 729 (TBA)	8-32k RAM: 8080: 19", 80x48 colour VDU: single 5 1/4" F/D (90k): Option: up to 26 Mb H/D.	DOS(ROM): Ex-Basic: A:M/A:T/E:Fortran: U	High res graphics avail: Many options including size of F/D and VDU. (S).
ITT 2020 (£867)	ITT: 0268 3040 (15)	16-48k RAM: 6502	Monitor: A: Ex Basic: Dis A.	360x192 high res graphics. Ex-Basic in 6k ROM: Options: single 5 1/4" F/D (116k): £425: 16k RAM, £110: RS232 port, £96: 32k system, £931: 48k system £995: (B).
Ithaca DPS1 (£3995)	Ithaca: 01-341 2447 (10).	64k RAM: Z80: dual 8" F/D (1 Mb): 2xRS232 ports: 4xP/P. Opt: H/D.	CP/M: Basic: Cobol. Fortran: Pascal: A: U.	Z8000 16-bit processor board avail. IEEE/S100 (8 or 16 bit) compatible. (E).
LX-500 (£3500)	Logabax Ltd: 01-965 0061 (13)	32k RAM: Z80: dual 5 1/4" F/D (180k): 12" 25x80 b&w VDU: 100 cps printer.	DOS: Basic: A.	Other printers available. (S).
LSI M-One (£4200)	LSI Computers: 04862 23411 (20)	8-16k RAM: 8080: dual 8" F/D (1.2 Mb): 12", 24x80 b&w VDU	FMOS: A	Choice of standard business packages included in price. (S).
LSI M-Two (£7900)	As above	64-128k RAM: 8085A: dual 8" F/D (1.2 Mb): 12", 24x80 VDU: 60 cps printer	Elsie: CP/M: Basic: Cobol. Fortran: Pascal: A: U	Max 8 VDUs and 4 printers. Many applications packages available. Option: 10 Mb H/D £2600. (S).
Macro 1 (£3950 or £294 pm).	Micro APL Ltd. 01-834 2687 (TBA)	64k RAM: Z80A: dual 8" F/D (1 Mb): 4xRS232 ports.	CP/M: APL: U: Basic: Fortran: Cobol: Word- 2star Algo: Pascal: Forth.	Designed as timesharing replace- ment. Macro 2 with 2 Mb F/D £4750 or £334 pm.
Megamicro (£6080)	Bytronix: 0252 726814(5)	56k RAM: Z80: dual 8" F/D (500k): 12", 20x80 green VDU: 180 cps printer: 2 S/P: 2 P/P.	CP/M: U: Basic: A: M/A.	Range of bus. packages now avail. from Ludhouse of Streatham. (H&B).
Micro Trainer 1 (£650)	Hewart: 0625 22030 (N/A)	16-32k RAM: 6800/6809: 10" 16x24 VDU: 2xC int: Opt: dual 5 1/4" F/D (160k) £595: 8k RAM £17.	Basic: A: Pascal: PL/M: W/P	SS50-based system. Graphics avail. Int card with real time clock £17. (1).
Microstar 45 Plus (£4800)	Data Efficiency Ltd: 0442 63561 (30)	64k RAM: 8085: dual 8" F/D (1.2 Mb): 3 S/P, RS232 port.	Stardos: CP/M: Basic: Cobol: Fortran	(E)
Microtan 65 (£69)	Tangerine: 0353 3633(6)	2k RAM: 6502: T Mint: Exp up to 277k RAM.	2k TANBUG monitor: 2k A, disassembler, cassette firm-ware: 10k Microsoft Ex. Basic.	Options: bulk I/O modules, hi- def graphics, CP/M, system racking, ASCII keyboard. Prestel adaptor (S&H).
Millbank Sys 10 (£2995)	Millbank: 01-788 1083(6).	65k RAM: Z80: dual 5 1/4" F/D (700k): 12", 24x80 VDU: 2x RS232 ports: RS4449 port: P/P.	CP/M: Basic: Cobol: Fortran: Pascal: PLI: W/P.	One high level lang. included. 12-month warranty. Main- frame comm. package. H/D avail. soon. (S&H)
MS5001 (£7450)	BMG Ltd: 0793 37813 (N/A)	64k RAM: 8085: dual 8" F/D (1 Mb): 12", 80x24 VDU: 80 cps printer: RS232.	CP/M: Basic: Cobol: Fortran: MP/M.	Price includes desk mounting and one computer. Hardware & software support. Leasing arrangements available. (E).
MSI 6816 (£1200)	Strumech: 05433 4321 (5)	16-56k RAM: 6800: dual 9" 16x64 b&w VDU: C int: 1 S/P: 1 P/P.	Basic: A.	Graphics & PROM programmer available. (S&H).
MSI System 12 (£8000)	As above	56-184k RAM: 6800: 10 Mb H/D: single 8" F/D (500k) 24x80 VDU: 1 S/P: 1 P/P.	SDOS: Basic: CBasic: U.	As above. Business packages avail. Up to four terminals. (H&S).
NEC PC 8001 (£599)	IBR 0734 6641 11	32k RAM: Z80A: P/P Option: dual 5 1/4" F/D (326k) £699	Basic N: (24k ROM) CP/M: Fortran: Cobol: Pascal.	Colour monitor £359 (low res) or £579 (high res) both 12", 25x80 many expansion units avail. (E) BT 6/81

List of Abbreviations

A Assembler	G/C Graphics card	M/A Macro assembler	S Software
BT Bench Tested	H Hardware	N/A Not available	S/P Serial port
C Cassette	H/D Hard disk	N/P Numeric pad	T/E Text editor
E Extensive	I Introductory	O/S Operating system	TBA To be announced
F/D Floppy disk	Int Interface	P/P Parallel port	U Utility

Please note: Software items listed in *italic* are not included in the basic price of the equipment. All prices are *exclusive* of VAT.

IN STORE

Machine (Price from)	Main Distributor/s (No. of Dealers)	Hardware	Software	Miscellaneous (Documentation)
Newbrain MB (£199)	Grundy: 0223 350355 (TBA)	32k-2 Mb RAM: Z80A: Nat 420: 2xC int: TV int: 2xV24 ports.	CBasic (16k ROM): A.	Graphics. Battery or mains. Options: ½ Mb RAM £450 16 char display £30.(E).
North Star Horizon (£2230)	Comart: (25) 0480 215005. Comma: 0277 81 1131. Equinox: 01-739 2387(20)	48-56k RAM: Z80A: dual 5¼" F/D (360k): 15", 24x80 VDU: 150 cps printer: 2 S/P: 1 P/P.	DOS: Basic: CP/M: Cobol: Fortran: Pascal.	Options: 18 Mb H/D.
North Star Advantage (£2195)	Comart 0480-215005 (25)	64k RAM: Z80A: dual 5¼" F/D (720k): 12", 24 x 80 VDU: S/P.	GDOS: CP/M: CBasic: MBasic: Fortran: Cobol: Pascal	Price includes business graphics & demo software. 6 slot expansion.
Oki if 800 (£400)	Encotel.	64k RAM: Z80A: 2k ROM: dual 5¼" F/D (560k): 12", 24x80 VDU: 80 col printer: loudspeaker: RS232 port: 20k ROM cartridge.	Basic: A: CP/M Cobol: Fortran:	Fully integral unit. Graphics. Options: dual 5¼" F/D (560k): RS232 port: PP. (1). BT 10/81
Onyx C8000 (£6875)	Onyx Dist Ltd: 0734 664343 Colt 01-577 2150. (TBA)	64k RAM: Z80: 12 Mb Cartridge: 10 Mb H/D: 4 S/P: P/P	CP/M: MP/M Oasis: Unix: Fortran: Pascal: W/P	C8001 with 128k RAM £8220. Multi-user version avail. using Oasis.(E) BT 3/81.
Oscar (£2560)	IDS Ltd: 0908 313997(30)	64k RAM: Z80: dual 5¼" F/D (800k): 12", 25x80 VDU: RS232 port: 1 P/P	CP/M: Basic: Pascal Fortran: Cobol: W/P:A	Also avail. with dual 5" F/D(1.6Mb) £2905 and 8" F/D(2 Mb) £3380. Advanced video board. S&H.
Panasonic JD 800U, JD840U (£4275, £4950)	Panasonic Business Equipment: 0753 75841 (10 regional dist)	56k RAM: 8085A: 12-4k PROM: dual 8" F/D JD800U (500k): JD840U (2 Mb): 12", 24x80 green VDU: 3xRS232 ports.	CP/M: Basic: Micro- Cobol.	Also available with 5¼" F/D: JD740U (570k) £4095. H/D avail soon. BT 3/80 (S).
Pascal Microengine (£2295)	Promo Electronic Systems Ltd: 01- 554 6222	64k RAM: MCP 1600: 2x RS232 ports: 2 P/P.	Pascal.	CPU instruction set is P-code: no interpreter needed. Avail- able with dual 8" F/D (2 Mb) £3900.
Pasca 640 (£3700)	Westrex Ltd: 01-578 0957 (TBA)	64k RAM: Z80A: dual 8" F/D (512k): 12", 24x80 VDU: RS232 port: P/P	CP/M: Basic: Cobol: Fortran: Pascal: A: W/P: U	Maintenance contracts avail. 10 Mb H/D avail. soon. (S) BT 5/18
Periflex 630z564 (from £2250)	Sintrom: 0734 85464(5)	64k RAM: Z80: dual 5¼" F/D(1.2 Mb): 2xRS232 ports. 1 P/P.	CP/M: Basic: Fortran: Cobol:A	One-day installation training on site included in price. Option: dual 5¼" F/D(630k) £464, dual 8¼" F/D(1 Mb) £1025. 35 Mb H/D. BT 6/80 (S&H).
Periflex 1024/64 (from £2750)	As above	64k RAM: Z80: dual 8" F/D (1.2 Mb): 2xRS232 ports: 1 P/P.	As above	As above
PET 16k, & 32k (£550, £695)	Commodore: 0753 79292 (150)	16-32k RAM: 6502: C: 9" 25x40 VDU: IEEE-488 port: Options: dual 5¼" F/D (353k) £695: same but (950k) £895	O/S: Basic (in 8k ROM): Forth: Pilot: Pascal: Comal: Lisp: A	8032 with 80-col screen (32k) BT 12/80. £895 Field service avail. (1).
Philips P2000 (£2444)	Philips Data	16-48k RAM: Z80: dual 5¼" F/D (140k): 12", 24x80 VDU: RS232 port.	PDOS: UCSD p-system: Pascal: Basic Fortran:A.	With 48k RAM, Pascal and Basic £3300: BT 12/81. (S).
Powerhouse 2 (£1125)	Powerhouse Micros: 0422 48422 (TBA)	32-64k RAM: Z80A: 5" 29x96 VDU: RS232 port: external bus.	4k Monitor: FDOS: Basic: ExBasic (14k EPROM)	VDU has flexible screen logic. Options: FDOS & Basic £210: graphics card £200. (H).
Powerhouse 3 (£2600)	As above	32-64k RAM: Z80A: dual 5¼" F/D (350k): 5", 29x96 VDU: RS232 port: external bus.	As above	VDU as above. With 1.2 Mb F/D £3500. ExBasic & FDOS in 14k EPOMs £300. (H).
Prince (£3045)	Digico: 04626 78172 (TBA)	48-64k RAM: 2xZ80: dual 5¼" F/D (800k): 2xRS232 port: 12", 24x80 VDU	CP/M: Basic: Pascal: Fortran: Cobol: W/P:A: T/E:U	High res graphics. Options: single 5¼" F/D (400k) £600: dual 8" F/D(2 Mb) £2000. Rentals avail. (S).
Raannd SPI (£4500)	Raannd: 0506 33372 (TBA)	64k RAM: MCP 1600: dual 8" F/D (2 Mb): 12", 24x80 VDU: RS232 port: P/P	Pascal ADA: Basic	Based on Microengine (with integrated P-code). Up to 4 F/D drives. 64k RAM expansion avail. BT 12/80. (S).
Rair Black Box 3/30 (£3750)	Rair: 01-836 6921 (N/A)	64-512k RAM: 8085: dual 5¼" F/D (260k): 10 Mb H/D: 2xRS232 ports.	CP/M: Basic: Cobol: Fortran: M/A	64k RAM expansion £500. 256k RAM £1250. Up to 16 RS232 ports.
Research Machines 380Z (£895)	Research Machines: 0865 49791 (N/A)	16-56k RAM: Z80A: 2xC: RS232 port. P/P.	ExBasic: A: T/E: U: CP/M: Fortran: Cobol: Algol: Cesil: Pascal.	High res colour graphics. Many pos- ible systems. With 48k RAM & dual 8" 'FD (1 Mb) £3394.
S/09 (£7000)	SWTP Ltd: 01-491 7507(16)	128k RAM: 6809: dual 8" F/D (2 Mb): 12", 24x80 VDU: 2xS/P: 1 P/P.	UniFLEX: Basic: Pascal: Fortran: A: Dis A: TIE:U.	Expands to 32 users, 768k RAM, 90 Mb H/D, UNIX 'look alike'. (S&H).
Saracen (£1925)	Bytronix 0252 726814 (TBA)	32-64k RAM: Z80: dual 5¼" F/D (800k): 2xRS232 ports.	CP/M: Basic: Cobol: Fortran: Pascal: A:	Applications packages & maint. contracts avail. With dual 8" F/D (2 Mb) and 64k RAM, £2676. (E).
SBS 8000 (£1449)	Manhattan Skyline Ltd: 0801 3442: C ltoh 01- 353 6090 (TBAz7)	64k, RAM: Z80A: 12", 16 x 64 VDU: 1 P/P: RS232 port (extra £133)	ExBasic (24k ROM): DOS	Options disk control card £237: dual 5¼" F/D (368k) £795: dual 8" F/D (2 Mb) £1400. BT 11/80. (S)
SEED System 1 (£2000)	Strumech: 05433 4321 (5)	32-56k RAM: 6800: various disk options: 12", 24 x 80 VDU: RS232 port: P/P	DOS: Basic U: Fortran: A: Pilot: Strubal: T/E	Graphics. PROM programmer Also system 19 multi-user (£3000). (E)

List of Abbreviations

A Assembler
BT Bench Tested
C Cassette
E Extensive
F/D Floppy disk

G/C Graphics card
H Hardware
H/D Hard disk
I Introductory
Int Interface

M/A Macro assembler
N/A Not available
N/P Numeric pad
O/S Operating system
P/P Parallel port

S Software
S/P Serial port
T/E Text editor
TBA To be announced
U Utility

Please note: Software items listed in *italic* are not included in the basic price of the equipment. All prices are *exclusive* of VAT.

Now you can add 64K CP/M[®] to your Pet Commodore for only £497,- With the CP/M[®]Maker

It takes only five minutes and £ 497,- to raise your standard Commodore operating level by CP/M and add a hefty 64K RAM.

Not another tag-on box, this module actually plugs inside your present console. No new power supply, no soldering, no fiddling.

Whether you own the 3000, 4000 or 8000 series model you can still add CP/M versatility.

The CP/Maker gives you a massive 96K RAM at your disposal.

The Z80 microprocessor, incorporated in the CP/Maker will also enable you to use your 6502 as an intelligent I/O processor.

Look at all these other CP/Maker advantages:

- Compatible with all CP/M software such as wordstar.
- Compatible with all normal CBM software, including 69K Visicalc.
- The Z80 and 6502 work simultaneously.
- Languages include CB 80 (the fastest Basic compiler for micros), C-Basic, M-Basic, M-Pascal, PL1, CISCobol, Fortran...
- Comes complete with CP/M 2.2 diskette and operating manual.

Enquire at:

Tamsys Ltd.

4 Park St, Windsor, Berkshire SL4 1

Tel: Windsor 56747, telex 849462 t

Micro Technology Ltd.

51/63 The Pantiles, Tunbridge Wells

Kent, Tel: (0892) 45344, Telex 954

for your local d



+
64K RAM
&
RS 232
CAPABILITY

* £ 497,- is a recommended retail price.
CP/M is a registered trade mark licensed
from Digital Research Inc. U.S.A.

Research Park B-3030 Leuven, Belgium
Tel. 016/20.24.96 Telex: 26202 vect

vector
international

THE
CP/Maker
a product
from the exclusive
European
supplier of CP/M

IN STORE

Machine (Price from)	Main Distributor/s (No. of Dealers)	Hardware	Software	Miscellaneous (Documentation)
Sharp MZ-80K (£460-34k)	Sharp Electronics (UK) Ltd: 061-205 2333 (22)	6-48k RAM: Z80: C: 10" 24 x 40 VDU: Option: dual 5 1/4" F/D (289k) £695	Basic, A. <i>CP/M: Pascal: Fortran:</i> <i>Forth</i>	Graphics: loudspeaker. BT 10/79 (B)
Sharp MZ-80B (£1095)	As above	64k RAM: Z80A: C: 9", 25 x 80 VDU: RS232 port: P/P.	Basic: <i>A: Pascal: FDOS</i>	High res graphics. Options: dual 5 1/4" F/D (560k) £800: 80 cps printer £415. (S)
Sharp PC3201 (£2995)	As above <i>CP/M: Cobol</i>	64k RAM: Z80A: dual 5 1/4" F/D (500k): C int: 12". 25 x 80 VDU: 70 lpm printer.	DOS: U: Basic: <i>CP/M: Cobol.</i>	Various expansion cards avail. BT 7/81 (I&B)
Sinclair ZX81 (£50-kit, £70-built- prices inc VAT).	Sinclair: 0276 66104 (100+)	1-16k RAM: Z80A: C int: TV inb: full K/B: 44-pin expansion port.	Basic (8k ROM).	Advanced 4-chip design. Printer now avail. soon BT 6/81
Signet 202 (£2145)	Interram 01-675-5325(N/A)	64k RAM: Z80A: dual 5 1/4" F/D (400k): 12", 24 x 80 VDU: 2 x RS232 ports: 80 col printer.	CP/M: <i>Basic: Fortran</i>	Options: dual 5 1/4" F/D (800k): dual dual 8" F/D (2M). (S)
Smoke Signal Chieftan (£1800)	Windrush 0692 405189: Seed 05433 78151 (TBA)	32-64k RAM: 6800/6809: dual 5 1/4" F/D (500k): 2 x RS232 port.	DOS: <i>68/FLEX: Basic:</i> <i>Fortran: Cobol: A:</i> <i>Disc A: Pascal: U.</i>	With dual 8" F/D (2 Mb) £2600. Designed as development system for industrial control. (H)
Solitaire WP & BS200 (£6750 & £8200)	Solitaire KPG: 01- 995 3573 (TBA)	64k RAM: 8085: 14" VDU (with own CPU): 45 cps printer: CPU port: dual 5 1/4" F/D (700k) 8" F/D (1.02 Mb) with BS200.	DOS: Basic	All solitaire systems are compatible: anmd can be upgraded to multi-user H/D system. (S)
Sord M100 ACE (£2339)	Midas Computer Services Ltd: 0903 814523 Exleigh Bus. Mach. 0735-66577.(10)	48k RAM: Z80: 8k ROM dual 5 1/4" F/D (245k): 24 x 64 green VDU: RS232 port: N/P	O/S: Basic: <i>A:</i> <i>Fortran: Pascal.</i>	Up to 3 drives possible. Colour graphics avail. Option S100 bus. (I)
Sord M223 Mk II-VI (£4078)	As above	64k RAM: Z80: 8k ROM: dual 5" F/D (700k): 12", 24 x 80 green VDU: RS232 ports: S100 bus: N/P	O/S: Ex Basic: <i>CBasic: Multi-User-</i> <i>Basic: Fortran:</i> <i>Cobol</i>	Expandable to 4 Mb F/D. 32 Mb. H/D. 5 screens, 2 printers. M243 with 192k RAM & 1.4 Mb F/D £5087.
SPC/1 (£3770) (TBA)	Digital Data: 01- 573 8854	64-1024k RAM: 8085 A-2: dual 5 1/4" F/D (90k): 12", 24 x 80 VDU: 2 x RS232 ports: Option: single 8" F/D (1 Mb) £1090:	Mikados, Comal: Pascal: A.	With 32k RAM and single F/D (Comal only) £1995. Expandable to multi-user system (8 users). BT 7/80 (S).
Superbrain (£1950)	Icarus: 01-485 5574 (45)	64k RAM: 2 x Z80: dual 5 1/4" F/D (320k): 12" 25 x 80 VDU: 2 x RS232 port.	CP/M: A: <i>Basic:</i> <i>Cobol: Fortran: APL:</i> <i>Pascal</i>	Limited graphis, Mainframe int avail. Full range of application packages avail. Also avail with 700k & 1.5 Mb F/D. BT 8/80. (S&H)
System 10 (£2995)	Millbank 01-788 1083 (TBA)	64k RAM: Z80: dual 5 1/4" F/D (700k): 12", 24 x 80 VDU: 2 x RS232 port: P/P	CP/M: <i>Basic: Fortran:</i> <i>Pascal: Cobol: PL/I: W/P</i>	12 month warranty. Maint. contracts. Applications packages avail. Choice of high level language in price. (E)
System 20 (£3500)	Extel: 01-739 2041 (TBA)	64-512k RAM: Z80A: dual 8" F/D (1 Mb): 12", 24 x 80 VDU: 3 x V2	CP/M: E Basic: <i>M Basic:</i> <i>Pascal: Cobol: Fortran</i>	Maintenance contracts avail (132 field service engineers). Expands to multi- user system. Options 13.7 Mb H/D £5799: 27.4 Mb H/D £6674. (S)
System 80 (£1355-48k)	Nascom: 02405 75155 (32)	16-48k RAM: Z80A: dual 5 1/4" F/D (560k): TV int: RS232 port.	CP/M: Basic (8k ROM)	EPROM firmware avail. Colour graphics card £165. Many config- urations possible. (S&H)
Tandberg EC10 (£4000)	Tandberg: 0532 774844 (N/A)	64k RAM: 8080 A: single 8" F/D (250k): 12" 25 x 80 VDU: 2 x RS232 ports: printer int.	CP/M: Ex Basic (24k) <i>Multi-user Basic:</i> <i>Pascal: Cobol: A: U:</i>	Up to 7 terminals. Includes V28 comms port. (S&H)
Tandberg TG 8450 (£2200)	As above	64k RAM: 8085: single 5 1/4" F/D (77k): C int: 12", 24 x 80 VDU: RS232 port: P/P	TDOS: <i>Basic: Cobol:</i> <i>Fortran: Pascal.</i>	TDOS is CP/M compatible. Opt: single 5 1/4" F/D (77k) £250 (up to four): dual 8" F/D (2 Mb) £1800. (S&H)
Tandy TRS-80 Model I (£252)	Tandy: 0922 648181 (200)	4-48k RAM: Z80: C: 12", 16 x 64 VDU: RS232: P/P	Basic (4k ROM): A.	Fully expandable. Option: single 5 1/4" F/D (175k) £320 (up to 4). Many extras available. 32k RAM £304. (I)
Tandy TRS-80 Model II (£2347)	As above	64k RAM: Z80: single 8" F/D (500k) 12" 24 x 80 VDU: 2 x RS232 port: P/P	Basic <i>M/A</i> <i>Fortran: Cobol</i>	Option: single 8" F/D (500k) £782 (subsequent £391, up to 4).
Tandy TRS 80 Model 3 (£500-£1700)	As above	See Model I Levels I and II		Fully integral unit. Up to 2 integral and 2 external 5 1/4" F/D. BT 8/81
Tandy TRS-80 Colour (£304)	As above	4-16k RAM: 6809: 8-16k ROM: C: 16 x 32 TV int: RS232 port.	Colour Basic.	With 16k RAM, 16k ROM & Extended Colour Basic £390 (I). BT 9/81.
TECS (£1200)	Technalogs Computing Ltd: 061-793 5293 B&B Computers Ltd: 0204 26644 (TBA)	4-56k RAM: 8k PROM: 6800/ 6809: 2xC: TV int: 2xRS232 ports: internal viewdata modem & printer port.	FLEX: <i>Basic: Pascal:</i> <i>TDOS: A: T/E:</i> <i>Pilot: Fortran: Cobol.</i>	Fully viewdata compatible. Options — dual 5 1/4" F/D (320k) £850: dual 8" F/D £120 £1200. (S&H).
Terodec PBM-1000 (£4095)	Terodec: 0734 664343 (40)	80k RAM: Z80A: single 5 1/4" F/D (819k): 2 S/P: 3 P/P	CP/M CP/Net CBasic: <i>Fortran: Pascal: Cobol</i>	System with Okidata 80 printer: TV1 910 VDU: W/P and various application packages £5995 (S&H)
Terodec DPS 64/2M (£3598)	As above	64k RAM: Z80A: dual 8" F/D (2 Mb): 2 S/P: 3 P/P. Options: 10 Mb H/D: Tape.	CP/M: <i>MP/M: CP/Net:</i> <i>CBasic: Fortran: Pascal:</i> <i>Cobol: Basic.</i>	2 user system with 10 Mb H/D £7400 4 user system with 34 Mb H/D & tape back up £11981. (S&H)
TI 99/4 (£299)	TI: 0234 67466 (TBA)	16k RAM: 26k ROM: 9900: 2 x C int: 24 x 32, 16 colour TV int: 3 tones & noise: P/P.	OS: Basic.	12 month guarantee. Options 32k RAM: 2 x RS232: 3 x 5 1/4" F/D (92k each): Speech Synthesiser.

List of Abbreviations

A Assembler
BT Bench Tested
C Cassette
E Extensive
F/D Floppy disk

G/C Graphics card
H Hardware
H/D Hard disk
I Introductory
Int Interface

M/A Macro assembler
N/A Not available
N/P Numeric pad
O/S Operating system
P/P Parallel port

S Software
S/P Serial port
T/E Text editor
TBA To be announced
U Utility

Please note: Software items listed in *italic* are not included in the basic price of the equipment. All prices are *exclusive* of VAT.

IN STORE

Machine (Price from)	Main Distributor/s (No. of Dealers)	Hardware	Software	Miscellaneous (Documentation)
Tuscan CP/M Starter (£999)	Transam: 01-405 5240 (N/A)	24k RAM: Z80: single 5 1/4" F/D (190k); Cint: TV int: RS232 port: P/P: N/P.	CP/M: <i>Basic: Fortran; Pascal: Cobol.</i>	Options: single 5 1/4" F/D (190k) £155; single 5 1/4" F/D (370k) £285; 8k RAM £50. (S&H)
Tuscan Starter Kit (£299)	As above	8k RAM: Z80: Cint: 56-key K/B Options: Case £110; 5 x S100 sockets £20; TV int £3.50	8k Basic	Fully assembled version £499 BT 1/81 (H&S)
UDS 3000 (£2300)	Kemitron: 0244 21817. (TBA)	64k RAM: Z80A: dual 8" F/D 2 Mb: 2 x RS232 ports. Option: 10 Mb H/D	CP/M: <i>Basic: Cobol; Fortran: Pascal.</i>	Full range of industrial support cards, and applications software. (E)
Vector MZ (£2650)	Almare: 0602 52657 (3)	56k RAM: Z80A: dual 5 1/4" F/D (630k); 3 S/P: 2 P/P.	CP/M: <i>Basic: Algol; Cobol: Pascal; Fortran: Coral; CBasic: A.</i>	High resolution graphics. Also system B with video board & terminal £3450. (E)
Vector System 2800 (£4600)	As above	56k RAM: Z80A: dual 8" F/D (2.4 Mb); 3 S/P: 2 P/P	As above	High-res graphics. Many Options. Fully expandable to 5005 multi-user system (max 5) £5400.
Vic 20 (£200)	Commodore: 0753 79292 (150)	5-32k RAM: 6502; Cint: 22 x 23 TV int: S/P: P/P: Games int.	Basic	Graphics 3 tone sound generator. Will interface to PET. Option: single 5 1/4" F/D (170k). BT 9/81(S).
VIP (£2650)	Almarc 0602 52657 (3)	64k RAM: 3k ROM: Z80B: single 5 1/4" F/D (630k); 12", 24 x 80 VDU: RS232 port, 3 x P/P	CP/M: <i>Basic: forttran; Cobol: Pascal: A.</i>	Up to 3 additional F/D drives. Options: dual 8" F/D (2 Mb) £1063, 32 Mb H/D (TBA). (H&S). BT2/81
Video Genie EG3003 (£300)	Low Electronics: 0629 4995 (N/A)	16k RAM: Z80: 500bps C: 16 x 64 TV int: extra C int: 1 P/P	Basic (12k ROM): <i>Pascal: A M/A: Fortran</i>	Graphics available with ex-Basic (13.5k) £3.50.
WH8 (£352)	Heath 0452 29451 (N/A).	16-64k RAM: 808A (or Z80): 4 S/P. Option: single 5 1/4" F/D (102k) £241.	OS: HDOS: CP/M: Fortran: Pascal: Basic	Kit. 3 drives max. Colour graphics avail. (S&H) BT 2/80.
Xerox 820 (£1750)	Xerox	64k RAM: Z80: dual 5 1/4" F/D (162k); 12", 24 x 80 VDU: 2 x RS232 ports: P/P	Monitor: CP/M: Basic: Cobol: Fortran: Pascal.	With 8" F/D (500k) £2250. CP/M: £95. BT 1/82 (S + H)
Zentec (£4838)	Zygal Dynamics: 02405 75681 (TBA)	32-64k RAM: 2 x 8080: dual 5 1/4" F/D (256k); 15", 25 x 80 VDU: RS232 port.	OS/: A: U: Basic: Cis Cobol	User programmable character set. Option: dual 8" F/D (1 Mb). (S)
Zenith WH-11A (£2673)	Heath Ltd: 0452 29451 & 01-636 7349 (N/A)	LSI 11: 16-32k RAM: 25 x 80 VDU: S/P: P/P.	O/S: Basic, Fortran: A: U.	PDP 11-compat. Option: 2 x 8" F/D (1 Mb). £1717 (S&H).
Zenith Z89 £1570-£1710	As above	16-48k RAM: Z80: single 5 1/4" F/D (102k); 12", 24 x 80 b&g vdu: RS232.	Basic: A: HDOS: CP/M: MBasic: CBasic: Fortran.	3 x 5 1/4" F/D possible. Options: dual 8" F/D (1 Mb) £1717, 20 Mb H/D.
Zilog MCZ 1/05 (portable); MCZ 1/20A (£3250)	Thames Systems: 084421 5471 (N/A)	64k RAM: Z80: dual 8" F/D (600k); RS232 port: MCZ1/20A only 1 P/P: Option: 10 Mb H/D £7100	RIO: O/S: Cobol: Basic: Fortran: Pascal: M/A: U.	Available desk top or rack mounted. Debug in 3k PROM. 1/20A runs multi-user Cobol, up to 5 terminals with 40 Mb H/D. (S&H).

SINGLE BOARDS

Machine (Price from)	Main Distributor/s (No. of Dealers)	Hardware	Software	Miscellaneous (Documentation)
Acorn System 1-5 (£65-£1600)	Acorn: 0223 312772 (35)	11/8k RAM: 6502; EPROM socket: Hex K/B: C int: 8-digit LED display: up to 16 ports. Options: Eurocard 64-way connector: VDU card: full K/B card.	1/2k monitor: <i>Basic. Pascal: Forth: DOS.</i>	Kit. Programmable address linking. On-board 5 V regulator. On-board 5 V regulator. Can be expanded to disk-based system. (S&H)
AEX-09 (£750)	Micro Design 0908 663655	8k RAM: 32k PROM: 6809: 16 I/O lines: RS232 port: RS422 port.	OS-9: (<i>Basic: Pascal: Fortran avail soon</i>)	Full A/D & D/A conversion facilities. 4 x 8 bit outputs. (H)
Aim 65C (£259)	Pelco: 0273 722155(7)	1-4k RAM: Full K/B 2 x C: 20 char LED: 20 char thermal printer: RS232 port.	A. Disc A: T/E: 8k monitor: <i>Basic (8k ROM): PL65. Forth</i>	Expandable using RM65 models to full disk systems. (E)
Bigboard (£450)	Maclin-Zand 01-837 1165 (N/A)	64k RAM: Z80, F/D controller: 24 x 80 VDU controller	2k monitor: CP/M: Basic: Fortran: Cobol: Pascal: A.	Many options. Will support up to four 8" F/D drives. BT 3/81. (E)
Biproc (£119)	B L Micros: 0494 44307. (TBA)	1k RAM: Z80: TV int: RS232 port. Opt: 4k RAM £8: K/B £30.	2k Monitor: A.	With 9980 instead of Z80 £155 as well as Z80 £180. Kit. (H)
Cromeco SC (£355)	Comart: 0480 215005 (25) Datron. 0742 585490.	1k RAM: Z80A: 8k EPROM sockets: RS232 port: 3 P/P. Option: S100 bus.	Monitor: <i>Basic.</i>	5 program interval timers. Can put own Basic program in EPROM. (E)
Elf II (£50)	Newtronics: 01-348 3325 (N/A)	1/4-64k RAM: RCA 1802: Hex K/B: 2-digit LED: TV int: C int: RS232. Options: Full K/B: VDU card.	1k monitor: A: Dis A: T/E: Elf-bug <i>Tiny Basic: Basic,</i>	TTY N-line decoders. Low resolution graphics (high res avail). Kits or built. Full range of peripherals. (H).
Explorer (£82)	As above	4-64k RAM: 8085: Full K/B. RS232 port: 6 x S100 bus: C int: 1k video RAM.	2k monitor: <i>Basic (8k) CP/M: Basic Fortran: Cobol.</i>	Supplied in kit or built. Full range of peripherals including F/D. (H)
Hewart 6800S (£299)	Hewart: 0625 22030 (N/A)	16k RAM: 6800: full K/B VDU int: 2 x C int: 1 S/P: 2 P/P: Option: 16k RAM £90	1k monitor: A: T/E.	Can be upgraded with 6809. (H)
Hewart 6800 Mk 111 (£152)	As above	1k RAM: 6800: VDU board	1k monitor.	Options: single 5 1/4" F/D (75k) £350: PROM programmer £32. (H)

List of Abbreviations

A Assembler
BT Bench Tested
C Cassette
E Extensive
F/D Floppy disk

G/C Graphics card
H Hardware
H/D Hard disk
I Introductory
Int Interface

M/A Macro assembler
N/A Not available
N/P Numeric pad
O/S Operating system
P/P Parallel port

S Software
S/P Serial port
T/E Text editor
TBA To be announced
U Utility

Please note: Software items listed in *italic* are not included in the basic price of the equipment. All prices are *exclusive* of VAT.

IN STORE

Machine (Price from)	Main Distributor/s (No. of Dealers)	Hardware	Software	Miscellaneous (Documentation)
Microaxis 1 (£250)	Micro Design 0908 663655 (N/A)	1k RAM: 1-8k PROM: 6809: 8 channel A-D system: 12 optically isolated I/O lines.	1k monitor	Designed for industrial control. Can be expanded to F/D system. (H)
MPC 09 (£750)	As above	17k RAM: 48k PROM: 6089: RS232 port: 50 I/O lines: 4 timers: 1 W audio amplifier.	1k monitor: <i>Multi-tasking OS</i>	As above. New 64k version avail.
Microtan 65 (£69)	Tangerine: 0353 3633 (6)	2k RAM: 6502: 16 x 32 TV int: Options: 64 Pixel graphics £6.50	2k monitor, <i>Basic</i>	TANEX expansion kit with 7k RAM: 4k EPROM sockets: 14k Basic: 4 S/P: 32 P/P £145. (E)
Nascom 1 (£125)	Nascom: 02405 75155 (20)	4k RAM: Z80: Full K/B: TV int: 2 P/P: 1 S/P. Options: 16k RAM £140: single 5 1/4" F/D (250k) £240 (4 disk controller £127).	2k monitor: <i>B Basic: Tiny Basic: A: T/E: U.</i>	Kit. Built version £140. Also Nascom 2 with 8k Microsoft Basic in ROM £225 (no RAM). (S&H)
77/68 (£90)	Newbear: 0635 30505 (N/A)	4k RAM: 6800: LED: C int: VDU int.	1k monitor: <i>Basic</i>	Expandable to 64k RAM with F/D. (B)
79/09 (£65)	As above	1k RAM: 6809: P/P: S/P	2k Monitor.	Designed to upgrade 77/68. (H).
SBC 100 (£135)	Airamco: 0294 57755 (TBA)	1k RAM: Z80: 8k ROM: S100: 1 S/P: 1 P/P.	<i>1k monitor: DOS in ROM</i>	Kit. Available assembled £196. (E)
Superboard (£188)	(as Challenger)	4-8k RAM: 6502: 10k ROM: full K/B: VDU int: C int.	Basic (8k ROM)	Options: RS232 port: single 5 1/4" F/D (100k) £316: 8k RAM £188. (S&H)
Smoke Signal SCB 68 (£181)	Windrush 0692 405189 (TBA)	1k RAM: 6800/6809: 8k EPROM: 1 S/P.	2k monitor	Fully expandable to 64k RAM with F/D. (H)
SYM-1 (£160)	Newbear: 0635 30505 (N/A)	1-4k RAM: 6502: C int: VDU int: 2 x 6522 ports. Option: TV int.	4k monitor: <i>Basic A.</i>	Expandable to 64k RAM with F/D. (B).
Tuscan (£299)	Transam 01-405 5240 (N/A)	8k RAM: 8k ROM: Z80A: 5 x S100 slots: RS232 port: TV int: C int: 1 P/P.	<i>2k monitor: 8k Basic: CP/M: Pascal</i>	High res graphics available. Can be expanded to F/D system. BT 1.81. (S&H)
UK101 (£149)	Comp Shop: 01-441 2922 (4)	4k RAM: 6502: full K/B: 16 x 48 VDU or TV int: C int: RS232 port, Options: 4k RAM £16	2k monitor: 8k Basic: <i>Dis A: U.</i>	Graphics. Expansion & colour avail. Kit or fully assembled. (S&H)
Windrush 6801 (£175)	Windrush: 0692 405189	2k RAM: 6801/3/5: 12k EPROM: S/P: 3 P/P	2k Monitor	Designed for industrial control & dedicated small systems. (H)
ZCB (£260)	Almarc: 0602 625035 (3)	1k RAM: Z80A: 3 PROM sockets: RS232 port: 3 P/P	<i>Will take any 2708/16 = 32 software.</i>	S100 bus compatible. Expandable to full system. (E)



TRANSACTION FILE

We know when we're beaten! The volume of readers using Transaction File is escalating beyond our resources to cope. Regrettably, therefore, we are increasing the flat fee to £2.50 per advertisement. Each ad must be printed on the form below, using a maximum of 30 words. We cannot accept Transaction File ads unless they are sent to us on this form. (If you don't want to damage your copy of PCW by cutting out the form then please use a photo-copy.) All ads must be accompanied by a cheque or PO for £2.50 made payable to SportsScene Publishers (PCW) Ltd. Ads are accepted only from non-commercial readers. We cannot repeat an ad unless a new form is sent in, nor can we guarantee to place an ad in a particular issue. Ads are printed on a strict 'first-come-first-published' rota basis. Please mark your envelope very clearly: Transaction File (PCW) 14 Rathbone Place, London W1P 1DE. Thank you for your co-operation.

ZX81... 16k RAM PSU (ex cond, both guar), leads, manual, books, mags and 5 cassettes full of exc. s/ware inc. invaders, 3 adventures and many others. £120. Tel: Ware 830735 after 5 w/days & w/ends.

ZX81... 16k, rebuilt in stylish case with proper keyboard. Books on games and machine code. Progs (Inc Defender). Worth around £190, only £130. 67 Boileau Rd, Ealing 997-6967.

ZX81... Sinc built, 16k RAM, leads, manual, Sinc cassette, ex cond. only 4m-old, £105 ono. Ring 0945 4555 after 6. Buyer collects.

ZX81... Sinc built, with 16k complete and as new 80. Cassette interface TR1 £5. Four Sinc cassettes and two books £2 each. Five inch b/w tv £40. Tel: 01-668 8541.

PET... 16k new ROM, cassette, toolkit, manual, cover, games and other programs. £450. Tel: Stoke on Trent 0782 618560.

Nascom 2... 32k with toolkit, Naspen, Zeap, graphics, case and full documentation. £400. Tel: 01-883 2182.

ZX81... Sinc built, 16k RAM pack. Leads, selection of books, all hardly used. £110 ono. Please phone Medway 362077 and ask for Mr Bedford.

Superboard II... 8k RAM, PSU, Cegmon monitor, 300/600 baud, soundboard, professionally built, all cased, manuals, s/ware. £280 ono. S Docking, Room G19, Brunel University, Uxbridge, Middx.

Sinc 16k RAM... used twice, boxed with guarantee slip, + 3 superb games on a TDK cassette; Defender, Breakout and Nightmare Park. Only £50 the lot (worth £65). Tel: 01-866 6321 eve.

Microtan 65 + Tanex... full expansion, 8k RAM, Microsoft Basic, XBug etc. In system rack with system Motherboard, Cost £480 will accept £300 ono. Tel: Dewsbury 45 24 24 after 6.

TRS80... LH 16k + VDU, CTR80, printer interface. Lower case mod, T-Bug, Edtasm, dis-assembler, manuals etc. £430. Phone David Fitzgerald 01-836 0386.

Mk 14... SC/MP processor, with revised monitor. Also available training manual with Nat-Senus assembler and applications manuals. + I/O RAM chip and tape interface. £60 ono. Tel: 01 807 4190 eve.

TI59 + PC100 Printer... Exc cond, in box with Master, Maths Utilities and structure, modules, printer utilities and fun, s/ware packettes, charger, case, paper rolls. 90 magnetic cards, complete with all literature. Any test. £230 ono. East Horsley, Surrey, 4239 eve.

Sharp PC1211... Pocket computer — still boxed with carrying case. K/board overlay, full instructions, program library containing over 100 programs and guarantee. £70 ono. Tel: Andrew Falconer after 6 on 01-452 1276.

Bargain Atom... 13k RAM 12k ROM via buffers etc. Lots of s/ware + books. Also Selkosh GP80 printer + paper. Sensible offers. Phone after 6.30pm 021-747 5084.

ITT... 2020 disk drive. Used only a few times as a second drive. £175. Phone South Benfleet 52147.

ZX80... PSU, manual + books + tapes + circuit. Exc beginner or upgrade. £45. Phone Burnley 29867 after 6.

Nascom 2... 32k RAM. Scards Kenilworth case, EPROM programmer, Zeap, Nasdis, Naspen, Z2, toolkit, TV and recorder. Lots of extra h/ware & s/ware: £400. Must sell for need of cash. Eve 01-581 2451.

PET 2001S... 8K, new ROMs, PET revealed, extensive s/ware. Worth £375, offers over £260. M Whitworth, Coombe Lee, Woodlands Crescent, Ashurs, Southampton SO4 2AQ. Highest offer secures.

TRANSACTION FILE

First 44 issues of PCW... all intact and in exc cond. Cover value £25.25 - best offer takes. Phone Cannonck 70016 eve.

TRS80... C2 16k+VDU, cassette recorder, Level I&II manuals, over £100 of s/ware/books. Worth £620 must sell!! The lot - £320. Phone Blackpool (0253) 48018 after 5.

Sharp MZ80 48K... Basic manuals cassettes etc. 1yr old. Perfect cond. £300. No offers please, buyer collects. Tel: 01-960 1404.

ZX81+16K RAM... Sinc built, manual, PSU, leads + 5 games books. Worth £150, accept £110. 19 Drayton Road, Cambridge.

Acorn Atom... 12k+12k complete with PSU, cassette player and all leads, manual and s/ware, factory assembled, almost new. £250 ono. Tel: Meopham, Kent (0474) 814592 eve.

TRS80... Level II 16k, hardly used & still boxed, numeric keyboard, manuals, cassettes, modulator, programs etc. Must sell quickly. First offer over £320 secures. Unused cassette recorder inc. Tel: 01-954 4304.

Exchange... Evinrude '25HP' outboard motor. Longshaft, exc cond. Value approx £200 and cash adjustment maximum £100. For best computer offered. Prefer PET/Apple. Abingdon (0235) 25146 eve/w. ends.

IBM Golfball Printer... 2 years old but in fine cond. Suitable for any computer with an IEE 488 user port. Adrian Berry 353-3491 in London after 11am.

ZX81... Sinc built + 16K RAM, inc lead, adaptor, manual and Interface. Good cond. Under guarantee, s/ware. Inc Invaders and Music. £141. Tel Dave 01-767 6569 after 4.

ZX81... + 16k RAM, Sinc built. 5months old, still under guarantee. Exc cond. with all leads & manual. £40 worth of games s/ware: £120 ono. Phone 01-894 7818 eve.

Sharp MZ-80K... 48K per cond. Many prog inc Missile Command, Invaders and adventure games. Club newsletters and machine code language. Only £350 ono. Tel: 041-776 3250.

TRS80... LII, 16K, new ROM, num k'pad, inc CTR41 cass recorder, all leads, manuals, tapes + assorted s/ware. 10 months, faultless, working with original packing. £295 the lot. Tel Epsom 24727 - Dick.

Atari 400... 16K + 410 tape deck, pair joysticks. Invitation to Programming I, Basketball, Space Invaders, Star Raiders all by Atari worth £500, nearly new £400 complete. Tel: 01-505 3991.

Acorn Atom... 12K + 12K, printer drive, V.I.A. fitted, power supply, leads, cass recorder, full documentation, magic book, carry case, games incl Space Invaders, Breakout etc. £200 ono. Tel: Stonehouse 791940 (Scotland).

Apple II... Pascal language system, discs + operating system and Language reference manuals £200. Tel: Formby (Merseyside) 70998 after 7.

Atari 400... + 410 program recorder only 6 months old, with original packing £340 ono. Tel: Didcot 814656.

PET 2001... 8K, old ROM, integral cassette, reasonable cond. will accept £220, buyer collects unless in area. Tel: 0632 733707 after 6.

Apple II... Europlus 64K, Apple Pascal, dual drives (3.3), B&W Monitor, all leads, manuals, software & extra software, all perf working cond £1600. Tel: Kings Langley 62403 after 6.

Mattel... Intellivision, 1 year old, great cond, with 12 cartridges worth £416. will sell for £300 ono. Tel: 594 7222 ex 3107 weekday between 2 and 4 only. Need quick sale.

TRS80... Level II 16K with VDU, power supply and cassette recorder, complete with manuals, leads, etc, games on tape £400 ono. Tel: Gloucester 411410.

PET... 8K old ROM, integral cassette deck, small keyboards, recently overhauled and guaranteed, complete with £100 of games cassettes, £265 ono. Tel: 01 486 61009.

Exidy Sorcerer... 32K computer with standard Basic, TV interface, many manuals and much software incl Adventure games £350 video monitor and tape recorder available. Tel: 063881 2399.

Superboard II... 8K RAM, metal case with PSU switchable monitors, mono 1 and Ceg'mon switchable 1 or 2 MHz with manual and software excellent working order £150 ono. Tel: Medway, 0634 252845.

ZX81... 16K Sinc built unwanted present incl all leads, £40 of software and compatible tape recorder. Guarantee still valid. A snap at £180. Tel: 01-995 9485.

Acorn Atom... 12K RAM + F.P. ROM, all leads, plenty of games incl Invaders, plenty of blank tapes £180 ono. Tel: 01-594 7222 ex 3107 weekdays between 2 and 4 only.

UK101... cased, 2 monitors 1-2 MHz, normal-reverse video, many games, Chess, Invaders etc £180 ono. Decoding board (newer machines), assembled, incl transformer + 8T28's £27. Tel: Uppminster 22726. Buyer collects.

Vic 20... 21K, cassette recorder, tapes, manual, leads, PSU, 1 month old £300 ono. Tel: 0604 716294 after 6.

ZX81... printer as new but without main adaptor £35. 36 Hoe Way, Roade, Northants. Tel: 0604 862369.

PET 3008... new ROM twin C2N cassettes, toolkit, documents, manuals, cover, lots of software, incl microchess, Startrek, Invaders, everything VGC, can deliver UK £385. Tel: Didcot 812905 MARTIN.

ZX80/81.3... reliable 8K memory expansion board expandable to full 16K £25. Tel: Ian 0724 61688.

Commodore Vic 20... one house used only, purchased on 11/2/82, receipt as proof £150. Tel: 01-937 2280 evenings, Nicholas.

Apple II... +48K, Dos 3.3, Applesoft Basic, Integer Basic, colour card, paddles, oodles of software, games, all manuals + Basic, Advanced Basic, colour graphics, all original software, accept £1000 ono Tel: Yateley 876775 evenings/weekends.

Exidy Sorcerer... 48K, Basic/Development Pack, all leads and games/applications software £550 ono. Tandy Quick Printer II £70 - J Reid, 78 Hazel Ave, Stillorgan, Dublin, Eire.

ZX81... Sinc built + 16K RAM Pack + PSU + all leads + 'Getting Acquainted With Your ZX81' + 'The ZX81 Companion' offers for quick sale, perf cond. Tel: East Horsley (Surrey) 3330.

Acorn Atom... 12K + 12K, printer drive, wordpack, magic book, Atom business, Getting Acquainted, recorder, prog £300. Altair 8" drive, S100 controller + cables £300? Will exchange either for PET, TRS80, MZ80K. Tel: 01-958 8924 evenings.

UK101... 16K cased with Cegmon, Basics 1,3,4, 300/600 Baud, 1-2 MHz, 16/32 lines 9 amp power supply, colour graphics, masses of programs (Assembler, Toolkit, Forth, Space Invaders etc) £250. Tel: Hamilton 426973.

MZ-80K... 20K RAM, 12 months old, very good cond, incl Space Invaders and other programmes £350 ono. Tel: 0256 26057.

ZX81... factory built, hardly used, 16K RAM, leads, manual and software, complete with Redditch electronics full-size quality keyboard £140 ono. Tel: 01-946 5161 preferably between 7.30 and 9.30

6802 Computer... machine code, colour (uses same colour chip as Acorn Atom), display on TV, 10K RAM, needs ASCII keyboard £50. Tel: Hamilton 426973.

Atari 800... 32K + cassette player, 3 games 'Le Stick' £700. ZX81 1K Sinc built, manula etc, £40 12" B/W TV £35. Tel: 01-731 5512. after 8.30.

Wanted... Sharp MZ80K, 48K, used peripherals, owner state model no., purchase date and supplier. Dr W F Coxon, 3 Talycote Court, Monmouth, Gwent, NP5 4HR.

Epson MX-80... printer, F/T Type-2, hi res graphics, 1 month old £450. Video Geneie EG3003 some books and software, worth £100, all for £250. Parelal interface £20. Tel: 01 947 8837.

32K Pet... new Rom, integral cassette desk, soundbox, super-chip, toolkit, reset switch, 15 cassette game progos £680. Tel: B. Taylor 031-667 1971 ext 28 or 0557 30856.

Video Genie... sound level extra keys in box + £200 software incl editor/ass + Level 3 Basic, T-Bug, Temple Apsah, Cosmic Fighter + many more £350. Tel: 0926 23850 after 5.

Genie I... 16K, purchased Feb '82 complete in original packing £290. Tel: Bristol 568305.

Superboard III... cased, PSU, leads, full documentation, games on cassette, excellent cond, 4K RAM, 8K microsoft in Rom £130 ono. Write: Graeme Hills, 27 Devonshire Ave, Southsea, Hants

Superboard III... 8K RAM cased with PSU & Modulator. 24 x 24 or 48 x 12 display, DAC, software incl Space Invaders, magazines & manuals £175 ono. Tel: 0827 62714.

ZX81... 3K expandable 8K, mini superboard, full size QWERTY keyboard all in case, room for more. Software cassette library and 4 books, plus more! worth £160, want £100. Tel: 03752 5934.

Transaction File advertisement form

All Transaction File ads must be submitted by readers on this form or a photo-copy of this form. Maximum 30 words. Print one word per box, very clearly. Name, address and/or telephone number must be included in the 30 words. All ads must be accompanied by flat fee of £2.50. Make cheques or POs payable to Sportscene Publishers (PCW) Ltd. Ads accepted from private readers only. Ads cannot be repeated (unless sent in on another form) and we cannot guarantee to print an ad in any specific issue. Please help our typesetter to help you by printing your ad very clearly. Send form to: Transaction File (PCW), 14 Rathbone Place, London W1P 1DE.

Please find enclosed my cheque/PO for £2.50 for the following Transaction File ad.

TRANSACTION FILE

O.S.I. . . Superboard II, PSU, modulator case, 48 x 32 display, Cegmon, 8K RAM, leads and manuals £200. Tel: Paul 01-778 6402 after 6.

MZ80K. . . Sharp Assembler and machine code tapes, both with manuals hardly used, cost new £65 accept £22. Tel: 0706 45019.

ROM Pet. . . 32K new, cassette, soundbox, toolkit. Pet-revealed, much software incl: many Cursors, Adventures, Invaders, Meteorites, Asteroids, Assembler course, Extramon, P.E.P., Microchess, 3-D Startrek, Glooper, £750. Tel: Cuffley 2865.

Power Supply unit. . . open frame type, 5v, 24v and 12v, suitable for floppy disc etc £19. Tel: 01-573 5635.

Wanted. . . ZX81 in exchange for CB radio Cybernet 2000, K40 MAE mount, noise cancelling mic, power supply, free 45w amp, all boxed, worth around £130. Tel: Aldershot 21489.

Centronics 737-2. . . printer unused £400 ono. ICL Termi-printer 30cps typewriter quality ASCII code send/receive terminal, many features, RS232C/V24. ideal for Nascom etc £50. Tel: Jon 021-743 8442 evenings.

Sharp MZ80. . . 48K Basic, machine language, Zen, Knight Commander, lots of games and cassettes, monitor and other listings, all manuals incl 18 months guarantee still remaining £395. tel: 0709 816721.

Tandy Line Printer VII. . . few months old, still under guarantee, cost £239 new, will accept £179. P. Bramwell, 87 Anderson Cres, Great Barr, Birmingham B43 7ST Tel: 358 5312

Pet 3032. . . 32K + dual disc drive (4040) + diskettes + tape + various manuals + complete 'Basic Basic' course on disc + tape. Buyer collects. Tel: G Smith 01-928 1858.

ZX81. . . Sinc built with 5K RAM and fullsize keyboard with case, lost of v. good software inc Space Invaders, Asteroids etc. all leads and manuals. For quick sale £90. Tel: Mr Quigley 01-549 7657.

UK101. . . in microtype case with 8K RAM. New monitor and Basic in eproms. Complete with manual £200 ono. Tel: 0908 662437.

Ohio Superboard II. . . 8K RAM, 32x32 screen, modulator, PSU, new Cegmon monitor, Basic 3, all manuals etc. Also Exmon, PIA, & VIA interface boards inc, upgrading, hence £160 + postage. Tel: 0225 20074 day or w/nd.

8080 Digital board. . . 8K static RAM, 1K monitor Rom inc 8255, 8251, 8224, 8228, NE556A, MC1488, MC1489, Data, Schematics, connectors etc. £25 ono. Tel: 0484 89 3711

ZX81. . . 16K RAM, Sinc built, ex cond only 4 months old, unwanted gift, with 16K games inc Invaders and Startrek. A bargain at £100. Tel: Stourbridge 3420.

Pet 32K. . . Basic 4, keyboard reset buttons etc 4040 twin disk drive, latest DOS, cass rec, lots disk software inc word processor + documentation + books. Offers over £850. Tel: 01-741 755 evenings.

Nascom 1. . . expanded, 32K RAM, Cottis-Blandford interface, Rom graphics, 3amp P.S.U., Nasys monitor, tapes inc Zeap, Basic and games, cost £470, accept £350 ono for quick sale. Tel: Steve Winchester 65410.

Pet 3032. . . 32K, £600. CMB 3040 dual disk drive with 15 disks £600, CMB 3032 printer £400, cass drive £45, all items little used offers invited. Tel: 0243 574014.

Intellivision. . . TV game £160, 5 cartridges at £15 each ono. Mr Wilson, 70 Cambridge Way, Haverhill, Suffolk Tel: 0440 705531.

Acorn Atom. . . 12K + 12K, 6522 VIA, all leads, manuals etc £240 chess cassette £4, several games cass + personal finance cass £3 each. Tel: 01-508 2895 evenings.

S100. . . several S100 boards, CPU, floppy disk controller, RAM, video etc also ASR 33 upgrading system, most boards SD-sales. Tel: Norrie 0294 822634, evenings 7-9.

MPs 6550. . . memory chips for old Commodore Pet, only £7.50 each. Tel: Bitton 6206 (nr)

TRS80. . . Level II 16K, VDU monitor and cass rec, + loads of programmes £330. Tel: 01-381 5312.

Compshop TV game. . . Break out £10 also Touch Me by Atari £3.50 also Optim 600 Video cartridge programmable TV game with cartridge £8. Tel: 01-903 3089.

ZX80. . . Sinc built 8K ROM with video upgrade (Compshop allows use of fast and slow mode), books and software, ideal for beginners £50. Tel: Hertford 56751.

ZX81. . . with 16K RAM, complete with adaptor, instruction book, all leads and compatible tape recorder also games book and tape, £120. Tel: Ipswich 713134 after 5.

APPLE II. . . Europlus 48K with one disk drive, controller, manuals, software £875. Tel: Rickmansworth 78335 after 6.

UK101. . . 40K with 10K Basic, Cegmon, interface boards, 58174 clock/calendar, Space Invaders and manuals, £450 ono or sell in parts, S Riddle, 51 Marshalwick Lane, St Albans, Herts.

Acorn Atom. . . 12K + 12K, PSU, leads, manuals, printer driver chips, fully working, software incl Space Invaders, Astrobirds, Breakout, Star Trek, Star Gate, Maze, Asteroids and many more, £170. Tel: Ingerbourne 70681.

ZX81. . . Sinc built, also Sinclair printer and paper, 7K RAM, leads, PSU + manual, software incl Defenders, Invaders, Cassette 1, £150. R Snell 19 Fulbeck Rd, Scunthorpe, South Humberside DN16 2LL.

CT64 Terminal. . . RS232, 56 stations kb, alpha lock, 2 page memory, 32 or 64 char/line screen reversal, hi defn monitor, full docs, perfect, £150. Tel: Berkhamstead 4194.

PET 4032. . . 4040 Disk Unit, 3022 Dot Matrix Printer, all cables, disk covers, games programs, Visicalc etc, as new £1300. Mark Thomas. Tel: 01 853 0702 evening.

Wanted. . . Nascom 2, Old Pet, Acorn Atom, Nascom 1 + VDU or Superboard 2 + VDU system for student with only £160. Tel: 01-942 6800.

TRS80. . . Model 1 Level II 48K, VDU, tape, lower case, RS232C, books, games, six months old, original boxes £650. Cumana (Teac) twin discs, TRSDOS, LDOS, Scripsit, £500. Tel: 0625 524596.

ZX81. . . Sinc built, brand new, full guarantee £65. Unwanted gift. Tel: 01-521 3237 after 6.

Atari 800. . . 16K with Atari 410 recorder, 'Le Stick', assem/editor, Basic, Star Raiders cartridges, 9 months warranty remaining £600. Tel: 0253 35967.

TI 99/4. . . chess, statistics, American football, modules, double cassette lead and manuals incl, bought Oct '81 for £400, will sell for £275. All as new. Write with tel. no. R Muldoon, QEMH, Woolwich, London SE18 6XN.

TI-59. . . programmable mag, cards, charber, case, manuals, original box, VGC £60. Tel: 0436 71151.

PET. . . 32K New ROMS, large keyboard, Green screen, cassette, soundbox, many programs incl PETChess, Microchess, Temple of Apsal etc, excellent cond, manuals, buyer collects £600. Tel: 01 521 8897.

8K PET. . . old ROM with built-in cassette £240 ono. Tel: Bristol 292685.

Atari 800. . . 48K, cassette recorder, interface module, joysticks, paddles, 3 cartridges, 4 cassettes incl assembler, dis-assembler, character generator hardware and software manuals, best offer around £800. Tel: 0903 812227 after 6.

Acorn Atom. . . 12K RAM, 12K ROM, Via power supply (10 amp), Euro connector, printer interface, with software £225. Tel: Canvay Island 699364 evening.

ZX81. . . Sinc. built as new with leads, manual, adaptor, original packaging + about 50 progs £50. UK postage free. Tel: Geoff 0632 577186.

ZX80. . . for sale VGC still in original packing, leads and manual for quick sale, £35. P Gower, 4 Clyffard Cres, Newport, Gwent.

ZX81. . . +16K RAM all sinc built and in VGC, manual, Leads, and OSU incl £80. R Haydon, 21 Manchester mansions, Hazellville Rd, London N19.

Sharp MZ. . . 80K 48K, manuals etc. excellent cond £295. Tel: 01-868 9709.

ZX81. . . +16K RAM, Sinc built, 1 software tape, all leads, manual, power pack, original box etc, first offer of £95 secures, David Brookwood, Tel: 04867 5100, 5-9 evenings.

Aculab. . . floppy tape for Genie complete with manual, extended Basic plus manual and 13 wafers, assorted software on wafers, perf. cond £150. Tel: 0429 61667.

Atari Video Computer. . . complete system plus Combat, Invades, Adventure Outlaw, Basketball, Asteroids, cartridges, excellent cond 11 months old, worth £250, only £150 ono. Tel: Letchworth 72904 after 6.

Video Genie. . . 16K RAM with cassette, lots of software, programmes, books etc. £225. Tel: Spalding 3999.

UK101. . . 8K prof built, metal case, fan, tape recorder, all leads, incl powerful sound generator, large number of programs incl Space Invaders and Screen Editor, £300 ono. Tel: South Benfleet 54200.

TRS80. . . 48K, Level II, with Hitachi 12" VDU, cass, manuals etc, £499 ono or will split. Tel: 0494 444612.

Nascom 2. . . 16K graphics, toolkit, zeap, Nas-Dis, Microsoft and Xtal Basic, cases, lots of software and N2 literature £325. Tel: 0323 57572 after 6.

PET. . . 32K, old ROMS, Integral cassette, small keyboard, many programs in word-processor invaders, £450 ono. Tel: 0602 708011 after 6.

IBM. . . I/O electric typewriter, upper & lower case, spares, manual, super print quality £180. Tel: 0621 740075.

Commodore PET. . . 24K plus Compuhink discs £650. Tel: Cwmbran 71921.

ACC NEWS

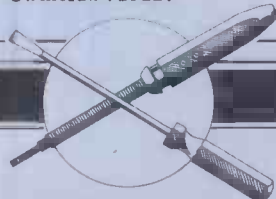

This month, I thought I'd tell you about the ACC Club Affiliation Scheme, whereby your club can obtain a cheap newsletter via the ACC. I have mentioned this before, but the full gory details come this month. But first, here is the news. . .

At a Committee meeting which I was locked out of (inadvertently — at least that's their story and I believe them), the ACC Committee considered changing the ACC's name to remove the apparently taboo

word 'Amateur'. One suggestion was 'National Association of Computer Clubs' or NACC for short — I don't like that since I was brought up knowing that NAK meant transmission error, please retransmit, while ACK meant message received and understood (some bright spark will point out that the ASCII codes are 6 for ACK and 25/21/19 (depending on your favourite radix) for NAK). But seriously, I don't see what's wrong with the name Amateur. I happen to

work as a computer professional but I choose to devote part of my spare time to hobby computing. When I am being a hobbyist, I am quite happy to be an 'amateur'; it is only because the others around me are also doing it for fun that I do it for fun — otherwise I would charge the going rate. I don't really believe that the computer hobbyist exists to be exploited by businessmen who want a machine to do a job. Well there's a nice provocative view. I hope you'll all write

to me and tell me what you think of this issue.

The ACC was at the National Amateur Radio Show at Belle Vue, Manchester on the 4 April, and a good time was had by all (or so our correspondent writes). There were several thousand people there and the crush was somewhat reminiscent of last year's PCW Show at the Cunard Hotel. All sorts of computer and radio equipment was there, including homebrew, surplus and shiny boxes. As the

winner of last year's inter-club quiz, the ACC was punished by having to run the quiz this year (teach our Chairman to be so damn clever). This year it was won by Bury Radio Society, with the other computer club at the Exhibition, the Manchester Computer Club, being sadly knocked out in an early round.

Clubs... if you want space at the next (I think it's the fifth!) PCW Show for your club, then write to: Dr David Annal, 142 Windermere Road, Norbury, London SW16 5HE as soon as you can, as he's sorting out the space in the ACC's area (on which your club may have a stand - if there are any left) very soon. The show will be at the Barbican complex; David has all the details.

I have heard of one new club this month, namely Bottisham BBC Micro Users' Group. The guy to contact there is Mr P M Rank, 27 Bell Road, Bottisham, Cambridge, CB5 9DF. Perhaps they have meetings composing rude letters asking about late delivery...? If you're in that area and have another machine, I'm sure they might consider broadening their horizons to more than just the Beeb machine. There's a Club in Nottingham which seems to deserve a plug, if only because they wrote to me (hint...), the Nottingham Micro-computer Club (Mr K Swainson, 9

Brayton Cres, Bulwell, Nottingham). Our friends in Oxford, OPeCC (Oxford Personal Computer Club) have tugged my sleeve again, to point out that they're taking off very successfully, with a recent large speaker meeting on computer music. Contact: Tim Fowler, 39 Charles Street, Oxford. The membership fee is £8 per annum, including affiliate membership of the ACC (see below). I hear a rumour that a full barrel of crude oil will be accepted as payment for a year's subscription.

I have frequently informally described the ACC full affiliation scheme (which has been taken up by North London and Oxford Clubs, since its somewhat tentative launch a few months ago), whereby a club pays a much reduced subscription to make all its members ACC affiliate members, and the club uses the ACC's newsletter *ACCumulator* as its own newsletter by the simple insertion of a flysheet. This enables the club to take advantage of the ACC's large and therefore cheap print runs; it will often be cheaper for a club to affiliate then to produce its own newsletter, plus there are the benefits of ACC affiliate membership. To show you exactly what is meant, I will give you the text of a sample set of terms for our imaginary friends the West Somewhere Computer Club.

of each club's application for full affiliation will differ widely, and that each application will have to be treated as a special case. In particular, it may be possible to reduce the costs for very large clubs.

1. The ACC shall provide W Somewhere with one copy of each issue of *ACCumulator* published during the currency of this agreement, for each paid up member of W Somewhere, plus a margin of 5% to cover honorary members and the like.
2. The individual members of W Somewhere will become affiliate members of the ACC, and will be granted the following rights and privileges: a) A copy of each issue of *ACCumulator*, supplied to W Somewhere as in (1) above and distributed by them; b) Eligibility for members' special offers; c) Use of the ACC libraries. Affiliate members are not allowed to vote at ACC General Meetings.
3. W Somewhere will pay to ACC, during September 1982, the sum of two pounds 75 pence for every paid up member of the club. This sum is to be reviewed according to the ACC's costs for each annual renewal of this agreement.
4. Special provisions exist for those members of W Somewhere who are already individual members of ACC. These members will continue to remain full members of the ACC, but the ACC will pay to W Somewhere the sum of one pound 50 pence per such member as a discount. The ACC feels that it might be appropriate for the club to pass such sums on to the members concerned. Those ACC members who are paying at the concessionary rate of two pounds per annum shall not attract the discount.
5. W Somewhere shall be responsible for notifying the ACC of the names and addresses of its members. The ACC will assign each affiliate member an individual membership number, which he should use when applying for special offers or using the libraries. The ACC will also provide W Somewhere with labels for the distribution of *ACCumulator*, should W Somewhere wish to distribute any or all the copies by post.
6. The ACC will promote W Somewhere at any exhibitions or other events attended by ACC. It is hoped that W Somewhere will assist in this by providing publicity material.
7. W Somewhere will notify the ACC Membership Secretary of the names and addresses of new members of the club during the course of the year, and include their capitation fee of two pounds 75 pence (or whatever sum shall be agreed in the future in (3) above). The ACC will include a set of back numbers of the current year's *ACCumulator* for the new affiliate member in the next mailing of *ACCumulator* to W Somewhere.
8. The ACC will provide each affiliate member with a membership card.
9. These provisions apply for the year 1982/83 (1 Oct to 30 Sept), ie, *ACCumulator* Volume 10. The W Somewhere membership shall initially be as on 15 August 1982, but subject to increase under item (7) above.

Terms of Club Affiliate Membership

These terms are applicable only to the agreement between the Amateur Computer Club (abbreviated herein ACC) and the West Somewhere Computer Club (abbreviated herein W Somewhere). Whilst they may be a guide to the kind of agreement with other clubs, the ACC realises that the details

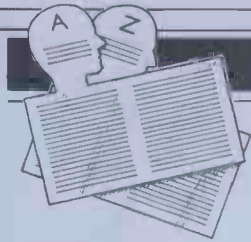

USER GROUPS INDEX

Here's an update of changes and new clubs. Full listing in July.

INTERNATIONAL

EZUG: Educational ZX users' group. 1982 sub £2 (UK), £2.50 (Europe), £4/£8 (rest of world). Bimonthly newsletter, ZX Directory £1, 16k RAM £32.50 (UK). Contact: Eric Deason, Highgate School, Birmingham B12 9DS.

PPC (Personal Programming Centre): Worldwide group of Hewlett-Packard calculator & computer users. The 1st and largest calculator user group in the world. 5-weekly journal - good source of hardware & software advice. For sample issue & other information send 8x12 SAE with 2 int reply coupons (or 20z US postage) to: PPC, 2545 West Camden Place, Santa Ana, CA92704, USA.

Amateur Computer Club, 2650 Library. 2650 related data and

assistance only. No newsletter or meetings. Still alive & kicking following a rather quiet 1981 in which Roger Munt (contact) moved house. New address: Tyn-Y-Coed, Kilnwood Lane, South Challey, East Sussex BN8 4AU. Tel: (0273) 400347.

NATIONAL

Amateur Computer Club. National Organisation with seminars, local group meetings. Bi-monthly newsletter 'ACCumulator'. Fee £4.50. SAE to: Rupert Steele, St John's College, Oxford.

BEEBUG: BBC Micro Independent User Group. Regular magazine with programs feature in each issue, hardware tips, software library, advice and reviews. Discounts on hardware, software, maintenance and books. £4.50 half year, £8.50 full. BEEBUG, PO Box 50, St Albans AL1 2AZ

Atom User Group. Quarterly newsletter, software library, technical help whenever possible. Some local groups. Membership £4 pa. Contact Peter Frost, 18 Frankwell Drive, Potters Green, Coventry CV2 2FB.

Church Computer Users Group: There are a few people already interested in starting one. Are there any others? Teaching programs, humn choosers, agendas, addressers etc. ZX81, BBC Micro and others. For Information SAE to Nigel Hardcastle, 112 Rotherfield Road, Birmingham B26 2SH.

VIC User Club & Software Library: soon to be formed. Library contributions welcome - all tapes returned & programs paid for. SAE for information to: Matthew Stibbe, The Lawn, Lower Woodfield Road, Torquay Devon.

REGIONAL

Gwent Amateur Computer Club. Anyone in the South Wales area interested contact Ian Hazell, 50 Ringwood Hill, Newport, Gwent NPT 9EB (SAE appreciated) or phone Rotheray Harris on Newport 852924. Meetings at St May's Church Hall, Stow Hill, Newport on Thursdays from 8pm.

North West TRS-80 User Group. Monthly Meetings, bi-monthly newsletter, software library, sub-groups and more. Will exchange newsletters with any other TRS-80 group. Contact: Melvyn Franklin, 40 Cowlees, Westhoughton, Bolton BL5 3EG. Tel: Westhoughton 812843

Strathclyde Computer Club. Meetings 3rd Wednesday monthly at Strathclyde University Wolfson Centre, 106 Rottenrow. Contact: Brian Duffy, 24 Lomond Drive, Condorath, Cumbernauld G67 4JW.

USER GROUPS INDEX

COUNTY

North Wilts Computer Club, Meetings at Holt Village Hall, 2nd & 4th Wednesdays monthly. Entrance fee 50p to non-members. Speakers welcome. Contact: Matthew Jones, Pinhills, Bowood, Calne, Wilts SN11 0LY or Gary Hawkins, 198 The

Common, Holt, Trowbridge.

TOWNS

Edinburgh ZX User Group. Meetings 2nd Wednesday monthly, Claremont Hotel, Claremont Crescent, Edinburgh, from 7.30pm. Also Saturday workshops & outings arranged. Newsletter, software library. Membership £3 for children.

students, OAP and unemployed. £5 otherwise. Contact: Keith Mitchell, 19 Meadowplace Road, Edinburgh EH12 7UJ (031 334 8483) or John Palmer 031-661 3183.

Leicester Apple User Group for Help & Support (Laughs) — affiliated to BASUG. Meetings now at the Winstanley Arms, The

Glade, Narborough Road, Leicester. Contact: Hazel Brown, 7 Bude Drive, Glenfield, Leicester LE3 8BA (0533 875 253).

York Computer Club new venue: Guppy's Enterprise Club, 'The Old Brit', 17 Nunnery Lane, York.

NETWORK NEWS

These are all the European networks of which we're aware. Most are free — but phone them for details.

Forum-80 Hull. . . (Forum-80 H,Q) Tel: 0482 859169, System operator Frederick Brown. International electronic mail, library for up/down loading software. Forum-80 Users Group, Pet Users section shopping list system hours, 7 days a week midnight to 8.00am, Tues/Thurs 7.00pm to 10.00pm Sat/Sun 1.00pm to 10.00pm.

Forum-80 London. . . Tel: 01-747 3191. System operator Leon Jay. Electric mail, library for downloading. System hours: Tues/Fri/Sun 7.00pm to 11.00 pm.

Forum-80 Milton. . . (TRS-80 Users Group 80-Net) Tel: 0908 566660. System Operators: Leon Heller and Brian Pain. Electronic mail, library, newsletter, TRS-80 information system hours: 7 days a week 7.00pm to 10.00 pm.

Forum-80 Holland. . . Operator: Nico Karssemeyer, tel 01 313 512 533. Facilities: electronic mail, program up/downloading, shopping list. Hours: Tues-Sat 1800-0700 nightly, continuous from 1800 Sat — 0700 Tues.

CBBS London. . . Operator: Peter Goldman, tel 01-399 2136. Facilities: electronic mail, program downloading. Hours: Wed 0700-0930 & 1900-2200, Fri 1900-2200, Sun 1600-2200.

Mailbox-80 Liverpool. . . 051-220 9733, System Operator: Peter Tootill, Electronic mail, downloading TRS-80 information.

ACC. . . members bulletin board, Peter Whittle (0908 44262)

ABC-80. . . Stockholm, Sweden) Tel: 010 468 190522.

University Research Computer. . . Sweden. Tel: 010-468 23660, guests use password "66,66" for access.

Elfa. . . Sweden 010 468 7300 706

Tree Tradet. . . Sweden 010-468 190522.

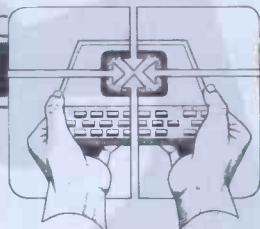

CTUK! CENTRES

Ray Skinner, 62 Central Avenue, Billingham, Cleveland TS23 1LN

David Tebbutt, 7 Collins Drive, Eastcote, Middx HA4 9EL

Vernon Gifford, 111 Selhurst Road, Croydon, London SE25 6LH

John Stephen Bone, 2 Claremont Place, Gateshead, Tyne & Wear NE8 1TL

Mike Baker, 5 Edinburgh Road, Hanwell, London W7 3JY

Vernon Quaintance, 50 Beatrice Avenue, Norbury, London SW16 4UN

R L Saunders, 14 St Nicholas Mount, Hemel Hempstead, Herts.

Roger Shears, 18 Woodmill Lane, Bitterne Park, Southampton SO2 4PY

Brian Taylor, Tonbridge Area Library, Aveybur Avenue, Tonbridge, Kent

Robin Bradbeer, Polytechnic of North London, Holloway Road, London N7

B J Candy, CTUK! Gloucester, 9 Oakwood Drive, Gloucester GL3 3JF

Ted Broadhead, 27 Cardinal Road, Leeds LS11 8EY

Andrew Holyer, 10 Masons Field, Mannings Heath, Horsham, Sussex RH13 6JP

Brigitte Gorton, 18 Purbright Crescent, New Addington, Croydon CR0 0RT.

Susan Kelly, Head of Reference Services, PO Box 4, Civic Centre, Harrow, Middlesex.

Ron Wright or Bill Phillips Mounview Youth Centre, Mounview School, Fisher Road, Harrow Weald, Middlesex

Philip Joy, 130 Rush Green Road, Romford, Essex.

Richard Powell, 22 Downham Court, South Shields, Tyne & Wear

Derrick Daines, 18 Cuttings Avenue, Sutton in Ashfield, Notts

Keith Taylor, Carter Hydraulic Works, Thornbury, Bradford BD3 8HG

Chris Woodford, CTUK! Burton, 31 Hopley Road, Anslow, Burton-on-Trent, Staffordshire

J.M.A. Kilburn, Headmaster, Shawfield Norden Community Middle School, Shawfield Lane, Norden, Rochdale OL12 7QR

Derek Knight or Bob Carter, Rayners Lane Library, Imperial Drive, Rayners Lane, Middlesex.

Bill Gibbings, 3 Longholme Road, Retford, Notts DN22 6TU

Alan Northcott, Rushmoor, 464 Reading Road, Winkers, Wokingham, Berks RG11 5ET

Alan Sutcliffe, 4 Binfield Road, Wokingham, Berks RG11 1SL

Tony Cartmell, 54 Foregate Street, Worcester WR1 1DX

Tom Graves, 19a West End, Street, Somerset BA16 0LQ

Alan S Waring, 50 Drayton Gardens, Winchmore Hill, London N21 2NS

Derek Moody, 2 Victoria Terrace, Dorchester, Dorset DT1 1LS

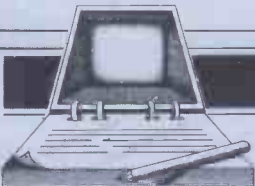

DIARY DATA

Readers are strongly advised to check details with exhibition organisers before making travel arrangements to avoid wasted journeys due to cancellations, printer's errors, etc.

Hong Kong	Int Computer Technology Exbn. Contact: Industrial & Trade Fairs Ltd, 021-705 6707	19-21 May
Wembley	(Conf Centre) Int Word Processing Exbn & Conf. Contact: Business Equipment Trade Assoc, 01-405 6233	25-28 May
London	(Earls' Court) Consumer Electronics Trade Exbn. Contact: Andry Montgomery Ltd, 01-486 1951	30 May - 2 June
London	(Cunard Hotel) 3rd International Commodore Computer Show. Contact: Print Promotions & Publicity Ltd, Slough (0753) 79292	3 - 5 June
London	(Barbican Centre) Nat Office Automation Show & Conf Contact: Clapp & Poliak Europe Ltd, 01-747 3131	15 - 17 June
London	(Royal Lancs Hotel) Nat Conf & Exbn on Computers in Personnel. Contact: Peter Mirrington Exbns Ltd, Brentwood (0277) 74290.	22 - 24 June

MICROMART



**QUME
EPSON
ANADIX
DYSAN**

All Business Applications
Full Personal Attention

Hugh S. O'Neill Computers
111 High Street, Selsey,
CHICHESTER, SUSSEX.
Tel. Selsey (024361) 5856

COMPLETE NESTAR SYSTEM

8" Controller with 1.26 KB Clusterbus system. Power supplies, cooling and system software. Clusterbus communication cards.

NEAREST OFFER TO RETAIL PRICE SECURES

Inventory Controller
Personal Computers Limited
Masters of Personal Computer Technology
194 200 Bishopsgate London EC2M 4NR Tel 01-626 8121

GAMER

SHARP MZ80K (48K) £347 + V.A.T.
SHARP MZ80B P.O.A.
ATARI 400 (16K) £285 + VAT
ATARI 800 (16K) £499 + VAT
TEXAS TI99/4 £250 + VAT
VIDEO GENIE I (16K) £289 + VAT
ATOM (assembled) £150 + VAT

+ software, books, chess computers
+ Intellivision + Ace TV games
+ SF, Fantasy & Wargames

BRIGHTON 24, GLOUCESTER RD
TEL 0273 698424

HULLFORTH

This new Forth compiler for NASCOM I/II is now also available for TRS-80 Level II and Video Genie

HULLFORTH is a structured high level language which runs over 10 times faster than BASIC.

- Runs in under 16K
- Supplied on cassette with full documentation
- Nascom users please quote NAS-SYS or NASBUG

Hullforth is a Nascom approved product.
Price - £25

Send SAE for further information to:

Mr A.F.T. Winfield,
148 Goddard Avenue, Hull, HU5 2BP

LEISURE LINES

by JJ Clessa

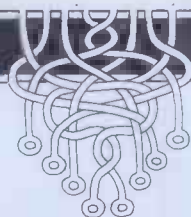

We must have got it about right this time. 128 entires came in, with 92 correct. For those who couldn't manage the problem (or didn't get it right) the largest number whose prime factors add up to exactly 100 is $2^2 \times 3^{22} = 7,412,080,755,407,364$. This month's winner is from Northern Ireland - Jim Henry of Belfast. Congratulations, Jim. By the time you read this you should have received your prize.

Quickie

No answers, no prizes. How is it possible to be on board an ocean liner halfway

between Newfoundland and Ireland, and yet to be only two miles from the nearest land?

Prize puzzle

Tadpoles cost 59p each. Terrapins cost £1.99 each, tortoises cost £2.87 and turtles £3.44. £100 exactly has to be spent on the purchase of 100 of these creatures. How many of each one can be bought?

Answers, on postcards only please, to: June Prize Puzzle, PCW, 14 Rathbone Place, London W1P 1DE, to arrive not later than June 30 1982.



PROGRAMS

PCW is interested in Basic or Pascal Programs for any popular micro - please tell us which one you wrote your program on and how much memory it uses.

Make sure your programs are fully debugged before you send them in on cassette (although we will accept disks) with a clear listing on plain paper. Documentation would be welcome, and if you want it returned please label everything with your name and address and include an SAE. Send contributions to Maggie Burton, PCW Programs, 14 Rathbone Place, London W1P 1DE

RML Altered Basic

by H Pyle

This program will search and alter the Basic command table in RML's 12k Basic interpreter. This is done by scanning the table (located between addresses 8702 and 9148) into an array, I\$(), for the commands and I () for their locations. The new command is entered, converted to upper case and checked against the contents of the array until a match is found.

If LIST is replaced by a string of numbers (eg 1234) the command is effectively disabled as the computer will interpret this as a line number. The program uses roughly 2k and the variables another 2k so with the 12k interpreter this program requires 16k to run.

The actual interpreter used is Extended Basic VSID from RML.

<pre> 1000 : 1010 REM INSTRUCTION FIND/CHANGE FOR 390-Z 1020 : 1030 REM HIGH PYLE , DEC. 1981 1040 : 1050 CLEAR 1000 1060 DIM I\$(113),I(113) 1070 I(1)=8702 1080 C=1 1090 TEXT : PUT 12 1100 ? "INSTRUCTION FINDER" 1110 : 1120 FOR J=8702 TO 9148 1130 : A=PEEK(J) 1140 : IF A>128 THEN 1580 1150 : IF A<32 THEN 1170 1160 : I\$(C)=I\$(C)+CHR\$(A) 1170 NEXT J 1180 : 1190 FOR J=1 TO 112 </pre>	<pre> 1200 : ? I\$(J)CHR\$(9) 1210 NEXT J 1220 : 1230 ? "WHICH INSTRUCTION " 1240 INPUT AS 1250 GOSUB 1660 1260 : 1270 FOR K=1 TO 112 1280 : IF I\$(K)=AS THEN 1330 1290 NEXT K 1300 ? "INSTRUCTION NOT FOUND." 1310 GOTO 1230 1320 : 1330 ? "OK, "AS 1340 ? "CHANGE TO " 1350 INPUT AS 1360 IF AS="" THEN 1340 1370 IF LEN(AS)=LEN(I\$(K)) THEN 1410 1380 ? "WRONG LENGTH. TRY AGAIN." 1390 GOTO 1230 1400 : </pre>
---	--



ACORN
Atom & BBC

Your local Fruit and Nut

NORTHERN COMPUTERS
Churchfield Rd, Frodsham,
Warrington WA6 6RD.

0928 35110

NASCOM 1/2

Good Programs @ Fair Prices

Extension Basic £15 (£25 in ROM)
Enhances ROM BASIC with 30 new keywords: FIND, GET, AUTO, EDIT, CALL, RENUMBER, REDUCE, IF..THEN..ELSE, REPEAT..UNTIL, WHILE..WEND, LINE, WRAP, COPY, XREF, TRACE etc. And you can add more yourself. Only 4K, an interpreter in its own right & a superb toolkit.

Asteroids: fast action in space. Must be seen! £8

Bomber: Flatten your least favorite city £5

Fantasy: mythic adventure in a weird mansion . £8

Missile Defence: fast action nuclear defence . £8

Nightmare Pork: go the whole hog and sty it! . £5

Games Collection: Breakout, Gunner, Minefield, Surround and Wumpus on a single cassette £6

FREE P&P. NO VAT. Money back if not happy. Full documentation. (Nascom 1s need Nas-Sys/Cottis B.)

Order or large SAE for ILLUSTRATED CATALOGUE to:

LEVEL 9 COMPUTING

229 Hughenden Road, High Wycombe, Bucks. HP15 5PG

PROGRAMS

```

1410 GOSUB 1660
1420 IF LEN(A$)-1 THEN 1540
1430 FOR L=1 TO LEN(A$)-1
1440 : POKE I(K)+L,ASC(MID$(A$,L,1))
1450 : PRINT CHR$(ASC(MID$(A$,L,1)))
1460 NEXT L
1470 ? RIGHTS(A$,1)
1480 POKE I(K)+L,ASC(RIGHT$(A$,1))+128
1490 ? "OK, CHANGED."
1500 AS=GET$(100)
1510 RUN
1520 :
1530 :
1540 POKE I(K)+1,ASC(A$)+128
1550 ? AS
1560 GOTO 1490
1570 :
1580 A=A+128
    
```

```

1590 IF A<32 THEN 1630
1600 IS(C)=IS(C)+CHR$(A)
1610 C=C+1
1620 I(C)=J
1630 GOTO 1170
1640 :
1650 :
1660 IF LEN(A$)=0 THEN RETURN
1670 FOR U=1 TO LEN(A$)
1680 : U1=ASC(MID$(A$,U,1))
1690 : IF U1>96 AND U1<123 THEN U1=U1-32
1700 : BS=BS+CHR$(U1)
1710 NEXT U
1720 AS=BS
1730 BS=""
1740 RETURN
1999 :
    OK,
    
```

VIC-20 Large Characters

by M Ahmed

Using this program should provide VIC users with some insight into how to make full use of VIC's graphics. It will display chosen characters in magnified form on the screen. Characters available are the alphabet, all ten digits, &, *, £, \$ and mathematical signs. Graphics characters themselves cannot be reproduced using this program.

Input is requested by a large flashing cursor, and characters are displayed simply by pressing the appropriate key. Deletion is done by backspacing.

For use on PET computers the following modifications are all that are needed; in line 106 change T=T-4 to T=T-5; in line 240 change T=T+4 to T=T+5; line 140 should be IF T>38 THEN PRINT "QQQ": T=Q (here 'Q' is in inverse video).

An inverse 'R' and '-' in this listing mean inverse on and off respectively. An inverse heart is the symbol for clear screen. 'Q' reversed is cursor down and a circle (inverse) is cursor up. Listing courtesy of Lasky's.

```

10 DIMB$(45,4),C$(45):L=45
20 FORI=1TOL:READC$(I):FORJ=1TO4:READB$(I,J):NEXTJ,I
30 U$="III"
90 PRINT"J";
100 GETG$:IFG$=""THENGOSUB300
105 IFG$=CHR$(13)THENT=0:GOTO90
106 IFG$=CHR$(20)THENF=1:GOSUB300:T=T-4:IFT<1THENT=0:GOTO115
110 GOSUB200:IFX=0THENG$="":GOTO100
115 GOSUB220
120 PRINTU$;TAB(T);
140 IFT>18THENPRINT"QQQ":T=0
150 GOTO100
200 X=1:FORJ=1TOL
210 IFC$(J)=G$THENC=J:RETURN
215 NEXTJ:X=0:RETURN
220 FORI=1TO4
230 PRINTTAB(T)B$(C,I):NEXT
240 IFQ=0THENT=T+4
290 Q=0:RETURN
300 IFF=1THEN350
310 G$="CR":F=1:Q=1:RETURN
350 G$="":F=0:Q=1:RETURN
500 END
1000 DATA"A"," ", " ", " ", " ", " ", " ", " ", " ", " "
1010 DATA"B"," ", " ", " ", " ", " ", " ", " ", " ", " "
1020 DATA"C"," ", " ", " ", " ", " ", " ", " ", " ", " "
1030 DATA"D"," ", " ", " ", " ", " ", " ", " ", " ", " "
1040 DATA"E"," ", " ", " ", " ", " ", " ", " ", " ", " "
1050 DATA"F"," ", " ", " ", " ", " ", " ", " ", " ", " "
1060 DATA"G"," ", " ", " ", " ", " ", " ", " ", " ", " "
1070 DATA"H"," ", " ", " ", " ", " ", " ", " ", " ", " "
    
```

MICROMART

Architects Surveyors Builders

2 Serious Programs for the ZX81 (16K)

Gives the U Value and enables Wet and Dry temperature drops to be plotted through composite wall and roof constructions.

Works for any construction and for both flat and pitched roofs. Demonstrates the risk of interstitial condensation and shows where it will happen.

Allows the speedy comparison of various types of construction and shows whether they comply with the Building Regulations (April '82 Revision).

Fully documented.

£20 all incl from:
John Green Partnership
Marbyl Cottage
Baker's Yard
Lee Road
LYNTON
North Devon

SOFTWARE

TRS-80 MODEL I LII AND GENIE

CLUSTER CONFLICT is a one player space strategy war-game. A large fleet of Alien Ships has invaded Human Space, can you survive long enough to defeat them and time itself? Very tough wargame needing thought and planning. At the higher levels each game can provide many hours of battle. Gamesave is included to allow return to family life. A snip at £211.80* needs 16K. SYSTORE is a m/Code package that will save you money by producing copies of your expensive software. Will copy m/Code and basic programs (with variables) and write any Ram block to tape. SYSTORE programs can be loaded in different memory locations to avoid clashing with resident programs. Check your system with the RAM DIAGNOSTIC provided. No knowledge of M/Code needed, full instructions supplied. An essential addition to your library at £12.90. 16k and 4k versions. GAMESAVER is a m/code program that loads below basic text for use with programs that need all 16k of memory, ie DUNJON QUEST series. Full instructions to allow GAMESAVER S to return as if they never left. Hellfire warriors can now return retaining Dunjon position, magical items, character, treasures etc, one continuous quest. Get the best from your complex games for only £4.95. All items are double recorded on high quality cassettes and are guaranteed. All prices include VAT & postage, please state computer system. Send cheque/PO to

J.K. Gosden (Software - W),
13, Ashted Common,
Ashted, Surrey KT21 2ED.

ACORN ATOM USERS

Get your programs into EPROM and throw away those slow cassettes! Our EPROM PROGRAMMER will get your BASIC and machine code programs into 2716, 2156 (2K), 2532, 2732, 2732A (4K), EPROMS under full software control. The board comes fully built and tested, complete with zero insertion force socket, EPROM containing control software, and full documentation (needs 28v supply). PRICE £45.00. POWER SUPPLY to provide 28V (sorry, only supplied with programmer). PRICE £9.50. Want somewhere to put your EPROMS? Try our 16K EPROM CARD (takes 4 x 2732 EPROMs (not supplied), comes assembled and ready to plug in). PRICE £19.50 or our 16K EPROM/RAM card, takes any mix of 2716 EPROMs and 6116 CMOS RAMs (not supplied). PRICE to be announced. All of these boards can be supplied to connect direct to your Atom socket or into our MINI MOTHER BOARD which has one two row and four single row connectors, and is compatible with Acorn built modules. PRICE £19.50. Available soon, A to D and RS232 interface cards. All prices are fully inclusive, terms are CWO. Send SAE for further details of specification and options available, to: DEIMOS 4 Gravelly Hill, Eckington Rd, Birmingham, Peshore WR10 3DB

New Books for the Apple II "The Power of Visicalc"

— a tutorial and reference manual for Apple's most powerful software tool. Essential reading for users and potential users. £7.95
"6502 Assembly Language for the Apple II" by Randy Hyde — The best assembly language tutorial for Apple users, written by the author of the LISA assembler. Also covers the SWEET-16 interpreter. £10.95
"Beneath Apple DOS" — the ultimate reference manual on the workings of DOS. Essential reading for every Apple owner. £11.20
"DOS-Source 3.3" — also by Randy Hyde. A complete, annotated and labelled disassembly of DOS 3.3, as a text file on a 3.5 diskette. You can customize DOS to your needs by modifying this source code, and re-assembling using LISA!! £29.95 inc VAT and post.
"What's where in the Apple" — an atlas for the Apple. Now you can find out what those PEEKs and POKES DO!! £10.95

Add 75p postage per book.
Protocol Computer Products 01-460 2580
Dept PCW,
Apartment 3,
114 Widmore Road,
Bromley, Kent BR1 3BE

ZX81 - PSE

*P.S.E. GAMES TAPE 1 (16k) — Tower of Brahma, Wipe-out, Missile Attack, Stopwatch, Space Adventure, and Depth Charge £3.75 (inc p&p)

*P.S.E. GERMAN LANGUAGE EDUCATION SYSTEM (16K). Children with 'O' or 'A' levels to take? Business abroad? Penfriends? Want to improve your current standard? System covers grammar, verbs, vocabulary, hints and aids for learning, including games to test progress and help drive lessons home. First tape (GERMAN GRAMMAR 1) available March '82 £5.50 (inc p&p)

Professionally-produced tapes and documentation by mail order only from: Precision Software Engineering, 20, Shelton Ave., Newark, Notts NG24 4NX. SAE for further details/up to date pricelist.

'Second Hand Stock Clearout'



264 Newmarket Road,
Cambridge, CB5 8JR.
Tel. 0223-314855

Texas 810 Printer £650
Two CT-64 visual display units £250
Two Southwest Technical Products 6088 inc 40K £550
Two SWTPC DMAF-1A 8" Dual Disc Drive £450
Plus VAT

MICROMART

DISKS! DISKS! DISKS!

LOWEST PRICES FOR THE BEST

BOXES OF 10 MINI DISKS (5.25")

MEMOREX

S/S - S/DENSITY S/SECTOR £15.70

D/S - D/DENSITY S/SECTOR 19.70

VERBATIM DATALIFE

Single or Double Density

S/S - S/SECTOR (40 TR CERT) 16.50

D/S - S/SECTOR (40 TR CERT) 24.00

S/S - S/SECTOR (77 TR CERT) 24.00

BASF

S/S - S/DENSITY S/SECTOR 15.00

S/S - D/DENSITY S/SECTOR 19.00

D/S - D/DENSITY S/SECTOR 25.00

DISKETTE DRIVE HEAD CLEANING KIT 16.30

— ADD £1/BOX P.P. & 15% VAT ON TOTAL

Pinner Wordpro

34 CANNONBURY AVENUE,
PINNER, MIDDX, HA5 1TS
Tel: 01-868 9548 ANYTIME.

TO ADVERTISE IN
MICROMART RING
01-631-1433

THE

BUFFER

MICRO SHOP

374A, STREATHAM HIGH RD,
LONDON SW16.

(NEXT TO STREATHAM STATION)

NEW RETAIL SHOP FOR

★ ZX81 ★

"ADD-ONS", GAMES, SOFTWARE
THE BEST OF THE MAIL ORDER
ITEMS ADVERTISED IN THIS
MAG. AVAILABLE OVER THE
COUNTER.

NOW OPEN

★ RING 01-769 2887 OR ★
CATALOGUE AND OPENING DATE

ZX81 16K

ZX-MC

ELIMINATE MACHINE CODE PROBLEMS with ZX-MC. (M/C debug/monitor)
ENTER, RUN & DEBUG machine code independently of Basic. With ZX-MC
loaded you have 128K of RAM to work with.

SAVE & LOAD your machine code programs AT DOUBLE SPEED. At last you
are freed from storing M/C in arrays or REM lines.

REGISTERS DISPLAY & BREAKPOINTS to make debugging easier. PLUS
many more useful commands.

A MUST FOR BEGINNERS & ADVANCED USERS — concentrate on your M/C
programs, not on how and where to stop them.

ZX-MC is supplied on a high quality cassette, with a 36 page operating manual.

£7.50 Incl. VAT & P+P
(CWD)

SCREEN KIT1

A suite of M/C routines for use in Basic programs, to enhance your screen display,
and create DATA FILES on cassette

DATA FILES — Save & Load, at double speed, just the Basic variables. Load
different variables into your program, or swap data between programs.

• DRAW A BORDER • KEYBOARD SCAN + FLASHING CURSOR

• CLEAR PART OF SCREEN • LOAD ANY CHARACTER TO WHOLE SCREEN

• INVERT VIDEO OR PART OF SCREEN • MEMORY LEFT

• CLEAR SCREEN BY SCROLLING UP, DOWN, LEFT OR RIGHT

Supplied on cassette with instructions. £5.70 Incl. VAT & P+P
(CWD)

PICTURESQUE

6 Corkscrew Hill, West Wickham,
Kent BR4 9BB

Programs available mail order only.
Please make cheques/PO payable to:
Send SAE for more details.
Allow up to 14 days delivery.

PROGRAMS

```

1080 DATA "I", " ", " ", " ", " ", " ", " ", " ", " ", " "
1090 DATA "J", " ", " ", " ", " ", " ", " ", " ", " ", " "
1100 DATA "K", " ", " ", " ", " ", " ", " ", " ", " ", " "
1110 DATA "L", " ", " ", " ", " ", " ", " ", " ", " ", " "
1120 DATA "M", " ", " ", " ", " ", " ", " ", " ", " ", " "
1130 DATA "N", " ", " ", " ", " ", " ", " ", " ", " ", " "
1140 DATA "O", " ", " ", " ", " ", " ", " ", " ", " ", " "
1150 DATA "P", " ", " ", " ", " ", " ", " ", " ", " ", " "
1160 DATA "Q", " ", " ", " ", " ", " ", " ", " ", " ", " "
1170 DATA "R", " ", " ", " ", " ", " ", " ", " ", " ", " "
1180 DATA "S", " ", " ", " ", " ", " ", " ", " ", " ", " "
1190 DATA "T", " ", " ", " ", " ", " ", " ", " ", " ", " "
1200 DATA "U", " ", " ", " ", " ", " ", " ", " ", " ", " "
1210 DATA "V", " ", " ", " ", " ", " ", " ", " ", " ", " "
1220 DATA "W", " ", " ", " ", " ", " ", " ", " ", " ", " "
1230 DATA "X", " ", " ", " ", " ", " ", " ", " ", " ", " "
1240 DATA "Y", " ", " ", " ", " ", " ", " ", " ", " ", " "
1250 DATA "Z", " ", " ", " ", " ", " ", " ", " ", " ", " "
1260 DATA "E", " ", " ", " ", " ", " ", " ", " ", " ", " "
1270 DATA "I", " ", " ", " ", " ", " ", " ", " ", " ", " "
1280 DATA "X", " ", " ", " ", " ", " ", " ", " ", " ", " "
1290 DATA "&", " ", " ", " ", " ", " ", " ", " ", " ", " "
1300 DATA " ", " ", " ", " ", " ", " ", " ", " ", " ", " "
1310 DATA "*", " ", " ", " ", " ", " ", " ", " ", " ", " "
1320 DATA " ", " ", " ", " ", " ", " ", " ", " ", " ", " "
1330 DATA " ", " ", " ", " ", " ", " ", " ", " ", " ", " "
1340 DATA "0", " ", " ", " ", " ", " ", " ", " ", " ", " "
1350 DATA "1", " ", " ", " ", " ", " ", " ", " ", " ", " "
1360 DATA "2", " ", " ", " ", " ", " ", " ", " ", " ", " "
1370 DATA "3", " ", " ", " ", " ", " ", " ", " ", " ", " "
1380 DATA "4", " ", " ", " ", " ", " ", " ", " ", " ", " "
1390 DATA "5", " ", " ", " ", " ", " ", " ", " ", " ", " "
1400 DATA "6", " ", " ", " ", " ", " ", " ", " ", " ", " "
1410 DATA "7", " ", " ", " ", " ", " ", " ", " ", " ", " "
1420 DATA "8", " ", " ", " ", " ", " ", " ", " ", " ", " "
1430 DATA "9", " ", " ", " ", " ", " ", " ", " ", " ", " "
1440 DATA "CR", " ", " ", " ", " ", " ", " ", " ", " ", " "
    
```

BBC Breakout

by R Trevelyan

After roundly proclaiming that I'll have nothing to do with 'old faithfuls' like Lunar Lander, Space Invaders, Life and Nim, I feel a bit of a hypocrite publishing this. But it is a genuine *bona fide* BBC Micro program and, as such, merits a public viewing.

It is the same as any other Breakout game as far as rules are concerned but the author pointed out some aspects of the program itself which show facilities not mentioned in the manual. Lines 100-190 are an assembler routine which

draws a new wall as soon as the old one is completely knocked out. Line 100 reserves space for this routine. In lines 380 and 430 "?" provides PEEK and POKE depending on the context. ?215 gives the code (non-ASCII) of the key being pressed and is used here because INKEY (0) does not repeat fast enough.

Instructions are given before you start which are programmed in mode 2. The main program uses 2K. Breakout was written on a model B.

```

60 VDU23:240,0,255,145,177,255,177,145,255
70 VDU23:241,0,255,137,141,255,141,137,255
80 MODE2:PROCTITLE
90 MODE7:SCREEN=HIMEM-58
100 DIMP%100
110 LOF%0
120 .WALL LDA #255
    
```

ZX80/81 KEY BLEEP UNIT

Keyboard entry problems solved with a "Key-Bleep audible sound module, fits to the expansion socket and provides an audible tone on each Keyboard entry. £9.95 or kit £8.85 inc p/p. Instructions provided. Optional connector £2.35

SS50-SS30 EXTENDER CARDS
Make it easy to work on those boards
SS50 £9.95, SS30 90° £8.75, SS30 straight
£7.75 all ready built with connector.

6800/6802 SYSTEM OWNERS
Super monitor program giving many extra commands, Hexadd, Ramcheck, Blockmove, Disassemble, plus many more. Supplied in 2x 2716. From FOOOH, RAM A000H but can locate as required, state when ordering. £13.80

MICROTRONIX 3 Buxton Avenue
Carlton, Nottingham N94 3RR

UK101 and SUPERBOARD SOFTWARE

UK101 48x16 or 48x32 display:
Tape 1: Startrek (8k), Robot Chase (4k), Maze (6k), Go Up (uK), Space Invaders (4k), Chessboard (4k), Graphics (4k), Fourier Series (8k), Best Fit Polynomial (4k), Hangman (8k), Docking a Space Ship (4k).

Tape 2: Adventure (8k), King (8k), Moon Landing (6k), Simultaneous Equations (4k), Gunlight (4k), Hexapawn (6k), Doughtif (4k), The Tower of Brahma (4k), Nim (4k), Life (8k), Myzump (4k).

Tape 3: Real Time Startrek (8k), Mastermind (4k), Tank Battle (4k), Surround (4k), Integration (8k), Asteroid Shoot (4k), Graphic aid (4k), Space War (4k), Biorhythm (4k), Breakout (4k), Graph Plotter (8k).

£6.00 each or all three for £16.00;
Superboard 48x32 display:
Tape 4: Robot Chase (4k), Golf (4k), Chessboard (4k), Graphics (4k), Fourier Series (8k), Adventure (8k), King (8k), Best fit Polynomial (4k), Hexapawn (6k), Tower of Brahma (4k), Nim (4k), Mugwump (4k), Graph Plotter (6k), Docking a Space Ship (4k).

Only £7.00
Machine Code for UK101 or Superboard:
Space Invaders, Asteroids, Pacman, Life, Assembler.
£3.00 each, all for £12.00
(ERPOM - washing 50p + Postage)
Mr M. Ward 9, St. Andrews Avenue,
Crewe, Cheshire, CW2 6JL.

PROGRAMS

```

130 LDY #220
140 .LOOP STA SCREEN,Y
150 STA SCREEN+80,Y
160 STA SCREEN+160,Y
170 INY
180 BNE LOOP
190 RTS:J
200 PRINT' " *****"
210 FORA=1T022
220 PRINT' #
230 NEXT
240 VDU30
250 FORB=1T08:FORA=129T0133STEP2:PRINTCHR%A: NEXT: NEXT
260 CALL WALL
270 LVE=5: SCORE=0
280 YPAD=24
290 X=RND(36)+1
300 Y=8
310 PAD=18
320 PRINTTAB(PAD,YPAD)"-----";
330 T=TIME: REPEAT: UNTILTIME>T+99
340 XINC=RND(3)-2: IFXINC=0GOTO340
350 YINC=1
360 PRINTTAB(X,Y)"o";
370 FORA=1T02
380 M=7215
390 IFM=159 PROCLEFT ELSEIFM=249 PROCRIGHT ELSE PROCDELAY
400 NEXT
410 NX=X+XINC: NY=Y+YINC
420 IFY=24PROCLIFE: GOTO290
430 BALL=?<(HIMEM+NX+40)*NY)
440 IFBALL=32PROCSFACE: GOTO360
450 IFBALL=95PROCSIDE: GOTO410
460 IFBALL=96PROCBAT: GOTO410
470 IFBALL=255PROCHIT: GOTO360
480 DEFPROCSFACE
490 PRINTTAB(X,Y)" " : X=NX: Y=NY
500 ENDPROC
510 DEFPROCLEFT
520 IFPAD=1=0PROCDELAY: ENDPROC
530 PRINTTAB(PAD,YPAD)" " ;
540 PAD=PAD-1: PRINTTAB(PAD,YPAD)"-----";
550 ENDPROC
560 DEFPROCRIGHT
570 IFPAD+1=35PROCDELAY: ENDPROC
580 PRINTTAB(PAD,YPAD)" " ;
590 PAD=PAD+1: PRINTTAB(PAD,YPAD)"-----";
600 ENDPROC
610 DEFPROCHIT
620 PROCSFACE: YINC=-YINC
630 SCORE=SCORE+1: IFSCORE/100<>INT(SCORE/100)ENDPROC
640 PRINTTAB(PAD,YPAD)" " ; YPAD=YPAD-1
650 PRINTTAB(PAD,YPAD)"-----"; CALL WALL: VDU7
660 ENDPROC
670 DEFPROCBAT
680 IFRND(2)=1: IFX<36PRINTTAB(X,Y)" " : X=X+1: PRINTTAB(X,Y)"o"
690 YINC=-YINC
700 ENDPROC
710 DEFPROCSIDE
720 IFNY=1YINC=-YINC: ENDPROC
730 XINC=-XINC
740 ENDPROC
750 DEFPROCLIFE
760 VDU7
770 LVE=LVE-1: IFLVE=0PROCFIN: RUN
780 PRINTTAB(PAD,YPAD)" " ;
790 PRINTTAB(X,Y)" " ;
800 ENDPROC
810 DEFPROCFIN
820 T=TIME: REPEAT: UNTILTIME>T+99: CLS: *FX 15,0
830 PRINT' "End of game"
840 PRINT' "You scored ",SCORE;" points"
850 PRINT' "Another game (Y/N)?" : Z#=GET#
860 IFZ#= "N"END
870 ENDPROC

```

ZX81 **DATABANK** 16K
Serious Programs

- * 3 Programs on one tape
- * Create your own format
- * Vocabulary Keyword feature
- * Add, Sort, Search, Delete your own Databank
- * Change Data by Cursor select

Many serious uses: Job/Work programming
Multiple Indexing, Disco/Music Library

With full documentation - £5 incl. p&p

PO or Cheques to: D Sanderson
1 Manor Court, Breaston, DERBY DE7 3AW

RING ME LAST Ring ROGER MAY

on 0342 832244

before you make the final decision
ring me and check the price. You'll
find I am the cheapest for your

Apple, Commodore
& various printers.

For printers now at trade price

Computertrade

MICROMART

NASCOM SOFTWARE

We offer the following quality software for NASCOM systems:

NASPAS - a 12K PASCAL compiler which produces Z80 code directly, i.e. no P-code. The compiler offers floating point and integer arithmetic, arrays, sets, strings and all major Pascal statements together with fully recursive functions and procedures with value and variable parameters. The object program runs very quickly.
Price: £35.00.

NASMON - A new monitor for NASCOMs. Occupies 4K and includes a sophisticated screen editor, a 'front panel' mode, blocked and buffered tape routines and powerful debugging commands. Price £30.00 in EPROM

BAS112K - a 12K BASIC interpreter offering 11 digit precision arithmetic, PRINT USING, IF... THEN... ELSE and other advanced features. Price: £26.00

NASGEN - a fast 3K assembler generating a full symbol table and with many assembler directives and commands. Price: £15.00 on tape, £25.00 in EPROM.

NASDEM - a 25K disassembler which interfaces to NASCOM's front panel to produce single step disassembly. Optionally it produces labels and o/p may be directed to a text buffer suitable for NASGEN. Price: £10.00 on tape, £15.00 in EPROM.

All the above software runs under NASMON except NASPAS which can run under NASMON or NAS-SYS. All prices are fully inclusive.

FREE: a free CHESS program with every order of NASMON.

GEMINI DISK OWNERS: HISOFT offer a Z80 development package to run under CP/M 1.4 on the Gemini Floppy Disk System. Included in the package are:

- a powerful screen editor.
- a fast Z80 assembler with conditional assembly.
- a debugger based on the Front Panel on NASMON together with a labelling Z80 disassembler. All this for the inclusive price of: £50! Send for details NOW.

Full details may be obtained from:

**HISOFT 60 HALLAM MOOR
LIDEN, SWINDON, WILTSHIRE**

PET and VIC Southampton

HIRE Commodore equipment by the week, all including manuals, cassette deck, media etc.
16K £20, 32K £25, Disk or Printer £25 VIC 20 £9
Ex hire equipment with guarantee usually available; 32K from £425. Part exchange your old 8K PET.

**NOW LOWEST EVER PRICES
FOR NEW PRODUCTS**

4016N	12" screen	£455.00
4032N	12" screen	£555.00
8032N	80 columns	£795.00
4040	Dual Disk	£625.00
2031	Single Disk	£355.00
4022	Printer	£355.00
C2N	Cassette Deck	£ 44.95 (inc VAT)
VIC20	Colour Computer	£189.95 (inc VAT)

Large range of software, books etc stocked

TOOLKIT BASIC 4 £30.00
6550 RAMs £12.00

All prices are cash-and-carry and exclude VAT

OFFICIAL COMMODORE DEALER

SUPER-VISION

13 St James Road, Shirley, Southampton
Telephone (0703) 774023
After hours (0703) 554488

SHARP MZ80K HARDWARE

ADC 8 BIT, 16 CHANNEL X11 £85.00
ADD JOYSTICKS, MONITOR TEMPERATURES ETC.

EPROM PROGRAMMER 2716/2732/2764 X10
READ, COPY, VERIFY £89.00

I/O 8 RELAY O/P 8A 240V X08 £98.00

+ 12 OPTO I/P 2-50V AC/DC

BI-DIRECTIONAL SERIAL I/O X05 £99.00

RS232 OR TTL WITH "DUMB TERMINAL" S/WARE

EXTENDER BOARD X02 £19.00

CONVERTS TO 0.1 INCH FOR YOUR BREAD-BOARDS

AVAILABLE SOON:-

MEMORY STORAGE BOARD 32K X04 E.P.O.A.

KEEP PROGRAMS IN EPROM, SAVE LOADING FROM TAPE

ALL BOARD ARE SUPPLIED FULLY ASSEMBLED, TESTED & WITH SOFTWARE.

X SERIES BOARDS PLUG DIRECTLY INTO MZ80 I/O UNIT.

Y SERIES BOARDS AVAILABLE SOON TO PLUG DIRECT ONTO MX80K 50 WAY CONNECTER.

POST & PACKING FREE.

PLEASE ADD 15% VAT, S.A.E. FOR DETAILS.

£45.35 - FOR FURTHER DETAILS WRITE

PETERSON ELECTRONICS LTD.,

ACADEMY STREET, FORFAR,

ANGUS DD8 2HA. PHONE: 0307 62591

MICROMART

ZX81 MEMORIES with a DIFFERENCE

ANNOUNCING THE END OF THE FLOPPY RAM PACK! - Now, for the first time, all you need to fit up to a full 56K of low power memory INSIDE your ZX81 is a normal with more expensive personal computer, is a screwdriver. Experience has shown that the two commonest causes of ZX81 memory add on failure are:

1. Lack of rigidity in the connection to the expansion port.
2. Inadequate regulated power supply.

Both these problems have been overcome with our low power, internally fitting INCREMENTAL and MAXIMEM memories.

INCREMENTAL 1.2 The truly expandable memory system that starts you off at a price you can afford but places no restrictions on your future expansion.

EASY TO FIT - The uniquely designed board plugs straight in to the existing microprocessor (CPU) socket on ZX81 board (See page 162 of ZX81 manual) so, following the instructions provided, you simply open up the ZX81 case, unplug the CPU and plug it into the memory board, then plug the memory board into the vacant CPU socket. Four additional bolts fit through existing holes in ZX81 board to give high rigidity/reliability. Simple to follow instructions makes child's play of fitting (and removing).

TRULY EXPANDABLE - Expandable up to 16K bytes in increments of 2K simply by plugging in memory chips - but does not stop there! Plug and socket switches allow running in conjunction with external memory add-ons - e.g. with Sinclair 16K RAM pack to give up to 32K and with 32K and 48K packs to give up to 48K and 56K (max. poss.) respectively. Full instructions provided.

ULTRA LOW POWER - A full 16K takes typically less power than existing 1K Sinclair RAM (about 40mA).

ECONOMICAL - Incremental 1.2 with one 2K chip giving 3K of RAM costs only £18.43 (plus VAT) and you won't have to throw it away when you want more memory.

MONEY BACK GUARANTEE - Return within 14 days of receipt secures full refund of price of goods.

Introducing the new - **MAXIMEM 1.1** The ZX81 microprocessor can address a maximum of 64K of memory directly. More than this would require frequent additional statements in programs to switch between different memory banks. 8K of this 64K is already taken up by the Sinclair ROM (containing the Operating system program and Basic interpreter) thus leaving a maximum RAM capacity of 56K (=64K-8K). The MAXIMEM 1.1 attains this upper limit in one bound by utilising the latest in high density, ultra low power memory. Board design is similar and fitting identical to the Incremental memory described above.

Orders and enquiries to: East London Robotics, Finlandia House, 14 Danwell Close, East Ham, London E64BT. Or call us on 01-471 3308.

ORDER FORM

Quantity	Item	Price per Item	Total
	Incremental 1.2 socketed for max of 8K	£10.50	
	Incremental 1.2 socketed for max of 16K	£11.50	
	2K CMOS 6116 memory chips	£4.93	
	Maximem 1.1 56K memory	£33.50	
		15% VAT	
		TOTAL	

NOTE: Postage 50p for orders under £15

I enclose a cheque/postal order payable to East London Robotics for £

Name: _____

Address: _____

PROGRAMS

- 880 DEFPROCTITLE
- 890 COLOUR131:CLS
- 900 COLOUR12
- 910 PRINTTAB(2,14)"BREAKOUT"
- 920 COLOUR1
- 930 PRINT""Instructions? (Y/N)"Z#=GET#
- 940 IFZ#<>"N"PROCINST
- 950 ENDPROC
- 960 DEFPROCINST
- 970 COLOUR126:CLS
- 980 COLOUR?
- 990 PRINT""You must knock""bricks from the wall"
- 1000 PRINT"by hitting the ball""back with your bat."
- 1010 PRINT"CHR#240;" Moves it left""CHR#241;" Moves it right."
- 1020 PRINT""You have 5 lives."
- 1030 COLOUR15
- 1040 PRINT""Hit any key to Play" A=GET
- 1050 ENDPROC
- 1060 DEFPROCDELAY
- 1070 FORA=1TO60:NEXT:ENDPROC

VIC-20 Trailblazer

by Bob Chappell

This is a colourful, fast-moving game in which you and the computer both draw different-coloured trails about the screen for as long as possible without colliding with part of either trail or going back on your own trail. The game is played in rounds, the first (either VIC or user) to win 10 rounds being the overall winner.

Trailblazer is a game which needs fast thinking and quick reactions. The computer makes a worthy adversary even at the slowest trail speed (the program includes speed options). Full playing instructions are presented at the beginning of the game.

Listing courtesy of Lasky's.

- 2 GOTO300
- 10 PRINT"TRAILBLAZER"
- 20 H=7948:V=7958:OOSUB80:OOSUB90
- 25 A=FNR(4):OOSUB99:H=H+M:LH=A
- 27 A=FNR(4):OOSUB99:V=V+M:OOSUB80:OOSUB90:LV=A
- 30 FORJ=1TO4:A(J)=0:NEXT:OETA\$:IFA#=""THENA=LH:GOTO32
- 31 A=ASC(A#)-132:IFR(10R)4THENA=LH
- 32 OOSUB99:IFH+MCL1GOTO35
- 33 H=H-L3:IFPEEK(H+M)=4600TO45
- 34 GOTO200
- 35 IFH+M>L2GOTO40
- 38 H=H+L3:IFPEEK(H+M)=4600TO45
- 39 GOTO200
- 40 IFPEEK(H+M)<4600TO200
- 45 LH=A:H=H+M:OOSUB80
- 46 A=LV:IFA=2ORA=3THENFV=A
- 47 J=FNR(24):IFJ>4GOTO51
- 48 A=J:IFFV=2ANDR=3THENA=FV:GOTO51
- 50 IFFV=3ANDR=2THENA=FV
- 51 OOSUB99:IFV+MCL1GOTO54
- 52 IFPEEK(V-L3+M)=46THENV=V-L3:GOTO62
- 53 GOTO61
- 54 IFV+M>L2GOTO57
- 55 IFPEEK(V+L3+M)=46THENV=V+L3:GOTO62
- 56 GOTO61
- 57 J=V+M:IFJ>L2ANDJ<L1ANDPEEK(J)<46GOTO63
- 61 IFPEEK(V+M)<46GOTO63
- 62 LV=A:V=V+M:OOSUB90:GOTO30
- 63 FORJ=1TO4
- 64 A=FNR(4):IFR(A)=1GOTO64
- 65 A(R)=1:OOSUB99:IFPEEK(V+M)=46GOTO62
- 70 NEXT:GOTO205
- 80 POKEH,160:POKEH+P,6
- 85 IFY3=1THENFORJ=1TO2:K=FNR(L3)+L2:POKEK,46:POKEK+P,2:NEXT
- 87 GOTO95
- 90 POKEV,102:POKEV+P,5
- 95 POKEN,NN:FORJ=1TOV/10:NEXT:POKEN,0:FORJ=1TOV:NEXT:IFV=1THENV=V-5
- 97 RETURN

SILVERSOFT

- 16K ZX81 SOFTWARE
- "STARTREK"
- "SUPER-WUMPUS"
- "GOLF"
- "HOME-ACCOUNTS"
- "GAMES PACK 1"
- "3DMYSTERY MAZE"

COMING SOON ARCADE GAMES
Prices £4.95 first cassette any two
£8.95 inclusive
Send S.A.E. for details.

TO SILVERSOFT (DEPT PCW)
35 BADER PARK, BOWERHILL,
MELKSHAM, WILTS.

ATOM SPECIALISTS

ACORN
ATOM

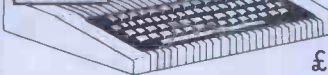

From
£119.00.

Atom Kit 8K 2K	£119
Atom Assy. 8K 2K	£149
Atom Assy. 8K 12K	£172
Atom Assy. 12K 12K	£191
Atom Assy. 12K 12K with Printer Interface	£199
1K RAM Sets	£1.90p
Atom Power Supply	£8.00p
Atom Econet Interface	£70
Atom Eprom Programmer	£40
Programmer's Toolbox	£24.50p

VIC Memory Expansion	£105
VIC 3K RAM Expansion	£25
VIC 8K RAM Expansion	£37
VIC 16K RAM Expansion	£60
VIC Joysticks	£6.50p
VIC Paddles	£11.70p

Printers

Seikosha GP 80	£195
Epson MX 80	£350
Epson MX 80 FT1	£355
Epson MX 80 FT2	£370

- * Authorised Acorn Dealer
- * Acorn - Bug Byte - VIC Software
- * Selection of Atom and VIC Books
- * Spares and Repairs Service
- * Send for Price Lists

VIC-20

VIC 20 C.P.U.	£160
VIC Cassette	£36
VIC Printer	£200
VIC Floppy	£325

Please Add 15% V.A.T. to total cost - Postage Free on orders over £20, otherwise add 50p.

D.A. Computers Ltd.,
184, London Road, LEICESTER LE2 1ND. Telephone (0533) 549407

ZX81 16K PROGRAMS GCE/CSE CHEMISTRY

Four revision-tutorial programs on one cassette for £4.95

Elements, compounds and mixtures.
Structure, bonding and properties. Redox, electrolysis and the ECS. Acids, bases and salts.

CALPAC COMPUTER SOFTWARE

J.J. Warren, Hermitage Woods Crescent,
St Johns, WOKING, Surrey, GU21 1UF.

ABSOLUTE BACK-UP

Copies & verifies disks 5 tracks at a time. Takes 57 sec to copy a side. Faster than PIP for multi-file backup with less head changing.

£23 or SAE for details

FJS Software, 4 Oakfield Rd.
Bristol BS8 2AL (0272-739662)

PROGRAMS

```

99 ONAGOTO101,102,103,104
101 M=U:RETURN
102 M=L:RETURN
103 M=R:RETURN
104 M=D:RETURN
200 PRINT"MM":A=H+M:K1=160:K2=6:GOSUB200:PRINT"DDDDYOU M":VS=VS+1:GOTO210
205 PRINT"MM":A=V+M:K1=102:K2=5:GOSUB200:PRINT"DDDDVIC M":HS=HS+1
210 PRINT"CRASHED!":PRINT"DDDDVIC":VS:"DDYOU":HS
215 IFVS=10THENPRINT"DDDDVIC WINS!T":GOTO500
220 IFHS=10THENPRINT"DDDDYOU WIN!T":GOTO500
230 PRINT"DDDPRESS F,S,M D OR R
260 POKE198,0:PRINT" ":GOTO430
280 IFA>L1-1THENA=A-22
282 IFA<L2+1THENA=A+22
285 FORJ=1TO30:POKEA,42:POKEA+P,1:POKEN+2,J+190:FORK=1TO30:NEXT
287 POKEA,K1:POKEA+P,K2:POKEN+2,0
290 FORK=1TO30:NEXTK,J:RETURN
300 N=36874:POKEN+S,29:POKEN+4,15
301 DEFFNA(A)=INT(A/RND(1)+1):L=-1:R=1:U=-22:D=22:P=30720:A=RND(TI)
305 L1=8186:L2=7679:L3=506
310 PRINT"DDDDTRAILBLAZER
320 PRINT"DD YOU ARE DD":PRINT"DD VIC IS DD"
330 PRINT"DD YOU MUST NOT CROSS":PRINT"YOUR OWN OR VIC'S":PRINT"TRAIL.
340 PRINT"DD TO CHANGE DIRECTION,":PRINT" HIT DD F1 DD DD":PRINT" F3C >F5
350 PRINT"DD VDDF":PRINT"DD FIRST ONE TO WIN 10 ROUNDS IS THE WINNER.
360 PRINT"DD PRESS ANY KEY NOWDD
370 GETA$:IFA$=" "THEN370
380 PRINT"DD TO START A NEW":PRINT" ROUND PRESS:-
400 PRINT"DD F FOR FAST SPEED
410 PRINT"DD M FOR MEDIUM SPEED
420 PRINT"DD S FOR SLOW SPEED
425 PRINT"DD R FOR RISING SPEED
426 PRINT"DD O FOR FAST + OAPS
427 PRINT"DD PLEASE PRESS ONE OF":PRINT" DD THESE KEYS NOW.
430 NN=150:V=0:Y=0:Y3=0:T1=TI
440 IFTI-T1>999GOTO10
450 GETA$:IFA$=" "GOTO440
460 IFA$="M"THENV=100:NN=170
470 IFA$="S"THENV=300:NN=190
480 IFA$="R"THENV1=1:V=300
485 IFA$="O"THENV3=1
490 GOTO10
500 FORJ=1TO40:CP=PEEK(N+5):CR=CPAND8:POKE36876,(CR=0)*30+160
502 IFCR=0THENCP=CP+0:GOTO506
504 CP=CP-8
506 POKE+N+5,CP:FORK=1TO50:NEXTK POKE36876,0:NEXTJ:FORJ=1TO4000:NEXT
510 POKE198,0:POKEN+S 27:PRINT"DDDDDD PLAY AGAIN (Y OR N)
520 GETA$:IFA$=" "THEN520
530 IFLEFT$(A$,1)="Y"THENRUN
540 END LIST
    
```

The (MZ-80K) Next to Last One

by Simon Pack

This is a fascinating piece of programming which will generate subroutines for adding pretty titles to other programs. It is not so much for its actual use as for its interest value that I have chosen it. The NTLO will actually generate listable code from instructions

input via the keyboard (namely title characters and shade). Using the program is self-explanatory.

A final point worth mentioning is the author was a mere 13 years of age when the program was written.

```

99 REM *****
100 REM+DO NOT CARRIAGE RETURN PAST **
101 REM+DISPLAYED PROGRAMME IF PARENT*
102 REM+PROGRAMME HAS NOT BEEN SAVED *
103 REM+AND LINE 106 HAS BEEN DELETED*
104 REM+*****
105 Z$="NEW":GOSUB2000
106 Z$="REM":REM - THIS LINE SHOULD BE DELETED BEFORE SAVING PARENT PROGRAMME
107 PRINT"BTHE NEXT TO LAST ONE":PRINT" "
108 PRINT"BT This parent programme will create"
109 PRINT"other sub-routines each of which will"
110 PRINT"display a single row of large letters"
111 PRINT"suitable for adding titles to other"
    
```

WANT TO LEARN PROGRAMMING?

**TRIAL COURSE
4 HOURS for £10**

For this or other assistance on microcomputers ring Jack or Iris on 928 8989 ext. 2468 or write to: Microcomputer Advisor Centre, Polytechnic of the Southbank, Borough Rd., London SE1 0AA.

User Port EPROM

PROGRAMMER ^{£49} inc. s/w p&p £1.50

- Single I/O Port Connection
- Professional Standard High Speed Machine Code
- Read, Write, Verify, Check & Dump all popular 2K & 4K 5v EPROMs.
- Software controlled with protection.
- 2K software for CBM 3000 & 4000
- Also available for other machines.
- Trade and Industrial enquiries welcome.
- Leaflet on request form:



640 Melton Rd.
Thurmaston, Leicester LE48BB Tel.
Leicester 704492

MICROMART

ZX 81

CASSETTE ONE (£3.80)

11 programs for 1k ZX81, 7 of them in machine code.

CASSETTE TWO (£5)

10 games in Basic for 16k ZX81

CASSETTE THREE (£5)

8 programs for 16k ZX81:

STARSHIP 'TROJAN'

Fix your starship, despite hazards including radiation, asphyxiation, and escaped biological specimens.

STARTREK

PRINCESS OF KRAAL

An adventure type game.

BATTLE (1 to 4 players)

KALABRIASZ (strange card game)

CUBE (Rubic cube simulator)

SECRET MESSAGES

Send your messages in code.

MARTIAN CRICKET

Addictive and VERY fast machine code game.

Recorded on quality cassettes, sent by first class post, from:

Michael Orwin, 26 Brownlow Rd., Willesden, London NW10 9QL

Some of this software is also available from: K.J. Software, 8 Cawrse Street, Elizabeth Field, South Australia 5113; and Electronic and Commercial Services, Ermou & 8 Fokionos, Athens, Greece

TO ADVERTISE IN MICROMART RING

631-1433

A.I.M RESEARCH

Good software needn't cost the earth.

XFORTH

Highly praised version of Forth-79 with many enhancements.

AMETHYST

Professional word processing software by Mark of the Unicorn. Available now or soon for many Systems including CP/M, CP/M 86 and Unix.

THE WORD

The best spelling checker yet the cheapest.

We will try to beat any advertised prices. Dealer enquiries welcome.

No.20 Montague Road, Cambridge CB4 1BX
Tel: 0223 353985

PET BUSINESS SOFTWARE

ANALYSED CASHBOOK £95
Cash, Bank, Vat, Net entered, computed and analysed for posting to nominal & personal ledgers. An essential business tool. (3 programs).

WORDMAIL £45

An inexpensive word processor including mailing list generator. For reports or letters: justification feature. (2 programs).

DATASTAX £30

Keyboard/video/tape/disk/printer: data transfer in any logical direction. Store and recover any data you want.

Add 15% VAT. State machine, printer, disk unit.



PO Box 12
Bentham
Lancaster

Tel: Bentham (0468) 61848

NASCOM/GEMINI-MULTIBOARD

GRAPHICS SOFTWARE FROM CCSOFT

NAS GRAPH PAC adds graphics commands to your NASCOM ROM BASIC, fast, powerful and easy to use. Requires graphics ROM. Supplied on tape in N2 format. £20
 GEM-GRAPH PAC For CP/M systems fitted with the Gemini G812 video card. This runs with Microsoft's Mbasic adding over twenty graphics commands. Supplied on disc. £35

GEMINI ECONOMY BASIC for cassette or disc systems running under RP/M or CP/M fitted with the Gemini G812 IVC. This low cost CP/M compatible floating point BASIC also includes commands found in GEM-GRAPH PAC. £25 on cassette in Gemini format or £28 on disc.

Stocked by your local Microvalue dealer
 DATA SHEETS AVAILABLE

PENUP	PSET X,Y	PLOT A,D
PENDOWN	PRESET X,Y	DOWN X,Y
		"string"
PENFLIP	PTEST X,Y	CIRCLE R,
		A1,A2
PENERA	DRAW X,Y	FCON
STARTAT X,Y	DRAWTO X,Y	FCOFF

Mail order from P&P £1 per order



83, LONGFIELD STREET,
 LONDON SW18 5RD

PROGRAM POWER

PROGRAMMER'S TOOLBOX
 (packed 4K EPROM)

1200 BAUD Cassette Operating System.
 Visible Load & Save Routine.

*TRACE	READ	WHILE
*STEP	DATA	ENDWHILE
FIND	RESTORE	ON ERROR
ELSE	AUTO X,Y	BEEP X,Y
KEY	VAR	POP
INKEY	LVAR	VECTOR
HEX	L TRACE	STOP
IHEX	DELETE	ZERO
CURSOR X,Y	RENUMBER X,Y	

(*VIA chip required)

Suitable for any memory size.

only... £24.50 (+VAT @15% & 25p
 from P&P)

PROGRAM POWER
 5, WENSLEY ROAD, LEEDS LS7 2LX
 TEL: (0532) 683186

PROGRAM POWER

As seen on BBC TV "Computer Programme"
BIG EARS

SPEECH
 INPUT
 FOR ANY
 COMPUTER



Hugely successful Speech Recognition System,
 complete with microphone, software and full instructions. **£49**
 BUILT TESTED & GUARANTEED ONLY
 PLEASE STATE COMPUTER: UK101, SUPERBOARD, NASCOM2,
 Vic 20, Micron, ZX80/81, PET, TRS80, MZ80K, APPLE II, BBC MICRO

ZX80 ZX81
 MUSIC SYNTHESIZER
 + 16 LINE CONTROL PORT

Play 3-part music, sound effects,
 drums etc. Full control of attack, decay
 and frequency. Input/Output lines provide
 control and monitor facility for Home Security, Robot Control,
 Model Railway, etc. etc. Works with or without 16K RAM
 Add keyboard to make a live performance polyphonic synthesiser!
 Full instructions/software included.
 AMAZING VALUE AT ONLY **£19.50 (KIT)**
 Extra 23 way connectors at £2.50
 The "Composer" Music Program (16K) £7.40 **£25.50 (BUILT)**

COLOUR MODULATOR **KIT £12**
 RGB In, PAL/ULF out (not for ZX) **BUILT £18**
 UK101/NASCOM COLOUR GRAPHICS **KIT £45**
 Inc. Modulator. Still the best selling system! **BUILT £60**

Please add VAT at 15% to all prices. All enquiries
 Barclay/Access orders accepted by telephone S.A.E. please

WILLIAM STUART SYSTEMS Ltd
 Lower House, Billericay Road,
 Herongate, Brentwood, Essex CM13 3SD
 Telephone: Brentwood (0277) 810244

PROGRAMS

```

112 PRINT"programmes."
113 PRINT"The title may be about nine characters"
114 PRINT"ions and in addition to letters and"
115 PRINT"numbers, the following symbols may also"
116 PRINT"be used :-"
117 PRINTTAB(14);"! & ( ) . ? "
118 PRINT"JUST A MOMENT";
119 DIMA$(50,5):FORB=1TO5:PRINT": ";
120 READA$(1,B),A$(7,B),A$(14,B),A$(31,B)
125 FORA=16TO25
132 READA$(A,B)
135 NEXTA
137 FORA=33TO58
142 READA$(A,B)
145 NEXTA,B:FORE=1TO5:READA$(6,B),A$(8,B),A$(9,B),A$(10,B):NEXTB:PRINT
150 PRINT"WHAT STARTING LINE No. IS REQUIRED ?"
152 INPUT"Q":A:IFAK1THEN158
160 PRINT"WHAT INTERVAL BETWEEN LINE Nos. ?":INPUT"Q":B:PRINT"Q"
170 R=0:PRINT"TYPE IN THE TITLE OF YOUR CHOICE":INPUT"Q":H$
175 FORD=1TOLEN(H$):B$=MID$(H$,D,1)
177 IF(B$="I")+ (B$="L")+ (B$=" ") + (B$=".") + (B$=",")+ (B$=";")+ (B$=":") THENR=R+5:GOTO189
180 IFB$="W" THENR=R+6:GOTO189
182 IF(B$="1")+ (B$="2")+ (B$="3")+ (B$="4")+ (B$="5")+ (B$="6")+ (B$="7")+ (B$="8")+ (B$="9")+ (B$="0")+ (B$="A")+ (B$="B")+ (B$="C")+ (B$="D")+ (B$="E")+ (B$="F")+ (B$="G")+ (B$="H")+ (B$="I")+ (B$="J")+ (B$="K")+ (B$="L")+ (B$="M")+ (B$="N")+ (B$="O")+ (B$="P")+ (B$="Q")+ (B$="R")+ (B$="S")+ (B$="T")+ (B$="U")+ (B$="V")+ (B$="W")+ (B$="X")+ (B$="Y")+ (B$="Z")+ (B$=" ") + (B$=",")+ (B$=";")+ (B$=":") THENR=R+3:GOTO189
184 IF(B$="I")+ (B$="L")+ (B$=" ") + (B$=".") + (B$=",")+ (B$=";")+ (B$=":") THENR=R+2:GOTO189
185 IFASC(B$)>90THEN190
186 IFLEN(A$(ASC(B$)-32,1))=0THEN190
188 R=R+4
189 A$=A$+B$
190 NEXTD:IFR>40THENPRINT"TOO LONG ENTER AGAIN.":GOTO170
191 J=INT(27-(R/2)):S=J-7:PRINT"WHAT SHADE OF LETTERING 1 = * , 2 = # "
192 GETG:IF(G<1)+(G>2)THEN192
194 K=0:PRINT"DO YOU WISH THE TITLE TO BE UNDERLINED"
195 GETX$:IFX$="Y"THEN195
197 IFX$="Y"THENPRINT"WHAT TYPE THE SYMBOL YOU WISH FOR UNDERLINING"
198 IFX$="Y"THENINPUT"Q":Y$:Y$=1
200 PRINT"Q"
202 Q=53373:POKEQ,73:POKEQ+1,98
205 POKEQ+2,198:POKEQ+3,193:POKEQ+4,193:POKEQ+5,193
210 FORC=ATOR+(C+6)*8:STEPB:PRINTC:" ":NEXTC
220 A=53328+(40*3)+5
230 FORC=ATOR+(C+5)*40*2:STEPB:POKEC,73:POKEC+1,98:NEXTC
300 FORI=1TO5:PRINT"Q":FORA=1TO4+1:PRINT"Q":NEXTX
305 FORI=1TOJ:PRINT"Q":NEXTI
310 FORZ=1TOLEN(A$):B$=A$(ASC(MID$(A$,Z,1))-32,Y)
320 C$="":FORU=1TOLEN(B$):U=VAL(MID$(B$,U,1)):O=660SUBS500,600
330 NEXTU:PRINTC$;
400 NEXTZ,Y:R=R-2
405 IFK=0THEN430
410 PRINT"Q";FORA="I":S="TO":S=R+1:TAB(A);";Y$:"";NEXTA
420 Q=53248+(17*40)+28:IFB>9THENQ=Q+1
425 POKEQ,98:POKEQ+2,98
430 PRINT"DOES THIS PROGRAMME LOOK O.K.(Y or N) ?"
440 GETY$:IFY$="Y"THEN440
450 IFY$="Y"THENPRINT"Q" - PRESS C.R. UNTIL TITLE APPEARS."
455 IFY$="Y"THENPRINT"Q";FORU=1TOLEN(B$):U=VAL(MID$(B$,U,1)):O=660SUBS500,600:PRINT"Q";:END
460 IFY$="N"THENPRINT"Q":A$="":GOTO150
470 GOTO440
500 IFU=0THENC$=C$+" "
505 IFU=1THENC$=C$+"*"
510 IFU=2THENC$=C$+"#"
515 IFU=3THENC$=C$+"@"
520 IFU=4THENC$=C$+"$"
525 IFU=5THENC$=C$+"%"
530 IFU=6THENC$=C$+"^"
535 IFU=7THENC$=C$+"&"
540 IFU=8THENC$=C$+"="
545 IFU=9THENC$=C$+"!"
550 RETURN
600 IFU=0THENC$=C$+" "
605 IFU=1THENC$=C$+"*"
610 IFU=2THENC$=C$+"#"
615 IFU=3THENC$=C$+"@"
620 IFU=4THENC$=C$+"$"
625 IFU=5THENC$=C$+"%"
630 IFU=6THENC$=C$+"^"
635 IFU=7THENC$=C$+"&"
640 IFU=8THENC$=C$+"="
645 IFU=9THENC$=C$+"!"
650 RETURN
1000 DATA10,10,00,4130,4130,410,4130,4130,10000,1110,4130,1110,4130,4130,4130
1010 DATA1130,4130,1130,1110,1110,4130,1010,10,0010,1010,1000,1310,1010,4130
1020 DATA1130,4130,1130,1110,1110,1010,1010,1010,1010,1010,1110,1110,10,20,00
1100 DATA6010,1010,010,6010,6010,10000,1000,1000,0420,1010,1010,1010,1010,1060
1110 DATA010,1000,1000,1000,1010,10,0010,1020,1000,15210,1310,1010,1010,1010
1120 DATA010,1060,0100,1010,1010,101010,5020,1010,0020,10,00,00,0420,1010,010
1130 DATA4120,0170,10100,5130,1130,0100,9170,5110,1010,1130,1000,1010,1100
1140 DATA1100,1000,1110,10,0010,1100,1000,10010,1510,1010,1120,1010,1120,5130
1150 DATA0100,1010,1010,101010,0100,5120,0100,00,00,00,00,1010,010,1000,0010
1170 DATA1110,0010,1010,0100,1010,0010,1110,1010,1000,1010,1000,1000,1010
1180 DATA010,10,0010,1030,1000,10010,1010,1010,1000,1010,1030,0010,010,1010
1190 DATA9070,501070,4030,0100,4000,10,00,10,0100,5120,010,1110,5120,00100
1200 DATA5120,5120,0100,5120,5120,1010,1120,5120,1120,1110,1000,5110,1010,10
    
```

BERKHAMSTED'S

New Computer Store for:

GENIE 1 & 2
 NASCOM

Vic-20

and others...

CSS

Software, Components, Disks
 Friendly HELP and ADVICE

Chrisalid, 13, High Street
 BERKHAMSTED Herts. (Tel:
 74569)

THE PERSONAL COMPUTER BOOK

by Robin Bradbeer. New ed. just published.

Buying your own micro? Then you need Robin Bradbeer's Personal Computer Book. It includes an illustrated up-to-date survey of 60 micros available in the UK. Contains information on what you can do with micros, details of your nearest computer club and a survey of books and magazines. **Only £5.95.**
 Available from W.H. Smith and leading booksellers, or direct from the publishers by sending £6.95 (including p&p) to Virginia Ayers, Dept. PCW, Gower Publishing Co Ltd, Gower House, Croft Road, Aldershot, Hants., GU11 3HR.

PROGRAMS

```

1210 DATA120,1010,1110,10010,1010,5120,1000,5113,1010,5120,0100,5120,0100
1220 DATA0100,1010,0100,1110,4130,470,530,000,5020,100,010,000,4200,100,010
1250 DATA000,1010,100,010,000,5120,570,520,000
2000 PRINT"#####SHAVE YOU SAVED THE PARENT PROGRAMME"
2005 GETY$:IFY$=""THEN2005
2010 IFY$="N"THENPRINT"WELL,DO SO NOW,BUT FIRST DELETE LINE 106000":END
2020 IFY$="Y"THENRETURN
2030 GOTO2005
    
```

MZ-80K Tarot

by D Boylen & B Harvey

If you want to know whether or not PCW will publish that article you sent in in January or if you're likely to meet a tall, dark stranger on the morning bus, Tarot sets out to provide the answers. It will give a straightforward Tarot reading of the past, present and, more importantly, the future (please note: PCW accepts no responsibility if it tells you you're due for a big windfall and you overdraw in anticipation!).

When the program is run it presents a neat title routine followed by the instructions. Good use is made of sound and graphics throughout and a

well-constructed tune accompanies the instructions. There is then a pause while the computer 'shuffles the cards' and a number must be input to begin the reading. It is necessary to press any key between cards to continue the reading — this is not mentioned in the instructions.

All in all, this is a well thought out and executed program and makes quite decorative viewing. The program itself uses 25.86k leaving 8.82k free after loading on top of Basic SP5025. It will, therefore, require a 48k machine to run.

```

1 PRINT"0":FORH=1TO300:NEXT
2 FORX=1TO2
3 FORG=1TO5
4 FORT=1TO4
5 PRINT"#####"
6 PRINT"
7 PRINT"
8 PRINT"
9 PRINT"
10 PRINT"
11 PRINT"
12 PRINT"
13 PRINT"
14 PRINT"
15 PRINT"
16 PRINT"
17 PRINT"
18 PRINT"
19 PRINT"
20 PRINT"
21 PRINT"
22 PRINT"G":NEXTG
23 PRINT:FORV=1TO4:FORU=1TO10
24 PRINT"
25 PRINT"
26 PRINT"
27 PRINT"
28 PRINT"
29 PRINT"
30 PRINT"
31 PRINT"
32 NEXTU
33 FORZ=1TO160
34 PRINT"##### By D.Boylan"
35 PRINT"&"
36 PRINT" B.Harvey":PRINT"0"
37 M1$="A5#C3#D#E#F#G#H#I#J#K#L#M#N#O#P#Q#R#S#T#U#V#W#X#Y#Z#0#1#2#3#4#5#6#7#8#9#.#$%&'()*+,-/:"
38 M2$="A3#D2R0#D1#E2#D#C3B#C7#C3"
39 TEMPO5:MUSICM1$,M2$
40 PRINT"G"
41 PRINT"#####The TAROT cards come from antiquity."
42 PRINT"Nobody knows the orisin of the Tarot "
43 PRINT"cards,but in the many years that have"
44 PRINT"passed since that date many people have"
45 PRINT"used the Tarot's mystical power to"
46 PRINT"to seek knowledge of the past,"
47 PRINT"the present and the future."
48 PRINT
49 PRINT"A readings from the Tarot can only be"
50 PRINT"understood when it is placed in the"
51 PRINT"context of the receivers life."
52 PRINT
    
```

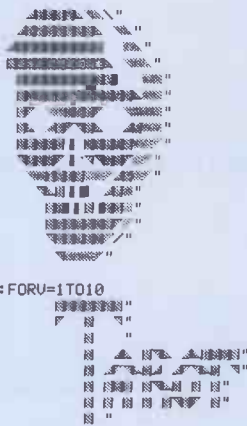

DAI SOFTWARE FROM IQ SERVICES

* ANIMAX

A general purpose 3D graphics generator for use in all modes providing easy to use drawing and animation facilities. £7.50

* ANIGRAM

As ANIMAX but designed specifically for the easy production of diagrams in education and including annotation facilities. £8.50

Full instructions supplied with each cassette. Prices include VAT & pp. CANAL HOUSE, ARDISHAIG, ARGYLL, SCOTLAND Tel: 0546 3212

TRS-80 SOFTWARE DISPLAY CREATOR

Presenting...

Use the many features of this machine code utility to create superb screens of graphics & text. At a key, the current screen can be encoded into machine code which can be merged onto any Basic program. When RUN, the screen(s) can be displayed instantly, in any order, at any time, any number of times, as presentation, high score displays, game boards, pictures etc.

FEATURES INCLUDE:

- * A unique quadruple size, large character set
- * Extensively controlled, fully non-destructive cursor
- * Repeat key
- * 5 different graphic modes
- * Multiple screen creation
- * Border control

£15.00
model 1 16K L2

H. Steers, 32 Castlewood Drive, Eltham SE9

MICROMART

COLOUR and SOUND



'SIMPLY FILE' RECORDS SYSTEM (DBMS). Select by any key. Print alphabetic lists, mailing labels. Calculate, total, average columns. Fast, easy, robust and VERY versatile. DISK ONLY: £65

'SIMPLY WRITE' FAST WORD PROCESSOR. Some £300-£400 programs have no more facilities. Tape or disk, any printer, 40-80 column PET. Needs 16K. TAPE £40, DISK £45

GOTTA PET? ADDA VIC! High resolution graphics, programmable characters, colour and sound on your PET? All this PLUS a complete extra computer using your PET's drives, printer etc? Under £200 including VIC and our super PET-VIC LINK! (Available separately)

PRICES PLUS VAT BUT INCLUDING P&P. SEND FOR DETAILS, MORE UNUSUAL ITEMS. GET OUR FREE 'MICROMAIL' PET NEWSLETTERS.

SIMPLE SOFTWARE LTD.
15 HAVELOCK ROAD
BRIGHTON SUSSEX BN1 6GL
(0273) 504879



ZX 81 16K SOFTWARE BUSINESS SIMULATION £5.45

A highly entertaining yet demanding simulation of the manufacturing world for 2 to 4 players.

This program is most definitely not an arcade game and is designed to make YOU think.

Both graphics and numerics are used to show each companies monthly progress. The ZX81 printer can be used in conjunction with this program to produce a hard copy of your annual profit/loss statement and balance sheet.

Program length 13.2K plus 905 bytes reserved in variable store. Full documentation included with tape.

K.W. Software
155 Ringinglow Rd
Sheffield S11 7PS



ACORN DUST COVERS.

Protect your Acorn keyboard from dust & grit.

- | | |
|---|-------|
| 1. Meteorites, Hunter, Lander, Mines (3k) | £2.95 |
| 2. Computer startrek 3k & 8k versions | £4.95 |
| 3. Sub killer, Scoring ball (3k) | £4.95 |
| 4. Football score predictor (based on previous seasons) (8k) | £4.95 |
| 5. Information sys. catalogue your records, stamps, books etc. runs in any memory | £7.95 |
| 6. Hi-res character gen. create your own character set and save it on cassette | £7.95 |

ARCADE GAMES

FULL COLOUR-HI-RES-SOUND-MACHINE CODE

- | | |
|---|-------|
| 7. The Cyber Men. Get the Cyber men before they get you | £7.95 |
| 8. Vic — roids shoot asteroids as they hurtle through space | £9.95 |
| 9. Vic — Man. Dotz, Maze & monsters | £9.95 |

HARDWARE

- | | |
|---|--------|
| 10. Vic single supply EPROM PROGRAMMER (2516, 2716 & 2758). Program entire or partial & verify. | £59.95 |
| 11. Vic-telephone dialler (single relay), with software to keep names & addresses Auto dialler | £49.95 |

send SAE for information. All prices inc. VAT & P/P.

OMEGA PLUS
2c Graham R.D London E8 1BZ

PET HI-RES

The new HR-40 board offers —

- 8k of its own RAM
- 64,000 individually addressable points
- 320 by 200 resolution
- machine code utility software in EPROM
- existing PET features unaffected
- easily fitted, no soldering necessary
- low price of £149 plus VAT

There's no limit to what you can do when you have the HR-40 board fitted to your PET. The single dot resolution allows you to draw smooth curves, accurate diagrams and much more. If you've got one of the new 4000 machines with a 12 inch screen then you'll need the HR-40B, but it won't cost a penny more.

The HR-80 board for the 8032 is now available at the same low price £149.00 plus V.A.T.

SUPERSOFT are PET/CBM software specialists. Other top quality products include MIKRO, the assembler in a chip (£50) and SUPERCHIP, the biggest selling British chip (£45).

Our catalogue is available free to PET owners.

SUPERSOFT



Dept. P3, 10-14 Canning Road,
Wealdstone, Harrow, Middlesex.
Tel: 01-861 1166

ZX81 WITH 16K RAM-PACK

6 GAMES ON CASSETTE
FOR ONLY £3.50 (Post free)

Not one, not two, but SIX exciting games on one high-quality cassette, ready to load on your ZX81 with add-on 16K RAM pack. Easy to operate, fun to play! Hours of entertainment for all the family!

***THE MONSTERS OF DRARGOOL** Enter the underground labyrinth of Drargool at your peril. Risk death fighting the many weird and fierce monsters in your search for treasure.

***SNAIL RACE** Back the snail you fancy in each of four races — unless you lose your shirt first!

***GUNFIGHT** Shoot it out across a canyon with three desperadoes. Get them all before they get you!

***ROULETTE** For two players against the ZX81. The classic casino game, with eight different betting options and simulated wheel-spin.

***BATTLESHIPS** The schoolboy game brought up to date. How good a naval gunner will you be?

***ONE-ARMED BANDIT** Your own "fruit machine" on the TV screen. "Hold" facility and constantly-updated screen display of your progress.

All the above games have informative and attractive screen displays with none of the unpleasant "screen-flashing" that spoils some other ZX81 games. Get your cassette of six games today!

SEND TODAY! MONEY BACK IF NOT DELIGHTED!

Price includes cassette, library case, inlay, documentation and postage.

Send £3.50 cash/PO/cheque to:

MOVIEDROME VIDEO (PE1)

19 Leighton Avenue, Pinner HA5 3BW

C24 Green Filter Sheet

Enhance VDU contrast ratio

(typ. from 6:1 to 9:1 for b/w TV screen)

Reduce glare

Improve visual acuity

Reduce eye fatigue

Suitable for white & green phosphors

10" x 12" (up to 14" screen) £ 3.00

18" x 23" (up to 26" screen) £ 5.00

trim to size, fixers supplied

Mesotec

204 Harrogate Road

Leeds LS7 4QD

PROGRAMS

```

53 PRINT "A reading from the Tarot may bring "
54 PRINT "much happiness and peace of mind."
55 PRINT "but because it can reveal hidden truths"
56 PRINT "and give indications of what may come"
57 PRINT "a reading may not tell you what you"

58 PRINT "what you want to hear."
59 PRINT "Press any key to continue":WZ$
60 GETWZ$:IFWZ$=""THEN60
61 RESTORE:CLR:PRINT "*****There are Three Card Spreads you"
62 PRINT "may choose from:"
63 PRINT:PRINT:PRINT "(1)The Nine Card Spread
64 PRINT "*****Relates to Past,Present and Future)"
65 PRINT:PRINT "(2)The Circular Spread":PRINT "*****Relates to the Year Ahead)"
66 PRINT:PRINT:PRINT "(3)The Horseshoe Spread"
67 PRINT "*****Relates to Specific Questions)":PRINT
68 PRINT " "
69 PRINT " | "
70 PRINT " | Please Press Button 1,2 or 3 | "
71 PRINT " | "
72 PRINT " | "
73 GETW$:IFW$=""THEN73
74 SP=VAL(W$)
75 IFSP>3THENPRINT "I forecast a long wait unless you press the right button"
76 IFSP=1THENU=10:GOTO80
77 IFSP=2THENU=14:GOTO80
78 IFSP=3THENU=8:GOTO80
79 GOTO73
80 GOSUB160
81 PRINT "*****Please cross my keyboard with Silver":PRINT
82 PRINT "*****while I shuffle the cards"
83 DEF FNR(Q)=1+INT(RND(7)*Q)
84 LIMIT51999
85 FORA=5200T052500:POKEA,200:NEXT
86 DIMH$(15)
87 FORA=1T078:GOSUB695:NEXT
88 FORA=1T014:READH$(A):NEXT
89 GOSUB160
90 PRINT "*****Your generosity overwhelms me!":PRINT
91 PRINT "*****Now you have to cut the cards"
92 INPUT "*****Enter any Number from 1 to 500 and then press CR ":D

93 IFD>500THEN92
94 Z=0:NC=0:DR=D
95 Z=Z+1:IFZ=VTHENGOTO682
96 IFD>500THEND=1
97 CD=PEEK(52000+D):IFCD=NCTHEND=D+1:GOTO96
98 IFCD=200THEND=D+1:GOTO96
99 PRINT "This card refers to:"
100 IFSP=1THENGOSUB115
101 IFSP=2THENGOSUB121
102 IFSP=3THENGOSUB135
103 NC=CD
104 IFCD>78THENC$=CD-78:GOTO106
105 CS=CD
106 IFCD>78THENPRINT "*****<Reverse>":PRINT:GOTO108
107 PRINT " "
108 IFCS<8THEN218
109 IFCS<15THEN338
110 IFCS<23THEN458
111 IFCS<37THEN143
112 IFCS<51THEN167
113 IFCS<65THEN184
114 GOTO201
115 IFZ=1THENPRINT "Your present circumstances":RETURN
116 IFZ=2THENPRINT "The highest you can attain at this time":RETURN
117 IFZ=3THENPRINT "Hidden factors in your affairs":RETURN
118 IFZ=4THENPRINT "Past causes of your Situation":RETURN
119 IFZ=5THENPRINT "The outcome if present trends continue":RETURN
120 IFZ=5THENPRINT "Your progress in the near future":RETURN
121 IFZ=1THENPRINT "The overall tone of the readings"
122 IFZ=2THENPRINT "Conditions a Month hence":RETURN
123 IFZ=3THENPRINT "Conditions Two Months hence":RETURN
124 IFZ=4THENPRINT "Conditions Three Months hence":RETURN
125 IFZ=5THENPRINT "Conditions Four Months hence"
126 IFZ=6THENPRINT "Conditions Five Months hence"
127 IFZ=7THENPRINT "Conditions Six Months hence"
128 IFZ=8THENPRINT "Conditions Seven Months hence"
129 IFZ=9THENPRINT "Conditions Eight Months hence"
130 IFZ=10THENPRINT "Conditions Nine Months hence"
131 IFZ=11THENPRINT "Conditions Ten Months hence"
132 IFZ=12THENPRINT "Conditions Eleven Months hence"
133 IFZ=13THENPRINT "Conditions Twelve Months hence"
134 RETURN
135 IFZ=1THENPRINT "Past Influences"
136 IFZ=2THENPRINT "Your Present Circumstances"
137 IFZ=3THENPRINT "General Future Conditions"
138 IFZ=4THENPRINT "The Best Policy for you to follow"
139 IFZ=5THENPRINT "The Attitudes of those around you"
140 IFZ=6THENPRINT "Obstacles standing in your way"
141 IFZ=7THENPRINT "The probable final outcome"
142 RETURN
    
```

PLYMOUTH POLYTECHNIC

HONOURS DEGREE IN COMMUNICATION ENGINEERING

SATELLITE TV — ELECTRONIC MAIL — OPTICAL FIBRES
DATA NETWORKS — COMPUTER CONTROL

Ensure that YOU have a career in the new Information Society by studying for a degree in the interesting and rewarding field of Communication Engineering.

FOR FURTHER INFORMATION WRITE TO:

Department of Communication Engineering, Plymouth Polytechnic,
Drake Circus, Plymouth, Devon, PL4 8AA. (Ref.TEC.1)

Or Phone: (0752) 264646

PROGRAMS

143 N=CS-22:PRINT"
 144 PRINT"
 145 PRINT"
 146 PRINT"
 147 PRINT"
 148 PRINT"
 149 PRINT"
 150 PRINT"
 151 PRINT"
 152 PRINT"
 153 PRINT"
 154 PRINT"
 155 PRINT"
 156 PRINT"
 157 PRINT"
 158 PRINT"
 159 GOT0595
 160 PRINT"68"
 161 PRINT"
 162 PRINT"
 163 PRINT"
 164 PRINT"
 165 PRINT"
 166 RETURN
 167 N=CS-36:PRINT"
 168 PRINT"
 169 PRINT"
 170 PRINT"
 171 PRINT"
 172 PRINT"
 173 PRINT"
 174 PRINT"
 175 PRINT"
 176 PRINT"
 177 PRINT"
 178 PRINT"
 179 PRINT"
 180 PRINT"
 181 PRINT"
 182 PRINT"
 183 GOT0595
 184 N=CS-50:PRINT"
 185 PRINT"
 186 PRINT"
 187 PRINT"
 188 PRINT"
 189 PRINT"
 190 PRINT"
 191 PRINT"
 192 PRINT"
 193 PRINT"
 194 PRINT"
 195 PRINT"
 196 PRINT"
 197 PRINT"
 198 PRINT"
 199 PRINT"
 200 GOT0595
 201 N=CS-54:PRINT"
 202 PRINT"
 203 PRINT"
 204 PRINT"
 205 PRINT"
 206 PRINT"
 207 PRINT"
 208 PRINT"
 209 PRINT"
 210 PRINT"
 211 PRINT"
 212 PRINT"
 213 PRINT"
 214 PRINT"
 215 PRINT"
 216 PRINT"
 217 GOT0595
 218 N=CS-60:PRINT"
 219 PRINT"
 220 PRINT"
 221 PRINT"
 222 PRINT"
 223 PRINT"
 224 PRINT"
 225 PRINT"
 226 PRINT"
 227 PRINT"
 228 PRINT"
 229 PRINT"
 230 PRINT"
 231 PRINT"
 232 PRINT"
 233 PRINT"
 234 PRINT"

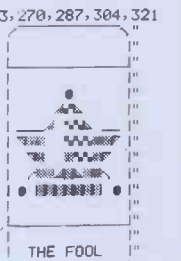
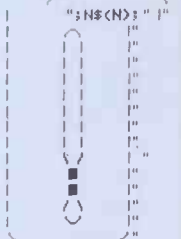
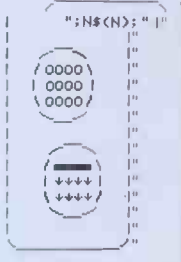
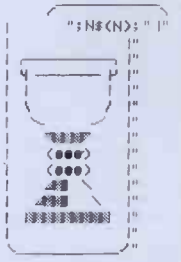

235 GOT0595
 236 PRINT"
 237 PRINT"
 238 PRINT"
 239 PRINT"
 240 PRINT"
 241 PRINT"
 242 PRINT"
 243 PRINT"
 244 PRINT"
 245 PRINT"
 246 PRINT"
 247 PRINT"
 248 PRINT"
 249 PRINT"
 250 PRINT"
 251 PRINT"



252 GOT0595
 253 PRINT"
 254 PRINT"
 255 PRINT"
 256 PRINT"
 257 PRINT"
 258 PRINT"
 259 PRINT"
 260 PRINT"
 261 PRINT"
 262 PRINT"
 263 PRINT"
 264 PRINT"
 265 PRINT"
 266 PRINT"
 267 PRINT"
 268 PRINT"
 269 GOT0595
 270 PRINT"
 271 PRINT"
 272 PRINT"
 273 PRINT"
 274 PRINT"
 275 PRINT"
 276 PRINT"
 277 PRINT"
 278 PRINT"
 279 PRINT"
 280 PRINT"
 281 PRINT"
 282 PRINT"
 283 PRINT"
 284 PRINT"
 285 PRINT"

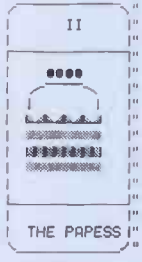

286 GOT0595
 287 PRINT"
 288 PRINT"
 289 PRINT"
 290 PRINT"
 291 PRINT"
 292 PRINT"
 293 PRINT"
 294 PRINT"
 295 PRINT"
 296 PRINT"
 297 PRINT"
 298 PRINT"
 299 PRINT"
 300 PRINT"
 301 PRINT"
 302 PRINT"



303 GOT0595
 304 PRINT"
 305 PRINT"
 306 PRINT"
 307 PRINT"
 308 PRINT"
 309 PRINT"
 310 PRINT"
 311 PRINT"
 312 PRINT"
 313 PRINT"
 314 PRINT"
 315 PRINT"
 316 PRINT"
 317 PRINT"
 318 PRINT"
 319 PRINT"
 320 GOT0595

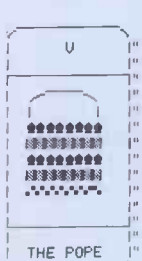
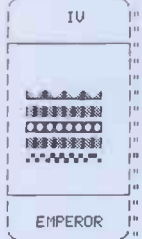

MICROMART

Great products from Mutek Tiny PILOT

Mutek's Tiny PILOT (MTP) is a small-scale yet comprehensive implementation of the PILOT text-oriented programming language for OSI and UK101 computers.

Commands are: R: remark; T: type text (or graphics character); ?: accept name; A: accept answer (numeric or alphanumeric); M: match (full range of comparisons); J: jump to label; U: use subroutine at label; E: end subroutine; C: compute (26 single-character variables); I: input numeric value to variable; P: produce random number; S: stop (end program)

Numeric functions are performed in 16-bit unsigned form, giving a range 0-65535. A full line-editor is included in the package.

Note: MTP uses CEGMON facilities extensively and will not operate with non-standard monitors such as WEMON or MONUK02. MTP is available as a package with the relevant version of CEGMON at a special reduced price. This gives you the special facilities of CEGMON as well as the best use of MTP.

The EPROM package is available ex-stock, and comes complete with fitting instructions, manual and reference card.

PILOT package £17.50+VAT
 PILOT/CEGMON package £29.50+VAT

StarLink Communications package

A complete comms. package for OSI systems, including:

- 'Smart terminal' mode for link to external mainframe, mini or micro;
- half-duplex/full-duplex operation;
- transmit/receive prepared text or files (on-line/off-line preparation);
- direct upload/download of programs;
- 'indirect file' handling for transfer of programs/data between external computer, disk or ROM BASIC; full editing; and many other features

Available in EPROM in two versions:

StarLink I for disk or ROM BASIC systems, and StarLink II for non-disk operation of Superboard Series II. Specify type required when ordering!

Starlink (either version) £17.50+VAT

Coming shortly

Modem (acoustic coupler) for use with StarLink — c.£50 or less

High res (256x256) graphics for Superboard/C1 — bare board + instructions, software c.£35, ready-built c.£110

FigFORTH (full Forth Interest Group implementation) in ROM — c.£50, source listing c.£15

MUTEK Quarry Hill, Box, Wilts
 Tel: Bath (0225) 743289

Come in on the home computer boom.

For £1,000 we can provide you with an agency selling home computers into an exciting new market with massive growth potential — and give all the training, technical and marketing support required. Now's the time to stake your claim and secure your future in your own exclusive territory. And you could start part-time. For further information write with full details to Russel Price, Adda Computers Ltd., Unit 8, I-7 Broomfield Road, West Ealing, London W13 9AP.

COMPUTER SUPPLIES

Continuous Stationers/1000 sheets
 9 1/2" x 11" lined or plain £4.61
 9 1/2" x 11" (with 1/2" margin) £5.96
 14 1/2" x 11" lined or plain £6.06
 Prices inc. delivery

We also supply disk Media, Printers from Epson Newbury Labs and Olivetti. Plus VDU's from Newbury Labs.



GPD Consultants Limited
 Clavering (0799 85) 617
 cash with orders please.

MICROMART

RAM BARGAINS

4116	- 250ns	70p each
	100+	55p each
4116	- 200ns	80p each
	100+	68p each
2114	- 300ns	85p each
	100+	75p each
2114	- 450ns	80p each
	100+	70p each
2114	- Low Power-300ns	95p each
	100+	83p each
6116	- 150ns	£6.00 each
2716	- 6v - 450ns	£2.40 each
2732	- 450ns N.E.C.	£4.00 each
2532	- 450ns TEXAS	£4.00 each

OTHER IC'S AVAILABLE
ADD 50p P&P + VAT @ 15%.

ATHANA FLOPPIES

Minis with free plastic library case & Hub Rings

S/S	S/D	£17.95 for 10
S/S	D/D	£19.95 for 10
D/S	D/D	£23.50 for 10
S/S	77 Track	£26.50 for 10
S/S	96 Track	£29.50 for 10
8" Discs		
S/S	S/D	£15.50 for 10
S/S	D/D	£24.50 for 10
D/S	D/D	£25.50 for 10

ALL OTHER DISCS AVAILABLE
ADD 85p P&P VAT @ 15%

Quantity Discounts available - Official orders welcome.
Dept C.W.

OPUS SUPPLIES

10 Beckenham Grove, Shortlands, Kent.
01-464 5040

24 Hour Telephone Service for
Credit Card Holders.

ZX81 MONOPOLY

Occasionally during the life of a Micro a program is written that can go on to become a standard. ZX81 MONOPOLY could be such a program. Most computer simulations are solitary affairs using a program that caters only for one or two players. ZX81 MONOPOLY allows six players to compete with the machine doing all the boring bits, acting as board, rule-book, umpire, dice-thrower and accountant. No cheating is allowed and when required a list of a player's properties and the development situation for each can be listed. No need to worry about missing the rent either, you ZX81 is also trained as a rent collector. The program is well driven by a clear MENU at the start of each players turn and after the dice has been thrown ZX81 MONOPOLY also allows the game to be SAVED with a WINNER so far report. The program requires 16K RAM and comes complete with instructions. Let all your friends and family appreciate the ability of your ZX81 NOW. ZX81 MONOPOLY for 16K at £8.00 inc VAT and postage. Cash with order from the publishers.

WORK FORCE
140 Wilsden Avenue,
Luton, Beds LU1 5HR
Overseas order + £1.00 p&p

ZX81 SOFTWARE

DATABASE

Amazingly versatile program allowing the creation of files of any description: anything from stock-control to employee records, and more. Features include add, delete, update, print, sum, count, average and security lock. Supplied with detailed documentation and tape containing two samples files. Excellent value at only £10.

BUDGET/ADDRESS-BOOK

BUDGET will record all your income/expenditure for home or office budgeting. ADDRESS-BOOK maintains a list of names, addresses and telephone numbers. Uses machine code for fast access. Both programs for only £4.

Educational programs available, including WORDSTORE, QUIZPACK, FUNCTION PLOT, STATISTICS.

Send SAE for full details of these and other programs to

J PURVES
12 Stobhill Road, Gorebridge, Midlothian
EH23 4PL

PROGRAMS

321 PRINT"
322 PRINT"
323 PRINT"
324 PRINT"
325 PRINT"
326 PRINT"
327 PRINT"
328 PRINT"
329 PRINT"
330 PRINT"
331 PRINT"
332 PRINT"
333 PRINT"
334 PRINT"
335 PRINT"
336 PRINT"
337 GOT0595
338 S-CS-7:ONSGOT0339,356,373,390,407,
424,441



339 PRINT"
340 PRINT"
341 PRINT"
342 PRINT"
343 PRINT"
344 PRINT"
345 PRINT"
346 PRINT"
347 PRINT"
348 PRINT"
349 PRINT"
350 PRINT"
351 PRINT"
352 PRINT"
353 PRINT"
354 PRINT"
355 GOT0595



356 PRINT"
357 PRINT"
358 PRINT"
359 PRINT"
360 PRINT"
361 PRINT"
362 PRINT"
363 PRINT"
364 PRINT"
365 PRINT"
366 PRINT"
367 PRINT"
368 PRINT"
369 PRINT"
370 PRINT"
371 PRINT"
372 GOT0595



373 PRINT"
374 PRINT"
375 PRINT"
376 PRINT"
377 PRINT"
378 PRINT"
379 PRINT"
380 PRINT"
381 PRINT"
382 PRINT"
383 PRINT"
384 PRINT"
385 PRINT"
386 PRINT"
387 PRINT"
388 PRINT"
389 GOT0595



390 PRINT"
391 PRINT"
392 PRINT"
393 PRINT"
394 PRINT"
395 PRINT"
396 PRINT"
397 PRINT"
398 PRINT"
399 PRINT"
400 PRINT"
401 PRINT"
402 PRINT"
403 PRINT"
404 PRINT"
405 PRINT"
406 GOT0595

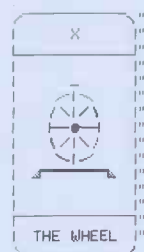

407 PRINT"
408 PRINT"
409 PRINT"
410 PRINT"
411 PRINT"
412 PRINT"
413 PRINT"
414 PRINT"
415 PRINT"
416 PRINT"
417 PRINT"
418 PRINT"
419 PRINT"
420 PRINT"
421 PRINT"
422 PRINT"
423 GOT0595



424 PRINT"
425 PRINT"
426 PRINT"
427 PRINT"
428 PRINT"
429 PRINT"
430 PRINT"
431 PRINT"
432 PRINT"
433 PRINT"
434 PRINT"
435 PRINT"
436 PRINT"
437 PRINT"
438 PRINT"
439 PRINT"
440 GOT0595

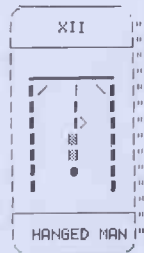

441 PRINT"
442 PRINT"
443 PRINT"
444 PRINT"
445 PRINT"
446 PRINT"
447 PRINT"
448 PRINT"
449 PRINT"
450 PRINT"
451 PRINT"
452 PRINT"
453 PRINT"
454 PRINT"
455 PRINT"
456 PRINT"
457 GOT0595
458 S-CS-14:ONSGOT0459,476,493,510,527,
544,561,578



459 PRINT"
460 PRINT"
461 PRINT"
462 PRINT"
463 PRINT"
464 PRINT"
465 PRINT"
466 PRINT"
467 PRINT"
468 PRINT"
469 PRINT"
470 PRINT"
471 PRINT"
472 PRINT"
473 PRINT"
474 PRINT"
475 GOT0595



476 PRINT"
477 PRINT"
478 PRINT"
479 PRINT"
480 PRINT"
481 PRINT"
482 PRINT"
483 PRINT"
484 PRINT"
485 PRINT"
486 PRINT"
487 PRINT"
488 PRINT"
489 PRINT"
490 PRINT"
491 PRINT"
492 GOT0595



5 DAY MICROCOMPUTER PROGRAMMING COURSES START EVERY MONDAY INCLUSIVE COST £170

Part-time courses
seven days a week

MICROTEACH

160 Edmund Street,
Birmingham
Tel: 021-236 4322

ZX81 X 8 Bit Parallel Interface

Features 16 user programmable input/output lines under your control. Use it to control School Experiments Heating Robots Printer Lighting

Many more applications. Example software and circuit suggestions supplied with each board.

APPLE A/D Converter

Reads 8 analogue channels with 8 bit resolution. Bipolar inputs. Turns your Apple into an eight channel data logger/chart recorder/oscilloscope. Supplied with notes and software (Specify DOS 3.2, 3.3 or Cassette), in an attractive ring binder.

APPLE Universal Printer Interface/ Real Time Clock

Clock gives time/date to tenth sec. and interrupt. Interface includes software to drive most common printers. (Can also be used as 8 Bit port.)

ZX81 Card 16.50 + 2.48 V.A.T. + 30p p.&p.
APPLE A/D Converter 49.95 + 7.49 V.A.T. + 1.00 p.&p.
APPLE Universal Printer Interface/Real Time Clock 79.00 + 11.85 V.A.T. + 1.00 p.&p.

ANDREW DEVELOPMENTS
93 BEACONSFIELD VILLAS, PRESTON PARK, BRIGHTON. Tel. 0273 564629

PROGRAMS

493 PRINT"
494 PRINT"
495 PRINT"
496 PRINT"
497 PRINT"
498 PRINT"
499 PRINT"
500 PRINT"
501 PRINT"
502 PRINT"
503 PRINT"
504 PRINT"
505 PRINT"
506 PRINT"
507 PRINT"
508 PRINT"
509 GOT0595
510 PRINT"
511 PRINT"
512 PRINT"
513 PRINT"
514 PRINT"
515 PRINT"
516 PRINT"
517 PRINT"
518 PRINT"
519 PRINT"
520 PRINT"
521 PRINT"
522 PRINT"
523 PRINT"
524 PRINT"
525 PRINT"
526 GOT0595
527 PRINT"
528 PRINT"
529 PRINT"
530 PRINT"
531 PRINT"
532 PRINT"
533 PRINT"
534 PRINT"
535 PRINT"
536 PRINT"
537 PRINT"
538 PRINT"
539 PRINT"
540 PRINT"
541 PRINT"
542 PRINT"
543 GOT0595



544 PRINT"
545 PRINT"
546 PRINT"
547 PRINT"
548 PRINT"
549 PRINT"
550 PRINT"
551 PRINT"
552 PRINT"
553 PRINT"
554 PRINT"
555 PRINT"
556 PRINT"
557 PRINT"
558 PRINT"
559 PRINT"
560 GOT0595
561 PRINT"
562 PRINT"
563 PRINT"
564 PRINT"
565 PRINT"
566 PRINT"
567 PRINT"
568 PRINT"
569 PRINT"
570 PRINT"
571 PRINT"
572 PRINT"
573 PRINT"
574 PRINT"
575 PRINT"
576 PRINT"
577 GOT0595
578 PRINT"
579 PRINT"
580 PRINT"
581 PRINT"
582 PRINT"
583 PRINT"
584 PRINT"
585 PRINT"
586 PRINT"
587 PRINT"
588 PRINT"
589 PRINT"
590 PRINT"
591 PRINT"
592 PRINT"
593 PRINT"
594 GOT0595

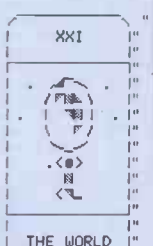
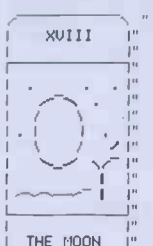
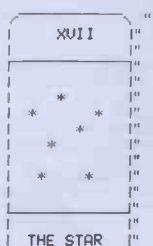

595 MUSIC"G2=R2G2":RESTORE:FORA=1TODD+14:READD#:NEXT
596 PRINT:PRINT"and indicates:"
597 PRINTCD\$
598 GETA\$:IFA\$=""THEN598
599 GOT095
600 DATA "A", "2", "3", "4", "5", "6", "7", "8", "9", "10", "P", "KN", "Q", "K"
601 DATAUnexpected Influence,Initiative or Diplomacy
602 DATAInfluence of a Woman,Intuitive insight,Fruitfulness,Stability
603 DATAInfluence of a great person,Will-Power,Enlightenment
604 DATARA time of choice by intuition,Success over obstacles
605 DATARA act of judgement,A just outcome,A need for advice or planning
606 DATARA new start,Good luck,opportunity through courage
607 DATAFlexibility,Thoughtfulness,A major change,A blessings in disguise
608 DATASuccess through skillful control,A need for selfcontrol
609 DATASuffering through destiny,Possibilities in the future
610 DATARA need for intuition not reason,Success against all odds
611 DATARA new lease of life,"The successful finish to any matter in hand"
612 DATASuccess despite adversity,Success through equilibrium
613 DATARAheaval for somethings better,Peace and order from strife
614 DATARA need to accept the inevitable,The solving of immediate problems
615 DATARA need for prudence against powerful opposition,"Restrictions
616 DATAStrength through sufferings
617 DATADisruption but things can only improve
618 DATADiplomacy and keen sightedness,Courage for coming battles
619 DATAIntelligence and versatility,Inventiveness and ambition
620 DATAJoy and plenty,Friendship,Co-Operation
621 DATA The healing of ills,Emotional happiness already attained
622 DATADisappointment to be overcome,Happiness from the past
623 DATAChoice through careful judgement,A change of perspective
624 DATAEmotional stability,Generosity of spirit,peace and concern
625 DATAPoetic,Foresighted,Mediative,Ideas,Offers and opportunities
626 DATAHighly imaginative,Easily influenced,skilled in worldly things
627 DATAMaterial security,movement and change
628 DATASuccess in work and business,Financial stability
629 DATAMaterial worries,balance in material matters
630 DATAGood fortune by swift action,the use of skills for material gain
631 DATAComfort,Good sense,family wealth
632 DATASound business sense and responsibility,lover of practical virtues
633 DATADown to earth and compassionate,cautious methodical and practical
634 DATANew beginnings,Fertility,strength of will,Earned success
635 DATADreams turned to reality,artistic achievement
636 DATAOpposition to be fought by ingenuity,success earned by hard work
637 DATAPossibilities to be grasped,hopeful change,The end of delays

MICROMART

ELCOMP BOOKS and SOFTWARE

For ATARI - PET/CBM - OSI - 6502

8K Microsoft BASIC Reference Manual

Authoritative reference for the original Microsoft 4K + 8K BASIC developed for Altair and later computers including OSI, PET and TRS-80.

Order-No. 141 \$9.95

Expansion Handbook for 6502 and 6802

S-44 Card Manual describes all of the 4.5 x 6.5 44-pin S-44 cards incl. schematics. A MUST for every KIM-, SYM- and AIM-owner.

Order-No. 152 \$9.95

Microcomputer Application Notes

Reprint of Intel's most important application notes including 2708, 8085, 8255, 6251 chips. Very necessary for the hardware buff.

Order-No. 153 \$9.95

Complex Sound Generation

New revised applications manual for the Texas Instruments SN 76477 Complex Sound Generator. Circuit Board available (\$8.95).

Order-No. 154 \$6.95

Small Business Programs

Complete listings for the business user, Inventory, Invoice Writing, Mailing List and much more.Introduction to Business Applications.

Order-No. 156 \$14.90

The First Book of Ohio Scientific

Introduction to OSI computers, Diagrams, Hardware and software information not previously available in one compact source. 192 pages.

Order-No. 157 \$7.95

The Second Book of Ohio Scientific

Very valuable information about OSI microcomputer systems. Introduction to OS-65 D and OS-65U Networking, Hardware and Software hints and tips. Systems specifications. Business applications.

Order-No. 158 \$7.95

The Fourth Book of OHIO

Very Important Programs Many interesting programs for OSI computers, Sorting (Binary Tree), Differential Equations, Statistics, Astrology, Gas Consumption, Games a.o.

Order-No. 160 \$9.95

VIP Package - Above book plus a cassette with the programs

Order-No. 160 A \$19.95

Invoice Writing Program for OSI-C1PMF, C4P, Disk and Cassette, 8K RAM.

Order-No. 8234 \$29.80

Mailing List for C1PMF or C4PMF 24K RAM

250 addresses incl. phone number and parameters on one 5 1/4 Disk

Order-No. 8240 \$29.80



Programs for the Challenger C1/C2 8K

Order-No. 2004 "Bare Bones" Wordprocessor \$9.95

Order-No. 2005, "Bare Bones" Mailing List \$9.95



Care and Feeding of the Commodore PET

Eight chapters exploring PET hardware. Includes repair and interfacing information. Programming tricks and schematics.

Order-No. 150 \$9.95

ELCOMP Publishing, Inc.
53 Redrock Lane, Pomona, CA 91766
Phone: (714) 623-8314

Payment: Check, Money Order, VISA, Mastercard, Eurocheck, POSTPAID or PREPAID in USA. \$ 5.00 handling fee for C.O.D. All orders outside USA: ADD 15 % shipping. CA add 6 % sales tax. ATARI is a registered trademark of ATARI INC. PET/CBM is a registered trademark of Commodore Business Machines.

DATEX MICROS

Limited offers. 12+12 with PSU ATOM \$239.00
Disc Drive Available Now \$299.00
BBC Basic \$39.75
GP100a Printer \$215.00
Wabash 5" discs In Lib. box \$20.00
Cassettes 10 pack for £4.50

Software *New*
Atom Accounts Purchase/Sales Bank/ Nominal
By an Accountant £35.00
Dictionary Learn/Test. Enter words in French, German, Latin (400) £10.00
Phone check. Day/Time Cost
Display & Summary £10.00
Rubiks Cube & Polaris (New) £10.00
Swarm & Air Raid (New) £10.00
SAE. for Prices & Details
Barclaycard & Access DATEX Micro's
193 Tarring Road Worthing Sussex 39290

ZX81 FLEXI SCREEN SUPERSROLL

These two amazing machine code routines, called by USR, will greatly improve your display by allowing you to selectively process any area of screen - INSTANTLY!
Firstly, DEFINE WINDOW, which may range from any single Print position to the whole of the screen. Then, to process ONLY within your defined window, SELECT OPTION.
FLEXISCREEN allows you to work within your window on only the character set (ignoring graphics/spaces) or on everything and enables you to:-
• REVERSE - turns any character to its opposite video
• NORMAL - turns any inverse video into normal video
• INVERSE - turns any normal video into inverse video
• CLEAR - remove any character
This allows a total of eight options
SUPERSROLL allows you to scroll, up or down, ONLY the text within your defined window and can set the print position at the start of the blank line.
FLEXISCREEN and SUPERSROLL are mutually compatible i.e. work within the same window or may be used independently. Absolute simplicity in use and MUST for any ZX81 user (1-3% RAM). Think of the possibilities - flash words/area of screen, prompts highlights, games, scroll columns, underscored headings etc. etc.
1K FLEXISCREEN - Don't be left out 1K owners! the 1K version allows all of the facilities of its big brother, except the defined window and the "fill character" clear, i.e. seven options.
FLEXISCREEN and SUPERSROLL - £3.75 each, £6.50 both.
1K FLEXISCREEN - £2.50

Make cheques/p.o.s payable to - J. Towers, 381a Foxhill Road, Sheffield S6 1BG

MICROMART

UK 101 SOFTWARE ON TAPE
from the guy who wrote "Le Passe Temps"

GALACTIC HITCHHIKER (8K). An adventure, all in machine code. A beauty! (£7.00)
SUPERTREK (8K). Sail boldly through the universe, zap-ping moving Klingons in real time. Superb graphics. (£7.00)
STARTREK (8K). The old favourite, beautifully presented. (£6.00)
LUNAR LANDER. A real challenge. You won't get down in less than 3 hours. (£3.00)
HANGMAN. Excellent graphics, P.E. said so! (£3.00)
BASIC TUTOR (8 x 4K). The only way to learn - at the keyboard. (£12.00)
LE PASSE-TEMPS. You NEED this, if you haven't already got it. (£3.00)
MAD MONK (8K). It's ready at last! A machine code adventure with some truly remarkable graphics, this programme is in a class by itself. (£9.50)
These ORIGINAL PROGRAMS are compatible all 2K Monitors and are available for 16 x 48 and 32 x 48 displays (including enhanced Superboards).

HARDWARE

These kits are complete in every way: - Full socketed high quality PCB, all components, switches etc, plus performed cable assembly for easy interconnection to J1, or our...
MOTHERBOARD SYSTEM. Now you can add on all those extras easily. Provides eight, yes EIGHT, fully buffered J1 type sockets. (£19.50)
8K STATIC RAM BOARD (£39.50)
HI-SPEED CASSETTE INTERFACE. At last, a system that works. COMPLETELY RELIABLE 4000 baud (8000 with reasonable cassette) plus software for named file handling. A delight to use. (£19.50). For software in EPROM, add £6.00

VIDEO ENHANCEMENT. Switch selectable 16 x 48 or 32 x 48 displays without butchering your computer. (£19.50)

Monitor EPROMS re-blown to suit for just £2.50
8K EPROM BOARD (£19.50). A 2K Extended Monitor is available in EPROM for £12.00 plus, coming soon, TOOLKIT in EPROM and BASIC V.

MONITOR BOARD. Plug into Monitor socket to provide switch selection of up to 4 EPROMS. (£9.50)

AVAILABLE SHORTLY: EPROM Programmer. PIA/Sound Board. Analogue Board and something rather nice on the graphics side.

All inclusive

Please add 15% V.A.T.

Write or phone for further details.

MERLIN (MICRO SYSTEMS) LTD.

93 High St.,

Eston,

Cleveland

Tel: (0642) 454883.



FOOTBALL MANAGER

Addictive Games for ZX81 ZX80 TRS80 VIDEO GENIE

★ AS MANY SEASONS AS YOU LIKE ★ 4 DIVISIONS ★

★ PROMOTION & RELEGATION ★

★ FULL LEAGUE TABLES ★

★ TRANSFER MARKET ★

★ INJURIES ★

★ 7 LEVELS OF PLAY ★

★ SAVE GAME FACILITY ★

★ MANAGERIAL RATING ★

★ PICK YOUR TEAM FOR EACH MATCH ★ F.A. CUP ★

This is NOT a mere simulation. This is an exciting and highly enjoyable game in which you play the part of a Football Manager coping with the problems and decisions involved in running your club. There are so many features it is impossible to list them here but included are team top teams NORMAN (1) wind, giant-killing, wage bills to pay, and you can even be sacked! It is a game requiring a great deal of skill, and people play it for literally hours on end (we have proof!).

WE GUARANTEE that this is one of the best computer games you've ever played!

BE CAREFUL: this game is extremely addictive!

FOOTBALL MANAGER IS SUPPLIED WITH INSTRUCTIONS BOOK WHICH OCCUPIES THE ENTIRE 16K RAM.

HARDWARE REQUIRED

ZX81/ TRS80/ To Order send Cheque/P.O. £7.95 made payable to: ADDICTIVE GAMES

ZX80/ Video Genie or Dept. P.C.W. P.O. BOX 278

8K ROM CONSUMER MILTON KEYNES MK14 7NE

16K RAM 16K RAM PLEASE STATE COMPUTER

BUSINESS & COMPUTER SERVICES

292 Caledonian Rd, London N1 1BA
Tel: 01-607 0157 (24-hour Answering Service)

We are
Micro-computer Consultants & Programmers

- and specialise in industrial & commercial programs written to clients' specifications.

VAT & Post incl.

Cash Analyser £20.00

Vehicle Cost Analyser £25.00

Book Keeping (min 48k & 2 drives) £150.00

Please ask us for fuller details of the above. All are disk based for the TRS-80

Model I or III. Please state your DOS when ordering. Apple II versions soon.

PROGRAMS



```
638 DATASaftey and security,the triumph of force
639 DATAResourcefulness and enthusiasum,unreasoning but intuitive
640 DATAFertility physically and mental,t.virility and passion
641 REM REVERSE *****
642 DATAImpulsive action can cause problems,weakness of will
643 DATAProblems through emotional instability,domestic upheaval
644 DATAFailure of ambition,Immaturity,misinformation.Bad advice
645 DATADanger of moral lapse,overbearinssness,Ruthlessness
646 DATAInjustice.Bias,refusal of sound advice
647 DATAThe closing of a cycle of fortune,surrender to unworthy impulses
648 DATAOver-reliance on the concrete mind,enforced removal
649 DATAOpposition through ineptitude,abuse of one's position
650 DATAUnnecessary suffering,rigidity of mind
651 DATAFailure of nerve,misJudgement.Fantasies
652 DATALoss.Guilt.Punishment,stationation
653 DATANegative force,love of tension and discord
654 DATAdiscord.Disorder,failure of nerve.Depression
655 DATAWeakness could result in disaster,need for continued effort
656 DATAFailure of nerve,hard work with little reward
657 DATAisolation from help,a false dawn
658 DATAdeviousness and vindictiveness,headstrons carelessness
659 DATAUnderhandedness and slander,cruelty and coldness
660 DATADespair.Loss of faith,dissent.Jealousey
661 DATAUnbridled passion,excesses of all kinds
662 DATAMorries and anxieties,inability to adapt to change
663 DATASelf-delusion.Fantasy,restlessness and dissatisfaction
664 DATAVanity and complacency,anti-social actions
665 DATASelfishness.Surface knowledge,duplicity and fraud
666 DATAIdle fantasy.Untrustworthyness,treachery and dishonesty
667 DATAGreed,Avarice,Miserliness,inconsistency and foolhardiness
668 DATAConceit or prejudice,covetousness.Inability to delegate
669 DATALack of imagination,carelessness with money
670 DATASelf-induced money worries,the misuse of skills
671 DATASuccess on others misfortunes,the restricting effect of tradition
672 DATADull-wittedness.Idleness,lack of foresight.Smugness
673 DATANarrow mindedness.Extravaganace,dullness and weakness
674 DATAOver-confidence and greed,unbridled ambition
675 DATAFrustration with reality,decadence and snobbishness
676 DATAavoidable litigation,news delayed
677 DATAIndecisiveness I think?,wasted brilliance
678 DATAObstrancy and suspicion,deceit and suile
679 DATASlanderous gossip,wilful destruction of order
680 DATAOverbearingness and a cruel wit,lacking in feelings.Autocratic
681 STOP
682 GOSUB160
683 PRINT"#####Do you wish to.":PRINT
684 PRINT"#####(1)See the cards again.":PRINT
685 PRINT"#####(2)Try another spread.":PRINT
686 PRINT"#####(3)Finish the readings."
687 GETX:IFX$=""THEN687
688 XR=VAL(X$):IFXR=1THEN=DR:GOTO94
689 IFXR=2THEN61
690 GOSUB160
691 PRINT"#####Thank you for your valued enquiry"
692 PRINT"#####Do come again and I#####brins some money"
693 PRINT"#####next time"
694 FORU=1TO3000:NEXT:GOTO699
695 B=52000+FNA(500):IFPEEK(B)>200THEN695
696 E=FNA(2):IFE=1THENJ=A
697 IFE=2THENJ=A+78
698 POKEB,J:RETURN
699 PRINT"##"
700 PRINT"
701 PRINT"
702 PRINT"
703 PRINT"
704 PRINT"
705 PRINT"
706 PRINT"
707 PRINT"
708 PRINT"
709 PRINT"
710 PRINT"
711 PRINT"
712 PRINT"
713 PRINT"
714 PRINT"
715 PRINT"
716 PRINT"
717 PRINT"
718 PRINT"
719 GOSUB721
720 END
721 TEMP04:MUSIC"AS#CS#D#E#F#G#H#I#J#K#L#M#N#O#P#Q#R#S#T#U#V#W#X#Y#Z#0#1#2#3#4#5#6#7#8#9#.#$%&'()*+,-./:;=<=>@#CBAS'D2R0'D1'E2'D'#C3E'#C7"
722 PT=53703:POKEPT,0:POKEPT-39,119:POKEPT-40,67:POKEPT-41,118:POKEPT-80,71
723 GOSUB736
724 POKEPT-39,0:POKEPT-40,0:POKEPT-41,0:POKEPT-81,86:POKEPT-80,67
725 POKEPT-79,66:POKEPT-120,71:GOSUB736
726 POKEPT-81,0:POKEPT-80,0:POKEPT-79,0:POKEPT-120,67:POKEPT-161,78
727 POKEPT-160,71:POKEPT-159,78:POKEPT-158,77:POKEPT-118,66
728 GOSUB736
729 POKEPT-121,86:POKEPT-120,0:POKEPT-119,67:POKEPT-161,78:POKEPT-160,77
730 POKEPT-159,71:POKEPT-158,78:POKEPT-118,0:POKEPT-157,77:POKEPT-117,66
731 GOSUB736
732 FORU=0T06
733 POKEPT-121,66:POKEPT-117,86:POKEPT-155,66:POKEPT-151,86:GOSUB736
734 POKEPT-155,86:POKEPT-151,66:POKEPT-121,86:POKEPT-117,66:GOSUB736
735 NEXT
736 FORA=0T0100:NEXT:TEMP07:MUSIC"AI"R1G1#":RETURN
```



BIRMINGHAM

Software support person needed by established microcomputer company. CP/M and assembly language essential. Apple knowledge desirable.

Apply:
Westwood Computers Ltd.,
117 Tennant St.,
Birmingham
B15 1E7
021-632 5824

NEC PC-8000

Come and see Japans best selling micro
A.N.AUDIO
37 KING ST., ROYSTON, HERTS and
46 MARKET SQ., ST. NEOTS, CAMBS.
TEL: HUNTINGDON
(0480) 72071



Meanwhile, Chris Horseman was looking at the lighter side of computing.

As a games designer, I was particularly interested to see what was new on the games scene. The vast majority of new American games fall into the 'arcade' category, although the original fervour for producing copies of 'Space Invaders' has largely died down. Most games producers have finally come around to the idea that arcade games need to be in machine language. We are thus seeing better use of graphics and a generally more professional standard of quality. There are still more games available for the Apple than for any other system, though this is largely due to the time it has been on the market. Most of the top games are now being converted for the Atari (eg, Raster Blaster and Apple Panic), but these conversions do not usually take advantage of the superior graphics capability. There is still much copying of ideas for games with a sort of 'goldrush fever' surrounding Pacman. I saw perhaps ten versions, each with their own strong points and improvements but still copies. This has finally aroused some copyright action from Atari who bought the rights for the game from the designers. There have already been some minor court proceedings over Pacman but no one has been successfully sued yet.

There were some excellent new games on show and some people are beginning to stand out as producers of games software. Possibly the most noticeable of these was Scott Adams Inc, who had a large mock castle set up in the windows. Scott has a large (and still growing) range of software available for all of the popular machines including his increasingly famous adventures. These have been recently enhanced on the Apple by the addition of colour graphic illustrations and a 'voice track' which can be used if you own a Vocoder. The graphic adventures should soon be available for the Atari.

Nasir Gebelli's company Gebelli Software Inc is one of the newer US software producers, and to judge by the high quality of the games will become one of the majors very soon. Nasir (who I believe used to program for Sirius) is producing a range of arcade type games for the Apple and Atari which should be available in this country soon. The

games include a high quality racing car game for the Atari called Match Racer.

One of the most original games that I saw was the Swashbuckler by Datasoft; this is a simple game but has stunning animation. In the game you control a man with a sword and must fight off a series of piratical and animal opponents whilst descending through the decks of a pirate ship. Swashbuckler runs on Apple II. Datamost also produces a range of other games including the obligatory Pacman-type game called in this case Snack Attack; all Datasoft's programs so far are for the Apple.

Broderbund produce software for the Apple, Atari and TRS-80. This includes an excellent pinball game called David's Midnight Magic for the Apple (and shortly for the Atari); also a very compulsive game called Apple Panic. This is a 'man with a hammer' game, and also involves knocking rampaging apples through floors (honestly!). This is also available for Apple and Atari. Their TRS-80 games are less arcade-oriented and include Galactic Empire and Galactic Trader.

On-line Systems produce highly polished and professional games for Apple and Atari, including Jawbreaker — which is arguably the best Pacman-type game. Mouse Attack is an excellent Pacman-inspired game with additional features such as two-player option. On-line are also producing a version of the arcade game Frogger for the Atari which looks remarkably close to the original. They are also producing a mammoth graphic adventure called Time-Zone which is retailing for a hundred dollars and is reckoned to take over a year to play. (Does this mean that it will be obsolete by the time you finish it?)

Sirius Software produces games for the Apple II with excellent cover art work and some amazing captions on the games. The games don't look bad and were certainly attracting interest from the crowd. Titles include Hadron, Space-Eggs and Cops and Robbers.

One company producing solely for the TRS-80 is Big Five Software, which makes imaginative use of the limited graphics facilities. It produces six games, including Supernova and Robot Attack, which has voice sound.

Automated Simulations continues its EPYX adventure range with Crush, Crumble and Chomp. Datamost was showing an original game called Tumble Bugs (or sometimes Dung Beetles), which uses an unusual 'lens' effect to magnify part of a maze on the screen and has some simple voice synthesis.

GO TO Page 187

INCREASE INCOME

using "Midas", a successful inflation beating user friendly program written for a

3032/4032 (32K) PET

Test this £55 program for only £2.99, and confirm that MIDAS & PET make MONEY. All we ask is that within 21 days, you either pay the balance of £52, or simply return the original cassette and owe nothing more.

Amron, 21, Grosvenor Road,
Birkdale, Southport. PR8 2TG

PET UPGRADE

We can upgrade your large keyboard PET at a fraction of the 'New Price' difference.

8K to 16K £44.00
16K to 32K from £56.00
8K to 32K £69.00

NO EXTRA CHARGE

If expansion area drilled with quarter inch holes . . .

All new RAMs fitted with sockets
Fast 2 hours while you wait service.

Tel: Mick Bignell
01-953 8385.

MICROMART

AIM 65

EPREL . . . CONSISTS OF TWO PROGRAMS LOCATED ON THE SAME 2K EPROM AND DESIGNED FOR USE WITH AN INTERFACE (WHICH WE SUPPLY) PLUGGED INTO THE J1 CONNECTOR OF THE AIM 65. THE TWO PROGRAMS ARE:-

EPROM. . . FOR BURNING 2K(2716 - 5V) AND 4K (2532 - 5V) EPROMS. IMMEDIATELY AFTER BURNING THE EPROM CAN BE CHECKED AND READ INTO MEMORY IF THIS IS REQUIRED.

RELOC. . . FOR RELOCATING PROGRAMS (INCLUDING EPREL) PRIOR TO USING EPROM. THE PROGRAM INCLUDES A VERY CONVENIENT "OFF SET" OPTION ALLOWING USER CHOICE OF FINAL EPROM ADDRESS RANGE.

* BOTH PROGRAMS ARE USER FRIENDLY ALLOWING FAST CHOICE BY SINGLE KEY RESPONSES LISTED IN AN ACCOMPANYING MANUAL.

* STARTING ADDRESSES FOR EPREL INCLUDE D000. . . AIM 65 ASSEMBLER SOCKET B000. . . AIM 65 BASIC SOCKET OR ANY OTHER CHOICE. WHEN ORDERING PLEASE STATE REQUIRED STARTING ADDRESS. THE DEFAULT OPTION IS D000.

* THE INTERFACE CARD SUPPLIED HOLDS THE TARGET EPROM IN A QUICK RELEASE ZERO INSERTION FORCE SOCKET. NO SOLDERING — YOU CAN BE BURNING YOUR FAVOURITE PROGRAMS INTO EPROM WITHIN MINUTES OF RECEIVING EPREL.

PRICE £45 INC. INTERFACE CARD, EPREL ON 2K EPROM, MANUAL — P/P AND VAT.

ORDERS TO:-

PEACH COMPUTERS LTD

192 GREENOCK ROAD,
LARGS,
AYRSHIRE
24 HOUR ANSWERING SERVICE
0475 (LARGS) 873768

ZX81 owners

Protos



Keyboard is here!

At last! A real, full size keyboard in a top quality case for your ZX 81.

Simply unscrew your ZX 81 printed circuit board from its black Sinclair case and plug into Protos.

FULLY BUILT £64.95 inc. VAT.

- More accurate, faster typing with bigger and real keys.
- 40 colour coded key-tops for easy reading
- Robust, 'big' computer construction
- PCB prepared for more add-ons to come
- New edge connector provided for Sinclair and other manufacturers' peripherals
- Key legends can be changed for future new ROM functions
- Sinclair PCB fully enclosed — and room for much more

If you feel you've outgrown your ZX 81 don't sell it for peanuts and move to another system. Add it to Protos and make your ZX 81 grow.

For details, large SAE, please. For orders add £2.50 post and packing. Cheques to 'Frome Computing'.

Protos Computer Systems

Frome Computing, 20 Ashtree Road,
Frome, Somerset, BA11 2SF.



ZX 81

THE INCREDIBLE GULP (16K)

GULP Smash hit game for all ages as seen at the ZX fairs. £6

SHOPWINDOW exciting new display system using 'window' language. £7

DATABASE business system for mailing lists, many other uses — already the standard work for ZX81. £10

All use machine code to make them hum, and are delivered on tape with full documentation. SAE for catalogue.

CAMPBELL SYSTEMS Dept PCW
15 Rous Rd, Buckhurst Hill, Essex IG9 6BL.

MICROMART

TRS80 Models I+III and VIDEO GENIE

Turn your



Into one of these

Announcing ACCEL3 — the practical BASIC compiler for home, education, or business.

Are you troubled by gradual graphics, languid loops, tedious table searches, or capricious keyboard response? ACCEL3 is the cure. Highly compatible with interpreted BASIC — correct programs compile without modification.

On Tape or Disk £49.95

southern software

PO Box 39, Eastleigh, Hants, SO5 5WQ

SEARCHING FOR 'BEST PRICE'

FOUND 'BEST PRICE' . . . GOTO		OUR PRICE
PET	RRP	PRICE
C2N TAPE	£55	£35
4016 16K	£550	£467
4032 32K	£695	£590
8032 32K	£895	£760
8096 96K	£1195	£1015
DISK DRIVES		
2031 170K	£395	£335
4040 343K	£695	£590
8050 1M	£895	£760

PRINTERS		
4022P 80COL	£395	£335
8023 136COL	£895	£760

VAT TO BE ADDED @ 15%
CARRIAGE — £5 PER ITEM
IF YOU KNOW WHAT YOU WANT WHY WAIT?

THESE ARE THE PRICES YOU NEED

ORCHARD COMPUTER SERVICES

Orchard House, 21 St Martins St
Wallingford, Oxon
Tel: Wallingford (0491) 35529
Open 6 days per week



EPSON MX80 & MX100 PRINTER RIBBONS RE-INKED

A new Epson ribbon costs around £10. We will re-ink your present ribbon for £5 inc p&p and VAT.

Epson make printers under other names. If you have an MX80 based printer, we can re-ink your ribbon too.

Cash with order. Cheques made payable to, Douglas Recordings.

Send your ribbon in its cartridge to:

DOUGLAS RECORDINGS

2 Glebe Park, Dumbarton, G82 3HF
Telephone (0389) 64384

NOT CALCULATOR CORNER

Continued from page 99

character (whatever the size) increments. In text mode the printer can LLIST programs and print manual calculation results as well as program ones.

In GRAPH mode the paper is mapped with a coordinate grid with 220 units on the X-axis across the paper. The origin can be set to the current pen position by the SORGN command and the pen placed anywhere without drawing by GLCURSOR [X,Y]. If a point off the paper is specified, no error results; if neither coordinate exceeds +/-2048, the pen merely stops at its limit. LINE draws between any number of pairs of points, so a whole polygon may be drawn in one statement; its parameters include the colour and any one of 10 styles of dotted and dashed line! RLINE behaves in the same way but draws relative to the current pen position rather than the origin. With these few but powerful and well-conceived commands almost any type of plot can be produced (curves are approximated by polygons with short sides; when the side is less than 10 units the illusion of a smooth curve is achieved. Text can be added to plots, so you can label graphs and diagrams. The whole system works so well that one must be very hardboiled indeed not to emit some sort of 'wow!' on seeing it in action.

The cassette interface function of the CE-150 allows for two recorders, one input and one output, to be remote-controlled by a program so that automatic data processing and storage can be performed, or large segmented programs run with storage of results. The side of the unit sports a 60-pin expansion bus socket for the connection of future peripheral devices.

Documentation

The good news is that most of the manual is written by an American and is in a comprehensible, English-like language for a change. The bad news is that he has a dreadful, coy sense of humour which makes me want to barf, upchuck or otherwise lose my lunch. However, it does cover most of what you need to know with the notable exception of PEEK and POKE and some of the STATUS values. The section on the cassette operations is definitely in the venerable Japanese tradition, with a terse and original syntax which often defies understanding, and the documentation of the 80 error messages often does not correspond to reality; I have seen an Error 203 once or twice. The

program library contains all the old maths and engineering favourites plus a game called 'Mole Banging' which is not in my edition of Krafft-Ebing.

Expansion

Sharp has promised for this year, in addition to an 8k RAM module, an RS232 interface and a touch-sensitive pad with 150 user-definable keys on it. There are rumours as well of a full 132 character wide printer and a video interface. The extensive facilities will probably attract more of an independent software base than previous hand-helds and already MICROL has announced an enhanced version of its Procos and a package of plotting and charting routines for the 1500.

Conclusions

The PC1500 is a real *tour-de-force* which, at its price of £150, or £375 for the whole system (11k), is going to make life difficult for competitors. For scientific and engineering, or even some business applications which demand portability and sophisticated hard-copy records, it is very attractive. To maximise its appeal in the scientific area, though, some sort of instrument interface would be advantageous and possibly ROM software for complex statistical and other calculations; the design of the machine leaves the road wide open to both of these possibilities. As to its power as an executive toy/psychological weapon, it is bound to cause gaping mouths wherever it is wielded. And it's a hell of a lot of fun to play with, too. **END**

PCW BENCHMARKS

BM1	15
BM2	70
BM3	121
BM4	122
BM5	178
BM6	293
BM7	383
BM8	51

CALCULATOR BENCHMARKS

	Time	% mem used
HP41CV	37 secs	3.5
Sharp PC1211	52 secs	5.9
Casio fx702p	20 secs	4.6
Sharp pc1500	13 secs	1.2

CONSULTANT ELECTRONICS

VIDEO GENIE COMPUTERS
Books — C10 Cassettes — Disks

Your own 'Basic' Genie /
TRS80 Programs listed.

Vic 20, ZX81, Genie, TRS80
Software.

59 Mason Road, Erdington,
Birmingham. Tel 021-382 7247

UNIQUE TELE-CRYSTAL

WORLD PATENTED
REDUCES GLARE
AND
REFLECTIONS BY UP TO 90%

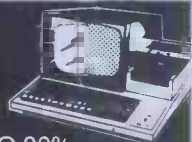

INCREASE OPERATOR EFFICIENCY

- * Specially formulated for VDU and TV Screens
- * Reduces Screen Static
- * Increases operator efficiency by reducing eye strain
- * Will not harm screen surface
- * Recommended installed price £18 for up to 26" screens

DEALER & O.E.M. ENQUIRIES WELCOME
STATIFLECT - GUARD, 55 FAIRBURN DRIVE, GARFORTH,
LEEDS LS25 2AR. TEL: (0532) 864981 (24hrs)

Bill Budge's Raster Blaster has been available in this country for some time, but only for the Apple II. This game has just been released for the Atari, although the colours don't come out well on the British television system. Bill received *Softalk* magazine's game of the year award for this game, and I was astonished to see that Bill is only 19, although an old man of the software industry.

On the subject of awards, Chris Crawford, head of Atari's games research group won the Creative Computing game of the year award for his innovative and excellently engineered Atari war game *Eastern Front*.

The only British contributions to the games software market that I saw were my *Darts* and *Pool* produced by Thorn

EMI! These are being distributed by Creative Computing and were drawing a good deal of interest from the crowd.

It's worth mentioning the huge discrepancy in the price of software between the US and the UK. In the US, games prices range between \$12.95 and \$34.95, while in the UK, prices are between £12 and £29. An additional factor in this is that most software in the US is produced on diskette, which is more expensive than the tape used in many cases here. I originally thought that this was a result of shipping costs but even British software is much cheaper in the US. One can only hope that as the market here expands the prices will drop to sensible levels and so reduce the incentive to make pirate copies. **END**

BOOK FARE

Continued from page 110

versus the drive of the technology and marketing forces to override individuality — which is more striking in the end than Kidder's analogy between computers and cathedrals.

His desire to depict West as the hero leads Kidder to allow criticisms to be made but not to be explored. Many problems arose, both technical and personal, which derived from West's personality and management style. In the end he delivered the goods, but a more objective assessment of West would have been fairer.

Finally, Kidder fails to question his own role. Data General let him sit on the project for most of its duration, although it became worried towards the end because of security reasons.

One of the main motivations of the Eagle team was that the project was backed by de Castro and would be seen to a conclusion, when other projects they had worked on had been scrapped.

Obviously, Kidder's presence contributed to that sense of importance and of excitement. This is a relatively minor criticism but I think that the role of the reporter on TV or in written journalism is important when the end product presents itself as an objective report.

My criticisms are therefore on broader issues than Kidder's original objective. And he does at least mention aspects which I feel he did not investigate properly. It is, however, a book well worth reading. And what is more, it is as enjoyable and unput-downable as a good thriller. **END**



BLUDNERS

In the March edition of *Calculator Corner* it was erroneously stated that the Casio FP-2 is a 'dumb' printer. Subsequent investigation reveals that there is in fact an IC for decoding on the reverse side of the board, in fact the printer works with the 502, 602 and

702 without the FA-2 adaptor being present.

In the April edition of *Newsprint* we gave the price of the CP/M add-on for the Hewlett Packard HP-87 as £927; this was an error in the press release and the correct price is £354.

CENTRONICS

Qualified dealers
LOW PRICE PRINTERS
 Model 737 Letter Quality Printer
 Parallel £339 RS232 £389
 Model 739 plus high res graphics
 (74x72 dots per inch)
 Parallel £439 RS232 £485
 Add £7 carriage & 15% VAT
 SAE for data sheets

SCREEN-SCENE
 144 St George's Road, Cheltenham
 Glos, Phone (0242) 28979

Access/Visa orders accepted

:GO FORTH

Complete DIY FORTH kit
 1) Installation manual £10
 How to do it + definitions + editor
 2) source code listing for one processor.... £10
 6502, 6800, 6809, 8080, 8086/8088, 9900,
 1802
 manul + one listing £19
 Dual 8" disc drives £525 + VAT
 2 x 8" single-sided double-density Shugart
 drives + box + PSU + intelligent controller



MicroProcessor Engineering Ltd
 21 Hanley Road Shirley
 Southampton SO1 5AP
 Tel: Southampton 775482

MICROMART

DISCS ETC

VERBATIM double-density 40-track	£18.00
VERBATIM double-density 77-track	£25.00
ACCUTRACK double-density 40-track	£16.00
Ribbons for CBM 3022/Epson TX80	3 for £ 4.90
Cartridge for CBM 4022/Epson MX80	£10.00
Refill for above	3 for £ 9.00
Disk library cases (hold 10 disks)	£ 2.75
Disk storage pages (hold 2 disks)	£ 0.50
Dustcover for small screen PET/CBM	£ 4.50
Dustcover for large screen PET/CBM	£ 5.75
Dustcover for 3022/4022/3040/4040/8050	£ 3.50
PET to IEEE 2-metre cable	£32.00
IEEE to IEEE 2-metre cable	£32.00
Perspex green screen for PET	£ 7.50
As above, for large screen models	£ 9.50
Cassette cleaner & demagnetiser kit	£ 7.50
Basic 4.00 Commodore Users Manual	£ 5.00
Power on/error indicator 3040/4040	£17.50
PET REVEALED or LIBRARY OF SUBROUTINES	£10.00
PET GRAPHICS (book) £12.00 (disk)	£10.00
PETMASTER SUPERCHIP (state model)	£45.00
ARROW fast loading chip (state model)	£30.00

PET GAMES

SUPER GLOOPER, METEORITES 8k	each	£ 8.00
ASTERIODS, SPACE RESCUE 8k	each	£ 8.00
HITCHHIKERS GUIDE TO THE GALAXY 32k		£16.00
CRACKS OF DOOM (Lord of the Rings) 32k		£16.00
HALLS OF DEATH 16k		£14.00

ADD 15% VAT (except books) — POST FREE IN UK

SUPERSOFT

Dept. P3, 10-14 Canning Road
 Wealdstone, Harrow, Middlesex
 Tel: 01-861 1166



PUBLIC APOLOGY

We would like to apologise for our extremely low prices but we can't help it. Our 5 1/4" Library Cases really are only £1.90 each; our MX80/Commodore 4022 ribbons are only £5.95 each; our BASF SSSD 5 1/4" discs are only £15.00 per ten; our Verbatim Datalife SSSD discs are only £17.00 per ten; our 11" x 9 1/2" Listing Paper is only £10.00 per box of 2000 sheets; our mailing labels start from £7.00 per 1000 labels; and we could go on. In fact you would be hard put to find better value for money than ConSup when you need consumables for your computer.

We would also like to apologise for having two of the best 4K Eproms ever developed for the Commodore PET. "BASMON" is an assembler and disassembler with extended monitor functions including interrupt driven M/C Trace; Hex/Dec Convert; Dump; Screen Dump; and many more. "PLUSDOS" has all the usual functions such as Auto-Number; Renumber; Find; as well as many new ones including Join and Merge new programmes. Both chips reside inside the PET and are outstanding value at £35 each or both for £65. (Dealer enquiries welcomed).

We faithfully promise to continue to give good value and reliable service. We've always sold the Commodore system and now we can also supply the new SIRIUS I — Circle the number below and we'll rush you details. Alternatively, write or phone us today.

ConSup

62 Tritton Road, London, SE21
 Tel: 01-6704411 (40 lines)

(One last apology — prices do not include VAT or P & P so check with us first).

Announcing the

UK 101 DONKEY

The amazing new programme writer that takes the slog out of your graphic listings. Draw your display/design, etc. quickly and easily in plotting mode. Then sit back & let DONKEY write & save the programme, commencing at any number, any increment.

- * Super plotter with full editing facility & protection against accidental rebut.
 - * Commands include: store, restore, edit, write/save, rebut, clear screen, etc.
 - * Runs in 4K (MON 02 only)
- Cassette and user manual £15.95 inc p&p. Also available: 'How To' cassettes at £5.95 ea. Graphics 1 covers: orbiting planets, homing missiles, on-screen explosions, and more. Graphics 2 covers: large figures/letters, simulation/animation, digital clock, and more. Both above are in two complete 4k sections.

Super pack — all 3 cassettes only £24.95 inc.

OF US 2 (Software), 525/531 London Road, Westcliff on Sea, Essex. (0702) 42339.

BACK ISSUES SERVICE

Here is a complete guide to all available back issues of *PCW*. A quick guide to their contents is shown below. Check the coupon overleaf for the issues you require.

HP-125: Vol 5 No 3



Volume 1 No 1, 1978
The 77-68/Practical hints on kit building/Nascom 1/Charity case study/Flowcharting/Pontoon flowchart

Volume 1 No 2, 1978
Kit building/Basic — first steps/Case study — a software house/PET 2001/Research machines 380Z/School computing/E78 — Europa Bus.

Volume 1 No 3, 1978
More efficient programs/Cosmac 1802/The PDP11 Part 1/Small business computing — an approach/The 280/EPROM programmer construction.

Volume 1 No 11 March 1979
SYM-1/Mk14/IEEE-488 Bus/Motorola 6809/Small computer networks/TMS-9900 homebrew.

Volume 2 No 1 May 1979
Chess programming/Using a small business computer Part 1/Smart 1/In defence of PET/3D Noughts & crosses.

Volume 2 No 2 June 1979
Different computer languages/(MSI) 6800/Using a small business computer Part II/Demonstrations using the Apple II Part I.

Volume 2 No 3 July 1979
Basic or Pascal?/The Sorcerer/Z8000/Chess programming/Graphics for the TRS-80/Apple-Visio — part II/

Volume 2 No 4
Apple medical application/North Star Horizon/Word processing/High speed cassette interface/Sorting/Buying a computer for a small business

Volume 2 No 5 September 1979
Benchtest: Compucolor II/Checkout: Heuristics Speech Lab/Testing Precognition/Pascal series — Part I/Programs: 6800 Time response, Apple memory test, Fx 201p spaceship, PET Orbit sim, PET digital clock, Acronyms.

Volume 3 No 6 June 1980
Benchtest: Tandy TRS-80 Model II/Benchtest: Sintrom Periflex 630/48 / Staff case study/Checkout: Softy Intelligent EPROM Programmer/Checkout: Exatron Stringy Floppy/Practical examples of the IEEE-488 bus use/UK101 Nedge/PET Horse Race/Basic & PET Renumbers/UK101 Dogfight/Mk14 frequency counter/Basic Maths Test/PET Sweeper.

Volume 3 No 12 December 1980
Benchtest: Microwriter/Printerfacing: Series — Part 1/Sharp PC-1211 speed-up/Programs: TRS-80 Tarot, PET Cat & Mouse, PET Rebound, MZ-80K Alligator Swamp, PET Connect, UK101 Minefield, PET Simon
Benchtest: Raandnd SP1

Volume 4 No 1 January 1981
Benchtest: Transam Tuscan/Real-time control using trains — part 1/Recover from a data tape disaster/PET Music/Multi-user systems — part 1/Programs: TRS80 Four in a row, TRS80 Target Practice, PET Convoy, PET Wire, PET Maze Chase, PET Android Attack, PET Anagram

Volume 4 No 3 March 1981
Benchtest: Onyx C8002/Benchtest: Bigboard/Micro music software package/ALC circuit/Commons report/HP 34C/Programs: TRS80 Show Jumping, PET Grand Prix, PET Aircraft landing, PET Bouncy.

Volume 4 No 5 May 1981
Benchtest: Pasca 640/WP Benchtest: Magic Wand/PET colour/Low-cost digital tape system/Using calculator printers on micros/Apple music-making/Multi-user Benchtest: MVT-Famos/Programs: PET Grand Prix, PET Aircraft Landing, PET Bouncy.



Volume 4 No 6 June 1981
Benchtest: NEC PC-8001/Multi-user Benchtest: MP/M/Benchtest: Sinclair ZX81/West Coast Faire report/Radio Teletype/WP Benchtest: Wordpro 4 Plus/Budget tape interface/Further Casio quirks/Programs: UK101 Zor, PET Chords.



Volume 4 No 7 July 1981
Benchtest: Sharp PC-3201/Multi-user Benchtest: Acorn Econet/Case study: Accident investigation on TRS-80/Zilog Z8 family/WP Benchtest: Format-80/Pascal Benchmarks: readers' letters/Quicker Casio computations/Programs: ZX80 Sliding Letters, UK101 Car Rally, TRS-80 Calendar, UK101 m/c code to Basic converter, PET Exam Questions, MZ-80K Designer, ZX81 Sketch Pad.



Volume 4 No 8 August 1981
Benchtest: Tandy Model III/Viewdata update/WP Benchtest: Spellbinder/Printer survey/Microholism/Programs: ZX80 Othello; Easter Sunday; Apple Mondrian; MZ-80K Duck Shoot; PET Gomoku; MZ-80K Football.



Vol 4 No 9 September 1981
Benchtests: Tandy Color Computer, Commodore VIC/Checkouts: Hi Tech Speakeasy, Tantel/ Multi-user Benchtest: HMSOS/WP Benchtest: Memorite III/Word proc program for PET/Apple dealership run by spastics/Printerfacing extra/Calc Corner: Casio fx602p review/Programs: PET Arithmetic test, ZX80 Eldorado, 380Z Memory test.



Volume 4 No 10 October 1981
Benchtest: OKI if-800/Checkouts: Heuristics speech link, Softy 2/Calc Corner: Texas TI51-III/Jeff Taylor on computer literacy projects/Introducing TJ's Workshop/Control Your Own Substation pt 1/Programs: TRS-80 Sailing



Vol 4 no 11 November 1981
Benchtests: Osborne 01, IBM Personal Computer, Checkout: Sharp IQ3100 Microtranslator, Calc Corner: Casio fx702p, PCW Show report, Benchmark Summary, Euro Micro Chess Championship report, Programs: TRS-80 Sheepdog trial, ZX81 Sun and Planets.

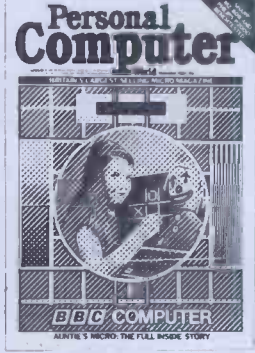

Vol 4 No 12 December 1981
Benchtests: Sharp MZ-80B Philips P2000/School network/ BBC Micro inside story/ 'Turtle' Graphics for Apple/ Forth language/ Curve fitting/ Calc corner: HP14C review/ Programs: PET Fantasy, ZX81 Battleships and cruisers.

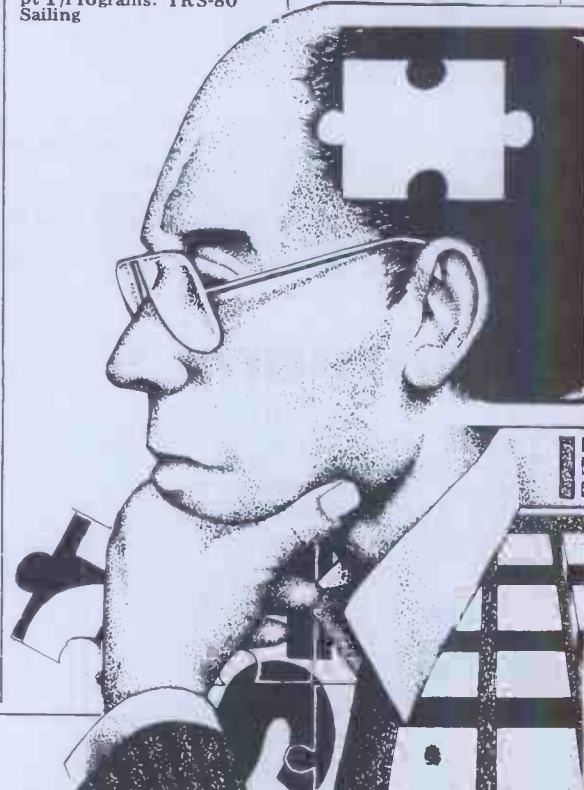



Vol 5 No 1 January 1982
 Benchtests: BBC Micro, Xerox 820/Frames of Reference (new series), ZX81 Printer Checkout/Digital Drummer for PET/Calc Corner: Benchmarks/Programs: MZ-80K Fortune, TRS-80 Reaction Timing, ZX80 Laybrinth, Apple Letters.



Vol 5 No 2 February 1982
 Benchtests: Sirius-I, Casio fx-9000p, Gemini Multiboard/Word Processor Benchtest: Scripsit 2.0/Plotter Checkout: Watanabe/Hardware feature: High Density VDU card project/Music system: FREQUOT/Calc Corner: Aerial Navigation/Programs: Pet Haemophilia, Pet Cheese, TRS-80 Extra, Sharp PC1211 Exam, Personality test.



Vol 5 No 3 March 1982
 Benchtests: Texas Instruments 99/4A, Hewlett-Packard 125/Choosing a Database/Compsort DMS reviewed/Screenplay (new series)/Calc Corner: Hewlett-Packard Interface Loop/Programs: TRS-80 Solitaire, TRS-80 Ducks, Nascom Business Documents, MZ-80K Race Chase, ZX81 Graphplot.



Volume 5 No 4 April 1982
 Benchtest: Monroe OC8820/DB Benchtest: FMS-80/Checkout: Sid 1/Generating screen forms/Comal/Logo/Brain Dump-New series/Calc Corner: Casio FP-10 printer/Programs: TRS-80 Maths & Trig, PET Boot the Cat, ZX81 Resistor & Res code.

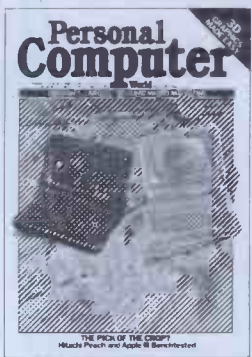

Vol 5 no 5 - May 1982
 Benchtests: Apple II, Hitachi Peach/Database Benchtest: dBase II/3D Graphics Made Easy/Equation Solving/Calc Corner: fx 602 quirks/Programs: PET Mini-Animate, MZ-80K Catch, Apple Maze, Atari Sums For Kids, ZX81 Book Index, PET Stockmarket, Microtan 3D Rotation, Extra for MZ-80K, UK101 Crossword Notepad.

BACK ISSUES CENTRE

We have a complete selection of all available PCW back numbers in our flashy new Back Issues Centre in the West End of London, just half a minute's walk from Oxford Street (close to Tottenham Court Road tube station). Of course, you could order them from our excellent mail order service using the coupon below, but by visiting in person you save on postage costs. The Back Issues Centre also often has back numbers of PCW on sale which we cannot offer through the mail order service because of shortage of stock. Our receptionists will also be happy to sell you a set of binders or take your subscription. And there's a range of interesting computer books on sale as well.

Drop by next time you're in the West End. We're open Monday to Friday, 10am to 6pm, The address is 14 Rathbone Place, London W1.

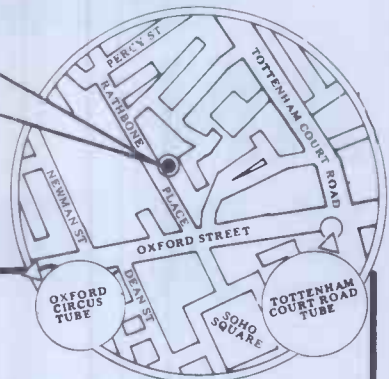

COME UP AND SEE US..



DESK TOP COMPUTING

A COMPREHENSIVE GUIDE TO SUCCESSFUL BUSINESS AND PROFESSIONAL MICROCOMPUTING

Send £2.25 to Desk Top Computing Offer, 14 Rathbone Place, London W1P 1DE. Cheques should be made payable to *Personal Computer World*.

PCW BINDERS

Strong, durable, attractive yellow PCW binders — £3.95 each, including postage and packing. See coupon below.

Any one issue £1.50; all additional issues £1.00 each. Binders £3.95 each. All prices include post and package. *Overseas orders requiring Air Mail postage add £1.00 per copy. Cheques/P.O. payable to (PCW) Sportscene Publishers Ltd, 14, Rathbone Place, London W1P 1DE. Please allow

up to 3 weeks for delivery and don't forget to state your name and full address with your order. Please send me the following copies of PCW. I enclose a cheque/P.O. for £. . . Please tick appropriate boxes.

Volume 1	Volume 2	Volume 3	Volume 4	Volume 5
1 <input type="checkbox"/> 2 <input type="checkbox"/> 3 <input type="checkbox"/>	1 <input type="checkbox"/> 2 <input type="checkbox"/> 3 <input type="checkbox"/> 4 <input type="checkbox"/> 5 <input type="checkbox"/>	6 <input type="checkbox"/>	1 <input type="checkbox"/> 3 <input type="checkbox"/> 5 <input type="checkbox"/> 6 <input type="checkbox"/> 11 <input type="checkbox"/>	1 <input type="checkbox"/> 2 <input type="checkbox"/>
11 <input type="checkbox"/>	Binder <input type="checkbox"/> DTC <input type="checkbox"/>	12 <input type="checkbox"/>	7 <input type="checkbox"/> 8 <input type="checkbox"/> 9 <input type="checkbox"/> 10 <input type="checkbox"/> 12 <input type="checkbox"/>	3 <input type="checkbox"/> 4 <input type="checkbox"/> 5 <input type="checkbox"/>

Name _____ Address _____

PERSONAL COMPUTER WORLD

BINDERS



AN EXPANDING BUSINESS!

We heard you!! The size of *Personal Computer World* has been growing at such a rate that our Mark II binders just couldn't keep pace. Twelve issues used to fit very comfortably into a binder, but now it's too much of a squeeze.

Enter our Mark III binder. Bigger and stronger. We've widened the spine to allow twelve issues room to breathe. We've added strength to the back of the binder to carry the additional weight. And we've done it without resorting to the metal rod system of binding magazines . . . a system which causes problems if the rods bend.

PCW Mk. III binders are still attractively bound with the logos of the magazine printed in gold on the front and spine. They keep your back issues of *PCW* in pristine condition and discourage other persons from 'borrowing' your copies. They lie completely flat, even when full, to allow ease of reading and reference. And they come mailed to you in a specially designed protective pack to guard against any over-enthusiasm on the part of the Post Office delivery system.

All in all, they represent exceptional value at £3.95. (A price below that charged by many competing magazines. Indeed, we know of several organisations who keep *all* their back issues of computing magazines in *PCW* binders because of their sturdy construction and their value for money. This is not a practise we can formally condone, but it's flattering nonetheless.) The price covers all postage, VAT and handling. Use the coupon below, or if you do not wish to deface your copy of *PCW*, send your order with remittance clearly written to the address indicated.

BUSINESS!



Please rush me..... *PCW* Mk III binders at £3.95 each. I enclose a cheque/ PO for £.....

Name.....

Address.....

.....

.....

Cheques should be made payable to *Personal Computer World*. Send this coupon to *Personal Computer World*, 14 Rathbone Place, London W1P 4DE

TWO BOOKS YOU CAN'T AFFORD TO BE WITHOUT

SUCCESSFUL PROFESSIONAL AND BUSINESS MICROCOMPUTING

We live in an age of cheap computing power.

For the first time the cost of a computer is within the reach of the small businessman, the professional or the private citizen.

But will your desk top computer be a boon or a curse?

Will it increase your profits or disrupt your workplace?

Success in computer installation depends on taking a logical approach to your task — the Systems Approach; the side of the microcomputing revolution they didn't tell you about.

Desk Top Computing, from the publishers of PCW, Britain's largest-selling micro magazine, tells you.

Lyn Antill explains, in language plain enough for the most non-technical user, the secrets of Systems Analysis.

Step by step, this book tells you how to:

Define exactly what tasks you wish your computer to undertake.

Choose the right machine for your present and future needs.

Buy off-the-peg software.

Hire and supervise a programmer when necessary.

Write program specifications tailored to your staff and working methods.

Test programs and introduce them into your business with minimal disruption.

Maintain and modify programs.

Also included are several case studies covering the installation of desk top computers in small businesses.

COMPREHENSIVE BENCHTESTS OF TWENTY-FIVE LEADING MICROCOMPUTERS

Here are twenty-five of the most popular micros in the world benchtested to the exacting standards that only PCW insists upon before going into print.

We believe that even rival publications here and in the USA will concede that PCW's Benchtests have set an industry standard which is now a byword.

Completely updated and revised by Dick Olney, *Benchtest Special* contains 164 pages of fascinating and essential information covering hardware, software, speed of operation, potential, expansion, documentation and conclusions on each machine.

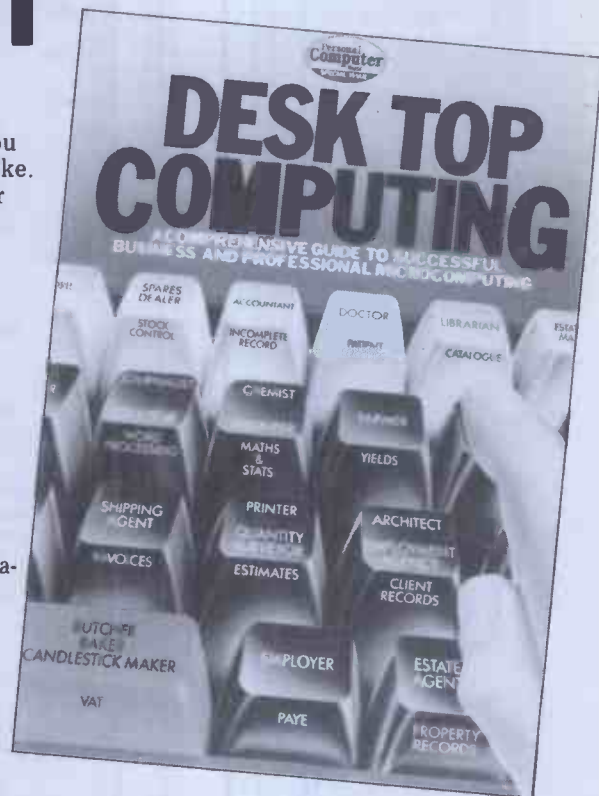

For just £1.50 you can obtain the results of hundreds of hours of Benchtesting by our skilled team of reviewers.

We are not exaggerating when we say that demand for this special issue has been enormous and we advise you to send off now, using the coupon below, before we go out of stock.



MACHINES TESTED INCLUDE:

- | | |
|-------------------|--------------------|
| ABC 24 | NEC PC-8001 |
| Acorn Atom | OKI if-800 |
| Apple II | Onyx C8002 |
| Atari 400 & 800 | Osborne O1 |
| BBC | Sharp MZ-80B |
| Computer | Sharp PC-3201 |
| CBM 8032 | Sinclair ZX81 |
| Commodore VIC | Superbrain |
| Cromemco System 3 | T199/4 |
| DAI Personal | Transam Tuscan |
| Computer | TRS-80 Model II |
| HP-85 | Tandy Model III |
| IBM Personal | TRS-80 Color |
| Computer | Vector Graphic VIP |

Please send me copies of PCW's *Desk Top Computing* @ £2.25 (inc postage) and/or copies of *Benchtest Special* @ £1.80 (inc postage).
I enclose a cheque for £. . . . payable to *Personal Computer World*,
14 Rathbone Place, London W1P 1DE.

Name
Address
.
.

The '6809' centre

RECOMMENDED SYSTEMS . . .

EX VAT INC VAT

RECOMMENDED SYSTEMS . . .	EX VAT	INC VAT
STIRLING '77-68', 6809 Based Kit System, on 8" x 8" PCB's.		
6809 CPU BOARD; 1K RAM, 2K EPROM Socket (2716), RS-232 & TTL serial interface, 8 bit parallel I/O port, 77 way bus.	10.43	12.00
VDU BOARD; 40 x 24 memory mapped, inverse characters, video output, 8 bit parallel keyboard input, 77 way bus.	10.43	12.00
CASSETTE BOARD; Kansas City CUTS standard, TTL levels, 300-2400 baud operation, 3.5" x 4.5" board.	5.22	6.00
80 WAY EDGE CONNECTORS; one required per 8" board.	5.00	5.75
78 WAY BACKPLANE; to take edge connectors.	7.83	9.00
19" CARD FRAME; to hold backplane and boards.	43.04	49.50
SM-BUG; 2K Monitor EPROM, linking CPU with VDU & keyboard.	20.00	23.00
DESIGN NOTES; construction notes & diagrams for each board.	0.87	1.00
COMPLETE SYSTEM, CPU, VDU, CASSETTE,	109.56	126.00
(Excluding Power Supply, TV/Monitor, Keyboard & Components)		
Full Range of 11 Boards Available, Including Disk Controller, Parallel Ports, Memory Boards, etc. Send for further details.		
FUJITSU, FROM JAPAN.		
MICRO-8, 6809 PROCESSOR & KEYBOARD, Twin '6809' processors, 64k RAM, 48k Colour Graphics RAM, Cassette, RS-232, Parallel Printer and Analogue Interfaces, RGB Colour and B & W Video output, 40 x 20 or 80 x 24 Screen, 32k ROM Basic, Numeric and Cursor control pad, Function Keys.	868.70	999.00
BMC RGB COLOUR MONITOR, 14" Screen, with TTL input levels. 8 pin connector supplied.	260.00	299.00
FUJITSU, DUAL 5 1/4" DRIVES, Single Density, Double Sided, with 656 Kbyte capacity. Supplied complete with adaptor for Micro-8.	1216.52	1399.00
COMPLETE SYSTEM, MICRO-8, MONITOR & DISKS,	2345.22	2597.00
SOUTH WEST TECHNICAL PRODUCTS CORP - Superb Value from the USA.		
SWTPC S/09-64K PROCESSOR, 6809 based CPU, with 64K RAM, expandable to 512K, with 2 Serial RS-232 & 1 Parallel Printer Port. Can be expanded to Multi-User system. Standard SS-50c bus.	1347.83	1550.00
SWTPC 8212 TERMINAL, 12" Intelligent Terminal, with full Keyboard & Cursor Pad. 82 x 20/24 Screen Format, Green Screen, Full Cursor Controls. RS-232 Serial & Parallel Printer Interfaces, Selectable Baud Rate.	860.87	990.00
SWTPC D-5, TWIN 5 1/4" DISK DRIVES, Single Density, Double Sided Drives, 740 Kbyte Capacity. Supplied with Flex9 Operating System for S/09-64K.	1129.57	1299.00
COMPLETE SYSTEM, PROCESSOR, TERMINAL & DISKS,	3338.27	3839.00
SOFTWARE - 6800 & 6809 - on Cassette - 300 Baud, CUTS, S1 Format.		
6800 Disassembler, with Move function.	10.00	11.50
6800 Text Editor, with Source Listing.	28.00	32.20
6800 Assembler, with Source Listing.	28.00	32.50
6800 Text Processor, with Source Listing.	28.00	32.50
6800 Relocator, with Source Listing.	16.09	18.50
6800 8K Basic Interpreter (V2.3).	15.22	17.50
6809 Text Editor, with Cassette Routines.	60.78	69.90
6809 Macro Assembler, Memory to Cassette.	60.78	69.90
6809 10.5K Basic Interpreter.	60.78	69.90
FLEX9, 6809 Disk Software, on 5 1/4" or 8" Disks. j		
Configurable Flex, with Text Editor & Assembler	120.00	138.00
Sort/Merge Package, with File Editing Facilities	58.26	67.00
Debug Package, a complete 6809 Simulator	58.26	67.00
Disk Utilities, Additional Commands for FLEX	46.96	54.00
Text Processor, for Text Formatting	58.26	67.00
Text Editor & 6800/6809 Macro Assembler	69.57	80.00
Disk & Memory Diagnostics, Further FLEX Commands	52.17	60.00
Extended Basic, Advanced Business Basic for 6809	75.65	87.00
Pascal, 6809 Machine Code Compiler	145.22	167.00
RMS, A Record Management System for 6809	145.22	167.00
Tabula Rasa, Financial Reporting Package	120.00	138.00
Stylograph, The Complete Word-Processing Package	173.04	199.00
Micro-Modeller, Now Available for FLEX9	694.78	799.00
SHARP MZ-80A	477.39	549.00
Now in stock, the latest SHARP MZ-80A Personal Computer, 48K, Screen, Cassette & Sound.		
APPLE SYSTEMS		
Full Range of APPLE II Systems in Stock, together with a wide range of Business and Leisure Software.		
<ul style="list-style-type: none"> • Come and try any of our systems or make use of our mail order service. • All prices include carriage charges within the mainland UK. • All prices are correct at time of going to press and subject to availability. • Send for our latest price list and catalogue covering our vast range. • Further information is available on all the products listed, send for details. • Store opening hours - 9.30 to 5.30 - Monday to Saturday - Access & Visa. • STIRLING MICROSYSTEMS LTD - THE '6809' HARDWARE & SOFTWARE STORE. 		

STIRLING MICROSYSTEMS

241 Baker Street, London NW1 6XE.
Telephone: 01-486 7671.

Hard Disks for the PET

The Small Systems **HARDBOX** acts as an intelligent controller for up to 4 Corvus Winchester drives

- PET DOS 1 and 2 compatibility
- Multi user capability on Corvus Drives
- 16 Megabyte max file size
- 65535 max records per relative file
- Over 2000 files on 5 MB drive

CORVUS DRIVES

Well proven systems with nationwide support and maintenance.

- 5, 10, 20MB capacity
- Up to 4 drives can be daisy chained
- Backup onto standard video cassette using the Mirror unit
- Up to 64 users with the Constellation multiplexer unit.

5MB Corvus drive	£2295
10MB	£3595
20MB	£4495
Mirror back up unit	£495
Constellation	£495

SSE MINI WINCHESTER

The MW-1000 Mini-Winchester is a compact desktop unit that just plugs into the PET-gives you up to 12 Mb of hard disk storage under CP/M or PET DOS or both !!

At the flick of a switch, this amazing unit allows you to have:-

- The whole disk under CP/M (plus 60k of RAM and Z80)
- The whole disk under PET DOS
- Half of the disk under PET DOS and half under CP/M !!

No changes to the PET or ROMS are required - just plug in and go.

Prices include CP/M, utilities, 60K RAM and Z80

SOFTBOX and CP/M SOFTWARE

SOFTBOX allows the PET to run the worlds most popular operating system for micros. Operates with PET floppies and/or a Hard disk system.

Comprehensive range of CP/M software available - ask for our Catalogue.

Softbox	£550
RS232 Option	£45
Corvus Option	£65

IEEE-488 INTERFACES

Comprehensive range for PET and HP-85 e.g. B300 RS232 40 char buffer, full handshake

£186

PETSPEED

Optimising Basic Compiler

£240

S100 - CP/M

Software development tools	
8048 family in circuit emulator	£850
8748 programmer	£395
Prom emulator	£295
Range of cross assemblers for most popular micros	£95
8048 BASIC compiler	£195

COMPLETE PET and HP-85 SYSTEMS

Telex 264538



small
systems
engineering
limited

2 4 Canfield Place - London - NW6 3BT

Telephone 01 328 7145 6

CUMANA

TRS 80 MODEL III DUAL DENSITY DISK DRIVES



FOR DEPENDABILITY AND QUIET OPERATION



INTERNAL DRIVE PRICES CAPACITY

1 x 40 Track Drive	£419	184K Bytes
2 x 40 Track Drives	£590	368K Bytes
1 x 80 Track Drive	£455	368K Bytes
2 x 80 Track Drives	£665	737K Bytes
1 x 80 Track Double Sided Drive	£620	737K Bytes
2 x 80 Track Double Sided Drive	£999	1474K Bytes

Internal Drive prices include Disk Controller Board, Power Supply Unit and all Cables and Connectors required for installation.

EXTERNAL DRIVE PRICES

1 x 40 Track Drive	£199
2 x 40 Track Drives	£369
1 x 80 Track Drive	£265
2 x 80 Track Drives	£495
EXTERNAL 2 Drive Cable	£15

External Drives are directly compatible with the TRS 80 Model I and Video Genie Expansion Interfaces.

You can depend on **Cumana**; we scour the world markets for top quality products to give you efficient, trouble free operating. Like DISKS from TEAC of Tokyo and other leading names. Cumana are alert for the latest proven developments and promise you attentive service. Write or 'phone for Data Sheets – Dealer and O.E.M. enquiries welcome.

Call your nearest dealer for a demonstration:

RADIO SHACK LTD.,
188, Broadhurst Gardens,
London NW6
Tel: 01-624-7174

COMPSHOP LTD.,
14, Station Road,
New Barnet, Herts
Tel: 01-441-2922

COMPSHOP LTD.,
311, Edgware Road,
London W2
Tel: 01-262-0387

COMPSHOP LTD.,
19, Herbert Street,
Dublin 2
Tel: 604165

**LONDON COMPUTER
CENTRE**, 43, Grafton
Way, London W1
Tel: 01-388-5721

N.I.C.
61, Broad Lane,
London N15
Tel: 01-808-0377

**CROYDON COMPUTER
CENTRE**, 29a, Brigstock
Road, Thornton Heath,
Surrey.
Tel: 01-689-1280

P J EQUIPMENT LTD.,
3, Bridge Street,
Guildford.
Tel: 0483-504801

**R.D.S. ELECTRICAL
LTD.**, 157-161, Kingston
Road, Portsmouth.
Tel: 0705-812478

**TANDY HASTINGS
LTD.**, 48, Queens Road,
Hastings.
Tel: 0424-431849

**MICROWARE
COMPUTING
SERVICES**, 57, Queen
Charlotte Street, Bristol.
Tel: 0272-279560

**BLANDFORD
COMPUTERS**, Higher
Shaftsbury Road,
Blandford Forum.
Tel: 0258-53737

TAPE SHOP
32i Viaduct Road,
Brighton.
Tel: 0273-609099

PARWEST LTD.,
18, St. Mary Street,
Chippenham.
Tel: 0249-2131

COMPUTER SHACK
14, Pittville Street,
Cheltenham.
Tel: 0242-584343

**TANDY
GLOUCESTER**,
13, Clarence Street,
Gloucester.
Tel: 0452-31323

COMSERVE,
98, Tavistock Street,
Bedford.
Tel: 0234-216749

**CLEARSTONE
COMPUTERS**, Prince of
Wales Ind. Estate,
Abercarn, Gwent.
Tel: 0495-244555

EMPRISE LTD.,
58, East Street,
Colchester.
Tel: 0206-865926

**MAGNUS MICRO-
COMPUTERS**,
139 The Moors,
Kidlington, Oxford.
Tel: 08675-6703

**CAMBRIDGE
COMPUTER STORE**,
1, Emmanuel Street,
Cambridge.
Tel: 0223-65334

I.C. ELECTRONICS,
Flagstones,
Stede Quarter,
Biddenden, Kent.
Tel: 0580-291816

MICRO CHIP SHOP,
190, Lord Street,
Fleetwood, Lancs.
Tel: 03917-79511

**HARDEN MICRO-
SYSTEMS**, 28-30, Back
Lord Street, Blackpool.
Tel: 0253-27590

**AMBASSADOR
BUSINESS COM-
PUTERS LTD.**,
Ashley Lane Works,
ShIPLEY, W. Yorks.
Tel: 0274-595941

Q-TEK SYSTEMS LTD.,
2 Daltry Close, Old
Town, Stevenage, Herts.
Tel: 0438-65385

COMPUTER & CHIPS,
Feddinch Mains House,
St. Andrews, Fife,
Scotland.
Tel: 0334-72569

**HEWART MICRO-
ELECTRONICS**,
95, Blakelow Road,
Macclesfield.
Tel: 0625-22030

KARADAWN LTD.,
2 Forest Way,
Great Sankey,
Warrington.
Tel: 0925-572668

PHOTO-ELECTRICS,
459 London Road,
Sheffield.
Tel: 0742 53865

ARC ELECTRONICS,
54 Heron Drive, Sandal,
Nr. Wakefield,
W. Yorks WF2 6SL.
Tel: 0924-253145

**VICTOR MORRIS
LTD.**, 340 Argyle
Street, Glasgow,
G2 8LY.
Tel: 041-221 8958

COMPRITE LTD.,
Thorite House,
Laisterdyke,
Bradford.
Tel: 0274-663471

GNOMIC LTD.,
46, Middle Street,
Blackhall,
Hartlepool.
Tel: 0783-863871

**BRIERS COMPUTER
SERVICES**, 1, King
Edward Square,
Middlesbrough,
Cleveland.
Tel: 0642-242017

3 LINE COMPUTING
36, Clough Road, Hull.
Tel: 0482-445496

**H.C. COMPUTER
SALES LTD.**, 182,
Earlsway, Team Valley
Trading Estate,
Gateshead.
Tel: 0632-874811

EWL COMPUTERS LTD.,
8, Royal Crescent,
Glasgow.
Tel: 041-332-7642

**EVERYMAN
COMPUTING**,
14 Edward Street,
Westbury, Wilts.
Tel: 0373-864644

CUMANA LTD

35 Walnut Tree Close, Guildford, Surrey, GU1 4UN.
Telephone: (0483) 503121. Telex: 858306

Please add VAT to all prices.
Delivery at cost will be
advised at time of order.

A NO-NONSENSE ADVERTISEMENT FOR NO-NONSENSE PRICES.

Commodore	£
8096 Processor	985
8032 Processor	740
8050 Disk Drive	740
8023 Matrix Printer	740
8026 Daisy Wheel	820
4016 Processor	455
4032 Processor	575
4040 Disk Drive	575
4022 Matrix Printer	325
2031 Single Disk Drive	325
Pet to IEEE cable	17
IEEE to IEEE	21
Visicalc	99

Apple	£
Apple][48K	650
Disk Drive with Controller	325
Disk Drive	255
Monitor (Green or Amber)	125
Silentype Printer	165
Apple /// Processor	2050
Apple /// Extra Disk	320
Monitor ///	145
Apple][Visical	99

All prices exclusive of VAT

We also offer a full consultancy and support service and can supply a wide range of Apple and Commodore software with full training.

All units are bench tested and fitted with appropriate plug.

Insured delivery £15 per unit.

Apple prices include one year warranty.

Commodore prices include 90 days warranty, one year warranty is available for an extra £50 per unit.

How to order:

**By telephone on 01-907 2655 or send your order with remittance to:
Micro's by Mail, Freepost, Harrow, Middx.**

All orders will be acknowledged – delivery 14 days. **Official tenders welcomed.**

ANGLIA COMPUTER CENTRE

SPECIALISTS IN MICROCOMPUTERS
FOR BUSINESS, SCIENCE AND
EDUCATION

FOR ALL YOUR COMPUTER REQUIREMENTS!!!
BESPOKE SOFTWARE FOR BUSINESS AND
INDUSTRIAL CONTROL SYSTEMS

APPLE III BUSINESS SYSTEMS

ACORN ATOM

BBC COMPUTER

APPLE II

SHARP

NORTH STAR

COMART

HEWLETT PACKARD

NASCOM

+PRINTERS AND

OTHER

PERIPHERALS

BOOKS**

SOFTWARE*

MAGAZINES**

STATIONERY***

BUSINESS+

INDUSTRIAL

CONTROL

OSBORNE I

A.C.T. SIRIUS I

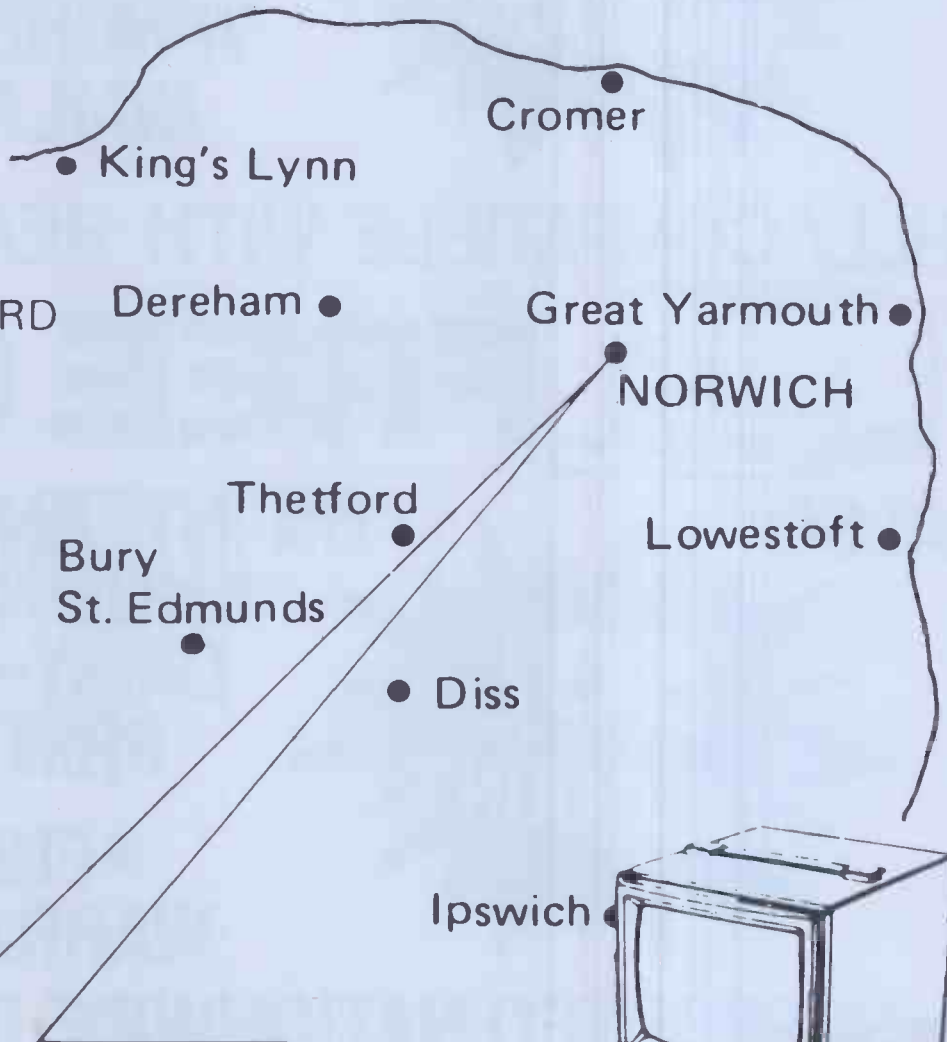

WE ARE HERE!!!

**88 St. Benedict's Street
NORWICH NR2 4AB
Tel. (0603) 26002**

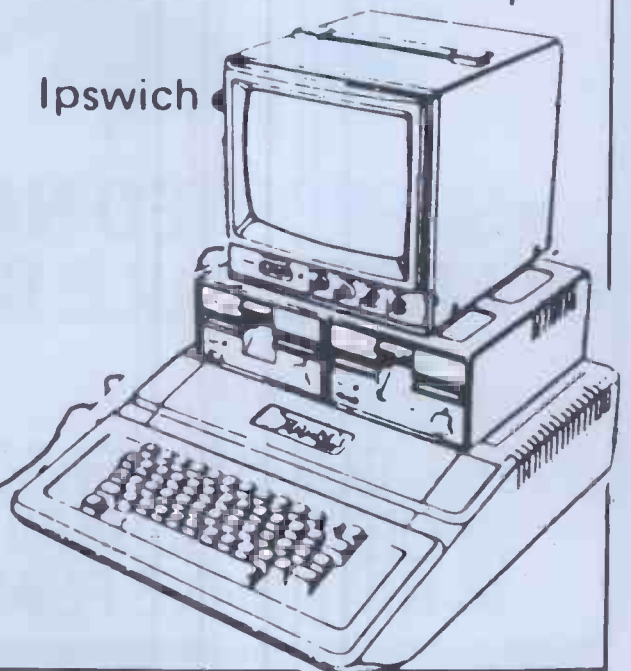

BARGAIN MICRO COMPUTERS

**50%
DISCOUNT**

64K MULTI Z80A CHIP CPU
TWIN 400K/800K
FLOPPY DISCS.

WINCHESTER
AVAILABLE

FULLY COMPATIBLE WITH HEATH/ZENITH

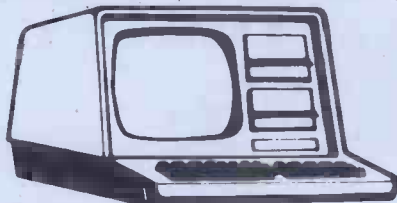

WITH

FREE CP/M

ALSO

**50%
DISCOUNT**

ON INTERNATIONALLY
KNOWN 45 CPS
DAISY-WHEEL
PRINTERS

• FULLY
WARRANTED

• SUPPORTED NATIONWIDE IN THE U.K.
BY A REPUTABLE BRITISH MANUFACTURER

ENQUIRIES TO:

P.O. BOX SE PERSONAL COMPUTER WORLD
SPORTSCENE PUBLISHERS
14 RATHBONE PLACE LONDON W1P 1DE

MICROMART make a good deal a good deal better!

VIC-20 only £159.99



The best home computer in the world.

24 colours * 3 - tone Generator *

Expandable to 32K. Complete range of peripherals

Cassette Unit — £35.99 8K RAM cartridge — £34.99
 4022 Printer — £189.00 Single Disk Drive — £292.00
 Expansion Board — £99.99

Or step up to a **4000 series PET**

4016 16K PET — £459
 4032 32K PET — £580
 4040 Disk Drive — £580
 Printer — £360

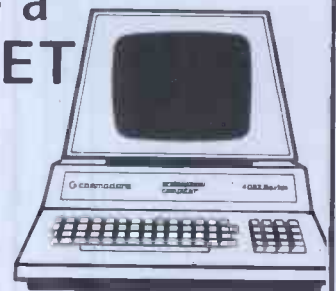

Complete range of printers and supplies including:

Epson MX80 Printer (inc. PET interface) £415 * 77- track disks including Library Box — £28 for box of 10 * plain listing paper 9½" x 11" — £11 for 2000 sheets. Add VAT at 15% and £3 for delivery. (If you can't see what you want - send for our mail order lists.) All products unconditionally guaranteed. To order just write with cheque. Credit card holders can ring 01 637 5551 and order direct. New low prices - same quality.



MICROMART LTD

32 Windmill Street,
 (off Tottenham Court Road)
 LONDON W1P 1HH
 Tel:- 01 637 5551 (24hrs)

143 Cranbrook Road,
 Ilford,
 Essex IG1 4PU
 Tel:- 01 553.3026/7

Personal callers welcome. Open Monday — Friday 9.30 — 5.30

They said it couldn't be done!

Galactic FIREBIRD

Those ever circling, swooping, diving Firebirds of the famous arcade machines, brought to the micro in Mike Chalk's ultimate achievement—Galactic Firebird

Yes, it's the latest in the Kansas Arcade series, but alas, his last, for Mike has been writing these right back from the original Arcade Invaders, and feels he wants a rest.

The reason being that he has always bettered his preceding program, and feels that with Firebird he has reached a pinnacle.

Many programmers of many machines have tried to emulate the arcade game, Firebird, but nobody, the Americans included, have managed to get the circling, swooping firebirds on a computer. Until now!

It is incredible how the Firebirds peel away, circle around in numerous positions on the screen, then suddenly sweep in to attack, all the while raining down their bombs.

Even if you manage to dodge all their bombs whilst shooting them down, it is as though they realise they will not get you this way, for without warning they'll take kamikazi action and come straight for you!

Then come the Astro Blasters, shooting down a solid energy bolt, to fry you completely, in addition to their own brand of super bomb. Oh, you can fire at them, but a solitary hit will have no effect whatsoever on these nasties.

As though Firebirds and Astro Blasters are not enough, as the game progresses, come the Megon Bombs. With no less than three hits needed to destruct! And you can't dodge them easily either, as their explosions spread.

Scores are kept of course, and there is the now expected realistic sound effects. And—wait for it—it progresses to FOURTEEN levels of difficulty! Mike's last words: "Nobody will ever get there!"

It's ONLY available direct from Kansas but at a sensible £9.50 Vat and post paid

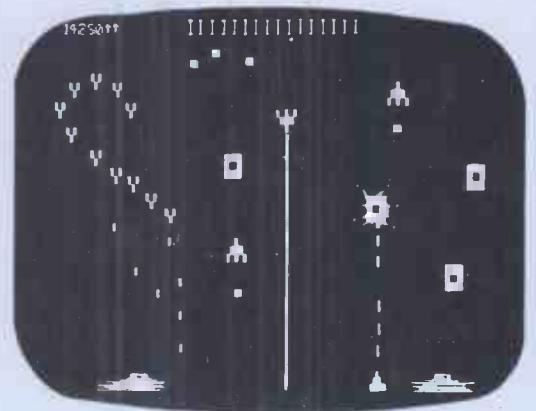

For TANDY TRS-80 & VIDEO GENIE

Kansas

Kansas City Systems, Unit 3, Sutton Springs Wood, Chesterfield, S44 5XF. Tel. 0246 850357

As publishers (we do not retail other people's programs) we have absolute quality control and thus give an unconditional guarantee on all our software. And of course all programs are always in stock for our famed return first class post service whether ordered by cheque or credit card. Ask for a copy of our free catalogue, you won't find any 'South Coast' prices there! Access and Barclaycard welcome.

MICROS MEMORIES TTLs AND INTERFACE DEVICES

Z8	£24.00	6800	£3.00	6502	£4.00
Z80	£3.20	6802	£3.50	6502A	£5.00
Z80A	£3.60	6809	£8.50	2650A	£12.00
8085A	£4.50	6809E	£15.00	6520	£2.80
Z80B	£15.00	8205	£2.20	6522	£4.50
Z80CTC	£2.80	8212	£1.60	6532	£6.00
Z80ACTC	£3.00	8216	£1.00	6821	£1.20
Z80DMA	£10.00	8224	£2.00	6845	£7.00
Z80ADMA	£12.00	8228	£2.50	6850	£1.40
Z80 ADART	£8.00	8251	£3.20	6852	£2.50
Z80 PIO	£2.80	8255	£3.00	6875	£4.00
Z80A PIO	£3.00	8279	£5.50	6551	£6.50
Z80 SIO-0/1/2	£9.00				

Large range of PERIPHERAL devices available.

SPECIAL OFFERS

	1-24	25-99
2114 Low Power - 450ns	90p	85p
2716 (+5v)	£2.25	£2.10
2732 (+5v)	£4.25	£4.00
2532 (+5v)	£4.25	£4.00
4116 - 200ns	£0.80	£0.85
6116/3 - 150ns	£5.50	£5.00

UNIVERSAL INTERFACE FOR PET

Self contained all purpose interface unit for OLD or NEW PETS - providing a range of parallel input/output ports, 16 Bit Timers, ultra fast MULTI-CHANNEL ANALOGUE TO DIGITAL CONVERTERS, DIGITAL TO ANALOGUE CONVERTERS and PROGRAMMABLE SOUND GENERATORS. Internal Motherboard System allows easy upgrading.

Unit complete with a dual voltage power supply is housed in an attractive case. £149 + £2 for p&p

SEND FOR TUI/I FOR FULL DETAILS

ACORN ATOM

Basic 8K + 2K Kit £120 Built £135
Fully expanded 12K + 12K + VIA £185 (p&p £2.50/unit)
Power supply: 18A 8v £8 3A 5v £22 (p&p £1.20)
4K FP from £20 1K RAM (2 x 2114L) £2.00
6522 VIA £5 Buffer: DP 8304 £4.50 81LS95 £0.90
Connectors
PL6/PL7 £3.50 SK6/SK7 £4.00 PLS/SK5 £2.00 PL4/SK4 £0.90 SK5 with cable £2.50 Centronix Type Connector £8.50
64K DRAM Card (fits inside ATOM CASE) 200MA at 5v £95.00 (expandable to 128K)
SOFTWARE
Games Pack 1-10, Soft VDU, Data Base, Desk Diary, Word Tutor & other ACORN SOFTWARE CASSETTES £10.00 ea. WORD PROCESSOR ROM £26.
747 Fit, Simulator, Galaxian, Invaders £7.00 ea. Chess £7.80 Breakout, Fruit Machine, UFO Bomber, Disassembler £3.50 ea.

SEND FOR DETAILS ON ATOM VISION & ATOM SOUND BOARD
BBC micro accessories now available

SOFTY II

An ideal software development tool. A program can be developed, debugged and verified and then either committed to an EPROM or the program can be used in any host computer by plugging the SOFTY into its EPROM socket. See SEPT 81 PE for the SOFTY review detailing the various facilities provided on the SOFTY. SOFTY II complete with PSU and ROMulator & TV leads.

£169 + £2 p&p

PRINTERS

EPSON MX80 FT 1	£350
80 CPS Bidirectional with logic seeking	
80 cols with condensed, emphasised and enlarged letters. + Carriage.	
EPSON MX80 FT 2	£350 + carriage
As MX80 FT 1 but with full graphics capability	
SEIKOSHA GP100A	£199 + carriage
80 cols 30cps. Dot matrix Unihammer Action. Full graphics capability - Double width characters, self testing. Up to 10" paper	
12" BMC Green screen monitor	£140 + carriage
TEAC FD 50A Drive mechanism	£150 + £3 p&p
Olivetti FD501A Drive mechanism	£150 + £3 p&p

UK101: INTERFACING SYSTEM

A TWO BOARD HARDWARE INTERFACE
DECODING MODULE: plugs into UK101/OH1011 socket to provide 16 bit user port plus a wide variety of decoding lines for interfaces (incl. full decoding for AY3-8910/12 PSG) and a 40 pin skt for further expansion. Kit Price £27.50

ANALOGUE BOARD: interfaces with Decoding Module to provide D/A Converter, 8 channel multiplexed A/D converter. AY3-8910 PSG plus 6522 via allow complex timing & complex timing functions plus 16 bit port. Kit Price £39.95
Reprint of PE articles £1.50 + large SAE.

PLEASE ADD P & P 40p AND VAT AT 15%
ASK FOR DETAILED PRICE LIST

TECHNOMATIC LIMITED

Colleges, Govt etc.
orders welcome.

Barclaycard &
Access orders
accepted.

SHOPS:
15 Burnley Road,
London NW10
305 Edgware Road,
London W2.
Tel. 01-723 0233.

MAIL ORDERS:
17 Burnley Road,
London NW10
Tel. 01-452 1500/
450 6597
TLX 922800

Software for CP/M™

MICRO PRO

Wordstar™ 3-X

Mail Merge

Data Star

Supersort I

Spellstar (USA dictionary)

Calcstar

LIST

£250

£ 60

£170

£120

£120

£150

MICRO SOFT

Basic-80 Interpreter

Basic Compiler

Fortran-80

Cobol-80

LIST

£150

£190

£210

£310

MISC

Compiler Systems

Sorcim

Sorcim

Ashton Tate

Ecosoft

Organic

CBasic-2

CB 80

Pascal/M

Supercalc

d Base II

MicroStat

Milestone

(critical path)

LIST

£ 65

£280

£120

£170

£380

£150

£160

CP M is TM of Digital Research. WORDSTAR is TM of Micro Pro
Other Products constantly being added to our range.
Send large s.a.e. for latest list

TRADE ENQUIRIES WELCOME

Ordering Instructions:

Cash with order. Specify disk format.

Add £3.00 per item P&P. Add 15% VAT

BARCLAYCARD

VISA

the
soft
option

BAMBERPLAN LTD
PO BOX 11 CRANBROOK KENT
TN17 2DF Tel: (058 080) 310

SPRINTER —

*the
faster,
universal
interface*

Mutek

Quarry Hill, Box, Wilts
Tel: Bath (0225) 743289

If you're waiting for your printer to type out that document, and you're bored with waiting for it as usual, we may have the solution for you.

The answer is Mutek's **Sprinter**.

Your daisy-wheel can only manage 50 characters per second at best; but your computer can probably 'print' at two thousand per second or more. With **Sprinter** between them, your computer can print as fast as it likes; your printer can take as long as it needs, without tying up the computer in the meantime. That's just 15 seconds to dump a 30,000 character document; then continue your work without interruption.

Sprinter is an 'intelligent buffer', capable of storing up to 32K (ten pages or more) of text at a time. No changes are needed to your system or your software — it just plugs in. What's more, you'll only need one **Sprinter** to connect almost any peripheral to your system — it has RS232 serial, Centronics parallel and IEEE interfaces all built-in (six interfaces in all). So you can use a parallel printer from your computer's serial port, an ordinary modem on your Pet, or almost any other device you want.

Since **Sprinter** has its own intelligence and memory, it can easily be tailored to your needs. Converting from one interface standard to another; one data format to another; or even both at the same time. Call us today for a new way to solve your interfacing problems.

Prices depend on specification and start at £185 (exc. VAT) for a 16K **Sprinter** complete with all six interfaces. And that's much less than the extra cost of a faster printer!

**Typeset text
from your disks**

Unlike some computer-typesetting services you've seen advertised, wordsmiths' Anvil service is ready for you *now* if you use any of the following machines:

Superbrain SD or QD (or any compatible system);
Apple II under DOS3.3 or CP/M; *Tandy* TRS-80
Model I or III; *North Star Horizon*; *Comart*; or
Ohio Scientific C2 or C3 series.

(We'll have links to other systems ready by the time you read this advert — ring for details).

We have special software support for *WordStar*, *Spellbinder*, *Scriptit* and *Applewriter*: so even tricky jobs such as directories, technical publications, tables and foreign languages are no problem for your word-processor and Anvil.

If you're not sure how to do it, come to one of our *word-processing workshops* and see how we can help you to produce anything from a price list to a batch of bar-code labels.

(And since we're in central Somerset rather than on the Central Line, we might even offer you some cyder and a byte to eat as well!).

— NOW

*Quite simply, we're the specialists in
print for micro-computer users.*

For details of our typesetting, print and other services for the word-processor user, and for dates of our word-processing 'workshops', return the coupon or ring Mike Cooper on 0458 45359.

wordsmiths
computers
in type

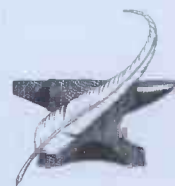

Name _____ Position _____

Company _____

Address _____

_____ Tel. No. _____

wordsmiths

West End, Street, Somerset BA16 0LQ
Tel: Street (0458) 45359. Telex: 46401

PROTECT YOUR SOFTWARE INVESTMENT

COPY II PLUS

Apple Copy II Plus gives you the power to make back-up copies of nearly all the "protected" software packages currently available.

INSURANCE

With Copy II Plus you can protect your valuable software investment. Make back-up copies of Visicalc, DB Master, DeskTop Plan, the Apple Special Delivery Software range and many other packages.

RELAX

Copy II Plus allows you to make back-up copies for normal use, so you can keep your originals safely locked away – away from the dangers of spills or stray magnetic fields, or just the wear and tear of everyday usage.

EASILY PAYS FOR ITSELF

While some software companies offer replacement of expensive damaged diskettes, many do not. With Copy II Plus you eliminate the time, expense and worry of costly accidental damage.

FAST

The high-speed option allows you to copy diskettes in less than 45 seconds – faster than any other bit copier – ideal for backing-up your ordinary data disks.

Send £50.00 + VAT to:–
Apple Orchard
1 New Cavendish Street
London W1
or Phone 01-580 5816

and quote your Access or Diners Club Card



MICROAGE ELECTRONICS LONDON'S BIGGEST ACORN STOCKIST

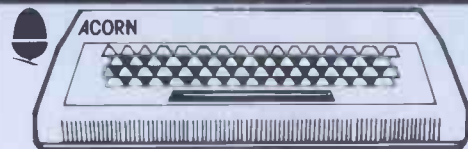

OFFICIAL
BBC
STOCKIST

Working BBC machine in stock. Call in for 'hands-on' experience.

ATOM KITS

In our books the best computer kit available. Build yourself an Acorn Atom for **only £135.** plus £2.50 p+p

New Software from Acornsoft. Come and get them all including Atom Chess • Desk Diary • Adventures • Interactive Teaching • FORTH • Atomcalc • Database LISP • Game Packs 1 – 11 • From £11.50 + 30p p&p

BBC ROM

Update your Atom to the BBC operating system.

Atom Discpack. **£345**

5¼ discpack only £345, operating manual, cables, plus £2.50 p+p

The BBC Cassette Recorder **£28**

As chosen by the BBC, but cheaper! £2.50 p+p

ORDERS TAKEN NOW FOR BBC MACHINE

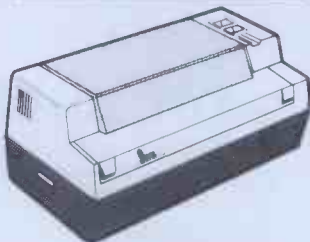

THE GP-80A dot matrix printer. LOWEST EVER PRICE **ONLY £199** £4.50 p+p Dot Matrix, Full 96 ASC11 character

New! Just arrived. The fantastic GP100A printer. Full printing width.

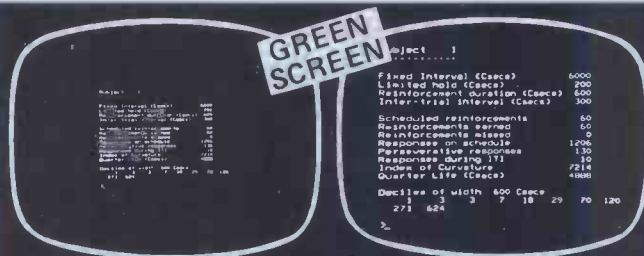

FROM THIS TO THIS AT THE FLICK OF A SWITCH

With the new ZENITH Monitor. Choose between small or large format depending on what you're doing. Small format for definition, large format for display. Full 12" GREEN screen. Only £85 while stocks last. It doesn't change the output from your computer, just changes the size of the display. Ideal for VIC 20, TRS 80, Atom, BBC, + Genie machines. £4.50 p+p



Blank Cassettes 40p each, **£3.50** for 10. 70p p+p

RACOMM COLOUR MONITOR Absolute high resolution. 700x300 pictals 12" £350 + £5 p+p Atom BBC, & Genie machines.

DAI Personal Computer. **£684**
48K RAM 24K ROM

If it's not in the advertisement, send for our mail order lists.

We accept company/institutional orders.

Also available:
2114 IC's, Paper for most printers, Enormous selection of Books, Leads, etc, etc, etc,

**ALL PRICES INCLUDE VAT
ABSOLUTELY NO MORE TO PAY.**

MICROAGE ELECTRONICS
135 HALE LANE EDGWARE MIDDLESEX HA8 9QP
TEL: 01-959 7119 TELEX 881 3241

COMPUTECH for apple

Authorised dealer, service centre and system consultancy

SUCCESS BREEDS SUCCESS!

As authorised dealer and service centre for Apple computers we have acquired extensive experience of users' needs and the most cost effective means of satisfying them from the considerable resources of this popular and reliable machine. Over 1,000 of our financial accounting packages have been installed. In the process we have detected areas of special need and opportunities for enhancing these resources. Our own manufactured hardware and system software have been produced to meet these requirements. As a result we have compatible products for all configurations of Apple II and ITT 2020 installations - and the new Apple /// !

Apple /// now on demonstration - systems from	£1,645
Pro-File 5 MB mass storage for Apple ///	£2,256
Computech mass storage for Apple II and Apple ///, up to 12 MB, from	£1,950

COMPUTECH SOFTWARE AND HARDWARE INCLUDES:

Payroll for 350 employees, 100 departments, all pay periods, printed payslips, approved year end documents, very quick and easy to use, **£375**. **Sales, Purchases and General Ledgers** **£295** each, detailed statements. **Job Costing and Group Consolidation** are amongst many and various applications of the **General Ledger** package, which supports values to totals of one thousand million accurate to a penny! Our **Utilities Disk** available like other packages in 13 sector or 16 sector format, is widely used for reliable, error checking, copying, including single drive, and the renowned **DPATCH** program beloved of programmers for **£20**. We have developed a **Terminal Utilities** package which enables Apple to Apple and Apple to mainframe communications with local processing and storage as well as Apple to host communications from the amazingly low price of **£130**. Our **Graphics Utilities** program for use with the **Microline** and **Epson** families of printers enable the plain paper production on low cost printers of high resolution screen pictures, graphs etc. - free with **Microlines** or **£30** separately. **Keyboard Driver** enables the use of our **Lower Case** adaptor with BASIC programs and **Applewriter Patches** supplied **FREE** with our character generator package (total cost **£50**) is separately available on disk with documents for **£10**. At the same price **CAI** (convert Apple pictures for ITT) makes binary high resolution picture files display properly on the ITT 2020. We sell the famous **Visicalc** for **£111** and have delivered systems using it to do amazing things like production control, shipping accounts and stocks and shares valuations! The versatile **Applewriter** word-processing package at only **£39**, especially employed with our **Lower Case Character Generator** is widely used by people who cannot type to produce word-perfect copy! Experience with Apple systems has led to the design and manufacture of compatible products with enhanced features at very favourable prices to satisfy users' needs. These include the **Diplomat Serial Interface** which has handshaking capability and switchable options (**£80**), the **Diplomat Parallel Interface** which enables the direct use of text and graphics with the **Microline** and **Epson** printers and is a complete 'plug in and go' item with gold-plated edge-connector at **£80** and has optional direct connection for **Centronics 730/737** printers. Our new **Diplomat Communications Card** at **£95** is a sophisticated peripheral especially suitable for Apple to mainframe communications at high speeds in full duplex mode with switch selectable bit rates and other options. The **Lower Case** adaptor is available for Apples (revision 7 and earlier) as well as ITT 2020, complete with diskette software for **£50**. It offers true descenders on screen and the £ sign. We also have an **Optional Character Generator** for the ever popular **Microline M80** at **£15**. This provides £ sign and improved digits and lower case characters with USASCII special symbols. Our price for the **Microline M80**, with graphics, 40, 80 and 132 characters per line, friction, sprocket and teleprinter feed, is only **£295**, amazing for this small, quiet reliable 'look alike' printer. Tractor option is **£40** and **Serial Adaptor** **£80**. The **Microline M82**, bidirectional printer with both parallel and serial input is only **£345**, it can have an optional 2K buffer, while the **Microline M83** full width adjustable tractor 120 cps printer with similar specification is only **£595**. Then for all computer users there is the unique **Micromux** which from **£800** provides up to 16 ports for simultaneous independent serial asynchronous communications! Telephone for data sheets or to arrange a demonstration or for the address of our nearest dealer. Please hurry - the demand for our products has been such that some have been temporarily out of stock. We offer the effective low cost solutions you need. **Prices exclude V.A.T., carriage and packing.**

COMPUTECH SYSTEMS

168, Finchley Road, London NW3 6HP. Tel: 01-794 0202

AGENTS THROUGHOUT THE UK AND OVERSEAS

TRS 80 LEVEL II & VIDEO GENIE SPACE GAMES

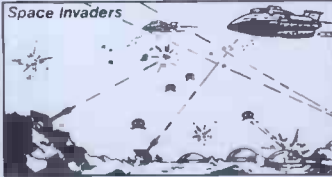

ASSAULT COURSE £7.50

An authentic 'SCRAMBLE' written entirely in fast, smooth Z80 machine code and complete with sound. 'Assault Course' has no less than 7 sections. You must face Mountains, Dancing Midgets, Meteors, Rockets, Caves and Mazes. You have 6 keys, 4 to move and 2 to fire. Probably the best TRS 80/Genie game we have ever seen.

LUNAR VOYAGER £7.50

The most exciting 80/Genie voyage you will ever take. After leaving the command module you must land on the Lunar surface, blast off, dock with the command module, negotiate Asteroid Storms on the return voyage, pass through the atmosphere and then with a spectacular display of graphics land at Houston. You won't make it first time!!!!

SPACE INVADERS £7.50

Like 'Assault Course' and 'Space Pirates', 'Space Invaders' is written in machine code. In case you haven't heard the idea is to shoot down aliens before they destroy your shields and laser base and invade earth. A superb version of a classic game. No set of 'Space Games' would be complete without it.

SPACE PIRATES £7.50

Also written totally in machine code by Frank Johnson the author of 'Assault Course' and also with sound. 'Space Pirates' is something new. In Video Games. The idea is to use your weapons to protect your star bases against pirates who are cunning enough to set traps for you. Very good real time action.

THE SET OF FOUR **£19.30**

SEND 95P (REDEEMABLE AGAINST FIRST ORDER) FOR FULL CATALOGUE AND FREE LISTING. PLEASE STATE 'TRS80' OR 'VIDEO GENIE' ON ORDER
ALL PRICES INCLUDE VAT AND P&P AVAILABLE FROM
OASIS SOFTWARE LOWER NORTH STREET CHEDDAR SOMERSET. TEL: CHEDDAR 743409
DEALER ENQUIRIES WELCOME



ACCESS ORDERS
TAKEN BY PHONE
24 HOURS A DAY



Happy Memories

Part type	1 off	25-99	100 up
4116 200ns	.95	.85	.70
4116 250ns	.90	.80	.60
4816 100ns For BBC comp	3.30	2.95	2.70
4164 200ns	6.15	5.25	4.65
2114 200ns Low power	1.25	1.15	.95
2114 450ns Low power	1.20	1.10	.90
4118 250ns	3.45	3.15	2.65
6116 150ns CMOS	4.95	4.45	3.65
2708 450ns	1.95	1.85	1.80
2716 450ns 5 volt	2.25	2.15	1.95
2716 450ns three rail	6.40	6.00	4.95
2732 450ns Intel type	4.25	3.95	3.35
2532 450ns Texas type	4.25	3.95	3.35

481b 100ns (for BBC) 3.30 2.95 2.70
Z80A-CPU £4.75 Z80A-P10 £4.25 Z80A-CTC £4.25

Low profile IC sockets:
Pins 8 14 16 18 20 22 24 28 40
Pence 9 10 11 14 15 18 19 25 33

Soft-sectored floppy discs per 10 in plastic library case:
5 inch SSSD £17.00 5 inch DSDD £21.00
8 inch SSSD £19.25 8 inch SSSD £23.65
5 inch SSSD £19.25 8 inch DSDD £25.50
74LS series TTL, large stocks at low prices with
DIY discounts starting at a mix of just 25
pieces. Write or 'phone for list.

Please add 30p post & packing to orders under £15 and VAT @ 15%.
Access & Barclaycard accepted. 24hr service on (054 422) 618.
Government & Educational orders welcome, £15 minimum. Trade
accounts operated, phone or write for details.
Prices are still tending to drop, 'phone for a quote before you buy.



Happy Memories (PCW),
Gladestry, Kington, Herefordshire,
HR5 3NY
Tel: (054 422) 618 or 628

Computer Enterprises



16-bit MICROPROCESSOR,
128K RAM-MEMORY, 400*800
Pixels, 80*25 or 132*50 Display,
3 INTERFACES, CPM86, BASIC.
86 Audio controller Etc., for only
2190 + VAT + FREE DELIVERY
DEAL A: SIRIUS 1 + EPSON
MX80 (FT/2) = 2590
DEAL B: SIRIUS 1 + TEC
STARWRITER = 2990

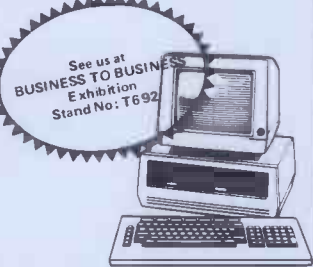

See us at
BUSINESS TO BUSINESS
Exhibition
Stand No: T692

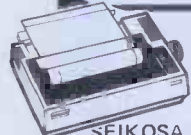

Printers Software

- SEIKOSA GPp80A 179
- SEIKOSA GP100A 199
- EPSON MX80 (FT/1) 349
- EPSON MX80 (FT/2) 380
- EPSON MX82 (T) 399
- EPSON 82(FT) 395
- EPSON MX100(FT) 499
- OKI Microline Series from 250
- PRISM 80 590
- PRISM 132 790
- ANACOM 150 699
- TEC STARWRITER 995
- QUME from 1390
- Interfaces from 39
- Cables from 20

- Pulsar Accounting 460
- Pulsar Database 249
- Micro modeller 460
- Wordstar 240
- Supercalc 110
- Spellstar 95
- Mailmerge 75
- CIS Cobol 399
- Pascal 280
- Fortran 335
- Forth 95
- Stock Control 360

01-947 8837
For information & Orders
Computer Enterprises, 5 Farnham Gardens, SW20 OUE.
* All items POST FREE but exclusive VAT. * All prices
subject to change. * All goods carry manufacturers guarantee.



USE YOUR COMPUTER (PET, ZX81 and others)
to control an electronic sign. Messages, patterns,
graphics may be stored in the computer and then
made to run from right to left across the sign.
The sign has an L.E.d. matrix that can display two
inch high characters. The length of the sign can be
varied to suit the user.

Programs are available for immediate use on the
above computers. These signs are ideal for shops,
garages, clubs, home etc.

For further information and prices write to the
address below, asking for details of COMPUTER
SIGN.

ADH Systems Ltd

209 Mackie Avenue,
Brighton SX BN1 8SE.
Tel: 0273 557429



NASCOM

FULLY BUILT AND TESTED SYSTEMS

CARRY ONE YEAR GUARANTEE

NASCOM 2

16K in Microtype Case, Graphics and Sound

£395.00

48K in Kenilworth Case, Nas-Sys 3 and Graphics Sound

£499.00

NASCOM 3

8K in Nascom Case, Graphics, Nas-Sys 3

£416.00

16K in Nascom Case, Graphics, Nas-Sys 3

£476.00

NASCOM

Single Disc Drive

£470.00

Dual Disc Drive

£685.00

NASDOS

Disc Operating System

£45.00

CP/M 2.2

Disc Operating System

£100.00

PRINTERS Epson MX80 F/T dot matrix printer. Olympia daisy wheel printers - RO or KSR. Telephone for further information and prices.

SHARP MZ80B Now on demonstration with WORDSTAR and CALCSTAR.

All the above prices exclude VAT

Business & Leisure Micro Computers

16, The Square, Kenilworth Tel: (0926) 512127



THE SYMBOL OF VALUE

NASCOM

KITS	
Nascom 1, with NAS-SYS 1 less PIO	£112.50
Nascom 2, no user RAM	£202.50
BOARD LEVEL	
Nascom 1, with NAS-SYS 1 less PIO	£126.00
Nascom 2, no user RAM	£238.50
CASED SYSTEMS	
Nascom 3, no user RAM	£338.40
8K user RAM	£36.00
16K user RAM	£90.50
32K user RAM	£103.50
48K user RAM	£117.00
POWER SUPPLY	
Kit form	£29.25
MEMORY CARDS	
RAM B memory card with 16K RAM - kit	£72.00
RAM B memory card with 16K RAM board	£90.00
Additional 16K RAM	£13.50
Additional 32K RAM	£27.00
I/O BOARDS	
I/O boards for 3 x PIO, 1 x CTC, 1 x UART (kit) ex PIO	£40.50
PIO for above I/O	£10.80
CTC for above I/O	£12.60
UART for above I/O	£14.40
DISC SYSTEMS	
Nascom single disc drive (350KB) incl. FDC card	£423.00
TAPES	
Nascom dual disc drive (350KB each) incl. FDC card	£616.50
NAS DOS disc op system	£40.50

SOFTWARE	
NAS-SYS 1 ROM	£10.80
NAS-SYS 3 EPROM	£18.00
ZEAP 2.1 for NAS	£26.30
SYS in 4 x EPROM	£22.50
ZEAP 2.1 for NAS	£18.00
SYS on tape	
8K microsoft basic IN ROM	

ATARI

800 Computer	
400 Computer	
Recorder	
Disk Drive	
16K RAM	
Joysticks (pair)	
Blank Diskettes (5)	
Assembler Editor	
Space Invaders (ROM)	
Star Raiders (ROM)	
Missile Command (ROM)	
Asteroids (ROM)	
Invitation to Programming (1)	
Invitation to Programming (3)	
Touch Typing	
Conversational French	
Conversational German	
Conversational Spanish	

TAPES

Blank C12	£5.00
Tapes (6 mins/side)	for 10

SHARP MZ80K (48K RAM)

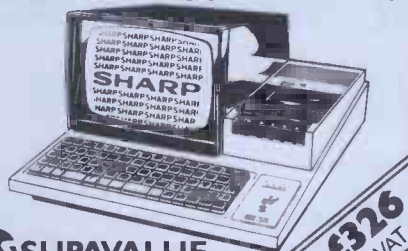

SUPAVALUE

£326 + VAT

SHARP PC1211

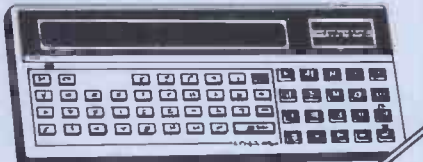

SUPAVALUE

£60 + VAT

ATARI 800 (16K RAM)



SUPAVALUE

RING FOR OUR SUPA LOW PRICES

CBM VIC

VIC 20	
VIC Cassette Unit	
VIC Printer	
VIC Disk Drive	
3K RAM Cartridge	
8K RAM Cartridge	
16K RAM Cartridge	
Programmers Aid	
Machine Code	
Joystick	

VIC SOFTWARE

Introduction to Basic	
Avenger (ROM)	
Super Slot (ROM)	
Alien (ROM)	
Super Lander (ROM)	
Road Race (ROM)	

BOOKS

Computers for Everyone	£6.00
Science & Eng Prog Apple II Ed	£11.60
File BASIC Data	
Apple Programming	£8.95
Make a success of Micro-computing in your Business	£4.95
Inside BASIC Games	£11.50
Intro to PASCAL	£11.50

RING FOR SUPA LOW PRICES.

PASCAL H'book	£13.95
Program the Z-80	£11.95
Your First Computer	£7.75
6502 Applications Book	£10.25
Advanced BASIC	£8.95
Apple II User's Guide	£11.10
Basic BASIC	£8.95
BASIC Business Software	£7.05
BASIC Computer Games	£5.95
BASIC Comp Progs	
in Science & Eng	£8.55
BASIC with style	£6.95
BASIC A self teaching guide	£5.95
CP/M User's Guide (Osborne)	£10.10
Game Playing with BASIC	£8.20
Getting acquainted with your Acorn Atom	£7.95
Instant BASIC	£8.75
Micros Vol 0	
Beginner's Book	£3.50
Micros Vol 1	
Basic Concepts	£10.10
Microsoft BASIC	£8.75
More BASIC Games	£6.25
Mostly BASIC	
Applies Apple II	£7.95
Mostly BASIC	
Applies PET	£7.95
Programming a Micro - 6502	£8.05

YOU'LL VALUE OUR EXPERIENCE YOU'LL VALUE OUR PRICES

ACCESS & BARCLAYCARD WELCOME - HIRE PURCHASE & PART EXCHANGE AVAILABLE ALL PRICES EXCLUDING VAT & O.E.

SRS MICROSYSTEMS
161 Bramley Road, Oakwood, London N14 4XA.
Telephone: 01-363 8060.
Open Mon-Sat. 9-5.30.

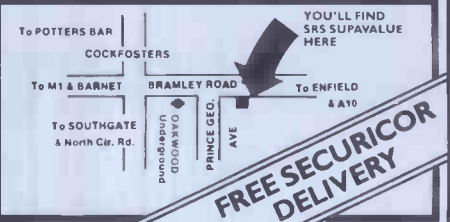

FREE SECURICOR DELIVERY

LOW PRICE HIGH QUALITY SOFTWARE FOR 32K COMMODORE PET

DATABASE £100 + VAT (For 4032, 8032 or 8096 only)

A complete information retrieval system for office or school administration. Lay out files for dates, numbers, money or other data. Display, update or amend as required.

PURCHASE AND SALES CONTROL £50 + VAT

Runs both purchase and sales ledgers with optional calculation of VAT from the gross or net amount analysis by accounting period, "due for payment" report, totals for net VAT and gross, etc.

INVOICE PRINT £50 + VAT

Prints invoices on your own stationery laid out according to your own instructions. This programme is an optional add-on to be used in conjunction with "purchase and sales control".

STOCK CONTROL £40 + VAT

Keeps detailed stock records including stock location, re-order level, quantity on order, cost and selling prices and stock valuation.

NOMINAL LEDGER £40 + VAT

Produces trial balance and up to 20 reports in addition to profit and loss and balance sheet from up to 1,000 nominal accounts. This programme is intended for use on its own, but it can read files set-up by our purchase and sales control and stock control programmes.

INTEGRATED ACCOUNTING SOFTWARE CUSTOM DESIGNED

COST ACCOUNTING
PURCHASE AND SALES LEDGERS
INVOICE, STATEMENTS ETC.
CASH POSTING
DISCOUNTS
AGED DEBTORS
DUE FOR PAYMENT REPORT
PAYROLL COST ANALYSIS
STOCK CONTROL
NOMINAL LEDGER
JOURNAL ENTRIES
TRIAL BALANCE
PROFIT AND LOSS

Don't let the computer dictate how you run your business! Get an integrated system designed to your particular needs.

**MYTHE CREST, THE MYTHE,
TEWKESBURY, GLOS. GL20 6EB**

ELECTRONIC AIDS (TEWKESBURY). Telephone (0386) 831020 or (0684) 294003

PRO PASCAL - THE MODERN WAY TO PROGRAM

Pascal provides means of structuring both data and code. Pro Pascal is a true compiler, generating programs which make full use of the Z80's registers and instructions.

Fast, compact object code — see published benchmarks

Separate compilation facility allows large programs to be subdivided into manageable segments

For business applications:

- nine-digit integers (32 bits)
- string handling
- sequential and random access to files

For scientific users:

- single (32-bit) and double (64-bit) precision real values
- input/output and all math functions available in both precisions

For system programmers:

- object code is reentrant and ROMable for non-CP/M applications
- assembler-coded modules can be incorporated in object programs

Pro Pascal runs on any Z80 micro with CP/M and at least 52K RAM, for instance:

- Apple + Softcard
- Clenlo Conqueror
- Cromemco (with CP/M or CDOS)
- Digico Prince
- Nascom/Gemini
- NEC PC8000
- North Star Horizon & Advantage
- Pet + Softbox
- Research Machines 380Z
- Sharp MZ-80B
- Superbrain
- Televideo
- Vector MZ
- Xerox 820
- Zilog MCZ

Pro Pascal is developed and supported in the UK. The single-user price is £190 plus VAT. The software package includes disc-to-disc linker and cross-reference generator.



Prospero

PROGRAMMING LANGUAGE SPECIALISTS

Prospero Software, 37 Gwendolen Avenue, London SW15 6EP Tel: 01-785 6848

A BETTER WAY TO DO BUSINESS

GREAT NORTHERN Computer Services was founded in 1979 to provide users and dealers of Apple II and CP/M based micro-computers with a source of first-class software, consultancy and support. Since then we have provided software packages, training courses and consultancy to more than 150 leading micro-computer dealers and major organisations like ICI, Plessey, Post Office, North Eastern Gas Board, British Steel etc.

DIAGRAM OF GREAT NORTHERN PACKAGES AS USED BY A SMALL BUSINESS

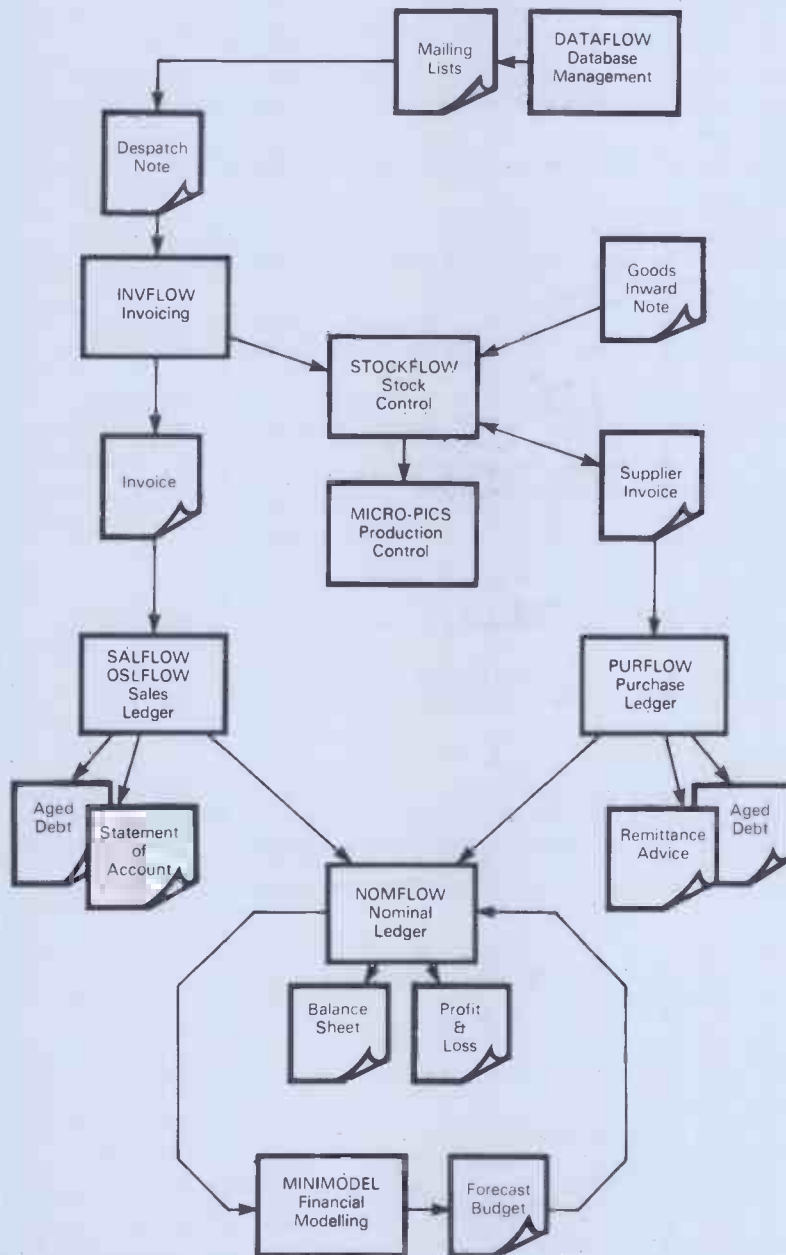

Amongst the software packages we supply are:-

For CP/M based micro-computers

SALFLOW	Balance Brought Forward type Sales Ledger package	£250.00
OSFLOW	Open Item type Sales Ledger package	£300.00
INVFLOW	Invoicing package	£295.00
PURFLOW	Purchase Ledger package	£250.00
NOMFLOW	Nominal Ledger package	£250.00
STOCKFLOW	Stock Control package	£250.00
BILLFLOW	Professional Client Billing (Invoicing & Sales Ledger) package	£375.00
MINIMODEL	Financial Modelling system	£399.00
DATAFLOW	Database Management and Information Processing package	£ 99.95
MICRO-PICS	Production and Stock Control with Bill of Material explosion	£595.00
BASKAM	Index Sequential routines for use with MBASIC	£ 95.00
MAGSAM	Index Sequential routines for use with CBASIC	£110.00

For Apple based micro-computers

IAS	Inter-Stat Statistical package	£150.00
AMR	Advanced Mathematical routines	£150.00
IFO	Information File Organiser Database Manager package	£120.00
VMD	Video Message Display system	£150.00
MIN	Micro Inventory stock control package	£150.00
MGL	Micro-General Ledger Nominal ledger and accounting system	£150.00
COLOURING BOARD	Paddle drawing & graphics system	£ 75.00

So - whatever your micro-computer software needs - Contact

GREAT NORTHERN Computer Services Limited

16 TOWN STREET, HORSFORTH, LEEDS LS18 4RJ TELEPHONE 0532-589980

it's a better way to do business Tel. 0532 589980

VIC GAMES FROM HI-TECH

YOU'VE TRIED THE OTHERS NOW HAVE THE BEST
Exclusively for the VIC 20 Computer

GAME TITLE	DESCRIPTION	
HEAD ON	Drive round a track – try to avoid the Vic car hitting you head on!	£8.75p
VIC CUBE	Can you solve the Rubic Cube? A great test of skill.	£8.75p
CRAZY BALLOON	Guide the swaying balloon through a prickly path. An addictive game.	£8.75p
MOLE ATTACK	A great game. Quick reflexes are needed to shoot the moles as they pop out of their holes.	£8.75p
BALLOON BOMBER	Destroy the air ships before they drop their bombs on you. An exciting game.	£8.75p
SKIER	Ski down the Olympic run. The better the course you take the faster you go. Try to improve your record each time.	£8.75p
TREASURE CARRYING	Your man wants the loot!! – Get him back alive as often as possible avoiding the hail of arrows. Very funny and addictive game.	£8.75p
SUPER MOON LANDER H. Res Graphics	Make a soft landing on the moon. Watch out for the mountains! You control thrust direction etc. As good as the arcade game!	£8.75p
OTHELLO H. Res Graphics	This is an 8 x 8 board game played with black and white counters. Pit your wits against the computer. Excitement mounts with each move! The last move can win the game!	£8.75p
SPACE SHOOT	Defend the earth from being invaded by fiendish aliens!	£8.75p
I.C.B.M.	Fire a rocket from your battleship! Navigate it through the attacking anti-ballistic missiles to hit your enemy's targets.	£8.75p
INDY 500	Your Grand Prix car is racing against others. You control steering and acceleration. Very good graphics.	£8.75p
SLOT MACHINE	Go for the Jackpot!! Just like one-arm bandits! Very good graphics.	£8.75p
PACK MAN H. Res Graphics	Just like the arcade game! Excellent graphics. Currently the best selling Vic game.	£8.75p
SUBMARINE	Try to blow up the submarines before they sink you. Great fun and good graphics.	£8.75p
GUNMAN H. Res Graphics	Watch out – He's quick on the draw!! Have a gunfight against the gunman controlled by the computer. Great graphics.	£8.75p
NAVAL BATTLE	An exciting game! You have submarines and guns against you. Try to win! It's tough but it can be done!!	£8.75p
SPACE INVADERS	Yes – THE Space Invaders!! Need we say more?	£8.75p
FIRE TREK	Open the force screen on your ship to search for the enemy. When located the ship's computer works out range, energy etc. to help you annihilate them. Amazing graphics!	£8.75p
ALIEN WARS	When in range, your on-board computer locks on target. This game has 'got to be seen to be believed' graphics!!	£8.75p
VIC COVER	Keep your keyboard clean. Dust free.	£2.95p
SUPER-BREAKOUT	A brilliant version of the 'Arcade' game	£7.50p
DEFLECTION	Deflect a fast moving ball to hit a target	£7.50p
CAR DRIVE	Drive your car through a forest track	£7.50p
3-D MAZE (U)	Walk through a maze in 3D & try to find the exit	£7.50p
INVADER FALL (U)	Destroy the invaders before they destroy you	£7.50p
DRAGON MAZE (U)	Can the dragon eat you before you get out of the maze	£7.50p
ALIEN MAZE (U)	Build your force field against the aliens after you	£7.50p
MISSILE COMMANDER	(U) Fire your A.B.M. at I.C.B.M. cutting in to destroy your cubes	£8.75p
3 RAM PACKS	are required for (U) Games. We are giving a FREE GAME with every purchase	£29.50p

Barclaycard/Visa Access welcome.
 Dept PCW

BUY DIRECT FROM US
OR FROM YOUR LOCAL DEALER

*No extra costs – the price includes
 VAT, post and packing.

7 Queensway, Hemel Hempstead
 Herts. Tel (0442) 50450

HI-TECH
COMPUTERS LTD.

A Guide to good British Software

Lesson No. 1

"What is DMS?"

DMS is Britain's best selling records management program for micro computers. You can think of DMS as a computerised super-efficient filing cabinet. Nearly 3000 companies, colleges, hospitals and other organisations use DMS to increase efficiency.

"What machines does it run on?"

It runs on all Commodore Machines, plus virtually any micro with an operating system known as CP/M or MP/M. This includes the ACT SIRIUS, the NEC PC 8000, the Rank Xerox 820 or 860, Superbrains, Apples with CP/M cards, the ICL Personal Computer. The Rair Black Box, the Sharp MZ 80B, the LSI M2 and M3, and the Caltext, and all machines with standard 8" disks.

"Who uses it?"

It's designed for use by managers, secretaries and clerical staff. They use it to make life easier by storing their personnel records, their student or patient records, their stock records, library lists, contract records, customer and client records, parts files, property and policy records etc etc.

"How do I use it?"

All instructions are in everyday conversational english, so you need never have used a computer before. Just tell DMS what information you need to store, then type your information on to disk. Once they are on there you really start to reap the benefits. For instance DMS will find an individual records for you to check, amend or print, or it will find all those which meet various parameters handling batches of record faster than you could image possible. It can sort them into any order need print lists, or transfer the information into your wordprocessor (eg Wordstar, Spellbinder, etc) to do selective mailing. (It even gives a little extra help by printing labels to match.) Or it can do some clever calculations. Or print reports, to your own special layouts. Every facility is designed to save you time, remove those tedious clerical tasks and make your organisation more efficient. More than anything, DMS allows you to have all your information at your fingertips as soon as you want it.

"How much does it cost?"

Work on the Commodore version costing around ,290, and the CP/M versions from 0400. Staff can be trained on regular courses run at your training centre, both on DMS and Wordstar.

"What about Lesson No. 2?"

Ring Compsoft Ltd, on Guildford (0483) 898545, or write or visit us at Hallams Court, Shamley Green, Nr Guildford, Surrey GU4 8QZ.

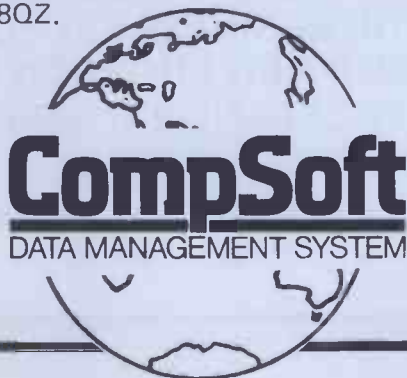

Croydon Micros

FOR THE COMPLETE ANSWER



MZ-80A £477, Complete with Disks & Printer £1799
MZ-80B £999, Complete with Disks & Printer £2299
IBM from £2800, EXTEL with networks from £7000
ATHANA & BASF disks from £15.20, PAPER & RIBBONS
EPSON F/T1 £349, TRANSTEC 12" Green Monitor £85
* Specialists in Interface Design & Manufacture *



**IF YOU WANT ASSISTANCE IN CHOOSING
A MICRO FOR BUSINESS, OR YOUR HOME
COME TO OUR NEW CROYDON PREMISES
FOR PROFESSIONAL SERVICE**

Ring Malcolm Greenaway now on:

01-689 4349

Eltron House, 20 Whitehorse Road, Croydon, CR9 2NA

Prices exclude V.A.T.

FRONTREALM LTD (T/A)

All major Credit Cards accepted

THE

VIC

NEEDS

VIC

REVEALED



THE DEFINITIVE REFERENCE BOOK ON THE VIC SYSTEM
FROM NICK HAMPSHIRE

NOW AVAILABLE PRICE £10.00 FROM COMMODORE DEALERS AND BOOKSHOPS.
NICK HAMPSHIRE PUBLICATIONS P.O. BOX 13 LYSANDER ROAD, YEovil, SOMERSET.

ZX99 AUTOMATIC TAPE CONTROL

The logical extension for the Sinclair ZX81 giving data retrieval & word processing

£59.95
plus P & P

The ZX99 Tape Control system is a sophisticated extension to the Sinclair ZX81 Microcomputer, providing remarkable additional capabilities, which allow both the beginner and expert access to a professional computing system without the expected expense.

★ DATA PROCESSING

The ZX99 gives you full software control of up to four tape decks (two for loading and two for saving) allowing 'mixing' of data files to update and modify them. This is achieved by using the remote sockets of the tape decks to control their motors as commanded by a program.

★ PRINTER INTERFACE

The ZX99 has a RS232C interface allowing you direct connection with any such serial printer using the industry standard ASC11 character code (you can now print on plain paper in upper and lower case and up to 132 characters per line.)

★ MANY SPECIAL FEATURES

There are so many different features that it is difficult to list them all:

For example:

AUTOMATIC TAPE TO TAPE COPY: You can copy any data file regardless of your memory capacity (a C90 has approx 200K bytes on it) as it is loaded through the Sinclair block by block.

TAPE BLOCK SKIP without destroying the contents of memory.

DIAGNOSTIC INFORMATION to assist in achieving the best recording settings.

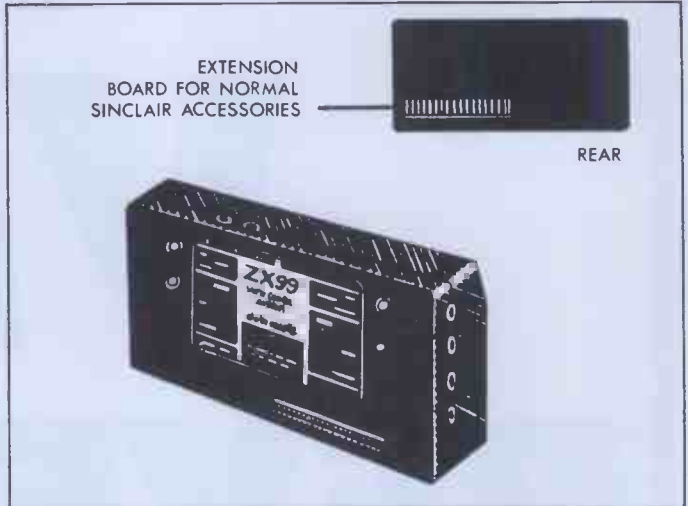

The ZX99 contains its own 2K ROM which acts as an extension to the firmware already resident in your ZX81'S own ROM. The ZX99's ROM contains the tape operating system, whose functions are accessed via Basic USR function calls. Each function has an entry address which must be quoted after the USR keyword. All of the functions can be used in program statements, or in immediate commands (i.e. both statements with line numbers and commands without them).

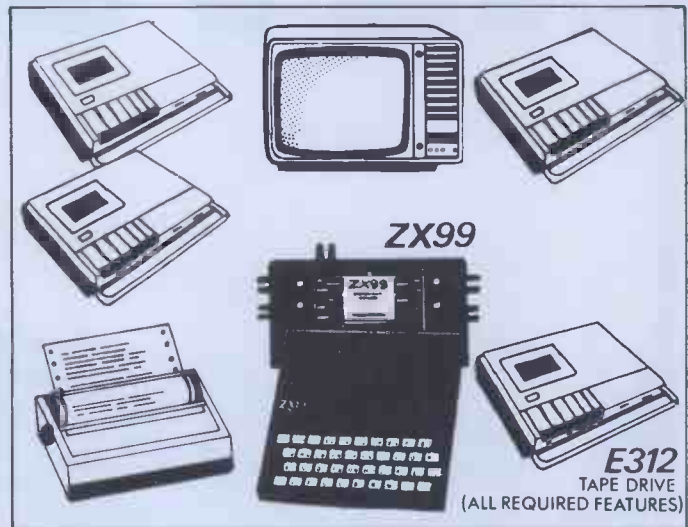

BUSINESS, EDUCATION & FUN



COMPREHENSIVE USER MANUAL INCLUDED IN PRICE

COMPUTER CASSETTES	QTY	PRICE	TOTAL	ITEM	QTY	PRICE	P&P	TOTAL
C5		35p		ZX99 Automatic Tape Controller + Super Software		£	£	
C10		37p				59.95	2.95	
C12		38p		E312 Cassette Tape Drive		24.00	1.00	
C15		39p		Cheque/PO payable to Storkrose Ltd.				
C20		41p		  or Charge my Access/Visa card no.:				
C25		43p		<input type="text"/>				
C30		44p		SIGNED _____				
C15 Leaderless		£1.00						
Add min £1.50 or 10% P & P								

ORDER FORM TO:
data-assette®

Dept: PCW4
44 Shroton Street,
London NW1 6UG Tel: 01-258 0409
Telephone enquiries welcome

NAME _____
ADDRESS _____

N°1 FOR DIGITAL X-Y PLOTTERS

If you are looking for a high quality X-Y Plotter, then look no further, we will almost certainly have one from our large range to suit your requirements (we have 14 different models in A3 size alone). Our Watanabe Plotters are available in sizes from A3 to A0, flatbed or drum type, with a choice of 1 up to 10 pens. With parallel, RS232 or IEEE interfaces.

Our prices must make these Plotters the best value for money available with A3 Plotters starting at £892.50 (1 pen, 12-intelligent functions, parallel interface) and at the top of the range in A3 size our 10 pen high speed Plotter with 42 intelligent functions (including digitizing) is only £2,430 plus interface.

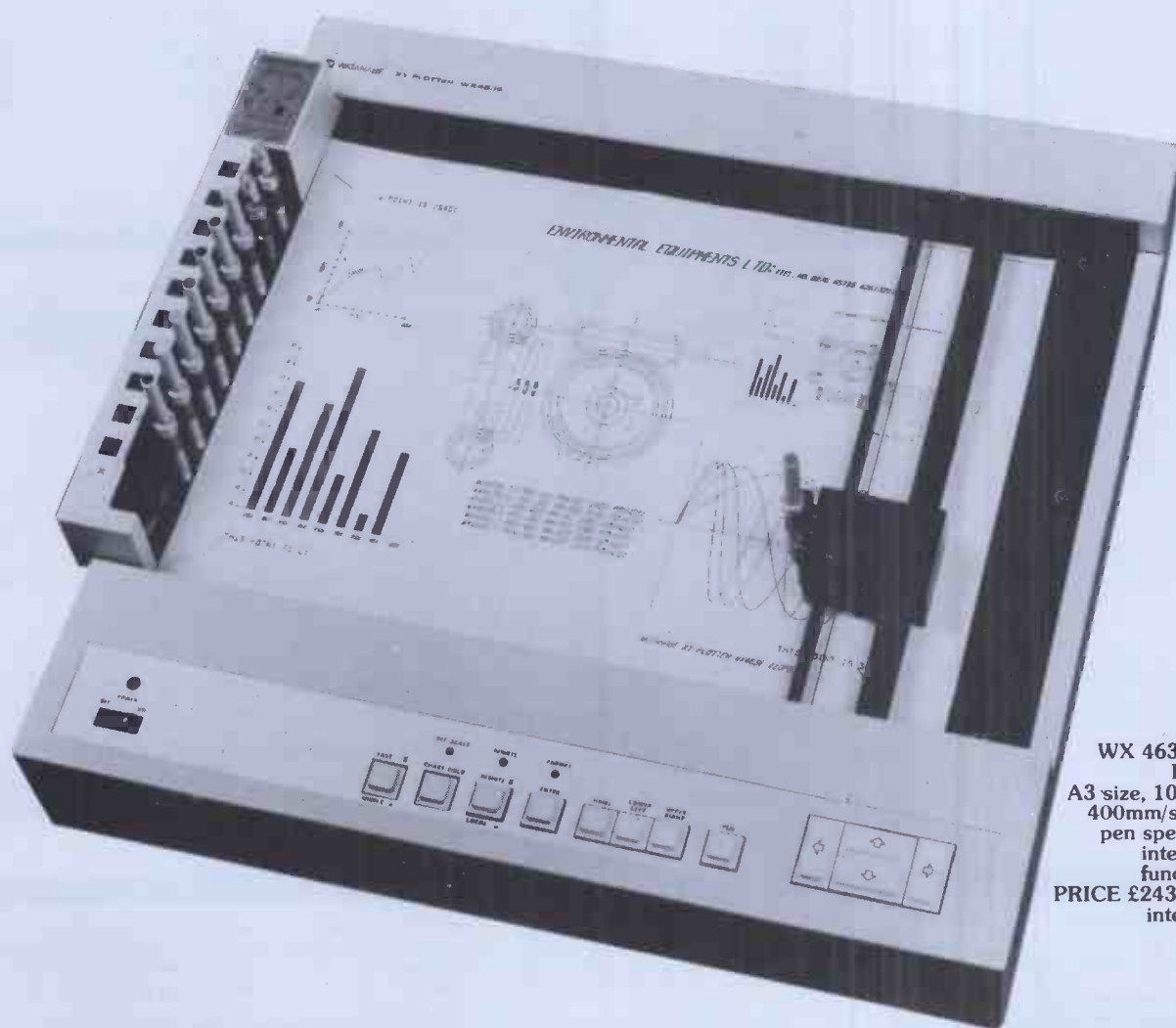

**WX 4636 X-Y
Plotter**
A3 size, 10 pens,
400mm/second
pen speed, 42
intelligent
functions.
**PRICE £2430 plus
interface.**

Why not contact us on (0270) 625115, 626132, we will be pleased to send you further information or arrange a demonstration.



Environmental Equipments (Northern) Limited

Tel.: Nantwich.(0270) 65115 - 626132 - 626605 - 627306

ENVIRON HOUSE, 64 WELSH ROW, NANTWICH, CHESHIRE CW5 5ES

Superior Systems Ltd.

178 West St, Sheffield S1 4ET. Tel. (0742) 755005

ACORN

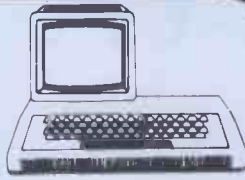

Acorn Atom 8k ram, 5k ram, P.S.U & Colour Board	199.00E
Atom Disk Pack, 96k Single Disk Drive	299.00E
Atom Colour Board	39.00C
Word Pack Rom	26.00A
Business	10.00A
Business Book	6.95A
Desk Diary	10.00A
Database	10.00A
Adventures	10.00A
Atom Chess	10.00A
Floating Point Rom	20.00A
B.B.C. Rom Pack	PHONE
B.B.C. Basic Programming Book	5.95B

VIC 20



Vic 20 Computer	PHONE	
Vic Cassette Deck	39.00D	
Vic Printer	200.00E	
Single Disk Drive	344.35E	
Programmers Aid Cartridge	30.39B	CASSETTE SOFTWARE
Machine Code Cartridge	30.39B	
3k Ram Cartridge	26.04B	
8k Ram Cartridge	39.09B	Pack Man (high resolution)
16k Ram Cartridge	65.17B	Submarine
Vic Revealed	10.00B	Gunman (high resolution)
Getting Acquainted with the Vic 20	7.95B	Naval Battle
Vic Programmers Reference Guide	14.95B	Space Invaders
		7.50A
		7.50A
		7.50A

NEC

PC 8001 (32k computer)	599.00E
PC 8011 32k Expansion Unit	489.00E
PC 8012 32k Expansion Unit	399.00E
PC 8023 Dot Matrix Printer	399.00E
PC 8031B Dual Disk Drive	669.00E
PC 8032B Add on Dual Disk Unit	569.00E
PC 8041 12" Green/Orange Monitor	159.00E
PC 8043 High Res. Colour Monitor	579.00E
PC 8045A Light Pen	199.00E
CP/M Disk & Manual	64.00D

ACT SIRIUS ONE

Act Sirius One 16 Bit Computer Including CP/M, Microsoft 86 Basic & Utilities. 495.00E
Memory Upgrade to 256K 1495.00E
Memory Upgrade to 512K 695.00E
Act 911 Matrix Printer 1295.00E
Act 921 Daisy Wheel Printer

SIRIUS SOFTWARE

Pulsar Accounting Package	495.00D
Pulsar Database	295.00D
Supercalc	150.00D
Micromodeller	595.00D
Wordstar	295.00D

SHARP



MZ80K (48k)	PHONE
MZ80A (48k)	FOR BEST
MZ80B (64k)	PRICE
MZ80 P3 Printer for MZ80K	360.00E
MZ80 I/O Interface unit MZ80K	95.00E
MZ80 FB Dual Floppy Disk Unit	550.00E
MZ80 EU Interface Unit for MZ80B	46.00B
MZ80 P6 Printer for MZ80B	409.00E
PC 1211 Pocket Computer	69.50D
PC 1500 Pocket Computer	139.00D
CE 122 Printer Interface (pc1211)	60.83C
CE 150 4 Colour Printer (pc1500)	125.00D

Apollo Word Processor (tape)	34.95B
Database (cassette based)	29.50B
MZ80 Calc II	34.50B
Zen Editor Assembler	19.50B
Zen Dos (editor assembler disk)	37.50B
Zen Dissassembler	10.50A
MZ80K Dust Cover	5.00A
P3 Printer Dust Cover	5.00A

SOFTWARE

Wordpro Word Processor (tape)	39.50B
Wordpro Word Processor (disk)	79.95B

VIDEO GENIE



Genie I Computer	295.00E
Genie II Computer	295.00E
EG 3014 Expansion Unit	199.00E
EG 3015/16 16k Ram Card	91.50C
EG 3015/32 32k Ram Card	128.80E
EG 400 Single Disk Drive	215.00E
Colour Board for Genie I/II	35.00B
Dust Cover for Genie I/II	5.00B

SOFTWARE

Acquire Business Game	11.27B
Adventures (various titles)	11.97 each B
Adventure Sampler	8.75B
Asteroids	8.75B
Accel II Basic Compiler	39.95C

Copypis Program Copier	11.25B
Database	25.00B
Editor Assembler Plus	21.70B

APPLE

Apple II (48k) Computer	670.00E
Disk Drive with Controller	370.00E
Disk Drive Without Controller	290.00E
12" B.M.C. Green Screen Monitor	119.50E
Epson MX80 FT/1 Printer	399.00E
Graphics Table	85.00D
14" Colour Monitor	480.00E
D.M.S. Colour Card	250.00E
	90.00D

APPLE II SOFTWARE

Visicalc	104.00D
Micro Modeller	420.00D
Visidex	105.00D
Visiplot	96.00D
Visitrend/Visiplot	135.00D
Visiterm	80.00D
Apple Writer	39.00D

ADLER

Special Adler Package

The Adler P2 Computer, integral unit with twin disk drives, 12" green monitor, The Adler SE 1010 Typewriter/Printer, & the Lexicom II Word Processor.

Special Package Price

2900.00E

Postage Rates

a.75p b.1.00 c.1.50 d.2.50 e.5.00

ALL PRICES EXCLUDE VAT

Prices and offers were prepared many weeks before publication of this magazine, and whilst every possible effort will be made to meet our offers, in some cases, prices may fluctuate and we would advise you to confirm by telephone before ordering.

MAIL ORDER

Please Supply _____

£

Name _____

£

Address _____

£

£

£

£

£

Access/Barclay/Cheque _____

P&P+VAT _____

£

Card No. _____

Total _____

£

Code _____

Tel _____

PET SPEED

Put some zipp into your programs



Petspeed compiled programs Just ZIPP through your Commodore computer.

To illustrate the point Oxford Computer Systems (Software) Ltd., have produced an enlightening demonstration disk entitled "Life in the Fast Lane", which gives objective comparisons between Pet Basic, Petspeed and the alternative Basic Compiler.

Petspeed is the only **optimising** Basic Compiler available for any microcomputer, which is only one of its other advantages.

FASTER – Petspeed is capable of double the speed of the DTL Basic Compiler and up to 40 times the speed of Pet Basic.

SHORTER PROGRAM SIZE – the size of long programs is considerably reduced.

COMPATIBLE – Petspeed will compile ANY Pet Basic program.

OPTIMISATION – Petspeed is the only optimising Basic Compiler available for any microcomputer, because of its optimisation, programs run much faster.

SECURITY – Your programs belong to YOU. Oxford Computer Systems (Software) Ltd. makes no claim on Petspeed Compiled programs. No key or security device is required for compiled programs and users can build in their own protection. Petspeed code is unlistable and compiled programs cannot be tampered with.

PRICE – we will leave you to compare prices.

Also available **COMPILED INTEGER BASIC** – 150 to 200 times the speed of Basic Compiled. Compiled Basic is for those applications where the speed of the machine is required without the inconvenience of assembly level programming. Ideal for scientific and educational users. Compatible with Petspeed.



Petspeed for 8000 series £240
Compiled Basic £165

Special Offer: Petspeed for 8000 series PLUS
Compiled Basic for just £320.

Prices do not include VAT or postage & packing.

Write or phone today for a free copy of the 'Life in the fast lane' demonstration disk.

Oxford Computer Systems (Software) Ltd.
7 & 8 Park End Street, Oxford OX1 1HH
Telephone Oxford (0865) 49597

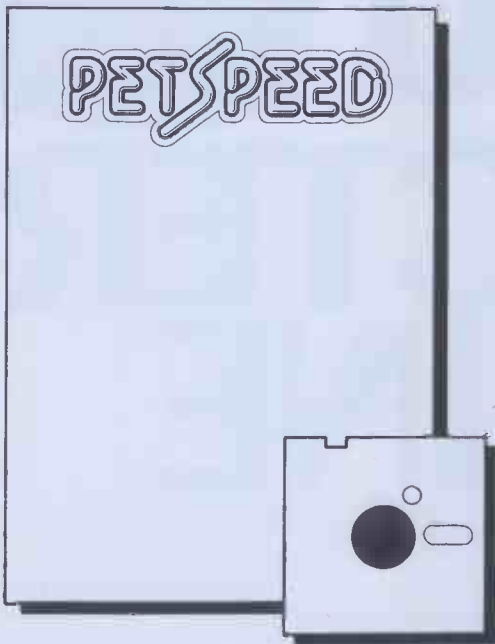
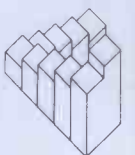

SPECIAL OFFER FOR EDUCATIONAL USERS

Volume discount on all
orders placed by accredited
educational users before
31st October 1982. Consult
your local dealer or ring
Oxford 49597.

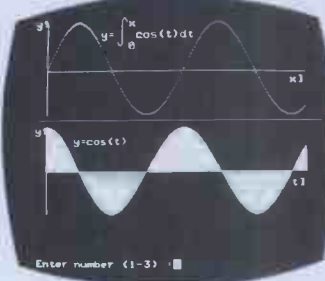
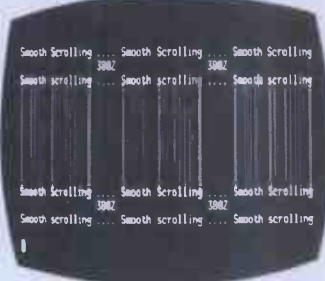
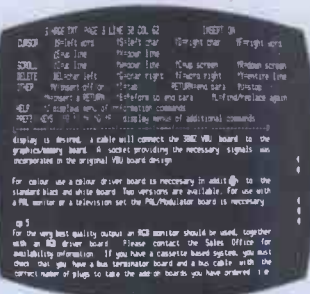
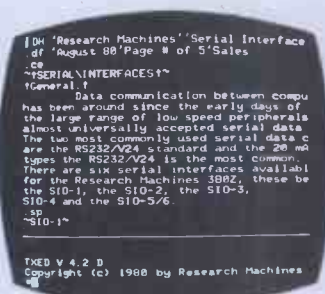

80/40



CHARACTER MACHINE

Providing exactly the right facilities for different applications can be a real problem when a system is as versatile as the 380Z.

Take, for example, screen line length. Not only do different users have different needs; so too do individual users.

They might welcome forty character clarity for presentation, display, and control applications; but they also want eighty character capacity, because word processing, some programming languages, and many general-purpose applications demand it.

So we've developed Varitext — to provide both, on the same machine.

Varitext means that the 380Z user can always choose the line length best suited to the application. It gives access to a growing range of 80 character software without losing all those well-established and popular 40 character applications. It makes the 380Z equally effective as a computer and a word processor. It lets programmers use the character mode with which they are familiar — or which languages like ALGOL, FORTRAN, and PASCAL really need.

And it improves the quality of our already exceptional graphics, by offering a smaller character size for neater annotation.

But the Varitext option goes a great deal further than that. We also saw it as the opportunity for a major enhancement of the 380Z's screen handling capabilities.

So we added:

- an 8 x 10 dot matrix, to further refine the character set;
- an additional set of 128 user-definable characters;
- reverse video, underlining, and selective character dimming;
- smooth scrolling and faster screen filling;
- user defined windowing (and independent scrolling) of screen areas;
- audible tone generation (option)

And all that, we believe, makes the 380Z's screen handling the best on the market.

The Varitext option is available with new systems or as a user-installable enhancement to existing 380Z systems. Contact our Sales Office for details.

RESEARCH MACHINES
MICROCOMPUTER SYSTEMS

RESEARCH MACHINES LTD Mill Street, Oxford OX2 0BW, Tel: (0865) 49866

For all your Micro needs and more...

Data Efficiency dealers offer printers from Centronics, Olivetti, Anadex and Integral Data (Paper Tiger) including the new Prism Colour Printer, monitors from Philips and Kaga (former manufacturers of BMC) with black/white, green, amber and full colour displays. Apple accessories including the



Mountain Hardware range and more – you'll find that a DE dealer has a lot more to offer.

Price is important, so is service, and with access to

over £1 million worth of stock, your DE dealer will get you what you want, when you want – with prices to match.

Data Efficiency Ltd
Computer Division,
Finway Road,
Hemel Hempstead,
Hertfordshire, HP2 7PS

Tel: (0442) 40571/2
Telex: 825554 DATEFF G

SPECIAL OFFER

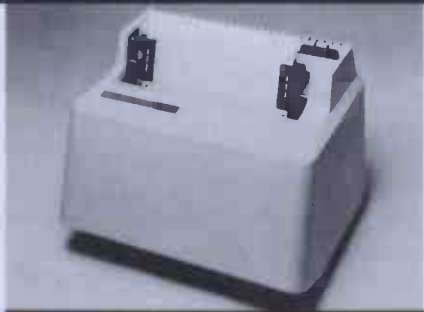

For a limited period whilst stocks remain we're offering Paper Tiger Printers at low, low prices.

T 445 92 cps.
Serial/Parallel Interface.
Graphics

ONLY **£450**

PT 460 152 cps.
Serial/Parallel Interface.
Graphics.

ONLY **£550**

Ring for details of your nearest stockist

(0442) 40571/2

DE

Data Efficiency Ltd

Dealer enquiries welcome

Flexible Relational Database System



CONDOR

from M.O.M. (Systems)

For Business People Who Use English

User Friendly	Business English commands like ENTER, LIST, DISPLAY, SORT, COMPUTE etc.
Advanced	Uses relational commands like:- COMBINE, PROJECT, & JOIN to connect two or more datasets
Screen Formats	Create your own screen formats rapidly
Processing	Calculations of totals, subtotals on many keys. Sorting and selection on one or more keys
Compatible	For use on any Z80 based Micro operating under CPM 2.2 eg: SUPERBRAIN, CROMEMCO, NORTH STAR, TRS etc. or A.C.T. SIRIUS (INTEL 8088)
Flexible	For use by Doctors, Dentists, QS, Estate Agents, Lawyers, Librarians, Engineers, etc, etc. Requires no special programming knowledge to implement systems
CONDOR is a product of Condor Computer Systems Inc. It is now available in the U.K. after extensive testing by MOM.	

For prices and consultancy call or write to the main U.K. Distributor:-
M.O.M. Systems Ltd. **Granite Chips Ltd.**
 40/41 Windmill Street, Gravesend, 21 Bon Accord Street, Aberdeen AB1 2EA
 Kent DA12 1BA (0474) 57746 (0224) 22863
 (Dealer enquiries also welcome)

Knights Unbeatable Sharp Deals

DEAL A1	MZ-80A with 4 languages – BASIC, PASCAL, FORTH and MACHINE CODE + 100 programs to get you off to a flying start.	
DEAL A2	Trade in any Sinclair computer and get a £50 allowance against deal A1	
DEAL A3	Everything in deal A1 plus expansion unit	£559
DEAL A4	Complete MZ-80A system – computer, floppy disk, printer expansion unit, all interface cards, cables, manuals etc	£1399
DEAL B2	MZ-80B with BASIC, DOUBLE PRECISION BASIC, ASSEMBLER, DISASSEMBLER and 70 programs	£999
DEAL B11	Complete MZ-80B system, printer, floppy disk, expansion unit, cables, cards etc, all languages and programs in deal B2 + KNIGHT MZ-80B COMMANDER	£1999

New Knights Software for MZ80A

KNIGHTS WEE PASCAL + 4 programs	£20
KNIGHTS MACHINE CODE (as supplied to Sharp)	£30
KNIGHTS FORTH LANGUAGE + 4 programs	£25
KNIGHTS MONITOR PLUS (adds 30 commands)	£40

New Knights Software for MZ80B

2001 – A Space Odyssey	£15	Starfleet	£15
Flight Simulator	£15	KNIGHTS EASY ASSEMBLER	£30
KNIGHTS B DISK COMMANDER	£65		

All prices exclude VAT but include delivery.

108 ROSEMOUNT PLACE
 ABERDEEN
 Telephone 0224 630526
 Telex 739169

Knights T.V. & COMPUTERS

Use Your Atom for-

Planning Writing Estimating
 Scheduling Calculating Recalculating Erasing
 Revising Critical Path Analysis....
 With ATOMCALC only £39.10 inc. VAT

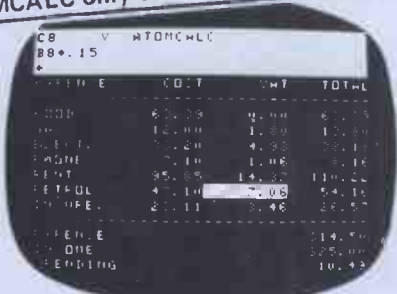

What is it?

Atomcalc is supplied as a plug-in 4k ROM with an all-purpose planning and modelling program. It is so easy to use - if you can use a calculator you can use Atomcalc. No programming skill needed.

The ROM creates an enormous grid of columns and rows like a ledger. All you do is to enter the headings and formula once and Atomcalc does the rest. Supplied with a very detailed 30pp user handbook.

What will it do?

Atomcalc can cope with anything from a household budget to company accounts. You set up a series of automatic calculating functions like totalling or percentages. Then fill in the columns with your figures and the program produces the answers. If you want to change one figure in the calculation it immediately changes the relationship of all the other figures involved. So, for example, you can see what effect on profit a 5% increase in sales might have or a 10% increase in production, or a 3% drop in transport.

And do not forget you can print them out on an optional printer or store them on tape.

How Can I Buy One?

Go to your Atom Dealer, or if there are none in your area just send a cheque for £39.10 (incl. VAT and P & P) to the address below. Credit Card holders can ring Cambridge (0223) 316039 and order direct.

Dept. 1 Acornsoft Ltd, 4a Market Hill, CAMBRIDGE.

ACORNSOFT

Brand new colour board NOW YOUR LIFE CAN BE MORE COLOURFUL!

£39

The board fits inside the Atom and generates colour output suitable for all makes of monitors and TV's.

Two colour palettes can be achieved
 Red, Yellow, Green, Blue and White, Cyan,
 Magenta, Orange. In text modes this provides
 green on blue or orange on black displays.

Three outputs are provided:-

- Red, Green, Blue drives at TTL levels with a composite sync, the polarity of which may be link selected.
- A 1v composite video in monochrome only.
- A PAL encoded signal on Channel 36 suitable for feeding into the aerial socket on a domestic television.

You can fit the board yourself using a fine soldering iron or your dealer will fit it for you. The board can be used in a minimum Atom with the existing power supply, or if used in a maximum Atom a 5V externally regulated supply will be necessary.

Available from all Acorn Dealers or direct from Acorn at £45.24 inc VAT and p+p. Credit card holders can ring (0223) 245200 and place their orders direct.



Acorn Computers
 Fulbourne Road,
 Cherry Hinton, Cambridge

it's here at last!

NEW

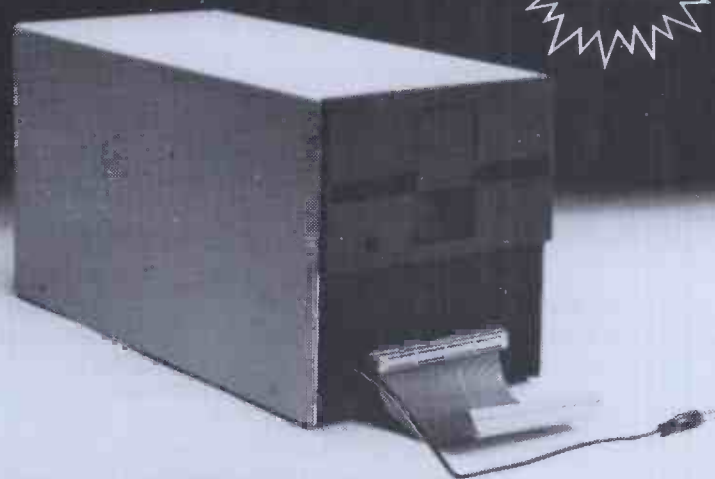

Disc pack for the atom

Upgrade your atom with our new low cost disc pack only £299 plus VAT

- 40 - track single-sided 5 1/4" disc drive
- power supply to run both the disc pack and a fully expanded Atom
- disc controller card with 4K DOS ROM
- 3k bytes of static RAM
- 64-way Euro-connector plug and cable
- full operating instructions and manual

The disc controller is based on the Intel 8271 chip. This highly intelligent device minimises the amount of control software and memory requirement and so allows phenomenal high speed operation. Both soft and hardware has been vigorously tested and proved very, very reliable.

You will need an Atom with bus buffers and indirect edge connectors. The mail order price is £350 including VAT post, packing and insurance, the price at your Atom dealer £345.

If you do not have a dealer near you just write to us at the address below, or credit card holders can ring Cambridge (0223) 245200 and order directly.



Acorn Computers Ltd.,
 Fulbourne Road,
 Cherry Hinton, CAMBRIDGE

The disk operating system (DOS) decodes the following commands used to control the storage of files on disk:-

- * CAT catalogue files on disk
- * LOAD load image of memory contents as file
- * SAVE save image of memory contents as file
- * DELETE delete file from disk
- * SPOOL store all printer characters on disk
- * EXEC read characters from disk as if from keyboard

The DOS also replaces the cassette operating system vectors as used by BASIC to allow the use of the following commands in Atom BASIC:-

- LOAD load BASIC program from disk
- SAVE save BASIC program to disk
- FOUT open file for output
- FIN open file for input
- SHUT close file
- EXT find extent of file
- PRT find value of pointer into file
- PUT put number to file
- BPUT put byte to file
- SPUT put string to file
- GET get number from file
- BGET get byte from file
- SGET get string from file

These commands provide full random access of up to 5 disk files simultaneously.

G.M.MICROTRONICS LTD.

UNIT 14, GODINTON WAY INDUSTRIAL ESTATE,
GODINTON ROAD, ASHFORD, KENT TN23 1JB
Telephone: ASHFORD (0233) 38671/38672

*"Add the power of speech
to your computer"*

TMS 5100 TALKING BOARD as featured in ELEKTOR

Features 170 word vocabulary in
3 Eproms

Easily interfaced to any computer
(via Bus or Parallel port) ie:

Acorn, Atom, Apple, Atari, Pet,
Vic, and ZX80/81.

Requires $\pm 12v @ 50 \text{ ma}$ and
 $+5v. @ 300 \text{ ma}$.

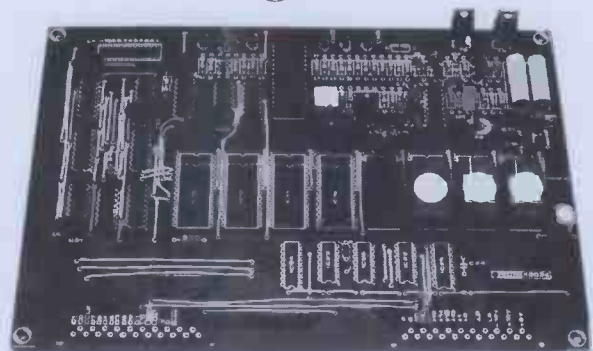

GM510 Talking Board Kit (with interface IC's)	£82.95p
GM511 Power supply Kit to Power above	£16.10p
GM5100 Ready Built with power supply and cased	£144.00p
Design notes (inc in above) if bought separately	£1.00p

SOFTY II NOW IN STOCK @ £182.00 inc VAT

ALSO AVAILABLE SHORTLY

6808/6809 6u Board Expandable Computer System

Send for further details and specification



Please send the following items:

- Box
- Softy II
- GM510 Talking Board Kit
- GM511 P.S.U. Kit
- GM5100 Ready Built Cased Unit
- Further Details
- Design Notes
- 6808/9 Details

I enclose cheque P/O for value of £..... please add £2.00
p&p. All prices inc. VAT.

Name

Address

Post Code

THE **Micro-Spares** SOLUTION TO SMALL BUSINESS COMPUTING

Micro-Spares can supply you with an integrated system that has everything you require to run a small business for under £4000 including VAT.

HARDWARE

Galaxy.I. computer.
Epson MX80FT-I dot
matrix printer.
BMC green screen
monitor.
All cables.
Paper.
10 floppy disks.

SOFTWARE

Sales ledger.
Purchase ledger.
Nominal ledger.
Stock control.
Word processor.

SERVICE

Full training on the system which will be delivered and installed on your premises.

A full 48 hour maintenance contract for one year.
ALL FOR ONLY £3,390 + VAT.

For further details contact Mr Anthony on
031-337-5611.

COMPUTER MAINTENANCE

A Third Party Maintenance for your computer system is available throughout Great Britain. For further details give us a call on 031-337-5611. We have a lot to offer and we are not expensive.

THE SUPERB BMC MONITOR

12" green phosphor ONLY £145 + VAT.

TELEVIDEO MODEL 925 VDU with all the features expected of one of the best videos on the British market complete with full screen facilities and detachable keyboard ONLY £699 + VAT.

For leaflet and more details call us at Micro-Spares.

The **Micro-Spares** catalogue is now available at 15p for a range of computers, monitors, interface-boards, computer components, memories, Third Party maintenance, computer repairs, consultancy, books, programmes, second-hand computers etc. 5% OFF. purchases with special token* on back of catalogue. All our prices are the best on the market. For quality at a good price the catalogue is a must.

*This token is valid 14 days from date on the token.
Does not apply to Galaxy Business System.



Micro-Spares

19 Roseburn Terrace, Edinburgh EH12 5NG.

Tel: 031-337 5611.

SUPPLIERS TO TRADE
LOCAL GOVERNMENT
EDUCATION
INDIVIDUALS
INDUSTRY

EDINBURGH



COMPUTERS
PERIPHERALS
COMPONENTS
& NATIONWIDE
MAINTENANCE

SCOTLAND



COMPUTER WAREHOUSE

NOW OPEN
MONDAY-SATURDAY
9.30-5.30

BULK BUY SPECIALS

RAM SCOOP

4116 200 NS 8 for £12.95
4164 200 NS £8.50 each
2102-650 NS 8 for £5.50
INC VAT



25 WAY "D" CONNECTORS

	50+	100+
25p	1.70	0.95
25S	1.90	1.00
ALL + VAT		

WIRE WRAP SKTS.

24 Pin Vero 28p
14 Pin Gold 22p
16 Pin Gold 24p
100 PCS Min Ord.

C10 DATA CASSETTES
10 for £5.75
Inc. VAT

RF CONNECTORS

50Ω BNC PLG 50p
75Ω BNC PLG 50p
PL259 PLG 40p
SD239 SKT 35p
100 PCS MIN ORD.

TELETYPE ASR33 I/O TERMINALS



From £195 + CAR + VAT

Fully fledged industry standard ASR33 data terminal. Many features including: ASCII keyboard and printer for data I/O, auto data detect circuitry, RS232 serial interface, 110 baud, 8 bit paper tape punch and reader for off line data preparation and ridiculously cheap and reliable data storage. Supplied in good condition and in working order. Options: Form stand £12.50 + VAT

KSR33 With 20ma loop interface £125.00 + VAT.

Sound proof enclosure £25.00 + VAT

"OLIVETTI TE300" PRINTER/TERMINALS



A complete I/O terminal with integral 8 hole paper tape punch and reader, full ASCII keyboard, 120 column printer, and control unit. The printer is capable of 150 baud with a serial TTL or balanced input-output sold in good overall condition but untested. Complete with circuit unguaranteed. Connect direct to your micro at ONLY £99.00 + £11.50 carr + vat.

MPU EXPERIMENTORS +5v, 12v, 12v, 24v POWER SUPPLY

Once again we are very pleased to offer this superb Power Supply Unit, and hope to satisfy most of our previous customers who were disappointed when we sold out due to demand last time they were advertised!!! These units may just have well been made for your lab., they consist of a semi-enclosed chassis measuring 160mm x 120mm x 350mm containing all silicon electronics to give the following fully regulated and short circuit proof outputs of:

+ 5v @ 2 amps DC	+ 12v @ 800 ma DC
- 12v @ 800 ma DC	+ 24v @ 350 ma DC

and if that's not enough a fully floating 5v output @ 50 ma DC which may be seriesed to give a host of other voltages. All outputs are brought out to the front panel via miniature jack sockets and are also duplicated at the rear on short flying leads. Units accept standard 240v mains input. They are ex GPO and may have minor scratches on the front panels, they are sold untested but in good internal condition. £16.50 each + £2.50 p+p complete with circuit and component list. Transformer guaranteed. **HURRY WHILE STOCKS LAST!!**

HIGH SPEED DATA MODEMS

A superb piece of engineering made by SE Labs Ltd. to a "no cost spared" spec for the GPO, the Modem 12 is a synchronous Modem for use on DATEL 2412 services, or other data links. Many features include switchable V26 modulation, 2400 baud full duplex 600/1200 standby, auto answer, 4 wire or 2 wire operation. Self test LED status indicator CMOS technology, modular construction, original cost over £700 each. Believed brand new, supplied complete with PSU etc.
£185.00 + £9.50 carriage + VAT.
*Permission may be required for connection to PD lines

DISTEL ©

"Dial our Database!"

Get information on 1000's of stock items and order via your computer. 300 baud on 01-689 8800
18.30 to 0900 6 days a week and all day Sundays. **IT'S FREE!**

DIABLO S30 DISK DRIVES

Another shipment allows us to offer you even greater savings on this superb 2.5 MB (formatted) hard disk drive. Two types are available both fully refurbished and electronically identical, the only difference is the convenience of changing the disk packs.

S30 front loader, pack change via front door £550 + vat

S30 fixed, pack change via removal of top cover £295 + vat

+ & - 15v PSU for 2 drives £125 + vat
Carriage & insurance on drives £15.00 + vat fully DEC RK05, NOVA, TEXAS compatible further info on controllers etc on request.

MAINS FILTERS

Professional type mains filters as used by "Main Frame Manufacturers" ideal for curing those unerving hang ups and data glitches. Fit one now and cure your problems! Suppression Devices SD5 A10 5 amp £6.95
Corcom Inc F1900 30 amp £13.95 + pp £1.00

DC SYSTEM SUPPLY

Professional fully cased fan cooled system supply. Standard 240 V ac input with the following DC outputs 5V @ 1.1 amps +15-17v @ amps, -15-17v @ 8 amps and +24v @ 4 amps. All outputs are fully crowbar protected and the 5 volt output is fully regulated. Sold tested and in a new or little used condition complete with circuit £55.00 + carr £8.50 + vat DIM 15.5" x 9" x 6"

NATIONAL MA1012 LED CLOCK MODULE

- ★ 12 HOUR
- ★ ALARM
- ★ 50/60 HZ

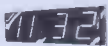

The same module as used in most ALARM/CLOCK radios today, the only difference is our price! All electronics are mounted on a PCB measuring only 3" x 1 1/2" and by addition of a few switches and 5/16 volts AC you have a multi function alarm clock at a fraction of cost. Other features include snooze timer, am pm, alarm set, power fail indicator, flashing seconds cursor, modulated alarm output etc. Supplied brand new with full data only Suitable transformer £1.75. **£5.25**

ELECTRONIC COMPONENTS & EQUIPMENT

66% DISCOUNT

Due to our massive bulk purchasing programme which enables us to bring you the best possible bargains, we have thousands of I.C.'s, Transistors, Relays, Cap's., P.C.B.'s, Sub-assemblies, Switches, etc. etc. surplus to our requirements. Because we don't have sufficient stocks of any one item to include in our ads., we are packing all these items into the "BARGAIN PARCEL OF A LIFETIME" Thousands of components at giveaway prices! Guaranteed to be worth at least 3 times what you pay plus we always include something from our ads. for unbeatable value!! Sold by weight

2.5kls £ 4.75 + pp £1.25 5kls £ 6.75 + pp £1.80
10kls £11.75 + pp £2.25 20kls £19.99 + pp £4.75

SAVE OVER £1400

THE PRINTER SCOOP OF THE YEAR THE LOGABAX Z80 MICROPROCESSOR CONTROLLED LX180L MATRIX PRINTER



A massive bulk purchase enables us to offer you this superb professional printer at a fraction of its recent cost of over £2000. Utilising the very latest in microprocessor technology, it features a host of facilities with all electronics on one plug in P.C.B. Just study the specification and you will instantly realise it meets all the requirements of the most exacting professional or hobbyist user.

STANDARD FUNCTIONS ★ Full ASCII character set ★ Standard ink ribbon ★ RS232/V24 serial interface - 7 xtal controlled baud rates up to 9600 ★ I94 characters per line ★ Parallel interface ★ Handshakes on serial and parallel ports ★ 4 Type fonts, italic script, double width, italic large, standard ★ Internal buffer ★ Internal self test ★ 170 CPS ★ Variable paper tractor up to 17.5" wide ★ Solid steel construction ★ All software in 2708 eeproms easily reconfigured for custom fonts etc
All this and more, not refurbished but BRAND NEW At Only **£525** + VAT

OPTIONAL EXTRAS * lower case option £25.00 * 16k buffer £30.00 * 2nd tractor for simultaneous dual forms £85.00 * Floor stand £45.00 * specialist carriage £19.00 All items plus VAT data sheet on request.

8" FLOPPY DISK DRIVES

Unbelievable value the DRE 7100 & 7200 8" disk drives utilise the finest technology to give you 100% bus compatibility with most drives available today, the only difference being our PRICE and the superb manufacturing quality. The 7100 single sided & 7200 double sided drive accept hard or soft sectoring, IBM or ANSI standard giving a massive 0.8 MB (7100) & 1.6 MB (7200) of storage. Absolutely SHUGART, BASF, SIEMENS etc compatible. Supplied BRAND NEW with user manual and 90 day warranty.

7100 single sided	£225.00 + 9.50 carr + vat
7200 double sided	£295.00 + 9.50 carr + vat

full technical manual £20.00 alone £9.00 with drive, refund of difference on purchase of drive. Data sheet on request. SPECIAL new, KODE PSU, drives 2 DRE drives £39.99 + carr + vat. 8" single sided, single or double density diskettes £1.80 each £15.00 for 10 inc. lib case + vat.

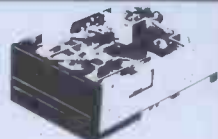

COOLING FAN SPECIAL

Keep your equipment cool and reliable with our range of professional fans.
ETRI 99XU01 Miniature equipment fan 240 vac working DIM 92 x 92 x 25 mm BRAND NEW complete with bearing guard. Makers price £16 our price £10.25
BUHLER 69.11.22 mini miniature 8-16 v DC reversible fan. Measures only 62 x 62 x 22 mm. Uses a brushless DC servo motor, almost silent running ideal portable equipment. Life in excess of 10,000 hours. BRAND NEW manufacturers price £32.00 our price £13.95
MUFFIN/CENTAUR cooling fans, tested ex equipment 240v £6.50, 115v £5.50 + pp £1.90
KOOL TRONICS Powerful snail type blower gives massive air movement with centrifugal rotor. DIM as a cube 8" x 8" x 6" air aperture 2.5" x 2.5" with flange fixing. BRAND NEW 110v/50 Hz ac working ONLY £9.95 + £1.90 pp.



ELECTRONICS

Dept. P.C.W., 64-66 Melfort Rd., Thornton Heath, MAIL ORDER Croydon, Surrey, Tel: 01-689 7702 or 01-689 6800 INFORMATION
Unless otherwise stated all prices inclusive of V.A.T. Cash with order. Minimum order value £2.00 Prices and Postage quoted for UK only. Where post and packing not indicated please add 60p per order. Bona Fida account orders minimum £20.00. Export and trade enquiries welcome. Orders despatched same day where possible. 3% surcharge on Access and Barclaycard orders.

SOFTY 1 & 2 EPROM BLOWER

Software development system invaluable tool for designers, hobbyists, etc. Enables open heart surgery on 2716, 2708 etc. Blows, copies, reads EPROMS or emulates EPROM/ROM/RAM in situ whilst displaying contents on domestic TV receiver. Many other features. £115 + carr. + VAT. Optional 2716, 2716 Function Card £40 + VAT, PSU £20 + £1.50 carr. + VAT.
Softy 2 for 2716/2732 **£169 + VAT**
Write of phone for more details

9" VIDEO MONITORS

Ex-equipment 9" Motorola Video Monitors 75Ω composite input, tested but unguaranteed. £39.99 + £7.50 carriage + VAT. Complete with circuit.

SEMICONDUCTOR 'GRAB BAGS'

Mixed Semis amazing value contents include transistors, digital, linear, I.C.'s, triacs, diodes, bridge recs., etc. etc. All devices guaranteed brand new full spec with manufacturer's markings, fully guaranteed, 50c bag £2.95 100c bag £5.15 TTL 74 Series.
A gigantic purchase of an "across the board" range of 74 TTL series I.C.'s enables us to offer 100+ mixed "mostly TTL" grab bags at a price which two or three chips in the bag would normally cost to buy. Fully guaranteed at I.C.'s full spec. 100+ £6.90 200+ £12.30 300+ £19.50

RCA FULLY CASED ASCII CODED KEYBOARDS

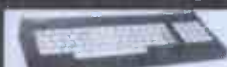

10EAL - TANGERINE, OHID ETC.

Straight from the U.S.A. made by the world famous R.C.A. Co., the VP600 Series of cased freestanding keyboards meet all requirements of the most exacting user, right down to the price! Utilising the latest in switch technology. Guaranteed in excess of 5 million operations. The keyboard has a host of other features including full ASCII 128 character set, user definable keys, upper/lower case, rollover protection, single 5v rail, keyboard impervious to liquids and dust, TTL or CMOS outputs, every on-board tone generator for keypress feedback, and a 1 year full R.C.A. backed guarantee.

VP601 7 bit fully coded output with delayed strobe, etc. **£43.95**
VP611 Same as VP601 with numeric pad. **£54.95**
VP606 Serial, RS232, 20MA and TTL output, with 6 selectable Baud Rates. **£64.26**
VP616 Same as VP606, with numeric pad, Plug and cable for VP601, VP611 **£2.25**
Plug for VP606, VP616 **£2.10**
Post, Packing and Insurance. **£1.95**
ORDER NOW OR SEND FOR DETAILS

5v D.C. POWER SUPPLIES

Following the recent "SELL OUT" demand for our 5v 3 amp P.S.U. we have managed to secure a large quantity of ex-computer systems P.S.U.'s with the following spec: 240 or 110v A.C. input. Outputs of 5v @ 3-4 amps, 7.2v @ 3 amps and 6.5v @ 1 amp. The 5v and 7.2v outputs are fully regulated and adjustable with variable current limiting on the 5v supply. Unit is self contained on a P.C.B. measuring only 12" x 5" x 3". The 7.2v output is ideal for feeding "on board" regulators or a further 3 amp LM323K regulator to give an effective 5v @ 7 amp supply. Supplied complete with circuit at only **£10.95 + £1.75 pp.** Believed working but untested, unguaranteed.

SHARP MZ-80K/MZ-80A/MZ-80B

Functional cassette software by Dale Hubbard

Buy 2 at £19.95 - take 1 at £5.95 FREE!!!

All programs in Standard Sharp Basic for 48k RAM upwards.
All programs supplied with exhaustive and attractively bound documentation.

DATABASE

The program that everyone needs. Facilities include sort, search, list, delete, change, totals, save file, line print if required, etc. etc. Can be used in place of any card index application.

£19.95

STOCK CONTROL

All the necessary for keeping a control of stock. Routines include stock set up, user reference no., minimum stock level, financial summary, line print records, quick stock summary, add stock, delete/change record, and more.

£19.95

MAILING LIST

A superb dedicated database to allow for manipulation of names & addresses & other data, with selective printing to line printer. Features include the facility to find a name or detail when only part of that detail is known. Will print labels in a variety of user-specified formats.

£19.95

DECISION MAKER

A serious program that enables the computer to make a sound decision for you based on various criteria.

If you want to buy a car, hi-fi, house, etc., or you don't know which woman to marry then you need this one.

£5.95

INVOICES AND STATEMENTS

Ideal for the small business. A complete suite of programs together with generated customer file for producing crisp and efficient business invoices and monthly statements on your line printer. All calculations including VAT automatic and provision for your own messages on the form produced.

£19.95

RUBIK SOLVER

It's not our policy to offer games but we make an exception here for a program to solve the cube from ANY position. Shorthand notation makes learning the solution by heart possible for most active brains.

£12.95

THE CATALOGUER

This dedicated database is ideal for use in any situation where a catalogue could be utilised. E.g. stamp collection, coins, photos, slides, books, records etc.

£19.95

COMMERCIAL ACCOUNTS

A gem of a program, all for cassette, with the following features:-

Daily Journal	Sales Ledger
Credit Sales	Purchase Ledger
Cash Sales	Bank Account
Credit Purchases	Year to Date Summary
Purchases - other	

A fully interactive program suitable for all businesses. Files can be saved and loaded and totals from one file carried forward to another on cassette. Particularly useful from a cash flow point of view, with an immediate accessibility to totals for debtors and creditors. Bank totally supported with entries for cheque numbers, credits and, of course, running balance.

£19.95

HOME ACCOUNTS

£19.95

Runs a complete home finance package for you with every facility necessary for keeping a track of regular and other expenses, bank account, mortgage, H.P. etc etc etc!! You'll wonder how you ever managed without it.

CHOPIN - LES ETUDES

Six beautiful studies from Opus 10 and 25 performed for you live by Mr. Sharp - Spellbinding!!!

£5.95

MOTOR ACCOUNTANT

Find out exactly what that car is costing you and keep a data file with all your expenses therein!

£5.95

RECIPE FILE

Let all those computer widows have a bash! The wives will really enjoy the fun of this program designed to keep all her recipes. Will even suggest a menu for a day/week! Excellent value.

£19.95



Access Welcome

Send cheque or P.O. or Cash (registered) or Credit Card no. to:

Gemini Marketing Ltd

Dept PCW(3) Quay House Quay Road Newton Abbot Devon TQ12 2BU
Or telephone us with your credit card order on (0626) 62869

All orders despatched by return - no waiting.

All prices include VAT and post & packing except Hardware. Full range of Sharp peripherals available - please 'phone for quotations.

Please state machine type (A.K. or B) when ordering software.

SPECIAL
HARDWARE OFFER!!
MAIL ORDER ONLY
MZ-80A PLUS ANY 3
PROGRAMS
£477 + VAT
LIMITED STOCKS -
HURRY!!!

LONDON COMPUTER CENTRE

TOMORROW'S COMPUTING TODAY

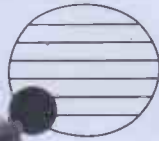

ACT Sirius 1

£2395
16 BITS FOR THE PRICE OF 8
BITS
128K RAM 1.2M DISK
STORAGE

SOFTWARE AVAILABLE

WORDSTAR, MAILMERGE, SELECT,
SUPERCALC, MICRO MODELER,
PULSAR ACCOUNTING, TABS
ACCOUNTING, INTEGRATED
ACCOUNTS, COCOL - FORTRAN,
PASCAL - M BASIC



TELE-VIDEO SINGLE-USER TO MULTI-USER

802 £2095
Superbrain Compatability
800K Disk Storage
Green Screen True desenders
22 function keys
802E 1.6. M/b Disk Storage £2595
802H 10.M/b Hard Disk £4295

806 £4495
Up to 6 user
Multi tasking
10 M/b hard disk

800 User stations £1050
64K RAM
280 CPU
Intelligent Terminal



**HARD DISKS FOR SUPERBRAIN
TRS 80 MOD II APPLE OWNERS.**
MODEL 6. 6mb £1850
MODEL 12. 11.5mb £2295

EPSON MX-80 FT
MX-80 FT2
MX-100



**SUPERBRAIN
WITH NEW EXTRA FEATURES**
Dedicated Keyboard from £1595



AUTO SHEETFEEDER £580

New! 12"
wide
Automatic
Sheet Feeder
fits all
below



AUTHORISED TANDY DEALERS

Model I
40K System
2 Disk Drives
Green Screen
Complete £995

Model II
with TRS DOS
and CPM at
No extra charge
from £1995

Model III
16K £499
48K £549
48K with 2 disk
drives £1350



PET! APPLE! TRS80! HORIZON! OWNERS!

Let LCC - the BIG COMPUTER CENTRE -
put you a cable's length away from

LETTER QUALITY PRINTING with 7 Star Printers.

OLIVETTI ET21. 20 CPS. Doubles as typewriter £795
TEC 40. 40 CPS. JAPANESE DIABLO 630 uses Diablo Daisy Wheel &
Ribbons £1,235
DAISY WHEEL II 60 CPS. RICOH 1600 Daisywheel £995
QUME SPRINT 5. 45 CPS £1,350
FLOWRITER RP 1600 60 CPS.

The most intelligent Daisy. Proportional Spacing with Right Justifi-
cation on Word Star, Wardpro, Apple Writer, Scripsit etc. £1500

NEC. 55 CPS. £1,650
FUJITSU 80 CPS. Plastic/Metal wheels £1,695
DEMONSTRATIONS ON ALL MODELS



ALL PRICES ARE EXCLUSIVE OF VAT AND
DELIVERY DEALER ENQUIRIES INVITED ON
ALL PRODUCTS

43 GRAFTON WAY, LONDON W1P 5LA (Opposite Maples)
OPENING HOURS: 11-7 MON-FRI 12-4 SAT Tel: 388 6991/2
24 hour answer phone: 01-388 5721

IT SPEAKS ANY LANGUAGE

Mc Combo

The specifications
speak for themselves!

Single board computer

Z80A (4 Mhz)

64K RAM

12K EPROM (including monitor)

4 serial RS232 (sync/async/bisync)

1 Centronics (bi-directional)

Facilities to add further disks
(5¼ or 8")

8 timers (4 user addressable)

Hard disk option

IBM 3740/34 format



Designed and built in the U.K. after intensive research into the requirements of the micro market, the McCombo represents a breakthrough in the price and performance of CP/M based computers. By using the latest state of the art design, the McCombo offers specifications usually found on larger and more expensive systems. The McCombo is capable of conversing with mainframes and being CP/M compatible has a vast library of fully intergrated software for most applications.

DESIGNED AND BUILT IN GREAT BRITAIN BY:

Megabrain
Computers Limited

2, Ganton Street, London W1
Telephone 01 734 9462/3
New distributors considered

Prices
start from:

£1088

"A leading computer company proves that if you've got something worth showing, it's good business sense to make an exhibition of yourself."



THE THIRD INTERNATIONAL COMMODORE COMPUTER SHOW OPENS JUNE 3RD

The Commodore Show is one of the finest opportunities to see the best of today's microcomputer systems in action. A wide range that covers our home colour computer and our selection of sophisticated business systems as well as the latest in software and related products.

Also we'll demonstrate just how they can improve efficiency, whatever line of business you're in.

There'll be seminars on education, communications and a wide variety of business applications.

Guests include knowledgeable and interesting people like Jim Butterfield, who's the foremost authority on the PET and its capabilities.

All in all, it's the biggest and best Commodore Show yet, and definitely not to be missed.

See us at: The Third International Commodore Computer Show, Cunard Hotel, Hammersmith, London.

Thursday June 3rd	12am - 6pm
Friday June 4th	10am - 6pm
Saturday June 5th	10am - 5pm



For further details ring
SLOUGH (0753) 79292

675 Ajax Ave, Slough, Berks.

 **commodore**
COMPUTER
Quite simply, you benefit
from our experience

VICTUALS

VIC COMPUTING is the magazine for the Commodore Vic.

We don't write about any other computers — Just the Vic.

So if you have a Vic, or if you're thinking of getting one, you can't afford not to subscribe.

We give you tips, tweaks and advice. We review any and all Vic-compatible hardware and software. We give you tested programs from readers and from our contributors: utilities, games, character editors. We give you all the Vic news — and our views of it. We give you columnists like Jim Butterfield and Mike Todd.

We give you what you want. And we give you what you need.

Please enter my annual subscription to Vic Computing Magazine. I enclose a cheque/postal order made out to Vic Computing for (please tick one):

£6 UK

£1RL 8.50

£9 Europe

£16 Elsewhere

NAME

ADDRESS

Send this form with your payment to: Vic Computing, 39-41 North Road, London N7 9DP.
Telephone: 01-607 9489.

ZX81 SOFTWARE 16K

Supplied on tape with full instructions

DATABASE A business system which can be used for mailing lists, stock control, telephone directory etc. Hundreds of uses. £10

ACCOUNTS Keeps up to date track of all your private or business transactions. Many useful functions included £6

MESSAGE DISPLAY Continuous moving display of your message in large letters. Eye catcher for shop windows. Fun for parties. £4

Send SAE for full details of these and many other interesting programs.

Datafax

 Dept PCW
Riviera House, Queens Road,
Buckhurst Hill, Essex

Trade and overseas enquiries welcome.

ZX software

ADVENTURE GAMES

Mission of the Deep. Fight your way through giant crabs, eels & explosive cargo to get the radioactive device. 16K £5.95.

Nightmare Park. The keeper challenges you to match your wits against unknown odds. No human has succeeded! 14K £4.95.

Warrior. Find and rescue your princess and battle with monsters, 3 dimensional display. 16K £4.95.

SPACE GAMES

Space Invaders. Fast interactive graphics, on screen scoring, destructable protective shields. 1K £4.95. Super 3K £5.95.

Space Rescue. Save your crew from the planet surface, avoiding the moving stars. 16K £3.95.

Planetoids. Skilfully plot your craft through the Asteroid Belt before your energy runs out. 16K £3.95.

16K RAM Pack

assembled, tested and cased £37.50 inc (P&P) Allow 21 days delivery

All supplied on cassette with instructions send cheque, P.O. or Card no. with order

Access Visa

26 Spiers Close, Knowle, Solihull
West Midlands, B93 9ES, England



MACRONICS

research ltd.

A/D BOARD FOR NASCOM

- 8 input channels
- 30 microsec conversion
- Over voltage protection
- Prototyping area
- 8 bit resolution
- Sample and hold
- Full flat/interrupt control
- NASBUS compatible

Price £120 + 15% VAT (post free)

GRAPHICS BOARD FOR NASCOM

- 384(H) x 256(V) high resolution graphics display
- Fully bit mapped
- Full software control
- Mixed text and graphics
- NASCOM 2 or 4MHz
- NASCOM 1

- Graphics software supplied

Price £55 + 15% VAT (post free)

EPROM PROGRAMMER

- Programs 3 rail: 2708/2716
- Single rail: 2508/2758, 2516/2716, 2532/2732
- Software supplied for Read/Program/Verify
- Can be used with other machines with 2 parallel ports

Price £63 + 15% VAT (post free)

DUNCAN

- Fast real time interpreter/control language for NASCOM 1 or 2 (please specify)

Price £12 + 15% VAT (post free)

MEMORIES

- 4116-150ns 95p each + 15% VAT (min order 8)
- 64K-200ns £6 each + 15% VAT

MONITORS

- BMC 12" green phosphor - 18MHz
- Price £150 + 15% VAT (carriage paid)

6 Laleham Avenue, Mill Hill,
London NW7 3HL
Tel: 01-959 0106



research ltd.

"PLUTO" COLOUR GRAPHICS PROCESSOR

Pluto is a self-contained colour display processor on an 8" x 8" NASBUS and 80-BUS compatible card featuring:

- Own 16 bit microprocessor
- Up to 192 Kbytes of dual-ported display memory for fast flicker-free screen updates. (Outside of the host address space).
- 640(H) x 288(V) x 3 planes (8 colours) - 2 screenfills OR 640(H) x 576(V) x 3 planes (interlaced display)
- Fast parallel I/O interface usable with ALMOST ANY MICRO. Only single +5v supply required.

Pluto executes on-board firmware providing high level functions such as:

- Fast vector draw - over 100,000 pixels/sec. Lines can be drawn using REPLACE, XOR, AND, OR functions
- User-definable characters or symbols
- Spare display memory with memory management facilities for allocating symbol storage space or workspace
- Rectangle Fill and copy using REPLACE, XOR, AND, OR plus 5 other functions
- Fast access to single pixels
- Write protect memory planes during copy
- Double-buffered screen memory for animated displays
- Complex polygon colour fill

Pluto is expandable. An expansion board will be available later this year to give Pluto up to 8 memory planes with no loss of resolution.

AVAILABLE NOW. Please contact us for further details

6 Laleham Avenue, Mill Hill,
London NW7 3HL
Tel: 01-959 0106

ZX81 Workstation...



... is a stylish and ergonomic plinth for the ZX81. It raises and tilts the TV to avoid eyestrain, holds the 16K RAM in place and hides the wiring and power supply. This very professional unit costs £15, a built-in power switch is £3, plus postage at £2.00 inc. VAT. Peter Furlong Products, Unit 5, South Coast Road, Trading Estate, Peacehaven, Sussex. Tel 01690 7799. Visa, Access.

AT LAST!

A COMPLETE COMPUTERISED SYSTEM FOR THE ENTHUSIASTIC RACEGOER

COURSEPLAN □ 200

- * The product of 10 years' exhaustive statistical research
- * Programmed to achieve a MINIMUM 50% winning selections
- * Unique and safeguarded Staking Plan built in to the system.
- * The 1981 Flat season produced 52.61% winners and a paper profit of £4,035 during the 10 week peak period of the program (£10 Base-unit). Level stakes only, would have shown a £1,371 profit. (All figures AFTER tax @ 10%)

COURSEPLAN WILL BE RESTRICTED TO 200 SALES ONLY. THE REASON FOR THIS EXCLUSIVITY SHOULD BE SELF EXPLANATORY

Full details of this brilliant and long-awaited program will be provided on receipt of your written enquiry to:-

● Francoform

6 SANSOM STREET, CAMBERWELL, LONDON SE5

Timeshare your Colour Monitor with the Family Colour TV-RGB-PAL Video



PortaTel LUXOR
TV Receiver
14" Colour Monitor
RGB3711

BBC Micro lead included
Excellent resolution, geometry

PortaTel conversions limited

25 sunbury cross centre, staines road west
sunbury-on-thames, middlesex tw16 7bb
telephone sunbury-on-thames 88972



Essential reading for all computers

FORTH THEORY AND PRACTICE LISP THEORY AND PRACTICE

Two books from Acornsoft that provide a thorough introduction to programming in LISP and FORTH. Many practical examples of programs are included.

Most of the contents of the manuals are applicable to any machine, although the manuals also explain the operations for the Acorn Atom. Both manuals are spiral bound to lie flat and have been produced and laid out clearly and concisely.

Each manual costs £6 including post and packing and is available from dealers or direct from:- Acornsoft Ltd, 4A Market Hill, Cambridge CB2 3NJ.

Credit Card Holders can ring 0223 316039 and order direct.



ACORNSOFT

NEW LOW PRICES!

HEWSON CONSULTANTS

ZX81

HINTS AND TIPS FOR THE ZX81 £3.95

"Good value and quite fascinating... a very inexpensive way of acquiring months of programming experience"

YOUR COMPUTER Nov 1981

"Excellent... very good value for money"

SYNC

80 pages explaining clearly how to squeeze a computing quart out of a Sinclair pint pot.

Saving Space — vital reading for all ZX81 owners.

Understanding the Display File — using the display file as memory, clearing a part of the display, using tokens in PRINT statements.

Converting ZX80 programs — explaining simply but comprehensively how to convert the hundreds of published ZX80 programs.

Chaining programs — revealing techniques for passing data between programs, calling subroutines from cassette and establishing data files.

Machine Code Programs — all you want to know about Z80 machine language.

Explained how to write, load, edit and save machine code and how to debug your routines.

Routines and programs are scattered liberally throughout the text and the final chapter consists of twelve useful, interesting and entertaining programs such as LINE RENUMBER, BOUNCER, SHOOT, STATISTICS etc.

16K RAM PACK £24.95

A top quality add-on 16K dynamic memory specially designed for the ZX81. Simply plugs into the port at the back of your Sinclair. Can be used in conjunction with the ZX printer. Neatly packaged in a black plastic shell to match your ZX81.

64K RAM £79.00

Developed by Memotech this amazing 64K RAM needs NO extra power supply. Simply plugs neatly and firmly into the rear port of your ZX81. Can be used with the ZX printer and other add-on hardware.

Just look at these features:

* 8 — 16K can be switched in and out in 4K blocks to leave space for memory mapping

* 12 — 16K can be protected against overwriting during loading from cassette.

* Directly addressable and user transparent.

* Up to 15K of Basic program area

* 32K or more of variables area.

Z80 OP CODES £1.45

A must for the beginner and the experienced programmer alike. This handy ready reckoner lists all 600 plus Z80 machine code instructions in decimal and hexadecimal with their mnemonics. Each Op Code is succinctly explained and cross-referenced. Supplied in a protective transparent wallet for easy reference and durability.

PROGRAMMERS TOOLKIT

£6.50

Are you writing your own programs for your ZX81? Then use our TOOLKIT to do the donkey work. Copy into RAM before you start work and then you will have it at your fingertips.

Comprehensive LINE RENUMBER including GOSUBs and GOTOs; LOAD, EDIT, and RUN machine code programs; INSPECT the ZX81 system routines; COPY them into RAM and PATCH and/or EXTEND them; FIND a given piece of Basic code and Replace all occurrences of it; move blocks of Basic lines with EDIT.

LANGUAGE DICTIONARY £3.75

Now you can construct your own English/French, English/Anything dictionary with our LANGUAGE DICTIONARY. UPDATE the entries, SEARCH for a word, CREATE a new dictionary and SAVE it on tape all with the same fully-

detailed program.

STATISTICS 1K SOFTWARE £3.75

Three programs on the one cassette.

- 1) i) Statistics — prints the current mean and standard deviation after each value is entered.
ii) Regression — prints the current mean and standard deviation of the x, y values and the intercept and slope of the regression line.
iii) Trend — prints the current mean and standard deviation of the x, y values and the intercept and slope of the trend line.
- 2) CHI SQUARED TEXT — prints the current value of the Chi squared statistic and the current sample size.

GRAPH PLOT Plots a graph of data entered from the keyboard

16K SOFTWARE SPACE

INTRUDERS £5.95

Not to be missed. All action display. 40 alien ships in each squadron. Automatic option, the machine plays itself. Squadron after squadron attack your position. Three laser bases. Full score display. Written in machine code for super fast fun.



PILOT

NEW!
£5.95

New and exciting, Pilot challenges you to take off, fly between beacons, then land whilst watching wind speed and dodging craggy mountains — either could lead to disaster! If you take the challenge, you may soon learn to fly solo — so detailed are the flying instructions. Coast along in Autopilot — just to gain confidence, then battle your way through 5 further modes, 5 different ways of trying to steer your plane safely back to base, increasing in difficulty, testing your skills. Good luck with your flight against the unpredictable elements!



Cheque with order or quote Access or Barclaycard number to:

HEWSON CONSULTANTS Dept PCW,

60A St Mary's Street, Wallingford, Oxon, OX10 0EL
Tel: (0491) 36307

If that Apple
is just out of Reach....

Rent One!

If you have a short term requirement for a microcomputer system for evaluation, training or just hands-on experience — come to Atlanta Data!

Apart from Apples we have top quality printers, monitors, disk drives and a huge range of software including VisiCalc, Visidex, Wordstar, Format-80, Magic Window, Micromodeller, APM, CIS COBOL and all accounting programs.

A complete system can be working for you within a few days of your enquiry with *no* capital expenditure!

Line plotters now available.

Rental Hotline 01-729 1411/2

Atlanta Data Systems

350/356 Old Street, London, EC1V 9DT. 01-739 5889

QADS

Q. A. Data Systems Limited

QA DATA SYSTEMS INFORMATION SERVICES

MARKETING HARDWARE OR SOFTWARE — OR
JUST CONSIDERING DOING SO.

USE OUR UNIQUE SERVICE TO ASSIST YOU,
SUPPORTED BY A NATIONALLY DISTRIBUTED
MINICOMPUTER NETWORK.

SEARCHING FOR HARDWARE OR SOFTWARE.

LOOKING FOR THAT SPECIAL OR FOR THE
NEAREST CONVENIENT SOURCE.

USE OUR UNIQUE ELECTRONIC DIRECTORY
SERVICES FOR AN ON LINE OR BY RETURN
ANSWER.

FOR FURTHER INFORMATION CONTACT
P HAYES Q.A. DATA SYSTEMS LTD. FREEPOST
11, ST. GEORGES STREET CHORLEY LANCS PR7
1BR (NO STAMP REQUIRED) TELEPHONE
CHORLEY (02572) 66955.

Two second hand S100 Z80 Computers

for private sale

A. comprising:

- * Heavy duty main frame and Power supply with 6 slot mother board
- * SD Systems SBC 100 for MHz 280 CPU card
- * SD Systems UFII Disk controller
- * SD Systems 64 Byte Expandoram II
- * 1 Serial and Parallel 1/0 Port
- * 2 x 8" double sided Disk Drives
- * Pentland P31 UDU + numeric pad

Offers over £1,500. Phone 0294 67699 after 7pm.

B. comprising:

- * Desk Top 1 Box computer with integral U.D.U. (24 x 80, P31)
- * 2 x 8" double sided disk Drives
- * S.D. Systems SBC 100 for MHz Z80 CPU card
- * SD Systems UFII Disk controla
- * 64K static ram card
- * 12 Slot Mother Board
- * 1 serial 21 parallel 1/0 port
- * Detachable 117 Key Keyboard
- * CPM 2.2

Offers around £1,950

There are also a number of second hand S.100 cards available i.e. 64K Systems expandoram I for £100 built & tested.

Phone 0294 67699 after 7pm or write to:—
Mike Parry, 30 Witches Hill, Avdossaw,
Ayrshire, KA 22 8NP.

REGISTERED REFERRAL CENTRE
FOR THE BBC PROJECT

BEEBUG FOR THE BBC MICRO

INDEPENDENT NATIONAL USER
GROUP FOR THE BBC MICRO

IF YOU OWN A BBC MACHINE, OR HAVE ORDERED ONE,
OR ARE JUST THINKING ABOUT GETTING ONE, THEN
YOU NEED BEEBUG.

BEEBUG runs a regular magazine devoted exclusively to the
BBC Micro (10 issues per year).

Latest news on the BBC project. What you should know before
you order a machine. Members' discount scheme on books and
hardware. New program listings, regular advice clinic, and hints
and tips pages in each issue.

April Issue: 3D Noughts and Crosses, Moon Lander, Ellipse and
3D Surface.

Plus articles on Upgrading to Model B, Making Sounds,
and Operating System Calls.

May Issue: Careers, Bomber, Chords, Spiral and more.

Plus articles on Graphics, Writing Games Programs,
and using the Assembler.

Membership

Introductory offer (closes 30 June)

6 mths £4.50

1 year £8.50

After 30 June £4.90 and £8.90

Send £1.00 and A4 SAE for sample

(Overseas add £1.00 for 6 mths, £1.50 for 1 yr)

Make cheques to

BEEBUG

and send to

BEEBUG, Dept PCW,

374 Wandsworth Rd.,

London SW8 4TE

For technical queries and editorial material, send to:
The Editor, BEEBUG, PO Box 50, St Albans, Herts AL1 2AR

apple accessories

Multifunction card (Real-Time Clock with battery-
backup and Centronics Printer Interface) £85

Analogue to Digital Converter (8 channel, 8 bit
accuracy) £59

16K RAM card £79

Z80 card £95

80 Column Video card and Applewriter II
FREE! £250

8048 Single-chip microprocessor Development
PROMULATOR £390

REMDACS Multi-device Multiprocessor Remote
Data Acquisition and Control System from £335

Mains Control Panel 1KW 6 Channels £385

4 Channels £260

Silentype Printer (includes Interface & paper) £199

Seiko GP100A Printer £215

Epson MX80FT2 Printer £390

TEC Starwriter Daisywheel Printer £1285

Wabash floppy discs & free library box £19

Printer ribbons — Centronics 737 £3.20

— MX80 £7

PLEASE ADD VAT @ 15% TO ALL PRICES

BARCLAYCARD/ACCESS PHONE

ORDERS TAKEN. PHONE 0903 39290.

ENQUIRIES WITH S.A.E. PLEASE

STATING WHICH PRODUCT(S).

DATEX MICROS

193 TARRING ROAD,
WORTHING,
W. SUSSEX



BRITISH
MADE

VisiCalc USERS

Spreadsheet

SpreadSheet the communications medium of
the International Electronic SpreadSheet
Users Group

InterCalc

is now available in the UK

For free sample of Newsletter and more information
send a stamped self-addressed foolscap sized envelope
to:

InterCalc (UK) Branch
7th Floor, Alpha House,
Rowlandsway. Manchester M22 5RG

VisiCalc is a registered trade mark of Personal Software Inc.
InterCalc is in no way associated with Personal Software
VisiCalc is a copyrighted program of Software Arts Inc.
The name InterCalc is copyright of InterCalc (USA)

Step by step with the computer system designed for tomorrow.

- ★ 6502 Microprocessor
- ★ 2K Monitor TANBUG
- ★ Intelligent socket accepts keypad or full ASCII Keyboard
- ★ Chunky Graphics and Lower Case Options
- ★ Connects to unmodified B/W or Colour TV

For the first time buyer or experienced user, Microtan 65 is a superb route into personal computing. If you are looking for a sophisticated machine with the capability of expansion into a professional system, then this is the



computer for you. Step by step with the computer system designed for tomorrow...

6502 Microprocessor
Probably the most popular CPU (central processing unit) for personal computers, having a powerful instruction set and architecture.

2K Monitor TANBUG
The built-in 'mind' of the machine, TANBUG controls all system functions and gives comprehensive machine-code facilities. Functions include: set and clear breakpoints, single step through program, execute program, copy block of memory, modify memory locations and much more.

Intelligent keyboard socket
For absolute beginners we can supply an easy to use 20-way Hex keypad; for the more experienced user there is a full typewriter style ASCII keyboard. Either way, Microtan will work out exactly which type you are using and act appropriately.

Chunky Graphics Options
For drawing simple lines and graphs, or for animated games, Chunky Graphics is a low cost answer. This set of chips plug into the Microtan board

Microtan 65

£79.00 Ready
+VAT Built

£69.00 Kit
+VAT

and allow graphics to be built up on the screen at a resolution of 64 rows by 64 columns.

Lower Case Option

To extend the character set to 128 characters, allows for real descenders on lower case characters and a set of extra symbols and characters for simple graphics.

Microtan Accessories

20-way Hex keypad MPS 1 Basic power supply

Aerial connector lead

Full ASCII Keyboard

MPS 2 Full system

power supply

Mini — motherboard

Microtan is available

ready-built or as a kit.

We recommend that

you should have some

soldering experience

before attempting the

Microtan Kit, although

if you do run into

problems you can

make use of our "Get

you Going" service

(telephone for details).

TANEX

- ★ 7K Static Ram
- ★ 10K Microsoft Basic
- ★ 32 Parallel I/O lines
- ★ 1 Serial I/O port
- ★ XBUG
- ★ Cassette Interface

The first step in expanding your system. Tanex provides the extra facilities necessary for the serious programmer. Memory expansion: Tanex has provisions for up to 7K of static RAM and up to 14K of EPROM using 2716 or 2732 chips.

XBUG and BASIC

XBUG is a 2K extension to TANBUG, that contains a mnemonic assembler and disassembler and cassette firmware running at 300 Baud CUTS, standard or high speed. 2400 Baud Tangerine standard with 6 character filenames. Tangerine have taken out a full O.E.M. licence for Microsoft BASIC, the microcomputer industry standard, this is a full feature implementation with interrupt and machine code handling, and a superb program editor.

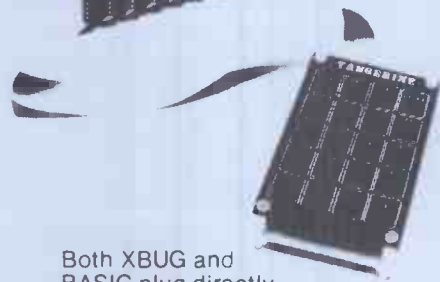
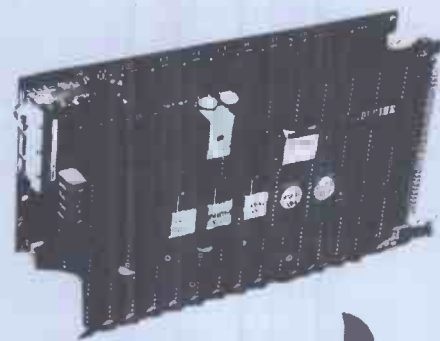

Both XBUG and BASIC plug directly into Tanex and are supplied with comprehensive user manuals.

Parallel I/O

When fully expanded Tanex includes two V.I.A.s (Versatile Interface Adaptors) which implement the cassette interface and the parallel I/O ports. Software in TANBUG V2.3 enables you to plug in and use a Centronics type printer. The two V.I.A.s also contain counter timers that can be used for a variety of applications enhanced by the use of the integral handshake facilities.

Serial I/O

Also on the expanded board is a serial I/O port that can be used to interface RS232 or 20Ma loop terminals or VDU's, again all controlled by TANBUG V2.3.

Dealer and OEM enquiries welcome
contact Microtan Hardware
Tel: 01-693 7659

tangerine
computer systems ltd

THE SCIENCE PARK
MILTON ROAD
CAMBS

TO TANGERINE COMPUTER SYSTEMS LTD.,
THE SCIENCE PARK MILTON ROAD CAMBS

PLEASE SEND ME:

- MICROTAN 65, READY BUILT £92.35 incl. VAT+P&P.
- MICROTAN 65 KIT £80.85 incl. VAT+ and P&P.
- TANEX (MIN CONFIG) KIT £50.95 incl. VAT and P&P.
- TANEX (MIN CONFIG) ASSEMBLED £62.45 incl. VAT and P&P.
- EXPANDED TANEX KIT £104.66 incl. VAT and P&P.
- EXPANDED TANEX ASSEMBLED £116.16 incl. VAT and P&P.
- PLEASE SEND ME THE NEXT SIX ISSUES OF TANSOFT GAZETTE AT £15.00.

(enclose my cheque for £
or debit by Access/Barclaycard

Signature

Name

Address

PCW/6/82

(Block capitals please)



APPLE II (48K) APPLE III (128K)
 SYSTEM A: £939 SYSTEM B: £3152
 SYSTEM B: £1843 SYSTEM C: £3900
 SYSTEM C: £2580 SYSTEM D: £5335



SUPERBRAIN (64K)
 SYSTEM B: £2380 SYSTEM D: £4380
 SYSTEM C: £2830



VECTOR (64K)
 SYSTEM B: £3844 SYSTEM E: £8944
 SYSTEM C: £4280 (Three Users)
 SYSTEM D: £5324 SYSTEM E: £10419
 SYSTEM E: £7469 (Four Users)
 SYSTEM E: £11894 (Five Users)

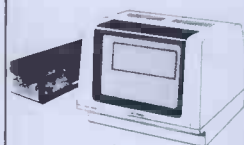

ICL/RAIR (64K)
 SYSTEM B: £3199 SYSTEM E: £7029
 SYSTEM C: £3575 (Three Users)
 SYSTEM D: £4699 SYSTEM E: £7644
 SYSTEM E: £6164 (Four Users)
 SYSTEM E: £8109 (Five Users)

NEW RAIR 3/50 (256K RAM)
 — with 15 Mbyte Hard Disk/630K Floppy

SYSTEM E: £8164 SYSTEM E: £9094
 (Two Users) (Four Users)
 SYSTEM E: £8629 SYSTEM E: £9559
 (Three Users) (Five Users)

BUY OR LEASE

A wide selection of Computers plus a service facility that's second to none.

- SYSTEM A:** Basic Computer including display screen and keyboard
SYSTEM B: Computer including display screen, keyboard, dual disk drive(s) and matrix printer for Business Users (e.g. Accounts, Database, etc)
SYSTEM C: Computer including display, keyboard, dual disk drive(s) and daisy-wheel correspondence quality printer for Word Processing.
SYSTEM D: Computer including display, keyboard, floppy disk drive, plus hard disk drive for 5 Mbyte+ on-line and matrix printer. (SOME Systems expandable to 120 Mb).
SYSTEM E: Multi-User Computer — AS SYSTEM D — plus Additional VDU Terminals for up to 5 Users.

Prices exclude VAT.

Johnson microcomputers



Johnson House · 75-79 Park Street · Camberley · Surrey · Telephone 0276 20446
 Robophone Answering 24 hrs. Prestel page No. *200632 Mailbox No. 027620448
 48 Gloucester Road · Bristol · Telephone 0272 422061
 148 Cowley Road · Oxford · Telephone 0865 721461

BBC SOFTWARE

WORDWISE — THE WORD PROCESSOR for the BBC Micro — A professionally written program supplied in ROM, containing all the usual word processor facilities plus several unusual ones like a fully automatic word count. Extremely fast and very simple to use, a powerful piece of software. Supplied with a full manual for £65 + £1.50 p&p + VAT.

SNAKE — This highly addictive game for the model B makes full use of the amazing graphics and sound facilities of the BBC Micro, it will give hours of fun. Supplied on a quality cassette for £5.80 + VAT.

RAM KITS Upgrade the model A to 32k RAM — supplied with full instructions for £29.90 + VAT.

CASH or royalties waiting for any interesting software for the BBC machine. The better the program the more we will pay.

Send an SAE at least 6" by 9" for latest details of our software and to get your name on our mailing list. Please add VAT to all prices. Mail order only.



Dept PW3
 16 Wayside
 Chipperfield
 Herts. WD4 9JJ
 Tel: (09277) 62955

ACORN ATOM
 BBC MICROCOMPUTER

SUPERBRAIN
 TORCH

SHELTON SIGNET

RAIR BLACK BOX
 ICL MICROCOMPUTER

Business systems with speciality software from Dental Appointments Package to Integrated Accounts.

CP/M BUSINESS SYSTEMS

FROM £2,750 including printer and software

AMAZING PRINTER OFFER

Epson Printers

MX80T	£319
MC80F/T	£349
MX82T	£349
MX82F/T	£399
MX100	£499



Plus VAT and £6 delivery charge

CONTACT US FOR DETAILS

OF THE FABULOUS NEW TORCH COMMUNICATOR

● NEW FROM VIXSOFT

BBC DISASSEMBLER £5.95 inc VAT

VIXON COMPUTER SYSTEMS

49 GRIMSBY ROAD
 CLEETHORPES
 TEL. GRIMSBY (0472) 58561



MICROCOMPUTER COMPONENTS
LOWEST PRICES - FASTEST DELIVERY

MEMORIES — SPECIAL OFFER

2114 LOW POWER 200ns	0.84	4118 150ns	6.00
2114 LOW POWER 300ns	0.84	4118 200ns	3.90
2716 450ns (Single + 5V)	1.95	5516 200ns	9.75
2532 450ns	4.20	6116 LOW POWER 150ns	10.83
2732 450ns	4.00	6116 LOW POWER 200ns	10.00
4116 150ns	0.84	6116 150ns	5.25
4116 200ns	0.70	6116 200ns	4.95

BBC MICRO — UPGRADE KITS

Part No	Description	Price Each
BBC 1	16k Memory Upgrade Kit	32.00
BBC 2	Printer/User I/O Kit	9.50
BBC 3	Floppy Disc Controller Kit	42.50
BBC 4	Analogue Input Kit	9.50
BBC 5	Serial Interface and RGB Connector Kit	11.45
BBC 6	Expansion Bus and 'Tube' Kit	6.95
Special price for all kits purchased together (Converts Model A to Mode B)		99.95

OFFICIAL
ORDERS
WELCOME



24 HOUR TELEPHONE SERVICE FOR
CREDIT CARD USERS



QUANTITY
DISCOUNTS
AVAILABLE

★ Free Reply Paid Envelope with every order ★
 ★ All CWO's receive a voucher value £1 against future purchases ★
 ★ All prices exclude VAT & P & P (0.75) (Free on CWO's over £10) ★

★ All orders despatched on day of receipt with full refund on out of stock items if requested ★

MIDWICH COMPUTER CO. LTD.
 DEPT PCW, HEWITT HOUSE, NORTHGATE STREET,
 BURY ST. EDMUNDS, SUFFOLK IP33 1HQ
 TELEPHONE: (0284) 701321 TELEX: 817670



9" PM 101



12" PRINCE in Apple colours.

Become part of
our Dealer
Network.

Buy from us!
We'll sell for you.

Our Monitors
probably offer the
best cost/
performance ratio
available.

Send or phone
for data.

CROFTON ELECTRONICS LIMITED

35 GROSVENOR ROAD, TWICKENHAM,
MIDDLESEX TW1 4AD

Telephone 01-891 1923/01-891 1513

Telex 295093 CROFTN G

Dealer Enquiries Welcome



**THE PROFESSIONAL
SPELLING
CHECKER**

- * TOTALLY BRITISH SPELLING
- * SOFTWARE PRODUCT of the YEAR 1981
- * Recommended by OSBORNE for the
OSBORNE 1 Personal, Portable Computer
- * Over 3,000 Licensed Users
- * 20,000+ Word dictionary
- * Legal, Medical & Financial dictionaries

BRITISH SPELLGUARD

- * The *VERY BEST* Spelling Checker
- * The *PERFECT PARTNER* to Wordstar,
Magic Wand, Electric Pencil and many more
- * The *BRITISH* version of America's top product

**VISION
ASSOCIATES**

57 Woodham Lane,
New Haw,
Weybridge,
Surrey KT15 3ND.

Tel: Weybridge (0932) 55932

**From West London's
mail order specialists:**

**ONLY
£240**

incl. cassette deck
+ FREE GAME

+ FREE
DELIVERY



SPECIAL OFFER

Order the superb VIC-20 and cassette deck at £240 (incl. VAT!) and get a FREE game ("Breakout" or "Stunt Cycle") worth £7.99 – and delivery is free, too!

We stock all VIC-20 software, peripherals, paddles, etc – including the full Stack and Arfon range.

The best microcomputers from leading makers (Apple, Commodore, etc) plus peripherals, printers, software, games, books – and all at low prices! Order today from the mail order specialists – send coupon with cheque (or phone your Barclaycard no). Delivery in 28 days or money-back option.

Please supply 1 VIC-20 & Cassette Deck & "Breakout"/"Stunt Cycle" (state which required)

NAME: _____
 ADDRESS: _____

**TWICKENHAM
COMPUTER CENTRE LTD**

72 Heath Rd Twickenham Middx TW1 4BW (01-892 7896/01-891 1612)

ATTENTION

NASCOM USERS

ATTENTION

ARE FLOPPY DISKS TOO EXPENSIVE ?

Why not consider the HOBBIT fully automatic mini-cassette system

£99

+ VAT

- Full operating system
- Transfer rate of 750bytes per second
- More than 100K storage
- Reliability better than 1 bit in 10

ALSO AVAILABLE
Microsoft R Basic Upgrade Kit £10 + VAT

£99

+ VAT

Allows easy file access from Basic, no more peeks and pokes

For further information contact:

IKON COMPUTER PRODUCTS

KILN LAKE LAUGHARNE, CARMARTHEN, DYFED
Tel: 099-421 515

THE ZX 81 COMPANION

by Bob Maunder.

ISBN 0 907211 01 1

If you have a Sinclair ZX81 and want to use it to its full potential then, as the experts have all agreed, this is the book for you. It contains detailed guidelines and documented programs in the areas of gaming, information retrieval and education, as well as a unique listing of the 8K ROM for machine code applications.

'Far and away the best . . . once again Linsac has produced the book for the serious end of the market'. — *Your Computer, November 1981.*

'The ZX81 Companion is a most professional product . . . with many good illustrative programs, tips and warnings'. — *Education Equipment, October 1981.*

'Bob Maunder's attempt to show meaningful uses of the machine is brilliantly successful . . . thoughtfully written, detailed and illustrated with meaningful programs . . . To conclude — the book is definitely an outstandingly useful second step for the ZX81 user'. — *Educational ZX80/81 Users' Group Newsletter, September 1981.*

Send cheque for **£7.95** to: (P&P INCLUDED IN U.K.)

LINSAC
(PCW)

68 Barker Road, Linthorpe,
Middlesbrough, Co. Cleveland TS5 5ES

ZX81 16k SOFTWARE

PACK 16/1 includes all of:
AIR TRAFFIC CONTROL: Animated radar screen of busy airport shown, you must bring planes into land;
INVADERS SELF PLAY; PHONEBOOK — keep friends' and relatives' numbers on cassette; DATE '81 — computer dating program. Who will it pick for you?
ALL ONLY £4.95

PACK 16/3 includes all of:
INDI 500: video roadster; DRAUGHTS: Computer Chequers; BATTLESHIPS — nautical warfare on your own computer.
MASTERMIND — Brain Teaser, see if you can beat a microelectronic mind.
ALL ONLY £4.95

PACK 16/2 includes all of:
ADVENTURE ATLANTIC: You may become very rich or you may be marooned forever; BREAKOUT: SQUASH PRACTICE; LANGUAGE TRANSLATOR translates any European language to any other; COMPUTAPRINT — use this program to predict results of horse races, football pools; etc.
ALL ONLY £4.95

The breakthrough you've waited for:
PROGRAM THE ZX81 IN ENGLISH!!!
With GAMAL 81 you can now write adventure programs in hours not weeks and with GAMAL 81 you'll have every adventure you'll ever want for the price of one. Comes on cassette with instruction book. £7.95

All our software comes with full instructions and is **SAVED** and ready to **RUN**, no need to spend hours laboriously typing in from books.

CONTROL TECHNOLOGY —
PERSONAL
COMPUTER SCIENCE

ZX-81

Cassette 1½

A super value cassette of 16K and 1K software written in Machine Code and Basic.
Includes:
React, Invaders, Phantom Aliens, Maze of Death, Planetlander, I Ching, Hangman, Invaders, Laser Base, rectangle plus more.
ALL ONLY £4.95

Tapebook 50, Version 3

50 programs for the IKRAM ZX81.
Latest version includes:
SQUASH, BREAKOUT, COLUMBIA, SPLAT, INTEGRATION, CREDIT CARO CALCULATOR, BANK A/C, V4CHECK, TANK BATTLE, TORPEDO, HEXLOADER, BINARY CONVERTER, AND LOTS, LOTS MORE.
Still amazing value at £6.95 the lot.

ZX AUTOCODER

This program takes your BASIC and converts it into Z80 assembly language. ZX AUTOCODER compiles a sub set of ZX81 BASIC for the following:
PRINT, PRINT AT, PLOT, CLS, PAUSE, GOTO, GO SUB, IFTHEN GOTO, AND LET statements.

£6.95

Including cassette and instruction book.

All prices include VAT and postage and packing

CONTROL TECHNOLOGY,
39 Gloucester Road, Gee Cross,
Hyde, Cheshire SK14 5JG
061-368 7558

SIMPLICALC

NOW ON
VIC 20!

....FROM CRONITE

THE LOW COST ALTERNATIVE

SIMPLICALC is a small, powerful work sheet program. It runs on any CBM PET, except "old ROM", even cassette-based. The sheet is viewed on the screen.

SIMPLICALC makes the "what if" exercise available on all sizes of CBM. On a 32k it provides a much larger useable matrix than any other similar program: on an 8k it provides enough space to analyse a capital purchase or personal tax computation.

SIMPLICALC is freeform. Its uses are many. For instance, it's been used for calculating chemical weights, projecting profits by product group, and costing out salary reviews. Be inventive.

SIMPLICALC is simple to use, with 8 single-key commands. Print your sheet out, and save it on cassette or disk depending on version. A comprehensive manual is provided.

To order your copy of this versatile numeric tool, send cheque with details of your system, specifying whether your CBM is *2001/3000/early 4000 (PEEK (144)=46) *late 4000 *8032 and whether you want cassette £29.90 incl. VAT or disk £36.80 incl. VAT (specify drive type). Security copies available (no backup possible) at £4.00 cassette and £6.00 disk incl. VAT.

Cronite Computer Systems Limited

Montgomery Street

Birmingham

B11 1DT

Further details from Mark Turner on 021 773 8281 telex 338247

Micro General

MATRIX PRINTERS...

Please contact us for advice on printer selection

MICROLINE 82A £399+VAT

Fast 120 cps model having true descenders on lower case. Serial/Parallel Interfaces are switch selectable.

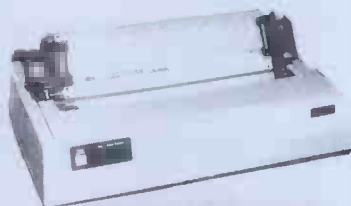

MICROLINE 83A £650+VAT

Full width printer with descenders on lower case. Prints at 120 cps and could replace larger printers giving lower costs. Serial/Parallel Interfaces are switch selectable.

MICROLINE 80[!] Special low price for this rugged and reliable 80 cps printer. Supplied complete with Roll Paper Holder. £265+VAT



FREE INSTALLATION in Berkshire.

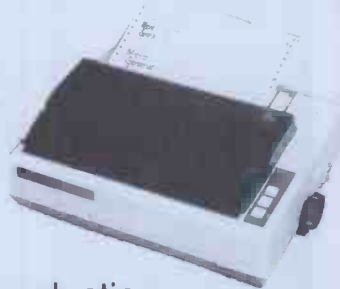

EPSON MX-80F/T £399+VAT

Versatile printer with a variety of interfaces to suit most applications. All other Epson models available.

XEROX 820 MICRO COMPUTER

Budgeting-Planning-Forecasting-Wordprocessing. Superb Rank Xerox nationwide service.

Systems from **£1,750+VAT**

Authorised Rank Xerox Micro Computer Dealer.

NEW!

MICROLINE 84 £950+VAT

200 cps Standard Printing with descenders 136 Columns. Proportional Print (Near letter quality 18x18 Matrix). Pin-addressable graphics. Sub-script, super-script, underlining. Emphasised print, Down-line loadable character set.

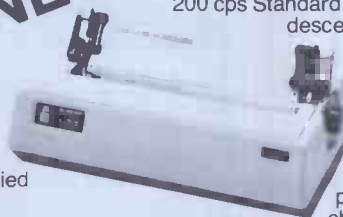

MICRO GENERAL 6 The Birchwoods, Tilehurst, Reading, Berks. Tel: 0734 25226

THE ADMINISTRATOR

SHE'S GOT WHAT YOU NEED . . .

. . . A HISTORY

THE ONLY TRANSACTIONAL INFORMATION SYSTEM

- ★ "Set up is simple" Accepting information for processing in one hour
- ★ Desk top equipment CBM8000 series
- ★ Transactional processing provides unlimited history records
- ★ Finding information by single or multiple selection
- ★ Statistics & report by user definition
- ★ Calculation within records & report
- ★ Service and support from the first established CBM software producers



Recommended by
COMMODORE

For details or to arrange a demonstration without obligation contact S.O.S. today.

STAGE ONE SOFTWARE LTD

STAGE ONE COMPUTERS, 300 ASHLEY ROAD, PARKSTONE, POOLE, DORSET, UNITED KINGDOM. Tel: 735656 Code 0202

SPIDER SOFTWARE APPLE SOFTWARE

OH NO - NOT ANOTHER APPLE DATABASE?!!

Some Questions and Answers on ACCESS - A new database management system for Apple computers from SPIDER SOFTWARE.

How many records can I have?

This depends on the size of each record. The maximum record size is 1560 characters. The maximum number of records per disk volume is 7936 but this is dependent on the record size. As an example, if your records are 200 characters long, you may have a maximum of 671 records per volume. A maximum of 40 fields per record is available.

How long will it take to find a record?

A powerful advanced IRAM (Indexed Random Access Method) is utilised for major record retrieval purposes giving an access speed of either instant recall within 3 seconds. Any field (or combinations thereof) with multiple search criteria will either give instant recall or will take a maximum of 23 seconds. On the SyMBfile hard disk everything is at least 7 times faster.

How long will it take to sort a disk full of information?

All sorting is done on an index. If the sort is on the primary index it will take 0.2 seconds regardless of the number of records. To sort on any field which is not indexed involves first creating an index for that field which is then sorted. The time taken depends on the record size (generally less than 3 minutes). Any index can be saved for later use or made into a primary index. Sorting a disk need not involve creating a sorted version of the database.

How many disk drives do I need?

ACCESS will ideally run on 2 drives. However, it will support a single drive system and a version is available for the SyMBfile 5 megabyte hard drive.

How about report formats?

Reports are user-configured and can contain report headings, column headings, column sub-totals, brought forward totals, grand totals, computed fields, page numbering etc. Reports can be on selected and/or sorted data.

What if the dog chews my program disk?

We provide copy routines for backing-up of the program disk and the data disks as many times as you require. The ACCESS system is a combination of hardware and software.

Is the program menu-driven?

YES. ACCESS constantly displays prompts indicating the options available wherever you may be in the program.

How is the data stored?

ACCESS creates and uses its own data disks. However, facilities are provided to enable you to produce standard DOS 3.3 text files in either sequential or random access format using any sorted or selected fields. Because of ACCESS's own data storage techniques a very large database may require more than one disk to store the text file(s) produced.

How easy is it to create records and edit them?

ACCESS has a powerful word processor style screen editor enabling insertion and deletion of the characters, etc., full cursor control across fields and pages of a record. A maximum of 40 screen pages are available. Password protected fields are supported as are computed on-screen fields.

What if I delete a record by mistake?

ACCESS only marks a record as deleted. Facilities are given to either 'undelete' deleted records or purge deleted records from the database.

My current database takes ages for me to add and save records because it needs to re-structure the entire file to keep the 'primary key' in alphabetical order. Will this happen with ACCESS?

No!!! ACCESS uses logic and technique to handle your data; there is no reason (should you have the stamina) why you should not fill an entire disk with information as fast as you can type and immediately retrieve all the information in sorted order or order of entry, etc. All complex and time-critical functions including disk input and output, indexing, sorting, searching, screen display and editing are performed by ACCESS using powerful machine-code routines.

What hardware do I need?

48K Apple II Plus with DOS 3.3 and 1 or 2 disk drives. Most makes of printer are supported.

Why should I buy ACCESS and how much is it?

Most facilities in ACCESS are available in other comparably priced database managers. However, ACCESS is more powerful and faster than its competitors in each function. ACCESS has gone beyond the boundary of merely complex facilities, it is powerful and 'intelligent' enough to make itself extremely simple to use. The retail price including VAT is £199.95.

A technical sheet is available on the ACCESS system from your local Apple dealer who should also be able to give you a demonstration of its flexibility.

We stock a large range of packaged software for the Apple. Please write or telephone for a copy of our comprehensive list.



SEE US ON STAND 29 AT APPLE 82



DEALER INQUIRIES INVITED.
PERSONAL CALLERS BY APPOINTMENT ONLY PLEASE.

SPIDER SOFTWARE

98 AVONDALE ROAD,

SOUTH CROYDON,

SURREY.



Tel: 01-680 0267 (24 hours a day - 7 days a week)

SPECIAL OFFERS

PETS

Please phone for latest prices.
We offer some of the best deals around!

CBM 4016 - 16K 12" Screen 40 Col. Computer
CBM 4032 - 32K 12" Screen 40 Col. Computer
CBM 4031 - 170K Single Drive Floppy Disk
CBM 4040 - 340K Twin Floppy Disk Drive
CBM 4022 - 80 Col. 60cps Tractor Printer
CBM 4038 - 32K 80 Col. 12" Screen Computer
CBM 8096 - 96K 80 Col. 12" Screen Computer
CBM 8050 - 1 Meg. Twin Floppy Disk Drive
CBM 8422 - 22 Meg. Winchester Disk Drive

APPLES

All Apple related products available.
Please call for prices.

Apple II - 48K Computer
Apple III - 128K Computer
Video Monitors - Colour and Black & White
Disk Drives
Silentype Printer

PRINTERS

We will quote for any type of make of printer available.

Epson MX80FT - 80/132 Col. Precision/Tractor
Auto Bi-Directional 9x9 Head True Descender
Rieth RF 800 - 184 Col. 60cps Daisy Printer.
Scripts - 17cps Daisy Printer at low prices.

SOFTWARE

Word-processing
Payroll
Purchase Ledger
Incomplete Records
Book-keeping
Invoicing
Stock Control

Sales Ledger
Record Keeping
Financial Package
Time Recording
Silicon Office

VIC

Low price computer.
New accessories coming in all the time. Call for latest news and prices.

VIC20 - Computer, Works with your colour TV
VIC1530 - Cassette Unit
VIC1540 - Single Floppy Disk Drive
VIC1515 - Printer
Expansion Memory, Games Cartridges,
Programmers Aids & Tutorials.

INTELLIVISION

Free soccer game with unit.

Superb TV Game for your TV. Vartridges include: Space Battle, Skiing, Bowling, Poker, Golf, Tennis, Roulette, Horse Racing, Basketball, Backgammon & many others.

BOOKS

Full range of computer books available from Beginners Guides to Advanced Machine Code Programming.

ACCESSORIES

All types of accessories and stationery supplied

Floppy Disks
Storage Boxes
Printer Ribbons
Cassettes
Maintenance

Stationery
Continuous Labels
Daisy Wheels
Auto Sheet Feeders
Dust Covers
Ink Ribbon & Tanning

2'ND HAND

We have a constant changing range of 2nd hand and ex-demo equipment at considerable savings.

DEMONSTRATIONS AT YOUR PLACE

We are able to demonstrate complete business systems at your site in our mobile demonstration unit (up to 4 people at a time).
Just phone for an appointment anytime.

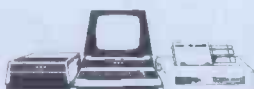

DAVINCI COMPUTER SHOP
65 High Street

Edgware, Middx. HA8 7DD.

Open Mon-Fri. 9.00-5.30
Sat. 9.30-5.00

TELEPHONE
01-952 0526



Da Vinci Computer Shop

A BRITISH 5 1/4" WINCHESTER DISK DRIVE

INTERFACE-COMPATIBLE WITH YOUR MICROCOMPUTER

- * 3.14, 6.28, 9.42, 12.56 MEGABYTE CAPACITIES
- * FAST ACCESS TIMES
- * OPTIMISED SEEK TIMES
- * ON-BOARD MICROPROCESSOR CONTROLS DRIVE OPERATION AND PROVIDES DRIVE DIAGNOSTICS

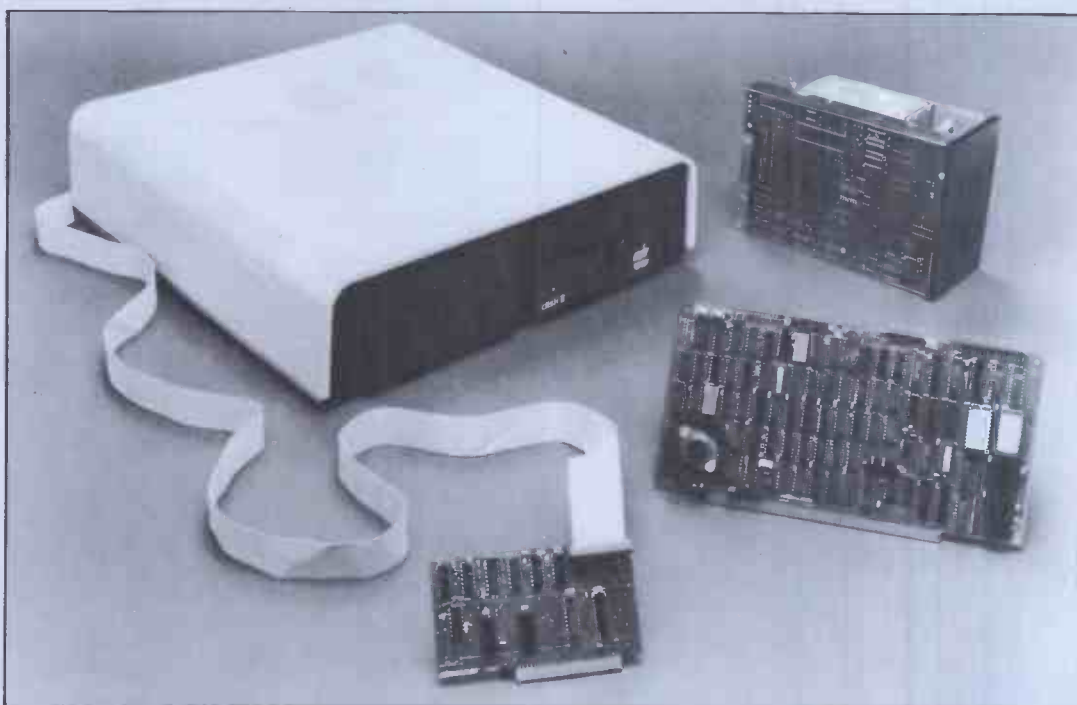

THE ICE WINCHESTER SUBSYSTEM COMPRISES:

- * Winchester Drive/s (RODIME), Controller, Cables, Cabinet and Software to support your system.
- * Subsystem can be enhanced to provide 2 Winchester drives, or Winchester plus floppy disk drive.
- * Your BACK-UP problem solved with 20 Megabyte Streamer Tape Subsystem.
- * Whisper Quiet Operation.
- * Apple, S100 Bus, IBM Personal Computer, Xerox 820, Superbrain, Direct Z80 Connection. Call us with your Interface Problems.

OEM & END USER ENQUIRIES TO: Ashford (STD 07842) 47271 or 47171

ICE - INDEPENDENT COMPUTER ENGINEERING LIMITED

16/18 LITTLETON ROAD, ASHFORD, MIDDLESEX TW15 1UQ, TELEX 8952042

SALES RENTAL

and other services

64K



**A
P
P
L
E

S
U
P
E
R
B
R
A
I
N

6
4
K**



SUPERBRAIN 64K

£1800 SUPERBRAIN STANDARD MODEL
(350KB DOUBLE DENSITY DISK DRIVE)
£1950 SUPERBRAIN QUAD MODEL
(700KB QUAD DENSITY DISK DRIVE)

APPLE 48K £600
DISK DRIVE WITH
3.3 CONTROLLER £320

LANGUAGES

PASCAL
FORTRAN
CIS-COBOL
COBOL 80
FORTRAN 80
MBASIC
CBASIC
APL
MPM
PLI

STANDARD

WORDSTAR
MAGIC WAND
SPELLBINDER
MAILMERGE
DATASTAR
SUPERSORT 1
IBM 3780 EMU
STATIONERIES

ACCOUNTANCY

INCOMPLETE RECORDS
INTEGR. ACCOUNTS
SALES LEDGER
PURCHASE LEDGER
NOMINAL LEDGER
INVOICING
PAYROLL
STOCK CONTROL
DBMS

ADVENTURE GAMES

14 ODDESSY
16 ZORK
16 SANDS OF MARS
8 STELLAR INVADERS
17 TEMPLES OF ARSHAI
10 MISSION ASTEROID
12 MYSTERY HOUSE
15 WIZARD AND THE PRINCESS

BOARD GAMES

18 SARGON II
12 FAST GAMMON
12 BRIDGE PARTNER
12 CHECKER KING
10 WINDFALL
6 TANK COMMAND
12 FRACAS

EPSON Unbelievable quality from
the world's largest print head manufacturer.

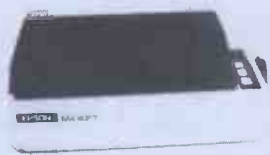

Qume
£1350

MX80F/T₁ = £340
MX80F/T₂ = £380 **MX100 - £525**

VIDEO MONITORS
100 9" HIGH RESOLUTION B/W MONITOR
100 9" BLACK & WHITE VIDEO MONITOR
165 12" BLACK & WHITE VIDEO MONITOR
CABLE FOR VIDEO MONITOR
120 12" VIDEO MONITOR GREEN OR
AMBER DISPLAY MONITOR WITH
CABLE
250 12" COLOR MONITOR

HARDWARE
600 APPLE 48K VIDEO OUTPUT ONLY
260 DISC DRIVE WITHOUT CONTROLLER
320 DISC DRIVE WITH CONTROLLER
25 16K ADD ON
170 Z80 SOFT CARD/CPM/MANL

SOFTWARE
95 APPLE DESK TOP PLAN
60 CCA DATA MANAGEMENT SYSTEM
10 DISC UTILITY PACK
300 APPLE BUSINESS CONTROLLER
PROGRAM

25 APPLE POST PROGRAM
35 3.3 DISK OPERATING SYSTEM
100 APPLE FORTRAN PACKAGE
110 VISIPILOT VISI-TREND
100 DB MASTER
110 VISICALC DISK & BOOK
COMPLETE 3.3
50 MICROBASE MAILING LSIT
100 MICROCHASE STOCK CONTROL
20 3D SUPER GRAPHICS
8 CIRCUIT ANALYSIS

DOCUMENTATION

12 FORTRAN
9 APPLE II REFERENCE MANUAL
10 6602 HARDWARE MANUAL
8 6502 SOFTWARE MANUAL
3 APPLE II BASIC PROGRAM MANUAL
4 APPLESOFT II REFERENCE MANUAL
4 DOS 3.2 MANUAL 3.3
4 APPLE II BASIC TUTORIAL MANUAL
4 AUTOSTART ROM MANUAL
11 PASCAL MANUALS
14 BENEATH APPLE DOS

WAR GAMES

17 WARP FACTOR
10 LORDS OF KARMA
25 BISMARCK
25 AMBUSH
16 CONFLICT
25 AIR COMBAT
25 NAPOLEONICS
17 BASEBALL

PRINTERS

175 SILENTYPE 80-COL GRAPHICS PRINTER
25 10 ROLLS THERMAL PAPER FOR
A2M0034
795 ET121 KFR OLIVETTI
DAISY/WHEEL PRINTER INCLUDES
PARALLEL RS232 AND IEEE 488
700 DY211P OLIVETTI PARALLEL DAISY
PRINTER
890 DY211PS OLIVETTI SERIAL/
PARALLEL DAISY PRINTER
1200 DY 311 OLIVETTI SERIAL/
PARALLEL DAISY PRINTER
18 LISTING PAPER 2000 SHEETS
1350 QUME 5/45 RO
110 QUME FORM TRACTOR
400 CENTRONIC 739
460 PAPER TIGER 445
560 PAPER TIGER 460
725 PAPER TIGER 560
760 ANADEX DP9500
795 ANADEX DP9001
900 ANADEX DP9501

CARDS & ACCESSORIES

120 ALF MUSIC SYNTHESISER CARD
10 TIMING MODE INPUT BOARD
7 ALF MUSIC ALBUM 1
7 ALF MUSIC ALBUM 2
7 ALF MUSIC ALBUM 0 (CHRISTMAS)
180 ANALOG OUTPUT BOARD 4 CHANNEL
280 ANALOG OUTPUT BOARD 8 CHANNEL
200 A1-02 DATA ACQUISITION CARD
200 AD-DA 16 CH 12 BITS
11 PROTOTYPE/HOBBY CARD
40 PARALLEL PRINTER INTERFACE CARD
100 COMMUNICATIONS CARD
80 HIGH SPEED SERIAL INTERFACE CARD
90 LANGUAGE CARD
50 CENTRONICS CARD
80 RAM CARD 16K
100 Z80 CARD
75 EUROCOLOUR CARD
120 SPEECH LAB
400 GRAPHICS TABLET
90 CONTROLLER CARD
APPLETEL SYSTEM
180 80-COL DISPLAY CARD (VIDEOTERM)
10 DISC TO CONVERT DV80 TO PASCAL
180 APPLE JUICE POWER SUPPLY
5 APPLE BLACK & WHITE MODULATOR
58 HEURISTICS CONTROLLER 70
168 HEURISTICS SPEECHLINK 200
219 IEEE INTERFACE
160 CLOCK/CALENDAR CARD
180 SUPERTALKER
110 ROM-PLUS CARD
100 ROMWRITER
30 COPYPLUS ROM
300 MUSIC SYSTEM COMPLETE
220 PASCAL LANG SYST.

MAIL ORDER TO CENTRAL OFFICE

SEND FOR FURTHER DETAILS ON REST OF OUR EXCELLENT RANGE OF SOFTWARE HARDWARE

*All prices ex. V.A.T. *Our own low cost maintenance 24 hrs. service *Please ask for other brands of software and hardware

MICROCOMPUTER HIRE SERVICE

A TRIAL PERIOD FOR YOUR COMPUTERISATION
A COMPREHENSIVE SERVICE FOR RENTALS
Superbrain with application packages ·
Apple System · PET Tandy Sorcerer Horizon Printers

CENTRAL OFFICE: Microcomputer Spacedrome,
3 Westholm, London NW11. 01-458 5845
Promglow Ltd., 12 Dene Road, New Southgate.

PLEASE SEND DETAILS OF SEMINARS ON
WORD PROCESSING TRAINING ETC.

NAME

ADDRESS

COMPANY

TEL

PCW 6/82

WHY BUY FROM CAMDEN...!

- * WE SUPPLY : THE HARDWARE :
- * WE SUPPLY : THE SOFTWARE :
- * WE SUPPLY : THE BACK-UP :
- * WE SUPPLY : THE EXPERIENCE :
- * WE SUPPLY : THE KNOWLEDGE :

APPLE III
128K MODEL
INCLUDES MONITOR
VISICALC III - SDS.
MAIL LIST MANAGER
AND APPLE BUSINESS
BASIC
PLUS SILENT TYPE
PRINTER.
PLUS ADDITIONAL
DISK DRIVE.
£21 PER WEEK LEASE
OR PURCHASE

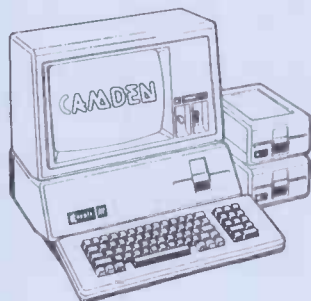

Main Distributors for all the leading makes of microcomputers and peripherals.

Off the shelf programs to suit most applications from the leading software houses - with proven reliability.

From our own engineering workshops with fully qualified technicians or - on site service - your choice.

As one of the countrys leading distributors with proven sales records - and one of the pioneers of the microchip our fully trained staff will advise on your requirements to suit your needs and improve your business.

SUPERBRAIN
64K QD MODEL
PLUS EPSON MX80 FT
PLUS FULLY
INTEGRATED
ACCOUNTS PACKAGE
£21 PER WEEK LEASE
OR PURCHASE



MAIN DISTRIBUTORS OF RICOH DAISYWHEEL PRINTERS



CAMDEN ELECTRONICS LTD. (SYSTEMS DIVISION)
462 COVENTRY ROAD, SMALL HEATH, BIRMINGHAM, B10 0UG
PHONE: 021 773 8240 - 021 772 5718 - TELEX 335909 (CAMDEN G)



ZX80

JRS SOFTWARE

19 WAYSIDE AVENUE, WORTHING, SUSSEX, BN13 3JU
TELEPHONE WORTHING 65691 (Evenings and Weekends only)

ZX81

16K RAM PACK £35 (1969.95)

WHY PAY MORE

Fully built, tested and guaranteed
Black case
No 'wobble' problems - fully supported by ZX81
Fully compatible with printer etc. etc.
Full refund if not delighted

(Please allow 14-21 days for delivery)



An ESSENTIAL addition to your 1K RAM ZX81 (or ZX80 8K ROM)
(please state which when ordering)

TOOLKIT (written by PAUL HOLMES)

Provides the following additional facilities:-

Line renumber - you state starting number and increment value.
Search and replace - changes every occurrence of a character as you require.
Free space - tells you how many free bytes you have left

SPECIAL GRAPHICS ROUTINES

Hyper graphics mode - graphics never seen on a ZX81 before.
Open - instantly sets up as many empty print lines as you require. (1K version only)
Fill - used in conjunction with OPEN fills your screen instantly with your specified character
Reverse - changes each character on your screen to its inverse video.

TAPE ROUTINE - provides a system WAIT condition until a signal is received in the cassette ear jack - many uses!

All these routines are written in machine code and together take up only 164 BYTES of your precious RAM - an incredible achievement!!

The price is incredible too! ONLY £3.95 (\$7.90) for cassette, including FULL instructions and example programs.

ALSO available 16K version ONLY £4.95 (\$9.90) which includes all the above PLUS: GOTO's and GOSUB's included in line renumber.

Search for and list every line containing specified character.

16K VERSION

CASSETTE professionally recorded by SOUND NEWS STUDIOS

GAMES PACK - Beat this for value! 5 x 16K programs PLUS 2 x 1K programs £4.95
3-D Battle (M/code-1K) - Fast-moving space battle with continuous count-down of energy units left. £9.90

City Bomb (M/code-1K) - Destroy the buildings and land your plane. Your fuel has nearly gone and you circle the city lower and lower.

Warp Wars (Basic & M/code-16K) - Features realistic space-craft moved by M/code for (previously sold at Microfair with instant response. Sweet Tooth for £4.95)

Snake (Basic-16K) - A game of thought and skill. Pass through all the marked squares without crossing or doubling back on your path, but watch out for the expanding black blob.

Sweet Tooth (Basic & M/code-16K) - M/code routines used to move your fat face round the screen and gobble the sweets.

PLUS Slalom and Black Holes (previously sold together for £4.95)

OVERSEAS CUSTOMERS
PLEASE NOTE

Payment may be made in Sterling (Money Order available at your bank) or \$U.S. (U.S.A. customers only).

ALL GOODS SENT AIRMAIL



MOVING AHEAD WITH ZX SOFTWARE

ZX CHESS & ADVENTURES

ZX CHESS I
reduced to £6.50

ZX CHESS II
now only: £12.99

ADVENTURES

ADVENTURE 'A'
£6.00

ADVENTURE 'B'
£7.00

ADVENTURE 'C'
£8.00

GALAXIANS

All the features of the arcade game in a fast machine code program. Swooping attackers, explosions and personalised scoring.

£6.50

ZXBUG

A 30 in 1 machine code tool and disassembler, allows access to registers and to search through, and modify memory; with cassette routines.

£7.00

GALAXY WARRIOR

Fast and exciting interactive animated graphics game. Hunt clingons and go through black holes...

£3.00

1K GAMES PACK

and many more. For a catalogue giving full details, please send a S.A.E. to,

£6.00



ARTIC COMPUTING

396 James Reckitt Avenue
Hull, HU8 0JA



MICROTEK Ltd

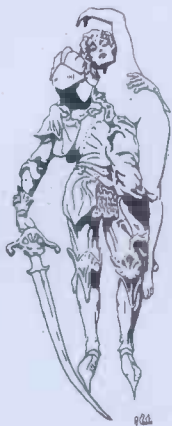

where SOFTWARE
meets HARDWARE

Business Software on the MZ80B
LETTERWRITER - A simple screen based word-processor for correspondence, with mailing list capabilities £35.00.
CASHBOOK/ANALYSIS - A comprehensive system for MZ80B with a printer. Comes in 2 versions (1) Cashbook (2) Cashbook/Analysis cassette or disk versions from £40.00.
PAYROLL - Various versions for all purposes. Manages up to 100 employers. Calculates complex bonus rates etc. For all Sharp systems cassette or disc operated. From £65.00.
For further details write to:
MICROTEK LTD, 15 LOWER BROOK ST. IPSWICH
SUFFOLK. TEL: (0473) 50512 or 52466.

VIC PET APPLE SOFTWARE

NEW GRAPHICS - full screen super graphics package for the VIC. Adds 18 commands to BASIC. Draw detailed pictures using 152 X 160 points. Hires & Multicolor graphic modes on same screen! Switch between text and graphics screens with function keys. Save/load pictures to/from tape or disk. Requires 3K or 8K expander. With sample programs and user's manual. Price \$25; manual only \$5.

VIC/PET VIGIL - Interactive Games, Language - Program your own or play the 9 games included. With 60+ powerful commands. Easy to learn. VIC version has color (requires 3K or 8K expander). Complete with user's manual. Price \$35; manual only \$10.

VIC/PET PIPER - the MUSIC MACHINE - Simplest way yet to compose, conduct and play music. Complete music control of notes, rests, volume, repeats, tempo, etc. Written in fast machine language. With sample compositions and user's manual. Price \$25; manual only \$5.

VIC HIRES/MULTICOLOR GRAPHICS UTILITIES - Add graphics to VIC BASIC. Requires no extra memory. Plot points, lines and boxes in fine detail - 104 X 152 points. With sample programs and user's manual. Price \$15; manual only \$3.

PET TINY Pascal PLUS+ - structured language alternative to BASIC. With Editor, Compiler and Interpreter. All programming constructs supported. With user's manual. Graphics or non-graphics versions. For NEW/4.0/8032. W/graphics (32K) - disk \$50; cassette \$55. W/O graphics (16K) - disk \$35; cassette \$40; manual only \$10.

NEW APPLE II DYNASOFT Pascal - complete Pascal development system with Editor, Compiler, Interpreter and Supervisor. All programming constructs and data types: scalars, char, array, pointer, integer. Hires, Lores and machine language interface. With sample programs and user's manual. Disk \$50; Disk with complete machine readable source code \$85; manual only \$10.

PET TINY BASIC COMPILER - Produces true 6502 code. Supports all floating point operations. Subset of the full PET BASIC. Compiler listing optional with 16K version (included). With user's manual. For OLD/NEW/4.0/8032 and 8K+. Price \$25; manual only \$5.

PET MACHINE LANGUAGE GUIDE - Now in its ninth printing. Learn the hidden talents of your Old, New or 4.0 Rom PET/CBM. 30+ routines fully detailed. Price \$9 (\$11 foreign).

NEW ABACUS - Beautifully crafted Chinese abacus. Teach children basics of math or use as lovely decoration. With free 50+ page manual explaining use. Price \$14.95 + \$2.00 postage (\$4.00 foreign).



ABACUS SOFTWARE
P. O. Box 7211
Grand Rapids, Michigan 49510
616 / 241-5510



Unless noted, prices are for cassette. Add \$3.00 per disk package. Foreign orders add \$5.00 per package or \$2.00 for manual only. All orders must be prepaid in US Dollars, VISA, MC, ACCESS, Eurocard.

SOFTWARE FOR CP/M®

HIGH QUALITY SOFTWARE - WITH HIGH QUALITY SERVICE

★ **NEW!** The Formula: £300. Application builder and reporter. SUPERCALC: £165. Spread sheet financial planning. SPELLSTAR: £125. Option for Wordstar.

WORDSTAR - Professional word processing software. On-screen formatting, wordwrap, pagination, line and character count on view. Micro-justification on daisy-wheel printer. Search and replace. Block/paragraph manipulation. External file read/write. Background printing during editing etc.	£250	MICROSOFT FORTRAN COMPILER	£205
MAIL-MERGE - Powerful Wordstar enhancement for file merging and document personalisation.	£65	MICROSOFT COBOL	£310
DATASTAR Screen orientated system for Data Entry, Retrieval and Updating.	£175	MAGSAM - Versatile easy to use Keyed File Management System for Microsoft Basic or CBASIC.	£130
SUPERSORT - Sort, merge and selection program.	£125	CIS - COBOL - ANSI' 74 implementation to full level 1 standard. Supports random, indexed and sequential files, features for conversational working, screen control, interactive debugging, program segmentation etc.	£425
CONFIGURABLE BUSINESS SYSTEM (CBS) - Unique information management system with user definable files, powerful report generator, menu-driven for ease of use. No programming experience necessary!	£225	FORMS-2 - Automatic COBOL code generator for screen formats.	£100
ACCOUNTING PACKAGES by Median - Tec: PAYROLL, SALES, PURCHASE, NOMINAL Specially developed by UK software house to exacting specifications. Written in Microsoft Basic each package may be customised by end user, all are widely used. Ledgers are open item. Payroll caters for weekly and monthly pay.	£500 each	PASCAL-Z	£255
PROJECT COST CONTROL/JOB ACCOUNTING - A comprehensive set of programs to monitor budgets, account for expenditure and project completion etc. Ideally suited for contractors. Written in CBASIC-2.	£150	STRUCTURED BASIC - Relocatable compiler	£160
STATISTICS PACKAGE - Over 25 routines including Regression & ANOVA	£100	CBASIC-2 - Extended Disk Basic pseudo compiler and run-time interpreter.	£75
MATHS PACKAGE - Over 40 easily used routines.	£100	SELECTOR III - C2 - Information management system written in CBASIC-2	£185
IBM - CP/M COMPATIBILITY - Powerful utility to transfer data to/from IBM machines in standard disk format.	£110	SELECTOR IV - Upward compatible version of III with enhanced reporting.	£300
MICROSOFT BASIC INTERPRETER	£155	BSTAM - Telecomms facility for exchanging files between CP/M computers.	£75
MICROSOFT BASIC COMPILER	£205	ASCOM - Facility for communicating with other computers.	£95
		TRANSFER - CP/M to CP/M file exchange - telecomms source code	£95
		MACRO 80 - Macro Assembler	£99
		CP/M 2.2 - Standard Version 8" Single Density.	£99

Please contact us for availability of other products
All orders must be PREPAID. Add £1 per item P & P (Minimum £2.00) and VAT
CP/M is trade mark of Digital Research





TELESYSTEMS LTD

P.O. Box 12, GREAT MISSENDEN, BUCKS, HP16 9DD

Telephone (02406) 5314



MICRO-PRINT LTD.,

  (Members of the Booksellers Association) 

59, Church Street, Stoke-on-Trent, Tel: (0782) 48348

60 Programming the 6502 (Zaks)	10.25	401 ZX81 Companion	7.95
200 Programming the Z80 (Zaks)	11.95	404 ZX81 Pocket Book	5.95
181 Artificial Intelligence	1.25	434 Understanding your ZX81 ROM (Logan)	8.95
178 Vol.1 (Knuth) Fundamentals Algorithms	10.95	436 49 Explosive Games ZX81 (Hartnell)	5.25
179 Vol.2 (Knuth) Semi-Numerical Algorithms	16.50	295 CRT Controller Handbook	5.95
180 Vol.3 (Knuth) Searching and Sorting	16.50	383 CP/M Users Guide (Osborne)	10.10
327 Basic Computer Programs for Business Vol.1.	8.55	279 CP/M Handbook (Zaks)	11.50
344 CP/M Primer	8.45	437 Apple BASIC Data File Programming	8.95
335 Microsoft BASIC Decoded	19.45	381 Data File Programming in BASIC	6.50
250 Sorting and Sort systems Lozin	15.25	414 Apple Pascal	10.00
367 Pract. Progs. for Scientists and Engs.	12.70	365 Apple II Users Guide	11.10
217 Z80 Micro Design Projects	8.95	422 Software Tools in Pascal	
51 Z80 Programmes for Logic Design	8.35	(Kernighan and Lauger)	9.95
408 Getting Acquainted with the VIC20	5.95	444 Make a Success of Micro Computing	
413 Getaway Guide to ZX81	5.95	in your Business	4.95
385 Getting Acquainted with your ZX81	4.95	443 WORD STAR made easy (Osborne)	7.60
417 Hints and Tips for the ZX81	4.25	Algorithms Writers Guide	4.00
409 Mastering Machine Code ZX81	5.95	Software Secrets (MZ80K)	5.95
402 Machine Language made simple for the ZX81	8.95	Apple Machine Language	9.70
412 Not only 30 Programmes for the ZX81	6.95	Apple BASIC for Business 11-20	11.20
416 Sinclair ZX81 Prog/real Appl.	6.95	Pascal Programming for the Apple	9.70

HARDWARE
VIC 20, Nascorn, Tuscan, Video Genie, Printers etc.
Cassettes MP12 5-20 per ten incl. postage
S.A.E., envelope for catalogue
Postage 80p. per book.
24 hours ordering service

DATABOOKS
Data Conversion Aquisition 5.60
Memory Databook 3.80
T.T.L. Databook 5.50
Linear Applications 4.00
CMDS Databook 4.50
Linear Databook 6.00
N.E.C. Electronics Europe Catalogue 4.00

ALL PRICES SUBJECT TO CHANGE WITHOUT NOTICE.

(Members of the Booksellers Association)



**FAST SERVICE,
24 HOUR ORDERING SERVICE**



CRYSTAL ELECTRONICS CC ELECTRONICS

FOR YOUR SHARP MZ80K CP/M 2.21 (XTAL)

BASIC CP/M FACILITIES INCLUDE:

- Dynamic file management Fast assembler
- General purpose editor • Advanced debugging utility

YOUR SHARP CP/M 2.21 (XTAL) PACKAGE INCLUDES:

- Hardware modification (if fitted by a SHARP dealer does NOT break the guarantee) • SHARP CP/M 2.21 (latest version) on disc • XTAL Monitor and Operating system • 7 Digital Research manuals • 12 months guarantee and up-dates (on all our products)

CP/M 2.21 (XTAL) FROM £150 + VAT

Ask your SHARP dealer for further details or contact CRYSTAL ELECTRONICS

CP/M SOFTWARE HOUSES—XTAL CAN HELP YOU ESTABLISH YOUR SOFTWARE ON THE SHARP.

XTAL BASIC (SHARP)

Takes 5K less memory, has all the features of SHARP BASIC PLUS Multi dim strings, error trapping, logical operators, machine code monitor, more flexible peripheral handling, improved screen control, increased list control, auto run. If, then..else—and it doesn't stop there—it grows. You can extend the commands and functions at will—10K, 12K, 16K, BASIC?. SHARP to XTAL BASIC conversion program is included. £40 plus VAT.

Bi-directional serial board for your SHARP RS232 compatible 150 Baud to 2400 Baud adjustable < 5.6,7,8 Bit words, plugs into MZ80I/O £99.50 plus VAT. Includes software for bi-directional use in XTAL BASIC. software for using SHARP BASIC with serial printer and self-diagnostic software for testing Baud rate etc

Members of Computer Retailers Association & Apple Dealers Association
Shop open 0930—1730 except Saturday & Sunday
40 Magdalene Road, Torquay, Devon, England. Tel: 0803 22699

Access and Barclaycard welcome



ATOM

ZX81

VIC

MAKE THE MOST OF YOUR MICROCOMPUTER WITH OUR POPULAR RANGE OF PROVEN BOOKS:—

- GETTING ACQUAINTED WITH YOUR ZX81**, by Tim Hartnell. Eighty plus programs in this 120-page book, including draughts. **£5.95**
- 20 SIMPLE ELECTRONIC PROJECTS FOR THE ZX81 and other computers** by Stephen Adams **£6.45**
- SYMPHONY FOR A MELANCHOLY COMPUTER** by Tim Hartnell. 20 great Vic games **£6.95**
- 39 TESTED PROGRAMS FOR THE ACORN ATOM** Best of Interface **£6.45**
- MASTERING MACHINE CODE ON YOUR ZX81 OR ZX80**, by Toni Baker. 180 pages, teaches machine code from first principles. **£7.50**
- 49 EXPLOSIVE GAMES FOR THE ZX81**, edited by Tim Hartnell. **£5.95**
- PASCAL FOR HUMAN BEINGS** by Jeremy Ruston **£6.45**
- 34 AMAZING GAMES FOR THE 1K ZX81** by Alastair Gourlay **£4.95**
- THE GATEWAY GUIDE TO THE ZX81 AND ZX80**, by Mark Charlton. Over 60 programs and routines, ZX BASIC explained in detail. **£6.45**
- GETTING ACQUAINTED WITH YOUR ACORN ATOM**, by Trevor Sharples and Tim Hartnell. 184 pages, 80 programs, including draughts. **£7.95**
- GETTING ACQUAINTED WITH YOUR VIC 20**, by Tim Hartnell, with over 60 programs to get your VIC up and running from day one. **£6.95**
- INTERFACE**, the monthly magazine published by the National ZX80 and ZX81 Users' Club, in conjunction with the Independent Atom Users' Group, is just £9.50 (UK), £12.50 (Europe) for 12 issues. **Sample copy**, with many programs for each machine, book, software and hardware reviews, education, contact addresses, just **£1**.

Please send me the items marked. I enclose £

Name:

Address:

Postcode

Please make cheques payable to **INTERFACE** and send the above form, or a copy, to: **INTERFACE, Dept. PCW, 44-46 Earls Court Road, London W8 6EJ**

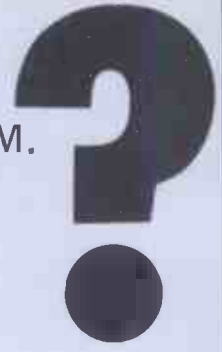

SELLING YOUR COMPUTER.
UPGRADING – PART EXCHANGE YOUR SYSTEM.
LOOKING FOR A NEW OR USED COMPUTER.
SEARCHING FOR A SUITABLE SUPPLIER.

COMPUTE A COMPUTER WITH

KELLYS COMPUTER MARKET

01-659-7997

New APPLE 48k £595
Refurbished ITT2020
Used 5¼ floppies

New ACORN ATOM – Ring for details
Used Computers – printers – Peripherals etc.
Software for all. Bespoke + off the shelf.

NEW

ELECTRONIC TILL. Everything for the small BUSINESS. INSTANT STOCK UPDATE, Invoice printer, daybook, VAT Calculations, Posting, Accounts, Low Stock Warning, Reorder printing, Visual verification of Inputs, Transactions analysis, Remote keypad + VDU. INCLUDING PRINTER from £2700.

All prices exclude VAT and Carriage

PARAGON HOUSE, 46 KENT HOUSE LANE, Beckenham, KENT

MICRO-80

UK Subscription Dept.

24 Woodhill Park Pembury Tunbridge Wells Kent TN2 4NW

GET THIS free software offer when you subscribe to MICRO-80 – The specialist magazine for TRS-80 and VIDEO GENIE.

LOOK AT the programs you get FREE when you subscribe . . .

★ **Level I in Level II** – Convert your Level II TRS-80 to operate as a Level I machine. Opens a whole new library of software for your use.

★ **Copier** – Copies Level II System tapes, irrespective of where they load in memory. Copes with multiple ORG programs.

★ **Z80 MON** – A low memory, machine language monitor which enables you to insert OP codes, edit memory, punch system tapes etc.

★ **Improved Household Accounts** – Powerful enough to be used by a small business.

★ **80 Composer** – A music generating program which enables you to play music via your cassette cord.

★ **Plus Two Games** – Poker and Cube (a version of the Rubiks cube for Disk users)

and don't forget MICRO-80 is now available in monthly cassette edition as well – all the published programs each month ready to load on cassette.

Please enrol me for an annual subscription and send me my FREE cassette program. I enclose £16.00 (magazine only) or £43.60 (magazine and cassette edition).

(enclose your cheque/P.O. made payable to MICRO-80 and send to the above address)

Software offer, and cassette edition prices applies to U.K. residents only. Overseas subscription rates on application.

Name:

BLOCK CAPITALS PLEASE

Address

.....

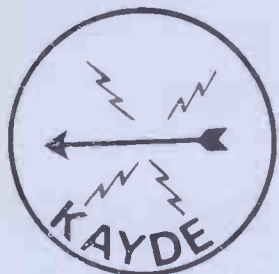

ZX 80/1 WAR!



ZX KEYBOARD FULLY CASED WITH REPEAT KEY

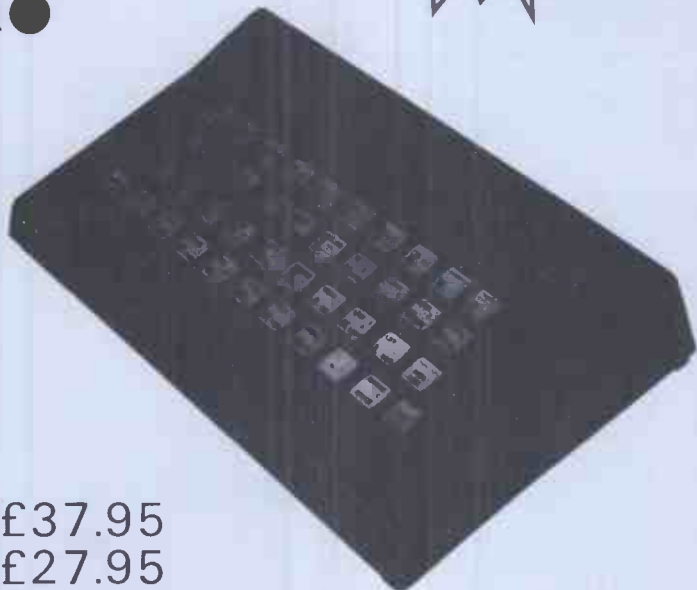

FULLY CASED KEYBOARD	£37.95
UNCASED KEYBOARD	£27.95
KEYBOARD CASE	£10.95

This is a highly professional keyboard using executive buttons as found on top quality computers. It has a repeat key and comes, complete in its own luxury case. This is a genuine professional keyboard and should not be confused with toy keyboards currently available on the market.

16K RAMPACKS MASSIVE ADD ON MEMORY FULLY CASED



comes fully assembled, tested and guaranteed

The 16K Rampack plugs straight into the user port at the rear of your computer. And, of course, as in all our products the Rampack is fully enclosed in a matt black slimline plastic case.

This means you can handle it with complete safety and you do not have to stare at ugly components – as in other makes of 16K. The Rampack NEEDS NO EXTRA POWER and will operate quite happily on your Sinclair power supply. Fully built and tested.

Don't forget you can always order on the telephone with your credit card.

Six days a week for a same-day service.

WHY WAIT TO PAY MORE FAST IMMEDIATE DELIVERY

Post to:
DEPT PCW6

Kayde Electronic Systems
48/49 Exmouth Road
Great Yarmouth
Norfolk NR30 3DP Tel: 0493 57867



Please send me RAM pack/s £32.95 each
 Please send me cased keyboard/s £37.95 each
 Please send me uncased keyboard/s £27.95 each
 Please send me keyboard case/s £10.95 each

I enclose £.....
 Name
 Address

Please add £1.50 p/p and make cheques payable to Kayde Electronic Systems.

All products include VAT are fully built and tested and come with a COMPLETE MONEY BACK GUARANTEE

NASCOM USERS

Take a look at the NASCOM APPROVED HS-IN STORAGE SYSTEM. Where else can you get features like these. . .
A full on screen instant display of the catalogue.
Auto verification of each file as it is written.
CRC error checking.
Link selectable 2MHz or 4MHz option.
Fast data transfer rate of 6000 bps.
Powered from NASBUS.
8" sq NASBUS compatible PCB.
Far more reliable than any floppy disk system.
112K on-line storage with 2 drive system.
 The HS-IN has a Command Set which makes it a floppy-disk "look-alike". It can load an 8K program in under 11 seconds and can store up to 56K (28 files) on each side of tape. Why spend £700 on a floppy disk system when the less expensive HS-IN system has a command set like this. . .

BRIDGE THE GAP BETWEEN EXPENSIVE FLOPPY DISK SYSTEMS AND UNRELIABLE CASSETTES.

- B** - Write a Basic file
- C** - Instant display of catalogue.
- D** - Delete file
- J** - Jump to Basic.
- N** - Jump to NAS-SYS.
- Q** - Warm start to NASPEN text editor.
- R** - Read a file.
- T** - Transfer file to another drive.
- W** - Write a file.
- X** - Exit and rewind cassettes.
- Z** - Warm start to Basic.

This Mini-Cassette Storage System is technologically far ahead of anything like it on the market and is extremely reliable into the bargain. **AND THE COST?**

Single Drive System built and tested	£199
Double Drive System built and tested	£279
Carriage	£3.50

MICRO-SPARES CARRY FULL RANGE OF NASCOM AND GEMINI COMPUTERS.
 MICRO-SPARES ARE A MEMBER OF THE MICROVALUE GROUP
 See pages 12, 13

QUALITY MEMORIES

AT PRICES THAT CANNOT BE BEATEN IN THE U.K. MICRO-SPARES can supply these memories in quantities from 1 to 10,000+. Parts delivery is fast - orders received by 4.30pm are shipped same day.

All memories are guaranteed for 1 year from date of purchase. Memories supplied are good quality but should you have a faulty part a replacement will be sent as soon as the part is received - without question.

Thousands of memories have already been supplied to Manufacturers Computer Traders, Government Bodies and Individuals all over the U.K. and the continent. If you are buying in large quantities please telephone for price. Official orders are welcome!

2114L (200ns & 300ns) low power	1-49	50-249
Suitable for Acorn Atoms	96p	93p
2114N (200ns & 300ns)	96p	93p
4116 (250ns)	63p	63p
(200ns)	65p	63p
(150ns)	75p	73p
2708 (450ns)	1.40p	1.34p
2716	2.05p	1.92p

Buy an EPSON PRINTER

and Micro-Spares will supply an interface for your computer.
 Offer closes end of MAY.

EPSON MX80T	£359 + VAT
EPSON MX80FT1	£379 + VAT
EPSON MX80FT2 (new type)	£425 + VAT
EPSON MX100	£525 + VAT

All come with cables and paper

PAYMENT AND DELIVERY

Payment is by Cheque, Postal Order, ACCESS, VISA etc. PLEASE add postage and VAT. Postage on component orders under £30 is 50p. All in stock items sent same day. All none Kit items have a 1 year guarantee. Official orders welcome. Discount on large orders by arrangement.

SUPPLIERS TO TRADE
 LOCAL GOVERNMENT
 EDUCATION
 INDIVIDUALS
 INDUSTRY



EDINBURGH

Micro-Spares

19 Roseburn Terrace, Edinburgh EH12 5NG.
 Tel. 031-337 5611.



SCOTLAND

COMPUTERS
 PERIPHERALS
 COMPONENTS
 & NATIONWIDE
 MAINTENANCE

30+ PROGRAMS FOR THE BBC MICRO

This Book contains program listings, with explanations & tips on using the BBC Micro.

GAMES, UTILITIES, EDUCATIONAL, GRAPHICS & MUSIC.

"ASTRO RUN" "SCREEN PAY" "3D GRAPHICS"

Most programs will run on Model A & B.

Edited by C. Evans, various Authors.

APRIL 1982

£5.00 inclusive of p&p

CARRYING CASES FOR MICRO'S

Fibreboard cases for:- ZX81; BBC Micro; Acorn Atom; VIC; Apple; 2 Apple Disks; Atari 400 or 800. £18.50 p&p £2.50.

For ZX81 only, COMPACT BLACK ABS BRIEFCASE £19.50 p&p £2.50.

CASSETTE LEADS

Cassette Leads for the BBC Micro (The BBC Micro comes with an incomplete lead)

7 Pin Din to 7 Pin Din	£4.65 p&p 35p
7 Pin Din to 5 Pin Din & 2.5mm minijack	£4.65 p&p 35p
7 Pin Din to 2 x 3.5mm & 2.5mm minijacks	£4.65 p&p 35p
7 Pin Din Plus	Two for £0.65 p&p 35p

RAM CHIPS

4816 As used in the BBC Micro 8 Chips give 16K	£5.00 each
2114 As used in the Acorn Atom 20 Chips give 10K	£1.30 each
6116 As can be used to replace Ham chip inside ZX81 to give 2K internal memory	£7.50 each
p&p RAM chips 50p per order	

Programmes & hardware designs for the BBC Micro wanted. Send SAE for full price list. VAT included where appropriate

C.J.E.
Microcomputers

25 HENRY AVE, RUSTINGTON,
 WEST SUSSEX. BN16 2PA
 (09062) 74998

SINCLAIR COMPUTERS

We are the leading world-wide Sinclair export specialist including Norway, Sweden, Finland and Denmark. Write for our surprisingly low prices.

PRINTERS

Buy any of the below and get a free interface kit and word processor program for UK101 or Superboard. Seikosa GP100A £205. Centronics 731 £335. Centronics 739 £419. OKI Microline 80 £285. OKI Microline 82A £399. Epson MX70T £259. Epson MX80T £339. Epson MX80F/T1 £375. Epson MX80F/T1 £375. Epson MX80F/T2 £375. Epson MX100 £495.

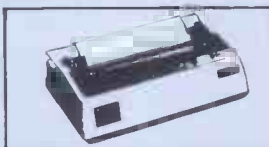

SHARP COMPUTERS

MZ80K 48K £335. 46 sample programs for £15. We can supply any Epson MX80 printer to run direct from the MZ80K (I/O box not needed) for £39 plus printer price. We also specialize in interfacing printers to the MZ80K, MZ80A and MZ80B both with and without the I/O box.

VIC 20 COMPUTER

Two special offers:- If it is bought with the Vic20 we can supply the cassette recorder for £30.43. Alternatively, we will supply a free kit with each Vic20 to allow the use of an ordinary cassette recorder. Vic 20 £185. Ordinary cassette conversion kit £6. Vic20 cassette recorder £36.50. Vic printer £189. Floppy disc drive £309. Ram cartridges:- 3K £24. 8K £35. 16K £57. Game cartridges:- Superlander. Alien or Avenger £15 each. Joystick £6-52. Intro to Basic Part1 £12. New low cost memory board, no need for a mother-board, comes with 3K ram on board + socket for a rom + sockets for another 24K of low current Nmos ram (Just plug in chips to expand memory) £49. Extra memory chips £7-80 per 2K.

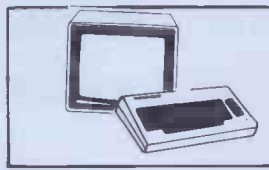

SWANLEY ELECTRONICS

Dept PCW, 32 Goldsel Rd, Swanley,
 Kent BR8 8EZ.
 Tel Swanley (0322) 64851

UK101 AND SUPERBOARD

UK101 32 x 48 display expansion kit £9. The below accessories suit both the UK101 and Superboard:- Extra ram £2-10 per K. 16K memory expansion complete kit £50, built £58. 32K memory expansion kit £74, built £82. Cegron £22-50. Wemon £14-95. Word processor program £10. Centronics interface kit £10. 610 expansion board £179. Cased mini-floppy disc drive with DOS £275. The below suit only Superboard:- Guard band kit £10. Series 1 only 30x50 display expansion kit £14.

NEW GENIE 1 £299

EG3014 Expansion box with 16K/32K ram £199/£213. We are Cumana disc drive specialists for the Genie. Single sided disc drives drives:- 40 track £205, dual 40 track £345, 80 track £269, dual 80 track £469. Double-sided disc drives:- 80 track £399, dual 80 track £699. Double density converter £72. Parallel printer interface £36.

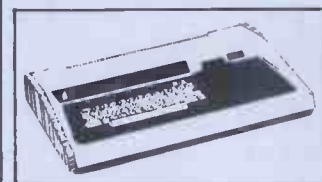

5V POWER KITS

Fully stabilized 5V computer and TTL power kits. Short circuit and over-voltage protection. 1.5A £7.83, 3A £12-17. 6A £20.

TEACH YOURSELF COMPUTING VIA THE BBC SERIES AND HAVE FUN!

Introducing the TEXAS TI99/4A home computer which plugs direct into any T.V. for full colour.

Superior colour, music, sound and graphics – and a powerful extended BASIC – all built in. Plus a unique, new Solid State Speech™ Synthesizer and TI's special Solid State Software™. Compare it. Pound for pound. Feature for feature. There's a computer in your future. And the future is now . . . We've entered a new and exciting era – the age of the home computer. Perhaps you're already quite knowledgeable about computers and are looking for the most programming power and versatility for your money. Perhaps you've just read about it, and want to learn more. Either way, you need to look closely at Texas Instruments TI99/4A Home Computer. The TI99/4A was designed to be the first true home computer-skilled computer users and beginners alike will be able to put it to effective use immediately.

If you're new to computers, the TI99/4A is for you.

You can begin using the TI Home Computer literally minutes after you unpack it.

Without any previous computer experience or programming knowledge. You simply snap in one of TI's Solid State Software™ Command Modules and touch a few keys.

Step-by-step instructions are displayed on the screen. So you or just about anyone in your family can use the TI99/4A.

Two pioneering technological developments in particular set the TI99/4A apart from the rest.

Solid State Speech™ – This optional speech synthesiser enables the TI99/4A to literally speak-to provide verbal prompts and special messages to the user. Actually reproduces the human voice electronically. Hundreds of words are available, and plug-in word modules will add hundreds more.

TI's exclusive technology lets you call up the words you want by simply typing them in. Outstanding voice clarity and fidelity. Solid State Speech is a proven technology already on the market in TI's unique Speak and Spell™ electronic learning aid for children.

Solid State Software™ Command Modules – Available in a wide range of application areas including many games, (Chess, Blackjack/Poker, Pin Ball, Bingo, Attack From Outer Space.) to name but a few. These optional ROM modules actually add application program memory to your TI99/4A. Software now includes Teach Yourself Basic, Extended Basic, Teaching Aids for Young Children etc. etc. **They let you use the TI Home Computer immediately, with no programming.**

Serious programmers will appreciate the time and effort saved by these pre-programmed modules. Plus, they'll let you introduce your family to the computer in the easiest possible way. Solid State Software was pioneered by TI for use with its powerful programmable calculators.

If you know computers you'll quickly see the difference in the TI99/4A.

Texas Instruments has taken those features you've been wanting-plus some you may not have heard about yet-and included them in one incredible, affordable computer system. The TI99/4A gives you an unmatched combination of features and capabilities, including:

- **Powerful TI-BASIC** – Built-in 13-digit, floating point BASIC. Fully compatible with ANSI Minimal Basic, but with special features and extensions for colour, sound and graphics.
- **Up to 72k total memory capacity** – 16K RAM (Random Access Memory) (Expandable to 48K). 26K ROM (Read Only Memory) plus up to 30K ROM in TI's Solid State Software Command Modules.
- **26K ROM** – Operating system, BASIC, floating point, sound and colour graphics software are contained in ROM.
- **16-colour graphics capability** – Easy-to-access, high resolution graphics have special features that let you define your own characters; create animated displays, charts, graphs . . . and more.
- **Music and Sound effects** – Provides outstanding audio capability. Build three-note chords and adjust frequency, duration and volume quickly and simply. You can build notes with short, straightforward commands. Five octaves from 110 Hz (Hertz) to beyond 40,000 Hz.
- **Built-in equation calculator** – Unique convenience feature helps you find quick solutions to every day maths problems, as well as complex scientific calculations. Directly accessible from the keyboard.

Ideal learning aid for every member of your family – including pre-school children and fun too only –

FOR MAIL ORDER DELIVERY OR FURTHER INFORMATION TEL: 01-455 9823

£287.50
INCLUDING
VAT

MOUNTAINDENE 22 Cowper Street London EC2

AVAILABLE NOW! AVAILABLE NOW! AVAILABLE NOW!

From Network Designers –

CP/M™ for the IBM Personal Computer

- with U.K. Character set
- supports double sided disks (up to 2.5Mb)
- keyboard programmable to generate character strings from single key depression
- console output escape sequences for cursor positioning, attribute control etc.
- cache buffer for optimal disc accessing

Utilities

- disk formatting
- volume copy
- DOS to CP/M file transfer

Hardware Upgrade

- upgrade to provide 1.3 megabyte internal diskette storage
- we also offer comprehensive maintenance cover throughout the U.K.



For further information contact:

Mike O'Neill Leeds (0532) 628646
Bryan Parker Manchester (061) 962 9418
Pat Thompson Freeland (0993) 883166

We represent a group including Doxiver, Network Designers, Micron Design.
CP/M™ is a registered trademark of Digital Research.

WATCH THIS SPACE FOR FUTURE DEVELOPMENTS . . .

VIDEO GENIE and TRS80

THE ROM-VIDEO GENIE & TRS 80 (3 ROM Models)

Are you fed up of loading a lower case drive every time you switch on? — Want your name inside our computer — Better loading (TRS80) — Sick of bouncy keyboards-!

You need our new ROM—simply remove old—plug in new.

- 1) Firmware driver for lower case
- 2) Security code displays—(your name & post code?)—up to 21 characters
- 3) Improved tape loading
- 4) Alleviates repeating characters (key-bounce)
- 5) Checks for feature ROMS

£14.95 + VAT + P&P (80p)

FEATURE ROMS £18.95 + VAT + P&P (80p)

A series of ROMS starting with FEATURE 'A'

- 1) Single keystroke commands
e.g. Shift A = Auto etc.
- 2) Flashing cursor (can be toggled on/off)
- 3) Repeating characters—with delay—(toggle)
- 4) Machine code monitor and editor
- 5) System load and save for backing up those system Programs —uses no RAM and so can deal with a FULL 16K program

NEW

FEATURE 'B'—extended basic

- 1) Merge—two basic programs to one
- 2) Renumber
- 3) Screen print
- 4) Various basic tools PLUS

Access and Barclaycard accepted.

General Northern Microcomputers (GNOMIC)

46 Middle Street, Blackhall, Hartlepool, Cleveland. Tel. Peterlee (0783) 863871

Plug on for feature ROMS

Now you can simply plug on the back of your computer, insert RDM and away you go.

VG £29.95 inc. ROM A + VAT + P&P
TRS80 £34.50 + VAT + P&P (80p)

48K RAM—internal
TRS80 & VG £70 + VAT + P&P (80p)
Plug in our modules. Connect three wires (VG) or five (TRS80). You are not required to piggyback chips. Keep your old RAM (or sell it!). Compatible with expansion.

LOWER CASE HARDWARE (VG & TRS80)

Unplug two IC's, plug in two modules, connect three wires—EASY! £19.00 + VAT + P&P

BOOKS

"Disassembled Handbook for TRS80"—A Self Teach—Series of Books—Written by Bob Richardson of New York. Very well received by U.S. Reviewers, *Essential Reading* for TRS80, Video Genie & Radio Hams.

Vol. 1 Decoding the ROM & Calls, etc. £6.45
Vol. 2 Using Calls, to shorten programs, etc. £8.75

Vol. 3 DJA—AD, Spooling, etc. £10.50
Vol. 4 Teletype, Morse Techniques 14.50
Vol. 5 Voice Systems TBA

+ Much else in each volume.

Various Books—Lists on application.

+ VG—Expansion—Disk Drives—Printers, etc. Details on application.

Try This:

M x 80T

£285 + CARR. + VAT (Cash/Chq. only)

M x 80 FT II

£345 + CARR. + VAT (Cash/Chq. only)

LNW PCB's & Full Manuals

High Res. Colour Computer

£108 (+ CARR. + VAT) Inc. Level 2 & Colour Roms.

Expansion (RS232-MEM-PRINTER-DISK-CLOCK) £65 (+ CARR. + VAT)

TANTEL Prestel Adaptor (colour)

£160 + CARR. + VAT

COMPUTERS FOR PEOPLE



VIC 20 The expandable colour computer from Commodore. Comes complete with leads and manuals £197. Program Recorder £44.95. VIC and Recorder together £240.



ATARI 400 A new generation micro for family entertainment and education. Amazing sound and graphics direct from your colour T.V. Atari 400 £299.95. 410 Program recorder £50.

NEW Atari 400PCP. Unique system includes 400A; Program Recorder; Power supply; BASIC cartridge; 'Atari BASIC' and 'Games for the Atari' books; all leads and manuals £350.



ATARI 800 The advanced, expandable computer with all the features needed on a Business computer plus a great colour, sound, graphics and speed. £599.95 with free dust cover. Cassette recorder £50. Disk drive £345.

CALL IN IF YOU CAN, OR USE OUR EXCELLENT MAIL ORDER SERVICE.

Same day despatch. Please write your order carefully or phone us for information/order form. Callers welcome. Open 9.00-6.00. Closed Thursday.



BUY FROM THE PEOPLE WHO CARE.
All prices inclusive of 15% VAT.



All our equipment is covered by the unique Personal Computer Palace Service Scheme, which provides free installation, one years parts and labour guarantee and optional maintenance contracts.



PERSONAL COMPUTER PALACE

4-6 CASTLE STREET, READING, BERKSHIRE.

Telephone: (0734) 589249

THE FINEST PRINTER/TYPEWRITER MONEY CAN BUY.

THE CROWN RANIER ONLY £795 + VAT

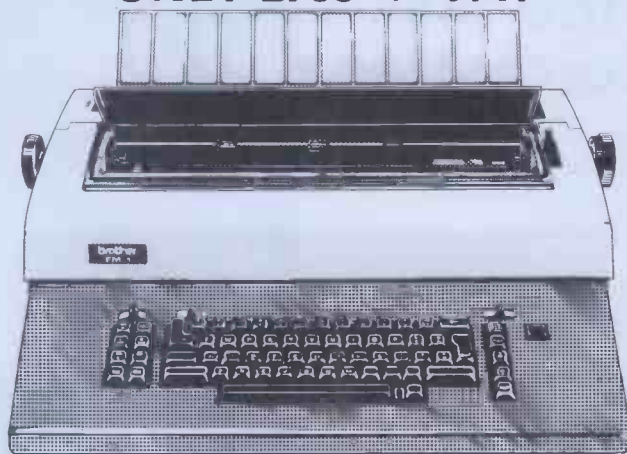

We offer a heavy duty daisy wheel printer/typewriter at the flick of a switch. This machine has the very latest linear motor — no cables or belts to break, stretch or wear. Beware of light weight, low cost machines, these can never give long term reliable service. THIS MACHINE WILL!!

Centronics or IEEE interface. Interchangeable daisy wheels — variable pitch — whole line memory. Uses standard type IBM ribbons and lift off correctors. Perfection as a typewriter (used by local authorities). Perfection as a printer.

Ask your local computer or office equipment dealer for further information. EXSTOCK DELIVERY

SOLE UK AGENT. TRADE ENQUIRIES INVITED.



CROWN BUSINESS CENTRE
EASTBOURNE, 56-58 SOUTH ST.,
SUSSEX. (0323) 639983.



SUPPLIES LTD.
Computer & Business Supplies



TELE SALES HOT LINE 'PHONE 23745/6/7

Phone your order through today ask for Julie, Mary or Bob!!!!

CBS Says Yes to Stocking the Products you require.

High Quality Dysan Disks
High Quality Flexette Disks
Disk Storage Fan Files
Disk Storage Library Cases
Disk Storage Locking Boxes
Disk Cleaning Products
Anti Static Spray
Anti Static Foam Cleaner
V.D.U. Screen Cleaner
Pressurised Air Dusters
Listing Paper All Sizes
Ribbons Full Range Includes:-
Commodore, Qume, Diablo
Cassette Tapes
Digital Tapes
Large Reel Tapes
Turntables
Anti Glare Screens
Copy Holders
Anti Static Mats
Disk Racks
Fire Safes
Fire Extinguishers
Work Stations
Micro Desks
Ergonomic Furniture
DP Binders
DP Storage Units
Computer Labels
Word Processing Labels
Dust Covers
Computer Books

CBS Says Yes to the Best in Mail Order Specials!!!

Scotch C.10 Box 10 52p each
Scotch C.30 Box 10 69p each
5 1/4" Disk Storage Box (40 Capacity Lockable) £14.95 each
5 1/4" Dysan High Quality Disks From £2.50 each
8" Dysan Disks From £3.50 each
Computer Fire Extinguishers £12.00 each
Cleaning Products
Anti Static Foam Cleaner £1.62 can
Anti Static Spray £3.12 can
Disk Cleaning Fluid £2.36
Disk Drive Cleaning Kits £21.50
Dust Covers
PET 8000 £9.99
Disk Drive £9.99
4022 Printer £9.99
Qume Printer £9.99
Diablo printer £9.99

Computer & Business Supplies Ltd,
Bowmaker House,
21, Etruria Road,
Hanley,
Stoke-on-Trent.

All Prices Exclusive of V.A.T.
All Mail Orders - Cheque, Postal Order or Official Company Order.

The only thing we discount is the price.

- CREDIT FACILITIES (NAME DAY POSSIBLE)
- AFTER SALES SERVICE
- MAIL ORDER
- EXPORT

M.O'BRIEN
MICROCOMPUTER DISCOUNTS
01 946 1528/0331

95 High Street
Wimbledon Village
London S.W.19
13 Bus route
Open 9.00 am - 5.30 pm
Tuesday/Saturday
Closed all day Monday
Please include 10% on all purchases in order to receive 10% discount on standard goods only.

Apple computer

APPLE II 48K £669
DISK II (WITH CONTROLLER) £314
DISK II (W/O CONTROLLER) £285

APPLE III £2150

Computer plus Video Monitor III and information Analyst Software Package comprising of: VisiCalc™ III, The Apple Sophisticated Operating System (SOS) and Apple Business BASIC Language.
Additional Disk Drive III £139

Accounting Business Systems
TABS

Software
Foundation Module £82
Sales Ledger £165
Purchase Ledger Module £165
Nominal Ledger Module £165
Stock Control Module £165

PERSONAL SOFTWARE

APPLE VISICALC £107
APPLE VISIDEX £107
APPLE VISIPILOT £97
APPLE VISITREND/PLOT £137
APPLE VISITERM £80
APPLE VISIFILE £137

VIC-20

ONE FREE GAMES CARTRIDGE WITH EVERY VIC-20 CPU

VIC 20 CPU £173.90
VIC C2N Cassette Unit £39.09
VIC Printer £200.00
VIC Single Drive Floppy £344.35
VIC 3K RAM Cartridge £26.04
VIC 8K RAM Cartridge £39.09
VIC 16K RAM Cartridge £85.17
VIC Programmers Aid Cartridge £30.39
VIC 'Avenger' ROM Cartridge £17.35
VIC 'Star Battle' ROM Cartridge £17.35
'Super Slot' ROM Cartridge £39.09
'Jelly Monsters' ROM Cartridge £85.17
'Alien' ROM Cartridge £30.39
'Super Lander' ROM Cartridge £17.35
'Road Race' ROM Cartridge £17.35

ALL PRICES EXCLUSIVE OF VAT

BUY ATOM LISP and discover artificial intelligence

Essential for :

- * students learning LISP
- * research
- * hobbyists interested in artificial intelligence
- * systems designers.

ATOM LISP is an interpreter for the language LISP consisting of 5 1/2K of machine - code interpreter plus 2K of initialised LISP utilities and constants which can be deleted if not required.

Important Features

- fully interactive with explicit EVALUATE and VALUE IS messages
- automatic parenthesis count
- SUPERPRINT to format the printing of large expressions
- screen editing or built-in LISP editor
- errors trapped and optional full traceback printed.

ATOM LISP includes a number of extensions to basic LISP, including:

- PEEK, POKE and CALL to control hardware and machine-code programs
- functions can have optional arguments with default values
- improved interactive control structures using LOOP, WHILE and UNTIL functions
- automatic access to COS or DOS commands
- cassette (or disk) input/output control.

The fast compacting garbage collector automatically finds space for numbers, lists, or character strings if there is any space at all remaining. This means that the programmer never need be concerned about the details of storage allocation.

LISP Functions

AND, APPLY, ATOM, BLANK, CALL, CAR, CDR, CAAR, CADR, CDAR, CDDR, CHARP, CHARS, CLOSE, COND, CONS, CR, DEFUN, DIFFERENCE, DOLLAR, EDIT, EQ, ERROR, ERRORSET, EVAL, F, FSUBRP, GET, GETCHAR, GREATERP, LAMBDA, LESSP, LIST, LISTP, LOAD, LOOP, LPAR, MESSOFF, MESSON, MINUS, NIL, NOT, NULL, NUMBERP, OBLIST, OPEN, OR, ORDINAL, PEEK, PERIOD, PLIST, PLUS, POKE, PRINO, PRINT, PROG, PUT, QUOTE, QUOTIENT, READ, READLINE, RECLAIM, REMAINDER, REMPROP, RPAR, RPLACA, REPLACD, SAVE, SET, SETQ, SUBRP, SUPERPRINT, SUPERVISOR, T, TIMES, UNDEFINED, UNTIL, WHILE, WRITE, WRITEQ, ZEROP.

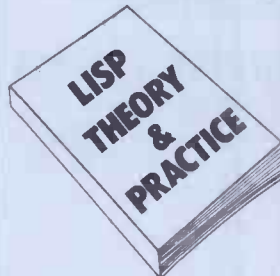

ATOM LISP is available on cassette at only £17.25 inc VAT from your Acorn dealer or direct from Acornsoft. Accompanying 44 page instruction manual "Lisp Theory and Practice" available for £6 (no VAT).

All Acornsoft products are available from authorised Acorn dealers or can be ordered direct from Acornsoft Ltd. 4A Market Hill, Cambridge CB2 3NJ.

Credit card holders can ring 0223 - 316039 and place their orders direct.

ACORNSOFT

G.M. MICROTRONICS LTD.

UNIT 14, GODINTON WAY INDUSTRIAL ESTATE,
GODINTON ROAD, ASHFORD, KENT TN23 1JB
Telephone: ASHFORD (0233) 38671/38672

*"Add the power of speech
to your computer"*

TMS 5100 TALKING BOARD as featured in ELEKTOR

Features 170 word vocabulary in
3 Eproms

Easily interfaced to any computer
(via Bus or Parallel port) ie:

Acorn, Atom, Apple, Atari, Pet,
Vic, and ZX80/81.

Requires $\pm 12v @ 50 \text{ ma}$ and
 $+5v @ 300 \text{ ma}$.

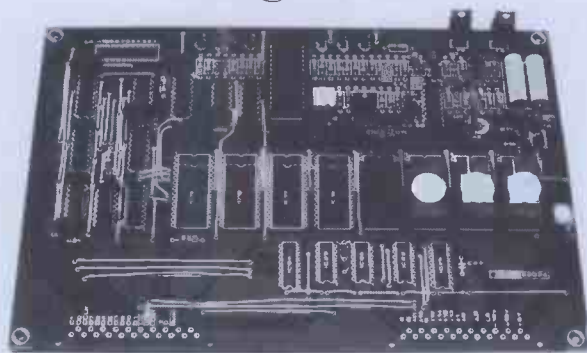

GM510 Talking Board Kit (with interface IC's)	£82.95p
GM511 Power supply Kit to Power above	£16.10p
GM5100 Ready Built with power supply and cased	£144.00p
Design notes (inc in above) if bought separately	£1.00p

SOFTY II NOW IN STOCK @ £182.00 inc VAT

ALSO AVAILABLE SHORTLY

6808/6809 6u Board

Expandable Computer System

Send for further details and specification

Please send the following items:

- Box
- Softy II
 - GM510 Talking Board Kit
 - GM511 P.S.U. Kit
 - GM5100 Ready Built Cased Unit
 - Further Details
 - Design Notes
 - 6808/9 Details

I enclose cheque P/O for value of £..... please add £2.00
p&p. All prices inc. VAT.

Name

Address

..... Post Code



The
Special Epson distributor
with
Special Epson prices

£399

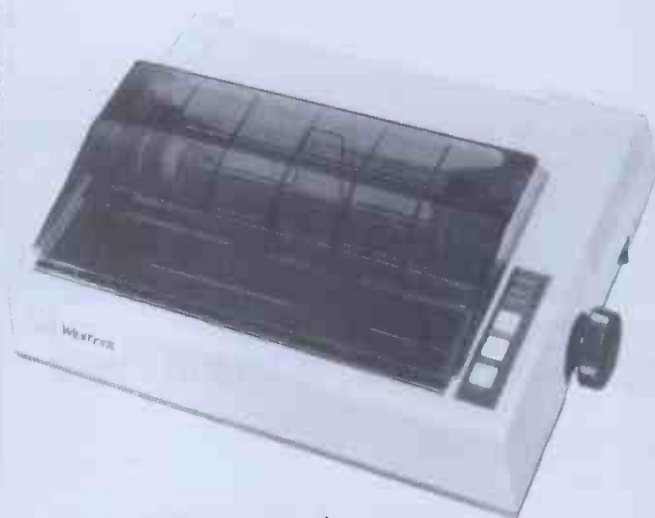

MX-80 F/T Type II

**Dealer
discounts
available**

Westrex Company Limited
Bilton Fairway Estate · Long Drive · Greenford · Middlesex
Telephone: 01 578 0950 & 578 0957/8/9



The POWER BANK

The Uninterruptable Power Supply
that will run ANY Micro-Computer System ...
A VITAL PIECE OF EQUIPMENT FOR RUNNING BUSINESS SYSTEMS

THE COMPLETE ANSWER TO YOUR POWER SUPPLY PROBLEMS!

Just plug your Micro-Computer, Video, Disc Drives and PRINTER into The Power Bank and continue to run your system in the event of a mains supply failure.

Electrical spikes and surges suppressed which protects your hardware as well as your programme and data.

Output voltage stabilised for all conditions of input voltage.

System compatible sine wave output.
Built-in sealed for life batteries

The Power Bank illustrated is rated continuously at 120 VA output. A typical load being a micro-computer, 2 floppy disc drives, video display and a 9.5 inch dot matrix printer.

250 VA SYSTEMS ARE ALSO AVAILABLE

Depending upon the load, your system will continue to operate for up to one hour from the internal batteries with the electrical supply off, while an audible alarm warns of a loss of the mains supply. The batteries are monitored when the mains supply is off.

120 VA unit at:

250 VA unit at:

£320

£450

One off price

One off price.

Power Testing (Sales) Ltd.

137a High Street, Brentwood, Essex. CM14 4RX
Telephone: Brentwood 220617. Telex 24224586

Flexibility at the heart of your system.

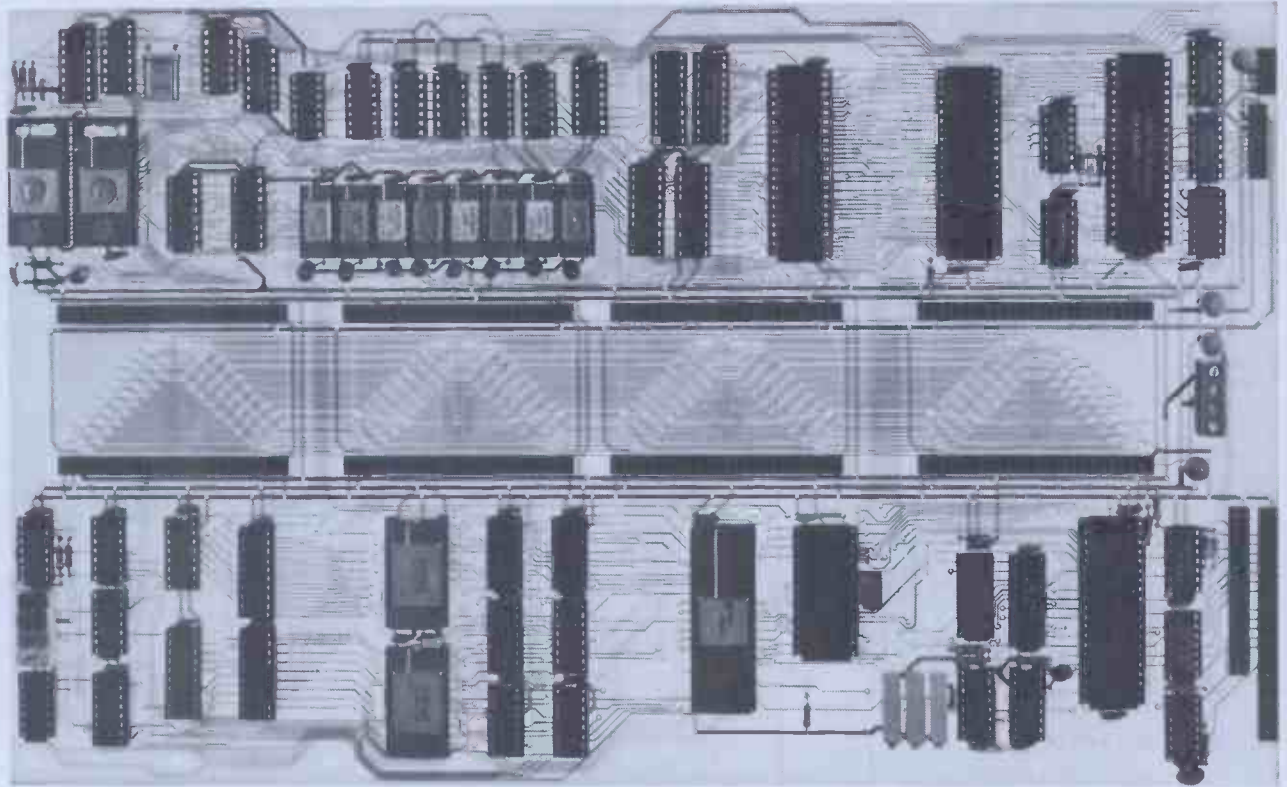

The RADER single board computer has been developed and tailormade to offer the user a combination of economy by using the most up-to-date techniques of microprocessor technology coupled with the built in facilities of ultimate expandability and flexibility.

The board is configured to run the latest CP/M version 2.2 and is ideally suited as the basis for small to medium business machines, games machines, industrial control machines, research and development equipment.

standard features

- 64K RAM
- 4 MHZ Z80A CPU
- 5¼" or 8" Disk Interface, single/double /sided density
- Z80A CTC (clock/timer/counter)
- DMA Controller
- Memory Mapped Video Display
- Memory Mapped RAM Character Generator
- Programmable Video Controller
- 8 Expansion Connectors

add on option boards

- Dual Parallel Ports
- Dual Serial Ports
- Cassette Interface
- RAM Expansion Board – Capacity 192K, in 64K Increments
- External ROM Board
- User Prototyping Board
- Hard Disk Interface
- Real time clock with battery back-up

- Full Custom software development support available
- Sample evaluation board £350 + VAT Postage & Packing £4.00.
- CP/M DOS available Send for complete technical specification

Rade Systems Ltd., 53-55 Ballards Lane, London N3 1XP
Telephone 01-349 4714 Telex 46523 Simsys G.

RADE
Dedicated Intelligence

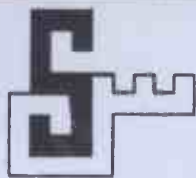

STEMMOS LTD

344 Kensington High Street,
LONDON W14.

Telephone: 01-602 6242 (3 lines)

Telex: 893003

SOFTWARE WITH

SUPERBRAIN AND ACT SIRIUS 1

REASONS FOR CONTACTING STEMMOS

SUPERBRAIN	
Superbrain 360KB	£1895
Superbrain QD 720KB	£2195
Superbrain 1.5MB	£2795

PRINTERS	
Oki Microline 82A	£390
Oki Microline 83A	£730
NEC-Spinwriter	£1900
+ others	

ACT SIRIUS I	
Sirius I 128K RAM	£2395
Sirius I 356K RAM	£2890
Sirius I 512K RAM	£3890

HARDWARE MAINTENANCE	
1 - On contract basis	
2 - On call basis	
We specialise in Intertec and ACT Sirius	

WIDE RANGE OF RELIABLE AND WELL-TESTED SOFTWARE

STEMMOS AND OTHERS	
Programmers Superscreen	£300
Estimation/Civil eng	£2500
Microsoft range	-
Graphics	-
Data base information	£300
Job costing	£300

STEMMOS - ENGINEERING	
SuperFrame 3D	£1000
Demo-kit	£100
Shells of Revolution	
Analysis	£1500
SuperPipe	£2500
Superig	£2000
Superframe II	£1500

MICROBUREAU	
Stock control	£400
Purchase ledger	£400
Sales ledger	£400
Nominal ledger	£500
Payroll	£400
Job costing	£500
Full integrated pkg	£2000

LOW COST	
Wordstar	£240
With Merge	£290
Mail Merge	£70
Data Star	£150
Wordmaster	£150
Supersort	£150

GOOD DISCOUNT FOR EDUCATIONAL INSTITUTIONS

DEALERS AND SALES AGENT - GOOD DISCOUNT AND COMMISSION

RAVEN COMPUTERS



THE NORTH'S LEADING MICRO SUPPLIER
PRESENTS

SIRIUS I AND SOFTWARE



PLUS THE SYSTEM
THAT DOES WHAT THE
'LAST ONE' SHOULD HAVE
DONE

FMS-80

THE WORLD'S PREMIER
DATABASE AND
APPLICATION
GENERATOR

PROVEN PACKAGES FOR:-
SALES/PURCHASE/NOMINAL LEDGERS
ORDER PROCESSING
STOCK CONTROL
JOB COSTING
BILL OF MATERIALS
FINANCIAL MODELLING
WORD-PROCESSING
CRITICAL PATH ANALYSIS
PAYROLL
FIXED ASSETS
STATISTICS

RAVEN COMPUTERS LTD, VICTORIA MILL
MANCHESTER ROAD, DROYLSDEN, MANCHESTER M35 6EP

Tel: 061-370 0900 ALSO IN LEEDS & SHEFFIELD

PLEASE SEND DETAILS OF SIRIUS & SOFTWARE
NAME _____
POSITION _____
COMPANY _____
ADDRESS _____
TEL. NO. _____

Two things about the new Transtec BC2 will impress you.



The quality. And the price.

The Transtec BC2 is a brand new business computer with a 64K capacity and double sided double density disk drives – 500K per drive. It features a 12" non glare green screen and is housed in a beautifully styled cabinet with separate matching keyboard. And for under £2,000, you'll find it's designed to make you, not break you. Find out more about the full range of Transtec business computers by clipping the coupon and sending it to your nearest Transtec office.

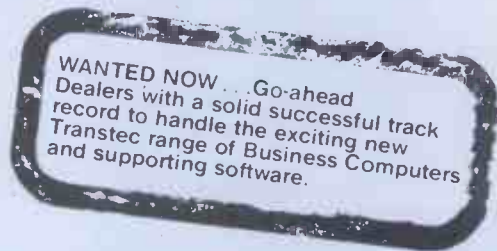

I'd like to know all about Transtec.

Name _____

Company _____

Address _____

✂

transtec
computers

13A Small Street, Bristol W.1. Tel: 0272-277462
35 Lisburn Road, Belfast. Tel: 24009
IDA Complex, 22 Mäcken Street, Dublin 2.
Tel: 713049/715954



At last... a choice of off-the-shelf CP/M packaged software...

Finding CP/M software can often be a problem; for this reason Software Limited has created the complete software source for *your* microcomputer.

Not only can we instantly supply many popular products, such as Wordstar, Datastar and Supersort; but we can supply them to suit various formats, including I.B.M., Apple, Tandy and Superbrain.

If you would like to find out more about making your software buying as easy as pressing a button, then please phone for our catalogue.

Software Limited, 01-387 8832
or 01-388 9927.



The Software Source

...at a price that's right on the button.

Software Ltd., is a new joint venture from Computability and Abacus Business Systems.

CP/M is the trademark of Digital Research.
Wordstar, Datastar & Supersort are
trademarks of Micropro International.

Attractive quantity
& dealer discounts
available

Bullock Computers

A NEC Main Dealer

The Business Computer People Who Speak Your Language.

Most companies which supply business computer systems tie you up in knots with their terminology. At Bullock Computers it's different — we appreciate just how confusing it can seem when you first consider buying a system.

The problem is that the majority of business computer companies seem to forget that not everyone understands computers.

That's why at Bullock Computers we talk to you in plain English and provide a full consultancy for the businessman considering making use of computers. We will help you to match the right system to your requirements. If we feel that there are no real benefits to your company in computerising, we will tell you!

We support the **NEC PC8000 Micro Computer System** because we feel that it offers the best in terms of flexibility and value for money of all the systems currently

available.

The system is modular allowing you to expand its capacity at your own pace, and there is a wide range of software packages available covering most applications, including:-

- Word Processing
- Stock Control
- Telecommunications
- Structural and Civil Engineering Analysis
- General Accounting

The flexibility of the **NEC** allows it to run under the Industry Standard Operating System, CP/M, giving access to the enormous range of CP/M packages available — which in plain English means almost unlimited business applications. Prices start at **£599 + VAT** for the basic keyboard unit, and typical business systems cost in the region of **£2000-£3000**.

This system is now available for demonstrations at our City Centre Showroom — or at your own office at a time to suit you. Why not contact me, John Bullock on **08894 3055** for an early appointment, or write to the address below.

**Bullock Computers, Monaco House,
Bristol Street, Birmingham. Tel: 08894 3055**

Bullock Computers

A NEC Main Dealer

TRS 80 Software

We still support the most amazing graphics software yet for the **TRS 80**, extensive use of sound, real time etc. etc.

ARCADE

Eliminator — you're the pilot of the Eliminator, a space fighter armed to the teeth with awesome firepower. But you're outnumbered and your attackers are keen. (super-sharp graphics and sound)

Defense Command — The Galaxy Invaders have returned in this newest game of skill and excitement with a new twist. (absolutely incredible voice effects — with high quality graphics)

Valkyrie — Leo Christopherson at his best. One of the finest graphics-based adventures available.

Forbidden Planet — The first talking adventure; three different voices—the best yet. (Disk only). All voice output through cassette port — no special equipment required!

Armour Patrol — Real time battle action with excellent use of graphics. Requires great skill.

Adventure (the system) — Now you too can create your own adventure type game. The Adventure System allows you to create data-base containing your own instructions, this database is then used by the machine language driver part of the program to actually run the adventure you just created!!! (Disk only)

Forbidden City — The second follow-up part of Forbidden Planet — can you escape the deadly robots?? All the features of Forbidden Planet. (Disk only)

Scarfman — More popularly known as 'Pukman', this game is now available for the **TRS 80**. Extensive use of graphics makes this as exciting as the Arcade version. Includes sound.

Joysticks — Now you can add fast action to all your games with our latest joystick. The adaption for the **TRS 80** includes a list of patches; this allows you to use your joystick with many of the popular Arcade games. **£23.00**

TRS 80 USERS! If you are thinking of upgrading to another computer consider the **NEC PC8000**. It offers 24K Microsoft Basic incorporating all of the Tandy commands. 32K RAM: Colour: Sound: Built-in Terminal Capability: Printer Interface. **£599.00 + VAT**

£	£
Disk	Cass
19.50	16.00
16.00	12.50
30.00	26.00
30.00	
19.50	16.00
30.00	
30.00	
16.00	12.50

The following programs are available to order:

Scarfman	Missile
Sky Warrior	Command
Speak (mod 3 only)	PowerDraw
Super Utility	(graphics)
Plus	Super Utility
Microproof	Lazywriter
Starfighter	Basic-S/CMD
Macro-Monitor	Basic-S

Announcing **EDAS 3.5** — **EDAS** is a sophisticated Editor and assembler for the **TRS 80**.

- All text may be input in upper or lower case
- Assemble directly from one or more disk files via *GET
- Assemble to disk or memory
- Binary, octal, decimal, hex and string constants; multiple constants may be input on a single line
- CMDFILE utility included
- Conditional assembly support
- Cross-reference utility
- DOS functions DIR, FREE, KILL and LIST
- 14-character labels including special characters @, \$, , , ?
- Editor includes block move, global change, renumber and find
- EDTASM & M-80 source files can be read or written.

The features above are only half of what this package can do. In our opinion it's the best! We feel we must mention that **EDAS** is the only commercially available Editor for the **TRS 80 Model 3**.

EDAS Model 1 or Model 3 £60.00

All Program prices include VAT at 15 % Please add **£1.50** for Postage & Packing. All Programs available for Model 1/111. Please state Model and whether Disk or Cassette when ordering.

Bullock Computers, Monaco House, Bristol Street, Birmingham. Telephone: 08894 3055

CITY MICROSYSTEMS LIMITED

65 LONDON WALL, LONDON EC2M 5TU
01-588 7272

SUPERBRAIN®



320K, 680K and 1.5MB Diskdrives.
Full graphics available.
Wide range of standard packages.

TELEVIDEO



Multi-user, Multi-task, Multi-processor
Televideo reliability with
complete expandability
one to sixteen users

VIDEO GENIE with VISICALC



Complete system £1275 inc Computer, Monitor
Expander 1 Disk Drive & Software
Vast library of standard software

COMPLETE BUSINESS ACCOUNTING SYSTEMS FROM £2000 WORD PROCESSORS FROM £1420

ADVICE, TRAINING AND MAINTENANCE

ALL YOUR COMPUTER REQUIREMENT READILY AVAILABLE

IN THE CENTRE OF THE CITY- LONDON EC2

VISITORS TO OUR OFFICES MOST WELCOME 10.30am – 4.30pm

DAISYWHEELS ARE DOWN

.....down to a new low price!

For less than the price of some dot matrix printers, the Smith-Corona TP-1 brings the benefits of daisywheel printers within the reach of most micro users. Now letters, documents, forms, invoices, reports, price lists etc., can be printed with the quality that until now was not readily affordable.



- Simple reliable mechanism
- Serial or Parallel interface
- IEEE option
- Single sheet and fanfold paper

£485

+ VAT

Sole Distributors:

discom

Dresden House, 51, High Street, Evesham, Worcs. WR11 4DA
Telephone (0386) 3591 Telex 335402

Please send me details of the TP-1

Name Trade/OEM*

Address

Tel. No *Delete as necessary

It's here!

The new XEROX 820 micro-computer system

Budgeting-Planning-Forecasting-Wordprocessing etc.

A brilliant new development specifically designed for the decision making businessman. And his pocket. Made by Xerox the 820 is one of the most inexpensive and versatile computers on the market. And you can keep adding to the system from a wide range of software options.

Also you can have the full backing of the Rank Xerox on-site, full service and maintenance agreement, so you can buy in total confidence.

So if you're a businessman looking for a superb micro-computer system, come along and see the new Xerox 820.

XEROX 820

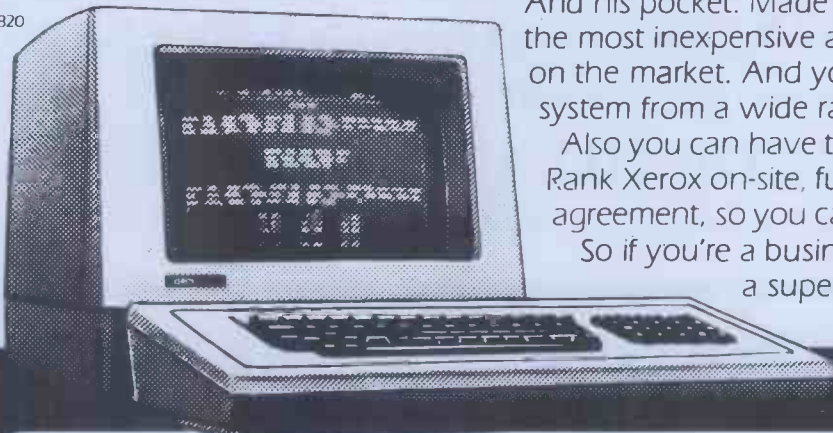

+ HARD DISK + NETWORKING + PRESTEL ADAPTORS

Johnson microcomputers

Johnson House, 75/79 Park Street, Camberley, Surrey. Telephone 0276 20446
Robophone Answering 24 hrs. Prestel Page No. 200632 Mailbox No. 027620446
48 Gloucester Road, Bristol. Telephone 0272 422061
148 Cowley Road, Oxford. Telephone 0865 721461

RANK XEROX®

COMPUTER

AUTHORISED DEALER

**Over forty
of the world's
leading
software
houses have
one thing in
common.**



They support a worldwide standard in software, and so do we.

We understand that one of the most important considerations, before buying a computer, is the software which will be available to you.

This is made easy by the choice of the CP/M operating system. TCL Software, a division of Transam, provides an enormous range of software packages for commercial, scientific, educational and personal needs.

But there is one important difference - we at Transam really understand the CP/M based computer.

CP/M has the advantage of being adopted by an ever



increasing number of software houses. This means that there is a wide range of other software packages written to run on a CP/M based system.

And, of course, any programs you may develop yourself will be compatible with, and can be run on, other systems which are CP/M based.

The Transam range of computers are designed and built in Britain. Our experience gives us the capability to support our users at a very high level, with advice and spares only a phone call away.

Call in to our West End showrooms for all the advice you need about computers and what they can do for you, or for further information write to Transam Microsystems Limited, 59/61 Theobald's Road, London WC1. Telephone 01-405 5240/2113.

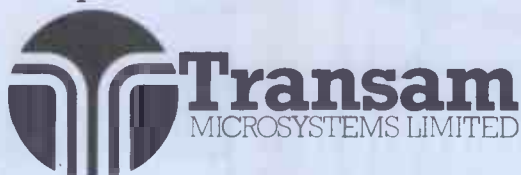

STOP HERE

APPLE SYSTEM
WANT TO BUY AN APPLE II ?

£550.00

HERES HOW

PURCHASE OUR HARDWARE PACKAGE

HARDWARE

- *48K APPLE X
- * DISK W/CONTROLLER
- * DISK W/OUT CONTROLLER
- * BMC 12" GREEN SCREEN HI-RES MONITOR
- * MX80 F/T2 HI-RES PRINTER
- * PRINTER INTERFACE

SOFTWARE AVAILABLE

- INVOICING
- PURCHASE/SALES LEDGER
- STOCK CONTROL
- PAYROLL
- VISICALC
- VISIDEX
- VISITREND/VISILOT
- WORD PROCESSING
- CP/M

HARDWARE PACKAGE PRICE £1699

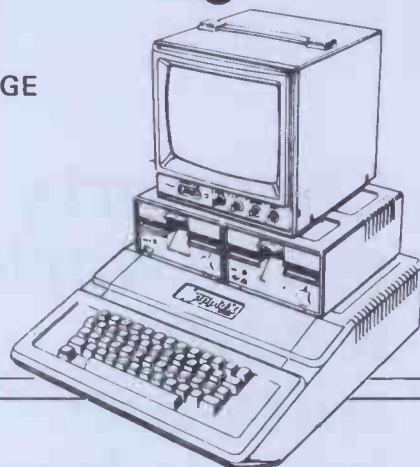

**PET SYSTEMS
EDUCATION**

- 8032 32K Computer 80 column 755.00
- 8096 96K Computer 80 column 1040.00
- 8050 950K Dual Drive 755.00
- 8023 Tractor Feed Printer 785.00

NEW PRODUCTS NOW AVAILABLE

- 8422 22 Megabyte Winchester Disk POA
- 9000 Super PET 134K Multilanguage POA

WORD PROCESSING

- 4016 16K Computer 445.00
- 4032 32K Computer 560.00
- 2031 171K Single Drive 349.00
- 4040 343K Dual Drive 560.00
- 4022 Tractor Feed Printer 350.00



COMPLETE 32K SYSTEM
APPROVED COMMODORE DEALER

CHOICE OF SOFTWARE PACKAGES AVAILABLE SUCH AS:
WORDPROCESSING, INTEGRATED ACCOUNTS WITH STOCK, INVOICING & FINANCIAL PLANNING
AND MANY OTHER APPLICATIONS

LONDON'S MAIN EPSON DISTRIBUTOR

PRINTERS

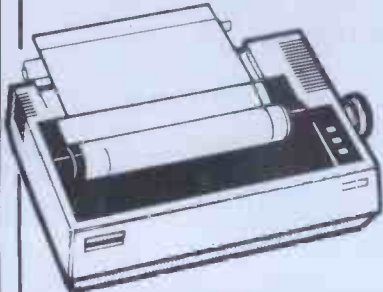

- EPSON MX100 £575**
15" in carriage, 254 columns. Hi-res graphics, true descenders, Bi-directional.
- EPSON MX80 £359**
Dot-matrix printer PET and Apple compatible. True bi-directional 80 cps.
- EP80 MX82 £399**
As MX80 plus high Resolution Graphics parallel and serial interfaces.

- EPSON MX80 FT/1 £399**
Dual single sheet friction and tractor feed, 9 wire head, true descenders.
- EPSON MX80 FT/2 £399**
An FT/1 with high resolution graphics.
- SEIKOSHA GP100 £215**
Dot matrix 5 x 7, 80 columns, 30 cps graphics, double width characters.

JUST PHONE FOR FURTHER DETAILS

TERMS

ALL ITEMS CARRY
1 YEAR GUARANTEE
PARTS & LABOUR
DELIVERY AT COST
ALL PRICES EXCLUSIVE
OF VAT.
TELEX: 22568
OFFICIAL ORDERS
WELCOME

CHROMASONIC electronics

48 JUNCTION ROAD, ARCHWAY, LONDON N19 5RD 100 yds from Archway Station & 9 bus routes
TELEPHONE 01- 263 9493 01-263 9495 TELEX : 22568

RAMEX 16 £75 16K Ram Board for Apple II

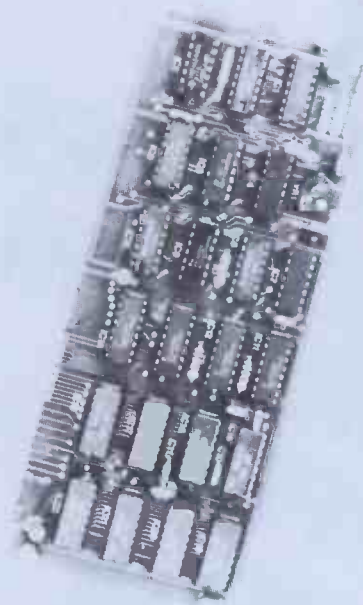

Now you can afford to extend your Apple II without taking up a mortgage. Now you can run Pascal, Fortran, 56K CPM with a Z80 Softcard, Integer Basic, Applesoft and other languages on your Apple. Now you can increase your usable memory for Visicalc.

At just £75.00 this is the cheapest RAM Expansion Card available, but you lose nothing in quality or reliability. The only thing you LOOSE is having to remove a RAM chip from the motherboard as the RAMEX 16 has no strap, its memory re-fresh is integral.

RAMEX has its own MANAGER for giving you even more usable space in your Apple. This is achieved by putting DOS into another RAMEX 16 located in any other available slot, thereby freeing up another 10.5K of memory at a cost of only £20.

Order your RAMEX 16's and the MANAGER by calling (0268) 728484. All major credit cards accepted or send your cheque to DDP Research & Marketing, 17 Nobel Square, Basildon, Essex. SS13 1LP.

RAMEX 16 P & P add £1.50p.
The Manager P & P add £0.50p.

All prices are subject to VAT.

DDP Research & Marketing

17 Nobel Sq., Basildon, Essex. SS13 1LP
Tel. Basildon (0268) 728484



In a Class of Their Own.

ARE YOU A ZX81 USER WHO'S NOT PLAYING GAMES?



£47.50
Including VAT.
complete

ECR 81 DATA RECORDER SAVES AND LOADS YOUR PROGRAMS EVERY TIME!

The ECR81 Enhanced Certified Recorder from MONOLITH is a major advancement in cassette recorder technology which minimises the problems associated with standard audio recorders. The unit is a high reliability program store for ZX computers based on a modified, proven cassette mechanism. The two sections of data recording circuitry automatically ensure precise levels are written onto the tape and that optimised signals are received by the computer.

**THE ECR81 IS NOT SUITABLE FOR AUDIO REPRODUCTION
NO MANUAL VOLUME OR TONE CONTROL ADJUSTMENT PROVIDED**

- Each ECR81 comes complete with its own individual certification tape, tested and serial numbered to prove your machine reliability.
- Mains Operation only.
- Mains & DIN connector leads provided.
- Certification of tape head alignment - height and azimuth.
- Certified tape tension, torque and speed.
- Fast forward and rewind tape search controls.

The ECR81 is also suitable for Sinclair ZX80

- Please allow up to 28 days delivery. ● The ECR81 is backed by our 14 day money-back option.

MONOLITH
electronic products

Telephone: Crewkerne 0460 74321 Telex: 46306

To: MONOLITH ELECTRONICS CO. LTD., 5/7 CHURCH STREET, CREWKERNE, SOMERSET		
Please supply me with:	Price	Total
..... (Qty.) Monolith ECR 81 Enhanced Certified Recorder(s) to be used with my ZX81	£47.50 (Each)	
I also enclose postage & packing per recorder	£2.50	
Please print	Prices include VAT	£ <input type="text"/>
Name: Mr/Mrs/Miss. _____		
Address _____		

**The biggest Apple event
ever held in Britain!**



Whether you're an active Apple user, or just fascinated by the rapid development of microcomputing generally, you won't want to miss the action-packed weekend that will make up Apple '82.

From Friday, June 4, to Sunday, June 6, the whole of the ultra-modern Fulcrum Centre in Slough will be completely devoted to the onward march of the micro, when some of Britain's top computing experts will be revealing their secrets.

FRIDAY

is education day – the staging of the first National Apple Education Forum and a chance for teachers and lecturers to exchange ideas, evaluate software and listen to a series of lectures covering every aspect of computer-assisted learning. Some 25 Apples will be on show, demonstrating a wide range of applications in the school environment.

SATURDAY and SUNDAY

will be for users generally – the first National Apple Users Convention. So many leading figures in microcomputing want to take part that presentations will be given simultaneously in two adjoining theatres throughout the weekend.

The full timetable of events covers database systems, graphics, music and speech synthesis, Pascal, Cobol and other languages, commercial and industrial applications, hardware and software troubleshooting and micros in medicine.

A central feature of the convention will be a communications workshop, to explore latest developments in linking Apple to Apple, Apple to mainframe, remote information retrieval systems and bulletin boards. It will give a unique insight into a subject that is rapidly becoming one of the most exciting aspects of computing today.

And for light relief, there will also be the national finals of the nail-biting Apple Olympics.

Mail the coupon below for full details of plans for Apple '82 – and about the first-class accommodation that can be reserved for you at some of the best hotels in the area for a modest £17 a night – far below their normal rates.

This major event in the Apple world is attracting users from all parts of the British Isles and overseas. But tickets are limited, so early booking is advisable.

Send for free Apple '82 fact pack now!

Please send full details of Apple'82 to:

Name _____

Address _____

**POST TO: Apple '82, Europa House, 68
Chester Road, Hazel Grove, Stockport SK7
5NY.**

U-Micro 'make it easy on yourself' U-Micro

**EIGHT
SERIAL
INTERFACES
FOR YOUR
APPLE**



The U-Port provides 8 individually addressable full RS232 ports for input and output at individually settable baud rates on a single board. And its price is less than for two separate interfaces!

**for only
£195.00**

Available from Apple Dealers worldwide or direct from U-Microcomputers.

Prices do not include VAT or p. & p. (£1.00 per board)
U-Microcomputers Limited,
Winstanley Industrial Estate,
Long Lane, Warrington,
Cheshire, WA2 8PR, England.
Telephone: 0925 54117/8
Telex: 668920 U-ONE



U-MICROCOMPUTERS

a range of quality peripheral cards to enhance your Apple

**We now make
more Apple cards than Apple!**

U-Micro 'make it easy on yourself' U-Micro

FULLER FD SYSTEM FOR ZX80/81

THE MOST VERSATILE SYSTEM FOR EXPANDING YOUR ZX

STANDARD KEYBOARD AND CASE

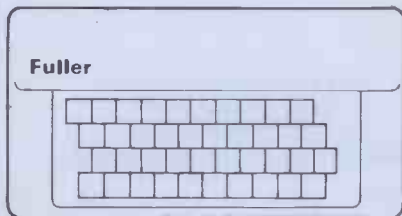

This splendid keyboard and case houses your ZX81 printed circuit board, which is simply screwed into place, the keyboard plugs into the ZX. You can now enter data with ease. The 40 key switch board is a custom unit not made up out of other manufacturers parts. The keytops are our own design and have the ZX Qwerty and functions foil printed onto them. Access to the user port, TV, MIC, and ear sockets are as per the ZX case.

Built keyboard and case £36.70 or £30.70 as a kit plus £2.10 postage and packing.

EXTENDED KEYBOARD AND CASE

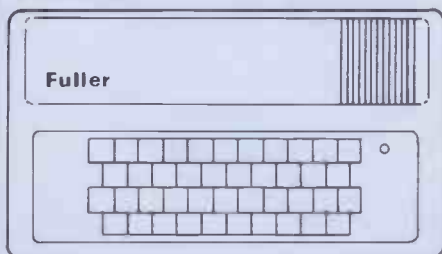

The case is designed to house not only the keyboard and ZX but also our motherboard, power supply, RAM cards and two other boards, not necessarily of our manufacture. The injection moulded case measures 200 mm x 350 mm x 60 mm and houses a 42 keyswitch board, the extra keys can be assigned to other functions. The case is supplied with a "Power On" LED.

Built keyboard and case £39.95 or kit £33.95 plus £2.50 postage and packing. Motherboards £15.95 plus 80p postage and packing. 16k RAM board £35.95. 64k RAM board £79.95.

Keyboard Only Available!

Built £24.95

Kit £18.95 (+P.P. 80p)

Send SAE for details to:-

**FULLER MICRO SYSTEMS, The ZX Centre,
Sweeting Street, Liverpool 2.**

ROCK SOLID TRAINING SYSTEMS FROM BRITAIN'S BRIGHTEST EXPERTS

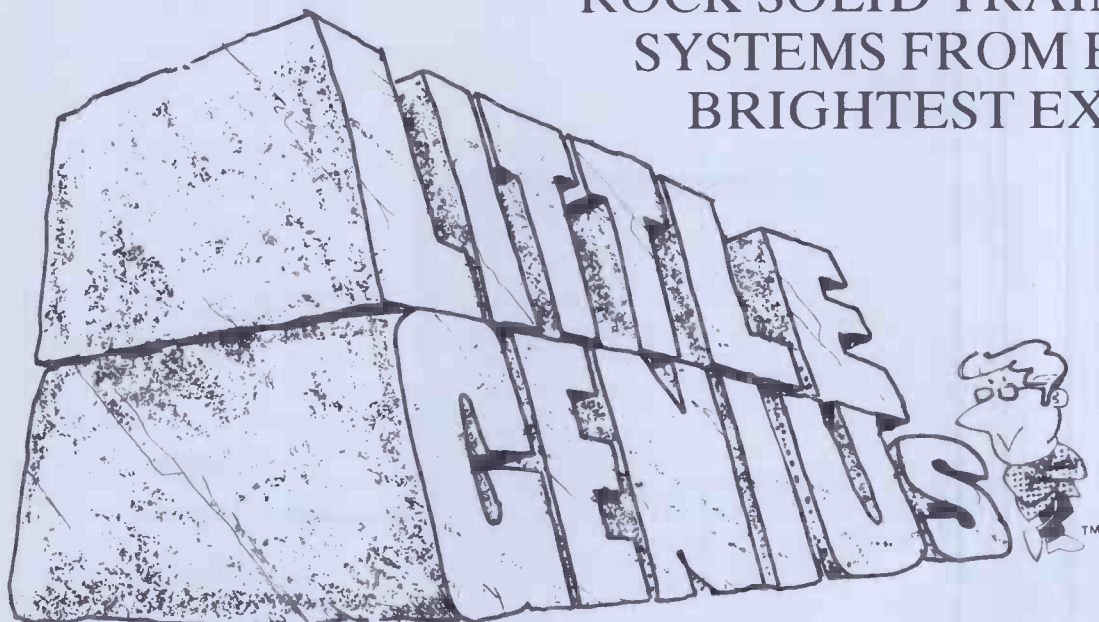

Teach yourself BASIC in 12 hours. Our LITTLE GENIUS self-instruction courses on floppy disk will teach you to master your Micro in 3 easy stages.

Each course consists of well-structured fully interactive lessons and is available in 3 separate disk modules.

1. Beginners 2. Advanced 3. Disk operating system at £19.95 each+ VAT
OR take advantage of our SPECIAL OFFER—3-in-one pack price £49.95+VAT

BE A LITTLE GENIUS YOURSELF

Courses in BASIC for Apple, ITT 2020, PET and RML 380Z.

Also PASCAL for Apple.

Available from most computer retailers or direct

In the U.K. write to:

Little Genius, Suite 504, Albany House,
324, Regent Street, London W1R 5AA.
England. Tel: 01-580 6361

In the US write to:

Little Genius, 34-38 83rd Street,
Jackson Heights, New York, U.S.A.

Rush me my order for/send information on:

*BASIC/PASCAL for Machine
Stage Nos. 1, 2, 3 or 3-in-One (Ring as Required)

Name

Address

Cheque enclosed/Purchase Order Enclosed/Send C.O.D.*

*Delete as required



COMPUTER SYSTEMS FOR THE HOME & BUSINESS ENTHUSIAST

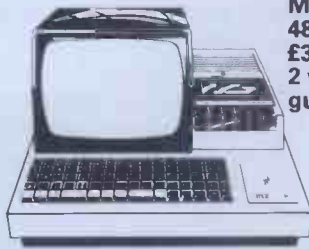

Sharp MZ80K
48K RAM
£359
2 year guarantee

Twin Disk Unit £620
Column Printer £399
Single Disk Unit £412
FURTHER ACCESSORIES AVAILABLE



Sharp MZ80B
64K RAM
£1064
Fully Guaranteed

Twin Disk Unit £620
Column Printer £356
Single Disk Unit £412
Graphic RAM II....CPM....RS232
Basic compiler....Pascal....Double
Precision Basic....FDOS....IEEE Interface
...132 Col Printer... & many more
accessories available

Sharp 3201 Business Computer £1449
Monitor £240
Printer £434
Twin Disk Unit £649
Interface £118

SPECIAL OFFER ON COMPLETE SYSTEM £2772

Sharp PC1211 Pocket Computer
£93
• Programs in basic • Querty
Alphabetical Keyboard • 1.9 K RAM •

(Long Battery Life with Interface £105)
Printer for the above £67

VIC 20
£199

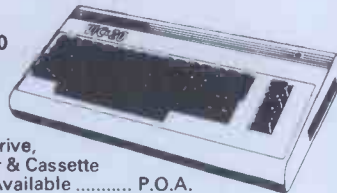

Disk Drive,
Printer & Cassette
Deck Available P.O.A.

Atari 2600 plus Combat £95.45
Philips G700 Computer
Game of the Future only £84
Mattel Intellivision the most advanced
computer game an unbelievable £189

* Credit facilities available
* Mail order - make cheques/P. Order
payable to Video Services Bromley.
PHONE FOR FURTHER DETAILS

The Amazing Atari Personal Computers



32K upgrade for Atari 400 . POA
Atari 400

16K RAM **from only £299**
Expandable to 32K - amazing
graphics & sound effects. The game
computer of the future must be seen
to be believed. Programs in "Basic"
"Assembler" "Pilot"

Atari 800 16K RAM **£599**
(Accessories for the Atari 400/800)
Single Disk Drive £435
16K RAM £65
Atari 410 Recorder £50
Joysticks £12.50
Printer Phone For Details

SPECIAL DISCOUNTS ON COMPLETE SYSTEMS SOFTWARE

Philips (G7000) from £12.99
Mattel Intellivision £16.75
VIC 20 from £14.95
Sharp Software from £6.32
Atari 400/800 from £9.95 (offering Arcade
& adventure games + education
& Business Applications)
Atari 2600 from £15.50

VIDEO SERVICES (BROMLEY)

8 SUNDRIDGE PARADE
PLAISTOW LANE BROMLEY KENT
near Sundridge Park Station

THE BROMLEY COMPUTER CENTRE

Prices include VAT
& may change during month

TELEPHONE 01-460 4169/8833

WP2020 is an advanced word processing system which runs on selected 8080/Z80 and 16 bit 8088/8086 based microcomputer systems. All standard word processing functions are incorporated plus custom keytops which makes the system easy to use for the beginner or experienced typist. Some of the other main features include, multi-printer support plus background printing, spelling checker, merge documents and communications for electronic mail.

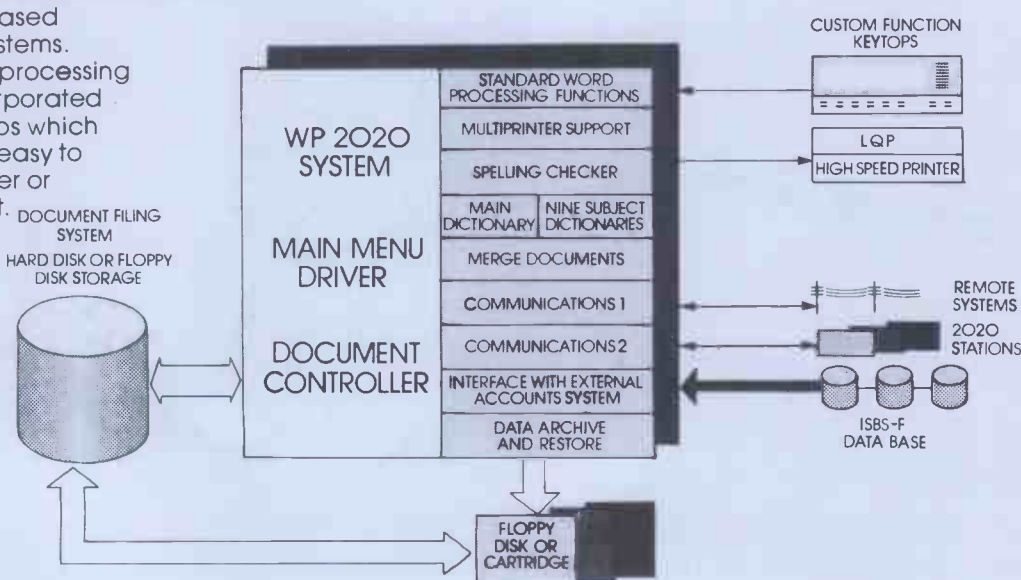

GRAFFCOM
SYSTEMS GROUP

For further details or a demonstration of the 2020 series then call us direct or contact your nearest dealer. Attractive dealer and superdealer arrangements available on request.

GRAFFCOM SYSTEMS, 102 PORTLAND ROAD, LONDON W11 4LX 01-727 5561

NON-STOP HONEYWELL PRINTERS.



NON-STOP TECHNOLOGY

Honeywell Information Systems Italia is a reality in the world of printers and is out to prove it. Today marks the birth of a second generation of matrix printers created, designed and produced in Europe to meet European demands. Printers characterised by intelligent engineering, total reliability, safety and completeness.

NON-STOP INNOVATION

To supplement those small printers already operational, such as the L11 and S11 80-column series and the larger L31 and S31 132-column series capable of linking with all parallel or serial interface systems, which have been recently updated, Honeywell Information Systems Italia proudly announces the birth of the L32, R32 and L38. These new printers go to enrich an already glittering range of products. They are designed for a professional public, those very people who demand always higher standards of product quality, work continuity, operational simplicity and enhanced speed.

NON-STOP PERFORMANCE

The new L32 and R32 printers provided with a 9 needle matrix head, operate at 150 characters per second on 132 columns. The L32 parallel inter-

face printer furnishes such an outstanding print quality that is characteristic of the whole range of Honeywell products. The serial interface R32, is equipped



with special software to automatically interpret programmer's commands to realize even the most complicated graphics. The L38, on the other hand, employs the latest 14 needle matrix head technology and is capable of printing 400 characters per second. Such performance does not imply that the equipment is functioning at its operational limits: in fact, its ability to print over a billion characters without adjustments proves the level of technological advance reached. Honeywell printers: a complete range of customer designed printers, capable of silent, safe and reliable performance. Day after day.

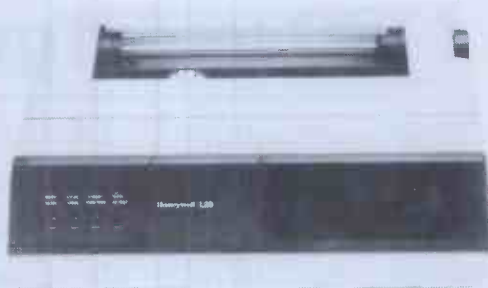
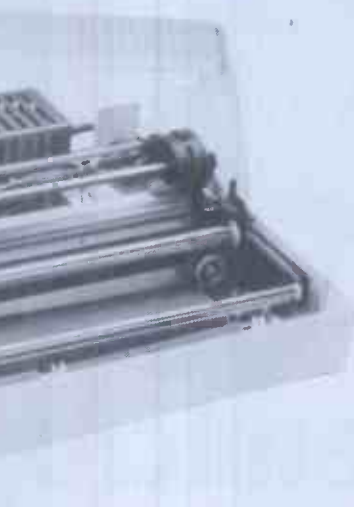

ATA-Univas

**O.E.M.
Products**

If you are interested in receiving more detailed information about Honeywell Information Systems Italia products, please fill in the following coupon and mail it to:

**Honeywell Information Systems Italia
United Kingdom Office - Maxted Road
Hemel Hempstead - Herts HP2 7 DZ**

Name

Position

Company

Address

Tel.

Interested in

Honeywell

Honeywell Information Systems Italia

SEIKOSHA

**NEW
WIDER VERSION.
TAKES STANDARD
PAPER.**

The Seikosha GP100A
Manufactured by the Seiko Company, Japan.

The micropriced microprinter

80 col dot graphics for around **£215**^{EX. VAT.}

Seikosha introduce the GP100A. A wider and updated version of the highly successful GP80. Now able to take standard width paper, the amazingly compact GP100A offers big printer performance at a fraction of the cost.

With a high quality output that includes full graphics capability, the Seikosha's proven reliability and variety of interfaces make the GP100A the ideal choice for hobbyists, educationalists and businessmen. Full service support is provided by DRG Business Machines' nationwide distributor network.

FEATURES INCLUDE:

- 80 col. 30 cps.
- Dot Matrix unihammer action.
- ASCII standard. 116 characters.
- Full graphics.
- Upper and lower case.
- Double width printing.
- Up to 10" paper width.
- Original + 2 copies.
- Tractor feed.
- Self testing.

INTERFACING for most systems:

- Standard: Centronics.
- Options: RS232C, Serial TTL, 20mA current loop. IEEE-488. Apple II, Sharp (GP100D).

DIMENSIONS:

- Depth - 9¼" (234mm)
- Width - 17¼" (420mm)
- Height - 5¼" (136mm)

OPTIONS:

- Pinch feed.

Telephone the number below and we'll tell you where your nearest distributor is located.

See the remarkable Seikosha GP100A in action.

(Peripherals & Supplies Division) 13/14 Lynx Crescent, Winterstoke Road, Weston-super-Mare, BS24 9DN. Tel: (0934) 416392.

THE FINEST WORLDWIDE SUPPORTED NATIONWIDE.

DRG (UK) Ltd, Reg No. 22419 England.

DRG
**BUSINESS
MACHINES**

DOUBLE your disk capacity

ONLY £55

KEELE CODES' unique compression utility E40 will compress files written in English to approx 40% of their original size in the same time as it would take to make a copy.

- | | |
|--|--------------------------------------|
| Making backups? | - receiving disc lasts twice as long |
| Archiving a Winchester? | - half as many disc changes |
| Data by telephone? | - powerful archive commands |
| Running out of space? | - halve the cost |
| Computer/ | - double the space you 'see' from |
| computer transfer? | the terminal |
| You don't believe it? - If not satisfied | - part of the package - and twice |
| return within 30 days - we | as fast as a bonus |
| will refund your | |
| money. | |

Proven & Working

Fully developed, E40 is the result of extended research at the University of Keele.

Optimized for English, E40 will compress any text/data files. Numeric or tabular material compresses to about 50%. Database files can come as low as 20%. All 256 ASCII characters are processed, and the decode program faithfully restores the original file.

A third utility transfers E40 files through a serial port.

CP/M formats include - Xerox 820, Superbrain, North Star, Osborne, Z80-Apple, IMS 5000, RAIK, Vector, NEC, Sharp, Heath/Zenith, 8" IBM. Also available for PDPII and GEC 4080 series.

Write or phone for full details



**Keele Codes Limited, University of Keele,
Keele, Staffs ST5 5BG
Tel: 0782 629221
Telex: 36113**

ORDER NOW!

Cut out the coupon

Access accepted. You may phone your order 24 hours service. Guaranteed despatch within 72 hours

Please send me

E40 for CP/M.....£55 + VAT (incl postage)

CP/M manual..... £5

Further details

Name

Address

I enclose a cheque for

Access no

My computer is

Year of purchase

PCW 6/82

THE DAWN OF A NEW ERA

COME TO THE ZENITHPLAN BUSINESS FAIR. Demonstrations and informal discussions throughout both days. Let Zenithplan and the Sirius 1 solve your Business problems. JUNE 8th to 9th 1982. All day at our Offices.



SIRIUS 1 ZENITHPLAN MARKET

The Sirius - which provides a new level in Price/Performance for the Business and Professional MICRO COMPUTER USER.

A full range of proven application software is now available...

- * Order Processing * Invoicing * Sales, Purchase and Nominal Ledgers
- * Inventory Management * Micro Modeller
- * Supercalc * Wordstar * Database Access
- * Publishers Accounting System
- * International Portfolio Valuation
- * Job Costing * Estimating
- Zenithplan Provide a full range of Business Services
- * Consultancy * Profit Enhancement
- * Bureau facilities (word and data processing)
- * Maintenance * Training
- ZENITHPLAN TRAINING CENTRE PROVIDES PROFESSIONAL COURSES ON
- * Business Computer Appreciation
- * Sirius and CP/M - 86 Workshop
- * Micro - Modeller * Supercalc
- * Wordstar * Accounting Systems

ZENITHPLAN LTD., Shropshire House, 2-10 Capper St., London, WC1E 6JA. Tel: 636 5364-8.

NAME: _____ I am interested in...

TITLE: _____ The Sirius

ORGANISATION: _____ Application Software

ADDRESS: _____ (please specify)

_____ Training Courses

_____ (please specify)

Tel. No. _____ ATTENDING THE ZENITHPLAN BUSINESS FAIR

ZENITHPLAN LTD., Shropshire House, 2-10 Capper St., London, WC1E 6JA. Tel: 636 5364-8

ADVERTISERS INDEX

Abacus	238	Cumana	62,193	Kram	70	Pete & Pam	38
ACT	40,41	DAI	39,57	Kuma	59	Pet Show	223
Acorn	217,226,245	DDP	257	L&J	146	Portatel	226
Adda	25,77	DRG	262	Leicester	134	Power Testing	247
ADH Systems	202	Data Efficiency	215	Level	134	Premier	20
Almarc	42	Fatafax	225	Lifeboat	160	Prentice Hall	60,61
Anglia	195	Datarite	27	Linsac	232	Preston Computer Centre	26
Anglo-American Software	24,32	Datex	228	Little Genius	259	Prospero	204
Anita		Davinci	234	Logic Computers	18	Q A Data Systems	227
Apple Orchard	200	Deans	26	London Computer Store	221	Rade Systems	248
Appropriate Technology	111	Digico	30	Lowe	48,76	Ravenscarr	249
Artic	237	Digitek	47	Lucas Logic	51	Research Machines	214
Atlanta Data Systems	227	Digitus	1	MOM	216	Richard Computer Products	29
Atlantic	17	Discom	253	MPI	35	SRS	203
Audio Computers	IBC	Display	219	Macronics	225	Sinclair	64,120,121
Beebug	228	Electronic Office Services	19	Maplin	37	Small Systems	192
Beelines	28	Electronic Aids	204	Megabrain	222	Soft Option	198
Bergquist & Hobberstad	58	Environmental Equipment	211	Melbourne House	150	Software Ltd	251
Blythe	21	Epson	34	Memotech	75	Spider Software	234
Bristol Software	78,79	Equinox	86,87	Metrotech	68,69	Stage One	234
Broadside	31	Essential Software	154	Micro 80	240	Stemmos	249
Bug Byte	14,15	Frankoform	226	Microage	200	Stirling	192
Bullock	252	Fuller Designs	259	Microcentre	IFC	Storkrose	210
Business & Leisure	203	Furlong	226	Microcomputer Spacedrome	236	Sumlock Manchester	46
Butel	146	G B Computers	16	Microgeneral	233	Superior Systems	212
C/E	242	G M Microtonics	218,246	Micro House	6	Swanley	242
C/WP	54	G W Computers	52,53,142	Microl	72,73	Tab	97
Camden	237	Geest	36	Micromart	197	Technomatic	198
Caxton	82	Gemini	105,220	Microperipherals	49	Telecomputing Oxford	243
Chromasonic	256	General Northern	244	Microprint	239	Telesystems	238
City Microsystems	253	Graffcom	260	Microspares	218,242	Teletone	250
Comart	140	Great Northern	205	Micros By Mail	194	Tempus	65
Commodore	84,85	Guestel	55	Microsystems	74	Tex	134
Commodore Vic	33	Happy Memories	202	Microtanic	229	Texas	6,7
Comp Shop	44,45	Hewlett-Packard	8,9	Microtechnology	66,67	Thorn EMI	5
Comp Soft	207	Hewson Consultants	227	Microtek	238	Timedata	36
Computabits	209	Hitech Computers	206	Microtex	50	Transam	255
Computech	201	Hitech Elec	56	Microvalue	12,13	Transtec	29
Computer Bookshop	144	Honeywell	261	Midwich	231	Twickenham	231
Computer &		I O Systems	225	Molmerx	22,23	U Microcomps	258
Business Supplies	245	ITT	10,11	Monolith	257	Vector	164
Computer Concepts	230	Ikon	232	Mountandene	243	Vic Computing	224
Computer Enterprises	202	Independent Comp Eng	235	Northamber	88	Vision Associates	231
Computer Plus	154	Intercal	228	North Star	122	Vixon	230
Comshare	263	Interface	235	O Computers	127	Warrick Computers	18
Consup	60	JRS Software	237	Oasis	202	Westrex	246
Control Technology	232	T&V Johnson	230,254	O'Brien	245	Windfall	258
Cream	71	KGB	148	Osborne	112,113	Wordsmith	199
Crofton Electronics	231	Kansas	197	Oxford Computers	213	Xitan	63
Cronite	233	Kayde Electronic Systems	241	Mike Parry	228	Zenith Plan	115
Crown Business Centre	244	Keelcodes	115	Personal Computers	OBC	Peachtree	128
Croydon Micros	208	Kellys	240	Personal Computer Palace	244	Pearl Software	43
Crystal	239	Knights	216				



The life of a micro-hack isn't — as many seem to imagine — a constant round of free booze-ups accompanied by a deluge of gifts. Occasionally, though, there's a break in the drudgery of sorting through hundreds of press releases, and one such break occurred recently in the form of the Commodore trip to the Hanover trade fair. This year's trip was nothing like as exclusive as last year's (when the PET Jet was pressed into service, allegedly to Jack Tramiel's annoyance) but made up for this in entertainment value. Some 15-odd (or 15 odd) hacks assembled one evening at the Gatwick Hilton (sic) for a press briefing on the new machines and dinner. Rather oddly, the dinner took place before the briefing, so the latter was considerably, er, enlivened by the antics of those who had become, well, lubricated. The festivities continued in a late-night bar which was some-

thing to do with the Miss Reigate contest taking place in the hotel's ballroom and where, to his horror, 'Legless' found himself conned into paying for a round (with his American Express card)! To cut a long story short (ie, we can't remember much of what followed), when the hacks assembled at 6.30am the following morning to catch the plane to Hanover, three of their number refused steadfastly to leave their bedrooms and were thus left behind when the plane took off. For a medium-sized consideration from each of these stay-at-homes, we shall refrain from publishing their names next month. Worse was to follow, though, when Henry 'Shoestring' Budgett developed 'food poisoning' and had to keep leaving the room during the technical briefing on the Commodore stand at Hanover. . . Long standing readers of 'Chip Chat' (if there are any)

will vividly recall our contre-temps with Commodore a year or more ago, when CBM insisted on billing us for a review machine, even though we'd returned it. Not to be outdone, and, having waited a decent interval to avoid being accused of jumping on a bandwagon, Ingersoll has taken to doing the same over an Atari plus extras which we borrowed — and returned — some months ago. First a request to return the goods, then an invoice have been received in the PCW ivory tower. On both occasions it was explained in words of few syllables that the machine had been returned. But now we've received another invoice, with an accompanying letter which includes the immortal phrase: '... according to our Computerised ON APPROVAL Ledger the above amount is due to us and the goods are definitely in your possession'. Well, we have news for the

'Computerised' Ledger — the goods are definitely *not* in our possession and we don't owe the £1305 on the invoice. We'll keep you posted. . . Has Editor Rodwell gone mad? Not only has he put himself into hock to buy a Sirius to accompany his ageing Cromemco but he decided to put Sinclair to the test at the recent Spectrum launch — when somebody asked about delivery times, Uncle Clive promptly replied: 'If you order one today you'll get it in two weeks.' Equally promptly, 'Rodders' filled in an order form and handed it to a surprised Clive; now he's going around claiming to be the first person in the world to order a Spectrum. . . Finally, news of a new micro from Acorn, due for volume production in October or thereabout: 32k RAM, 32k ROM, BBC Basic, colour, sound, Econet capability and a rubber membrane keyboard, selling at around £120-£150.

THE BEST ADD-ON MEMORY MADE FOR YOUR COMPUTER



VIC 20
ZX81
ATOM
VIDEO GENIE

TRS 80
PET
UK 101

SEE IT HERE, BUY IT NOW. AUDIO COMPUTERS AT STAND V35 (IN THE ZX81 VILLAGE)

- VIC:** The VCR-20 is an ultra low power (CMOS) 20K RAM plug-in cartridge, retailed at £54.00 in kit form and £59.00 in ready-built.
We can also supply with only 4K of RAM, ready-built at £20.00 and as many extra 2K RAM chips (HM6116) as you require at £5.00 each. No PSU required, beige plastic cover.
The VCS is a cartridge simulator and combines the advantage of the motherboard with two slots and the 8K battery back-up CMOS RAM. This emulates cartridges and adds 8K to RAM.
Available end of April in kit form £39.00 and ready-built £45.00.
- ATOM:** The DUO-1 is the latest 64K memory add-on designed for the Atom, combining very low power consumption (200mA at +5V) and RAM power. This runs, loads and saves 64K basic programs. Kit form £64.00, ready-built £70.00. No PSU required.
- ZX81:** The SPECIAL RAMPACK is the nicest around, only 3in x 4in cased in a black trim matching case, offers 56K of RAM to make together with the 8K Sinclair ROM the most powerful system in that size. No PSU required. Kit form £54.00, ready-built £60.00.
- 32K RAM CARD:** 48340 bytes free . . . for TRS 80 and Video Genie. No PSU required. Kit form £40.00, ready-built £46.00.
- 64K DRC MODULE FOR PET & UK101:** Kit form £70.00, ready-built £80.00.

All prices are correct at time of going to press — Prices include VAT @ 15% and P&P for the UK — Quantity discount available for export and dealers — Order by phone: ZX81, TRS-80, Video Genie and Z80 based: Southend (0702) 613081 — Vic, Atom, Pet, UK101 and 6502 based: Southend (0702) 618144. Telex: 995337 G AUDCOM. Access and Barclay. All mail to: Audio Computers, 87 Bournemouth Park Road, Southend On Sea SS5 2JJ,

BUYING THE HARDWARE IS ONLY HALF THE STORY...

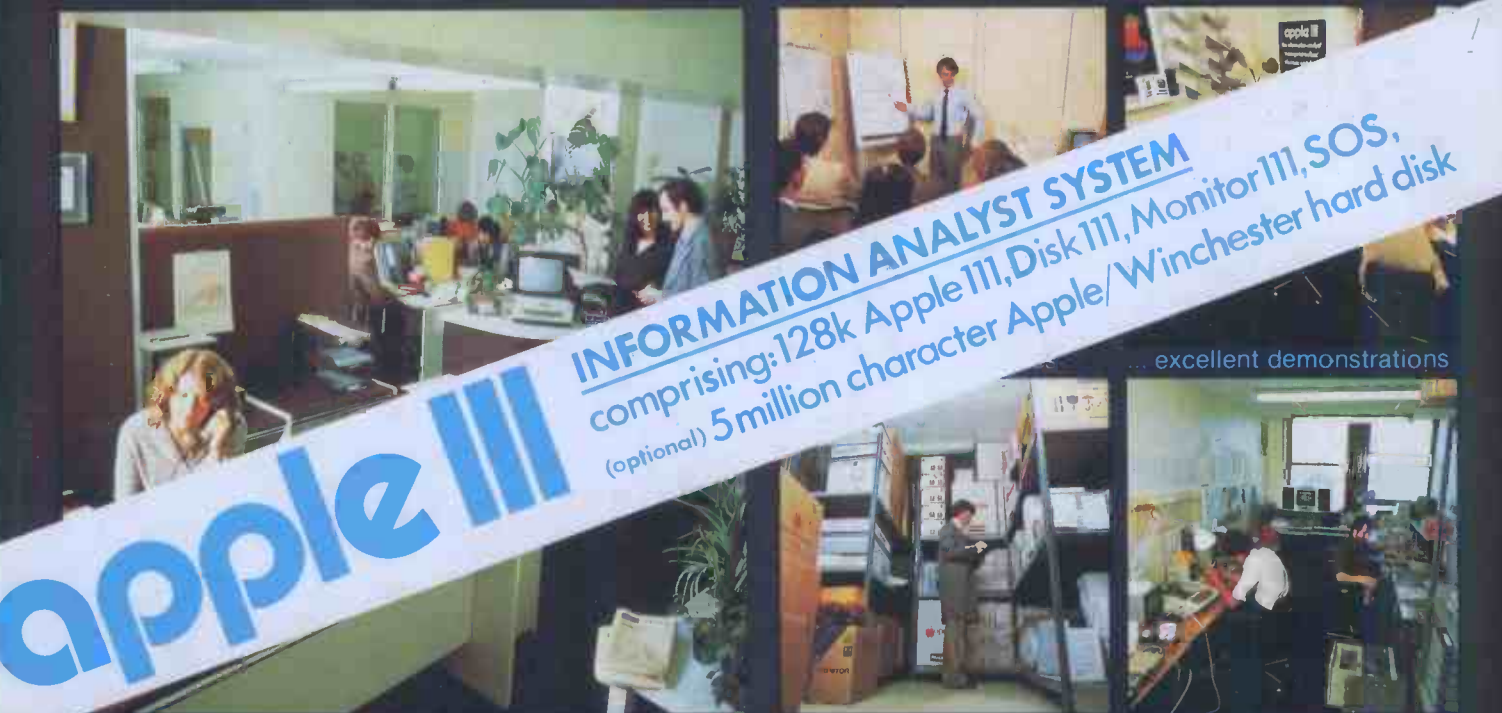

Come & visit us

... ex-stock items

... excellent demonstrations
... in the unlikely event.

... At Personal Computers we'll give it a happy ending.

Personal Computers Limited have been in the personal computing business right from the start — so we've got our values sorted out.

It's important for you to choose the right hardware and vital to select the right software.

To help you make the right choice we offer our highly-trained staff.

They know what makes computers whirr, and they know how to give you the right kind of support and maintenance.

THE BEST AVAILABLE

We stock the best available hardware and software packages in the market.

Such as Apple and Sharp units, with the latest additions like 16K RAM card.

We have I.E.E.E. Interface, low cost serial, parallel interfaces, Doublevision 80 character card, numeric keypads, personal computer plotters, Paper Tiger printers and much more besides.

Whatever you need in computing, we will satisfy your requirements.

FROM PERSONAL COMPUTERS

- **Small Business/Accounting.** We provide low-cost invoicing, purchase, sales and general ledger systems.
- **Financial Planning.** Micromodeller or Visicalc for ad hoc or regular financial reporting.

- **Dow Jones & Prestel** (including I.P. Terminal) services to the city, plus access to city commodities data base.
- **Word Processing.** Our Format 80 system is recognised as the best of its kind.
- **Databases.** State-of-the-art products like Personal Filing Systems and Data Factory.
- **Graphics.** Pad to plotter software and low-cost plotter.
- **Technical Support.** Our knowledge of computer languages and application requirements is unrivalled. And we can supply either on-site or in-house maintenance.

Once again ... Personal Computers Limited give the story a happy ending.

Computers are only as good as the people who use them ... and sell them. Think about that! Then give us a call.

APPLE NATIONAL ACCOUNT SUPPORT DEALER

Personal Computers Limited
Masters of Personal Computer Technology
218 & 220/226 Bishopsgate London EC2M 4JS
Tel: 01-377 1200 New Address Now Open