

57 VILL

# Personal Computer

ZX80 BOOK REVIEWS - A BUMPER BUNDLE

Canada \$2.25/US \$2.00/FF8.80/Lire 3000/FL 4.00/  
BFR64/SKr 9.30/DKr 17.00/NKr 11.70

World April 1981 75p

EUROPE'S LEADING MICRO MAGAZINE

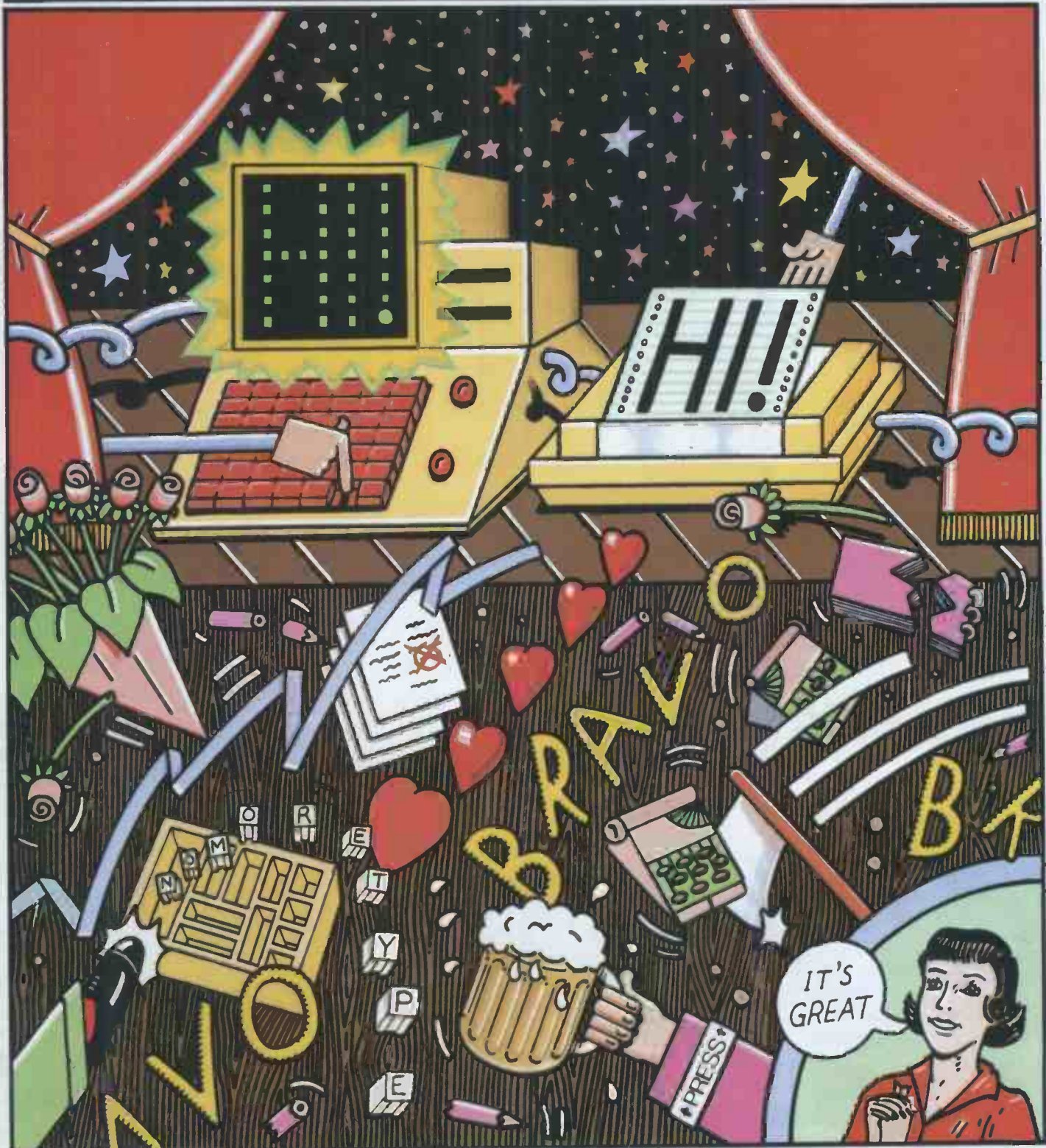

**CHOOSING A WORD PROCESSOR**  
The launch of an important new series



MicroCentre introduce . . . . .

# High Resolution Graphics

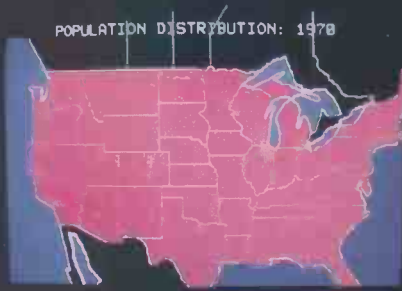

Demographic Display

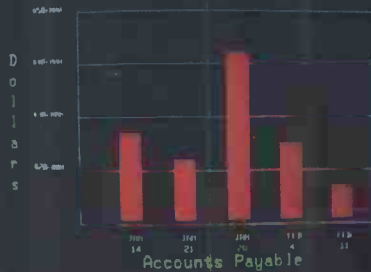

Management information

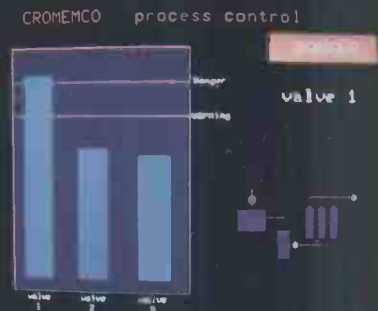

Control system display

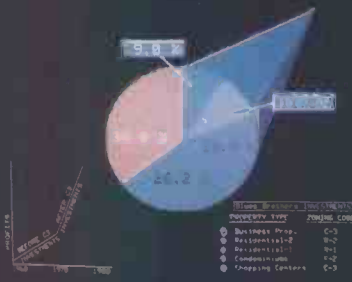

3-D display with angled labels

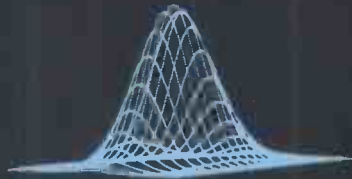

3-D plots



482 (vertical) x 756 (horizontal)

High-resolution display with alphanumerics

Up to 16 colours can be displayed simultaneously, from a choice of 4069. Areas can be filled with colour, windows created, graphs plotted, etc—all under control of simple Basic, Fortran or Assembler functions.

At the heart of any Cromemco graphics system is Cromemco's "SDI" board, the most versatile video interface in the microcomputer industry today. The Cromemco SDI is designed to meet the challenge of professional and industrial environments where uncompromising performance, reliability, and continued compatibility are essential. With its high point resolution, colour map selection, dual page windowing function, automatic fill mode, and NTSC or PAL broadcast compatibility, the most demanding requirements for a video interface can be met. The SDI provides a choice of 4096 individual colours and up to 754 by 482 point resolution. Its different modes of operation include bit or nybble mapped displays with varying levels of resolution, and window effects requiring as little as 12k data storage.

### RGB-13 Colour Monitor

The Cromemco RGB-13 Colour Monitor has been specially designed for optimum colour graphics performance when used with Cromemco's SDI video interface. It includes a fine-pitch 13" CRT with a high-precision electron gun, internal magnetic shielding, and implosion protection band. The monitor combines alphanumeric character generation with colour graphics and

high resolution, to give an overall performance vastly more superior than conventional colour TVs or CRT terminals.

### Graphics Software

Cromemco's graphics software package provides an interface to Fortran IV, Ratfor, Macro Assembler, 16K Extended Basic and 32K Structured Basic. It is written for ease of use and takes full advantage of the RGB-13 monitor's special graphics facilities. Thus it is efficient, flexible and extremely fast. The package contains routines to change the colour map, scale the display area, draw dots, lines and circles, display text, and fill areas with colour. Screen addressing can be by absolute or relative co-ordinates.

### Model Z2H/GS Graphics System

The Z2H/GS is a special configuration of the Z-2H Hard Disk computer which includes full graphics capability and software. Yet at under £8,000 it's a fraction of the cost of comparable systems. It is ideal for applications in medical imaging, computer-aided instruction, pattern recognition, and the television industry.

The Z2H/GS includes a Z-80A processor, 64k of RAM memory, integral 11 megabyte hard disk, RGB-13 colour monitor, 2 floppy disks, printer interface, RS-232 serial interface, and graphics software package.



The high-performance Z2H/GS colour graphics system includes a Z-2H hard disk computer, RGB-13 colour monitor, and comprehensive graphics software package—all for under £8,000!

For  **Cromemco... call the experts**

MicroCentre  
Tel: 031-556 7354

LEADING UK DISTRIBUTORS

Complete Micro Systems Ltd.,  
30 Dundas Street  
Edinburgh EH3 6JN

# CONTENTS

Volume 4 No 4 April 1981

Founder  
Angelo Zgorelec

Editor  
David Tebbutt

Deputy Editor  
Peter Rodwell

Sub Editor  
Jon Wall

Art Director  
Paul Carpenter

Art Editor  
Shelley Gray

Address  
14 Rathbone Place  
London W1P 1DE  
01-637 7991

Advertisement Director  
Stephen England  
01-636 4461

Assistant Advertisement  
Manager  
Patrick Dolan  
01-636 4462

Advertisement Executives  
Margaret Burton  
01-636 4463  
Jacquie Hancock  
01-631 1682

Production Manager  
Dick Pountain

Typesetter  
Jane Hamnell

Subscriptions manager  
Alexandra James

Subscription rates  
UK: £10.00  
Overseas: £17.00

Published by SportsScene  
Publishers (PCW) Ltd., 14  
Rathbone Place, London  
W1P 1DE, England. Tel:  
01-637 7991/2/3. Telex:  
8954139 A/B 'Bunch' G  
London

Copyright notice  
Personal Computer World is  
published by SportsScene  
Publishers (PCW) Ltd.  
© 1981 Felden Productions.  
No material may be reproduced  
in whole or part without  
written consent from the  
copyright holders

Printed by Riverside Press  
Whitstable

Distributed by  
Seymour Press  
334 Brixton Road  
London SW9  
Tel: 01-733 4444

**1 CONTENTS:** Our quick-reference guide to what's in *this month's PCW*.

**40 NEWSPRINT:** Guy Kewney reports the latest micro-happenings.

**48 YANKEE DOODLES:** Tom Williams writes from Silicon Gulch.

**49 CTUK! NEWS:** ComputerTown is spreading fast!

**52 COMMUNICATIONS:** Our readers' write-in.

**54 BENCHTEST:** Mike Dennis reviews the ABC 24.

**60 GATEWAYS TO LOGIC:** The final part of Derrick Daines' series.

**62 COMPETITION:** Your last chance to enter our win-a-computer contest.

**67 SLOW SCAN TV:** How micros are putting themselves in the picture.

**70 A HISTORY LESSON:** How the IDPM can help micro users.

**75 UP THE SHARP END:** Every month Mike Knight takes a no-holds-barred look at the *real world*.

**76 PATTERNS:** Alan Sutcliffe continues his series.

**81 WORD PROCESSING:** We introduce a new series — WP Benchtests.



Cover illustration Des Lynch

**89 LAS VEGAS REVISITED:** Julian Allason describes the Consumer Electronics Show.

**94 COMPUTER ANSWERS:** Sheridan Williams and his team answer your queries.

**97 SECRETS OF SYSTEMS ANALYSIS:** Lyn Antill describes the second stage in specifying a program.

**101 PROGRAM PACKING:** Alan Shelley describes the micro equivalent of having your cake and eating it.

**103 FEATURE INDEX:** See what you've missed this year.

**105 BOOKFARE:** More in-depth reviews from Malcolm Peltu plus a special look at ZX80 books.

**109 BACK ISSUES:** Buy now while stocks last!

**110 COMMONS REPORT:** Ian Lloyd MP presents his correspondence with James Prior on the impact of micros.

**113 GAMES:** Gomoku is David Levy's latest candidate for computerisation.

**119 YOUNG COMPUTER WORLD:** Especially for our younger readers.

**121 CALCULATOR CORNER:** Dick Pountain reviews the new Casio fx-3500p.

**123 NEWCOMERS START HERE:** Our quick intro for those new to the micro scene.

**124 DIRECT ACCESS:** Including IN STORE, TRANSACTION FILE, NETWORK NEWS, USER GROUPS and DIARY DATA

**135 PCW SUB SET:** Useful subroutines, compiled by Alan Tootill.

**138 LEISURE LINES:** More brainbursters from J J Clessa.

**139 PROGRAMS:** Our readers' latest listings.

**149 BLUNDERS:** Our monthly confession!

**191 CHIP CHAT:** Europe's leading microgossip page.



# Have we got a program for you!

EXCELLENT QUALITY PROGRAMS CHOSEN FOR THEIR SUPERB GRAPHICS AND SMOOTH ACTION

**Apple TRS 80 Video Genie ZX80**

**ATTACK FORCE WITH SOUND!**

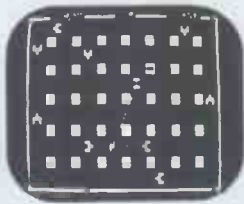

Dodge the alien Ramships and fire missiles to destroy them before they get you. The alien Flagship uses his deadly laser bolt to transform a Ramship into another Flagship or into your ship's double. Look out! Destroy your double and you could destroy yourself.  
**TRS 80 Level 1 or 11.16K Tape £10**  
 Hours of exciting fun.

**NEW**  
**ASTEROID NOVA**



For the first time the amazingly popular ASTEROIDS pub game is now available for your microcomputer. Huge asteroids have invaded the galaxy. Your mission is to destroy them and the alien saucers before they destroy you. But beware, big asteroids break up into smaller ones.  
**TRS80 Levels 1 & 11.16K Tape £10**  
**Video Genie 16K Tape £10**  
**Apple 11 or 11+32K Disk £15**

**GALAXY INVASION WITH SOUND**

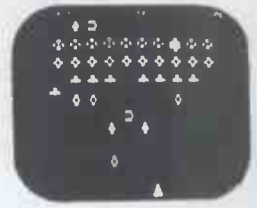

The newest and most exciting invaders type game yet! Cruel and crafty aliens attack Earth. You are the sole defender. As you fire your laser at the aliens they swoop down and bomb you. Exciting use of graphics! Must be seen.  
**TRS 80 Level 1 or 11.16K Tape £10**  
**Video Genie 16K Tape £10**

**Stop press**  
 JUST ARRIVED -  
**VISICALC for TRS 80**  
**32K DISK ONLY**  
**£75**

SEE OUR COMPLETE RANGE.  
 SEND STAMPED ADDRESSED ENVELOPE FOR FREE CATALOGUE

THE ESSENTIAL SOFTWARE COMPANY  
 (Viscounti Ltd.)  
 47 Brunswick Centre, London WC1N 1AF 01-837 3154

I have a ..... microcomputer  
 Please send me your software catalogue. I enclose a stamped self addressed envelope.  
 Please send me .....  
 I enclose a cheque/postal order for £ .....  
 (plus 50p post & packing)

Signature .....  
 Name .....  
 Address .....  
 Postcode .....

# NICE AND EASY DOES IT Panasonic Hardware + CPS Software

The quality and reliability of Panasonic microcomputers is complimented by two new CPS programs specially developed to work with Panasonic hardware—OASIS and COMTEXT



**Dealers!** CPS are Panasonic Distributors  
 Would you like to sell Panasonic micros, OASIS and COMTEXT

**CPS (DATA SYSTEMS) LTD**

Third Floor, Arden House,  
 1102 Warwick Road, Acocks Green,  
 Birmingham B27 6BH  
 Tel: 021-707 3866



A member of the CPS Group

## OASIS PLUS COMtext

Wordprocessing and Communications System

Business system  
 Fully integrated  
 Easy to use

An interlinked suite of programs forming an advanced wordprocessing and communications system which facilitates the creation, manipulation and distribution of text simultaneously around an organisation with offices in different locations

If you want to know more about OASIS, COMTEXT and Panasonic microcomputers, talk to CPS on 021-707 3866 or complete the coupon

Linked Functions

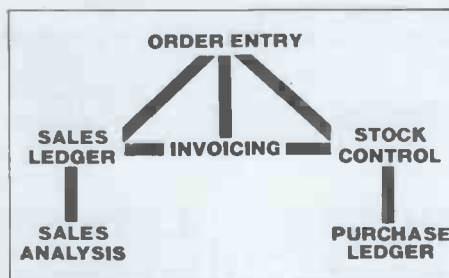

CPS (Data Systems) Limited,  
 FREEPOST, Birmingham B27 6BR  
 Please send me details of Panasonic micros,  
 OASIS and COMTEXT

Name.....  
 Position.....  
 Company Name and Address.....  
 Telephone.....

CPS where performance and good value matter



# CASTLE ELECTRONICS MICRO COMPUTER CENTRE

Now out of twelve years' experience in electronics and communication comes the South Coast's own Computer Centre. Choose from our wide range of micro-computers and support material. Ideally suited to the hobbyist about to enter the fascinating world of computers. Personal callers or mail order welcome.

## TANGERINE

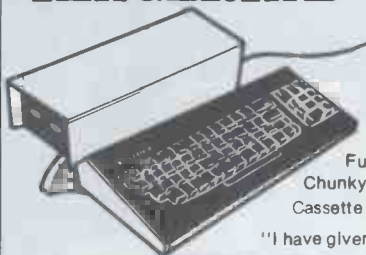

## microtan 65

£69

Microtan 65 is the most advanced, most powerful, most expandable microcomputer available —It also happens to be the most cost effective.

6502 Microprocessor 1K Tanbug 1K User RAM Full TV Display £79 (ready-built). 20-way KEYPAD—£10.  
**TANEX—£43**  
 1K 16 parallel I/O lines. Cassette Interface—1 serial I/O line. 2 x 16 BIT counter timers OPTIONS 7K.  
 RAM total—32 parallel I/O lines. 4 x 16 BIT counter timers—RS232. 20MA current loop.  
**10K MICROSOFT BASIC—£49**  
 System Rack—£49 in black/tangerine in brushed aluminium.  
 Full Ascii Keyboard with numeric pad—£60.85. Cabinet available—£20. Lower Case option—£9.48.  
 Chunky Graphics Pack—£8.52. Tanram Full Memory Expansion to 40K—£119.00. Mini Motherboard—£10.00.  
 Cassette with counter—£21.70.

"I have given TANGERINE five bonus points for getting just about everything right!"—E.T.I. Mag., May 1980.

## COMMODORE PET



Everything has been said about PET—Britain's number one selling microcomputer. A full range of accessories and software, (both games and business), is held in stock.

8K Inbuilt Cassette—£399,  
 8K Large Keyboard—£425  
 16K Large Keyboard—£499  
 External Cassette—£55  
 Dual Disc Drive—£695  
 Tractor Printer—£425

**CASSETTE SOFTWARE:** Strathclyde Basic Course, Basic Basic Course, Invaders, Treasure Trove of Games 1 to 10 (10 selections of games), Basic Maths, Algebra, Statistical Packs and lots more!



£399



£599



The Apple II+ is more powerful than its predecessors with built-in sound and high resolution graphics, which make it ideal for scientific and games applications.

16K—£599  
 32K—£649, 48K—£659, Epsom printer—£349, cassette with counter—£21.70.  
 Disc-drive without controller—£299  
 Disc drive with controller—£349, 16K add-on—£69. **CARDS:** Prototype/hobby card—£15, parallel printer interface card—£104, communications card—£130, high speed serial interface card—£113, Pascal language system—£299.

**NASCOM** NASCOM 1 — £125 (Kitform)  
 NASCOM 1 — £140 (Ready-built)  
 NASCOM 2 — £225  
 IMP PRINTER — £325

**VIDEO GENIE** Fully TRS80 compatible — £299

**SHARP MZ80** £449

**SINCLAIR ZX80** taken in part-exchange for all Micros.

## Atari Video Computer Game

Atari 800 Standard cartridges £13.90

Every cartridge held and latest Space Invaders, Night Driver, Adventure, Hangman, etc.

Chess Challenger Sensory—£110, Chess Challenger 7-level—£75, Chess Challenger 10-level (voice)—£180. Galaxy Invaders—£17.50.

Amtron Electronic Kits Ex-Kit electronic Kits

## BUSINESS SOFTWARE SALE

PETACT Purchase Ledger (Disc.)	£75.00
PETACT Sales Ledger (Disc.)	£75.00
Commodore Word Processor III (Disc)	£75.00
Commodore Stock Control (Disc)	£75.00
Commodore Sales/Purchase/Nominal Ledger...	£500

Further details of business software available on request

## BOOKS (No V.A.T.)

Basic Computer Game—£5.50, Instant Basic—£7.20, Pet Revealed—£10.00, Library of Pet Subroutines—£10.00, Your First Computer—£5.95, Guide to Basic Programming—£8.85. Basic Basic—£6.50. Advanced Basic—£6.00. Basic Programming Z80—£8.95, 6520 Applications Book—£7.95 and lots more. Send for full list of microcomputer and electronic books.

## PET SCIENTIFIC & INDUSTRIAL APPLICATIONS

16-channel A/D converter	£300
16-channel Relay Unit	£360
8-channel D/A Converter	£350

## MEMORIES & MEDIA

2114 £3.00	2708 £5.00	Cassettes 10 for £5.00
4116 £3.00	2716 £6.90	Floppy Discs 10 for £25.00
		Listing paper 2,000 sheets for £15.00

MATTEL 3D TV Game due JAN.

CB rigs now available

ATARI Computer due MARCH

ALL PRICES—ADD 15% VAT. DELIVERY: POSTAGE/PACKING WILL BE NOTIFIED BARCLAYCARD AND ACCESS ORDERS TAKEN BY PHONE

# CASTLE ELECTRONICS

7 CASTLE ST., HASTINGS, EAST SUSSEX TN34 3DY  
 Shop hours 09.00 to 17.30 Mondays to Saturdays

Telephone: Hastings (0424) 437875  
 Personal callers welcome

# NOW YOU CAN PLAY SUPER INVASION ON YOUR ZX80!

**SENSATIONAL**

● **TOTALLY FLICKER FREE**

Absolutely no flicker. You don't need to press anything for the display to move!

● **3 LEVELS OF PLAY IN EACH GAME**

From easy to dangerously difficult – you'll find it hard to resist the challenge time after time!

● **MOVING GRAPHICS**

No hardware modifications are necessary to get moving graphics. Just follow the instructions for cassette loading and off you go; no extra memory needed, uses the 4K ROM.

● **MACHINE LANGUAGE**

These programs are written in the computer's own language – only this way is it possible for continuous, flicker free action to occur.

● **ALL PROGRAMS ON CASSETTE**

Loads just like any other program on cassette. Each tape contains instructions on how best to load the cassette.

● **FITS IK BASIC MACHINE**

Amazing as it is, all these moving graphics programs fit into your basic IK Sinclair!

**COME & SEE  
THE ACTION**

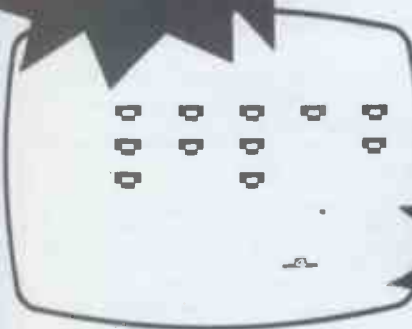

**3 LEVELS  
OF PLAY**

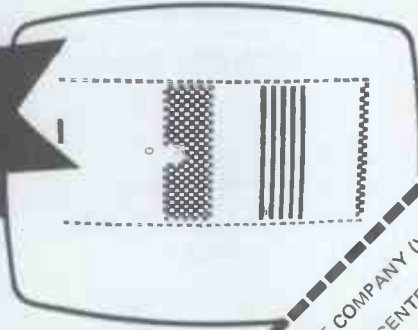

## SUPER ZX80 INVASION

SUPER ZX80 INVASION is the machine language game you and your Sinclair have been waiting for. Cruel and crafty invaders have been spotted in battle formation ready to attack with your ship just below them! Quickly and skilfully you shift right and left as you carefully fire your lasers at them. But watch out – they are accurate! 3 levels from easy to almost impossible to beat. Added bonus – each cassette also has more sophisticated 2K version which will automatically reset and challenge you for hours! £8

## DOUBLE BREAKOUT

You'll be amazed to see how difficult it is for you to break through the ZX80 DOUBLE BREAKOUT – and even more astonished to see this exciting game fit into your IK Sinclair ZX80! Try your skill on the easiest level because even with the most skilfull bat control you'll find it hard to catch at the fastest level! Breaking through the first barricade is easy but don't be fooled for the second – it's much harder than you think! Two ball angles and curved bat will keep the excitement going for hours!

**PLUS ASTEROID LANDER,  
PING PONG AND  
MANY OTHERS**

**AT LAST.**

THE ESSENTIAL SOFTWARE COMPANY (VISCINTI LTD)  
Company Address 47 BRUNSWICK CENTRE, LONDON WC1N 1AF  
TEL: 01-837 3154

Please send me ..... copies SUPER ZX80 INVADERS and  
copies DOUBLE BREAKOUT.  
I enclose cheque/postal order for .....  
Name .....  
Address .....

plus 50p  
post and pack





# Number one for PET in London.

## 01-579 5845

The news is travelling fast amongst the professionals that Adda are the Number One people to go to for Commodore PET microcomputer systems.

Commodore's new generation of desk-top computers and software - including packages for accountants, solicitors and doctors - can be made to realise their full potential with professional advice from Adda. This, together with exceptional standards of service back-up, will help you stay on top and in complete control of the latest advances in microcomputing.

### WORD PROCESSING FROM AS LITTLE AS £2900

With the WORDCRAFT 80 programme, Adda can show you how to make use of a Commodore Business System in the dual role of a fully fledged word processor. There's capacity for 250-300 pages of text, the functions you'll find on very much more expensive word processors, and a wide choice of output printers including daisy-wheel. Add on the DMS file management programme for £195 and you can access several thousand names and addresses for personalised mailing. Mu-Pet enables you to build up a multi-terminal word

processing system linking from three to eight microcomputers to one Commodore disc drive and printer for as little as £595.

### CALCULATOR, PEN AND PAPER - ALL IN ONE - WITH VISICALC

When you need to work things out on paper, using a calculator, the VisiCalc programme can do it so much easier and quicker on computer - and instantly display the answers you are looking for. And you can get a hard printout later. The applications are numerate and innumerable - get Adda to show you.

### MEDICOM PRACTICE MANAGER - JUST WHAT THE DOCTOR ORDERED

Medicom Practice Manager provides the information needed

to ease the clerical workload and aid the running of an efficient practice. Designed by doctors in general practice, this practical computing system controls and prints repeat prescriptions, maintains the age/sex register and monitors patient care - in a complete package costing less than £3000. A pharmacy stock control system can be added for just £400.

Find out more about how these developments can best be employed in the professions - with professional advice from Adda.

Phone 01-579 5845 today.



Adda Computers  
14 Broadway  
West Ealing  
London W13 0SR  
Entrance in  
Kirchen Road  
01-579 5845



we add up to a great deal.

WE TALK  
SOFT  
in all languages!

Only  
**75p**

From Computer  
Stores & leading  
Newsagents!

# SOFTWARE GAZETTE

If you're into Software you'll find "The Software Gazette" invaluable because it covers every aspect and development from A to Z!

Get "The Software Gazette" now from your local Computer Store or Newsagent and you'll be on the button with all the hard facts about Software.



The Computer  
Bookshop

The UK Distributors:- Temple House, 43/48 New Street, Birmingham B2 4LA

**RETAILERS - WE OFFER FAST BULK DELIVERY, SO PLACE YOUR ORDERS NOW!**

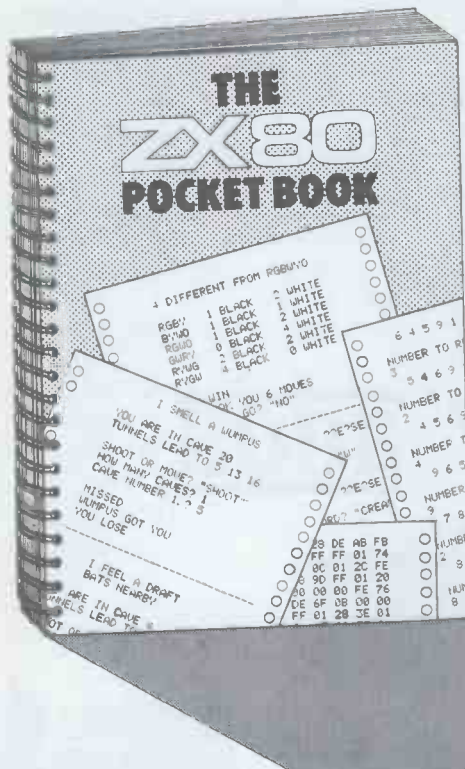

## THE ZX80 POCKET BOOK

### 7 NEW PROGRAMS

- Mastermind
- Reverse
- Space-Docking
- Putting

- Hangman
  - Wumpus +
  - Share Valuation +
  - Plus Others
- + Requires more than 1K.RAM

### PLUS HINTS AND TIPS ON

- Program Writing
- Graphics

- Cassette Use
- Program Efficiency

### PLUS REFERENCE SECTIONS ON

- Basic
- ZX80 Op Codes
- Error Codes
- Useful Subroutines

128 Pages

**£4.95**

Including Postage & VAT

Cassette Tape of Programs above plus book **£14.95**

**PHIPPS ASSOCIATES** 3, DOWNS AVENUE, EPSOM, SURREY. KT18 5HQ  
or Telephone Epsom (03727) 21215 Quoting your Access Card Reference. No callers please.





Ask for details  
about Almarc  
Hard Disc  
Systems

# Almarc + Vector Graphic

The complete partnership  
in Microcomputing

#### System VIP

- \* Vector 3 terminal with 6-slot S100 bus.
- \* Fast (4 MHz) CPU using the powerful Z80.
- \* 56K of user RAM.
- \* Serial RS232 port (110-9600 baud selectable), 3 8-bit parallel ports.

- \* 80 x 24 display using 8 x 10 matrix.
  - \* Full QWERTY keyboard plus separate numeric keypad and capacitance keys.
  - \* UNISTOR disc drive giving 315K bytes of storage.
- PLUS CP/M 2, Microsoft BASIC 80, SCOPE (text editor) and RAID (simulator debugger).



#### System B

- \* Vector mindless terminal.
- \* Z80 CPU with fast 4 MHz clock.
- \* 64K bank-selectable RAM (56K user RAM).
- \* 4 serial ports (all switch-selectable 110-9600 baud), 5 parallel ports.
- \* Flashwriter II video board (80 x 24).

- \* Interrupt handling on I/O board.
- \* Twin disc drives – 630K capacity.
- \* CP/M 2.2 operating system.

PLUS  
Microsoft BASIC 80, SCOPE (screen-oriented program editor), RAID (full screen dynamic simulating debugger), ZSM Z80 Assembler.



#### System 2800

- \* Vector 3 console chassis with 12 inch CRT and capacitance keyboard.
- \* Z80 based single board computer with serial port, 3 8-bit parallel ports, 3 PROM slots and 1K RAM.
- \* 64K dynamic memory board and disc controller.

- \* Flashwriter II video board (80 x 24).
- \* 6 slot S100 motherboard
- \* Switch-selectable asynchronous baud rates (110-9600 bits/sec).
- \* IBM-compatible DUALSTOR twin 8 inch double density disc drives, giving 2M bytes capacity.



At ALMARC Data Systems, you can be sure of our experience of hundreds of Vector Graphic systems installed throughout the U.K. – all with 12-month warranty and the back-up of full service facilities carried out by experienced staff.

ALMARC are the specialists in Vector Graphic equipment with applications in word processing, business

systems, laboratories, research, schools, colleges, universities and industry. Plus an ever-growing list of compatible software – Pascal, Fortran, Cobol, APL, Algol, Basic Compiler and others.

We will be pleased to demonstrate how ALMARC + VECTOR GRAPHIC Systems equals The Complete Partnership in microcomputing.

# Almarc

DATA SYSTEMS

906 Woodborough Road, Nottingham NG5 5QS. Telephone: (0602) 625035.

FROM **CTS** THE UK'S TOP OHIO DEALER:

### THE NEW SUPERBOARD III

The best value for Money-Home Computer available, with the following features:

- Full ASCII Keyboard
- 4K RAM Expandable to 8K on Board
- 161 Graphics Characters
- RS232 Port In and Out (Printer Interface)
- Cassette Interface
- Modulator for input to T.V.
- Special module giving the most stable T.V. picture in the UK.
- Expandable to 32K and Dual Mini Floppies

#### SPECIAL FEATURE:

24 characters on 28 lines or 48 characters on 14 lines  
 – Software switchable with our NEW INTAMON MONITOR (Note the OHIO Swap tape is not needed)  
 THE NEW MONITOR ALSO OFFERS THE FOLLOWING EXTENDED BASIC

Trace ON	Machine Code SAVE
Trace OFF	Machine Code LOAD
Inkey	Clear Screen
GET	Clear window
EXIT	Home Cursor
SYS	TEXT
RUB OUT	GRAPH    Format Switch

This new ROM is suitable for old and new Superboards and can be customised to other screen formats. It is also compatible with all currently available monitors.

#### PRICES:

NEW SUPERBOARD III WITH MODULATOR            £164.95 + VAT  
 NEW INTAMON ROM            £ 27.50 + VAT

#### BUSINESS SYSTEMS

SCHOOL SPECIAL Up to 16 C1Ps (Superboard III in a case) tied into a C8P or C3 Host System enabling C1Ps to access the Host System's Dual 8" Floppies and Printer. The 32K Host System is a full Business System capable of handling School Records, Accounts etc. Double-sided 8" Floppies are optionally extra, giving over 1MByte on line storage.

#### OTHER OHIO SYSTEMS

C8P – C3 – C30EM – C3B and C (Hard Disk Systems up to 74 MegaByte) – networking systems.

PRINTERS ANACOM – MICROLINE – GP80 – CENTRONICS – EPSON – QUME – OLIVETTI ETC  
 VDUs TVI – VOLKER CRAIG – LEAR SIEGLER – CIPHER ETC.

RING **CTS** AND DISCUSS YOUR

REQUIREMENTS ON:

LITTLEBOROUGH (0706) 79332 or 74342

C.T.S.  
 31/33 Church Street  
 Littleborough, Lancs.

TEL: (0706) 7932 or 74342 ANY TIME.

## The best prices for peripherals

with full dealer support

### Centronics 737

£349



- Letter quality printer
- \* 7x9 dot matrix
  - \* 3-way paper handling, up to 8 1/2"
  - \* 5, 10 or 16 characters per inch
  - \* Proportional characters/spacing
  - \* Up to 80 characters/second
  - \* Parallel interface standard
  - \* Serial interface option

### Epson MX80

£359



- Complete range of interfaces
- \* 9x9 dot matrix
  - \* Fast bidirectional printing
  - \* ASCII and graphics, with £ sign
  - \* Bold, expanded, condensed print
  - \* Parallel interface standard

### NEC Spinwriter £1390

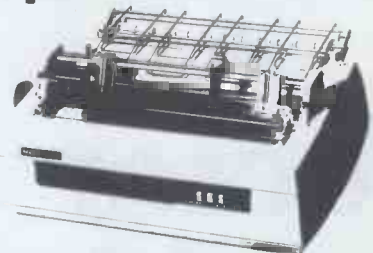

Professional quality for word-processing systems  
 NEC's 'Spinwriter' series of high-quality printers use a print 'thimble' for faster, quieter printing and more characters than equivalent daisy-wheels. 128 character set; 55 chars/sec; friction or tractor feed; up to 5 copies; single-sheet feed option.

Model 5510 - RS232 interface; Model 5530 - parallel

### OKI Microline 80

£329



- The quiet workhorse
- \* ASCII and graphics characters
  - \* 9x7 dot matrix
  - \* Condensed, double width print
  - \* Friction or pin feed
  - \* Rugged, quiet and reliable
  - \* Parallel interface standard

### TVI 912C terminal

£475



- Fully intelligent terminal
- \* 24x80 character display
  - \* Dual intensity, blinking, reversed, underline, and protected fields
  - \* Full upper/lower case ASCII
  - \* Separate numeric keypad

Anacom 150 – fast, reliable commercial matrix printer ..... £699  
 Pet computers – new 32K 80-column 'SuperPet' ..... £825  
 – 16K standard large-keyboard model ..... £499  
 – 32K standard large-keyboard model ..... £559

NOTE: All prices quoted exclude VAT

## NORTHAMBER

Importers, Distributors and Wholesalers  
Great Oak House, Albany Close, Esher, Surrey

Telephone: Esher (0372) 62072



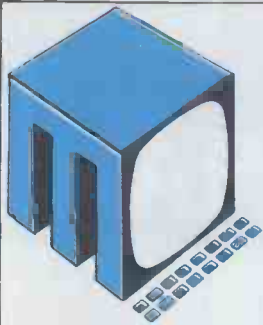

# METROTECH

## CP/M SOFTWARE

### WORDPROCESSING

WORD-STAR<sup>tm1</sup> is the most complete integrated word processing software system ever seen on a microcomputer. In less than six months more than four thousand people have proudly purchased WORD-STAR.

**WORD-STAR 2.0** £255/£30  
**WORD-STAR 2.0 with MAILMERGE** £315/£40

### NEW \* Commercial Operating System \* NEW

At last a secure commercial environment can be created under CP/M. COSY offers a **true COBOL compiler**, ISAM files, enhanced disk I/O, screen formatting and printer spooling.

**COSY** — including COBOL compiler £450  
**COSY** — run time system £200  
**PSORT** — utility sort £50  
**FDUMP** — utility file dump £30  
One manual for all the above £15.

### INTEGRATED BUSINESS SYSTEMS

Written specially for the U.K. market, Version 2.0 of GRAFFCOM'S Integrated Small Business Software is now available for both floppy (ISBS-F) and hard (ISBS-W) disk systems. Modules available are:— Payroll, Company Sales, Company Purchases, General Accounting, Stock Control, Order Entry and Invoicing, Name & Address, Time Recording, Lease, Rental & HP.

Prices are available on request, discounts quoted for bundles of the above systems. Manuals £35 each.

### LANGUAGES/UTILITIES

**CBASIC II**  
Commercial Disk Extended Basic £75/£20  
**SBASIC**  
Compiler Structured Basic £175/£30  
**SUPERSORT I** £125/£20  
**WORD-MASTER** Superior Text Editor £75/£20  
**MET/TWAM** Index sequential file  
Access in CBASIC II £55/£15

All software is Ex-stock and available on standard 8" disks or 5" disks for Cromemco Z2H, North Star Horizon, Vector MZ, Superbrain & Dynabyte.

- \* Add 15% VAT
- \* Postage and Packing £2 per order
- \* State which disk type and size
- \* all orders prepaid

Telephone orders welcome for Access, Barclaycard, American Express or Diners Club

**CALL 0895 58111 Ext. 247 or 269**

or Write to **METROTECH MAIL ORDER**  
**WATERLOO ROAD**  
**UXBRIDGE**  
**MIDDLESEX UB8 2YW**

enclosing cheque, PO's payable to METROTECH.

Prices are shown as Software with manual/Manual only.

METROTECH are sole U.K. distributors of DYNABYTE microcomputer systems.

### COMMUNICATIONS

BISYNC-80/3780 and BISYNC-80/3270 are full function IBM 2780/3780 and 3270 emulators for microcomputers.

BISYNC-80/3780 gives you a Remote Job Entry terminal for the price of a micro!

BISYNC-80 combines the local processing power of a micro with a sophisticated screen capability. Make your dumb terminal smart!

I/O Master is a superb S100 buffered I/O board which supports 3780 & teletype communications, plus serial and parallel peripherals.

MET/TTY will connect your micro to a timesharing service in simple teletype emulation.

**BISYNC-80/3780** £275/£15  
**BISYNC-80/3270** £275/£15  
**MET/TTY** £95/£15  
**I/O Master Board** £225/£20

### DATA MANAGEMENT

#### SELECTOR III-C2

An easy to use Information Management System; requires CBASIC II £185/£30

#### SELECTOR IV

An advanced Information Management System; requires CBASIC II £275/£35

#### DATASTAR

Powerful data entry, retrieval and update system £195/£30

### FINANCIAL REPORTING

#### REPORT WRITER

You input the values — Report Writer will perform your calculations and produce a report with your headings, totals and summaries £150/£15

#### GLECTOR

General ledger option to Selector III; Requires Selector III & CBASIC II £185/£30

### Micro Data Base Systems

MDBS is a database system offering full network CODASYL-oriented data structures, variable length records, read/write protection, one-to-one, one-to-many and many-to-many set relationships. Add on features are:— an interactive report-writer and query system, a dynamic restructuring system and a recovery-transaction logging system.

**MDBS prices start from** £600/£35  
**Primer manual** £9

<sup>tm1</sup> WORD-STAR is a trademark of Micropro.

# KEEN COMPUTERS PUT LONDON ON THE MAP



## A new London base for the unbeatable team that offers a complete service in microcomputing.

Just a few minutes from Chancery Lane or St. Paul's tube station, you can now see the most impressive display of micro-computer power in South-East England. At Keen Computers' new London office and showroom, 5 Giltspur Street EC1.

As number one specialists in the U.K., Keen Computers offer an unmatched microcomputer service...

**Networking systems** that bring you microcomputer power on tap...

**The Keenstar range** of over 200 hardware and software products...

**A consultancy and software capability** that is second to none...

**Staff training** plus seminars for top management...

**Purchase and leasing terms** over five years and...

**Superb service back-up** from highly trained engineers, based in London and Nottingham.

On all end-user hardware purchases, you get a 14-day exchange or full refund guarantee plus a 12-month full parts and labour warranty. On networking systems, the unique Microcover Guarantee<sup>†</sup> includes delivery, installation, commissioning and 90-day on-site parts and labour

warranty in the purchase price. Complete protection for your investment is provided by full, on-site maintenance agreements available for 5 years, renewable annually thereafter.

**Networking systems**  
Miracle. Up to 72Mb of Corvus hard-disc capacity can be shared by 2-64 micros through a Constellation host multiplexer, with a further sharing of printers, plotters and many other peripherals. Inexpensive back-up for the hard-disc system is provided by the unique Corvus Mirror VCR interface.

Onyx C8002 handles up to 8 users, and the Z8000 16-bit processor at the heart

of the system has a faster throughput than the PDP11/45\* 18Mb of Winchester hard-disc drive, 12Mb of 3M cartridge tape-drive, 512Kb of RAM and the UNIX 7\* timesharing operating system give you the power of a mainframe in a desk-top device.

### Microcomputers

Apple II, Apple III (details now available), North Star Horizon, Keenstar S-100 mainframe, Onyx C8001 (8-bit, 280 CPU), and the C8002.

### Peripherals

TVI, Cifer, Ambassador, Volker Craig, and Keenstar black and white and colour monitors. Printers by Anadex, Qume, Papertiger, Silentype and Olympia.

### Software

A full range of packaged software for Apple and North Star (under CP/M\*), including Fully Integrated Accounts, Stock Control, Payroll, Graphics, Critical Path Analysis, Word Processing, and Addressing/Mailing. Bespoke software is available from our team of experienced programmers.

### Keenstar 'add-ons'

Over 200 hardware and software products for expansion of all systems.

Personal callers are most welcome – but better still make an appointment for a demonstration of Keen Computers' systems and software capability, or complete the coupon below. Showrooms open 10.00am – 6.00pm Monday to Friday.

**London 01-248 7307**  
**Nottingham 0602 583254**

**Keen Computers** 

Please send me details and prices on:

Miracle/Corvus  
 Onyx C8000 series micros  
 S100 micros  Apple micros  
Peripherals (please state) \_\_\_\_\_

Other services or products \_\_\_\_\_

Name \_\_\_\_\_

Position \_\_\_\_\_

Company/Establishment \_\_\_\_\_

Address \_\_\_\_\_

Tel: \_\_\_\_\_

Please post to Keen Computers, Marketing Department,  
5 Giltspur Street, London EC1A 9DE

<sup>†</sup>Available in U.K. only  
\*CP/M is a trademark of Digital Research Inc. UNIX is a trademark of Bell Telephone Laboratories, PDP-11 is a trademark of Digital Equipment Corporation

ENQUIRIES FROM OEMs DEALERS AND OVERSEAS WELCOME. SPECIAL TERMS ARE AVAILABLE FOR EDUCATIONAL/GOVERNMENT DEPARTMENTS



# MIRACLE MICRO NETWORKS -AT MAGICAL PRICES!

When 2-64 micros share up to 72Mb of Corvus hard disc through Constellation host multiplexing, you get a Miracle - no less.

Miracle puts distributed data processing on tap, with each user station enjoying high-speed access and total flexibility. A Miracle can outperform a mini-network and save you money all along the line.

You can expand your network as your needs expand with many kinds of micros: Apple II and III, S100 North Star, Vector Graphic, Cromemco, Superbrain, TRS-80 I and II, DEC LSI II - and more to come.

In addition to his own dedicated computer and associated memory, each Miracle user has access to a central hard disc memory - normally twenty times faster than floppies - without interference from other users. Like computers can communicate with each other in the network and peripherals shared.

Traditional peripherals, such as printers and VDUs, and interactive devices like speech output, voice recognition, colour graphics, light pens and digitisers, can be linked up to give a Miracle system unrivalled configurability.

## How a Miracle system works

Each Constellation host multiplexer links 2-8 micros in star configuration to 10Mb or 18Mb of Corvus hard disc drive. Up to 8 host multiplexers can be connected together, allowing up to 64 micros to use four disc drives for a total system capacity of 72 Mb.

Inexpensive back-up for the hard disc system is provided by the unique Corvus Mirror. It interfaces the data signals on the disc with a 100Mb capacity video



**2-user from £7,359**

**4-user from £9,705**

**8-user from £14,405**

**16-user from £24,249**

tape system; and the entire contents of a 10Mb disc can be archived in about 15 minutes.

## Applications software

Miracle can make use of a comprehensive range of languages, from BASIC, COBOL and FORTRAN to PASCAL, ALGOL and APL.

PASCAL-written applications software packages include: Accounting Systems, Payroll and Stock Control (fully integrated with order processing/invoice generator); Addressing/Mailing; Database

Management; Incomplete Records; Job Costing; Time Records; Graphics; Critical Path Analysis.

Come and see Miracle being put through its paces at our London or Nottingham showrooms. Phone now for an appointment or complete the coupon below.

**London 01-248 7307**

**Nottingham 0602 583 254**

**Keen Computers**



Typical five-user Miracle system

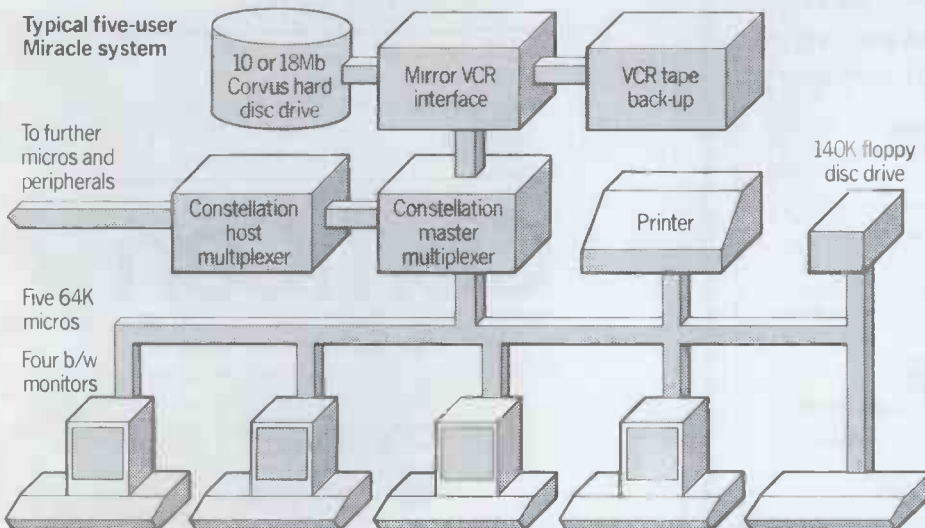

Please send me details of:  
Miracle with the following micros

Applications software packages  
(please state) \_\_\_\_\_

Name \_\_\_\_\_

Position \_\_\_\_\_

Company/Establishment \_\_\_\_\_

Address \_\_\_\_\_

Tel \_\_\_\_\_

Please post to Keen Computers,  
Marketing Department,  
5 Giltspur Street, London EC1A 9DE

ENQUIRIES FROM OEMs DEALERS AND OVERSEAS  
WELCOME. SPECIAL TERMS ARE AVAILABLE FOR  
EDUCATIONAL/GOVERNMENT DEPARTMENTS



## Pete & Pam Computers

Microcomputer hardware & software  
Specialists in Applefare.

We are distributors for: Microsoft, High Technology, Stoneware, Computer Station, California Pacific, Dalin 5, Broderbund, Starcraft, M&R, SSM, and Versa computing.

### HAVE YOU BEEN WATCHING OUR ADVERTISEMENTS?

If you have, you'll have noticed that one thing is common to all of them — FAIR prices. This month is no different. We bring you the latest Applefare at prices we hope you can afford.

#### M & R ENTERPRISES

**SUP-R-TERMINAL** An 80 column by 24 line plug-in compatible board for APPLE II. 128 ASCII chrs. Upper and lower case — with descenders. Shift lock feature. Synchronous operation with APPLE. Incorporates PASCAL and BASIC control characters. £195.00

#### PROGRAMMA

Apple P.I.E. text editor £75.00

A powerful and versatile 80 col word processor — a great companion for Sup-R-Term. (Videx & Double Vision versions also)

#### MICROSOFT

**Z-80 SOFTCARD.** A true Z80a microprocessor plug-in board to allow you to run CP/M software. Includes MICROSOFT'S BASIC 5.0. £175.00

**FORTTRAN for SOFTCARD.** Has a strong advantage over APPLE Fortran. 4 to 6 times faster because it generates true machine code rather than "P" code. Featurewise, the two are essentially the same. £99.95

**COBOL for SOFTCARD.** The only COBOL available for APPLE. Ask for more information and our special SOFTCARD/COBOL deal. £359.95

**BASIC COMPILER for SOFTCARD.** Get fast program execution times without giving up BASIC. 3-10 times faster than interpreted BASIC. £192.95

**OLYMPIC DEATHLON.** Latest game from MICROSOFT. 10 events presented in extraordinary graphics. 1-8 players can play. £15.95

**ADVENTURE.** Yes, this is the original written for the PDPII, and played during many a lunch hour on expensive main frames! £15.95

**TYPING TUTOR.** Runs in INTEGER (incl. relocated) It works! £8.95

#### PERSONAL SOFTWARE

**VISICALC.** Yes, the one sold elsewhere for £95.00. Our price £75.00

**CCA DATA MANAGEMENT.** Our price just £49.95.

**DESKTOP PLAN.** Develop your own large business model. £49.95

#### HIGH TECHNOLOGY

**INFORMATION MASTER.** The latest data management system from High Tech. We use it for all our book-keeping up to trial balance and for our price lists. Can be user tailored for many uses. £73.95

**DATA BASE MANAGEMENT SYSTEM.** High Tech's original system. Not as many features as Info. Master, but is user oriented with lots of error trapping. £49.95

**DATA MASTER** A utility for use with both Info. master and D.B.M.S. allows you to re-define field types, transfer data from one system to another, using a wide set of parameters. We use this too. £49.95

#### STONEWARE

**D B MASTER** Up to 1020 Bytes per record. Up to 100 fields per record. Up to 9 Screen Pages per record. Up to 4 fields in primary ISAM Key. Supports Multi-diskette files. Automatic 'Data Packing' for increased disk capacity. A great Data Base Manager for big applications. £109.95

#### GAMES

**TRANQUILITY BASE.** Try to land a Hires spacecraft £13.95

**BLOODY MURDER.** Like playing with knives? (Integer) Disk £9.95

**MICROLEAGE BASE BALL** with real HIRES little people £11.95

#### SUB LOGIC

Flight simulator (cassette £12.95) Disk £17.96. Animated pack (cassette £24.95) Disk £27.95.

#### SOUTH COAST ENTERPRISES

Plexi-Glass Lid for Apple £15.95

Dust covers — a full range of nylon hand sewn dust-covers available for Apple, disks, monitor, in any constellation

#### VERSA COMPUTING

VERSA WRITER £124.95

#### COMPUTER STATION

VISILIST lists out the grid location and formulas of any Visicalc file. £10.95

MACRO SCREEN EDITOR Cursor oriented editing tool. £19.95

APPLEWRITER GRAPHICS. Links with Applewriter and any of the 28 character sets supplied in APPLE's "Dogs Tool Kit" to provide word processing, with a difference! Tiger 440G, J445G, G Silentyne. £17.95

#### CALIFORNIA PACIFIC GAMES

AKALABETH Latest Adventure type game. £16.95

TRILOGY £15.95. TRANQUILITY BASE £13.95.

HEAD-ON From Japan £13.95 BILL BUDGE'S SPACE ALBUM £20.95

SIERRA SOFTWARE — New Games £15.95

RETROBALL. An air hockey game, so fast it comes with a video sych connector.

ALIEN LANDER 3D lunar lander in colourful landscape £13.95

#### VARIOUS

PHANTOM FIVE. New from SIRIUS. Amazing hi-res graphics scroll-bi-directionally £15.95

BASE 5.25 IN DISKS FOR APPLE. At a good price. 10 for £18.50

DAKIN5. Find your way around the new APPLE DOS with Programming Aids 3.3 12 Utility programs on one Diskette (16 sector). Well documented £13.95

#### STARCRAFT (Tokyo)

APPLE GALAXIAN The best 'Invader' game we've set a bar none. We mean it! £13.95

GALAXY WARS Another arcade game beautifully implemented on APPLE £13.95

BRODERBUND Do you like Startrek adventures? 4 GALACTIC SAGAS From Broderbund, provide a level of complexity and sophistication not seen before. £13.95

GALACTIC EMPIRE, TRADER AND REVOLUTION (3 separate disks) £13.95

TAWALA'S LAST REDOUBT each £16.95

PLEASE ADD 15% VAT TO YOUR ORDER  
POSTAGE AND PACKING FREE  
ASK FOR OUR FULL CATALOG  
IF YOU KNOW WHAT YOU WANT AND DON'T WANT TO PAY  
AN INFLATED PRICE  
GIVE US A CALL — WE SELL ALL SORTS OF THINGS  
FOR APPLE  
TEL 01-677 2052 (24 HRS) 7 DAYS A WEEK  
98 MOYSER ROAD LONDON SW16 6SH  
POST OFFICE GIRO NO. 585 6450

# NEW from Computer Centre

## WINCHESTERS

Our Winchester fixed disc systems  
are now in production.

### OEM 4

Stand alone S100 main frame with  
DMA controller to the hard disc.

20 MEGABYTES  
(DRI 3100 WINCHESTER)  
Z80 . 80K BYTES . FLOPPY  
SERIAL & PARALLEL I/O

£4,950

### SUB SYSTEM

This will interface to any single density  
floppy disc controller. Plug  
compatible to most existing 8 inch  
floppy systems.

20 MEGABYTES  
(DRI 3100 WINCHESTER)  
INTELLIGENT INTERFACE

FROM £2,500

### NEXT...OEM 5

MULTI USER SYSTEM  
16 BIT MICRO  
128K BYTES RAM  
20 MEGABYTE FIXED  
1 MEG FLOPPY  
FRONT END PROCESSOR  
FOR UP TO EIGHT TERMINALS

ALL FOR UNDER

£6,500



Comcen are also Apple dealers  
- Ring us for a quote - We have  
the best prices nationwide.

# ComCen

9 De La Beche Street, Swansea, SA1 3EX  
Tel: (0792) 460023, Telex: 48638  
45-46 Wychtree Street, Morriston, Swansea,  
Tel: (0792) 796000

computer

centre



# Everything you want and more from Computer Centre



## OEM FROM £1,970

High speed Z80 microprocessor. Twin 8" floppy disc drives. 16K to 256K bytes RAM. Up to 2 Megabytes on floppy discs. Supports Cobol, Fortran, Basic, Pascal, and PL/1. Multi-user versions. 20 Megabyte Winchester sub-systems.

The range of Comcen OEM machines starts with a six slot stand alone, Z80 with serial and parallel I/O at £499 and at the top of the range there are multi-user systems with 60 Megabyte Winchester fixed discs.

The common disc operating system for the OEM range of machines is CP/M which supports an extensive range of high level software. COMCEN also offer a free library of more than 40 8" diskettes packed with utility software, programming languages, user programs and games.



## MEGABOX £890

**MEGABOX DRIVES** Two 8 inch single or double sided drives in an attractive case with built in power supply. Front panel has illuminated mains switch. Units are supplied with appropriate cables for direct mains connection and plug compatibility to mainframes. Versions are available for Apple (SVC controller required), Tandy Model 2, as well as add-on drives to COMCEN kits or OEM systems, and other Shugart compatible disc systems.



## 525 SPECIAL £195

**BOXED 5 INCH DRIVE SA400** (or equivalent) Minifloppy drive with power supply and attractive enclosure. Compatible add on to TRS80, COMCEN OEMO, Horizon, Nascom, and many other standard floppy controllers. Mains cable and plug supplied, 34 way cables and connectors available to order.

Educational + OEM Volume Discounts Available

### FIRMWARE + MANUALS

Please write or call for details.

### PRICE LIST

#### OEM ASSEMBLED MACHINES

1560.00	OEMO Z80; 1SER; 1PAR; 2 120K Disks
1970.00	OEM1 Z80; 32K; 1SER; 1PAR; 2 1/4 MEG Disks
2270.00	OEM2 Z80; 48KB; 1SER; 1PAR; 2 1/4 MEG Disks
4950.00	OEM4 Z80; 1SER; 1PAR; 20 MEG Fixed; 1 Floppy

#### COMPUTER CENTRE KITS

800.00	K1 Computer Centre Mini System 5 Inch Disk
911.00	K2 Computer Centre Maxi System 8 Inch Disk
208.00	Z80 Starter Kit

#### TIME SHARING SYSTEMS

2350.00	MUO 2 User MP/M 2 120K Floppy Drives
3290.00	MU1 2 User MP/M 2 1 MEG Floppy Disc
6660.00	MT 2 VDU'S + MP/M + 20 MEG Fixed + Floppy
5150.00	SD-200 Computer 64K

#### DISC DRIVES

890.00	Megabox-S Twin 8" Single Sided Drives Boxed
995.00	Megabox-D Twin 8" Double Sided Drives Boxed
2950.00	20 MEG Winchester Sub-System
275.00	8 In Single Sided Disc Drive
395.00	8 In Double Sided Disc Drive
195.00	Boxed 5 Inch Drive with Power Supply
135.00	SA 400 Minifloppy Disc Drive
1350.00	DRE 3100 20 MEG Winchester Drive

#### VDU'S

695.00	Wordstar VDU
575.00	Pentland (Full Spec)

#### PRINTER'S

1790.00	QUME Sprint Daisywheel Printer
188.00	QUME Tractor
890.00	ANADEX 9500
449.00	ANADEX 8000
325.00	EPSON TX80
51.00	TX80 Graphics Option
345.00	EPSON MX 80

#### SOFTWARE

219.00	MP/M + Manuals
70.00	CP/M Operating System + 6 Manuals + Basic E
94.00	CP/M 2.2 + Manuals
209.00	COSMOS Multi-User OP. System
4.50	Library Copies on 8 Inch Media
4.00	Library Copies on 8 Inch Media (10 or more)
85.00	Microsoft Macro 80
148.00	Microsoft Basic
202.00	Microsoft Basic Compiler
255.00	Microsoft FORTRAN
376.00	Microlocus Compact COBOL
590.00	Microlocus VERS 4 COBOL
60.00	C Basic 2
148.00	Datastar
179.00	Wordstar 2.1
49.00	Mailmerge
63.00	Z80 SD Global PKG
113.00	SDOS
60.00	FORTRAN LIB for FPB
216.00	Configurable Business Package
60.00	Z-SID
255.00	Selector 4 C-2
127.00	Supersort 1

#### KITS MPU Assd

125.00	CB2 Z80A 1EEE S100	163.00
118.00	Godbout Z80	145.00
178.00	SBC100 Z80 + Serial + Parallel	197.00
194.00	SBC 200	224.00
163.00	Godbout 8085/8088 Tandem Board	219.00

#### KITS DISC CONTROLLER Assd

126.00	Tarbell Single Density	179.00
179.00	Tarbell Double Density	233.00
149.00	Versafloppy 1 - Single Density	181.00
214.00	Versafloppy 2 - Double Density	240.00
99.00	Tarbell Cassette Interface	

#### KIT RAM Assd

86.00	8K Bytes Econoram 2 (4Mhz) Static Ram	94.00
—	16K Econoram XIV (4Mhz)	155.00
180.00	16K Static Bank Sel/Ext Addr	185.00
231.00	24K Static Bank Sel/Ext Addr	236.00
298.00	32K Static Bank Sel/Ext Addr	333.00
245.00	Expandoram 2 (Dynamic) 16K Population	251.00
285.00	Expandoram 2 (Dynamic) 32K Population	290.00
322.00	Expandoram 2 (Dynamic) 48K Population	367.00
362.00	Expandoram 2 (Dynamic) 64K Population	

#### KIT INPUT/OUTPUT Assd

105.00	2SIO (2 Serial Full Handshaking Uarts)	130.00
82.00	IO4 2 Serial/Parallel	138.00
332.00	MPC-4 Serial I/O Controller	358.00

#### KITS SPECIAL BOARDS Assd

226.00	VDB-8024 (80 Chis 24 Lines) Video	263.00
88.00	PB1 2716/2708 Eprom Programmer	127.00
125.00	SD Prom 100 Programmer	150.00
49.60	2708 Prom Board (Ex Proms)	65.00
24.20	Active Terminator Kit	33.00
36.20	Memory Manager	46.00
98.00	VB2 64 32 Video + Keyboard Input Port	129.00
266.00	VB3 80 (Up to 51 Lines) + Graphics:	303.00
175.00	Spectrum Colour 8K + Parallel	184.00
29.60	S100 Extender + Logic Probe	—
21.00	MT3 11 Slot Motherboard	—
—	Floating Point	268.00
—	A/D 16 Channel 12 bit	450.00

#### POWER SUPPLIES

195.00	S100 Laboratory Cardcage and Powersupply
77.00	Power Supply for Mini/Maxi Kit (1 Drive)
81.00	Power Supply for Mini/Maxi Kit (2 Drives)
16.00	Transformer (Bus + Drives)

#### CONNECTORS

2.80	PIS 100 Edge Connectors
0.20	Card Guides
2.20	AC + DC Connectors for Dr Disc
1.80	DC Connectors for SA400
7.80	50 Pin Edge Connector for Dr Disc
9.80	50 Way Speed Block Connector
1.60	50 Way Ribbon Cable (Per Foot)
7.00	34 Pin Edge Connector for SA400
8.00	34 Way Speedblock Connector
1.00	34 Way Ribbon Cable (Per Foot)
5.00	26 Pin Edge Connector for SBC100
6.00	26 Way Speedblock Connector
0.80	24 Way Ribbon Cable (Per Foot)
11.60	D25 Special Ribbon Cable Edge Connector
1.60	16 Pin IC Sockets (Pack of 10)
1.60	14 Pin IC Sockets (Pack of 10)

#### IC'S

14.80	WD 1771 SD Disk Cont
5.00	2114
3.00	4116 (Or Equivalent) 250 NS
1.00	2102
15.00	Z80A
5.00	5257 4K 1 Static
8.20	8251
77.00	16K Expansion (TRS 80/Apple)
7.40	2708 Eprom
23.40	2716 Eprom 350 NS
11.60	2716 Eprom 450 NS

#### MEDIA

23.40	8" Single Sided Floppy Media (Box 10)
35.80	8" Double Sided Floppy Media (Box of 10)
26.20	5" Single Sided Floppy Media (Box of 10)

#### CONSUMABLES

14.00	11" 14.5 Continuous Lined Paper (2000 Box)
12.40	12" 9.5 Continuous Plain Paper (2000 Box)
8.60	11" 9.5 Continuous Plain 60g. (2000 Box)
37.40	Multistrike Ribbon (Qume Type) 12/Box
53.00	Singlestrike Ribbon (Qume Type) 12/Box
40.20	Fabric Ribbon (Qume Type) 12/Box
18.80	TX80 Ribbon 12/Box
6.60	Daisywheel Qume Type

Terms are Cash with Order  
Please add 2% for Post and Packing and 15% VAT

# ComCen

9 De La Beche Street, Swansea, SA1 3EX  
Tel: (0792) 460023, Telex: 48638

45-46 Wychtree Street, Morriston, Swansea,  
Tel: (0792) 796000

computer  
centre

# GW Computers Ltd

55 Bedford Court Mansions, Bedford Avenue, London W.C.1.  
call only by appointment



## SUPERBRAIN™

Intelligent Video Terminal Systems

### 350K or 700K of Disk Storage

SuperBrain's CP/M operating system boasts an overwhelming amount of available software in BASIC, FORTRAN, COBOL, and APL. Whatever your application... General Ledger, Accounts Receivable, Payroll, Inventory or Word Processing, SuperBrain is tops in its class. And the SuperBrain QD boasts the same powerful performance but also features a double-sided drive system to render more than 700K bytes of disk storage and a full 64K of RAM. All standard!



## COMPUSTAR™

MULTI-USER TERMINAL SYSTEM

CompuStar user stations can be configured in a countless number of ways. A series of three intelligent-type terminals are offered. Each is a perfect cosmetic and electrical match to the system. The CompuStar 10-a 32K programmable RAM-based terminal (expandable to 64K) is just right if your requirement is a data entry or inquiry/response application. And, if your terminal heads are more sophisticated, select either our CompuStar 20 or CompuStar 40 as user stations. Both units offer dual disk storage in addition to the disk system in the CompuStar. The Model 20 features 32K of RAM (expandable to 64K) and 350K of disk storage. The Model 40 comes equipped with 64K of RAM and over 700K of disk storage. But, most importantly, no matter what your investment in hardware, the possibility of obsolescence or incompatibility is completely eliminated since user stations can be configured in any fashion you like - whenever you want - at amazingly low cost!

## DISK STORAGE

### Options for the Superbrain and CompuStar Video Terminal

"Backup" for the 20 megabyte Century Data drive is provided via the dual disk system housed in the CompuStar or the SuperBrain. The Control Data CMD Drive features a removable, front-insertable top loading cartridge of 16 megabyte capacity plus a fixed disk capacity of either 16 or 80 megabytes.

Each drive is shipped equipped with an EIA standard 19" rack mounting system and heavy duty chassis slide mechanisms to permit easy accessibility for fast and efficient servicing.

\*\*\*\* WIDELY USED IN UK AND USA \*\*\*\*  
\*\*\*\* TESTED AND PROVEN \*\*\*\*  
\*\*\*\* POWER AT YOUR FINGERTIPS \*\*\*\*  
\*\*\*\* JUST COMPARE THIS LIST \*\*\*\*

### ★★ SALES COMMENT ★★

No other program in the world combines these features in one. Many other programs, less integrated, do not provide even some of those features to be found on our 'bus'.

- 1 = Total integration of sales/purchase/nominal 'stock' addresses etc
- 2 = Full random access enables retrieval of any record in a second
- 3 = Flexible prompts enables word change even to foreign language.
- 4 = Files may be named and set to drive default, maximising storage.
- 5 = Easy to use, menu driven, no serious need of manual.
- 6 = Tested and debugged in many installations world wide.
- 7 = Priced less than the acquisition of a library of programs.
- 8 = The program is ★★★ totally ★★★ in core, maximising disk space.
- 9 = Core program means that disks may be interchanged during use.
- 10 = Core program means your main drive is ★★★ free ★★★ for data
- 11 = Numerous reports may be generated (eg: sale ledgers up to 30).
- 12 = Invoice produces immediate stock update + double journey entry.
- 13 = Reference on invoices enable cost centre build-up on ledgers.
- 14 = Stock valuations and re-order reports easily generated.
- 15 = Bank balance and reports plus standard mailing facilities.
- 16 = Customer statements and invoices printed on plain paper.

As prices vary from dealer to dealer we append for your guidance, some details of the justification in our prices being higher than the cash/carry concept of trade. A standard Superbrain 64K ★320K Disk at 1795.00 includes the following values not normally expected at the lower price.

- 1) Equipment is burned and tested for a minimum 48 hours
- 2) Delivery in U.K. is free of charge
- 3) All goods & software are stocked on immediate delivery
- 4) 6 month main unit, 12 month memory guarantee
- 5) 24/48 hour mailing of any spare module free within warranty
- 6) Same service as 5) outside warranty for ad hoc charge
- 7) 10 free Diskettes (28.50)
- 8) 10% of hardware value in free software (1795.00)
- 9) Positive before ★★ and ★★ after sales service

If the transaction includes a printer and the business programs then the following are also added:

- 10) All cabling between printer and Superbrain free (25.00)
- 11) Ribbon and thimble free (eg: Spinwriter 4.75 + 9.75)
- 12) Extra 10 Diskettes free (28.50)
- 13) Additional free software based on 10% of printer value
- 14) Free training session plus all necessary follow up
- 15) Box printer paper (28.50)

A typical deal could look like this:

Superbrain	1795.00
NEC Spinwriter	1695.00
	3490.00

BUS Program 775.00 plus Basic 150.00 (less 349.00) = 576.00  
Total Purchase Price 4066 plus V.A.T.

The total value of free items on this deal was in excess of 500 pounds in virtue of incidental items as well as extended warranty and software.

Do consider your purchase on the basis of some of the things you may be likely to need after your equipment purchase, and may either fail to obtain because the dealer has no stock or has lost interest in you, or because you aimed at the short term gain in price and are then compelled to pay heavily for small needs afterwards.

GRAMA WINTER, 55 BEDFORD COURT MANSIONS, BEDFORD AVE.,  
LONDON WC1. TEL NO. 636 8210/631 4818



**\*\*\* MAIN MENU DISPLAY \*\*\***

**New! Produced in U.K. and widely used in England and the U.S.A.  
Complete Business Package**

**INCLUDES EVERYTHING FROM INVENTORY TO SALES SUMMARY  
PROMPTS USER AND VALIDATES ENTRIES. MENU DRIVEN**

PET AND CP/M SUPERBRAIN, TRS80 ii, N'STAR, IMS5000.

APPROXIMATELY 60-100 ENTRIES/INPUTS REQUIRE 2-4 HOURS WEEKLY  
AND ENTIRE BUSINESS IS UNDER CONTROL

\* PROGRAMS ARE INTEGRATED .. SELECT FUNCTION BY NUMBER .....

- |                               |                                |
|-------------------------------|--------------------------------|
| 01=*ENTER NAMES AND ADDRESSES | 13=*PRINT CUSTOMERS STATEMENTS |
| 02=*ENTER/PRINT INVOICES      | 14=*PRINT SUPPLIER STATEMENTS  |
| 03=*ENTER A/C RECEIVABLES     | 15=*PRINT AGENT STATEMENTS     |
| 04=* ENTER PURCHASES          | 16=*PRINT TAX STATEMENTS       |
| 05=*ENTER A/C PAYABLES        | 17=LETTER TEXT AREA            |
| 06=*ENTER/UPDATE INVENTORY    | 18=ALTER VOCABULARIES          |
| 07=*ENTER/UPDATE ORDERS       | 19=PRINT YEAR AUDIT            |
| 08=*ENTER/UPDATE BANKS        | 20=PRINT PROFIT/LOSS A/C       |
| 09=*REPORT SALES LEDGER       | 21=OPEN AREA                   |
| 10=*REPORT PURCHASE LEDGER    | 22=PRINT CASHFLOW FORECAST     |
| 11=*INCOMPLETE RECORDS        | 23=ENTER PAYROLL (NO RELEASE)  |
| 12=*USER DBMS AREA            | 24=DISK SWAP/EXIT              |

**DATABASE MANAGEMENT INCLUDES**

\*\*\* FILE OR RECORD CREATE/DELETE/AMEND/SEARCH/PRINT 4 WAYS \*\*\* INFORMATION RETRIEVAL ON ANY KEY RECORD OR PART THEREOF \*\*\* AUTOMATIC CHECK TO PREVENT DOUBLE ENTRY TO FILE SYSTEM \*\*\* DYNAMIC ALLOCATION OF INFORMATION CONSERVING DISK SPACE.

VERY FLEXIBLE. EASY TO USE.

G.W. COMPUTERS LTD. UK ARE THE PRODUCERS OF THIS BEAUTIFUL PACKAGE. \*AUTHOR\* TONY WINTER (B.A.LIT; B.A.HON.PHIL).

PET VER 3.00 LOW LEVEL INTEGRATION = 475.00. PET VER 4.00 INCLUDES AUTO STOCK-UPDATE = 575.00.

PET VER 5.00 INCLUDES AUTO BANK UPDATE = £675.00. CPM VER 6.00 IN CORE, TRANSLATABLE PLUS

DBMS = 775.00. CPM VER 7.00 AUTO STOCK-UPDATE = 875.00. CPM VER 8.00 AUTO BANK UPDATE = 975.00.

CPM VER 9.00 INCLUDES OPTIONS 19, 20, 22, 23 (LATER RELEASE). +++ EACH LEVEL AUGMENTS LOWER ONE.

**WE EXPORT TO ALL COUNTRIES CALLERS ONLY BY APPOINTMENT**

**CONTACT TONY WINTER ON 01-636 8210 01-631 4818**

**55 BEDFORD COURT MANSIONS, BEDFORD AVENUE, LONDON W.C.1.**

**NOTE!!! LEVEL 9.00 TOTALLY IN CORE PROGRAM LEAVES MASTER DRIVE FREE  
(SAVING OF 200 POUNDS HARDWARE).**

**IMPORTANT!!! No computer hardware is ever of value without software, so we provide you with a starting set of programs \*\*\*\* free \*\*\*\* at 10% of hardware purchased. A Superbrain and NEC Spinwriter could give you up to 400 pounds of programs. See [ ] .**

**PET + PET + PET + PET + SOFTWARE + SOFTWARE + SUPERBRAIN + SUPERBRAIN**

CBM 3032 32K	595.00	BUS VER 3.00	PET	475.00	SUPERBRAIN 320K	1795.00
CBM 3040 DISKS	595.00	BUS VER 4.00	PET	575.00	TWIN Z80 64K+CRT	.....
CBM 3022 PRINTER	425.00	BUS VER 5.00	PET	675.00	+2 D'D-D'S DRIVE	.....
CBM 8032 32K	875.00	BUS VER 6.00	CP/M	775.00	SUPERBRAIN 800K	2195.00
CBM 8050 1MEG DISKS	875.00	BUS VER 7.00	CP/M	875.00	TWIN Z80 64K+CRT	.....
CBM EPSON PRINTER	395.00	BUS VER 8.00	CP/M	1000.00	+2 D'D-D'S DRIVE	.....
CBM MULTI USER	650.00	BUS VER 9.00	CP/M	1075.00	SUPERBRAIN 2MEG	2795.00
CBM 3032 + EPSON +	.....	CBM WORDPRO II		75.00	COMPUSTAR 10	1595.00
CBM 3040 + BUS V3	2215.00	CBM WORDPRO III		150.00	COMPUSTAR 15	1495.00

**PRINTERS + PRINTERS +**

DIABLO 630 40CPS	1595.00
DOLPHIN BD80 125CPS	495.00
NEC 5510 PRINTER	1695.00
MICROLINE 80 120CPS	475.00
TELETYPE 43SR 30CPS	875.00
DEC-LA34 TRACT 30CP	875.00
NEC-5630 PRINTER	1595.00
QUME DAISY SPRINTS	1950.00
TEXAS 810 150CPS	1390.00

**SPECIALS + SPECIALS +**

N'STAR QUAD .7 MEG	1500.00
IMS 5000 48K D'D	1200.00
COMPUTHINK * 800K *	795.00
2 WAY CROLESS PHONE	135.00
TELEPHONE ANSWER	230.00
SHUGART SA400 5" DR	135.00

CPM* WORD-STAR	195.00
CPM* MBASIC 80	150.00
CPM* COBOL 80	320.00
CPM* PASCAL MT	150.00
CPM* FORTRAN 80	200.00
CPM* DATASTAR	175.00
CPM* PASCAL-M	250.00
CPM* BYSTAM S'BRAIN	75.00
CPM* SUPERSORT	120.00
CPM* BASIC COMPILER	190.00
CPM* DESPOOL	30.00
CPM* BYSTAM IMS'N-STAR	75.00
CPM* TEXTWRITER	75.00
CPM* POSTMASTER	75.00
CPM* SELECTOR 3	180.00
CPM* CBASIC	75.00
CPM* MACRO 80	75.00
CPM* W'STAR M'MERGE	245.00

BUS MANUAL *****	9.00
SUPERBRAIN 320K	1695.00
TWIN Z80 32K+CRT	.....
+2 D'D-S'S DRIVE	.....

**NEW + NEW + NEW + NEW + NEW**

Specialist Business Computer system  
Z80 64k RAM single floppy disc  
drive 372k. Plus five meg hard disc  
all in one integral unit £5,250

**WARRANTY  
6 MONTH FULL REPAIR \*\*\***

+++++ SPECIAL INSTITUTION AND UNIVERSITY DISCOUNTS +++++

MOST ITEMS IN STOCK. (ACCESS 'AMEXCO' BCLYCARD OTHERWISE CHEQUE WITH ORDER)

CONTACT TONY WINTER 01-636 8210/01-631 4818

55 BEDFORD CT MANS, BEDFORD AVE W.C.1.

# Microtrend software and the Adler Alphatronic NOW YOU'RE TALKING BUSINESS

Microtrend Ltd., has software now for the microcomputer with a future. This wide range of well-specified, user-friendly and professionally-packaged products includes five accounting systems, two word processors (plus an inter-micro communications system for electronic mail and other data transfer operations).

Adler Business Systems provide Microtrend's Trendisk/1 Data Management System free of charge with each Alphatronic.

Combine our excellent software with the superb Alphatronic and you are really talking business. Microtrend products are available off the shelf from your local dealer or distributor.

Call 0423-711878 or write to  
Microtrend Ltd.,  
P.O. Box 51,  
Pateley Bridge,  
Harrogate, HG3 5DP.,  
for more details.



Professional Software for Microcomputers



# NOW £1550 CAN BUY YOU A LOT OF COMPUTER.

Alphatronic printers guarantee highest print quality.

12" professional size screen with easy-to-read characters.



Alphatronic is from Adler — reliability and nationwide dealer service is assured.

Central processor big enough to handle the most sophisticated programs.

## NEW ADLER ALPHATRONIC.

The new Alphatronic — everything you'd look for in a micro with one important difference. It has the Adler reputation for reliability and the network of Adler dealers to give an unrivalled back-up service.

Compare the features Alphatronic gives with others at a higher price and we think you'll agree — Alphatronic is a lot of computer for the money.

★ Two double density floppy disk drives — 160 KBytes each for program and data storage.

★ 48 KBytes Random Access Memory.

★ An impressive baud rate of 4800.

★ High resolution screen giving 24 lines of 80 characters.

★ A dot matrix printer that produces 80 characters per second.

★ Languages that include Basic, Basic Compiler, with Fortran and Pascal to come, as well as a CP/M† disk with Assembler and text editor.

★ An extensive software library.

★ Conventional typewriter format keyboard for easy use.

★ Input/output interfaces for future expansion of system.

### What do you get for your money?

Alphatronic P1 is £1550\* and includes a 2000 character screen, keyboard and integral double density floppy disk unit. You can easily add to your Alphatronic. For example, the P2 includes a 2000 character screen, keyboard, two integral double density floppy disk units together with a dot matrix printer, CP/M† disk and manual, and costs just £2345\*.

\*Prices exclusive of VAT. †Trade mark of Digital Research Inc.

### FREE

With Model P1, a two disk basic teach-in course, worth £85.  
With Model P2, a two disk data retrieval program, worth £120.



### The Adler Alphatronic from £1550. Brilliantly simple.

Alphatronic Division, Adler Business Systems Ltd., 27 Goswell Road, London EC1M 7AJ. The UK subsidiary of Triumph-Adler.

Tel: 01-250 1717. (Alphatronic Division)

Please send me further information on the Alphatronic computer and the name and address of my nearest Alphatronic dealer.

Name .....

Company .....

Address .....

Telephone .....

# Intex DATALOG LTD

## COMPUTERS

### MICROPAY-200

£195.00 + VAT

Micropay-200 is a complete payroll System designed to run on a COMMODORE 32K PET microcomputer, interfaced to dual floppy disk drives and a printer.

**The System provides:**

1. Weekly/monthly payslips
2. Summary page of all payments and deductions that month
3. Summary page of all payments and deductions for the tax year to date.
4. Weekly/monthly cash analysis slip for all cash payments made.
5. Monthly summary of all payments and deductions
6. Year end summary of all payments and deductions

### STOCK CONTROL 3750

Stock Control 3750 is a complete stock control system designed and written to meet the needs of a small business. It will accommodate up to 3747 stock items and runs on a COMMODORE PET micro-computer interfaced to a printer and COMPU/THINK disk drives.

**The System Incorporates programs to:**

1. Set up a Supplier file
2. Set up Stock files
3. Copy Data files
4. Insert/delete stock records
5. Insert/delete supplier records.
6. Update/display stock file.
7. Update/display supplier file.
8. Print stock list.
9. Print supplier list.
10. Print reorder report.
11. Print stock movement report.
12. Print stock valuation report.

And perform other useful routines.

Stock Control 3750 is fully protected from misuse and can easily be used by someone with no knowledge of computers or their operation.

The System costs £195.00 + V.A.T. and this price includes a full back-up and advisory service from INTEX DATALOG.

**FOR FULL SPECIFICATION WRITE TO:**  
 INTEX DATALOG LTD, DEPT PCW 0281  
 EAGLESCLIFFE IND. EST., EAGLESCLIFFE  
 CLEVELAND TS16 0PN. TEL: 0642 781193

### MAIL ORDER SERVICE

BARCLAYCARD - ACCESS

INDEX	PRICE	TOTAL INC. VAT		
***DUSTCOVERS			*** CONNECTORS	
PET - ALL MODELS	5.75	6.90	USER/EEE PORT	1.30 1.78
T/T43 PRINTER	5.75	6.90	CASSETTE PORT	99 1.43
ANADEX DP8000	3.50	4.35	USERPORT COVER	2.50 3.16
CBM 3040 DISK	3.50	4.35	MALE 'D' PLUGS	2.50 3.16
CBM 3022 PRINTER	3.99	4.80	FEMALE 'D' SOCKETS	3.50 4.31
COMPUTHINK DISK	3.00	3.75	'D' CONNECTOR COVERS	2.50 3.16
ACCOUSTIC COVER FOR			***RIBBONS	
CBM 3022 PRINTER	49.00	62.00	TELETYPE 43	7.72 9.17
*** D/D DISKETTES IN FREE CASE			ANADEX DP8000	2.75 3.45
BASF	35.00	40.83	ANADEX DP9500/1	15.00 18.40
ACCUTRAK	30.00	35.08	CBM 3022	2.75 3.45
LIBRARY CASE	3.50	4.60	QUME (FABRIC)	4.25 5.18
***BLANK CASSETTES			QUME (CARBON M/S)	4.50 5.46
C15 (PER 10)	4.00	5.75	QUME (CARBON S/S)	5.00 6.04
C60 (PER 10)	6.00	8.05	DAISY WHEELS	
			QUME SPRINT 5	6.50 7.76
			***PROGRAMMERS TOOLKIT	
			***SPECIAL OFFER	
			OLD ROMS 8K	65.00 75.90
			NEW ROMS 8K	65.00 75.90
			NEW ROMS 8/16/32K	45.00 52.90

### PROKIT 1

**PROKIT 1 - PROGRAMMERS AID.**

ADDS THAT TOUCH OF PROFESSIONALISM TO EVERY PROGRAM YOU WRITE.

**NUMERIC INPUT ROUTINES** - AUTOMATICALLY ADD LEADING AND TRAILING ZERO'S AND RESPOND ONLY TO MERIC KEYS AND DECIMAL POINT.

**GENERAL INPUT ROUTINES** - SET THE LENGTH OF FIELD REQUIRED. SPECIFY WHICH CHARACTERS YOU WANT PET TO RESPOND TO AND ALL OTHERS WILL BE IGNORED.

**DATE INPUT ROUTINE** - THE PROGRAM WILL NOT CONTINUE UNTIL YOU HAVE ENTERED A VALID DATE.

**STRING SEARCH ROUTINE** - FINDS A MATCHING SUB-STRING WITHIN A STRING ENABLES YOU TO USE ON GOTO WITH ANY CHARACTERS, NOT JUST NUMBERS.

**SCREEN ROUTINES** - CAN STORE SCREEN DISPLAYS IN MEMORY AND RETRIEVE THEM IN A FLASH - SUPER FOR MENUS AND GAMES!

PROKIT 1, DEFINITELY THE BEST THING FOR PROGRAMMERS SINCE THAT OTHER KIT! AVAILABLE ON DISK OR TAPE READY TO INCORPORATE IN YOUR OWN PROGRAMS!

PRICE £40.25 INC. VAT AND POSTAGE



**Digital Design and Development**  
 18/19 Warren Street London W1P 5DB Tel: 01 387 7388

### Scientific and Industrial Interface Specialists.

### SHARP MZ-80K CBM PET

**Specialist Suppliers of Complete Systems for Industrial and Laboratory Monitoring and Control.**

### SHARP MZ-80K INTERFACES

- Parallel Printer Interface £110
- Serial Printer Interface £150
- Bi-Directional Serial Interface £210
- 16-Channel A/D Converter Unit £280
- Fast Data Acquisition System - 40,000 readings/sec. 4 analog channels channels IN and 4 channels OUT. £1200

### PET INTERFACES

#### IEEE-488 Compatible Units

- 16 Channel 8-Bit A/D Converter £300
- 8 Channel 8-Bit D/A Converter £350
- 8 Channel 12-Bit A/D Converter £600
- 12-Bit D/A Converter £695
- X-Y Analog Plotter Interface £200
- Digital Data Input Unit, 64 Bits £400
- Digital Data Output Unit, 64 Bits £350
- 16 Channel Relay Unit £350

Also . . .

- USER Port Converter A/D plus D/A £200
- Fast Data Acquisition System 40,000 readings per sec. 4 A/D + 4 D/A £1200

All units boxed complete with IEEE-488 address internally selectable, with integral power supply, cables, switch, fuse, indicators and illustrative BASIC software.

TERMS: All prices Ex-VAT. P&P extra. Cheques should be made payable to 3D Digital Design & Development. All goods supplied under 90 days warranty. CUSTOM DESIGN UNDERTAKEN.



# Microcomputers on a mini budget

Businessmen and professional people alike can rid themselves of day-to-day problems and increased workload with a microcomputer.

Just a few tasks a microcomputer could be organising for your company, division or department:-

- Accountants
- Estate Agents
- Retailers
- Insurance Brokers
- Doctors
- Dentists
- Solicitors
- Architects
- Engineers
- Chemists
- Farmers
- Bankers
- Teachers

to name but a few



- Sales Ledger
- Purchase Ledger
- Nominal Ledger
- Sales Forecasting
- Stock Control
- Job Costing
- Estimating
- Payroll
- Word Processing

(automatic compilation, editing and production of repetitive letters and documents).

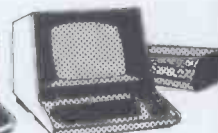
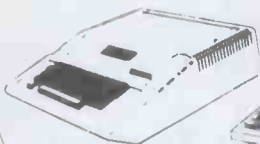

	PET	APPLE II	SHARP	SUPERBRAIN	RAIR
<b>SYSTEM A</b> Basic computer including screen & keyboard	£399	£775	£450	—	—
<b>SYSTEM B</b> As 'A', plus floppy disk drive(s) and matrix printer for small business user.	£1700	£1655	£1750	£2200	£2480
<b>SYSTEM C</b> As 'B', but quality printer for word processing as well.	£2700	£2050	£2250	£2600	£2850
<b>SYSTEM D</b> As 'C', plus hard disk for up to 10,000,000 bytes on line.	—	£5550	—	—	£5350

\*Prices exclude VAT

# Johnson

microcomputers

A member of the T. V. Johnson Group



Johnson House, 75-79 Park Street,  
Camberley Surrey. Telephone 0276 20446  
48 Gloucester Road, Bristol. Telephone 0272 422061  
148 Cowley Road, Oxford. Telephone 0865 721461

INTERFACE

# INTERFACE SOFTWARE

INTERFACE

introduce their  
**\*\* VERSION 2 BUSINESS PACKAGES \*\***

Tried and proven enhancements of the successful Release 1 systems.  
Now for floppy and hard disks, single and multi-user microcomputer systems.

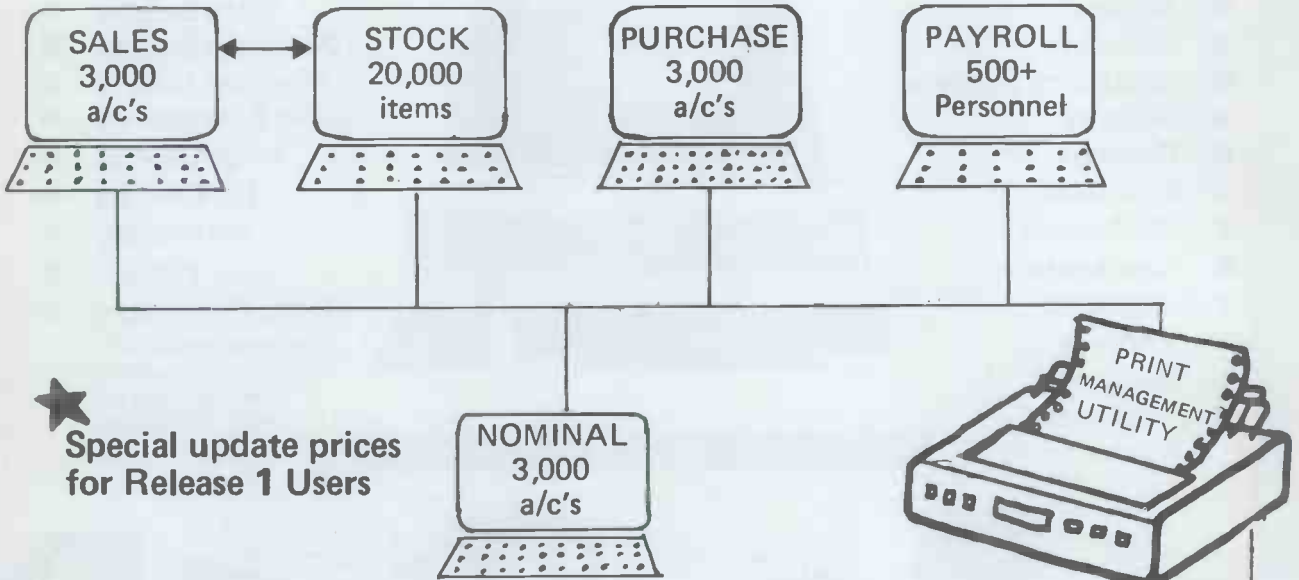

★ Special update prices for Release 1 Users

- Nominal Ledger Accounting Transfers
- Stock integration on Invoicing with Stock Update
- CP/M and MP/M operating systems
- Full Audit Trails
- Inbuilt Training and diagnostic aid
- Free 24hr problem solving service
- Hard or Floppy Disk systems
- Multi-Tasking
- Print Management Utility
- Distributor/Dealer enquiries welcome
- Dealer Demonstration Packages

- VAT ANALYSIS
- SALES ANALYSIS
- INVOICE
- CREDIT NOTE
- TRANSACTION REPORT
- CASH REQUIREMENTS
- INVENTORY UPDATE REPORT
- PROFIT & LOSS a/c
- TRIAL BALANCE
- AGING REPORT
- COST OF SALES
- ETC.,
- ETC.

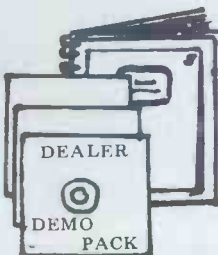

**INTERFACE SOFTWARE BUSINESS PACKAGES**  
**THE HARDWEARING SOFTWARE**  
 100 Park Street, Camberley, Surrey, GU15 3NY  
 (0276 27982)



# SERVICE PROBLEMS?

## Problem

"I live in a remote part of the west country and have a video problem on my 32K Pet"

## Problem

"I work in industry in NW England, need my Pet most days and am worried over breakdown problems"

## Answer

"Phone **STACK** and ask for details of our repair service contract with shipping by express carrier"

## Answer

"Ring **STACK** and ask for a quotation on our on-site service contract with radio controlled vehicles"

**RING OUR SERVICE RECEPTION ON  
051 933 5511**



## PET 4022 Printer

**£395**  
Plus VAT

- Full graphics printing
- True decenders on characters
- 12 month express carrier warranty
- 80 columns

- Consumables
- Apple

- Printers
- Disk Drives

Ring us for a catalogue or quotation  
051-933 5511 or just post the coupon

## PET TOOLKITS!

3.0 Basic            £25.00  
NOW 4.0 Basic    £35.00

## NOW 12 MONTHS PARTS & LABOUR WARRANTY

- PLUS FREE 24 Hr EXPRESS CARRIER COLLECTION AND DELIVERY

(on all equipment over £250 (ex VAT) bought at list price.)

- Offer subject to change without notice.

For more information cut out this coupon  
Please send me details of

- Pets
- Apple
- Service Contracts
- Consumables

and add me to your mailing list.

Name \_\_\_\_\_

Address \_\_\_\_\_

\_\_\_\_\_

\_\_\_\_\_

Please send to **STACK COMPUTER SERVICES LTD**  
290-298 Derby Road, Bootle, Liverpool 20.  
Telephone 051-933 5511 for all your enquiries.

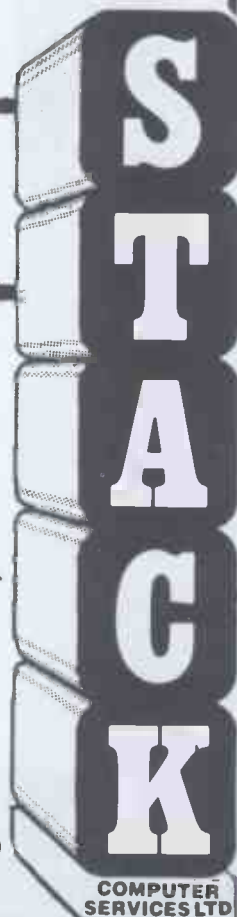

EUROPE'S LARGEST SELECTION OF MICROCOMPUTER SOFTWARE, BOOKS AND MAGAZINES  
FOR THE HOBBYIST, EDUCATIONALIST, PROFESSIONAL AND RETAILER

## BOOKS

### BY OSBORNE

Introduction to Microcomputer Series	
Vol 0: Beginners Book	£5.95
Vol 1: BASIC Concepts	£8.25
Vol 2: Some Real Microprocessors (without binder)	£18.95
Vol 2: Some Real Microprocessors (with binder)	£20.50
Vol 2: Updating supplement set Nos. 1-6	£18.95
Vol 3: Some Real Support Devices (without binder)	£11.95
Vol 3: Some Real Support Devices (with binder)	£13.50
Vol 3: Updating supplement set Nos. 1-6	£18.95
1 Binder (Specify for Vol 2 or 3)	£5.75
1 Updating supplement (Specify for Vol 2 or 3)	£4.00
PET and the IEEE 488 (GPIB) Bus	
6800 Programming for Logic Design	£6.30
8080 Programming for Logic Design	£6.30
Z80 Programming for Logic Design	£6.30
Z80 Assembly Language Programming	£10.75
6502 Assembly Language Programming	£10.75
8080A/8085 Assembly Language Programming	£7.95
6800 Assembly Language Programming	£7.95
Accounts Payable and Accounts Receivable (C BASIC or Wang)	£13.15
Payroll with Cost Accounting (C BASIC or Wang BASIC)	£13.50
General Ledger (C BASIC or Wang BASIC)	£12.25
Some Common BASIC Programs	£8.95
Practical BASIC Programs	£9.25
Running Wild	£2.00
8089 I/O Processor Handbook	£4.00
Z8000 Assembly Language Programming	£13.50
The CRT Controller Handbook	£4.50
Apple User's Guide	£13.95
CP/M User's Guide	£13.95
The 68000 Handbook	£13.95
16 Bit Microprocessor Handbook	£13.95
6809 Assembly Language Programming	£13.95

### GENERAL

See Magazines and Subscriptions!	See Osborne Books!
Microprocessors from Chips to Systems	£7.00
Microprocessor Interfacing Techniques	£9.95
IC OP-AMP Cookbook	£8.95
RTL Cookbook	£4.25
Circuits Circuit Cellar	£5.50
Buyers Guide to Microsoftware	£2.40
Calculating with BASIC	£4.95
Computer Programs that Work (in BASIC)	£3.95
Dr Dobbs Journal Volume 1	£13.95
Dr Dobbs Journal Volume 2	£13.95
Dr Dobbs Journal Volume 3	£13.95
Best of Byte	£8.95
Scelbi BYTE Primer	£8.95
Best of Creative Computing, Vol 1	£6.95
Best of Creative Computing, Vol 2	£6.95
Program Design	£4.25
Programming Techniques: Simulation	£4.25
Numbers in Theory and Practice	£5.50
PHMS - A Database Management System	£6.50
Best of Interface Age - Software	£9.95
Programming the Z8000	£7.95
CPM Handbook	£8.95
K2 FDOS	£12.95
8086 Book	£11.25
Microsoft BASIC University Software Inc., Listings: Home and Economics Programs	£15.00
Education and Scientific Programs	£20.95
Small Business Programs	£29.50

### FOR THE Z80

See Osborne Books!	
Z80 Instruction Handbook (Wickworth)	£2.95
Programming the Z80 (Zacs)	£9.95
Z80 Software Gourmet Guide and Cookbook	£8.95
32 BASIC Programs for the TRS-80 (Level II) 16K	£10.10
Introduction to the T-Bug (Guide to TRS-80 Machine Language Monitor)	£4.50
30 Programs for the Sinclair ZX80	£6.95

### FOR THE 6800

See Magazines and Subscriptions!	See Osborne Books!
6800 Software Gourmet Guide and Cookbook	£7.15
6800 Tracer - An Aid to 6800 Program Debugging	£3.95
Tiny Assembler	£5.75
RA 6800 ML - An M6800 Relocatable Macro Assembler	£15.95
Link 68 - An M6800 Linking Loader	£5.50
MONDEB - An Advanced M6800 Monitor Debugger	£3.50

### CONCERNING LANGUAGE

Beginners guide to UCSD PASCAL	£7.50
SCELBAL - BASIC Language Interpreter (Source Code)	£15.00
Instant BASIC	£6.95
BASIC BASIC	£6.50
Advanced BASIC	£6.00
Users Guide to North Star BASIC	£10.00
A Practical Introduction to PASCAL	£3.95
Microsoft BASIC (a guide)	£6.50
Secret Guide to Computers	£4.00
BYTE Book of PASCAL	£16.25

### FOR THE 6502

See Magazines and Subscriptions!	See Osborne Books!
Best of Micro, Vol 1	£5.50

### FOR THE 6502

Best of Micro, Vol 2	£5.50
Programming the 6502 (Zacs)	£7.95
6502 Applications	£7.95
6502 Software Gourmet Guide and Cookbook	£7.25
The PET Revealed	£10.00
32 BASIC Programs for the PET	£10.10
First Book of KIM	£7.00
PET/CBM Personal Computer Guide	£10.00
Library of PET Subroutines	£10.00

### FOR THE 8080

See Osborne Books!	
8080 Programmers' Pocket Guide	£1.95
8080 Hex Code Card	£1.95
8080 Octal Code Card	£1.95
8080 Software Gourmet Guide and Cookbook	£7.15
8080/8085 Software Design	£6.75
8080 Standard Monitor	£9.95
8080 Standard Assembler	£9.95
8080 Standard Editor	£9.95
8080 Special Package: Monitor, Editor, Assembler	£20.00
BASEX - A simple Language and Compiler for the 8080	£5.50

### FOR FUN

BASIC Computer Games	£5.00
More BASIC Computer Games	£5.50
8080 Galaxy Game	£6.95
SUPER-WUMPUS - A Game in 6800 Assembler Code & BASIC	£4.25
Computer Music Book	£6.95
Computer Rage (a Board Game)	£6.95
Games, Tricks and Puzzles for a Hand Calculator	£2.49
Introduction to TRS-80 Graphics	£5.75
Take My Computer Please... (Fiction)	£3.25
Introduction to Low Resolution Graphics for PET, Apple TRS-80	£5.50
Starship Simulation	£4.50
Microsoft BASIC: University Software Inc., Listings:	
Fun and Games Programs 1	£9.50
Fun and Games Programs 2	£9.50
6502 Games	£7.95

### FOR THE NOVICE

See Magazines and Subscriptions!	See Osborne Books!
Getting Down to Business with Your Microcomputer	£5.50
Introduction to Personal and Business Computing	£5.50
Getting Involved with Your Own Computer	£6.50
How to Profit from Your Personal Computer	£6.50
Microcomputer Potpourri	£1.95
Hobby Computers are Here	£3.95
New Hobby Computers	£3.95
Understanding Microcomputers and Small Computer Systems	£6.95
Understanding Microcomputers and Small Computer Systems and Audio Cassette	£8.75
How to Make Money with Your Microcomputer	£5.75
From the Counter to the Bottom Line	£10.00
Buying a Business Computer	£9.75
You Just Bought a Personal What?	£7.95

### MAGAZINES

MAGAZINE SUBSCRIPTIONS (all processed within 3 weeks)	
Micro 6502 Journal (12 issues)	£14.50
68 Micro (12 issues)	£18.00
Personal Computing (12 issues)	£18.00
Interface Age (12 issues)	£25.50
Dr Dobbs Journal (12 issues)	£16.00
Recreational Computing (6 issues)	£11.50
BYTE (12 issues)	£33.00
Creative Computing (12 issues)	£22.00
Kilobaud Microcomputing (12 issues)	£26.00
Compute for the 6502 (12 issues)	£22.00
80' Microcomputing (12 issues)	£25.00
S-100 Microsystems (for CPM users) (6 issues)	£10.50

### MAGAZINE BACK ISSUES

Micro 6502 Journal	£1.75
Personal Computing	£1.95
Interface Age	£2.95
Dr Dobbs Journal	£1.95
Computer Music Journal	£3.75
Recreational Computing	£1.95
BYTE	£3.25
Creative Computing	£1.95
Calculators and Computers	£1.95
Kilobaud Microcomputing	£3.25
Compute - for the 6502	£2.25
68' Micro	£1.95
80' Microcomputing	£2.95
On Computing	£1.95
S-100 Microsystems	£1.95
Magazine Storage Box (holds 12)	£2.00

### BYTE NIBBLE REPRINTS:

a) A TMS 9900 Monitor	£3.50
b) BASIC Cross Reference Generator	£1.75
c) A Micro Word Processor	£4.50
d) Tiny PASCAL in 8080 Assembly Language (if needed to use this)	£13.90
e) A Tiny PASCAL Compiler	£13.50
f) An API Interpreter in PASCAL	£13.00
g) Computer Assisted Flight Planning	£2.35
h) Computerized Wine Cellar	£2.00
i) The Design of an M6800 Lisp Interpreter	£13.00



8-11 CAMBRIDGE HOUSE, CAMBRIDGE ROAD, BARKING, ESSEX IG11 8NT, ENGLAND.  
Telephone: 01-591 6511 Telex: 892395

## SOFTWARE Software/Manual Only

## SOFTWARE Software/Manual Only

**Byrom Software** BSTAM—Utility to link one microcomputer to another also using BSTAM. £70/5  
BSTITIS—Utility to link a micro to a mini or mainframe. £95/10

**Compiler Systems** CBASIC v2.06 £65/15

**Computer Plus** FMS 80 (File Management System) £395/25

**Computer Services** Bidirectional driver for Diablo Hytype printers for use on CPM & CDOS systems £65/10

**CP/M User Library** 42 Volumes (one volume per disc) 8" £4/  
42 Volumes (one volume per 2 discs) 5" £8/  
Index £1/

**Creative Computing** CS-9001 BASIC Games 1 £12/  
CS-9002 BASIC Games 2 £12/  
CS-9000 BASIC Games 1 and 2 £22/  
CS-9003 ADVENTURE I.O. £12/  
CS-9004 BILINGUAL Original Adventure £12/  
CS-9005 BASIC Games 3 £12/  
CS-9006 BASIC Games 4 £12/  
CS-9007 BASIC Games 3 and 4 £22/  
CS-9008 BASIC Games 1, 2, 3 and 4 £40/

**Digital Research** (Most formats now available)  
MPM 1.1 £175/18  
CP/M 1.4 £65/18  
CP/M 2.2 £90/18  
CP/NET £130/12  
SID £45/12  
ZSID £55/12  
MAC £55/12  
TEX £45/12  
DESPOOL £30/5  
PL/1 £325/25

**Information Unlimited** WHATSIT (Database Management System) on North Star £59/  
on CP/M £75/  
on APPLE 2:48k (requires int Basic) £72/  
on APPLE 2:32k (requires int Basic) on ITT 2020 (see Apple) £59/

**KLH Systems** Spooler for CPM systems £65/5

**MPI Ltd.** Diablo driver runs 110 to 9600 baud for CP/M or CDOS £30/5  
OMNIX—UNIX like multiuser, multitasking operating system for Z80 i.e. IMS, Cromemco £495/40  
Multiforth £65/20

**Micah Inc.** CP/M for CDOS Users: Program to Expand CP/M system to be compatible with Cromemco CDOS software £59/5

**Michael Shroyer Inc.** Electric Pencil Word Processor £100/  
SSII for tty etc £100/  
DSII for Diablo £105/  
TRS-80 Cassette/disc £50/

**Microfocus Ltd.** CIS COBOL version 4.3 £425/25  
FORMS 2 £100/10

**Micropro Inc.** WORD-MASTER 1.7 £70/20  
TEX-WRITER 2.6 £35/15  
WORD-STAR 2.1 £240/35  
MAIL-MERGE 2.1 £70/10  
WORD-STAR with MAIL-MERGE £310/45  
SUPER-SORT: Version 1 £120/20  
Version 2 £100/20  
DATASTAR 1.1 £165/20

**Microsoft Inc.** BASIC-80 £175/17  
BASIC Compiler 5.2 £195/17  
FORTRAN-80 £220/17  
COBOL-80 4.0 £355/17  
M/SORT £70/11  
EDIT-80 £45/11  
MACRO-80 £80/11  
MICROSEED £TBA/20  
MULISP £TBA/20  
MUMATH £TBA/20  
XMACRO-86 £185/11  
XFORTRAN-86 £410/17

**MT Microsystems** Pascal MT 5.1 £145/20

**Northshare** Multi-user system for Horizon Users 5.1 £40/5

**Osborne & Associates** Accounts Payable & Accounts Receivable (disc only) £50/  
General Ledger (disc only) £50/  
Payroll with Cost Accounting (disc only) £50/

**Phoenix Software Associates** PLINK—Disc to disc link loader £65/15  
(For Z80 only) PASM—Macro assembler £65/15  
PEDIT—Line editor with Macros £65/15  
BUG—Very powerful debug £65/15  
Package with all the above £175/30

**Structured Systems** Sales Ledger £350/15  
(All Converted to UK Standard) Purchase Ledger £350/15  
Nominal Ledger £350/15  
Stock Control £350/15  
Letterright £95/10  
Analyst (File management Reporting System) £115/10  
NAD (Name and Address selection system) £50/10  
OSORT £50/10

**TDL Software** Business Basic £80/  
(Technical Design ZTEL (Text Editing Lang.) £35/  
Labs) MACRO II (Z80 Macro Assembler) £35/  
LINKER £35/  
DEBUG II (for 8080/Z80) £45/

**Tiny-C Associates** Tiny-C language for 8080, 8085, Z80 systems £50/35

**Supersoft Inc.** DIAGNOSTICS 1 £35/5  
TERM £65/5

## ORDER INFORMATION

Software prices reflect distribution on 8" single density discs. If a format is requested which requires additional discs a surcharge of £4 per additional disc will be added.

Please add £3.00 for postage, packing and insurance plus VAT on ALL software items (including manuals) purchased. For overseas please add £4.50 per item.

If required, DATAPOST D service is available for an extra charge of £8.50.

Most software on this Advertisement is available from stock and a 72-hour return service is thereby offered on most prepaid orders. When ordering CP/M software please specify the format you require otherwise software will be dispatched on an 8" single density disc.

For more information on any of these items, please phone, write or visit. (We are open during office hours).

All publications are published in the U.S.A. and are stocked in Britain by L.P. Enterprises: M.P.I. Ltd.

We aim to keep all of these books in stock and as a

result of this most mail orders are despatched by return of post.

**MAIL ORDER TELEPHONE ORDER VISIT**  
Send Cash, Cheque, Credit Card No., Postal Order, IMO

All Payment must be in sterling and drawn against a UK bank.

Subscriptions are processed to start with the next current issue, after the date of order

Please add £0.75 for postage on ALL books or magazines purchased.

These details are all current as of December 1980.

Prices are subject to change without notice, due to fluctuation in the dollar rate.

Trade Enquiries welcome. Bulk Purchasers welcome.

L.P. Enterprises  
Room P. C. W.  
8 Cambridge House  
Cambridge Road, Barking  
Essex IG11 8NT, England  
Tel: 01-591 6511  
Telex: 892395

OEM  
terms  
available

# CHROMASONIC electronics

48 JUNCTION ROAD, ARCHWAY, LONDON N19 5RD 100 yds from Archway Station & 9 bus routes  
TELEPHONE 01-263 9493 01-263 9495

YOUR SOUNDEST CONNECTION IN THE WORLD OF COMPONENTS AND COMPUTERS

8N 8K RAM  
16N 16K RAM  
32N 32K RAM  
CASSETTE DECK  
343K TWIN FLOPPY DISK

## PETS & SYSTEMS

NEW 32k with 80 col screen  
Twin Disk Drive 950K

All with new keyboard  
and green screen  
Friction Feed Printer  
Tractor Feed Printer



PHONE 263-9495 FOR OUR MOST COMPETITIVE PRICES



### MEMORY EXPANSION KIT

Suitable for UK101, Super-board expansion using 2114s each board has 16K ram capacity kit contains:

- ▶ On board power supply
- ▶ 4K Eprom expansion
- ▶ Fully buffered for easy expansion via 40 pin socket
- ▶ 8K kit                   £79.95
- ▶ 16K kit                  £106.95
- ▶ Printed Circuit Board           £29.95
- ▶ 40 pin-40 pin header plug           £8.50

## NEW SHOP

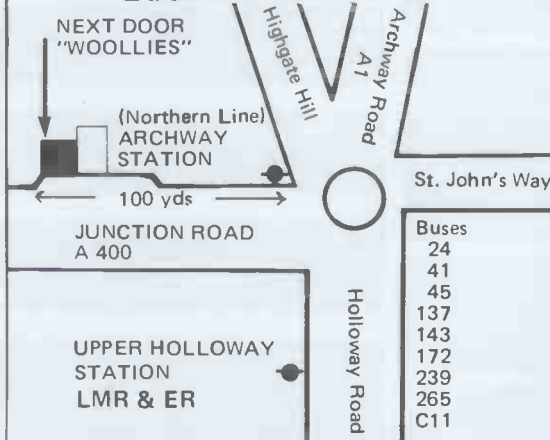

### VIDEO GENIE

VIDEO GENIE based on TRS80



Utilises Z80, 12k level II Basic, Integral Cassette Deck, UHF O/P. 16k RAM

all TRS80 features                   £289

### CASES

Available for U.K. 101, Superboard Nascom Appx. DIM. 17" x 15" 435 x 384 mm

PRICE £24.50

Post & Packing £1.50

### UK101 P.P.I.

BUILT & TESTED. INTERFACES TX80 PRINTER DIRECT, CAN BE PROGRAMMED TO OPERATE RELAYS, MOTORS, VARIOUS OTHER PERIPHERALS "CENTRONICS COMPATIBLE PLUGS INTO IC SOCKET. RED BINARY DISPLAY FULLY DOCUMENTED.

£29.95

### UK101

£179 IN KIT FORM

£229 READY BUILT & TESTED

£255 COMPLETE IN CASE

4K EXPANSION (8 x 2114) NOW ONLY £18.00

- No extras required
- ★ Free sampler tape
- ★ Full Qwerty keyboard
- ★ 8K basic
- ★ Ram expandable to 8K on board (4K inc)
- ★ Kansas City tape interface

★ NEW MONITOR ALLOWS FULL EDITING & CURSOR CONTROL

£22.00



### PRINTERS

EPSON TX-80

MX-80 £359  
TX-80 £295

Dot-matrix printer with Pet graphics interface: Centronics parallel, options: PET, Apple and compatible

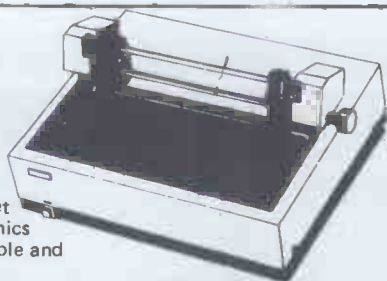

PLEASE ADD VAT 15% TO ALL PRICES. POSTAGE ON COMPUTERS, PRINTERS & CASSETTE DECKS CHARGED AT COST. ALL OTHER ITEMS P&P 30p. PLACE YOUR ORDER USING YOUR ACCESS OR BARCLAYCARD (Min. Tel. order £5.00). TRADE & EXPORT ENQUIRIES WELCOME, CREDIT FACILITIES ARRANGED.





# NEW SHOP & SHOWROOM NOW OPEN

TELEPHONE  
01-263 9493/01-263 9495

## UK101 SOUND

SOUND GENERATOR  
AND COMBINED  
PARALLEL IN/OUT  
PORT KIT  
CONTAINING P.C.B.,  
AY-3-8910, 6520 PIA,  
FULLY DOCUMENTED  
AND DEMO TAPE.

£29.95

AY-3-8910 £8.50

## UK 101 SOFTWARE

SPACE INVADERS	6.50
REAL TIME CLOCK	3.00
CHEQUERS	3.00
OTHELLO	4.00
GAME PACK I	5.00
GAME PACK II	5.00
GAME PACK III	5.00
SCREEN MONITOR	4.00
ASSEMBLER EDITOR	14.90
10xC12 BLANK TAPES	4.00

## CPUS

Z80 2.5 MEG	7.95
Z80A 4 MEG	9.95
6502	6.95
6800	6.50
8080	4.75
9900	25.95

## SUPPORT CHIPS

Z80 CTC	5.95
Z80A CTC	6.95
Z80A PIO	5.95
Z80A PIO	6.95
6520	3.95
6522	6.85
6532	8.50
6821	4.25
6850	3.60
6852	4.35
8212	1.95
8216	1.95
8224	2.75
8228	3.75
8251	4.95
8253	9.75
8255	4.50
TMS9901	13.16
TMS9902	11.18
TMS9904 (74LS362)	8.40

## MEMORY

D. RAMS	£	p
4027		2.75
4050 (350NS)		2.35
4060 (300NS)		2.39
4116		3.95
S. RAMS		
2102A		1.30
2102A2		1.69
2112A		2.75
2114/4045		2.75
4035		1.07
4044-5257		6.93
6810		3.50
BULK PURCHASE		
8x2114		14.00
8x4116		18.00
16x2114		26.00

## EPROMS

2708	4.25
2716 (5v)	6.95
2532	29.95

## ROM

2513 (UC)	5.95
-----------	------

## I.C. SOCKETS

	DLL	W/W
8 pin	.09	.25
14 pin	.11	.35
16 pin	.12	.42
18 pin	.16	.50
20 pin	.20	.62
22 pin	.22	.65
24 pin	.24	.70
28 pin	.30	.80
36 pin	—	.99
40 pin	.40	1.10

## BUFFERS

81LS95	1.25
81LS96	1.25
81LS97	1.25
81LS98	1.25
SN74365	.52
SN74366	.52
SN74367	.52
SN74368	.52
BT26	1.50
8T28	1.50
8T95	1.50
8T96	1.50
8T97	1.50
8T98	1.50

## BAUD RATE GENS

MC14411	8.75
MM5307	8.75

## UARTS

AY-5-1013	3.95
AY-3-1015	4.75
MM5303	4.75
TMS6011	3.55

SEND S.A.E. FOR COMPLETE  
PRICE LIST OR PHONE 01-263 9493



# Wiley

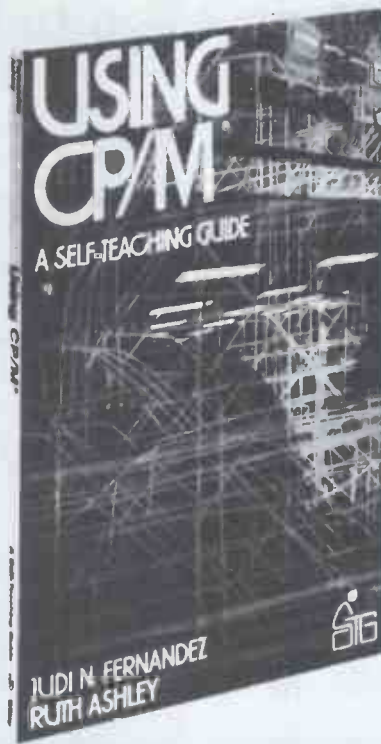

## USING CP/M

by Judi N. Fernandez and Ruth Ashley  
*Duotech, San Diego*

Here is the first complete, detailed self-paced introduction to CP/M (Control Program/Micro Computers), the most widely used microcomputer operating system. By fully understanding how the CP/M software package works, you can operate your computer at its full potential, performing routine work functions and sophisticated tasks with maximum flexibility and efficiency. The book can be used with any hardware that uses CP/M.

Two best-selling Wiley computer authors explain in logical sequence how to implement all the functional programs provided by CP/M. Shows how to create, erase and copy files, run other programs, translate and test 8080 assembler language programs, print data from files, displays the directory of a disk and more. This clear, comprehensive guide assumes no prior computer experience.

*A Wiley Self-Teaching Guide*

November 1980  
0471 08011 X

258 pages  
(paper) £5.95

## PASCAL PROGRAMMING

by L.V. Atkinson,

*Dept. of Computer Science, University of Sheffield*

A first course on Pascal Programming which can be used as an introductory text for those with no previous knowledge of programming or as a conversion text for those with experience of some higher level programming language other than Pascal.

*Wiley Series in Computing; Series Editor: D.W. Barron*

October 1980  
0471 27773 8  
0471 27774 6

438 pages  
(cloth) £16.50  
(paper) £6.95

## John Wiley & Sons Limited

Baffins Lane · Chichester · Sussex · England

You have to go a long way to find  
a Company like ours . . .

You have to go to Bar Hill.

Our new business microcomputer showroom is opening on the 1st April 1981, and you are invited to view our wide range of microcomputer hardware and business software which we have on permanent display.

As well as catering for the more general applications such as Business Forecasting, Word Processing, Accounting, Stock Control etc., we will design and produce customized systems where a package cannot suit your needs.

Better still, we'll teach you how to write your own software so that you are able to tailor your programs to the changing needs of your company.

We offer a comprehensive service from consultancy to hardware supply; specifically orientated to the needs of small business.

“Now, where's Bar Hill?”

The Avery Computer Company

13 The Mall

Bar Hill

Cambridge Tel: Craft's Hill (0954) 80991/2 (24 hour answering service)

## Announcing Next Day delivery of computer supplies, accessories and cables!

Anything in Inmac's new Catalogue can be in your Computer Room *tomorrow* (2 days to Northern Ireland). Even faster in an emergency! There's a wide range of over 500 top quality accessories, supplies and cables to choose from, many of which are hard to find elsewhere. A direct telephone line offers you an instant, trouble-free ordering service, with advice always available.

Everything covered by the Inmac no-nonsense Guarantee of Satisfaction.

**IF YOU DON'T BELIEVE US -  
TRY US!**

For FREE Catalogue, telephone Runcorn

**(092 85) 67551**

Telex 629819 INMAC G or write to:

INMAC LTD., Dept K,  
18 Goddard Road, Astmoor Industrial  
Estate, Runcorn, Cheshire WA7 1QF.



Name \_\_\_\_\_

Company \_\_\_\_\_

Company Address \_\_\_\_\_

# OHIO..

## ..24 hours a day!

Yes that's right, we are at your service 24 hours a day offering a complete OHIO SCIENTIFIC service, giving technical information, advice on hardware expansion and satisfying your requirements in any of the following:

OSI SYSTEMS-including the popular SUPERBOARD II and CHALLENGER 4P as either cassette or disk based systems.

OSI SOFTWARE-cassette and disk based software covering a broad spectrum of uses. Some of the cassette based software can be run on the UK101.

BEAVER SOFTWARE-business, educational and entertainment software professional programs with full listings and documentation. Also available for other programs especially the UK101.

BEAVER PROGRAMMING AIDS-including video workpads, BASIC workpads, machine code workpads, cassette index cards, labels and blank cassettes, all available for OSI UK101 and TRS-80.

In addition to the above, we also have available cases for the SUPERBOARD II (and others).

Demonstrations of all the systems and software available can be arranged in your own home or business premises (within a 50 mile radius of Oxford).

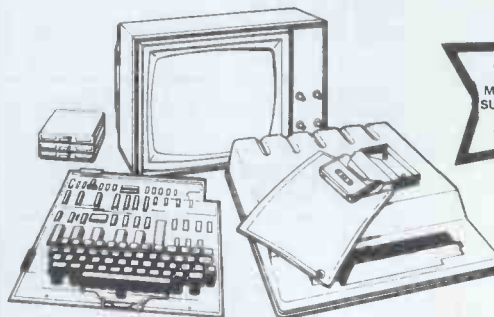

NOW  
AVAILABLE  
NEW  
MONITOR FOR  
SUPERBOARD II  
UK 101  
£29.50 +VAT

**OHIO..**  
SYSTEMS

Norlett House, Dormer Road, Thame, Oxon OX9 3UC  
Telephone Thame (084421) 5020 (24hr)



# OHIO IS NOW IN BERKSHIRE

Which will upset geographers but delight OEM systems designers.

Ohio Scientific, you don't need telling, are one of the largest microcomputer manufacturers in the States.

From our new full-service base in Berks, OS (UK) now supply all the low-priced high-production state-of-the-art value-for-money equipment you need:

Hardware. Software. Pre-tested. Burned-in. Ready-to-go. Backed-to-the-hilt with the sort of quality control and service back-up that made them third largest in five years.

For example, Ohio Scientific's C2-OEM is designed to be the cost effective solution to business and industrial applications which can effectively utilize typical microcomputer execution speed. The C2-OEM benefits from Ohio Scientific's years of volume microcomputer

production experience yielding an extremely competitively priced medium performance microcomputer. The C2-OEM utilizes the popular 6502 microprocessor operated at 1Mhz clock speed in conjunction with 48K of 450 NS Dynamic RAM memory.

The C3-D mates the electronics of the popular Challenger III triple processor microcomputer system with the cost effective 8" Winchester disk. The C3-D features the three most popular microprocessors - the 6502A, 68B00 and the Z80A. When operated in the 6502 processor mode, the machine executes instructions approximately twice as fast as competitive microcomputer systems. The C3-D incorporates 52K high speed static RAM, serial I/O port, bootstrap and diagnostic firmware, 8" floppy disk for transport and backup as well as an 8" Winchester. The C3-D comes complete with OS-65U disk operating system which is optimized for use with the Winchester hard disk and includes a fast 9-digit BASIC by Microsoft.

The C3C is one of the most economically priced 36 megabyte hard disk systems available in the UK. C3C qualities include three processors, 6502, 6800, and Z80A with software control and full multi user and multi tasking facilities, with floppy disk or Alloy Engineering tape drives. C3C is 'state of the art' in microcomputing.

All systems come with fully operational software and languages include BASIC, FORTRAN, AND PASCAL with CP/M (R) on C3 series machines. Complete application software also available.

For details, put in a short-distance call to Ohio on Slough (0753) 75915.

**OHIO SCIENTIFIC**

(UK) Ltd\*

Middlegreen Estate,  
Middlegreen Road,  
Langley, Berkshire.  
Telephone: Slough  
(0753) 75915



\* Ohio Scientific (UK) Ltd is a wholly owned subsidiary of American Data Home & Office Computers Inc.



# CALL IN AND BUY A BETTER BUSINESS AT CREAM

ONE OF THE UK'S TOP BUSINESS SYSTEM DEALERS FOR BOTH THE COMMODORE PET RANGE.

PROFESSIONAL DEMONSTRATIONS AND ADVICE.

WIDE RANGE OF RELIABLE & POWERFUL HARDWARE TO CHOOSE FROM.

COMPREHENSIVE CHOICE OF FLEXIBLE SOLID SOFTWARE FOR MOST BUSINESS APPLICATIONS, i.e. WORD PROCESSING, PAYROLL STOCK CONTROL, RECORD KEEPING, INVOICING, AND FULL ACCOUNTING PROCEDURES.

OUR OWN EXPERIENCED SOFTWARE HOUSE TO HANDLE PROMPTLY & PROFESSIONALLY ANY BESPOKE SOFTWARE OR TAILORING NEEDS TO PROGRAMS.

FAST DELIVERY (MOST ITEMS ARE EX-STOCK)  
FULL ENGINEERING SUPPORT.

FULL STOCK OF BOOKS, DISCS, TAPES, & OTHER ACCESSORIES FOR THE COMPUTER USER.

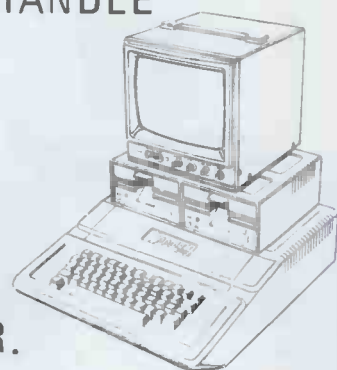

**BUY FROM CREAM – IT MAKES GOOD BUSINESS SENSE.**

CALL US TO DISCUSS YOUR PARTICULAR APPLICATION  
POWERFUL APPLE II COMPUTER AND THE FULL

## CREAM COMPUTER SHOP

380 STATION ROAD, HARROW, MIDDLESEX HA1 2DE. Tel. 01-863 0833

OPEN TUESDAY – SATURDAY 10AM – 6PM.  
(3 MINS FROM HARROW-ON-THE-HILL TUBE STN  
ACCESS AND BARCLAY CARD WELCOMED.



# NEW!! - 10Mb HARD DISK SYSTEM



UP TO 104Mb ON LINE! The Morrow Hard Disk Controller can support as many as four hard disk drives at either 10Mb, 20Mb, or 26Mb each.

Horizon Computer + 64K Ram + 2 Quad Drives (720K)  
+ Morrow 10Mb Hard Disk + Televideo TVI-912c VDU + CP/M 2.2

**SPECIAL PACKAGE PRICE £4,595**

## EPSON



£350

**EPSON MX-80** — The best value for money printer available! Many useful features:— fast, (80cps) bi-directional, logic-seeking ★ microprocessor electronics ★ 9 x 9 character matrix ★ cartridge ribbon ★ forms control ★ 40, 66, 80 or 132 columns per line ★ U.K. character set (inc. £) ★ standard parallel interface ★ forms tractors opt. ★ prints enlarged, condensed and condensed-enlarged characters ★ compact and lightweight.

Interface options for RS232, Apple 2+, TRS-80, PET.

**EPSON MX-70** — low cost version of MX-80 with high resolution graphics (8 x 480 dots) — £275.

## DP9500 — Fast Line Printer ★

50 to 200+ lines/min ★ Double width printing ★ High density graphics ★ Bi-directional, logic seeking ★ Adjustable width tractor paper feed to 15.6 inches ★ Serial, parallel and current loop interfaces ★ Complete forms control ★ Horizontal and vertical tabs ★ Full communications control ★ Self test ★ Original plus 5 copies ★ Black long-life ribbon cartridge ★ 9-wire print head ★ 600 character buffer ★ Three print densities — 10, 12 and 13.3 cpi ★ 6 or 8 lines per inch.

## ANADIX



£795

### HARDWARE

Morrow 10Mb Hard Disk System + CP/M .....	£1995
Morrow 20Mb Hard Disk System + CP/M .....	£2595
DMB6400 64K Dynamic Ram + Bank Switching .....	£ 495
DM6400-64K Dynamic Ram .....	£ 395
Horizon Computer-32K Ram, 2 D/D Drives .....	£1685
Horizon Computer-32K Ram, 2 Quad Drives .....	£1965
NEC 5510RO Spinwriter - RS232 + tractors .....	£1450

### SOFTWARE

Wordstar - Word Processing Package .....	£ 175
Mail-Merge - Letter Generation for Wordstar .....	£ 55
Datatar - CP/M Database Management System .....	£ 145
Supersort 1 - CP/M Sort Utility .....	£ 95
Microsoft Basic Interpreter .....	£ 155
Microsoft Basic Compiler .....	£ 195
CP/M V2.2 - Supports Double-Sided Drives .....	£ 95

UK Distributor:  
**INTERAM** Computer Systems Ltd.  
59 Moreton Street,  
Victoria, London SW1V 2NY  
Tel: 01-834 0261/2733  
Telex: 925859

# SEED

## microcomputer products



At SEED you will be dealing with professionals with extensive experience in all fields of computing, add to that our four years of dealing exclusively with only one type of microprocessor assures you of obtaining a system tailored to suit your application. You may wish to develop your own software or alternatively only require a small accountancy system; for which our 'SYSTEM ONE' would be ideally suited. Larger applications requiring up to 40 megabyte of online storage, four terminals and two printers then our 'SYSTEM 12' range is for you.

Prices range from £565.00 to £20,000.00+, we not only suit your application but also conserve your bank balance. If you are thinking of installing a micro computer system, then give us a call and take advantage of our free advice. In the unlikely event of our current range not being able to accomodate your requirements, then our shortly to be announced 6809 based system may well be the answer.



PLEASE CALL US ON 054 3378151 FOR YOUR FREE DEMONSTRATION OR DETAILS WITHOUT OBLIGATION.

# Strumech Engineering Electronics Developments Limited

PORTLAND HOUSE, COPPICE SIDE, BROWNHILLS, WALSALL WEST MIDLANDS

TELEPHONE: 054 33 78151      TELEX: 335243



# NEW LOW PRICES!

**\*FREE FLOPPY DISC**

**\*\*FREE DATA DESK**



**CPS Data Systems is not just a hardware shop. Our name means what it says**

Whilst we have a fine reputation for a wide range of computer hardware WE ALSO OFFER ALL THE SERVICES you would expect from one of the longest established companies in the microcomputer industry.

**Systems Analysis  
Programming  
Personnel Training  
Installation and Commissioning  
Total Engineering back-up**

Ring us to find out more about any of these essential services.

*Our hardware deals are:-*

### Commodore micros

at competitive prices e.g. 8032—for £820.00 + VAT  
32K 4000 series CPU £555 + VAT

### Qume Daisy Wheel Printers

For volume output of letter quality from £1,550 + VAT

### New Olympia Scripta

Daisy Wheel Printer from £800 + VAT

### Sanders Media 12/7

The unbelievable letter quality printer that can change type size and style as it prints—has to be seen to be believed.  
From £2,390 + VAT

Ask about our special deals on demonstration equipment—at well below list prices.

\* Before you buy! ring us and if we can't match or better the price you already have we will send you free a 5 1/4" mini floppy discette with our compliments

\* Free with all orders over £2,000.00



**CPS (DATA SYSTEMS) LTD**

Third Floor, Arden House,  
1102 Warwick Road, Acocks Green,  
Birmingham B27 6BH  
Tel: 021-707 3866

*A member of the CPS Group*

# TEC



End user price:  
**£1,085**  
+ VAT

**The FP1500-25,  
a high quality  
25 CPS  
daisy wheel printer,  
at a remarkably  
low cost.**

- 136 column width. 25 cps
- 96 character set
- 1/120 inch min. character and 1/48 inch min. line spacing
- 3 copy capacity
- High degree of vertical and horizontal positioning control
- Forward and reverse paper feed
- Hopper feed option
- Industry standard parallel interface or RS 232C compatible.

Call or write for more information and details of your nearest dealer.

**DRG**  
**BUSINESS**  
**MACHINES**

Unit 8, Lynx Crescent,  
Winterstoke Road, Weston-Super-Mare,  
Avon BS24 9DN Tel: (0934) 416392

**THE FINEST WORLDWIDE  
SUPPORTED NATIONWIDE**

# **FERGUSSON COMPUTER SERVICES**

**WE ARE PLEASED TO ANNOUNCE  
THE OPENING OF OUR NEW  
DEMONSTRATION CENTRE  
in SURREY**

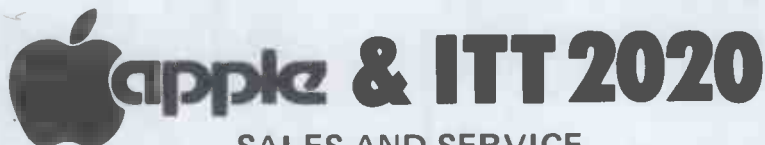

#### **SALES AND SERVICE**

##### **Contract Maintenance:-**

- \* On-site repair contracts
- \* Total system or only items required
- \* 24hrs response to calls
- \* Very competitive rates

##### **Ad-hoc Repair Service:-**

- \* Ring for repair quotation
- \* Same day service
- \* Collection from Red Star if required

##### **Hardware and Software Sales:-**

- \* 32K RAM free with each system purchased with this advertisement
- \* Integrated ledger system (open item) £2575 for everything!!

For further information ring  
Byfleet (09323) 45330

**COME AND SEE US SOON AT**

**Fergusson Computer Services  
4 Pyrford Road, West Byfleet, Surrey**

**NEW**

# SEIKOSHA

**The lowest cost,  
smallest size,  
80 column impact  
dot graphic printer  
in the world.**



**GP80A**

Suitable for home, educational and business use, the Seiksha GP80A features include:- Plain paper. 80 column width. 30 cps. Full ASCII character set. Graphics facility. 5 x 7 dot matrix. Double width characters. Pin feed. Centronics interface standard.

Other interface and cables available:- IEEE/488, PET, TANDY, APPLE, RS/232C.

**Ring the Master Distributor, DRG Business Machines,** (Supplies and Peripherals Division). Weston-Super-Mare, (0934) 416392 or your nearest dealer:

- |                         |           |                |
|-------------------------|-----------|----------------|
| Chromasonic Electronics | London    | (01) 263 9493  |
| Computerama             | Bath      | (0225) 333232  |
| Datalink                | Bristol   | (0272) 213427  |
| Electronic Brokers      | London    | (01) 278 3461  |
| Microdigital            | Liverpool | (051) 227 2535 |
| Sigma Systems           | Cardiff   | (0222) 21515   |
| Watford Electronics     | Watford   | (0923) 40588   |

**DRG  
BUSINESS  
MACHINES**

Unit 8, Lynx Crescent,  
Winterstoke Road, Weston-Super-Mare,  
Avon BS24 9DN Tel: (0934) 416392

**THE FINEST WORLDWIDE  
SUPPORTED NATIONWIDE**

**What...  
throw away  
my calculator,  
pencil,  
paper,  
dictionary,  
& reference  
manual?**

**Yes!**

Turn the page for the answer from  
**Almarc**  
DATA SYSTEMS



 **commodore**

**INDUSTRIAL  
MICRO  
SYSTEMS**



**Qume**

**NorthStar**



**Anadex Ltd.**



# MICRO FACILITIES

**APPROVED**

for  
Commodore  
Apple II  
North Star Horizon  
Industrial Micro Systems 5000  
& 8000

**APPROVED**

by  
Local Government  
Central Government  
National Laboratories  
Maritime Research  
Universities  
Schools

**APPROVED**

by  
Accountants  
Importers/Exporters  
Retailers  
Manufacturers  
Printers  
Surveyors

## WE WILL GET YOUR APPROVAL

**Why?** Because Micro-Facilities know that whether you are a large establishment or a small business you are going to need **help** and good **service**. We believe, and our hundreds of satisfied customers seem to agree, that the service we give is second to none.

Our service starts right from your initial contact. We will meet with you to discuss your requirements and your **business**, without blinding you with computer jargon. We will arrange for you to have a demonstration of one or more computers from our range together with programs to suit your particular needs. If a ready-made program is not suitable then we can analyse, design and program your particular procedures (we have nearly twenty years experience of doing this). As a further service we are able to arrange both **leasing** and **financing** of your computer equipment.

Our service does not stop when you have purchased your system; to ensure the smooth transfer of your work we **train** you and your staff to use the computer and its programs in your own environment. As additional security we offer full **maintenance contracts**. Above all we will be available to give you genuine **after sales service**. Not for just one week or one month but everytime it is wanted.

Please contact us to discuss your problems and requirements, we offer you a lot more, but only charge the same. Our ability will give you peace of mind and confidence that the job will be done properly.

Central Computer & Telecommunications Agency Approved  
Tenders from Local Authorities, Education and Government  
Departments welcomed.

Micro-Facilities Ltd. 129 High Street,  
Hampton Hill, Middlesex TW12 1NJ

**01-941 1197 and 01-979 4546**

**MICRO FACILITIES**

# TRS 80 and VIDEO GENIE Software

## DEATH DREADNAUGHT(x)

Is this the first (x) rated adventure ?

You have found alien spacecraft floating lifeless in the deep void between galaxies..... you enter the airlock hoping to find clues to its origin and the fate of its crew. Then to your dismay the airlock will not re-open and there are signs of carnage and destruction everywhere, and worst of all the THING which caused it is still on board, hungry and waiting. There is still one lifeboat spaceworthy but the "ALIEN" lies in wait.

**Level II Cassette** £8.95  
**IRV**

Video Editor allows cursor oriented editing of your programs. Just move the flashing cursor to the line to be edited and type the corrections, insert or delete.

Relocate a line by editing the line number - re-number lines individually.

Input Shorthand - one keystroke can enter a whole line ! All keys user programable.

IRV is faster than LEVEL II BASIC. More powerful than a speed typist. Able to leap ten subroutines at a single bound.

**Level II Cassette** £13.95

**Datestones of Ryn (R.T.G.)** £10.95

Recover Datestones from Rex (the Reaver) and his friends. He is not at all happy that you shall recover them so he has set some traps and sprinkled a few monsters to entertain you in your quest.

**Temple of Apsai (R.T.G.)** £14.95

200 rooms and 30 monsters - 16 million alter-egos possible! Graphic representation of dungeon room you are in and of monster gobbling you!

**Invasion Orion** £13.95

Tactical Space battle - you may set up entirely new scenarios using from 2 to 15 spacecraft or use data provided (on cassette) to play pre-set scenarios.

R.T.G. - Real Time Graphics.

All prices include p & p and V.A.T.

# ALGRAY

ALGRAY House, 33 Bradbury Street, Barnsley, South Yorkshire Tel: Barnsley (0226) 83199

Please Send Me:

Death Dr. .... @ £9.95

IRV ..... @ £13.95

Catalogue ( S.A.E. please)

Name: \_\_\_\_\_

Address: \_\_\_\_\_

Tel No: \_\_\_\_\_

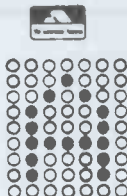

The answer:  
from  
**Almarc**  
DATA SYSTEMS  
is Execuplan and Memorite III

Execuplan is a great new software package NOW available from Almarc.

It's the 'never-forget' perfect typist that lets you play 'What if?' It's a superb information system that you can type the changes and reprint. So for those whose daily need is pencil, paper and calculator - now is the time to consign them to the dustbin -

Execuplan is here! Features include: matrix planning, budgets, cash flow analysis, estimates, formatting and printing capabilities, primer manual for easy learning, plus help screens. Execuplan out performs other calculator/planning systems on the market.



And here's another great innovation from Almarc.

**The Memorite III** - the ultimate in up-to-date word processing economy from Vector. There's an on-screen reference manual, with automatic spelling verification. A phrase plus mass mailing and list-processing facility. It saves time, expense and most of all that 'frayed-at-the-edges' feeling. It's Vector's commitment to CP/M word processing designed specifically to allow systems houses and large company programming staff to add features easily. For more information cut out the coupon and post to: Almarc Data Systems Ltd., 906 Woodborough Road Nottingham NG3 5QS. Tel: (0602) 625035

Please send me lots more information on: Memorite III  Execuplan

Name .....  
Company .....  
Position .....  
Address .....  
Tel. No. ....

Almarc Data Systems Ltd.  
906 Woodborough Road,  
Nottingham NG3 5QS  
Tel: (0602) 625035

# LONDON COMPUTER CENTRE

**New! – Improved! RP-1600 NEW LOW PRICE £1095 Additional Facilities**  
**+ Built in proportional spacing + Look-ahead logic + On-off switch**

60 CHARACTERS PER SECOND  
 THE FASTEST DAISY WHEEL PRINTER.  
 FAST, heavy duty commercial DAISY WHEEL printer, with high quality printout, coupled with low noise necessary for office environment. 124 char: upper/lower case. \* 10/12 chars per inch giving 126 or 163 columns. \* 15 inch wide friction platen. \* BOLDING, underline, and host of other features. \* Centronics type parallel interface as standard options: serial interface £60. \* PET interface £65. \* APPLE interface £75.



Made by Ricoh in Japan Dealer enquiries invited

- ← TRS 80 Model I & II
- ← SUPERBRAIN
- ← APPLE
- ← PET
- ← HORIZON Etc

TRACTOR FEED O/E £175  
 SHEET FEEDER OPTIONAL EXTRA £550

**NEW MAXI ANADEX WITH GRAPHICS £895**



Takes up to 13.5 inch wide paper \* Upper/lower case with decoders \* £ sign \* 132 or 175 chrs/line with double width printing \* Fast 150 CPS bi-directional logic seeking printing \* Heavy duty print head giving 650 million chrs print life \* serial, Parallel and Current Loop interfaces built in \* Host of other features found on printers costing twice as much.

Also Available  
 DP8000 £425 (Not IIIus)  
 DP 9501 £995 (Same as 9500 IIIus)

**NEW Revolutionary! Epson MX80F/T £425 the PRINTER with FRICTION & ADJUSTABLE Removable TRACTOR FEED**



ULTRA QUIET. HIGH quality PRINT. LOWER CASE DECODERS BI DIRECTIONAL. LOGIC SEEKING PRINT HEAD 80, 66, 132 Columns per line UNIQUE BOLDING BUILT IN FEATURE 64 Graphic Characters (TRS 80 & Prestel) 9 x 9 PRINT MATRIX. £ Sign Forms Handling: Top of Form Horizontal and Vertical Tabs, Centronics parallel interface standard. Optional extra Serial PET & APPLE interfaces. Easily replaceable head.  
 DEALER ENQUIRIES INVITED

**737**



80 CPS + double spacing and mono spacing 10 and 16.7 CPI \* nx9 proportional spacing, 3 way paper handling \* 96 character set \* Expanded print \* Right margin justification \* Underlining \* Bidirectional \* £ sign contronics parallel and serial interfaces standard \* optional extras: PET & Apple interfaces.

**OKI MICROLINE 80/132. THE QUIET PRINTER YOU CAN LIVE WITH**

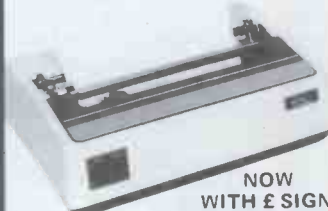

NOW WITH £ SIGN  
 The quietest Dot Matrix available. 40, 80 or 132 cols per line \* excellent print quality \* 3 way paper handling: letterheads, fanfold, or paper rolls \* graphics \* ideal for software written for large 132 col printers \* continuous rating printing day in and day out \* centronics parallel standard. Options: Rs-232, PET, Apple.  
**NEW LOW PRICE £350**  
 DEALER ENQUIRIES INVITED.



**TRS-80 MODEL II**

State of the art second generation computer. Over 10,000 already sold in USA, 8 slot bus ensures expansion of hard discs & other peripherals., 76 Key professional keyboard, self test on power up, TRSDOS & Level III basic standard. CP/M available as option, making a wide range of accounting, educational, scientific & word processing packages instantly usable. Nationwide service through 180 Tandy stores & computer centres.

NOW WITH CP/M 2.24 £1999



**SUPERBRAIN**

350K £1595  
 700K £1995  
 1600K £2595

**64K RAM Standard on all models**

NOW with MULTICOLOURED DEDICATED KEYS for MAGIC WAND, the ULTIMATE WORD PROCESSOR



**TRS 80 Model I**

**NEW LOW PRICES**  
 48K System with dual disk drives £1095  
 with Epson Printer £1350

New green screen VDU with rock steady display. Redesigned 32K expansion interface with trouble free operation & two 40 track disc drives.

16K Keyboard with Modulator £312  
 16K System: Keyboard, Green screen & cassette £414  
 Dual 40 track disc drives & cables £420  
 32K Expansion Interface £299

VISICALC for TRS-80 MODEL 1 £52

**CPM SOFTWARE**

Word Star £250.00  
 Word Star Mail-Merge £315.00  
 Magic Wand £185.00  
 Magic Wand with dedicated keys £235.00  
 Data Star £195.00  
 T/Maker £155.00  
 Report Writer £ 90.00  
 Accounts Packages from £295.00  
 Payroll from £295.00  
 Various other packages available – ask for details.

**SOFTWARE FOR TRS-80**

Electric Pencil (disc) £80.00  
 Electric Pencil (cassette) £35.00  
 Scripsit (disc) £75.00  
 Scripsit (cassette) £60.00  
 Mail-Merge for Pencil/Scripsit £45.00  
 VAT Aid Programme £45.00  
 Visicalc £52.00

**MISCELLANEOUS**

Floppy discs (Box of 10) including library case.  
 XLtron Silver 5" S/Slided D/Density for TRS-80, PET, Apple & Superbrain £25.00  
 XLtron Gold 5" D/slided D/Density for Superbrain £30.00  
 XLtron Silver 8" S/Slided S/Density £20.00  
 Memorex 8" S/Slided D/Density for TRS-80 Model II £35.00  
 Qume Daisywheel £6.00  
 RP-1600 Daisywheels £15.00  
 2000 Sheets 11" x 9.5" Fanfold Paper £15.00  
 2000 Sheets 11" x 14" Fanfold Paper £20.00  
 Ribbons, Paper Rolls etc. POA

DEALER ENQUIRIES INVITED ON ALL PRODUCTS

**LOW COST WORD PROCESSOR I**

Based on TRS-80 level 2 16K cassette recorder, electric pencil software, upper/lower case mod, printer interface and OKI Dot Matrix printer. Complete ready to go £895 free mailing list program.

**WORD PROCESSOR II**

Same as above but with 48K, 2 disc drives and ricoh daisy wheel printer £2275

**WORD PROCESSOR III**

Based on Superbrain computer shown above. With Ricoh printer & "Magic Wand" the ultimate in word processing. Letters automatically formatted with addresses fetched from separate file. Complete system £2950. Invoicing, stockcontrol, sales ledger, purchase ledger, payroll available for above computers from £250 per package.

43 GRAFTON WAY, LONDON W1P 5LA (Opposite Maples)  
 Tel: 388 6991/2 OPENING HOURS: 11-7 MON-FRI 12-4 SAT  
 24 hour answer phone: 01-388 5721



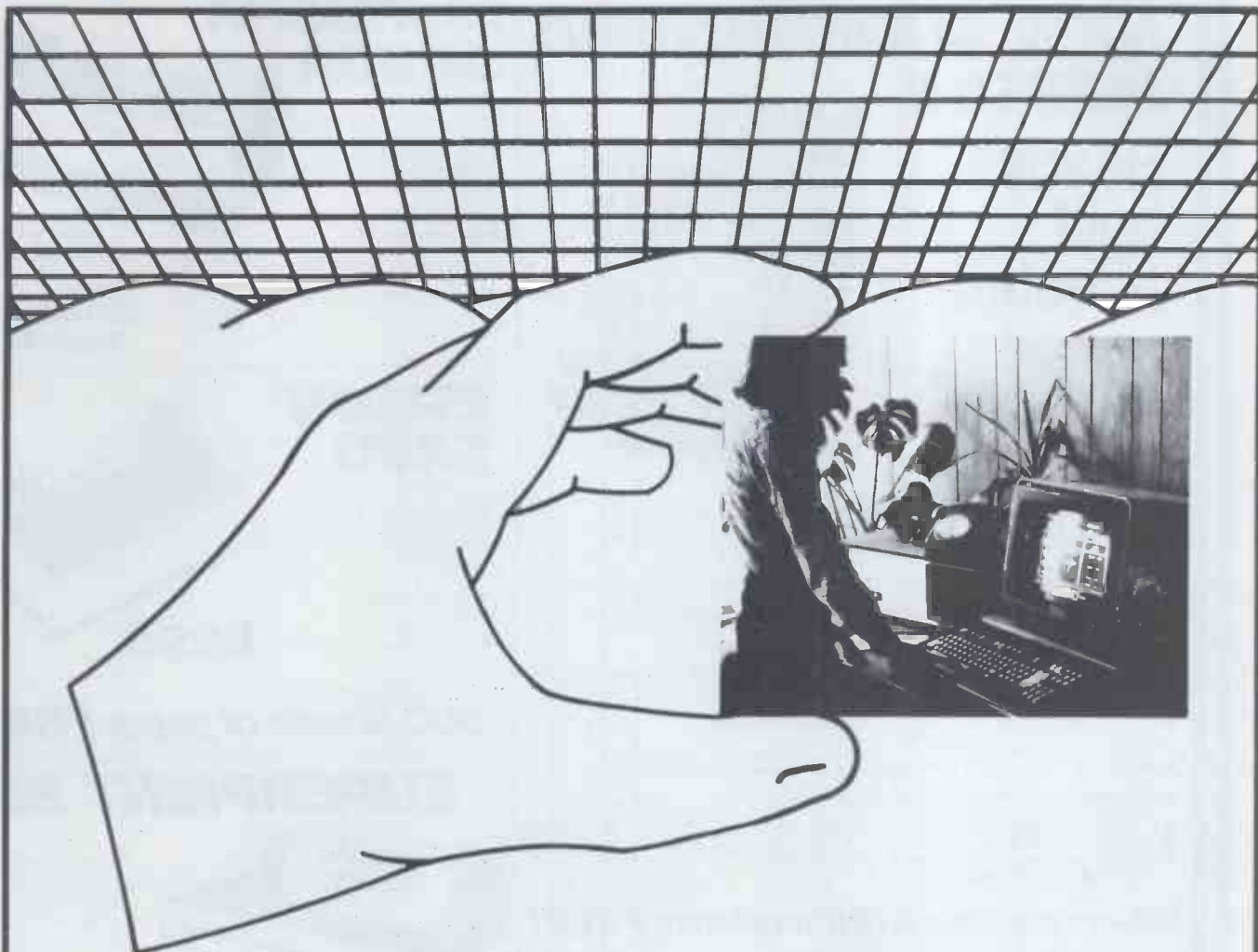

S100 COLOUR VIEWDATA DISPLAY CARD-UHF	£295
S100 COLOUR VIEWDATA DISPLAY CARD- RGB	£244
S100 PRESTEL AUTODIAL MODEM (2 CARDS)	£300
14" COLOUR VIEWDATA MONITOR (RGB)	£325

PRICES DO NOT INCLUDE VAT

**FULL RANGE OF VIEWDATA ITEMS SUPPLIED  
CALL FOR DETAILS**

**HI·TECH ELECTRONICS**

54 HIGH ROAD, SWAYTHLING, SOUTHAMPTON SO2 2JF  
TEL 0703 581555 TELEX NO.47388 HTEL



# OFFER YOU A GREAT DEAL

## NEW SUPERBOARD SERIES II

### Ready built & Tested

New from OSI - Series II. Everything series I had but with more on a single board. Ideal for the beginner or experienced engineer alike. It needs only a 5V 3A power supply to be up and running. Fully expandable to a Floppy Disc and small business system.



### STILL ONLY £149 + P&P £3.50 + VAT

- 625 lines jitter free Display
- Memory Mapped Video Display with upper/lower case graphics and gaming characters.
- Software selectable Display 24 x 24 48 x 12
- Uses the ultra powerful 6502 Micro.
- 8K Microsoft Basic in Rom.
- Full feature Basic runs faster than currently available computers and all 8080 based business computers.
- 4K static Ram on board expandable to 8K.
- Full 53 Keyboard with upper/lower case and user programmability.
- Power on reset-standard.
- 2 second action break key.
- Kansas City standard Audio cassette interface for high reliability.

- 6 latch outputs available for control purposes
- 8 bit Digital to Analogue converter.
- Full machine code monitor and I/O utilities in Rom.

Superboard II Series II	£149.00 + VAT
Black ABS case	£ 24.50 + VAT
Extra 4K Ram	£ 14.00 + VAT
PSU 5A Ready Built	£ 23.00 + VAT
Numeric Key Pad Kit	£ 11.95 + VAT
610 Expansion Board with 8K fitted (expandable to 24K)	£150.00 + VAT
CD3P Floppy Disc	£269.00 + VAT
WEMON	£ 19.95 + VAT

Series 2 User's Manual  
The best single source of information £6.95. no VAT

### Video swap tape & UHF modulator FREE!

## SOFTY

The complete microprocessor development system for the engineer and beginner alike.

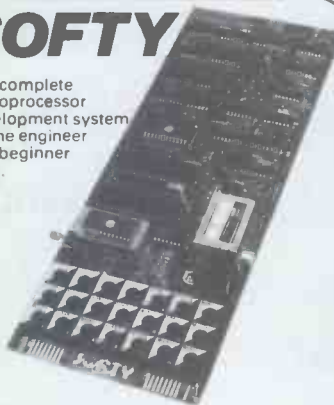

- Displays memory contents on standard UHF TV.
- Can replace monitor Rom to test and develop programs.
- Ideal training aid.
- Two 8-bit I/O ports.
- Fast cassette interface.
- On-board Eprom programmer.
- Copies software.
- Simple modification for single rail.

Price: Kit.....£ 99.00 + VAT  
 Ready built.....£120.00 + VAT  
 PSU.....£ 20.00 + VAT  
 P & P.....£ 1.50 + VAT

### FREE 2716 with each Softy

## STAKPAK

Unique filing system comprising stackable drawers, each containing 2 digital quality C12 cassettes. Complete with index cards & blank labels.



5 Stakpaks (10 cassettes)  
£5.25 P&P 75p + VAT

## VIDEO GENIE

A complete Computer System

- 16K User Ram
- 12 K Microsoft Basic in Rom.
- 64 x 16 line Display
- 128 x 48 dot graphics resolution.
- Software compatible with TRS80 level II.
- Built in Cassette Recorder.
- Output and Control for Second Cassette.
- Full expansion via Expansion box to Disc-Printer



### £289

P & P £5 + VAT

A Z80 based computer system with Full Keyboard and built in Cassette recorder plus outputs for Monitor and/or TV  
Parallel Printer Interface £35 + VAT

## SEIKOSHA GP80A

This Unihammer dot Matrix Printer gives Normal and Double Width Characters as well as Dot resolution Graphics.

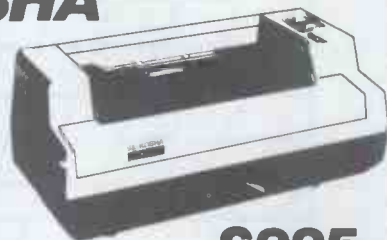

- Printing Speed 30 cps
- Character Set 5 x 7 Matrix
- Print Density 12 CPI at 80 CPI
- Paper Feed 8" Tractor
- Parallel Interface Standard

Other Interfaces  
RS 232£49 + VAT  
IEE 488 or  
Apple £35 + VAT  
Pet £35 + VAT

### £225

P & P £4.50 + VAT

### 500 Sheets of paper FREE!

## EPSON TX80

A complete 80 column dot matrix printer, available in tractor or friction feed versions.



- Speed: 125cps.
- Undirectional print
- PET compatible graphics.

### £295

P & P £4.50 + VAT

Various Interfaces available from £35.00

### 500 Sheets of paper FREE!

## SUPERPRINT 800



This rugged and reliable printer offers more features and flexibility than competitive units but at a new Special Offer price

- 64, 72, 80, 96, 120, or 132 characters/line.
- RS-232, 20ma, 1EEE-488 and Centronics
- Self-test switch.
- I/O fitted as standard.
- 16 baud rates to 19,200.
- Tractor and Friction Feed
- 60 lines per minute.
- Multiple character sets facility.

### £299

P & P £4.50 + VAT

### 500 Sheets of paper FREE!

## ACCESSORIES

TEX Eprom Eraser	£33
6Mhz Modulators	£2.80
8Mhz Modulators	£4.50
Cassette Recorders	£13.95
8" Fan-Fold Paper 500 sheets	£5.95
9 1/2" Fan-Fold Paper 500 sheets	£5.95
TELEPRINTER ROLL	£3.00
9" B & W Monitor	£65.00
HEX PAD	£3.50
ASCII Keyboard 756	£40
CEGMON any version	£29.50
Space Invaders 8K	£4.60
BASF Floppy Discs - each	£2.85

ALL PRICES EXCLUSIVE OF VAT & CARRIAGE



# WATFORD ELECTRONICS



# OFFER YOU A GREAT DEAL

## The Definitive Monitor

A 4k monitor specially designed to produce the best from your Superboard, Superboard Series 2, UK101 or Enhanced System.

Look at these superb facilities:

- Full screen editing.
- Home cursor/screen clear facility.
- True insert/delete.
- Fully programmable cursor control with meaningful symbols on screen.
- Single key Basic
- True ASCII keyboard routine.
- Auto remote control of tape recorder (requires only a relay).
- Open line facility.
- Named tape files.
- Two key video swap (Series 2 only).
- Bell (Series 2 only).
- Cursor indication of quotes mode.
- User definable flashing cursor character.
- User controllable command vectoring for your own machine code routines.
- Full or partial scroll-up or scroll-down (callable by program).
- Auto list on error (displays faulty line upon carriage return).
- Single command save (automatically returns "list").
- Centronics compatible printer driver.

Monitor functions include:

- Scrolling list in data mode.
- Warm restart vector.
- Fill memory.
- Search memory.
- Two save and three load routines.
- Floppy disc vector.
- Break handling routine.
- Tabular display of memory.

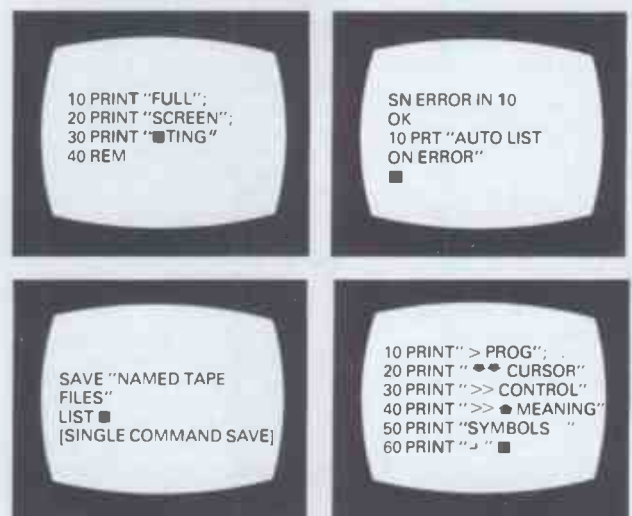

### All this for only £19.95

+ 50p P&P + VAT.

To order: Send £23.52 or phone your ACCESS number for same day despatch. State version required.

TTL 74 (TEXAS) Series		74LS Series		LS173		74S Series	
7400	11	74123	65	LS001	13	74S04	73
7401	11	74126	45	LS02	15	74S132	138
7402	11	74128	45	LS03	15	74S138	240
7403	14	74132	55	LS04	16	74S158	240
7404	14	74136	55	LS05	23	74S188	210
7405	18	74141	75	LS08	23	74S189	158
7406	36	74142	185	LS09	23	74S194	360
7407	36	74143	250	LS10	20	74S241	540
7408	17	74144	250	LS11	32	74S262	850
7409	20	74145	90	LS12	32	74S287	325
7410	17	74147	150	LS13	40	74S470	325
7411	25	74148	125	LS14	60	74S472	1150
7412	20	74150	130	LS15	40	74S475	825
7413	32	74151	70	LS20	21		
7414	38	74153	70	LS21	32		
7416	30	74154	120	LS22	35		
7417	30	74155	75	LS26	44		
7420	19	74156	75	LS27	35		
7421	38	74157	70	LS28	35		
7422	25	74159	165	LS29	35		
7423	28	74160	99	LS32	25		
7425	28	74161	99	LS33	35		
7426	43	74162	99	LS37	30		
7427	32	74163	99	LS38	35		
7428	35	74164	120	LS40	28		
7430	19	74165	120	LS42	66		
7432	27	74166	130	LS47	85		
7433	36	74167	205	LS48	105		
7437	35	74170	205	LS49	105		
7438	32	74172	375	LS51	25		
7440	20	74173	110	LS54	30		
7441	68	74174	100	LS55	30		
7442	58	74175	82	LS63	150		
7443	120	74176	80	LS73	45		
7444	116	74177	85	LS74	35		
7445	105	74178	110	LS75	45		
7446	132	74179	150	LS78	50		
7447	72	74180	90	LS78	50		
7448	75	74181	280	LS83	105		
7450	20	74182	85	LS85	80		
7451	20	74184	130	LS86	38		
7453	20	74185	130	LS90	50		
7454	20	74188	310	LS91	125		
7450	20	74190	130	LS92	75		
7470	40	74191	120	LS93	60		
7472	30	74192	120	LS95	115		
7473	35	74193	120	LS96	120		
7474	34	74194	102	LS107	45		
7475	56	74195	75	LS109	75		
7476	40	74198	99	LS112	40		
7480	52	74197	88	LS113	75		
7481	120	74198	160	LS114	40		
7482	75	74199	160	LS122	70		
7483	90	74221	150	LS123	75		
7484	99	74246	150	LS124	180		
7485	105	74247	151	LS125	45		
7486	33	74248	189	LS126	45		
7489	205	74249	189	LS132	60		
7490	42	74251	110	LS133	35		
7491	84	74255	66	LS136	55		
7492	50	74273	267	LS138	70		
7493	57	74278	249	LS139	70		
7494	85	74279	99	LS145	120		
7495	70	74283	149	LS147	210		
7496	80	74284	350	LS148	170		
7497	176	74285	350	LS151	90		
74100	130	74290	107	LS153	85		
74104	62	74293	135	LS155	75		
74105	62	74297	236	LS156	95		
74107	34	74298	185	LS157	70		
74109	60	74365	95	LS158	70		
74110	54	74366	95	LS160	90		
74111	68	74367	95	LS161	98		
74112	170	74368	95	LS162	110		
74116	170	74390	185	LS163	115		
74118	85	74393	185	LS164	115		
74119	120	74490	185	LS165	145		
74120	75			LS166	175		
74121	35			LS168	210		
74122	50			LS169	210		
				LS170	288		

CRYSTALS		'D' CONNECTORS (Cannon type)		OIL PLUGS (Headers)		DIL switches SPST	
100KHz	300			14 pin	44p	4 way	10 way
455KHz	370			16 pin	49p	6 way	175p
1MHz	295			24 pin	88p	8 way	SPDT
1.008M	295	9 way	90p	40 pin	295p	115p	190p
1.8432M	300	15 way	120p				
2.0MHz	305	25 way	180p				
2.4576M	305	37 way	268p				
3.2768M	150						
3.57954M	150						
4.0MHz	290						
4.032M	290						
4.194304M	270						
4.433619M	150						
5.0MHz	290						
5.185M	300						
5.24288M	390						
6.0MHz	290						
6.144M	295						
6.5535M	290						
7.188M	290						
7.68MHz	300						
8.0MHz	290						
8.867237	270						
10.0MHz	290						
10.7MHz	270						
12.0MHz	290						
14.31818M	320						
16.0MHz	290						
18.0MHz	290						
18.432M	290						
26.69M	390						
27.648M	330						
38.66667	290						
48.0MHz	270						
100.0MHz	375						

The above is just a selection of our vast stocks of brand new, full spec, electronic components.  
 To Order: Please add 15% VAT to all orders unless stated. On orders of less than £10 add 40p P&P.  
 Terms of Business: Cash/Cheque/P.O.'s or Bankers Draft with order.  
 Government, Education Authorities & Trade Welcome.  
 Access Orders: Minimum £10 please.



33/35 CARDIFF ROAD, WATFORD, HERTS. Telephone 40588





Guy Kewney, editor of Datalink, presents the latest micro news.

## Acorn's growing

El Grando is here. El Grando is the biggest 16-bit micro invented, the Motorola 68000 (count them, three noughts) or 68k to avoid misprints. It will form the processing heart of a system from Acorn in Cambridge, to follow up the successful (6000 sold) Atom.

Actually, the real successor to the Atom will be something without El Grando on it — it will be a 'twin processor' system called Proton, to be announced this summer. But the twin to the Proton can be a processing board with another 6502 on it, or with a Motorola 6809 on it, or a Zilog Z80 on it, or (trumpets) El Grando, the 68k.

I think it's worth making a fuss about. So far, the closest anybody else has got to announcing a system using El Grando was Apple, which has reluctantly leaked the possibility that it will use it on the Apple Four (or was it Five?) some time. In Acorn's case, Proton by itself is worth a little flurry. It will be different from the Atom, mainly in being more suitable for non-enthusiasts to use.

Chris Curry, one of the two Acorn partners, put it this way: 'There are holes on the back of the Atom for constructors to bolt on their own goodies, or bought bolt-on goodies. But we've been told that for office use, you don't want a hole that an office junior can stick a hair clip into.' The Proton, therefore, is not expected to conflict with the Acorn Atom but to open up a new market.

Technically, it looks exciting because of the twin processor concept. The idea is that you can use the Proton's fast 6502 chip to do your word processing, file searching and fast Fourier Transforms (just to pick three obvious things for a processor to do at random) until you decide that it is running out of address space, or steam, or whatever. Then you get a second board, which does all these things, and the Proton passes messages from this second board to the rest of the world — to the operator,

to the disks, to the printer, and to the local network. Price of the Proton isn't decided yet — I guess it'll be a bit above the Atom, just to make sure that there really isn't any conflict, but that could be done by pulling the Atom down a tenner or so, perhaps.

To run a system with the 68000 on, however, there is a rough price. It is worked out like this: 'You'd probably need quite a full Proton system to use as a 'front end' to the 68k,' Curry mused, 'say around £450. Then the 68k with...let's see...say 256 kbytes of memory — or maybe 512 kbytes, it depends on how memory prices shift, but it looks as if it'll stay cheap...anyway, however much memory it is, the board will cost around £1000.'

To go with the big 68k processor, the operating system will not be the common or garden CP/M but an option of two, probably either Unix, or Tripos. Tripos is one of those Cambridge University inventions of undoubted technical merit, about which little is known except by those enthusiasts who have fought their way into it. It was clear that Curry was much impressed by what Tripos could do but less struck by how Cambridge had promoted it. For an operating system to succeed, lots of people must understand it and understand how it stores data on disks and things.

There, Unix scores. It looks like becoming the universal operating system for 16-bit micros. It was based on the 16-bit DEC family of PDP/11 minicomputers and was designed inside America's telephone company, Bell Labs, where it naturally had lots of features put into it for telecommunication activities like sending electronic mail, like network control, and so on. The drawback here is that despite its undoubted popularity, Unix is promoted in a very negative way by Bell, which is miserly in its aid to commercial users and domineering in its attitude to allowing anything to happen outside

its control. The result is that versions are springing up outside its control, which could lead to the end of its best feature — compatibility.

## Free computer

Doesn't anybody out there realise we're actually planning to give away a free computer?

All we ask is that you have some ideas on what micros can do to help the disabled. You don't have to interface a micro to a wheelchair. You needn't be able to write code to control a video camera so that it will track moving objects for paraplegics. You can be totally and blissfully ignorant about automatic focussing of spectacles. All you have to do is think up a few such simple ideas and then expand on them — how, why, how many people might be pleased, who might help, what spin-offs there might be. Remember, having false teeth is one way to be disabled; suffering from severe hay fever can certainly be another. And disabled people need to live in houses, travel, eat, find their way round town, hear instructions on the Underground, make tea, answer the door...all we want is 2500 words and some thought into the problems that might arise — your idea may not even need

to win the contest to be picked up by one of the judges and turned into a very useful product. To say nothing of making money for you.

And if you win, we'll give you a DAI personal computer worth some £600 all for your very own. You don't even have to be able to use the DAI machine to perform your magic.

Send your entry to IYDP Competition, 14 Rathbone Place, London W1P 1DE, by April 30.

## In the lab

The last line of a recently-published paper states, 'even inexpensive desk computers can be used successfully in kinetic or equilibrium studies if efficient mathematical methods are used.' This is an important observation as the marriage with such methods gives small computers a much wider field of application. The advances which have led to powerful but cheap and small computers are well known and documented and such cheap computer power is now widely used for business uses such as stock control and accounting.

Scientific research work, however, places more



*I should be pleased. I know I should be pleased. Please, make me pleased. I told Hewlett-Packard that the HP-85 was too expensive, at nearly £2000; and that it should cost nearer £1200. This (above) is, as HP says, essentially identical to the HP-85, and it's called HP-83. It doesn't have a tape, or a printer but it does cost £1200. How can I tell them it ought to cost £800? Phone 0734 61022.*

stringent demands on computers with the requirement to perform complex calculations. A parallel development, less acknowledged than that in computers, has been that of the application of mathematical techniques to data from scientific experiments. Such applications have increased as computer systems have become more common in the laboratory, particularly in such fields as chromatography and spectroscopy where high sample throughputs and data acquisition rates are common.

A paper by Maeder and Gampp, presented at an international conference in Yugoslavia, illustrates well the combination of such mathematical techniques and small computers. The subject is the study of the structure of transition metal co-ordination compounds in solution using spectrophotometry. In solution, several different complexes will exist in equilibrium, each complex usually having a different and typical absorption spectrum between 300 and 800nm. In order to overcome difficulties which arise in practice it is necessary to use very precise data at several wavelengths and to use nonlinear regression analysis. This results in a large amount of data. Computer programs to handle this data have been used previously but required either a large computer or good estimates for some of their linear parameters.

Maeder and Gampp describe the use of matrix rank analysis to calculate the number of absorbing species in a series of measured spectra. Representation of the observed spectra as linear combinations of eigen vectors leads to significant reduction of the data set and the calculation can then be performed on a small computer. The paper says an Apple II with 50 kbyte memory is used. No details of the program are given but since no mention is made of language card or assembler, Basic was presumably used.

Original reference: Maeder, Marcel and Gampp, Harald, Institute for Inorganic Chemistry, University of Basle: 'Spectrophotometric data reduction by eigen-vector analysis for equilibrium and kinetic studies and a new method of fitting exponentials.' *Analytical Chimica Acta* 122 (1980) II 303-313.

Manufacturers of scientific instruments who have been incorporating microprocessors into their products for some time now seem to be recognising the potential of the personal computer. A recent application note from Varian describes the interfacing of an Apple II to a Cary 210/219 spectrophotometer.

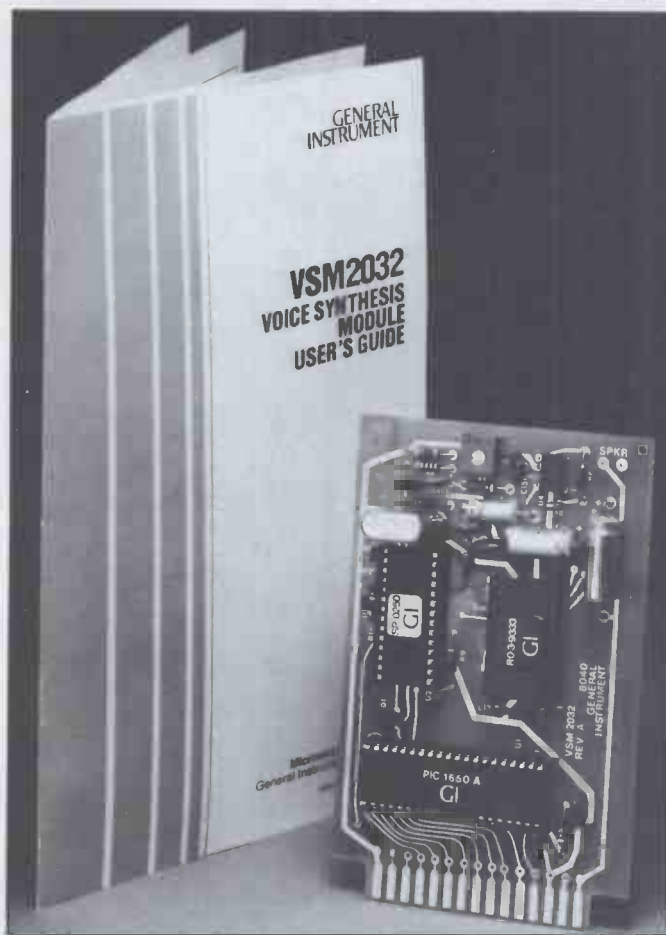

*One day, General Instrument will have a voice synthesis chip available. Till then, you can get a system ready for that chip to plug in by using this little development board. It generates up to 32 words in any sequence, (which GI stupidly says allows more than a billion different phrases to be formed — okay, okay, they didn't say 'meaningful') and will be replaceable by the SP-0256 chip one day. Details on 01-439 1891.*

Hardware requirements are Apple II Plus with 48k RAM, dual floppy disks, clock/calendar card and AIO interface card. In addition, the spectrophotometer should be fitted with the Digital Interface Port (DIP). The application note gives machine language routines for AIO initialisation, read DIP and write to DIP. Details are given for using the routines and a full discussion including input and output timings is presented for those who wish to understand the details behind the interfacing.

Varian has also recently announced a program for the Cary 210/219 — Apple combination which allows for multicomponent analysis using up to ten standards. The design of the program is claimed to make the analysis as easy as possible to perform, with the operator guided throughout necessary actions by instructions displayed on the Apple's screen.

The program is written in Pascal, a particularly interesting development since most programs of this type are currently written in Basic. Does this mark the start of the much heralded Basic v

Pascal battle or is it merely another skirmish?  
Jeff Turner

## Auntie gets upset

How to ingratiate yourself with a lot of people inside the BBC. Lesson One: first, write in your column in PCW that the Beeb is doing a programme to teach the subject of computing to the British. Second: add the fact that it has been far too ambitious in the speed it wants to get it done. Third: say that it appears to be the wrong outfit to do it anyway. (The technical phrase for this is 'they're all a bunch of Gonzos'.)

You will then be surprised at the number of people who ring you up and tell you how angry some of their colleagues are — but since the analysis is correct, can't something be done about all the gonzoing?

Apparently, one of the keys to the whole project is Government money. The cost of the project to the BBC would be fairly frightening in a good year but at the moment viewers are not

paying their licence fees: even when they do, the licence is too cheap. So when the Department of Education offered to pump a lot of cash into the project, naturally the Governors — sorry, the chartered accountants — were very eager to please the Department.

What has this to do with micros? It's simple enough: the Government has a lot of money invested in a micro, and would like to see it supported. That micro is to be produced by Newbury Laboratories, which is a subsidiary of DRE, a computer company which in turn is a subsidiary of the National Enterprise Board (NEB). It became obvious, early on, that if the BBC did a programme on computers, featuring a computer, that computer would instantly be demanded by millions of people. The big problem was: would it be available for those millions?

It is clear now that one of two things should have happened. First, the BBC could have gone to a company which had proved that it could build thousands of micros at low price and handed the project over, asking for a share in the profits. Second, it could have designed a micro and put the specification up for grabs. This is what executives will still tell you they did. What they actually did was to pick the Newbury Newbrain and then define it and then announce that that spec was up for grabs.

For instance, the specification of the language which is to be run on the BBC machine is ABC — it is a 'standard' Basic. It is a fundamental requirement of ABC that it should be compiled, not interpreted, direct from the Basic instructions. The only micro in the world that does this is the Newbrain. It's a good way of making sure that the programs run fast, since almost any compiled list of machine code instructions will run faster than a program that has to read the English words of Basic and act on each letter as it comes in from memory. But it is also an excellent way of ensuring that programs don't run at all — because errors aren't picked up as the code goes into memory. For a normal user, this is not a disaster, because he can recompile the program if it turns out to have errors. For somebody following a course, it is a lot less than ideal, because of the long time between finding what appears to be an error and finding out whether the correction works.

So, which machine is going to be picked?

By the time you read this, the decision should have been made. It would be nice to be



able to predict that prejudice won't play the major role, but prejudice is certainly the basis of the relationship between Uncle Clive Sinclair and the bureaucracy. He doesn't see why they should ask him impertinent questions to establish his bona fides when he's already got more users than any other UK computer manufacturer. And they don't trust this man with the aggressively high IQ (head of British Mensa and all that) who seems to regard their advice as a lot of gonzoing.

So a new version of the ZX80, even at the price of... well, it's supposed to be a secret, will probably go into the melting pot with a smoother version of the Atom from Acorn. And this, at press time was looking like the favourite. Then, of course, everybody will start making the new machine, and Sinclair will probably make more, sooner, than anyone else — because making a lot, fast, is what he's good at. Afterthought: maybe the Beeb people ought to talk to their colleagues in the Dutch TV service, which ran a programming course (based around the Exidy Sorcerer) some 18 months ago.

## Get together with Polynet

Two computers can be connected by a single two-wire cable. Three can be connected by three. Four, however, need six cables. Five need ten, six need 15... by the time you reach a dozen computers, printers, terminals and disks all interconnected, it becomes obvious why people try to find clever ways of linking them all together in local area networks.

The Cambridge ring is one way of connecting many devices with an intelligible network consisting of one continuous cable — and it has just been turned into a

real, marketable product, by a company called Logica. Logica calls it Polynet.

That's good news. The sad thing is that, although Logica has configured it for Intel microsystems among others, its main thrust has been towards larger mini-computers made by the world's biggest minicomputer builder, Digital.

Theoretically, by being Digital Equipment and Intel based, it matches exactly the planned system called Ethernet, which Xerox invented and which Digital and Intel are helping develop.

Unfortunately, Ethernet has long since passed beyond the control of Xerox, Digital or Intel — it has become the underlying assumption behind several micro operating systems that can fit inside a network. Micro users can already plug in things like Digital Research's CP/Net, the Apple Nestar net, the Acorn Econet and other things like Net One from Ungerman-Bass (in California) which are nearly all based on the Ethernet principle.

It will take a bit more push from Logica and Cambridge University than their lofty statement that 'Logica VTS is willing to develop other special-purpose interfaces for customers' needs' if they hope to arrest the American standard. Selling Polynet to the Science Research Council is not to be sniffed at in itself but, in comparison with the progress of various versions of the competition, it isn't enough. Logica VTS is on 01-637 5171.

## Apple's big buy

Nobody can accuse Mike Brewer, head of Apple's new UK subsidiary and ex-head of its ex-agents, Microsense, of boasting about how much he made out of being bought out by Apple because he won't say what he was paid. He got 52 per cent of whatever it was, however, and at the time the deal was signed, Microsense was



*This guy is for real, the Apple is for real, the guitar strings are for real, too and they all work together. He is Bill Fickar, lead 'guitarist' of The Broken Rubber Band and he uses the Apple to play synthesised guitar music. As long as he can keep his elbow off the RESET button, he remains a superb advert for the ALF Products Range of computer music products for the Apple — floppy disks that not only look like music disks but sound like them, too.*

*Worse: Alf has used the power of the Apple to teach music. The computer plays you a chord and you have to define it (augmented, diminished and so on) or pick out the notes by playing the same ones. The computer decides if you've got it right and whether you can move on to understand other things like scales.*

*Hang on a moment, and I'll sing you a bit...no? OK, get in touch with ALF Products Inc at 1448 Estes, Denver, Colorado 80215 or phone (303) 234 0871.*

turning over around £10 million for the year. *The Guardian* said the amount was 'well into seven figures' which may well be true but it is equally likely that people who put forward a figure of £250,000 are right. Either way, Mike Brewer can now afford a much bigger house than the rest of us and he remains managing director of the new Apple UK firm, as well as his other business, Data Efficiency, which supplies computer furniture.

He has been vindicated for putting up (in his own sour way) with all the anti-Microsense publicity and bad feeling generated when he took on the Apple distributorship in July 1979. Largely due to his ability to manage a big warehousing and distribution business, Apples have been available to far more of the people who wanted to buy them, than was the

case when something called Eurapple ran the show from California, taking a large cut. And since Kewney's Law of Micro Supply still holds true ('If you've got them, somebody will buy them') boosting availability has boosted sales.

Perhaps it's time to observe that the Apple has overtaken the PET as the number one seller in the UK. It still doesn't have the market size of the PET (I'd guess that there are around 20,000 Apples and ITT 2020 machines to the PET's 35,000 to 40,000) but unofficial Customs figures show that more Apples are coming in to the country.

And despite all the rude things I've said about the newest Apple, the Apple III, Brewer says that it, too, is now vindicating Kewney's Law by selling — even though it has more internal memory

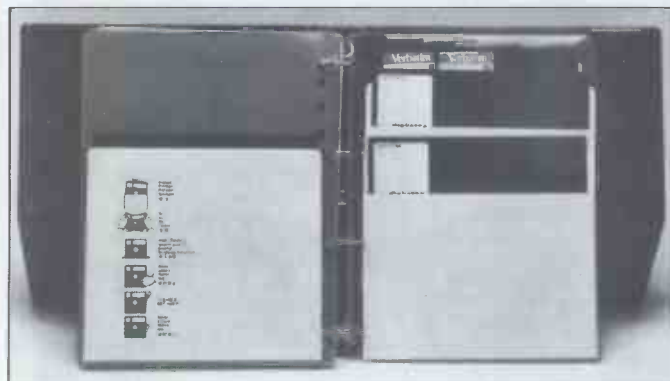

*Watch a disk going round and round in a drive. Fast, isn't it? Now put a little kink in the plastic, and watch the head jump around. Acrobatic, isn't it? Want something to store the disk in now? Details from Rexel, tel Aylesbury 81421. Should stop them kinking.*



than disk space and costs twice as much as its little brother. First samples arrived here in January and a couple of hundred have gone to users.

If any of you users would like to drop me a note and tell me what it is that makes it worth the money, I'd really like to hear it, you know.

## Don't blame us ...

There is no point in taking legal action against The Software House if your boss runs one of their payroll packages and it refuses to pay you — because The Software House starts its latest catalogue off with a disclaimer.

It reads: 'All software is guaranteed on a replacement basis only. We do not accept liability for misuse of, or result from the software supplied.' It also adds that software damaged by the user will not be replaced.

This could turn out to be a bigger legal problem than the one about copyright, on which lawyer Alistair Kelman hopes to build a successful political career. I suppose Keith Jones, who runs the Software House, must think it's worth trying, but the problem may prove bigger than a simple disclaimer.

For example, the *Sunday Times* once produced a book on do-it-yourself home extensions (a compiled version of its DIY series in the colour magazine at the time). Shortly after the book appeared, two house-improvers demolished a load-bearing wall in accordance with the *Sunday Times* instructions then went out to tea before moving to the next step. On their return from the pub, they found a

collapsed house and successfully sued the *Sunday Times* for the repair bill.

The law on most points of software doesn't exist ('has not been tested' is the legal term) but I would like to take a small bet that this one will go against the supplier if it ever gets to court. It might be a lot harder to blame the writer, however...

Keith tells me that he's only passing on disclaimers which he, in turn, has had to sign. And anyway he likes the business software he sells. It's written by Microsense (Apple?) and Computech.

## Exidy goes Dutch

Exidy is a company which makes computers — the Sorcerer — and also has its names on a lot of amusement arcade games. Now, under new management, Exidy says it 'has come to understand the differences between the arcade business and computer business' and the time has come for 'a separation of church and state,' according to Paul Terrell, president of the new subsidiary which will handle only the Sorcerer. He doesn't say which is church and which is state.

According to Terrell, there are 15,000 Sorcerer machines in the hands of users and the machine was launched in June 1978. It could have done better, and price and availability need some fine adjustment. Price and availability could both be affected in the right direction by the decision to manufacture the machine in Holland, by Computata Systems BV, under licence. The company is a software producer which already has the European distribution



*These disks are, according to their producer, covered with a thicker oxide coating, which is in turn covered with a better lubricant and is certified to an amazing degree of error-free performance. The supplier, BFI Electronics, says it is replacing its normal stock of Verbatim disks with these, called Data Life, also made by Verbatim.*

rights of the Sorcerer. It claims it will have production going by the second quarter of this year. If that's true, then I suspect that what we will see is an assembly operation, not true manufacture, and that it won't really affect the UK situation one way or another for several months after the summer. To boost availability, after all, you have to get more agents, and to do that, you have to offer them a better discount. And to do that, you need a big, successful production line, not a brand new one.

## Adler launched

It is over a year now since Triumph Adler first let slip that it was building a £1500 system with floppy disk and video display — comparable with a Superbrain from its cheaper suppliers, or an Apple with a single disk, and a lot cheaper than several 'upmarket' offerings. At the time, it struck several observers that the machine could frighten people in both the micro industry, and the orthodox minicomputer business — for example, Triumph Adler itself, with several machines not a great deal more powerful, but a great deal more costly.

Now it is out — and you should see the brochure! You can see your face in the paper's gloss. All the software has been carefully packaged, too. You'll have noticed that new software company Microtrend — well it has got a lot of backing from Triumph Adler, and has put every scrap of its stuff on it. Tridata, too, is in on the act. Its payroll package has already been validated and accepted by Alphatronic. Its other ledger packages are expected to be ready soon.

The price is the interesting thing: one would have expected an established company to make the Hewlett-Packard mistake of deciding Quality Means Price and overcharging. Instead, the Alphatronic looks very competitive. All that really remains to be seen is if Triumph Adler can attract dealers — if they can latch onto 50 to 100 in the first year, they will come in strong behind tetappletandy machines.

Details from Mike Davies at Adler Business Systems on 01-250 1717. He will tell you the Alphatronic will be no threat to existing TA designs. He will also tell you that if TA didn't do it, someone else would. There, he's quite right.

## Baldachin branch-out

The man who set up Little Genius courses — the programs which you load into your computer to let it teach you how to use it — has set up in business on his own. He is Jonathan Baldachin and he has set up in partnership with John Saunder, a freelance programmer, with new offices at 203 Kilburn High Road, London NW6 7HY.

Whatever his part-time leisure activities may have been, they are going to be dropped for a bit — he was owed a couple of thousand pounds by a course-running company called Infotech when it went bust early in February and even Baldachin will have to burn a little midnight oil to make up that ground. I only hope it isn't at the expense of the Association of Independent Computer Specialists, a sort of club for one-man contract programmers and consultants,



Adler's new Alphatronic — see 'Adler launched'

# NASBUS NEWS

## More great deals from 6 Nascom Dealers

### A NASCOM-2 BASED SYSTEM FOR £1499 + VAT

The proven Nascom-2 microcomputer can now be bought as a complete system from £1499 + VAT. For this price you get the Nascom-2 kit, 16K RAM board kit, Kenilworth case with 2 card frame, Centronics 737 printer, 10 inch monitor, and the

Gemini Dual Drive Floppy Disk System. The CPU and RAM boards are also available built - the additional cost is available on application.



### GEMINI G805 FLOPPY DISK SYSTEM FOR NASCOM-1 & 2

It's here at last! A floppy disk system and CP/M.

**CP/M SYSTEM.** The disk unit comes fully assembled complete with one or two 5 $\frac{1}{4}$ " drives (FD250 double sided, single density) giving 160K per drive, controller card, power supply, interconnects from Nascom-1 or 2 to the FDC card and a second interconnect from the FDC card to two drives, CP/M 1.4 on diskette plus manual, a BIOS EPROM and new N2MD PROM. All in a stylish enclosure.

Nascom-2 Single drive system. **£450 + VAT**  
 Nascom-2 Double drive system **£640 + VAT**  
 Nascom-1 Single drive system **£460 + VAT**  
 Nascom-1 Double drive system **£650 + VAT**  
 Additional FD250 drives ..... **£205 + VAT**

**D-DOS SYSTEM.** The disk unit is also available without CP/M to enable existing Nas-Sys software to be used. Simple read, write routines are supplied in EPROM. The unit plugs straight into the Nascom PIO.

Single drive system ..... **£395 + VAT**  
 (please state which Nascom the unit is for)  
 Certain parts of the CP/M and D-DOS disk systems are available in kit form. Details available on request.

### KENILWORTH CASE FOR NASCOM-2

The Kenilworth case is a professional case designed specifically for the Nascom-2 and up to four additional 8" x 8" cards. It has hardwood side panels and a plastic coated steel base and cover. A fully cut back panel will accept a fan, UHF and video connectors and up to 8 D-type connectors. The basic case accepts the N2 board, PSU and keyboard. Optional support kits are available for 2 and 5 card expansion.

Kenilworth case ..... **£49.50 + VAT**  
 2-card support kit ..... **£7.50 + VAT**  
 5-card support kit ..... **£19.50 + VAT**

### GEMINI EPROM BOARD

The Nasbus compatible EPROM board accepts up to 16, 2716 or 16, 2708 EPROMs. It has a separate socket for the MK36271 8K BASIC ROM for the benefit of Nascom-1 users. And for Nascom-2 users, a wait state for slower EPROMs. The board also supports the Nascom Page Mode Scheme.

EPROM Board (kit) ..... **£55 + VAT**  
 EPROM Board (built & tested) ..... **£70 + VAT**

### CASSETTE ENHANCING UNIT

The Castle interface is a built and tested add-on unit which lifts the Nascom-2 into the class of the fully professional computer. It mutes spurious output from cassette recorder switching, adds motor control facilities, automatically switches output between cassette and printer, simplifies 2400 baud cassette operating and provides true RS232 handshake.

Castle Interface Unit ..... **£17.50 + VAT**

### A-D CONVERTER

For really interesting and useful interactions with the 'outside world' the Milham analogue to digital converter is a must. This 8-bit converter is multiplexed between four channels - all software selectable. Sampling rate is 4KHz. Sensitivity is adjustable. Typical applications include temperature measurement, voice analysis, joystick tracking and voltage measurement. It is supplied built and tested with extensive software and easy connection to the Nascom PIO.

Milham A-D Converter (built and tested) ..... **£49.50 + VAT**

### PROGRAMMER'S AID

For Nascom ROM BASIC running under Nas-Sys. Supplied in 2 x 2708 EPROMs. Features include: auto line numbering; intelligent renumbering; program appending; line deletion; hexadecimal conversion; recompression of reserved words; auto repeat; and printer handshake routines. When ordering please state whether this is to be used with Nas-Sys 1 or 3. **Price £28 + VAT.**

### DUAL MONITOR BOARD

A piggy-back board that allows N1 users to switch rapidly between two separate operating systems. **Price (kit) £6.50 + VAT.**

NASCOM-2 Microcomputer Kit **£225 + VAT**  
 NASCOM-1 Microcomputer Kit **£125 + VAT**  
 Built & tested **£140 + VAT**  
 IMP Printer. Built & tested ..... **£325 + VAT**

### CENTRONICS 737 MICRO PRINTER

A high performance, low price, dot-matrix printer that runs at 80cps (proportional) and 50cps (monospaced). This new printer gives text processing quality print. And can print subscripts and superscripts. It has 3-way paper handling and parallel interface as standard. Serial Interface is optional. **Price £425 + VAT.** Fanfold paper (2000 sheets) **£18 + VAT.**

### GEMINI 'SUPERMUM'

12 x 8 piggy-back board for Nascom-1 offering five-slot motherboard, quality 5A power supply and reliable buffering with reset jump facility. **Price £85 + VAT.**

### BITS & PC'S PCG

5 x 4 board which plugs straight into Nascom-2. Operates on call structure of 128 dots, producing 64 different cells. Once defined, each cell may be placed anywhere, any number of times on screen simultaneously. Max screen capacity: 768 cells. Dot resolution: 384 x 256 = 98304. Many other features including intermixing of alpha-numeric characters and pixels. **Price (kit) £60 + VAT.**

### GEMINI 64K RAM BOARD

Newly developed Nasbus compatible board that can accommodate up to 64K of RAM with optional Page Mode facility. **Prices: £90 (16K), £110 (32K), £130 (48K), £150 (64K). Add VAT to all prices.**

All prices are correct at time of going to press.

### DISKPEN

The powerful text editor written for the Nascom is now available on a 5 $\frac{1}{4}$  inch floppy disk with a number of new features. **Price £43.25 + VAT.**

### PORT PROBE

Allows monitoring of input and output of Nascom PIO. This board can generate interrupts and simulate handshake control. **Price (kit) £17.50 + VAT.**

### HEX & CONTROL KEYPADS

Hexadecimal scratchpad keyboard kit for N1/2. **Price £34 + VAT.**  
 As above but including (on the same board) a control keypad kit to add N2 control keys to N1. **Price £40.50 + VAT.**

### BASIC PROGRAMMER'S AID

Supplied on tape for N1/2 running Nas-Sys and Nascom ROM BASIC. Features include auto line number, full cross-reference listing, delete lines, find, compacting command, plus a comprehensive line re-numbering facility. **Price £13 + VAT.**

### PROM-PROG

2708 (multi-rail) and 2716 (single-rail) EPROM programmer kit controlled by N1/2 PIO. Supplied with comprehensive software for use with Nas-Sys. **Price £25.95 + VAT.**

**WE STOCK**  
**Nasbus**  
 COMPATIBLE  
**COMPUTER**  
**PRODUCTS**

All the products are available while stocks last from the Nascom dealers below. (Mail order enquirers should telephone for delivery dates and post and packing costs.) Access & Barclaycard welcome.

**BITS & PC'S**  
 4 Westgate, Wetherby, W. Yorks.  
 Tel: (0937) 63774.

**BUSINESS & LEISURE MICROCOMPUTERS**  
 16 The Square, Kenilworth, Warks.  
 Tel: (0926) 512127.

**ELECTRO VALUE LTD.**  
 680 Burnage Lane, Burnage, Manchester M19 1NA.  
 Tel: (061) 432 4945.  
 28 St Judes, Englefield Green, Egham, Surrey TW20 0HB.  
 Tel: (0784) 33603. Tlx: 264475.

**TARGET ELECTRONICS**  
 16 Cherry Lane, Bristol BS1 3NG.  
 Tel: (0272) 421196.

**INTERFACE COMPONENTS LTD.**  
 Oakfield Corner, Sycamore Road, Amersham, Bucks.  
 Tel: (02403) 22307. Tlx: 837788.

**HENRY'S RADIO**  
 404 Edgware Road, London W2.  
 Tel: (01) 402 6822.  
 Tlx: 262284 (quote ref: 1400).



for which he is publicity executive.

Any potential customers are probably people involved in 'telecommunications in the office,' according to Baldachin; he and Saunders expect a large demand for services based on Prestel or Ethernet networks. Useless information: my Oxford dictionary defines 'baldachin' as 'canopy projecting, suspended, or carried, over altar, throne, priest, etc.' It comes from the Italian word for Baghdad, apparently. Never let it be said that I don't provide the full story.

## Having disk troubles?

There is a good way and a bad way of expanding the data storage capacity of a computer beyond the few hundred thousand characters of a floppy disk. Unfortunately, both involve buying a hard disk, and there is little information on which to base the choice.

In a nutshell, some hard disks are failing more often than they should. Dealers tend to agree on the name of one particular culprit, but until someone does a proper survey, it doesn't seem fair to publish the name.

So: if you have a hard disk which has broken down, please drop me a postcard. Say who supplied it, when, and how long it ran before the fault developed. And, most important, who made it, and what the fault was. Mark your postcards 'HARD LUCK' and send to me, Guy Kewney, at PCW, 14 Rathbone Place, London W1P 1DE.

## Go faster with Forth

Speed-up-your-processor claims are always made by users of the language Forth and also by people who provide a special add-in processor to do arithmetic.

Naturally the Microspeed Language System for Apple II, which does both, claims truly enormous speed improvements '...enables users to run programs at six to 60 times faster than Applesoft Basic,' according to the UK supplier (Datalink Micro-computer Systems in Bristol).

At a cost of £265 plus tax, you get the auxiliary processor card, Applesoft replacement memory chip (read-only memory) and a 120 page user manual, plus system software disks. The system apparently isn't a pure Forth language; it 'preserves the desirable features of the Forth concept, including extensibility,

inherent program structuring, ease of software development, and compactness of the compiled code,' says Geoff Smythe, who imports MLS from Applied Analytics Inc. Unfortunately Smythe's outfit claims to be the sole European source, so I can't give any reassurance on price levels or availability beyond 'you have to trust them.' Details on Bristol 213427.

## Bus bandwaggon

Computers can readily be persuaded to learn codes other than the internal ASCII they use for our alphabet — Morse, for instance, or the Telex baudot. This doesn't make it easy to send messages from one type of machine to another and a lot of people would pay a lot of money for something that would make it easy.

A company called Xionics thinks it has a way to get that money. The problem isn't just in the code matching between something like the PET, with its own internal code and more normal machines: it is in a whole series of little details which each machine assumes — like how long a line of type is, whether going back to the edge of the machine automatically means going down one line at the same time, whether graphics are drawn as a connection of patterns, or a connection of dots on graph paper — any number of these protocols need to be converted. Now, there is a network which can do it.

Xionics makes a network called a Xibus. It has sold samples of this network to

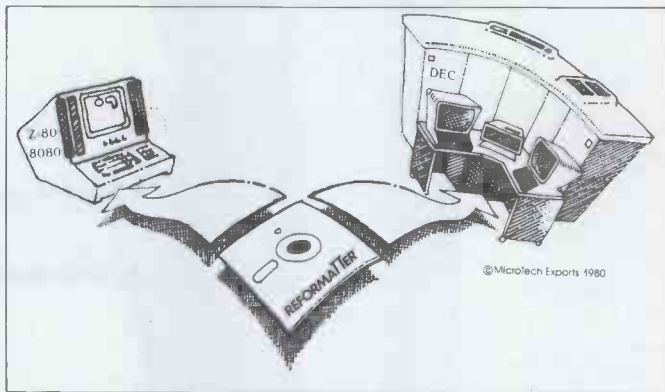

Putting a disk between your micro and your firm's mainframe could save you a bundle if you can do it. A lot of people aren't too keen on allowing it: according to MicroTech Exports who sent us this announcement, America's Government could save something like \$80 million a year if the data processing industry could agree on how the disk should be used. Naturally, the DP industry isn't all that keen on seeing the money saved.

MicroTech's marketing director Oscar A Rosenbloom reckons his Reformatter line of disk utility programs can do it for you anyway — providing you have a micro using the Intel 8080 or Zilog Z80 micro chip. He also says the picture explains how it is done better than any verbal lecture and he's right. Contact him in Palo Alto, California 94301; his address is 467 Hamilton Avenue and his phone (415) 324 9114.

several top companies in the UK, and they are 'evaluating' the Xibus, using it to convert protocols between devices. The question Xionics must answer now is: when these big companies decide they like the Xibus, will they buy what they need from Xionics? Or will they want to go for a bigger supplier — that is, tell the IBM and Univac and Burroughs type companies who supply their big systems to provide the Xibus features?

It is a race for Xionics to get big enough to command the business respect of these firms before the technology respect can fade and, therefore, the news that the company has managed to get some £300,000 out of

Meritor, an investment company owned by Midland Bank and Rolls-Royce, is good. In the words of Mike Bevan, chairman of Xionics: 'It strengthens our position greatly.'

## Fast finder

How long it takes to find data in a database depends on what you are looking for and which bit of software you are using to look for it.

The latest sort/search software for the Tandy TRS-80 or Video Genie is actually 'not recommended for any application in which fast searching or sorting is not a prime requirement,' by the supplier, A J Harding, because it is so good at doing those things that it is relatively second-rate at storing huge volumes of data as easily as possible. At £22.43, it is possibly the most serious-looking program in the latest catalogue addition from Harding. Other fascinating products include a simulation of the Solar System with accurate orbits, in which the operator has to navigate a ship from planet to planet, and a disassembler. Details on (0424) 220391.

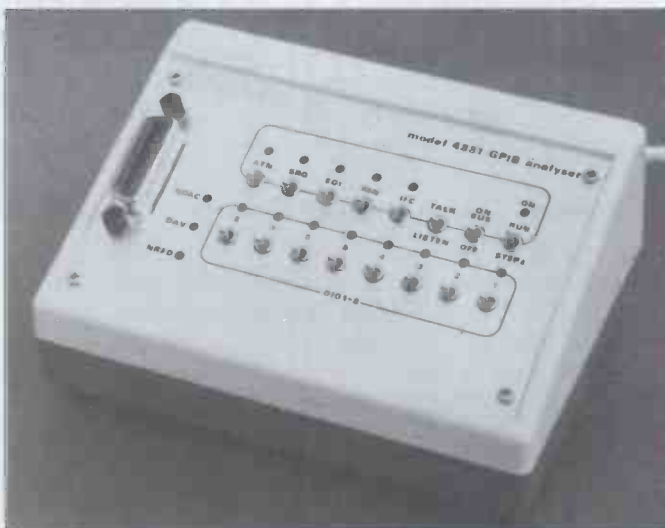

If one of the 16 lines coming out of the back of the PET, or Apple, or ABC80 or Research Machines RML 380Z or HP 85 — or any machine with the general purpose interface bus — has a fault, then rubbish will emerge from any device attached. Connect this set of lights and switches to the GPIB and you can make very simple tests. You can also plug in a scope at the same time. It may be some help. Try Wasec on 01-669 2423.

## Brain boost

Competition seems to be good for suppliers of the Superbrain computer, whether they are the original high-price suppliers, or one of the new revolutionaries fighting the price down around the £1500 mark.

Icarus has illustrated this by responding to price-cutting with a couple of improvements. First, there is a big boost in add-on



**Comart Approved Dealers**

**Belfast**

O & M Systems  
95 Dublin Road  
Tel: 0232 49440

**Birmingham**

Byteshop Computerland Ltd  
94/96 Hurst St, B5 4TD  
Tel: 021 622 7149

**Cambridge**

Cambridge Computer Stores  
1 Emmanuel St, CB1 1NE  
Tel: 0223 68155

**Cornwall**

Benchmark Computer  
Systems Ltd  
Tremena Manor  
Tremena Road  
St Austell, PL25 5GG  
Tel: 0726 610000

**Dublin**

Lendac Data Systems Ltd  
8 Dawson St  
Tel: 0001 372052

**Glasgow**

Byteshop Computerland Ltd  
Magnet House  
61 Waterloo St, G2 7BP  
Tel: 041 221 7409

**Leeds**

Holdene Ltd  
Manchester Unity House  
11/12 Rampart Road  
Woodhouse St  
Tel: 0532 459459

**London**

Byteshop Computerland Ltd  
324 Euston Road  
London W1  
Tel: 01-387 0505

Digitus  
9 Macklin Street  
Covent Garden WC2  
Tel: 01 405 6761

Jarrogate  
67 Tulsemere Road,  
West Norwood,  
London SE17  
Tel: 01-670 3674

**Manchester**

Byteshop Computerland Ltd  
11 Gateway House  
Piccadilly Station Approach  
Tel: 061 236 4737

NSC Computers  
29 Hanging Ditch  
Tel: 061 832 2269

**Newbury**

Newbear Computing Store  
40 Bartholomew St  
Tel: 0635 30505

**Nottingham**

Byteshop Computerland Ltd  
92A Upper Parliament St,  
NG1 6LF  
Tel: 0602 40576

**Sheffield**

Hallam Computer Systems  
451 Eccleshall Road, S11 9PN  
Tel: 0742 663125

**Southampton**

Xitan Systems  
23 Cumberland Place,  
SO1 2BB  
Tel: 0703 38740

**Sudbury**

Eurotec Consultants  
Holbrook Hall  
Little Waldingford  
Tel: 0206 262319

**Warwick**

Business & Leisure  
Microcomputers  
16 The Square  
Kenilworth  
Tel: 0926 512127

**Watford**

Lux Computer Services  
108 The Parade  
High Street  
Watford WD11 2AW  
Tel: 0923 29513

Comart Microcomputer dealers are located strategically throughout the country to give support, guidance and assistance. In the event of difficulty contact Comart direct.



## Horizon Hard Disc adds a new dimension to cost effective data processing

With its parentage already established as the proven performer in its price range, North Star's Hard Disc Horizon is set to break new barriers in cutting the cost of data storage and retrieval.

It offers 18 Megabytes of on line storage, and at current prices that works out at less than 0.03p per byte. And, with up to 10 times the speed of operation of the more conventional floppy discs, and the convenience of storing all your data on-line, it's a basic price incentive that's amplified

even more in reduced operating costs and efficiency.

Add to that the new North Star Application Software, Word Processing, Information Management and Reporting System and you'll understand why we say that North Star is set for new horizons of application.

Find out the facts about expanding your North Star Horizon today!

The U.K. Leaders in Microcomputer Development, Application and Support.

# comart

St Neots HUNTINGDON Cambs PE19 2AF  
Tel (0480) 215005 Telex: 32514 Comart G.

storage with the addition of a £3500 big disk — it offers 16 megabytes of fast-access data, a lot more than provided in the floppy disks supplied as standard with the Superbrain. And second, Icarus has developed a £100 'fix' for the machine, so that it will give a better video image — either reverse video, or standard, plus Prestel type graphics. Details on 01-485 5574.

## Getting better...

Hewlett-Packard may have stuck to its guns on price for its HP85 micro system but it has bowed to comment about the software. It is now official: there is a Software Supplier program, designed to help you write software to sell to other users. Inevitably and necessarily, this doesn't restrict you to the powerful but unchangeable instructions found in Hewlett-Packard's Basic programming language.

However, HP has gone further, as one might expect from this outfit. It has announced an assembler package — to allow users to program the machine in its

own, fast and detailed machine level code — which actually directs the user into the ready-written routines existing in permanent (read-only) memory in the computer already.

These routines for mathematics and input/output are already there because the Basic has to have them to operate. Most computers have Basic: none of their makers are thoughtful enough to offer you pointers into the code so that you can use them for your own purposes. HP even lets you write new Basic instructions. And the very friendly editor which is available on the little screen is available while you run the assembler — misspell an instruction mnemonic, and it will be picked up. For £159, that must be a winner — shame the HP85 isn't just a wee bit cheaper, isn't it?

## Going down again

The Japanese Sharp MZ-80K continues to catch up with the petappletandy machines; pricing policy must have something to do with it. Sharp has just announced price cuts — again — on peripherals. Now, the

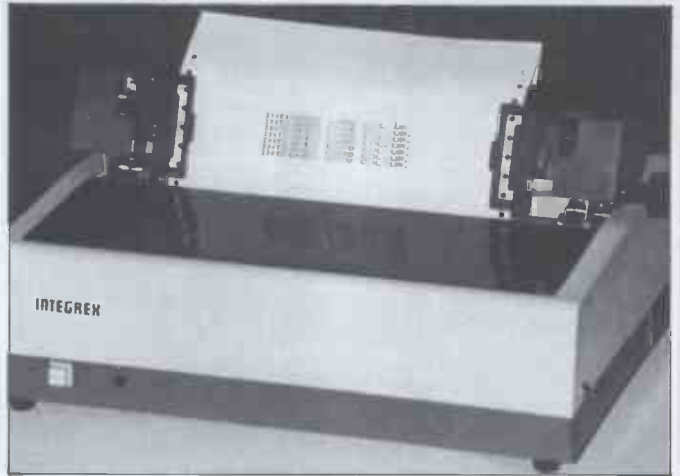

You've probably seen those stands at fairs and computer shows where they take a TV camera, feed its output into a computer, and print out something like your face (assuming the camera was pointing at your face) on a piece of paper. The latest ones do it in full colour. Now the outfit which does that stunt, Computer Art, is distributing this cheap (£900) smaller version of its printer, made by Integrex. The computer controlling it can generate graphics, characters and special PET graphics: you can bang any needle any time with any colour ribbon. It's quite a printer — about the only thing it won't do is print nice black characters but the blue is pretty legible for letters if you must. Integrex is on Burton on Trent (0283) 215432, and Computer Art in Manchester on 061-483 8984 or 6475. They'll print you a colour tee-shirt, too.

MZ-80FD twin floppy disk drive costs £615 instead of its old £695 price. The

printer, the MZ-80P3, now costs £92 less, giving a recommended price of £425.

# COMPUTERMARKET '81 PREVIEW

Computermarket is a series of exhibitions for senior management, executives and directors of organisations using, or considering the use of computers. Here are the details. Scotland —

March 17 — 19: Albany Hotel, Bothwell Street, Glasgow. North West — March 24 — 26: New Century Hall, Corporation Street, Manchester. Midlands — March 31 — April 2: Albany Hotel, Smallbrook Queensway, Birmingham. London April 7 — 9: West Centre Hotel, Lillie Road SW6

Further information is available from Roger Frampton at Couchmead Ltd, 42 Great Windmill Street, London, W1V 7PA. Telephone: 01-437 4187

The coating on the surface of the new Data Life diskettes can be examined at Comp Computermarket, on the BFI stand, to see if it really is that crucial number of microinches thicker and more uniform. It is the new Verbatim diskette, and will eventually replace the normal magnetic floppies. Stand B121.

A large number of PCW readers apparently don't run microsystems but Digital minis — the PDP-11 range. They will want to move off to the Megabyte stand to see new add-ons or imitation DEC products. Included in the list will be a VT100 display (compatible, any way); some add-on Winchester disks with 84 megabytes emulating RK06; printers, a hand held terminal, and add on storage modules — plus software in Basic Plus for various business applications.

A new version of the Micos Management System (NMS) is to be launched at Computermarket by MCS Minicomputer systems — people whose computers are based on 16-bit mini processors made by Data General. The new

version, MMS II covers the same functions as the first — accountancy, mainly — bit is designed 'for the larger company' says MCS.

Fortunately for suppliers of paper, computer users don't keep all their records in computers. Carter-Parratt intends to show several ways of storage for paper used in computer rooms — manuals and so on. It will also show bits of furniture to put terminals on — terminal stations, the word is — and other cabinets. They're not exactly offering to fix any duff equipment you bring along to the stand, but Kode Services are going to be pushing the idea of servicing and repair. To attract customers, to the Glasgow Computer market at least, Kode will show some Anadex printers and a Teletype terminal, driven by a Vector Graphics micro which is one of the systems Kode services through the UK. 'It's an area which, regrettably, receives little attention from the Press,' mourns J E May, managing director. A new computer for most

of our readers: TKT Computer Services will show the EDS POINT 4 mini — a typical configuration with a ten megabyte disk, two video displays, and a printer, would fetch around £15,000, not including software — that's extra. There will also be printers. Racks to store disks and tape on will be the stars of the Divi (UK) stand at Computermarket North West. There will also be trolleys, cabinets, and video display desks.

First public showing of Pragma's 'intelligent video display', the Visual 400, will be in the Glasgow Computermarket. It is an editing video based on the Zilog Z80 micro. There will also be a colour system called the MCD 4001, made in Germany by HMW. Finally, Pragma will show printers from Printronix.

At least there will be PETs at Computermarket; they will be shown in the Midlands location, by Computer Services Midlands. Xylogica have warned Computermarket that they will be at three venues — Scotland, Midlands and

London — showing their latest disk controllers designed for system builders using DEC, Data General and Intel components. There will also be a Xylogics built system based on the DEC LSI-11 'microprocessor'.

Power supply cleaners Edcel Electronics will be at all the four Computermarket shows, demonstrating their ways of smoothing out mains 'spikes' which can interrupt processing, mainly using a battery as intermediate storage to drive their own generators.

A range of turntables, allowing video display users to move their terminals round without the rubber feet falling off the edge of the table, will be shown at the London Computermarket by IEM. Prices from £24 to £135.

High quality printers made by Diablo and GE Terminus will be displayed by Zygol Dynamics. There will also be video terminals, and storage terminals, promises managing director John McLean.





## YANKEE DOODLES

Tom Williams reports on the American side of the microscene

Are you biting your nails and biding your time until a Winchester disk becomes available for that system of yours which now runs only floppies, yet nevertheless represents a sizeable investment? Have you given up hope because yours is an oddball this-and-that for which no-one shows any signs of designing that needed interface? Help may be on the way, if you are willing to pay a small price in performance.

One of the main obstacles preventing the immediate use of 8 and 5¼in Winchester drives on many of today's small systems has been the lack of a proper interface to connect the host system to the Winchester's controller. This problem becomes even more intimidating when the system in question is not bus-oriented. Alpha Systems of San Jose, California, has come up with a method that allows the user to simply plug his Winchester drive daisy-chain fashion onto the existing drives and run it as if it were just another (very large) floppy disk.

Alpha has come up with two subsystems — one using Seagate Technology's 5¼in ST506 drive, and another using Shugart Associates' SA1004 8in drive — which have an intelligent interface called the 'transformer' which makes them appear as floppy drives to the host's floppy controller. The tradeoff here is that one does not get the speed and performance of which a Winchester is capable. Instead, one gets the vastly increased capacity and immediate usability with the same access times that floppies give.

The 'transformer', a Z80-based interface board in the subsystem, performs reads and writes on the

Winchester, during which it stores a whole track at a time in its on-board RAM. This RAM is then read or written to by the host's controller as if it were a track on a floppy disk.

It must be emphasised that this arrangement does not give the speed and performance that a fully-interfaced Winchester drive does. What it does do is give the full capacity of a Winchester and goes a long way towards overcoming problems not only of interfacing but also of operating system compatibility. Alpha systems will deliver slight modifications for popular operating systems to allow them to recognise the increased number of tracks available on the hard disk. These modifications will also make the hard disk the drive on which the operating system resides.

All the user needs do is daisy-chain the subsystem onto his existing system, change the address jumpers to make the Winchester the first drive and run the program provided to modify the operating system. Alpha systems is planning to provide programs in the immediate future to modify TRSDOS, CP/M and ISIS to accept the 'transformer' subsystems. Other operating systems may be added in the future.

The AS-105 (5¼in, 5 Mbyte) is expected to cost in the region of \$2,300 and the AS-110 (8in, 10 Mbyte) about \$3,200. Each will consist of Winchester drive, 'transformer' interface board, power supply, OS modification program and documentation.

To overcome the problems created by single/double systems, the 'transformer' has been designed for double-density controllers. However, for systems with single-

density drives, a jumper can be changed to cause the transformer to present the data to the controller in single-density form.

### Meanwhile in Texas...

Texas Instruments is still trying to find a way to deal with that persistent albatross around its neck, the TI99/4. The 99/4, which depends mostly on software in ROM packs grandiosely named 'Solid State Software' command modules, ran into the problem that computers for which a large selection of ready-to-run software exists, don't have.

One of the main problems TI ran into was the chicken-and-egg problem that software sells hardware, and that it's difficult to get people to write software independently if the system involved makes it prohibitively expensive. TI's typically Texan solution was to offer development systems to interested parties to produce ROM-based programs. The problem was that development systems cost between \$50,000 and \$96,000. Thus, only large companies, primarily publishers, could afford to get into the TI 99/4 software business and not many of them were interested — not that much hardware in the field, you see.

Undaunted, TI is now offering a 'low-cost' development system which uses Pascal. TI doesn't, however, say in its press release how 'low' this cost really is, which leads to the suspicion that if you have to ask, you probably can't afford it. TI is still aiming its software development appeal at companies and publishers and apparently has not realised

that some of the most successful commercial software developers have been relatively modest folks who later made a real killing on their labours — and incidentally made it possible for the hardware manufacturer to vastly increase sales.

In another move, TI has entered an agreement with Source Telecomputing to develop a TI 99/4 information and communications service called TEXNET. TEXNET, which will apparently operate as a subset of The Source, the consumer computer network, will support TI graphics and the 99/4's sound and speech capabilities. Despite the auspicious sound of all this, one really must raise a polite eyebrow at the news.

Now it looks as if the two major personal computer networks in the US will have specialised machines dedicated as terminals for use with those networks. MicroNet, the other one, has a similar deal with Radio Shack and its TRS-80 Color computer. That will, in turn, probably mean that owners of incompatible computers or terminals will be locked out of some of the special services and capabilities.

Source Telecomputing itself was in dire financial straits (and has recently gotten a new president) when it was acquired by Reader's Digest. Presumably, the publishers saw an opportunity to infuse a tired and under-financed operation with new life. TI and The Source seem to have indeed found a mutual interest... and applied a typical Texas solution: if you have a problem, throw money at it.

# WRITING FOR PCW

PCW welcomes approaches from would-be writers, even those who may never have appeared in print before. In this game it is often those with practical experience who have important things to say so we don't mind too much if their prose is less than perfect. Providing that submissions have a sensible structure and follow a logical sequence, we can take care of the polishing. Here are some tips:

If the article is already written, simply send it in, making sure that your name, address and phone number appear on both the article and the covering letter. If you have submitted the same work to other magazines you

should tell us — it would be embarrassing (to say the least) if the same article appeared in more than one.

If you have an idea for an article or a series, write us a letter outlining your ideas. A one or two page synopsis giving the proposed structure, sequence and content will give us a sound basis for discussion. Please give us a daytime phone number if possible.

If you have nothing specific in mind but feel qualified to conduct case studies, Benchtests or whatever then drop us a line saying what you'd like to do and why you think you're qualified to do it. We're not particularly looking for strings of academic qualifications —

experience carries just as much weight.

Dick Pountain is always on the lookout for interesting calculator features and we wouldn't mind seeing one or two readers getting on their soapboxes but remember: even articles such as this need a structure.

Reading PCW will give you a good idea of the style we prefer. You may notice that we try to avoid pomposity at one extreme and flippancy at the other (except in 'Chip Chat', that is).

Finally, have a look through back issue indexes and try not to re-invent any wheels. Oh, we almost forgot — PCW does pay for all published work.





# NEWS

*ComputerTown is an ever-growing network of volunteers making their time and computers available to the local community to promote computer literacy. For a detailed description of its purpose, see the November 1980, PCW. For further information, send an SAE to: ComputerTown UK!, 14 Rathbone Place, London W1P 1DE.*

Our thanks to all those people who have written to us this month. We've reached the stage where we can no longer give space in *PCW* to everyone who writes to us, so what we'll have to do is mention those who are actually planning to set up their own ComputerTowns and for the rest we'll just mention the town from which they come. Of course, news and tips from existing ComputerTowns will always have their place in this column.

Talking of news, you'll be pleased to hear of a ComputerTown starting in Croydon. It will be run every Monday from 3.30 to 7.00 in the Children's Library in Katherine Street. If you'd like to join in the fun, either go along next Monday or write to Vernon Gifford at 111 Selhurst Road, London SE25 6LH, enclosing a first class stamp for your reply. This ComputerTown was started by members of Croydon Computer Club — our thanks to them for such a splendid effort. While I'm on the subject of computer clubs, we were very sorry to learn recently that this ComputerTown theme has upset a few clubs who have been doing their bit for computer literacy for years. If you are among the disgruntled then we apologise to you; it has never been ComputerTown's intention to replace the initiatives already under way all over the country — we are here primarily to act as a focal point and a forum for the exchange of ideas and news. We welcome letters from anyone genuinely concerned about computer literacy, whether they actually call themselves ComputerTown or not. The important thing is what we're all doing, not what we call ourselves.

David Gipson of Newcastle upon Tyne wrote for information about the Newcastle ComputerTown and at the end of his letter he suggested a slogan — 'ComputerTown Rules UK'. We quite like it, despite its arrogance.

We've had our second letter from Australia, this time from Keith Stewart who is considering a ComputerTown Camden. Anyone interested can contact Keith at PO Box 47, Camden, NSW 2570, Australia.

A couple of swift grovels coming up — first to Don Thomasson of Rayners Lane, whom we called Ian in the last issue. The second is to Peter Hibbs, secretary of the Bournemouth Area Computer Club. We got his name wrong too, in the User Groups section. He wrote to tell us that he's planning a ComputerTown Bournemouth. Anyone interested write to him at 54 Runnymede Avenue, Bournemouth, Dorset BH11 9SE.

Philip Joy wrote to us again to say that he will have a ComputerTown running in his local library, using a machine loaned by local computer shop, Compuskill. We look forward to hearing more news from Philip very soon. Anyone interested should write to him at 130 Rush Green Road, Romford, Essex.

Bob Clifford has responded to the earlier plea for a different name for ComputerTown. He has suggested that CLiP BOARD is less awe inspiring. He says that CLiP is derived from Computer Literacy Project, while BOARD could help local groups to persuade dealers to hang a clipboard containing news in their shops. Another way in which Bob suggests spreading the word is to have a social arm of the project and call the sessions Clipboard Coffee Pots. Thanks for your suggestions Bob, I'm sure that several centres will take them up. I think that because we've used ComputerTown as a name for some six months now that we should continue to refer to the overall project as such but, as I said earlier, we can call ourselves what we like locally. It is enough to claim affiliation to the movement as a whole.

Good news from Sutton in Ashfield. The permanently-installed Acorn Atom has probably received its most thorough field test, with queues of teenagers waiting to use the machine at peak times. Plans are afoot to provide a couple of unemployed school-leavers with full-time paid employment as instructors but we'll have to wait until the funds are forthcoming before we can say who is backing this project. Computerland in Nottingham has kindly offered a PET and this should be running by the time you read this. Finally from Sutton, the Director of Social Services Mansfield came in to see what was going on and left feeling very enthusiastic — he was even talking about putting machines in other local libraries.

Mr A Young from Worthing came up with a good point in his letter. He asked what we do about insurance. Well, what do *you* do about it? Please write and let us know. In Eastcote we've not really given the subject a lot of thought, but we believe that in Sutton they got a local insurance agent to 'donate' the insurance.

Richard Ross-Langley of Mine of Information kindly helped us compile a book list. This is available from us on receipt of an SAE.

Now for a list of people wanting to start ComputerTowns. Our thanks to all of you for your interest and we're sorry

that we are only able to publish the bare facts: Mark Posen, Churchill Hall, Stoke Park Road, Bristol BS9 1JG; Philip Colmer, 43 Victoria Road, Fordingbridge, Hampshire; Pete Shaw, 15 St Vincents Road, Clacton-on-Sea, Essex; Ian Briscoe, 26 Moore Street, Hartlepool, Cleveland; Andrew Holyer, 10 Masons Field, Mannings Heath, Horsham, Sussex; Ted Broadhead, 27 Cardinal Road, Leeds LS11 8EY; Alan Waring, 50 Drayton Gardens, Winchmore Hill, London N21 2NS; John Wellsman (High Wycombe or London) 222 Caledonian Road, London N1; O H Ozturk, 12 Pembroke Road, Muswell Hill, London N10 2HR; Patrick Colley, 52 Queensway, Caversham Park Village, Reading RG4 0SJ; M G Harrison, 17 Holden Lane, Baildon, Shipley, W Yorkshire; Alan Sutcliffe, 4 Binfield Road, Wokingham, Berkshire RG11 1SL; A Young, 33 Chesswood Road, Worthing, Sussex.

If you do write to these people then I think that they would appreciate an SAE in which to post their reply.

Other districts from which we have received interest this month are: Biggin Hill, Croydon, Hereford, Merseyside, Newcastle on Tyne, Rayleigh, St Albans and Woking. We look forward to further news from you all.

Keep writing those letters and remember that we aim to cover the country with ComputerTowns and affiliated groups. We reckon then that we need to hear from a few thousand more people before this will be achieved. Please enclose an SAE if you want a reply to your letter and address your correspondence to CTUK, 14 Rathbone Place, London W1P 1DE. Please don't try to ring us at the office since CTUK! is run entirely in our spare time.

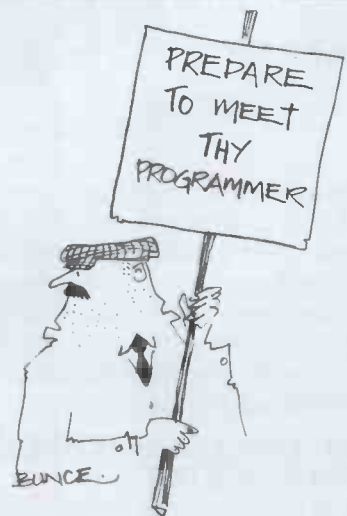



# The Commodore PET offers you a safe passage through the primeval swamp of computerisation.



The miracle of microchip technology has made the main-frame computer seem like a dinosaur. But how many microcomputers will go the same way?

Without good software and support a micro-computer is less capable than your office calculator. So as competition grows amongst manufacturers in this industry, only those with the finest software and the best supporting facilities will survive.

## SHARE A SECURE FUTURE WITH A COMMODORE PET

We at Commodore have been producing high technology

products for over 20 years. And unlike most other manufacturers of micro-computers, we make everything ourselves (including the silicon chips) to keep our costs to a minimum.

These cost savings are passed on to you in excellent value for money. So you can now buy a self-contained Commodore PET microcomputer for £450, or a complete business system (including Floppy Disk Unit and High Speed Printer) starting from as little as £2000.\*

However, computer hardware can only be as good as the software available. That's why, to maintain our position as



Britain's most popular micro-computer, we have made sure that the quality and versatility of our software is second to none.

## LARGEST, FINEST CHOICE OF SOFTWARE...

To complement our microcomputers, we have the finest and most comprehensive range of programs available in the U.K. today. This covers everything from such important business applications as Payroll, Stock Control, Accounting, Filing, Mailing; to our series in the field of Education. Each program is thoroughly tried, tested and tailored to BRITISH needs. You won't catch us palming you off with an irrelevant American version!

## ...AT SURPRISINGLY LOW PRICES

With over 30,000 Commodore PETs employed in Britain, the demand for programs is tremendous. And through mass-production we are able to keep our costs to you surprisingly low. So you can buy a Petpack program (on cassette) for between £5 and £50, while business programs (on disk) range from between £50 and £500.

## OUR OWN UNIQUE TRAINING COURSES

Commodore programs are designed with operational simplicity in mind. Commands are in plain English and guidance is built into each package. So that even a stranger to computers can quickly feel at home with a PET.

Nevertheless, to maximise the potential of your Commodore system, you will find a certain amount of training of immense value. Of the well-known names in microcomputers, Commodore is the only one to offer a

range of training courses and seminars. And these have already proved of great benefit to thousands of PET users.

## KEEP IN TOUCH WITH THE PET USERS' NEWSLETTER

Another unique way in which Commodore helps you get the most out of your microcomputer is by publishing the regular PET Users' Newsletter. For an annual subscription of only £10 you can keep up-to-date with developments and share new ideas and applications with over 3,000 PET users.

## WORDPROCESSOR AS WELL AS COMPUTER

In addition to Commodore's own high quality range of hardware and software, there are compatible products of other manufacturers which have gained our official stamp of approval.



Look out for this sign.

You'll find it on such famous programs as WORDPRO and WORDCRAFT, which turn your PET into a first-class wordprocessor; as well as on hardware like the MUPET system, which allows a number of PETs to be run with a single letter-quality printer.

## PROFESSIONAL DEALER SUPPORT COUNTRYWIDE

When you consult a Commodore dealer, you won't find yourself talking to a typewriter salesman. Our dealers are qualified to examine your needs, and to demonstrate which hardware and software will suit you best. Trained engineers are at hand and a 24-hour field maintenance service is available countrywide.

### LONDON AREA

Adda Computers Ltd,  
W13, 01-579 5845  
Advanced Management Systems,  
EC2, 01-638 9319  
C.S.S. (Business Equipment)  
Ltd, E8, 01-254 9293  
Centralex - London Ltd,  
SE13, 01-318 4213  
Computer Sales & Software  
Centre Ltd,  
ILFORD, 01-554 3344  
Cream Computer Shop,  
HARROW, 01-863 0833  
Da Vinci Computer Shop,  
EDGWARE, 01-952 0526  
Henderson Bennett,  
SE25, 01-654 5609  
Home and Business Computers,  
E12, 01-472 5107  
L & J Computers,  
NW9, 01-204 7525  
Logic Box Ltd,  
SW1, 01-222 1122  
Merchant Systems Ltd,  
EC4, 01-353 1464  
Micro Computer Centre,  
SW14, 01-878 7044  
Micro-Facilities Ltd,  
HAMPTON HILL, 01-979 4546  
Sumlock Bondain Ltd,  
EC1, 01-250 0505  
Sumlock Bondain Ltd,  
EC4, 01-626 0487

Amplicon Micro Systems Ltd,  
BRIGHTON, 562163  
T & V Johnson (Microcomputers  
Etc) Ltd, CAMBERLEY, 20446  
Cambridge Computer Store,  
CAMBRIDGE, 65334  
Wego Computers Ltd,  
CATERHAM, 49235  
Dataview Ltd,  
COLCHESTER, 78811  
Amplicon Micro Systems Ltd,  
CRAWLEY, 26493  
S.M.G. Microcomputers,  
GRAVESEND, 55813  
South East Computers,  
HASTINGS, 426844  
Bromwall Data Services Ltd,  
HATFIELD, 60980  
Alpha Business Systems,  
HERTFORD, 57425  
Commonsense Business Systems  
Ltd, HIGH WYCOMBE, 40116  
Kingsley Computers Ltd,  
HIGH WYCOMBE, 27342  
Brent Computer Systems,  
KINGS LANGLEY, 65056  
Computopia Ltd,  
LEIGHTON BUZZARD, 376600  
South East Computers Ltd,  
MAIDSTONE, 681263  
J.R. Ward Computers Ltd,  
MILTON KEYNES, 562850  
Sumlock Bondain (East Anglia)  
Ltd, NORWICH, 26259  
T & V Johnson (Microcomputers  
Etc) Ltd, OXFORD, 73101  
C.S.E. (Computers),  
READING, 61492  
Slough Microshop,  
SLOUGH, 72470  
Business Electronics,  
SOUTHAMPTON, 738248  
H.S.V. Ltd,  
SOUTHAMPTON, 22131  
Super-Vision,  
SOUTHAMPTON, 774023

Symtec Systems Ltd,  
SOUTHAMPTON, 38868  
Stuart R Dean Ltd,  
SOUTHEND-ON-SEA, 62707  
The Computer Room,  
TUNBRIDGE WELLS, 41644  
Orchard Computer Services,  
WALLINGFORD, 35529  
Photo Acoustics Ltd,  
WATFORD, 40698  
Microchips,  
WINCHESTER 68085  
P.P.M. Ltd,  
WOKING, 80111  
Petaltect Electronic Services  
Ltd, WOKING, 69032  
Oxford Computer Systems,  
WOODSTOCK, 812838

### MIDLANDS & S. HUMBERSIDE

C.B.S. Consultants,  
BIRMINGHAM, 772 8181  
Computer Services Midlands  
Ltd, BIRMINGHAM, 382 4171  
Marchant Business Systems Ltd,  
BIRMINGHAM, 706 8232  
Micro Associates,  
BIRMINGHAM, 328 4574  
Peach Data Services Ltd,  
BURTON-ON-TRENT, 44968  
Jondane Associates Ltd,  
COVENTRY, 664400  
Davidson-Richards Ltd,  
DERBY, 366803  
Allen Computers,  
GRIMSBY, 40568  
Caddis Computer Systems Ltd,  
HINCKLEY, 613544  
Machsize Ltd,  
LEAMINGTON SPA, 312542  
Arden Data Processing,  
LEICESTER, 22255

Roger Clark Business Systems  
Ltd, LEICESTER, 20455  
Lowe Electronics,  
MATLOCK, 2817  
A.J.R. Office Equipment Services  
Ltd, NOTTINGHAM, 206647  
Betos (Systems) Ltd,  
NOTTINGHAM, 48108  
PEG Associates (Computer  
Systems Ltd), RUGBY, 65756  
Walters Computer Systems Ltd,  
STOURBRIDGE, 70811  
System Micro Ltd,  
TELFORD, 460214

### YORK & N. HUMBERSIDE

Ackroyd Typewriter & Adding  
Machine Co. Ltd,  
BRADFORD, 31835  
Microprocessor Services,  
HULL, 23146  
Holdene Ltd,  
LEEDS, 459459  
South Midlands Communications  
Ltd, LEEDS, 782326  
Yorkshire Electronics Services  
Ltd, MORLEY, 522181  
Computer Centre (Sheffield) Ltd,  
SHEFFIELD, 53519  
Hallam Computer Systems,  
SHEFFIELD, 663125  
Holbrook Business Systems Ltd,  
SHEFFIELD, 484466

### NORTH EAST

Currie & Maughan,  
GATESHEAD, 774540  
Elfton Ltd,  
HARTLEPOOL, 61770  
Dyson Instruments,  
HETTON, 260452  
Fiddes Marketing Ltd,  
NEWCASTLE, 815157

Format Micro Centre,  
NEWCASTLE 21093  
Intex Datalog Ltd,  
STOCKTON-ON-TEES, 781193

### S. WALES & WEST COUNTRY

Radan Computational Ltd,  
BATH, 318483  
C.S.S. (Bristol) Ltd,  
BRISTOL, 779452  
T & V Johnson (Microcomputers  
Etc) Ltd,  
BRISTOL, 422061  
Sumlock Tabdown Ltd,  
BRISTOL, 276685  
Sigma Systems Ltd,  
CARDIFF, 34869  
Reeves Computers Ltd,  
CARMARTHEN, 32441  
A.C. Systems,  
EXETER, 71718  
Milequip Ltd,  
GLOUCESTER, 411010  
Jeffrey Martin Computer Services  
Ltd, NEWQUAY, 2863  
Devon Computers,  
PAIGINTON, 526303  
A.C. Systems,  
PLYMOUTH, 260861  
J.A.D. Integrated Services,  
PLYMOUTH, 62616  
Business Electronics,  
SOUTHAMPTON, 738248  
Computer Supplies (Swansea),  
SWANSEA, 290047

### NORTH WEST & N. WALES

B & B (Computers) Ltd,  
BOLTON, 26644  
Tharstern Ltd,  
BURNLEY, 38481

Megapalm Ltd,  
CARNFORTH, 3801  
Catlands Information Systems  
Ltd, CHESTER, 46327  
Catlands Information Systems  
Ltd, WILMSLOW, 527166

### LIVERPOOL

Aughton Microsystems Ltd,  
LIVERPOOL, 548 7788  
Stack Computer Services Ltd,  
LIVERPOOL, 933 5511

### MANCHESTER AREA

Byte Shop Computerland,  
MANCHESTER, 236 4737  
Computastore Limited,  
MANCHESTER, 832 4761  
Cytek (UK) Ltd,  
MANCHESTER, 872 4682  
Executive Reprographic Ltd,  
MANCHESTER, 228 1637  
Professional Computer Services  
Ltd, OLDHAM, 061-624 4065

### SCOTLAND

Gate Microsystems Ltd,  
DUNDEE, 28194  
Holdene Microsystems Ltd,  
EDINBURGH, 668 2727  
Gate Microsystems Ltd,  
GLASGOW, 221 9372  
Robox Ltd,  
GLASGOW, 8413  
Thistle Computers (Macmicro),  
INVERNESS, 712774  
Ayrshire Office Computers,  
KILMARNOCK, 42972  
Thistle Computers,  
KIRKWALL, 3140

### N. IRELAND

N. Ireland Computer Centre,  
HOLLYWOOD, 6548

For further information about Commodore services and products, contact your local dealer, or send off this coupon to obtain our free literature pack.

To: Commodore Information Centre, 360 Euston Road, London W1 3BL Telephone: 01-388 5702

Name \_\_\_\_\_ Position \_\_\_\_\_

Address \_\_\_\_\_

Intended application \_\_\_\_\_

05PC1

# Commodore

This list covers dealers participating in our advertising. \*Prices quoted ex. VAT.

# COMMUNICATIONS

*PCW welcomes correspondence from its readers but we must warn that it tends to be one way! Please be as brief as possible and add "not for publication" if your letter is to be kept private. Please note that we are unable to give advice about the purchase of computers or other hardware/software — these questions must be addressed to Sheridan Williams (see 'Computer Answers' page). Address letters to: 'Communications', Personal Computer World, 14 Rathbone Place, London W1P 1DE.*

## Where's the Newbrain?

I have contacted Newbury Laboratories several times concerning the delivery of my Newbrain, which was originally promised in early November 1980. My last contact with them was soon after my purchase of the February issue of *PCW*.

In the magazine there is an article by Guy Kewney, referring to Newbury Laboratories in connection with the BBC and the fact that, it is said, 'orders are trickling through'. This comment prompted my phone call to Newbury Laboratories to enquire when I could expect delivery of my machine. I was told that 'I should not believe all I read in the press' and that 'no deliveries have been made.'

If the above comments are correct then there must have been an error in your information.

Is it possible for you to approach Newbury Laboratories on behalf of the many deflated future Newbrain owners and find out exactly what is going on? B M Morris, Bracknell, Berkshire

*We contacted Newbury Labs, who told us that orders are not 'trickling through'. In fact, at the time of going to press, the machine was still not in production. Newbury is reluctant to give any firm commitment yet — Ed.*

## Prestel is 'aware'

I thought Guy Kewney and his elf friend Marvin (*PCW*, January) might like to know that British Telecom is aware of the market needs mentioned and is developing ways of meeting them.

Admittedly, we are unlikely to introduce all the frills that micro users might desire: Prestel must remain relatively cheap, robust and unsophisticated if it is to capture a mass market.

However, closed user groups are available in small numbers, primarily for use within businesses or among special market sectors such as travel agents, and supply is planned to increase dramatically within a year.

Furthermore, a full user-to-user message service has a high priority, though the complexity of implementing a really reliable service on our network (currently 17 com-

puters) means that introduction is unlikely to be before 1983.

We are not the victims of being the first into viewdata; indeed slippage in France and Canada suggests that we have extended our two year lead on the opposition and our export successes (with Italy joining Germany, Holland, Belgium, Austria, Switzerland and Hong Kong as purchasers of Prestel systems) confirm this. For once, we don't have to knock Britain! Ederyn Williams, Prestel Database Services, London

## Another 'Last One'

Reading David Tebbutt's article on 'The Last One' gave me a strong case of *deja vu*. It took me back to 1956 and machine coding, when the eraser was as much the programmer's tool as the pencil and all IBM had to sell was an inefficient machine for which you had to 'optimum program' (when the drum came round).

Cobol was to do away with programmers. All you had to do was fill in a form and then define the problem. Filling in forms became programming. All you have to do with 'The Last One' is to define the environment, the data structure and the problem.

*Plus ca change, plus c'est la meme chose.*  
Fred Musk, Silloth, Cumbria

*If you pause to think, the constraints in any attempt to computerise are the environment, the data and the problem. However English-like programming becomes, it will still be necessary to define these. You miss the point Mr Musk — it's a question of level — Ed.*

## Letter from PCW

The Commodore PET 'Space Invaders' program can be further modified than suggested by William Roberts in the February issue of *PCW* with the following POKES that should be entered after loading but before running the program:

POKE 1952, 234: now when the 'fire' key is held down your cannon repeatedly fires;  
POKE 3640, X: where X is the number of bases you wish to have at the

beginning of each game (don't POKE too high a value!);  
POKE 2480, 96: for a very fast invader left (after you have eliminated all the rest of a frame) and a few other unusual effects;  
POKE 3584, X: where X is the speed of movement of your cannon and missiles. (Usual value is 2 — anything greater will slow them up and anything smaller will speed them up);  
POKE 3592, X: where X is the speed of the invaders dropping bombs (usually 4);  
POKE 3597, X: where X is the speed of the mystery ships (usually 6).

By the way, to make your own copy of the program it is only necessary to press five keys!  
Paul C Williams, Horsham, Sussex

## Forth news

In the July *PCW*, Bill Stoddart mentioned me as a source of listings (free?) of the marvellous new language, Forth. I am afraid some are unanswered and some are still coming in. Let me apologise and explain...

Forth started some ten years ago in radio astronomy. It is public domain, though the originator, Charles Moore, now runs a software house called Forth Inc. The name Forth is used rather as we use 'Biro' and now covers many implementations. One is in the PDP-11 Decus user library (No 232) and STOIC is in the CP/M library. Others are CONVERS, URTH and IPS, all developed in universities.

As personal computing grew in the USA, the Miller and Programma versions were offered. More notable was the founding of the 'Forth Interest Group'. Pooling their experience, this group has issued a version of Forth which is 'written in Forth' as a model. This is called the Fig-Forth installation manual. There are also assembler listings of this configured for PDP-11, PACE, 6800, 6809, 8080, 6502 available from Fig. You can get these for \$13 from: PO Box 1105, San Carlos, Ca 94070. Most are circulating among UK enthusiasts and may be copied as long as the Fig acknowledgement is included. I have loaned these to a number of enquirers in the past but find that now there are a fair number of people up and running, and I no longer offer this 'service'. It is better to phone

me on 0279 723593 and I will try to put you in touch with someone near you with similar hardware. Please don't write. There was a special Forth issue of *Byte* magazine in August, and Fig is now receiving 50 enquiries per day; retailers seem to have sold out of the August issue of *Byte*.

This level of interest really calls for more than amateur effort and I hope someone here in the UK will start stocking Forth manuals, Fig listings and August 1980 *Byte* magazines.

We do hold meetings in the UK at 7pm on the first Thursday of even-numbered months at the Polytechnic of the South Bank, Borough Road, London. In future I expect Harry Dobson will handle new enquiries (025 16 6254) and a newsletter is planned by Gil Filbey (01-794 7493). A course on Forth is being run by Bill Stoddart at Willesden Polytechnic and he has copied some of the Fig material for sale to course members and others.

I would advise newcomers to start on a small version and with this in mind I have implemented one for an 8k UK101. It will be offered for sale publicly when a friend has finished tidying it up, but in the meantime I can offer an untidy version. Next comes Fig-Forth which is very up to date and not too large for beginners. The most comprehensive are the versions in the Decus and CP/M libraries.

I hope that it won't be too long before *PCW* carries a column on Forth.  
W H Powell, Sawbridgeworth, Herts

## TRapped

I use my next-door neighbour's TRS-80 Level II considerably, thanks to his kindness. Recently he bought a TRS-80 software cassette: 'Pyramid 2000'. All was well, or so it seemed; the program seemed to have great possibilities, it had an extensive vocabulary and held the promise of an exciting game, but it was not to be so.

Having covered the first five or six rooms and collected food, water, statue box, Bird god, sceptre (spelt Scepter in the American produced program) with an Ankh (the symbol of life) on one end, and a nugget of gold, we found ourselves in a room. To the west was an uncrossable bottomless pit (I found out the hard way), to



the south is a small room with no passages, the east is the way back and the north was the 'Pharaoh's Chamber' with passages leading off in all directions. Ah ha! we thought, now the game will really start, but it was not to be for 'a huge fierce green serpent barred the way' and continued to bar the way despite all coaxing. For six days now we have tried everything we can and still the serpent bars the way. My local Tandy store was unable to help, except to give the number of Head Office, which has yet to be tried.

Is there anyone else out there who has (had) this problem and if someone has, how do you get round the sticky serpent?  
J Griffon, Upper Belvedere, Kent

## MW enthusiast

May I, as a daily user of Microwriter, be allowed to say a little in its praise? I am a BBC current affairs TV producer but I am also a microcomputer nut. I use Microwriter, and the computer, in my daily task of making films for television.

I have a SWTPC computer, running two processors, switch selectable between the 6800 MPU and the 6809. And I can run under three operating systems — Flex 1, Flex 2 and Flex 9. The system has 48k of RAM, twin minifloppies, Anderson Jacobson daisywheel printer, microspeech speech synthesiser board, music and sound effects generator, and last but not least, Microwriter with serial interface, screen dump interface and cassette interface. At the software level I run Pre-compiled Basic and Extended Basic, Pascal, Common Pilot, Lisp, and the system carries a powerful Text Editor, Text Processor, Sort/Merge package, RMS database manager, as well as an optimizing assembler and standard assembler with conditional assembly and macro expansion. So you can see that I spend as much time writing computer programs as television programmes.

Before I had Microwriter, I used the normal qwerty-type keyboard on the computer and on my typewriter. I should explain that an awful lot of script writing is done in hotel bedrooms, filming being an away from home type of activity. Since Microwriter, I use it at all times, in hotel bedrooms or at home, both when I am writing a script and when I am working on a computer program.

It is the only keyboard on which I can touch-type, and learning to type on it was amazingly easy. I will store 8k of text in its CMOS RAM.

I can dump to a monitor screen, 16 lines to the page, at 1200 baud. If I am away from base, I can store endless pages on a micro-cassette recorder. And finally, I can dump the whole lot into the computer and save it on disk, again at 1200 baud. Then I can use the powerful computer facilities to do any text editing before finally printing via the text processor.

I have found it the best thing since sliced bread. Microwriter and microcomputers go together like kippers and jam. Not the least of its virtues is that it only weighs a pound and a half. You can carry your electronic notebook with you wherever you go. And it is not overpriced. The CMOS inside is very expensive. But Microwriter would be worth twice its price for what it offers in portability, ease of use and reliability.

This, as you would imagine, was written on Microwriter, and I am lying comfortably in bed.  
Frank Dale, BBCTV, London

## Whose copyright?

How original is original? I have just seen the PET Brickstop program published in your excellent magazine and out of curiosity asked a friend with a PET to run it up. As I suspected, it is almost identical with our 'Stopablock' program for the Sharp MZ-80K which we give free with our Bank Robber game (£5 on cassette!).

I am not in the least bothered about this; as I say, we give this particular game away anyway but it does raise an interesting point regarding copyright. If an 'original' game is designed for one type of machine and it is later adapted to run on another, who owns the copyright of the second version? The original programmer who thought it up for say the TRSMKZX80 or the bright spark who altered it to fit the (for example) Supercomputerpetnascopip? I suspect I am not the first to ask this question. In fact I fed it to my personal MZ-80K but all I got was 'syntax error'!  
R E Bailey, Videosyncracies, Huyton, Merseyside

*It seems that anyone who copies an original idea without consent is in breach of copyright. The only exception is where an idea can be described as being 'in the public domain' as some Commodore educational programs are for example. This means that whether you pinch a listing or just program your own version of an idea you are in danger!! — Ed.*

## Program praise

I have to write and congratulate you on Rick Litherland's article 'ZX80 Bumper Bundle' in your February issue.

I purchased a ZX80 for my son's ninth birthday from your 'Transaction File' of the same issue. Since copying Mr Litherland's 'Duck Shoot' program, this has been my son's favourite game.

The machine code listing for the 'Pause Routine' was very good. It was without error, and I have already found it useful for other things apart from games.

The Hex Loader was also very useful as it enables a machine code section of program to be treated as a part of the main program and not as is usually the case as a variable to be erased if one should press 'Run'. I presumed that lines 1 to 3 of this routine had to be entered on the edit line only to prevent the program corrupting itself. Also I did not understand the second part of line 3: PEEK(16394) = 0, but put it in anyway and the program seemed to work okay.

The only real fault in the Duck Shoot routine was in lines 210 and 230. You had printed a 5 instead of an S.

Even the hint to POKE inverse graphics into strings instead of PRINT CHR\$ is a good memory saver when you only have 1k to play with. I hope we can have some more articles by Mr Litherland in future.  
M J Bates, Chelmsford, Essex

## 'Limping along ...'

I was heartened to read about the POLIS system at the House of Commons. Those who are developing the system have something to be proud of and I hope the users will be pleased with it. I say I am heartened because I thought we had dropped out of this kind of system altogether, but here we are, entering the penultimate decade of the 20th century, still just about limping along at the back. When I visited Washington three years ago I was able to use an extensive database system in the Library of Congress. I do not have up-to-date information, but at that time there were four databases up, including the (incomplete) catalogue of the library itself (the equivalent of the British Library), an index to all US federal legislation, and the activities of the two Houses of Congress.

Some 700 terminals were scattered around Washington and elsewhere and the system

is available in many offices, in addition to those of members of Congress. When I mentioned this system in an article in 1979, a reply from someone in the British Library said they had a system just as good if not better. Shortly after that their project was cancelled.

How did I get access to this system? Was I perhaps a privileged overseas visitor being shown around? No, I just walked into the library as anyone can and sat down at one of the four or five public terminals in an area near the manual catalogue. There is no charge and an assistant is on hand to help anyone not familiar with using a terminal or the system. The documentation is good enough and the system so straightforward that I was able to use it after a two minute demonstration. One of the terminals has a printer. For some research it may be cheaper to fly to Washington and back than to use a commercial database here.

Let me say it again: the system is available to anyone, free of charge. That is what I call ComputerTown.  
Alan Sutcliffe, Wokingham, Berks

## PET bite-back

Reference Kit Spencer's letter in the February issue, looking down the list of 'authorised' add-ons I don't see that many that are actively in competition with Commodore's own offerings. However, be that as it may, I would like to draw readers' attention to the more important point that I made in 'Computer Answers' — that from the outset Commodore has tried to make it as difficult as possible for purchasers to expand their PETs unless they purchase the extra memory at the same time, ie bought a 32k PET instead of a 16k PET. Currently I see that the price of a 16k PET is about £499. An extra 16k of RAM will cost you around £27.50 from component suppliers. The price of a 32k PET is £599 and you don't need a degree in maths to work out how much extra you'll end up paying if you do it the Commodore way. To prevent customers from saving around £70, Commodore has been known to drill out the spare sockets on the mother board of a 16k machine, making it very difficult to upgrade at a later date. This is the 'attitude' that I referred to and perhaps if this underhand trick was more widely known then the PET might just not have caught on in the way that it has.  
Mike Dennis, Evesham, Worcestershire

**BENCH  
TEST**

# ABC 24

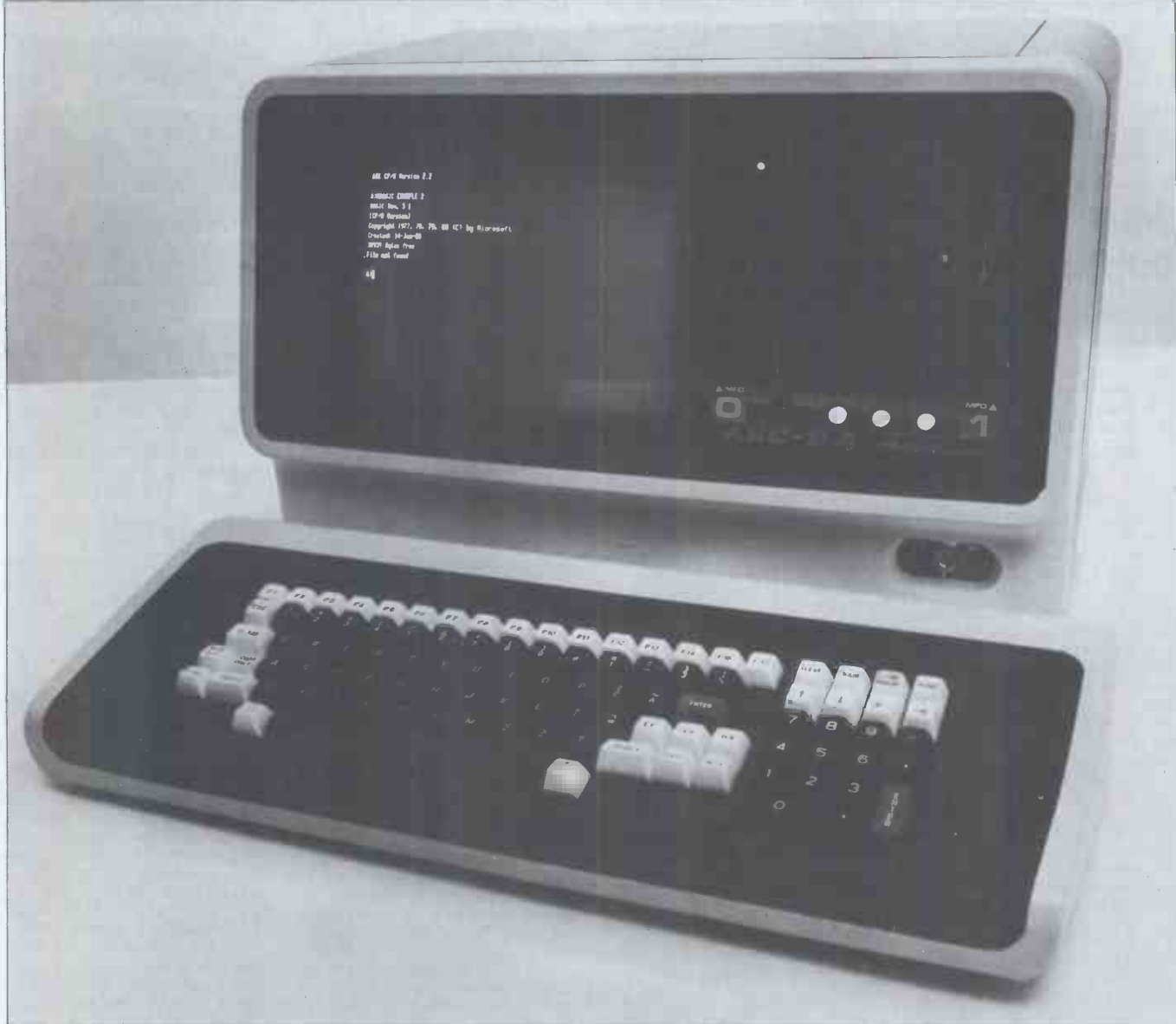

This particular ABC comes from Japan and is not to be confused with the ABC-80 from Luxor. AI Electronics manufactures this particular range of machines, which are all characterised by the integrated approach adopted by the Superbrain, the BASF and others.

The range of systems available is quite wide and features various combinations of 9in and 12in screens coupled with 5in and 8in floppy disk drives, although Sun Computers, the main distributor, is currently only offering two from the range, the ABC-26 and the ABC-24; the main difference between the two is a mere 1660 kbytes of floppy disk storage!

*Mike Dennis reports on this recent Japanese offering.*

## Hardware

The ABC-24 is an integrated unit with a 12in screen and two 5in double density, double sided floppies.

Rather interestingly, AI has decided to format the disks at nine sectors/track and while this decreases the available maximum capacity to only 640 kbytes, it does mean that the ABC-24 should be relatively immune to the sort of problems that beset some users of other

drives. I hear quite a lot from users of both 5in and 8in drives that they experience difficulty in formatting with disks from certain manufacturers — and not always the same ones, at that. It seems that by pushing the available capacity to the limit, the compatibility between disk and drive must be that more finely attuned for reliable performance and, frankly, I'd rather have slightly less capacity with increased reliability coupled with a wider range of available disks than to squeeze the last drop of storage out — or in. I think that AI has adopted the correct approach and I had no problems with the drives at all during the Bench-



test.

The keyboard is detachable and features 16 function keys, a numeric keypad, cursor controls but no direct method for either inserting or deleting characters. It also has the rather novel feature (although predictable for a machine of Japanese origin) of being able to switch instantly from alphabets and symbols to either EURO or JIS (Katakana), depending on which mode the monitor was operating in previously.

I would have preferred a detachable keyboard because the machine is very heavy to move around and the keyboard is too awkward when attached. The feet are very hard, so if you're not careful that fancy plush mahogany executive desk is going to get scratched!

The unit is housed in a metal cabinet, finished in a rather fetching two-tone orange and pale beige. This case clearly contributes to the overall weight of 30kg (the ABC-26 is 41kg!) and is a surprising choice in this age of plastic.

Inside, the works are very well engineered: two knurled finger-knobs release the back panel upon which the substantial mains transformer and power supply are mounted. This panel can be easily removed for maintenance and two more knobs release the single board on which the rest of the main components are mounted, excluding the disk drives and monitor. This board is constructed extremely well, using techniques akin to those used in the main-frame world and reflects AI's other interests (in the mini world). All connections to this are via edge connectors — the whole arrangement is very well-made and maintenance should present no problems. The CPU is a Z80A running at 4 MHz, with 64k RAM plus a separate 3k for the display fitted as standard. It has a couple of timers, two RS232 serial ports and a twin-channel port with DMA access. This last feature is potentially very useful for linking into the computer in the most efficient way but if that is a bit too advanced for you then you can use the IEEE-488 bus instead. Last but not least is a 9511A arithmetic logic chip that, although not used by the Basic interpreter, is there just in case. Certainly, there are a lot of features available.

The monitor screen is green with a format of 80 x 24 characters which are reasonably well-formed but not very well focussed. Under high ambient lighting I doubt that it would perform very well, as the screen had a tendency to defocus even more when the intensity control was turned up to a reasonable level.

A fair selection of graphics can be displayed which, together with reverse video, blinking, half-tone and underline, turn the display into a reasonably flexible unit. The rate at which data was displayed on the screen was rather pedestrian and this extended to a noticeable delay when the backspace was used. The action of the repeat key was also slightly strange in that you could repeat the last key pressed by just hitting the repeat key. If you were backspacing along the line using the repeat key then, because of the slow screen, it was very easy to overshoot the mark. This suggests a buffered keyboard but any advantage gained

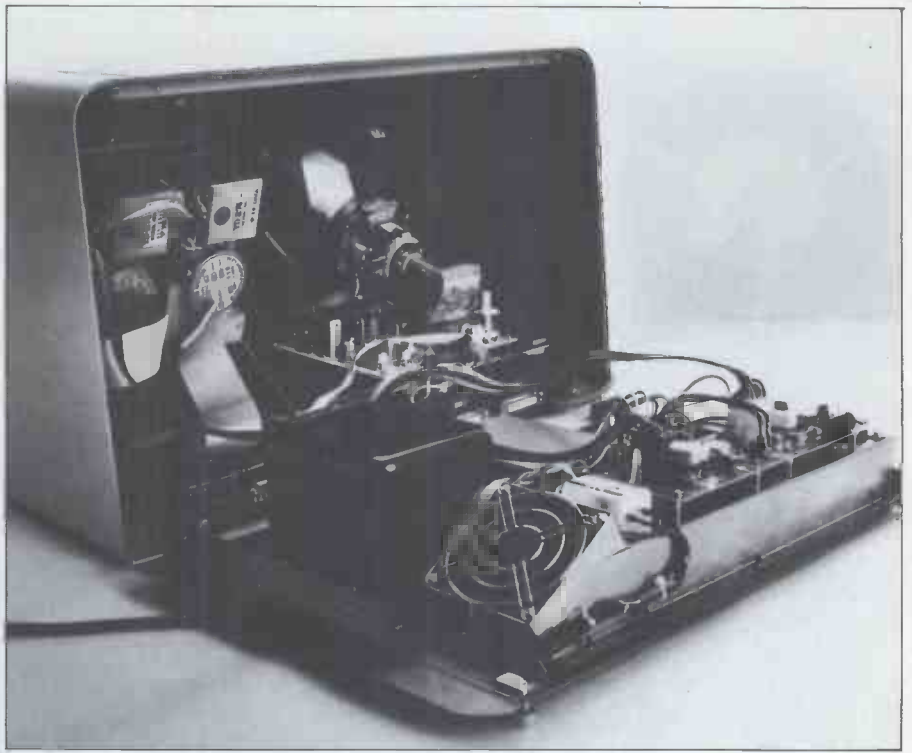

*A bit of a tight squeeze... inside the ABC24.*

was offset by the slow screen. However, I understand that improvements are in hand.

The disk drives are mounted vertically to the right of the screen and I couldn't detect any interference between the two. They are very quiet in operation, perhaps too quiet, as the red 'action' light is on when the drive is selected and not when it is running. Since the user guide sternly warns you not to remove the disk while the drive is running, the user could be forgiven for being a bit apprehensive. The fact that the guide tells you that you 'need to know what the system software or your program is doing at that time' is not a great help to the office junior who is concerned about whether it is safe to remove the disk. Coupled with this little problem is a row of most unfortunately placed push-buttons immediately underneath, labelled STOP, START and MONITOR. Pressing any of these instantly returns you to either a full system reset or back to the monitor and I foresee many a red face out in the field when they are inadvertently pressed. In my view, whoever put them there needs his bumps felt.

## Software

Two disk operating systems are available, AI's own under the peculiar name of Dosket (!) and the ubiquitous CP/M version 2.2. Dosket was originally written for AI's range of Aidac mini-computers and is, in fact, a general name for groups of utility software such as Assemblers for 8080, Z80 and Z8000, a text editor, a real-time debugger and even an in-circuit emulator, or so it says in the Dosket manual — a substantial document, at 2½in thick — although I couldn't find any reference to the in-circuit emulator other than that mentioned on the first page. High level support comes in the form of Fortran together with a library of sub-routines, Cobol, a 'super' Basic interpreter/compiler and Pascal.

I tried very hard to get to like Dosket but found it a finicky, irritating system to use. I admit that a large part of this is due to lack of familiarity with the equipment but when you can't get past a simple section in the user's guide then I tend to despair. I was trying to make a back-up copy of the master disk and the manual asked for SRUN,3,COPY (CR) which merely resulted in a query no matter how I tried to enter it. Since one has no real idea of what is exactly going on at this point it was very frustrating. The operation of the keyboard is also non-standard in having separate ENTER and Carriage Return keys, the responses to both depending on what system you are running.

For example, in CP/M pressing ENTER only displays one file entry under DIR. Under Dosket, the backspace key, although it backspaces, does not delete and the code for backspace gets entered as data by Dosket so that again you get a query. The main problem I feel is that this particular Dosket seems to be a sub-set of the main version and, unfortunately, the documentation is totally inadequate when it comes to differentiating between the two. The fact that I had trouble with the User's Guide is unforgivable. I tried getting some help from Sun on this matter and although they were extremely helpful in many other respects, it was perhaps unfortunate that the one person who could help with Dosket was in Japan.

It's a pity, for the Basic looks very powerful, with several interesting features such as matrices and multi-line functions which I expect a programmer should find very rewarding once familiar with it. However, there is never enough time in Benchtests and so it was with some relief that I turned to the more familiar ground of CP/M and MBasic.

Microsoft Basic version 5.1 is supported, together with CBasic and Cobol-80. Pascal is coming as well, if it's not here already by the time you



# QUPRO COMES TO BRITAIN

The first public opportunity to see the QUPRO 16 bit Pascal P-Code machine Q-Engine, which has attracted so much interest in North America - particularly in educational and research establishments - will be at Computermarket '81 - London.



The Q-Engine is a complete disc based system designed specifically with educational, scientific and engineering applications in mind, although the data structuring facilities of Pascal are well suited to the requirements of business applications.

The processor is based upon the 16 bit Pascal Microengine from Western Digital and features hardware floating point and 16 bit integer multiply and divide instructions. A standard configuration is 64K bytes of RAM, two RS-232-C ports capable of synchronous or asynchronous operation, 24 bit parallel I/O port, floppy disc controller with direct memory access, floating point arithmetic and high speed 16 bit integer arithmetic. A disc sharing logic board is available to allow the addition of a second processor.

Another standard feature is the powerful UCSD Operating System which includes up to 36 integers, random access files, complete file management utility and disc patch utility. A range of applications packages is available including screen formatting, online communications, text processing, time sheet analysis and reporting and IBM 3740 compatible diskette utility. Commercial Packages including BOMP, requirements, planning etc., scheduled soon.

The Q-Engine is ideal for teaching PASCAL with a powerful editor helping in the preparation of source files by prompting operator functions. A novel feature of the compiler allows the user to optionally exit to the editor when an error is detected - the cursor is positioned in the source file at the point where the error has been found.

Computational performance attracts scientific and engineering users to the Q-Engine. The power of Pascal combined with the floating point and integer arithmetic considerably simplify the expression of complex algorithms.

Typical cost of a Q-Engine with processor, floppy disc drive, visual display and keyboard complete with Operating System is £4300 with quantity and educational discounts being available. Hard disc versions, multitasking and 128k bytes are available.

You can be among the first in Britain to see the Q-Engine by visiting QUPRO Data Systems Limited stand at Computermarket '81 - London between 10 and 5 on 7th, 8th or 9th April at the West Centre Hotel, Lillie Road, London SW6.

If you are unable to visit QUPRO at Computermarket, write for full details from:

OEM Quantity  
or Educational  
discounts  
available on  
the sensational  
Q-Engine.

**QUPRO Data Systems Ltd.**

Qupro House, Green Acres  
Woolton Hill, Newbury, Berkshire.



read this. Support software supplied with the review machine was Wordstar, Datastar and Supersort together with full documentation. These really deserve a separate review to themselves and as most of them have been mentioned in other Benchtests and elsewhere I shall move on to applications. At the moment the only business package is Sun's own integrated suite, originally written for the Superbrain. Some minor bugs still need to be overcome but these are mainly to do with the screen formatting and it looks quite a reasonable package.

The usual Benchmarks were run under CP/M and MBasic and, as you can see, were quite fair. Occasionally, during the Benchtest, odd hiccups seemed to occur, particularly when writing to disk under CP/M and, again, I am prepared to put this down to lack of complete experience with the machine although my knowledge of CP/M isn't *that* bad! Nevertheless there is a little niggling doubt at the back of my mind that maybe there is a small gremlin lurking there — it was very easy to crash systems for instance — although it's not something tangible that I can put my finger on.

My overall feeling is that it doesn't seem to be a very 'friendly' machine to use.

#### Benchmark timings

	Integer	Single prec.	Double prec.
BM1	1.2	1.8	
BM2	4.0	6.0	7.0
BM3	16.0	16.0	54.0
BM4	15.0	15.5	55.0
BM5	16.0	16.0	56.0
BM6	25.0	29.0	68.0
BM7	38.0	45.5	86.0
BM8	8.0	8.0	8.0

#### Disk timings

(using 200 records of 128 bytes each).

Test 1	1 sec
Test 2	32 secs
Test 3	32 secs
Test 4	17.5 secs
Test 5	16.0 secs

Tests 2 and 3 included read after write verify.

## Documentation

At first glance the documentation looks extremely well done, as all the AI manuals are bound up into book form rather than the loose-leaf system that many others use. However, this impression is short-lived once you try to use them. Although the words are written in English, the order in which they occur, and relevance to each other, while not quite up to the 'descend the button most fully' tradition, are well on their way. I couldn't find any indices at all, although the contents pages were fairly extensive. It is a pity that, having taken so much care with the presentation, the contents are really quite horrible and difficult to use in any meaningful way. Still, to the typical user in an office environment, this doesn't matter because they will be using Sun's own documentation on their business system which is generally very well written although again lacking an index.

## Expansion

According to the manufacturer's literature other interesting products are available. For example, 1 Mb of memory using page mode, various Winchester hard disks and cartridge units, a colour graphics display and an X-Y plotter, although I understand that none of these is in this country at the moment.

As far as the in-built features are concerned, the four ports are certainly advantageous if only there were adequate details on how to use them. The ABC supplied came with a NEC Spinwriter with its special interface lead, which is just as well since I had great difficulty in connecting up a different printer.

## Potential

Obviously intended for the business market with its clean lines and integrated approach, the ABC will sink or swim on its applications software. At the price I don't see it in the educational market although the IEEE port must make it a contender for wider application.

## Conclusion

The ABC-24 is a well made integrated computer but with no particularly outstanding features. It's clearly intended for the business market primarily and with good software should find a niche in that marketplace. However, it seems very user unfriendly at the 'elemental' level and so any software must get around this problem. The inclusion of the START, STOP and MONITOR buttons on the front panel is tempting fate just too much. Other machines are available which offer similar facilities but at a cheaper price. I'm thinking of the Superbrain, in particular. The fact that, at the moment, the available business software runs or will run shortly on both machines means that one has to look elsewhere to justify the higher price. To that end, the ABC is better made than the Superbrain and so should make after-sales support easier as well.



## Prices

ABC24	£3350
Basic interpreter	£150
Basic compiler	£190
Fortran-80	£200
Cobol 80	£320
Wordstar	£250
Datastar	£125 approx.
Supersort	£160 approx.

## At a glance

The ABC 24 is an integrated computer, well-made and with a number of useful output ports. Disk capacity is good, with a sensible compromise at 640 kbytes. System software looks good but has been let down in a big way by poor documentation. This shouldn't bother the end user if supported by a well-designed program suite but there are other, cheaper contenders in the marketplace that are equally capable of similar results. In the long run, it may be that the reliability of the ABC-24 will make up for the extra price.

### TECHNICAL SPECIFICATION

CPU	Z80A, 4 MHz
RAM	64k plus 3k screen RAM
Disks	twin 5in double sided/density — total capacity 640kb
Serial ports	two
Parallel port	one
IEEE port	one
Arithmetic logic chip	one
Screen	12in diagonal — 80 x 24 green
Keyboard	101 keys, num. keypad, 16 function keys
System software	CP/M and Dosket
Languages	MBasic, Cobol, Fortran, Cobol-80, Pascal (coming)

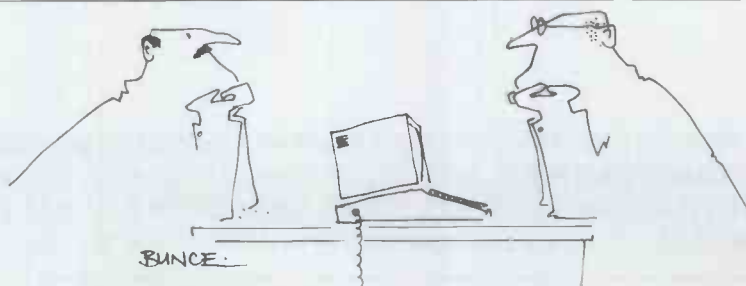

# the software house

146 OXFORD STREET, LONDON, W.1. Tel: 01-637 2108

APPLE SDFWARE		COMPUTER BISMARK	£ 36	HIGHER TEXT	£ 21	SARGDN II (C)	£ 20
TITLE	UK	DATA FACTORY	60	HI-RES FOOTBALL	24	SARGDN II (D)	24
ACE SPACE DISC	£ 12	DATESTONES OF RYN(C)	9	HOUSE/7 GABLES	8.5	SAVAGE ISLAND	9
ADVENTURELAND	9	DATESTONES OF RYN(D)	12	INTERLUDE(C)	10	SCREEN MACHINE	12
AIMS DATABASE	80	DESK TDP PLAN	60	INVASION ORION(D)	15	SIDE SHOWS	8
AIR FLT/SIMULATOR-C	15	DISC ADVENTURES 1/3	24	INVASION ORION(C)	12	SPACEQUEST D	15
AIR FLT/SIMULATOR-D	20	DISC ADVENTURES 4/6	24	JOURNEY	14	SPEED CONTROL/PAGE LIST	12
AIR TRAFF CTRLR /C	7	DOGFIGHT	18	JOURNEY/CENTRE/EARTH	8.5	SPIDER MOUNTAIN ADV	10
AIR TRAFF CTRLR /D	10	DOG 3.2 TUTOR	20	LOST DUTCHMANS GOLD	9	SPORTS & SPACE GAMES	10
ANDROID NIH	12	DOG 3.3	44.5	MAGIC CAVE ADV.	10	STAR INVASION D	12
APPEL GAME	10	DOG 3.3 TUTOR	20	MAGIC PAINTBRUSH	18	STARFLEET ORION (C)	12
APILOT II	60	DOG 3.3 TOOLKIT	44.5	MAILING LIST DATABASE	21	STARFLEET ORION (D)	15
APPLE ADVENTURE	24	OR MEMORY	30	MAILING LIST	24	STOCKCONTROL/INVOICING	120
APPLE BOWLING	10	ORACULAS TOOMBE C	10	MASTERCATALDG	15	SUPER EDITOR	27.5
APPLE CASHIER	221	ORACULAS TOOMBE D	10	MAZE GAME	8	SUPER ROBOTS	10
APPLE 'CONTROLLER'	391	DUNGEON CAMPAIGN(C)	9	MICROSOFT ADVENTURE	17	SUPER INVASION C	12
APPLE COLLISION	10	DUNGEON CAMPAIGN(D)	10.5	MIDWAY CAMPAIGN	9	SUPER INVASION D	12
APPLE FORTRAN	138	EASY READER	14	MILLIKIN MATHS	230	STRANGE ODYSSEY	9
APPLE 21	10	ELECTRIC CRAYON	11	MISSION IMPOSSIBLE	17	SUPER ROBOTS	10
APPLE LISTENER	12	ENCHANTED ISLAND	8.5	MODIFIABLE DATA BASE	50	SUPER TEXT II	90
APPLE PILOT	87	ENGINEERING MATHS	9	MORLOCS TOWER (C)	9	TEMPLE OF APSHAI (D)	18
APPLE PLOT	42	ESCAPE FROM THE ZYGOLS	10	MORLOCS TOWER(D)	12	TEXT EDITOR	39
APPLETALKER	10	ESTATE AGENTS	575	MYSTERY HOUSE	10	THE COUNT	9
APPLE WOROPROCESSER	48	FASTGAMMON	12	MYSTERY HUSE (HI-RES)	15	THE VOICE	24
APPLEWORLO	29	FORTE	12	MYSTERY FUN HOUSE	9	THINKERS GAME DISC	12
ASTEROIDS IN SPACE	12	FORTH H	30	N/ATLANTIC RAIDERS	9	TYCOON	10
AUTO-GRAPH	40	GALACTIC REVOLUTION	15	NUKEWAR	9	U-DRAW 1	11
BI NUCLEAR BOMBER	9	GALACTIC TRADER	15	ODYSSEY	18	U-DRAW 2	24
BASEBALL	9	GALACTIC EMPIRE	15	PACKING SUITE	27.5	UNCLE SAMS JIGSAW	8
BEST OF MUSE	24	GAME PLAYING/BASIC	9	PIRATE'S ADVENTURE	9	VISICALC	90
BIORHYTHM(D)	10	GENERAL MATH TAPE	9	PLANET MINERS	9	VISICOPY	18
BRIIDGE CHALLENGER	12	GHOST TWON ADV. C	9	PORK BARRELL	6	VOODOO CASTLE	9
CCA DATABASE	60	GHOST TWON ADV. D	9	PROGRAM LINE EOITOR	24	WALLBANGER	10
CESIL	25	GLOBAL WAR	11	PYRAMID OF DOOM	9	WIZARDS MOUNTAIN C	9
COMPUTECH S/LEDGER	339	GRAPHIC GAMES PACK	12	REAL-TIME STARTREK	12	WIZARDS MOUNTAIN D	11
COMPUTECH G/LEOGER	339	HANGMAN(C)	6	REMEDIAL MATHS TUTOR	12	WIZARD & PRINCESS ADV	20
COMPUTECH P/LEOGER	339	HANGMAN(D)	9	RESCUE AT RIGEL (C)	12	WILDERNESS CAMPAIGN (D)	12
COMPUTECH PAYROLL	431	HAUNTED HOUSE(D)	10	RESCUE AT RIGEL (D)	15	WILDERNESS CAMPAIGN (C)	10.5
COMPUTECH UTILITIES	23	HELLFIRE WARRIOR (D)	18	REL/INTEGER DISC	16	ZDRK (D)	25
COMPUTER AMBUSH	36	HIGHER GRAPHICS	15	SANTA PARAVIA	6	3 MILE ISLAND	24
						3.2 DISC UTILITY	16

ALL PRICES INCLUDE 15% VAT (BUT PLEASE ADD 80p P&P) ACCESS OR BARCLAYCARD WELCOMED (WITH NO. & CARD EXPIRY DATE) OUR ILLUSTRATED CATALOGUE GIVES LOTS MORE PROGRAMS FOR ALL POPULAR MICROS & COSTS £1 (REFUNDED AGAINST FIRST ORDER). WE ARE OPEN MONDAY/FRIDAY 9.30-5.30 TEL: 01-637 2108



# FLOPPY DISK DRIVES FOR TRS 80 AND VIDEO GENIE

## DUAL DISK UNITS

2 x 40 TRACK DRIVES

£440

2 x 80 TRACK DRIVES

£595

## SINGLE DISK UNITS

1 x 40 TRACK DRIVE

£236

1 x 80 TRACK DRIVE

£315

## DISK DRIVE CABLES

2 DRIVE CABLE

£19

4 DRIVE CABLE

£30



## PERCOM DATA SEPARATORS

£20

Plugs into the TRS 80 expansion interface and corrects 'READ/VERIFY' and 'CRC ERROR! TRACK LOCKED OUT!' problems on the inside tracks of any floppy disk system. Comes with full installation instructions — NO SOLDERING, NO CUTTING, JUST PLUGS INTO THE EXPANSION INTERFACE.

**Call your nearest dealer for a demonstration:**

**RADIO SHACK LTD.,**  
188, Broadhurst Gardens,  
London NW6  
Tel: 01-624-7174

**COMPSHOP LTD.,** 14, Station  
Road, New Barnet, Herts.  
Tel: 01-441-2922

**COMPSHOP LTD.,**  
311, Edgware Road,  
London W2. Tel: 01-262-0387

**MICRO-CONTROL LTD.,**  
224, Edgware Road,  
London W2. Tel: 01-402-8842

**LONDON COMPUTER  
CENTRE,** 43 Grafton Way,  
London W1. Tel: 01-388-5721

**TRANSAM COMPONENTS  
LTD.,** 59-61, Theobalds Road,  
London WC1.  
Tel: 01-405-5240

**N.I.C. 61,** Broad Lane,  
Tottenham, London N15  
Tel: 01-808-0377

**ZERO ONE ELECTRONICS,**  
36, Oaklands Avenue,  
THORNTON HEATH,  
Surrey  
Tel: 01-689-7924

**P & J EQUIPMENT LTD.,**  
3 Bridge Street,  
GUILDFORD  
Tel: 0483-504801

**SEVET TRADING,** 14, St.  
Paul's Street, Bristol 2  
Tel: 0272-697767

**PARWEST LTD.,** 58, Market  
Place, Chippenham.  
Tel: 0249-2131

**COMPUTERAMA LTD.,**  
5, Cleveland Place East,  
London Road, Bath.  
Tel: 0225-333232

**ENSIGN,** 13-19, Milford  
Street, Swindon, Wilts.  
Tel: 0793-42615

**H.C. COMPUTERS LTD.,**  
541, Durham Road,  
Low Fell, Gateshead.  
Tel: 0632-821924

**CAMBRIDGE COMPUTER  
STORE,** 1, Emmanuel Street,  
Cambridge. Tel: 0223-65334

**PORTABLE MICRO-  
SYSTEMS,** 18, Market Place,  
Brackley, Northants  
Tel: 0280-702017

**I.C. ELECTRONICS,**  
Flagstones, Stada Quarter,  
Biddenden, Kent.  
Tel: 0580-291816

**MICRO CHIP SHOP,**  
190, Lord Street, Fleetwood,  
Lancs. Tel: 03917-79511

**MICRO CHIP SHOP,**  
197, Waterloo Road, Blackpool.  
Tel: 0253-403122

**MICRO CHIP SHOP,**  
93, Friargate, Preston, Lancs.  
Tel: 0772-22669

**HARDEN MICROSYSTEMS,**  
28-30, Back Lord Street,  
Blackpool. Tel: 0253-27590

**NORTH WEST COMPUTER  
CONSULTANTS LTD.,**  
241, Market Street, HYDE,  
Cheshire  
Tel: 061-366-8624

**HEWART MICRO-  
ELECTRONICS,** 95, Blakelaw  
Road, Macclesfield.  
Tel: 0625-22030

**KARADAWN LTD.,**  
2 Forrest Way, Warrington  
Tel: 0925-572668

**PHOTO ELECTRICS,**  
459, London Road,  
Sheffield  
Tel: 0742-53865

**GNOMIC LTD.,**  
46, Middle Street,  
Blackhall, Hartlepool  
Tel: 0783-863871

**EWL COMPUTERS LTD.,**  
8, Royal Crescent, Glasgow.  
Tel: 041-332-7642

**CUMANA LTD**

35 Walnut Tree Close, Guildford, Surrey, GU1 4UN.  
Telephone: (0483) 503121.

*Please add VAT to all prices.  
Delivery at cost will be advised  
at time of order.*

# GATEWAYS

Derrick Daines concludes his series on teaching microcomputing to others.

The one question that crops up time and time again is: 'Are computers going to take over the world?'

My stock answer is: 'Are screwdrivers going to take over the world?'

It takes a lot of effort to undo the impressions that people have. The idea that a computer is merely a tool is very slowly replacing the notion that it is a sentient brain existing within itself. Even if, or when, the concept is accepted there is always a reservation. What about tomorrow, or the year after?

It is the common experience of all computer enthusiasts that the uninitiated fall into two main groupings: those who are scared of the computer and those who are bored by it. Both are characterised by their determination to stay well away. For example, the introduction of a computer to a school is often greeted by a remarkable lack of enthusiasm on the part of the teachers. Now teachers represent an intelligent section of the community, so the reason can only be that individual teachers cannot see any connection between their particular discipline or teaching methods and the computer. In short, there is a breakdown of communication and imagination.

Given time, these can be overcome through early and continuous exposure to real, as opposed to fictional computing. The computer will eventually be looked upon as one more teaching tool — the most powerful and versatile yet. However, the micro revolution has burst upon us so quickly that there has not been enough time to train sufficient technicians, let alone users of systems, so what do we do about it?

There is one way of exposing the greatest school population to the computer in the shortest possible time and that is by means of the school project. I don't mean that we should have projects *about* computers — heaven forbid — but that we should have projects *with* computers, which is a totally different thing. A properly conceived and organised project can bring the entire school population into close contact with one small computer.

Very little is to be gained by computer enthusiasts *telling* everyone how useful the computer is — let them find out for themselves, or show them. A cunningly-designed project should use the computer to enhance it in a way that is seen by all to have been extremely difficult or even impossible any other way. Let the computer demonstrate its value in practical terms. Let the uninitiated see results unobtainable elsewhere, or obtainable only with the greatest difficulty. Here are a few examples of projects used in schools:

## Junior school-intelligent games

This was a project involving 100 children and four teachers over a whole

term, some 30 percent of the teaching time available. It was based on a game that reached the UK from America in 1977 in which Players adopt a character and a profession and various personal attributes are assigned. Children formed themselves into 'exploration' parties of six and, under the guidance of a teacher, prepared to explore the dungeons of Castle Dementia. These had been previously mapped and a copy was given in secret to each teacher with treasures marked.

The children made their own decisions about direction, which doors to open, etc; at intervals the teacher would roll a dice to see if they had encountered a monster. If so, more dice were rolled in conjunction with tables to see which monster or monsters had been met.

At this point, the children went off to research their monster, to do story- or poetry-writing, draw pictures, make models and so on. This was the serious part of the project and teachers found many ways of extending it. The works of Shakespeare, Poe, Tolkien, Wells and others were studied; superstitions, myths and legends from around the world; ancient customs, treasures and remains of all kinds; arms and armour; and the music teacher found suitable songs and music. One teacher even ran cookery lessons using ground-up bones (flour), witches' blood (cochineal) and other renamed ingredients. As can be imagined, the children were highly delighted.

In their turn, the groups were directed to the computer to determine the outcome of their confrontation with a monster. As published, the rules and tables on this part of the game cover dozens of pages. A hundred types of monster are included, each with its own attributes — many of them magical — and each must be treated differently. Each explorer type and profession has differing attributes and, as if that were not enough, there are different levels of profession, many types of weapons and armour and numerous artifacts such as magic swords, flying carpets, etc. Some monsters are friendly, some attack on sight, remain in their lair, are immobile or run away. Clearly, the game was perfect for computerisation.

The long and complex program, however, quickly resolved the whole confrontation. Inputting details of the

```

$$$$$$$$$$          $$$$$$$$$$
0000$$          $$$$$000
00$$          *****          $$$$
00  ****          ****  00
$$  ****          $$  ****  $$
**  $$$$$$$$$$  **
**  0000$10000  **
**  $$$$ $100$  **
**  0000$10000  **
**  $$$$$$$$$$  **
$$  ****          $$  ****  $$
00  ****          ****  00
00$$          *****          $$$$
0000$$          $$$$$000
$$$$$$$$$$          $$$$$$$$$$
    
```

Fig 1 Computer printout

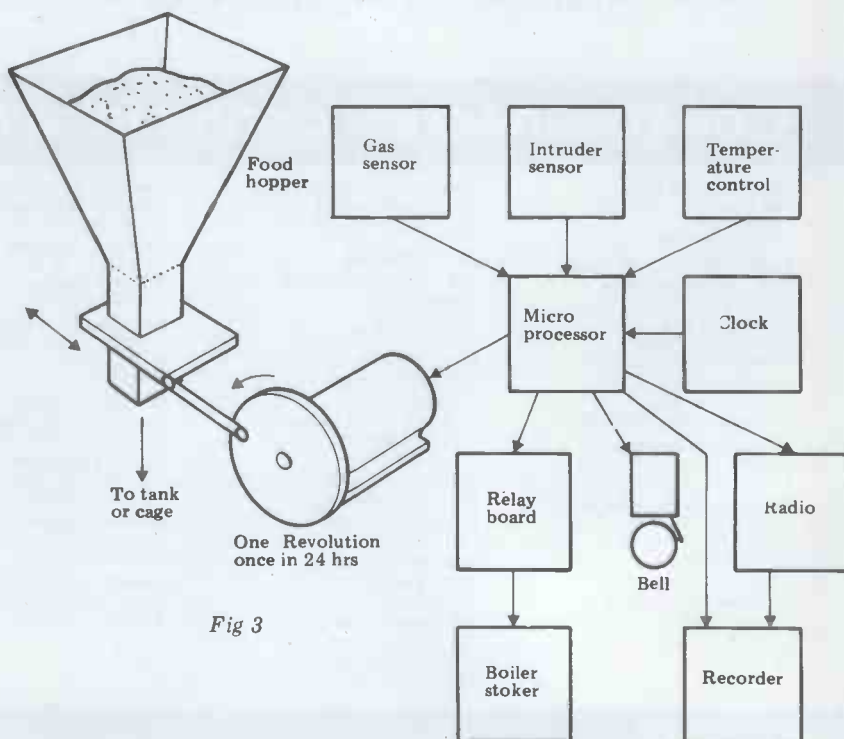

Fig 3



# TO LOGIC

## CHAPTER 9: TYPICAL TEACHING PROJECTS

individual characters making up the party took about two minutes, after which a code number was input to indicate the monster type. From there on the computer took over, indicated monster reaction and at intervals gave the children a choice of action. If a battle ensued, it gave a running account of the battle. The mortality rate among players was kept to a minimum by an adjustment of the mathematical model, but any child who was 'killed' or 'spelled' started the game again with a new character.

With the monsters dead, the computer accessed a random number again to determine if treasure was found and, if so, what it was, with bigger and better treasures in deeper recesses of the dungeon. Finally, the computer calculated the experience points to be awarded to each player, which accumulated towards advancement in his chosen profession. The players then went back to their teacher for the next exploration stage.

It was found that, on average, each group spent eight to ten minutes at the computer for each visit, being five percent of their project time. Altogether, some 15-20 visits were made per child, so that in one term 100 children each spent between 1½-2½ hours in close and involved contact with the computer. Interest and commitment were at their absolute peak.

It was inevitable that with such a highly-complex program, some errors and anomalies would crop up. These were dealt with as they arose and usually involved some slight adjustment of the program. One or two unimportant errors were left as they were in order to stress the point — if it needed stressing — that the computer was not some *deus ex machina* but the tool of humans, reflecting the errors of humans — in this case, the programmer.

### Middle school- the sea

The pressure for this project came from the children when one of them brought an article on the subject of sea warfare to school. Each pupil was given the rank of Able Seaman and told that he/she could rise to become First Lord of the Admiralty, given a combination of luck, skill and application. Studies were made of all things nautical — flora and fauna, winds, tides, navigation, history, geography, the Navy — a whole range of subjects that would take a lifetime to study fully. At this time, improvements in rank were given only for exceptional work.

From time to time 'war' was declared, when the chances of promotion were greater. War was assumed to be against some particular enemy and at different times in history, giving the opportunity to study history itself and especially different naval tactics, using galleys, Napoleonic warships, Dreadnoughts,

guided missiles, etc. The senior-ranking player deployed his forces as he saw fit against the enemy force specified and the computer was used to determine results.

Inputs to the machine were the state of the sea, visibility, range, relative speeds and bearing, calibre of shell, rate of fire and so on. The program calculat-

ted the likelihood of a hit, used a random number generator and calculated the damage inflicted if a hit was scored. A readout gave the location and severity. Any player who, as captain, sank an enemy vessel was automatically elevated one rank; if he was sunk he was relegated one rank.

The project was undertaken by a

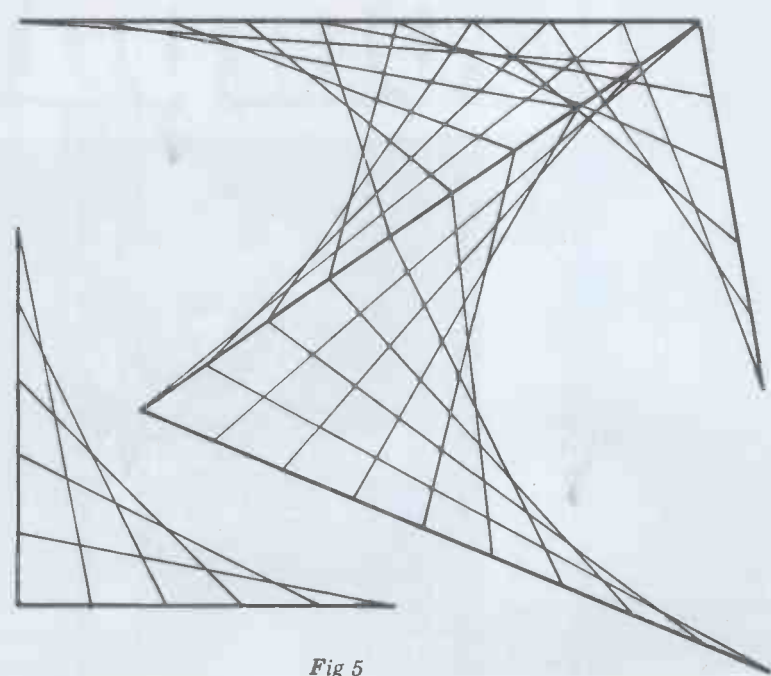
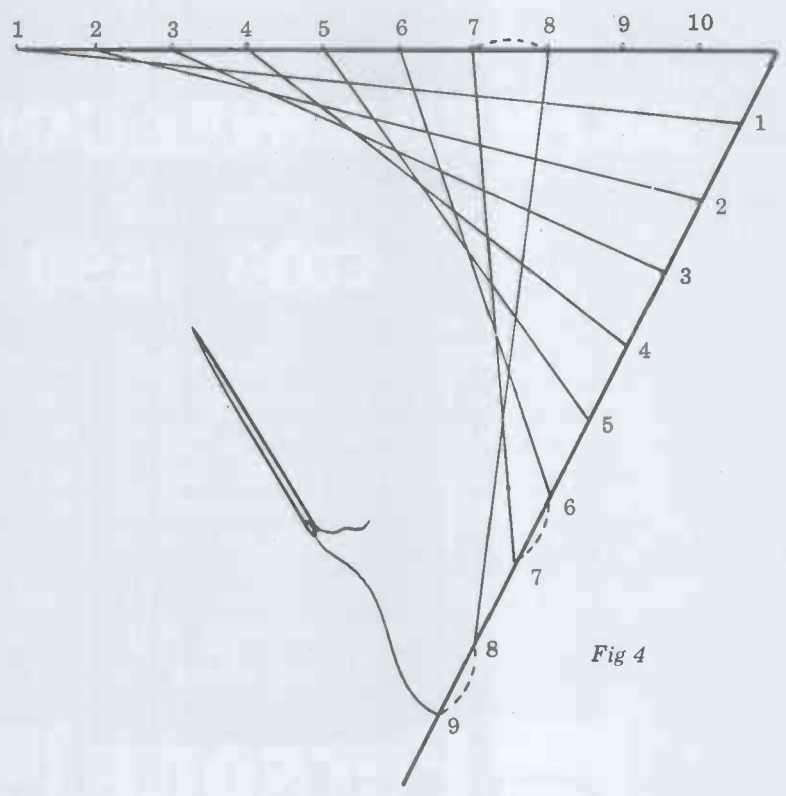

# COMPETITION

Modern microcomputer technology has many applications, but one where it has so far had little impact is in reducing the problems of disability.

To mark the designation by the United Nations of 1981 as 'The International Year of Disabled People', *PCW*, in conjunction with the IYDP Technology Working Group, is holding a competition for the best article on the subject:

'The application of micro-computer technology to the problems of disability'.

There must be many possible applications for microtechnology in the fields of physical and sensory disabilities — remember, these include handicaps such as deafness, blindness, diabetes and epilepsy, as well as the more obvious physical impediments.

1st Prize

**DAI PERSONAL COMPUTER**

2nd Prize    3rd Prize

**£100    £50**

Articles of around 2500 words are invited, which can be either theoretical or a description of an actual application (with photographs, if possible), and which we will print in *PCW* later in the year. Entries will be judged by *PCW*'s Editor, David Tebbutt, Adrian V Stokes, Chairman of the IYDP Technology Working Group and Judith Hann, presenter of *Tomorrow's World* and science writer.

Please send your entry to IYDP Competition, 14 Rathbone Place, London W1P 1DE, to arrive not later than 30 April 1981, enclosing a suitable SAE if you would like it returned.

**Personal  
Computer**  
World



International Year of  
Disabled People

Data Applications Ltd has kindly donated the first prize of a 48K personal computer worth £595. Plugging into the domestic TV, it provides sound, colour and high-resolution graphics. Sharp Electronics (UK) Ltd has kindly donated the third prize of £50.



class of 36 children but it became clear that the computer was grossly under-used and that it could easily have coped with ten times that number of users. Apart from the warfare program, the machine was also loaded with simpler programs reflecting the wider interests of the children and the scope of the project. One games program involved sailing a ship round Cape Horn and necessitated rudimentary knowledge of sail setting. Another involved a round-Britain power boat race and tested knowledge of 32 compass bearings; yet another was a quiz on seas and oceans.

Imagine the chagrin of the boys when a girl was the first to reach Sea Lord rank!

## Senior school-business studies

The business game is well established as a training venture. For years, many universities and large commercial enterprises have utilised it to predict the results of various commercial decisions, or have tested various mathematical models against the real-life events.

Students are divided into groups representing the boards of competing companies and divide functions among themselves; one becomes chairman, another accountant, another advertising manager and so on. Collectively, each group must make its own decisions regarding wages, prices, advertising, R & D, etc, the number of parameters limited by the organisers of the game and the computer model used.

At a given time all decisions are input to the computer, which weighs the various considerations to produce balance sheets for each company for the game period — usually one year per turn. Players then determine their next year's strategy. The game is usually played over ten years and the computer may have a hidden parameter built into it so that the game takes place on a rising or falling market.

Apart from the obvious insights into market forces, the game provides tremendous material for graphs, commercial balance sheets, letter writing

and so on. Concepts such as Government fixed-price contracts can also be introduced.

Other games of this type include Town and Country Planning, City Management, Environmental Control, National Economics and so on (see also 'Computer Simulation Models' by John Smith, MA, Griffin, 1968).

## Other classroom applications

The able children in the Senior School require little encouragement to involvement in computer work, but it is not these that we should be worried about. Many youngsters have few ambitions or realisable hopes and, by a quirk of fate, it is these children who are most at risk from the changes that will be brought about by the new technology and who are therefore most in need of an understanding of it.

Luckily, many children are fascinat-

# GATEWAYS TO LOGIC

ed by one-arm bandits, pinball machines, TV games, etc, which offers a way of capturing interest. Every manufacturer knows this: it is no accident that many computer software suppliers start their product lists with individual games or games packs. Don't knock it — games lead to more important things.

Some computer games are more useful than others in their potential but I would not scorn any. I offer here a short list — readers can be sure that all will contribute to the interest of computers, while some will open doors onto a wide variety of other subjects: Startrek, Noughts & Crosses; Animals; Golf; Hangman; Chess; Mastermind; Nim; Number Guess.

With a little encouragement, children

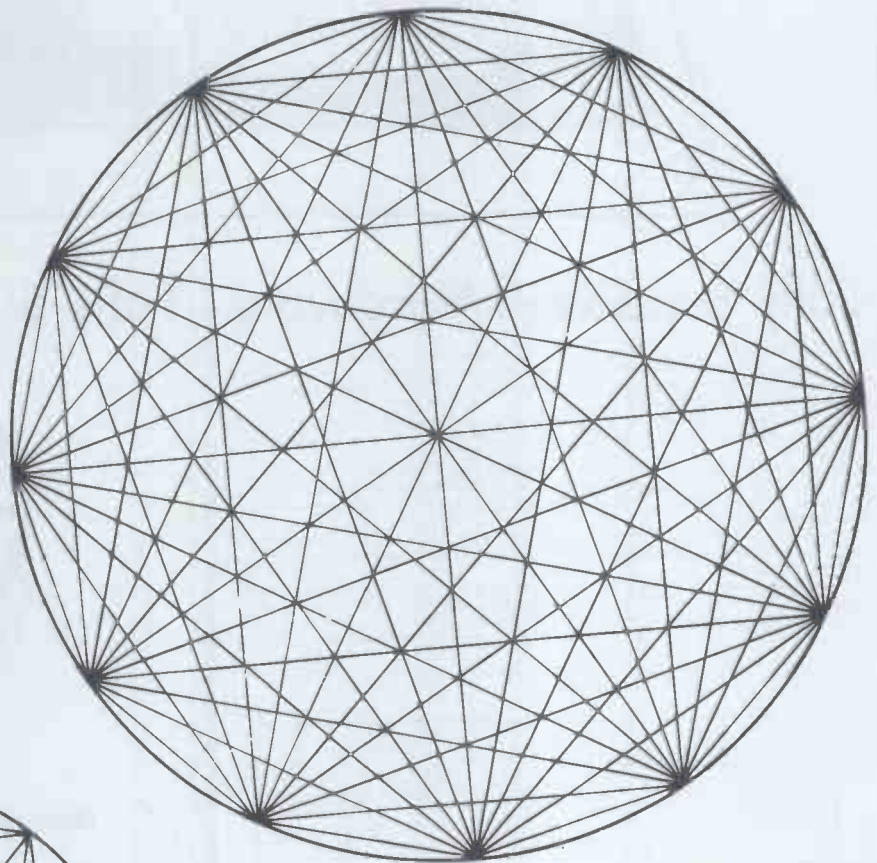
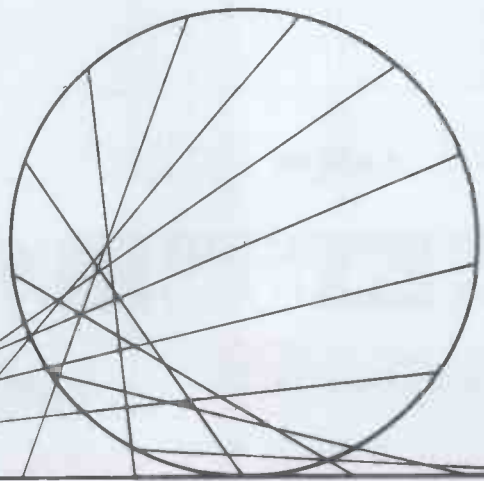
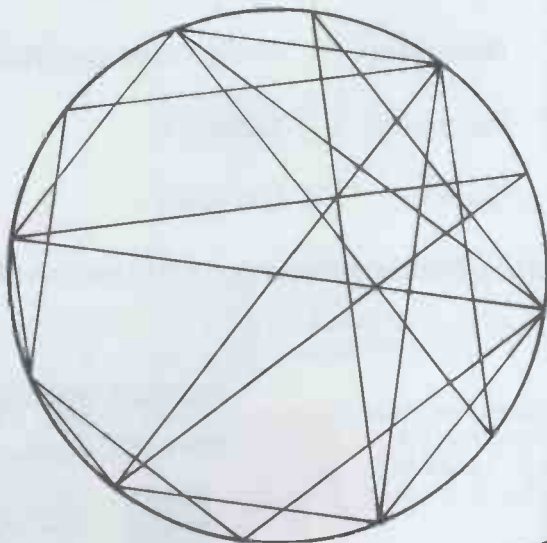
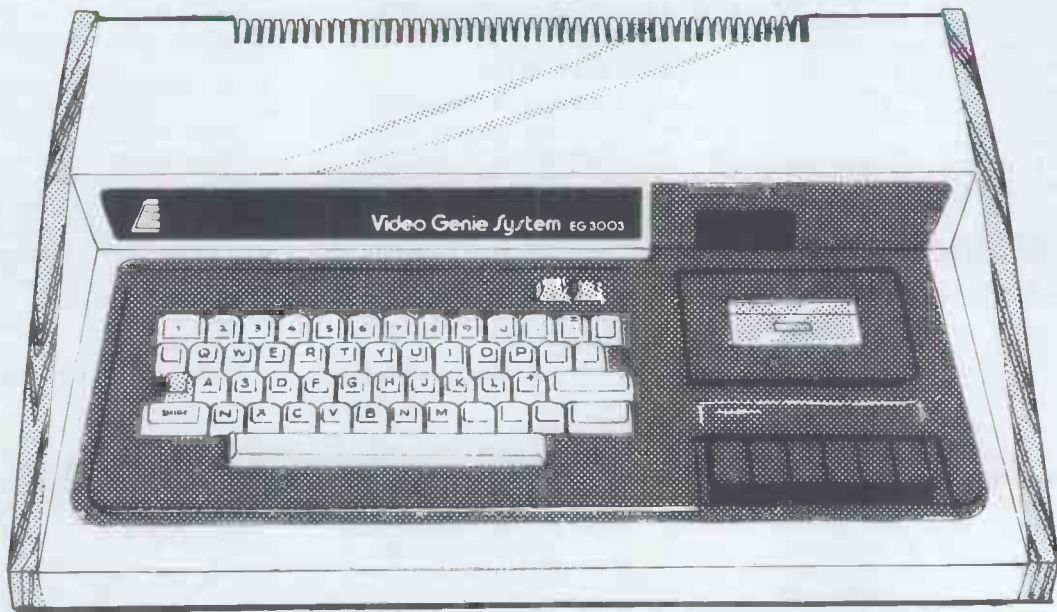

Fig 6



Amazing Value – compatible with TRS-80 16K level II

# VIDEO GENIE (Mk1A model).



## Fully Supported Hardware

Microdigital are the hardware experts – here's why you should buy your Genie from us  
 ★ Low Price of £280 + VAT ★ Each computer tested by our engineers before despatch ★ 12 month parts and labour guarantee ★ Free delivery within mainland U.K. ★ Bona fide official orders welcome. ★ Latest version of Genie

The Video Genie is a complete computer system, requiring only connection to a domestic 625 line TV set to be fully operational, or if required a video monitor can be connected to provide the best quality display

The system case contains the Central Processor Unit (CPU), 16,000 bytes RAM memory, the cassette system, a 12,000 byte operating system and BASIC interpreter in ROM, and a full size keyboard, in a stylish case, at a price that makes the Video Genie better value than some "kit" computers.

### Applications

The Video Genie System has many uses in all spheres of life, the easy to use BASIC language means that programs are easily written for specific applications, and pre-recorded program tapes are available in great variety

The system has great scope in the home, sophisticated games programs can introduce the computer age to all the family, who can then progress to writing their own programs in BASIC or even machine code. Software is continuously being developed to aid home budgeting and education

In a school or college the machine can be used with a large screen TV to teach a whole class to be taught at once

The powerful Extended BASIC interpreter makes the solution of complex scientific problems simple, and the graphics allow pictorial displays of results.

Prices	Nett	Vat	Total
Video Genie Computer	280.00	42.00	322.00
EG3013 Expander with RS232	215.00	32.25	247.25
EG3013 Expander without RS232	185.00	27.75	212.75
32K Memory Board S100	130.00	19.50	149.50
16K Memory Board S100	95.00	14.25	109.25
Dual Disk Drive (40 track)	410.00	61.50	471.50
2 Drive Cable	17.00	2.55	19.55
4 Drive Cable	32.00	4.80	36.80
Printer Cable	17.00	2.55	19.55
Centronics Parallel Interface for unexpanded Genie	33.00	4.95	37.95
Sound kit	10.00	1.50	11.50
fitting above	5.00	75	5.75
Lower case kit	35.00	5.25	40.25
fitting above	5.00	75	5.75

## Fully Supported Software



- ✓ Business ✓ Programming Aids
- ✓ Personal ✓ Custom
- ✓ Games ✓ Utilities

## 7 Years Microprocessor Experience!

Send large SAE (44p) for our current Catalogue of TRS-80/Video Genie software.

A. J. HARDING (MOLIMERX)  
 28 COLLINGTON AVE,  
 BEXHILL, E. SUSSEX.  
 Tel: (0424) 220391



24 Hr Telephone Credit  
 Card Orders 051-236 0707



Mail Orders to:  
 MICRODIGITAL LIMITED  
 FREEPOST (No Stamp required)  
 LIVERPOOL L2 2AB



Retail Premises at:  
 25 BRUNSWICK STREET  
 LIVERPOOL L2 0PJ  
 Tel: 051-227 2535/6/7

# MICRODIGITAL — MOLIMERX LTD



# GATEWAYS TO LOGIC

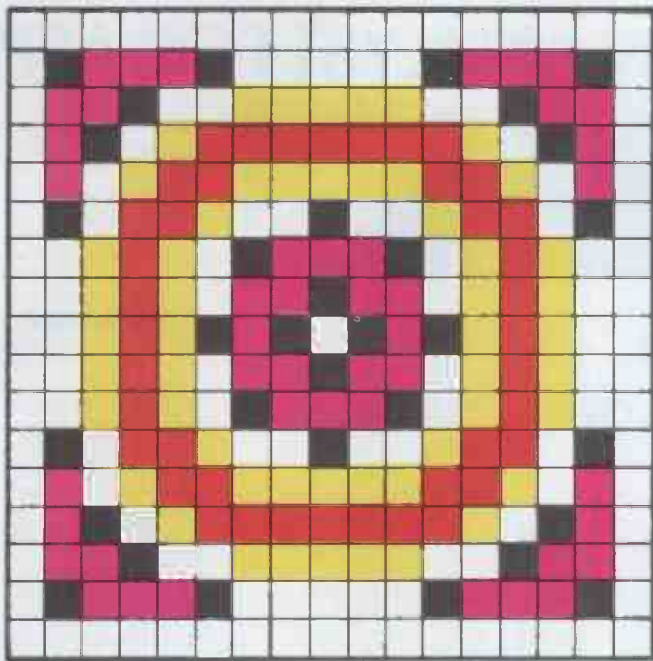

Fig 2

may write their own programs for simple games. A good example is hexapawn, which could hardly be simpler. Two players each have three pawns and start on the base row on opposite sides of a 3 x 3 matrix, so that there is one clear row between them. The winner is the one who prevents his opponent moving or who gets a pawn to the opposite side, moves being as in chess.

The American gadget for teaching children to spell has already been mentioned and it suffers from the obvious limitation that in order to change the range of words offered, the ROM must be changed. However, computers with the capability of automatically starting and stopping a cassette recorder may be programmed so that the cassette speaks the word and the computer checks the answer from the keyboard. This method gives infinite flexibility. Hangman is another way of teaching spelling.

One simple program is so widely used that I expect to see it in ROM very soon. I refer to the multiple-choice quiz, a method universally used to test anything from geography to art appreciation. The computer format is common to all and it would not take much to have a ROM with slots in the program for the teacher to add choices and the number of the correct answer. An extension of this idea leads to what used to be called programmed learning, where incorrect answers stimulate further relevant information; of course, whole courses of training lend themselves to computerisation.

The use of a computer to create art is a whole subject in itself about which several books are available. In my view, the subject is still in its infancy. Numerous programs are available and various tactics employed but the main idea is that the computer uses complex mathematical relationships to print a

choice of symbols or colours in a matrix. The skill of the artist lies in his choice of relationships and the adjustment of input numerical values. No great mathematical skill is called for as long as the user understands roughly what is happening; the computer does all the computation. Figure 1 is a print-out of one very simple example, while Figure 2 is the conversion of the print-out into colour, made by hand. Computers with a colour graphics capability can print on the colour TV screen directly, where the user may manipulate inputs to change colour values to his heart's content before copying in colour. To date, there is no simple or inexpensive method of copying in colour except by hand or by camera.

The program that produced Figure 1 is based on the idea of a linear progression of numbers rotated about the centre. Other programs involve two axes of rotation, while others have different parts of the matrix interacting in complex ways. Moire patterns are easily produced, too, although it seems to this writer that they can hardly be termed computer art. It seems certain that developments in this field will involve various combinations of ideas plus the carefully-controlled use of random numbers.

Computer music is likely to develop in unexpected ways. A sound generator circuit (see last month's PCW) is easily added to any computer and with suitable programming the computer can play any piece of music, or the keyboard can be played like an electronic organ. Mozart himself designed a game in which successive bars of music were selected by the roll of dice and, of course, he wrote the music to go with it.

In spite of all this, however, it seems likely that the micro will invade the

classroom not necessarily as part of a computer, but as a dedicated part of something else, like a spelling device or sewing machine. The Zanussi sewing machine saved 120 moving parts by the installation of one microprocessor and much the same sort of thing is going to happen with other devices. An early contender is likely to be a micro-controlled school bell system. Gone will be large and heavy-current bells triggered by time switches; in their place will be a few small loudspeakers. Other devices will stoke the boiler, monitor for smoke or intruders and may even look after the hamster over the long holidays (see Figure 3)!

## Curve stitching

There is no doubt that computer art offers much to designers of ceramics, wallpapers, lace and fabrics of all kinds, which completes the circle back to Joseph Jacquard. Curve stitching is another approach to computer art as well as to the understanding of curve production by computer. It was invented by an American lady teacher about 100 years ago who sought a way of interesting her pupils in mathematical curves. Most teachers will be familiar with the idea (see Figure 4). Numbered holes are joined by cotton or wool in the manner shown. Figures 5 and 6 show other examples of this technique; it is easy to see how, given high resolution graphics, this could be implemented on a computer.

## And finally...

This chapter of projects brings me to the end of 'Gateways to Logic'. We have looked at the techniques and materials on which computers are based and how these elements are then integrated to form microcomputer systems. In the last few chapters, we have studied examples of the uses to which microcomputers can be put; the way is now open for you to exercise your ingenuity.

This series was originally written for primary school teachers, but anyone involved in 'spreading the microword' should have found it useful. Given the possibilities of microtechnology and the central role it is likely to play in the future, it is vital that our appreciation of it is based upon sound knowledge and not the myths and fears of science fiction. The computer is not going to render mankind disposable through some innate higher intelligence. What it will do, however, is to significantly alter many modes of human thought and interaction. There are parallels with the changes wrought by the technological and scientific developments of the last 200 years, but the possibilities of the micro revolution should be much more far-reaching.

Our fear should not be of such changes in themselves, but rather that we should not be left behind by them. By educating ourselves and our children to these possibilities, now, we stand a much greater chance of turning this revolution to our advantage. This series has been merely a start; the rest is up to you...

# FANTA STICK-1

**£55**  
plus VAT and p&p

## DIGITIZER & PATTERN ANALYST FOR APPLE II

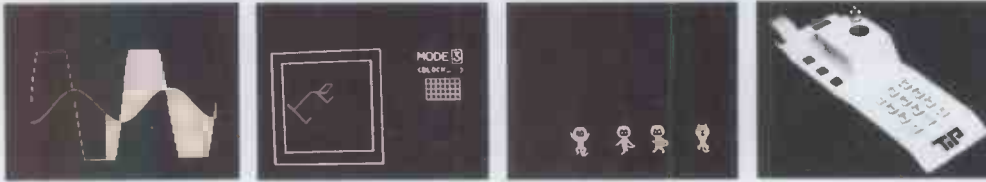

FANTA STICK-1 is a multifunctional terminal that lets you draw and move patterns on the screen, it is also capable of analyzing drawn patterns. It is plug compatible with APPLE II and especially designed for production of commercial animation, graphic analysis and software development.

### Hardware

FANTA STICK-1 consists of a joy-stick, 10 key pad, 3 position switch, I/O expansion connector, pilot lamp and change-over switch. Stick and switch are used for making patterns and game inputs. Keypad is used for inputting dots to the screen, graphic mode, box-position, and save and load pattern commands.

If you need higher performance, you just add another FANTA STICK-1 to the I/O connector.

### Software

The screen may be divided into twenty individual boxes for drawing patterns. The boxes may be reassembled in different ways. Slide and revolve commands can be used to create new images. Additional features include box expansion up to three times, computing the area of dots in a designated window and colour control. With a disk, you can freely operate a graphic pattern with save and load commands.

### GRAPHIC SOFT BOX-1 (15K LEVEL)

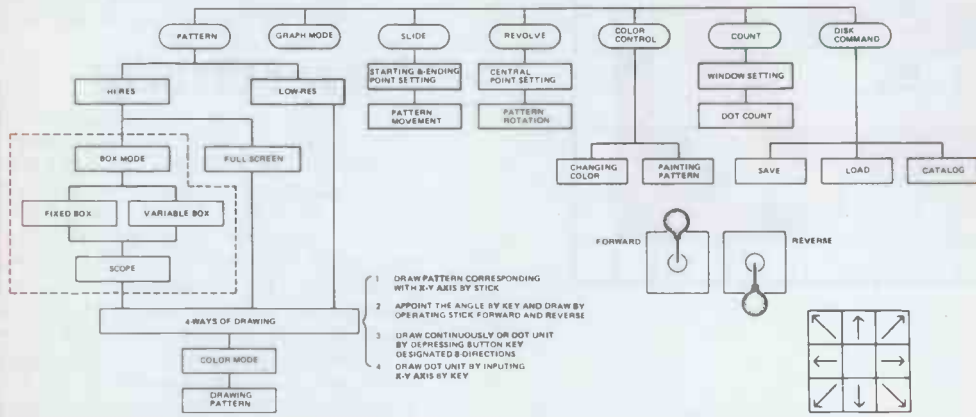

Colin Grace Associates Ltd  
Fairfields House, Ashdon, Saffron Walden, Essex CB10 2NA

Telephone: Ashdon (079984) 682  
Telex: 81653

# LOOK

## NASCOM USERS

YOU CAN HAVE A DUAL DRIVE SYSTEM FOR LESS  
THAN £300

Based on the highly reliable Philips Mini Cassette Drive .....

• Uses the powerful Z80 SIO • Faster than stringy floppy • Highly Structured Command Set Includes Catalog / Transfer / Jumps, etc.

Single drive kit £230 Dual drive kit £299 Send sae for details.

### C.I.E.L.

46. MOREDUN PARK GARDENS,  
EDINBURGH, EH17.

TEL 041 221 3399

COMPUTER INTERFACING & EQUIPMENT LTD.





# 'TUSCAN' FROM TRANSAM



## Take a step up to your next Computer!

### THE CONCEPT

How many ways are there to build an S100 system? Not many, and all expensive. TUSCAN changes all that.

Five S100 boards on one single board — just for starters. Plus five extra slots for future expansion.

What a combination! Z80 and S100 with the TRANSAM total package of system and applications software.

How do we do it? Our prices start at £195 and you can build up in easy stages to a fully CP/M compatible disc based system. Something to think about!

### THE HARDWARE

The first Z80 single board computer with integral S100 expansion. British designed to the new IEEE (8 BIT) S100 specification, the TUSCAN offers total system flexibility. A flexibility available now.

The board holds the equivalent of a Z80 cpu card, 8k ram, 8k rom video and I/O cards with 5 spare S100 expansion slots and offers a price/performance ratio which is hard to beat.

Just compare our price with a commercial S100 ten slot motherboard with this specification.

### THE SOFTWARE

TUSCAN offers the user the choice of system monitor, editor, resident 8k basic, resident Pascal compiler or full CP/M disk operating system. All options are upwards

compatible and fully supported with applications software. Both 5¼" and 8" drives are supported in double density.

### THE PACKAGE

TUSCAN is available in kit form or assembled. With several hardware and software options to suit your requirements and budget. Attractive desk top case also available holds 2 x 5¼" Drives.

# TRANSAM

## NOBODY DOES IT BETTER!

Send to Transam Components Ltd., 59/61 Theobald's Road, London WC1.

I am interested in the TUSCAN Z80 based single board computer with S100 expansion and enclose a S.A.E. for further details.

Name \_\_\_\_\_

Address \_\_\_\_\_

Telephone \_\_\_\_\_



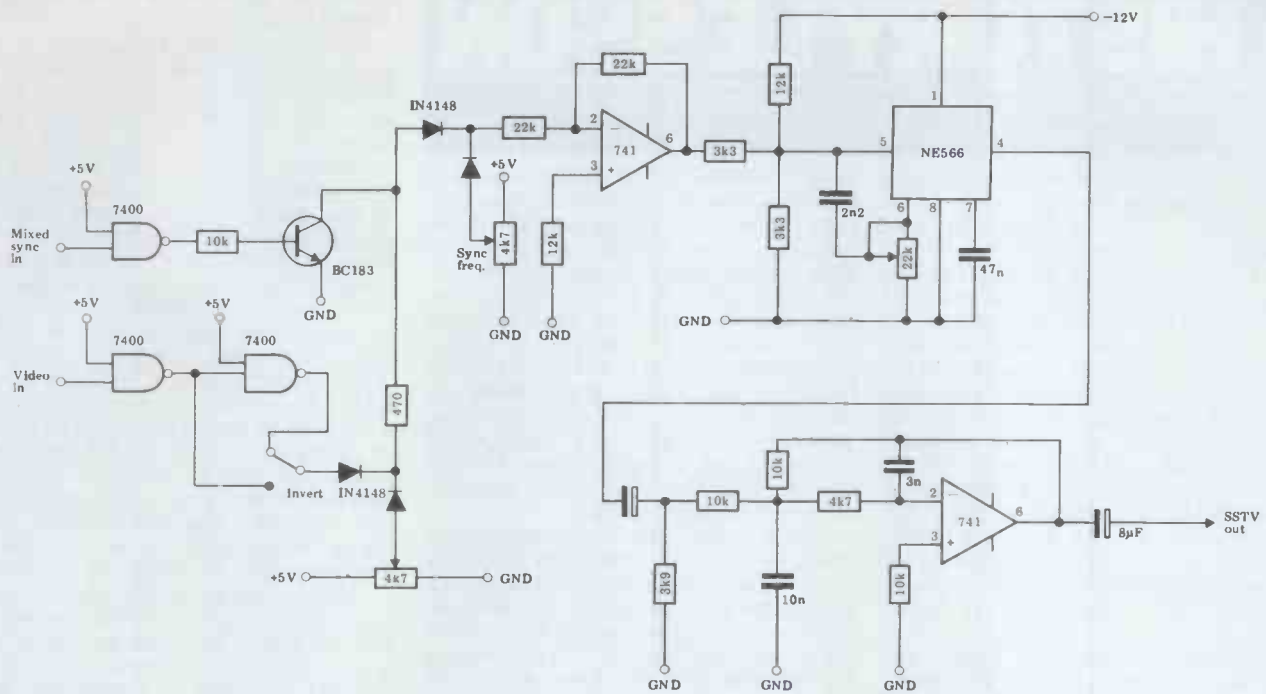

Fig 3

The first program to make use of this insertion technique was one which could insert a title line into the picture; the title to be displayed as either black or white letters on a background which could be either a strip of neutral grey or the normal picture — see Figure 4. The timing for the program must be linked to the line and frame synchronising pulses, so these are fed to the computer and sensed by software; the computer then feeds back to the circuit of Figure 5 a switching pulse which selects either the current video or the computer video using the character generator described earlier.

means that 16 levels of grey can be displayed. This is about the minimum which can be used to produce a reasonably acceptable picture without 'contouring' becoming noticeable. This is the effect observed when large areas of picture are at the same level of grey.

then a 128 x 128 definition should be used. Most printers, however, will not cope with any form of grey-scale and my Olivetti 318 has upper case only. However, a little thought shows that by selecting suitable characters and using over-printing for the darker



Fig 4

Another program samples the incoming video and stores a picture of reduced definition (64 x 64 pixels) in computer memory. By storing two 4-bit pixels in each byte we only need 2k of memory. Using the same technique, this picture can be inserted into the normal display. An extension of the program could store up to four such pictures for simultaneous display and would, of course, need 8k storage space. Alternatively, we could display a full-sized, lower definition picture from each 2k of memory — or we could use the full 8k of memory to store a single picture of higher definition (128 x 128 pixels). For all these applications it should be noted that each pixel is represented by four bits which

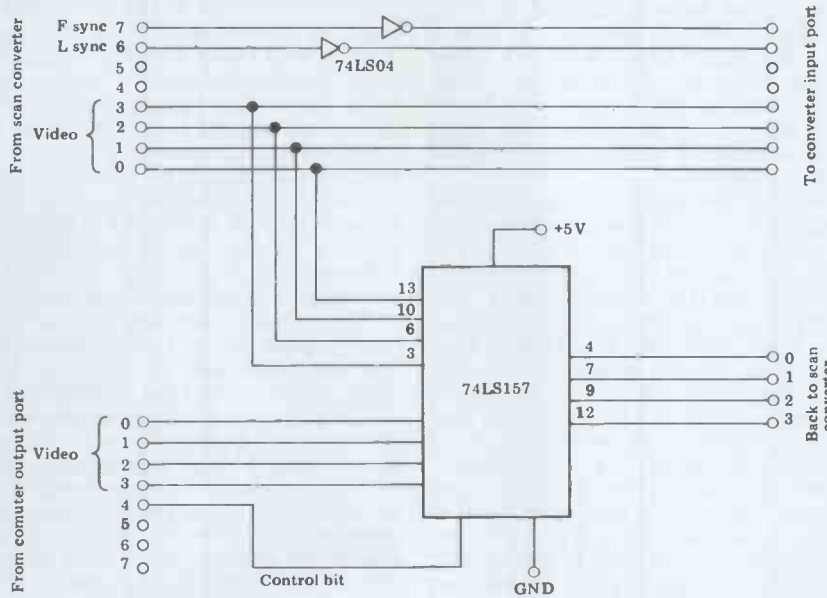

Fig 5 Computer/scan converter interface

Clearly, if one has a printer which can deal with dot graphics and can cope with levels of grey, it is a simple matter to produce a permanent print-out of the picture which has been stored in computer memory. If this can be done,

shades where necessary it is possible to produce something which resembles a picture, even though the aspect ratio is far from the 1:1 of the original. A tolerable likeness of me is obtained by

GOTO page 147

Hex digit giving level of grey	0 1 2 3 4 5 6 7 8 9 A B C D E F
Character used in first print	M M 0 0 % O H I * ! = ; , , .
Character used in overprinting	W O = :
(N.B. 0 is black and F is white)	

Table 1

# A HISTORY LESSON

*Edward G Cluff, secretary-general of the IDPM, offers his advice to would-be business micro buyers.*

*The Institute of Data Processing Management is a thriving practical organisation of almost 7000 professionals and students. Apart from setting examinations twice yearly for its students, it provides quality literature as part of its 'Benefits to Members' package in order to help members improve their performance. Affiliate membership is also open to individuals and companies who wish to support the work of the Institute and want to become involved in its activities. Affiliates receive all the benefits of membership except some voting rights. Subscription rates are extremely low and on payment of the first year's subscription, readers of Personal Computer World are offered a 330 page book containing 50 useful articles.*

*Enquiries, mentioning PCW, to: Edward G Cluff, Secretary-General, Institute of Data Processing Management, 50 Goschen Buildings, 12/13 Henrietta Street, Covent Garden, London WC2E 8NU. Tel: 01-240 3304/5.*

Should a visitor from outer space arrive on our planet about now, he would be forgiven for believing that computer technology began with the development of the micro. This hypothesis would be an interesting exercise in dialectics if we were so inclined, but the question I want to address just now is the view that those who are using micros today are not taking advantage of history. By this I mean that micro users are inclined to re-invent the wheel because many of the lessons of the past are being ignored.

Perhaps the reason for this is that the majority of DP professionals have stayed aloof from micros while, by and large, the users of micros have been the hobbyist and the first-time user. The hobbyist will be driven by the technology itself and almost certainly does not need to be restricted by the disciplines of the data processing profession while the inexperienced user will, regrettably, not even be aware of any such disciplines. To the hobbyists, I have nothing to offer since they have virtually created the market in the first place. It is they who test each new frontier as it is reached. It is they who determine if the frontier is safe for others to occupy and provide us with warnings when it is not. Without the exercise of their ingenuity, the micro business would probably be a shadow of its present self.

To those DP professionals already involved with micros, particularly those who regularly read *PCW*, the Institute of Data Processing Management believes you, too, are making an essential contribution. You will be able to perform the evaluations and decide when a mainframe continues to be the best answer in your circumstances. But you will also be able to decide when to service your own interests as well as those of your company by introducing micros to your users. You will be able to ensure that they are as well-protected from the risks involved with computers

as it is possible to be, having regard to the fact that all commercial exercises carry some risk. Of course, when the users see advertisements stating: 'with a desk-top personal computer system you get big computer power without big computer complications or cost,' they may actually find it helpful to have a professional around to tell them the real facts of life which approximate to 'if you want to solve your travelling problems at the price of a Metro, don't expect to get a Rolls-Royce.' Neither are the facilities of a Rolls normally described as complications.

But it is the small businesses that the Institute wants to address in particular — those who both need and want the advantages of a computer but lack the professional data processing expertise to sail in with confidence. It is to them we say that learning the fundamentals of programming may be fun and even ego-satisfying but is a long way from creating an environment in which you have a very high chance of succeeding with your investment in the long term.

One of the elementary disciplines of DP professionals before committing a new task to a computer is to carry out a feasibility study. This might embrace a number of facets but it can be expected to highlight deficiencies in the existing system as well as the advantages, if any, of conversion to a computer system. One thing above all others has been learned by our 25 years experience. This is that the problems of a bad system are always compounded by the introduction of a computer without the analysis and design to render it more suitable to the technology. The other thing learned by experience is that when a 'dirty' system has been overhauled following an analysis of its faults, a computer may not even be necessary.

This is not to say that the computer professionals did not themselves make the same mistakes in the past. Very many of the computer applications of the first ten to 15 years which developed from punched card systems were virtually a computerised replica without adequate thought being given to exploiting the alternative techniques possible with electronics. So it is a matter for concern when users without the skills available in the market attempt to move a horrid unmanageable clerical system onto a micro without establishing first of all what is wrong with the existing system and then how the potential of a computer can best be exploited.

This error in approach is largely due to a self-created myth. While the micro vendors themselves do not suggest that their customers need acquire an in-depth knowledge of computers before embarking on 'the grand experiment', users, often half-afraid and half-suspicious, feel they first have to crack the technology. This, coupled with a brief period at the keyboard and the generation of a few example programs, of half-a dozen instructions each, creates the self-deception that, in fact, the technology has been cracked and it isn't

nearly as difficult as these computer people pretend.

To these brave enthusiasts, I say: good, you have disposed of some of the mysteries. Now you can talk more easily and with confidence and some experience to people with much more experience. But now start thinking like managers and stop pretending you have, in the space of a few hours, acquired all the experience of someone who has been at it for years. If you were going to invest a sum equivalent to the cost of a micro and its software in typewriters or accounting machines what would be your criteria for choosing the supplier? Apart from price, it is highly likely you would be concerned to select a supplier with a track record and a fair likelihood of being in business in the foreseeable future and able to provide a full maintenance service. You might even consider the possibility that the vendor is offering a model soon to be replaced by another, with no means of upgrading.

In your study of the micro market, you will have 'got a feel' for the price of the hardware but still be more than a little confused by the different prices for the programs and software. It is difficult enough to choose between competing packages with a five to one price ratio but even more difficult to face up to the possible need to pay perhaps ten times the price of the more expensive packages to have a custom-written system. But even where I am completely wrong and you do understand the justification for the price hierarchy, you will probably not think too deeply about software/program maintenance, the need for which will be just as inevitable as hardware maintenance. So don't underestimate the importance of your investment in the programs. If you have identified the most marvellous micro in the world that, to all intents and purposes, never goes wrong, it will avail you nothing if your programs were written by a young man introduced to you by a third party who, in a time of crisis, is found to be taking a long holiday on a kibbutz.

When faced with the disappearance of the person who wrote the programs or even the company which may have sold the standard package, there is a solution well-known to DP professionals even if practiced by them a little less than the text-books advise. This is to always have available quality documentation to accompany all programs. Furthermore, such documentation must be amended as the programs themselves are changed. With such documentation, it would be possible to recover from quite serious situations, and so users are encouraged to include this question in their list of criteria when choosing a supplier.

So success with micros will not come from a one-day course using the keyboard and a few simple instructions. Success will come from knowing what criteria to apply to a business-decision about an investment which happens to be in a micro. And if you commonly make a habit of investing without obtaining advice, then go ahead and do so again. But if you are like me and worry at nights until you *know* you have the right answer, then you will invest a little by buying in some professional advice *before* signing any contracts.



NEWBURY NEWBURY NEW

# Smart Micro-based Visual Display Terminals

24 lines of 80 characters per line. 96 ISO/ASCII character set. Dual interface - CCITT V24 and 20/60 mA current loop. Selectable half or full duplex. Green phosphor non glare display.

Hard copy print out  
Numeric pad  
Video output for external monitors

**7000**

**7002**



**7007/9**

Full keyboard editing features. Additional 6 pages of memory (7009). Block transmission by line or page.

## Matrix Printer



125 cps printing speed  
CCITT V24 (RS232) interface  
80-132 characters per line

from **£440**\*

Prices from \*

**£495**

### Emulations:

APL, DEC VT52, ICL 7181 Honeywell  
VIP 7006 & 7250

\*Prices inclusive of delivery in UK and cables ready to plug in.

**NEWBURY  
LABORATORIES LTD**

Head Office & Sales:  
King Street, Odiham, Hampshire RG25 1NN  
Tel: 025-671 2910 Telex: 858815

### Sales and Service:

North East Tel: York (0904) 412043  
North West Tel: Stockport 061-491 0134  
Midlands Tel: Birmingham 021-707 7170  
East Anglia Tel: 0223 64862  
Scotland Tel: Edinburgh 031-554 0051

# New! Sinclair ZX81 Personal Computer.

**Kit: £49.<sup>95</sup> complete**

**Reach advanced  
computer comprehension  
in a few absorbing hours**

1980 saw a genuine breakthrough – the Sinclair ZX80, world's first complete personal computer for under £100. At £99.95, the ZX80 offered a specification unchallenged at the price.

Over 50,000 were sold, and the ZX80 won virtually universal praise from computer professionals.

Now the Sinclair lead is increased: for just £69.95, the new Sinclair ZX81 offers even more advanced computer facilities at an even lower price. And the ZX81 kit means an even bigger saving. At £49.95 it costs almost 40% less than the ZX80 kit!

### **Lower price: higher capability**

With the ZX81, it's just as simple to teach yourself computing, but the ZX81 packs even greater working capability than the ZX80.

It uses the same micro-processor, but incorporates a new, more powerful 8K BASIC ROM – the 'trained intelligence' of the computer. This chip works in decimals, handles logs and trig, allows you to plot graphs, and builds up animated displays.

And the ZX81 incorporates other operation refinements – the facility to load and save named programs on cassette, for example, or to select a program off a cassette through the keyboard.

### **Higher specification, lower price – how's it done?**

Quite simply, by design. The ZX80 reduced the chips in a working computer from 40 or so, to 21. The ZX81 reduces the 21 to 4!

The secret lies in a totally new master chip. Designed by Sinclair and custom-built in Britain, this unique chip replaces 18 chips from the ZX80!

**Built:  
£69.<sup>95</sup>  
complete**

**Kit  
or built –  
it's up to you!**

The picture shows dramatically how easy the ZX81 kit is to build: just four chips to assemble (plus, of course the other discrete components) – a few hours' work with a fine-tipped soldering iron. And you may already have a suitable mains adaptor – 600 mA at 9 V DC nominal unregulated (supplied with built version).

Kit and built versions come complete with all leads to connect to your TV (colour or black and white) and cassette recorder.

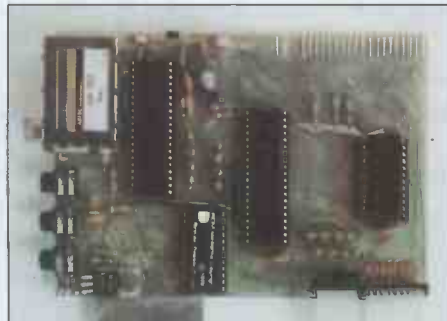

*Proven micro-processor, new 8K BASIC ROM, RAM – and unique new master chip.*



### **New BASIC manual**

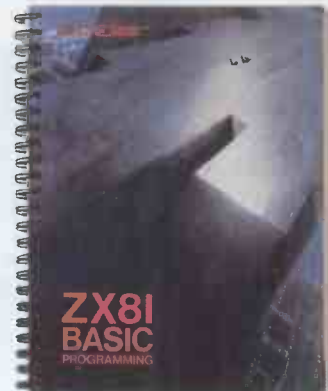

Every ZX81 comes with a comprehensive, specially-written manual – a complete course in BASIC programming, from first principles to complex programs.



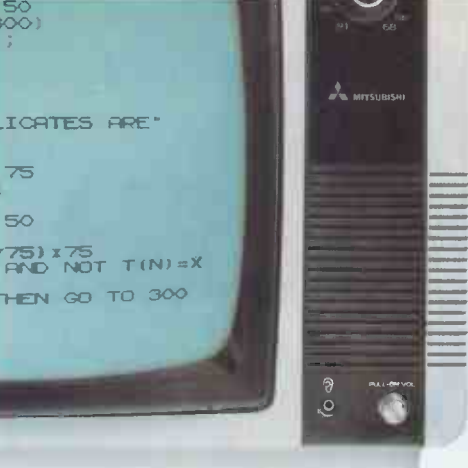

## If you own a Sinclair ZX80...

The new 8K BASIC ROM used in the Sinclair ZX81 is available to ZX80 owners as a drop-in replacement chip. (Complete with new keyboard template and operating manual.)

With the exception of animated graphics, all the advanced features of the ZX81 are now available on your ZX80 – including the ability to drive the Sinclair ZX Printer.

## Coming soon – the ZX Printer.

Designed exclusively for use with the ZX81 (and ZX80 with 8K BASIC ROM), the printer offers full alpha- numerics across 32 columns, and highly sophisticated graphics. Special features include COPY, which prints out exactly what is on the whole TV screen without the need for further instructions. The ZX Printer will be available in Summer 1981, at around £50 – watch this space!



## 16K-BYTE RAM pack for massive add-on memory.

Designed as a complete module to fit your Sinclair ZX80 or ZX81, the RAM pack simply plugs into the existing expansion port at the rear of the computer to multiply your data/program storage by 16!

Use it for long and complex programs or as a personal database. Yet it costs as little as half the price of competitive additional memory.



### How to order your ZX81

**BY PHONE** – Access or Barclaycard holders can call 01-200 0200 for personal attention 24 hours a day, every day. **BY FREEPOST** – use the no-stamp-needed coupon below. You can pay by cheque, postal order, Access or Barclaycard. **EITHER WAY** – please allow up to 28 days for delivery. And there's a 14-day money-back option, of course. We want you to be satisfied beyond doubt – and we have no doubt that you will be.

### New, improved specification

- Z80 A micro-processor – new faster version of the famous Z80 chip, widely recognised as the best ever made.
- Unique 'one-touch' key word entry: the ZX81 eliminates a great deal of tiresome typing. Key words (RUN, LIST, PRINT, etc.) have their own single-key entry.
- Unique syntax-check and report codes identify programming errors immediately.
- Full range of mathematical and scientific functions accurate to eight decimal places.
- Graph-drawing and animated-display facilities.
- Multi-dimensional string and numerical arrays.
- Up to 26 FOR/NEXT loops.
- Randomise function – useful for games as well as serious applications.
- Cassette LOAD and SAVE with named programs.
- 1K-byte RAM expandable to 16K bytes with Sinclair RAM pack.
- Able to drive the new Sinclair printer (not available yet – but coming soon!)
- Advanced 4-chip design: micro-processor, ROM, RAM, plus master chip – unique, custom-built chip replacing 18 ZX80 chips.

# sinclair ZX81

**Sinclair Research Ltd,**  
6 Kings Parade, Cambridge, Cambs.,  
CB2 1SN. Tel: 0276 66104.  
Reg. no: 214 4630 00.

To: Sinclair Research Ltd, FREEPOST 7, Cambridge, CB2 1YY.				Order	
Qty	Item	Code	Item price £	Total £	
	Sinclair ZX81 Personal Computer kit(s). Price includes ZX81 BASIC manual, excludes mains adaptor.	12	<b>49.95</b>		
	Ready-assembled Sinclair ZX81 Personal Computer(s). Price includes ZX81 BASIC manual and mains adaptor.	11	<b>69.95</b>		
	Mains Adaptor(s) (600 mA at 9 V DC nominal unregulated).	10	<b>8.95</b>		
	16K-BYTE RAM pack(s).	18	<b>49.95</b>		
	8K BASIC ROM to fit ZX80.	17	<b>19.95</b>		
	Post and Packing.			<b>2.95</b>	
				<b>TOTAL £</b> _____	
Please tick if you require a VAT receipt <input type="checkbox"/>					
*I enclose a cheque/postal order payable to Sinclair Research Ltd, for £ _____					
*Please charge to my Access/Barclaycard account no. _____					
*Please delete/complete as applicable.				Please print.	
Name: Mr/Mrs/Miss _____					
Address _____					
_____					
_____					
<b>FREEPOST – no stamp needed.</b>				<b>PCW04</b>	

# BLACK BOX III MICROCOMPUTER SOLUTIONS

Conventional microcomputers can have problems – too little memory, not enough storage, poor communications, no expandability.

RAIR's Black Box III range provides all the solutions. With up to 512K bytes of memory, 200M bytes of

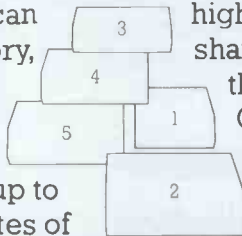

high-speed hard disk, 16 simultaneous users, and shared-resource multi-computer networking, the only thing micro about the Black Box III is the price.

Call your nearest Dealer for details.

- 1 Single mini-disk system
- 2 Dual mini-disk system
- 3 Single mini-disk plus 5" hard-disk system
- 4 Single 8" hard-disk system
- 5 Add-on 8" hard-disk



# RAIR

A. Healey Office Equipment Unit 7, Westfield Industrial Estate, Portsmouth Road, Horndean, Hants Tel: 0705 597555  
 Digitus Ltd 9 Macklin Street, Covent Garden, London WC2 Tel: 01-405 6761 Hallam Computer Systems Ltd 1 Berkeley Precinct,  
 Eccleshall Road, Sheffield S11 8PN Tel: 0742 663125 Holdene Ltd Manchester Unity House, 11-12 Rampart Road, Leeds Tel: 0532 459459  
 Lion Micro Computers Ltd 227 Tottenham Court Road, London W1 Tel: 01-636 9613 and 21 Bond St Brighton Tel: 0273 601838  
 Micromedia Systems, Seymour House, 14-16 Chepstow Road, Newport, Gwent Tel: 0633 59276  
 Newbear Computer Store 40 Bartholomew Street, Newbury, Berkshire Tel: 025-671 2910 NSC Computer Shops 29 Hanging Ditch,  
 Manchester Tel: 061-832 2269 T & V Johnson (Microcomputers) Johnson House, 75-79 Park St Camberley Tel: 0276 20446 also  
 148 Cowley Road, Oxford Tel: 0865 721461 and 48 Gloucester Road, Bristol BS7 8BH Tel: 0272 422061

Rair Limited, 30-32 Neal Street, London WC2H 9PS Tel: 01-836 4663



# UP THE SHARP END



*Mike Knight of Mike Rose Micros spends a lot of time helping to get microcomputer installations running. Despite the salesman's patter, a computer user's life can sometimes be less than rosy and Mike will 'tell it as it is'. Every story will be factual and readers might like to join in with their tales — write to 'Sharp End', PCW, 14 Rathbone Place, London W1P 1DE*

It's amazing how a customer's perception of engineering support changes as he makes the metamorphosis from prospective purchaser to user. Before a sale is made, he indulges in conversations like, 'Reliability sir? Our equipment has a mean time between failures of some 30,000 hours!' 'Does that mean it will never break down?' 'Well, of course we can't guarantee that, sir, but even if your machine were to break down an engineer would be with you in... minutes/hours.' (This time is determined by the distance of the client from the supplier.)

Now, before all you suppliers start writing and complaining to the editor, let me make it clear that, although these statements were made in my presence, most suppliers would not have made them. In fact, many suppliers would not mention engineering support at all during the sale unless specifically asked. Then they would probably explain their equipment warranty conditions and the continuing maintenance support possible, usually at a cost of between ten and 15 percent of the purchase price.

Who can blame a supplier for glossing over the possibility of a breakdown when he's trying to convince someone of how good the equipment is? In fact, he may well have good reason to avoid the mention of breakdowns. I have a machine manufactured by one of the biggest microcomputer suppliers. This company has its own large engineering support section yet, when my machine developed a fault, it took them four weeks to fix it! Would you tell a small businessman that he may have to stop his business transactions being posted for several weeks while his machine is out of action? Most suppliers would prefer to accept an investment in standby equipment to cover such an eventuality.

One of my customers bought a computer from a fairly reputable supplier, or at least it seemed that way until the supplier went bust, leaving my client feeling more than a little concerned. His fears were swiftly allayed when an announcement was made to the effect that a much larger computer concern had taken over the defunct company along with all its obligations, including engineering support. Soon after this happened my client's machine developed a couple of faults: the whole system would go to sleep

from time to time and it also had something wrong with the keyboard. He duly rang the new computer company and they despatched an engineer. Unfortunately, as is always the case with a machine fault, it refused to manifest itself in the presence of the engineer. The keyboard problem could be demonstrated, but would the machine go to sleep? Would it heck! The engineer left, promising to return with a new keyboard.

Six weeks elapsed and my client rang the computer firm to see what had happened to the engineer. 'Your maintenance agreement has lapsed and we won't be renewing it,' said the computer company. Now my customer began to find out just how difficult it is to find an engineer when you need one. He plodded on for a few months, switching the machine off, letting it cool down and then switching

on again whenever it went to sleep until one day it finally gave up the ghost. It appeared to go to sleep for good.

The first thing he did was to ring the computer company who had failed to renew the agreement. 'Yes sir, we can get someone round next Friday week.' Well that was no good; with cash flow a constant problem, statements had to be produced to catch all those people who didn't pay on invoices. My client dredged the computer magazines for local engineers and tried phoning them. One of two things happened: either he couldn't get through or they said: 'Oh you've got an XYZ machine have you? Sorry we don't have any expertise in that equipment. Why don't you try...?' and so on. He tried to hire some standby equipment but to no avail. He sent someone out to find a copy of the *Computer User's Year Book* and to ring

the engineers listed there. Unfortunately most of them were only concerned with mainframe work. Eventually he found someone who was prepared to come round immediately.

The engineer arrived and spent an enormous amount of time undoing and doing up bits of the machine. He looked at the boards, the screen and the disk drives. He checked all the connections and then declared that there was absolutely nothing wrong. He suggested that the problem must lie with the disks — 'They're very worn,' he said. 'On the other hand, it could be the carpets. You see, they can cause static electricity and computers really don't like that at all.' He suggested the purchase of an anti-static spray. My customer didn't have a clue where to get such a spray and, having exhausted all the furniture shops in his district, hit on the idea of a record shop. Sure enough he found an anti-static spray. It was for records, not carpets but it was anti-static. It didn't help. He bought 20 new disks but these made no difference either.

In the end, my client gave up. He transferred his accounts to a computer bureau. His problems weren't solely caused by the engineering saga as his best operator had left and the programs he'd bought (not from me) left a lot to be desired. I think the engineering thing was just the last straw for him. Still, despite that, there are some inevitable conclusions to be drawn from this unhappy tale. Machines do break down and you should make sure that you have a deal with someone should such an eventuality arise. It's not enough to rely on finding someone just when you need them. You may as well also get used to the fact that most machines will refuse to misbehave when the engineer is there. I suggest that you write down the circumstances of the breakdown as carefully as possible at the time it happens — this can be an invaluable help to the engineer.

Finally, I must say that almost all the engineers I know are nice people and very hard-working. The trouble is that because they are usually good you never get their names given to you by other users. 'Got hardware problems have you? I'd put you in touch with our engineer but I know he's too busy to take on anyone else!' They're not mad — the more people using him, the more people likely to encounter the problems discussed in this article.



# BATTLESIPS

This month Alan Sutcliffe brings you a new game, the knight's tour and tessellated tiles.

Some tasks are easy to define, seem at first sight very simple, but turn out to be rather difficult. With a computer they may become as easy as they at first appeared to be.

Playing the game I am going to describe seems such a task. At Christmas my daughter got a chip-based version of Battleships. I was writing my last article on Knight's moves to the accompaniment of its incessant pinging. The two fused together to suggest a game where there is partial information, as in Battleships and where the moves are taken from chess. Unlike Battleships, the information is dynamic. The last move your opponent made is kept from you until you have made your move. The object of the game, moving like a Queen (do you mean mincing? — Ed), is to land on or pass through the cell where your opponent is.

Here is the formal set of rules:

1. The player and the opponent each have a 5x5 board hidden from the other;
2. The player and the opponent each have a Queen, the piece that can move any number of squares diagonally or orthogonally;
3. Each player has a marker to show the last known position of the other player's Queen;
4. The two Queens are initially placed as shown in Figure 1;
5. The player and the opponent play turns alternately. A turn consists of:
6. The player moves his Queen;
7. The opponent tells the player where his Queen is;
8. The player declares Hit, Pass or Miss, according to whether his Queen has landed on, passed through or missed the opponent's Queen. If a Hit is declared:
9. The player scores 3 points;
10. The player makes a second Queen's move in any direction. If a Pass is declared:
11. The player scores 1 point.
12. The player makes a second move with his Queen, but is limited to a King's move, which is one square in any direction, except that it is not allowed to move back in the direction just moved (else a Hit might then result);
13. If a Miss is declared, the player takes no further action. The turn is at an end;
14. The first player to reach, say, 10 points is the winner.

In my experience at least, this simple game is confusingly difficult to play. Without going into theories of cognition, it just seems hard to remember that you do not know where your opponent is and he does not know where you are. Perhaps that is why, to my limited knowledge, the game has not been thought of before.

Here is where the computer comes to

our aid. Preferably one with two terminals, to make data protection easy. With only one terminal, a human umpire may be used to enter moves and report scores. In either case the program to run the game is fairly straightforward.



Fig 1 The initial placing of the pieces.



Fig 2 The vulnerabilities of the player's possible first moves.

5	2	3	2
2	1	4	3
3	4	1	2
0	3	2	5

Fig 3 Least number of Knight's moves needed starting from a corner square.

2	1	4
3	-	1
0	3	2

1	4	1
2	-	2
3	0	3

Fig 4 Least number of moves on a 3x3 board.

Before you set about coding it, however, here are some comments on the rules and some possible alternatives:

1. The game can be played on boards of a variety of shapes and sizes. The smallest board which seems worthwhile is 3x3. In this case the Queens should be placed initially a Knight's move apart, so that the first to play cannot immediately Hit the other. If you follow the logic of this version, you will find there is always a move that keeps your piece a safe Knight's move away from the opponent, so preventing him from scoring, provided that he is taking the same avoiding action to prevent you scoring. If you depart from this pattern of mutual wariness to mount a surprise attack, you may score. But if you don't

you will then be vulnerable to a Hit or Pass by your opponent. Above about 6x6 the chance of scoring becomes so low that the game is boring, since almost every move results in a Miss;

2. Other pieces may be tried and on larger boards more than one piece each might be allowed;
3. As well as the logic of the immediate situation, something will be learnt about how the opponent thinks and moves;
4. These positions are chosen to avoid an easy Hit on the first move. Other pairs of squares have the same property. An alternative is to allow the players to place the pieces anywhere. This placing then becomes a special first move, and the second player may score a Hit by choosing the same square as the first;
5. No comment;
6. Null moves might be allowed — that is, staying on the same square;
7. An alternative rule here is that the player tells where his piece has just moved from. The opponent then has to declare, without giving any other information on where his piece is, whether the player has scored. Played without computer aid, this version seems to be even more confusing than the original. With a computer it may be more fun, for just the same reason;
8. No comment;

9. The ratio of the scores for Hit and Pass should be adjusted for different-sized boards to be roughly in line with their relative probability. On a larger board, for example, a Hit becomes much less likely than a Pass, and so should score correspondingly more;

10. It seems awkward to leave the two Queens on the same square after a Hit. The opponent would then know where the Player was, though unable to score, unless a null move were allowed;
11. No comment;
12. It seems unfair and unnecessary to allow the same freedom of movement after a Pass as after a Hit, and this rule gives the opponent some chance of striking back. If a second move were not allowed then the opponent could always score at least a Pass by moving back to the edge of the board in the direction the player just moved from. This is known to the opponent from her own position and the last known position of the player;
- 13 and 14. No comment.

No doubt many other variations and developments are possible. Taking the rules as originally stated, it is possible to begin to analyse play and identify likely best moves. From the opening position, Figure 2 shows the possible moves of the player and their immediate vulnerability. A cell which can be reached by the opponent on his first move is marked '-', while '+' indicates one that cannot be so reached.

This analysis can be continued to show the relative merits of each possible move, increasing the chance of the player scoring and decreasing the chance of the opponent scoring. However, as mentioned for the 3x3 game, following this apparent optimum is not always the best course because the opponent can make similar computations and so anticipate the player's moves. This is where the bluff comes in.

**Knight moves**

Last month I wrote about Knight's moves on a chessboard and showed that,



on a board of 5x5 cells, any square can be reached from any other square in at most four moves. I gave two quite different programs for computing the shortest path between any two squares. I asked what is the smallest square board on which five moves are needed to get from one square to any other?

There is a slight trick in the question, or rather in the answer. Four moves suffice on a 5x5 board, but if you only looked at larger square boards then you missed the correct solution. On a 4x4 board it takes five moves to get from a corner cell to a cell in an adjacent corner. Figure 3 shows this together with the number of moves necessary to get from a corner cell, to any other cell. Every other path between two cells on a 4x4 board takes four or fewer Knight's moves.

Figure 4 shows the same information for a 3x3 board where the longest path is four moves: from a corner or side cell to the one diametrically opposite to it. It could be argued that the longest path here is infinite, since the centre cell cannot be reached by a Knight from any of the other cells. Incidentally, from any cell on a 3x3 board any other cell can be reached in just one move of a Queen or of a Knight, but not both.

On a 2x2 board the question does not arise since no two cells are a Knight's move apart. Table 1 summarises this information, together with the longest minimum path between any two cells for each square board up to the standard 8x8 chessboard. On this board the only path of six moves is from a corner cell to the opposite corner, as shown in Figure 5. I would be glad to hear from any reader who has carried the search to larger boards or has investigated boards of shapes other than square.

5	4	5	4	5	4	5	6
4	3	4	3	4	5	4	5
3	4	3	4	3	4	5	4
2	3	2	3	4	3	4	5
3	2	3	2	3	4	3	4
2	1	4	3	2	3	4	5
3	4	1	2	3	4	3	4
0	3	2	3	2	3	4	5

Fig 5 Least number of moves from a corner square on an 8x8 board.

A device that is often useful in studying problems of this kind is to redraw the network of cells and paths, opened out to have the fewest possible lines intersecting. Figure 6 shows (a) a 4x4 board with all possible moves by a Knight as it appears to us and below this is exactly the same information as it appears to a Knight. Cells which are one move away for a Knight are now adjacent. It is easy to see from this Knight's view that the shortest path from a corner to an adjacent corner is indeed five moves.

Size of board	Longest minimum path between 2 cells
3x3	4 or
4x4	5
5x5	4
6x6	4
7x7	5
8x8	6

## Complete tours

The tour of a chessboard by a Knight, visiting each square just once, is a problem of some antiquity. The first known solution was given by Abraham de Moivre (1667-1754), a French mathematician living in London, and sent to Brook Taylor, who may have proposed the problem. Both men have well-known theorems named after them. Of particular interest are re-entrant solutions which start and finish on the same square. Almost every book on recreational mathematics discusses the problem, so I will say no more about it.

A related problem, that I have not seen mentioned elsewhere, is a Knight's tour which passes along each link just once. Since there are usually more links than cells, such a tour will probably involve visiting some cells more than once.

Each cell has a fixed number of links into or out of it. The numbers for a 4x4 board can be seen in Figure 7. Each corner cell (c) has just two links, each side cell (s) has three links, and each middle cell (m) has four links. Each time a cell is visited clearly two links are used: one in and one out. The only exception is the start cell, where only one link out is used, and similarly for the finish cell.

From this it follows that, for a complete tour of all the links to be possible, either every cell has an even number of links and the route is re-entrant, beginning and ending on the same cell, or every cell has an even number of links except for the start and finish cells, which have an odd number.

This is part of what Leonhard Euler showed in a famous paper to the St Petersburg Academy in 1736. He started from the problem of finding a route around Konigsberg which passed just

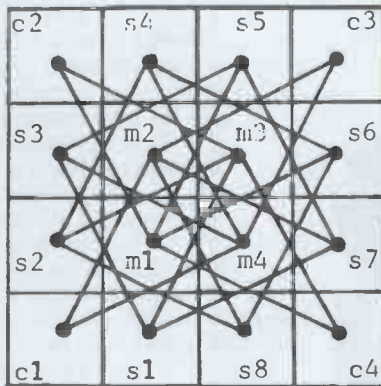

(a)

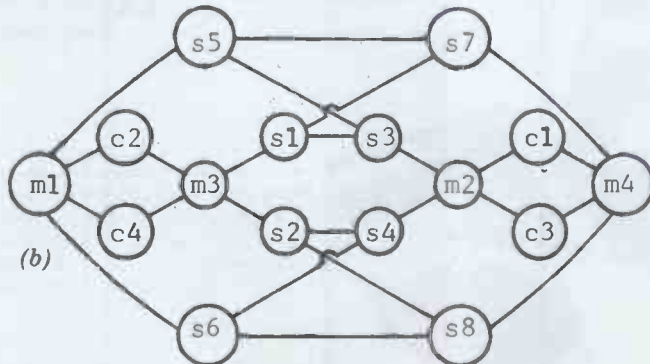

(b)

Fig 6 All possible Knight's moves on a 4x4 board: a) as seen by a human. b) as seen by a knight.

## PATTERNS

once over each of its seven bridges. His general solution founded the subjects of topology and graph theory.

It follows that, if there are more than two cells with an odd number of links, then a complete tour of links is not possible. This is always the case for a square chessboard of 4x4 cells or greater size, because each cell along a side next to a corner cell has three links, and there are eight such cells. From each

2	3	3	2
3	4	4	3
3	4	4	3
2	3	3	2

Fig 7 The number of nodes on a 4x4 board.

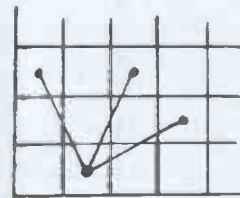

Fig 8 The three moves from the square next to a corner.

such cell a Knight can reach just three other cells in one move. Figure 8 makes this clear.

So here's a problem; on what shape of board is a complete tour of links possible? The outline of the board may be quite irregular, but may not include any separated cells (islands) and there must be no holes (lakes) in the board. Every cell must be visited at least once. To be more specific, what is the smallest board satisfying these conditions, and what is the largest such board?

It is easy to construct a board of island cells, like stepping stones in a river of non-board. Indeed just two cells a Knight's move apart satisfy the main requirement but that is just too simple. The 3x3 board almost satisfies the conditions, but the centre cell is a lake that cannot be reached from any of the other cells.

And if you find that too easy you can bend your mind with boards wrapped round a cylinder so that a pair of opposite sides of the board meet, or

# PATTERNS

both pairs of opposite sides if you like, or you can go on to boards in three and more dimensions.

Once you have a program that will compute the number of links at each cell for a generalised configuration of cells, the topological complexity of a particular board ceases to be a difficulty. For example, on a cubic board of 4x4x4 cells, a complete re-entrant tour of links is possible starting at any cell.

There are no programs in my article this month because I have been away admiring and being overwhelmed by some of the world's greatest works of digital art — the mosques and madrasahs of Uzbekistan in Soviet Central Asia. The most impressive, if not the most beautiful are the huge buildings on three sides of the Registan square in Samarkand. Cecil B de Mille himself could not have conceived a finer setting or one more grand. Marvellously reconstructed and restored, there are acres of ceramic tiles in abundant profusion of patterns from stunning simplicity to subtle complexity. Nowhere in the works of man are geometry and art more closely or more richly woven together.

That is my excuse. It is also partly inspiration for my own modest contribution next month, which concerns a pastime with tiles. It does not require a computer, at least to begin with. It arises from the idea of square tiles that match where they meet.

In any problem about tessellations it must be specified whether the tiles may be rotated or turned over. In this case neither is allowed: to use the jargon, they are oriented and one-sided tiles. The simplest pattern to run across two tiles is a straight line in the middle of their common side: the perpendicular bisector, to use that beloved phrase from school-book geometry. A tile may have such a line or not on each of its four sides. All 16 possible tiles of this kind are shown in Figure 9.

The first puzzle is simply to make an arrangement of all the tiles such that: — there is a match wherever two tiles meet, either two lines or two blanks; — no outside edge of the arrangement has an unmatched line — they are all blank edges.

One such arrangement is shown in Figure 10. Tile 0, with no lines, can be placed anywhere next to an outside edge. Since this is always trivially easy, this tile can be ignored. Next month I shall give some more examples with specific properties, and write about a program to enumerate all possible arrangements.

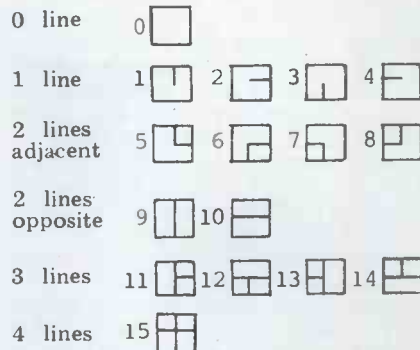

Fig 9 All 16 possible tiles.

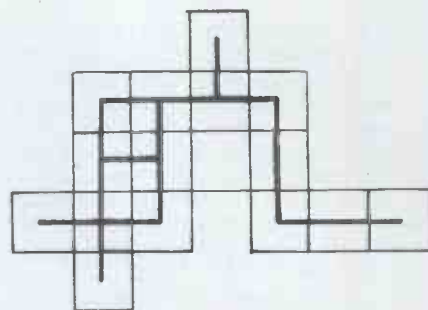

Fig 10 One configuration of all the tiles.

# PIG IN A POKE GOING CHEAP!

Look at it this way: No-one in their right mind would go out and spend £5000 on a motor car without first satisfying himself of its reliability, and overall value for money.

Likewise with hi-fi.

Whether you're planning to invest several thousand pounds, or you simply need a cheap set of headphones, some products are bound to be superior to others, and mistakes can be expensive. The *Hi-Fi Choice* range is specifically designed to eliminate this element of chance.

We can't make your mind up for you. But we can provide the type of information that will help you decide for yourself. Alternatively, you could always buy a pig in a poke...

The Choice is yours.

## HI-FI CHOICE

Simply a better way of buying hi-fi.

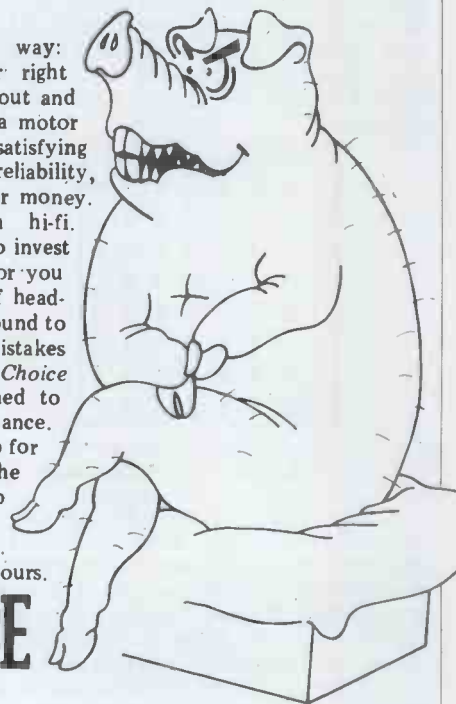

Please send me the following copies of *Hi-Fi Choice*. Add 40p p&p for each issue. (Overseas postage 60p)  
 \_\_\_copies of Loudspeakers @ £2.00! \_\_\_copies of Turntables and Tone Arms @ £2.00  
 \_\_\_copies of Systems @ £2.00 \_\_\_copies of Cartridges & Headphones @ £2.00  
 \_\_\_copies of Cassette Decks & Tapes @ £2.00 \_\_\_copies of Receivers Tuners & Amplifiers @ £2.00  
 \_\_\_Hi-Fi Choice Binders (holds a complete set) @ £1.95 (incl p&p)

Name \_\_\_\_\_ Address \_\_\_\_\_

PCW4

I enclose a cheque/P.O. for £\_\_\_\_\_ payable to SportsScene Publishers Ltd. Allow 3 weeks for delivery. Mail coupon to *Hi-Fi Choice Offer*, 14 Rathbone Place, London W1P 1DE. If you do not wish to clip this coupon please send your order, clearly printed, together with your remittance to the above address.



# DISTRIBUTORS WANTED



The "IMAGINATION MACHINE" is a new breed of personal computer from APF. If you've been following the microcomputer revolution in America, you'll have heard of us already. You'll know that we're big, and we mean business. Now that we've got our slice of the US market, we want a share of Europe – simple as that.

So if you're ready to accept that challenge, then contact us now or come and see us at the European Consumer Electronics Show, 10-13 May (Booth #B258). We're ready to talk . . . . . big!

**APF** (Far East) Ltd. 1/F Luen Tai Industrial Bldg., 72-76 Kwai Cheong Rd., Kwai Chung N.T.  
Hong Kong. Tel: (12) 241124 Tlx: 54755 POSIT HX Cable: POSITRON

**Comart Approved  
Dealers**

**Belfast**

O & M Systems  
95 Dublin Road  
Tel: 0232 49440

**Birmingham**

Byteshop Computerland Ltd  
94/96 Hurst St, B5 4TD  
Tel: 021 622 7149

**Cambridge**

Cambridge Computer Stores  
1 Emmanuel St, CB1 1NE  
Tel: 0223 68155

**Cornwall**

Benchmark Computer  
Systems Ltd  
Tremena Manor  
Tremena Road  
St Austell, PL25 5GG  
Tel: 0726 610000

**Dublin**

Lendac Data Systems Ltd  
8 Dawson St  
Tel: 0001 372052

**Glasgow**

Byteshop Computerland Ltd  
Magnet House  
61 Waterloo St, G2 7BP  
Tel: 041 221 7409

**Leeds**

Holdene Ltd  
Manchester Unity House  
11/12 Rampart Road  
Woodhouse St  
Tel: 0532 459459

**London**

Byteshop Computerland Ltd  
324 Euston Road  
London W1  
Tel: 01-387 0505

**Digitus**

9 Macklin Street  
Covent Garden WC2  
Tel: 01-405 6761

**Jarrogate**

67 Tulsemere Road,  
West Norwood,  
London SE17  
Tel: 01-670 3674

**Manchester**

Byteshop Computerland Ltd  
11 Gateway House  
Piccadilly Station Approach  
Tel: 061 236 4737

**NSC Computers**

29 Hanging Ditch  
Tel: 061 832 2269

**Newbury**

Newbear Computing Store  
40 Bartholomew St  
Tel: 0635 30505

**Nottingham**

Byteshop Computerland Ltd  
92A Upper Parliament St,  
NG1 6LF  
Tel: 0602 40576

**Sheffield**

Hallam Computer Systems  
451 Eccleshall Road, S11 9PN  
Tel: 0742 663125

**Southampton**

Xitan Systems  
23 Cumberland Place,  
SO1 2BB  
Tel: 0703 38740

**Sudbury**

Eurotec Consultants  
Holbrook Hall  
Little Waidingford  
Tel: 0206 262319

**Warwicks**

Business & Leisure  
Microcomputers  
16 The Square  
Kenilworth  
Tel: 0926 512127

**Watford**

Lux Computer Services  
108 The Parade  
High Street  
Watford WD11 2AW  
Tel: 0923 29513

Comart Microcomputer dealers  
are located strategically  
throughout the country to give  
support, guidance and  
assistance. In the event of  
difficulty contact Comart direct.

 **Cromemco**



# Flexibility + Versatility

## System Flexibility

Cromemco give you the high performance, reliable computer power you need now, with the in-built capability for future expansion and adaption as demands and requirements change.

The choice is wide. Cromemco's S-100 bus construction provides for expandable memory capability and the widest choice and future options in peripheral support.

Now there is the exciting range of Cromemco High Resolution Colour Graphics Systems.

## Applicational Versatility

Cromemco's CDOS Operating System supports proven, well documented Software for Business, Industry, Science, Research and Education; COBOL, RPG II, Macro Assembler, 16K and 32 BASIC, FORTRAN IV, LISP, RATFOR, Word Processing and Data Base, are all included in the range.

Now, there is the new CDOS compatible, Cromix Multi-user Multitasking Operating System which opens up new avenues in application and performance for Cromemco System Users.

The U.K. Leaders in Microcomputer  
Development, Application and Support.

**comart**

St Neots HUNTINGDON Cambs PE19 2AF  
Tel (0480) 215005 Telex: 32514 Comart G.



# CHOOSING A WORD PROCESSOR

*Following the amazing success of our Benchtests we've decided to push our luck further with an additional series concentrating on word processing systems. Peter Rodwell provides some guidelines on choosing a WP system and describes the aims and objectives of the series.*

Word processors are very much a product of the so-called 'micro revolution'. In the bad old days it was totally unthinkable to use an entire computer for text processing — the machines were just too expensive for all but the most 'serious' of uses. Text editing programs have, of course, long been available on big computers but these were really designed for entering the source code of programs for later compilation.

Today, thanks to micros, computers are cheap and plentiful and it makes perfect sense to dedicate one to a specific task, such as text processing. In the last few years dozens of word processing (WP) systems have appeared on the market, most of them comprising a microcomputer system plus a WP program to run on it. At the top end of the market are the dedicated WP systems, microcomputers designed solely for WP and usually marketed by the big office equipment manufacturers.

Once you've made up your mind that you need (or want) a WP system, deciding which one is most suitable for your requirements can be a bewildering experience. With several dozen permutations of packages and systems now available, it's important to get a few things clear in your mind before you start looking. As with any other computer/package purchase, you've got to define your needs — existing and future. But before we get involved with that, let's take a look at what word processors are and what they can — and cannot — do.

## What is word processing?

If you wanted to be pedantic, you could say that word processing at its simplest is somebody writing on a piece of paper. However, we're concerned here with the use of computers to input text, store it and to reproduce it onto paper only when you're completely satisfied that it's properly spelt and nicely formatted.

Because the text is stored in a computer's memory, it is very easy to make changes to it. The facilities for doing this range from the very simple to some quite powerful capabilities. For example, when you're reviewing your masterpiece, you may discover a typing mistake. By positioning the 'cursor' (the mark on the screen which shows you where you are in the text block) and typing in the correct spelling, the mistake is rectified within the computer's memory. If you find you've omitted a word, or you want to delete something, you position the cursor appropriately and, using special commands, either insert or delete as desired.

More sophisticated commands, available in all but the simplest word processors, allow you to move entire blocks

of text around or to insert blocks or delete them. Search and replace commands are also available; these would allow you to, for example, replace every occurrence of the letter 'a' in your text with a '\*', if you were so inclined, with a single command line.

Finally, you can send the text to a printer and perform various formatting operations to give an aesthetically pleasing appearance to the text.

Word processors are very good for certain jobs such as the repetitive typing of standard form letters, producing long, complicated documents which may need extensive revisions before they are ready for typing, or reproducing documents — guarantees, for example — which need a specific item included, such as a serial number, which differs with each copy. On the other hand, they have certain disadvantages: cost and the time taken to learn to use them may make word processors impracticable for very low volume work.

If you produce just a very small volume of unique documents such as one or two short letters a day, then a word processor is not for you. You'd find it cheaper and easier to buy a conventional typewriter as a full word processor system probably wouldn't be cost-effective.

To decide which word processor is best for you — or whether you need one in the first place — you must look carefully at the use to which you propose to put it.

## Types of user

We've identified four potential WP users with differing word processing requirements. Firstly there's the author or journalist, who will be using a word processor to enter large amounts of text, each piece of which will be a unique, one-off document. On the hardware side, this user will need plenty of memory and a large disk capacity to cope with large volumes of text. Keyboard and screen considerations will be vital but the type of printer chosen may not be so important — a script or article which will be typeset doesn't necessarily have to be an immaculate document and most such users will probably be satisfied with a dot matrix printer, especially as these are much faster than daisywheel units.

Software considerations will tend to focus on the editing end of the package — authors want extensive editing capabilities such as moving around blocks of text, inserting whole blocks mid way through text, deleting blocks, substituting strings, etc. The command format should be easy to learn and to use, so as not to interfere with the thinking process and it helps here if as many as possible of the frequently-used commands, such as insertion and deletion, are available as special function

keys. For work on very lengthy documents like that best-selling novel, the speed at which the system can jump backwards and forwards through text, pulling sections off disk and writing back to disk, becomes important; if these operations take too long you might almost as well go back to the typewriter and masses of easily-accessible pages of manuscript because sitting waiting for a system to do its thing becomes quite frustrating if you've a flash of inspiration burning to be inserted somewhere way back at the start of the story.

Formatting is less important to the author. He isn't out to impress a business client as such, so it really isn't necessary for him to have extensive formatting commands at his fingertips. He will want to be able to vary the spacing between lines, as most publishers require double- or triple-spaced manuscripts but the author will want single spacing on his file copy. Automatic page numbering is very useful, as is the ability to centre headings and put a heading at the top of each page (which may have to change as the article/novel progresses). Automatic compilation of an index is extremely useful, although I know of only one microcomputer-based system which does this. In general, though, the author's requirements centre mostly around the editing end of the package and, as long as certain fairly rudimentary formatting features are available, he should be happy.

The next user is the technical/managerial report writer. Again, this user will be inputting large amounts of text and again he will require extensive editing capabilities. It probably doesn't matter too much if the commands are a little on the complicated side as the whole job of report-writing is made infinitely easier when you use a word processor. Special function keys make life easier, of course, but this user would probably be prepared to spend a while learning a comprehensive system if it provided him with powerful facilities.

Unlike the author, the report writer will require very comprehensive formatting facilities. Apart from 'simple' functions such as justification and pagination, he will require features such as indenting and 'outdenting' of paragraphs, page titles and subtitles, centered headings, automatic blank lines for the later insertion of figures and the ability to do fancy things with the margins. Additionally, if he's using a daisywheel printer with proportional spacing, he'll need a formatter which enables him to exploit all its facilities, particularly the insertion of spaces between characters in a word. This gives a much better effect when justifying than simply inserting extra blank spaces between words, as has to be done with a simpler printer. Given a good-quality



daisywheel printer with a carbon ribbon, it is possible to produce camera-ready copy for printing.

Next on our list of users is the manager. According to 'office of the future' theory, managers will soon be doing all their own word processing, leaving secretaries free to do other things. I don't see this happening for quite a while, particularly in Britain, so we'll assume an 'office of the semi-future' situation in which the manager prepares rough drafts of his documents on a word processor and hands them over to the secretary for final formatting and printing. This means, of course, that either the two will have to share a system or that the two systems should be compatible, at least to the extent of being able to read each other's disks.

The manager, then will not require particularly extensive editing facilities other than the usual insertion and deletion features, perhaps with block move and deletion thrown in to make life easier. He wants to be able to type in his rough drafts in much the same way as he might currently dictate 'unformatted' documents to his secretary from rough notes. This allows the secretary to get on with other work instead of tying them both up, as dictation does at present. (I once heard of a civil servant who, unable to dictate off the cuff, used to write out all his letters in longhand before dictating them to his secretary — I hope he's bought himself a word processor.)

The manager's formatting requirements will be even more rudimentary, as the secretary's supposed to take care of all that. At the most he may want to print out draft documents, perhaps for reference while the disk's being processed in the 'outer office'.

If the manager requires only rudimentary facilities by word processing standards, what does he want? Ease of learning is going to be his main priority, as few managers have time to learn how to use a really complex system. User friendliness is essential, too. The manager needs a simple system which he can sit down and use after spending the minimum possible time with his nose in an instruction manual.

Printerwise, the manager should be perfectly content with a dot matrix unit for rough, reference drafts.

The secretary is our fourth user type and is probably the most demanding user of all. She will need a system with extensive editing and formatting commands and the fact that these may require a special training course to master should not be a particular disadvantage — the cost of such a course, in time as well as money — should be amply repaid in terms of the greatly increased efficiency brought about by the word processor.

On the editing side, the secretary will still want extensive facilities. After all, she's got to read through her boss's drafts, correcting spelling and punctuation and inserting commands for the formatter. She'll also want search and replace commands to correct any abbreviations used by the boss. (Search and replace commands are one of the beauties of word processors. In writing this article, for example, it would have been tedious to keep typing 'word processor' or 'word processing'; I therefore used the abbreviations 'wp' and 'wping' and used the replace com-

mand to replace 'wp' with 'word process' throughout before printing the final text.)

The secretary might also require a special kind of text entry facility, the ability to build up files. For example, suppose the marketing department wants to send letters to several hundred prospective clients. A file of names and addresses can be created on disk, each with a code to indicate the products that a particular customer is interested in. A second file can then be created of standard paragraphs, each describing a product corresponding to a particular code. The secretary can then prepare a standard letter and get the word processor to type out an 'individual' letter to each client, pulling the name and address off the file, typing it at the head of the letter and then inserting the correct standard paragraph at the appropriate place within the letter.

The secretary's formatting requirements will range from basic, for one-off letters and memoranda, to comprehensive, for complex managerial, financial and company reports production.

Summarising these, then, we have four users with different requirements:

- Author/journalist: needs powerful editing, simple formatting, ease of use;
- Report writer: needs powerful editing and formatting, would be prepared to spend some time learning;
- Manager: needs simple editing and formatting, ease of learning;
- Secretary: needs powerful, complex editing and formatting, will be prepared to take a training course if necessary.

## Choosing the hardware

Several elements are necessary on the hardware side. First, of course, you need a computer with a full alphanumeric keyboard and screen, so you can type in your text. Then you need some form of mass storage device on which to store the text when you've finished typing it in; while it's possible to use tape for this, disks are far more practical, especially if you're going to use the word processor for lots of text (anything more than single-page letters, in fact). Finally, you need a printer so that your prose can be immortalised on paper.

In choosing the hardware — the computer or word processor system — you'll have to take several things into account. First and often overlooked, are the ergonomics of the keyboard and screen. If you're going to be pounding away at a keyboard, you might as well make sure from the start that it's a keyboard you can live with. The keys should be of standard typewriter pitch and have a good, solid feel to them. Only you can judge whether this latter

attribute suits you so you (or your secretary, or whoever's going to use the machine) should spend a while in the supplier's showroom typing at the machine to get its 'feel'. Keyboard layout is also important — a non-standard layout can be most annoying if you keep hitting, say, the repeat key because it's where you expect to find the shift key. A repeat key is vital, by the way, for moving the cursor around.

The display is also important because you're going to spend a lot of time looking at it. First priority is that it can show at least 24 lines each of 80 characters, although you could get by with a 64 characters by 16 lines format — anything less becomes a real nuisance. The 80 x 24 format is as close as most computers can get to the size of an A4 page, although a few dedicated word processor systems do have full A4 size screens. Some computers come with the screen and keyboard built in while others require a separate terminal, which gives you a greater choice. Other important features of the display are that it is legible, with proper descenders on letters like 'p' and 'q' and that it is steady, with no flickering. The brightness control should be easily accessible and a non-reflective screen surface also helps tremendously in reducing eye fatigue.

The subject of eye strain caused by VDUs is a controversial one, by the way, with experts contradicting each other. From personal experience I can say that peering at a flickering or over-bright display can strain the eyes, especially if the screen is reflecting ambient light as well. As far as I can gather, though, provided you pay close attention to the points I've mentioned above, you shouldn't have any trouble, although it seems there is some evidence to suggest that VDUs do tend to exaggerate any vision defects you may have (and a surprising number of people have minor vision defects without realising it).

As to the computer itself, what you buy isn't too important if you're just going to do word processing. You should go for the largest memory available on the system you choose, 64 kbytes on most micros, as this gives plenty of room for text after the editor and/or formatter have been loaded in. The reason for this is simple: once the memory is full, a good word processing package will automatically save the first part of the text onto disk. If you then want to read or revise what you wrote earlier, the system will have to recall it from disk, while saving the end of the text onto disk, which all takes time. Continued reading and writing from and to disk slows the whole editing process down so the longer you can put off this situation (by having as large a memory



*'It's so infallable it's like having your own Pope!'*



or 'text buffer' as possible in the machine), the happier you'll be.

With disks, there's something of a compromise to be made. Most micros are available with 5¼in minifloppy disks, which are convenient but if you're going to need a lot of disk space for masses of text, you should consider 8in floppies or even hard disks. Be warned about the latter, though: cost apart (a hard disk unit is likely to cost almost as much as the rest of the system put together), hard disks have a back-up problem — should something go wrong with the disk unit, you could well lose everything you've put onto the disk, immensely frustrating if you were just reaching the end of that novel! You'll need to keep back-up copies somehow and this would generally involve using either very large numbers of floppy disks or a system available for some microcomputers which records data onto standard video cassettes using a VCR. On the other hand, it's fair to point out that hard disks are considerably more reliable than floppies. They're also a lot faster in use.

Unfortunately, the disk problem doesn't end there. There are different formats for recording data onto disks and they're mutually incompatible. Very briefly, the 'basic' disk is single-density, single-sided and holds about 80 kbytes of data; a double-sided, single-density disk will hold twice this amount. Double-density disks hold twice the amount of information — sometimes double-sided double-density disks are called 'quad density'. One 'kbyte' is, roughly, a thousand characters; dividing by eight gives a rough idea of how many words this equals and assuming that a single-spaced A4 page holds roughly 450 words, you can work out the disk capacity you need in terms of pages of text, by far the most useful way of thinking. Hard disks, by the way, typically hold 8-10 megabytes, say a million words or well over 2000 A4 pages! But don't worry too much about disk formats; it only becomes important if you have several machines and you want to exchange disks between them, in which case the disk formats must be identical for all your machines. Personally, I would go for single-density, double-sided disks as I'm not at all convinced of the reliability of double-density disks; I'd rather trade off storage capacity in favour of peace of mind as there's nothing as annoying as finishing a long editing session and saving it to disk, only to lose it — I speak from personal experience!

Finally, you'll want a printer, as there's usually little point in saving text on disk and only being able to view it on your screen. Which type you choose will again depend on your application but there are two basic types in common use, dot matrix and formed character. Dot matrix printers form the characters by firing a series of small needles at the paper. They are quite fast and cheap but the result is a rather 'dotty' appearance, fine for rough drafts or manuscripts but not so good for important business correspondence which needs to impress its recipient. For this you'll need a formed character printer, which contains individual type elements like a typewriter, the most popular kind these days being the daisywheel

printer. Adapted golf-ball printers are available but they are painfully slow — typically 15 characters per second — and quite noisy. Daisywheels are quieter and faster — 45 — 60 cps, usually — but cost from around £1000 upwards.

Most printers take fanfold paper which comes in a continuous sheet with holes along both vertical edges to allow the printer mechanism to pull it through and horizontal perforations so that you can easily tear it into individual sheets. It's not the stuff for serious business correspondence, although you can buy it ready-printed to form invoices or whatever; further, like most computer-oriented products, its physical format was devised in the States where they haven't heard of international standards, so that a typical paper size is 9½in wide by 11in long instead of the standard A4 format of 210mm by 297mm. All this is building up to say that if you want to print letters on your own company stationery, you'll probably need a sheet-feeding device to attach to your printer; currently these are shockingly expensive, typically £5-700 on top of the printer price.

## Choosing the software

On the software side, there are two distinct sections to a word processing package. First, there's the input section, usually called the 'editor', which allows you to type in text, alter mistakes and carry out more sophisticated actions such as searching for every occurrence of a particular letter, word or phrase and substituting another. Having prepared your text with the editor, you use another section called the 'formatter' to prepare it for printing. This side of things is concerned with the appearance of the text on paper and usually provides facilities for setting margins, centering headings, numbering pages and justifying text (making the right-hand edge line up, as it does here on this page). The commands to do this are frequently 'embedded' in the text, denoted by special marker characters, during the editing stage.

Generally, the more complex word processing packages come with the editor and formatter as two separate programs. You enter text with the editor, save it on disk and run the formatter to print it out nicely. This can be quite inconvenient if you start printing and realise you haven't achieved quite the format you wanted; you've got to exit the formatter, run the editor, make the necessary changes, exit the editor and save to disk before you can re-run the formatter. The big advantage of the 'split packages' is that they leave more memory free in the computer for text. If you want only simple editing and formatting features, or if you're content with a smaller memory buffer, then the integrated package is usually more convenient.

If you have already been investigating micro-based word processing systems, you will probably have come across CP/M. This is a piece of software called an operating system and, briefly, what it does is to carry out the routine work, such as operating the disks, getting characters from the keyboard, and put them into the computer's

memory and sending text to the screen and printer. CP/M was designed to make things easy for computer programmers and presents a very unfriendly aspect to the novice user; for example, to copy a block of text from one disk to another, you have to type a semi-incomprehensible command such as 'PIP B:WORDS.TXT=A:WORDS.TXT' — this transfers the text file called 'WORDS' from disk A to disk B. CP/M can also be very unhelpful when things go wrong, typing a curt '?' if it doesn't understand the command you've just entered or flashing up unhelpful messages like 'BDOS ERROR ON DISK A: . . .'. The overall effect of CP/M is somewhat intimidating to the newcomer who merely wants to get on with his word processing but you should persevere as some very powerful word processing packages are available for CP/M-based systems.

## Dedicated WP systems

I have already mentioned that, as well as microcomputer-based word processors, you can also buy dedicated systems. On paper these look like a pretty bad buy as the cheapest cost from £4500, enough to buy a big micro with a good quality printer which you could use for other applications such as accounts, stock control and Star Trek. But it would be wrong to dismiss dedicated systems out of hand.

If you're going to do an awful lot of word processing and you don't — and won't — want to do anything else on the system, you should look carefully at dedicated systems as they have several big advantages.

Firstly, as they're designed specifically for word processing, dedicated systems come with all sorts of useful things like special function keys and, in some cases, full A4-sized screens. Then there's the question of back-up or maintenance; most dedicated systems are marketed by large office equipment manufacturers who already have extensive maintenance procedures, something noticeably rare on the microcomputer scene. Finally, the big manufacturers offer almost guaranteed compatibility with products further up the range or in the pipeline; this means that you shouldn't have any problems if you want to move to a bigger system, or turn your existing machine into a multi-user system or even just add some new bits announced a year or more after you bought your system.

## Comparing WP systems

Having decided that you need a word processor and having decided which type will fit your current and future requirements, your next problem will be to sort out which of the (possibly) several systems is the best one for you. This will usually involve visiting numerous showrooms and being subjected to slick sales patter and dazzlingly confusing demonstrations. Listen to the sales patter by all means but be sure to ask all the questions which remain unanswered — Lyn Antill, in the January episode of her 'Secrets of Systems Analysis' series, gave some useful tips



# INNOVATIVE

# TRS-80 SOFTWARE

## FROM THE PROFESSIONALS

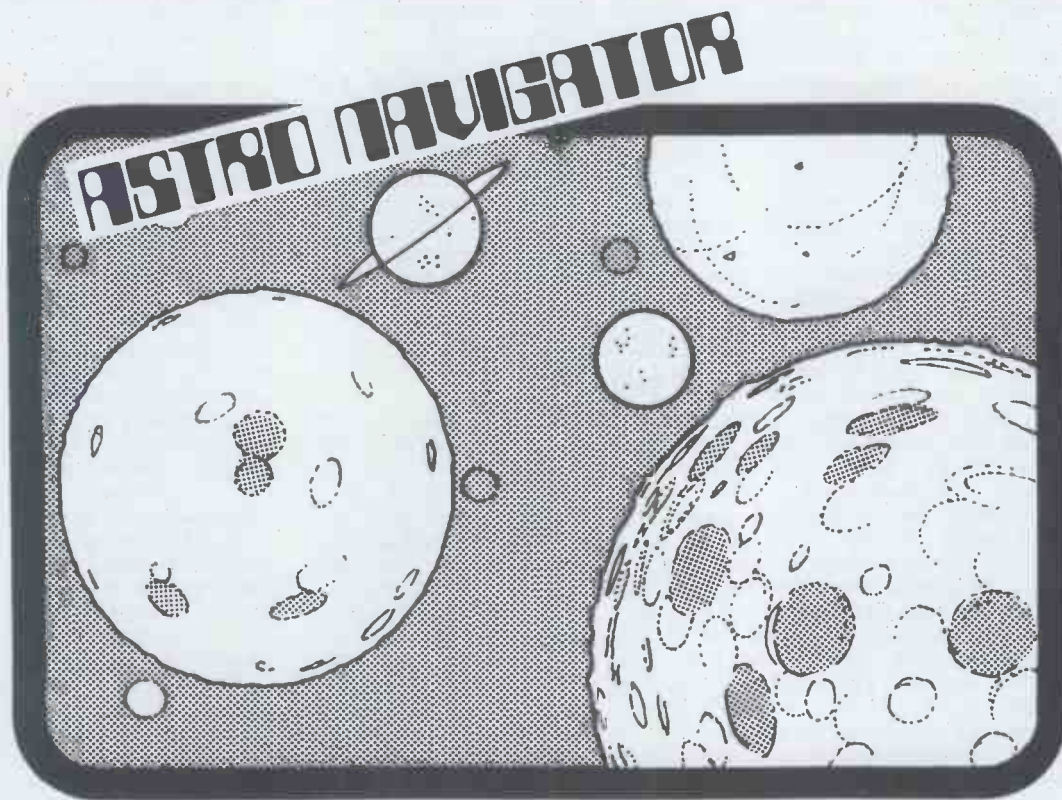

Coming as it does shortly after the recent successful Voyager probe to Saturn, this program is particularly well timed. It programs the TRS-80 or Video Genie to produce a complete and highly accurate simulation of the solar system. All of the orbits of the various planets are correctly calculated, as are their orbital speeds and gravitational pulls. Each time the game is played, the members of the solar system are differently placed, but still in correct relationship to each other and to the Sun. Hence every game is different and presents different problems to the player. There are only one or two small deviations from actual fact. One is that each planet has a mythical shuttle orbiting it from which, if you can get into orbit with the planet, you can draw fuel and so continue your journey. The purpose of the game is to blast off from the planet of your choice and travel throughout the solar system. There is no other purpose. There are no prizes, no free goes, nothing else. If you succeed in making a landing on another planet then your reward is the thrill of having been able to do so. And for some inexplicable reason, it really is a thrill. Probably this is because the game is unbelievably difficult as all of the physical laws and relationships are obeyed. Although the player of this game has the help of a computer, it will only tell him the statistics of the journey. It is for the player to decide how much fuel to take on, what thrust to use, whether to try and blast off slowly so that fuel can be taken on at the orbital station (this, incidentally, is mandatory where the gravity is very high, such as Jupiter, as it is not possible to take off with enough fuel to attain escape speed) or whether to try and get away from the home planet as quickly as possible. The astronaut has three maps to which he may refer. The first is of the outer planets, the second of the inner planets and the third a close up view, if he is in the proximity of any planet. Superimposed on these maps is the present position of the spaceship together with the last few positions which have been occupied. It takes a large degree of experience to play the game in order to make any headway with it at all. One has to get used to a whole new mode of travel where the attitude of the craft may bear no relation whatever to the direction in which it is travelling. At all times gravitational pull, the laws of momentum and many other considerations are acting on the craft's course. Furthermore, journeys are judged in lengths of months and years. For instance, if you take off from Earth and have a look at the map to see where Jupiter is, then point your craft in that direction, and blast, there is not much chance that you will get anywhere near Jupiter because by the time you get there it will be long gone! Just as the Voyager used Saturn to pull itself, like a sling shot, onto a different path, so the player of Astro Navigator can use the gravitational pull of planets to change course without having to use valuable fuel. Most of the time, of course, the craft is not under the control of its motors at all, but is coasting through space, affected, as we have said, by many different laws of the universe as it goes. Frankly, we are not sure why the game is so appealing, graphics are used but are really only subsidiary to the play. Probably it is simply the fact that one is entirely on one's own out there and will fail or succeed entirely by reason of one's own skills. For what it is worth, it is one of the very few programs in which we got so engrossed when testing it, that the session has gone on ever since! Astro Navigator is written in Level II Basic but is also compatible with Disk Basic.

Tape for 16K TRS-80 or Video Genie .....£15.70 including VAT and P & P.

Send large SAE (58p) for our current Catalogue of TRS-80 software. Add £2.15 for a binder.



**A.J.HARDING (MOLIMERX)**  
**MOLIMERX LTD.**

28 COLLINGTON AVENUE, BEXHILL-ON-SEA, EAST SUSSEX.

TEL: [0424] 220391

TELEX 86736 SOTEX G





# INNOVATIVE

# TRS-80 SOFTWARE

## FROM THE PROFESSIONALS

### INSTANT SORT/SEARCH DATABASE

Everything in electronics takes a finite time, consequently nothing can be instantaneous. However a database that will search 500 records and sort the names into alphabetical order in 1½ seconds, that will go on to do the same thing with 1,000 names in only 2½ seconds, is fast. If you add that ability to search 500 or 1,000 records for a specific range of names or ages or sexes or whatever, in such a small amount of time that it is not worth timing it, then the program deserves to be described as instantaneous. Especially as these times are attained on a standard Level II TRS-80.

These results are achieved, obviously, by some very clever machine language coding. This however is not enough. After all GSF from Racet will sort 1,000 arrays in about 11 seconds and that is indeed a clever program. No, in order to achieve the results required from this program it is necessary to change one's entire overview of database.

There are many databases available for the TRS-80 now. All of them have been designed to store as much data as possible, as easily as possible. Not as an afterthought, but nor as a prime design requirement, they have also incorporated as fast a sort as was practicable. This program was designed from the outset to achieve unbelievably fast sort and search times. Indeed we do not recommend this database for application in which fast searching or sorting is not a prime requirement. And what are the applications? It's a hackneyed phrase to say that they are limited only by the user's imagination, but that's about it. Let's take an example. Suppose you are running a marriage or data bureau. An ordinary database will file all the names and addresses away together with the necessary information as to sex, age and so on and with some you would be able to sort the list, so that only people with similar characteristics were eventually obtained. With this database you could, for instance, file the name, sex, age, category of hobby, category of chief interest, vital statistics and other data so that at the touch of a button you could instantaneously display on the screen all women of a certain age with certain vital statistics, living in a certain area. You could also display men with similar (excluding the vital statistics!) data that fall into similar categories. And all of this almost instantaneously. Not everybody runs a marriage bureau, but other applications are not hard to think of. Estate agents can file details of property away so that they can instantaneously obtain data on houses in a certain area or of a certain size. Doctors can reach information as to patients with similar diseases, ages or whatever immediately. In the home, a record library can be stored and every record by a certain composer written in a certain year can be accessed without delay. The list of applications is endless. For any use where it is important to extract information within a certain range or it is important to sort information, this database will find a use.

The prime commands and features of this program are as follows:

- | Datafile creation |                        | Sort/Search |                                      |
|-------------------|------------------------|-------------|--------------------------------------|
| 1.                | Create a file.         | 1.          | Sort up or down.                     |
| 2.                | Add a record.          | 2.          | Page forward or backward.            |
| 3.                | Delete a record.       | 3.          | Select a range for search.           |
| 4.                | Display a record.      | 4.          | Select or exclude a category.        |
| 5.                | Tape a file.           | 5.          | Select or exclude on initial letter. |
| 6.                | Amend a record.        | 6.          | Resort records in a sort.            |
| 7.                | Display the file data. | 7.          | New sort all records.                |
| 8.                | Load a tape.           | 8.          | Extended sort.                       |
|                   |                        | 9.          | Arithmetic.                          |
|                   |                        | 10.         | Display file data.                   |
|                   |                        | 11.         | Load a tape.                         |
|                   |                        | 12.         | Printout sorted data.                |

The data is displayed in columnar form and the data may be alphabetical, alphanumeric, integer or decimal. The number of columns is from 2 to 10 and the records may contain a maximum 44 - 60 characters depending upon the number of columns used. Columns may be of any width within the screen capacity but integer or decimal columns more than five and six characters wide respectively will not have the option of searching within a range.

The program consists of two parts. The first is used for entering the data and the second for the sort or search. The second part overlays the first when it is loaded so only 4K of memory is used by the entire program. The remainder of your memory space is available for data. The amount of data that can be contained will of course depend upon the amount of memory available, but as a rough guide a 16K user will be able to manipulate at one time 250 records of 39 characters each or 514 records of 17 characters each. As a further rough guide on sorting speed, the time to sort 1,000 records on fields of random strings of random length, or of random number between 1 and 99,999, averages under 2½ seconds.

Numeric columns either integer or decimal may be arithmetically manipulated almost instantaneously. A total may be cast or an average taken for any numeric column up to five digits. This is so fast that when adding 1,000 numbers totalling over 50 million, only a slight hesitation can be noticed before the total is given.

In summary therefore this program is ideal for any application concerning the manipulation of information whether it be business, personal or hobby which can be comfortably displayed as one record per line upon the screen and in respect of which it is required that super fast searches or sorts be carried out. The program is supplied on cassette. At this time it is not compatible with disk systems. A disk version is in the course of preparation. The cassette includes a set of data randomly generated which can be fed into part 2 of the program to demonstrate the fantastically fast sort and search features.

Tape for 16K TRS-80 or video genre .....£19.50

All prices exclusive of VAT which should be added at the prevailing rate. Postage and packing including VAT 75p regardless of the number of programs ordered.

Send large SAE (44p) for our current Catalogue of TRS-80 software. Add £1.85 for a binder.



**A.J.HARDING (MOLIMERX)**  
**MOLIMERX LTD.**

28 COLLINGTON AVENUE, BEXHILL-ON-SEA, E. SUSSEX.  
TEL: (0424) 220391

TELEX 86736 SOTEX G



for handling salespersons.

Unfortunately, no salesman is likely to let you test the system in the best possible way — by letting you take it away for a fortnight to try out. Disks are all too easy to copy and anyone with a Xerox machine can acquire his own documentation, so the salesman won't let it out of his sight until you've parted with your money. At best you'll be left alone for an hour or so to try out the system but even this may not be possible if other clients are waiting. Trudging from shop to shop is also very time-consuming and there's no guarantee that you'll find the system you really want at the end of the day. Which is why we have decided to Benchmark word processing packages.

Primarily, we will be testing the word processing packages rather than the hardware on which they run. However, hardware is important and as the series progresses we will be reporting on as wide a variety of hardware configurations as possible. Some of the hardware will have already been subjected to our regular Benchtests but in this series we will concentrate exclusively on the hardware's suitability for word processing.

A series of Benchmark tests has been devised to test the time taken to perform certain operations — the article following this one explains these tests in detail. The aim of the word processor Benchtests is to provide an indication of each system's suitability from the view-

point of the four users outlined earlier; each Benchtest will therefore end with a summary indicating which user or users (if any!) will find the system most useful.

Finally, you may have noticed that I haven't mentioned a fifth type of user, the private user or hobbyist. If you're in this group, you haven't been forgotten but you're in a much more fortunate position than the 'Gang of Four' described earlier. While they have to worry about things like cost-effectiveness, staff training time and maintenance contracts, your only criterion is whether or not you can afford a particular package.

## WP BENCHMARKS

A standard piece of text has been chosen for use in all WP Benchmark tests. It is, in fact, the first 3000 words of the Microwriter review printed in December's PCW and contains, 17,772 characters. The number of occurrences of the string 'Microwriter' has been increased to a nice, round 50 for reasons which will become apparent.

Once the text has been typed in and saved on disk, the following series of tests is performed and timings taken:

1. Load the text from disk into memory for editing; this time includes calling the editor program — if it is not possible to load the editor and text with a single command line, separate timings are taken for calling the editor and loading the text and are added together to give a total;
2. Save the text to disk and exit the editor;
3. With the text re-loaded, jump from the start of the text to the end;
4. Jump from the end to the start;
5. Substitute all 50 occurrences of 'Microwriter' with the five-letter string 'QQQQQ'. In doing this, the system has to differentiate between the string to be substituted, 'Microwriter', and the strings 'Microwrite', 'Microwrites' and 'Microwriting', each of which occurs once in the text. At each substitution, the system has to close up the entire text block by six characters;
6. Re-substitute 'Microwriter' for all 50 occurrences of 'QQQQQ'. This time the system has to open up the text as a result of each substitution.

Running these tests once provides a set of base times, which will be printed at the end of each Benchtest. However, a 3000-word text isn't particularly long and it is useful to see how the system performs when the text buffer is, firstly, almost full and, secondly, over-full. In this latter case, a good system will automatically save the first part of the text

onto disk and this is where it will begin to slow down, usually quite dramatically.

To provide an at-a-glance idea of how performance drops off as the text buffer fills and overflows, we need to provide a nominal performance degradation factor; in fact we'll provide two factors, one for a nearly-full buffer and one for a buffer which overflows onto disk. These factors are arrived at in the following way.

Firstly, the standard text is copied within the buffer by however many times it takes to fill the buffer with complete copies. Thus, with a text buffer of 40,000 characters, we can make only one complete copy. The Benchmarks are then repeated as before, except, of course, that we have 100 substitutions to make if we have the original text plus one copy in memory. All this gives us a second set of timings. We can now calculate a degradation factor using the formula  $f=t/(n*b)$  where  $t$  is the second timing,  $n$  is the number of copies of the 3000-word text in memory and  $b$  is the base time for the operation. Figure 1 gives some dummy timings to show how this will appear. As you can see, increasing the amount of text actually speeds up the time taken per 3000 words, particularly in the disk read/write tests.

We now have to repeat the process by making a further copy of the original 3000-word text; on a good word processor, the overflow will stimulate the automatic saving on disk of enough of the start of the text to accommodate the new text. As before, we re-run the Benchmarks, work out the percentage increases and arrive at a second degradation factor. Ironically, the first word processor we'll be testing doesn't automatically save text on disk when the buffer overflows so we won't be able to carry out this final series of tests.

Timings for Benchmarks 3 and 4 may not always be very accurate as some systems manage these forward and backward jumps almost instantaneously. Unlike our Basic and Pascal Benchmarks, we cannot get a word processor to carry out these operations  $n$  times automatically and then arrive at the once-only time by dividing the resulting total by  $n$ . In these cases, the base time for the two tests will depend to some — hopefully not too significant — extent on the Benchtester's reaction times.

The Benchmarks are primarily designed to show how the easy or difficult the system will be to live with when you're editing large amounts of text. If your application involves shorter texts, they will be of less interest, although Benchmarks 1 and 2 will be important as, if you're editing many short documents, the time taken to begin and end the editing of each document will be important — you don't want to spend more time waiting for the system to do its thing than you spend actually editing.

None of these Benchmarks tests the package in isolation from the hardware; the time taken to perform each operation will depend partly on the efficiency of the programmer's efforts but mostly on the hardware configuration on which the package was tested. In particular, Benchmarks 1 and 2 say more about the disk system being used than the package itself. But, as many packages are to be tested on hardware for which they have been specifically designed or adapted, this should not invalidate the timings — many users will be buying identical or very similar hardware to the configuration tested.

In addition to these tests, we will also examine the printer supplied with each system and, as far as possible, we'll be using a variety of different printers throughout the series. We shall be describing their facilities, ease of use and how pleasant or otherwise they are to work with and commenting on their suitability for different types of work. We shall also test how long the printer takes to print out the standard text of 3000 words. To keep this timing comparable throughout the WP Benchtests, the printer will be run at the maximum speed possible with the computer being used and the text will be printed

Benchmark	Base time	Buffer full	Overflow	Degradation	
				DF2	DF2
1	27.3	33.8	35.1	0.6	0.4
2	29.2	32.1	34.8	0.5	0.4
3	1.7	2.1	11.7	0.6	2.3
4	1.5	1.9	14.2	0.6	3.2
5	6.1	11.0	21.7	0.9	1.2
6	7.2	13.6	22.5	0.9	1.0

DF1: n=2

DF2: n=3

Fig 1 A set of dummy WP Benchmark timings showing degradation factors.



# THE GREAT COVER-UP!

Not since the days of Watergate has there been a public scandal of such far-reaching implications.

It has recently come to the attention of the PCW Secret Police that certain regular readers have been storing their valuable back issues 'au naturelle'.

We consider this practise to be singularly lacking in dignity, and would therefore appeal to you in the name of common decency to please ensure that your

magazines are properly dressed at all times.

This may be achieved by the simple expedient of purchasing one or more of our sturdy yet colourful PCW binders.

So why not join in the great cover-up and preserve your precious PCW's in their original pristine perfection.

Just check the coupon at the foot of the page.

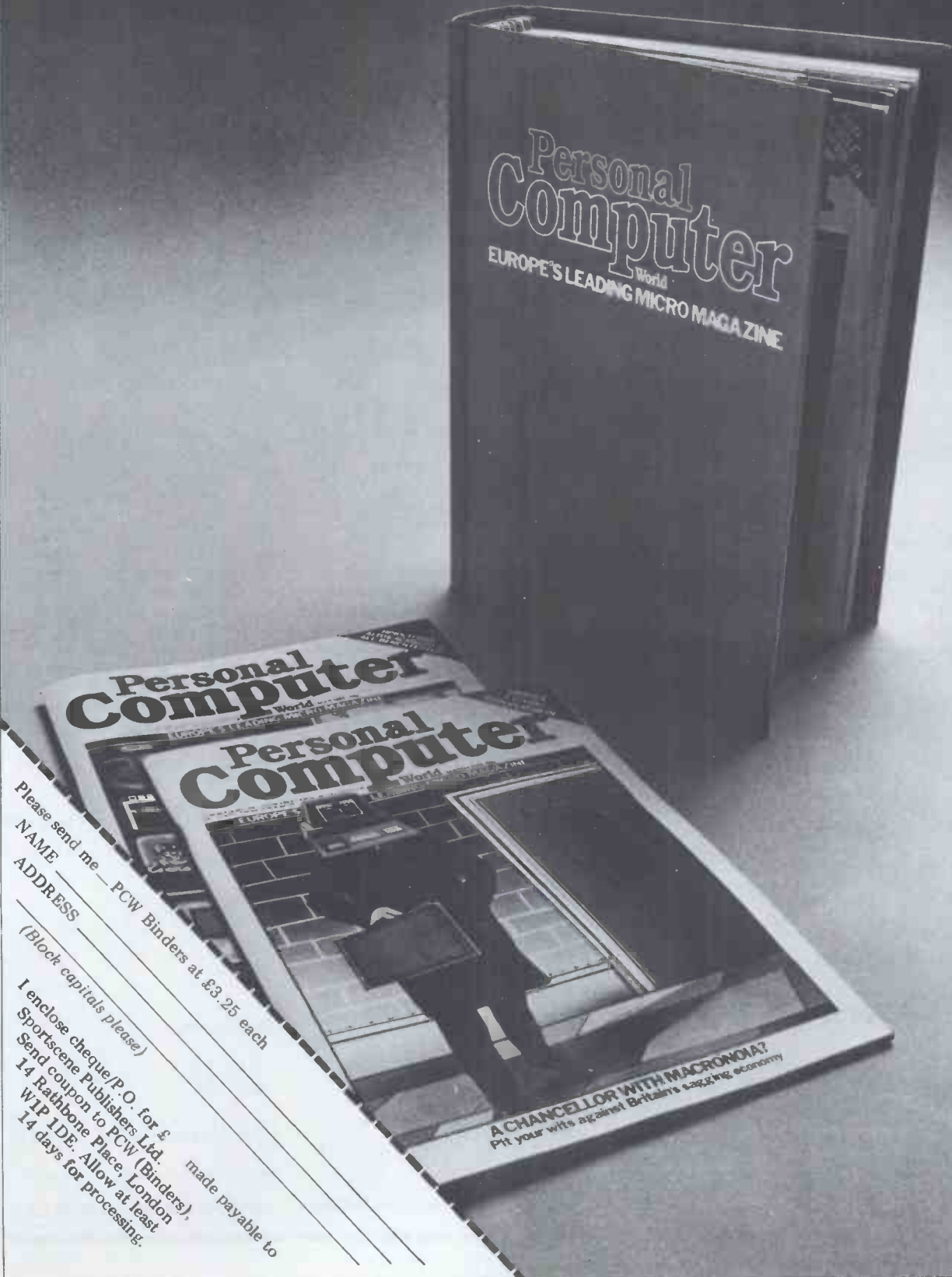

Please send me — PCW Binders at £3.25 each

NAME \_\_\_\_\_  
ADDRESS \_\_\_\_\_

(Block capitals please)

I enclose cheque/P.O. for £ \_\_\_\_\_ made payable to  
Sportscene Publishers Ltd. (Binders),  
14 Rathbone Place, London  
W1P 1DE. Allow at least  
14 days for processing.

# Z-80 Books at Microdigital

## Programming the Z-80 - R. Zaks

Another in the highly successful Sybex Series by Rodney Zaks. This book combines the function of a teaching text, that Sybex do so well, with an extensive reference section. The book is much more than an introduction to the Assembly Language syntax of the Z-80. **9.70**

**Practical Microcomputer Programming with the Z-80 - Weller**  
18 chapters of solid accurate programming information. Debugging techniques, interrupt modes, array and table handling, number base conversation, floating point arithmetic, programmed input/output stackpointer usage. The book includes an editor assembler listing for Z-80 and 8080. If you return the coupon at the back of the book you receive either paper tape or TRS 80 cassette of the object code for the assembler. **19.50**

**Z-80 Assembly Language Programming**  
Instruction set plus examples plus algorithms. An accurate and reliable textbook. **10.45**

**Z-80 Programming for Logic Design - A. Osborne**  
These books describe the implementation of sequential and combinational logic using assembly language. They describe the meeting ground of the programmer and the logic designer and are written for readers in both fields. **6.25**

**Z-80 Microprocessor Programming and Interfacing Volume 1 - Nichols and Rony**  
This book is the first of a two volume series on the Z-80. It covers programming at the assembly and machine language level for the Z-80. Book 2 will cover interfacing. The books are laboratory orientated texts. The strong emphasis is on learning through experiment. This book requires no background in computers. **7.70**

**Z-80 Programming and Interfacing Book 2 - Nichols and Rony**  
Address interfacing digital circuits with the Z-80 CPU, P10 and CTC chip and progresses on from Book 1 (Interfacing assuming the reader is familiar with the topics covered in Book 1). **8.45**

**Instruction Handbook (Z-80)**  
This slim volume constitutes a powerful and comprehensive guide. About seven hundred instruction codes are obtainable from the basic instructions. **3.05**

**Z-80 Microcomputer Design Projects - W. Barden Jnr.**  
A solid introduction to the Z-80 microcomputer and the EZ-80 chip. Simple construction of the EZ-80 microcomputer and several applications. **9.10**

**Z-80 Microcomputer Handbook - W. Barden Jnr.**  
This book provides essential information on Z-80 technology and is organised into three sections: Hardware, software and microcomputers built around the Z-80. **6.90**

Post and Packing free. No VAT on Books. Bona Fide official orders welcome.

I enclose cheque/P.O. for: \_\_\_\_\_

Name \_\_\_\_\_

Address: \_\_\_\_\_

Post Code \_\_\_\_\_

Goods required \_\_\_\_\_



24 Hr Telephone Credit  
Card Orders 051-236 0707



Mail Orders to:  
MICRODIGITAL LIMITED  
FREEPOST (No Stamp required)  
LIVERPOOL L2 2AB



Retail Premises at:  
25 BRUNSWICK STREET  
LIVERPOOL L2 0PJ  
Tel: 051-227 2535/6/7

# MICRODIGITAL

## FREE BASIC TRAINING COURSE WITH EVERY SHARP MZ-80K



- Includes
- \* 20K RAM
  - \* One day BASIC course
  - \* BASIC Cassette & Manual
  - \* 12 months guarantee
  - \* Many options & programmes available

	NETT	VAT	TOTAL
MZ-80 Computer 48K	£478.00	£71.70	£549.70
MZ-80K 28K UPGRADE	£87.00	£13.03	£100.05
MZ-80 I/O Interface Unit	£62.00	£6.30	£68.30
MZ-80 FD Dual Disk Drive	£693.00	£103.95	£796.95
MZ-80 FDK Additional MZ-80FD	£616.00	£92.40	£708.40
MZ-80 RS232 Interface	£110.00	£16.50	£126.50
MZ-80 P3 Matrix Printer	£430.00	£64.50	£494.50
CP/M Operating System	£196.00	£29.40	£225.40
PC-1211 Pocket Computer	£91.00	£13.65	£104.65
CE-121 Cassette Interface	£12.60	£1.89	£14.49
RP1600 Daisywheel Printer	£1450.00	£217.50	£1667.50
Ledger and stock control packages free with computer systems			

Please send me .....

Name .....

Address .....

I enclose cheque/P.O. for £..... (£10 P & P)

**Butel-Comco Limited**  
Garrick Industrial Centre  
Garrick Road Hendon  
London England NW9 6AQ  
Telephone 01-202 0262  
Telex 47523

Barclaycard

Access

Signed \_\_\_\_\_

Technology for business

\*INSTANT H.P. CREDIT AVAILABLE\*

PCW



# LAS VEGAS REVISITED



The Show was the largest ever, covering several hundred acres of former desert now occupied by the convention centre, Hilton and Jockey Club. Last year a CES delegate turned up at the Jockey Club clad in racing silks; he was thrown out for being improperly dressed, a hitherto unknown punishment in Vegas, which must surely qualify as the home of the worst-dressed holidaymakers in the world.

An enthusiast in the press office was using Texas Instruments' new talking calculator to estimate how long it would take to traverse every aisle of the exhibition area. With a 'median body-crush of 0.15' the result was computed at 4½ hours without stopping. With something fascinating to be seen on virtually every stand, my tour was more likely to last the full four days.

First stop was Toshiba which in a stunning tour de force, was showing no fewer than three pocket-size televisions, using Liquid Crystal Displays in place of cathode ray tubes. The units measure 6.8in long by 3.2in wide and a mere 0.7in thin, with an overall weight of 10.5oz. The screen size is 1.2in by 1.6in or approximately 2in diagonally. One feature which will intrigue microcomputer designers was the ability to zoom in for a two times magnification of

*Julian Allason reports from this year's Consumer Electronics Show in Las Vegas.*

part of the image. In addition to the basic TV, one model had a built-in digital clock, while the other includes a radio. The question dealers were asking was, 'How long before these high resolution LCDs show up on miniature microcomputers?' How long, indeed.

Toshiba's deadly rival Hitachi was having fun with its new microwave oven that comes equipped with voice recognition ready to obey such spoken commands as, 'Two quadruple cheeseburgers, medium rare.'

Meanwhile a new gizmo from Mattel Electronics was proving indispensable to those of a nervous disposition — the Invisible Alien Neutralizer which enables one to 'detect presence and strength of unseen enemy aliens'. The man on the stand assured me that the Show is stiff with aliens; indeed he had already zapped several including one cunningly disguised as a female demonstration-person clad only in T-shirt and roller skates; this was one alien I would have enjoyed meeting.

The star of the Show was undoubtedly Commodore's VIC computer, a stunning new portable micro into which has been crammed most of the features of the PET, plus sound and colour capability. Yet it's no bigger than most

keyboard units and will retail for just \$299. Any colour TV can be used as a display. The full PET graphics character set is implemented, while hi-resolution graphics are available as a plug-in extra.

Not surprisingly, members of the trade were falling over themselves to play with it and Commodore claimed to have taken over 4000 orders on the first day of the show. Not everyone was quite so happy, however, and competitive manufacturers wasted no time in announcing price cuts. Texas Instruments knocked a further \$300 off the TI99/4, APF slashed \$200 off its Imagination Machine, bringing it down to \$399, while Atari reduced the price of its 8k 400 system to \$499. At the heart of the VIC is a 2 MHz 6502A microprocessor, so the machine runs a little faster than the PET. The name VIC is derived from the Video Interface chip, a unique device with ROM, RAM and video-control circuitry, all present on the same chip. It is also mask-programmable, so Commodore should have no difficulty in turning out the UK version compatible with our PAL television system.

The VIC itself comprises a self-contained keyboard unit containing the processor, 5k of RAM and 20k of ROM

operating system, plus power supply, modulator and various input/output ports. Standard PET Basic is resident with a number of additional commands to handle colour and sound. The keyboard is laid out like a typewriter, with the addition of return, and various cursor direction, editing and control keys. Additionally, it has four undefined function keys which (when shifted) offer eight programmable functions that can be assigned under program control.

The one disappointment is the 22 characters by 23 lines screen format. Actually it is even worse than this, as the border accounts for two of these print positions, horizontally and vertically. However, a 40-column version is promised at the end of the year.

PET users running programs written for 40 or 80 column screens will experience some interesting effects as the longer lines will wrap around on VIC's display. Eight colours are available for screen and border. This can in effect be increased to 16 by changing the background colour of each character.

Sound capability is at present in the form of three tone generators, each of three octaves, and one sound generator capable of producing rifle shots, space zaps and sundry other useful effects. All operate through the tele-



vision loudspeaker.

Given the desirable features of PET Basic (superb editing, extensive graphics), the VIC-20 is nonetheless a fairly basic machine. Of the 5 kbytes of RAM, only 3.6k are normally available to the user. Fortunately its expansion capabilities are considerable and the price minimal.



The new Commodore VIC home computer. This one was on-line to The Source.

Additional RAM cartridges can easily be plugged in and a number of ROM cartridges are also available. The latter include 'Super Expander', comprising 3k extra RAM (converting the VIC to a nominal 8k), 176 x 176 pixel High Resolution Graphics and plotting commands, pre-assigned function keys and the ability to scroll horizontally. There is also a 'Programming Aid' ROM cartridge that offers Commodore's version of the Programmers Toolkit, a machine-language monitor and some user-assigned and pre-assigned function keys. Standard PET cassette decks are accepted by the cassette port, although Commodore has promised a special VIC model at lower cost. The company is very communications-conscious so it has a user port with RS232C capability for connecting a modem. One VIC was online to the Source, which must make it the cheapest terminal yet for micro networking.

There is also something called the Commodore Serial Bus, a unique animal into which the new 170k single minifloppy may be plugged. No price on that yet, but it could be somewhere around the £295 mark, maybe even less.

A low-cost serial printer is promised, the advantage being that the RS232C port would remain free for communications. VIC users would thus end up buying their hard copy device from Commodore, too...

At the side is a small game port for joystick, game paddle or light pen. Commodore says that a game controller capable of accepting multiple peripherals is

planned.

Finally we come to the expansion port into which ROM cartridges or the 3k RAM cartridge may be plugged directly. To attach more than one expansion device, a 'Master Control Board' is needed. This is a four slot multiplexer that accepts combinations of 3k, 8k and 16k

RAM cartridges, ROM firmware and IEEE devices. The maximum additional ROM/RAM addressable seems to be 27k.

Lurking on the stand was Ramon Zamora, one of the originators of the Computer Town USA! project. Ramon, it emerges, has been commissioned by Commodore to write the VIC documentation, some of which will take the form of a manual, the rest as software. Compatibility with PET is almost complete as far as Basic is concerned, he says. The only problems relate to the differing screen formats and PEEK/POKE locations.

However, help is at hand since the VIC is the first Commodore machine to incorporate the Kernel, a high level utility that promises to make all future Commodore computers compatible.

The consensus was that the Show was excellent; that Apple, not exhibiting this year, may have difficulty selling the Apple III, which the trade considers to be overpriced; that Commodore will have a tough time getting Federal Communications Commission approval for the VIC; that the Video Disk had finally arrived; and that the most significant new personal computer was Mattel's Children's Discovery System.

Mattel's Children's Discovery System is the first serious attempt to bridge the gap between computers and video games, Atari and APF notwithstanding. It is tiny, even smaller than the VIC, about 11in long by 6 high, and that includes a largish Liquid Crystal Display. In normal mode, resolution is about 50 x 15, which allows only two short lines of text on screen at a time.

At power-on (batteries, incidentally) three modes can be selected from the flat film keyboard: Type, Art and Music. A choice of plug-in ROM cartridges extends this. These modules, which will each sell for less than \$20, consist of the ROM cartridge, keyboard overlay and an illustrated manual. Supplied with the machine is one entitled 'Discoveries in Math'. Since the system is intended for the six-to-11 age range, the quizzes are pitched at fairly basic level. I suspect that the Children's Discovery System will actually end up in the hands of an even younger age group. Other cartridges announced by Mattel will cover Words, Science, History and Arcade Games.

All in all, a fascinating system that, with a price tag of around \$125, could prove highly successful. The only mystery is why the designers deliberately chose to limit the programmability of the machine.

Mattel already manufactures a video game system called Intellivision. Connoisseurs rate its colour graphics capabilities more highly even than Atari's. A year ago it announced a keyboard mod-

ule that would upgrade it into a fully-fledged computer. None of those keyboard units have yet been delivered, although several are on display. 'When can we expect them?' I asked. 'Soon,' an embarrassed-looking salesman said and fled.

From last year's Show I reported the arrival of the first 'talking' consumer products. This time synthetic voices were babbling away everywhere; clearly the pace of development is hotting up. Votrax was demonstrating a range of sophisticated synthesisers including one on a self-contained CMOS chip. This synthesises continuous speech of unlimited vocabulary by combining phonemes (the building blocks of speech) into an appropriate sequence from data fed to it at 70 bits per second. The SC-01 chip includes its own audio pre-amplifier.

It is doubtful if anyone has spent more on this type of research than Texas Instruments. When its 'Speak & Spell' game first came out many were bought up and cannibalised for the chips. The good news is that TI has now developed an even better system that will be made available for its TI99/4 pers-



Mattel's Children's Discovery System features an integral LCD display.



Lurking quietly in a corner... the Casio FX-9000P.



onal computer. Although it is still some way from being a finished product, I did manage to try out the 'Text-to-Speech' system. It does exactly that; convert a stream of incoming text into the best synthetic speech I have yet heard.

TI has achieved this by adopting a somewhat novel approach, using allophones rather than phonemes. The Text-to-Speech peripheral comprises two devices: the Alphon, which contains a library of 120 allophones, and the synthesiser itself. Incoming words are scanned letter-by-letter for phonetic combinations the system recognises. By following a set of rules, special codes are inserted that instruct the synthesiser to vary the pitch of the various sounds. It is this ability to stress certain syllables that makes Text-to-Speech more comprehensible than the flat Dalek-like output of most other voice synthesis systems. It has obviously been optimised for speech, and runs in real time. To do this, the software has been written in impenetrable 9900 code. It is programmable by the user, however, and I found I could vary the pitch of the voice from high camp to sub-John Wayne with a couple of simple commands.

The beauty of it is that the Text-to-Speech peripheral is treated just like any other output device by the TI99/4 File Management System. So in future, rather than printing text, it can be 'spoken' instead.

Suffering as I was from mild culture shock, it came as no surprise when a lady clad in only the smallest of bikinis, invited me to place my head in a tank of water. She was demonstrating the 'Underwater Bone Fone', a stereo radio for skin divers! Whatever next . . .

I had dinner with Atari who took over Paul Anka's multi-million dollar Jubilations restaurant for the evening. Christopher Morgan, Byte's new editor-in-chief, persuaded me to try a Harvey Wallbanger. What followed was either the most exciting demonstration of colour graphics yet or the Wallbangers were stronger than they seemed. After a brief spiel in which a series of overdressed executives introduced one another, academy award style, the lasers let rip and Atari's latest product range was unveiled.

After more than two years' research into holography, Atari has discovered a technique of generating three-dimensional images inexpensively. The result is Cosmos, a 3D programmable video



The Quasar/Panasonic and its add-ons fit into a briefcase.

game, small enough to be handheld. It has a control panel with buttons to select skill level, number of players, direction and firing. Various Space Invaders-type video games are played out with red Light Emitting Diode displays over a three dimensional background image of, in this case, a flying saucer. As you lose, a horribly life-like alien (modelled on the company's founder, I am told) jumps out at you. A number of other game cartridges with different holograms are to be made available at \$10 each. The Cosmos unit itself will sell for \$100. This is a remarkably low price when one considers how expensive holography has hitherto been.

That's not the only surprise Atari had for us. A new Home Information Retrieval System is unveiled as a part of a joint venture with American Express. Users of the Atari 800 computer in areas served by the QUBE two-way cable TV system will now have access to a wide range of public databases via their existing TV cable link, thus cutting out the need to tie up a telephone line. There are also plans to distribute software in this way.

To use the service, the QUBE subscriber presses only two keys on his computer. The screen responds by welcoming him to the system and asking for a password and ID number. A menu of options is then displayed on the TV screen. Thereafter, information from the *New York Times* Database and many other sources linked to the Comuserve network can be interrogated.

An extraordinary cacophony was drawing crowds to the Casio stand. On show was a 12in long gizmo called the VL-Tone. It is a (more or less) pocket-size music synthesiser with a range of about two and a half octaves. And there were a whole lot

of budding musical geni queuing up to murder Mozart, torture Tchaikovsky and bash Beethoven. A very good job of it they were making, too, since the 29-key device is so simple to use that even those with no musical talent do not feel inhibited from playing. Once a tune is tapped out note by note, it can be re-played at the press of a key; speeded up, slowed down and have rhythm added. The bad news for those in favour of noise abatement is that the VL-Tone is going to retail at \$70. (£29).

Hands clamped to ears, I made my excuses and started to leave. As I did, something caught my eye. There, in a deserted corner of the stand, was an unfamiliar-looking computer. Closer inspection revealed several very interesting features.

It was an integral unit with small - 5 1/2in diagonal - high resolution screen sitting atop a more-or-less standard keyboard and numeric keypad. And here is the bit that intrigues: alongside the screen were four slots, each containing a memory cartridge, in this case one for additional ROM - 'Extended Basic' - and three RAM packs. One of these bore the designation 4k CMOS RAM. The

significance is this: while CMOS technology is still a little more expensive to manufacture, it has a very much lower power requirement than the standard MOS circuitry. This RAM cartridge actually contains its own battery, so that the program or data stored on it are preserved when the computer is switched off. The cartridge can even be removed from the host computer and plugged into another, or merely stored on the shelf - all without losing data.

The Casio FX-9000P is the first microcomputer to use CMOS RAM, and the maximum capacity of the cartridges is presently limited to 4k. Nevertheless the ability to program the computer immediately at power-on without having to load the program and data from tape or disk is important. For one thing, it represents a major step towards the totally solid-state computer system.

Since the machine had been delivered direct from Japan, no-one on the stand knew much about it. The processor is said to run at 2.7 MHz, but which chip it is remains a mystery. Screen resolution is 256x128 dots, straight lines, curves and rectangles to be drawn relative to the X and Y axes. Screen display is 16 lines of 32 characters in standard mode.

A glance at some of the other features gives a pretty clear indication of who the FX-9000P is aimed at. There is a powerful statistical processing unit capable of calculating standard deviations and coefficients of correlation and performing regression analysis. Hewlett-Packard isn't going to be amused when Casio start selling into 'its' market, the engineers and analysts, this October. It will be even less pleased when it learns the price: \$995 (£430 approx); 4k CMOS RAM with power back-up will sell for \$120, 16k dynamic RAM cartridges



Allason in wonderland.

# A Word Processor, Report Writer, Mailing System, Data Base Manager, and a Computer all for £1995\*



Yes, we are offering all this with our SERIES 5000 5" floppy-disc system for the incredibly low price of £1995.\*

Not only do you get a powerful Z-80A system on the S-100 bus built to high quality standards by Industrial Microsystems, one of the longest and best-established companies in the microcomputer industry, and supported by Equinox, specialists in microcomputers and multi-user systems.



You also get the popular CP/M Operating System (from Digital Research), a 12-slot bus for easy expansion, a Z-80A CPU for powerful performance, 2 serial and one parallel interfaces, 64KB of dynamic RAM with in-built error detection capability,

and dual 5" double-density drives with the option of a third drive (or quad capacity drives in place of double-density) in the same cabinet.

Additionally, there is the Turbocharger option providing both enhanced disc capacity, disc performance and diagnostics. And if even greater storage is required we can supply 8" floppy drives and cartridge disc drives.

A powerful system for the computer-user and system developer - and one with eventual access to OS/2000, the Industrial Microsystems networking system.

And for the office or business user we are including as standard a powerful Word-Processing package (Wordstar), a Mailing and Letterwriting package (Mail-Merge) and the Datastar Data Base Manager. All these packages are widely accepted and professionally written by Micropro International.

Being CP/M based, the system with suitable configuration will also run the business software developed by (for instance) Graffoom, Peachtree, Paxton, etc.

It will also run a wide range of languages - Basic, Cobol, Fortran, Pascal, APL, Algol, C. Lisp, and Forth and will support a wide range of add-on S-100 devices, such as floating point processors, Prestel interfaces, speech synthesisers, digitisers and plotters, etc.

And just to make certain that you get full use out of your system, nationwide field service support is available at a modest extra cost.

\*add VAT and the terminal and printer of your choice at the costs shown.

**Series 5000 with 64KB Dynamic RAM, dual 5" double density drives, CP/M Operating System, Wordstar, Mail-Merge and Datastar** £1995

**The same system with quad drives in place of the double density drives** £2230

**Add-on double density drive** £290

**Add-on quad drive** £405

**Peripherals:**

**Televideo 912C VDU** £595

**Elbit 1920X VDU with Wordstar keyboard** £895

**OKI Microline 80 printer** £595

**Texas 810 150cps printer** £1450

**NEC Spinwriter RO Word processing printer** £1850

All prices exclude VAT, carriage, training and installation and are subject to our standard terms and conditions.

OEM dealer and educational enquiries welcome.

## EQUINOX

COMPUTER SYSTEMS LIMITED

Kleeman House, 16 Anning Street,  
New Inn Yard, London EC2A 3HB  
Tel: 01-739 2387/9 & 01-729 4460



for \$160. An additional plug-in expansion board is promised, offering clock, calendar, alarm, cassette memory and parallel printer interfaces.

There aren't many good places to eat on the Strip, and the Hotel 'Gourmet' rooms are among the worst. The Palace Court in Caesar's Palace is an exception and it was there, after a long wait spent studying the migratory patterns of American matrons feeding fruit machines, that I met up with Chuck Peddle.

In Silicon Valley circles, Peddle enjoys a very special status as the man responsible for the 6502 microprocessor and subsequently the PET. His recent departure from Commodore caused more than a few raised eyebrows. So it is interesting to be able to report that he is indeed working on a new computer that could well have as great an impact as the PET, although it will not be competitive with it. The approach is in every department innovative and in certain respects revolutionary. But this is about as much as I am allowed to tell you for now, except that it will give the Japanese a run for their money.

Although American TV is still light years behind British broadcasting, the content and quality of reception has improved during the past couple of years. This has largely been due to the growing adoption of cable TV. Most of the material is still originated by the major networks, who transmit it to the cable distributors via satellites hovering 22,300 miles about the earth.

All you need to receive these satellite transmissions direct is a 12ft fibreglass and aluminium dish antenna. So in the past few months the 'Earth Station' business has boomed. Naturally the cable companies aren't too happy about it but there isn't a lot they can do.

More than a dozen manufacturers were exhibiting Earth Stations at CES and the retail prices were being marked down towards the \$3000 level as the Show wore on. With the use of a computer-directed motor — Solar Electronics Inc was using a PET for this purpose — any number of communications satellites can be accessed. One manufacturer was picking up the Soviet Union's Molniya, hovering above the Indian Ocean. And there was the proof: the joy of East German television in living black and white.

Apple and Tandy were both conspicuously absent. Having its own captive retail chain of several thousand



'Video disks have arrived. . .'

Radio Shack stores, Tandy has no need to exhibit to the rest of the trade. It would have been interesting to make a side-by-side comparison of its new \$399 colour TRS-80 with the VIC, or the TRS-80 pocket computer (also sold in the UK by its manufacturer, Sharp) with the Quasar/Panasonic Hand-Held Computer System.

Both units are pocket size, use CMOS integrated circuits, built-in ROM, miniature keyboard and a single-line Liquid Crystal Display. But there the similarities end. Sharp opted for two 4-bit microprocessors in a unique serial combination, whereas Quasar/Panasonic employed the more usual single 8-bit processor (a 6502).

It was clear from the crowds surrounding both Panasonic and Quasar's stands that the Hand-Held Computer System has really caught the trade's imagination. Both companies stressed that it is not a toy. 'This isn't another desktop micro reduced in size,' said Quasar's Tom Lauterback. 'We have designed the HHC system for the executive, salesperson or engineer who needs immediate access to data while paralling around the country.'

And to prove it, they were demonstrating a set of modular units small enough to fit into a briefcase. The 'brain' of the system is the HHC itself, with either 2k or 4k bytes of RAM. In practice, nearly 1k is used up by pre-programmed functions and for control of the various peripherals. These include a 16-column micro-printer,

110/300 bps modem to allow the HHC to communicate with other computers over the telephone, 1200 bps cassette adaptor for storing programs and data on two audio cassette recorders and a TV adaptor to allow any television or video monitor to be used as a 32 character by 16 line display. Up to six 4k memory modules can be attached, bringing user RAM up to approximately 27 kbytes. A range of pre-programmed ROM capsules are planned.

The HHC is the fruit of an unusual partnership between Friends/Amis of San Francisco, a small group of ex-Atari people who did the design, and the Japanese industrial giant, Matsushita, which manufactured it. The technical innovations incorporated in the finished product are really quite remarkable. Not the least of these has been their success in harnessing the same microprocessor used in the Apple II, Atari and PET computers. The power-hungry characteristics of the 6502 have been moderated by giving it as few tasks as possible to perform. A special circuit switches parts of the system off when they are not in active use. In fact the HHC is never truly off, a tiny amount of current being continuously drawn to preserve the display, RAM real-time clock and keyboard functions.

Thanks to the designers' almost excessive regard for user friendliness the Hand Held Computer is also exceptionally easy to use. Any key can be redefined within a

Basic program and relabelled with a keyboard overlay. Should you forget the definition of one, you have only to press the HELP key for an explanation up to 80 characters in length. Heavy emphasis has been placed on menus. When you switch on, the primary menu appears, offering a choice between the various internal and plug-in programs available.

In order to conserve memory, a special text-packing algorithm has been incorporated. This uses a technique of variable bit-length codes, called Huffman coding, to compress character information down from the more usual one byte per character to an average destiny of just over four bits.

Several applications programs are built-in. There is a 'secretary' function that is really an alarm clock with a programmable message feature. 'Calculator' is what you would expect, but the 'Memory Bank' filing system is really ingenious: files consist of up to 80 characters and can be edited or searched fairly easily using a cursor-controlled system.

Although both companies were reluctant to comment, a voice synthesiser has already been demonstrated to the directors of Matsushita, to whom it spoke respectfully in both Japanese and English.

The HHC is due to go on sale in June in the US but both Quasar and Panasonic were playing dumb on the subject of price. An educated guess would put the basic machine in the \$600 price range. I can hardly wait.



# COMPUTER ANSWERS

I regret that I am unable now to answer questions personally, even if an SAE is enclosed, due to pressure of work. In future, I will only be able to answer those letters which are printed in this section; these, inevitably, will be a selection of the most interesting letters received each month. Here, then, are a few guidelines for you if you have a problem:

1. First, check in back numbers of PCW to see if the same (or a similar) question has already been dealt with;
2. If you don't find the answer in previous issues, write to me at the address below but keep your question short and precise;
3. Within the constraints of 2, above, include all relevant details possible;
4. Don't ask whether machine X is worth buying without stating the use to which you intend to put it;
5. Don't ask for the names and addresses of companies; these letters make boring reading and, in any case, during the eight weeks which elapse between receipt of a letter and its publication, you could have found out the answer yourself;
6. I'm not a subset of 'That's Life' so please don't write to me about slow delivery times of equipment; the person to contact about these problems is PCW's advertisement director, Stephen England — you'll find his address on the contents page.

Finally, I need to contact Exidy, Sorcerer and Acorn Atom experts.  
My address is: 35 St Julian's Rd, St Albans.

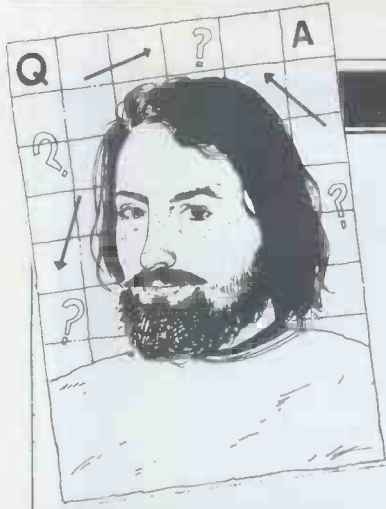

## ZX80 queries

Is it possible to connect a printer to the ZX80?  
A J Shah, Woking, Surrey

The new ROM (due out March/April) will allow a Sinclair-designed printer to interface with the ZX80. The main problem with connecting up printers is that the ZX80 does not use the 'standard' ASCII code (which assigns certain patterns of 0s and 1s to letters, symbols and numbers) which most printers require. An ASCII printer can be connected, but only by making certain hardware modifications to the ZX80 (see PCW, February 1981 for a suitable circuit).  
Tim Hartnell, National ZX80 Users' Club.

What sort of video screen can I use with my ZX80 in place of a TV?  
M Hewitt, Charlton, London.

Any video system which has 625 lines can be used with the ZX80; however, an unmodified computer will not give the best possible picture on a video monitor. The minor modifications required are outlined in the book *The ZX80 Magic Book*, published by Timedata, 57 Swallowdale, Basildon, Essex.  
Tim Hartnell, National ZX80 Users' Club.

Are there any problems involved in operating a ZX80 from a 'proper' keyboard?  
Alan Ehrlich, Geneva, Switzerland.

I've been operating a 'proper' keyboard ZX80 for over six months and apart from a slight interference with the clarity of the graphics (they tend to 'bleed' a little down the right hand side) there have been no problems. Connecting up a keyboard is very simple. There are solder points on the front eight keys and these connect — in sequence — with points on a non-ASCII-coded keyboard. You'll find an outside keyboard enhances your ZX80 to a considerable extent. Keyboards ready to connect up with the ZX80 are available from Database Consultancy, 105 Fairholme Ave, Romford, Essex.  
Tim Hartnell, National ZX80 Users' Club

## Forget Fortran

In your reply to M McKenzie regarding the language in which Adventure is written, may I put the record straight. Early Adventures were indeed written in Fortran; in recent years, though, they have been written in anything but Fortran and many do not require disks or large memory. An excellent example is the series of Adventures by Scott Adams, who wrote in Basic and assembler. Gregg Haslett has become popular for his Basic Adventures. There is also a full length SAM76 Adventure available on CP/M disks. This is the full original version and if you type FRANCAIS half-way through, the rest is played in French; all this on one 5.25in disk.  
Peter D Scargill, Tynemouth

I am indebted to Mr Scargill for the above information, as it has corrected a popular misconception which I was perpetuating. Mr Scargill has sent *Creative Computing* a Microsoft Basic Adventure of his own, and has now developed a Z80 assembler system using 4k of RAM for the program and around 8-16k for the files. I agree with Mr Scargill's final comment which was: 'Fortran — who needs it?'; there are so many better languages around.  
SW

## ITT = Apple ?

I thoroughly enjoyed the articles by Malcolm Banthorpe and wonder if you could answer the following questions: 1. What size of ITT 2020 or Apple is needed for the kind of displays shown; 2. What should I ask the dealer to supply so that I get the correct model; 3. Are the Apple and ITT equally suitable for the displays; 4. Are there any other computers which would

give similar results at less cost?  
John Mitchell, Wishaw, Scotland

I must admit that I, too was quite fascinated with the articles. Here are your answers:  
1. A 16k system will do;  
2. Get either the ITT or Apple basic model but check that it has the colour board and Palsfoot Basic;  
3. Both will do, except that the ITT has 360 horizontal points whereas the Apple has 280;  
4. It is possible that you would be happy with the Acorn Atom with colour card, which is certainly cheaper. An alternative at roughly the same cost as the Apple is the DAI, which looks promising but no-one has lent me one to look at yet.

SW

## Repelling invaders

I had a somewhat curious experience when trying to modify a Space Invader game for the CBM 3032. The program seems to be written entirely in machine code, the listable Basic portion consisting of just one line: 10 SYS (1039). Once started, the only way to stop it is to switch off. My aim is to restart it without switching off. I assume that the program was cycling in machine code and not returning to line 10. When I try to add extra Basic lines before or after I only succeed in corrupting the program. If one puts a RET value at the end of a machine code program which is accessed by a SYS call from Basic, will it return to the line of Basic following the call?  
A R Moss, Welwyn Garden City

You roughly have the correct idea. Yes, the computer is loading a machine code program from cassette and then activating it by the SYS 1039 call. The moment you add an extra line to your Basic program you overwrite an important piece of machine code, thus corrupting it. Your only way of modifying it is to load the machine code program from the monitor and modify it there but I don't envy you the task of sorting through the code without a disassembler. The answer to your second question about RET is yes, it will return from whence it came.  
SW

## What's the rule ?

I have a printer which has an underlining character but cannot seem to get it to underline on the same line. I know that Electric Pencil achieves this but I don't know the secret. Can you help?  
D Upton, Surbiton, Surrey

Almost certainly it will be as simple as making the carriage return without 'line-feeding'. In Basic this would be done as PRINT "HELLO"; CHR\$(13); "\_\_\_\_\_". Hope this gives you the idea.  
SW

## Moonage daydreamer

At the risk of being too controversial, may I enquire if there are any programs that go to more depth on the calendars problem. By that I mean that they include full moons and Easter days?  
D Sacks, Barnet, London

I know of none that I can guarantee, but Radar and



Electronic Publications, Highlands, Needham Market, Suffolk IP6 8DR market one giving full-moons and the positions of the four major planets but it doesn't mention Easter.

Please don't write telling me that you have a program because I won't be able to acknowledge it. Sorry.  
SW

## Monitor unmasked

I have an 8k new ROM PET and I understand that it contains a built-in monitor that will enable me to load, save, etc, machine code programs. What is this monitor, and how do I use it?  
Barry Gilpin, Oldham, Lancs

The Commodore Terminal Input Monitor (TIM) is a program which allows one to display and edit memory locations, load and save blocks of memory and execute machine code routines. This program is standard on all new ROM PETs and available on cassette for the old ROM versions.

The program is described in the PET user manual but if you don't have this, then here are a few tips on its use. The machine code instruction BRK points to this section. Therefore executing a SYS command to a zero location will cause a jump to this. SYS 1024 will do this. The computer then displays the following:

```
B*
PC  IRQ SR AC XR YR SP
:0401 E62E 32 04 5E 00 F8
```

This is a display of the processor registers when this routine was called. The computer is then inviting you to enter one of a number of commands. If you type M 0400,0480 you will see a display of the memory locations between 0400 and 0480 in hex in rows of eight locations. If you have a Basic program loaded at the time, you will see the Basic statements as they are actually stored in memory. You can change these locations by positioning the cursor over the location, typing the new number and pressing return. (Try putting 01 in location 0401 and see what happens to your Basic program.) You can change the registers in a similar way by typing 'R' and moving the cursor over the register values.

Thus you can enter a machine code program by hand assembling it and keying in the values. This program can then be executed by using the command 'G', for example, G 033A will execute a program sited in the second cassette buffer. You can also load and save blocks of

memory using the monitor. The command S "PROG", 01,0401,2000 will save the block of memory from 0401 to 2000 on device 1 (first cassette) as a file called PROG. The load command is similar but you omit the last two parameters as the location of the block has been stored on the file header label; the block will be loaded automatically into the relevant place. Finally the command 'X' will exit back to Basic.

TIM is useful in creating and editing small machine code programs and I would strongly recommend a book such as *The PET Revealed* which, although expensive at around £10, will help you delve deeper into machine code on the PET.  
Mark Wratten

## Tennis tabulated

I am interested in buying a small computer to run a rating system for up to 600 table tennis players. This awards points to winners and deducts them from losers, depending on the existing difference in rating and on whether the higher rated play player beats the lower or vice-versa. The points to be awarded are contained in a table with four columns and 11 rows. (The highest number involved in the table is 250.)

What is the cheapest computer which could handle this? Which computer would you recommend for this use?  
R E Etheridge, Beckenham

The very cheapest micro-computers were, until recently, notable for what they didn't have: very little memory, hex-only keyboard, no high-level language, very little I/O. But Clive Sinclair (aided and abetted by Tangerine and Acorn!) has luckily changed all that. So could you use a ZX-80? One of our first considerations in looking at small machines must be how much memory is needed. As all the numbers involved are, as you have detailed, integer, and less than 32,767, it would be possible to use Integer arithmetic on those machines that have it, thus using only two bytes of memory per number. Otherwise four will be needed. So the 'master table' will need some 100/200 bytes. The two individuals' scores (before and after the calculation) will take a few more. So, provided we can keep the 600 scores on tape and keep headings, etc, down to the minimum, we might well get away with 1k of memory for data and program. However, on the ZX-80 quite a lot of the memory is used by the screen handling routines, so it would be wise to have at least 2k.

Unfortunately, the 1k memory expansions are no longer being advertised for the ZX-80, so we have either got to get by with 1k, or move up to a price of nearly £150 (ready built, including VAT and postage). This is bringing us towards the Acorn Atom, at about £180/£190 on the same basis.

The Acorn scores if you want a printed output, now or later, as it can interface to printers, which the ZX-80 cannot yet do. However, if a printed output is important, then you should consider the Rockwell Aim 65 with a built-in printer at £285. As the Aim 65 can now be interfaced to Acorn equipment, you could end up with the best of both... but that's all putting the price up!  
P L McIlmoyle

## Tuscan teaser

I intend to expand my Tuscan Z80 system to have 56k of RAM and a single 5in double-density disk drive (Shugart) with a second drive to be added later.

I am interested in running a USCD implementation of Pascal under CP/M 2.2. I have details of such a system offered in the USA by Softech Microsystems, which says that 'the software is supplied on an IBM 3740 8in disk and requires a minimum of 175k of disk storage space.'

Is there any way I could run this with the one disk drive? Failing this, could it be run with the two drives?

Is there a distributor in the UK who can copy the 8in disk to my 5in Shugart format?  
A Wood, Rugby

I suspect you are going to be out of luck with the Softech Pascal using your proposed disk drive. The standard double-density Shugart 5.25in drive gives about 156k of formatted disk space under CP/M. As CP/M regards each disk drive as a separate entity, adding a second drive will not help, unless there is some part of the Pascal system which is contained in a separate file that can be either loaded manually, or called by the rest of the system.

There are two solutions to this particular problem. One is to use a double-sided, double density 5.25in floppy disk drive, which would give 320k bytes per disk. Of course, the problem is that you would need a double-sided drive and double-sided disks, both of which are more expensive than single-sided (perhaps an extra £80-£100 on the cost of a single-drive).

The second solution is to use an 8in disk drive! This would obviously overcome your other problem of copying from the format

supplied to 5.25in. The big snag is the obvious one of price. Not only would you have the cost of the bigger drive, but also that of an extra controller board. These two items could cost upwards of £700!

I am not aware of a distributor for Softech Microsystems in the UK, although various software houses might be prepared to do the transfer from 8in to 5.25in, for a price.

Alternatively, have you thought of buying your Pascal from a UK dealer like Lifeboat Associates or Interam, who could supply it on an appropriate disk for you? A number of other sources also advertise Pascal to run under CP/M in PCW. If a suitable implementation of Pascal is available from such a source it should have the added advantage of easier support, in the event of either difficulties, or upgrades!  
P L McIlmoyle

## UK TV OK in NZ?

I want to take a micro-computer which uses a television set for its display to New Zealand, but I don't want to have to take a UK TV as well! The television system in New Zealand is PAL colour, with 625 lines, but differs from the UK in being VHF rather than UHF. Would it be difficult or expensive to adapt the micro to work with the NZ TV set?  
B Davy, Newcastle-upon-Tyne

The necessary adaption is, in principle, quite straightforward. In essence it is a question of altering the frequency of the modulator from the UHF band to the VHF band. This will need a change in the size of the coil or the capacitor (or in practice probably both) in the tuned circuit of the modulator. Calculating the new sizes needed and making the alteration should be well within the scope of most radio amateurs. If you cannot do this yourself, there are plenty of Radio Hams in NZ who you could contact through the clubs. You might very well find your micro the centre of attention.

Alternatively it may be possible to buy ready-made VHF modulators for micros in New Zealand, especially as you mention you are not going there until a year from now. In either case it will obviously be easier to make the adaptation if you choose a microcomputer that has a separate UHF modulator, rather than one that is built-in. Fortunately this is quite a common arrangement (examples being the Apple II and the TRS-80 Model One) when bought without its own screen.

P L McIlmoyle



# the ABC's of CP/M®



## NEW! CP/M HANDBOOK MAKES CP/M EASY AS ABC

CP/M—the industry standard in operating systems: now Sybex makes it easy as ABC with a new step-by-step guide: THE CP/M® HANDBOOK (with MP/M™).

Gain a clear understanding of CP/M's basic operation, learn how to use the editor and assembler, then explore all versions of CP/M, including CDOS and multi-user MP/M.

Numerous sample programs, practical operating hints and handy reference tables make the CP/M HANDBOOK a must for anyone—from beginner to experienced programmer.

For sophisticated editing or simple copying, the new CP/M HANDBOOK gives you a hand—and makes CP/M easy as ABC.

By Rodney Zaks, 250 pp., Ref. C300,

CP/M® and MP/M™ are trademarks of Digital Research

Get your copy of the CP/M Handbook from your local Computer store or Bookshop. In case of difficulty, send cheque/ P.O. for £8.95 + 70p post & packing to the SYBEX UK Distributor.

**The  
Computer  
Bookshop**



**Temple House,  
43/48 New Street,  
Birmingham B2 4LH**

Please send me a copy of the CP/M Handbook.

I enclose Cheque/P.O. for £9.65

Name .....

Address .....

.....

.....

PCW



# SECRETS OF SYSTEMS ANALYSIS

## PART 8: THE SECOND STAGE IN SPECIFYING A PROGRAM

*This month Lyn Antill looks at how to define what must actually happen in a program for it to meet your requirements.*

Last month I looked at what must be specified in order to define the input to and output from a program. This month I come to the rather more difficult area of specifying what it is that the user wants done inside the machine to turn available input into desired output. The difficulties lie in the fact that you cannot actually see what is going on inside a program (unless you become a proficient programmer yourself) so you may feel less confident than you would about the things you *can* see, like printouts. Once a user is convinced that there is no mystery to it, then specifying program procedures and data files need present no problems.

The analogy I find most useful is that of the computer and the dumb clerk. If you have just taken on a new clerk and are trying to explain to him/her how a particular job is done, then you are doing much the same as you would be if specifying what the computer is to do — not an easy task. You have to go back and establish what the clerk knows and build on that. Does s/he know how to write a business letter? Or will you have to show him/her what goes where, and what phrases are most suitable, etc, etc?

### What does the computer already know?

Of course, I'm using 'know' in metaphorical sense because I want to draw an analogy between the computer and a willing, but ignorant, clerk. If you are defining a job, you can say things like 'Add up that column of figures,' 'Put the total in that box,' etc. Anyone who has been to school should be able to do that. But you need to know what are the elementary operations from which your computer program can be created. Exactly what you can do will be limited or defined by the particular machine and language you are using, but they will all look very much like this:

- accept information from the keyboard and display it on the screen or printer;
- perform calculations using + - \* / and \*\* (ie add, subtract, multiply, divide, raise to the power of). You may have a few other functions like square root, but statistical functions are unlikely;
- combine fields (ie individual data items) into records and store records into files, sort the files and make copies of them;
- retrieve records from these files,

either taking them in the order they come (sequential files) or picking out particular ones, like opening a book at a certain page in the middle (relative files), or sifting through the whole file to pick out records which satisfy certain requirements (eg, listing all the customers who have bills which have been unpaid for more than one month);

- store constant information to use in calculations or on the screen or as part of a printout;
- combine all of these in whatever order and variety is needed to do the job.

These are the terms in which the computer program is going to be written and in which your requirements must be presented.

### File specification

There is a nice distinction between information and data. Data (or 'raw data') refers to all the individual items — a name, a street, a telephone number, a town — which have very little significance on their own. It is only when the bits are grouped together that we have information — in this case somebody's address. The file and record specifications show how the computer is to do this grouping.

There are quite a few sophisticated techniques for what is known as data analysis, ie, finding out what data is needed and how it should best be arranged, but it is probably not essential to a microcomputer system because the user should already have a good idea of how the data fields are grouped into records. You know what information you keep on your customers. The additional questions that you need to ask yourself are practical ones such as: 'Should all the customer information be held on one file or should it be split between two files — one with static data, like names and addresses, and one with volatile data, like payments outstanding?'

Well, what are the practical considerations that have to be taken into account? One refers to the volume of the files — if you keep all the data together will there be room for it all? This may relate to the amount of space on the discs or the limitations of the system or language (relative records on my Tuscan can only have 127 characters because of the way in which the data is stored). If you are not sure about size restrictions, discuss them with your supplier or programmer.

The only main consideration is one of access. Which bits of information are going to be used together? Sometimes

this will give you a clear-cut answer, but you will often find that items are used in two different places and you have to make a decision about where they are to be stored. Storage in a single place is more desirable than two locations: whenever it changes, it must be altered in both occurrences, eg, if I store a telephone number in my diary and in an address book at home, it may be necessary to change both versions if a new number is issued. If it's me that's doing the changing it's not too bad — I should remember what I've changed! But if my husband changes the one in the flat and doesn't tell me, I'll go on trying to use the one in my diary, and wondering why I can't get through. This situation is analogous to what happens when one program uses one version of a data item, and another program uses its own version stored in a different file.

Once the details of what goes where have been sorted out, they have to be written down. Two of the NCC forms are very helpful here, and are widely used. They are so popular, in fact, that it is hard to imagine a mainframe programmer surviving without them, or an in-house form derived from them. There are so many things you have to specify about a file (its size, contents, identity, frequency of use, security classification, storage medium, storage time, error procedures, backup procedures, etc) that if you didn't have the standard boxes of the form to put that information in, it would be easy to forget to specify some of it, or for the programmer not to know where to start looking for a particular item.

### File definition chart

Not all that is on the NCC form is necessary for a micro because not all of the choices available on a big computer will apply. For the File Definition I would suggest something like Figure 1. I have tried to simplify the form and get rid of the jargon, but we're inevitably stuck with a bit.

**File name.** Every file should have a clear, unique, self-explanatory name. This is what it is called when you are talking about it or writing descriptions and instructions.

**File-ID.** Every file stored on a computer has to have a unique code name. This is used by the operating system and the program to find the file on disk or tape.

**Approximate number of records.** It is important for the programmer to know the approximate size of records both when they are being set up and when they are being used. This is because there are certain things you can only

do with small files, eg, read the whole file into memory, or search sequentially through it every time you want to retrieve a single record. As the files get larger, the programs have to organise them more carefully so that you don't spend all your time waiting for the program to search around for your records. When files grow so large that you cannot accommodate them all on one disk, you run into additional problems. *Approximate number of record changes per run.* Known as volatility. It has an effect on the way in which the programmer arranges and accesses the files. Records may change for two different reasons. It may be that part of the data in them has changed, eg, if a bank file has a record for each account which shows, among other things, the balance outstanding on that account, then the balance field on many of the records will change during the course of the day. In this case the records will still exist and will still occupy the same amount of space, and still be in the same relationship to the other records around them, so that although the data on the file has changed, the organisation of it hasn't. There may also be a change in the records stored, eg, if a new customer opens an account there will be a record to be added to the file. It may be possible to tag it on at the end of the file, but it could be necessary to slot it into the middle in order to preserve the logical sequence. Similarly, if records are deleted it may be necessary to rearrange the file so as to close up the gaps. If a file is going to have many insertions and deletions of records, this has to be organised in such a way that it causes the least problems.

On a simple system, a program may use just one file, creating it and then updating it when necessary. More complex systems often contain one program to create files in the first place with separate programs updating them. An example of this would be a file of sales orders. You could have one program which allowed the details to be typed in as soon as the morning post was opened. These details could be kept on the file and then read back into other programs to do invoicing, picking lists for the warehouse, etc.

If you have a complex system where different files and programs are used by different people, you might want to introduce some sort of password system to make sure that only authorised users have access to certain files. On a more mundane level, the programmer needs to know where the data is going to be used, to ensure that the organisation of data is compatible with the reading program. It may be that one program creates the file, others read it and others still are permitted to make changes to the file. These may be updating information already on the file, or they may be 'housekeeping' programs which are used for making corrections, etc.

The possibility of records being wiped out by mistake can be avoided by forbidding all but 'housekeeping' programs to delete any records. Other programs are only allowed to insert a 'delete marker' into the record — perhaps every record could start with 'L' for live or 'D' for dead. Only after the work has been checked does a housekeeping program go through the file and remove those records marked with a 'D'.

**Backup Copies.** This is an important

<b>File Title:</b>	<b>File ID:</b>
Approx. number of records — now: — eventually:	
Approx. number of records changing in one run:	
Is the file on 5¼in disk, 8in disk, hard disk, cassette?	
Which programs are allowed to read it? — change or add records to it? — delete records from it?	
How often are backup copies to be taken?	
What should be done if the current version is destroyed?	
How long are backup copies to be kept?	
What records are to be stored on the file?	
Are the records to be stored — serially, randomly, indexed?	
On what key are the records to be accessed?	

Fig 1 File specification chart

factor in using any form of computerised record keeping. Micros do go wrong from time to time, possibly corrupting files, or leaving them in a mess halfway through writing something. Disks and tapes are prone to occasional failures so that all or part of the data will be unreadable. And users can do silly things like forgetting to press the record button when writing a file to tape. The commonest way out of the problem of a useless data file is to start again with yesterday's backup copy and put in all the new data again. This can be speeded up if you keep a separate file of the new data as it is entered, so that, if you do break down, your program can read the data back off the file. This brings the backup copy to pre-breakdown condition. Of course you must write a routine into your program that will read the data from tape rather than the keyboard. When taking backup copies you have to specify how long they should be saved just in case they are needed. Two previous versions are enough for most purposes.

**What records are to be stored on the file?** Records are not very well defined in Basic, where files effectively consist of variables and strings in whatever order the program wrote them, separated by commas. Cobol has a very well-defined record structure (although it can also use the Basic format). Pascal also has records. A Cobol record consists of a defined number of characters and it is both written and read as a unit. The sizes of all the fields are fixed, too — you can specify that a name should be 20chs long (with spaces at the tail end if need be) so that they all line up neatly when being printed, or you can specify that a number should be only two digits, to prevent the entry of an item which is too big. A file may have more than one type of record, eg, it could start off with a control record holding information about the date the file was created, who keyed the data, etc, that might be followed by any number of individual records, each having the same format, and a total record at the end. A note should be made on the file definition chart of each type of record, and the order in which they occur.

**File Organisation.** Sequential (or serial) means that the records are taken in sequence. Sequential records have been sorted into order by a key field within the records which determines where in

<b>Record title:</b>		<b>In file?</b>				
<b>Key field is?</b>						
<b>From</b>	<b>To</b>	<b>Field name</b>	<b>Type</b>	<b>Occurs</b>	<b>Range</b>	

Fig 2 Record specification chart

the sequence each record should go. Random (or relative) means that you could read the 52nd record, then the third, etc. One great advantage of random files is that amendments to the records can be made without the need to change any of the others. For example, you could read the 21st record, alter it, and then write it back again. If you want to alter part of a sequential file you have to copy all the records in front of the one you want to change, then make the change, and then copy all the records after it.

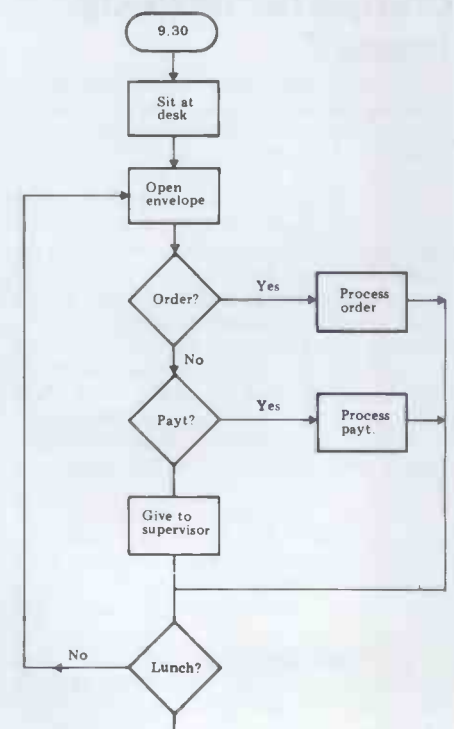

Fig 3



# Record definition chart

In Cobol and Pascal you can prescribe the number of characters in a given field. Indeed, in Pascal you can specify acceptable values for a field, eg, an exam mark might be defined as a three digit number, but the maximum value would be 100. Whether the maximum sizes and values can be built into the data definitions within the program, or whether special routines have to be written to check the data, they should still be put into the specification. The more the programmer knows about what the data ought to look like, the more steps he can take to prevent bad data getting into the files.

You need to know each record's name and the file it belongs to. The fields within the record are then described in the order in which they occur. Each field has a name and an indication of the type — alphabetic, numeric, integer, real number, etc. (which of these are available to you depends on the language being used). It should have the maximum number of characters in the field and/or the range of permitted values. This is so that entries can be tested to see whether they fit into what is allowed (eg, so that I can't accidentally give my students 500 marks instead of 50). The end of a field can be marked by a delimiter such as a comma. If this is so, it should be specified. If you don't want commas, or if you are reading a file that hasn't got any, then that should be specified too.

The use of one of the fields as a key might also be relevant, eg, a customer record might use the customer account number as the key. This should be shown and should correspond with the information given on the file specification.

Now I wouldn't expect the non-programming user to write this sort of thing on his own, but he should know what fields he wants on which records, what values are permitted in these fields, and which field is to be used as the key. If even this seems a bit ambitious, then he should at least be able to make sense of what the programmer is saying about them. The programmer can supply information about what sorts of fields, record lengths, delimiters and so on are available. The file and record definitions are, therefore, a joint effort with some adjustments usually having to be made to fit the data into the limitations of the file handling available — Micro languages really haven't yet caught up with the needs of data processing.

A program is composed of a number of instructions about what is to be done, and many more about what sequence they have to be done in, and under what circumstances. The aim of top-down (or structured) design is to separate the two types of instruction so that your program consists of procedures (groups of instructions for performing a particular job) and control loops which determine which procedure should be called in when. This produces a hierarchical arrangement which is usually several layers deep — the control loop calls in the major procedures, and the major procedures call in the minor ones.

There are various ways in which this

top-down decomposition can be arranged. People have their own favourite methods according to the type of work they are doing and the language they are working in. However, the principles are always the same:

- Identify the jobs to be done.
- Identify the rules for putting those jobs into order.

The first of these can usually be done without too much difficulty, at least for the small systems that we are concerned with. Mistakes tend to be of two kinds — leaving out details (or taking them for granted) and blurring distinctions. The first of these should not cause any real difficulties — if the procedures have been designed properly the details can be slotted in, eg, if you forget to specify that you want the date to be printed with the heading at the top of the page, the programmer will have to add some extra lines of code to the procedure that deals with the headings. What's likely to play havoc with the program is the blurring of distinctions. Very often two processes seem similar, but are either significantly different in some respects, or are done at quite different stages in the work. So, when identifying individual processes, you have to bear in mind the way in which they fit into the structure of the whole.

It is usually more more difficult to nail down the exact order in which things are to be done because this order has to include all the errors and exceptions — you can't afford to be in the position of having written something on to your files before you discover there was a mistake in it.

The thing to be avoided is taking a worm's eye view of the work. (This is what a flowchart does if you're not careful.) That would be rather like saying to a new clerk: 'Come in to the office at 9.30am. Sit down at your desk and open the first letter. If it's an order check whether the goods are in stock. If they are then make out a delivery note. . . At 5.30pm get up and go home.' The structured approach sounds rather more like this: 'You will be expected to work in the office from 9.30am to 5.30pm with breaks for lunch. . . Your job will be to deal with the morning mail and do the filing. The morning mail is mostly orders and payments, with a few queries and other items you will bring to me. To process an order, you first check the customer's credit rating and the stock position. . .'

Figure 3 shows the flowchart and Figure

4 the structure chart. Notice how the structured version starts with the complete job, defines its start and finish and breaks it down into its major components. The first of these, the mail, is then split into three — orders, payments and others. At the detail level, instructions are given about how to process an order and so on.

A structured design is made up of the following:-

- Elements, individual processes, eg, 'print the heading', 'add up the figures'.
- Sequences, things which are done one after the other: 'print the heading, list the figures, print the total' is one sequence of three elements.
- Iterations, also known as loops, something which is done repeatedly, eg, 'list the figures' could be further broken down into an iteration of 'list a figure'.
- Selection, either do this, or do that, eg, 'if it's a debit subtract it from the balance, if it's a credit add it to the balance.'

Implicit in the idea of an iteration is the control of how many times the action is to be repeated, or under what conditions (eg, 'you will receive your pay each month as long as you're employed') or else when the iteration is to stop 'continue dealing with the mail until there are no letters left'. Selection implies doing a test, or a series of tests, to decide which action is appropriate. Very often you will find that the selection is being made between an error and a valid item, and between an exception and an ordinary item.

## Specifying procedures

If you want to explain to someone what needs to be done, there is no better way than to demonstrate it and then get the person concerned to explain it back to you, just to make sure he's got it right. Of course, this only works for things that are small enough to fit into a single demonstration, and would be unsuitable for a large and complex system. Formal specifications ensure you don't forget to fill in the details and to close all the loopholes.

Structured design provides one method (my favourite) for specifying procedures, but it is only one of several, and it does impose a particular style on the programmer which he might not like. Another method is the Decision Table. This enables the user to specify complex tangles of conditions and actions that have to be taken under various combi-

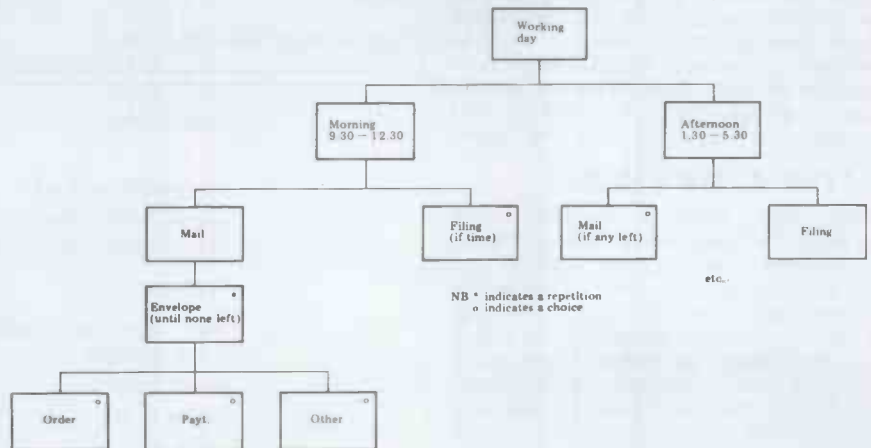

Fig 4 Structure Chart

nations of these conditions. It also enables you to check whether all the possible combinations of conditions have been included so that the program doesn't finish up not knowing what to do next if some unusual combination crops up. Figure 5 shows the outline of a decision table. In the top left corner you list all the tests that have to be made, and on the bottom left you list all the actions that have to be taken, depending on the results of those tests. Both actions and conditions are listed in the order in which they would actually be done. The right hand side consists of a series of columns, one for each possible permutation of conditions. In the simplest form of decision table each test results in an answer of 'yes' or 'no', so for one condition there are two columns needed. For two conditions the results could be YY or YN or NY or NN, ie, four columns are needed. For three conditions, eight columns are needed, and for four conditions it is 16. This is as many as I would recommend. If you find that you have a truly complicated situation with more than four different tests to be made, it would probably be simpler to split it into two different decision tables, then the first decision to be made determines which table to work from.

In certain combinations of circumstances you don't need to ask all the questions, eg, if a customer has sent cash with his order you don't need to ask whether his credit is good. This is indicated by '-' in a column instead of 'Y' or 'N'. Every time this happens there are, in effect, two rules being covered in one column. This is why Figure 6 has only four columns instead of the eight that would have been expected. Rule 1 actually covers four situations, ie, there may or may not be cash with order, and in either case the customer may or may not be credit-worthy.

On the bottom right of the Decision Table are the indicators of which actions are to be taken in each of the situations. For each column, ie, each unique combination of yesses and nos, you put an X against each action to be taken. Each one of these columns is called a 'Rule', ie, 'in this situation take these actions'.

Perhaps the easiest way of getting a feel for what decision tables are all about is to look at the example in Figure 6. This is the simplest form of decision table that I have described here, and I have not gone into all the ramifications of it. On mainframes there are several programming languages (NCC's Filetab is one of them) which work directly from a decision table to produce programs. People who have worked on these tend to be very enthusiastic about decision tables; your programmer may be one of them.

## Error conditions

Every time there is an interaction between the machine and the operator, or wherever the program tries to use the disk or printer, then there is the chance that something may go wrong. A wrong disk may be loaded, or a disk may be corrupt, an operator may make a typing error, or enter a wrong item, the printer may have been accidentally switched off or the paper not loaded correctly. It is even possible that someone is viciously or fraudulently trying to

tamper with the system! Here are some of the checks that are worth building into the specification to try to prevent these errors, or at least to mitigate their effects and allow one to recover from them.

- For every data entry the range of acceptable values should be specified and the program should check that the entry is within the permitted range.
  - All dates should be checked for validity (including leap years!).
  - Unusually large money amounts should be queried even if they are within the limits (just as some cash registers have a guard over the £10 keys just so they can't be hit by accident).
  - Ask the operator for confirmation (preferably in different words from those used for the original instruction) before anything is physically deleted.
  - If a file is being updated the first record should contain control information about when it was written, so that you can make sure that it really is yesterday's file you're updating and not the day before's.
  - Always print some dummy information on the first page of a printout and then stop and wait for the operator to confirm that the paper has been lined up correctly, repeating the dummy page if necessary for a second attempt.
  - Always print something at the end of a printout so that you can make sure you've got all the pages, and the last one hasn't been torn off by mistake.
  - If it's important that some parts of the program are accessed before others (eg, like taking backup copies before closing the day's work) then store a note somewhere in the program or on file to show what has been done and what hasn't.
  - Make the program insist that an operator types in a password before accessing privileged information, or before deleting records which might be important.
  - Write a trailer record at the tail end of a file so that you can be sure that the last part of it didn't get wiped out.
- These are only a few hints but they are an attempt to indicate the sorts of

Conditions							
Question 1	Y	Y	Y	Y	N	N	N
Question 2	Y	Y	N	N	Y	Y	N
Question 3	Y	N	Y	N	Y	N	Y
Actions							
Action 1							
Action 2							
Action 3							

Fig 5 outline decision table

things that can, and should, be done to ensure the safety and security of your computer system.

## Conclusion

Specifying a program is a difficult process - it should never be underestimated. You can't just say to someone: 'Write a program to do this and that' and expect them to come up with just what you had in mind. Neither is it a process of such technicality that the lay user need fight shy of it. The right foundations must be laid by analysing the problem to be solved. Looking at other people's programs and at the packages that are on sale should give the user a much clearer idea of what to ask for in a program. Probably the most difficult thing for a user is knowing where to start as he may well have only the haziest notions of what the machine is actually doing in terms of the instructions it obeys.

A program specification does two jobs. It enables the program to be thought through in detail, and it is an instrument of communication between the user and the programmer, telling the programmer what is to be done. The best way to make sure that both of these jobs are being done properly is to spend time discussing the specification, with user and programmer producing it between them.

There will be various constraints on the program from the limitations of the machine or the language being used - it is the programmer's job to know about these, and to warn you if something looks as though it is going to be unnecessarily tricky in practice. On the other hand he may also have positive suggestions about good ways to do things or about extras that could be added without too much difficulty. (Do check that these extras really are easy to add - enthusiastic programmers have been known to get carried away trying to add all sorts of knobs and twiddles and messing up the program in the process.)

So when you've written your specification, make sure it hangs together and that the programmer understands what it is you want.

I've been blithely talking all this time about your programmer, but you may well not have one. Next month I'll be looking at how you go about looking for a programmer, and deciding whether or not s/he'll do a good job.

Conditions	Rules			
	1	2	3	4
Are goods in stock?	N	Y	Y	Y
Is cash with order?		Y	N	N
Is customer's credit good?			Y	N
Actions				
Send 'goods pending' note	X			
Send delivery note.		X	X	
Send invoice.			X	
Refer to supervisor.				X

Fig 6 Sample of a decision table.



# PROGRAM PACKING

Alan Shelley explains how you can hold several programs in memory at once and switch between them without reducing their running speeds.

Do you often think how dreary it is to have to keep reloading programs when you want to change to another game? Have you ever gone on to think how convenient it would be to have three or four or even more simultaneously in memory so you could select the one you wanted by RUN followed by the first line number of the chosen program? Have you then used the Programmer's Toolkit or an append routine to actually string together several programs, or, not having such luxuries, laboriously keyed them in only to find that, for some reason, they seemed to run slower than usual? Well, this program could be the answer to your problems.

There's a simple reason why programs linked in such a way often run slowly and you may well have already worked it out for yourself. Spare a moment to think how the operating system works. Starting at the lowest line number, it runs through, statement by statement, until it reaches a GOTO or a GOSUB or a THEN followed by a line number. It has to jump to that line by examining all the line numbers from the beginning of the program, using the link bytes to find the location of each, until it comes to the one that matches the instruction.

This is usually satisfactory, but when you are running the third or fourth program in a string and it is a real time simulation whose line numbers required are several hundred from the beginning (actually so, not just high numbers), the GOTOs, though fast, begin to take a significant number of microseconds to perform. When you consider that many of these games contain GOTOs and nested GOSUBs galore, and multiply by the significant number of microseconds, then reaction times measured in hundredths of a second begin to be affected. Hence the problem. Now for the solution.

The object is to get the operating system to avoid looking through the whole list of numbers of the preceding programs. This is achieved by changing the pointer to the beginning of Basic. This is held in locations 40 & 41 decimal (0028H & 0029H) and normally points to location 1025 (0401H); a glance at Figure 1 will make this clear. To enter the monitor, type SYS1024 and press RETURN. This will cause the contents of the various registers to be displayed, whereupon typing M 0028 0030 followed by RETURN will display 16 bytes of memory starting with the two which form the pointer to the start of Basic. If these are set to point to the start of the second program, the operating system will jump straight there, ignoring preceding line numbers as though they did not exist. It applies equally if the pointer is set to the third or a subsequent program. To return to

the first program, it is merely necessary to reset the pointer to its original value.

The difficulty lies in discovering the start addresses of the various programs. It can, of course, be achieved by examining the program via the machine code monitor, looking for the first line number of each program in hex. This is a time-consuming procedure and a simple direct routine in Basic will speed things up no end.

```
FOR J = 1024 TO 32768 :
IF PEEK(J)+256*
PEEK(J+1) < N
THEN NEXT
```

is such a routine where N must first be set to the line number being sought. When this is found, the system will come out of the routine and print READY.

```
POKE 41,(J-2)/256 :
POKE 40,(J-2) -
INT((J-2)/256)*256
```

will now set the start of Basic pointer to the correct address to run the program from the line number selected.

Obviously, this will be a slow routine (it takes 64 secs to find line 700 of

LINKINDEX) because it examines every byte of memory from the start of Basic RAM to the starting line number of the program required. It, too, can be accelerated by alterations which take advantage of the link bytes. This will avoid the necessity of examining all the locations in between the line numbers. Enter X = 1025 : Y = 32768 as a direct statement then

```
FOR J = X TO Y :
K = PEEK(J)+
256*PEEK(J+1) :
IF PEEK(J+2)+
256*PEEK(J+3) < N
THEN J = K - 1 :
NEXT
```

as a complete line after setting N equal to the line number required. This time POKE 41, J/256 :

```
POKE 40, J -
INT (J/256)*256
```

will set the pointer as required.

A better way is to determine the start addresses at the time of linking programs together. When one program has been entered, or appended and edited as required, then PEEK (42) +

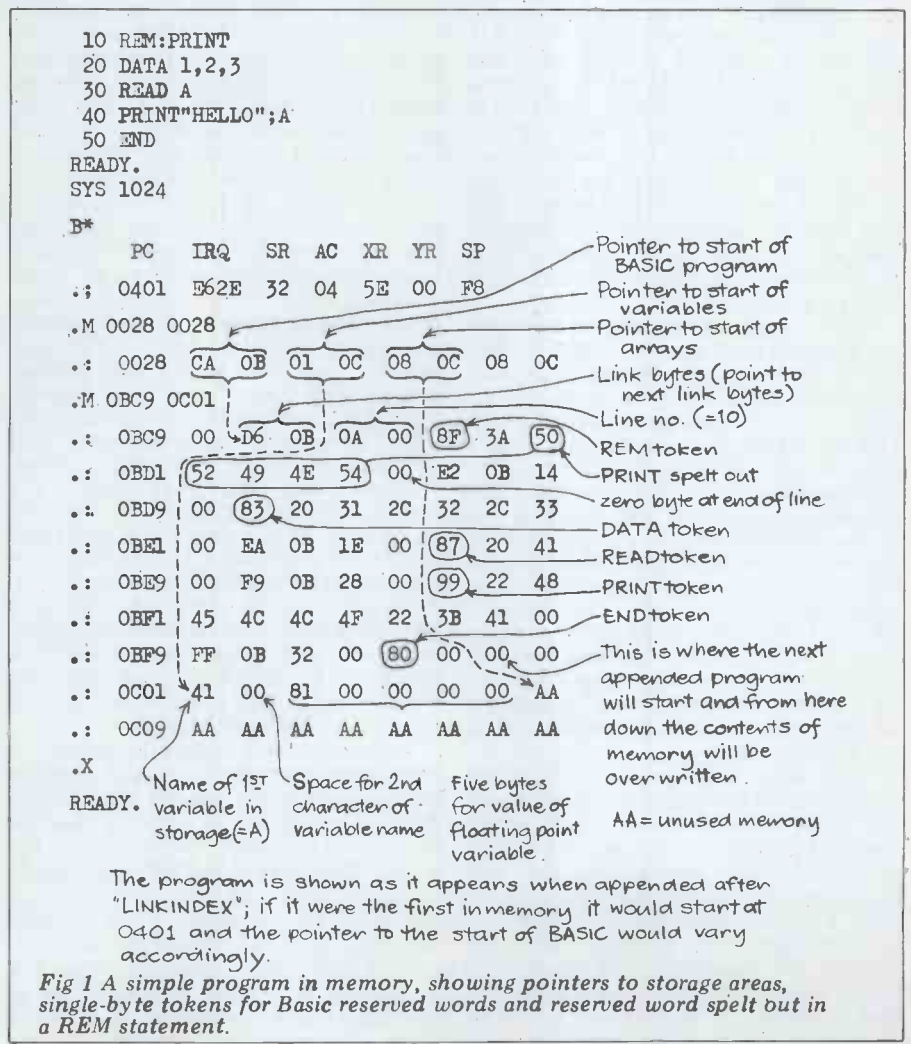

Fig 1 A simple program in memory, showing pointers to storage areas, single-byte tokens for Basic reserved words and reserved word spelt out in a REM statement.



256\*PEEK(43) gives the beginning of the storage area for variables. Subtracting 2 from this gives the decimal start address for the next program to be entered. This principle is used in the method which will be described next.

The direct method is useful but it is much better to use a control program which selects the game or working program required by number from an index. The various start addresses are held as DATA statements and are POKEd under program control. It is important to make provision within each program for returning to the control program when the game is finished. This necessitates the addition of the following line to each of the programs used (with the line number amended as appropriate).

Leaving the program via the statement

```
2900 POKE 40, 1 : POKE 41, 4 : RUN.
```

will cause the index to appear ready for a further selection to be made.

The control program which follows is essentially in four parts: lines 10 - 290 form and operate the index to the working program; lines 300 - 430 POKE the machine code link routine; 440 - 640 operate it; and lines 700 - 790 delete redundant lines when the compendium is complete.

The index comes into its own once the other programs have been assembled but since this is the object of the exercise its operation will be explained first. When complete, lines 30 - 70, 210 and 250 will be deleted and the REM in line 80 will be DATA; lines 100 - 200 will contain the names of the programs in the compendium. Each line so used will have its REM changed to a PRINT so that when the program is run the titles of the available programs will be displayed. Selection is made by number entry + RETURN in line 240; in line 200 the relevant decimal address is read from the DATA in line 80. Lines 280 and 290 prepare the two byte hex address which is POKEd into the start of Basic pointer; RUN at the end of line 290 begins execution of the chosen program.

Since games compendiums are used by inexperienced people, input protection is achieved by opening a file with the device number zero in line 160. Zero is the file number of the keyboard and the system waits until a valid input is received - pressing RETURN without entering data will not exit the program. Alpha input will return Q = 0 in line 260 and will go straight back to the input routine. If INPUT#1, Q were used expecting only numerals, then alpha input would exit the program with a 'FILE DATA ERROR' message. This input protection could be achieved with a GET statement but the routine used avoids the possibility of leaving the program due to accidental operation of the RUN/STOP key.

This does, however, make it tricky to get out of the program when required, hence the 'X' in the DATA statements. Entering '11' in response to the request for the program number will cause the system to exit the program with a 'SYNTAX ERROR in line 70', because alpha data is being read when numeric is expected. The reason for doing it this way instead of putting in a high number is that when programs containing DATA statements have been

appended, these will be read and will cause strange values to be POKEd into the start of Basic pointer. This will cause nothing more serious than a SYNTAX ERROR but will necessitate resetting the pointer, which is tiresome if it occurs repeatedly. The pointer is reset in direct mode by

```
POKE 40, 1 : POKE 41, 4.
```

Before we look at the operation of the assembly line, a brief word about the machine code link routine. This lives in the second cassette buffer and is entered afresh each time the link is used. This avoids corruption by machine code subroutines in any of the programs being assembled. The machine code uses the normal operating system subroutines to load the required program, but it discards the start address 0401H found on the program header and substitutes the end address of the program already in memory. Thus the new program neatly follows the previous ones and the correct end address is inserted in locations 42 and 43. The link bytes are adjusted but the line numbers are not changed, producing the strange phenomenon of non-consecutive line numbers where the joins occur. This does not matter because when each program is run, the start of Basic pointer is adjusted as above, so the operating system thinks it is running the first (or only) program in memory.

The 'assembly line' section of the control program consists largely of PEEKs and POKEs interspersed with PRINT statements. The purpose of these is to maintain continuity past operations which return the computer to the direct or READY mode, by printing commands on the screen and then forcing carriage returns through them. Locations 623, 624, 625 form part of the keyboard input buffer and the value 13 POKEd into these locations is a carriage return. Location 158 is the record of how much data is present in the buffer and the END statement causes the release and implementation of the number of items recorded there. It is important to note the cursor movements, as the required commands must be printed beforehand in the positions where the carriage returns will occur. Thus, it is essential that the cursor control characters and print statements are right, and that the semi-colons are in the right places.

Lines 450 and 560 PEEK the contents of the pointers to the start of variable storage area and POKE them into a protected area in line 10 where the characters ABCDEF held the necessary locations in readiness. The data held there will cause various meaningless characters and occasional key words to appear on listing the program so do not execute RETURN through this line or the data will be corrupted.

If variables are stored in this way, a new program overwrites the variable storage area when loaded and a CLR must be performed in order to reset the pointers. The beauty of it is that the compendium can be saved half-assembled, as it were, and when it is re-loaded the necessary variables will all be there ready to take up where you left off.

The SYS 826 command in line 470 is printed four lines from the top of the screen and is executed by a forced carriage return which automatically

occurs after the END statement in line 760. This command could be carried out under program control but it was decided to accomplish it under direct control by a forced carriage return. This allows the use of other append routines which may need to be called by this method. To do this it is merely necessary to replace the command SYS 826 with whatever alternative is applicable within the double quotes. Another reason for using this direct method is to ensure that the message 'FOUND PROGRAM NAME' is displayed, since this does not occur if the load is performed under program control.

When the new program has been appended, the next part of the program is implemented by an automatic carriage return through the command CLR : GOTO 500, which was printed eight lines below the SYS command. The correct start address for the program just loaded is now retrieved from its safe abode in line 10 and is POKEd into the DATA statement in line 70; a second address is calculated and placed into the REM statement in line 80. This duplication allows the selected program to be run and edited during the assembly process and allows the maximum use of memory afterwards by deleting the unnecessary lines in the control program when the assembly is finished.

In line 610 'CHR\$(19) : LIST 70-200' is printed ready for a carriage return (CHR\$(19)=cursor home) and the contents of line 630 are printed near the bottom of the screen in preparation for another carriage return which is released after the LIST has been completed. The title of the program just loaded will then be printed at the bottom of the screen.

When lines 70 - 200 have been listed, the title of the program just loaded can be added in the next available line and the REM can be changed to a PRINT. In doing this, it is essential not to alter the line length or the start addresses for all the programs will be inaccurate and will result in difficult-to-rectify SYNTAX ERRORS. Alteration can be best achieved by typing spaces over the 'R' and 'E' of REM and replace the 'M' with '?'. When listed, the line will appear to be a different length but will actually occupy the same amount of memory as all the Basic reserved words are compressed into single-byte tokens in memory and are merely expanded by the operating system during listing (see Figure 1). When entering the title, be sure to keep it within the quotes and do not delete any superfluous blank spaces - this would be disastrous.

The direct command RUN 90 will now cause the index part of the program to operate and your program number can be selected. As soon as you press RETURN, the chosen program can be run, listed and edited to your heart's content. Notice when you list it that there is no sign of the index or the link program - it seems to have disappeared entirely. This, however, is not so - it still resides, happily, just where it always was, only the pointer to the start of Basic has changed.

While editing each program that has been added, provision must be made for returning to the controlling program; the line 2900 mentioned above should be added to do this - it need not be



2900, though. If you wish to return to control during the editing process or without going to the bother of running the program, just enter POKE 40, 1 : POKE 41, 4 and listing will now reveal the entire program, additions and all. Notice that the line numbers of the appended programs are not in sequence with the main program. They can, of course, be remedied by renumbering with a Toolkit or a Renumber program but this has no real value. Incidentally, if renumbering is carried out it should only be done before appending further programs — if the number of digits changes, then all GOTOs, etc, will be affected and the length of the program will change. The Renumber routine may also eliminate extra blank spaces within program lines with similarly disastrous results to those mentioned above.

When you are satisfied that all the programs you want or have room for have been linked together, the redundant lines may be eliminated by executing RUN 90 and selecting option 12. All unnecessary lines will then be automatically deleted by forced carriage returns (this is quite fascinating to watch) and you will be left with only the index and your attached programs. A further refinement is that two lines have been added to the delete subroutine so that it can readily be used to remove blocks of unwanted lines during editing, provided these are in increments of ten by entering RUN 700. If this facility is not required, omit lines 700 and 710.

Two words of caution. The REM statements at the beginning are important; if they are omitted, other values within the program will have to be amended. It was mentioned above that the ABCDEF in line 10 changes after the program has been run because

it contains the values of certain variables. Take care not to execute RETURN through this line because this will corrupt the data, not all of which is visible when the program is listed. The other thing to notice is that the first colon in each of lines 40 and 50 has been replaced by REM; this is intentional as these lines only need to be executed once. Do not RETURN through these lines in this condition as the Basic keywords in those lines will immediately expand from token form to letter form and will take up more program space, rendering the DATA statements inaccurate.

If you wish to experiment with the program, these lines may be reset by deleting these two REMs and inserting the original colon in their place. Line 10 may also be reset to ABCDEF

— in fact it is a good idea once the extra lines have been deleted to put it back to that form for safety's sake.

One further thing worth mentioning is that if any unwanted items of DATA remain in line 80 they must not be deleted, for the reasons already given. Instead, change the first block — which is unused — to Xs. Then, if a number higher than the available options is entered, the program will merely terminate with a syntax error and can easily be re-started by RUN. Omit line 111 when keying in the program.

Old ROM users may use the accompanying program in conjunction with either the Programmer's Toolkit or their own append routine. The machine code routine given will not work on old ROMs, so here's a complete list of amendments for old ROMs:

*For full listing see 'Programs'.*

Line No.	
30	change Y = 1177 to Y = 1179
30	change PEEK (42) to PEEK (124)
40	change PEEK (43) to PEEK (125)
280	change POKE 41, W to POKE 123, W
290	change POKE 40, etc. to POKE 122, etc.
300 — 430	omit
Change 440	to 440 POKE 113, 143 : POKE 1144, 143
450	change PEEK (42) to PEEK (124)
460	change PEEK (43) to PEEK (125)
520	change -1610 to -1612
650	change POKE 1244, 131 to POKE 1246, 131
720	change 190 to 70
740	change CR = 21 to CR = 9
760	change POKE 158, CR to POKE 525, CR
Change 770 to 790	FOR J = 0 TO CR - 1 : POKE 527 + J, 13 : NEXT : END
780	omit
790	omit

# Personal Computer

## World

### FEATURE INDEX

Index to current volume. (Previous volumes were indexed in March and April 1980 and January 1981.)

#### Benchtest

Transam Tuscan	4-1
Vector Graphics VIP	4-2
Onyx C8002	4-3
Bigboard	4-3

#### Series

Secrets of Systems Analysis	4-1,2,3
Gateways to Logic	4-1,2,3
Computer Games	4-1,2,3
Face to Face	4-1
Printer Interfacing	4-1,2,3
Microchess	4-1,2,3
Multi-user Systems	4-1,2,3
Sub Set	4-1,2,3
Patterns	4-2,3,

#### Evaluations

MTU PET Music Board	4-1
MTU Instrument Synthesis package	4-3

#### Calculator Corner

Casio Routines	4-1
More Casio Quirks	4-2
HP 34C review	4-3

#### Hardware Projects

ZX80 Printer	4-2
Auto level control	4-3

#### Special Features

Printer Survey Update	4-1
MAVIS — Aid for Handicapped	4-1
Model Train Control System	4-1,2
Data Tape Recovery	4-1
The Last One (Program-writing system)	4-2
Punter's PET	4-2
Unix operating system	4-3
Data compression	4-3
Commons Report	4-3

#### Programs

TRS-80 Four in a Row	4-1
TRS-80 Target Practice	4-1
PET Convoy	4-1
PET Wire	4-1
PET Maze Chase	4-1
PET Android Attack	4-1
PET Anagram	4-1
PET Obstacle Course	4-1
PET Greenfingers	4-2
ZX80 Bumper Bundle (3 programs)	4-2
PET Brick Stop	4-2
TRS-80 show jumping	4-3
PET Grand Prix	4-3
PET aircraft landing	4-3
PET Bouncy	4-3

## Lowest Prices Yet! Memory Chips

Guaranteed quality – Any faulty chips should be returned to us within 12 months of purchase with proof of purchase for replacement by return of post.

### 4116 and 2114 chips at the same price

4116 dynamic memory chips guaranteed to 200 nanoseconds full cycle time. Suitable for Apple, TRS 80, Nascom, Exidy Sorcerer, Sharp MZ 80K etc (8 chips give 16k bytes of memory).

2114 static memory chips guaranteed to 300 nanoseconds full cycle time. Low power, suitable for Superboard CompuKit, Atom, ZX 80 etc. (2 chips give 1K byte of memory).

No. of Chips	Unit Price	Total Price		
		Nett	Vat	Total
2	1.80	3.60	.54	4.14
8	1.70	13.60	2.04	15.64
24	1.60	38.40	5.76	44.16
100	1.40	140.00	21.00	161.00
500	1.30	650.00	97.50	747.50
1000	1.25	1250.00	187.50	1437.50

Official orders welcome. Post and Packing free:  
24 Hr Telephone Credit Card Orders 051-236 0707



Mail orders to:  
MICRODIGITAL LIMITED  
FREEPOST (No stamp required)  
LIVERPOOL L2 2AB



Retail Premises at:  
25 BRUNSWICK STREET,  
LIVERPOOL L2 0PJ.  
Tel: 051-227 2535/6/7

# MICRODIGITAL

# 6502 Books at Microdigital

### Programming the 6502 – R. Zaks

This book is an educational text designed to teach programming, using the 6502. It does not require any prior programming knowledge, yet can be used to advantage by anyone wishing to familiarize himself with the 6502. An invaluable book for owners of the PET, Apple, Kim, etc. **8.70**

### 6502 Applications Book – R. Zaks

This book presents practical applications techniques for the 6502 ranging from a complete home alarm system to an industrial control loop for temperature control. Also includes analog to digital conversion and simple peripherals from paper-tape reader to micro printer. **8.70**

### 6502 Games – R. Zaks

A book of ten games which will teach you assembly language, algorithm design and data structures in a straight-forward and enjoyable manner. **8.90**

### Programming a Microcomputer (6502) – Foster

This book will teach you how to program a microcomputer in machine language. Although designed specifically for the 6502 microprocessor used in the Kim 1, PET and the Apple. The basic principles involved apply to all computers. **7.20**

### Practical Microcomputer Programming The 6502 – Weller

This book examines the detailed assembly level programming characteristics of the 6502 microprocessor and includes appendices giving an assembly listing of the assembly program (6502 Resident Assembler) an assembly listing of Apple II input/output subroutines for the assembly computers and assembly listing of the D-Bug program for Apple II. A very comprehensive reference book. **19.50**

### 6502 Assembly Language Programming – Leventhal

Another fine manual in the Osborne Assembly Language series to join the best selling 8080, 6800 and Z-80 books. **10.45**

### 6502 Cookbook – R. Findley

Various component programme units given may be combined at will, and these recipes will help you to explore some of the possibilities available. **7.70**

### Programming and Interfacing the 6502

An excellent starting point for 6502 micro-computer novices, who need experience in assembly language programming or chip-level interfacing. Examples are shown using a KIM, AIM or SYM system. **8.90**

### 6502 Software Design – L. Scanlon

Fundamentals of 6502 operation are explained and then extended to give a comprehensive coverage of 6502 use. **7.90**

Past and Packing free. No VAT on Books. Bona Fide official orders welcome.

I enclose cheque/P.O. for: \_\_\_\_\_

Name \_\_\_\_\_

Address: \_\_\_\_\_

Post Code \_\_\_\_\_

Goods required \_\_\_\_\_



24 Hr Telephone Credit  
Card Orders 051-236 0707



Mail Orders to:  
MICRODIGITAL LIMITED  
FREEPOST (No Stamp required)  
LIVERPOOL L2 2AB



Retail Premises at:  
25 BRUNSWICK STREET  
LIVERPOOL L2 0PJ  
Tel: 051-227 2535/6/7

# MICRODIGITAL

## BUTEL-COMCO

### RP1600 Daisywheel Printer

60cps!



List Price:

**£1450**

(excluding VAT)

- Price includes an interface
- Interfaces available are  
Serial V24/IEEE/Centronics/Qume/Hytype
- Trade/OEM discounts available

Write or call for further information

Butel-Comco Limited  
50 Oxford Street,  
Southampton,  
England SO1 1DL  
Telephone 0703 39890  
Telex 47523

**BUTEL**  
Technology for business

I am interested in purchasing the RP1600

for connection to \_\_\_\_\_

Name \_\_\_\_\_

Company \_\_\_\_\_

Address \_\_\_\_\_

Telephone \_\_\_\_\_



Malcolm Peltu reviews history books and an invaluable treatise on legal protection, while Peter Turk reports on a clutch of ZX80 offerings.



## Pascal and Ada: the intimate truth

*The Making of the Micro* by Chris Evans is a wonderful book. It is enjoyable, informative and attractively produced. Unfortunately, Evans died before the manuscript had been completed and so it is incomplete. It is more aptly described by its subtitle, 'A History of Computers', because it does not develop the background to microelectronics with the same blend of vivid historical perspective and technical progress that is applied to the development of computing systems from the abacus to the mainframe.

This, however, should not detract from the contents and the thoughtful editing work by Anne Charlish.

The basic text is similar to the first part of Evans' best seller and TV series, *The Mighty Micro*, with added biographical details of major contributors to the development of computing and some fine illustrations.

*The Making* is a treasure trove of anecdotal gems which identifies many of the strands that have been woven into the tapestry of computing history. This personification of the past brings history to life and sustains interest while major practical and philosophical ideas and technologies are described.

For example, one of the most important early computing figures was the French mathematician and philosopher Blaise Pascal, who designed the first significant calculating machine in the 17th century, called the Pascaline. In addition to describing and illustrating the Pascaline and placing it in the context of developments in automatic calculating machines, Evans provides an insight into scientific thought of the time.

Evans demonstrates that the inter-linking of personal characteristics with mathematical and philosophical ideas and contemporary technology are central to the historical developments that have culminated in the current micro-based information technology revolution.

Of course, you do not need to know about the history of computing in order to program your micro. But the understanding of how the micro could change society and industry is enhanced through an insight to the most significant aspects of the technology, which is not how a silicon chip is fabricated but how information is processed.

The dangers of trying to explain information technology primarily in electronic terms is illustrated in the latest Department of Industry (DoI) publication in its Microelectronics Awareness Project, *Microprocessors: A Short Introduction* by Eric Morgan of the DoI.

Surprisingly, this book has been recommended by a number of publications for its supposed lack of jargon. I find it confusing, dull and packed with unnecessary and at times misleading esoterica. It is aimed at the non-

electronics engineer, designer and executive. So why does it begin with a statement that would have most meaning to someone with electronic training: 'The electronics elements used in integrated circuits — transistors, capacitors, resistors — do not differ fundamentally in function from those used before the advent of microelectronics'?

The book is packed with diagrams of microcomputer boards that are of interest primarily to electronics engineers or those actually implementing systems. In losing itself in RAMs and ROMs and circuits, it fails to provide a real perspective on the applications to which they could be applied and how they should be exploited within a system.

The emphasis on the micro, which is a component in a system, gives the DoI work a false orientation, as if there are innate magical properties in mere use of the micro. Yet there is continual confusion over the word 'microcomputer', which encompasses everything from the microprocessor in a sewing machine to a fully-fledged business data processing microcomputer. The section on data capture and recall lumps together micro-controlled machine tools, word processors and a hand-held data entry device, while failing to point out that 'recall' functions could involve complex information retrieval software. The section on distributed systems multiplies this confusion. The ICL Distributed Array Processor is mentioned in the same breath as a network of 'loosely-coupled' personal computers' confusing the use of a number of microprocessors within the architectural design of a particular processing system with distributed processing involving many independent computers and terminals.

This confusion is indicative of the way the government and mass media's obsession with the micro has focused on the component rather than on the system. It is like trying to explain the impact of the wheel on industry through detailed examination of the structure of the wheel rather than the transport systems in which the wheel is a component.

The DoI publication is also part of a propaganda campaign and thus fails to fully explore the negative effects of badly-designed systems. In its enthusiasm to convince British industry to use microelectronics, Morgan poses a false binary choice for the future: 'Firms can accept microelectronics and reap the benefits or they can ignore it and expect to reap the whirlwind.'

It is time that the government tried to place the micro in perspective, to provide more guidance on what can go wrong as well as what can go right — and stop trying to hone everything down into a silicon straightjacket.

Although *The Making of the Micro* does not attempt to provide a practical reference guide, it illustrates more accurately the nature of the technology that poses such a threat or such an opportunity to Britain. Its personalised approach illustrates the wide range of

concepts and techniques involved. There are mathematicians and logicians such as Pascal, Leibnitz, Boole, Bertrand Russell, who have provided the theoretical framework that has been exploited by engineering visionaries such as Charles Babbage, Herman Hollerith, Vannevar Bush, Konrad Zuse, and many other early computing developers of the transistor, Bardeen, Brattain and Shockley but their important invention only has meaning in the context of computing and other information technology developments.

In addition, *The Making of the Micro* illustrates how chance, personal ingenuity and government backing (or lack of support) can influence technological and therefore national and international developments. For example, Germany twice had the chance of leading the world in computing. The first time was in 1679 (over a hundred years before Charles Babbage in England defined his Analytical Engine, which was the first design for a programmable computer). Gottfried Leibnitz developed the binary system of notation and a calculator which could do multiplication in a more efficient way than the Pascaline. His calculator, however, used decimal arithmetic, which meant that it relied on the use of complex, interconnected cogs. He did not, however, link the binary concept to the calculating machine. Instead he became obsessed with trying to prove the existence of God using binary logic. He suggested that the number 1 represented God and 0 the empty universe. From this he developed a 'proof' which converted the Chinese Emperor!

If Leibnitz had put his binary theory to work in conjunction with his calculator, he could have overcome the engineering problems involved in developing cogs for decimal calculations. The result, speculates Evans, could have been giant steam-driven computers in the 19th century with the Industrial Revolution starting 50 years ahead of its time, and in Germany rather than Britain. It was only the personal eccentricity of the inventor which meant that Germany missed a footing on the computing ladder.

Almost 300 years later, it was the personal arrogance of Adolf Hitler which prevented Konrad Zuse from getting the backing that could have turned his inventions, the Z computers, into the first fully-fledged electronic computers. In 1940, Hitler thought the war was nearly over so he did not back Zuse's plan because it would have taken many years of development. The war, however, gave a major boost to computing in the UK and US. At Bletchley Park, the Colossus code breaker had a decisive role in winning the war, while in America, John Presper Eckert and John William Mauchly of the Moore School of Electrical Engineering at Pennsylvania University developed the world's first general purpose electronic computer, Eniac, designed primarily to carry out ballistic calculations.

The urgency and government backing





to experimental projects which is characteristic of periods of war found a peacetime equivalent in the 1960s when President Kennedy gave the space race top priority. This provided the stimulus and finance which created the environment in which microelectronics flourished, and is a classic example of how public expenditure can provide the basis for innovation and expansion in industry.

In some ways *The Making of the Micro* is better than *The Mighty Micro*. Chris Evans was a super-optimist and tended to exaggerate the positive possibilities of computing and micro developments, which marred some of the speculative aspects of *The Mighty Micro*.

The new book is a backward look; a placing in perspective rather than a projection into the future. As such, I would recommend it to students, users or developers of computers and to anyone who is interested in computing history: the subject should be as well known as Newton's apple or Archimedes' bath.

## Softly software

The long arm of the law has recently been delving into the sometimes murky soft underbelly of the personal computer business. Arrests, writs, High Court cases, out-of-court settlements and the other legal paraphernalia have become a regular part of the micro scene. Such legal activity has been impending for a long time. Software is becoming increasingly valuable and software products are a normal part of the computing industry. In legal terms, however, it has been difficult to pin down the definition of software in the same way as a physical product. This has made detection and prosecution difficult where there has been theft, breach of 'copyright' or other illegal acts relating to software.

Although there has been much concern about this in the traditional computing world, it has taken the mass personal computer market to bring the sharks out into the open and to lead to a spate of legal actions.

Bryan Niblett's *Legal Protection of Computer Programs* could not have been published at a better moment and, given its aim, could hardly have been any better. It is crisp, lucid and practical — rare qualities in the usually complex and confusing jungle of legal jargon.

For a non-computer expert, the book also avoids unnecessary jargon — Niblett presents the necessary technical concepts with remarkable simplicity and precision. He has managed to synthesise his expertise gained as a barrister and computer scientist (he is professor of computer science at the University of Wales) into a compact summation of the current legal position of software.

The book is a must for anyone developing software for sale. It also makes interesting reading for users of computers because it helps to clarify the liabilities of someone who has bought software from a supplier who, in turn,

has pirated it from the rightful owner.

Niblett examines the five main ways of protecting software: by patent, copyright, the Law of Confidence (breach of confidentiality), contracts and trade marks. These methods are summarised in tabular form in an appendix which briefly states the effect of each in terms of, for example, what may be protected, period of protection, remedies available and any proposals for revision of UK Law. This provides a handy reference following the detailed descriptions in the body of the book.

In a 'coda', Niblett summarises his recommendations in a legal nutshell: 'Eschew patents, assert copyright, keep novel parts of the program confidential, draft tightly-drawn contracts with licencees and select apposite trademarks to the products.'

One of Niblett's most surprising recommendations is that, as a means of protecting software, the existing copyright laws have been greatly underestimated. 'Many of the lawyers who advise computer companies are not conversant with copyright law, a specialist subject with which the average industrial lawyer is unfamiliar. Many of the doubts about adequate protection for programs would be removed if the present law were better understood by the legal adviser.' This is a surprising conclusion because recent publicity about software copyright has tended to focus on the inadequacies, rather than the potential, of existing legislation.

Niblett does not claim that the current law is satisfactory and discusses the areas in which it needs clarification. But he does explain how the Copyright Act could be exploited, despite the fact that it was passed in 1956 before the significance of software was appreciated. In fact, the Act does not refer to software at all.

The protection, however, comes as a 'literary work' for the programs and documentation and 'artistic work' for flowcharts and diagrams. Although these are strange classifications, Niblett believes they confer protection against a wide range of acts, such as the unauthorised reproduction or publication of a program. It does not, however, cover the unauthorised use of a program, provided that, for this purpose, the program is not 'reproduced in any material form'. This appears to be a major loophole which could invalidate all the other protections and arises from the position of a program as a 'literary' work. It is obviously not an infringement to 'use', ie read, a literary work.

But Niblett argues that this loophole can be closed. In practice, he points out, it is unlikely that a program could be used to run a computer unless, at some stage, it is reproduced in material form, which would be a restricted act.

Another area of concern about copyright protection is that detection of infringement could be difficult. Once again, however, Niblett believes that the problems have been overestimated and that the nature of what has to be revealed in order to exploit the program 'may point unerringly to the infringing use of

the proprietary product.'

He also suggests that programs could be seeded with deliberate errors, or with routines that perform no function, in order to identify the origin of the program. The whole question of copyright laws in the UK is being revised and a Government Green Paper is expected shortly.

Any new legislation is likely to draw on the work of the Whitford Committee which presented its report in 1977. This Committee was strongly in favour of providing clear and effective protection of computer programs against copying but within the framework of the current classification as 'literary' and 'artistic'. A majority of the Committee was also in favour of protecting the 'use' of a program as a restricted act.

In summary, Niblett is in favour of using copyright as a major means of protecting software because it is cheap, quick and simple to implement with a wide range of remedies for infringement and with the protection automatically extended to all countries who are parties to international conventions.

No expense is involved in creating or maintaining copyright. As soon as the program is written down, the copyright subsists in the author without any formalities and costs of registration. The patenting system, in contrast, is expensive, cumbersome, complex, uncertain and does not automatically provide worldwide protection. That is why Niblett recommends readers to 'eschew patents.'

Patenting is aimed primarily at providing an inventor with monopoly rights over the invention for a limited period in return for public disclosure of the invention. The Patent Act of 1977 sets the main conditions before providing a patent: the invention must be new and involve an inventive step; it must be capable of industrial application; and it must not belong to a list of activities that are explicitly excluded from protection.

And one of the items excluded is 'a program for a computer'. So why even bother considering patenting as an option? With a logic that baffles the average mortal but is second nature to legal eagles, Niblett explains: 'What would clearly be excluded is a computer program *per se*, for example, a sheet with a program printed on it. What would as clearly *not* be excluded is an invention which includes a computer program, for example, a novel industrial process in which a program forms a part but not the whole of the novelty.'

Under the previous act, there were a few cases in which programs were patented on this basis. It was considered that a program could be likened, for example, to a cam on a lathe which controlled the operation of the machine.

Despite the loophole through which programs could be patented, Niblett says that only 'a very small proportion' of programs could hope to be patented. Finding out about the patentability of a program involves a fee of at least about £2000 to cover the search that has to be undertaken to ensure that the invention





is new and involves an 'innovative step'. An innovative step is defined as one which is not obvious to a person skilled in the art. As Niblett points out, it would be hard to justify this for a program, as most of the programming steps use standard techniques and algorithms. In other European countries, it is clear that the aim is to exclude all programs, so any UK program patent is no guarantee that it will be of any value in different countries.

These and other descriptions of the intricacies and nuances of the law are discussed by Niblett in a way which manages to be both comprehensive and brief.

He includes descriptions of many cases relevant to the protection of the programs. The main weakness of the book, however, is that it cannot be updated to include the many new cases that have been coming to light on the personal computing scene. This, of course, could be rectified in a future edition.

The book, however, is an invaluable aid in helping to put current cases in perspective and provides a concise reference guide to anyone developing a program and concerned about safeguarding the intellectual and financial investment in the software.

This month's Bookfare included:

*The Making of the Micro* by Christopher Evans (Gollancz, £5.95)

*Microprocessors: A Short Introduction* by Eric Morgan (Department of Industry, £5.00)

*Legal Protection of Computer Programs* by Bryan Niblett (Oyez Publishing Ltd, £10.00)

## TECHNICAL REVIEWS

by Peter Turk

*Thirty Programs for the ZX80 1k* (Melbourne House, £6.95.) (ISBN 0 86161 100K0)

As its title indicates, this book contains 30 programs, which can (just) fit into

the 'unadorned' 1k ZX80; unfortunately it contains very little beyond the listings, in particular, none of the comments, explanations and helpful hints that make Tim Hartnell's book (see below) such a good buy in comparison. Having said that, its Gcmoku plays a good, though heavily defensive, game and the others have good, visually entertaining features.

Without adequate comments, some beginners are going to be thrown by the pyramid, which represents a space, and instructions like G\*O T\*O, which invite seven key depressions instead of one. A sprinkling of printer's errors will not make life any easier for users of 'canned' programs such as these.

A number of useful subroutines are included such as Line renumber, Bubble sort, and Machine code which is, in fact, a hex loader. It's a pity, though, that this last program doesn't include a routine to display the memory as hex rather than as decimal.

All in all, this book is bettered, both in quantity and quality of programs as well as in price by Tim Hartnell's offering, while those who want to know more about the ZX80 are best catered for by *The ZX80 Companion* (see below).

*The ZX80 Pocket Book* by Trevor Toms. (Phipps Associates, £4.95) ISBN 0 950 7302 0 3

This book is written for 'the experienced programmer who wants a concise summary of the unique characteristics of this machine' — the raw beginner is thus warned off!

For the user it's aimed at, it lives up to its promise, the most valuable features being one-page summaries of the Basic command set and Z80 op-codes in assembler, hex and decimal. It contains 13 program listings, five of which need 2k RAM or more.

All the suggestions are both practical and sensible, though it's a pity that some aren't carried through into the author's own code.

*The ZX80 Companion (Second Edition)* by Bob Maunder, Terry Trotter and Ian Logan. (Linsac, £10.00.) ISBN 0 907211 003.

A subtitle to this book is 'The Monitor Revealed' and it clearly sets out to emulate the quality and success of Nick Hampshire's *The PET Revealed*. If you

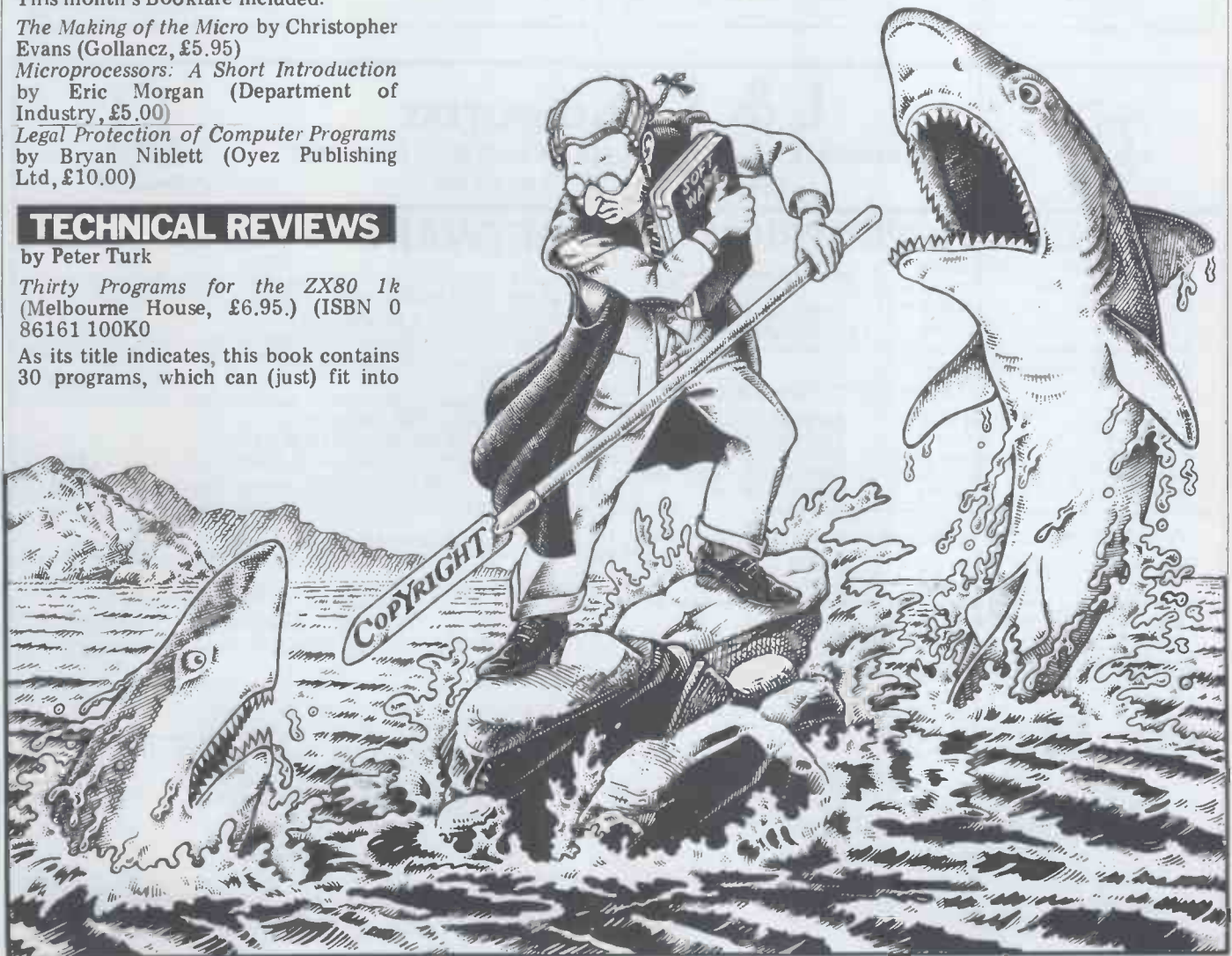

Illustration by John Storey

# We're showing off again in Cambridge!



TRS-80 Model I & II  
 Apple II & III  
 North-Star Horizon  
 Communicator  
 Commodore Pet  
 Daisy-wheel printers  
 Computer books



Acorn Atom  
 Hewlett-Packard HP85  
 UK101 kit computer  
 Sharp pocket computer  
 Wordstar/Datastar  
 Plotters/digitisers  
 Electronic components

First time buyer or experienced user? See what's best in microcomputers today — a comprehensive selection from £100 to £10,000, all generally on demonstration and available from stock. Take this opportunity to choose your ideal system, with the active help of our team of computer professionals.

Interested in microcomputers? — then we've got the Show for you at:

## Cambridge Computer Store

1 Emmanuel Street Cambridge CB1 1NE  
 Telephone: (0223) 65334/5

Mon.—Fri: 9.00 to 12.30, 1.15 to 5.30. Sat: 9.00 to 5.30

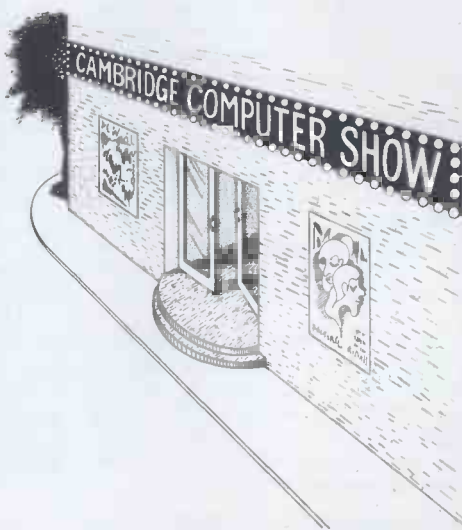

# L & J COMPUTERS

3 CRUNDALE AVENUE, KINGSBURY NW9 9PJ 01-204 7525  
 THE "PET" SPECIALISTS



## NEW LOW, LOW 'PET' PRICES!!

### AVAILABLE FROM STOCK

Pet 8K (large keys) £420 \*  
 Pet 16K £499 \*  
 Pet 32K £630 \*  
 Ext. cassette decks (+ counter) £55 \*  
 8032 (80 col. screen; new keyboard)

TRY US!  
 YOU WILL NOT BE  
 DISAPPOINTED

### SUPERPETS NOW EX-STOCK!

<b>Printers</b>	<b>Disc Drives</b>	<b>Sundries</b>
PET 3023	PET 3040	Tool kits: library cases
PET 3022	Compu 400K	Disks: C12 cassettes
Centronic 779	Compu 800K	Paper (roll & tractor feed)
Spinwriter	Interfaces	Labels: Dust covers

Petmaster Superchips — upgrade your pet even more! £45  
 Toolkits — £29 for 4032 & 8032 £35

The 'MUPETS' are HERE!  
 3 to 8 PETs only need 1 DISK DRIVE . . . .  
 Daily demonstrations: Ring for details.



COMPLETE SYSTEMS  
 FROM £1700!!

THE ESTIMATES WE SUPPLY & INSTALL ARE COMPLETE  
 ESTIMATES GIVEN FREE WITH NO HIDDEN EXTRAS:  
 FULL BACK-UP: GUARANTEED EXPERTISE.

\*PRICES DO NOT INCLUDE VAT

## SOFTWARE

As well as a full range of Petsoft and Commodore Software, we have some highly reliable "Home-Brewed" programs available.

**STOCK CONTROL & INVOICING** £60  
 (Handles up to 500 items — 32k) (80 on 16K): Stock depleted on invoicing, search etc. Cassette, disk (& colour print option).

**CASH BOOK** £90  
 Enter daily/weekly amounts printout and totals, weekly monthly analysis, totals and balances.  
 (4032, & 8032 Versions £110 & £120.

**MACHINE HIRE Typewriter & Plant Hire** £420

**STOCK TAKING Cuts out all the hard work** £230

**OUTSIDE SERVICES (For Mini-Cabs etc.)** £220

See for free software booklet

### SPECIALISTS IN:

Commodore Business Programs: Superpay;  
 Bristol Trader, Item & Monitor: Word Processing.

SPECIALISED SOFTWARE APPLICATIONS  
 UNDERTAKEN. RING FOR DETAILS

### 2 FOR JUST OVER THE PRICE OF 1!

We now have limited stock of new cassette decks with a built-in counter/soundbox for PETS!  
 At ONLY £65\*  
 Orders dealt with in strict rotation.

PERSONAL SHOPPERS WELCOME  
 Phone & Mail Orders accepted.

ALL GOODS SENT SAME DAY WHEREVER POSSIBLE  
 LARGE S.A.E. FOR LISTS ETC.







want to know about the 4k ROM monitor, then this is the book for you. Its coverage of both tables and routines is both accurate and detailed and I hope that when the 8k ROM is eventually released a third edition will quickly appear on the scene. By the way, be careful when buying this book; there was a first edition which didn't contain details of the monitor and was deficient in certain other respects.

You may think that £10 is a bit steep for this book; the one all-redeeming feature that justifies it for me is the ability to move RAMTOP to protect machine code from corruption by the stack, something taken for granted by owners of more expensive machines.

If you have a 4k ROM version of the ZX80 and want to know it inside out, this is the book for you.

*Making the Most of your ZX80* by Tim Hartnell. (Computer Publications Unit, £5.95) ISBN 0 907442 00 5.

If, in any sense you are a beginner to programming or computing, this is undoubtedly the book to read. Full of insight, witty, sensible and extremely funny, it eases you into programming

practically from the word go. Its attractive presentation is complemented by games that beg you to improve upon them, with text that has a racy but very informative style, obviously aimed at kids of all ages. The problem for me was to borrow the book long enough from my son (aged eight) to review it! Of the 40-odd programs, my favourites were Frustration, a (literally) maddening game, and Frenzy, a very similar speed game. Like other books reviewed here, there are a few printing errors and/or bugs, but, unlike them, it provides a lively stimulus to correct them. If you have bought a ZX80 for your children, buy this as well. Don't be afraid that the new 8k ROM monitor will date the programs — it has a page (new ROM/old ROM) on converting them.

*Learning Basic with your Sinclair ZX80* by Robin Norman. Soon to be published by Newnes Technical Books.

When Newnes heard about our special ZX80 book reviews they rushed us printers' proofs of their forthcoming offering on the subject. It is a teaching text, designed as a first exposure to computing for younger readers, say up

to school-leaving age. It's drawn from teaching experience and is competently written with its 25 short chapters building up to a thorough treatment of the ZX80's 4k integer Basic. A lot of short two-to-four page chapters could have added up to an unstructured text; in fact this approach is one of its strengths, you can digest small or large chunks to your taste.

Good features stand out — short summaries in each chapter reinforce what has (hopefully) been learnt; Mickey Mouse (in Walt Disney's *Fantasia* as the Sorcerer's Apprentice) is used to illustrate the computer's Tom-like attributes ('Totally Obedient Moron' to you) — a still from the film would have been nice to press home the point.

At the time of review the book had no information about the new ROM. We told Newnes that an appendix should be added, they promptly held up production of the book to add exactly that. The book was good; this addition makes it excellent.

## BACK NUMBERS

PLEASE NOTE THAT THE FOLLOWING ISSUES ARE SOLD OUT  
 VOLUME 1 Nos. 4, 5, 6, 9, 10, 11, 12  
 VOLUME 2 Nos. 5, 6, 8  
 VOLUME 3 Nos. 1, 2, 3, 4  
 ALL OTHER ISSUES MAY BE ORDERED USING THIS FORM.

Volume 1 No. 1 May 1978  
 Mascom 1/77-68: The Mighty Micromite/A charity system

Volume 1 No. 2 June 1978  
 Research Machines 380Z/Computer in the classroom/The Europa Bus.

Volume 1 No. 3 July 1978  
 Buzzwords — A to Z of computer terms/Pattern recognition/Micro music

Volume 1 Number 7 Interfacing PET to X-Y Plotter/Structured Programming/Programming Decision Tables

Volume 1 No. 8 December 1978  
 Computers and Art/3-D Noughts and Crosses/Mickie — the interviewing micro.

Volume 2 No. 1 May 1979  
 Small computers for small organisations/Sorcerer graphics/Chess Programming Hints/Parkinsons Revas.

Volume 2 No. 2 June 1979  
 MSI 6800/Witbit — disassem-

ble your programs/The Multilingual Machine/Polytechnical Processing.

Volume 2 No. 3 July 1979  
 Vision link: Interfacing and Software for the Superscamp VDU/Pet Preening/Extended cursor graphics for the TRS-80.

Volume 2 No. 4 August 1979  
 The North Star Horizon/High Speed Cassette Interface for the SWTP 6800/Garage Accounting program/Apple Medical Application.

Volume 3 Number 5 May 1980  
 Benchtests — TI 99/4, Altos ACS-8000-2, HP-85/West Coast Faire report.

Volume 3 Number 6 June 1980  
 Benchtests — TRS-80 Model II, Periflex 630/48/Stringy Floppy Checkout/CompuColor Case Study

Volume 3 Number 7 July 1980  
 Benchtests — Acorn Atom, DDE SPC-1/Animistics

—Humanoid Micros/Sharp PC 1211 review

Volume 3 Number 9 September 1980  
 Benchtests — BASF 7120, CBM 8032/Hi-Tech Colour Board Checkout/Portable Basic

Volume 3 Number 10 October 1980  
 Benchtests — DAI Personal Computer, Atari 400 and 800/Robotics/3D Graphics/Program 'Tuning'

Volume 3 Number 11 November 1980  
 Benchtest — SBS 8000/ComputerTown UK! — Community Computer Literacy Project/Apple Colour Graphics

Volume 3 Number 12 December 1980  
 Benchtest — Raannd SP1/Pascal Micro-Engine/Microwriter Checkout/Micro-based Toys Review

Any one issue 95p; Any two issues £1.75; Any three issues £2.50; Any four issues £3.00. All additional issues @ 50p each. Binders @ £2.95. All prices include post and packing. Cheque or P.O. payable to (PCW) Sportscene Publishers Ltd., 14 Rathbone Place, London W1P 1DE. Please allow up to 3 weeks for delivery and don't forget to state clearly your name and full address with your order. Please send me the following copies of PCW. I enclose a cheque/P.O. for £

Volume 1				Volume 2						
1	2	3	7	8	1	2	3	4		
<input type="checkbox"/>	<input type="checkbox"/>	<input type="checkbox"/>	<input type="checkbox"/>	<input type="checkbox"/>	<input type="checkbox"/>	<input type="checkbox"/>	<input type="checkbox"/>	<input type="checkbox"/>		
Volume 3								Volume 4		
5	6	7	9	10	11	12	1	2	3	
<input type="checkbox"/>	<input type="checkbox"/>	<input type="checkbox"/>	<input type="checkbox"/>	<input type="checkbox"/>	<input type="checkbox"/>	<input type="checkbox"/>	<input type="checkbox"/>	<input type="checkbox"/>	<input type="checkbox"/>	

Name \_\_\_\_\_

Address \_\_\_\_\_

\*Tick appropriate boxes

# AN EXCHANGE OF VIEWS

by Ian Lloyd, MP

At the conclusion of my previous article (March PCW) I referred to a number of encouraging developments in Information Technology at Westminster, in particular to an important speech by the Secretary of State for Employment, the Rt Hon James Prior, to the Parliamentary & Scientific Committee. I was delighted to discover that Jim Prior was showing such a close interest in this subject but I disagreed profoundly with a central premise of his argument, that microelectronics was just another technical revolution like steam, the petrol engine or the electric motor. As he invited those who disagreed to put their case, I did so. Here is my letter and his reply. I hope that these will stimulate a wider and important debate, perhaps through the pages of *Personal Computer World*.

## A LETTER TO JAMES PRIOR

May I first congratulate you on your interesting address to the Parliamentary & Scientific Committee on November 18. I am sorry that I was unable to attend or listen to the subsequent discussion which may conceivably have covered some of the points that I discuss in this letter. Before doing so, however, may I also say how very pleased I was to be able to conclude, on the *prima facie* evidence of your paper, even more so than on the rather less convincing bout of name-plate changing elsewhere in Whitehall, that an impressive change has occurred within the last few months in the Government's attitude to information technology and its broad significance for the country. I am reminded of one of the more legendary exchanges between the actress and the bishop — 'I never knew that you cared'!

Frivolities apart, I have two main reasons for writing. The first is to say that I agree generally with the vast majority of your conclusions and welcome the Government's decision to exempt the MAP and other training and familiarisation programmes from the current budgetary austerity. That decision is, in my opinion, correct and fully defensible. If the OECD report on 'Technological Change and Economic Growth' means anything, it

means that the West will not escape from its present dilemma by reducing R & D still further, and most especially not in this area. I also welcome your broad optimism about the scale of industrial opportunities and the employment associated with them. I recognise the scale of the political, social and economic problems associated with these changes and respect the formidable power of the forces which have resisted and will continue to resist change. After all, it has taken us 15 years to put Parliamentary Questions on a computer in the House and the answers will doubtless require several more. But that brings me to my second reason, which is where we disagree and where, I think, our disagreement reflects a somewhat different level of involvement in this issue over the years. It is summarised in paragraphs 4 and 5 on Page 2 of your speech in which you state:

'Those who take the view that this technology is going to change our industrial and commercial structure radically over the short-term are in effect discounting our historical experience. All major technological breakthroughs (the printing press, steam engine, internal combustion engine, electric motor) have taken considerable time both to establish themselves and to give rise to unforeseen opportunities in providing new goods and services. I know it is argued that somehow this technological revolution is different and that its effects will be seen this time much more quickly. But such a view runs counter to all our previous experience.'

'Surely the onus ought to be on those who hold the view that it is going to be different this time, and to have that view rather than those who are following the historical and economic evidence available.'

I accept that onus and believe that it may be help-

ful if I state why I take the view that we are facing not merely another rather more powerful piece of technology, such as the printing press or electric motor, but a new influence on human affairs and activity which is of a different order of magnitude and significance. Indeed I believe that many of our present woes are, and will increasingly come to be seen to be, the direct result of our failure at many levels to appreciate this distinction and to gear our response and policies accordingly.

First, the universal availability of the computer made possible by microelectronics represents the *first* occasion in human history when an intellectual revolution has been associated with an immediate, dramatic and significant enlargement of *intellectual* power. Hitherto it is human *muscle* which has benefitted; this time it is the brain. That has never happened before. There are no historical precedents by which we can be guided as to the consequences.

Second, although the application can be and is generally costly, the consequences of a virtually unlimited capacity to measure, memorise, analyse, apply and store information will involve a transformation of the very basis of human activity, which has hitherto been limited, even in advanced industrial societies, to the amount of administrative and industrial routine and repetition which 90 per cent of the population even of such societies has been able to organise and willing to endure. There is now no reason why any process or activity which can be logically defined should, in future, require the continuous physical or intellectual involvement of human beings beyond the stage of definition and construction of the computer-controlled system required to achieve this objective.

Third, the capital invest-

ment required for each piecemeal application of microelectronics, is generally a very small proportion of that required to develop it. The product, in essence a brain of incalculable power and sophistication by comparison with anything that has appeared before, is incredibly cheap and has the capacity to transform, again by orders of magnitude, the versatility, applicability and power of industrial processes or products or the sophistication, relevance and flexibility of administrative or commercial systems.

Fourth, the human skills which had to be developed to take advantage of printing, steam or electricity could not be delegated to any form of inanimate object or system. Those required to benefit from microelectronics can be so delegated in the most remarkable fashion and they will be applied, universally, by those who, at least in the early stages, have neither the capacity nor the inclination to distinguish between a Josephson junction and a thyristor.

Fifth, since telecommunications of all kinds represent an area in which microelectronics finds a particularly potent and productive application, the new technology will underwrite, as it were, its own exponential dispersion at a speed which will exceed, once again by orders of magnitude, the development and diversification of printing, steam or electricity.

Sixth, the arrival of microelectronics has coincided with the arrival of other technologies of great power, such as fibre optics and the laser, which in themselves extend its potential and reinforce the incentives to apply it in ways for which no precedent can be found in any earlier technology.

Seventh, I can find no precedent in the earlier development of any technology, for the universality of application on the scale which microelectronics now appears to offer. Even electricity allowed the survival of some forms of competitive energy. Microelectronics will allow none except where the exclusion is a result of deliberate human decision, ignorance, obstruction or sheer poverty of imagination.

These are some of the reasons why I believe that we are 'in a completely new ball game'. The implications for policy are vast and far-reaching. We have much



less time than we imagine in which to anticipate, adjust and adapt to events and trends which can already be discerned. I believe that those who sense, even if they cannot describe, an impending transformation of human organisation and affairs of quite staggering proportions and significance are right, and that those who argue that microelectronics is just another little piece of technology which we will absorb at our own pace and in our own good time are wrong. If this and future British Governments take this matter seriously they will, in effect, continue to govern. If they do not they will rapidly become actors in a charade of power which will have dispersed in a manner and directions over which they will have no real control. I believe that it is important that this issue should be addressed with some vigour and conviction and there is no sign, as yet, that this has been done. I hope you will do it.

## JAMES PRIOR REPLIES

Thank you for your letter of December 16 1980 about the future implications of microelectronics. I was impressed by the depth of thought you have given to the subject and am glad to continue the discussion.

Perhaps I should begin by explaining that paragraphs 4 and 5 on page 2 of my speech referred to the application and diffusion of microelectronic technology rather than its longer-term social and economic effects. I agree that microelectronic technology will have profound effects on most aspects of human affairs. I would not, therefore, dispute the greater part of your analysis.

I think the main difference between us is our views of the speed at which new technology will be applied and permeate the economy. I referred to some of the constraints in my speech — capital investment costs, the time taken to educate and retrain workers and longer-term skill shortages. The report which I referred to in my speech, 'The Manpower Implications of Microelectronic Technology', concluded that, although the long-term effects of new technology will be far-reaching, the



James Prior



Ian Lloyd

change will be neither as sudden or disruptive as was once feared. As far as employment is concerned, overall economic considerations generally exert a greater influence than technological change. I agree with these conclusions. Furthermore, the signs are that Britain is not adopting new technology as fast as its industrial competitors. All this does not mean, of course, that the implications of new technology outlined in your letter are any the less tenable in the longer term.

The Government is concerned about these implications and is continually reviewing and modifying its policies in the area of new technology. I touched on some of these in my speech. You will recall references to Grey Gowrie's brief to identify manpower factors inhibiting the faster spread of new technology; to Government education and training initiatives; and to the MAP and MISP schemes. I also mentioned that the Government has been considering the implications of reports by the Advisory Council on Applied Research and Development (ACARD) on issues such as biotechnology, joining / assembly and computer design and manufacture.

Information technology and its implications are being given special attention. You will probably recall that Adam Butler (and now Kenneth Baker) was given special responsibility within the Department of Industry for the promotion of information technology awareness and application and further initiatives are being prepared.

I believe that although new technology has many far-reaching implications, immediate drastic changes in Government policies are not required. In the shorter term, employment and training policies are flexible and they are being adapted appropriately. The key longer-term objectives for the Government must be in helping to raise general standards of awareness, education, training and achievement.

## AND FINALLY...

May I conclude by saying that I have taken up an invitation to visit the Department for further discussions with Lord Gowrie and senior officials this month.

If this ad. doesn't convince you that **Epson** produce the **worlds' best** low cost quality printers...

- the **FREE** printout samples will!!

### THE MX 80 FT/1

- both single sheet (friction) and continuous (tractor) feed & 9 wire head with true descenders

**£399** + VAT

### THE MX 80 FT/2

- as MX80 FT/1 and with HIGH RESOLUTION GRAPHICS

**£449** + VAT



Ideal for  
PET, Apple,  
Sharp, TRS80, Video  
Geni, RM 380Z, Nascom,  
Superbrain and most Micro's

### THE MX 70 T

- budget printer, tractor feed 7 wire head, and HIGH RESOLUTION GRAPHICS

**£259** + VAT

MX80 Features include:

- \*True Descenders - 9 x 9 dot matrix for sharp legibility.
- \*Emphasised and Double Characters - solid characters, a real must for word processing.
- \*Dual Paper Handling - ideal for long print runs or single sheets with up to 3 copies.
- \*Systems Flexibility - full range of optional interfaces and graphics ROM's.
- \*International Versatility - internally selectable characters UK, USA, French and German.
- \*Full Graphics Capability - 64 graphics blocks and on MX80 FT/2 high resolution graphics.
- \*Fast through-put - 80 characters per second, bi-directional, quasi start line logic seeking.
- \*Full Control - with a variety of print densities to 132 columns and top of form, horizontal and vertical tab controls.
- \*Reliability - Precision engineered quiet operation. Full twelve months warranty.

Call us for your local dealer or return this coupon.

THE EPSON DISTRIBUTOR

**Micro Peripherals**

61 New Market Square,  
Basingstoke, Hampshire RG21 1HW

Tel: 0256 56468 (4 lines) Tlx: 858575

Ring lan for up to the minute prices and technical information on a whole range of Japanese Micro Products

To: Micro Peripherals, 61 New Market Square, Basingstoke, Hants.  
Please send me full details of the EPSON range including printers.

Name..... Position:.....

Company:.....

Address:.....

..... PCW 4

(BLOCK CAPITALS PLEASE)





# GO-MOKU

David Levy continues his series with an old Japanese game.

This month we shall look at a game with an enormous number of possible moves at every juncture. The game is known as Go-Moku in most Western countries, though in Japan it is called Jenju. Go-Moku is a two-person game played on a Go board using Go stones; it is the size of the Go board (19 x 19) that gives rise to the enormous branching factor of the game tree.

Black always starts and makes a move by placing a black stone on any of the intersections. Thereafter, the players move alternately and the player who first completes a horizontal, vertical or diagonal line of five of his own stones is the winner.

Since five men in a row is enough to win, if you get four men in a row with the two adjacent intersections (at each end of this row) vacant, then on the next move you can complete a row of five (unless your opponent can do so immediately). So an unblocked row of four men is a winning formation. It is now easy to understand that if you have a completely open row of three you are threatening to force a win by making it into an open row of four on the next move and then a row of five on the following turn. The threat to convert a completely open row of three into an open row of four can normally be blocked, simply by closing the row of three at one end and then, when the opponent places a stone at the other end of the row to make a row of four, it is possible to block the only open end of the row of four to prevent it becoming a row of five.

Although it is possible to counter the threat of making one completely open row of three into an open row of four, it is obviously not possible to counter two such threats if they exist simultaneously. Thus, the most fundamental winning tactic in Go-Moku is to try to force a position in which you have, simultaneously, two completely open rows of three stones. The simple examples of Figure 1 will help to illustrate these principles.

The following rather obvious statements should be sufficient to teach the absolute beginner enough so that he can understand the principles of the game:

a. The four black stones at N7, O7, P7 and Q7 in Figure 1 form an open row of four. Unless, on his next move, White can complete a row of five stones elsewhere on the board and thereby win the game, White has no way to avoid defeat. If he plays on M7 then Black will play on R7 and win,



Illustration by Catherine Denvir



Unique in concept—the home computer that grows as you do!

# The Acorn Atom

# £120

plus VAT and p&p

Special features include

- \* FULL SIZED KEYBOARD
- \* ASSEMBLER AND BASIC
- \* TOP QUALITY MOULDED CASE

**NEW!**  
Colour Encoder  
for full colour  
graphics  
**£21.50**



Also available  
ready-built  
**£150**  
plus VAT and p&p

● The picture shows mixed graphics and characters in three colours

The Acorn Atom is a definitive personal computer. Simple to build, simple to operate. A powerful, full facility computer with all the features you would expect. Just connect the assembled computer to any domestic TV and power source and you are ready to begin. (Power requirement: 8V at 800mA). There is an ATOM power unit available – see the coupon below.

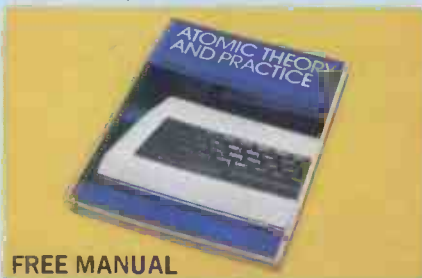

**FREE MANUAL**

Free with every ATOM, kit or built, is a computer manual. The first section explains and teaches you BASIC, the language that most personal computers and the ATOM operate in. The instructions are simple and learning quickly becomes a pleasure. You'll soon be writing your own programs. The second section is a reference

manual giving a full description of the ATOM's facilities and how to use them. Both sections are fully illustrated with example programs.

**The standard ATOM includes:**

**HARDWARE**

- Full-sized QWERTY keyboard
- 6502 Microprocessor
- Rugged injection-moulded case
- 2K RAM
- 8K HYPER-ROM
- 23 integrated circuits and sockets
- Audio cassette interface
- UHF TV output
- Full assembly instructions

**SOFTWARE**

- 32-bit arithmetic ( $\pm 2,000,000,000$ )
- High speed execution
- 43 standard/extended BASIC commands
- Variable length strings (up to 256 characters)
- String manipulation functions
- 27 x 32 bit integer variables
- 27 additional arrays
- Random number function
- PUT and GET byte
- WAIT command for timing
- DO-UNTIL construction
- Logical operators (AND, OR, EX-OR)
- Link to machine – code routines
- PLOT commands, DRAW and MOVE

**The ATOM modular concept**

The ATOM has been designed to grow with you. As you build confidence and knowledge you can add more components. For instance the next stage might be to increase the ROM and RAM on the basic ATOM from 8K + 2K to 12K + 12K respectively. This will give you a direct printer drive, floating point mathematics, scientific and trigonometric functions, high resolution graphics.

From there you can expand indefinitely. Acorn have produced an enormous range of compatible PCB's which can be added to your original computer. For instance:

- A module to give red, green and blue colour signals
  - Teletext VDU card (for Prestel and Ceefax information)
  - An in-board connector for a communications loop interface – any number of ATOMs may be linked to each other – or to a master system with mass storage/hard copy facility
  - Floppy disk controller card.
- For details of these and other additions write to the address below.



**ACORN COMPUTER** 4a Market Hill, CAMBRIDGE CB2 3NJ

Your ACORN ATOM may qualify as a business expense. To order complete the coupon below and post to Acorn Computer for delivery within 28 days. Return as received within 14 days for full money refund if not completely satisfied. All components are guaranteed with full service/repair facility available.

Quantity	Item	Item price inc. VAT+p&p	TOTALS
	ATOM KIT-8K ROM+2K RAM (MIN)	@ £140.00	
	ATOM ASSEMBLED-8K ROM+2K RAM (MIN)	@ £174.50	
	ATOM KIT-12K ROM+12K RAM (MAX)	@ £255.00	
	ATOM ASSEMBLED-12K ROM+12K RAM (MAX)	@ £289.50	
	1K RAM SETS	@ £11.22	
	4K FLOATING POINT ROM (inc. in 12K Version)	@ £23.30	
	PRINTER DRIVE 6522 VIA	@ £10.35	
	(inc. in 12K version) LS244 Buffer	@ £3.17	
	COLOUR ENCODER	@ £21.50	
	MAINS POWER SUPPLY (1.3 amps)	@ £10.20	
	TOTAL		

To: Acorn Computer Ltd., 4a Market Hill, CAMBRIDGE CB2 3NJ

I enclose cheque/postal order for £ \_\_\_\_\_

Please debit my Access/Barclaycard No. \_\_\_\_\_

Signature \_\_\_\_\_

Name (Please print) \_\_\_\_\_

Address \_\_\_\_\_

Telephone No. \_\_\_\_\_

Registered No: 1403810. VAT No: 215 400 220

PCW 4/81





and vice versa.

b. The white stones at C6, D6 and E6 form a completely open row of three. Unless Black takes remedial action against this row, or unless Black can himself force a win on some other part of the board, this row of three threatens to win by becoming an open row of four. For example, if it is now Black's turn and he plays a stone on some useless point, White may place a stone at B6 or F6, in either case creating an open row of four which next move will become a winning row of five.

c. If we now add to the board two more white stones, on F5 and G4, we can see that unless Black has a win on some other part of the board, White will win by making one or other of these rows of three into an open row of four on his next move. Black may stop the horizontal row by placing a stone at B6 or F6, or he may stop the diagonal row by placing a stone at H3 or D7, but he cannot do both simultaneously; and whichever row he does not stop immediately will grow on the next move into an open row of four and then into a winning row of five.

Because this double threat, created by simultaneous rows of three, is absolutely decisive, the game loses much of its interest if no restriction is placed on the players. Try for yourself, playing Go-Moku against a friend and you will both soon discover that it is not terribly difficult to force a double threat situation early in the game. For this reason it is often the rule that a double threat may not be created if both rows of three are capable of being extended into open rows of four. In some cases this restriction is only applied to Black, in order to offset the advantage of the first move.

## Program design

Since Go-Moku is a zero sum, two-person game, we can employ most of the tricks of the trade that have been discussed in earlier articles in this series. The program will grow and search a game tree, using some sort of evaluation function to evaluate terminal nodes on the tree. The obvious problem is the size of the tree itself — with 361 intersections on the board, even the alpha-beta algorithm will need to evaluate at least a quarter of a million terminal nodes when performing only a 4-ply search, and that assumes almost perfect ordering. The true number is likely to exceed five million terminal nodes in a 4-ply search, which puts the whole concept of full width search under a big cloud where Go-Moku is concerned. We will therefore need to find some way to prune the game tree, but more about that later.

## Evaluation

As I mentioned in an earlier article, there is always a trade-off between selecting a sophisticated but slow evaluation function, which provides a relatively accurate score for a game position, and the other extreme which is a fast but simple evaluation function which permits the search of a larger tree but which does not 'understand' so much when it is looking at a terminal node. William Blake once wrote: 'A fool sees not the same tree that a wise man sees' and his words of wisdom

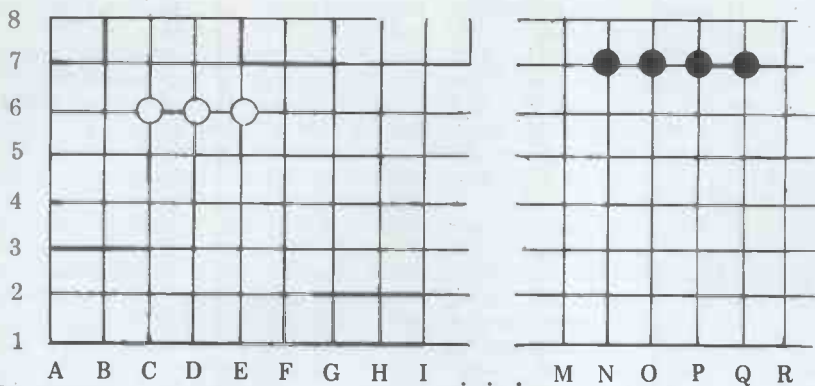

Fig 1

were clearly intended for programmers working on computer games.

In the case of Go-Moku, since the size of the game tree is so enormous, the use of a simple evaluation function with a deep tree search is clearly out of the question. In this sense, an important decision has been made for us by the very structure of the game itself. We must look at a relatively shallow tree, so we ought to ensure that our evaluation mechanism is wise rather than foolish.

Let's start by considering what features might usefully be incorporated in our evaluation function — we shall expand their scope a little further on in this article.

The key to a successful strategy is obtaining some of your own stones, in an unbroken row, in such a way that they could *conceivably* be extended into a row of five. Let us first define some variables.

W1 = the number of single white stones which are in a row, column or diagonal in such a way as to allow the stone to be extended into a row, column or diagonal of five stones.

Using the notation of Figure 1, imagine a white stone on D1 and black stones on A1, F1 and D5. There is no way that the stone on D1 can ever form part of a row or column of five stones, because the horizontal and vertical directions are sufficiently well blocked off by Black, but it is conceivable that the stone on D1 could form part of a diagonal of five stones, if White were to be able to place stones on E2, F3, G4 and H5. So in this case W1 would be 1, because this is the number of possible 5-rows that can be made using D1. If there were no black stone on A1 then the value of W1 would be 2 because D1 could be part of a horizontal or diagonal 5-row, and if there were no stone on D5 either the value of W1 would be 3, since 5-rows could be constructed horizontally, vertically and in one diagonal direction.

Similarly, B1 = the number of single black stones which are in a row, column or diagonal in such a way as to allow the stone to be extended into a row, column or diagonal of five stones (which we call a 5-row).

And W2, B2, W3, B3, W4, B4, W5 and B5 are the corresponding variables for situations in which White or Black has a row, column or diagonal with 2, 3, 4 or 5 of his own stones in an unbroken row.

Let us assume for the sake of simplicity that all terminal nodes are at even depth, that is to say we only evaluate a position in which it is the program's

turn to move. We shall further assume that the program is White. It is now necessary to assign weights to the features of the evaluation function in such a way as to reflect the worth of a 1-row, a 2-row, a 3-row, a 4-row and a 5-row. Of course a 5-row has infinite value, in the sense that if you make a 5-row you have won the game, so the weighting assigned to W5 and B5 should reflect this fact, in the same way that a chess-playing program would have an infinite value assigned to the kings.

Let the weightings which we assign to these variables be as follows:

AW1 is the weighting assigned to W1;  
AB1 is the weighting assigned to B1.

Then the whole of the evaluation function takes the form:

$$(AW1 \times W1) + (AW2 \times W2) + (AW3 \times W3) + (AW4 \times W4) + (AW5 \times W5) - (AB1 \times B1) - (AB2 \times B2) - (AB3 \times B3) - (AB4 \times B4) - (AB5 \times B5)$$

By ensuring that the weightings increase as the indices increase (ie  $AW5 > AW4 > AW3$ , etc) we are using our evaluation function to represent the statement: 5-rows are more valuable than 4-rows which are more valuable than 3-rows which are more valuable than 2-rows which are more valuable than 1-rows. And if we ensure that  $AB5$  lies between  $AW4$  and  $AW5$ , and that  $AW4$  lies between  $AB4$  and  $AB5$ , and that  $AB4$  lies between  $AW3$  and  $AW4$ ... etc, we are using the function to represent the statement: Make a 5-row if you can, otherwise prevent your opponent from making a 5-row of his own if you can, otherwise make a 4-row of your own if you can, otherwise prevent your opponent from making a 4-row of his own if you can, otherwise... etc. The actual values of the  $AW_i$  and the  $AB_i$  should be chosen by intelligent guesswork to begin with, and then modified in the light of experience. I have discussed how this might be done, manually and automatically, in earlier articles in this series.

## Refinements to the evaluation function

The function described above is simple to understand and to program, yet it encompasses the most important aspects of the game of Go-Moku. Nevertheless, it is rather unsophisticated and I should like to point out ways in which it might be improved.

Consider an empty board on which we place one solitary White stone on the intersection E1. This stone can conceivably form part of four different future 5-rows, or to be more accurate it can



form part of 5-rows in four different directions: horizontal, vertical, diagonal towards J5 and diagonal towards A5. So the value of W1 produced by that stone is 4, one for each direction. Now let us remove this stone from E1 and place it on J1. Is the stone of the same value on J1 as it was on E1? Since the value of W1 for the stone on J1 is also 4, just as it was for the stone on E1, it might seem at first as though the two stones are of equal value but they are not. Until the game nears its conclusion, much of the value of a particular 1-row, 2-row or 3-row lies in its potential as a threat — the opponent must react in some way to counter the threat. Therefore, part of the strategy of the game lies in placing a stone in such a way as to compel the opponent to reply to one threat and then taking advantage of a different threat which the opponent was unable to meet because he had to attend to something more immediate.

Let us consider the situation of two white stones on E1 and D1, with the rest of the board being irrelevant. If we add a third white stone to C1, a serious threat since a white stone on B1 or F1 would now force a win, the opponent would have to react to this threat by placing a black stone on B1 or F1. White has then not accomplished anything in the horizontal direction because his play has now been blocked and if he puts a stone on F1 Black can counter on G1, and if he plays on B1 Black can counter on A1. But the placing of the third white stone on C1 might well have much deeper implications — it might be part of a plan to create a strong formation over on the left hand side of the board, with a view to extending this formation into a winning threat later in the game.

Now we come to the important difference between having a single stone on E1 and having it on J1. If the planned future activity is in the area of the A-column, B-column and C-column, it is less likely to be successful than if it is in the E-column, F-column and G-column, simply because in the former case this activity is bounded by the left hand edge of the board. If your area of activity is bounded in some way, either by an edge of the board or by a strong (or even impregnable) formation of your opponent's stones, you will be less likely to win than if your area of activity is not bounded. In the latter case you have more opportunity to use the area of activity to create further threats.

What does all this mean in relation to our evaluation function? The obvious implication is that the weighting should vary in some way that reflects the number of vacant intersections to each side of a 1-row, 2-row or 3-row. (The number of vacant intersections to each side of a 4-row is not important, since the 4-row itself will determine the outcome of the game at once.) In the above example it might appear as though the small number of intersections to the left of E1 might be compensated for by the larger number of vacant intersections to the right of E1, and that therefore, E1 and J1 are of equal value. But if we think about the nature of the game it is clear that having a formation near the centre of a row, column or diagonal, gives greater flexibility than having that same formation near one or

more edges of the board. We should therefore adjust our weightings in some suitable manner, to reflect the desire to have useful formations nearer the centre than the edges. One possible way of doing this is to subtract from a weighting  $AW_i$  (or  $BW_i$ ), an amount  $C_i$ , where  $C_i$  is inversely proportional to  $(1 + \text{number of vacant intersections between the end of a formation and its nearest edge of the board (or enemy stone) in the same direction})$ . Thus, for a single black stone on the D1 intersection of an otherwise empty board, the weighting  $AB1$  would actually be  $AB1 - (1/3)$ , for the component of the score that is related to the horizontal 1-row. This is because in a horizontal direction the nearest edge intersection to the 1-row on D1 is the intersection on A1, which is two vacant intersections away from D1. The weighting  $AB1$  in the diagonal direction towards the left hand edge would be  $AB1 - 1/1$ ; the weighting in the diagonal direction towards the right hand edge would be  $AB1 - 1/1$ ; and finally the weighting towards the top edge would be  $AB1 - 1/1$  (these last three values are due to D1 being on the edge of the board).

The suggestion to subtract a value that is inversely proportional to the 'freedom of movement' of a formation is given here as an indication of the shape that this part of the evaluation function should take. You might find it more satisfactory to subtract the square of that number, or some other function.

Another important refinement of the evaluation function is needed to take care of those situations in which a stone of one colour may have a nearby neighbour of its own colour. For example, white stones on E1 and G1 with no other stones on the first horizontal row. The value of these two stones is clearly more than the value of two individual 1-rows, because the two stones can easily combine into a 3-row if White is permitted to play on F1. On the other hand, two white stones with one vacant intersection between them are worth slightly less than a 2-row because with a 2-row there are four distinct ways of creating a 5-row, whereas with two separated 1-rows there are only three distinct ways (since the vacant intersection between them *must* be occupied). This leads me to suggest that in a situation of this type we employ a weighting mid-way between that of a 2-row and the sum of two 1-rows. If there are two vacant intersections between the two 1-rows, use a weighting one quarter of the way between that of two 1-rows and that of one 2-row, and if there are three vacant intersections take a weighting one eighth of the way between them. Similar logic can be used to suggest weightings for (say) a 1-row separated from a 2-row (in the same horizontal, vertical or diagonal) by one or two vacant intersections, though here as usual, your first guesstimate as to the size of the weighting will almost certainly need to be changed in the light of experience.

The two refinements discussed here are probably necessary for a very strong program, but those of you who wish to keep things simple will, I'm sure, get an entertaining game from a program which employs only the most primitive form of the evaluation function.

## Combatting enormous tree growth

The potential size of the Go-Moku tree forces us to introduce some sort of forward pruning from the very first ply of search. The simplest way to do this is to employ the evaluation function also as a plausibility indicator. First your program generates a list of all the legal moves in the root position. (In fact it has this list readily available and updates it whenever a move is made in the tree — the updating consists simply of removing a now occupied intersection from the list of legal moves.) The program then evaluates all the resulting positions at ply-1, using the evaluation function and sorts the moves into descending order of merit based upon these evaluations. The worst  $n$  percent of the moves on the list may then be discarded ( $n$  can be chosen to suit the execution speed of your program — I would suggest that you start with  $n = 90$ ). You will now have a list of some 36 moves (at the start of the game) and from each of the 36 positions you again generate and evaluate, discarding the worst (say) 92 percent of the moves at the next ply. The percentage of moves discarded goes up as the tree gets deeper and deeper, and this parameter can be adjusted, dynamically if necessary, so that the program is made to respond in any desired time frame.

Your tree will now be no larger than the tree for a chess program, and move generation will be faster than for chess, so provided you code the evaluation routine in an efficient manner, you ought to be able to perform a search of 4-6 ply within a minute or two, if your program is written in assembler.

Those of you who have been following my earlier articles will already have encountered the concept of the alpha-beta window and the killer heuristic, both of which should be employed in your Go-Moku program. In a large tree the killer heuristic is particularly useful and the fact that you have sorted the moves prior to generation of the replies at each level will help considerably in the optimisation of the alpha-beta routine itself. One other method of speeding the search is to avoid the need to re-evaluate those parts of the board that are not affected by a move in the game tree. You might, for example, keep several different components of the evaluation, and update only those affected by a move. For example, let us assume that the evaluation function has separate components for each horizontal, each vertical and each diagonal. If the program considers a move on the intersection A1, this move will in no way affect the evaluation of a formation in the J column, so part of the evaluation process need not be repeated — it is known to be unchanged. The more you speed up the evaluation process, the deeper the tree can grow, so any technique which updates the evaluation function in an incremental way is certain to be useful.

## Tactical search

In most board games it is possibly to



distinguish strategic play from tactical play. We have discussed this point before, with particular reference to chess and it is well known that the tree search should look deeper in those parts of the tree that are of greater tactical interest. In Go-Moku, tactical play is represented by threats, counter threats and moves that defend against threats. We have seen how the very existence of a 3-row constitutes a threat and it would be possible to argue that the creation of a 2-row is a veiled threat since the 2-row can easily grow into a 3-row. But I would recommend that we assume the evaluation function will be sufficiently smart to provide scores that represent fairly accurately the value of having a 2-row. It is the tactical value of a 3-row that is not so easy to measure and your program should therefore consider any move which creates a 3-row as being worthy of further consideration, even if it would otherwise be a terminal node.

My suggestion for a tactical search is to examine any move which creates or blocks a 3-row or a 4-row or which creates a 5-row. This means that having grown the tree to what would normally be its full depth, the program examines the board to see if any 3-rows exist and if so, whether the opponent can block them. The program also examines moves which themselves create 3-rows. It does

the same for 4-rows and it looks for moves which create winning 5-rows. This process can, particularly during the later stages of the game, lead to a substantial increase in the size of the tree but tactics are extremely important in Go-Moku and it is essential for a strong program to have a good command of tactics. In order to be able to extend the tactical search to (say) 4 or 6 ply beyond the usual depth of search, it may be necessary to reduce the depth of the first part of the search. To ensure that your program responds within an acceptable amount of time, you should make your tree search iterative, with a mandatory cutoff after a certain maximum number of seconds. Your program might then perform a full 1-ply search, plus (say) 6-ply of tactical search; then if it has not consumed all of its thinking time it can sort the 1-ply moves as suggested above, prune off 90 percent of them, generate the replies to the remaining ten percent and then perform a 6-ply tactical search from the resulting positions at depth 2-ply. Once again, if the search time is not exhausted, prune 92 percent of the second ply moves, generate the third ply moves and perform your 6-ply tactical search. In order to optimise the performance of your program, try playing around with the various parameters (not only the weightings in the evaluation fun-



ction, but also the percentage of moves pruned at each level and the depth of tactical search).

## Bibliography

E W Elcock & A M Murray: 'Experiments with a Learning Component in a Go-Moku Playing Program', *Machine Intelligence 1*, N L Collins & D Michie (Eds), Edinburgh University Press 1971, pp 87-103.

A M Murray & E W Elcock: 'Automatic Description and Recognition of Board Patterns in Go-Moku', *Machine Intelligence 2*, E Dale & D Michie (Eds), Edinburgh University Press 1971, pp 75-88.

# MICROPROCESSORS

## AN INTRODUCTION FOR THE PROFESSIONAL LAYMAN

by Paul Kimberley B.Sc., C.Eng., M.I.Prod. Eng.

### CAN YOUR BUSINESS AFFORD TO BE WITHOUT IT?

This book provides the much needed introduction to the principles and jargon involved in the modern microelectronic and computer systems that can and will rapidly transform business and industry. If the microelectronic revolution isn't going to pass you by, here's all you need to know about:

- ▲ The principles of the computer and the development of the related technology over the past 30 years
- ▲ Current market trends and the ever-widening range of applications
- ▲ Microelectronics: the components that make up a modern microprocessor
- ▲ Practical applications: two case studies, one industrial, one administrative, which provide a step-by-step guide to applying the technology

- ▲ Additional hardware surrounding the microprocessor
- ▲ Glossary: over 1000 of the most commonly used terms in the world of microelectronics

Planned as a businessman's self-defence kit against the secret language of the technocrats, this is a book that every manager needs.

Please supply . . . copies of MICROPROCESSORS by Paul Kimberley at £7.95 plus 85p. postage and packing (overseas orders: allow £1.20 p & p).

I enclose a cheque payable to Hayes Kennedy Ltd. for £ . . .

NAME: \_\_\_\_\_

ADDRESS: \_\_\_\_\_

Hayes Kennedy Ltd, 103 High Street, Thame, Oxfordshire OX9 3DZ Please allow 28 days for delivery. Also obtainable from your local bookseller.

# PROGRAM POWER

# NASCOM 1 & 2

## MUSIC BOX

Now you can make music with NASCOM. Easy to follow program allows you to key in old favourites or have fun composing your own tunes. 7 octave range with staccato option, 9 tempos. Set note duration or tap in rhythm as required. Comprehensive editing. Delete, insert or amend notes. Single-step forwards & backwards through tune. Add new lines within declared array size. The program includes tape generating & play-back routines & is supplied with 2 demonstration melodies & instructions for connecting your Nascom to an amplifier/speaker such as our unit below. Min.16K required — please state T4 or Nas-sys/2- or 4 MHz/with or without graphics. **Only £13.95**

## AUDIO INTERFACE BOARD & SPEAKER

Compact & ready assembled, suitable for use with "Music Box" & other 'sound effects' programs. 3 simple connections. Complete with instructions on programming for sounds £9.75.

## AY-3-8910 SOUND CHIP

Program up to three independent channels with music & sound effects! Supplied with detailed write-up £8.50  
**SOUND CHIP INTERFACE BOARD** — Using the PIO, program up to four sound chips at once, e.i. 12 separate programmable sounds. Each board contains an interface allowing a further board to be attached. Only simple link changes required. Connect to amplifier/speaker such as our unit above. £13.50  
**SOUND CHIP DEMO PROGRAM** — First mode gives direct entry to chip registers, making experimentation simple & thus rapid appreciation of chip's potential. Second mode turns keyboard into 7 octave 'piano', displaying state of registers & notes (up to 3) being played. £6.95

## GAMES GRAPHICS ROM

Contains graphics characters for NAS — CHESS, DRAUGHTS, BACKGAMMON, DICE & a number of other useful characters. Uses NAS-GRA ROM socket. £15.00  
**GAMES ROM ADAPTOR** — allows switching between NAS-GRA ROM & GAMES GRAPHICS ROM £5.90  
**COMBINED ROM & ADAPTOR** £18.90

**LUNAR LANDER SURPEME (16K/G/B)** — classic spacecraft-landing simulation. Short, medium & long-range scans show planet surface in arying detail. Continuously updated STATUS REPORT gives vertical, horizontal & relative velocity, altitude, fuel level, G factor & surface scan for suitable landing site. 8 skill selections. Brilliant graphics £13.95  
**STARTREKII (32K/G/B)** — enthralling, real-time version from our Invasion Earth author, using M/C code sub-routines to great effect. Special features include large, fast, shielded homing warheads (fired by Klingons), time slots & non stop action. £13.95  
**INVASION EARTH (MC/G)** — New improved version! 4 complexity ratings, 10 overall speeds. Variable shot speeds & alien descent rate. 4 invader types. Intelligent homing, exploding, angled, direct, multiple warhead & radio-jamming missiles. £10.95  
**INVASION EARTH (MC/G)** — as above with SOUND EFFECTS using AY-3-8910 CHIP £12.95  
**"NASCOUNT"** — PERSONAL FINANCE (16K/MC) — Make life simpler with this finance planner. Budget income/expenses month by month and highlight likely surpluses & deficits. Can be used to check bank account & record past income/expenses 50 entries eachperiod. Five digit codes with analysis by code & sub-code. Calculate cumulative cash flow to specified month end. Output to cassette & printer. £12.95  
**CONSTELLATION (16K/B)** — Turn your screen into a telescope & view the stars from any point in the Northern Hemisphere at any time & date. Display stars by magnitude, identifying number or constellation. The telescope can be raised & lowered, zoomed in & out. Also output of star map to printer. £8.95

## WORDEASE — WORD PROCESSOR (MC)

Professionally written 4K word processor: — 14 line window on text buffer & extensive on-screen editing facilities. Insert & delete characters, lines & paragraphs. Text manipulation — copy from one section of text to another, or read in additional material from tape to any point in the text. FIND & REPLACE facility. Text buffer size according to available memory. Exceptional formatting capabilities: — commands embedded in text allow complete flexibility e.g. variable tab position, indent, line length & page length. Use of up to 10 'MACROS' permits automatic inclusion of headings, footings & other 'text repeats', & also automatic page numbering. Output to printer — can vary character delay, inhibit line feeds & force upper case if required. An extensive manual is supplied (itself prepared on Wordcase). (MANUAL ONLY — £1/refundable against program order) £25.00

**DRAUGHTS (B/G)** — by a Country Player & member of English & American Associations, this program plays the standard E.D.A. rules & employs advanced end-game tactics, 6 levels & large clear graphics mean real value for beginners & experts. Hints/instructions included. State if games graphics ROM version required £9.95

**BACKGAMMON (16K/B)** — 5 levels of play are offered in this game, played to the standard rules. Program includes instructions. Available to run on its own or excellently presented using our special games graphics ROM £9.95

Special offer for one month deduct\* 25% from all program prices, except Wordcase.

Super Startrek (16K/B) £9.95, Cowboy Shoot-out (MC/G) £8.95, Allen Labyrinth (16K/B/G) £8.95, Musical Break-out (MC/G) £6.95, Super LIFE (MC/G) £8.95, Driver (B/G) £6.95, Cliff Invasion (B/G) £8.95, Labyrinth (B/G) £6.95, Space Fighter (B/G) £7.95, Death Run (B/G) £6.95.

**PROGRAM POWER**  
 5, Wensley Road, Leeds LS7 2LX  
 Telephone (0532) 683186

Please add 55p/order P & P + V.A.T. @ 15% Sae for FULL CATALOGUE (now over 50 items!)

\* \* NASCOM 1 — COTTIS BLANDFORD cassette interface for N2 format, reliability & fast load. £14.50 or £11.50 with program order.  
 B = Nascom BASIC (State Tape BASIC if required). MC = Machine Code, G = Nascom Graphics, 8k RAM required unless otherwise stated. Ask for NAS-SYS or T4 versions.  
**ALL PROGRAMS SUPPLIED ON CASSETTE IN CUTS/KANSAS CITY FORMAT.**

# ZX80

# 'THIS BOOK IS EXCELLENT'

## — Clive Sinclair

This unique book contains 30 programs all designed to fit in the Basic 1k version of the SINCLAIR ZX-80!! With this book you will realise that the ZX-80 is more powerful than you ever imagined!

112 pages packed with solid information!

**BLACKJACK** — actually contains a full pack of cards, shuffles them, keeps track of the dealer and players card totals, and the money bet, all within 1k.

**MEMORY LEFT** — an incredible routine especially useful as it enables you to know exactly how much memory is left, even during the running of a program. This also illustrates USR routines.

**DR. ZX-80** — A conversational program with the computer as analyst which uses an ingenious method of storage.

**GOMOKU** — the computer challenges you to this complex Japanese game. Incredibly this program including display of the 7 x 7 board fits into 1k — it only does so because it uses the display as memory!

Other programs included are HORSE RACE, LUNAR LANDER (with moving spaceship), NOUGHTS AND CROSSES, NIM, SIMPLE SIMON, HANGMAN, LIFE, MASTERMIND, PINCH and seventeen others.

As well as the programs, the book illustrates programming techniques you can use in your own programs — space compression, PEEKs and POKEs, USRs and so on.



**£6.95** (plus 50P p&p)

available by mail order only

Please send me, . . . . copies of 30 programs for the Sinclair ZX-80 1k

NAME .....

ADDRESS .....

**MELBOURNE HOUSE PUBLISHERS**

Orders to: 131 Trafalgar Road, London SE10  
 Correspondence: Glebe Cottage, Glebe House, Station Road, Cheddington, Leighton Buzzard, Bedfordshire.

Please enclose cheque or P.O. for £7.45 per copy. Orders outside the UK £7.95





## Computerised ink pellets

There was my young friend, minding his own business, staring at his monitor screen and wondering why his program wasn't working, when suddenly the darned thing spoke to him! Well, not *spoke* exactly; what it did was to print a rude remark without any provocation.

'Stop picking your nose,' it said, 'and get on with your work!' The boy was flabbergasted. He'd been told that computers didn't do that sort of thing. For a moment his mind reeled, then steadied and he began looking for explanations. Sir had rigged up a video camera! (He actually *had* absently poked at his nose before the monitor sternly told him not to.) Sir had written some stupendous program to detect him in the act!

He looked round the classroom, searching for the concealed camera — 1984 had come to school! — and then caught the eye of his mate, grinning at him from another terminal. The truth dawned — they were on a time-sharing system and it was possible, if you knew the port number, to print out something on someone else's monitor. He had, in fact, been flipped in the eyeball by the modern equivalent of an ink pellet!

My friend promptly replied with something appropriate printed out onto the other terminal screen (he didn't tell me what) and cheerful electronic insults flowed back and forth until the voice of the teacher, heavy with sarcasm, cut across the clicking of keys. 'Playing prettily, you two?'

Last month I waxed indignant about new computerised crime; here we have new computerised classroom fun. I can't help wondering how long it will be before a teacher, cutting at will into the output to any monitor, will commonly be able to give instruction or comment onto any pupil's terminal screen? Come to that, how long will it be before the teacher will devise some sort of electronic impost?

'Jones — you will type out 500 times, "I must not use the computer for rude purposes!"' or, 'Smith, you are messing about!' — and deliver six of the best; six jolts of 24 volts through the seat of the pants! All it would require would be the terminal bench to have a metal seat!

Musing further, at the stage — and with a suitable interface — it would be easy for the computer *itself* to deliver the electronic kick in the pants: 'wrong answer — take that!' or, 'You have programmed me into an infinite loop, you clot! Wham!'

On the subject of electronic practical jokes played on the teacher, I'll plead the Fifth Amendment — I refuse to

testify on the grounds that it might incriminate me.

Great stuff. Arthur C Clark (the 2001 man) points out that if a technology is sufficiently advanced, to the uninitiated it has all the appearance of magic. Just think how mystified a schoolboy of a hundred years ago would be by all of this!

## Programs recieved

Acorn Atom Roadrace, Missile Dodge, Four in a Row and Rotate, by Stuart Johnson (16) of Mevagissy, Cornwall; ZX80 2-Card Trick by Michael Lloyd (13) of Dublin; TRS80 2 Roulette by Iain Dawson of Bradford; ITT 2020 Message Encoder by Lawrence Roy and David Miller (16) of Bishop's Stortford (an uncrackable electronic Enigma, this!); Sorcerer Learning Aid by Steven Dockerill (13) of Fareham, Hants.; UK101 Grand Prix by L Booth of Peterborough; Video Genie Pixel Display by Adrian Douglas (16) of Woking, Surrey; Road Runner for PET, by Phillip Hewitt (16) of Solihull; Pascal Calculator by Clive Tong (14) of Canterbury.

It appears that there was been some sort of unofficial competition to have the first Acorn Atom program published. Well I can declare here and now that Stuart Johnson's programs were the first received in this office. I particularly liked his Roadrace: not only is it very good fun, but it also runs on an unexpanded Atom — no mean feat. Newcomers to Atom Basic will be puzzled by the listing, but fundamentally it is a shorthand version — with 'P,' standing for 'PRINT', 'G.' for 'GOTO' and so on. See page 146.

The game firmly falls into the group

known as 'Arcade' computer games and I have to confess surprise that very few people have offered their views on the subject of 'arcade' versus alphanumeric games. Could it be that readers of this page see no difference between them?

## Disabled user

A heartening and very interesting story came out of Nottingham recently. It seems that a boy severely disabled from birth became so engrossed in the game of Space Invaders that he spent a small fortune playing it. He played it all the time! Social workers became quite upset about it — but then it was noticed that in the months he had been playing, he had made tremendous improvements in just about everything else — his coordination of course, but also his speech, his school work, coping with disability — everything!

The story has a nice ending, too; the manufacturers presented a free machine to the hospital so that the boy could continue to play for free.

It would be stupid to suggest that we gave a Space Invaders machine to every disabled person but I have no doubt that computers and microprocessors have the most fantastic potential as aids to such people. Have you got your thinking caps on? How many uses can you come up with to help those less fortunate than ourselves? Please don't forget that, to mark 1981 as the International Year for the Disabled, *Personal Computer World* is running a competition. Let your flavour flood out! Make the postman delivering to PCW offices really work for his money! (Come to that, make the Editor work for his, too!)

## Acorn Atom maze by John Spilsbury

```

• 1P.#12
• 2DIM M(200)
• 3?#E1=0;GOS.400
• 4IN."WHAT SIZE MAZE (4 TO 16)",X
• 5P.#12
• 6Y=X
• 8CLEAR4
• 10GOS.c;GOS.d
• 12GOS.b
• 14GOS.l
• 16GOS.m
• 17D=A.R.%(4)
• 18%D=D;GOS.t;#A=A;#B=B;G.o
• 20hGOS.v;GOS.w
• 22B=#B;A=#A
• 24oGOS.P
• 26GOS.a
• 28B=#B;A=#A;GOS.J;IFM?Z>100;FORH=0T03000;N.;CLEAR0
• 30IFM?Z>100;P.'"WHO'S A CLEVER BOY THEN?";E.
• 32G.h
• 34E.
• 36aF.R=1T015
• 38#R=16#R
• 40#S=C#R/3+J;I=#R;S=#S
• 42MOVEI,192;PLOT5,S,0;PLOT5,S,N

```

GOTO page 148

# The heart of a system...

**NEW PRICE**  
effective  
March 16th



Exidy's Sorcerer has stood the test of time and has proved to be one of the most complete and versatile machines available. Versatility and expandability were the principal aims of the original design and whilst other major suppliers have been continually changing models to try and compete, the Sorcerer range has remained ahead of its time

**(48K) only £695.00**  
EX VAT

Whatever the application talk to the people who care — your Exidy Dealer. Consult your local supplier now or clip the coupon for further information about this outstanding machine.

**LIVEPORT**

DATA PRODUCTS

The Ivory Works, St. Ives, Cornwall TR26 2HF  
Telephone: (0736) 798157

Please send details of the complete Exidy range and a dealer list.

Name \_\_\_\_\_

Address \_\_\_\_\_

Tel No. \_\_\_\_\_

PCW C \_\_\_\_\_



Compiled by Dick Pountain

## CASIO'S BUDGET PROGRAMMABLE

There must be many readers of this column, who, like myself, are waiting with bated breath to see what Casio is going to introduce to top the fx-502p. Presumably it will be alphanumeric and will probably use Basic, like the Sharp PC1211.

Casio's newest programmable calculator, the fx-3500p (the subject of this test) offers no clues at all, since it is aimed at precisely the opposite end of the market. With a retail price of £25.95, Casio is going for the school and college market in competition with the Texas TI57 and TI51, though some of the advanced scientific functions will recommend it in professional circles.

### General features

True to house style, the 3500p is an ultra-slim machine, smaller even than the 502p and fitted into a similar plastic wallet. Unlike the 502, the case is in ABS plastic with brushed alloy covering on the keyboard. The display is LCD with ten digits plus signs, two-digit exponents and various annunciators for operating modes. Batteries are two silver oxide cells and auto switch-off operates after six minutes; battery life should be around 1000 hours, as on the 502. The 38-key keyboard has larger keys than the 502, which will please the thick-of-finger. Memory is continuous (non-volatile) and comprises six so-called 'K' registers, one independent 'M' register and storage for 38 (fully-merged) program steps plus six non-addressable pending operations registers. The latter allow a maximum of 18 pairs of parentheses nested to a maximum depth of six levels.

A MODE key permits selection of 11 operating modes, which include RUN, LRN (program write), three display formats and special modes for integration, regression and statistics, about which more later. No bulk program storage is provided, either by tape or card.

Oddly, Casio has increased the number of display formats available on this machine. In addition to 10-digit floating point, fixed point and scientific and engineering notations, as on the 501/502, the 3500 has a FIXn format similar to the Texas and HP versions, which displays n decimal places without truncating the internal value. SCIn format displays scientific notation with n significant figures shown and RND truncates the internally-held value to conform to the displayed value.

### Functions

The 3500 has a remarkably comprehensive set of maths functions for its price, more than the 501/502p, in fact. These include the usual arithmetic, trigonometric, hyperbolic and exponential functions, square roots and reciprocals, random numbers, rectangular to polar conversions, percentages and  $\pi$ , factorials and sexagesimal to decimal display

and conversion (DMS). ABS, INT and FRAC are missing, which would be serious if its programmability were not in any case rather limited. The extra functions are numeric integration and regression analysis on two variables including standard deviations and correlation coefficients. The fraction arithmetic allows  $\frac{a}{b}$  to be entered as  $\frac{a}{b}$ / $c$  and gives answers as fractions or converts to decimal.

The integration routine works by Simpson's Rule, like the version in the 502 program library. In fact its execution time is identical to the 502 program, which suggests it is just that program in ROM. To use it, a program must be written to evaluate the function to be integrated. The interval of integration is entered and the number of divisions of this interval (which sets the precision) between 2 and 512. The integral is then evaluated. This routine is considerably less sophisticated than that on the Hewlett Packard 34C (see last month's 'Calculator Corner') but runs very much faster. Integrating straightforward polynomial expressions using 32 divisions produced answers within 20 seconds, though this time rises if more precision is required. It is difficult to compare this routine directly with the HP 34C's without weeks of research using 'badly-behaved' logarithmic/trigonometric functions, for which I didn't have time. Certainly the Casio routine lacks the HP's inbuilt estimate of the accuracy, though on the expressions I tested they produced similar answers. The Casio manual is typically skimpy and does not go into the difficulties one should expect when numerically integrating certain classes of function. One would expect the more 'intelligent' HP routine to cope better with such functions. Nevertheless, for expressions with predictable characteristics, the Casio routine works well and is *much* faster.

### Programmed operation

The programmability of the 3500 is of a very limited but rather ingenious sort, designed to appeal to first-time users with little programming skill. With only 38 memory steps, no subroutines, no indirect addressing, no editing facilities and only a very crude form of branching, it is certainly not a 'computer-like' machine in the way that the 502, the TI 57/58/59 and the HPs are. Its programmability is more on the level of 'remembering' a manual calculation for repeated use. The technique of entering a program is exactly that — switch to LRN mode, perform the calculation manually and the calculator remembers the sequence of operations while rejecting variable data. Wherever a variable datum occurs in the calculation, you press ENTER after it. When the program is RUN, execution will halt at these points and display ENTER until you supply the new data and restart

execution.

Two program registers, P1 and P2, are provided, which store two programs with a maximum total number of 38 steps. Programs are executed by pressing P1 or P2. The programs are not viewable at all — no key codes exist — and as the only editing function is to delete one or both programs, in case of error you must re-enter. This means you must write down your programs on paper at all times, rather than 'improvise' at the keyboard, which is possible on the 502 (though of course it's a shockingly bad practice).

Three branch instructions are available. RTN is an unconditional branch to the first step of the program;  $x > 0$  branches to step one if the contents of the display register are positive, otherwise the following step is executed ('do if untrue'); and  $x \leq M$  performs a similar conditional branch by comparing the display and M registers. Since the only branches are to step one, loop structures are of necessity rather primitive and iterative routines are rather a headache (though some are possible with sufficient cunning). Execution is only stopped by a HLT to display results or an ENTER to enter data. A nice touch is that full register arithmetic is available on the six 'K' registers, using the same system as HP does, ie  $Kin+2$ ,  $Kin-4$ , etc (cf  $ST0+2$ ,  $ST0-4$ ).

Given the limitations of the 'language', I could not apply my usual Benchmarks in an exactly equivalent way. I did write the near equivalent of BM1 (store and recall), BM4 (cos) and BM5 (log) and to my surprise the 3500 was faster than the 502 on 4 and 5, at 47 and 32 seconds. The timings were sufficiently close to those of the 502 to suggest that the same processor (or a near relative) is used — my attempts to verify this foundered when I couldn't get the bloody case open.

### Summary

The fx-3500p is not likely to become an absorbing toy in the way that the computer-style calculators do. Its language is too limited to allow much beyond the evaluation of mathematical expressions. However, as a practical tool it has great potential as an 'easily-customisable' scientific calculator at a very keen price. For someone who wants to perform a few complex calculations repeatedly and isn't interested in learning a calculator language, this machine provides a cheap solution and comes with an excellent set of built-in functions to boot. What's more, I bet that within six months some madman out there will have sent me a Space Invaders program for it. . .

PCW would like to thank Tempus of Cambridge for the loan of the test machine.

# WOULDN'T YOU LIKE AN OSCAR FOR A SUPERB PERFORMANCE



To a casual glance, we must admit that there are several other computers which superficially resemble OSCAR. However, if you peek under the stylish structural foam housing, with its separate keyboard for better ergonomics, you'll notice the differences.

## S100 SYSTEM

OSCAR has a 6-slot motherboard, housed inside the VDU housing, with proven IDS S100 cards to international standards for a flexible, easily maintained, system.

## 4MHz Z80A PROCESSOR CHIP

Possibly the most powerful m.p.u. chip in its class, running at full speed, makes OSCAR more powerful than many mini-computers.

## 64K DYNAMIC MEMORY

A full sized system for your full sized applications.

## DISKETTE OR HARD DISK

The options are yours, starting with twin floppies at 400KBytes per drive or an 11MBytes Winchester located inside the VDU housing.

Maximum size? We're not saying, as we keep on increasing it, but it's unlikely to be too small.

## CP/M™ OPERATING SYSTEM

Use of the industry standard CP/M™ Operating System means that a wealth of applications software will run on your OSCAR.

## VISUAL DISPLAY UNIT

With the green phosphor recommended by opticians for low eyestrain, the VDU also has a bonded face-plate for extra safety. There is a full character set with real descenders on the lower-case letters. There are 24 lines each of 80 characters.

## KEYBOARD

Separate keyboard with full QWERTY and numeric pad for fast entry.

## PRINTER OPTIONS

A range of printers is available. Your dealer can help you select the appropriate one for your requirements.



## APPLICATION PROGRAMS FREE

Sales, Purchase and Nominal Ledgers plus Stock Control and Payroll are available from your dealer and to avoid the problems of pirating, all you have to pay for are the manuals and the media. If these packages do not suit, your dealer will be able to offer alternatives, although, these are unlikely to be free!

## NATIONAL SERVICE NETWORK

It's no good owning the best system if you can't get it mended, so IDS have arranged for a National Service Network to offer maintenance contracts on your OSCAR.

## PRICE

An OSCAR with twin floppies costs from £2,495.00 (excluding VAT and printer)

## NOW

Cut along this line, complete and post for further details.

Designed and manufactured in the United Kingdom by:-

**INTERACTIVE DATA SYSTEMS LTD.**

14 Heathfield, Stacey Bushes, Milton Keynes MK12 6HP  
Buckinghamshire, England  
Telephone (0908) 313997

Please send details of OSCAR and your other S100 products to:

Name \_\_\_\_\_

Position \_\_\_\_\_

Address \_\_\_\_\_

Company \_\_\_\_\_



# NEWCOMERS-START HERE

*This is our unique quick-reference guide, reprinted every month to help our new readers pick their way through the most important pieces of (necessary) jargon found in PCW. While it's in no way totally comprehensive, we trust you'll find it a useful introduction. Happy microcomputing!*

Welcome to the confusing world of the microcomputer. First of all, don't be fooled; there's nothing complicated about this business, it's just that we're surrounded by an immense amount of necessary jargon. Imagine if we had to continually say "numbering system with a radix of sixteen in which the letters A to F represent the values 10 to 15" when instead we can simply say "hex". No doubt soon many of the words and phrases we are about to explain will eventually fall into common English usage. Until that time, PCW will be publishing this guide — every month.

We'll start by considering a microcomputer's functions and then examine the physical components necessary to implement these functions.

The microcomputer is capable of receiving information, processing it, storing the results or sending them somewhere else. All this information is called data and it comprises numbers, letters and special symbols which can be read by humans. Although the data are (yes, it's plural) accepted and output by the computer in 'human' form, inside it's a different story — they must be held in the form of an electronic code. This code is called binary — a system of numbering which uses only 0s and 1s. Thus in most micros each character, number or symbol is represented by eight binary digits or bits as they are called, ranging from 00000000 to 11111111.

To simplify communication between computers, several standard coding systems exist, the most common being ASCII (American Standard Code for Information Interchange). As an example of this standard, the number five is represented as 00110101 — complicated for humans, but easy for the computer! This collection of eight bits is called a byte and computer freaks who spend a lot of time messing around with bits and bytes use a half-way human representation called hex. The hex equivalent of a byte is obtained by giving each half a single character code (0-9, A-F): 0=0000, 1=0001, 2=0010, 3=0011, 4=0100, 5=0101, . . . . E=1110 and F=1111. Our example of 5 is therefore 35 in hex. This makes it easier for humans to handle complicated collections of 0s and 1s. The machine detects these 0s and 1s by recognising different voltage levels.

The computer processes data by reshuffling, per-

forming arithmetic on, or by comparing them with other data. It's the latter function that gives a computer its apparent 'intelligence' — the ability to make decisions and to act upon them. It has to be given a set of rules in order to do this and, once again, these rules are stored in memory as bytes. The rules are called programs and while they can be input in binary or hex (machine code programming), the usual method is to have a special program which translates English or near-English into machine code. This speeds programming considerably; the nearer the programming language is to English, the faster the programming time. On the other hand, program execution speed tends to be slower.

The most common microcomputer language is Basic. Program instructions are typed in at the keyboard, to be coded and stored in the computer's memory. To run such a program the computer uses an interpreter which picks up each English-type instruction, translates it into machine code and then feeds it into the processor for execution. It has to do this each time the same instruction has to be executed.

Two strange words you will hear in connection with Basic are PEEK and POKE. They give the programmer access to the memory of the machine. It's possible to read (PEEK) the contents of a byte in the computer and to modify a byte (POKE).

Moving on to hardware, this means the physical components of a computer system as opposed to software — the programs needed to make the system work.

At the heart of a microcomputer system is the central processing unit (CPU), a single microprocessor chip with supporting devices such as buffers, which 'amplify' the CPU's signals for use by other components in the system. The packaged chips are either soldered directly to a printed circuit board (PCB) or are mounted in sockets.

In some microcomputers, the entire system is mounted on a single, large, PCB; in others a bus system is used, comprising a long PCB holding a number of interconnected sockets. Plugged into these are several smaller PCBs, each with a specific function — for instance, one card would hold the CPU and its support chips. The most widely-used bus system is called the S100.

The CPU needs memory in which to keep programs

and data. Microcomputers generally have two types of memory, RAM (Random Access Memory) and ROM (Read Only Memory). The CPU can read information stored in RAM — and also put information into RAM. Two types of RAM exist — static and dynamic; all you really need know is that dynamic RAM uses less power and is less expensive than static, but it requires additional, complex, circuitry to make it work. Both types of RAM lose their contents when power is switched off, whereas ROM retains its contents permanently. Not surprisingly, manufacturers often store interpreters and the like in ROM. The CPU can only read the ROM's contents and cannot alter them in any way. You can buy special ROMs called PROMs (Programmable ROMs) and EPROMs (Erasable PROMs) which can be programmed using a special device; EPROMs can be erased using ultra-violet light.

Because RAM loses its contents when power is switched off, cassettes and floppy disks are used to save programs and data for later use. Audio-type tape recorders are often used by converting data to a series of audio tones and recording them; later the computer can listen to these same tones and re-convert them into data. Various methods are used for this, so a cassette recorded by one make of computer won't necessarily work on another make. It takes a long time to record and play back information and it's difficult to locate one specific item among a whole mass of information on a cassette; therefore, to overcome these problems, floppy disks are used on more sophisticated systems.

A floppy disk is made of thin plastic, coated with a magnetic recording surface rather like that used on tape. The disk, in its protective envelope, is placed in a disk drive which rotates it and moves a read/write head across the disk's surface. The disk is divided into concentric rings called tracks, each of which is in turn subdivided into sectors. Using a program called a disk operating system, the computer keeps track of exactly where information is on the disk and it can get to any item of data by moving the head to the appropriate track and then waiting for the right sector to come round. Two methods are used to tell the computer where on a track each sector starts: soft sectoring

where special signals are recorded on the surface and hard sectoring where holes are punched through the disk around the central hole, one per sector.

Half-way between cassettes and disks is the stringy floppy — a miniature continuous loop tape cartridge, faster than a cassette but cheaper than a disk system. Hard disk systems are also available for microcomputers; they store more information than floppy disks, are more reliable and information can be transferred to and from them much more quickly.

You, the user, must be able to communicate with the computer and the generally accepted minimum for this is the visual display unit (VDU), which looks like a TV screen with a typewriter-style keyboard; sometimes these are built into the system, sometimes they're separate. If you want a written record (hard copy) of the computer's output, you'll need a printer.

The computer can send out and receive information in two forms — parallel and serial. Parallel input/output (I/O) requires a series of wires to connect the computer to another device, such as a printer, and it sends out data a byte at a time, with a separate wire carrying each bit. Serial I/O involves sending data one bit at a time along a single piece of wire, with extra bits added to tell the receiving device when a byte is about to start and when it has finished. The speed that data is transmitted is referred to as the baud rate and, very roughly, the baud rate divided by 10 equals the number of bytes being sent per second.

To ensure that both receiver and transmitter link up without any electrical horrors, standards exist for serial interfaces; the most common is RS232 (or V24) while, for parallel interfaces to printers, the Centronics standard is popular.

Finally, a modem connects a computer, via a serial interface, to the telephone system allowing two computers with modems to exchange information. A modem must be wired into the telephone system and you need British Telecom's permission; instead you could use an acoustic coupler, which has two obscene-looking rubber cups into which the handset fits, and which has no electrical connection with the phone system — British Telecom isn't so uppity about the use of these.

**DIRECT  
ACCESS****IN STORE**

Three new systems in the £2-3000 price range this month, the Millbank System 10, the Pasca 640 and Vector VIP (see February Benchtest). All of these are fully expandable 64k RAM systems. Another inclusion in the Raannd SP1, reviewed in December '80. This is based on the Western Digital 1600 CPU and thus, like the Microengine, needs no interpreter for its Pascal. The LSI M-Two replaces the Model 5 as its larger business system; note also the reduction in price of the M-One. The Bigboard is now available, an SBC designed as the basis of a business or control system, supporting up to four 8in F/D drives. Two other new single boards are the Microaxis 1 and MPC 09, manufactured by Micro Design for industrial control applications. Please send updates for 'In Store' to me, Dick Olney, PCW, 14 Rathbone Place, London W1P 1DE.

Machine (Price from)	Main Distributor/s (No. of Dealers)	Hardware	Software	Miscellaneous (Documentation)
ABC 80 (£738)	Datormark Ltd: 97 44896	16-40k RAM; Z80A; C; 12", 16 x 40 b&w VDU; 4680 bus; IEEE 488; RS232 port.	DOS; Basic (16k ROM); <i>Fortran</i> ; <i>Pascal</i> ; <i>A</i> ; <i>Multi user Basic</i> .	Colour video graphics with UHF output. Viewdata compatible. Loudspeaker. Numeric keypad. Options: dual 5 1/4" F/D (320k) £895; dual 8" F/D (2 Mb). BT 1/80. (1)
ACT System 800 (£3950)	ACT: 021-455 9898 (50)	48k RAM; dual 5 1/4" F/D (800k); 12", 30 x 64 VDU; 1 S/P; 1 P/P; Multi-screen int.	MDOS; Basic; <i>A</i> ; <i>CBasic</i> ; <i>PL/M</i> ; <i>Forth</i> ; <i>Fifth</i> ; <i>Cesil</i> ; <i>Pilot</i> ; <i>Fortran</i> .	IBM compatible K/B. High resolution graphics. Available with dual 8" F/D (2.4 Mb) £4950 — 4.8 Mb maximum. BT 2/80 (E).
Alpha Micro (£5650)	Alpha Micro (UK) Ltd: 01-250 1616 (TBA)	64k — 1 Mb RAM; 16 bit; dual 8" F/D (2.4 Mb); 6 S/P.	Multi-user OS; Basic; <i>M/A</i> ; <i>Pascal</i> ; <i>U</i> .	Modular. Expands to 1200 Mb, 24 terminals or multiprocessor system. (E)
Altos ACS 8000 (£3398)	Logitek: 02572 66803 (33)	64k RAM; Z80; 1k EPROM; dual 8" F/D (1 Mb); 2 x RS232 ports; 1 P/P.	<i>CP/M</i> ; <i>Basic</i> ; <i>CBasic</i> ; <i>Cobol</i> ; <i>Pascal</i> ; <i>Fortran</i> .	Expandable to 4-user system with 58 Mb H/D. Maintenance contracts avail; BT 5/80 (S&H).
Apple II (£695)	Microsense: 0442 41191 (190)	16-48k RAM; 6502; 8 I/O slots.	OS; <i>Basic</i> ; <i>Pascal</i> ; <i>Fortran</i> .	280 x 192 high resolution graphics; Integer Basic in 6k ROM; Option: single 5 1/4" F/D (116k) £349.
Atari 400 (£395-16k)	Ingersoll: 01-226 1200 (TBA)	8-16k RAM; 6502; C int; cartridge slot; 12 x 20 TV int; RS232C port; touchpad k/b; Opt: C £55.	OS (10k ROM); Basic (8k ROM).	High resolution colour graphics. 4-channel sound. Four games controller/light pen sockets.. BT 10/80. (1/B).
Atari 800 (£695-16k)	As above.	8-48k RAM; 6502; C int; 4 x cartridge slots; 12 x 20 TV int; RS232C port. Opt: single 5 1/4" F/D (90k) £525; 16k RAM £145.	As above.	As above. Software & RAM on cartridge modules. Up to 4 disk drives. BT 10/80. (1/B).
Athena 8285 (£5694)	Butel-Comco Ltd: 0703 39890 (TBA)	64k RAM; 8085A; dual 5 1/4" F/D (644k); 12" 25 x 80 VDU; 150 cps printer; RS232 port.	AMOS; T/E; Basic; <i>Cobol</i> ; <i>Fortran</i> ; <i>Pascal</i> ; <i>APL</i> ; <i>M/A</i> .	Extended ASCII K/B with numeric pad; graphics. Options: dual 8" F/D (2 Mb); up to 1200 Mb H/D.
Atom (£120)	Acorn: 0223 312772 (N/A)	2-11k RAM; 6502; Full K/B; C int; TV int; 20 I/O lines; 1 P/P.	Basic in 8k ROM; A Cass O/S.	High resolution graphics on bigger model; colour monitor O/P. Loudspeaker. Note also, systems based on Acorn SBC. BT 7/80 (B).
Attache System II (£8000)	Friargrove Systems Ltd: 01-572 3784 (10)	64k RAM; Z80; dual 8" F/D (1.2 Mb); 12" 24 x 80 VDU; 180 cps printer.	Basic; <i>Fortran</i> ; <i>Cobol</i> .	Upgradable to multiuser system with 34 Mb H/D. Full range of business packages included software dealers TBA. (S)
BASF 7120 (£5155)	BASF: 01-388 4200 (TBA)	64k RAM; Z80A; 3 x 5 1/4" F/D (480k); 12", 24 x 80 VDU; RS232 port; P/P.	DOS; <i>Ex Basic</i> ; <i>Cobol</i> <i>U</i> .	H/D available soon. Also 7110 with dual F/D £4275. Disk controller has own Z80A. BT 9/80. (1)
Billings BC-12 FD: (£3995)	Mitech: 04862 23131 (TBA)	64k RAM; Z80A; dual 5 1/4" F/D (640k); 12", 24 x 80 b&w (or b&g) VDU.	DOS; Basic; <i>Fortran</i> ; <i>Cobol</i> ; <i>A</i> .	With dual 8" F/D (2 Mb) £5995. Additional dual 8" F/D £3000. (S).
C/09 (£3975)	SWTP Ltd: 01-491 7507 7507 (16)	56k RAM; 6809; dual 8" F/D (2 Mb); 8"; 16 x 80 VDU; 1 S/P.	TSC FLEX; <i>Basic</i> ; <i>Pascal</i> ; <i>A</i> ; <i>Dis A</i> ; <i>T/E</i> ; <i>U</i> .	VDU is intelligent. Option: 15 Mb H/D £3575; with dual 5 1/4" F/D (350k) instead of 8", £3000. (H)
Canon BX-1 (£3850)	Canon Business Machines (UK) Ltd: 01-680 7700.	64k RAM; 6800; Single 5 1/4" F/D (65k); 12", 25 x 80 VDU; 5 x V24 ports.	DOS; <i>Ex Basic</i> ; <i>A</i> .	Also supplied with integral thermal printer instead of VDU. (S&H)
Challenger 1P & C4P (£220 & £395)	CTS: 0706 79332. Millbank Computing: 01-549 7262. Mutek: 0225 743289. U-Microcomputers: 0925 54117 (18)	4-32k RAM; 6502; C int; RS232 port. Options: dual 5 1/4" F/D (160k) £550; for C4P dual 8" F/D (1.15 Mb) and 20MB H/D	O/S; Basic (8k ROM) <i>Ex Basic</i> ; <i>A</i> .	D/A conv; colour capability. Runs OSI business software on 8" F/D Plato educational software avail. soon. BT 4/80. (S).
Challenger 2 (£1500)	As above	48k RAM; 6502; dual 8" F/D (0.5 Mb); RS232 port.	OS65U; <i>Ex Basic</i> ; <i>A</i> .	Designed as low cost business system (S).
Challenger C3 (£2334)	As above	32-56k RAM; 6502; 6800; Z80; dual 8" F/D (1.15 Mb); 2-16 S/P.	OS65U; Basic; <i>CP/M</i> ; <i>Fortran</i> ; <i>Cobol</i> .	Expandable to multi-user (8) system. Options: C3B & C3C H/D units. 74 Mb for about £8500. (S&H).
Clenlo Conqueror System B (£1950)	Clenlo Computing Systems Ltd: 01-670 4020 (TBA)	64k RAM; Z80; dual 8" F/D (1 Mb); 3 S/P; 2 P/P.	<i>CP/M</i> ; <i>CBasic-2</i> ; <i>Pearl I</i> ; <i>U</i> .	With four 8" F/D £2850. (S&H).

**List of Abbreviations**

A Assembler  
BT Bench Tested  
C Cassette  
E Extensive  
F/D Floppy disk

G/C Graphics card  
H Hardware  
H/D Hard disk  
I Introductory  
Int Interface

M/A Macro assembler  
N/A Not available  
N/P Numeric pad  
O/S Operating system  
P/P Parallel port

S Software  
S/P Serial port  
T/E Text editor  
TBA To be announced  
U Utility

Please note: Software items listed in *italic* are not included in the basic price of the equipment. All prices are *exclusive* of VAT.



Machine (Price from)	Main Distributor/s (No. of Dealers)	Hardware	Software	Miscellaneous (Documentation)
Clenlo Conqueror System D (£5150)	As above	64k RAM; single 8" F/D (500k); 10 Mb H/D; 3 S/P; 2 P/P.	CP/M; CBasic-2; Pearl 11; U.	With 26 Mb and no F/D £5950.
Compucolor II (£995)	Dyad Developments: 08446 729 (TBA)	8-32k RAM; 8080; 13" 32 x 64 8-colour VDU; single 5 1/4" F/D (51k); RS232 port.	DOS (ROM); Ex-Basic (ROM); A.	16k version £1078, 32k £1198. High resolution graphics. 6-month subscription to user magazine inclusive BT 9/79. (S)
Compucorp 625 (£6000)	Compucorp: 01-952 7860 7860 (17)	48-60k RAM; Z80; dual 5 1/4" F/D (630k); 9". 16 x 80 VDU; 40 col printer; RS232 port, P/P.	Basic; A; Fortran; Pascal; U.	IEEE-488 Controller and S100 int. Many applications packages avail. (E)
Compucorp 655/665/675 (from £5895)	As above	60k RAM; Z80; Up to 4 x 5 1/4" F/D (160k-2.4 Mb); 9", 20 x 80 or 12" 20 x 80 or 20" 60 x 80 VDU; 40-col printer; RS232 port.	As above	Prices incl installation and training. Opt: 10-20 Mb H/D
Computermart 2000 DS (£1500)	Computermart: 0603 615089	32-256k RAM. 8085; dual 8" F/D (1-2 Mb); S/P; P/P.	CP/M; Cis Cobol; Basic; Fortran	Expandable to multi-user, multi-tasking, multi-processor 96 Mb H/D system (around £15000).
Cromemco System 2, System 3, System Z2H. (£2100/£3730/£5430)	Datron: 0742 585490. Comart: 0480 215005. MicroCentre: 031-556 7354 (18)	64k RAM; Z80; dual 5 1/4" F/D (346k) on System 2 & Z2H; dual 8" F/D (1.2 Mb) on Sys 3; 10 Mb H/D on Z2H; S/P; P/P.	CDOS; Basic; Cobol; Fortran; RPG II; Lisp; A; W/P; Multi-user Basic.	All systems expandable to multi-user (max 7) £6408 Sys 2, £8304 Sys 3. Options: dual 8" F/D (996k); 11-22 Mb H/D. BT 10/79 (E).
DAI (£998-48k)	Data Applications (UK): 0285 2588 (TBA)	12-48k RAM; 8080; C int; 24 x 60 VDU int; RS232 port; over 20 industrial ints.	Basic (ROM); U.	Colour graphics up to 255 x 335; 3 notes & noise generator; PAL O/P to TV; Paddle int; H maths option. (I). ET 10/80
Diablo 3000 (£8950) (TBA)	Business Computers Ltd: 01-207 3344	32k RAM; 8085; dual 8" F/D (1.3 Mb); 12", 24 x 80 b&w VDU; 45 cps printer.	DOS; Basic; DACL; A; U.	Selection of business packages included (S).
Digital Micro-systems DSC-2 (£3525)	Modata: 0892 41555 (10)	64k RAM; Z80; dual 8" F/D (1.14 Mb); 4 x RS232 ports; EIA port.	CP/M; Basic-E; CBasic; Cobol; Fortran; Pascal.	14 or 28 Mb H/D available or additional F/D units (H).
Digital Micro-systems DSC-4 (£6045)	As above	128k RAM; Z80A; single 8" F/D (500k); 11 Mb H/D; 4 x RS232 ports; 2 P/P.	CP/M; Basic-E; CBasic; Cobol; Fortran; Pascal.	Also DSC-3 with 64k RAM. Options; 128k RAM £1295; up to 4 Mb F/D and 20 Mb H/D. (H).
Durango F-85 (£7500)	Comp Ancillaries: 0784 36455 (12)	64k RAM; 8085; dual 5 1/4" F/D (1 Mb); 9", 16 x 64 green VDU; 132 col 165 cps printer; N/P.	O/S; DBasic; CP/M; CBasic; Micro Cobol.	Up to 5 work stations; fully integrated system. Options: additional dual 5 1/4" F/D (1 Mb); 12-24 Mb H/D. (S).
Dynabyte 5200-5900 £2300	Metrotech 0895-57780 (15)	64k RAM; Z80; S100 bus; 2 ser ports; 1 par port; any com of 5 1/4" F/D (1.2 Mb) 9/27/45 Mb H/D, 32/64/96 Mb Cart Module Disk.	CP/Net, CBasic, MBasic Cobol, Fortran, Pascal, PL/1-80.	All systems expandable to multi-user and networking; CP/M inc in base price for F/D systems, MP/M for H/D systems.
Equinox 200 (£7500)	Equinox: 01-739 2387 (N/A)	64-512k RAM; Z80; 10 Mb-1200 Mb H/D; 6 x S/P; 1 P/P.	CP/M; CBasic; Cobol; Fortran.	Multi-user MVT/FAMOS available in place of CP/M. 16-bit version (Equinox 300) £10,000. (S&H).
Euroc (£7995)	Euroc: 01-729 4555 (TBA)	34k RAM; 8080A; dual 8" F/D (1 Mb); 15" 25 x 80 b&w VDU; 132 vol 140 cps printer.	CP/M; CBasic; A; U.	Financial software available. Supply of stationery included.
Executive Mini-computer (£378)	Binatone Int: 01-903 5211 (N/A)	16k RAM; Z80; 500 bps C; 32 x 64 TV int; extra C int; 1 P/P.	Basic (12k ROM); M/A; Fortran.	Graphics avail. F/D under development; Also 4k version called 'Oxford minicomputer'.
Exidy Sorcerer (£749)	Liveport Data Products: 0736 798147 (27)	16-48k RAM; Z80; RS232 port; 1 P/P; S100 connector; 30 x 64 VDU int.	O/S; Basic (ROM); T/E; A; CP/M; Algol; Fortran; Basic; 80.	High-resolution graphics capability; user programmable character set. 32k version £799; 48k £849. Option: single 5 1/4" F/D (316k) £600.
Gemini 801 (£1075)	Gemini: 02403 22307 (7).	64k RAM; Z80A; Single 5 1/4" F/D (315k); 25 x 80 VDU int; RS232 port. P/P.	CP/M Basic; Cobol; Fortran; Pascal; A; T/E.	Up to two integral & two external F/D. Graphics. With no F/D and C int. £750. (S)
Haywood 3000 (£2022)	Haywood: 65 28301. (TBA)	48k RAM; Z80A; dual 5 1/4" F/D (800k); RS232 port; P/P. Opt: 15" 28 x 80 VDU £799.	CP/M; Basic; Cobol; Fortran; Pascal; W/P.	Also system 7000 with 48-65k RAM and 8" F/D (2.5 Mb) £2999. (S)
HP 85 (£1830)	Hewlett Packard Ltd: 0734 784774 (16)	16-32k RAM; C.P.U.; 5", 16 x 32 VDU; C (200k); 64 cps printer; 4 P/P. Options: dual 5 1/4" F/D (540k) £1408; dual 8" F/D (2.4 Mb) £3744.	Basic (ROM)	Full dot matrix graphics. Complete range of interfaces, peripherals and application packages avail. 16k RAM £222. (S).
IMS 5000 (£1500)	Equinox: 01-739 2387 (20)	16-56k RAM; Z80; dual 5 1/4" F/D (320k); 2x S/P; 1 P/P.	CP/M; CBasic; Cobol; Fortran.	3 drives option: (S&H).
IMS 8000 (£2500)	As above	64-256k RAM; Z80; dual 8" F/D (1 Mb); 2 x S/P; 1 P/P	CP/M; CBasic; Cobol; Fortran; MicroCobol.	Multi-user MVT/FAMOS available in place of CP/M. (S&H).
ITT 2020 (£867)	ITT: 0268 3040 (15)	16-48k RAM; 6502	Monitor; A; ExBasic; Dis A.	360 x 192 high res graphics. Ex-Basic in 6k ROM; Options: single 5 1/4" F/D (116k), £425; 16k RAM, £110; RS232 port, £96; 32k system, £931; 48k system. £995. (B).
Ithaca DPS1 (£3995)	Ithaca: 01-341 2447 (10).	64k RAM; Z80; dual 8" F/D (1 Mb); 2 x RS232 ports; 4 x P/P. Opt: H/D.	CP/M; Basic; Cobol; Fortran; Pascal; A; U.	Z8000 16-bit processor board avail. IEEE/S100 (8 or 16 bit) compatible. (E).
LX-500 (£3500)	Logapax Ltd: 01-965 0061 (13)	32k RAM; Z80; dual 5 1/4" F/D (180k); 12" 25 x 80 b&w VDU; 100 cps printer.	DOS; Basic; A.	Other printers available. (S).

### List of Abbreviations

A Assembler	G/C Graphics card	M/A Macro assembler	S Software
BT Bench Tested	H Hardware	N/A Not available	S/P Serial port
C Cassette	H/D Hard disk	N/P Numeric pad	T/E Text editor
E Extensive	I Introductory	O/S Operating system	TBA To be announced
F/D Floppy disk	Int Interface	P/P Parallel port	U Utility

Please note: Software items listed in *italic* are not included in the basic price of the equipment. All prices are *exclusive* of VAT.

**DIRECT ACCESS**

**IN STORE**

Machine (Price from)	Main Distributor/s (No. of Dealers)	Hardware	Software	Miscellaneous (Documentation)
LSI M-One (£4200)	LSI Computers: 04862 23411 (20)	8-16k RAM; 8080; dual 8" F/D (1.2 Mb); 12", 24 x 80 b&w VDU	FMOS; A	Choice of standard business packages included in price. (S).
LSI M-Two (£7900)	As above.	64-128k RAM; 8085A; dual 8" F/D (1.2 Mb); 12", 24 x 80 VDU; 60 cps printer	Elsie; CP/M; Basic; Cobol Fortran; Pascal; A; U	Max 8 VDUs and 4 printers. Many applications packages available. Option: 10 Mb H/D £2600. (S)
Macro 1 & 2 (£3750 or £280 pm).	Micro APL Ltd. 01-834 2687 (TBA)	64k RAM; Z80; dual 8" F/D (1 Mb); 4 x RS232 ports.	CP/M; APL; U; Basic; Fortran; Cobol; Wordstar; Algol; Pascal; Forth.	Designed as timesharing replacement. (S).
Megamicro (£6680)	Bytronic: 0252 726814(5)	56k RAM; Z80; dual 8" F/D (500k); 12", 20 x 80 green VDU; 180 cps printer; 2 S/P; 2 P/P.	CP/M; U; Basic; A; M/A.	Range of bus. packages now avail. from Ludhouse of Streatham. (H&B).
Micro Trainer 1 (£650)	Hewart; 0625 22030 (N/A)	16-32k RAM; 6800/6809; 10" 16 x 24 VDU; 2 x C int; Opt: dual 5 1/4" F/D (160k) £595; 8k RAM £17.	Basic; A; Pascal; PL/M; W/P	SS50-based system. Graphics avail. Int card with real time clock £17. (I)
Mikro 1000 (£3950)	Airamco: 0294 57755 (TBA)	64k RAM; Z80; dual 8" F/D (1 Mb); 12" 24 x 80 VDU; S100; RS232; 1 P/P	CP/M; Basic; Cobol; Fortran.	Also word processor with 44 special function keys & NEC Spinwriter printer £4450. (S&H)
Microstar 45 Plus (£4800)	Data Efficiency Ltd: 0442 63561 (30)	64k RAM; 8085; dual 8" F/D (1.2 Mb); 3 S/P; RS232 port	Stardos; CP/M; Basic; Cobol; Fortran	(E)
Microtan 65 (£69)	Tangerine: 0353 3633 (6)	1k RAM; 6502; T Mint; Exp up to 277k RAM.	1k TANBUG monitor; 2k A, disassembler, cassette firm ware; 10k Microsoft Ex Basic.	Options: bulk I/O modules, hi-def colour graphics, DOS, system racking, ASCII keyboard. (S&H)
Millbank Sys 10 (£2995)	Millbank: 01-788 1083 (6).	65k RAM; Z80; dual 5 1/4" F/D (700k); 12", 24 x 80 VDU; 2 x RS232 ports; RS449 port; P/P.	CP/M; Basic; Cobol; Fortran; Pascal; PL1; W/P	One high level lang. included. 12-month warranty. Main-frame comm. package. H/D avail. soon. (S&H)
MS5001 (£8250)	BMG Ltd: 0793 37813 (N/A)	64k RAM; 8085; dual 8" F/D (1 Mb); 12", 80 x 24 VDU; 160 cps printer; RS232.	CP/M; Basic; Cobol; Fortran; MP/M.	Price includes desk mounting and one computer. Hardware & software support. Leasing arrangements available. (E)
MSI 6816 (£1200)	Strumech: 05433 4321 (5)	16-56k RAM; 6800; 9" 16 x 64 b&w VDU; C int; 1 S/P; 1 P/P.	Basic; A.	Graphics & PROM programmer available (S&H)
MSI System 7 (£3500)	As above	56k RAM; 6800; dual 5 1/4" F/D (160k); 9", 14 x 64 VDU; 1 S/P; 1 P/P.	FDOS; Basic; A; U.	As above. Multi-user O/S avail. Options: 10 Mb H/D.
MSI System 12 (£8000)	As above	56-184k RAM; 6800; 10 Mb H/D; 9", 16 x 24 VDU; 1 S/P; 1 P/P.	SDOS; Basic; CBasic; U.	As above. Business packages avail. (H & S).
Nanocomputer NBZ80S (£420)	Midwich: 0284 701321	4k RAM; 2k ROM; Z80; C int; 8 digit LED; Calc K/B; RS232 port; 2 P/P.	Machine Language; Basic; A; T/E.	Designed for hardware education. Full training manuals included. Fully expandable. (E).
Newbrain MB £219	Newbury Labs: 021-707 7170. Newbear: 0635 30505 (N/A)	2-4k RAM; Z80A; Nat 420; 14x 16 VDU; 2 x C int; TV int; V24 port. Option: C (50k) £60.	C Basic (16k ROM)	Graphics. Battery or mains. Mains only with 16k RAM £269. (low power battery version £299). (I).
North Star Horizon (£2230)	Comart: (7) 0480 215005. Comma: 0277 811131. Equinox: 01-739 2387 (20)	48-56k RAM; Z80A; dual 5 1/4" F/D (360k); 15", 24 x 80 VDU; 150 cps printer; 2 S/P; 1 P/P.	DOS; Basic; CP/M; Cobol; Fortran; Pascal.	With 32k and single F/D £1495. Options: 18 Mb H/D.
Onyx C8000 (£6850)	Onyx Dist Ltd: 0734 664345 (TBA)	64k RAM; Z80; 12 Mb Cartridge; 10 Mb H/D; RS232 port; P/P	CP/M; Basic; Cobol; Fortran; Pascal; W/P	C8001 with 128k RAM £8220. Multi-user version avail. using Oasis. (E)
Panasonic JD 800U, JD840U (£4275, £4950)	Panasonic Business Equipment: 01-262 3121 (10 regional dist)	56k RAM; 8085A; 2-4k PROM; dual 8" F/D JD800 U (500k), JD840U (2 Mb); 12", 24 x 80 green VDU; 3 x RS232 ports.	CP/M; Basic; Micro-Cobol.	Also available with 5 1/4" F/D; JD740U (570k) £4095. BT 3/80 (S).
Pascal Microengine (£2295)	Pronto Electronic Systems Ltd: 01-554 6222	64k RAM; MCP 1600; 2 x RS232 ports; 2 P/P.	Pascal.	CPU instruction set is P-code; no interpreter needed. Available with dual 8" F/D (2 Mb) £3900.
Paxa 640 (£3400)	Westrex Ltd: 01-405 4261 (TBA)	64k RAM; Z80A; dual 8" F/D (512k); 10", 24 x 80 VDU; RS232 port; P/P.	CP/M; Basic; Cobol; Fortran; Pascal; A; W/P; U	Maintenance contracts avail. 10 Mb H/D avail. soon. (S)
Periflex 630/64 (from £1995)	Sintrom: 0734 85464 (5)	64k RAM; Z80; dual 5 1/4" F/D (630k); 2 x RS232 ports; 1 P/P	CP/M; Basic; Fortran; Cobol; A.	One-day installation training on site included in price. Option; dual 5 1/4" F/D (630k) £464, dual 8 1/4" F/D (1 Mb) £1025. BT 6/80 (S&H).
Periflex 1024/64 (from £2750)	As above	64k RAM; Z80; dual 8" F/D (1.2 Mb); 2 x RS232 ports; 1 P/P.	As above	As above.
PET 8k, 16k, & 32k (£450, £550, £695)	Commodore: 01-388 5702 (150)	8-32k RAM; 6502; C; 9" 25 x 40 VDU; IEEE-488 port; Options: dual 5 1/4" F/D (353k) £695; same but (950k) £895	O/S; Basic (in 8k ROM); Forth; Pilot; Pascal.	Disk controller for 8k version £30. New 8032 with 80-col screen (32k). BT 12/80. £895. (I).
Powerhouse 2 (£1125)	Powerhouse Micros: 0422 48422 (TBA)	32-64k RAM; Z80A; 5" 29 x 96 VDU; RS232 port; external bus.	4k Monitor; FDOS; Basic; ExBasic (14k EPROM)	VDU has flexible screen logic. Options; FDOS & Basic £210; graphics card £200. (H)
Powerhouse 3 (£2600)	As above	32-64k RAM; Z80A; dual 5 1/4" F/D (350k); 5", 29 x 96 VDU; RS232 port; external bus.	As above.	VDU as above. With 1.2 Mb F/D £3500. ExBasic & FDOS in 14k EPOMs £300. (H)

**List of Abbreviations**

A Assembler	G/C Graphics card	M/A Macro assembler	S Software
BT Bench Tested	H Hardware	N/A Not available	S/P Serial port
C Cassette	H/D Hard disk	N/P Numeric pad	T/E Text editor
E Extensive	I Introductory	O/S Operating system	TBA To be announced
F/D Floppy disk	Int Interface	P/P Parallel port	U Utility

Please note: Software items listed in *italic* are not included in the basic price of the equipment. All prices are *exclusive* of VAT.



**Stop  
press**  
NOW ONLY £595 + VAT  
BEAT THAT FOR VALUE

# The DAI Personal Computer is Here

**\* High Performance \***  
**\* High Value \***

48k RAM

£795



COLOUR

SOUND

## Standard Features

- \* 24k Resident High-Speed Basic
- \* 16 Colour High-Resolution Graphics (255 × 335)
- \* Scrolling Screen Editor
- \* Sound Commands for Music Generation
- \* Very High Speed Hardware Maths Option
- \* Resident Monitor for Machine Language Programming
- \* 3 Programmable Parallel Ports
- \* Standard TV Interface via Aerial Socket
- \* RS232 Serial Port and Dual Cassette Interfaces

Manufactured by:

**DAI**  
THE  
MICROCOMPUTER  
ENGINEERING  
COMPANY

Brussels, Belgium.

Available from:

**Data Applications (UK) Ltd.**  
Personal Computer Division  
16b Dyer Street  
Cirencester  
Gloucestershire  
GL7 2PF  
Tel: Cirencester  
(0285) 61902

For further information please complete and post to:  
Data Applications (UK) Ltd, 16b Dyer Street, Cirencester, Glos GL7 2PF

NAME.....  
ADDRESS.....  
MY INTEREST IS:.....

Make your micro



## Get the most out of your microcomputer with Graham-Dorian Business software.

At any given time, your hardware is only as useful as the software you run in it. Our programs let you realise the full potential of your hardware.

Graham-Dorian provides highly detailed and well documented programs. All pretested on the job. Each so comprehensive that it takes little time to learn to run a program — even for someone who's never operated a computer before.

Graham-Dorian programs are on-line now working for us and others around the world. They are ready to go to work immediately or to be tailored for your more specific needs. Each package contains a software program in BAS and INT film form plus a user's manual and hard copy SOURCE LISTING.

Programs are compatible with most major computers using CP/M disk operating systems, and come in standard 8" or on various mini-floppy disks.

Graham-Dorian stand behind dealers with technical advice.

Yes, there's a world of difference in business software. Graham-Dorian has more per-package capabilities and more packages (with new ones added every few months).

Distributors for Micropro: - Wordstar, Datastar & Mailmerge. CP/M for Tandy Model I & II

†GDSS are appointing UK Dealers and European Distributors. Enquiries and applications invited.

\*CBASIC-2 is a trade mark (copyright 1980) of Compiler Systems, Inc. GDSS are the European Distributor for CBASIC-2.

### The Graham-Dorian line now includes these packages:

- Nominal Ledger
- Purchase Ledger
- Sales Ledger
- Job Costing
- Order Entry & Invoicing
- Payroll
- Manufacturing Inventory
- Manufacturing Job Costing
- Wholesaler Inventory
- Retailer Inventory
- Cash Register
- Apartment
- Surveying
- Dental

CBASIC-2\*

Ask your dealer for a demonstration soon.



### Graham-Dorian Software Systems

A division of Graham-Dorian Enterprises & Terodec (Micro Systems) Ltd.  
Unit 58, Suttons Park Avenue, Earley  
Reading, Berks RG6 1AZ  
Tel (0734) 664345/6 GDSS



# IN STORE

DIRECT  
ACCESS

Machine (Price from)	Main Distributor/s (No. of Dealers)	Hardware	Software	Miscellaneous (Documentation)
Raannd SP1 (£5500).	Raand: 0506 33372 (TBA)	64k RAM; MCP 1600; dual 8" F/D (2 Mb); 12", 24 x 80 VDU; RS232 port; P/P.	Pascal	Based on Microengine (with integrated P-code). BT 12/80. (S)
Rair Black Box (£2250)	Rair: 01-836 4663 (N/A)	32-64k RAM; 8085; dual 5 1/4" F/D (260k); 2 x RS232 ports.	CP/M; Basic; Cobol; Fortran; M/A	16k RAM expansion £250 10 Mb H/D £2500.
Research Machines 380Z (£1123)	Research Machines: 0865 49791 (N/A)	16-56k RAM; Z80A; 2 x C; RS232 port.	ExBasic; A; T/E; U; CP/M; Fortran; Cobol; Algol; Cesil.	Limited graphics. Many possible systems. With 48k RAM & dual 8" FD (1 Mb) £3394.
S/09 (£5350)	SWTP Ltd: 01-491 7507 (16)	128k RAM; 6809; dual 8" F/D (2 Mb); 8", 21 x 92 VDU 2 x S/P; 1 P/P	TSC FLEX; Basic; Pascal; A; Dis A; TIE; U.	VDU is intelligent. Expands to Option: 15 Mb H/D £3575. 60 Mb H/D multi-user system. Maintenance contracts. (S&H).
Saracen (£1925)	Bytronix 0252 726814 (TBA)	32-64k RAM; Z80; dual 5 1/4" F/D (800k); 2 x RS232 ports.	CP/M; Basic; Cobol; Fortran; Pascal; A.	Applications packages & maint. contracts avail. With dual 8" F/D (2 Mb) and 64k RAM, £2676. (E)
SBS 8000 (£1449)	Manhattan Skyline Ltd: 08012 3442; C Troh 01- 353 6090 (TBA)	64k RAM; Z80A; 12", 16 x 64 VDU; 1 P/P; RS232 port (extra £133).	ExBasic (24k ROM); DOS	Options: disk control card £237; dual 5 1/4" F/D (368k) £795; dual 8" F/D (2 Mb) £1400. BT 11/80. (S)
SEED System 1 (£2000)	Strumech: 05433 4321 (4)	32-64k RAM; 6800; dual 5 1/4" F/D (160k); 9", 16 x 24 VDU; RS232 port.	DOS; Basic U; Fortran; A; Pilot; Strubal; T/E	Several F/D options. With 64k RAM & dual 8" F/D (1.2 Mb) about £3000. (E).
Sharp MZ-80K (£480) (22)	Sharp Electronics (UK) Ltd: 061-205 2333 (22)	6-34k RAM; Z80; C; 10" 24 x, 40 VDU; Option: dual 5 1/4" F/D (289k) £780.	Basic (14k ROM); A.	Graphics; loudspeaker. 18k RAM version £529; 22k £549; 34k £599. BT 10/79 (B).
Sharp PC3200 (£2995)	As above	64k RAM; Z80A; dual 5 1/4" F/D (500k); C int; 12", 25 x 80 VDU; 70 lpm printer.	DOS; U; Basic.	CP/M may be avail. next year. Various expansion cards avail. (I&B)
Sinclair ZX80 (£100 inc VAT)	Science of Cambridge: 0223 311488 (N/A)	1-16k RAM; Z80A; C int; TV int; full K/B; 44-pin expansion port.	Basic (4k ROM).	Kit £80. Mains adaptor £9. (S)
Smoke Signal Chieftan (£1807)	Systems Implementation Ltd: 06924 5666 (TBA)	32-64k RAM; 6800/6809; dual 5 1/4" F/D (160k); 12", 24 x 80 VDU; RS232 port.	DOS; 68/FLEX; Basic; Fortran; Cobol; U.	With dual 8" F/D (2 Mb) £2712. Designed as development system for industrial control. (H)
Solitaire WP & BS200 (£6750 & £8200)	Solitaire KPG: 01- 995 3573 (TBA)	64k RAM; 8085; 14" VDU (with own CPU); 45 cps printer; CPU port; dual 5 1/4" F/D (700k) 8" F/D (1.02 Mb) with BS200.	DOS; Basic	All solitaire systems are compatible; graphics on 11 x 13 dot matrix. (S)
Sord M100 (£795)	Midas Computer Services Ltd: 0903 814523 Exleigh Bus. Mach. 0736-66577. (8)	48k RAM; Z80; 8k ROM 12" 24 x 64 green VDU; RS232 port; S100 bus; N/P.	O/S; Basic; A; Fortran; Pascal.	M100 ACE with single 5 1/4" F/D (143k) £1850. Up to 3 drives possible. Colour graphics avail. (I)
Sord M223 Mk II-VI (£3950)	As above	64k RAM; Z80; 8k ROM single 5 1/4" F/D (350k); 12", 24 x 80 green VDU; RS232 ports; S100 bus; N/P	O/S; Ex Basic; CBasic; Multi-User Basic; Fortran; Pascal; Cobol.	Expandable to 4 Mb F/D. 32 Mb, H/D, 5 screens, 2 printers. M243 with 192k RAM & dual 8" F/D £7000.
SPC/1 (£3770) (TBA)	Digital Data: 01- 573 8854	64-1024k RAM; 8085A-2; dual 5 1/4" F/D (90k); 12", 24 x 80 VDU; 2 x RS232 ports; Option: single 8" F/D (1 Mb) £1090; 20 Mb H/D £7000.	Mikados, Comal; Pascal; A.	With 32k RAM and single F/D (Comal only) £1995. Expandable to multi-user system (8 users). BT 7/80 (S).
Superbrain (£1995)	Icarus: 01-485 5574 (TBA)	64k RAM; 2 x Z80; dual 5 1/4" F/D (320k); 12" 25 x 80 VDU; S100 bus; RS232 port.	CP/M; A; Basic; Cobol; Fortran; APL; Pascal.	Limited graphics, Mainframe int avail. Full range of application packages avail. Opt: dual 5 1/4" F/D (320k); dual 8" F/D (2.4 Mb); 8.120 Mb H/D. BT 8/80. (S&H).
System 10 (£2995)	Millbank 01-788 1083 (TBA)	64k RAM; Z80; dual 5 1/4" F/D (700k); 12", 24 x 80 VDU; 2 x RS232 port; P/P	CP/M; Basic; Fortran; Pascal; Cobol; PL/1; W/P.	12 month warranty. Maint contracts. Applications packages avail. Choice of high level language in price. (E)
System 80 (£1355-48k)	Nascom: 02405 75155 (32)	16-48k RAM; Z80A; dual 5 1/4" F/D (560k); TV int; RS232 port.	CP/M; Basic (8k ROM)	EPROM firmware avail. Colour graphics card £165. Many config- urations possible. (S&H).
Tandberg EC10 (£4000)	Tandberg: 0532 774844 (N/A)	64k RAM; 8080A; single 8" F/D (250k); 12", 25 x 80 VDU; 7 x RS232 ports; printer int.	CP/M; ExBasic (24k) Multi-user Basic; Pascal; Cobol; A; U;	Up to 7 terminals. Includes V28 comms port. (S & H).
Tandberg TG 8450 (£2200)	As above	64k RAM; 8085; single 5 1/4" F/D (77k); C int; 12", 24 x 80 VDU; RS232 port; P/P	TDOS; Basic; Cobol; Fortran; Pascal.	TDOS is CP/M compatible. Opt: single 5 1/4" F/D (77k) £250 (up to four); dual 8" F/D (2 Mb) £1800. (S&H)
Tandy TRS-80 Level I (£335)	Tandy: 021 556 6101 (200)	4-16k RAM; Z80; C; 12", 16 x 64 VDU	Basic (4k ROM); A.	Expandable to Level II. Many extras available. (I).
Tandy TRS-80 Level II (£408)	As above	4-48k RAM; Z80; C; 12" 16 x 64 VDU; RS232 port; 1 P/P	Basic (4k ROM); M/A; Fortran.	16k machine includes N/P. 4- 16k upgrade £87, 48k system £620; Option: single 5 1/4" F/D (78k) £295, (subsequent £227), up to 4. BT 6/80 (I).
Tandy TRS-80 Model 2 (£1999)	As above	32-64k RAM; Z80A; single 8" F/D (500k); 12", 24 x 80 VDU; 2 S/P; 1 P/P; N/P.	DOS; Basic.	64k version £2249. Expandable to four F/D drives, single drive expansion £799; three drive £1589

#### List of Abbreviations

A Assembler  
BT Bench Tested  
C Cassette  
E Extensive  
F/D Floppy disk

G/C Graphics card  
H Hardware  
H/D Hard disk  
I Introductory  
Int Interface

M/A Macro assembler  
N/A Not available  
N/P Numeric pad  
O/S Operating system  
P/P Parallel port

S Software  
S/P Serial port  
T/E Text editor  
TBA To be announced  
U Utility

Please note: Software items listed in *italic* are not included in the basic price of the equipment. All prices are *exclusive* of VAT.

# 'Apple means business'

- who says so?

## Mobil

Oil Company Ltd.

says so . . .

'Just one 48K Apple, VisiCalc, disc-drive and printer enabled us to save over £13,000 p.a. in outside computer bureau costs' states Mobil's Manager, Financial Analysis, Mr E. A. F. Peach. 'With this sort of saving it is hardly surprising that our use of Apples has grown from one Apple to five in under six months. Our trolley-mounted Apples bring the analytical powers of VisiCalc direct to the user's desk; and the simplicity and robustness of the system make it as easy to use as a desk calculator. Apples are now producing virtually all our analytical work, profit plans, forecasts etc., promptly and cost-efficiently.'

## RANK XEROX says so . . .

'If small businesses are to continue trading successfully during the next 10 years they cannot afford to let the business equipment revolution pass them by' observed Mr B.H. Nicholson, International Director of Rank Xerox Ltd., at the recent opening of the Xerox Store, Piccadilly, London.

'This store carries almost everything the small business needs, and that has to include Apple microcomputers, and the software programs that go with them. Our research has identified 500,000 small businesses in the UK: Apple will feature strongly in our service to this mass market.'

## CROWN JOINERY and LAMINATING says so . . .

'Faced with a 100% increase in turnover in our factories in Chesham and Aylesbury, we recently installed an Apple microcomputer in our Accounts Department' comments Mr R.F. Alderton, Partner of the Company. 'The results have been a revelation to us. Apple gives us prompt management information on sales and bought ledgers, our cash flow situation is much improved because of our debt analysis control, and my P.A. accountant has really enjoyed the transition to computerised accounting with Apple.'

If you direct, manage or control a company or department then the Apple Computer can help you.

### Apple means . . . business

**software** which is available and in everyday use now. Below is listed just a small selection of business management programs available for users of the Apple Computer System:

- Apple Cashier
- Apple Desk Top/Plan
- Apple Plot
- Mailing List
- Job Costing System
- Stock Control
- Time and Cost Recording
- Accounting Programs for Apple Users:
- Apple Business Controller
- Fixed Asset and Plant Package
- Incomplete Records
- Invoicing System
- Sales Accounting and Invoicing System
- Sales and Purchase Ledgers
- Specific professions can benefit too:
- Agriculture and Business Group Package
- Architecture
- Contract Costing
- Estate Agents
- Matching Vehicle Service Records
- Personnel Matching
- AND IN ADDITION—most companies can use:**
- Payroll and Salaries
- Apple Writer (Word Processing)

\*This is just a small selection of the hundreds of programs available for the Apple business user.

**APPLE MEANS . . .** that you can have immediate access to vital, accurate business information, keep that same information up-to-date more easily and have printed copies instantly, thus giving your company or department a competitive and efficient edge.

**Apple means . . .** solving problems not creating them! Executives can make valuable use of their Apple System within only a few hours of delivery, administrative staff lose any fear of computers and are soon planning and printing their data at the touch of a button.

**Apple means . . .** reliability and service. To assure the Apple user that there are no unanticipated service costs and that their System is fully maintained, Apple offer an optional, renewable Extended Warranty

**Apple means . . .** you are not alone. Over 200,000 Apple Systems have been sold throughout the world. At £2,400 (smaller starter systems available) the Apple Business System is capable of running any of the programs listed here and many more besides.

Sole UK Distributor

## microsense computers limited

Finway Road, Hemel Hempstead, Herts HP2 7PS.  
Hemel Hempstead (0442) 41191 and 48151. Telex: 825554 DATEFF G.

**Apple means . . .** educationalists, scientists, engineers and computer professionals have a choice. Apple grows — with many useful accessories including sound, music and colour graphics. In addition to the BASIC language, Apple have their own UCSD Pascal, and more recently PILOT for the courseware author, and FORTRAN for the scientist.

**Apple means . . .** a problem shared is a problem solved when you share it with an Apple Dealer. For details of your nearest dealer please contact us at the address below.



\*Prices exclusive of VAT and correct at time of going to press.

\*Apple is a trademark of Apple Computer Inc, Cupertino, California, USA.



# IN STORE

**DIRECT ACCESS**

Machine (Price from)	Main Distributor/s (No. of Dealers)	Hardware	Software	Miscellaneous (Documentation)
TECS (£1200)	Technalogs Computing Ltd: 061-793 5293 B&B Computers Ltd: 0204 26644 (TBA)	4-56k RAM; 8k PROM; 6800/6809; 2xC; TV int; 2xRS232 ports; internal viewdata modem & printer port.	FLEX: Basic; Pascal; TDOS; A; T/E; Pilot; Fortran; Cobol.	Fully viewdata compatible. Options — dual 5 1/4" F/D (320k) £850; dual 8" F/D £1200. (S&H).
Terodec DPS 64/1 (£3099)	Terodec (Microsystems) Ltd: 0734 664343 (8)	64k RAM; Z80; dual 8" F/D (1 Mb); 12", 24 x 80 VDU; 2 S/P; 3 P/P. Options: dual 8" F/D (1 Mb) £1149; with 2 Mb £1455.	CP/M; Basic; Fortran; CBasic; Fortran; Algol; Pascal.	TM Z80 enhanced model in integral workstation £5595 (with 4 Mb F/D). DPS 64/2 with 2 Mb F/D £3494. (S&H).
TI 99/4 (£750)	TI: 0234 67466 (TBA)	16k RAM; 26k ROM; 9900; 24 x 32 VDU; 2 x C int; TV int; RS232 port.	OS: Basic.	Can run 16-colour TV screen. BT 5/80 (S).
Triton L8.2 (£611)	Transam: 01-405 5240 (N/A)	32k RAM; 8080; C int; 16x64 VDU int; 1 S/P; 1 P/P.	4k monitor; Pascal (20k ROM); CP/M; Pascal.	Graphics, 5 1/4" or 8" F/D are available; L7.2 with 2k monitor and Basic (no Pascal) £409. (S&H).
UDS 3000 (£2300)	Kemitron: 0244 2187. (TBA)	64k RAM; Z80A; dual 8" F/D (500k); 2 x RS232 ports. Opt: with dual 8" F/D (2 Mb) £2500.	CP/M; Basic; Cobol; Fortran; Pascal.	Full range of industrial support cards. Multi-user with H/D avail. soon. (E)
Vector MZ (£2595)	Almarc: 0602 62503 (3)	56k RAM; Z80A; dual 5 1/4" F/D (630k); 3 S/P; 2 P/P.	CP/M; Basic; Algol; Cobol; Pascal; Fortran; Coral; CBasic; A.	High resolution graphics. Also system B with video board & terminal £3195. (E)
Vector System 2800 (£4195)	As above	56k RAM; Z80A; dual 8" F/D (2.4 Mb); 3 S/P; 2 P/P.	As above	High-res graphics. Also System 3030 with 32 Mb H/D and single 5 1/4" F/D £7500. (E)
VIP (£2125)	As above	64k RAM; 3k ROM; Z80A; single 5 1/4" F/D (315k); 12", 24 x 80 VDU; RS232 port; 3 x P/P	CP/M; Basic; Fortran; Cobol; Pascal; A.	Up to 3 additional F/D drives. Options: dual 8" F/D (2 Mb) £1063, 32 Mb H/D (TBA). (H&S). BT 2/81
Video Genie EG3003 (£330)	Low Electronics: 0629 2817 (N/A)	16k RAM; Z80; 500bps C; 32 x 64 TV int; extra C int; 1 P/P	Basic (12k ROM); M/A; Fortran	Graphics available.
WH8 (£352)	Heath 0452 29451 (N/A).	16-64k RAM; 808A (or Z80); 4 S/P. Option: single 5 1/4" F/D (102k) £241.	OS; HDOS; CP/M; Fortran; Pascal; Basic	Kit. 3 drives max. Colour graphics avail. (S&H) BT 2/80.
Zentec (£4838)	Zygal Dynamics: 02405 75681 (TBA)	32-64k RAM; 2 x 8080; dual 5 1/4" F/D (256k); 15", 25 x 80 VDU; RS232 port.	O/S; A; U; Basic; Cis Cobol.	User programmable character set. Option: dual 8" F/D (1 Mb). (S).
Zenith WH-11A (£2673)	Heath Ltd: 0452 29451 & 01-636 7349 (N/A)	LSI 11; 16-32k RAM; 25 x 80 VDU; S/P; P/P.	O/S; Basic; Fortran; A; U.	PDP 11-compat. Option: 2 x 8" F/D (1 Mb). £1717 (S&H).
Zenith Z89 £1570-£1710	As above	16-48k RAM; Z80; single 5 1/4" F/D (102k); 12" 24 x 80 b&g vdu; RS232.	Basic; A; HDOS; CP/M; MBasic; CBasic; Fortran.	3 x 5 1/4" F/D possible. Options: dual 8" F/D (1 Mb) £1717, 20 Mb H/D.
Zilog MCZ 1/05 (portable); MCZ 1/20A (£3250)	Micropower: 0256 54121. Memec; 084421 5471 (N/A)	64k RAM; Z80; dual 8" F/D (600k); RS232 port; MCZ 1/20A only 1 P/P; Option: 10 Mb H/D £7100	RIO; O/S; Cobol; Basic; Fortran; Pascal; M/A; U.	Available desk top or rack mounted. Debug in 3k PROM. 1/20A runs multi-user Cobol, up to 5 terminals with 40 Mb H/D. (S&H).
Z-Plus (£3950)	Rostronics Ltd: 01-874 1171(16).	64k RAM; Z80; dual 8" F/D (1 Mb); 4 S/P; 2 P/P.	CP/M; A; U; Basic; Cobol; Fortran; Pascal; APL; PL/1; Algol.	Available with 2 Mb F/D. Option; 20 Mb H/D £4000. BT 12/79 (S&H).

# SINGLE BOARDS

Machine (Price from)	Main Distributor/s (No. of Dealers)	Hardware	Software	Miscellaneous (Documentation)
Acorn System 1 (£65)	Acorn: 0223 312772 (10)	11/8k RAM; 6502; EPROM socket; Hex K/B; C int; 8-digit LED display; up to 16 ports. Options: Eurocard 64-way connector; VDU card; full K/B card.	1/2k monitor; Basic.	Kit. Programmable address linking. On-board 5 V regulator. Available assembled £79. Can be expanded to disk-based system. (S&H)
Aim 65C (£285)	Pelco: 0273 722155(7)	1-4k RAM; 6502; 4-20k; ROM; Full K/B 2 x C; 20 char LED; 20 char thermal printer; RS232 port.	A. Dis A; T/E; 8k monitor; Basic (8k ROM); PL65.	Power supplies and two types of case avail. Can be expanded to disk system. (E)
Bigboard. (£395)	Maclin-Zand 01-837 1165 (N/A)	64k RAM; Z80; F/D controller; 24 x 80 VDU controller	2k monitor; CP/M; Basic; Fortran; Cobol; Pascal; A.	Many options. Will support up to four 8" F/D drives. BT 2/81. (E)
Biproc (£119)	B L Micros: 0494 443073. (TBA)	1k RAM; Z80; TV int; RS232 port. Opt: 4k RAM £8; K/B £30.	2k Monitor; A.	With 9980 instead of Z80 £155 as well as Z80 £180. Kit. (H)
Cromemco SC (£260)	Comart: 0480 215005 (17)	1k RAM; Z80A; 8k EPROM sockets; RS232 port; 3 P/P. Option: S100 bus.	Monitor; Basic.	5 program interval timers. Can put own Basic program in EPROM. (E)
Elf II (£60)	Newtronics: 01-348 3325 (N/A)	1/4-64k RAM; RCA 1802; Hex K/B; 2-digit LED; TV int; C int; RS232. Options: Full K/B; VDU card.	1k monitor; A; Dis A; T/E; Elf-bug; Tiny Basic; Basic.	TTY N-line decoders. Low resolution graphics (high res avail). Kits or built. (H).
Explorer (£82)	As above	4-64k RAM; 8085; Hex K/B; RS232 port; S100 bus; C int; 1k video RAM.	2k monitor; Basic CP/M.	Supplied in kit or built. Full range of peripherals including F/D. (H).
Hewart 6800S (£299)	Hewart: 0625 22030 (N/A)	16k RAM; 6800; full K/B VDU int; 2 x C int; 1 S/P; 2 P/P; Option: 16k RAM £90	1k monitor; A; T/E.	Can be upgraded with 6809. (H).
Hewart 6800 Mk III (£152)	As above	1k RAM; 6800; VDU board	1k monitor.	Options: single 5 1/4" F/D (75k) £350; PROM programmer £32. (H)

### List of Abbreviations

A Assembler  
BT Bench Tested  
C Cassette  
E Extensive  
F/D Floppy disk

G/C Graphics card  
H Hardware  
H/D Hard disk  
I Introductory  
Int Interface

M/A Macro assembler  
N/A Not available  
N/P Numeric pad  
O/S Operating system  
P/P Parallel port

S Software  
S/P Serial port  
T/E Text editor  
TBA To be announced  
U Utility

Please note: Software items listed in *italic* are not included in the basic price of the equipment. All prices are *exclusive* of VAT.

## SINGLE BOARDS

Machine (Price from)	Main Distributor/s (No. of Dealers)	Hardware	Software	Miscellaneous (Documentation)
Microaxis 1 (£250)	Micro Design 0296 86866 (N/A)	1k RAM; 1-8k PROM; 6809; 8 channel A-D system; 12 optically isolated I/O lines.	1k monitor	Designed for industrial control. Can be expanded to F/D system. (H)
MPC 09 (£750)	As above	17k RAM; 48k PROM; 6089; RS232 port; 50 I/O lines; 4 timers; 1 W audio amplifier.	1k monitor; <i>Multi-tasking OS.</i>	As above.
Microtan 65 (£69)	Tangerine: 0353 3633 (6)	1k RAM; 6502; 16 x 32 TV int; Options; 64 x 6 1 Pixel graphics £6.50; 16k RAM £56.	1k monitor, <i>Basic</i>	TANEX expansion kit with 7k RAM; 4k EPROM sockets; 10k Basic; 4 S/P; 32 P/P £145. (E)
Nascom 1 (£125)	Nascom: 02405 75155 (20)	4k RAM; Z80; Full K/B; TV int; 2 P/P; 1 S/P. Options; 16k RAM £140; single 5 1/4" F/D (250k) £240 (4 disk controller £127).	2k monitor; <i>B Basic; Tiny Basic; A; T/E; U.</i>	Kit. Built version £140. Also Nascom 2 with 8k Microsoft Basic in ROM £225 (no RAM). (S&H)
77/68 (£90)	Newbear; 0635 30505 (N/A)	4k RAM; 6800; LED; C int; VDU int.	1k monitor; <i>Basic</i>	Expandable to 64k RAM with F/D. (B)
79/09 (£65)	As above	1k RAM; 6809; P/P; S/P	2k Monitor.	Designed to upgrade 77/68. (H)
SBC 100 (£135)	Alramco: 0294 57755 (TBA)	1k RAM; Z80; 8k ROM; S100; 1 S/P; 1 P/P.	<i>1k monitor; DOS in ROM.</i>	Kit. Available assembled £196. (E)
Superboard (£188)	(as Challenger)	4-8k RAM; 6502; 10k ROM; full K/B; VDU int; C int.	Basic (8k ROM)	Options; RS232 port; single 5 1/4" F/D (100k) £316; 8k RAM £188. (S&H).
Smoke Signal PCB 68 (£174)	Systems Implementation Ltd: 06924 56666 (TBA)	1k RAM; 6800/6809; 10-20k EPROM; 1 S/P.	2k monitor	Many expansion boards available including F/D. (H)
SYM-1 (£160)	Newbear; 0635 30505 (N/A)	1-4k RAM; 6502; C int; VDU int; 2 x 6522 ports. Option: TV int.	4k monitor; <i>Basic A.</i>	Expandable to 64k RAM with F/D. (B)
Triton L5.2 (£294)	Transam: 01-405 5240 (N/A).	1-3k RAM; 8080; 1k VDU RAM full K/B; 16 x 64 VDU or TV int; C int; 1 S/P.	1 1/2 k monitor; 2 1/2 k Basic.	64-char graphics. Disk int running CP/M about £200. (S&H).
Tuscan (£195)	As above	8k RAM; 8k ROM; Z80A; 5 x S100 slots; RS232 port; TV int; C int; 1 P/P.	<i>2k monitor; 8k Basic; CP/M; Pascal.</i>	High res graphics available. Can be expanded to F/D system. BT 1.81. (S&H)
UK101 (£179)	Comp Shop: 01-441 2922 (4)	4k RAM; 6502; full K/B; 16 x 48 VDU or TV int; C int; RS232 port; Options; 4k RAM £29.	1k monitor; 8k Basic; <i>Dis A; U.</i>	Graphics. Will run Superboard software. New monitor EPROM with enhanced U £22. (S&H).
ZCB (£260)	Almarc: 0602 625035 (3)	1k RAM; Z80A; 3 PROM sockets; RS232 port; 3 P/P	<i>Will take any 2708/16/32 software.</i>	S100 bus compatible. Expandable to full system. (E)

## TRANSACTION FILE

The classified service that's free to non-commercial readers. Advertisements (50 words max) to: PCW Transaction File, 14 Rathbone Place, London W1P 1DE.

### For sale

**PET 2001.** . . 8K (old ROM), plus £50 worth of games, books etc, £375. Will deliver in Birmingham area. Phone Tamworth 281877.

**SUPERBOARD II.** . . perfect condition, 48x32 screen, runs at 2MHz, 8k RAM, RSU, R50 software, all manuals, £270 ono. Contact Mr C Boyle, J28 Revis Barber Hall, Laisteridge Lane, Bradford.

**UK101.** . . new and old monitors, 5k RAM, extended monitor tape and booklet, 2 months old, perfect working order, upgrading to TRS-80, hence sale at £210 ono. Write to S D Phillips, 36 Sherd Close, Marsh Farm Estate, Luton, Beds.

**ST6 MODEM.** . . decodes audio output from radio receiver to 5-bit Baudot code for direct drive of 20-40mA current loop teleprinter, diagrams, no extras req, 170Hz & 400Hz shifts, auto stop & anti-space circuitry, £50. Tel Mike 01-228 3421.

**SINCLAIR ZX-80.** . . with power supply, £75. Tel: Ruislip 30912.

**ZX80.** . . available now! Assembled, perfect, leads, manual etc, £75. Tel: Luton (0582) 22943/33483 (day).

**CASIO FX 501.** . . and FA1 cassette interface in full working order complete with manuals, £40. Tel: John Ward, 01-876 6661 after 8.

**NASCOM RAM-A.** . . board, fully working, £100 without RAM, £135 with 16k, £170 with 32k. Or will part exchange for a RAM-B board (any amount of RAM) if you don't need page mode. Write: Tim Arnold, St John's College, Cambridge CB2 1TP or leave message and phone number on (0223) 61621.

**CROMENCO SYSTEM 3.** . . with 3102 terminal, D+7A, joystick & a lot of software & disks, only 5 months old, financial crisis forces quick sale. S. Gimblett, 79 Calderwood Cres, Low Fell, Gateshead, Tyne & Wear. Phone 0632 876645.

**VIDEO GENIE.** . . as new with sound, manuals, £100 worth of books & tapes (Space Invader, Casino + more), £380 ono. Tel: 0253 734397 (eves).

**IBM.** . . Selectric 725 typewriter mechanism c/w solenoids and reed switches for remote operation, makes cheap high quality printer, £200 ono. Tel: Burgess Hill (044 46) 42670.

**ZX80 & 6800 boards.** . . ZX80 complete with manual, 1k and several novel programs, as new £67.50; SWTPC MP-S and MP-C interface boards, £12.50 each; 4k MP-M memory board £40. Tel: 0209-831274.

**TEXAS T159.** . . prog calc, up to 960 steps or 100 memories, magnetic card reader/writer, PC100C alphanumeric thermal printer, spare paper, cards and extra software, very good condition, £200. Write to A G Minter, CHI/217, University of Warwick, Coventry CV4 7AL.

**PET 8k old ROM.** . . extra key pad, colour graphics & A-3-8910 sound chip (not connected) + data, 60 pgms (mainly games/tutorial), PET manuals, £450 ono. Tel: 01-840 3610.

**Printer.** . . anybody want a rather noisy, slightly oily, but thoroughly working Teletype ASR with RS232 300 baud, a good reliable printer? Offers over £135 will be given serious consideration. Also PET 2nd cassette unit unused, £50. PET I/O box (LEDs + relays) for outside control, offers? Tel: 01-997 8959.

**32k PET.** . . large keyboard, new ROMs, 400k Computhink disks, 3022 tractor printer, complete business system with some programs, excellent cond £1,500 or will hire on monthly basis. Tel: 01-943 1357.

**Shugart.** . . SA400 5 1/4" mini-floppy disk drive, as new, with full documentation, bargain at £125. Contact Jon Griffin, Reading 690336 (day).

**UK101.** . . 8k RAM uprated to 2MHz, new monitor ROM in plastic case, all leads attached, fully working, manual, tapes and M/C code book, bargain at £199 plus postage. Tel: 0969 23462 eves or w/end.

**TRS-80.** . . Level II 16k with TV adaptor, 6 months old, plus cass. recorder, manuals, games tapes and books, £200. Tel: Manchester 061-202 3351.

**TRS-80.** . . 16k Level 2 with CTR-80 cassette recorder, Tandy instruction manuals, introduction to Basic books, games cassettes (including Microchess), £395 ono. Tel: 061-872 0346 (weekdays 10.00 to 6.00) or 0253 823279 (Blackpool) - Friday 8.00 to Sunday 10.00).

**8080 system.** . . SDK80 board, 2k monitor, Honeywell hall-effect keyboard (superb), Pettivid VDU, 10A PSU. Full Intel documentation, many spare chips (5 x 2708, 2 x 8233, 3 x 8212, etc), expand with Triton boards or make excellent terminal, £65 ono. 7768 4k RAM board, socketed, never used, £28. Tel: Tewkesbury (Glos) 296494.

**North Star.** . . single density disk board, documentation, 3 operating systems, Basic, £70. D Jesus College, Cambridge.

**Commodore 4032.** . . and floppy disk drive, 4040 and Superchip, as new, £995 ono. Tel: 01-622 1279.

**Sinclair ZX80.** . . with 3k RAM extension pack, leads, mains adaptor, manual, as new, £120. Norwich (0603) 52979.

**Sinclair ZX80.** . . as new, incl leads, adaptor and manual, games cassette and book of basic computing, worth £120, accept £70. Tel: Camelford 3315.

**PET 2001 8k.** . . built-in cassette, fitted toolkit and internal sound part that also gives audible checking of cassette loading, complete with documentation and books on Basic, £380. Lawrence, 32 Waterside Rd, Westfield, Radstock, Bath.

**Pocket TRS-80.** . . + cassette interface, 3 months old, cost £135, accept £90. Phone Letchworth (04626) 78669.

**Philips VC7000.** . . video computer with 2 cartridges, inc 'Invaders' type of game, cost new £114 Dec 80, swap for Sinclair ZX80 or sell £80. Tel: Cwmbran (Gwent) 70847 eves.

**PET 32k.** . . new ROMs, toolkit, manuals, books, cassette deck, dust cover, magazines, software & many other extras, any offer over £600 considered. D Mason, 324 Linnet Dr, Chelmsford. Phone 0245 354980.

**Nascom 2.** . . cased, 32k RAM, Graphics ROM, Naspen, Creed 7E teleprinter with routines in EPROM. Incl B+W portable TV, software, all documentation and leads, £600 ono. Tel: Bourne End (062 85) 23454.

**PET.** . . 32k, Toolkit, cass deck (with counter & sound), books, cover, many progs & tapes, £740. 01-866 5021, eves.



# TRANSACTION FILE

Nascom I... not working, with 3amp PSU and B-bug monitor, plus all documentation as supplied, buyer collects, £90 ono. N. Gibbs, 53 Arlington Court, Red Hill, Stourbridge, W Midlands DY8 1NN.

TRS-80 L2 16k... Sanyo c/ recorder, all necessary leads and manuals, loads of software, including Space Invaders, Draught Draughts, music, Startrek, Road race, androidnm, board games, 2 books of TRS-80 programs and over 35 computing magazines, £350. Tel: 01-435 0882, eve, ask for Alan.

TRS-80 Model I level II 16k... complete with monitor, CTR80 cassette recorder, Tandy lower-case mod & switchable level I/ level II — only £390 ono. Peter Tootill, tel Liverpool 05-220 9733.

Superbrain... 64K, 24 lines x 80 column screen, full size + numeric key board, twin double density 5 1/4" disk drive, using 1.4 C/PM operating system, twin Z80A microprocessor running at 4MHz, ask for £1150. Also, accounting package and business software for the machine at half price. Tel: 01-954 6273 for S C Poon.

MK14... neatly cased, VDU, cassette interface, new keyboard, extra RAM, large 9-digit LED display, programs, manuals, full documentation (including circuit diagrams for extra 2k RAM, VDU, cassette interface etc). Offers: Daryl, tel: Peterborough 252463.

APPLE II +... 48k, disk drive + controller, loads of software inc apple invaders, tranquility base, air simulator, microchess, £1000. Tel: 01-670 5909 (Dulwich), eves.

Acorn System 1... factory assembled with manual, £40; PE VDU System, £35. Tel: 0455 30186.

UK101... 8k RAM, cased and prof built with all leads inc, extended monitor and games on tape, £235. Ring 01-300 7633 (after 5).

PET 2001 8K... old ROM keyboard, excellent condition, Sound Box, many games inc chess, Starwars, Startrek, etc, books and articles, £350. Buckley, Worksop (0909) 771845.

Ohio Superboard II... 8k RAM, cased, upgrading, £200; PSU £15. Tel: Newport (IOW) (0983) 525119.

HP41C... +2 memory modules, all still under guarantee, unwanted Christmas present, new as brought, will consider securior delivery, sensible offers please, write to: T Anwar, 6 Emerald St, Saltburn, Cleveland TS12 1ED.

Elf II... 1802 Cosmac, giant board, 8k RAM, ASCII keyboard, Basic in cassette and ROM version, fully cabinet, Elf bug, text editor, assembler, disassembler, 2 years sub 'Quesada' and 'Ipsos Facto'. Best offer buy all, tel: 01-249 7097 after 6.

Triton computer... best offer secures, any considered! Phone: 01-748 0700 (home), 01-405 6761 (work).

Bush Dansette... record player (needs attention to case) + over 100 copies Practical Electronics 1970-79, £45 ono. May split or exchange for 1k ZX80, manual and leads. A Phillips, tel: Porthcawl (065671) 4304 after 5pm except Fridays.

Superboard... 5k RAM, PSU (fitted in case), case, modulator, manuals, tapes & cassette player, Zaks 6502 Prog book, £200 ono. Ring 061-428 8850 after 6.30.

ZX80... ready assembled, PSU including all leads and manual £70; tel: Cambridge 0223 42298.

Sharp PC-1211... pocket computer, unwanted gift, as new, 1.9k RAM, fully programmed in Basic, and with full calculator mode available, complete with cassette interface, cost £120 but will sell for £75 ono. Peter Walker, 84 Forrest Walk, Uphall, West Lothian. Tel: Broxburn (0506) 853703.

TI59... hardly used, still 3 months warranty, complete with manuals, charger, mag cards etc, £130 ono. Send SAE with offers to A Winterbottom, 38 Heaton Avenue, Wakefield Rd, Dewsbury West Yorks WF12 8AQ.

TI59... prog calculator, complete with master library module, magnetic storage cards, 110V and 240V adaptors, instruction manuals, coding forms, condition as new, £95 ono. Tel: 01-650 6258 or Redhill 65827.

ZX80... 3 weeks old, as new, boxed, leads & manual, £75. Tel: 01-642 3210.

Nascom 2... 16k, graphics ROM, cased, manual, games tape, completed by Nascom agent, £325 ono. Ivor Dugdale, tel: Maidenhead (0628) 37084.

ELF2 computer... 8k RAM, tiny Basic on tape, vid terminal, Elf bug on tape, 16 games on tape plus full documentation, £200 ono. Tel: 01-560 0793.

Computer enthusiast... holidaying in California April 81 will undertake any legitimate commission on West Coast. Tel: Kitchin, Swansea 460638.

ZX80... fully assembled with Sinc PSU, leads, manual, games prog on tapes/lists, '30 Progs for ZX80' book, perfect cond, £80inc post. Tel: Southwell (Notts) 813164 after 5.

Centronics 101... printer, 165 cps, 132 col, with RS232 int or can supply PET int, good working order, can view working, £200 ono. Centronics/PET (IEEE) int £25. Tel: Horsham (0403) 69835.

VDU... attractive case, 65 keys, 80 chars/line, 26 lines, V24 int or parallel TTL, bargain at £50, 65-key Hall effect keyboard, +5 V only reg, all keys prog for any code, £20. IBM golfball printer, working £150, repairable £75. Tel 01-778 3600 eves.

Casio FX-501 P... prog calc + FA-1 adaptor, £40 the lot. Tel: Peter 01-855 8376.

SUPERBOARD II... 8K RAM, PSU, modulator, case, leads, manuals, loads of software, £240. Tel. W Hornsby, Romford 46223.

Video Genie... 1 6 k, sound generator & key modification fitted, dust cover plus software mostly games incl. Invaders, Adventures, Star Trek, etc, 3 months old, £325. Tel. 0782 48782 after 6.

Boris... chess computer with alphanumeric read out, solid walnut case and chess pieces, as new, £110. Tel. 0775 3999 after 6.

Nascom I... buffer board, mother board, Snowplough ground plane (reduces interference, helps run at 4MHz), PSU, 19" card frame, keyboard case. Also Curtis Blandford high speed tape int, new 2708 EPILOM, lots of programs, extremely high quality construction, £250. Tel. Camborne (Cornwall) 712143.

TRS-80 16k L 2... green screen VDU, cassette, all one year old, software over 20 programs (worth £250+) inc. games, Adventures, chess, EDTASM, TBUG, SOUND, Typing Tutor etc, Manuals, m/c books, cassettes, £500. Tel. Wokingham (0734) 792635 after 6.

Casio FX502P... prog cal, plus FA-1 cassette interface, instruction manuals and program library. Ring Northalleron (0609) 2147 after 6pm.

ASR33 TTY... first class condition, recent overhaul, 2 spare type heads, circuits, paper rolls, any offer considered, sale or swap, 230 VAC seen working if required (London). Tel. 01-989 6741 after 6 or w/ends.

Atari VCS... video game with additional Circus and Dodgem cartridges, about 3 months old, £85 inc postage. K. Yeap, Northampton Hall, Bunhill Row, London EC1Y 8LJ.

ITT 2020 48k... auto start ROM, double-sided disk drive, integer card, music synthesiser card, games paddles, cassette, plus lots of software, offers over £1100. Tel Mr Webber Thanet (0843) 63566 day, 582099 eves.

PET 16k... new ROM, improved keyboard, separate cassette deck, all hardly used with manuals, PET Revealed and Stratchclyde Basic course £525, buyer collects. Tel. Beaconsfield (04946) 4372 eves & w/ends.

UK 101... 8k RAM, cased, with complex Sound Box (£40+), complete with cassette recorder leads and over 30 game programs on tape, full documentation, £280. Tel. Alan, 01-407 0505 (x.5) day or 01-733 6040 eves.

TI58C... brand new, a TI58 but stores programs indefinitely in non-volatile memory, with standard module, manuals and programs etc, £59. Buyer collects. Tel. Whitchurch (Hants) 2602 after 6 or weekends.

Nascom... Rama board, inc manuals, as new £105 ono. IBM 2741 Selectric I/O stand inc electronics/manuals, IBM maintained, highest offer around £50. Cambridge Programmable (Sinclair) good working cond, presentation box, manuals, highest offer. Tel. Ian, Ipswich 831353.

Casio FX502P... with FA1 cassette adapter, good condition, instruction manuals and original boxes, £75 ono. Phone Camberley (0276) 63726 after 4.

PET 2001 32k... large keyboard, external cassette, 5 months old, users manual, extra cassettes and 6502 programming book, £640. Tel: Farningham (0322) 864167.

UK101... new monitor chip, surplus to requirements due to sale of machine, cost £22+VAT originally, will sell for £17. Tel. Nigel, 01-607 7134 after 7.

TRS-80 L2 16k... only 6 months old, with TV modulator, power supply, cassette leads, c/recorder, computing magazines & books, loads of software, £330 ono. Tel. Alan Miller (evenings) 01-435 0882.

TRS-80 LEVEL II... 48k + 1 disk drive + software, £700; Microdasys 6809 S100 board, £100; Wameco 8k static S100 board, £75; Acorn atom. 12k+12k power supply etc, £200. Tel. Ware (0920) 67519.

PET 8k... 2001 with new ROMs, green screen, many tapes/programs, £295. Phone Hastings 752736.

Anadex... DP8000 Printer, £275; TECO-TM 12MM-D2A (ASTEC) uncased 12" Video Monitor, £40. Both perfect. Mr L Stroud, Castleton (02876) 281.

TRS80 32k Level II... expansion interface, 2 mini disk drives, 120 cps Line Printer III, 16 floppy disks, manuals, software etc, £1200 ono. Tel. 01-852 0438.

PET 2001 16k... new ROMs, large keyboard, Commodore cassette deck, Toolkit and Superchip, £500. BD80 printer, £400. Tel. Wolverhampton (0908) 787002 (eves).

TRS-80... level 2, 16k plus CTR-80 cassette recorder, manuals and leads included, only 3 months old, £350. Phone (0423) 887757 eves.

UK101... assembled and cased, 8k RAM, extended monitor and various games on tape, manual and book on programming, £175. Tel. Carlisle 32089.

Sorcerer... 16k RAM, 8k Microsoft Basic, bought Oct '80, £395, 12" TV, £50. Cassette recorder, £15. Tel. 01-660 6234.

TI-59 + PC-100C... printer, both unused since complete overhaul by Texas, £150 the two, inc over 80 mag cards, complete Texas Software catalogue and several Texas newsletters, Texas games programs, good unpublished games, dozens of other programs and listings, 3 spare paper rolls. Tel. John Still, 01-902 9030.

Apple II 32k... disk drive, Controller, b&w modulator, all brand new still in boxes, £1100 ono, may split. Tel: Westerham (0959) 64399.

Teletype 33 ASR... one working plus one low mileage mechanism, £120 the pair. Phone Ian Powers, Dunstable 67980.

Triton 3... 12k RAM, 11k ROM (musical Basic + monitor), fully built with cassette, some programs £550 ono. Tel: 01-805 1878 after 6.

UK 101... 8k RAM, 1 or 2 MHz, cased, AY-3-8910 sound, tapes, Doc, ect, £270 ono. 041-956 1768

TRS-80 Line Printer II... only a few months old, new condition, try a reasonable offer. Tel. any time 01-399 9022 (Surbiton, Surrey).

UK101... 8k RAM plus programs, books, tapes, £240. Video 100 Monitor, £60. Phone Bernie, Nottm. 625355 evenings.

Sorcerer 48k... inc UHF modulator, development pac, documentation and some software, 4 months old, £600 or part ex. for Apple peripherals. Phone 0734 882108.

PET... 32k, large keyboard, cassette deck, Toolkit ROM, cover, tapes, documentation etc, offers around £625. Phone Rossendale 26313 eves.

TRS-80 - Lev 2. 48k... with VDU expansion interface, one disk drive, Centronics PI printer, software (Adventure, Invaders, Library 100, Protek and many others), £1200 ono. Robert Bruchner, 01-458 1523, 9am to 5pm.

Sinclair ZX80... in perfect working order, inc all leads and manual, no adaptor, £70 ono. Tel. 01-550 3326.

ITT 2020... Grade 1 condition, mounted in expensive 19" vero lab case, keyboard extended on V24 connectors, 48k RAM, Fan on separate switch, colour RF output, cassette I/O, cassette palsoft, memtest, rom integer paddles, books, £600 ono. Write only to Jyoti Shah, 20 Hartley Avenue, London E6.

Exidy Sorcerer... 32k with Basic ROMpac, 6 months old, £435, as new, no VAT. Colin Taylor, 01-272 5896, after 6.

Atari... video computer, unwanted Xmas present, over 140 games inc Space Invaders, supplied with 3 carts, £130. Tel: Rotherham (0709) 78674.

Teletype... 33 KSR, excellent mech cond, with stand, £170. Sorcerer development pac, £50. Alan Knifton, Darley Dale, Derbys, tel: 0629 83 4426.

ZX80... Sinc built, PSU, manual, all leads, 'ZX80 Magic Book' by Timedata, few prog on C12 cassette & copies of User Club mags, £75. Tel: Jeff, 01-570 8509 after 6.30.

## TRANSACTION FILE

**VIDEO GENIE**... EG 3000, 16k, still in original box, purchased Oct 6th 80, complete with manuals and TRS-80 Level II workbook, game programs include space saucers, one arm bandit, keno, roulette, many other bits and pieces, £300, no offers. Phone 01-558 2518 (East London)

**32K Sorcerer**... complete system, 2 Micropolis disk drives, controller board, S100 expansion unit, monitor, development pac, Micropolis Basic, CP/M, CBasic, MBasic, Fortran, Word Processor and original business software, full set handbooks, 7 cassettes of software, all as new, £1750. Tel: 01-552 6026, eves.

## Wanted

**Acorn Atom**... + 2k, with floating point & graphics. Tel: Hartlepool (0429) 75559.

**Apple II**... want to trade new Autostart ROM for the older ROM. If you have old F8 chip and want to upgrade to Autostart phone 01-485 7308 eves.

**ZX80**... Sinc built with leads and manual etc please, 01-995 1533.

**£50-60**... offered for complete working ZX80 or £30-50 offered for non-working or working Nascom 1 if complete. Would collect if possible. Tel Aldershot 26160 eves.

## NETWORK NEWS

*Personal computer networks have been springing up all over the States for 18 months or more and now we have two in Britain. As more networks appear — and as more facilities are added to existing networks — we'll report them in this section, which appears monthly.*

**Forum 80**... operated by Frederick Brown, tel: Hull (0482) 859169. No access charge, open to any micro owner. Operating Tues & Thurs 1900 — 2200, Sat & Sun 1200 — 2200. Facilities: bulletin board, program

library for downloading programs (all in Microsoft Basic), program uploading for adding your own prog to library; Forum 80 Users Group (membership free) enables access to programs not in public domain.

**National TRS-80 Users' Group**... being set up at time of writing, will be available to all micro users, not just TRS-80 owners. Initially access charge will be a £10 sub, but as more join, this

will be reduced and refunds made accordingly. Facilities: bulletin board & programs for downloading. Contact: Brian Pain, tel 0908 566660 (office).

## USER GROUPS INDEX

*Here are the details of additions and changes recently notified. If we have failed to include YOUR group (or have published incorrect information) either here or in the complete listing, then please address changes/additions to: PCW (User Groups Index), 14 Rathbone Place, London W1P 1DE.*

*Finally, the next complete listing will appear in our May issue.*

### INTERNATIONAL

**European Sorcerer Club**. New name for SPEC (Sorcerer Program Exchange Club). Not confined to Europe, in fact, as 200-strong membership includes people from all over the world. Publishes newsletter 10 times a year. Annual sub: British Isles £5; Europe £7; Overseas £12. Contact: Colin Morle, 32 Watchyard Lane, Formby, Nr Liverpool L37 3JU, tel: 070 48 72137.

### NATIONAL

**Sharp MZ-80K Computer Users' Club**. Membership free, access to large user-written software library (Basic & machine language), meetings & newsletters. For details send SAE to Paul Chappell, Yeovil College, Goldcroft, Yeovil, Somerset BA21 4AE.

**FX500-P Users Association** (proposed). For Casio FX 501-P & FX 502-P users to exchange ideas, tips, programs etc. If interested send SAE to Max Francis, 38 Grymsdyke, Gt Missenden, Bucks HP16 0LP.

### NORTH WEST

**ACC (Merseyside 380Z Users Group)**. Contact: Alan Pope, Paal Enterprise, 37 Stuart Road, Crosby, Liverpool L23 0QE.

Anybody in the Warrington area interested in forming a Mattel Intellivision TV Game group to organise meetings, competitions and lay foundations for the forthcoming computer addition? Tel Warrington 62215 after 4 pm.

### WORCESTERSHIRE

**Worcester & District Computer Club**. Meets 2nd Monday monthly at 8 pm, Old Pheasant Inn, New Street, Worcester. Contact: D Stanton, 55 Vauxhall St, Rainbow Hill, Worcester WR3 8PA.

### YORKSHIRE

**York Computer Club**. Meets every Monday at 8 pm at the Holgate YMC, New Lane, Acomb, York. Contact: S Wilson, tel: York 470464 after 6.

## DIARY DATA

Manchester, England	(New Cent. Hotel) Computermarket. Contact: Couchmead Ltd., 01-437 4187	24 — 26 Mar
Dublin, Eire	Int Computing Exbn — COMPUTEX. Contact: SDL Exbns Ltd, Dublin 763871	24-27 Mar
London, England	(Wembley Conf Centre) Numerical Control Equip Exbn & Conf. Contact: British Numerical Control Socy, 01-579 9411	30 Mar — 1 Apr
Birmingham, England	(Albany Hotel) Computermarket. Contact: Couchmead Ltd, 01-437 4187	31 Mar — 2 Apr
London, England	(West Centre Hotel) Peripherals '81 Exbn. Contact: IPC Exbns Ltd, 01-837 3636	1 — 3 Apr
London, England	(West Centre Hotel) Computermarket. Contact: Couchmead Ltd, 01-437 4187	7 — 9 Apr
Paris, France	Int Exbn of Electronic Components. Contact: French Trade Centre, 01-439 3964	7 — 11 Apr
Kenilworth, England	(Nat. Agric. Centre) Computer Numerical Control Equip, Machine & Services Exbn & Conf. Contact: Corinthian Exbns, 01-681 7055	12 — 14 Apr
London	(Poly of N. London) London Computer Fair. Contact: R. Bradbeer, 01-607 2789	14 — 16 April
London, England	(Grosvenor House) All Electronics Show. Contact: All Electronics Show, (0799) 22612	22 — 24 Apr
Manchester, England	(New Cent Hall) Micro Show. Contact: Online, 09274 28211	29 Apr — 1 May
London	(Royal Hort Hall) Home Brew Show (Beer, not micros! But we thought you'd still be interested — Ed)	8 — 12 May
London	(Earl's Court) Sunday Times Business to Business Exbn. Contact: Silver Collins & Co, 01-407 4046	7 — 10 June
London	(Earl's Court) Electronics Comp Ind Fair COMPONENTS '81. Contact: Ind & Trade Fairs Ltd., 021-705 6707	9 — 12 June
Sao Paulo, Brazil	Electro-Electronic Trade Fair. Contact: Alcantara, 01-408 2104	22 — 28 June
London	(Wembley Conf Centre) Int Word Processing Exbn & Conf. Contact: Business Equip Trade Assoc, 01-405 6233	23 — 26 June



# PCW SUBSET

*Sub Set is not confined to Z80 routines; by sheer coincidence the original contributors were Z80 users, but contributions, documented as shown here, are most welcome from users of other processors. Send your subroutines to: PCW Sub Set, PCW, 14 Rathbone Place, London W1P 1DE*

## Where am I?

Our first Datasheet this month is a gem. It is called FOWIA, meaning 'Find Out Where I'm At' and is another contribution from Neil Imrie of Bedford and the Bedford Computer Club. You won't need to stay up all night working this one out, as it has only three instructions, including the RETurn. It has the most interesting and useful effect of putting into the HL

register the address of the current program instruction. Imagine what you can do with that! Send any practical results of your imaginings to 'Sub Set'.

If you don't like using a three byte instruction to CALL a three-byte routine, you can locate FOWIA at one of the Z80's restart locations with the same result.

## Datasheet

```
; = FOWIA — Find Out Where I'm At.
;/ CLASS: 1
;/ TIME CRITICAL? No
;/ DESCRIPTION: Gives in HL the address of the instruction it
;/               is then at, after returning to the code that
;/               called it.
;/ ACTION: H←(SP+1)
;/           L←(SP)
;/           (SP-2) ← L
;/           (SP-1) ← H
;/           PClow ← (SP)
;/           PChigh ← (SP + 1)
;/ SUBr DEPENDENCE: None
;/ INTERFACES: None
;/ INPUT: None
;/ OUTPUT: HL contains the address of the current program
;/          instruction; ie, the instruction immediately
;/          following the CALL TO FOWIA.
;/ REGs USED: HL
;/ STACK USE: None
;/ LENGTH: 3
;/ TIME STATES: 31
;/ PROCESSOR: Z80, 8080/85.
;/ FOWIA: POP HL      ; get return address in HL. E1
;/           PUSH HL   ; restore stack pointer   E5
;/           RET       ;                          C9
```

## Gray code

FOWIA was designed to help in implementing position-independent code. To show it in action, Neil has sent GRYCV, our second Datasheet, to convert a binary nibble to Gray code. The routine carries its own conversion table, which is referenced by adding a displacement to the address returned by FOWIA, so that the table will be correctly referenced wherever the routine is located.

In the comparison between decimal, binary and Gray code in Figure 1, you will see that, in getting from one number in the Gray code sequence to

an adjacent number, only one bit position changes value. This is an important property in some applications. In changing from a binary number to the next in sequence, several bits can change. They do not necessarily all change at exactly the same instant so that, during transition from one binary number to the next, combinations of bit values giving an out-of-sequence number can momentarily occur. This cannot happen with Gray code, which is often used to indicate the position of a rotating shaft or disc. Remember this the next time you are programming gun turrets on a battleship.

*Great products  
from Mutek*

## BASIC 1 & 3

Replacement PROMs for OSI/UK101  
BASIC-in-ROM

BASIC 1 allows direct entry of graphics from keyboard or cassette, adds a CALL command.

BASIC 3 fixes the string-handling 'garbage-collector' bug in the Microsoft BASIC.

**£15.00** +VAT

for the pair, including documentation

## 8K memory/ PIA board

A professional-quality expansion board for all Superboard and UK101 systems.

- ★ 8K of reliable static memory (2114L3) ★
- ★ Two-way parallel port (6821 PIA) ★
- ★ Fully buffered — boards can be linked ★

Assembled, tested and guaranteed

**£65.00** +VAT

Ribbon-cable and plugs: add £8.00+VAT

## CEGMON

The new monitor for all OSI and UK101 systems, with the right range of features!

- ★ Twin-cursor screen editor ★
  - ★ Improved keyboard routine ★
  - ★ New screen-handler ★
- with fully programmable protected areas, screen and 'window'-clear, cursor controls
- ★ New machine-code monitor ★
- with load/save, tabular display, modify' entry for text and hexadecimal, breakpoint handler, block move, and much more

- ★ Disc bootstrap ★

- ★ Full compatibility ★

**£29.50** +VAT

complete with full manual and reference card

*Coming soon —*

## PILOT

A 2K ROM implementation of this useful text-oriented language, for all OSI and UK101 systems

Available April '81

**MUTEK** Quarry Hill, Box, Wilts  
Tel: Bath (0225) 743289

# MICROMART

## march communications

Introductory offer — 10% off books ordered in April. Send for list describing over 200 computer titles.

Kemtron Multiboard Computer System. Send for details of this low-cost system with choice of CPU, memory and interface boards. Only £9.40 per bare board.

March power supply (+5v @ 4A, -5v @ 1A, ±12v @ 1A) Complete pcb, off-board components & heatsink 24.95  
Specially-wound 50VA transformer 85.95

Few only ex-equipment 5v 20A switched-mode PSUs 49.50  
Mail order only. Carriage 50p on orders up to £50. Add VAT @ 15% to total order amount, except books.

MARCH COMMUNICATIONS  
(Dept. PCW)  
7 Victoria Terrace Liverpool L15 5BH

## Axon

offers its ACCOUNTS' SUITE for 32k/16k new ROM PET, CPM disk & tractor printer.

Mutually compatible programs can be used independently & do not need special stationery  
**ANALYSED CASHBOOK** — the core of the system item, Cheque No., VAT Rate, Bank, Cash, Vat, Net & Account. Auto Vat calculation & Totals for each page. Auto selection of normal & personal items for posting to ledger. £25+VAT

**LEDGER STATEMENT** — Dual purpose program creates Ledger for each Account, balancing when you wish. Also provides a Statement for customers. £25+VAT.

**INVOICE** — Formatted Invoice with item, Debit, Vat, Vat Rate, Net and Account columns & Totals. £25+VAT.

**CHEQUEWRITE** — Writes cheques, records "counter-fol", auto-interface with ANALYSED CASHBOOK. (Needs stationery approved by bank). £25+VAT.

Also also offers:  
**DATABAS** — all purpose utility for transferring data: keyboard/tape/disk/video/printer in any logical direction. Disk not needed. On tape or disk. £15+VAT.  
**CUSTOM CHARACTER** — design your own characters for printing. Mathematical symbols, Greek & On tape or disk. £8+VAT.

AXON COMPUTER SERVICES  
PO Box 12, Benham, Lancaster  
Phone: Benham (0468) 61848

# DISCOUNTED CASH FLOW

Using both yield and net present value methods, Cash flows may be constructed for any number of years for any number of cost and receipt items depending on memory size.

To be run by registered users of CBASIC-2 and requires a 48k CPM tm system. Supplied as three versions according to type of terminal used including all source code. All on one 8 inch SS SD IBM standard floppy disc (188k Bytes) plus system notes. @ £100.00 + VAT.

Write for further details or order to:-  
Electronic Accounting Services,  
41, Budleigh Crescent, Wellins,  
Kent DA16 1DX

Telephone No.: 01-303 4468  
VAT registration no: 335 9720 40  
Terms strictly payment with order.

Note: CPM tm and CBASIC-2 are the registered trade marks of Digital Research and Compiler Systems Inc.

## THE ZX80 MAGIC BOOK £4.75

Programs including Moon Lander, Hammurabi, Othello and one which allows you to make music with your ZX80. Also sections on How it Works, Plotting, Using USR, Converting programs written in other BASICS, and hardware notes including circuits for static and dynamic RAM and I/O.

## THE ATOM MAGIC BOOK £5.50

Programs to run on your ATOM, including Brickout, Hexpawn, Othello and Space Battle. Also Programming Tips and Hardware Notes and Useful ROM & RAM addresses.

TIMEDATA LTD., 57 Swallowdale,  
Basildon, Essex

Decimal	Binary				Gray code			
	b <sub>3</sub>	b <sub>2</sub>	b <sub>1</sub>	b <sub>0</sub>	g <sub>3</sub>	g <sub>2</sub>	g <sub>1</sub>	g <sub>0</sub>
0	0	0	0	0	0	0	0	0
1	0	0	0	1	0	0	0	1
2	0	0	1	0	0	0	1	1
3	0	0	1	1	0	0	1	0
4	0	1	0	0	0	1	1	0
5	0	1	0	1	0	1	1	1
6	0	1	1	0	0	1	0	1
7	0	1	1	1	0	1	0	0
8	1	0	0	0	1	1	0	0
9	1	0	0	1	1	1	0	1
10	1	0	1	0	1	1	1	1
11	1	0	1	1	1	1	1	0
12	1	1	0	0	1	0	1	0
13	1	1	0	1	1	0	1	1
14	1	1	1	0	1	0	0	1
15	1	1	1	1	1	0	0	0

Fig 1

## Datasheet

; = GRYCV — Gray code conversion

;/ CLASS: 1

;/ TIME CRITICAL? The application using it could well be.

;/ DESCRIPTION: Converts a four-bit binary number to Gray code.

;/ ACTION: HL ← address of current program instruction.

;/ HL ← HL + displacement to start of conversion table within the routine.

;/ HL ← HL + four-bit binary number.

;/ A ← (HL)

;/ SUBr DEPENDENCE: FOWIA

;/ INTERFACES: None

;/ INPUT: The most significant nibble of the A register is zero and the least significant nibble holds the number to be converted.

;/ OUTPUT: The most significant nibble of the A register is zero and the least significant nibble holds the Gray code equivalent of the binary number input.

;/ REGs USED: AF, HL, DE

;/ STACK USE: 2

;/ LENGTH: 27

;/ TIME STATES: 70 + 31

;/ PROCESSOR: Z80, 8080/85.

GRYCV: CALL FOWIA ; get addr of current instrn. CD XX XX

LD DE, +8 ; load table offset 11 08 00

ADD HL, DE ; and add it to HL 19

LD E, A ; get binary nibble 5F

ADD HL, DE ; and add that to HL 19

LD A, (HL) ; pick up conversion 7E

RET ; value and return. C9

DEFB 0, 1, 3, 2, 6, 7, 5, 4, ; conversion 00 01 03 02

; 06 07 05 04

DEFB 12, 13, 15, 14, 10, 11, 9, 8; table 0C 0D 0F 0E

; 0A 0B 09 08

## Random numbers

Richard Steedman of Edinburgh points out that a random number in the range 0-127 can be taken from the Z80 R(efresh) register, using the LD A,R instruction if, in your system, an unknown period of time has elapsed since power up. Most microcomputer systems go into a loop of random durations, waiting for a character to be input from the keyboard and so the R register will contain a random number after any keyboard input in these systems.

Richard did not send a routine using the R register (he sent a good HL = HL/2, which we have already done) but all of you who did your typing practice program from Paul Jessop's 'Typing Without Tears' article in the second (June 1978) issue of PCW probably have one already. To illustrate Richard's point about the R register, I have dug out of my version of typing practice's RNDCH, which uses the R register to select a random character from a table — see our third Datasheet.

## Datasheet

; = RNDCH — Select random character.

;/ CLASS: 2 (not position-independent because of JP P, nnn.)

;/ TIME CRITICAL? No

;/ DESCRIPTION: Selects a character at random from a table in memory, depending on the state of the R register.

;/ ACTION: A ← R

;/ B ← length of table

;/ BC ← remainder from A divided by B

;/ HL ← address of 1st character in table + BC

;/ A ← (HL)

;/ SUBr DEPENDENCE: None



```

;/ INTERFACES: None
;/ INPUT: 1) A table in memory, having the number of characters
;/ in the table in its first byte and the characters
;/ from which the selection is to be made in its
;/ other bytes.
;/ 2) The table address in HL.
;/ OUTPUT: 1) The table in memory unchanged.
;/ 2) The table address in HL unchanged
;/ 3) The randomly selected character from the table in A
;/ REGs USED: AF, HL
;/ STACK USE: 4
;/ LENGTH: 18
;/ PROCESSOR: Z80
RNDCH:  PUSH HL      ; save table address          E5
        PUSH BC     ; save BC register            C5
        LD A, R      ; get random number from R   ED 5F
        LD B, (HL)   ; get no. of chrs in table    46
        INC HL       ; point to 1st chr in table.  23
LOOP 3:  SUB B       ; get displacement          90
        JP P, LOOP3  ; within                    F2 YY YY
        ADD A, B     ; table length              80
        LD C, A     ; into                       4F
        LD B, 0     ; BC                        06 00
        ADD HL, BC  ; add displacement to HL     09
        LD A, (HL)  ; get random chr.           7E
        POP BC      ; restore BC register.       C1
        POP HL      ; restore table address      E1
        RET         ;                          C9

```

Here is a bit of program to show this routine being used; 20 randomly-selected characters are put, one after the other, onto a memory-mapped display, after each depression of any key on the keyboard. If the same character is selected twice running, you will not notice any change on the display.

```

TABLE:  DEFB 26, "A", "B", "C", "D", "E", "F", "G", "H
        DEFB "I", "J", "L", "M", "N", "O", "P", "Q", "K
        DEFB "R", "S", "T", "U", "V", "W", "X", "Y", "Z
SCREEN:  EQU nnnn      ; screen addr. - £09A0 on Nascom
        ENT
        clear screen
        LD B, +20     ; count of selections to be made.
        LD DE, SCREEN
        LD HL, TABLE
LOOP 2:  get chr from keyboard
        CALL RNDCH   ; select random character
        LD (DE), A   ; display it.
        DJNZ LOOP2
        return to your monitor.

```

## Games

From Dave Barrow of Hemsworth we have our fourth Datasheet, RECT, a routine for drawing a rectangle on a memory-mapped display. This should be most useful for games so what about

having some other games routines to go with it! RECT is interesting in that parameters may be passed to it either in the registers specified with the carry set or in the main program following the CALL with the carry unset.

## Datasheet

```

; = RECT - Draw a rectangle on a memory-mapped display.
;/ CLASS: 1
;/ TIME CRITICAL?: No
;/ DESCRIPTION: Draws a rectangle composed of any one ASCII
;/ character on a memory mapped display. Parameters
;/ can be computed and passed in the registers or
;/ programmed and embedded in the program after CALL.
;/ If width or height is given as 1 then a vertical
;/ or horizontal line results.
;/ ACTION: (SP) ↔ HL
;/ save registers
;/ Test for input type
;/ If embedded then:
;/ Use HL as pointer and get parameters in registers
;/ incrementing HL to address byte following parameters.
;/ Save (incremented) Return Address.
;/ HL ← Top Left corner of rectangle
;/ DE ← Display line width
;/ For sides:
;/ (HL) ← A
;/ HL ← HL + DE
;/ repeat for each character height for each side.
;/ For top and base:
;/ (HL) ← A
;/ HL ← HL + 1
;/ repeat for each character wide.

```

## MICROMART

### STATISTICAL CALCULATIONS

on

### APPLE II PLUS

Our Package Includes:

- Enter, Change, Store, Load and List data (Max.: 100 observations of 10 variables)
- Distribution statistics
- Correlation
- Multiple Regression
- Time Series projections (by Exponential Smoothing with Trend and Seasonal)

Virtually self-explanatory in operation, but an instruction leaflet is provided.

On Disc (needs 48K) ) Either  
On Cassette (needs 32K) ) £25 (+ VAT)

Contact: -  
Philip Stanley, Sundridge Park Management  
Centre, Bromley, Kent, BR1 3JW.  
Telephone: 01-460 9821.

## SHARP MZ-80K software

- £5 DUST COVERS - Tailored specially for the MZ-80K.
- £5 MOONLANDER - Complex real time lander. Superlative graphics/sound (10K RAM).
- £4 COMPOSER - Play tunes via the keyboard. Replay your compositions. Print music strings for future use.
- £4 BANK ACCOUNT - Input your regular income/outgoings. See the year's cash flow in monthly statements.
- £5 CHASE - Excellent real time chase. Steal the gems but avoid the vicious dog!
- £5 CONNECT FOUR - You against the mean computer - and very likely to lose!
- £5 MANIAC - Exhausting real time maniac drive. Run down strays, but don't crash. 81 skills!
- £4 Each - BIORHYTHMS, MASTERMIND, FOX & GEESE, ADDRESS BOOK. £3 - REACTION TESTER.

Write or phone for full catalogue.

Cash with order. All prices fully inclusive.

FREE machine code SPACE INVADERS with all orders of £15 and over.

## HIGHLIGHT SOFTWARE

76 St. Cyrus Road, Colchester CO4 4LR  
Telephone (0206) 64437

## CMOS RAM SALE

NATIONAL MM74C921J 1K BIT  
£7.00 EACH + VAT  
£6.00 EACH + VAT 10 PLUS  
POSTAGE INCLUDED

Cash with order to:

**desfield limited**

10 BURDETT ROAD  
STONEHOUSE, GLOS  
GL10 2JW

**SOUND BOARD** £35 BUILT £30 KIT  
TUNES - CHORDS & EFFECTS - FULLY  
PROGRAMMABLE  
CONNECTS TO 10 BITS OF ANY I/O PORT  
LOUDSPEAKER, AMP & BATTERY  
INCLUDED.

**JOYSTICKS** £15 PER PAIR (BUILT)  
CASED & COMPLETE WITH 2 PUSH  
SWITCHES & 1 METRE OF CABLE PER UNIT  
PAIR OF 2 AXIS JOYSTICKS CONNECTS  
DIRECT TO MOST 8 BIT I/O PORTS.

**COMPUKIT/SUPERBOARD**  
**OWNERS: I/O PORT** £40 BUILT £35 KIT  
24 LINE I/O PORT COMPLETE WITH 2 8T28  
BUFFER CHIPS AND ON BOARD RELAY.  
PLUGS STRAIGHT IN TO 40 PIN EXPANSION  
SKT.

**LIGHT PEN** £15 INC SOFTWARE  
USES OUR I/O PORT. HARDWARE,  
SOFTWARE & MANUAL SUPPLIED.

**NASCOM OWNERS** M/C CODE PGMS  
KINESIS-SOUND BOARD OPERATING  
SYSTEM. COMPOSE TUNES & PROVIDE  
GRAPHICS. NEEDS 16K £15

**HYSPEC**  
P.O. BOX 39,  
LITTLEHAMPTON,  
WEST SUSSEX BN17 6NZ  
ALL PRICES INCLUDE VAT, P+P

# MICROMART

## ZX80 DISSASSEMBLED 4K BASIC

Complete with comments,  
Assembly, Hex and Cross  
Reference table: £9.50  
PROGRAMS: listings and on  
cassette, include: LIFE: V fast  
1/7 second per generation.  
STARTREK. SWORD OF PEACE:  
Dungeons and dragons game great  
fun

Send SAE for free Catalogue.  
ARTIC COMPUTING,  
396 James Reckitt Ave, Hull HU8 0JA

## ZX80 LIVE ACTION SOFTWARE

Top quality games at unbeatable prices:-  
BREAKOUT (1k0; £4.00. SPACE INTRU-  
DERS (2K): £4.00. Also MOVIES (2K plus),  
7x8 character pictures displayed in rapid  
rotation giving animation effect; £3.00. —  
No hardware modification whatsoever.  
Written in machine code without loss of  
TV Synchronisation.  
SOUNDS INCREDIBLE? — YES, but it's  
true. Reviews say the ZX80 can't be used for  
continuous live action ARCADE type  
games. — WELL IT CAN — WE'VE DONE  
IT — SEEING IS BELIEVING — Send  
cheques or PO's for program listing (or  
SAE for list of all software) to:-  
MACRONICS, (K. Macdonald), 26 Spiers  
Close, Knowle, Solihull, B93 9ES.

## Softcentre

OVER 100 PROGRAMS FOR CBM/PET  
Send 20p stamp for free catalogue or  
60p stamps for catalogue  
+ free program... worth £1!  
Part exchange your unwanted (Brand Label)  
Programs.

Top Royalties for your own original top  
quality programs — send cassette.  
(I.T.P. Sharp & TRS80/IV Genie also wanted).  
VIDEO GENIE £298 SHARP (4K) £498  
EPSON MX80 £395  
CENTRONICS 737 £395  
RADOFIN TELETEXT CONVERTOR  
ONLY £167.50  
PETMASTER SUPERCHIP £45 TOOLKIT  
(N.R.) £30  
VERBATIM MD525-01 DISKS (PET/ITT  
C)THINK £22/10  
PET SOUND BOX £14.50  
10x15 CASSETTES £3.99  
9" MONITORS £89.50 (b/w)  
9" MONITORS £109.75 (c/m)  
PET CASSETTE (PANTAL) £55  
WITH AUDIO MONITOR &  
COUNTER £57  
MOST MICROS BOUGHT, SOLD  
REPAIRED

26 ALBANY ROAD  
RAYLEIGH ESSEX  
Callers strictly by appointment  
(0288-774088) NOON - 8pm Mon-Sat  
ALL PRICES EXCLUSIVE  
OF VAT & CARRIAGE

OPTICO

## COMPUSENSE LTD.

8800/9 Software and Hardware  
SOFTWARE — TAPE  
1. CST003 SWTPC 8k BASIC V2.3 £11.00  
2. CST014 TSC Text Editor £22.00  
3. CST015 TSC Assembler £22.00  
4. CST017 TSC 8800 Relocator £16.50  
5. CST016 TSC Text Processor £26.00  
All software provided with manual and cassette.  
A complete range of disc and tape software is  
available, send for details.  
HARDWARE — PCB's supplied with parts list &  
Schematics.  
1. CSH001 SWTPC Motherboard £24.20  
2. CSH002 SWTPC MPA/2 CPU £35.00  
3. CSH003 SWTPC MPA/2 CPU Assembled £75.00  
4. CSH006 SWTPC MPS serial interface £ 6.60  
5. CSH005 SWTPC MP/LA parallel  
interface £ 6.60  
6. CSH008 F&D Floppy disk controller £35.00  
\*NEW\*  
7. CSH009 F&D 8800 to 8809 converter  
for MPA/2 £ 8.00  
\*NEW\*  
8. CSH020 8800 chip set: 8800, 8810,  
8820, 8850, 8876 £16.80  
9. CSH021 Molax connectors, female  
pack of 10 £ 3.00  
10 CSH022 Molax connectors, male  
pack of 10 £ 2.80  
— Prices include postage, add VAT at 16%  
Complete SWTPC systems available at prices  
beginning around £3,000  
FEW ONLY! SWTPC 8800 systems, 40k, twin  
minifloppies & VDU £1700.00. These are new,  
end of range systems at about half the current  
prices.  
— Official SWTPC Dealers —

```

;/ Restore Return Address to HL
;/ Restore registers
;/ (SP) ← HL
;/ SUBr DEPENDENCE: None
;/ INTERFACES: None
;/ INPUT: a) By registers: A = character used
;/ C = inclusive line height
;/ B = inclusive character width
;/ DE = address Top Left corner of rectangle
;/ Carry = 1 (SET)
;/ b) By program: The above parameters are embedded in
;/ the program after CALL RECT
;/ Carry = 0 (RESET)
;/ OUTPUT: Values loaded into video RAM appear as rectangle
;/ on the display.
;/ REGs USED: a) AF BC DE b) F
;/ STACK USE: 12
;/ LENGTH: 53
;/ TIME STATES: a) 205 + 52*W + 68*H b) as (a) + 60
;/ PROCESSOR: Z80
DLW EQU nnnn ; character line width (including
; Nascom margins) of display
RECT: EX (SP), HL ; save HL and get Return Address. E3
PUSH AF ; save flags F5
PUSH BC ; and C5
PUSH DE ; registers D5
JR C, INREG ; skip if parameters already in 3E 0A
LD A, (HL) ; else 7E
INC HL ; get 23
LD C, (HL) ; all 4E
INC HL ; parameters 23
LD B, (HL) ; and 46
INC HL ; increment 23
LD E, (HL) ; Return 5E
INC HL ; Address 23
LD D, (HL) ; past 56
INC HL ; them. 23
INREG: PUSH HL ; save Return Address. E5
EX DE, HL ; get Top Left corner address in HL EB
LD DE, DLW ; and display line width in DE 11 nn nn
PUSH HL ; save T.L. corner address E5
PUSH BC ; and dimensions C5
TOP: LD (HL), A ; draw 77
INC HL ; top 23
DJNZ TOP ; line 10 FC
DEC HL ; point back to Top Right corner 2B
RIGHT: LD (HL), A ; draw 77
ADD HL, DE ; down 19
DEC C ; right 0D
JR NZ, RIGHT ; side 20 FB
POP BC ; restore dimensions C1
POP HL ; and point back to Top Left corner E1
LEFT: LD (HL), A ; draw 77
ADD HL, DE ; down 19
DEC C ; left 0D
JR NZ, LEFT ; side 20 FB
OR A ; clear carry and B7
SBC HL, DE ; point back to B.L. corner ED 52
BASE: LD (HL), A ; draw 77
INC HL ; along 23
DJNZ BASE ; base. 10 FC
POP HL ; restore Return Address to HL E1
POP DE ; restore D1
POP BC ; registers C1
POP AF ; and flags F1
EX (SP), HL ; and HL, putting Ret. Add. on stack. E3
RET ; C9

```

## LEISURE LINES

by J J Clessa

A very good response to puzzle 17 — about 160 replies, of which 20 or so were wrong. Quite a few went into the bin since they were not on postcards; if you haven't got a postcard, then write the answer on the back of a sealed envelope and send that. Naturally we read your letters but we don't include them in the prize draw.

Back to the problem. The number of grains that each villager receives is — wait for it (and they do!) — 3,218,436, almost a bucketful, we reckon. What a

hell of a ceremony it is! It lasts for 12,167 hours, which is just over a year. By that time, of course, the waiting poor have all starved to death. . . First correct solution was from Mr (or Ms) S Crown of Bedford. Congratulations — your prize will be on its way soon.

## Quickie

As usual, no prizes, so no answers required. Which number, when added to 12, gives the same result as if it were multiplied by 6?



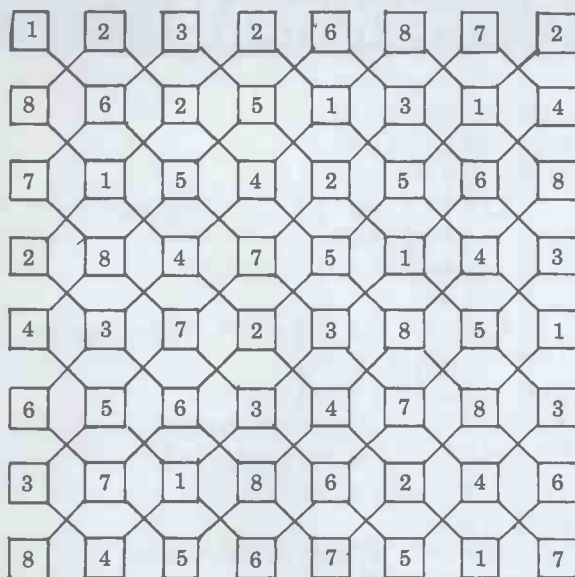

## Prize puzzle

This month's prize puzzle lends itself to a micro-based solution, although a nifty bit of logical thought and programming will be required.

1. Select any eight squares from the 64 squares in the diagram so that no two are lying on the same diagonal line;
2. Add the values in the squares chosen

to give a total;

3. The object is to choose the eight squares which yield the highest total.

Answers please on a *postcard*, circling the eight squares chosen together with the total to Puzzle 20, *PCW*, 14 Rathbone Place, London W1P 1DE, to arrive no later than April 30.

## PROGRAMS

### ZX80 maths test

by Guy Bean

This runs on a 1k ZX80. The program first asks you to chose a skill level of from 1 to 5 and then asks you which arithmetical operation +, -, \*, or

/ - you want to be tested on. After you've made this choice, you'll be given a test. At the end, the machine gives you a score.

```

10 PRINT "MATHS TEST"
20 PRINT "(1,2,3,4,5)"
30 INPUT A
40 PRINT "(+,-,*,/)"
50 INPUT A$
60 LET J=1
70 LET K=0
80 CLS
90 IF A=1 THEN GOTO 150
100 IF A=2 THEN GOTO 180
110 IF A=3 THEN GOTO 250
120 IF A=4 THEN GOTO 320
130 IF A=5 THEN GOTO 360
140 STOP
150 LET X=RND(9)
160 LET Y=RND(9)
170 GOTO 390
180 IF A$="*" OR A$="/" THEN GOTO 220
190 LET X=RND(50)
200 LET Y=RND(50)
210 GOTO 390
220 LET X=RND(15)
230 LET Y=RND(15)
240 GOTO 390
250 IF A$="*" OR A$="/" THEN GOTO 290
260 LET X=RND(99)
270 LET Y=RND(99)
280 GOTO 390

```

# MICROMART

## Southampton

SALE of ex-hire, second hand and demonstration PET's (2000 3000 and 4000 series) Prices from:

8K small keyboard	£275
16K small keyboard	£425
16K large keyboard	£450
32K large keyboard	£550

### Also new machines

4008N large keyboard	£425
4016N large keyboard	£510
4032N large keyboard	£625
404 Disk Unit	£640
4022 Tractor Printer	£405

Tensai Cassette Deck (inc sound and counter) £70

Commodore Software stocked  
6550 RAMs £10 each

HIRE Commodore equipment by the week

8K £23 16K £26 32K £30  
Disk Unit £30 Printer £30

All prices exclude VAT  
Above subject to availability

OFFICIAL COMMODORE DEALER

## SUPER-VISION

13 St. James Road, Shirley Southampton  
Telephone (0703) 774023 After hours  
(0803) 554488



### SHARPE Pocket Computers

Lowest UK PRICE!!!!

PC1211 Pocket Computer, Complete with CE121 Cassette interface. . . . . £105.95

PC1211 Only . . . . . £91.95

All prices include 15% VAT and UK Delivery.

FREE PAPERMATE PEN WITH ALL ORDERS

ELKAN ELECTRONICS  
28 BURY NEW ROAD, PRESTWICH  
MANCHESTER M25 8LD

## PET'S

### PETS - We Sell Them

As authorised Commodore Dealers we stock and supply all PET Hardware, Computhink Discs, Oki Microline 80 Dectwriter LA34, Texas 810, Qume Sprint 5 - all at competitive prices

### PETS - We Buy Them

Part Exchange is very welcome, we also buy for cash.

### PETS - We Hire Them

Our specialist hire service, with maintenance included for all Commodore equipment.

- Complete systems for evaluation
- Multiple units for educational courses
- Single units for individual use

From 1 day upwards, all units available. Delivery by arrangement, anywhere in UK.

### PETS - Software

We are fully authorised BUSINESS SOFTWARE DEALERS for Commodore Software - COMPAY COMSTOCK, WORDPRO etc. Also PETSOFT, BRISTOL SOFTWARE, LANDSLER PAYROLL & HOTEL SYSTEM.

PLUS for ACCOUNTANTS, the unique CSM INCOMPLETE RECORDS PACKAGE - this is the best available.

### MAIL - ORDER

All Hardware and Software can be bought by Mail Order Delivery by Securicor, or Registered Post. Discounts for Cash & Carry or Mail-Order. Access accepted or by Leasing (subject to acceptance)

### MICRO-FACILITIES LTD

127 High Street, Hampton Hill, Middlesex,  
TW12 1NJ 01-979 4546 or 01-941 1197

To advertise in  
MICROMART  
Please ring Jacquie Hancock  
on 01-631 1682

## DISCOUNT PRINTERS

**SEIKOSHA GP80** £235  
**OKI MICROLINE 80** £329  
**EPSON MX80** £359

### NEW OHIO SUPERBOARD III

Immediate Delivery  
 Full Warranty and Back Up  
 With FREE PSU Kit £159

### UK101/SUPERBOARD EXTRAS

610 BOARD (FREE 4K RAM) £159  
 48 x 32 VIDEO DISPLAY ONLY £15  
 2k Video Ram. Complete Kit, Instructions  
 etc. Cegmon Monitor for above £29.50  
 or BOTH £42

### NEW MONITOR I.C. £19.50

FULL SCREEN EDITING  
 EXTRA BASIC COMMANDS  
 MANY OTHER EXTRAS

### 2114L 300ns RAM £1.99

4k £15 10k (atom) £33  
 Full Spec. Despatched by return!

PROGRAMMABLE CHARACTER GENERATOR  
 AVAILABLE NOW!

HIGH SPEED CASSETTE INTERFACE KIT  
 Switchable from 300 up to  
 9600 Baud. £14.50

Send S.A.E. for free prog. + price list  
 High educational and club discounts

### NORTHERN MICRO

29 Moorcroft Park  
 New Mill

HUDDERSFIELD

add 15%VAT  
 Tel. HOLMFIRTH  
 (048489) 2062

10am-8pm Mon-Sat

# PET CHIPS

**PETMASTER SUPERCHIP** £45  
**PIC-CHIP** £45  
**PROGRAMMER'S TOOLKIT** £29  
**MIKRO ASSEMBLER** £50

Write for full details of these plug-in PET ad  
 add-ons which fit in the spare ROM sockets  
 of a large keyboard machine. If your PET  
 has a calculator keyboard you'll need an  
 extension board (£13) which will  
 accommodate any two of the chips.

BASIC 4.0 versions are available to fit the  
 4000 and 8000 series models — write for  
 information and prices.

We also sell programs on cassette and disk  
 (£2.50 extra) — there are over a 100 to  
 choose from including BLOCK  
 RENUMBER (£12), DISK APPEND (£15),  
 HALLS OF DEATH (£14), ALIEN ATTACK  
 (£10), and WIZARD'S LAIR (£10). And  
 MAKRO ASSEMBLER at £50 offers an  
 opportunity for machine code programmers  
 to really flex their mnemonics.

Why not phone for our free catalogue!  
 Add 15% VAT to all prices. Post Free.

## SUPERSOFT

28 Burwood Avenue,  
 Eastcote, Plinner, Middlesex

Telephone: 01-866 3326



# PROGRAMS

```

290 LET X=RND(30)
300 LET Y=RND(30)
310 GOTO 390
320 IF A$="*" OR A$="/" THEN GOTO 190
330 LET X=RND(500)
340 LET Y=RND(500)
350 GOTO 390
360 IF A$="*" OR A$="/" THEN GOTO 260
370 LET X=RND(1000)
380 LET Y=RND(1000)
390 IF A$="-" AND X<Y THEN GOTO 90
400 IF A$="/" THEN GOTO 640
410 IF J=11 THEN GOTO 710
420 LET J=J+1
430 IF A$="+" THEN GOTO 480
440 IF A$="-" THEN GOTO 580
450 IF A$="*" THEN GOTO 610
460 IF A$="/" THEN GOTO 670
470 STOP
480 LET Z=X+Y
490 PRINT X;"+";Y;"="
500 INPUT B
510 CLS
520 IF B=Z THEN GOTO 550
530 PRINT "NO - ";Z
540 GOTO 90
550 LET K=K+1
560 PRINT "YES, THAT WAS RIGHT"
570 GOTO 90
580 LET Z=X-Y
590 PRINT X;"-";Y;"="
600 GOTO 500
610 LET Z=X*Y
620 PRINT X;"*";Y;"="
630 GOTO 500
640 LET Z=X/Y
650 IF NOT X=Z*Y THEN GOTO 90
660 GOTO 410
670 LET L=RND(11)
680 LET X=(A*L)*X
685 LET Z=X/Y
690 PRINT X;"/";Y;"="
700 GOTO 500
710 PRINT "SCORE = ";K;"/10"
    
```

## ZX80 calendar

by I Bryant

This program — which fits into a 1k  
 machine — will enable you to find out  
 what day your birthday falls on in the  
 year 24759 or indeed any year  
 between 1753 and 25000. Note that  
 to fit the program on the page we've

split lines 210 and 325 but of course  
 you should enter these as complete  
 lines. In lines 507 and 565 you put  
 two spaces between the quotes; line  
 515 has four spaces between the  
 quotes and in line 530 there's just one.

```

1 REM CALENDAR
4 CLS
5 PRINT "YEAR (1753-25000)?"
10 INPUT Y
15 IF Y<1753 OR Y>25000 THEN GOTO 5
20 PRINT "MONTH (1-12, 0 FOR ALL)?"
25 INPUT M
30 IF M<0 OR M>12 THEN GOTO 20
    
```



# PROGRAMS

```

40 IF M=0 THEN GOTO 55
45 GOSUB 200
50 GOTO 75
55 FOR M=1 TO 12
60 GOSUB 200
70 NEXT M
80 GOTO 1

200 LET A=Y+1+31*(M-1)+(Y-1)/4-(3*((Y+99)/100)/4)
210 IF M>2 THEN LET A=Y+1+31*(M-1)-(4*M+23)/10+
      Y/4-3*(Y/100+1)/4

215 LET A=A-(A/7)*7
220 IF A=0 THEN LET A=7
225 LET A=A-1
300 IF M=2 THEN GOTO 320
305 LET N=31
310 IF M=4 OR M=6 OR M=9 OR M=11 THEN LET N=30
315 GOTO 400
320 LET N=28
325 IF Y-(Y/4)*4=0 AND NOT Y-(Y/100)*100=0 OR
      Y-(Y/400)*400=0 THEN LET N=29

400 CLS
412 PRINT,"YEAR",Y
414 PRINT,"MONTH",M
505 PRINT" SUN MON TUE WED THU FRI SAT"
507 PRINT " ";
508 IF A=0 THEN GOTO 525
510 FOR I=1 TO A
515 PRINT " ";
520 NEXT I
525 FOR I=1 TO N
530 IF I<10 THEN PRINT " ";
535 PRINT I;
540 LET A=A+1
545 IF NOT A-(A/7)+7=0 THEN GOTO 565
550 LET A=0
555 PRINT
565 PRINT " ";
570 NEXT I
580 INPUT Z$
590 IF Z$="S" THEN STOP
600 RETURN
    
```

## Link index

by Alan Shelley

This listing is for the routine described on page 101.

Note: For old ROMs substitute line 620 with PRINT "15 x Cursor Downs"

and change line 630 to PRINT "FORJ = 639 TO 655: ? CHR\$(PEEK(J)); : NEXT"

```

10 REM:LINKINDEX"ABCDEF
20 REM:A.W.SHELLEY:JAN1981
30 Y=1177:Z=256:W=INT(Y/2):A=PEEK(42)
40 ::POKE1045,A:A=PEEK(43):POKE1046,A
50 ::POKE1042,W:POKE1041,Y-W*Z
60 GOTO300
70 DATA01025,01025,01025,01025,01025,01025,01025,01025,01025,01025,x
80 REM01025,01025,01025,01025,01025,01025,01025,01025,01025,01025,x
90 PRINT"J"TAB(7)"**INDEX**"
100 PRINTTAB(9)"
110 REM" 1.
111 REM"012345678901234567890":OMIT 111
120 REM" 2.
130 REM" 3.
140 REM" 4.
150 REM" 5.
160 REM" 6.
170 REM" 7.
180 REM" 8.
190 REM" 9.
200 REM" 10.
210 PRINT" 12. DELETE"
220 OPEN1,0,0
230 PRINT"Enter no. required ";
240 INPUTH1,QE:Q=VAL(QE)
250 IFQ=12GOTO650
260 IFQ=0THENPRINT"000":GOTO230
270 FORJ=1TOQ:READA:NEXT
280 W=INT(A/256):POKE41,W
290 POKE40,A-W*256:RUN
    
```

# MICROMART

## THE ZX80 COMPANION



Bob Maunder & Terry Trotter

LOW COST FIRST ED. SPIRAL BOUND COVERING USE OF PACKAGES, PROGRAMMING THEORY, ZX80 BASIC, HARDWARE + CONSTRUCTIONAL DETAILS. FULLY DOCUMENTED PROGRAMS. NO OTHER BOOK ON THE ZX80 OFFERS SUCH VALUE.

68 BARKER RD. MIDDLESBROUGH TSS 5ES

## GUY FORREST

Announce  
"JACKPOT"  
The New Game of  
Chase the Ace  
A Professionally Produced  
Program for up to 4 Players  
Compulsive, Competitive,  
Compelling.  
Now available on Cassette  
(12K Required)  
for  
Sharp Mz 80K, . . . . Pet  
Apple, . . . . ITT2020  
for only £15.00  
fully inclusive From  
Guy Forrest (Games) Ltd.  
3, Westbourne Crescent,  
Southampton.  
Tel. (0703) 556413

## CARDIFF MICRO CENTRE

PETs & SUPERPETS  
+  
SHARP MZ-80s  
+  
HEWLETT PACKARD  
+  
COMPUTER BOOKS

## SIGMA SYSTEMS

54 Park Place  
Cardiff 21515/34869



## MICROTYPE STAK-PAK

CASSETTE STORAGE SYSTEM FOR EASY PROGRAM FILING.



- Each drawer section takes 2 cassettes.
  - Drawers lock together vertically.
  - Each twin pack comes with 2 C12 digital cassettes.
  - Each 'pak' is complete with index cards, cassette and drawer labels.
- FIVE TWIN PAKS (10 CASSETTES)  
FDR £6.60 INC. VAT & P&P.
- Send cheques or Postal Orders to:  
MICROTYPE, PO Box 104,  
HEMEL HEMPSTEAD,  
HERTS HP2 7QZ.

### SYSTEMICS LIMITED

3 Hillberry Court, School Lane, Bushey Herts. WD2 1BS (01) 422 3276 (24 hours)

### APPLE COMPUTER Sales and service HI - RES PROBLEM SOLVER £45

an all purpose hi - res processor, includes upper/lower case, mixed graphics and text, two way window scrolling, user shape definition with rotation, enlargement, slanting, stretching, reflection, inversion and many other hi - res functions

### Literature search £25

a suite of four programs forming a complete magazine article filing system allowing retrieval of references to items by keyword(s) within category

Many other quality packages including:

Stock control	£125
Linear programming	£85
Time analysis	£125
Mailing list	£100

Dealer enquiries invited

# OKI

**NEW LOW PRICE**

MICROLINE 80

**£329\***

We can also supply:

NEC . . . . .	£1390*
MX80 range from	£259*
DIP 81 . . . . .	£249*
Centronics 737.	£349*
Anacom 150 . . .	£699*
Base 2 . . . . .	£295*
Seikosha GP80.	£199*
TVI 912C. . . . .	£475*

**NORTHAMBER LTD**  
Great Oak House, Esher, Surrey  
KT10 9BR Tel: 0372 62071  
*\*plus VAT and delivery*

To advertise in  
**MICROMART**  
Please ring Jacquie Hancock  
on 01-631 1682

## PROGRAMS

```

300 FORJ=1TO11:READA&NEXT
310 FORX=826TO915:READA:POKEY,A:NEXT
320 DATA 162,0,134,157,232,134,212,32
330 DATA 86,246,32,18,248,32,10,244
340 DATA 32,166,245,165,150,41,16,240
350 DATA 1,96,32,60,246,56,165,42
360 DATA 233,2,133,199,133,251,165,43
370 DATA 233,0,133,200,133,252,56,165
380 DATA 199,233,1,133,192,165,200,233
390 DATA 4,133,193,24,165,192,101,201
400 DATA 133,201,165,193,101,202,133,202
410 DATA 32,46,244,32,94,248,165,201
420 DATA 133,42,165,202,133,43,32,66
430 DATA 196,96
440 POKE1112,143:POKE1142,143
450 A=PEEK(42):POKE1043,A
460 A=PEEK(43):POKE1044,A
470 PRINT"3000sys826"
480 PRINT"00000000c1r:goto500"
490 CR=2:GOTO760
500 ZZ=PEEK(1043)+256*PEEK(1044)-2
510 YY=PEEK(1041)+256*PEEK(1042)
520 OI=PEEK(1045)+256*PEEK(1046)-1610
530 Y=YY+67:Z=ZZ-DI
540 X&=STR&(Z):XX&=STR&(ZZ)
550 FORJ=1TO5:X=ASC(RIGHT&(X&,6-J))
560 XX=ASC(RIGHT&(XX&,6-J))
570 IFX=32THENX=48
580 IFXX=32THENXX=48
590 POKEY+J,X:POKEYY+J,XX:NEXT YY+Y+6
600 POKE1042,YY/256:POKE1041,YY-INT(YY/256)*256
610 PRINT"3000?chr&(19):list70-200"
620 POKE216,19:PRINT
630 PRINT"FOJ=639TO655:?CH(PE(J));:NE"
640 CR=2:GOSUB760:LIST70-200
650 POKE1244,131:PRINT"300"
660 FORJ=30TO70STEP10:PRINTJ:NEXT
670 PRINT"210":PRINT"250"
680 PRINT"K=300:F=790:GOTO720"
690 CR=8:GOTO760
700 INPUT"DELETE FROM";JK
710 INPUT"TO";F
720 PRINT"300":forj=0to190step10
730 IFK+J>FTHENCR=J/10:GOTO760
740 PRINTK+J:NEXT:CR=21
750 PRINT"F="F":K="K+J":GOTO720"
760 PRINT"0":POKE158,CR
770 FORJ=0TOCR-1
780 POKE623+J,13:'EXT
790 END
    
```

## ZX80 Moon lander

by Steven Ward

This runs on a 1k ZX80. The aim is to land on the Moon at a velocity greater than -101 but less than 0. The program then gives you a percentage and lets you know if you've survived the landing.

```

10 LET V=-50
20 LET H=1000
30 LET R=5000
40 GOTO 160
50 PRINT "THRUST (0-99)?"
60 INPUT F
70 PRINT F
80 PRINT "DURATION (1-10)?"
90 INPUT T
100 CLS
110 IF F*T>R/10 THEN LET F=R/10*T
120 LET R=R-F*T*10
130 LET A=F-32
140 LET H=A*T**2+V*T+H
150 LET V=2*A*T+V
160 PRINT,"MOON LANDER
170 PRINT
180 PRINT,"SPEED","HEIGHT","FUEL"
190 PRINT,V,H,R
200 PRINT
210 IF H>0 THEN GOTO 50
220 PRINT 100+V;" PERCENT"
230 IF V<-100 THEN PRINT "LANDER LEGS BEYOND REPAIR"
240 IF V<-150 THEN PRINT "LANDER SERIOUSLY DAMAGED"
250 IF V<-200 THEN PRINT "LANDER CREW DEAD"
260 IF V<-250 THEN PRINT "LANDER HAS BORED A HOLE IN THE MOON"
270 IF 100+V>50 THEN PRINT "EXCELLENT"
    
```



# PROGRAMS

## TRS-80 rocket attack

by John Gooderson

Stop the rockets landing on the nuclear power station. Good game.

# MICROMART

## topmark

computers

NEW! NEW! NEW!



APPLE FORTRAN  
(Needs language card)

Send only £120 + VAT £18 (Fortran only)  
or £419 + VAT £62.85 (complete system, includes Pascal and language card)

NEW! NEW! NEW!

NEW! DOS 3.3 — much improved capacity £40 + VAT £6.

NEW! Eurocolour card — vastly superior to previous versions £113 + VAT £16.95

Official Government and Educational orders accepted.

Contact Tom Piercy at  
Topmark Computers, 77 Wilkinson Close,  
Eaton Socon, St Neots, Cambs. PE19 3HJ  
Huntingdon (0480) 212563

## BUSINESS & COMPUTER SERVICES

Microcomputer Consultants  
and Programers

(TRS 80 Specialists)

Tel.  
01 607 0157  
292 Caledonian Rd,  
London N1 1BA

## NASCOM SOFTWARE

We offer the following quality software for NASCOM systems:

**NASPAS** — a 12K PASCAL compiler which produces Z80 code directly i.e. no .P-code. The compiler offers floating point and integer arithmetic, arrays, sets, strings and all major Pascal statements together with fully recursive functions and procedures with value and variable parameters. The object programs run very quickly. Price: £35.00

**NASMON** — A new monitor for NASCOMs. Occupies 4k and includes a sophisticated screen editor, a 'front panel' mode, blocked and buffered tape routines and powerful debugging commands. Price: £30.00 in EPROM

**BAS12K** — a 12K BASIC interpreter offering 11 digit precision arithmetic, PRINT USING, IF... THEN... ELSE and other advanced features. Price: £25.00

**NASGEN** — a fast 3K assembler generating a full symbol table and with many assembler directives and commands. Price: £15.00 on tape, £25.00 in EPROM.

**NASNEM** — a 2½K disassembler which interfaces to NASMON's front panel to produce single step disassembly. Optionally it produces labels and o/p may be directed to a text buffer suitable for NASGEN. Price: £10.00 on tape, £15.00 in EPROM.

All the above software runs under NASMON except NASPAS which can run under NASMON or NAS-SYS.

All prices are fully inclusive.

FREE: a free CHESS program with every order of NASMON.

Full details may be obtained from:

HISOFT 60 Hallam Moor, Liden, Swindon  
Wiltshire.

```
5 REM *****
10 REM ROCKET ATTACK BY JOHN GOODERSON. - COPYRIGHT 1981.
15 REM *****
20 FOR C=30001 TO 30040: POKE C,0: NEXT C
30 CLS: PRINT TAB(23) "ROCKET ATTACK"
40 PRINT:PRINT
50 PRINT " A NUMBER OF NUCLEAR POWER STATIONS ARE LOCATED IN"
60 PRINT "GREAT BRITAIN AND THEY ARE ALL UNDER IMMINENT ROCKET ATTACK"
70 PRINT "FROM A FOREIGN POWER. EACH POWER STATION IS DEFENDED BY A"
80 PRINT "COMPUTER CONTROLLED MISSILE LAUNCHING SITE."
90 PRINT " MISSILES ARE GUIDED BY THE MISSILE SITE COMMANDER WHO USES"
100 PRINT "KEYS 1 TO 5 FOR NORMAL GUIDANCE AND THE SPACE BAR FOR EMERGENCY"
110 PRINT "BOOST. ANY KEY CAN BE USED TO FIRE A MISSILE."
120 PRINT " EACH MISSILE SITE COMMANDER IS RATED FOR ABILITY TO DEFEND"
130 PRINT "THE POWER STATIONS. AS MIGHT BE EXPECTED THE RATING IS BASED ON"
140 PRINT "A COMBINATION OF SKILL AND LUCK"
150 PRINT:INPUT "HOW MANY SITE COMMANDERS ARE THERE?";CN
160 IF CN<1 THEN 150
170 IF CN>4 THEN PRINT "THERE ARE ONLY 4 TRAINED COMMANDERS AVAILABLE IN GREAT B
RITAIN":GOTO 150
180 PRINT:INPUT "HOW MANY POSTINGS TO ACTIVE SERVICE CAN EACH COMMANDER UNDERTAKE
";FN
190 IF FN<1 THEN PRINT "ALL COWARDS WILL BE SHOT AT DAWN.":GOTO 180
200 IF FN>3 THEN PRINT "ALL COMMANDERS GO INSANE AFTER MORE THAN 3 POSTINGS.":GOT
O 180
210 POKE 30035,CN:POKE 30036,PN:CC=1:FC=1:CLS
220 REM APPOINT COMMANDER
230 PRINT@649,"COMMANDER NO."CC:PRESS "P":
240 PRINT@716,"FOR POSTING NO."PC:
250 AS=INKEY$:IF AS<>"P" THEN 250
260 POKE 30037,CC:POKE 30038,PC
270 RUN 300
300 REM DRAW STATION AND LAUNCHER
310 DEFINT A=2:V=1:P=15360:M=867
320 CLS:PRINT@468,"AN ATTACK IS IMMINENT";
330 FOR T=0 TO 1000:NEXT:PRINT@537,"STAND BY":FOR T=0 TO 1000:NEXT
340 CLS
350 PRINT@931,CHR$(191)::PRINT@930,CHR$(184)::PRINT@932,CHR$(180);
360 FOR C=992 TO 998:PRINT@C,CHR$(191)::NEXT C
370 FOR C=969 TO 979:PRINT@C,CHR$(191)::NEXT C
380 FOR C=905 TO 915:PRINT@C,CHR$(191)::NEXT C
390 FOR C=842 TO 850 STEP 2:PRINT@C,CHR$(191)::NEXT C
400 REM HORIZONTAL ROCKET + MISSILE CONTROL
410 ON ERROR GOTO 860:H=X*100/2:PRINT@747,"AIMING ABILITY"H"% ";
420 Z=Z+1:D=63:D=RND(20):R=RND(3)
430 S=(100-(M*100/11))*(11-W)/(26-Z):IF S>99 THEN S=99
440 PRINT@683,"SURVIVAL CHANCE"S"%";
450 PRINT@811,"ROCKETS LAUNCHED"Z";
460 IF Z=26 THEN Z=Z-1:GOTO 4300
470 POKE(P+D),179
480 POKE(P+D-1),140
490 POKE(P+D-2),140
500 POKE(P+D-3),140
510 POKE(P+D-4),140
520 AS=INKEY$:IF AS="" THEN 550
530 PRINT@555,"
540 A=67-VAL(AS):PRINT@875,"MISSILES FIRED"Y":IF A<62 THEN A=62
550 IF A=0 THEN PRINT@555,"MISSILE"Y"READY";
560 POKE(P+M-U),42
570 IF PEEK(P+M-U-A)=140 OR PEEK(P+M-U-A)=179 THEN 1000
580 PRINT@D-4,"
590 POKE(P+M-U),32
600 D=D-R:U=U+A
610 IF U>888 THEN U=0:V=Y+1:A=0
620 IF P+D<(P+24-D) THEN 650 ELSE 470
650 REM VERTICAL ROCKET + MISSILE CONTROL
660 POKE(P+D),188
670 POKE(P+D+1),131
680 POKE(P+D-1),131
690 POKE(P+D+64),143
700 AS=INKEY$:IF AS="" THEN 730
710 PRINT@555,"
720 A=67-VAL(AS):PRINT@875,"MISSILES FIRED"Y":IF A<62 THEN A=62
730 IF A=0 THEN PRINT@555,"MISSILE"Y"READY";
740 POKE(P+M-U),42
750 IF PEEK(P+M-U-A)=131 THEN 1000
760 IF PEEK(P+M-U-A)=143 OR PEEK(P+M-U-A)=188 THEN 1000
770 POKE(P+D),32
780 POKE(P+D+1),32
790 POKE(P+D-1),32
800 POKE(P+D+64),32
810 POKE(P+M-U),32
820 IF PEEK(P+D+128)=191 THEN 2000
830 D=D+64:U=U+A
840 IF U>888 THEN U=0:V=Y+1:A=0
850 IF D>960 THEN 400 ELSE 650
860 RESUME NEXT
1000 REM DESTROY ROCKET
1010 PRINT@D-5," BOOM ":POKE(P+M-U),32
1020 FOR T=0 TO 150:NEXT
1030 PRINT@D-5," ":U=0:V=Y+1:PRINT@875,"MISSILES FIRED"Y":A=0
1040 X=X+1:PRINT@939,"ROCKETS DESTROYED"X;
1050 GOTO 400
2000 REM HIT POWER STATION
2010 POKE(P+D+128),32:W=W+1
2020 PRINT@1003,"HITS ON STATION"U;
2030 IF(D+128)>960 THEN 3000
2040 PRINT@D-66," WOOMF";
2050 FOR T=0 TO 200:NEXT
2060 PRINT@D-66," ";
2070 GOTO 400
3000 REM POWER STATION DESTROYED
3010 CLS
```

## BIAS POWER SUPPLIES

**FOR SYSTEM EXPANSION TO 64K**  
**BIAS 1** for general micro use  
 +5 @ 10 amps ±12v @ 2 amps  
 -5 @ 1 amp **KIT £42.50**

**BIAS 3** for S100 systems  
 +8v @ 10amps  
 ±18v @ 3.5amps **KIT £40.20**

**Over Voltage Protection**  
 - optional B1 - £12;

**HEAVY ALLOY CASE**  
 150 x 150 x 200  
 includes switches, connectors,  
 predrilled **£12**

**Assembled & Guaranteed add £15**

Mail order to:

## ONUSTECH ENG LTD

474 CHISWICK HIGH RD  
 LONDON W4  
 01-995 0160

p&p £3.50

Prices excluding VAT.

# ZX80

TV GAMES (4K)

**ZX80 INVADERS** the popular pub game  
**GALAXY WARS** Guide your spaceship  
 through the galaxies

m/c code routines with continuous  
 non-flicker display & fast moving graphics  
 £5 each listing or S.A.E. for details  
 J EDMONDS, 29 Chestnut Ave., Grays, Essex

# PET EXPERTS

SUPERSOFT are specialists in programming  
 aids - like SPEEDSORT (£12) which will  
 sort 1000 strings in about 4 seconds! DISK  
 APPEND adds a program on disk to one in  
 memory - just like the Tookit - for only  
 £15. BLOCK RENUMBER (12) is an  
 invaluable aid for the serious programmer  
 and SCREENSAVE (£6) is equally essential  
 for the artistic programmer. If you own a  
 printer then J-K-L is a must, for it copies  
 the screen to the printer every time the  
 keys J, K, L are pressed! (£8)

There are games too in our free catalogue.  
**HALLS OF DEATH** (£14) was described as  
 'better than Apshai' - but why not judge  
 for yourself. **BLACK BOX** (£6) and **NIMBO**  
 (£7) challenge your logic, whilst at £10  
**ALIEN ATTACK** and **WIZARD'S LAIR**  
 require you to be nimble-fingered as well as  
 quick-witted.

So now you know. We don't just market  
 the SUPERCHIP - we have over one hundred  
 tried and tested programs in our range.  
 Write to us today for your free catalogue!  
 Add 15% VAT to all prices. Post free.

## SUPERSOFT

28 Burwood Avenue,  
 Eastcote, Pinner, Middlesex

Telephone: 01-866 3326



# PROGRAMS

```

3020 PRINT@683,"SURVIVAL CHANCE 0%";
3030 PRINT@747,"AIMING ABILITY"H"%";
3040 PRINT@811,"ROCKETS LAUNCHED"Z;
3050 PRINT@875,"MISSILES FIRED"Y;
3060 PRINT@939,"ROCKETS DESTROYED"X;
3070 PRINT@1003,"HITS ON STATION"W;
3080 FOR T= 0 TO 100:NEXT
3090 PRINT@905,"* WARROOM *";
3100 FOR T= 0 TO 100:NEXT
3110 N=N+1:IF N>6 THEN 3120 ELSE PRINT@905,"          "1:GOTO 3080
3120 PRINT@337,"NUCLEAR POWER STATION DESTROYED";
3130 PRINT@398,"ALL BUT YOU DEAD WITHIN 50 MILE RAD:US";
3140 FOR T= 0 TO 2000:NEXT
3150 E=H*S/100
3160 PRINT@561,"YOUR RATING ON THIS POSTING WAS"E"%";
3170 GOTO 3000
4000 REM POWER STATION SURVIVES
4003 PRINT@811,"ROCKETS LAUNCHED"Z;
4005 PRINT@747,"AIMING ABILITY"H"%";
4010 PRINT@683,"SURVIVAL CHANCE 100%";
4020 PRINT@811,"ROCKETS LAUNCHED"Z;
4030 PRINT@747,"AIMING ABILITY"H"%";
4040 PRINT@464,"YOU SURVIVED THE ATTACK-CONGRATULATIONS";
4050 GOTO 3140
9000 REM COMMANDERS RATINGS AND PROSPECTS
9010 CC=PEEK(30037):PC=PEEK(30038):CH=PEEK(30035):PN=PEEK(30036)
9020 EE=30000+(PC*10)+CC:POKE EE,F
9030 IF CC=CH AND FC=PN THEN 9500
9040 IF CC=CH THEN FC=PC+1
9045 IF CC=CH THEN CC=0
9050 CC=CC+1
9060 GOTO 220
9500 PRINT@561,"YOUR RATING ON THIS POSTING WAS"E"%";
9510 PRINT@649,"PRESS 'R' FOR OVERALL RATINGS";
9520 PRINT@714,"AND COMMANDERS' PROSPECTS";
9525 A$=INKEY$:IF A$<>"R" THEN 9525
9530 CLS:PRINT:PRINT:PRINT:PRINT:PRINT
9540 PRINT TAB(24)"RATING"TAB(46)"PROSPECTS"
9550 FOR ZZ=1 TO CH
9560 R1=30010+ZZ:R2=30020+ZZ:R3=30030+ZZ
9570 E(ZZ)=(PEEK(R1)+PEEK(R2)+PEEK(R3))/PN
9580 IF E(ZZ)<101 THEN F$="PROMOTION AND KNIGHTHOOD"
9590 IF E(ZZ)<91 THEN F$="PROMOTION AND DECORATION"
9600 IF E(ZZ)<81 THEN F$="DECORATION FOR VALOUR"
9610 IF E(ZZ)<71 THEN F$="MENTIONED IN DISPATCHES"
9620 IF E(ZZ)<61 THEN F$="TO BE CONGRATULATED"
9630 IF E(ZZ)<51 THEN F$="PUT IN COMMAND OF NAIFI"
9640 IF E(ZZ)<41 THEN F$="TO BE DEMOTED"
9650 IF E(ZZ)<31 THEN F$="REDUCED TO THE RANKS"
9660 IF E(ZZ)<21 THEN F$="TO BE CASHIERED"
9670 IF E(ZZ)<11 THEN F$="TO BE SHOT IMMEDIATELY"
9680 PRINT"COMMANDER NO."ZZ TAB(24)E(ZZ)%" TAB(39)F$
9690 NEXT ZZ
9700 PRINT:PRINT:PRINT
9710 PRINT"PRESS 'N' FOR NEW CAMPAIGN"
9720 A$=INKEY$:IF A$="" THEN 9720
9730 IF A$="N" THEN RUN 150 ELSE END
    
```

# TRS-80 Dropout

by Simon Goodwin

This is a neat version of the popular  
 Breakout game.

```

50 GOTO 400 ' INITIALISE DISPLAY - MAIN PROGRAM IS AT START
   TO IMPROVE THE SPEED OF EXECUTION
100 A$=INKEY$: IF A$="" OR A$="1" OR A$="S" THEN 110
   ELSE A$=ASC(A$)-53
110 X=X+H: IF X>H(1 OR X+H)125 THEN 150
120 RESET(XL,YL): Y=Y+V: IF Y>45 OR Y<4 THEN 250
   ELSE IF POINT(X,Y) THEN 200
130 SET(X,Y): FOR XL=0 TO SP: NEXT XL: YL=Y: GOTO 100
140 REM ***** BALL CAUGHT AT EDGE OF SCREEN
150 X=ABS(X): PRINT @472," DIRECTION?": : RESET(XL,YL):
   SET(X,Y)
160 RESET(X,Y): A$=INKEY$: SET(X,Y): IF A$="" THEN 160
170 IF A$="U" THEN V=-1 ELSE IF A$="D" THEN V=1 ELSE 150
180 PRINT @472," ANGLE?": : SET(X,Y)
185 RESET(X,Y): A$=INKEY$: SET(X,Y): IF A$="" OR
   A$="1" OR A$="S" THEN 185
   ELSE H=ASC(A$)-53
190 IF H>X)127 OR H>X(2 THEN 185 ELSE XL=X: YL=Y:
   PRINT @472,"          " : S=(S+10)*(S-10): GOTO 110
199 REM ***** HIT SOMETHING, DO AN EXPLOSION
200 V=SGN(V)*-1:XL=X/2-1+INT(Y/3-1+(V=1))*64-1:
   PRINT @XL,"(+)": : GOSUB 210: PRINT @XL,"(*)": :
   GOSUB 210: PRINT @XL," " : S=S+1: PRINT @S,S:
   GOTO 100
210 IF SD THEN FOR YL=0 TO 4: OUT 255,4: OUT 255,8: NEXT:
   ELSE FOR YL=0 TO 50: NEXT
220 RETURN
249 REM ***** COUNT YOUR BALLS
250 B=B-1: PRINT @58,B: IF B(1 THEN 300 ELSE 550
299 REM ***** END OF GAME
300 PRINT @467,"GAME OVER - YOU SCORED":S": :
   FOR YL=1 TO 300: NEXT YL:
   PRINT @467,"HIT 'SPACE' TO PLAY AGAIN":
305 FOR YL=0 TO 500: NEXT YL
310 A$=INKEY$: IF A$="" THEN FOR YL=1 TO 200: NEXT YL:
   GOTO 300
320 IF A$="" THEN 470 ELSE 620
399 REM ***** INITIALISE THE PLAYER
400 CLS: DEFINT A-Z
405 PRINT TAB(18)"* * * D R O P O U T * * *": PRINT:
   PRINT"PRESS THE NUMBER KEYS TO KEEP THE 6 BALLS BOUNCING BETWEEN THE": PRI
   NT"VANISHING LINES ACROSS THE SCREEN FOR AS LONG AS POSSIBLE."
410 PRINT TAB(8): "1 TO MOVE FULL LEFT"
    
```





## SUPERBOARD II

STILL the best value in Home Computers. Just compare the features:

- 8K floating point BASIC in ROM
- Full ASC11 keyboard
- Standard cassette/TV interface
- RS232 printer interface
- 4K user RAM
- Expandable to 32K and dual mini-floppy
- Full range of OHIO Computers carried.

AVAILABLE NOW FROM:

C.T.S.  
31/33 Church Street  
Littleborough  
Lancs OL15 8DA

PLEASE RING OR WRITE FOR LATEST PRICES.

TEL: LITTLEBOROUGH (0706) 74342 or 79332 ANYTIME

## SPECIALS FOR PET

- |                                 |     |
|---------------------------------|-----|
| PROGRAMMER'S TOOLKIT            | £39 |
| LIGHT PEN (+ SOFTWARE)          | £25 |
| WORD PROCESSOR (M/CODE)         | £35 |
| MUSIC SYSTEM COMPLETE           | £37 |
| ADVENTURES 1 & 2 £ 7            |     |
| (ALL & VAT BUT INCL. POSTAGE)   |     |
| Send for details — state model. |     |



MICROCASE "turns a board into a real computer"

NASCOM 1 & 2  
COMPUKIT  
SUPERBOARD  
ALSO UN-CUT KEYBOARD MODEL

Direct from us or from your dealer — but make sure you see a GENUINE MICROCASE!  
About £30

## Simple Software Ltd

15 HAVELOCK ROAD  
BRIGHTON SUSSEX



## VETS FOR PETS

Anita Electronic Services (London) Ltd. are specialists in the repair and service of Commodore Pets.

We offer a fast on-site service, or alternatively repairs can be carried out at our workshops should you wish to bring in your Pet.

Pet maintenance contracts are available at very competitive prices. Trade inquiries welcomed.

For further information, tel or write to:

John Meade  
Anita Electronic Services  
15 Clerkenwell Close, London EC1  
01-253 2444

We also specialise in the repair of all makes of office equipment.

## PROGRAMS

```

700 PRINTP$:"GIANT: T"G$:PRINT"NDWARF: T"D$:PRINT"NDMOVES= 0 "
710 PRINTP$TAB(15)"YOUR MOVE: N":PRINTTAB(15)"WHICH DWARF?
720 GOSUB1430:IFRE=1THEN1700
730 P=PP:IFZ=0ORPP=17THENGOSUB1630:GOTO720
740 Z=0:U=LEN(DW$(P)):FORA=1TOU:J=ASC(MID$(DW$(P),A,1))-64
750 IFD(1)=JORD(2)=JORD(3)=JORD(4)=JORD(5)=JORD(6)=Z+1
760 NEXT:IFZ=0THENGOSUB1630:GOTO720
770 PRINT"J"TAB(28)A$:PRINT"X"TAB(18)"WHERE TO?
780 GOSUB1430:IFRE=1THEN1700
790 M=PP:IFZ=(GI=M)0THENGOSUB1630:GOTO780
800 Z=0:FORA=1TOLEN(DW$(P)):Z=Z-(M=ASC(MID$(DW$(P),A,1))-64)
810 NEXT:IFZ=0THENGOSUB1630:GOTO780
820 PRINT"J"TAB(28)A$:M$:D$:GOSUB1510
830 FORA=1TO3:IFD(A)=FTHEND(A)=M
840 NEXT:MM=MM+1:PRINTP$:"00000000"TAB(6)MM
850 Z=0:IFGI=17THENFORPP=14TO16:GOSUB1500:NEXT:IFZ=0THEN1690
860 IFMM<25THEN890
870 GOSUB1570:GOSUB1590
880 PRINTTAB(15)"-20 MOVES GONE" GOTO1700
890 Z=0:PP=17:GOSUB1500:IFZ=0THEN940
900 R=0:FORB=1TOLEN(GG$(GI)):
910 PP=ASC(MID$(GG$(GI),B,1))-64:Z=0:GOSUB1500
920 IFZ=0ANDR=0THENM=PP:R=1
930 NEXT:GOTO1390
940 SH=0:FORA=1TO3:K=99:FORB=1TO3
950 IFD(B)0KTHENK=D(B):N=B
960 NEXT:L(A)=K:D(N)=99:NEXT:GG=GI:GOSUB1630
970 IFD(3)=10ANDD(2)=9ANDD(1)=8ANDGI=12THENM=14+FNAC(2,2):GOTO1390
980 IFD(3)=120RD(2)<11THEN1010
990 IFD(2)=3ANDD(1)=2ANDGI=8THENM=6:GOTO1390
1000 IFD(2)=6ANDD(1)=5AND(GI=90ORGI=12)THENM=10:GOTO1390
1010 IFD(3)<120RD(2)<110PD(1)>70RD(1)=60R(GI)>15ANDGI>17:THEN1030
1020 M=(D(1)-7)*(D(1)-32)-(D(1)-6)*15:GOTO1390
1030 IFD(3)<110RD(2)=12)AND(GI=10ORGI=12)THEN1070
1040 SH=2:FORA=1TO3:VR=D(A):GOSUB1540:Z=0:VR
1050 NEXT:VR=GI:GOSUB1540:GI=VR:IFSH=2THEN1080
1060 GOSUB1600:GI=GG:GOTO900
1070 IFD(2)=11THEN1040
1080 FORA=1TO3:IFD(A)=12THEND(A)=11
1090 NEXT:IFGI=12THENGI=11
1100 D=1:E=2:F=3:T=0:G=0
1110 IFD(1)=DANDD(2)=EANDD(3)=FTHEN1150
1120 T=T+8:F=F+1:IFK<11THEN1110
1130 E=E+1:F=F+1:IFK<10THEN1110
1140 D=D+1:E=E+1:F=F+1:GOTO1110
1150 G=0+1:IFG=DORGE=DORF=FTHEN1150
1160 T=T+1:IFG<6ITHEN1150
1170 N=INT(T/64):AC=64
1180 IF T/64<NTHENAC=T-64*N:N=N+1
1190 U$=MID$(M$(H),AC,1):M=0:IFU$<>"*":THEN1220
1200 GOSUB1580:GOSUB1590
1210 PRINTTAB(15)"I CAN'T MOVE!" GOTO1700
1220 IFU$<"*":THEN1270
1230 R=0:FORB=1TOLEN(GI$(GI)):
1240 PP=ASC(MID$(GI$(GI),B,1))-64
1250 Z=0:GOSUB1500:IFZ=0THENM=PP:R=R+1
1260 NEXT:M=MV(FNA(R)):GOTO1340
1270 IFU$="0":THENM=10:GOTO1340
1280 IFU$="7":THENM=11:GOTO1340
1290 IFU$<MID$(H,M+1,1)THENM=M+1:GOTO1290
1300 IFN<10THEN1340
1310 IFM<10THENR=INT(M/10):S=(M/10-R)*10:GOSUB1610:GOTO1330
1320 R=11-S=(M/10-INT(M/10))*10:GOSUB1610
1330 M=R:IFFN(2)=0THENM=S
1340 IFSH=2THENGOSUB1600:GI=GG:M=-D(1)*(M+6)-(M+1)*5:GOTO1380
1350 FORA=1TO3:IFD(A)=11THEND(A)=12
1360 NEXT:IFM=11THENM=12
1370 IFGI=11THENGI=12
1380 M=INT(M+.01):GOSUB1570:
PRINTP$TAB(15)"I MOVE "CHR$(GI-64) " - "CHR$(M+64)
1390 P=GI:GI=INT(M+.01):M$:GOSUB1510
1400 FORA=0TO1000:NEXT:IFM>1THENGOSUB1570:GOTO1700
1410 GOSUB1570:GOSUB1590
1420 PRINTTAB(15)"BY ESCAPING" GOTO1700
1430 A$="":POKE158,0
1440 GETA$:IFA$=""THEN1440
1450 IF(ASC(A$)<65ORASC(A$)>81)ANDA$<>"":THEN1440
1460 IFA$<"":THEN1490
1470 GOSUB1640:IFRE=1THENRETURN
1480 GOTO1430
1490 PP=ASC(A$)-64:Z=0
1500 FORA=1TO3:Z=Z-(D(A)=PP):NEXT:RETURN
1510 FORA=0TO2:PRINTK$(P)B$:GOSUB1530:PRINTK$(P)B$
1520 GOSUB1530:NEXT:PRINTK$(P)B$K$(M)W$:RETURN
1530 FORB=0TO200:NEXT:RETURN
1540 VR=VR-6:IFVR<0ORVR=1THENSH=1
1550 IFVR=0THENVR=1
1560 RETURN
1570 PRINTP$:"J":FORA=1TO6
1580 PRINTTAB(15)" " NEXT:RETURN
1590 PRINTP$TAB(15)"RI WIN!" RETURN
1600 FORA=1TO3:D(A)=L(A):NEXT:RETURN
1610 IFB=0THENS=10
1620 RETURN
1630 PRINT"J"TAB(28)"0":RETURN
1640 PRINTTAB(15)"SUBMIT?":A$=""
1650 GETA$:IFA$<"Y"ANDA$<"N"THEN1650
1660 IFA$="Y"THENPRINTTAB(23)A$:RE=1
1670 IFA$="N"THENPRINTTAB(15)"J"
1680 A$="":RETURN
1690 GOSUB1570:PRINTP$TAB(15)"YOU WIN
1700 PRINTTAB(15)"PLAY AGAIN?"A$=""POKE158,0
1710 GETA$:IFA$<"Y"ANDA$<"N"THEN1710
1720 IFA$="Y"THEN620
1730 PRINT"J"

```



Acorn Atom Roadrace by Stuart Johnson (YCW)

```

5 P.$12
10 IN."ROAD WIDTH 1 - 5 "G;IF G<1 OR G>5 GO.10
15 W=4+G;?#E1=0;C=#80D0;A=10;F.L=1 TO 15;P.;N.;J=0;S=0;M=30
20 F.R=1 TO 500;L=R.&2
30 A=A+L;IF A<1 A=1
35 IF A>22 A=22
40 F=C-32
50 A?#81E0=160;A? (#81E0+W)=160;P.'
51 ?F=32;IF ?#B001<>?#F;C=C-1;IF C<#80C2T.C=#80C2
52 IF ?#B002=151 OR ?#B002=135 C=C+1; IF C>#80DF;C=#80DF
53 IF ?C=160;S=S-10;M=20
55 ?C=8
57 F.T=1 TO M;WAIT;N.;IF M>1 M=M-1
60 S=S+(6-G)
65 IF S<0 S=0;GO.80
70 N.
80 P."SCORE: "S';F.T=1 TO 60;WAIT;N.
81 IF S>450*(6-G) AND J=0J=1;P."FREE";GO.20
85 P.$30,"GAME OVER"
100 END
    
```

**WP BENCHMARKS**

Continued from page 86

in a standard format: a left margin of ten characters, 60 characters per line, justified, with a top and bottom margin of six lines each, centered headings but with no fancy formatting such as different typefaces (if available) or page headings and page numbering. This will enable us to produce some realistic

printing speed figures. Printer manufacturers quote speeds which can mislead — they measure the printing speed when the print head is printing at full speed in the middle of a line and this differs considerably from the average printing speed over several pages of text; one dot matrix printer on the market claims a printing speed of 80 cps but in fact prints out text more slowly than a 45 cps daisywheel because it doesn't print bi-directionally and has a very slow carriage return action at the end of each line.

**HAM TV MICRO**

Continued from page 69

viewing Figure 6 at a distance and from an angle which will tend to restore the original 1:1 aspect ratio. This picture uses a definition of 64 x 64 as the printer cannot cope with 128 characters in a line. Table 1 shows the characters used to represent the 16 levels of grey.

Finally we come to the fourth application, storing an SSTV picture in memory and displaying it on the fast-scan VDU. Here we reach the stumbling block on which the computer almost falls down as it is necessary to extract data from computer memory and display it on the fast-scan screen at a rate of about three million pixels per second. As we store two pixels in one byte it makes it a bit easier but it still requires one byte to be moved in about 660 ns and this is rather fast for most micros as several instructions may be needed for each move. By using separate hardware and direct memory access the micro can be halted while the data is read and displayed, leaving the remainder of the fast-scan line and the



Fig 6

duration of the line sync pulse as the operational time for the micro to do its normal task. I intend to investigate this in the near future. The problem has previously been tackled from a purely hardware point of view, without micro-processors, and there are two basic designs already in use; one uses four parallel shift registers for the memory, each consisting of 16 1k registers placed in series. It is this design which has produced the fast-scan display shown in the accompanying photograph. The other design uses dynamic RAMs in a 4 x 4 array of 4k chips. It seems logical to increase the flexibility of such a design by incorporating a

**REFERENCES**

- 1 'SSTV pictures from your micro-computer', B Sanderson, *QST*, Oct 1978
- 2 'SSTV meets the SWTP 6800', C Abrams, *73 Mag*, June, Nov, & Dec 1978
- 3 'The microprocessor and SSTV', P Jessop, *QST* Jan 1980
- 4 'Display SSTV pictures on SSTV', C Abrams, *Ham Radio*, July 1979
- 5 'SSTV and the microprocessor', C Grant Dixon, *CQ-TV*, June 1980
- 6 'Computer SSTV', C Grant Dixon, *CQ-TV*, August 1980

**MICROMART**

**ADP USED TELETYPE ASR 33's**



V24 INTERFACES ARE STANDARD  
ALL UNITS CARRY 30 DAY  
RETURN-TO-DEPOT WARRANTY

£250 + VAT

(QUANTITY DISCOUNTS AVAILABLE)

Call or Write to Chris Turner  
ADP Network Services Ltd.  
179-193 Great Portland Street  
London W1. Tele: 01-637 1355

**GAMES FOR THE PET**

We believe we are the first to implement the following games on a microcomputer:  
**WORLD WAR III** . . . £5.00  
 Up to eight armies fight it out over a map of the World. A game of strategy, luck and downright nastiness. Excellent graphics.  
**MATHSTREK** . . . . . £5.00  
 Designed to teach manipulation of mathematical expressions. A mind bending game of strategy. Full graphics.  
 We have completely new versions of the following old favourites:  
**LUNAR MODULE** . . . £5.00  
 Can you get to the Moon and back to the space station? Any number of degrees of difficulty. Operates in real time mode with full graphics.  
**KLINGONS** . . . . . £5.00  
 Three dimensional space battle. Are you quick enough to dodge when they fire back?  
 All prices include VAT but add 25p for post and packing.  
 PI-LOK Systems Ltd, 313 Bury & Rochdale Old Road, Heywood, LANCs. OL10 4BG.

**STOKE on TRENT**

for  
**TUSCAN**  
 and  
**TANGERINE**  
 and  
**VIDEO GENIE + SOFTWARE**  
 and  
**BOOKS**

**MICRO-PRINT Ltd.,**  
 59, Church Street, Stoke on Trent.  
 (0782) 48348. Barclaycard and Access

**EX EQUIPMENT SALES:**  
 5 to 8 Channel Mechanical Paper Tape Readers made by Kode Ltd. £10.00 each. Carriage £1.50  
 5 to 8 Channel Paper Tape Punches made by Addo. £15.00 each. Carriage £3.00  
 Keyboards — Mechanical action with interlock, complete with smart case and control panel — not encoded £7.50 each, Carriage £3.50  
 Power Supplies — excellent stabilized power supplies made by Weir for Kode Limited. £10.00 each. Carriage £3.50.  
 Small Electronic Sub assembly Racks with cards containing variety of TTL circuits and BC107 transistors etc. £5.00 each. Carriage £1.50  
 7 track ½" Magnetic Tape handlers ex Honeywell equipment, ideal for HIFI enthusiasts or fast dump. £20.00 each. Carriage at cost or buyer collects. More details on request.  
 Technical details are available for all above items.  
 Write or call VALLDATA SERVICES, 26 High Street, Melksham, Wilts, Tel 0225-705957

# MICROMART

SEE THE VERY LATEST

## SHARP-PC3200

### MZ-80K

BUSINESS SYSTEM  
80K - £1720+VAT  
FULL SOFTWARE  
SUPPORT

NASCOM \* NORTH STAR  
PC1211 + PRINTER  
NOW IN STOCK!

BOOKS \* SOFTWARE \* GAMES  
PHONE CHRIS ROBINSON  
C.J.R. IPSWICH (0473) 50152

## MICROTEK

15 LOWER BROOK ST. IPSWICH LTD

### VIDEO GENIE



£344 VAT paid  
Everything included  
Fully tested and run, and with full  
cassette modification

TOM CROSSLEY  
B.Sc., M.I. Mech. E, Engineer  
Sutton Springs Wood, Chesterfield,  
S44 5XF  
(0246) 850357 Ext. 10

A family of high level languages  
from RHA (Mihisystems) Ltd.  
ALGOL-60, the language from which  
PASCAL is derived. A mature imple-  
mentation with comprehensive operating  
system and machine code interfaces.  
SYSTEM-ALGOL, the subset of Algol-60  
in which all the compilers are written.  
Compiled code is shorter, execution  
faster.

Z80 based CP/M systems including TRS80  
RML Algol-60, includes the option of 32  
bit integers instead of floating point.  
About 7 times faster than TRS80 level II  
BASIC, speed comparable with Micro-  
soft Fortran. Document £10, system  
£99+VAT. System-Algol £50+VAT, free  
leaflet.

PDP11 with RT-11, RSTS, RSX or IAS and  
PDP8 with OS/8 or stand alone

Complete package including both  
compilers in machine readable source  
form £250+VAT. Documents only £10.

The author of the compilers is available as  
a consultant.  
83 Gidley Way, Horspath, Oxford OX9 1TQ  
(08677) 3625)

## COMPUTERCLUB

FREE details of independent  
advice and experience as well as  
discounts on a wide range of  
computer hardware, software,  
suppliers, etc.

Send large SAE to Dept PCW,  
COMPUTERCLUB, 42 Great  
Windmill Street, London  
W1V 7PA

microprocessor.

In the examples given above, I used a Triton computer, modified by adding I/O ports, and all the programs have been written in assembler language — programs written in Basic do not run fast enough for most applications. The Triton uses an 8080 which is, perhaps,

not so flexible as a Z80 for bit manipulation but has proved very satisfactory for SSTV use. Essentially, a computer is a controller and this article was written to draw attention to the fact that there is more to computers than using them for games, bank balance programs or running a business.

YCW listing continued from page 119

```
44N.  
46R.  
48wIFH=2;GOS.u;IFH>8000;R.  
50IFH=3;H=%D;H=(H+3)&3;%D=H;R.  
52IFH=1;H=%D;H=(H+1)&3;%D=H;R.  
54IF%D=0;%B=%B+1  
56IF%D=1;%A=%A-1  
58IF%D=2;%B=%B-1  
60IF%D=3;%A=%A+1  
62R.  
64d  
66F.B=0TO Y;MOVE3.(B*15+3)  
68PLOT1.(X*15),0;N.  
70F.A=0TO X;MOVE(A*15+3),3  
72PLOT1,0.(Y*15);N.  
74F.A=1TO (X*Y);M?A=0  
76N.;R.  
78t  
80A=A.R.%(X)+1;B=A.R.%(Y)+1  
82GOS.J;IFM?Z=0;G.t  
83IFM?Z>100;G.t  
84GOS.s;F.D=0TO5000;N.;R.  
86u  
88A=%A;B=%B;GOS.J  
90IF%D=0;IFM?Z&8=0;G.n  
92IF%D=1;IFM?Z&1=0;G.n  
94IF%D=2;IFM?Z&2=0;G.n  
96IF%D=3;IFM?Z&4=0;G.n  
98R.  
100nH=9000;P.#12;CLEAR0  
102P."YOU HAVE JUST WALKED INTO THE""WALL."  
104P."MEDICAL TREATMENT IS NOT""AVAILABLE";F.N=0TO9999;N.;R.  
106c  
108IFX<4;X=4  
110IFY<4;Y=4  
112IFY>12;Y=12  
114IFX>16;X=16  
116R.  
118j  
120Z=A+(B-1)*X  
122R.  
124b  
126A=A.R.%(X)+1;B=A.R.%(Y)+1  
130B=Y*3/4  
134GOS.J;M?Z=M?Z+128  
135s  
136GOS.1;MOVEC.D;PLOT1,15,15;PLOT0,0,-15;PLOT1,-15,15  
138R.  
140P  
142CLEAR4  
144D=160;F=120  
146C=D*3/5;E=F*3/5  
148GOS.k  
150IFV=-1;R.  
152IFC=0;R.  
154IF%D=0;B=B+1  
156IF%D=1;A=A-1  
158IF%D=2;B=B-1  
160IF%D=3;A=A+1  
162G.146  
164i  
166C=A*15-12;D=B*15-12;R.  
168R.  
170k  
172GOS.J  
174V=M?Z&15  
176V=(V*17)  
179H=%D  
180%H=2^H+.1;H=%H  
182V=(V<#FF:(H-1)))/H  
184GOS.q  
186R.  
188q  
190I=128-D;L=128+D
```



- 192J=128-C;K=128+C
- 194R=96-F;Q=96+F
- 196N=96-E;O=96+E
- 198MOVEL,R
- 200IFM7Z>100;MOVEI,R;PLOT5,K,N;MOVEJ,N;PLOT5,L,R
- 202PLOT5,L,Q;PLOT5,K,O;PLOT5,K,N
- 204MOVEI,R
- 206PLOT5,I,Q;PLOT5,J,O;PLOT5,J,N
- 208IFV&1=0;MOVEI,Q;PLOT5,J,N;PLOT5,I,R;PLOT5,J,O
- 210IFV&4=0;MOVEK,O;PLOT5,L,R;PLOT5,K,N;PLOT5,L,Q
- 212IFV&1=1;MOVEJ,N;PLOT5,I,N;MOVEJ,O;PLOT5,I,O
- 214IFV&4=4;MOVEK,N;PLOT5,L,N;MOVEK,O;PLOT5,L,O
- 216IFV&8=0;MOVEJ,O;PLOT5,K,O;MOVEJ,N;PLOT5,K,N;V=-1
- 218O=C;F=E;R.
- 220R.
- 222IF%L=X;R.
- 224E=0;U=M7Z&15
- 226FIFU=15;R.
- 228P=A.R.%4;Q=3&(P+2)
- 230%V=2^P+.1;V=%V
- 232%W=2^Q+.1;W=%W
- 234GOS.J;GOS.1
- 236S=Z;T=M?S;E=0
- 238IFT>128;R.
- 240eIFP=0;A=A-1
- 242IFP=1;B=B-1
- 244IFP=2;A=A+1
- 246IFP=3;B=B+1
- 248IFE>15;U=UIV;G.f
- 250GOS.J;E=M7Z
- 252IFE>15;P=Q;G.e
- 254IFA=0 OR B=0 OR A=(X+1) OR B=(Y+1) T.R.
- 256T=T!V;M?S=T!16;%L=%L+1
- 258IFP=0;MOVEC,D;PLOT3,0,15
- 260IFP=2;MOVE(C+15),D;PLOT3,0,15
- 262IFP=3;MOVEC,(D+15);PLOT3,15,0
- 264IFP=1;MOVEC,D;PLOT3,15,0
- 266F=E!W;M7Z=F!16
- 268G.1
- 270m
- 272F.H=1TO(X\*2);%L=0
- 2749A=A.R.%X+1;B=A.R.%Y+1
- 276GOS.J
- 278IFM7Z=0;G.9
- 280GOS.1
- 282N.
- 284R.
- 290v
- 292H=7#B001
- 296IFH=253;H=1;R.
- 298IFH=247;H=2;R.
- 300IFH=251;H=3;R.
- 302G.292
- 400P."THIS PROGRAM SLOWLY DRAWS A MAZE"
- 410P."YOU MUST NAVIGATE"
- 420P." TO THE 'MIDDLE'(WHICH IS INDICATED BY A CROSS.)"
- 455P."YOU ARE FACING N,E,S OR W AND "
- 460P."YOUR POSITION IN THE MAZE IS SHOWN BY A "
- 462P."CROSS,WHICH APPEARS BRIEFLY,AFTER THE 2-D MAZE HAS "
- 463P." BEEN "
- 464P."DRAWN. IF YOU HAVE MEMORISED THE MAZE CORRECTLY "
- 466P."YOU SHOULD""SUCCEED""
- 470P."PRESS G TO MOVE FORWARD. PRESS 3 TO FACE LEFT"
- 480P." AND - (MINUS) TOFACE RIGHT.""
- 500R.

*Listing courtesy of D Ellerby*

## BLUDNERS

Just a couple from the February issue. *Capitalist Technology and the Working Class* is published by CSE Books, 55 Mount Pleasant, London WC1.

Line 200 of the ZX80 Space Invaders program should read:  
LET B-(256\*PEEK(16415)+  
PEEK(16414))/10. Line 390 of the same program was incorrectly numbered 340.

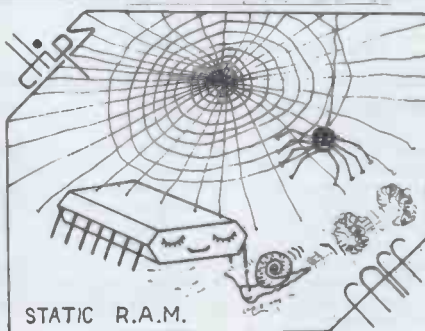

STATIC R.A.M.

## MICROMART

# sinclair ZX80 SOFTWARE

HANGMAN  
OTHELLO  
STARSHIP  
ADVENTURE  
HEXAPAWN

PONTOON  
LUNAR LAND  
AWARI  
SOLITAIRE  
DRAUGHTS

Send a large sae for the  
NEW CATALOGUE

CDS MICRO SYSTEMS  
10 Westfield Close, Tickhill  
Doncaster DN11 9LA  
Mail Order Only

### DELTA SYSTEMS LTD

Agents for DYNACOMP SOFTWARE

PET, APPLE II Plus, TRS 80 (Level II).

BRIDGE 2.0	£7.50 (TRS-80 only)		
Hearts 1.5	£6.25	Data	
Cribbage	£6.25	Smoother	£6.25
(TRS-80 Only)		Fourier	
Chessmaster	£8.30	Analyzer	£6.25
(TRS-80 Only)		Transfer	
Startrek 3.2	£4.00	Function	£8.30
Space Tilt	£4.50	Regression I & II	£8.30
(Apple only)		Black Hole	£6.25
Games Pack 1	£4.00	(Apple only)	
Games Pack 2	£4.00	Valdez	£6.25
Graphix	£5.50	Flight	
(TRS-80 Only)		Simulator	£6.25
Tidy	£4.50	Text Editor	£6.25

All programs on tape with  
superb documentation.

VAT extra. Postage 20p.

Send for full detailed list.

32 Finch Road, Douglas, Isle of Man.  
0624 27522

## ELCOMP

BOOKS AND SOFTWARE FOR  
OHIO SCIENTIFIC AND COMMODORE/PET

Order No.	Title	Price US \$
150	Care and Feeding of the Commodore PET	11.-
151	8K Microsoft BASIC Reference Manual	9.95
153	Microcomp. Application Notes	9.95
154	Complex Sound Generation	6.95
156	Small Business Programs in BASIC	14.90
157	The First Book of Ohio Scientific	7.95
158	The Second Book of OSI	7.95
160	The Fourth Book of OSI	9.95
	(40 BASIC Programs in BASIC for OSI)	
2004	Wordprocessor for OSI 8K	9.95
2005	Mailing List for OSI, 8K	9.95
3276	Editor/Assembler for PET 16/32K	69.-
2001	MONJANA Monitor ROM f. PET 16/32K	69.-
2002	Jana Monitor on Cassette	29.-
8095G	Blank Cassettes C-10 (Quantity 10)	4.99

Check, VISA or MC. CA add 6% sales tax. We also accept Eurocheck. Orders outside USA must add 15% shipping. Catalog \$1.-

ELCOMP Publishing, Inc., 3873-L Schaefer Ave.  
Chino, CA 91710 (714) 591-3130

To advertise in  
MICROMART  
Please ring Jacquie Hancock  
on 01-631 1682

# Discover the full professional power of Hewlett-Packard's personal computer.

Now you can extend the HP-85's power simply by plugging in high-performance printers, plotters and flexible disc systems.

## Power where you need it.

The HP-85 puts professional problem-solving power wherever you need it. There's a video display with high resolution and editing capability. A whisper-quiet thermal printer for hard copies of display graphics and alphanumerics. A magnetic tape unit with up to 217 K of storage per cartridge. And a complete keyboard, including eight keys you can define yourself. Powerful, easy-to-use features, thanks to HP's extended BASIC programming language.

## Decide the peripherals you need.

HP's Interface Bus (HP-IB/IEEE-488) lets you add up to 14 peripherals or instruments. No need to write special operating programs - HP's peripheral ROMs do it for you.

New HP enhancement ROMs and modules give you access to 80 K bytes of operating system, without significantly reducing user memory. The HP 2631B printer means high-speed, high-quality printing. And the HP 7225 Graphics Plotter gives you high-resolution, publication-quality graphics on paper or film.

For extra memory storage, use the HP 82900 series of 5 1/4" flexible disc drives. Each drive gives you about 270 K bytes of formatted storage on double-sided, double-density discs. The operating system is in the Mass Storage ROM, leaving the HP-85 main memory free.

Behind the HP-85 computing system is the strength of Hewlett-Packard. Continuous commitment to quality. One-source service and support.



For more details or a demonstration, contact your nearest HP Dealer shown below.



**HEWLETT  
PACKARD**

Contact your nearest dealer for a demonstration. Aberdeen Tyseal Typewriter Services, Tel: 29019; Belfast Cardiac Services, Tel: 625566; Birmingham Anglo American Computing, Tel: Coleshill 65396; Taylor Wilson Systems, Tel: Knowle 6192; Bournemouth South Coast Business Machines, Tel: Wimborne 893040; Brighton Office Machinery Engineering, Tel: 689682; Bristol Decimal Business Machines, Tel: 294591; Cambridge Cambridge Computer Store, Tel: 65334; Chelmsford Automatic & Electronic Calculators, Tel: 69529; Dublin Abacus Systems, Tel: 711966; Edinburgh Business & Electronic Machines, Tel: 226 4294; Holdene, Tel: 668 2727; Glasgow Robox, Tel: 221 5401; Leeds Holdene, Tel: 459459; Leicester Sumlock Services, Tel: 29673; Liverpool Rockliff Brothers, Tel: 521 5830; London Automatic & Electronic Calculators, Tel: 247 1886; Euro Calc, Tel: 739 6484, 636 8161, 405 3113; Sumlock-Bondain, Tel: 250 0505, 626 0487; The Xerox Store, Tel: 629 0694; Manchester Automated Business Equipment, Tel: 432 0708; Holdene, Tel: Wilmslow 529486; Newcastle Thos Hill Group, Tel: 739261; Newport Micromedia Systems Ltd, Tel: 59276; Reading CSE Computers, Tel: 61492; Sintrom Electronics, Tel: 85464; Royston (Herts) Electroplan, Tel: 41171; Southampton South Coast Business Machines, Tel: 22958; Sunderland Thos Hill Group, Tel: 42447; Tunbridge Wells DJ Herriott, Tel: 22443/4; Wallingford Midas Advisory Services, Tel: 36773; Watford Automatic & Electronic Calculators, Tel: 31571; Woking Petalect Electronic Services Ltd, Tel: 69032; Worthing Office Machinery Engineering, Tel: 207292; Channel Islands: (Guernsey) Professional Business Systems, Tel: 26011, (Jersey) Professional Business Systems, Tel: 75611.



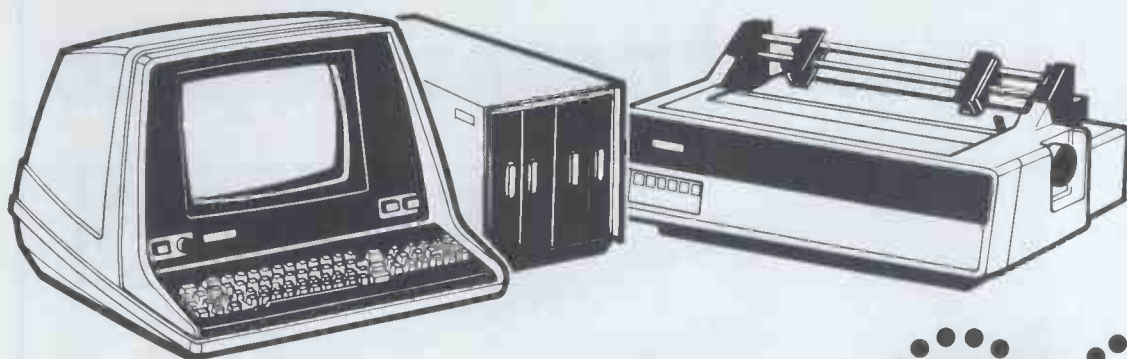

# Computer Hardware at Cash & Carry Prices.

## SHARP EQUIPMENT

Model	User Ram	exc.VAT	inc.VAT
Sharp MZ80K	20K RAM	<b>375</b>	431.25
Sharp MZ80K	36K RAM	<b>420</b>	483.00
Sharp MZ80K	48K RAM	<b>460</b>	529.00
Sharp MZ80FD	Floppy Disk	<b>576</b>	662.40
Sharp MZ80P	Printer	<b>372</b>	427.80
Sharp MZ80I/O	Input/Output Unit	<b>87</b>	100.05

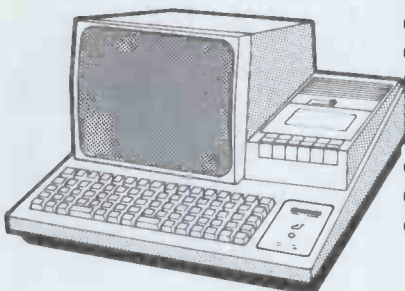

FREE LEDGER & STOCK CONTROL PROGRAMME WITH EVERY COMPLETE SHARP SYSTEM, i.e. 48K Sharp, Twin Floppy Disk, Printer and I/O Unit

## COMMODORE EQUIPMENT

Model	User Ram	exc.VAT	inc.VAT
3008 (4008)	40 Col. PET 8K Mem.	<b>378</b>	434.70
3016 (4016)	40 Col. PET 16K Mem.	<b>462</b>	531.30
3032 (4032)	40 Col. PET 32K Mem.	<b>585</b>	672.75
8032	80 Col. PET 32K Mem.	<b>755</b>	868.25
3040 (4040)	347K Disk	<b>585</b>	672.75
8050	1M Byte Disk	<b>755</b>	868.25
4022	Printer	<b>357</b>	410.55
8024	Printer	<b>975</b>	1121.25
C2N	Cassette	<b>47</b>	54.05

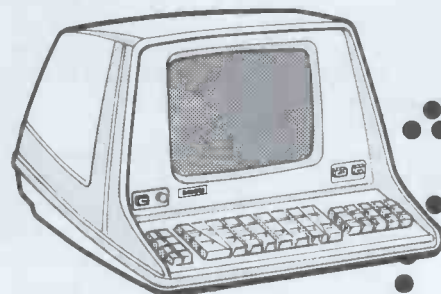
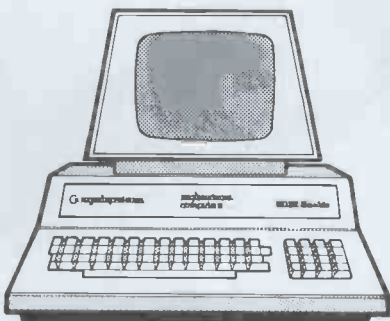

Every machine sold by Computer Supermarket is fully tested before despatch and is absolutely complete with instruction manual and tape, including free 13 amp plug fitted on mains lead.

All goods sold with full manufacturer's warranty and subject to conditions of sale. Copy available on request. All machines sold are full U.K. Standard.

All prices exclude VAT and delivery. Delivery anywhere in U.K. an additional £12.50 plus VAT.

## COMPUTER SUPERMARKET

3rd Floor  
Douglas House  
Queens Square  
Corby Northamptonshire  
Telephone (05366) 62571  
Telex COMPSU 341543/4



# THE INTELLIGENT PLOTTER....

## .... at a sensible price

**£892-50**

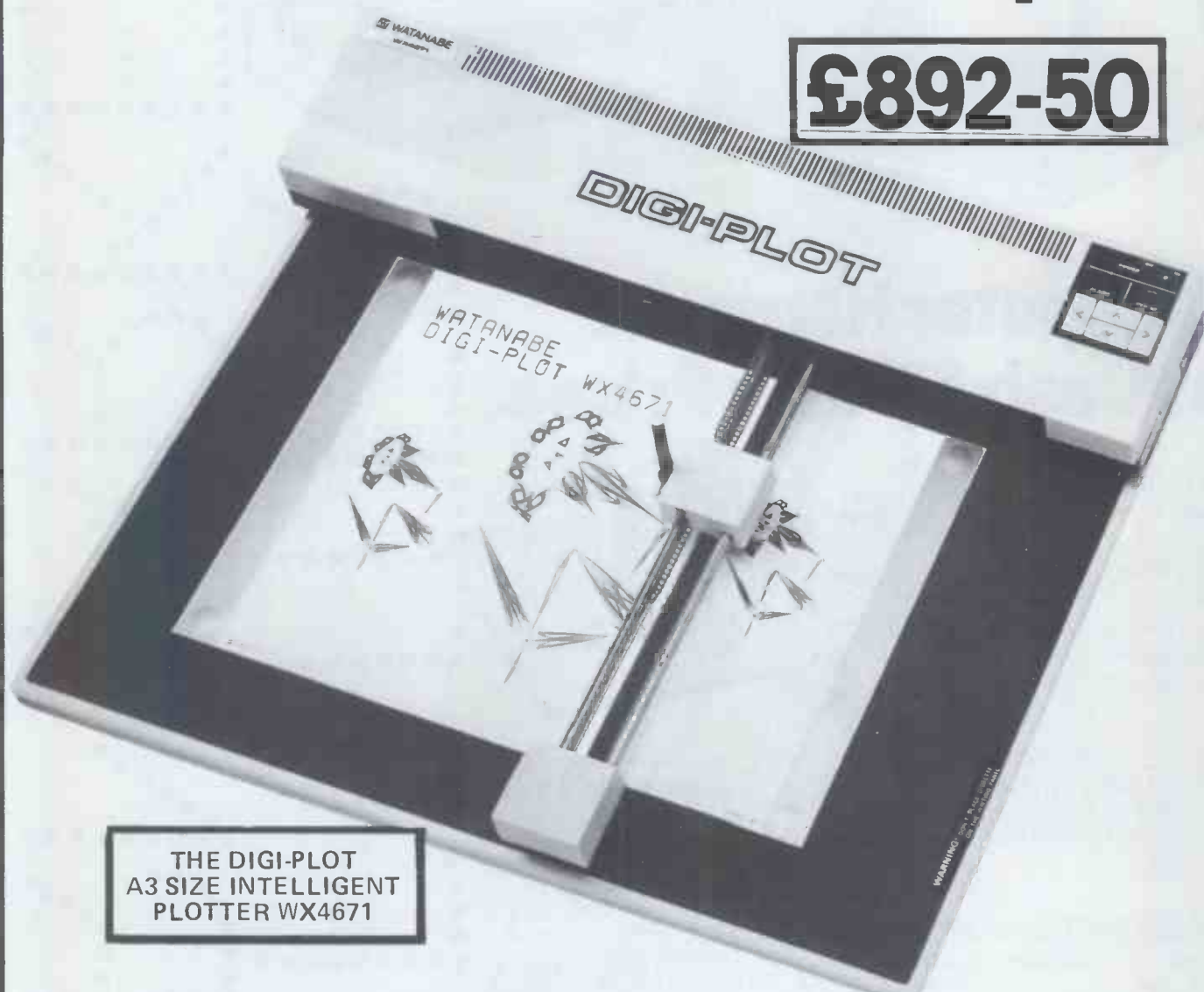

**THE DIGI-PLOT  
A3 SIZE INTELLIGENT  
PLOTTER WX4671**

The new Watanabe 'Digi-plot' intelligent X-Y plotter has many features you would expect to find on a plotter costing at least £1000 more, a built in character generator eliminates the need for the user to program graphic elements or alphanumeric characters. The characters can be upper or lower case, any of 16 sizes and rotated to four orientations, other functions include axes and broken line drawing.

The interface is Parallel 7-bit ASC11. With RS232 and 1EEE offered as options.

**AS SOLE U.K. IMPORTERS WE OFFER AN  
EXCELLENT AFTER SALES SERVICE.**

### SPECIFICATIONS

Plotting area	: 360mm x 260mm
Maximum plotting speed	: 50mm/sec (axially)
Programmable step size	: 0.1mm (internal interpolation in 0.05mm steps)
Distance accuracy	: Within 1%
Repetition accuracy	: Within 0.3mm
Pen type	: Hard fiber-tip (max. weight 7g)
Power supply	: 100, 110, 120, 200, 220, 230, 240 VAC ±10% (50/60Hz)
Power consumption	: 70 VA max.
Operating temperature	: 5°C ~ 35°C
Relative humidity	: 35% ~ 75%
Recording paper	: Max. size 420mm x 300mm (A3 size)
External dimensions	: 600 (W) x 520 (D) x 95 (H)mm
Weight	: Approx. 13kg

**ENVIRONMENTAL EQUIPMENTS (NORTHERN) & TD  
'ENVIRON HOUSE' 64 WELSH ROW, NANTWICH, CHESHIRE CW5 5ES  
HEAD OFFICE TEL (0270) 65115. SOUTHERN RECORDER SALES (0342) 311225**



# EXPLORER-85 COMPLETE BUSINESS SYSTEM AT A FANTASTIC PRICE

**64K COMPUTER — VDU —  
TWO 8" DRIVES —  
PRINTER — CP/M 2.2 —  
EXTENDED MBASIC**



**£2900.00**

*All you need to run your business We can supply software to suit your particular requirements*

## EXPLORER-85 COMPUTER Kits Start at £85

## 8085A cpu — S100 Based System Designed for maximum Flexibility

PROBABLY THE MOST EXPANDABLE KIT ON THE MARKET TODAY  
A COMPUTER FOR YOUR REQUIREMENTS TODAY AND TOMORROW BE IT BEGINNERS KIT:  
OEM CONTROLLER: OR FULL DISC DRIVE SYSTEMS  
EXPLORER-85 NOT THE CHEAPEST JUST THE BEST

8085A cpu — S100 slots (expandable to 6) — Powerful 2k Monitor — 4K RAM (expandable to 64K) —  
8k Microsoft Basic — Speed 3.1MHz — 4, 8bit I/O Ports — 1, 6bit Port — 14bit Binary counter — All  
programmable — Stand alone Keyboard Terminal — 64/32 char's 16 lines — upper & lower case — Full cursor  
control — Power supply unit — NO EXTRAS NEEDED

4K system complet kit ..... £327.00  
16K system complet kit ..... £410.00

Limited Budget? You can purchase your Explorer-85 in sub-kits starting from £85 for Level 'A' (Mother Board)

### EXPAND YOUR SYSTEM WITH 8" DRIVES

8" Control Data Corp Professional Drive  
\* LSI Controller \* Write protect \* Single or Double density \* Capacity 400K Bytes  
(SD) 800K Bytes (DD) unformatted \* Access time 25ns. Price £350  
DISC CONTROLLER I/O BOARD  
Controls up to 4 Drives \* 1771 ALSI (SD) floppy disc controller \* On board  
data separator (IBM compatible) \* 2716 PROM socket included for use in custom  
applications \* On board crystal controlled \* On board I/O baud rate \* Two serial  
I/O ports \* Autoboot to disc system when system reset \* Generators to 9600 baud  
\* Double sided PC board (glass epoxy). Price £170  
DISC DRIVE CABINET WITH POWER SUPPLY  
De luxe steel cabinet to house single drive with power supply unit to ensure  
maximum reliability and stability. Price £79  
DRIVE CABLE SET UP FOR TWO DRIVES Price £19.00

### 64K 'JAWS' S100 DYNAMIC RAM CARD

We offer you ... Hidden refresh ... fast performance ...  
lower power consumption ... latched data outputs ...  
200ns 4116 RAM's ... on board crystal ... 8K bank  
selectable ... fully socketed ... solder mask on both side  
of the board. Kits W/T

16K	£149	£169	
32K	194	214	16K upgrade kits £45
48K	239	259	
64K	284	304	

SOFTWARE — CP/M 1.4 £75 — CP/M 2.2 £98.00  
Microsoft extended MBasic £155  
Software tailored to special requirements

### 10" MONITOR



IDEAL FOR APPLE NASCOM U.K. 101, ETC. **£79.95**

- Designed for monitoring computers, closed circuit TV and Video Tape Recorders
  - 10" black and white video monitor
  - 10 MHz band width
  - High-quality metallic cabinet
  - Dimensions: 9" x 9" x 9 1/4"
- Trade Enquiries Welcome

## THE ELF11

IF YOU REALLY WANT TO  
UNDERSTAND COMPUTERS THEN

### ELF11 for YOU



Basic Specification  
RCA COSMAC 1802 cpu — 1/2K RAM expandable to 64K — DAM —  
interrupt — 16 registers — Fully Decoded Hex Keypad — Dual 7 segment  
display — Crystal clock — Onboard regulation 1861 Graphic Chip — 5 slot  
expansion bus — Double sided plated through PC Board.

Basic KIT ONLY **£49.95**

ELF11 is Ideal for Beginners — Engineers — Industry —  
Scientific and Educational purposes  
You will LEARN to program in Machine Code and really  
understand computers, from there you can expand it to meet  
your requirements up to 64K RAM working in Basic level 111  
Suggested Starters Pack:— ELF11 kit + RF Modulator +  
T. Pitmans Short Course for £56.70

ELF EXPANSION. We carry a full range of expansion kits  
— HARDWARE — FIRMWARE — SOFTWARE — MANUALS  
Send for brochures  
NOW AVAILABLE — FULL BASIC LEVEL 111 + RPN Maths  
package COMING VERY SHORTLY — EPRON BURNER

## Oki Microline 80



small light quiet  
Malmx Printer  
Only £2 99  
40, 80 or 132 cols.  
6 or 8 lines per inch.  
96 ASC II + 64  
graphic character set  
with Centronics  
compatible interface RS232 optional extra

## Centronics 737



LETTER QUALITY  
PRINTER ONLY £399

- \* Dot Matrix: 7x9 \* Paper Handling: 3 way
- \* Pitch: 5, 10 or 16 characters per inch
- \* Speed: 80 characters per second proportional/50 characters per second monospaced
- \* Line length: 40, 80 or 132 characters.
- \* Standard interface: parallel

### SEND SAE FOR COMPREHENSIVE BROCHURE

Please add VAT to all prices. P&P extra: Please make cheques and postal orders payable to NEWTRONICS or phone your order quoting BARCLAYCARD, ACCESS number.

We are open for demonstrations and Sales, Monday-Saturday, 9.30 a.m.-6.30 p.m.  
Near Highgate Underground on main A1 into London.



# Newtronics

255 ARCHWAY ROAD, LONDON, N.6  
TEL: 01-348 3325

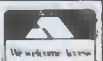

# SUMLOCK BONDAIN

makes the decisions easier

**NOW A CASIO PROGRAMMABLE  
FOR UNDER £20**

## CASIO *fx 180P*

£19.95 (inc. VAT)

Famous Casio Reliability

*Guaranteed 1 Year*

Complete with Batteries

Cover and Full Instruction Book.

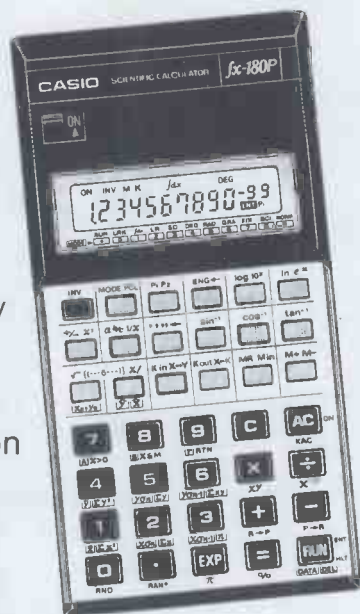

38 PROGRAM STEPS

55 SCIENTIFIC

FUNCTIONS

7 MEMORIES

18 PARENTHESES

TRUE ALGEBRAIC LOGIC

INTEGRATION

LINEAR REGRESSION

LOG, EXP, & POWER

REGRESSIONS

*fx 2700P* 50 Sci. Functions 38 Prog. Steps Notebook Size £19.95 (Inc. VAT)

*fx 3500P* 61 Sci. Functions 38 Prog. Steps Notebook Size £22.95 (Inc. VAT)

Same Capability as *fx180p* + Hyperbolics (6 Functions)

*fx 502P* 51 Sci. Functions 256 Prog. Steps 22 Registers £74.95 (Inc. VAT)

*fx 501P* 51 Sci. Functions 128 Prog. Steps 11 Registers £54.95 (Inc. VAT)

<i>fx 31-29fns-Green Display</i>	£12.95	<i>fx 120-40fns-Green Display</i>	£17.95	<i>fx 3200-43fns-LCD-10 digit</i>	£21.95
<i>fx 39-40fns-Green Display</i>	£15.95	<i>fx 310-50fns-LCD</i>	£17.95	<i>fx 6100-39fns-Clock,Stp.watch,Alarm</i>	£19.95
<i>fx 68-38fns-LCD Credit Card</i>	£19.95	<i>fx 330-38fns-LCD</i>	£15.95	<i>fx 7100-39fns-Cl.,Alm.,Stp.wch.,Cr.Cd.</i>	£24.95
<i>fx 81-30fns-LCD</i>	£12.95	<i>fx 510-50fns-LCD-10 digit</i>	£19.95	<i>fx 8100-46fns-Cl.,Calendar,Alm.,Stp.wch.</i>	£24.95
<i>fx 100 College-44fns-LCD</i>	£15.95	<i>fx 2600-43fns-LCD</i>	£19.95		

## SUMLOCK BONDAIN LTD.

263-269 CITY ROAD, LONDON EC1V 1JX

Tel: 01-250 0505 Telex 299844

and at Cannon Street Station, London EC4

All prices include VAT, p & p.  
24 Hour Ordering Service  
Barclaycard/Access accepted  
*Above offer applies UK only.*

WE STOCK THE ENTIRE RANGE OF **CASIO** CALCULATORS  
Request Full Competitive Price List





# MICRO BUSINESS CENTRE LTD.

1st FLOOR, LEWIS HOUSE, LINTHOUSE LANE, WEDNESFIELD, WOLVERHAMPTON.

Tel (0902) 725687

## NEW LOW LOW PRICES

On Apple hardware & software examples from our extensive range include:

- \* Visicalc ~~£125~~ our price £90
- \* Pascal Lang System ~~£299~~ our price £249
- \* Z80 Softcard ~~£225~~ our price £175
- \* New! double sided 3.2/3.3 DOS utility pack £35
- \* New! 8" double sided/double density 2.0 megabyte twin disk drive unit £1950.00
- \* 5¼ disks – box OF10 – 1st quality £19.95.
- \* Utilise both sides of your discs – gadget & simple instructions £9.95
- \* Complete business system inc. Visicalc + Printer £1749.00 or lease from £8.75 per week.

## \* FINEST QUALITY BUSINESS SOFTWARE \*

Word processing – payroll – sales, purchase, nominal ledgers – stock control – specialist programs – extensive games.

- \* SPECIAL OFFER – 4 great games on disk for £15.00

Send for our comprehensive catalogue.

Looking for a daisywheel printer???

The Olympia ESW 100 R.O. available at only £799.95

Access/Barclaycard: terms – please add 15% VAT on all prices.  
Leasing: mail order: add 75pp orders under £20: over £20 post free.

## MICROS MEMORIES TTL'S & INTERFACE DEVICES

Z80	£6.50	6800	£6.00	6502	£6.50
Z80A	£8.50	6802	£8.50	8080A	£4.50
8085A	£11.00	6809	£16.00	2650A	£16.00

LARGE RANGE OF PERIPHERAL DEVICES AVAILABLE.

### SPECIAL OFFERS

	1-24	25-99	100
2114L-450ns	£2.00	£1.80	£1.60
2708	£3.90	£3.60	£3.40
2716 (+5v)	£5.00	£4.50	£4.00
2732 (+5v)	£15.00	£12.00	£10.00
4116L-200ns	£2.00	£1.80	£1.60

Please add P&P 40p and VAT at 15%

## TECHNOMATIC LIMITED

Retail Shops:  
17 Burnley Road,  
London NW10

367 Edgware Rd., W2

Mail Order  
17 Burnley Road,  
London NW10  
Tel: 01-452 1500/  
450-6597  
Telex 922800



## You stand out in a crowd

Your business is not exactly the same as any other and neither are its problems. Any solutions are probably unique and must be tailored exactly for you.

You know your business better than anyone else and any system designed should use your knowledge. The micro-computer specialist should show you how to use the computer to meet your business requirements.

You should be able to get the micro-computer which best suits your business. It should be chosen after your requirements are specified.

You and your staff have a right to know all about YOUR system, including helping to program it if you want to. Training is your right – not an additional service.

If microcomputers cannot satisfy your business needs, you want to know – you don't want false promises.

67 Nova Road, Croydon, Surrey CR0 2TN.  
Telephone: 01-688 6013



# COMPUTECH for Apple

# COMPUTECH for **ITT**

Well proven software for business applications on the  
ITT 2020 and Apple microcomputers.

*Prices excluding V.A.T. for cash with order, F.O.B. London NW3*

PAYROLL	(300+ Employees, 100 Departments, hourly, weekly, monthly. Very powerful but easy to use).	£375
SALES LEDGER	(500+ Accounts, 100 Departments).	£295
PURCHASES LEDGER	(500+ Accounts, 100 Departments).	£295
GENERAL (OR NOMINAL) LEDGER	(1000 Accounts, 100 Analyses, multi-purpose package). Job costing etc.	£295
UTILITIES DISK 1	(Diskette patch, slot to slot copy, zap etc).	£20
APPLEWRITER	(Word Processing, see below for U/L case).	£42
VISICALC	(Financial Modelling, Costing, Analysis).	£125
CAI	(Converts Apple pictures for ITT display).	£10

*Over 600 packages in use, fully supported by us.*

## AND NOW HARDWARE!

**LOWER & UPPER CASE CHARACTER GENERATOR** £50  
Replaces character generator to display upper and lower case characters on screen, includes patches to work with Applewriter, supplies the missing link! Specify Apple or ITT.

**COMPUTECH DIPLOMAT H/S SERIAL INTERFACE** £80  
This card has been designed and built to the same professional standards that have resulted in the success of our software. The DIPLOMAT observes the proper "handshaking" protocol so that you can drive fast printers and send and receive data from other peripherals at high speeds without loss of data. Switch (& software) selectable baud rates to 19200 and many other options. Plug compatible with 'terminal' or 'modem' wired peripherals. Guaranteed.

**MICROLINE M80 PRINTER** £345  
This neat, reliable machine prints at 10 characters per inch, 80 characters on an 8 inch line, or 40 expanded characters, or 132 very readable characters, upper and lower case and graphics, 9 x 7 dot matrix, 6 or 8 lines per inch. Parallel interface is standard, serial optional. Both friction and sprocket feed are standard, tractor optional. We can also supply the parallel interface card for Apple System computers for £80 and a driver to enable both text and graphics to be used. Optional custom colour matching for Apple or ITT. Optional character sets. *Trade supplied at very generous discounts for modest quantities.*

**THE FABULOUS MICROMUX 8000** from £800  
This is a brand new product, an asynchronous serial multiplexor with up to 16 ports, any one of which may communicate with any other independently, like a 'telephone exchange' for data! Built in test function. Firmware may be customised for special applications. Available in multiples of 4 ports up to 16.

## COMPUTECH SYSTEMS

168, Finchley Road, London NW3 6HP. Tel: 01-794 0202

AGENTS THROUGHOUT THE UK AND OVERSEAS



**SC****NOW WITH MP/M**

# SIRTON COMPUTERS

76 Godstone Road, Kenley (Nr Croydon)

Surrey CR2 5AA

Tel: 01-668 0761/2

## MIDAS S100 SYSTEMS

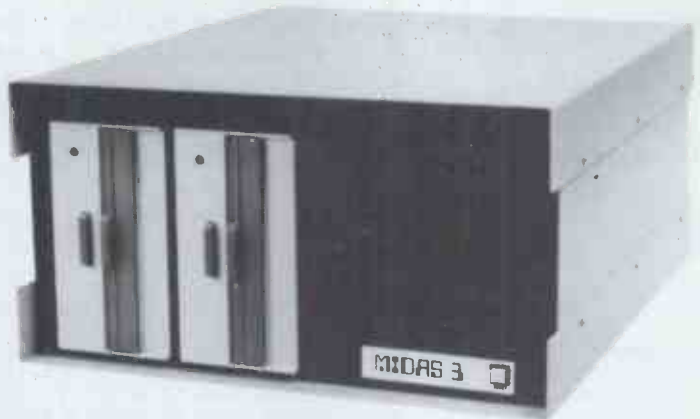

MIDAS 1 : From £750  
 MIDAS 2 : From £1580  
 MIDAS 3 : From £2150  
 MIDAS 4 : From £5900

ITHACA-DPS 1 : From £1075

- Our versatile Z80 Microcomputers are available as standard units or custom configured to your exact specification from a comprehensive range of stocked S100 boards.
- Disc storage capacity of the MIDAS 3 can be 2M Bytes, expandable to over 20M Bytes with a Winchester Hard Disc Unit in our MIDAS 4 range.
- MIDAS runs CP/M and MP/M is also available. Other Software includes M-BASIC, C-BASIC, FORTRAN, COBOL, CIS-COBOL, PASCAL and Word Processing.
- A MIDAS 3, with 64K RAM and 2M Bytes storage on two 8" drives with two Serial I/O Ports and CP/M 2 only £2835  
 Multi-User System (four users) – MIDAS 3 with four 48K blocks of RAM, 1 MByte disc storage on two 8" drives and four Serial I/O Ports, and CP/M 2 + MP/M – £3850.
- Printers, VDUs and other peripherals stocked to give complete package systems at keen prices.
- Business Packages include Accounts, Stock Control, Purchase Ledger etc etc.

Boards stocked from Ithaca, Godbout, SSM, S D Systems, Vector, Micromation Mullen, Mountain Hardware, Hi-Tech, Video Vector, Pickles & Trout, Central Data, Cromemco, Thinker Toys – Send for full Price List (many available in kit form).

### PROCESSOR

Z80 Starter Kit	£188
SBC100	£208
SBC200	£237
Z80 CPU's4 MHz	from £130

### EPROM

2708 EPROM (16K)	£60
2708/2716 Programmers from	£134

### VIDEO

16 lines, 32/64 ch	from £104
24 Lines, 84 ch	from £265

### DISC CONTROLLERS

Versafloppy S/D	£198
Doubler D/D	£280

### SOFTWARE

CP/M 1 & 2, MP/M, PL/1, C-BASIC 2, M-BASIC V5, XYBASIC, FORTRAN 80, COBOL 80, CIS-COBAL, PASCAL/Z, PASCAL (UCSD), PASCAL M/T, Forth, MAC, ZSID, Disassembler, Wordstar, Datastar, Magic Wand, Wordmaster, Supersort etc etc.

### MAINFRAMES

We are the sole UK Distributor for Integrand Mainframes and Disc Enclosures, available in nine models including Desk Top and Rack Mounting, with or without provision for Disc Drives. All units totally enclosed, painted on all external surfaces and complete with power supply etc.

### RAM

Dynamic RAM 16K – 64K	from £205
Static RAM 8K – 64K	from £95
Memory Manager	£52

### I/O

2S/4P prov 4K RAM/4K ROM	£169
2S/2P or 2S/4P or 3P/1S or 4S/2P	from £135
Analogue 8 or 12 bit	from £287
Optically isolated I/O	£114
IEEE 488 interface	£350

### MISCELLANEOUS

Real Time Clock	£180
High Dens Graph/8K RAM	£333
Hi-Tech Colour	£295
Motherboards – various from	£34
Extender Board/logic probe	£39
Maths Board AMD 9511	£330

WRITE OR PHONE FOR CATALOGUE PRICES EXCLUSIVE OF VAT

# IF YOU WANT YOUR COMPUTER TO COMMUNICATE YOU NEED A MODTECH MODEM

THE MODTECH M103 IS AN ORIGINATE ONLY MODEM COMPATIBLE WITH ENGLISH (CCITT) STANDARDS, DIRECT CONNECTION FOR SUPERIOR DATA RELIABILITY NOT FOUND IN ACOUSTIC COUPLERS. THE M103 PROVIDES IMMUNITY FROM ROOM NOISE AND MECHANICAL VIBRATIONS WHICH ARE COMMON PROBLEMS WITH ACOUSTIC COUPLING.

- \* HIGH DATA RELIABILITY USING VOICE GRADE LINES
- \* QUARTZ CRYSTAL ACCURACY AND STABILITY
- \* FULL DUPLEX ASYNCHRONOUS OPERATION (LOCAL COPY OPTIONAL)
- \* EIA RS232 TERMINAL INTERFACE
- \* 20MA TTY INTERFACE (OPTIONAL)
- \* RELIABLE DATA RATES UP TO 450 BITS PER SECOND
- \* COMPACT AND LIGHT WEIGHT FITS UNDER STANDARD TELEPHONE
- \* POWER AND CARRIER DETECT INDICATORS
- \* LINE CONNECT/DISCONNECT SWITCH
- \* AUTO LINE DISCONNECT WITH LOSS OF CARRIER

M103 Originate only ..... only £160.00 plus VAT  
 M103A Auto-answer ..... only £225.00 plus VAT

## LOW COST COMPUTER COMMUNICATIONS

NOW THAT FORUM-80 BULLETIN BOARDS ARE AT LAST BEING SET UP IN ENGLAND, 3-LINE COMPUTING HAVE DEVELOPED THE PCR-81 WHICH IS A RS232 BOX FOR USE WITH THE VIDEO GENIE 16K COMPUTER. THIS ENABLES THE GENIE TO COMMUNICATE WITH OTHER COMPUTERS OR FORUM-80 AND OTHER NETWORKING SYSTEMS AT LOW COST, ALSO IT CAN BE USED TO DRIVE A SERIAL PRINTER FROM THE 16K GENIE KEYBOARD. THE PCR-81 COMES COMPLETE WITH TERMINAL PROGRAM AND PRINTER PROGRAM. THE PCR-81 WILL ALSO BE AVAILABLE FROM LOWE ELECTRONICS OF MATLOCK AND VIDEO GENIE DEALERS. AT A VERY LOW PRICE OF 49.00 POUNDS INC VAT.

FOR MORE DETAILS CONTACT FREDERICK BROWN.

AVAILABLE ONLY FROM :-

**3-LINE computing**

36 CLOUGH ROAD HULL HU5 1QL Telephone: (0482) 445496  
 DEALER ENQUIRIES WELCOME

# LONDON SW1

Based in the heart of Westminster, Logic Box is well-positioned to supply all your microcomputer requirements. As specialists in Commodore PET and APPLE we provide a complete service to any company looking at microcomputer as a serious business tool and will be happy to supply:

- \* PET and APPLE hardware and peripherals
- \* a wide range of dot-matrix and letter quality printers
- \* packaged software for business planning, accounting, stock control, payroll, word processing and data management,
- \* customised software,
- \* operator training,
- \* full after sales and maintenance service.

If you are interested in any of the above please contact us for further details.

LOGIC BOX LTD  
 31 PALMER STREET  
 LONDON SW1  
 (near St James's Park underground)  
 Tel: 01-222 1122/5492

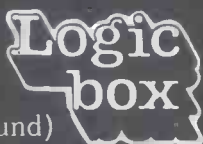

# WANTED

If you own a ZX80, Pet, TRS-80, Video Genie or UK101 then contact us. We will pay top rates for software for the above mentioned machines. Our areas of interest include games, tutors, utilities and business packages. If you enclose a large s.a.e. envelope we will return your cassette to you within 14 days of receipt together with an offer if we can make one. Please forward your programmer to

**OASIS SOFTWARE**

Lower North St Cheddar Somerset





# £1199!

## ITT 2020 SYSTEM

COMPRISING:-

- 48K COMPUTER
- DUAL DISK DRIVES
- 12" GREEN MONITOR
- PALSOFT & AUTO START ROMS

Equipment is brand new. Boxed & Guaranteed for 12 months.

Please send payment with order of £1393.85 (includes VAT & securicor delivery). Allow up to 28 days delivery.

**ELFTON LTD** ADVANCE CHAMBERS  
 SURTEES STREET  
 HARTLEPOOL  
 CLEVELAND  
 (0429) 61770

AUTHORISED APPLE, COMMODORE & ITT DEALERS

## DEANS Of Kensington Personal COMPUTER Centre

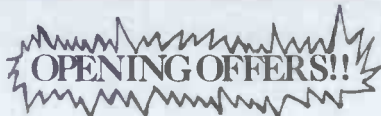

### APPLE

- 16K Video Output . . .P.O.A.
- Disc Drive w/o Controller . . . . .P.O.A.
- 16K Add on RAM . . .P.O.A.

### SHARP

- MZ 80K 48K RAM .£439.95
- PC 1211 Pocket computer . . . . .£79.95
- CE121 cassette Interface . . . . .£11.95

### TRS-80

- Level 14K RAM . . .£260.00
- Level II 16K CPU . .£345.00
- Expansion Interface 16K . . . . .P.O.A.
- TRS-80 Pocket computer 1.9K. . . £92.95

### GAMES SYSTEMS

- Atari . . . . .£84.95
- MOST Cartridges . . .£12.95
- Interton VC 4000 . . .£74.95
- Most Cartridges . . .£12.95

### TELEPHONES

- Freedom Phone . . .£125.00
- 500 ft Range compact Phone . . .£19.95
- GMTC A/Machine. .£126.00
- Record-A-Call . . . . .P.O.A.
- Sanyo. . . . .P.O.A.

Prices exclusive of carriage and VAT  
 Phone for your order 01-937 7896  
 Barclaycard & Access Accepted. Prices subject to change without prior notice

191 Kensington High Street, London W.8.  
 283 Edgware Road, London W.2. 01-723 4630

## Applesoftware from Leicester Computer Centre

VISICALC UTILITIES allows you to: « NEW!

- List out on your printer or monitor all the worksheet formulae
- Re-format the printout of your worksheets with variable column widths, additional text headings, dates and page control and numbering. £34.95 + VAT

## ASCII EXPRESS II

With this package your Apple can talk to just about anything that has dialup access, from another Apple II to mainframe systems! It features file oriented upload/download facilities, a built in line editor with full editing functions as well as support for your printer and keyboard macros in the terminal routine. Also included are support programs to help you convert Apple II programs, (Applesoft, Integer and binary) to their file form. Fast machine language "crunching" is used to compress program files to their minimum size to save online time. P.O.A.



THE CORRESPONDENT is sure to be one of the most versatile programs in your library! It can be used as:

- A Text Processor: Upper/lower case, 1-80 cols. (4-way scrolling). Text move/copy/insert/delete, tabbing, justify text, auto-centering and more!
  - A Database (with or without printer!) Extremely fast find routine and easy editing make it a natural for free-form data files. Create and fill out forms, access phone lists or index your magazines.
  - A Programming Utility: (printer or not). Examine, edit, transfer random or sequential text files. Create versatile exec. files. Even put bidirectional scrolling in your own programs!
- Use the Correspondent to print-out your Visicalc formula.  
 Apple disk £29.95 + VAT

### SUPER DISK COPY III

48K & DISK II required, APPLE II or APPLE II PLUS  
 SDC is a menu-driven programme that allows manipulation of all types of files under DOS 3.1, 3.2 and 3.3. SDC is the only disk utility available for the APPLE that combines these features: COPY single files (Integer, Applesoft, Binary, or Text), COPY DOS, COPY entire disk, UNDELETE deleted files, LOCK or UNLOCK files, PLOT of disk usage, and optional rearrangement of files so that they occupy contiguous sectors for improved access times, SDC supports the wildcard character "=" in file specifications. SDC makes the conversion to DOS 3.3 less painful (than MUFFIN) and also allows files to be transferred back to DOS 3.2 since both 13 and 16 sector disks can be assessed at the same time. £24.95 + VAT

## Apple-Doc By Roger Wagner

An Aid to the Development and Documentation of Applesoft Programs  
 This 3 program set is a must to anyone writing or using programs in Applesoft! It not only provides valuable info. on each of your programs, but allows you to change any element throughout the listing almost as easily as you would change a single line! With Apple-Doc you can produce a list of every variable in your program and the lines each is used on, each line called by a GOTO, GOSUB, etc., in fact, every occurrence of almost anything! You can rename variables, change constants and referenced line numbers or do local or global replacement editing on your listing. Apple-Doc is a must for the serious Applesoft programmer. Diskette complete with full documentation £24.95 + VAT



### PASCAL-FORTAN COMPATABLE

An exciting new addition to your Pascal library - enables you to create 3D graphics, viewable from any angle and distance. As easy to use as Turtlegraphics. Procedures include Ortho, Perspec, Rotate, View, Move to-3, View-from. Complete with comprehensive instructions. £49.95 + VAT

LEICESTER  
 computer centre limited

67 Regent Road, Leicester LE1 6YF. Tel: 0533 556268

apple computer  
 Sales and Service







# TEMPLEMAN SOFTWARE LIMITED



## ARE YOUR ACCOUNTS A PAIN IN THE NECK OR A SIGHT FOR SORE EYES

The answer is a new  
TOTAL ACCOUNTING CONTROL  
system for your business —  
at the touch of a button  
for less than £5,000!  
Take the first step to  
total BUSINESS CONTROL

Contact:- MYLES POLLOCK

25-26 Greenhill Street, Stratford Upon Avon  
Warwickshire CV37 8LR  
Telephone: Stratford Upon Avon (0789) 66237

SOFTWARE IS OUR MIDDLE  
NAME

### PAYROLL PROGRAMS FOR TANDY TRS-80

Don't buy standard payroll program and hope it will suit your requirements. We will build a tailor made program for up to 48 employees specifically for your Company.

Give us details of your payroll structure, ie, Hourly or Monthly pay, % overtime rates, pension plan, holiday pay etc.

Give us details of your equipment. Do you have a printer for payslips, or do you just require information on the V.D.U. screen? Are you using cassette or disc drives?

Minimum requirement 16K level 2.  
Price £275.00 + V.A.T.

PATCHWOOD LIMITED,  
3 Cockcrow Wood, St. Leonards-on-Sea, East  
Sussex, TN37 7HW.  
Tel. (0424) 752394.

**NEW**

### TRS 80 MODEL III



The Model III has arrived in the U.K.  
★ NEW FEATURES AVAILABLE ★

★ Upper and Lower Case characters (standard) ★ Real Time Clock ★ 500 or 1500 Baud Cassette ★ Parallel Printer Interface (standard) ★ Auto Repeat keys ★ Flashing Cursor ★ New Characters, Greek, Japanese Kana ★ Numeric Keypad ★ 16, 32 or 48K ★ Room for two D.D. Disc Drives & Interface ★ 12" VDU  
★ All in stylish cabinet.

16K **£649** INCLUSIVE

S.a.e. Enquiries. Delivery 4-6 weeks



**N.I.C.**



Unit 7, 61 Broad Lane, London N15 4DJ

Daytime 01-808 0377 Evenings 01-898 0726



# **apple**® ] [ **PLUS 48K RAM**

© Apple is a trade mark of Apple Computer Inc., Cupertino, CA. USA.



# £595 (Subject to availability)

Send cheque or money order for

**£692** (including VAT & Delivery in the UK) to:

Trade Enquiries  
Welcome

# QUESTEL LIMITED

**15 Grand Parade, Brighton, Sussex, BN2 2QB**  
**Telephone: 0273-695264**

Please allow 28 days for delivery

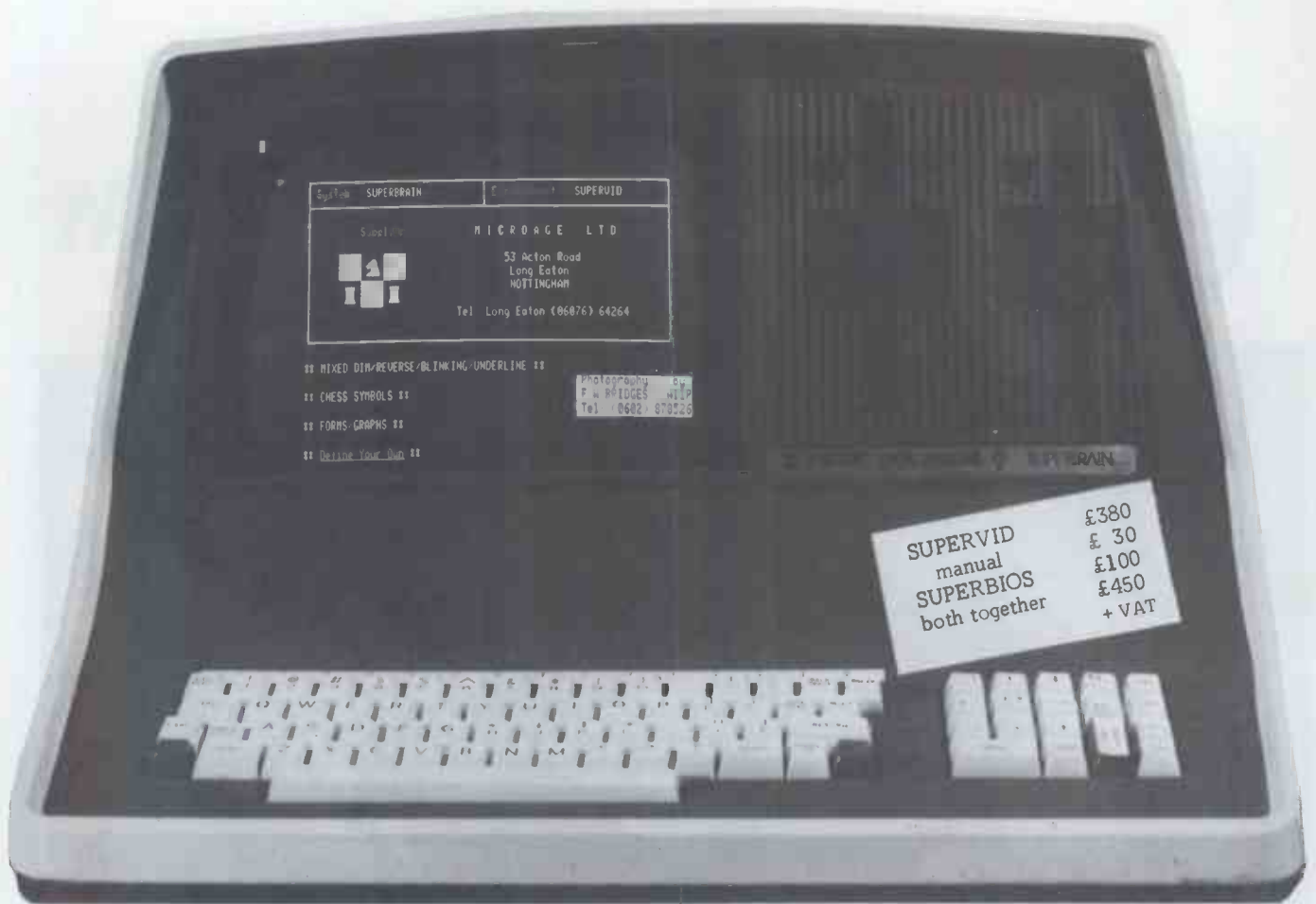

**SUPERVID** £380  
 manual £ 30  
**SUPERBIOS** £100  
 both together £450  
 + VAT

## sinclair ZX80

**Second edition**

The second edition of this popular course is now available, in a larger, improved format.

The course consists of a book and a cassette of programs, and has been designed to supplement the Sinclair manual. It is assumed that this has already been studied, and that the reader is capable of constructing very elementary programs. In our book, the ZX80's BASIC is explained in more detail, with special attention being given to those aspects likely to cause difficulty, for example, the use of PEEK and POKE and the USR function. An introduction to machine code is given, removing some of the mystery which surrounds this subject, and there is also a section explaining the workings of the Z80 microprocessor.

The accompanying cassette contains ready to run programs, which are dealt with in the text, which also includes many other useful programming examples. The emphasis is on understanding, and the course should give you the confidence to construct your own involved programs, thereby getting the most out of your ZX80.

**FREE C12 CASSETTE**

The ZX80 Programming Course costs only £8.95 inclusive. A free blank C12 cassette will be given with all orders for the Programming Course (2nd edn.) received before April 1st.



NEW! JUNIOR MATHS (6k) addition, subtraction, division, tables or mixture age 5-12 £7.50

NEW! FRENCH VOCAB I (16k) 200 words translates both ways £8.50

**BUG-BYTE**

251 HENLEY ROAD  
COVENTRY  
CV2 1BX

10 Graph-plotter; summation; histograms; square root. (1k) £3.75

ALL PRICES INCLUSIVE!

2K80 Software

ON HIGH QUALITY C12 CASSETTE

1. Moon-landing; reaction-tester; hangman; code-breaker; intercept.
2. Bio-rhythms; solitaire, battleships; dice.
3. Sine & cosine; simultaneous equations; differentiation; averages; circles.
4. Guess & gamble; number-sort; treasure-hunt; fruit machine.
5. Secret codes; horse race; stop-watch.

ALL ABOVE ARE 1k £3.65 per cassette

# Memories

2114L-300ns	£2.10
4116 -200ns	£1.89
2708 -450ns	£3.15
2716 -450ns	£4.99

# 74LS series

74LS240	£1.54
74LS243	£1.54
74LS244	£1.54
74LS245	£1.70

# Bridge Rectifiers

25Amp 50volt	£0.74
25Amp 100volt	£0.94
25Amp 200volt	£1.26
25Amp 400volt	£1.68
25Amp 600volt	£2.10
25Amp 800volt	£2.63

Please add 50 pence for postage.  
Send SAE for price list.  
Prices not inclusive of VAT.

---

# STRUTT LTD

3c, BARLEY MARKET STREET,  
TAVISTOCK,  
DEVON, England, PL19 0JF.  
Tel: TAVISTOCK (0822) 5439/5548.  
Telex: 45263



# interface components

## NASCOM SYSTEMS & PERIPHERALS



### 'SUPERMUM' COMBINED MOTHER/BUFFER/PSU BOARD

A 12 x 8 piggy-back board for the Nascom 1, it contains a five-slot motherboard, quality 5A power supply and reliable buffering with reset jump. The board facilitates easy floppy disk expansion.

**£85**  
+ £3.50 P&P + VAT

### FLOPPY DISC SYSTEM

Built and tested stand alone unit with 1/2 drives for both Nascom 1 & 2.  
Single drive CP/M (160K) . . . . £450 + £4 P&P + VAT  
Double drive CP/M (320K) . . . . £640 + £4 P&P + VAT  
Single drive D-DOS system . . . £395 + £4 P&P + VAT (enables existing NAS-Sys software to be used)  
Spare drive . . . . . £205 + £2 P&P + VAT  
Verbatim Diskettes £3.75 + VAT each  
10 for £32 + VAT

Nascom 1 owners: Add £10 + VAT to CP/M prices above for Reset Jump Kit

**NASCOM 1 kit £125** + £1.50 P&P + VAT  
**NASCOM 1 built £140** + £1.50 P&P + VAT

**SPECIAL INTERFACE OFFER**  
**NASCOM 2 WITH 16K RAM BOARD BUILT £345. KIT £295** (+ £2 P&P + VAT)

**NASCOM IMP PLAIN PAPER PRINTER £325** + £2.75 P&P + VAT

### RAM BOARDS—SPECIAL PRICES

16K RAM £90 + £1 P&P + VAT  
32K RAM £110 + £1 P&P + VAT  
48K RAM £130 + £1 P&P + VAT  
64K RAM £150 + £1 P&P + VAT

### SOFTWARE ON TAPE

BASIC Programmers Aid £13 + VAT  
8K BASIC £15 + VAT      ZEAP 2 £30 + VAT

### SHARP MZ-80K + Peripherals

Bi-Directional Serial Board £99.50 + VAT  
MZ80FD (twin floppies 208K) £675 + £5 P&P + VAT  
MZ80P3 Printer £425 + £5 P&P + VAT  
MZ80 I/O Interface £99 + £2 P&P + VAT  
CP/M 2.2 £200 + VAT  
Stock Control, Sales/Purchase Ledger and other business software and games in stock. Full list available on request.

**SPECIAL INTERFACE OFFER**  
**48K MZ-80K System £460**  
+ £10 carriage + VAT

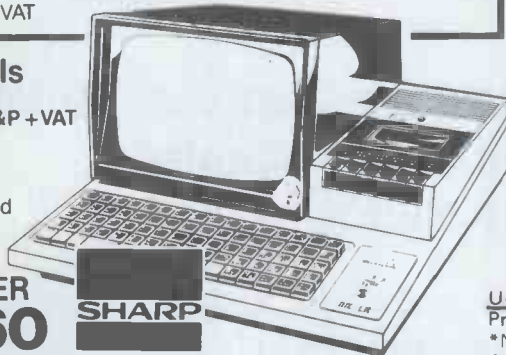

### SHARP PC-1211 POCKET COMPUTER

The PC-1211 uses BASIC and has up to 1424 program steps. 80 character Input line with full editing facilities, 18 user definable keys, 24 character alpha-numeric LCD display. Optional cassette interface is available. PC-1211 is battery-operated, has auto power off function and maintains all programs and data in its memory even after the power has been turned off.

Cassette interface **£86.92**  
£13 + VAT      +£3.50 P&P + VAT

### CENTRONICS MICRO PRINTERS

High performance — Low cost  
737—£425 + £3 P&P + VAT

737 Dot Matrix Printer runs at 80cps (proportional) or 50cps (monospaced) giving text processing quality print. This new printer is capable of printing subscripts and superscripts.

730—£375 + £3 P&P + VAT

730 Dot Matrix Printer can print 10cpl or 16.5cpl at 100cps and 165cps respectively.

Both printers have 3-way paper handling and parallel interface as standard. RS 232/V24 serial interface is optional.  
Fanfold paper (2000 sheets) £18 + £2.50 P&P + VAT



### MICRO MART

Voltage Regulators  
T0220 1 amp  
+ 5, + 12, + 15, + 24V. 80p + VAT  
- 5, - 12, - 15, - 24V. 65p + VAT  
T03  
1A + 5V LM309K . . . . 50p + VAT  
3A + 5V LM323K . . . . £3.50 + VAT  
5A ± 5V 78H05 . . . . £5.50 + VAT

ICs  
EPROMs 2708. £4.50 + VAT  
EPROMs 2716. £7.50 + VAT  
Memories  
21L02 . . . . . £0.80 + VAT  
4027 . . . . . £0.70 + VAT  
4116 . . . . . £2.50 + VAT  
4118 . . . . . £7.50 + VAT  
2114 . . . . . £3.00 + VAT  
280 Devices (4MHz 'A' version)  
MK3880 . . . . . £8.00 + VAT  
MK3881(PIO). . . . £5.00 + VAT  
MK3882(CTC). . . . £5.00 + VAT

Also extensive range of standard and LS TTL, CMOS and linear ICs, plus other semiconductors, in stock. Send for list.

Unless stated otherwise add 50p P&P to all orders  
Prices correct at time of going to press.  
\*New Interface catalogue now available on request.  
Access and Barclaycard accepted.

**INTERFACE COMPONENTS LTD.**  
**OAKFIELD CORNER, SYCAMORE ROAD, AMERSHAM, BUCKS HP6 6SU**  
**TELEPHONE: 02403 22307. TELEX 837788**

## PET' MACHINE LANGUAGE GUIDE

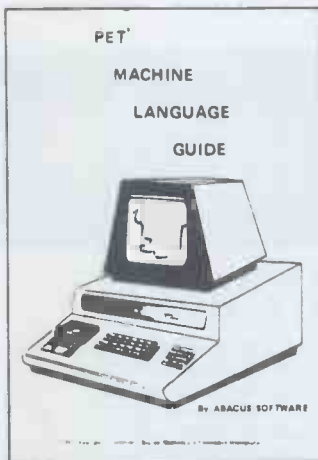

- Contents include sections on:
- Input and output routines.
  - Fixed point, floating point, and Ascii number conversion.
  - Clocks and timers.
  - Built-in arithmetic functions.
  - Programming hints and suggestions.
  - Many sample programs.

If you are interested in or are already into machine language programming on the PET, then this invaluable guide is for you. More than 30 of the PET's built-in routines are fully detailed so that the reader can immediately put them to good use.

Available for \$7.95 + \$2.00 postage and handling. Payment is in U.S. dollars or charged to your Barclaycard or Eurocard — include card number and expiration date. Quantity discounts are available.

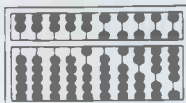

**ABACUS SOFTWARE**  
P. O. Box 7211  
Grand Rapids, Michigan 49510

PET & APPLE II USERS

## TINY PASCAL.

Plus +  
GRAPHICS

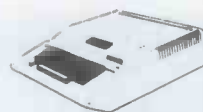

The TINY Pascal System turns your APPLE II micro into a 16-bit P-machine. You too can learn the language that is slated to become the successor to BASIC. TINY Pascal offers the following:

- LINE EDITOR to create, modify and maintain source
- COMPILER to produce P-code, the assembly language of the P-machine
- INTERPRETER to execute the compiled P-code (has TRACE)
- Structured programmed constructs: CASE-OF-ELSE, WHILE-DO, IF-THEN-ELSE, REPEAT-UNTIL, FOR-TO/DOWNTO-DO, BEGIN-END, MEM, CONST, VAR ARRAY

Our new TINY Pascal PLUS+ provides graphics and other builtin functions: GRAPHICS, PLOT, POINT, TEXT, INKEY, ABS AND SQR. The PET version supports double density plotting on 40 column screen giving 80 x 50 plot positions. The APPLE II version supports LORES and for ROM APPLESOFT owners the HIRES graphics plus other features with: COLOR, MGRAPHICS, HCOLOR, HPLOT, PDL and TONE. For those who do not require graphics capabilities, you may still order our original Tiny Pascal package.

PET BASIC 4.0 version available February 1981

TINY Pascal Plus + GRAPHICS VERSION-Includes manual	
PET 32K NEW Roms cassette.....	\$85
PET 32K NEW Roms diskette.....	\$60
APPLE II w/ROM Applesoft only w/DOS.....	\$60

TINY Pascal NON-GRAPHICS VERSIONS-Includes manual	
PET 16K/32K NEW Roms cassette.....	\$50
PET 16K/32K NEW Roms diskette.....	\$45
APPLE II w/ROM Applesoft 32K w/DOS.....	\$45
APPLE II w/RAM Applesoft 48K w/DOS.....	\$45

USER'S Manual (refundable with software order).....	\$12
6502 Assembly Listing of INTERPRETER-graphics.....	\$30
non-graphics.....	\$25

Includes Airmail Postage to Europe Orders may be prepaid by bankcard include card number and expiration date Eurocard Access, Barclaycard, etc.



**ABACUS SOFTWARE**  
P. O. Box 7211  
Grand Rapids, Michigan 49510 U.S.A.

# WEST MIDLAND MICRO'S

021 - 236 - 1794 EXTENSION 224

64K **SUPERBRAIN** - £1595.00 (+ VAT)

**\*\* INCLUDING DELIVERY AND INSTALLATION \*\***

+ O.K.I. MICROLINE 80 PRINTER (INC INTERFACE) £425.00  
OR QUME SPRINT 5 (THE BEST) D/W PRINTER FROM £1565.00

+ FULL SUPPORTING SOFTWARE INCLUDING:-  
INTEGRATED ACCOUNTS PACKAGE £900.00  
WORDSTAR & MAILMERGE £285.00  
ALL + VAT

COMPUTERS FOR ALL LTD. THE PRECINCT, SCHOOL ROAD, WELLESBOURNE,  
WARWICKS CV 35 9NL. Tel: 0788 840064

WE CAN ALSO SUPPLY ANY OTHER SOFTWARE OR HARDWARE CURRENTLY ON THE MARKET



**WE HAVE ALL THE NEW ATARI®  
VIDEO GAME PROGRAM™  
CARTRIDGES.**

**ATARI £86 + VAT**

**SILICA SHOP**

TELEPHONE FOR FREE BROCHURES 01-301 1111

# ELECTRONIC GAMES

## ATARI

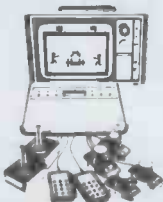

SPECIAL PRICE  
**£86 + VAT**

## INTELLIVISION MATTEL

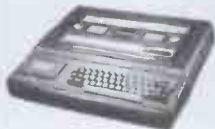

£173.87 + VAT

Available August 1980  
This is the most advanced TV  
game in the world.  
Expandable  
next year into a full  
microcomputer.  
COLOUR CATALOGUE  
AVAILABLE WITH  
DETAILS ON ALL THE  
CARTRIDGES

## CHESS



Send for further details.

### COMPUTERS

NEW RANGE  
AVAILABLE  
AUGUST 1980  
We specialise in  
computer chess  
machines & stock  
over 13 different  
models from  
£20 to £300

## TELETEXT



RADOFIN  
TELETEXT  
Add on Adaptor

**£173 + VAT**

## SPACE INVADERS



HAND HELDS + CARTRIDGES  
ATARI - ACETRONIC  
PRINZTRONIC  
RADOFIN - DATABASE etc.

We keep a full range!  
Send for cartridge lists stating which  
machine you own.

## BRIDGE

COMPUTER



- ★ Plays 1/2/3 or 4 Hands
- ★ Problem Mode
- ★ Audio Feedback
- ★ Instant Response
- ★ Auto scorekeeping

## BACKGAMMON

COMPUTERS

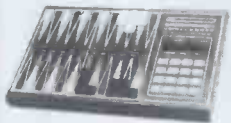

From £38 to £108. Send for further details.

OMAR 1  
OMAR 2  
CHALLENGER  
GAMMONMASTER

## DRAUGHTS

COMPUTER

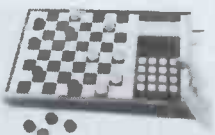

- ★ Solves Problems
- ★ Rejects illegal moves
- 2 level machine  
£43 + VAT
- 4 level machine  
£77.78 + VAT

## LEISURE

- ★ CHEAP TV GAMES
- ★ TELEPHONE ANSWERING MACHINES
- ★ AUTO DIALLERS
- ★ CALCULATORS
- ★ DIGITAL WATCHES
- ★ PRESTEL
- ★ HAND HELD GAMES

24 TUNE  
DOOR  
BELL  
£13.65  
+ VAT



**FREE  
CATALOGUE**

For a free copy  
of our 32 page  
catalogue, send  
a 12p stamp to  
Silica Shop Ltd  
or Telephone  
01-301 1111

MAIL ORDER SERVICE — Free postage & packing

TELEPHONE & MAIL ORDERS - accepted on:  
Access ★ Barclaycard ★ American Express ★ Diners Club ★ credit facilities arranged

CALLERS WELCOME — at our shop in Sidcup — Demonstrations daily  
Open from 9am-5.30pm Mon-Sat 9am-1pm Thurs 9am-8pm Fri

GUARANTEE — Full 12 months + After Sales Support!

We have comprehensive brochures on all products. Please let us know what you are interested in and we will send you detailed brochures AND our own  
32 page catalogue covering most games on the market.

**SILICA SHOP**

SILICA SHOP  
1/4 The Mews, Hatherley Rd.,  
Sidcup, Kent  
Tel: 01-301 1111

PCW. 3.81

*a special 24~page supplement in Elektor*

# THE 16-BIT PROCESSOR

The new generation of 16-bit microprocessor systems can equal or even better the performance of present day minicomputers. This means that a 'real' computer is now within the reach of any enthusiast. The only question is: "Which system do you choose?"

The April issue of Elektor contains a special 24 page supplement giving a brief survey of the field, concentrating in particular on the following types:

Manufacturer	Type	Second sources
Intel	8086	Mitsubishi, Mostek, Siemens
Motorola	68000	Hitachi, Rockwell, Thomson
National Semiconductor	16000 family	
Texas Instruments	9900	AMI, ITT
Zilog	8001	AMD, SGS-ATES

Comparisons are given of the basic capabilities, register sets, addressing modes, instruction sets, memory maps and support chips. The article has been checked for technical accuracy by specialists from the respective manufacturers.

## elektor

April issue on sale now, price 60p.  
Or direct from address below, price 80p (inc. 20p P&P)  
Elektor Publishers Ltd., 10 Longport, Canterbury, Kent CT1 1PE.  
Tel. (0227) 54439/0

## PortaTel

14" COLOUR MONITORS  
Colour display from EuroApple  
WITHOUT Colour card



model AM 3781  
£299 + VAT

Attractive trade  
terms available

Model TMTV 3781 £299 + VAT

TV Programmes  
PLUS  
American Standard Video  
PLUS  
European PAL Video

FULLY GUARANTEED  
LARGER SIZES AVAILABLE

**PortaTel** Conversions Limited

25 SUNBURY CROSS CENTRE  
SUNBURY ON THAMES MIDDX  
TEL. No. SUNBURY (09327) 88972  
VIDEO MODIFICATION SPECIALISTS

ACCESS & BARCLAYCARD WELCOME

## SHARP PC-3201

THE SENSATIONAL NEW MICRO-SYSTEM FROM SHARP

64K RAM 32K ROM	SOFTWARE FOR PC3201
INCLUDES TWIN DISCS	SALES LEDGER £300
HIGH RESOLUTION PRINTER	PURCHASE LEDGER £300
EASILY EXPANDABLE	INVOICING £300
ORDER NOW £2950	NOMINAL LEDGER £450
DEMONSTRATIONS NOW!	STOCK CONTROL £150

all prices exclude VAT at 15%

## 11Z-80K

video genie **NASCOM**  
NorthStar **HORIZON**

## BOOKS ♦ PC 1211s ♦ MEDIA

SOFTWARE — WE CAN DO IT!  
Whatever your desire we can satisfy it!  
Discuss your problems, listen to our solutions,  
programs written at low cost to HELP YOU!  
HELP and ADVICE with no obligation  
Phone CHRIS ROBINSON on (0473) 50152

## MICROTEK

15 LOWER BROOK STREET, IPSWICH



# MicroStyle

9 St. Peters Terrace,  
Lower Bristol Rd.  
Bath, BA2 3BT.  
Telex: 44371 (KEMP-G)

## COMPUTERS

PET 8K	£415
PET 16K	£525
PET 32K	£650
PET 8032	£895
OHIO CI-P	£220
OHIO CI-E	£255
SUPERBOARD	£160
SUPERBOARD 'E'	£195
VIDEO GENIE	£330
SHARP MZ80K	£480
APPLE II	£695

## SUPERBRAIN

SuperBrain's CP/M operating system boasts an overwhelming amount of available software in BASIC, FORTRAN, COBOL, and APL. Whatever your application. . . General Ledger, Accounts Receivable, Payroll, Inventory or Word Processing, SuperBrain is tops in its class.

320K £1850 700K £2400  
1.5Mb £2750

## DISC DRIVES

COMPU/THINK

400K	£795
800K	£995

## COMMODORE

CBM 30/40	£695
-----------	------

THE BEST IN THE WEST ARE THE FIRST IN THE WEST  
TO OFFER THE

# PETAL FOR PET

THE NEXOS RP1600 'PETAL' DAISY WHEEL PRINTER

The Fastest Daisy Wheel with these features at the price!

- \*Integral IEEE
- \*True £ Sign
- \*Addressable
- \*Switches for Single & 1 1/2 line spacing
- \*10/12/15 c.p.i.
- \*Reverse upper & lower case
- \*Self Test
- \*Rated speed of 60 cps
- \*Optional Tractor Feed
- \*Optional Serial I/F

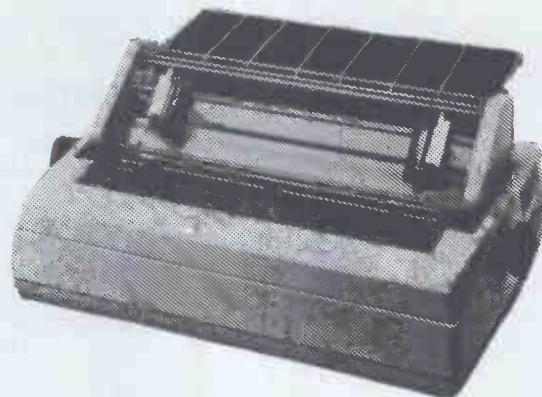

# £1195

Serial I/F	£65
Tractor Feed	£175
Single Sheet Feeder	£695
Acoustic Cover	£60

## ACULAB FLOPPY TAPE

The ideal graduation from Cassettes for all TRS.80 and Video Genie owners

TRS.80 Version £165: Video Genie £174

## PRINTERS

EPSON TX80B (inc. I/F & cable)	£359
EPSON MX80	£425
ANADEX DP8000	£495
ANADEX DP9500	£895
ANADEX DP9501	£995
PAPER TIGER	£585
MICROLINE 80	£359
IBM GOLFBALL	£595
CENTRONICS 737	£425
NEXOS PETAL	£1195

## VIDEO MONITORS

10" BLACK & WHITE	£85
10" GREEN SCREEN	£95

PLEASE ADD  
.15% VAT  
ON ALL PRICES

TEL: BATH (0225) 334659  
AFTER HOURS (0761) 33283

# J C L SOFTWARE

## OUR ROMS MEAN BUSINESS

NEW for PET DISK Users - a BUSINESS ROM with over 25 new properly tokenised KEYWORDS added to PET's BASIC language. No "SYS" calls or non-standard syntax. Using the new commands your programs can approach big system standards for data input, particularly from the point of view of reliability.

\* FOUR new commands RESPOND, GETKEY, CASHIN and INPFLD provide new methods of accepting alpha, numeric or mixed responses from the User. A Full Screen Input system called by SCRINP allows numerous responses to be edited prior to their becoming BASIC variables.

\* THREE new commands, SEND, RECEIVE and MATCH relate the screen fields directly to DOS2 Relative files so that file handling programs can be easily written. A full file Editor with Search can list on a single page.

\* FOUR new commands, SAVESCRN, GETSCRN, EXSCRN and DUMPSCRN allow full screen of display to be manipulated.

\* MEMSAVE and RELOAD make the recording and return of file blocks or screen displays a simple matter. OVERLAY will call an overlay program even when the STOP KEY is muted with STOPOFF.

\* PRINTAT makes plotting and other screen layout programs simpler.

\* DISK allows selective listing of a disk directory content.

\* PLIST lists a BASIC program on a 3022 series printer, automatically selecting lower case listing if the screen display is in lower case.

\* SKETCH provides a means of creating displays for use by the Screen Input system.

\* Also UPPER, LOWER, REPON, REPOFF, DELAY BELL, CLRFLD and ROMOFF.

All our ROMs include an enhanced DOS SUPPORT and an AUTOBOOT facility.

Available for BASIC 2 and 4 machines and the 8032 SuperPETs. Price including a detailed manual giving worked examples and reference section £120.00.

BUSINESS ROM goes in the s9000 socket in PET. If this conflicts with a Security or other ROM, use our new B socket Software controlled ROM-PAGER to solve the problem. Simply installed. Price £45.00 including instructions. Phone or write for further details of these and other products for PET from:-

47 LONDON ROAD SOUTHBOROUGH  
TUNBRIDGE WELLS KENT.  
TUNWELLS 27959

QUADRAPHENIA LTD  
HI-FI, VIDEO, TV  
COMPUTER CENTRES



SHEFFIELD  
AND  
DONCASTER

# SHARP

MZ80K full 48K version

£455+VAT=523.25

(Full Business Systems now in stock)

VIDEO GAME EG3003 New Keyboard 16K level II £275 + VAT = £316.25  
Apple - check Doncaster branch

### Printers

Seiko GP80 30 c.p.s. (interfaces in stock) £250 + VAT = £287.50  
Epson MX80 100 c.p.s. (interfaces in stock) £345 + VAT = £396.75

### Monitors

9" B/W (High Quality)	£85 + VAT = £97.75
9" Green Phosphor (High Quality)	£95 + VAT = £109.25
JVC 6" Colour TV/Monitor CX610GB Audio Video in and out PAL/Secan Systems	£199 + VAT = £228.85
Colour TV (Kill 2 birds with 1 stone)	
14" Ferguson	£189 + VAT = £217.35
14" JVC	£220 + VAT = £253.00
14" Toshiba	£207 + VAT = £238.05
14" Panasonic	£207 + VAT = £238.05

Full stock of software including cassette tapes floppy disks  
FAST EFFICIENT MAIL ORDER SERVICE  
Carriage free 2 day delivery on hardware!  
Full credit facilities available \* Ask for written quotations!  
Special school or computer club purchasing scheme including all maintenance!

# QUADRAPHENIA

HEAD OFFICE & MAIL ORDER: 10 NURSERY ST. SHEFFIELD S3 8GG TEL. (0742) 77824  
ALSO AT: 19 BRADFORD ROW HALLGATE DONCASTER DN1 3NF TEL. (0302) 21215  
BUSINESS HOURS Sheffield Mon-Sat 9am-5.15pm Doncaster Mon-Sat 10am-5.00pm

**IF YOU WANT TO BE CONVERTED. . . READ ON  
FAST 12 BIT A/D AND D/A CONVERTERS FOR A VARIETY OF MICROS:**

**FOR APPLE LOM 10**

- \* 16 SINGLE ENDED OR 8 DIFFERENTIAL INPUTS
- \* 30 KHZ DATA THROUGHOUT
- \* INPUT RANGES  $\pm 10V$ ,  $\pm 5V$ ,  $0-5V$ ,  $0-10V$
- \* EXTERNAL TRIGGER UNDER SOFTWARE CONTROL
- \* A/D's CAN BE SYNCHRONISED.

£375.00

**FOR S100 LOM 11**

- \* AS FOR APPLE, PLUS POWERFUL TIMER
- \* EVENT TIMER, TIME OF DAY, AUTO INTERRUPT ETC.
- \* AUTOCHANNEL INCREMENTING.

£495.00

D/A

**FOR APPLE LOM 20**

- \* 2 INDEPENDENT D/A's
- \* 3 MICROSEC SETTLING TIME
- \* 8 BIT PARALLEL PORT FOR PEN DOWN, ETC.
- \* OUTPUT RANGES  $\pm 2.5V$ ,  $\pm 5V$ ,  $\pm 10V$ ,  $0-5V$ ,  $0-10V$ .

£255.00

**FOR S100 LOM 21**

- \* 4 INDEPENDENT D/A's
- \* 3 MICROSEC SETTLING TIME
- \* OUTPUT RANGES  $\pm 2.5V$ ,  $\pm 5V$ ,  $\pm 10V$ ,  $0-5V$ ,  $0-10V$ .

£275.00

- FOR ANY MICRO WITH DUAL PARALLEL I/O PORT (380Z, ETC)  
12 BIT A/D WITH 20 MICROSEC DATA THROUGHPUT - LOM 30**
- \* GIVES 8 CHANNELS ON APPLE WITH CCS DUAL PARALLEL I/O CARD
  - \* GIVES 4 CHANNELS ON 380Z, ETC.
  - \* INPUT RANGES  $0-1 V$ ,  $0-5 V$ ,  $0-10 V$ , SWITCH SELECTABLE
  - \* A/D STANDS OUTSIDE COMPUTER FOR GREATER STABILITY
  - \* OWN INDEPENDENT POWER SUPPLY.

£295.00

PRICES FOR COMPLETE APPLE, ALTOS, AND S100 SYSTEMS (PLUS SOFTWARE)  
ON APPLICATION ALL PRICES EXCLUSIVE OF V.A.T. INCLUSIVE OF POST AND  
PACKING CASH WITH ORDER

**LOMBARDY  
COMPUTERS**

121, HIGH STREET, BERKHAMSTED, HERTS HP4 2DJ. TEL (04427) 4247

**THE MOST POWERFUL AND COMPREHENSIVE WORD PROCESSING SYSTEM  
IN THIS WORLD - OR OUT OF IT**

**MERGE PRINT £70**

Multi copy printing; form letters; variable insertion; file insertion at print-out; print-time formatting

**MicroPro**

£240

**WORDSTAR  
THE  
WORD PROCESSOR**

**DATASTAR £165**

Comprehensive data entry, search/retrieval and update system. Data verification; arithmetic functions; automatic field-fill

**WORDMASTER £75**

Powerful text editor with video edit mode; automatic floppy I/O; scratch pad memory; read/write to files other than that being edited

**SUPERSORT £120**

High performance sorting, merging and record selection of compatible BASIC, Fortran, COBOL and Assembler program data files.

**CUSTOMISATION NOTES**  
Source files and manual to permit customisation of WORDSTAR TO YOUR OWN REQUIREMENTS to your own REQUIREMENTS  
£75

also available/

**CIS COBOL £395**

**FORMS 2 £95**

**MT+PASCAL £175**

**CBASIC £65**



**INTERFACE SOFTWARE LTD**

100 PARK STREET, CAMBERLEY, SURREY. (0276) 27982

DEALER ENQUIRIES  
WELCOME



# LONDON COMPUTER CENTRE

NEW! Revolutionary! Epson MX80F/T £399  
the PRINTER with FRICTION & ADJUSTABLE

Removable TRACTOR FEED

Dual print modes letter quality standard dot matrix



ULTRA QUIET.  
LOWER CASE DECENDERS  
BI DIRECTIONAL, LOGIC SEEKING PRINT HEAD  
40,80,66,132 Columns per line  
UNIQUE BOLD FACE (BUILT IN FEATURE)  
64 Graphic Characters (TRS 80 & Prestel)  
9 x 9 PRINT MATRIX. £ sign  
Forms Handling; Top of Form  
Horizontal and Vertical Tabs.  
Centronics parallel interface standard.  
Optional extra Serial, PET & APPLE interfaces.  
Easily replaceable head.  
After 50,000,000 to \*100,000,000 characters  
the head can be replaced without technical  
knowledge or assistance for £15.00  
\* Approx. 38,000 copies of A4 letters.

43 GRAFTON WAY, LONDON W1P 5LA (Opposite Maples )  
Tel: 388 6991/2 OPENING HOURS: 11-7 MON-FRI 12-4 SAT  
24 hour answer phone: 01-388 5721

## ROBAL BUSINESS COMPUTERS

CUT THE COST OF COMPUTING

### PETS

2008S	£375
4008N	£395
4016N	£475
4032N	£625
8032	£825

### DISK DRIVES

4040	£625
8050	£825

### PRINTERS

Microline 80	£315
CBM 8024	£1050
Ricoh RP1600	£1250
Ricoh Ribbons	£36

(per doz)

### BUSINESS SOFTWARE

VISICALC	£100
WORDCRAFT	£325
PAYROLL	£125
HOTEL BILLING	£400

### GAMES

GALAXY ONE	£25
(24 Games on disk)	
INVADERS	£7
COSMIC JAILBREAK	£7
BREAK THROUGH	£7

### EXTRAS

Disks (per 10)	£25
Listing paper	£20
(per 2000 sheets)	

BEST VALUE  
IN LONDON

Please add £10 delivery on computers etc. Prices exclude VAT

CALLERS WELCOME AT 54-62 REGENT STREET, LONDON W1

Tel. - 01 439 4052

BEST VALUE  
IN LONDON

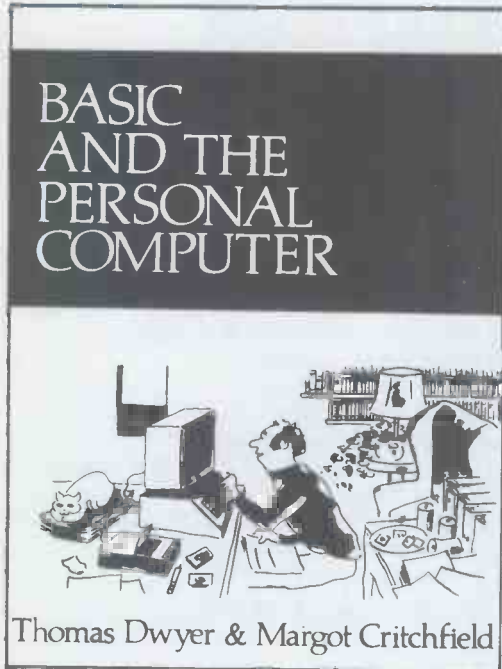

Thomas Dwyer & Margot Critchfield

SEND FOR OUR FREE CATALOGUE OF  
100 SELECTED MICROCOMPUTER BOOKS

Prices include P+P in UK.

Orders to: Mol(PW4)1 Francis Avenue · St Albans · Herts AL3 6BL · England · Phone 0727 52801 · Telex 925859

For overseas delivery add 10% (surface mail) or 20% (air mail)

### BOOKS ON BASIC

- 9.50 32 Basic Programs for the PET by Rugg & Feldman
- 9.50 32 Basic Programs for the TRS-80 by Rugg & Feldman
- 4.90 A Bit of Basic by Dwyer & Critchfield
- 13.50 Accounts Payable/Receivable in CBASIC by Lon Poole
- 9.90 Basic & the Personal Computer by Dwyer & Critchfield
- 9.90 The Basic Handbook by David Lien
- 8.90 Basic Programming - 3e by Kemeny & Kurtz
- 5.50 Basic Computer Games edited by David Ahl
- 4.90 Basic With Style by Nagin & Ledgard
- 4.50 Computer Programs That Work! - 3e by Lee, Beech & Lee
- 8.50 Computer Graphics Primer by Mitchell Waite
- 8.50 Fifty Basic Exercises by J P Lamotier
- 12.00 General Ledger in CBASIC by Poole & Borchers
- 3.60 Illustrating Basic by Donald Alcock
- 8.90 Inside Basic Games by Richard Mateosian
- 10.00 Library of PET Subroutines by Nick Hampshire
- 9.90 Learning Level II - 2e by David Lien
- 6.50 Microsoft Basic by Ken Knecht
- 16.50 Microsoft Basic Decoded by H C Pennington
- 5.50 More Basic Computer Games edited by David Ahl
- 9.90 Practical Basic Programs edited by Lon Poole
- 7.50 Programming in Basic for Business by Bosworth & Nagel
- 9.90 Programming for Poets in Basic by Conway & Archer
- 3.90 Stimulating Simulations by C W Engel
- 9.50 Some Common Basic Programs - 3e by Poole & Borchers
- 9.90 Some Common Basic Programs for PET/CBM by Poole et al
- 6.60 TRS-80 Basic! A Self-Teaching Guide by Albrecht et al

**NEW BOOK**

## Learning BASIC with your Sinclair ZX80

by Robin Norman

Whether you already have a Sinclair ZX80 or are going to buy one, this book will be of great value. It tells you how to get the ZX80 working, how to program it and how to develop your skills and get the best out of it.

Contains all the information necessary to use the Sinclair ZX80 to the full plus 14 specially written programs unavailable elsewhere.

Available from your local bookseller or in case of difficulty from the Publisher.

**Newnes Technical Books**  
Borough Green, Sevenoaks, Kent TN15 8PH

Please send me \_\_\_\_\_ copy/copies of Learning BASIC with your Sinclair ZX80 (Norman) 0 408 01101 7 illustrated paperback 216 x 135mm 160 pages @ £3.95

I enclose a cheque/PO for £ \_\_\_\_\_

In total payment

**ORDER NOW**

Cut out this coupon and return it to Patricia Davies Marketing Manager at the address above:-

From \_\_\_\_\_  
Address \_\_\_\_\_

(PCW 4/81)

NEW FROM

## arden-soft

### ARDENSOFT DISK-BASED TOOLPAK

Gives the sharp MZ80 Basic programmer the new commands, with numerous derivatives and options:

**AUTO, CONVERT, DEFINE, EXECUTIVE, HELP, RENUMBER, FIND, SDUMP, TABSET, TRACE, VDUMP.**

The output FIND, TRACE, VDUMP to either video or printer.

Other facilities include:.

1. Single key entry for 54 BASIC key-words - a set of key identification seals is included.
2. Auto repeat of the 4 Cursor direction keys, insert and delete keys.

Can you afford to be without?

Disk version £36.00 plus VAT.

**TOOLPAK**, Trade Mark applied for by Arden, will shortly replace the proven **TOOLKIT** as a cassette program also. **FLASH-TOOL PAK** (cassette version) now available.

Other SHARP software from ARDENSOFT includes:

**GAMESPAK 1** (Mastermind, Hangman, Apollo, Nim) Cassette £8.00 + VAT

**GAMESPAK 2** (Jaws, Plato, Solitaire, Labyrinth) Cassette £8.00 + VAT

**RAM CHECKER** £15.00 + VAT

Available from your Sharp dealer or from Arden Data Processing, Municipal Offices, Charles Street, Leicester.



ASSOCIATION OF LONDON COMPUTER CLUBS

Proudly presents

THE SECOND  
LONDON  
COMPUTER  
FAIR

APRIL 14th 15th & 16th 1981 10am - 6pm  
[7pm 15th]

Including: Retail Exhibitors • Hobbyists  
Club Stands • Seminars • Workshops  
Bring and Buy Sale

Admission 75p

POLYTECHNIC OF NORTH LONDON  
THEATRE

⊖ Opposite Holloway Rd. tube station ⊖

SPONSORED BY EDUCATIONAL COMPUTING and  
PRACTICAL COMPUTING

# TOMORROW TODAY

at  
**Birmingham Computer Centre**

Commodore official distributors



12 months warranty

4008-16-32 PETs  
-8032 -8050

The reliable value for money system with after sales support, instruction and training facilities and a wide range of programmes.



12 months warranty



48K Disk drive with controller  
£1,044 + VAT

Apple authorised distributors  
The sophisticated quality system with a reputation for advanced design and innovation.



12 months warranty



SHARP  
Z80K



The incredible computer system. Now available ex-stock including the new dual drive double sided floppy disk.

THE ULTIMATE IN DAISYWHEEL PRINTERS  
RICOH RP 1600



THE BEST WORLD PROCESSOR  
PRINTER AVAILABLE  
DEALER ENQUIRIES WELCOME



Camden Electronics Ltd.  
462 Coventry Road, Small Heath,  
Birmingham B10 0UG.  
Telephone 021 773 8240

Open Mon.-Sat. 9.30-6.00 p.m.

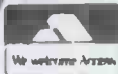

A MEMBER OF THE COMPUTER RETAILERS ASSOCIATION

A PROGRAMMABLE FOR THE PRICE OF A GOOD SCIENTIFIC

CASIO  
FX-3500P

Regression analysis

Integrals

RRP  
£25.95

ONLY  
£22.95

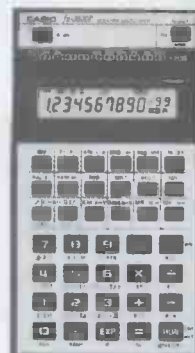

Statistical regression and integrals. Non-volatile memories and stores.

38 functional (non-volatile) steps. 2 programme storage capacity. Unconditional and conditional jumps. 7 (non-volatile) memories — one independent, 6 constant. 18 pairs of parentheses, nestable in 6 levels. 61 built-in functions, including: integrals (Simpson's rule), linear regression, logarithmic regression, exponential regression and power regression. Hyperbolics, sexagesimal and co-ordinates conversions. 10 digit mantissa or 10 + 2 exponent.

Two silver oxide batteries give approximately 1,000 hours continuous use with power-saving automatic cut-off, with data and memory protection. Dimensions: 7 x 71.5 x 132.4mm (9/32 x 27/8 x 5 1/4 inches). Comes complete with leatherette wallet, batteries, instruction manual.

Send 20p (postage) for details of Casio calculators and watches

PRICES include VAT, P&P. Send cheques, PO or phone your ACCESS or BARCLAYCARD number to:

## TEMPUS

Dept PCW, Beaumont Centre, 164-167 East Road, Cambridge CB1 1DB. Tel: 0223 312866



OVER 40 PROGRAMS  
AND ROUTINES

HOW TO PRODUCE  
MOVING DISPLAYS

COMPLETE ANALYSIS  
OF ZX80 MONITOR

THE ZX80 COMPANION  
Second Edition. ISBN 0 907211 00 3

This best-selling manual on the Sinclair ZX80 covers ZX80 BASIC, hardware, programs and the ZX80 Monitor, with a detailed explanation of monitor routines and entry points.

'An invaluable asset for ZX80 owners' — Micro Forecast.  
'A very detailed and carefully written guide to the machine' — Education Equipment.  
Accompanying cassette of ten programs — add £4.95.  
Send SAE for catalogue of Sinclair-tested software and other literature.

LINSAC  
(PCW)

68 Barker Road, Linthorpe,  
Middlesbrough, Co. Cleveland TS5 5ES



# BULK EPROM PROGRAMMING

P400 PRODUCTION EPROM PROGRAMMER

2 YEAR WARRANTY



This unit provides simple, reliable programming of up to 8 EPROMS simultaneously it has been designed for ease of operator use — a single 'program' key starts the self check — blank check — program — verify sequence.

Independent blank check & verify controls are provided along with mode, pass/fail indicators for each copy socket and a sounder to signal a correct key command & the end of a programming run. Any of the 2704/2708/2716 (3 rail) & 2508/2758/2516/2716/2532/2732 (single rail) EPROMS may be selected without hardware or personality card changes.  
PRICE £545 + VAT. Postage paid.

# BULK EPROM ERASING

EX-STOCK



## MODEL UV141 EPROM ERASER

14 EPROM capacity  
Fast erase time  
Built-in 5-50 minute timer  
Convenient slide-tray loading devices  
Safety interlocked to prevent eye and skin damage  
Rugged construction  
MINS & ERASE indicators  
Price £78 + VAT postage paid.

## MODEL UV140 EPROM ERASER

Similar to Model UV141 but without timer. Price £61.50 + VAT post paid.

# BULK EPROMS

EX-STOCK

	1-9	10-24	25-49	50-99	100 up
2716 (450ns) (single rail)	£6.00	5.50	£5.00	£4.50	£3.90
2708 (450ns)	£3.90	£3.50	£3.10	£2.90	—

Postage and Packing is included in all prices. ADD VAT at 15%. All our EPROMS are manufactured by leading companies and are fully guaranteed, branded and to full specification.

WRITE OR TELEPHONE FOR FURTHER DETAILS OR SEND OFFICIAL COMPANY ORDERS/CHEQUES TO:

PLEASE NOTE NEW ADDRESS & TELEPHONE NUMBER

## GP INDUSTRIAL ELECTRONICS LTD

Unit 6, Burke Road, Totnes Industrial Estate, Totnes, Devon  
Telephone: Totnes (0803) 863360 sales, 863380 technical  
Telex No. AS 42596

DISTRIBUTORS REQUIRED - EXPORT ENQUIRIES WELCOME

# STOP IT

Stop Wasting Time !!  
writing programs that

# FLEXIDATA

can write in minutes

THE ANSWER TO  
YOUR SOFTWARE  
PROBLEMS

THE FASTEST  
WAY TO  
PROGRAM

The end of programming  
for  
**APPLE~ITT2020**

- \* DEVELOP IDEAL SYSTEMS IN MINUTES NOT MONTHS !
- \* NO CODING REQUIRED \*BUG FREE !
- \* SIMPLE TO USE BUT FLEXIBLE
- \* SET UP SCREENS DATA ENTRY
- \* GENERATE FILES & REPORTS
- \* 100's OF APPLICATIONS
- \* ALTER PROGRAMS AT ANY TIME !
- \* A GIANT LEAP FOR SOFTWARE \*

## 14 Days Money Back Guarantee

SO WHAT HAVE YOU GOT TO LOSE ?  
ONLY YOUR TIME IF YOUR NOT USING

## FLEXIDATA

Telephone Enquiries  
Welcome

Dealer enquiries  
welcome

ORDER NOW - **£150.00** inc. p.& p.

# DATABANK

66 QUEENS ROAD - LOUGHBOROUGH  
LEICESTERSHIRE LE11 1HD  
TELEPHONE: (0509) 217671

PLEASE SEND  COPIES OF 'FLEXIDATA'  
YOUR COMPUTER? MORE DETAILS   
APPLE II  ITT 2020  (disc)

NAME \_\_\_\_\_

ADDRESS \_\_\_\_\_

CHEQUE WITH  
ORDER FOR OUR  
'BY-RETURN' MAIL  
SERVICE

POSTCODE \_\_\_\_\_

# WESTERN COMPUTERS LIMITED, of BLACKPOOL

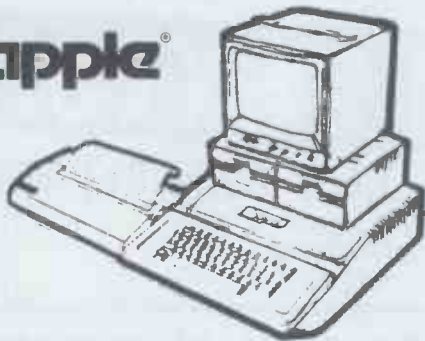

WESTERN COMPUTERS stock the full range of Apple products and Apple compatible peripherals

48K APPLE with video output	695.00
DISK DRIVE with controller (DOS 3.3)	383.00
DISK DRIVE W/O controller	299.00
PARALLEL PRINTER CARD	104.00
SERIAL INTERFACE CARD	113.00
PASCAL language system	299.00
FORTRAN for language system	120.00
12 inch VIDEO monitor (green screen)	162.00
8" TWIN FLOPPIES ½ MBYTE	1325
1 MBYTE	1435

## CP/M



Z-80 SOFTCARD for CP/M and Mbasic version 5.0	195.00
BASIC COMPILER compatible with Mbasic V 5.0 and 3-10 times faster execution. Includes Macro-80 assembler.	195.00
FORTRAN-80 ANSI-66 (except for complex) Much faster than Apple Fortran. Includes Macro-80.	205.00
COBOL-80 Ansi-74 Includes I.S.A.M.	325.00
BUSINESS SOFTWARE for APPLE CP/M.	
SALES LEDGER 500+ accounts	295.00
PURCHASE LEDGER with nominal	345.00
STOCK CONTROL	295.00
PAYROLL (up to 300 employees)	345.00

(All prices exclusive of VAT)

Please give us a ring or send for our catalogues.

WESTERN COMPUTERS LIMITED,  
BLACK POOL AIRPORT,  
BLACKPOOL, LANCs.

Tel: (0253) 42660/41879 Telex 67162

# GATE POST

ASTEROIDS IN SPACE (32K-d) Blas approaching Asteroids — beware aliens	£12.00
HORRIBLESCOPE (32K-d) Funniest horoscopes, great for parties! Includes your own insults!	£10.75
SPACE (48K-3) Simulation of human life in space. You develop characters — 6 games	£18.00
SPACE II (48K-D) A continuation of SPACE, with more characters and games	£15.00
ADVENTURELAND (32K-C) An enchanted world of lost treasures, wild animals — magical beings	£9.00
PIRATE ADVENTURE (32K-C) Can you recover Long John's lost treasure?	£9.00
ADVENTURELAND AND PIRATE ADVENTURE (48K) Both games on one disk	£16.00
FASTGAMMON (M-24K-C or D) Best computer backgammon available, with sound, hires graphics and cartoons.	C £13.00 D £15.00
You'll play for hours	
TEMPLE OF APSHAI (48K-D) Mythical labyrinth with fearsome monsters & treasure	£18.00
THE WIZARD AND THE PRINCESS (48K-D) Best game ever! 100's of beautiful Hires pictures. It is possible to win! — We haven't done it yet	£20.50
DATESTONES OF RYN (48K-C or D) Built in scoring system — beat your friends.	C £9.25 D £12.00
"MYSTERY HOUSE" HI-RES ADVENTURE (M-48K-D) See each room in 3D-type graphics	£15.00
CONEY ISLAND (16K-c) 22 Fast paddle games for 1 or 2 players. Colour graphics	£8.00
OTHELLO (16K-C) — by Softape — the best Othello game we've seen	£9.00
SAUCER WARS (24K-C) Oneperson game, with 150 levels of difficulty	£11.25
VOYAGER EXCURSION (24K-C) Hires lunar landing game	£11.25
FORTE (16K-C) A music language — You can save your songs	£12.25
APPLE TALKER (M-16K-C) Create programmes so your Apple talks to you	£9.75
APPLE LIS'NER (M-16K-c) Create programmes which understand up to 31 spoken words	£12.25
TALKER and LIS'NER are compatible with each other	
GOLF (20K-C) 18 holes for 1 or 2 players — full choice of clubs and direction £5.00	
AIR FLIGHT SIMULATION (16K-C)	only £6.50
OIL TYCOON (16K-C)	only £6.50
WINDFALL (32K-C) The oil crisis game	£9.25
B-1 NUCLEAR BOMBER (16K-C) Fly this Russian defences — and back! £9.25	
NORTH ATLANTIC CONVOY RAIDER (16K-C) The Bismark convoy raid of 1941	£9.25
ELECTRIC CRAYON (8K-C) Full colour graphics editor	£11.00
U-DRAW (16K-C) Hires graphics editor	£11.00
MUSIC BOX (8K-C) Full 3 octaves by semitones, Note-time, rests, tempo + full colour eight show!	£9.50
MAZE GAME (16K-C) 3-D Colour Maze Game	£9.50
RACER (24K-C) Best arcade racing game — Hires graphics	£8.00
BREAKTHRU (M-16K-C)	only £6.50
SPIDER TAG (M-16K-C)	only £6.50
ATOMIC CASINO (16K-C)	only £5.00
HIRES BASEBALL (M-16K-C)	£10.25
E.S.P. (32K-C) Test yourself — Telepathy and Psycho-kinesis	£6.00
NETWORK (48K-D) for 2 players — Try and programme a TV network	£12.00
THE COUNT (32K-C) You awake in a brass bed — in a castle — in Transylvanian	£9.00
VOODOO CASTLE (32K-C) Rescue Count Cristo from his fiendish curse!	£9.00
STRANGE ODYSSEY (32K-C) Escape from an anclent allen civilisation	£9.00
ALL THREE ABOVE GAMES ON ONE DISK	£25.00
MYSTERY FUN HOUSE (32K-C) Days of fun, but very difficult!	£9.00
AKALABETH (48K-D) 10 Hires monsters, infinite dungeons, perfect perspective	£21.50
FRACAS (32K-C or D) up to 8 players — monsters, sound — greatC	£13.00
cartoons & lights!	D £15.00 C £10.00 D £12.00
BATTLESHIP COMMANDER (32K — C or D) Strategy with sound,	
HELLFIRE WARRIOR (48K-D) A dreamworld of danger — very difficult!	£21.25
ASTRO APPLE (32K-D) A serious horoscope	£12.50
THE PRISONER (48K-D) A nightmare world of 1984 — avoid brainwashing!	£19.25
COMPUTER NAPOLEONICS (48K-D) Traditional war game — meticulous detail	£37.75
ACANTHOPTERYGIAN FORTUNE TELLING (22K-D) Great for parties!	£10.75
SARGON II (M-24K-D) The champ — No better chess for the Apple	£21.25
COMPUTER BISMARCK (48K-D) Accurate simulation of epic battle	£37.75
A2-FS1 FLIGHT SIMULATOR (M-34K-D) Extended and improved version, including British ACE 3D Aerial Battle Game only	£21.00

PLUS LOTS MORE!! S.A.E. for full list

All programmes in Applesoft, unless M (machine code)  
C — on cassette D — on diskette

VAT ALREADY INCLUDED!! Just add 50p P and P to your order and sned with cheque /P.O. to:—

## GATE MICROSYSTEMS LIMITED



The Nethergate Centre,  
35 Yeaman Shore,  
Dundee.



# INTELLIGENT ARTEFACTS LTD

## MICROS & MICROSYSTEMS

### Home Computers £

ACORN ATOM	150
PET 8K 4008 . . . . .	375
PET 16K 4016 . . . . .	459
PET 32K 4032 . . . . .	559
Cassette . . . . .	39
Toolkit . . . . .	24
Super Pet . . . . .	799
8050 Disk . . . . .	799

### Printers

Epson MX80B . . . . .	359
Centronics 737 . . . . .	349

### Professional Computers

Superbrain	
32K RAM +320K . .	1299
64K RAM +320K . .	1399
64K RAM +688K QD	1699

### North Star Horizon

32K DD dual drive. .	1399
32K QD dual drive .	1549
48K DD dual drive. .	1549
48K QD dual drive. .	1799

### Printers

Diablo . . . . .	1199
Spinwriter . . . . .	1399

IA Software for North Star Horizon Automated Accounts — 520 and  
Stock Control/Invoicing — 299 integrated with  
Automated Accounts

Easily installed into existing Automated Accounts users systems

1 year Guarantee

Prices Ex VAT.

INTELLIGENT ARTEFACTS LIMITED Cambridge Road, Orwell, Royston, Herts.  
Discount Hardware and Software Telephone: Arrington (022020) 689

## P. & R COMPUTER SHOP

EPSON MX-80 80.GPs, DOT MATRIX  
PRINTER WITH SPECIAL INTERFACES.  
3982 IBM I/O PRINTERS. VDU's. ASCII  
KEYBOARDS. ASR. KSR, TELETYPES.  
PAPER TAPE READERS PAPER TAPE  
PUNCHES. SCOPES. TYPEWRITERS.  
FANS 4" 5" 6". POWER SUPPLIES.  
STORE CORES, TEST EQUIPMENT,  
AND MISCELLANEOUS COMPUTER  
EQUIPMENT. OPEN:— MON TO FRI  
9am—5pm SATURDAY TILL 1pm.

COME AND LOOK AROUND

SOLCOTT MILL, GOLDHANGER RD,  
HEYBRIDGE, ESSEX.  
PHONE MALDON 57440

dde

## WHAT IS SPC/1

### SPC/1 is:

A single or true multi user microprocessor system; one to eight users each having up to 48 Kbytes of bank-switched memory and a professional VDU. A good starter and easily expandable.

### SPC/1 is:

DDE-COMAL (extended and structured BASIC); COMAL-B (extended precision COMAL); Pascal; and 8085 Assembler running independently under the MIKADOS real-time multi-process operating system.

### SPC/1 is:

Storage on: 90/280/560 Kbytes mini-floppy; 256K/1M bytes 8" floppy; 10 Mbytes Winchester technology hard-disc; 20 Mbytes hard-disc, whereof 5 Mbytes on cartridge — or a mixture of these.

### SPC/1 is:

A wide range of I/O and communications modules, including graphic video displays and printer interfaces.

### SPC/1 is:

"Word-Work", a ready-to-run screen orientated word processing package written in Pascal — for dedicated WP-systems or as part of multi-purpose systems.

### SPC/1 is:

Mini-facilities at micro prices, the obvious machine for educational or small to medium size business systems — a system that can grow with your requirements.

**digital data electronics ltd**  
clark house, pump lane,  
hayes, middlesex  
01-573-8991/8854



# TRS-80 OWNERS!



## LEVEL II CASSETTE GAMES

Adventures:	
Special Sampler*	£5.50
Adventureland*	£9.50
Pirates Adventure*	£9.50
Mission Impossible*	£9.50
Voodoo Castle*	£9.50
The Count*	£9.50
Strange Odyssey*	£9.50
Mystery Fun House*	£9.50
Pyramid of Doom*	£9.50
Ghost Town*	£9.50
Savage Island*	£9.50
Air Raid*	£8.50
Air Traffic Control*	£7.50
Amazon Mazes	£5.50
Android NIM	£9.50
Backgammon	£6.50
Balloon Race	£6.50
Barricade*	£8.50
Baseball	£6.50
Battleship	£7.50
Bee Wary	£9.50
Bingo	£4.50
Bowling (Ten Pin)	£6.50
Breakaway	£4.50
Bridge Partner	£9.50
Cribbage	£6.50
Death Dreadnaught*	£9.50
Dogstar	£6.50
End Zone II	£6.50
Fastgammon*	£12.00
Galactic Blockade	£6.50
Galactic Empire	£9.50
Galactic Revolution	£9.50
Galactic Trader	£9.50
Galaxy Invasion*	£9.50
Game of Life*	£6.50
Gammon Challenger*	£9.50
Gangster	£5.50
Hangman	£4.50
I Ching	£6.50
Interlude*	£10.50
Invasion Orion*	£12.00
Invaders from Space*	£9.50
Kamikaze	£6.50
Kreigspiel II	£9.50
Life Two	£9.50
Lost Dutchman's Gold	£9.50
Lost Ship Adventure*	£9.50

Mastermind II*	£5.50
Mean Checkers*	£11.00
Morloc's Tower*	£9.50
Noughts & Crosses	£4.50
Othello III	£6.50
Pentominos	£6.50
Pinball*	£9.50
Pork Barrel	£6.50
PR Dogfight	£6.50
Pre School Games	£6.50
Robots	£4.50
Round The Horn	£6.50
Safari	£6.50
Santa Paravia	£6.50
Sargon II*	£18.50
Ship Air Battles	£5.00
Slalom	£5.00
Snake Eggs	£9.50
Space Battles	£9.50
Starfleet Orion*	£12.00
Star Trek III.5	£9.50
Super Nova*	£9.50
Taipan	£6.50
Time Trek*	£9.50
Trek 80	£6.50
Trolls Gold	£4.50
Up Periscope	£9.50
Warfare I	£5.50
X-Wing Fighter II	£6.50

### EDUCATIONAL

Spelling Builder	£12.00
All other PDI Pgms	£9.50

### BUSINESS & UTILITIES

Accounts Receivable II	£13.50
Amateur Astronomer	£9.50
APL-80*	£9.50
Basic 1P*	£11.50
Basic Toolkit*	£11.50
Biorythms	£4.50
Calendar Functions	£7.50
Cash Register	£6.50
Cops*	£9.50
Data Base II	£17.50
Debug*	£12.50
Editor Assembler Plus*	£18.50
Electric Pencil*	£50.00
Electronics Assistant	£6.50
EMU 6502*	£16.00
ESP Tester	£4.50
File Handling	£7.50

Finance Pack	£7.50
Flight Simulator*	£15.00
Forth* (incl. Primer)	£37.50
GSF*	£17.50
General Accounting	£8.50
Ham Radio	£6.50
Histogram/Scattergram	£7.50
Home Finance	£6.50
Infinite Basic*	£31.00
Infinite Business*	£18.50
Instant Calculator	£7.50
Inventory Control	£11.00
Inventory 'S'	£16.00
IRV*	£16.50
Keyboard 80*	£7.50
KVP*	£9.50
Level III Basic*	£30.00
Linear Programming	£7.50
Magic Paper Calculator	£9.50
Mathdrill	£5.00
Maths Library I	£8.50
Maths Library II	£8.50
Memdump*	£8.50
Microtext Editor	£6.50
Mortgage Calculator	£5.00
Pascal*	£26.00
Periodical X-REF	£9.50
Personal Finance	£6.50
Pilot 2.2*	£9.50
Pre-Flight	£9.50
Remodel & Proload*	£23.00
Renumber*	£6.50
RPN Calculator	£6.50
RSM 2 Monitor*	£16.00
SCRIPSIT*	£39.95
Screen Hold*	£6.00
Statistics	£6.50
S.T.A.D.*	£16.00
ST-80*	£30.00
Super Simon	£6.50
Super T-Legs*	£6.50
T-Step*	£7.50
System Copy*	£8.50
T-Short*	£6.50
T-Short**	£12.50
Tarot Cards	£6.50
Teachers Assistant I	£9.50
Teachers Assistant II	£9.50
Timer*	£9.50
Tiny Comp	£12.50
TRS80 Opera*	£6.50

Typing Tutor	£11.50
Ultra Mon*	£15.00
X-Ref*	£9.50
Y-Bar	£9.50
76 Basic Programs	£23.00
Manual for Above	£7.00
Library 100	£40.00

## DISK

Accounts Receivable II	£40.00
Advanced Personal Finance	£15.50
Amateur Radio System	£15.50
APL 80	£30.00
Auto Disk Directory	£9.50
Basic Compiler	£110.00
CCA Data Management	£52.50
Comproc	£13.50
Data Base II	£30.00
DCV-1	£8.50
Dosort	£25.00
Dynamic Data Base	£22.50
Electric Pencil	£75.00
File Manager 80	£30.00
Flopp Disk Diagnostic	£13.50
Forth (incl. Primer)	£45.00
Inventory 2.3	£40.00
Inventory II	£50.00
Inventory 'S'	£40.00
KVP Extender	£16.00
Mailistiv	£45.00
Newdos 80	£87.50
Newdos +	£47.50
Newdos	£30.00
Pencil PAL	£12.00
Roots	£14.50
SCRIPSIT*	£65.00
Simplify It	£15.00
ST80D*	£45.00
ST80D III*	£85.00
SUPERSCRIP*	£17.50
Visicalc*	£65.00
Taranto & Accessories Conversion of Osborne & Associates Business Programmes	£90.00
Cash Journal (for G/L)	£40.00
Invoicing	£90.00
Accounts Receivable	£90.00
General Ledger	£90.00
Complete Co-ordinated System with Manuals	£350.00

## MODEL II

CPM 2.2 X	£165.00
CBasic (CPM)	£80.00
Disk Sort Merge	£87.50
Development System	£70.00
G.S.F.	£30.00
Pascal	from £100.00
Reference II	£30.00
RM Cobol	from £350.00
RSM II Monitor	£30.00
Supersort III (CPM)	£80.00
Utility Package	£87.50
Hard Disk Operating Sys	£250.00

## WORD PROCESSORS

Electric Pencil II (CP/M)	£200.00
Electric Pencil II TRSDOS	£225.00
Magic Wand (CP/M)	£230.00
Wordstar (CP/M)	£275.00

## BUSINESS SYSTEMS

Accounting	from £150.00
Mailist	from £100.00
Medical	from £100.00
Property Analysis	£175.00

## CP/M USERS GROUP

23 Volumes	Each £12.00
------------	-------------

ALL PRICES INCLUDE VAT AT 15% PACKAGING & RETURN POSTAGE TO U.K. ADDRESSES. PRICES TO OVERSEAS ADDRESSES INCLUDE RETURN AIRMAIL. SEND £1.00 FOR NEW DESCRIPTIVE CATALOGUE.

\*Denotes Machine Language TRS-80 Trademark of Tandy Corp. CP/M Trademark of Digital Res. C-Basic Trademark of Compuser Systems.



**MICROCOMPUTER APPLICATIONS**  
11 RIVERSIDE COURT,  
CAVERSHAM,  
READING RG4 8AL,  
ENGLAND.  
TEL: (0734) 470425

ALL TANDY HARDWARE AND SOFTWARE AVAILABLE AT CATALOGUE PRICES

Switch this data terminal off-line...



...and you've got a daisy wheel typewriter.

**SCRIPTA £998 + VAT**  
(RO Version £836 + VAT)

Manufactured in W. Germany by OLYMPIA INTERNATIONAL  
SOLE UK DISTRIBUTOR: DATAPLUS LTD.,  
39-49 Roman Road, Cheltenham GL51 8QQ.  
DATAPLUS Telephone 0242-30030 or 37373. Telex 43594

## THE BASIC HANDBOOK

An Encyclopedia of the Basic Computer Language  
By Dr. DAVID A. LIEN  
360 pages Softback Price £11.70



"Everything you need to know about the most important statements, functions, operators, and commands." (Book Reviewer)

"This book provides the key that can open your computer to programs written in BASIC dialects supplied with more than 50 of the world's most popular computers." (Kilobaud Microcomputing)

"The book is a very useful tool, which covers not only the possible uses, but test methods as well for each command or statement"

"The BASIC Handbook fills a void in the hobby computer field and does it well."

"This book is what has been needed as a universal guide for those like me who are not familiar with all of the various 'dialects' of BASIC."

"This is the only book now available to help software fans convert 'foreign' programs for use on their own computers." (Creative Computing)

Available at bookshops or your local computer store. In case of difficulty, send Cheque/P.O. for £11.70 to the U.K. Distributor



**The Computer Bookshop**

Temple House, 43/48 New Street,  
Birmingham B2 4LH



# INDEPENDENT COMPUTER ENGINEERING LTD

## CROMEMCO SYSTEMS & SOFTWARE

CP/M 2.2 FOR CROMEMCO – £95

### \$100 Peripherals:

Dump your hard disk to 'reel'  
tape in 10 minutes –  
½" 9-track 1600 BPI IBM/ANSI  
compatible tape drive  
+ controller + software – **£2500**

Hard Disk Systems – from £2500

Cartridge Disk – from £3950

## CALIFORNIA COMPUTER SYSTEMS

\$100 Boards and Systems

64K Dynamic RAM (bank select)  
**£350**

ALL PRICES EXCLUDE VAT

Further details, please contact:

ICE Independent Computer Engineering  
16/18 Littleton Road, Ashford,  
Middlesex TW15 1UQ

TELEPHONE : ASHFORD (STD 07842) 47171

TELEX : 8952042 (DPCUST G)



## EPSON MX80 SERIES DOT MATRIX PRINTERS

- \* 9x9 matrix (true descenders lower case)
- \* 80cps bidirectional printing, with 1 logical seeking print head
- \* 96 ASCII character set, plus 64 graphics incorporating 4 switch selectable European language options
- \* Programmable forms handling
- \* 12 different print modes, up to 132 characters per line
- \* Operator controls & indicators, self test
- \* Options – high resolution graphics, dual friction/tractor feed unit
- \* **£395** with standard parallel interface (interface options = RS232, Pet, TRS80, MZ80, Apple)

COMPUTER SOLUTIONS TO BUSINESS PROBLEMS – SOFTWARE PACKAGES/ HARDWARE  
MAINTENANCE/HARDWARE CONFIGURATION & DESIGN

**SPECIAL  
OFFER**

## AS RECOMMENDED BY COMPUTING TODAY – THE CENTRONICS 'MICRO-PRINTER'

Ask most people what they would like as their first peripheral and the chances are they will say "Printer". Here is an attractive electrostatic printer from the famous firm of Centronics. Capable of printing in three sizes of typeface it is easily attached to your machine by way of the parallel interface. The logic is fully TTL compatible and STROBE, Acknowledge and Busy lines are provided to make life easy. "Cost of this wonderful peripheral is a mere **£195.00 + VAT** The printer comes complete with documentation, connector and cleaning paper as well as a roll of the printing paper." (extract from COMPUTING TODAY).

## Ex-STOCK from HENRY'S Ideal for PETS-TANDY-NASCOM's

### Specification

- 150 lines per minute
- Selectable 20 40 80 columns
- 120 m/m aluminium – Finish paper unaffected by Heat, Light or Humidity.
- Full character ASC II set.
- Paper Feed, 220-240AC mains.
- On-Off Print Select.
- Paper Advance – Empty Controls.
- Size 10½ x 13½ x 4½" Weight 10lbs

Ideal for Home or Small Business use.

**LIMITED QUANTITY DON'T DELAY**

Brand new boxed fully  
guaranteed list price of  
this machine. **£459.95 inc.**  
VAT.

OUR PRICE

**£195.00**  
inc of VAT

POST PAID

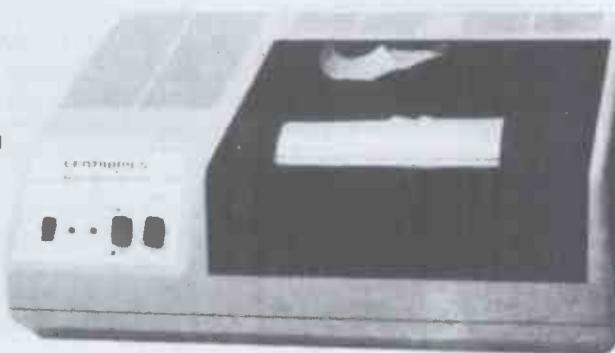

## CENTRONICS QUICK PRINTER

Complete with Full documentation  
connector & Printing Paper –

**HALF PRICE OFFER**

Just Plug in and it's ready to go!

AS RECOMMENDED BY "COMPUTING TODAY" MARCH/MAY 1980

Your London & National Nascom Distributor.  
Export Orders deduct VAT, but add 5% carriage  
Official Export & Educational Orders welcome  
Our Telex 262284 Mono Ref. 1400 Transonics

COMPUTER SEND  
BROCHURE 15p  
FREE STAMP



**Henry's**

Computer Kit Division  
404 Edgware Road, London, W2, England  
01-402 6822



# TRS-80+VIDEO GENIE=MICRO 80

## An equation that solves your micro problems

More and more owners of these two computers are finding that a subscription to MICRO-80 helps them to get the best out of their equipment. MICRO-80 is a specialist magazine devoted solely to these systems. It is full of programs, hardware hints, problem solving and other articles on the TRS-80 and Video Genie.

Find out what you have been missing by completing the coupon and sending with your remittance.

TO: MICRO-80 (UK SUB DEPT)  
24 WOODHILL PARK  
PEMBURY  
TUNBRIDGE WELLS  
KENT TN2 4NW

PLEASE SEND ME A SAMPLE  
COPY OF MICRO-80. I ENCLOSE  
CHEQUE/P.O. FOR £1.50.

NAME.....

ADDRESS.....

.....

.....

.....

PCW 3/81

## ADVANCED COMPUTER EQUIPMENT (LEEDS) LTD

95, MEADOW LANE, LEEDS, 11. Tel. 0532 446960

### New microcomputer store NOW OPEN

# PRICES SHATTERED

<b>COMMODORE PET 12 months warranty</b>	
32K Professional keyboard green screen	£575
Dual disk drive 347k	£625
Cassette deck C2N	£ 50
Printer 3022 Matrix Tractor	£375

<b>APPLE II PLUS 12 months warranty</b>	
48K Auto start	£695
Disk with controller	£345
Disk without controller	£295
Hitachi 9" monitor B/W	£120

<b>SHARP Z80 12 months warranty</b>	
48K with 34K user RAM	£475
36K with 22K user RAM	£422
20K with 6K user RAM	£380
Disk drives, printers etc.	

<b>SUPERBRAIN</b>	
64K with single density 320K disk	£1550
64K with double density 700K disk	£2150
Operating system * MBASIC * COBOL * FORTRAN	

<b>PRINTERS</b>	
BD80P — Hi-speed bi-directional with adjustable tractor feed 750 byte buffer. Fantastic offer £425	
IEEE * Parallel or RS232	
Aichol RP1600 Daisy wheel printer £1150	

<b>SUNDRIES</b>	
Data tapes super quality (10)	£3.75
5½" certified verbatim (10)	£27.00
Plain listing paper 2000 units	£12.50
Books * Games * Programs * galore	
Visicalc * Desktop planner special offer (P+P £1)	

Please add VAT to all goods except books — cash & carry or 24-hour delivery — your choice.  
All equipment is factory fresh and fully tested in our own workshops  
Standard conditions of sale applies to all products.



SOFTWARE ITT 2020 HARDWARE  
 COMPUTING APPLICATIONS  
 PAYROLL ANADEx  
 SPINWRITER Petsoft  
 PALSOFt  
 DOLPHIN CENTRONICS OLYMPIA  
 WORD PROCESSING NETWORKS  
 LEDGERS

# KING OF THE JUNGLE

Lion has tamed the microcomputer market by amassing a wealth of experience in micro-based small business systems, and by selecting the best systems available to market and support.

Lion's Business Systems Division is ready to demonstrate the power and flexibility of the micro in commercial applications, and is backed by Lion's established reputation for professionalism and support.

Phone now, at either location, to arrange a demonstration to show how micro's can help you, and why Lion is King of the Jungle.

Credit cards welcome and lease facilities available.



## LION MICRO-COMPUTER SHOPS LTD.

At Lion House  
 227 Tottenham Court Road London W1P 0HX Tel: 01-580 7383  
 21 Bond Street Brighton Tel: (0273) 601838

## THE WESTFARTHING SMALL BUSINESS SYSTEM

for Apple/ITT 2020 micros

Designed from first principles for the family business, it will pay for itself by keeping the accounts in good order, saving management time on paperwork, and accountants fees.

### FUNCTIONS: (in short, everything you need)

- \* Invoicing (+ discounts, quotations, delivery notes)
- \* Customer accounts and shop sales
- \* Bank and cash balances calculated weekly
- \* Sales and overheads (30 categories) totalled weekly
- \* VAT return calculated (while you have lunch)

### SPECIAL FEATURES FOR OWNER-MANAGERS:

- \* VAT-inclusive bills split automatically
- \* Messages can be printed on invoices
- \* Automatic payment entry when customer pays on the spot
- \* Uses plain fan-fold paper, prints your heading
- \* S/A customer address labels printed
- \* User's Manual (50 pages) in clear, non-technical style
- \* Designed to be user-modifiable

Requires 48K RAM, Applesoft in ROM, 1 or 2 disc drives, printer, Program lives in core. Includes pages of program information, hundreds of REMs, disc map, etc.

Cost: £750 + VAT (£750 only to non-regd trader). For information, send £1 for 10 page description or £10 for User's Manual.

Westfarthing Computer Services Ltd., 21 Wendron St., Helston, Cornwall. Phone Helston (03265) 4098.



...when you need a dependable supplier, an authorised distributor with a comprehensive range of products at keen prices, backed by large stocks for fast delivery, with full after-sales support. We promise you a rapid response.



**ANADEx DP8000**  
 Exceptional value and high reliability. 84 lines per minute, 112 cps. Parallel and serial interfaces as standard. 96 ASCII set, 9 x 7 font. Variable tractor. Forms handling facilities. 1K buffer store. Options include 2K extra store IEEE interface.

from only **£494**

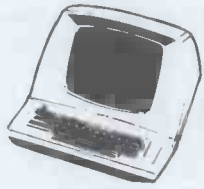

**LEAR SIEGLER ADM-3A**  
 The most popular visual display in the world. 1920 character screen capacity. Cursor addressing. Dual interface. Auxiliary port. Wide range of speed and word formats. Options include Tektronix 4010 compatible graphics.

from only **£450**

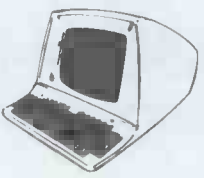

**LEAR SIEGLER ADM-31**  
 Low cost VDU with two page display and full editing features. Dual interface, 50-9600 baud data rates. Upper/lower case character set. Cursor addressing, editing, protected fields, dual intensity. Optional polling and addressing, printer port.

from only **£795**



**LEAR SIEGLER ADM-42**  
 Semi-intelligent VDU with up to 8 pages of display. Full editing features, blinking, blanking, cursor addressing, format transmission, protected fields, dual intensity, separate function keys, status display. Optional alternative character set, programmable function keys, synchronous interface, line drawing set.

from only **£1049**

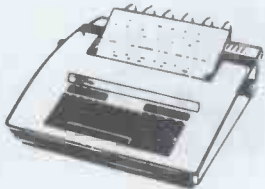

**TELETYPE 43**  
 Versatile, economic and reliable, 30 cps, serial interface keyboard printer. 132 or 80 columns. 94 ASCII set, 9 x 7 font. Crisp, high quality printout. Microprocessor controlled. Portable versions. Character set options.

**SPECIAL OFFER**  
**£625**

### LOW COST GRAPHICS TERMINAL



**£1190**

A low cost Tektronix 4010 software compatible option means that we can offer the well-known Lear-Siegler ADM 3A with powerful graphics capability. A Z-80A microprocessor and RAM sufficient to provide a 512 x 250 dot grid and automatic scaling from a 1024 x 780 dot grid enable point plotting, vector drawing and alphanumeric character display. Call today for a demonstration or more details.

**PERIPHERAL HARDWARE LIMITED**  
 Armfield Close West Molesey Surrey Telex 922175  
**SOUTH** 01-941 4806 **NORTH** Harrogate 501263/4 **IRELAND** Dublin 952316  
 A member of the VOLLWOOD Organisation

## Old tricks for new Pets...

COMMAND-O is a FOUR KILOBYTE Rom for the 4000/8000 Basic 4 Pets with all the "Toolkit" commands RENUMBER (improved), AUTO, DUMP, DELETE, FIND (improved), HELP, TRACE (improved & includes STEP), and OFF - plus PRINT USING - plus four extra disk commands INITIALIZE, MERGE, EXECUTE, and SEND - plus extra editing commands SCROLL, MOVE, OUT, BEEP, and KILL - plus SET user-definable soft key, 190 characters - plus program scroll up and down - plus 8032 control characters on key. Ask for Model CO-60N for the 8032 or CO-40N for the 4016/4032. £50.00 plus Vat

## New tricks for old Pets...

DISK-O-PRO is a FOUR KILOBYTE Rom that upgrades 2000/3000 Pets, but lets you keep all your old software - including Toolkit. As well as REPEAT KEYS and PRINT USING, you get all the Basic 4 disk commands CONCAT, OPEN, OCLOSE, RECORD, HEADER, COLLECT, BACKUP, COPY, APPEND, OSAVE, OLOAD, CATALOG, RENAME, SCRATCH and DIRECTORY - plus extra disk commands INITIALIZE, MERGE, EXECUTE and SEND - plus extra editing commands SCROLL, MOVE, OUT, BEEP and KILL - plus SET user definable soft-key, 80 characters - plus program scroll-up and scroll-down. We recommend the 4040 disk or upgraded 3040 for full benefit of disk commands. Ask for Model ODP-16N for new Pets 2001-3032, and 2001-8 with retrofit Roms & TK160P Toolkit. £50.00 plus Vat, other models available.

PRONTO-PET hard/soft reset switch for the 3000/4000 Pets. We don't think you'll "crash" your Pet using our software, but if you do the Pronto-Pet will get you out! Also clears the Pet for the next job, without that nasty off/on power surge. £9.99 + Vat

## and no tricks missed!

KRAM Keyed Random Access Method. Kid your Pet it's an IBM! VSAM disk handling for 3032/4032/8032 Pets with 3040/4040/8050 disks means you retrieve your data FAST, by NAME - no tracks, sectors or blocks to worry about. Over 2,500 users worldwide have joined the "Klub"! Now you can too, at the 1981 price, £75.00 plus Vat.

SPACEMAKER All our Rom products are compatible with each other, but should you want, say, Wordpro with Kram, or Disk-o-pro with Visicalc, then SPACEMAKER will allow both Roms to address one Rom socket, with just the flip of a switch, for £22.50 plus Vat.

*We are sole UK distributors for all these fine products. If your CBM dealer is out of stock, they are available by mail from us, by cheque/Access/Barclaycard (UK post paid) or send for details.*

# Calco Software

Lakeside House Kingeton Hill Surrey KT27QT Tel 01-546-7256

# Master Your Micro FAST with...

Little Genius floppy diskette based courses will teach you, how to use your system and how to realise the full potential of the "Mighty Micro". These fully interactive computer lessons will guide you quickly to a high level of understanding and confidence in your ability to make the most of your microcomputer system.

Courses now available:

- Applesoft BASIC
- Advanced Applesoft BASIC
- Using your Apple
- Palsoft BASIC
- Advanced Palsoft BASIC
- Using your 2020
- PET BASIC
- Advanced PET BASIC



## Little Genius

Each course, comprising a floppy diskette, and starting instructions, costs only £40.00 plus VAT.

SPECIAL "3 in one" OFFER for 3 courses covering the same system only £99.00 plus VAT.

Little Genius courses are available from most computer retail outlets, or direct mail order from:

### LITTLE GENIUS

Suite 504, Albany House, 324 Regent Street, London W1R 5AA.  
Telephone: 01-580 6361



# BLACK WHITE OR GREEN THE CHOICE IS YOURS.

Black & White model £85.00 + VAT + £4.50 car.  
Green model £95.00 + VAT + £4.50 car.

**OVM Video Monitors:-**  
Precision engineered Video Monitors, with a 9" screen, accepting standard 1.4V P-P inputs at 75 ohms or high impedance.

Metal cased, solid state and reliable, white or green.  
The choice is yours.

# LOWE ELECTRONICS

Bentley Bridge, Chesterfield Road, Matlock.  
Derbyshire. Tel: 0629 2817-2430.

Trade enquiries welcome.



New from Acorn Computers Ltd

# Two Computer Communications Systems

## Econet

The lowest cost computer communication network system available in the world. A ten station network with 400K byte file station costs around £3,000 and as little as £50 for each additional station.

## Cambridge Ring

A very high-speed (up to 20 million bits per second) ultra-low error rate, communications system for micro, mini and mainframe computers and their peripherals.

Now Acorn Computers can offer the very best in computer communications, covering all configurations, all price ranges. No other company can offer our experience and range of services.

For full details of Econet or Cambridge Ring please write to: Chris Curry, Acorn Computer Limited, 4a Market Hill, Cambridge CB2 3NJ.



**VIDEO DISPLAY UNIT  
TEX VT64 - £299**

★  
**UNIVERSAL KEYBOARD  
TEX KB62 - £99**

★  
**VT64 & KB62 - £389**

- 16 x 64 FULL SCREEN REWRITE IN 0.5 SECONDS.
- 128 CHARACTER U/L SET + FULL CURSOR/SCREEN CONTROLS.
- FOUR-TONE 'BEL': V24/20mA. 50-19200 BAUD.
- KEYBOARD INPUT PORT ACCEPTS & POWERS MOST TYPES.
- UPGRADEABLE TO 24 x 80 VT80 DURING 1981.
- KB62 HAS 464 x 8-BIT KEYCODES IN EPROM.
- 62 KEYS WITH DEDICATED CURSOR & USER FUNCTIONS.
- QUALITY 'FEEL': ALPHA-LOCK. AUTO-REPEAT.
- QUAD-MODE ENCODING. 2/N-KEY ROLLOVER/LOCKOUT.
- LATCHED DATA. ± STROBE. CONTACTS OF USER KEY.
- KB16 SEPARATE ADD-ON NUMERIC PAD DURING 1981.

### TEX EPROMPT ERASER - £39 inclusive



- SIMPLE 32-CHIP 1/2 HOUR PROCESS ON 200-250V A.C.
- TUBE RUNS COOL AT EXACT WAVELENGTH FOR EPROMS.
- 16-CHIP INTERLOCKED-DRAWER 'GT' MODEL £45 INCL.
- SOLID-STATE 30-MINUTE TIMER UNIT £15 INCL.

VT64/KB62 prices exclude shipping and value added tax.  
Terms C.W.O.C.O.D. or trade references for credit.

Trade enquiries invited for substantial discounts.  
O.E.M. quantities available with custom trim.

All orders and enquiries post-free to:-

**TEX MICROSYSTEMS LTD. FREEPOST**  
ST. ALBANS, HERTS. AL1 1BR TRING 4797/ST. ALBANS 64077 (DAY/NIGHT)

# HIRE

Hire from	Bargain Inc VAT	New Ex VAT
£20	PET 8K	£320
£25	PET 32K	£500
£25	TRS80	£280
	ITT2020 48K	£600
£18	SOCCERER 32K	£400
£68	SUPERBRAIN 64K	£1450
£60	HORIZON 56K	£900
£28	Euro & Apple II 32K	£610

# SALES or LEASE or EXCHANGE

NEC PRINTER . . . . . £1350 + VAT  
CENTRONICS 779 . . . . . £500 + VAT

APPLE II Guaranteed EUROPLUS.  
Price 32K £610 + V.A.T. Lots of exciting software, all types of cards: Asteroids in space, Zork Adventure, Rainbow software, hire text graphics space invaders. Z80 Card/CPM/COBOL, PASCAL, FORTRAL, ALL NEW

**SUPERBRAIN 64K**  
£1450 + VAT  
HIGH LEVEL LANGUAGES AVAILABLE

# PROMGLOW Ltd

01-368 9002 + EVENING  
12 DENE ROAD  
LONDON, N.11.

# Mini-Digital Cassette Recorder

## An alternative to disc for program & data storage

### FEATURES

- \* The Philips MDCR 220 mechanism of proven reliability
- \* Holds up to 120k Bytes/Cassette with fast data transfer
- \* Extra memory board with RAM and ROM to hold operating software
- \* Will read & write (in blocks from 256 bytes to 60k Bytes), backspace & search for end of data on tape
- \* Compatible with 6502 based systems ie PET, AIM65, OHIO, KIM, COMPUKIT ETC.

LIMITED OFFER TILL END OF APRIL £195 + VAT

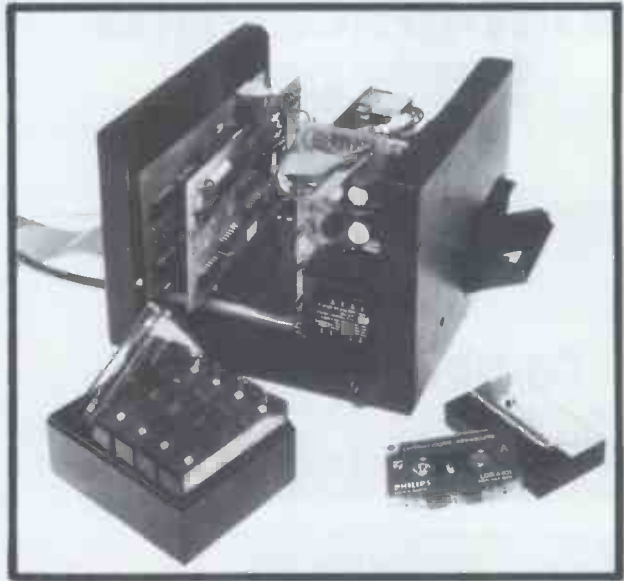

### PRICES (INCLUDING MANUAL)

MINI RECORDER MECHANISM	£95.00
INTERFACING BOARD (TYPEA)	£42.50
MEMORY BOARD (WITH ROMS FOR 6502)	£55.00
CASSETTES (BOX OF 6)	£15.90
CARRIAGE	£2.25

PRICES EXCLUSIVE OF VAT @ 15%

# CURRAH

## COMPUTER COMPONENTS

Unit 7 Hartlepool Workshops, Sandgate Industrial Est.  
Hartlepool, Cleveland

# BFI THE SOURCE.

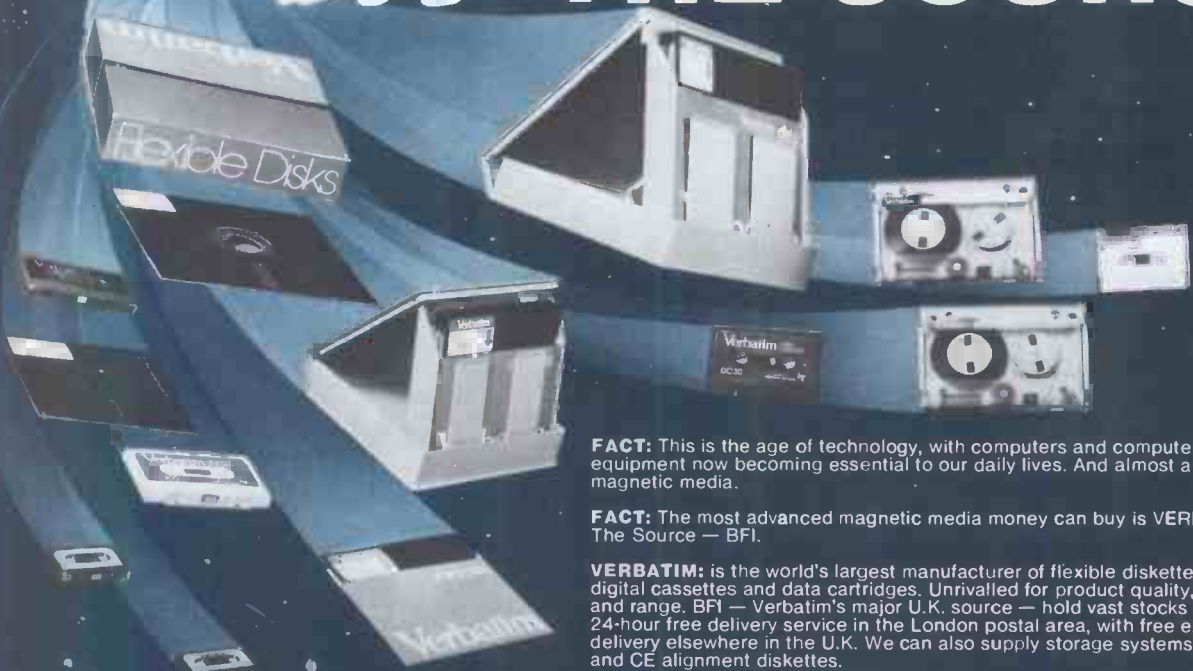

**FACT:** This is the age of technology, with computers and computer-based equipment now becoming essential to our daily lives. And almost all use flexible magnetic media.

**FACT:** The most advanced magnetic media money can buy is VERBATIM. The Source — BFI.

**VERBATIM:** is the world's largest manufacturer of flexible diskettes, minidisks, digital cassettes and data cartridges. Unrivalled for product quality, technology and range. BFI — Verbatim's major U.K. source — hold vast stocks and offer a 24-hour free delivery service in the London postal area, with free express delivery elsewhere in the U.K. We can also supply storage systems, cleaning and CE alignment diskettes.

GO DIRECT TO THE SOURCE. CALL BFI.

# BFI

BFI Electronics Ltd.,  
516 Walton Road,  
West Molesey,  
Surrey KT8 0QF  
Telephone 01-941 4066  
Telex 261395



# Now, for every Atom owner . . . Atomic games!

Make even more of your Acorn Atom with these, the first in a fast-growing range of imaginative, challenging and sophisticated games!

## Games Pack 1

**ASTERIODS.** Shoot them down before you collide.  
**SUB HUNT.** Choose your course and speed to catch enemy subs.  
**BREAKOUT.** Score points for knocking bricks from wall.

## Games Pack 2

**DOGFIGHT.** Shoot down your opponent without crashing into stars.  
**MASTERMIND.** Guess the computer's code.  
**ZOMBIE.** Lure all the zombies into the swamp to survive.

## Games Pack 3

**RAT TRAP.** Entangle your opponent before he entangles you. Action replay feature.  
**LUNAR LANDER.** Altitude, fuel, drift velocity.  
**BLACK BOX.** Deduce the position of four invisible objects.

## Games Pack 4

**STAR TREK.** The classic computer game. The Universe versus the Klingons.  
**FOUR ROW.** Beat the computer to get four marbles in a row.  
**SPACE ATTACK.** Save the earth from invasion.



## Utility Pack 1

**SOFT VDU.** Replaces the Atom VDU to give 128 characters, upper and lower case, mathematical symbols, etc.

### Order today!

Just send a cheque or money order for £11.50 (inc VAT and p&p) per Pack, stating which Pack you want, or write for full details to Acorn Soft Limited, 4a Market Hill, Cambridge. Allow 14 days for delivery.

**ACORNSOFT**

# Happy Memories

4116	200ns	£2.25	2114	200ns	£2.95
2114	450ns	£2.20	2716	5V	£5.28
2708	450ns	£3.95			

Memorex soft-sectored mini-discs with free plastic library case £19.95 per 10.

Low profile I.C. sockets:

Pins:	8	14	16	18	20	22	24	28	40
Pence:	10	11	12	16	17	19	21	28	37

Memory Upgrade Kits for TRS-80, Apple, 20-20 etc from £18.00

Please phone (054-422) 618

**ALL PRICES VAT INCLUSIVE**

Please add 30p postage to orders under £15.  
Government + Educational orders welcome  
£15 minimum

Dept PCW

Happy Memories  
Gladestry  
Kington  
Herefordshire  
HR5 3NY

Tel: (054 422) 618



BARCLAYCARD



# BITS & P.C.s

## COMPUTER PRODUCTS LTD

### The North's Leading Nascom Specialist

## NEW PRODUCTS FOR NASCOM

### PROGRAMMABLE CHARACTER GENERATOR FOR NASCOM 2

Gives 64 Programmable characters 8,192 Programmable dots.  
Free demonstration software. Ask for details. £60.00

### DISCS:

Single drive £380.00  
Double drive with CPM & EBASIC £640.00

Ask for details. Professionally designed for your NASCOM.

### KENILWORTH CASE:

A high quality case made from stelvete coated steel and solid mahogany £49.50

Mounting kit for two cards £3.50

Mounting kit for five cards £19.50

### SARGON CHESS PACK:

This pack includes the book and a tape with Sargon prepared to run under NAS-SYS. Also included is a special graphics rom and a PCB giving your NASCOM the ability to switch between two graphics ROMs, your original and the chess ROM.

All the above for only £35.00

### EPROM PROGRAMMER

This unit allows a NASCOM user to program both 2708 and 2716 EPROMS. Complete with operating software £25.95

### EPROM ERASER

Erasers 24 EPROMS in twenty minutes £35.00

EPSON MX80 £360.00

SEICOSHA GP80 £250.00

NASCOM interfacing details supplied

SHARP MZ80K (48k RAM) £460.00

PC1211 procket computer £82.00

PC1211 cassette interface £13.00

PC1211 printer £85.00

### INTERFACE EPROM BOARD:

Provides sockets for both 2708 and 2716 EPROMs (up to 16 EPROMs) and also provides a fully decoded socket for the NASCOM 8K BASIC ROM. This board is produced to full NASBUS specification and can be used in "page mode" together with the new NASCOM RAM B. Wait states may be generated on board to allow a NASCOM 1 to run at 4MHz in BASIC.

The complete kit at only £55.00

### CASTLE INTERFACE:

Gives the following features: Auto tape drive \* Auto cassette muting \* Auto serial printer muting \* 2400/1200/300 BAUD cassette. This interface built and tested complete with documentation at only £17.50

### ASTECC 10" B/W MONITOR:

A professional cased 10-inch Monitor giving superb resolution, only £82.00

### ANALOGUE TO DIGITAL CONVERTER:

This unit gives 4 channels with an Input Range of 0 to 120mV up to 0 to 24V. Conversion time (average) 0.5 mSec. Supplied built and tested at only £49.50

### DUAL MONITOR:

This kit allows switching between two monitors on a NASCOM 1 e.g. T4 and NAS-SYS £6.50

### PORT PROBE:

A very useful device for testing and evaluating ports and peripheral software with improved documentation £17.50

### HEX AND CONTROL KEY PADS:

Our popular range of add-on keyboards for the NASCOM micros.

HEX for NASCOM 2 £34.00

HEX & CONTROL KEYS for NASCOM 1 £40.50

### PROGRAMMERS' AID:

In 2 2708 EPROM gives the NASCOM rom BASIC many extra commands: AUTO, RENU, DELE, DUMP, FIND, HEX, APND, HELP. . . etc. £28.00

### BITS & P.C.s GAMES TAPE 1:

Good value, ten excellent games £8.00

**BUILT SYSTEMS REPAIRS MAIL ORDER and ADVICE are our SPECIALITY.**

BITS & P.C.s Computer Products Ltd.  
4 Westgate, Wetherby, West Yorkshire.  
Tel: 0937 63744.

SAE for details: prices exclude VAT and postage and package.

BARCLAYCARD

VISA



MasterCard

MasterCard

MasterCard

MasterCard

MasterCard

MasterCard

MasterCard

MasterCard

MasterCard

MasterCard

MasterCard

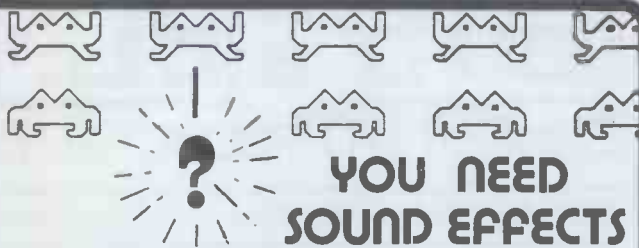

## YOU NEED SOUND EFFECTS

FOR PET, SUPERBOARD, UK101, NASCOM.

- \* COMPLEX EFFECTS AND MUSIC
- \* USES INCREDIBLE AY-3-8910
- \* COMPLETELY BUILT, SIMPLY PLUGS IN
- \* BASIC OR MACHINE CODE
- \* BUILT IN AMP & SPEAKER + STEREO
- \* INCLUDES 2 8 BIT I/O PORTS
- \* COMATIBLE WITH OTHER EXPANSIONS
- \* FREE DEMO PROGRAM + INSTRUCTIONS

**£43**  
+ VAT  
EX STOCK

Send for free information leaflets.

NB: 8T28 buffers (Superboard/UK101) next 6502 @ £3.00 per pair if required

**SOON** EPROM Programmer for Superboard/UK101.

**AVAILABLE!!** Peripheral board 24 I/O lines for relay driving etc., etc.

PHONE, WRITE FOR DETAILS.

**SUPERBOARD II 50Hz → £159 + VAT**

610 EXPANSION £159 + VAT  
CD3P FLOPPY DISC £285 + VAT  
BASE 2 800MST PRINTER £359 + VAT

### SOFTWARE EXAMPLES

Nascom — Star Trek Basic 16k @ £6.75  
Pet — Cribbage Profesional 24k @ £14.95

List of Pet, Nascom,  
Superboard + UK101  
Software free.

Trade enquiries welcome. Send for extensive software list.

Telephone orders Welcome  
0603 416352

**.Easicom**

57 PARANA COURT SPROWSTON  
NORWICH NR7 8BH 0508 46484



# COMPUTERS

From as little as £20 per week for your own business system with video screen, keyboard, twin floppy disk unit and printer. Choose any of the software programs available i.e.:

- ★ Word processing
- ★ Payroll
- ★ Invoicing
- ★ Stock control
- ★ Book-keeping
- ★ Incomplete records
- ★ Time recording
- ★ Information retrieval
- ★ Cash flow
- ★ Projection analysis

And when you've finished your easy days work we've got a few games for you to relax to including Space Invaders.

We have first hand experience in dealing with businesses and can offer you expert advice in setting up your very first system. We can also offer installation, training and maintenance contracts.

**NOW IS THE TIME**

#### EXTRAS & OPTIONS

Floppy disks  
Continuous Stationery  
Dustcovers  
Automatic sheet feeder  
Tractor feed  
Daisy wheels  
Printer ribbons

#### Special desk work station

Lockable disk boxes  
Payslips  
Sound boxes  
**HARDWARE**  
CBM 3032 Computer  
CBM 3040 Floppy  
CBM 3022 Printer

#### CBM 8032 Computer (new model)

CBM 8050 Floppy (New model)  
Qume Springs Daisy Wheel Printer  
**SERVICES**  
Installation  
Training  
Maintenance  
After Sales Service

Call into the

**DA VINCI COMPUTER SHOP**

65 High St., Edgware, Middx.

Tel. 952 0526

Open Mon-Fri. 9-5.30. Sat 9.30-5.00  
or send for details



BARCLAYCARD

VISA



Floppy Discs £2 each + VAT.

Qume sprint 5 £1,595 + VAT.

CBM 8026 Daisywheel Printer inc Keyboard

£995 + VAT.

# Arcade Invaders—it's the best!

## For Tandy TRI-80 and video Genie

Not another micro Invaders, but the real thing at last — exactly as you see in the pubs, clubs and motorway services.

Better in fact, for unlike those, this one has different levels of play from amateur up to expert. You have to be on your mark to beat it on amateur level, but on the top levels you will find it hard to obtain even a modest score, as the level selected determines the laser base lives, the speed and the number of bombs falling.

Unlike the normal 'micro' Invaders, this one has four different types of aliens, each with a different score rating, in addition to the mother ship zooming past from time to time.

You have a laser to destroy the aliens, with ultimate control over its direction and the firing of the 'missiles'. But in addition to destroying the invaders, you have of course to dodge the bombs as well.

Initially the game starts with 44 aliens, dropping their bombs and shuffling down lower and lower. If they reach your bases then the bases will be destroyed, and the game ends, as it will if the bombs get all your laser lives.

If however you manage to destroy all the aliens, you will proceed to another game with the score being added, and bonus bases being given.

Three scores are kept. The current one, the last one and the best to date.

Unlike the other 'Invaders', this one is suitable for the Video Genie as well as the Tandy, as the firing is displayed by graphic blocks, and not square brackets as are the others.

And of course there's sound — realistic sound too, adding more to the sheer realism of the game.

It's from Kansas—and only from Kansas—which means it's good and at a sensible price £9.50.

All prices VAT paid and post free. First class return post service. Barclay-card, Visa orders dispatched same day if phoned in by 3pm. Answering machine ordering service after 6pm and Sundays to allow use of cheap rate. Catalogue available on request.

# Kansas

Kansas City Systems, Unit 3, Sutton Springs Wood, Chesterfield, Derbys. Tel 0246 850357



# CBM now down £300 +

NE W 4000 Series with 2.1 DOS and 4.0 BASIC

**SUPER NEW DEAL £1699 ex. VAT.**  
CWO

For all this :

4032 Computer + 4040 Disc + 3022 tractor  
printer + 2 Cables + c2N cassette + PET  
Revealed.

\* Commodore price for 3000 Series +2.1  
DOS and 4.0 Basic equivalent to above was  
£2001 ex. VAT.

## Hurry! The PET is gone

**GET ONE WHILST YOU CAN!**  
2008 (Old Keyboard) £365.00  
3016N £485.00

(money with order price ex. VAT)

Our prices are lower than many unofficial  
sources but we ARE OFFICIAL DEALERS

## CCS MICROHIRE

16K Microcomputer £89/month — 32/48K £99  
2 — Discs £89/month

CCS MICROHIRE/MICROSALES

7 The Arcade  
Letchworth  
Herts

Telephone (04626) 73301

# OHIO SCIENTIFIC COMPUTERS

**SUPERBOARD 3 SPECIAL OFFER  
OF THE CENTURY.**



Only Swanley could do it!  
For just £159 we will supply Superboard 3 with a free power supply and modulator kit and our free guard band kit (A brilliant break through in itself for this kit extends the display to 32 x 32, allows 1200 as well as 300 Baud tape speeds, increases the computing speed by 50% and converts the display to 50Hz for flicker free viewing).

**CHEAPO EXPANSION OFFER**

Buy a 610 expansion board with 8K ram on board and space for another 16K for £159 and get a free 5V 4A power kit and any extra ram you want for £3/K. Buy a mini-floppy + case + power supply + 2 copies of DOS for £275 and we will do the extra ram for £2/k (Max 16K). We can also supply a version to suit UK101.

**SUPERBOARD ACCESSORIES**  
4K extra RAM £16.95. Case £27  
Cassette recorder £17. Degmon improved monitor ROM £29.50.  
Assembler/Editor tape £25.  
Word processor £10. Guard bank kit £10. Display expansion kit 30 lines x 54 characters for Superboard 2 (Not 3) £20.

## PRINTERS



Buy any of the below and get a free interface kit and word processor program for UK101 or Superboard. OKI Microline 80 (Illustrated) £329. Base 2 800 MST £299. Seikosha GP80 £225.

## SERIES 2 challenger

Official Ohio 8K version £259. Cheapo version (made in Swanleyland) 4K £202.

## 5V POWER KITS

Fully stabilized 5V computer and TTL power kits. Automatic current limiting and short circuit protection. Crowbar over-voltage protection. 1½A £7.83, 3A £10.44, 6A £17.39.

2114 450ns £2.15, 4116 200ns £2.83, 4027 £1.30. All low current.

## SWANLEY ELECTRONICS

Dept. PCW, 32 Goldsel Rd., Swanley, Kent BR8 8EZ

Telephone Swanley 64851. Please add 40p postage. Prices include VAT unless stated. Lists 27p post free. Overseas customers deduct 13%. Official credit orders welcome.

**SHARP**

# MZ-80K



48K RAM MODEL £470 + VAT  
MZ80 FD DUAL FLOPPY DISK DRIVES  
MZ80 P3 PRINTERS  
PC1211 POCKET COMPUTER £86.91 + VAT  
SOFTWARE ALL IN STOCK  
DISCOUNT PRICES AND REPAIR  
FACILITIES FOR SHARP, COMMODORE  
etc.  
COMMERCIAL COMPUTER SYSTEM  
DETAILS ON APPLICATION

Royal London House  
196-198 Deansgate  
Manchester M3 3WE

**Sumlock**  
Manchester

## ANGLIA COMPUTER CENTRE

MICROCOMPUTERS FOR BUSINESS,  
EDUCATION AND HOME

FOR ALL YOUR BUSINESS, EDUCATION & LEISURE  
COMPUTER REQUIREMENTS!!!

APPLE II  
TRS-80  
SHARP  
NORTH STAR  
HORIZON  
TANGERINE  
J.K. 101  
NASCOM

+PRINTERS AND  
OTHER PERIPHERALS  
BOOKS\*\*  
SOFTWARE\*  
MAGAZINES\*\*  
STATIONERY\*\*\*

BUSINESS+  
INDUSTRIAL  
CONTROL

**WE ARE HERE!!!**

88 St. Benedict's Street  
NORWICH NR2 4AB  
Tel. (0603) 29652  
24hr. Answering Service.

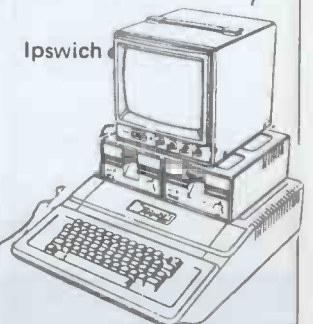
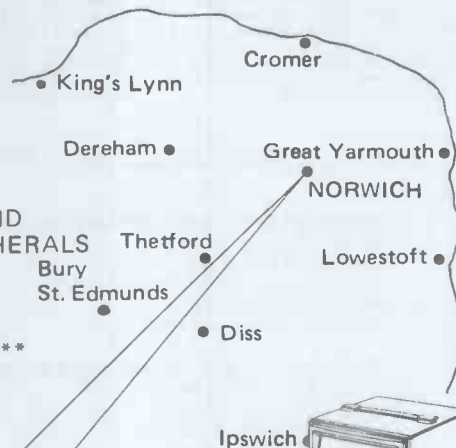

# NewBear

Computing Store Ltd



**BETTER PRICES!  
BETTER DELIVERY!  
WIDEST RANGE OF  
SOFTWARE**

For the best deal from the largest sharp dealer phone Newbear (0635) 30505

**SHARP**

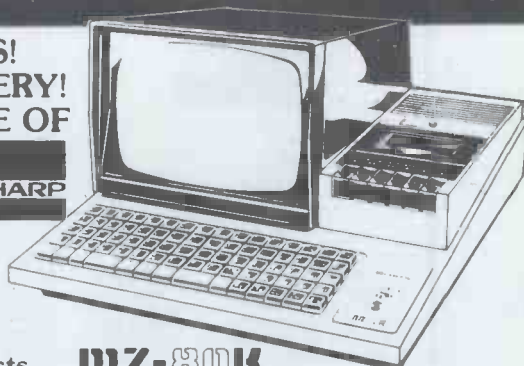

**MZ-80K**

Many unique products Zen/Listings/Word Proc,

Apple II plus  





For ex-stock delivery 12 months warranty

**ACORN  
PROM PROGRAMMERS  
PROM ERASERS  
KEYBOARDS  
5 1/4 AND 8"  
DISC DRIVES  
WIDEST RANGE  
OF BOOKS IN U.K.**

and Bear care  
Bear Bargains

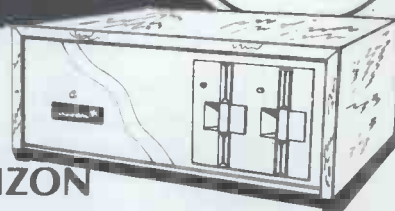
NORTH  
STAR



★ HORIZON

Installed on your site with full field service anywhere in U.K. fully C.P.M. compatible. Chosen by Newbear for its reliability and performance.

64K Dual Drive Quad	£1995.00
North Star Horizon	
Newbury Laboratory 7009 terminal	£795.00
Citoh8300 R.M. Printer	£499.00
CPIM 2.2.	£95.00

Please send urgently:

Sharp  B  
 North Star Horizon  Cat.   
 Booklist  Citoh  N.L. Terminals   
 Please contact me  Phone No. ....  
 Name .....  
 Address .....

**NEWBEAR COMPUTING STORE LTD. (HEAD OFFICE)**  
 40 BARTHOLOMEW STREET, NEWBURY, BERKS  
 TEL. (0635) 30505 TELEX 848507 NCS  
 FIRST FLOOR OFFICES, TIVOLI CENTRE, COVENTRY ROAD,  
 BIRMINGHAM. TEL. 021 707 7170  
 220-222 STOCKPORT ROAD, CHEADLE HEATH, STOCKPORT.  
 TEL. 061-4912290

DEVELOPED BY G.W. COMPUTERS LTD  
 NOW AVAILABLE FOR DEMONSTRATION IN THE NORTH  
**Freshfield Computer Services**

MAIN MENU DISPLAY

\* PROGRAMS ARE INTEGRATED ...

SELECT FUNCTION BY NUMBER ...

- 01- \*ENTER NAMES AND ADDRESSES
- 02- \*ENTER/PRINT INVOICES
- 03- \*ENTER A/C RECEIVABLES
- 04- \* ENTER PURCHASES
- 05- \*ENTER A/C PAYABLES
- 06- \*ENTER/UPDATE INVENTORY
- 07- \*ENTER/UPDATE ORDERS
- 08- \*ENTER/UPDATE BANKS
- 09- \*REPORT SALES LEDGER
- 10- \*REPORT PURCHASE LEDGER
- 11- \*INCOMPLETE RECORDS
- 12- \*USER DBMS AREA

- 13- \*PRINT CUSTOMERS STATEMENTS
- 14- \*PRINT SUPPLIER STATEMENTS
- 15- \*PRINT AGENT STATEMENTS
- 16- \*PRINT TAX STATEMENTS
- 17- \*LETTER TEXT AREA
- 18- \*ALTER VOCABULARIES
- 19- \*PRINT YEAR AUDIT
- 20- \*PRINT PROFIT/LOSS A/C
- 21- \*OPEN AREA
- 22- \*PRINT CASHFLOW FORECAST
- 23- \*ENTER PAYROLL (NO RELEASE)
- 24- \*DISK SWAP/EXIT

FOR FULL DETAILS SEE GW COMPUTERS AD

SUPERBRAIN + SUPERBRAIN + SUPERBRAIN  
 SUPERBRAIN 320K 1695.00  
 SUPERBRAIN 800K 2195.00  
 PRINTERS + PRINTERS + PRINTERS + PRINT  
 NEC-5530PRINTER 1595.00  
 MICROLINE 80 120CPS 475.00

SOFTWARE + SOFTWARE + SOFTWARE  
 BUS VER 6.00 CP/M 775.00  
 BUS VER 7.00 CP/M 875.00  
 BUS VER 8.00 CP/M 975.00  
 BUS VER 9.00 CP/M 1075.00

PLUS: Word Star — Mail Merge — MBasic 80 —  
 Supersort  
 PLUS: Graham Dorian Software Systems —  
 Payroll, Stock Control, Ledgers etc.

Demonstrations by Appointment only

CONTACT DAVID MAWDSLEY ON FORMBY (07048) 79186  
 RIPLEY HOUSE, 56 FRESHFIELD ROAD, FORMBY, MERSEYSIDE L37 3HW

**WILLESDEN COLLEGE OF TECHNOLOGY  
 SCIENCE DEPARTMENT  
 MICROPROCESSOR COURSES**

8 WEEK INTENSIVE (Wednesday Evenings)  
 Hardware, Software, Architecture and Applications of 8 bit Micros.  
 STARTING DATE 29th April  
 Fee £35

1 YEAR PART-TIME ADVANCED COURSE  
 (Wednesday Afternoon)  
 Software tools for 8080 Z80 6800 6809 6502 and PDP11. By courtesy of the Forth Interest Group the College is able to supply course participants with software for the above processors.

STARTING DATE Wednesday 30th September  
 Fee £25 + £30 for course material copy costs.

For further details telephone 01-451 3411,  
 or

write to Science Department, Willesden  
 College of Technology, Denzil Road,  
 London NW10.



**The Sinclair ZX80 is innovative and powerful.  
Now there's a magazine to help you get  
the most out of it.**

# Get in sync



SYNC magazine is different from other personal computing magazines. Not just different because it is about a unique computer, the Sinclair ZX80 (and kit version, the MicroAce). But different because of the creative and innovative philosophy of the editors.

## A Fascinating Computer

The ZX80 doesn't have memory mapped video. Thus the screen goes blank when a key is pressed. To some reviewers this is a disadvantage. To our editors this is a challenge. One suggested that games could be written to take advantage of the screen blanking. For example, how about a game where characters and graphic symbols move around the screen while it is blanked? The object would be to crack the secret code governing the movements. Voila! A new game like Mastermind or Black Box uniquely for the ZX80.

We made some interesting discoveries soon after setting up the machine. For instance, the CHR\$ function is not limited to a value between 0 and 255, but cycles repeatedly through the code. CHR\$(9) and CHR\$(265) will produce identical values. In other words, CHR\$ operates in a MOD 256 fashion. We found that the "=" sign can be used several times on a single line, allowing the logical evaluation of variables. In the Sinclair, LET X=Y=Z=W is a valid expression.

Or consider the TL\$ function which strips a string of its initial character. At first, we wondered what practical value it had. Then someone suggested it would be perfect for removing the dollar sign from numerical inputs.

Breakthroughs? Hardly. But indicative of the hints and kinds you'll find in every issue of SYNC. We intend to take the Sinclair to its limits and then push beyond, finding new tricks and tips, new applications, new ways to do what couldn't be done before. SYNC functions

on many levels, with tutorials for the beginner and concepts that will keep the pros coming back for more. We'll show you how to duplicate commands available in other Basics. And, perhaps, how to do things that can't be done on other machines.

Many computer applications require that data be sorted. But did you realize there are over ten fundamentally different sorting algorithms? Many people settle for a simple bubble sort perhaps because it's described in so many programming manuals or because they've seen it in another program. However, sort routines such as heapsort or Shell-Metzner are over 100 times as fast as a bubble sort and may actually use less memory. Sure, 1K of memory isn't a lot to work with, but it can be stretched much further by using innovative, clever coding. You'll find this type of help in SYNC.

## Lots of Games and Applications

Applications and software are the meat of SYNC. We recognize that along with useful, pragmatic applications, like financial analysis and graphing, you'll want games that are fun and challenging. In the charter issue of SYNC you'll find several games. Acey Ducey is a card game in which the dealer (the computer) deals two cards face up. You then have an option to bet depending upon whether you feel the next card dealt will have a value between the first two.

In Hurkle, another game in the charter issue, you have to find a happy little Hurkle who is hiding on a 10 X 10 grid. In response to your guesses, the Hurkle sends our a clue telling you in which direction to look next.

One of the most ancient forms of arithmetical puzzle is called a "boomerang." The oldest recorded example is that set down by Nicomachus in his *Arithmetica* around 100 A.D. You'll find a computer version of this puzzle in SYNC.

## Hard-Hitting, Objective Evaluations

By selecting the ZX80 or MicroAce as your personal computer you've shown that you are an astute buyer looking for good performance, an innovative design and economical price. However, selecting software will not be easy. That's where SYNC comes in. SYNC evaluates software packages and other peripherals and doesn't just publish manufacturer descriptions. We put each package through its paces and give you an in-depth, objective report of its strengths and weaknesses.

SYNC is a Creative Computing publication. **Creative Computing** is the number 1 magazine of software and applications with nearly 100,000 circulation. The two most popular computer games books in the world, *Basic Computer Games* and *More Basic Computer Games* (combined sales over 500,000) are published by Creative Computing. Creative Computing Software manufactures over 150 software packages for six different personal computers.

Creative Computing, founded in 1974 by David Ahl, is a well-established firm committed to the future of personal computing. We expect the Sinclair ZX80 to be a highly successful computer and correspondingly, SYNC to be a respected and successful magazine.

## Order SYNC Today

Right now we need all the help we can get. First of all, we'd like you to subscribe to SYNC. Subscriptions are posted by air directly from America and cost just £10 for one year (6 issues), £18 for two years (12 issues) or, if you really want to beat inflation, £25 for three years (18 issues). SYNC is available only by subscription; it is not on newstands. We guarantee your satisfaction or we will refund the unfulfilled portion of your subscription.

Needless to say, we can't fill up all the pages without your help. So send in your programs, articles, hints and tips. Remember, illustrations and screen photos make a piece much more interesting. Send in your reviews of peripherals and software too—but be warned: reviews must be in-depth and objective. We want you to respect what you read on the pages of SYNC so be honest and forthright in the material you send us. Of course we pay for contributions—just don't expect to retire on it.

The exploration has begun. Join us.

The magazine for Sinclair ZX80 users  
**SYNC**

27 Andrew Close  
Stoke Golding  
Nuneaton CV13 6EL, England

# The 4th Personal Computer World Show

Cunard Hotel Hammersmith 10-12 September 1981



**The Show which brings your market direct to you . . .**

The Personal Computer World Show is the only exhibition exclusively for the small computer industry. It is your opportunity to meet, face-to-face, potential buyers who visit the Show specifically to see demonstrations and discuss the application of your products.

**This is the Show where buyers come to buy ... not just look.**

To discuss how the 4th Personal Computer World Show could form the focus of your 1981 promotional calendar contact Timothy Collins on 01-486 1951 or write to him at Montbuild Ltd, 11 Manchester Square, London W1.



# ADVERTISERS INDEX

Abacus	166	Cumana	59	Interface Software	20,170	Newbury	71
Acorn	114,185	Currah	184	Intex Datalog	18	Newtronics	153
Adda	5	Data Applications		JCL Software	169	NIC	162
Adler	17	International	127	John Wiley	25	Northamber	8
Advanced Computer		Data Bank	175	Kansas City	186	Oasis Soft	158
Equipment	180	Data Plus	178	Keen	10,11	Ohio Scientific	27
Algray	35	Davinci Comp	186	Leicester Comp		Patchwood	162
Almarc Data		Deans	160	Centre	160	Personal Computers	OBC
Systems	7,33,35	Digital Data	177	Linsack	174	Pete & Pam Computers	12
Anglia Comp Centre	187	Digital Design &		Lion House	181	Phipps	6
APE (Far East)	79	Development	18	Little Genius	182	PHL	181
Arden Data	172	Display Electronics	161	Liveport Data		P & R Computer Shop	177
Avery	26	D.R.G. Business		Products	120	Promglow	183
Beaver Systems	26	Machines	33	L & J Computers	108	Program Power	92
BFI Electronics	184	Easi Comp	186	Logic Box	158	Quadraphenia	169
Bits & Pc's	185	Elfton	160	Lombardy Scientific	170	Qupro	56
Bug Byte	164	Elektor Publishers	168	London Computer		Rair	74
Butel	88,104	Environmental		Faire	173	Robal Business Comps	171
Butterworths	172	Equipment	152	London Computer		Science of Cambridge	72,73
Calco	182	Equinox	100	Centre	36,171	Silica Shop	167
Cambridge Comp		Essential Software	2	Low Electronics	182	Sirton	157
Store	108	Ferguson Computers	32	LP Enterprises	22,23	Software House &	
Camden Electronics	174	Freshfield Computers	188	Melbourne House		Mad Hatter Software	58
Castle Electronics	3	Gate Microsystems	176	Publishers	92	Stack	21
CCS Microhire	187	GP Industrial	175	Metrotek	9	Strumech	30
Chromasonic	24,25	Grama Winter		Micro Age	164	Strutt	164
Colin Grace Assoc	66	(GW Ltd)	14,15	Microbusiness Centre	155	Sumlock Bondain	154,187
Comart	46,80	Graham Dorian	128	Microbyte	159	Swanley Electronics	187
Commodore	50,51	Guestel	163	Microcentre		Templeman Software	162
Computer		Happy Memories	185	Microdigital	64,88,104	Tempus	174
Bookshop	6,96,178	AJ Harding	84,85	Micro-80	180	Tex Microsystems	183
Computer Centre	12,13	Hayes Kennedy	117	Microfacilities	34	3-Line Computing	158
Computer Interfacing		Henry's	179	Microcomputer		Transam	68
Equipment	66	Hewlett Packard	150	Applications	178	TVJ Micro Computers	19
CPS Data	2,31	Hitech Electronics	37	Microsense	130	Video Vector Dynamics	155
Comp Shop	192,IBC	Independent Computer		Microstyle	169	Visconti Essential	
Computer Supermarket	151	Engineering	179	Microtek	168	Software	4
Computech	156	Inmac	26	Microtrend	16	Watford Electronics	38,39
Cream Microcomputer		Intelligent Artefacts	177	Mighty Micro	1120	Wesfarthing Comps	181
Shop	28	Interactive Data		Mine of Information	172	West Midland Micros	166
Creative Computing	189	Systems	29	Nascom Dealers	44	Western Computers	176
C.T.S.	8	Interface Computers	165	Newbear Computing	188	Willesden College	188

## PCW

Clive 'Brains' Sinclair has just bought himself a £20,000 limited edition Porsche Carrera GT, the hairy turbo-charged version of the 924. That equals the profit on 800 ZX80s, we estimate. Said one Sinclair employee, 'I don't know why he got it — it's quicker for him to walk to the office'. . . Now here's a challenge for you: a certain company is offering £1 for every bug you find in its integrated accounts package, with a night out in London for the finder of the most bugs! . . . Susan Dewar of Perth sent us a very interesting Readers Survey form — you can drop by the PCW offices any time, Susan. . . You must be aware that a degree of rivalry exists between PCW and other publications which consider themselves competition. Well, we've been beaten in one (only one) respect by a certain other micro magazine which has finally been quoted in the notorious 'Pseuds Corner' in *Private Eye* (and no, we didn't send it in!)

. . . The eccentricity of Editor Tebbutt's new haircut stems from the recent installation by his barber of a Space Invaders machine. . . Crystal Electronics has jumped on The Last One bandwagon by helping in conversion work for other systems. . . Robin 'Bogey' Bradbeer tells us that he doesn't want to be called 'Bogey' — he prefers 'Buttons'. We explained that we call him 'Bogey' because of his resemblance to Humphrey Bogart but he wasn't convinced. . . Tim 'Rollerball' Keen has grown a very unbecoming moustache — who are you hiding from, Tim? . . . We hear remarkable rumours to the effect that the latest growth industry is Kewney-watching. Apparently some people believe that Guy's ramblings — no, writings — contain Hidden Meanings which can only be deduced by extensive study and cross-referencing with articles written months previously.

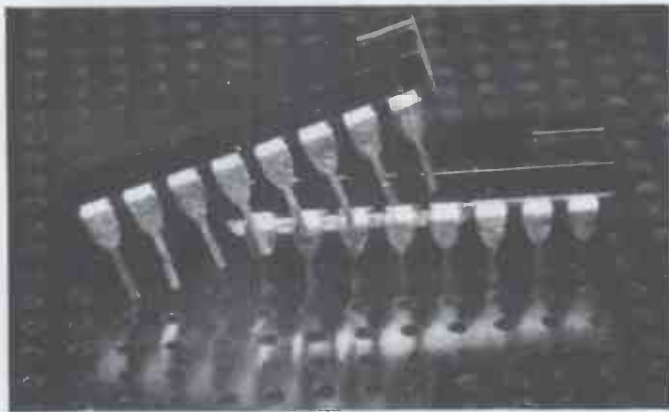

While the mainstream electronics industry has concentrated on products made of Silicone and, to a lesser extent, Germanium, the BUG Corp. has been developing a carbon based technology. The first product is a coupling IC. As might be expected, these circuits carry on the traditional carbon dating activities. These new chips go much further, however, as a matched pair of them can perform a multiplying function. The photo shows how this can be arranged on a piece of matrix board. (Sent in by stringer 'Tiger' Tom Moriarty.)

**ENTERED GUARANTEE BY COMPUKARE**

## THE NEW ANADEX DP9500 and DP9501

### A PROFESSIONAL PRINTER



- Bi-directional printing
- Up to 220 chars/line with 4 print densities
- 500 char buffer
- RS232C and Centronics Parallel interface built in
- Full software control of matrix needles allowing graphics capability
- 200 chars/sec
- Adjustable width tractor feed.

DP9500 — ONLY £795 + VAT  
DP9501 — ONLY £845 + VAT

RRP £540

only £399 - VAT

## ANADEX DP8000

Super Quality — Low cost printer Tractor Feed with full 96 ASCII character set Accepts RS232C at baud rates between 100 and 9600 and Parallel 8 bit data

Attaches either directly or through interfaces to Pet, Apple, TRS80, Sorcerer, Nascom, CompuKit etc

**ENTERED GUARANTEE BY COMPUKARE**

**INTRODUCING**

## THE NEW & EXCITING TRS80 MODEL III



**ENTERED GUARANTEE BY COMPUKARE**

16K £559 +VAT    32K £589 +VAT    48K £619 +VAT

## THE ATARI VIDEO COMPUTER GAMES SYSTEM

Atari's Video Computer System now offers more than 1300 different game variations and options in twenty Game Program™ cartridges!

Most Cartridges only £13.90 + VAT

Prices may vary with special editions Basic Maths, Airsea Battle, Black Jack, Breakout, Surround, Spacwar, Video Olympics, Outlaw, Basketball, Hunt & Score, Space War, Sky Diver, Air Sea Battle, Codebreaker, Miniature Golf.

Extra Paddle Controllers — £14.90 + VAT    \*Keyboard Controllers — £16.90 + VAT

SPACE INVADERS NOW IN STOCK £25

**ENTERED GUARANTEE BY COMPUKARE**

## WE ARE NOW STOCKING THE AUTOSTART APPLE II AT REDUCED PRICES



16K £549 + VAT  
32K £579 + VAT  
48K £599 + VAT

**ENTERED GUARANTEE BY COMPUKARE**

Getting Started APPLE II is faster, smaller, and more powerful than its predecessors. And it's more fun to use too because of built-in features like:

- BASIC — The Language that Makes Programming Fun.
- High-Resolution Graphics (in a 54,000-Point Array) for Finely-Detailed Displays.
- Sound Capability that Brings Programs to Life.
- Hand Controls for Games and Other Human-Input Applications.
- Internal Memory Capacity of 48K Bytes of RAM, 12K Bytes of ROM; for Big-System Performance in a Small Package.
- Eight Accessory Expansion Slots to let the System Grow With Your Needs.

You don't need to be an expert to enjoy APPLE II. It is a complete, ready-to-run computer. Just connect it to a video display and start using programs (or writing your own) the first day. You'll find that its tutorial manuals help you make it your own personal problem solver.

The Radio Shack TRS-80™ Model III is a ROM-based computer system consisting of:

- A 12-inch screen to display results and other information
- A 65-key console keyboard for inputting programs and data to the Computer
- A Z-80 Microprocessor, the "brains" of the system
- A Real-Time Clock
- Read Only Memory (ROM) containing the Model III BASIC Language (fully compatible with most Model I BASIC programs)
- Random Access Memory (RAM) for storage of programs and data while the Computer is on (amount is expandable from "16K" to "48K", optional extra)
- A Cassette Interface for long-term storage of programs and data (requires a separate cassette recorder, optional/extra)
- A Printer Interface for hard-copy output of programs and data (requires a separate line printer, optional/extra)
- Expansion area for upgrading to a disk-based system (optional/extra)
- Expansion area for an RS-232-C serial communications interface (optional/extra)

All these components are contained in a single moulded case, and all are powered via one power cord.

## HITACHI PROFESSIONAL MONITORS



9" — £129    £99.95  
12" — £199    £149

- Reliability Solid state circuitry using an IC and silicon transistors ensures high reliability.
- 500 lines horizontal resolution Horizontal resolution in excess of 500 lines is achieved in picture center.
- Stable picture Even played back pictures of VTR can be displayed without jittering.
- Looping video Input Video input can be looped through with built-in termination switch.
- External sync operation (available as option for U and C types)
- Compact construction Two monitors are mountable side by side in a standard 19-inch rack.

**ENTERED GUARANTEE BY COMPUKARE**

## APPLE DISC II 3.3 Dos

Disc with Controller £349 + VAT

Additional Drives £299 + VAT



- Powerful Disk Operating Software Supports up to 6 drives
- Name Access to Files for Ease of Use
- BASIC Program Chaining to Link Software Together
- Random or Sequential File Access to Simplify Programming
- Dynamic Disk Space Allocation for Efficient Storage
- Individual File Write-Protection Eliminates Accidental File Alterations
- Loads an 8K Byte Binary Image in 6.5 sec. (11.2 sec. in Pascal)
- Storage Capacity of 116 Kilobytes (143K Bytes with Pascal) on Standard 5 1/4" Diskettes
- Powered Directly From the APPLE (Up to 6 Drives) for Convenience and High Reliability
- Packaged In Heavy-Duty, Colour-Coordinated Steel Cabinet

**ENTERED GUARANTEE BY COMPUKARE**

## SPECIAL OFFER FOR MODEL III PURCHASERS

We will take keyboards only for TRS80 Model I and Level II in part exchange.

There will be refurbished Model I and Level II keyboards available later in the year — Phone for availability and price.

only £295 - VAT

## TRS80 EXPANSION INTERFACE

Expand your TRS80 by 32K 32K Memory on board Centronics parallel port Disk controller card Real time clock Requires Level II Basic Interface for 2 cassette decks complete with power supply



**ENTERED GUARANTEE BY COMPUKARE**



## LOW COST TELEPHONE ANSWERING MACHINE

only £99.95 + VAT

Microprocessor controlled answering machine. Plug into your phone line. Records any phone call messages. Remote bleeper enables you to listen to your messages from anywhere in the world. Uses standard cassettes. Comes complete with mains adaptor, microphone, remote bleeper, base unit, cassette with 30 sample pre-recorded messages.

**ENTERED GUARANTEE BY COMPUKARE**

## NEC SPINWRITER

only £1350 + VAT



NEC's high quality printer uses a print "thimble" that has less diameter and inertia than a daisy wheel, giving a quieter, faster, more reliable printer that can cope with plotting and printing (128 ASCII characters) with up to five copies, friction or tractor fed. The ribbon and thimble can be changed in seconds. 55 characters per second bidirectional printing — with red/black, bold, subscript, superscript, proportional spacing, tabbing, and much, much more.

**ENTERED GUARANTEE BY COMPUKARE**

**ENTERED GUARANTEE BY COMPUKARE**

We give a full one year's guarantee on all our products, which normally only carry 3 months guarantee.

We have one of the largest collections of Computer Books under one roof, along with racks of software for the PET and TRS80. Come and see for yourself.

## COMP PRO MIXER

Professional audio mixer that you can build yourself and save over £100.

Only £99.90 plus VAT for complete kit. Plus FREE power supply valued at £25.00



**ACCESSIT AUDIO ADD-ONS**

## TEAC DISK DRIVES



- TEAC FD-50A has 40 tracks giving 125K Bytes unformatted single density capacity.
- The FD-50A can be used in double density recording mode.
- The FD-50A is Shugart SA400 interface compatible.
- Directly compatible with Tandy TRS80 expansion interface.
- Also interfaces with Video Genie, SWTP, Heathkit, North Star Horizon, Superbrain, Nascom, etc. etc.
- Address selection for Daisy chaining up to 4 Disks.
- Disks plus power supply housed in an attractive grey case.

40 TRACK  
Single Disk Drive £225 + VAT    Double Disk Drive £389 + VAT

77 TRACK  
Single Disk Drive £299 + VAT    Double Disk Drive £499 + VAT

**ENTERED GUARANTEE BY COMPUKARE**

## THE VIDEO GENIE SYSTEM

Ideal for small businesses, schools, colleges, homes, etc. Suitable for the experienced, inexperienced, hobbyist, teacher, etc.

### EG3000 Series

16K £279 - VAT

- 16K user RAM plus extended 12K Microsoft BASIC in ROM
- Fully TRS-80 Level II software compatible
- Huge range of software already available
- Self contained, PSU, UHF modulator, and cassette
- Simply plugs into video monitor or UHF TV
- Full expansion to disks and printer
- Absolutely complete — just fit into mains plug.

The Video Genie is a complete computer system, requiring only connection to a domestic 625 line TV set to be fully operational; or if required a video monitor can be connected to provide the best quality display. 51 key typewriter style keyboard, which features a 10 key rollover. Supplied with the following accessories:-

- BASIC demonstration tape;
- Video lead;
- Second cassette lead;
- Users manual;
- BASIC manual;
- Beginners programming manual. Write useful programs in the BASIC computer language yourself.

**ENTERED GUARANTEE BY COMPUKARE**

**NEW**

## VIDEO GENIE EXPANSION BOX

Complete with RS232 interface and floppy disc controller. 0 memory. £225 + VAT.

Memory expansion card (S100) 16K £110 32K £159 + VAT

Further S100 cards available later in the year.

**ENTERED GUARANTEE BY COMPUKARE**



## NASCOM 2 DISC DRIVES

Add a powerful, double density, mini floppy disc to your Nascom system.

- Disc Controller Card (includes Nasbus 6 S100 interface)
- Will control 4 Drives.
- CPM operating system.
- Extended Disc Basic Compiler.
- Power supply included

One Disc System — £499 + VAT  
Additional Disc Unit — £299 + VAT



EUROPE'S FASTEST SELLING ONE BOARD COMPUTER.

# COMPUKIT UK101

★ 6502 based system — best value for money on the market. ★ Powerful 8K Basic — Fastest around. ★ Full Qwerty Keyboard. ★ 4K RAM Expandable to 8K on board. ★ Power supply and RF Modulator on board. ★ No Extras needed — Plug-in and go. ★ Kansas City Tape Interface on board. ★ Free Sampler Tape including powerful Disassembler and Monitor with each Kit. ★ If you want to learn about Micros, but didn't know which machine to buy then this is the machine for you.

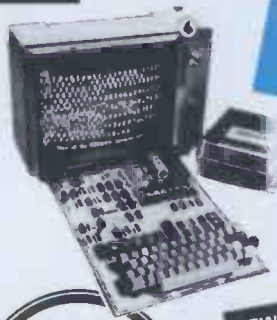

**NEW ISSUE COMPUKIT WITH ALL THE FEATURES THAT MADE IT THE MOST PROFESSIONAL COMPUTER KIT ON THE MARKET. NOW WITH FREE MONITOR (a saving of £22), which includes Flashing Cursor, Screen Editing, & Save Data on Tape.**

DEALER ENQUIRIES INVITED

Fully assembled £199

Build, Understand and Program your own Computer for only a small outlay

KIT ONLY **£149** + VAT NO EXTRAS NEEDED

NEW EXTENDED MONITOR IN EPROM — available separately at £22 + VAT

Improved BASIC function — revised GARBAGE routine. Allows correct use of STRING ARRAYS. This chip can be sold separately to existing CompuKit and Superboard users.

FOR THE COMPUKIT — Assembler Editor £14.90 Screen Editor Tape £1.90

GAME PACKS — 1). Four Games £5.00 2). Four Games £5.00 3). Three Games 8K only £5.00  
Super Space Invaders (8K) £6.50 Space Invaders £5.00 Chequers £3.00 Realtime Clock £3.00  
Case for CompuKit £29.50 40 pin Expansion Jumper Cable £8.50 All Prices exclusive VAT

## NASCOM 2 GAMES TAPE

featuring Space Invaders and Android Nim, Re-numbering program and other goodies!

£7.50 + VAT

## NEW REDUCED PRICES

8K £399  
16K £449  
32K £499 } + VAT  
RRP £795 for 32K



**The PEDIGREE PETS** Very popular for home & business use. 8K Microsoft Basic in ROM. 8K Pet 32K & 16K with new improved keyboard. All with green screen

Cassette Deck £55 extra Full range of software available.

Interface PET IEEE — Centronics Parallel  
Decoded £77.00 + VAT

## NEW TV GAME BREAK OUT

Has got to be one of the world's greatest TV games. You really get hooked. As featured in ET1. Has also 4 other pinball games and lots of options. Good kit for up-grading old amusement games.



MINI KIT — PCB, sound & vision modulator, memory chip and de-code chip. Very simple to construct. £14.90 + VAT  
OR PCB £2.90 MAIN LSI £8.50 Both plus VAT

A SELECTION OF APPLE INTERFACES ARE NOW AVAILABLE AT OUR NEW SHOWROOM.

## SALE MEMORY UPGRADES

16K (8 x 4116) £15.90 + VAT  
4K CompuKit (8 x 2114) £15.90 + VAT

WHETHER OR NOT YOU PURCHASE YOUR PRODUCTS FROM US OR NOT — OUR STAFF OF HIGHLY TRAINED ENGINEERS WILL BE ONLY TO PLEASED TO CARRY OUT ANY REPAIRS NECESSARY

## NOW OPEN OUR SHOWROOM & SALES CENTRE AT

311 Edgware Road, London W2

8MHz Super Quality Modulators	£4.90
6MHz Standard Modulators	£2.90
C12 Computer Grade Cassettes	10 for £4.00
Anadex Printer Paper — 2000 sheets	£25.00
Floppy Discs 5 1/4" Hard and Soft Sectorred	£3.50
Floppy Disc Library Case 5 1/4"	£3.50
Verocases for Nascom 1 & 2 etc.	£24.90

## SPECIAL OFFER

We will part exchange your Sinclair ZX80 for any of our products.



Refurbished ZX80's } fully }  
Refurbished MicroAces } guaranteed } £69.90 + VAT  
(Supply dependant upon stocks).

## ENGLISH COLOUR TV / AMERICAN NTSC COLOUR MONITOR

Suitable for Apple, Atari and Texas 99/4 £295 + VAT

## FANTASTIC FOR FILE HANDLING ACULAB FLOPPY TAPE

The tape that behaves like a disc, for TRS-80 LEVEL 2.

£169 + VAT

The Aculab Floppy Tape for the TRS-80 and Video Genie is a highly reliable digital storage system that provides many of the advantages of floppy disks at less cost. Automatic debounce routine for the Level 2 keyboard. Connects directly to TRS-80 Level 2 Keyboard. Operating and file handling software in ROM. 8 commands add 12 powerful functions to Level 2 BASIC.

## COMP POCKET COMPUTER GREATEST BREAKTHROUGH YET



£79.90 + VAT

COMPUTER POWER THAT ONCE FILLED A ROOM CAN NOW BE CARRIED IN YOUR POCKET!

- Programs in BASIC ● "QWERTY" Alphabetic Keyboard ● 1.9K Random Access Memory ● Long Battery Life.

Computer power that once filled a room can now be carried in your pocket! It's easy to load with ready-to-run software from cassette tape (interface and recorder optional) or program it yourself in easy-to-learn BASIC. 24-character liquid crystal readout displays one line at a time. Special feature — advanced non-volatile memory allows you to power on and off without losing the contents of memory. Note: Memory must be transferred to tape before changing batteries. Automatic statement compaction squeezes every ounce of memory space. Features power-off retention of programs and data. Powerful resident BASIC language includes multiple statements, math functions, editing, strings, arrays and much more. Multiple program loading capability subject to RAM availability. Carrying case and batteries included.

Delivery is added at cost. Please make cheques and postal orders payable to **COMP SHOP LTD.**, or phone your order quoting **BARCLAYCARD, ACCESS, DINERS CLUB** or **AMERICAN EXPRESS** number.

CREDIT FACILITIES ARRANGED — send S.A.E. for application form.

### MAIL ORDER AND SHOP:

14/15 Station Road, New Barnet, Hertfordshire, EN5 1QW (Close to New Barnet BR Station — Moorgate Line).  
Telephone: 01-441 2922 (Sales) 01-449 6596 Telex: 298755 TELCOM G  
OPEN (BARNET) — 10am - 7pm — Monday to Saturday

### NEW WEST END SHOWROOM:

311 Edgware Road, London W2. Telephone: 01-262 0387  
OPEN (LONDON) — 10am - 6pm — Monday to Saturday

- ★ IRELAND: 80 Marlborough Street, Dublin 1. Telephone: Dublin 749933
- ★ COMP SHOP USA, 1348 East Edinger, Santa Ana, California, Zip Code 92705. Telephone: 0101 714 5472526

### TELEPHONE SALES

OPEN 24 hrs. 7 days a week  
01-441 2922



"Europe's Largest Discount Personal Computer Stores"

We are now entering our fourth financial year of dealing solely in the personal computer market — in fact, we started it! Over this period, Personal Computers Limited have formed a group of graduate specialists who will help you in the fields of word processing, financial planning, statistics, economic modelling, forecasting, accounting systems, foreign exchange, banking and oil exploration. We also do rather well with computer graphics and highly recommend the graphics tablets and our plotter for Apple.

We can also offer two excellent items of software — Format 40 and Visicalc — at a combined price of **ONLY £189**, and the Super Sound Generator for only **£90!** (excl. V.A.T.)



**8" Disk Drive (above left)**

Our 8" disks are still as popular as ever — 2 drives give you 1.2MB with all the reliable security of Shugart Technology. Easily interfaced to Apple, uses the same D.O.S.

**A.I.O. Serial and Parallel Card (above centre)**

Three hand-shake lines (R.T.S., C.T.S. and D.C.D.). Firmware for serial interfaces on-board, software for parallel printer available, 2 bi-directional 8 bit parallel ports, plus 4 additional interrupt and hand-shaking lines.

**Light Pen (above right)**

A much sought after product which we introduced to the U.K.

**80 Character Card (below left)**

... opens up the real commercial world for all Apple owners.

**Paper Tiger (Below centre)**

132 character line, plus graphics, 8 character sizes, ordinary paper, multiple copy, upper and lower case 96 character, parallel/serial, form control.

**Centronics 730 (Below right)**

A substantial, robust printer from a major manufacturer. 3 way paper handling system, 100 character per second. Special low-cost including interface, 96 characters.



**Items pictured**

**Sharp MZ — 80K**

A new generation of personal computer, self contained, versatile and starting at only £570 (excl. VAT). Explore the Zilog Z80 now the easy way. Disks and printer available shortly.

**Numeric Keypad**

... with 8 function keys is a must in all financial applications.

**TCM 100 & TCM 200**

... both now have graphics as well as their own power supply, essential with this type of printer.

**Qume Sprint 5**

The quality word processing printer. Clean, clear executive reports the way you want them. Can print up to 5760 points per square inch — or even print in 2 colours.

# This is what we do...

and we do it rather well!



**Personal Computers Limited**

194-200 Bishopsgate, London EC2M 4NR. Tel. 01 626 8121

For further information, please complete this coupon and post to:  
 Personal Computers Limited, 194-200 Bishopsgate, London EC2M 4NR

NAME \_\_\_\_\_ ADDRESS \_\_\_\_\_

\* Now here details for **APPLE III** PCW 4.81