

HOW TO CHOOSE
A BUSINESS MICRO

Personal Computer

Canada \$2.25/US \$2.00/FF8.80/Lire 1700/DM 3.80/FL 4.00/
Bfr 59/Dkr 17.00/Skr 9.30/Nkr 10.50/S.FR 3.50

World DECEMBER 1980 60p

EUROPE'S LEADING MICRO MAGAZINE

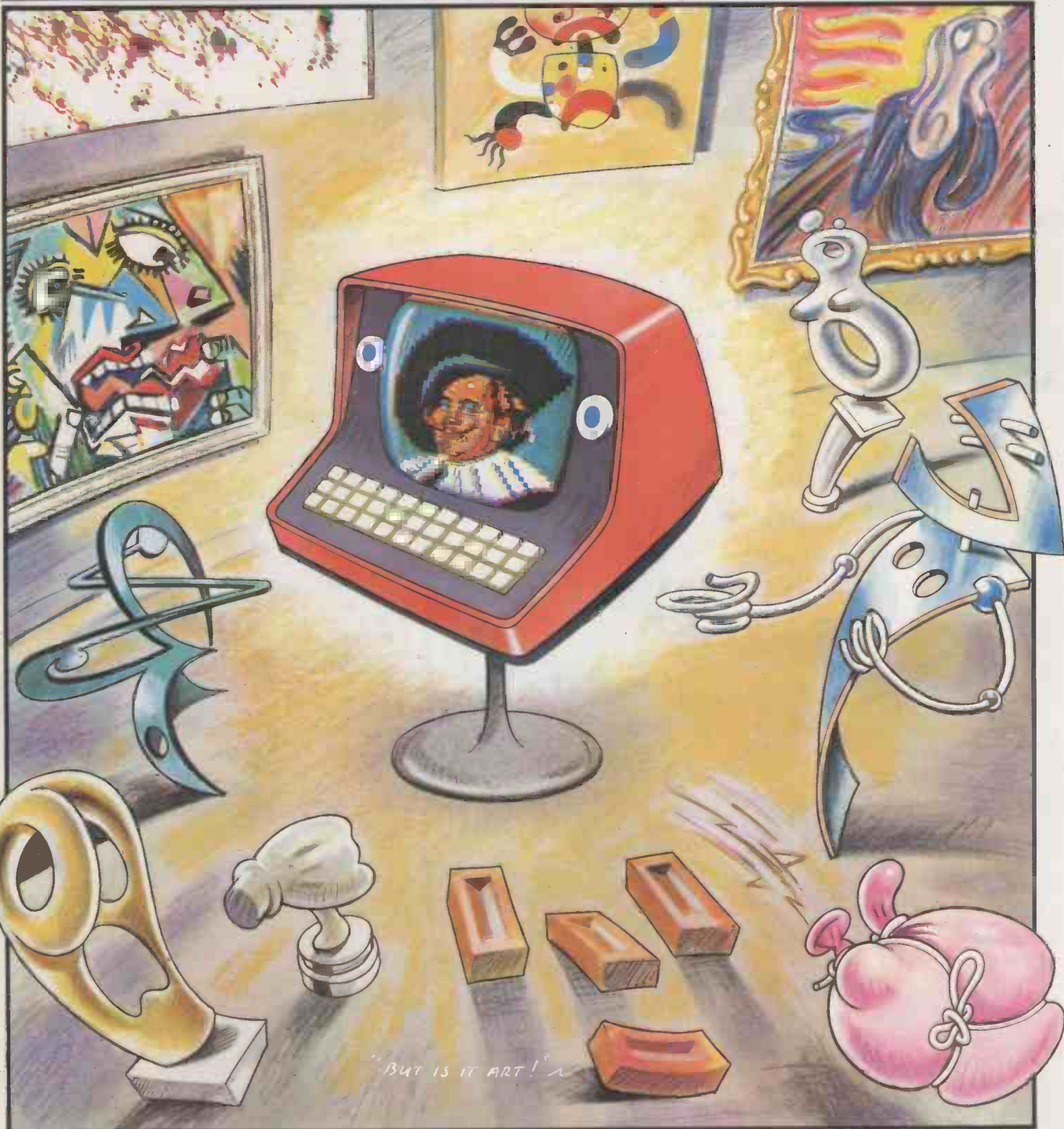

"BUT IS IT ART!"

YES, BUT IS IT ART?

771A LS

The best computers PLUS the best service

At MicroCentre, we're concentrating our resources on what we genuinely believe are the very best computers available today. . . . Cromemco computers, naturally. This way we can offer you the best deal possible.

What we don't do

What we don't do is spread our expertise thinly amongst umpteen different systems, or try to stock every S100 product on the market. We don't claim to offer "impartial" advice on the best buy. And we don't sell from price lists or catalogues.

The MicroCentre approach

Some micro-computer suppliers work like that, but we don't. Because we realise that when you're buying a computer you want more than the "brochures and boxes" approach. You want to see computers running; to try them out with different software products; to study the documentation; above all, you want expert answers to your most searching questions.

Cromemco specialists

That's why we've specialised in Cromemco systems. Not simply because we think Cromemco systems are the best serious computers available at the price.



Cromemco Model Z-2H hard disc computer, Z-80 computer and 64K memory. MicroCentre also stocks floppy discs,

But because by doing so we save you time, energy and resources, you expect the full range of our time, energy and resources. We stock Cromemco peripherals; single-user and multi-user systems; and interactive systems; and interactive systems.

Software

Expect a choice of operating systems and compilers to evaluate; expect complete documentation; and expect the largest collection of Cromemco systems software in the UK.

Expertise

Expect to find in-depth professional expertise at MicroCentre, the kind that is only acquired by installing Cromemco systems all over Britain. Expect a thorough appreciation of how Cromemco systems can be applied . . . in business, scientific research, industrial engineering, medicine and education.

Support

Expect to get frank, accurate answers to your questions at MicroCentre. Above all, once you've bought a Cromemco system from us, expect to get a very high standard of technical support with your hardware enhancements and continuing software needs.

At MicroCentre, simply expect the best.

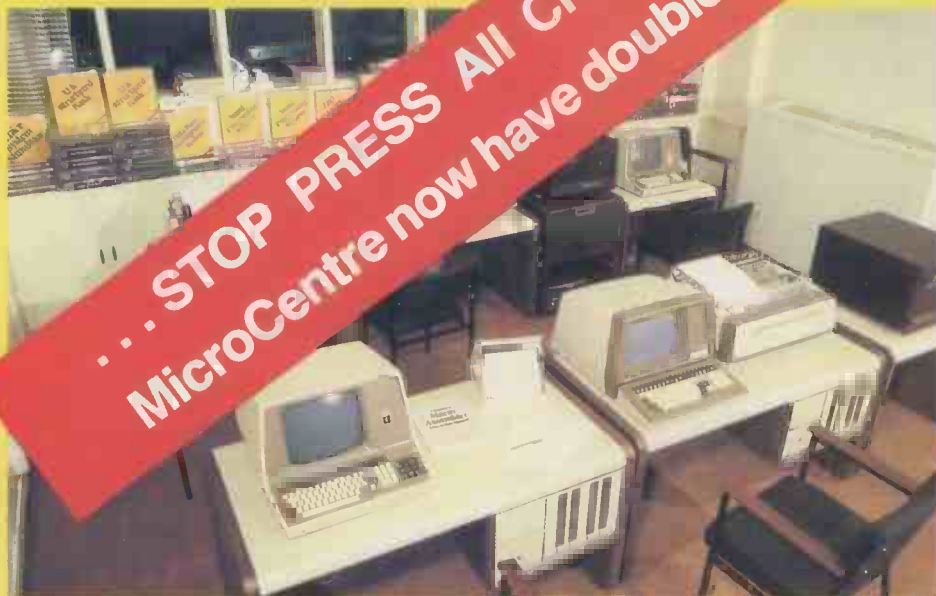

MicroCentre's Cromemco demonstration room, with the full range of Cromemco computers, peripherals, operating systems and software products on permanent exhibition. Why not pay us a visit? We're only an hour's Shuttle flight from Heathrow!

For  **Cromemco... call the experts**

**NOW IN SPACIOUS
NEW SHOWROOMS**

Tel. 031-556 7354

Micro Centre

**STILL IN
CENTRAL EDINBURGH**

Complete Micro Systems Ltd., 30 Dundas Street, Edinburgh EH3 6JN

CONTENTS

Volume 3 No 12 December 1980

Founder
Angelo Zgorelec

Editor
David Tebbutt

Deputy Editor
Peter Rodwell

Sub Editor
Jon Wall

Editorial Office
14 Rathbone Place
London W1P 1DE
01-637 7991

Advertisement Director
Stephen England
01-636 4461

**Assistant Advertisement
Manager**
Patrick Dolan
01-636 4463

Advertisement Executive
Jacquie Hancock
01-631 1682

Production Manager
Dick Pountain

Art Director
Paul Carpenter

Art Assistant
Shelley Gray

Typesetter
Jane Hammell

Published by Sportscene
Publishers (PCW) Ltd., 14
Rathbone Place, London
W1P 1DE, England. Tel:
01-637 7991/2/3. Telex:
8954139 A/B 'Bunch' G
London

Copyright notice
Personal Computer World is
published by Sportscene
Publishers (PCW) Ltd. © 1980
Felden Productions. No
material may be reproduced
in whole or part without
written consent from the
copyright holders.

Printed by Riverside Press
Whitstable

40 NEWSPRINT: Guy Kewney reports on the latest happenings in his own inimitable style.

48 COMPETITION: Win £100!

49 YANKEE DOODLES: A state-of-the-industry update from Tom Williams in California.

50 COMMUNICATIONS: Our readers in their own write.

52 BENCHTEST: A Pascal Microengine at last! Sue Eisenbach reports on the Raannd SP1.

59 PASCAL BENCHMARKS: Chris and Sue propose a definitive set of programs.

63 IS IT ART? Malcolm Banthorpe poses the question and offers some answers.

69 COMPUTERTOWN UK! The latest news on our computer literacy project.

72 BOOKFARE: Malcolm Peltu examines the latest printed words.

75 FEATURE INDEX: Find out what you've missed.

77 MICROWRITER: Peter Rodwell tests an intriguing device.

81 SECRETS OF SYSTEMS: Lyn Antill gets down to the nitty-gritty of buying a computer.

85 PRINTERFACING: A new series on hooking up a printer to your micro.



Cover Illustration Bush Hollyhead

90 CALCULATOR CORNER: Speed up your Sharp PC-1211 programs.

93 GATEWAYS TO LOGIC: Continuing Derrick Daines' unique guide to teaching microcomputing.

99 MICRO CHESS: Kevin O'Connell reports on two recent tournaments.

100 FESTIVE FUN! We test some micro-based toys on sale this Christmas.

104 COMPUTER ANSWERS: Sheridan Williams and his team answer your queries.

106 PCW SUB SET: Useful subroutines, compiled by Alan Tootill.

109 FUTURE PERFECT: Your chance to win the pools ... maybe.

113 COMPUTER GAMES: David Levy looks at backgammon in this month's part of his definitive series.

115 WEST COAST TRIP: Our luxury Californian jolly which includes the West Coast Fair.

116 YOUNG COMPUTER WORLD: Especially for our younger readers, compiled by Derrick Daines.

121 CRAM: David Tebbutt remembers his younger days and describes an awe-inspiring storage device.

124 FACE TO FACE: David Hebditch continues his series on user friendliness with a look at screen layouts.

126 NEWCOMERS START HERE: A quick intro for those new to the micro scene.

127 DIRECT ACCESS: Including IN STORE, USER GROUPS, DIARY DATA and TRANSACTION FILE.

137 PROGRAMS: Get those fingers tapping with the latest listings sent in by our readers.

144 LEISURE LINES LINES: J J Clessa poses more problems.

144 BLUNDERS: We confess all!

183 CHIP CHAT: Europe's leading microgossip page — news, rumours, facts even.

ATTENTION!

WRITE YOUR OWN SOFTWARE
— EFFICIENTLY.

TWO LOW COST CORRESPONDENCE
COURSES TO ENABLE YOU TO
CONSTRUCT PROGRAMS TO A
HIGH STANDARD FOR BUSINESS.

(1) PROGRAM CONSTRUCTION,
STANDARDS & CODING
TECHNIQUES.

(2) SYSTEM CONSTRUCTION
AND DOCUMENTATION FOR
BUSINESS APPLICATIONS.

BOTH TUTORED BY PROFESSIONAL
ANALYSTS.

COURSES FROM 6 TO 12 WEEKS.

CURRICULA & PRICES FROM:

TALBOT, RHYS (CONSULTANTS) LTD.
17 EPSOM RD., GUILFORD, SURREY

Sigma Technical Press

the UK software publisher

LIVING WITH THE MICRO by Martin Banks

By the editor of Microcomputer Analysis, this covers developments in the whole field of microelectronics. It emphasises 'Information Technology' — the combination of computers, communications and automation — and applications including: business systems, software, viewdata and education. "... a very brave effort at explaining a very complicated subject in simple terms, and the kind of book a managing director might read before recommending his board to spend half a million" (Electrical and Radio Trading).

Price £3.50, soft cover

SUCCESSFUL SOFTWARE FOR SMALL COMPUTERS by Graham Beech

This shows how to apply structured programming on a micro-computer, using BASIC. "... clear, easy-to-follow language. An excellent introduction to techniques such as LINKED LISTS, DATA STRUCTURES, SORTING, SEARCHING and SIMULATION. CHOCK FULL OF EXAMPLES ... EXCELLENT VALUE" (National TRS-80 Users Group Newsletter). Approved by Tandy Corp. for Model I, Level II.

Price £5.50, soft cover

TRS-80 Cassette £7.50

COMPUTER PROGRAMS THAT WORK! by J.D. Lee, G. Beech and T.D. Lee

24 BASIC programs in maths, statistics, science and games. The UK best seller! "Well thought out with plenty of variety" (Micro Forecast).

Price £3.95, soft cover

Cheques etc. must be in Sterling on a UK bank.

Sigma Technical Press (PC), 5 Alton Road, Wilmslow, SK9 5DY.

Compukit UK101 DISC DRIVES

with up to
32k
RAM
exp
free
games
disc



NEW

* 9 Digit extended Basic

* Plugs straight into 8k Compukit requires no hardware mods. (5v.5A required for 610) 610 Expansion (8k) ONLY £159 + VAT
Disc Drive with DOS ONLY £285 + VAT

Oki Microline 80

THE WORKHORSE MICRO PRINTER

- Small, light, quiet matrix printer.

* 40, 80, or 132 cols. * 6 or 8 lines per inch
* 96 ASCII + 64 graphics character set with Centronics compatible interface * 9x7 matrix
* 80 chs. per sec. * 200 x 10⁶ head warranty
* No duty cycle limitation * Double width characters * Friction and Pin Feed * Rugged business use - metal chassis - two motors



ONLY £359 + VAT RS232 option available

Anacom 150

150 CPS,
15" carriage
dot matrix printer



* 150 chs per sec * 9 x 9 dot matrix
* 10 chs per inch horizontal * 6 or 8 chs vertical * 136

£699
+ VAT

columns, 13.6" line length * 94 ASCII chs
* Upper and lower case with decs. * Logic seeking * Centronics and/or RS232

NEW
80 COLUMN 32k

Pet

ONLY £825 + VAT
Standard Large
Keyboard

16k - £499 + VAT
32k - £599 + VAT



Very popular for home & business, using 8k Microsoft Basic in ROM. Both models are with new improved keyboard and all with green screen. Extra Cassette Deck £55 + VAT

NEC Spinwriter

- for the
professional
word processing
system

£1390 + VAT



Model 5510 - RS232, Model 5530 Centronics 8bit par. NEC's high quality printer uses a print "thimble" that has less diam. and inertia than a daisy wheel. Giving a quieter, faster more reliable printer that can cope with plotting and printing (128 ASCII chs.) with up to 5 copies, friction or tractor fed. 55 Chrs/sec.

Mighty Micro

for a Mighty Good Deal!

Please add 15% VAT. Carriage extra, will advise at time of order. Official orders welcome.

61 NEW MARKET SQ., BASINGSTOKE, HANTS. RG21 1HWK Tel: 0256 56468 & 56417
also in association with O.S.I. COMPUTERS, ESHER, SURREY. Telephone: 0372 62071

Buy in confidence. If on receipt of your order the goods do not meet with your satisfaction return within 7 days for full refund. Credit facilities available.

DISCOUNTS: Attractive quantity discounts for OEM, Education and Dealers.



ROCKWELL AIM65 as you like it!

The only micro with a built-in printer.

AIM 65. The original bare-board version as it comes from Rockwell with: 20 col. printer. 20 chr alphanumeric display. 54 Qwerty Keyboard, TTY and dual cassette interfaces, 1K or 4K on-board RAM options, powerful 8K monitor in ROM. This 6502 up based product comes complete with full documentation, fully assembled and tested.

Price: A65-100 (with 1K RAM) £265.00
A65-400 (with 4K RAM) £315.00

AIM 65C. This 'special' packaged system developed by PML, for those of you who wish to limit your hardware involvement to the attachment of the 13 amp plug (we leave it off especially). It comes with 4K RAM, power supply, assembler or basic and desk-top case.

Price: A65-500C (basic) £485.00
A65-600C (assembler) £475.00

DAIM. A complete disk-operating system designed especially for use with the AIM 65. It makes use of the software hooks in the AIM 65 monitor program. The DAIM controller is capable of controlling up to two mini-floppy disk drives which adds up to 160K bytes of read/write memory to the AIM 65. Everything is complete — plug it in and the DAIM is ready to go.

DAIM Controller £388.00
Single-Disk Drive £307.00
Dual-Disk Drive £540.00

AIMEM. A 32K byte self-contained memory system for use with AIM 65. Housed in an attractive aluminium case with an integral power supply separate from the host micro. The system has a transparent refresh and uses the industry standard 4116 device configured in relocatable 4K byte segments.

AIMEM £335.00

VIDEO. Programmable display format of up to 100 char by 20 lines on a Monitor, 48 by 20 on a T.V. Both upper and lower case ASCII characters in ROM. On board display RAM adds up to 4K bytes of RAM to your system as display memory. Designed to operate with the AIM 65 monitor it offers hardware scrolling, programmable cursor, light pen, programmable video format.

A65-VID £196.00

Options:
assembler in ROM £60.00
basic in ROM £70.00
power supply £45.00
acoustic coupler £200.00
expansion motherboards A65-KIM £80.00
A65-6800 £135.00

Card Cage £25.00
Case with psu £110.00
Case £28.00
Thermal Paper 80p
22/44 connector £7.00
Expansion cable £10.00

NOTE All prices are subject to change without notice and are exclusive of V.A.T.



**Portable
Microsystems
Limited**

Forby House, 18 Market Place,
Brackley, Northants, NN13 5SF
Telephone Brackley (0280) 702017
Telex Micro 83147

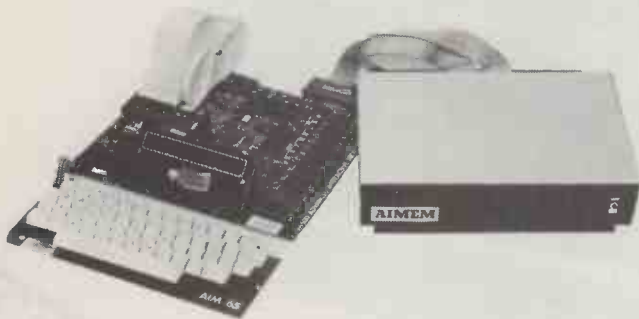
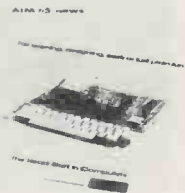
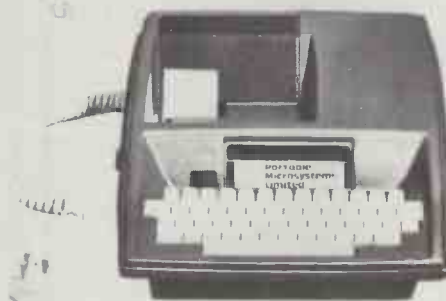
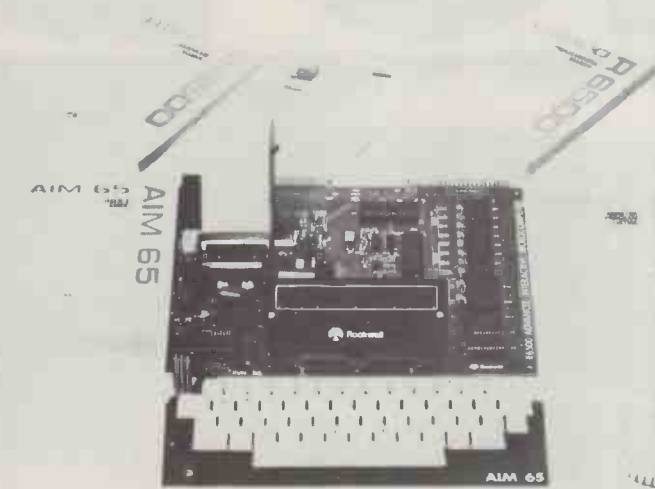

Ask about our similar models using Nascom 1 or 2 microcomputers.

The b

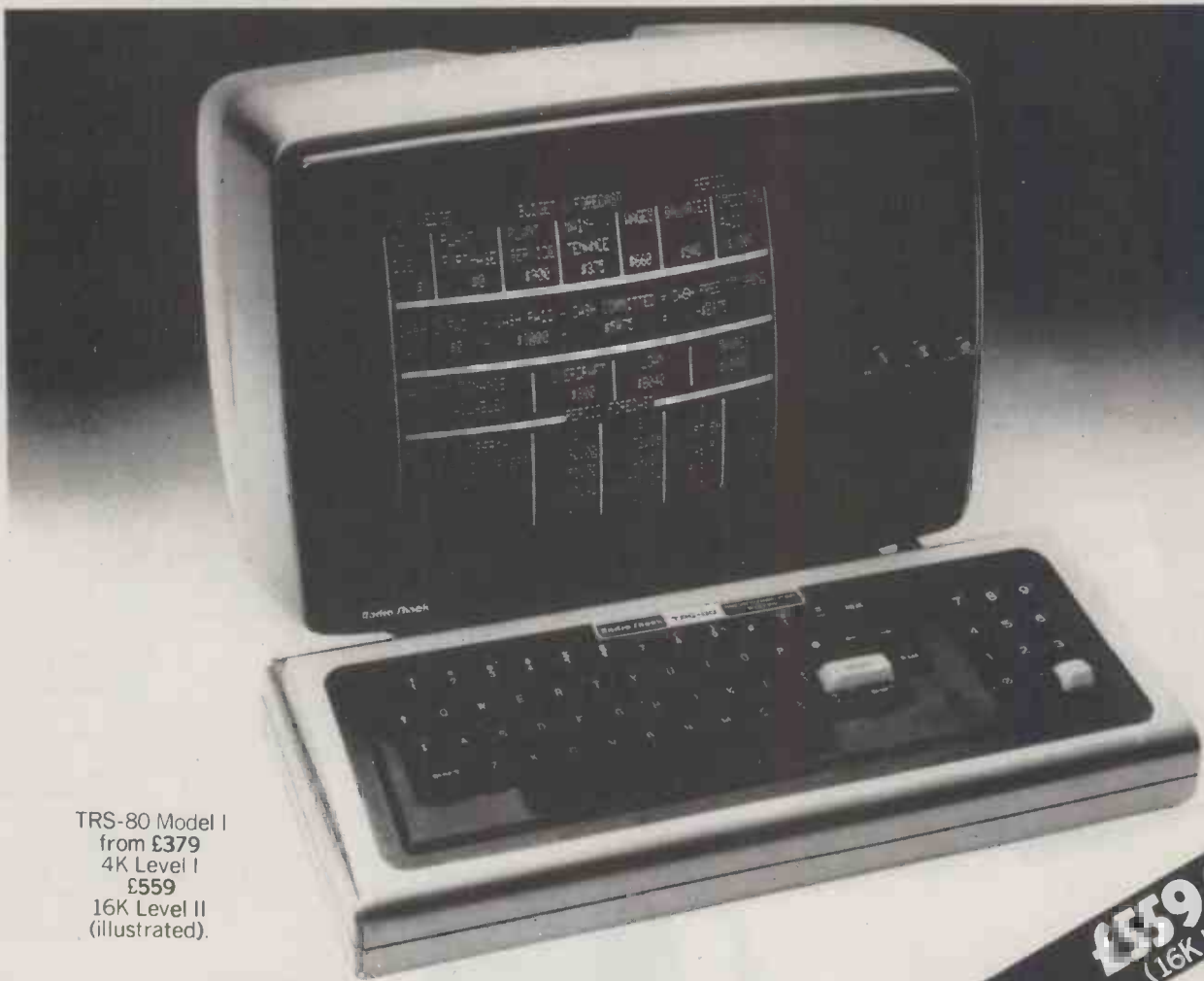

TRS-80 Model I
 from £379
 4K Level I
 £559
 16K Level II
 (illustrated).

£559.00*
 (16K Level II)

TRS 80 Model I Microcomputer Here's the push button brain, the entertainer, the tutor, the timesaver. Fun for the children, a helper for the businessman and the teacher, a catalogue for the housewife, an analyser for the investor and an informer for the salesman. Run Maths, English, Chess, Draughts and video game programmes for educational fun. Easy to learn and operate — you can even write your own programmes. Suddenly you have a ready and reliable source of brainpower — put it to work immediately.



TRS 80 Model I C.P.U.'s Complete and ready to run from your TV monitor. Just plug in and start computing. The lowest priced 4 K level CPU contains 4096 bytes of user memory and can be expanded to 16K within the keyboard unit. The 16K level II CPU is a more powerful and flexible version using an additional 12K ROM. Level II also incorporates a calculator style numeric keypad for faster data entry.

rains.



£2,199.00*

S-80 Model II Microcomputer A bigger, more powerful brother to Model I. Designed for more data storage and versatility. Like Model I is completely modular allowing easy, plug-in expansion. It's available memory will allow maximum use of future languages.

S-80 COMPUTER CENTRES NOW OPEN AT —
Birmingham — Edgbaston Shopping Precinct, Hagley Road.
Bradford — 214, Forster Square.
Bristol — Colston Centre, Colston Avenue.
London — 1-2, Seacoal Lane, Ludgate Hill, EC4.
111, Kingsway, WC2.
Manchester — 30, Market Place, Deansgate.

FULL COMPUTER FACILITIES AVAILABLE AT —
Leeds — 72, Merrion Centre.
Liverpool — 168, Market Way, St. Johns Centre.
Wednesbury — Bilston Road.
Wimbledon — 124-126, The Broadway, London, SW19

*All prices include VAT.

IT'S POSSIBLE, ONLY AT Tandy

Better Equipment. Lower Prices. No Middlemen.

The PIC-CHIP.... a powerful easy-to-use graphics facility for all New Rom PETs.

The PicChip is a ROM module which simply plugs into your PET making available immediately over forty new BASIC commands. These commands use BASIC variables as parameters (no PEEKing or POKEing) and enable the graphic possibilities of the PET to be fully exploited - even by beginners! Using an X, Y coordinate system based on an origin specified by program, lines, graphs and drawings of all kinds can be generated on the screen by simple programming. Other commands enable defined areas, or the whole of the screen, to be rolled or shifted up, down, left and right. Images can be stored to and retrieved from any RAM address.

Originally designed for scientific and technical applications, the PicChip is also being used in educational projects, games and design work of all kinds. The combination of fast plotting and area manipulation makes the PicChip ideal for the continuous display of real-time data in graphical form.

Just see how easy it is to use PicChip commands: the following examples were all photographed directly from a PET screen.

Picture 1 shows two curves, one drawn in fine-density and one in bar form, produced by two program lines:
 10 FOR X=0 TO 39:Y = X↑1.5:!WF:
 NEXT
 20 Y0=25:FOR X=0TO79 STEP 3:
 Y=SIN(X/12)*24:!WY:NEXT

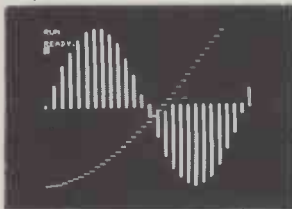

{1}

Picture 2 adds a third program line to plot a function as adjacent bars:
 30 FOR X = 0 TO 79:Y=SIN(X/12)*
 X/2:!WY:NEXT

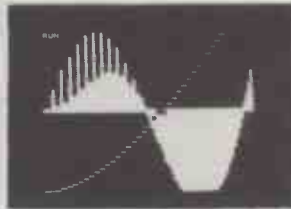

{2}

If we just take the second program line and change !WY to !WX, the bars are plotted horizontally:
 20 FOR X = 0 TO 79:Y=SIN(X/12)*24:
 !WX:NEXT

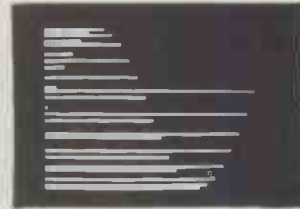

{3}

All the other pictures reproduced here were generated by the DEMONSTRATION PROGRAM included in the 20-page Handbook. What we can't show here are the amazing effects produced by shifting or rolling or otherwise manipulating different areas of the screen. There is even a repeat-key function, and commands for reading and setting the cursor position in X,Y coordinates.

PicChip Functions.

Command	Function
SYS 45056	PicChip On
!RE	Restore screen
!CO	PicChip off
!RP	Repeat-Key on
!RO	Repeat-Key off
!CW	Cursor-position Write
!CR	Cursor-position Read
!AF	Area Fill
!AR	Area Reverse
!AN	Area Normal
!AI	Area Invert
!AS	Area in Shift case
!AU	Area in Unshift case
!AC	Area Case invert
!SF	Screen Fill
!SR	Screen Reverse
!SN	Screen Normal
!SI	Screen Invert
!SS	Screen in Shift case
!SU	Screen in Unshift case
!SC	Screen Case invert
!US	Up Shift
!DS	Down Shift
!LS	Left Shift
!RS	Right Shift
!UR	Up Roll
!DR	Down Roll
!LR	Left Roll
!RR	Right Roll
!WP	Write Point
!EP	Erase Point
!WL	Write Line
!EL	Erase Line
!WC	Write Continuous line
!EC	Erase Continuous line
!WX	Write bar in X axis
!EX	Erase bar in X axis
!WY	Write bar in Y axis
!EY	Erase bar in Y axis
!WF	Write fine Y
!EF	Erase fine Y
!FW	Write fine X
!FE	Erase fine X
!CS	Copy Screen
!PC	Poke Character

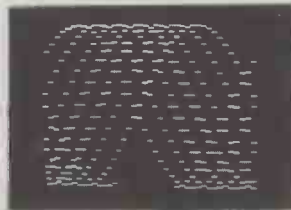

The standard PicChip plugs into socket UD4 of the PET, but is also available to fit either of the other two sockets. PicChip is therefore compatible with other PET ROM packages. Installation and use are fully described in the handbook.

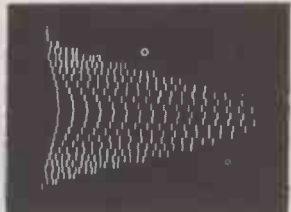

The PicChip costs just £50 + VAT. To buy the handbook separately costs £5 but this may be offset against an eventual purchase of the chip. State required socket when ordering. 10% discount to educational institutions.

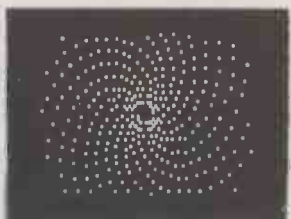

Mail Order to:-

Insel Computer Ltd.,
 7 Bramshill Mansions,
 Dartmouth Park Hill,
 London N.W.5.



PET 2001



commodore
authorised dealers

TRS 80



From Radio Shack Corp.

APPLE II

from £695



authorised dealers

SORCEROR

from £730



authorised dealers

ADVANCED SYSTEMS



MICROCOMPUTERS ETC

Registered business name
For Hardware, Software, Peripherals, Consultancy and Competitive Prices.



BASIC SYSTEMS

- PET 3016 (16K RAM) and large keyboard * £950.00
 - PET 3008 (8K) with large keyboard * £450.00
 - PET C2N External Cassette Deck * £53.00
- ACCESSORIES
- IEEE/RS232 Serial Interface 'A' Output only £106.00
 - IEEE/RS232 Serial Interface 'B' Input/Output £186.00
 - Programmers Toolkit - 10 powerful new commands for your Pet - plug in ROM, chip 8K and 16/32K, resp £75/£55

BASIC SYSTEMS

- TRS 80, 4K Level I consisting of Keyboard with 4K memory, Video Unit, Cassette Drive and 240v power supply unit £365.00
 - TRS 80, 4K Level III (as above with Level II Basic) £425.00
 - TR80 CPU 2 speed mod. £180.00
- ACCESSORIES
- Radio Shack Phone Modem £35.00
 - UHF Modulators (encased with leads for 625 lines) £40.00
 - RAM upgrade (4-16K, 16-32K, 32-48K) supplied and fitted at our premises (Kit: £80.00)
 - Stirny Floppy drive (complete with manual & waters) £180.00

BASIC SYSTEM

- Apple II Plus computer - APPLESOFT extended basic in ROM - (16K RAM) - video output £695
- Apple black and white modulator for domestic TV £14.00
- Eurocolor card - provides colour on domestic TV £79.00
- Parallel Printer Interface Card £104.00
- High Speed Serial (RS232C) Interface Card £113.00
- Communications Card £132.00
- Integer Basic Firmware Card £116.00
- PASCAL language system - includes language card to provide user with PASCAL, PALSOFT & INTEGER BASIC £299.00

BASIC SYSTEMS

- Sorcero (inc. UHF Modulator) Special low prices on limited stock
 - 16K RAM £590.00
 - 32K RAM £650.00
 - 48K RAM £695.00
- ACCESSORIES
- Eddy Video Disk Unit £240.00
 - Eddy Video Monitor £240.00
 - Integral 630K Dual Drive £1,590.00

ADVANCED SYSTEMS

- TRS 80, Model II, with integral 8" floppy disk drive and up to 64K RAM Expandable up to 3 Megabytes Disk Storage (Available for demonstration - by appointment only). From £2,300
- SUPREPETSYSTEM - CBM8032 Computer with 30 col. screen £895
- CBM8050 - Dual Disk Drive giving 950K User Storage £895

PET BUSINESS SYSTEM

- comprising CBM 3032 Micro computer, CBM 3040 Dual Disk Drive, CBM 3022 Tractor Feed Printer and all cables £1799.00

DISKS

- PET CBM 3040 (dual drive) 32K User Storage * £695.00
 - Computhink (dual drive) 400K storage £1145.00
 - Computhink (dual drive) 800K storage £1145.00
 - TRS80 Shugart drive £299
 - Microcops FD200 drive 110v £289
 - Microcops Dual Drive (394K storage) £275
 - Apple Hard Disk (11mb) £3500.00
- APPLE
- Apple Drive - 116K storage 1st drive £349.00
 - Apple Drive - 116K storage 2nd drive £299.00
 - Corvus Hard Disk (11mb) £3500.00
- SORCEROR
- Eddy - 315K Storage £630
 - Eddy Dual drive (630K storage) £1195.00
 - Corvus Hard Disk (11mb) £3500.00

PRINTERS

- PET CBM 3022 (80 col with PET graphics - tractor feed) * £425.00
- TRS80 TRS 80 Screen Printer (text - graphics) (1110v) £345.00
- New Radio Shack Micro Printer £245.00
- GENERAL Teletype 913 KSR Serial (pin or punch feed) 40, 80, 132 cols selectable £825.00
- RACAL Bander Printers - truly professional printers for microcomputers - high speed (up to 280 cps), upper/lower case OKI - parallel/serial (pin or punch feed) 40, 80, 132 cols selectable £499.00
- Centronics 779 parallel tractor feed, 132 cols £825.00
- DOLPHIN B808P tractor printer (125 cps bi-directional, 40-80 columns - optional 132, vJ case & graphics, Available with 5000 characters) £825.00
- Centronics Micro Printer (60, 80, 132 cols selectable) £395.00
- Heath WH 14 serial (80, 96, 132 cols) P.O.A.
- QUME daisy wheel printers P.O.A.
- TCM100/MICROHUSH Thermal Printer (40 cols) inc. interface for PET/APPLE £266.00
- SILENT PRINTER for APPLE... allows printing of high res. graphics £349

ETC.

- Disquettes 5 1/4" (blank) boxed (min order 10) each
- C12 Cassettes (min order 10) each £0.35p
- Ansback phonemate telephone answering machine, voice operated twin cassette £190.00
- Pace EZ PHONE - Cordless Telephone £225.00
- Hitech Video Monitors 9" 12" resp. £127/£187
- BOOKS - Large range of microcomputer related books and magazines

STATIONERY

- Listing Paper - most common sizes
- Alphabet for use with Printers
- PROBASIC BUSINESS PROGRAMS, TEXAS INSTRUMENTS, Business Programs
- Calculators - complete range. Send for list + prices (We are authorised TI dealers)

IF YOU DON'T SEE IT - ASK IF WE HAVE IT

SOFTWARE

- PET PETSOFI authorised dealers - over 160 programmes on cassette and disk. Send for catalogue
- STAGE ONE COMPUTERS SW dealers - RETAID, Stock Control, etc. Send for list. £15.00 P.O.A.
- PETACT Business Software - Sales and Purchase Ledger, Invoicing, etc.
- CBM DISK-BASED BUSINESS SOFTWARE COMWORDPRO/COMWORDPRO IV powerful word processor, low/high resp. £75/£150.00
- COMSTOCK - STOCK CONTROL - gives complete stock report £150.00
- COMBIS - BUSINESS INFORMATION SYSTEM - Storage & Retrieval of all types of company records £150.00
- COM ACCOUNTS - Full Financial Business Accounting System incl: Sales, Purchase, Nominal Ledgers £650.00
- COMPLAN (CP) - Personal information tool for the busy executive £150.00
- (We are authorised CBM Business Software Dealers) Send for List.
- GD 101 - Assembler Development System £50.00
- GD 101 - High Performance Language (Artificial Intelligence) £75.00
- BRISTOL SOFTWARE FACTORY S/W dealers - TRADER, ITEM, MONITOR, etc - Send for details £138

TRS 80

- CONVAC III SUITE - computerised accounting for TRS 80 (TVJ SOFTWARE) £75.00
- STOCK CONTROL - complete inventory control - recorder level - P/O's etc £115.00
- CP/M £95.00
- FORTRAN includes compiler, relocatable assembler text editor and linking loader £75.00
- PASCAL - tomorrow's programming language today £95.00
- ELECTRIC PENCIL - powerful word processor allows full cursor movement, insert/delete, string search block movement, adjustable line length, justification on cassette £39
- LOWER CASE MODE/VIT/LET for Electric Pencil £8.00/£28.00
- DATA MANAGEMENT/REPORT - easily formats disk files, allows entry, edit, delete and list of records and retrieves data for display or calculation on screen or printer £180.00
- RSW-2D DISK MONITOR - powerful system manipulates disk data, has Z 80 break routine £25.00
- ST80D communications software £25.00
- NEWDOOS - TRSDOOS with corrections and enhancements £25.00
- NEWDOOS - as above but with further facilities - KBFX, Remun, Screen to printer in one step, DOS commands from BASIC, Level II in II, Superzap, Disassemble, load and save faster, list variables LIBRARY 100 - an assortment of 100 programs £49.00
- SARGON CHESS - 16K Level II - the 1979 Champ Version I £14.00

APPLE

- CASHER - Retail Store Management System £195
- U-DRAW II - High Resolution graphics editor. Create a figure then rotate, expand, contract etc and store on disk £27.00
- US programming language suitable for research in artificial intelligence £30.00
- 3-MILE T-CALAND - Complete disk based game simulating nuclear reactor £27.50
- VISCALC - Instant Visual Calculator - provides a powerful planning and forecasting tool £92.00
- APPLE WORD PROCESSOR - Complete text editing, storage and retrieval of text (disk based) £95.00
- LITTLE GENIUS - Comprehensive disk based Apple Soft Tutorial £35.00
- ACT Appicare and WUSE authorised software dealers - Many programs on cassette and disk. Send for list.

* 5% DISCOUNT ALLOWED FOR EDUCATIONAL ESTABLISHMENTS

T&V JOHNSON (MICROCOMPUTERS ETC) LTD

Member of the TVJ Johnson Group of Companies

Oxford
48 Gloucester Road, Bristol
OX4 1UL
☎ (0865) 721461

Bristol
48 Gloucester Road, Bristol
and w/ends
☎ (0272) 422061

Hours of business
Mon-Fri, 9.30 - 5.30
Sat, 9.00 - 12.30



Directors: Dr. R.V. King BA, MBE
T.C. Johnson, BSc (Hons)
P. Johnson, BSc (Hons)
PHONE FOR PRICE LIST & BROCHURES
(All prices correct at time of compilation)

VISICALC™

VISICALC AND A PERSONAL COMPUTER DO TO THE CALCULATOR, PAPER AND PEN WHAT WORD PROCESSING HAS DONE TO THE TYPEWRITER AND PAPER. REVOLUTIONIZE IT.

Take virtually any problem you would explore using calculator, pen, and paper, working in rows and columns. Apply VisiCalc and you'll see why every reviewer of this product has said the same thing: VisiCalc is the most useful, most important program yet developed.



With VisiCalc, you work with an electronic worksheet of up to 63 columns and 264 rows. At the juncture of any column and row you can type in words or numbers. To put VisiCalc to work, you first create any format or form you need by typing in words — just like writing column headings across the top of a piece of paper and items down the left side. Then, where you want the worksheet to perform a calculation, you type a formula. VisiCalc automatically performs all arithmetic functions, net present value, and transcendental functions. Instantly — and we mean instantly — VisiCalc displays the results. And if you change any of the numerical data, the electronic worksheet instantly displays a new result. Automatically. You can play "what if" as often as you wish to solve thousands of different problems. When finished, you can get a hard copy of all the information on your worksheet from your computer printer.

Absolutely no programming is necessary. VisiCalc does all the work. Now, isn't THAT magic?

ANYONE WHO WORKS WITH NUMBERS USES VISICALC:

Managers and Management consultants: plan budgets, compare actual results to budgeted forecasts, and modify projections faster than ever before. VisiCalc is the most powerful and easy-to-use projection tool ever developed.

Financial Analysts: quickly determine rate-of-return under varying assumptions using the built in net present value functions. VisiCalc will also compute financial ratios, and project tax consequences.

Accountants: develop financial statements and "pro formas", making changes and comparisons easily with VisiCalc's ultimate "what if" recalculation feature.

Tax Accountants: compute the tax effects of many alternatives, and print out all the different scenarios for client discussion and documentation.

Engineers and Scientists: appreciate VisiCalc's transcendental functions, scientific notation, and features like eleven-digit precision in numeric calculations.

Marketing Managers: find VisiCalc is the answer to every forecasting and budgeting need. They refine assumptions—commission rates, sales costs, advertising expenditures, leads, sales closing percentage — and watch the effect on the bottom line.

For Apple II

£85

+ VAT

For PET

£150

+ VAT

CCA DATA MANAGEMENT SYSTEM™

The CCA/DMS stores and retrieves information. It is very simple to learn and use, and at the same time provides real data processing capabilities for you and your APPLE II.

You can computerize most, if not all of your record keeping. DMS will give you control over any type of information which lends itself to "row and column" storage, retrieval and analysis.

If you are familiar with the concept of a computer "data base" the power and flexibility of the DMS will amaze you. If you are not familiar with "data base" operation, don't worry. It is logical and

simple. You'll find it easy to store the system, sort, update and print all kinds of files. Files for your mailing list, accounts receivable or payable, customer list, expense reporting, budget analysis, or any report you need. The 130 page manual has full instructions plus samples for a mailing list and inventory application.

For Apple II

£80

+ VAT

CCA/DMS FEATURES:

- Fields may be alphanumeric, numeric, integer, floating point, or fixed decimal with commas.
- Fields may be COMPUTED FIELDS.
- Fields may be alphanumeric, numeric, integer, floating point, or fixed decimal with commas.
- Fields may be COMPUTED FIELDS. DMS will compute any field within a record, using constants or other fields in the same record. Functions include add, subtract, multiply, divide and raise exponential powers.
- Records are easily located, using the scan feature. Scan for records with a field over, below, or between a range of values.
- Records are easily added and updated. DMS "prompts" you with questions.

- Multi-diskette capabilities for larger files—up to 85,000 characters per file!
- Sort the records into almost any order, using up to 10 fields as "keys". So you can sort for customer numbers; within zip code, for instance.
- Delete records, "compact" files, and backup files on data diskettes easily.
- Print reports with records in any order.
- Select fields to be printed.
- Print mailing labels.
- Numeric totals and subtotals can be specified when a value in an unrelated field in the same record changes. For example, sort, subtotal, and print according to department, or month, or customer number, or model number.

A MUST FOR EVERY APPLE II IN BUSINESS

DESKTOP PLAN — A Programming Language for Analysis

Desktop plan is the software tool that makes it practical to develop your own customized. . . .

Strategic plan analysis
Budget planning system
Capital budget planning
Cash flow planning
Product pricing analysis
Job development estimating
Job cost estimating

Profit & loss projections
Manpower requirement planning
Salary/labor cost planning
Balance sheet projections
Financial report preparation
Make/buy analysis
Sales forecasting

... WITHOUT PROGRAMMING AT A LOW ONE-TIME COST!

£80

+ VAT

FORTRAN FOR YOUR APPLE



£110

+ VAT

FORTRAN is a powerful programming language, especially suitable for work in mathematics, engineering and the sciences. Apple FORTRAN, usable with the Apple Language System, is the ANSI Standard Subset of the recently defined FORTRAN 77 standard, in several areas. Apple FORTRAN contains enhanced features and capabilities.

Apple is providing FORTRAN for use by technical professionals and educators who are both familiar with the FORTRAN language and are using packages written in FORTRAN. Because FORTRAN is a well-established language, large libraries of FORTRAN programs are already in existence, particularly for engineering and scientific applications. Apple FORTRAN provides the sophisticated FORTRAN user with the capability to develop new and modify existing FORTRAN programs on an Apple. Apple does not recommend FORTRAN for the individual new to programming.

There are two minor differences between the ANSI Standard Subset FORTRAN 77 and Apple FORTRAN. They are:

- Subprogram names cannot be passed as parameters
- INTEGER and REAL data types have different storage requirements—two bytes for INTEGER, four bytes for REAL

Apple FORTRAN is written in Pascal and produces P-code which runs in the Apple Pascal Operating System

Diskettes: 16 sector format

To use Apple FORTRAN, you will need:

- Apple II or Apple II Plus, each with the Apple Language System;
- Apple Disk II drive with controller
- video monitor or television

*While a single drive system is adequate for very small programs, two drives are strongly recommended for ease of operation and more serious program development

Apple FORTRAN...

- offers enhanced features and capabilities because it supports the newest computer industry standard, ANSI X3.9-1978...
- provides a comprehensive software design environment including an editor, linker, file handler, assembler, Apple Pascal compiler, and system library, operating in the Apple Language System
- eliminates the need to recompile or reassemble existing code files when incorporating them into FORTRAN programs; compiled P-code and assembled machine code can be combined with a FORTRAN P-code file through the Apple Language System's linker facilities.
- allows you to take full advantage of Apple's Hires graphics capabilities by interfacing to graphics routines in the system library...
- gives programmers access to large libraries of material, since FORTRAN is a familiar, well-established language...
- provides access to special Apple features, such as sound generation and control paddles, through its system library routines...
- permits you to combine several source code files in a single compilation through compiler directives in the source code.

First, Some Words About FORTRAN 77

FORTRAN 77 contains significant additions and enhancements to the previous 1966 standard. For example mixed-mode arithmetic expressions are allowed. Structured programming is supported through expanded IF statement constructs. Logical IF, Block IF, ELSE IF, ELSE, and END IF statements provide a vastly improved method of clearly and accurately specifying the flow of program control. CHARACTER data type replaces Hollerith, alphanumeric data can be represented as strings rather than array elements.

Some Specifics About Apple FORTRAN

- Apple FORTRAN is the ANSI Standard Subset FORTRAN 77. It also supports enhancements and facilities from the full FORTRAN 77 language. In particular:
 - Subscript expressions may include array elements and function calls
 - DO statement limits may be defined by expressions, rather than just single variables.
 - I/O units may be specified by expressions, rather than just constants or simple variables.
 - The I/O list of a WRITE statement may include expressions

■ All combinations of FORMATTED/UNFORMATTED and SEQUENTIAL/DIRECT files are allowed, with the following restrictions:
 ---BACKSPACE is supported only for files connected to the blocked devices, it is not supported for UNFORMATTED SEQUENTIAL files; ---DIRECT files must be connected to blocked devices

Apple FORTRAN contains a number of enhancements beyond the full FORTRAN 77 specifications. In particular:

- Compiler directives may be included in the source code. For instance, the INCLUDE directive allows you to insert previously developed code into your program without having to repeat the code. This is useful, for example, when you are writing many subroutines which use the same COMMON block. You can write the COMMON block just once, and INCLUDE it in every subroutine.
- An additional parameter to the OPEN statement allows you to specify whether the file is blocked or unblocked

apple II PLUS 16K RAM

© Apple is a trade mark of Apple Computer Inc., Cupertino, CA. USA.



£485

Send cheque or money order for

£565 (including VAT & Delivery) to:

Trade Enquiries
Welcome

GUESTEL LIMITED

Refuge House, 2-4 Henry Street, Bath, BA1 1JT.
Telephone: 0225-65379

Please allow 28 days for delivery

MULTI-USER BUSINESS COMPUTER SYSTEM FOR £395/MONTH*

SALES LEDGER, BOUGHT LEDGER, NOMINAL LEDGER, CREDIT CONTROL, STOCK CONTROL, ORDER PROCESSING.

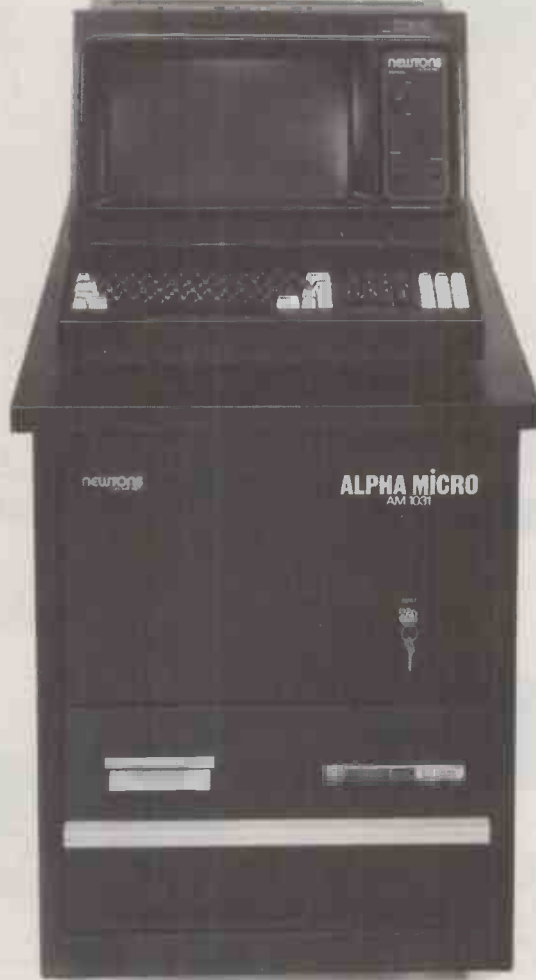

COMPUTER HARDWARE

Consists of a 16-Bit ALPHA MICRO central processor unit, 128 KB of dynamic random access memory, 6 terminal input/output ports, 10 Megabyte of disk storage of which 5Mb is fixed and 5Mb on a removable cartridge for security and backup purposes, all rack mounted in a universal cabinet. In addition there are 3 PERICOM visual display units with green phosphor screens, a LEAR SIEGLER 180 character/second printer on stand.

TOTAL PRICE FOR THIS HARDWARE DELIVERED, TESTED AND INSTALLED £14,685

This system gives a new meaning to the words "Cost Effective". It combines a powerful 16 bit processor with a proven timesharing disk operating system to give you data handling and software sophistication parallel to that of high performance mini-computers. It can be field upgraded from a simple single terminal system up to a 20 terminal, multi-printer, system with 400 Megabytes of disk storage and 768 Kilobytes of random access memory without any hardware redundancy. Ask us about any application you have in mind.

An integrated business accounting system is available virtually "off the shelf" and consists of 4 individual subsystems. Each subsystem can be individually implemented which allows you to

start with the sales ledger only and gradually introduce and integrate the others. If required, the individual subsystems can be tailored to match your specific business.

ORDER PROCESSING STOCK CONTROL

A truly professional piece of software. Complete inventory file maintenance. Order and back-order processing with credit control. Automatic salesman commission processing. Automatic stock allocation and update. Category and product sales analysis. Low stock reporting. Stock valuation and much, much more.

TOTAL 75 PROGRAMS. PRICE £1600.
MANUAL ONLY £25.

SALES LEDGER

Complete customer file maintenance. Open item and/or balance brought forward ledgers. Instant account enquiry. Statements, aged debt analysis with or without detail, sales journal, cash journal, VAT analysis, customer or area sales analysis and much, much more.

TOTAL 70 PROGRAMS. PRICE £800.
MANUAL ONLY £15.

BOUGHT LEDGER

Complete supplier file maintenance. Open item ledger with invoice, payment, discount and due-date details. Payment by date or selection. Automatic Cheque writing. Purchase register, cash requirement report, aged debt analysis and much, much, more. TOTAL 50 PROGRAMS. PRICE £800

NOMINAL LEDGER

Complete account file maintenance. Open item ledger. Instant account enquiry. Trial balance, source cross reference, user defined balance sheet and profit and loss accounts. Supports multiple profit centres or operating divisions. Journals, supporting schedules and much, much more. TOTAL 40 PROGRAMS. PRICE £800.

There is really only one way to find out more. Come to our office and showroom. As we have implemented all our systems in our own business we can even demonstrate in a live environment. Phone us for a demonstration or send us the coupon and we will phone you.

MULTI-USER BUSINESS COMPUTER SYSTEM

PC.W1.

REQUEST FOR A DEMONSTRATION

Name _____

Title _____

Company _____

Address _____

Postcode _____

Tel: _____

ORDERS FOR MANUALS MUST BE PREPAID.

NEWTONS
LABORATORIES

111-113 Wandsworth High Street,
London SW18 4JB.

Tel: 01-874 6511. Telex: 21768 (NEWTON G)

*£395/Month is based on a total system price of £18,750 leased over 5 years with zero residual value. Other terms available.

SUMLOCK BONDAIN

makes the decisions easier..



Discover the full professional power of Hewlett Packard's personal computer.

The portable, stand-alone HP-85 personal computer was only the beginning of a total system. By itself, the HP-85 lets you put professional problem-solving power wherever you need it. Because all its features are built into a single unit weighing less than 10 kgs.

And now you can extend the HP-85's power to match your increasing professional requirements. Simply plug in HP's new high-performance printers, plotters and flexible disc systems. In fact, you can add up to 14 peripherals or instruments. It's up to you.

It's your personal computer system. You decide which HP peripherals you need.

Add the HP 2631B printer for high-speed, high-quality printing - with choice of line spacing, character width and density. Add the HP 7225 Graphics Plotter for high-resolution, publication-quality graphics on A4-size paper or film. Add memory with the HP 82900 series of flexible disc drives, each 5¼" disc providing up to 270K bytes of formatted storage. And HP's new enhancement ROMs and modules let you expand to 80K bytes of operating system, without reducing user memory.

See the HP-85 and its new peripherals in action. Getting your hands on so much professional computing power was never so easy.



It costs less from the calculator specialists. Advanced calculators to solve your professional problems.

...with our latest range of advanced calculators to solve your professional problems.

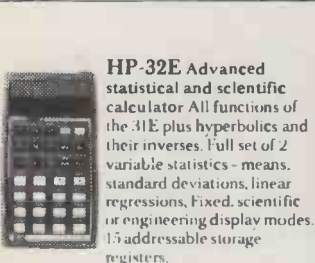

HP-32E Advanced statistical and scientific calculator. All functions of the 31E plus hyperbolics and their inverses. Full set of 2 variable statistics - means, standard deviations, linear regressions, Fixed, scientific or engineering display modes. 15 addressable storage registers.

£38.76



NEW

HP-34C Advanced programmable scientific calculator. Indirect addressing. Controlled memory varying between 210 program lines and 70 data registers. Innovative SOLVE and INTEGRATE functions. With Continuous Memory to retain data and programs even when switched off.

£79.50



£406.88

HP-67/HP-97 Magnetic card programmable calculators. Pre-recorded application packs covering maths, statistics, electrical engineering, business and finance. 26 data storage registers. 224 merged program lines with up to 3 keystrokes per line. HP-97 is a desk-top model with integrated thermal printer.

£196.87

NEW

HP-38C Programmable financial calculator

Direct solution of rate of return and NPV in discounted cash flow calculations. Interest rates, yields, payments, number of payments etc. Applications in securities trading, leasing, loans and savings. Calendar functions. Programmable facility for individual solutions. With Continuous Memory to retain data and programs even when switched off.

£79.50

HP-38E Lower cost version of HP-38C without Continuous Memory.

£66.45

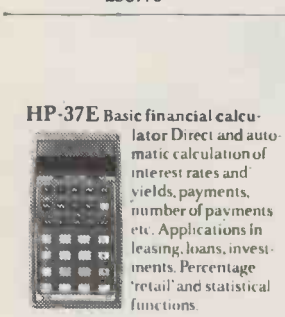

HP-37E Basic financial calculator. Direct and automatic calculation of interest rates and yields, payments, number of payments etc. Applications in leasing, loans, investments. Percentage 'retail' and statistical functions.

£41.78

No hidden extras. Every Hewlett-Packard calculator comes complete with: soft, zip-up lined case; owner's and application manuals (plus additional applications book where appropriate); factory-fitted rechargeable cells and recharger (apart from the 41C); two rolls of thermal paper on printing machines. Beyond the standard package, we've a wide range of optional accessories and our comprehensive software support, which gives you a choice of applications packs to really extend your range of ability.



NEW

HP-41C HP's unique expandable calculating system. Advanced 140-function programmable calculator. Full alphanumeric liquid crystal display. Up to 319 registers for data or programs. Add-on extras include Magnetic Card Reader and Printer.

HP41C £168.04
HP82104A £122.76
HP82143A £219.89



NEW

HP-33C Programmable scientific calculator. 49 lines of program memory. 3 levels of subroutines. 8 addressable storage registers. Integer, fraction and absolute value of a number. With Continuous Memory to retain data and programs even when switched off.

HP-33E Lower cost version of HP-33C without Continuous Memory.

HP33C £59.
HP33E £49.

Come to the Hewlett Packard open days at our new premises in City Road, December 2nd and 3rd. Come and hands-on test any of our superb range of products.

SUMLOCK BONDAIN LTD.

Head office: 263-269 City Road, London EC1V 1JX
and at Cannon Street Station, London EC4
Tel. 01-250 0505 Telex 299844

If you need advice, ask for it — WE CAN GIVE IT
Barclaycard/Access, official orders accepted by phone

All prices include postage, packing & VAT

The new
powerful
personal
computer
from
Sweden...



NEW! for your ABC80
FLOPPY DRIVES UP TO
1 MEGABYTE
VERSATILE MATRIX
PRINTERS
MEMORY EXTENSION
& I/O CARDS
SPECIAL PROGRAMMES...

ABC80

Now available from
UK stocks

The microcomputer which out-
sells all others in Scandinavia.

Write: Datormark Ltd. / Fox Oak / Seven Hills Road / Walton-on-Thames / Surrey KT12 4DG.

ANNOUNCING A BRAND NEW ACCESSORY FOR YOUR APPLE.

THE ARISTOCARD HIGH SPEED SERIAL INTERFACE

This Aristocard is the first in a series of plug compatible boards for the Apple 11 containing an asynchronous RS 232 interface which enables your Apple to communicate with all types of printers, terminals and modems.

- * Switch selectable baud rates of 110, 300, 600, 1200, 2400, 4800, 9,600, 19,200
- * Full handshaking capabilities containing: CTS, RTS, DTR, DSR, DCD.
- * Delay option-after carriage return.
- * Half or full duplex.
- * Fully guaranteed for one year.
- * Full documentation on interfacing Aristocard to printers, terminals and modems.
- * Terminal test function.
- * Parity (ODD/EVEN/NONE). 1 or 2 stop bits, 7 or 8 data bits.
- * Adjustable line width of: 48, 80 or 132 characters per line.
- * Lower to upper case translate option.
- * Automatic line feed option after carriage return.
- * Reset on break (Using remote terminal)
- * Supplied with ribbon cable wired to DB25 and molex connector.

To obtain the Aristocard High Speed Serial Interface complete the order form below and enclose your remittance for £66. (Price includes V.A.T. and postage & packing). Return in original condition within 7 days of receipt for full refund if not completely satisfied. Allow 28 days for delivery.

N.B. ARISTOCARDS ARE ONLY AVAILABLE THROUGH SIMON COMPUTERS LTD.

£66
inc VAT, p+p

WE STOCK APPLES WITH ACCESSORIES
AS WELL AS A LARGE RANGE OF
PERIPHERAL DEVICES, AND ALL
TYPES OF SOFTWARE.

Tel: 01-680 4646
FOR FURTHER DETAILS

SEND TO: SIMON COMPUTERS LIMITED
28 LOWER ADDISCOMBE RD, CROYDON, SURREY.

PLEASE SUPPLY THE ARISTOCARD
HIGH SPEED SERIAL INTERFACE

I enclose cheque/postal order for £66.

Name

Address

..... PCW/12/80

GW Computers Ltd

89 Bedford Court Mansions, Bedford Avenue, London W.C.1.
call only by appointment



SUPERBRAIN™

Intelligent Video Terminal Systems

350K or 700K of Disk Storage

SuperBrain's CP/M operating system boasts an overwhelming amount of available software in BASIC, FORTRAN, COBOL, and APL. Whatever your application . . . General Ledger, Accounts Receivable, Payroll, Inventory or Word Processing, SuperBrain is tops in its class. And the SuperBrain QD boasts the same powerful performance but also features a double-sided drive system to render more than 700K bytes of disk storage and a full 64K of RAM. All standard!



COMPUSTAR™

MULTI-USER TERMINAL SYSTEM

CompuStar user stations can be configured in a countless number of ways. A series of three intelligent-type terminals are offered. Each is a perfect cosmetic and electrical match to the system. The CompuStar 10-a 32K programmable RAM-based terminal (expandable to 64K) is just right if your requirement is a data entry or inquiry/response application. And, if your terminal heads are more sophisticated, select either our CompuStar 20 or CompuStar 40 as user stations. Both units offer dual disk storage in addition to the disk system in the CompuStar. The Model 20 features 32K of RAM (expandable to 64K) and 350K of disk storage. The Model 40 comes equipped with 64K of RAM and over 700K of disk storage. But, most importantly, no matter what your investment in hardware, the possibility of obsolescence or incompatibility is completely eliminated since user stations can be configured in any fashion you like - whenever you want - at amazingly low cost!

DISK STORAGE

Options for the Superbrain and CompuStar Video Terminal

"Backup" for the 20 megabyte Century Data drive is provided via the dual disk system housed in the CompuStar or the SuperBrain. The Control Data CMD Drive features a removable, front-in-sertable top loading cartridge of 16 megabyte capacity plus a fixed disk capacity of either 16 or 80 megabytes.

Each drive is shipped equipped with an EIA standard 19" rack mounting system and heavy duty chassis slide mechanisms to permit easy accessibility for fast and efficient servicing.

**** WIDELY USED IN UK AND USA ****
**** TESTED AND PROVEN ****
**** POWER AT YOUR FINGERTIPS ****
**** JUST COMPARE THIS LIST ****

No other program in the world combines these feature in one. Many other programs, less integrated, do not provide even some of those features to be found on our 'bus'.

- 1 = Total integration of sales 'purchase 'nominal 'stock 'addresses etc
- 2 = Full random access enables retrieval of any record in a second
- 3 = Flexibles prompts enables word change even to foreign language.
- 4 = Files may be named and set to drive default, maximising storage.
- 5 = Easy to use, menu driven, no serious need of manual.
- 6 = Tested and debugged in many installations world wide.
- 7 = Priced less than the acquisition of a library of programs.
- 8 = The program is *** totally *** in core, maximising disk space.
- 9 = Core program means that disks may be interchanged during use.
- 10 = Core program means your main drive is *** free *** for data
- 11 = Numerous reports may be generated (eg: sale ledgers up to 30).
- 12 = Invoice produces immediate stock update + double journal entry.
- 13 = Reference on invoices enable cost centre build-up on ledgers.
- 14 = Stock valuations and re-order reports easily generated.
- 15 = Bank balance and reports plus standard mailing facilities.
- 16 = Customer statements and invoices printed on plain paper

Also at: Gamma Data Systems, Dollard House, Wellington Quay,
Dublin 2. Tel Dublin 711877

***** MAIN MENU DISPLAY *****

**New! Produced in U.K. and widely used in England and the U.S.A.
Complete Business Package**

**INCLUDES EVERYTHING FROM INVENTORY TO SALES SUMMARY
PROMPTS USER AND VALIDATES ENTRIES. MENU DRIVEN
PET AND CP/M SUPERBRAIN, TRS80 ii, N'STAR, IMS5000.
APPROXIMATELY 60-100 ENTRIES/INPUTS REQUIRE 2-4 HOURS WEEKLY
AND ENTIRE BUSINESS IS UNDER CONTROL**

* PROGRAMS ARE INTEGRATED .. SELECT FUNCTION BY NUMBER ..

- | | |
|-------------------------------|--------------------------------|
| 01=*ENTER NAMES AND ADDRESSES | 13=*PRINT CUSTOMERS STATEMENTS |
| 02=*ENTER/PRINT INVOICES | 14=*PRINT SUPPLIER STATEMENTS |
| 03=*ENTER A'C RECEIVABLES | 15=*PRINT AGENT STATEMENTS |
| 04=* ENTER PURCHASES | 16=*PRINT TAX STATEMENTS |
| 05=*ENTER A'C PAYABLES | 17=LETTER TEXT AREA |
| 06=*ENTER/UPDATE INVENTORY | 18=ALTER VOCABULARIES |
| 07=*ENTER/UPDATE ORDERS | 19=PRINT YEAR AUDIT |
| 08=*ENTER/UPDATE BANKS | 20=PRINT PROFIT/LOSS A'C |
| 09=*REPORT SALES LEDGER | 21=OPEN AREA |
| 10=*REPORT PURCHASE LEDGER | 22=PRINT CASHFLOW FORECAST |
| 11=*INCOMPLETE RECORDS | 23=ENTER PAYROLL (NO RELEASE) |
| 12=*USER DBMS AREA | 24=DISK SWAP/EXIT |
| 04=* ENTER PURCHASES | |

DATABASE MANAGEMENT INCLUDES

*** FILE OR RECORD CREATE'DELETE'AMEND'SEARCH'PRINT 4 WAYS *** INFORMATION RETRIEVAL ON ANY KEY RECORD OR PART THEREOF *** AUTOMATIC CHECK TO PREVENT DOUBLE ENTRY TO FILE SYSTEM *** DYNAMIC ALLOCATION OF INFORMATION CONSERVING DISK SPACE.

VERY FLEXIBLE. EASY TO USE.

G.W. COMPUTERS LTD. UK ARE THE PRODUCERS OF THIS BEAUTIFUL PACKAGE. *AUTHOR* TONY WINTER (B.A.LIT; B.A.HON.PHIL).

PET VER 3.00 LOW LEVEL INTEGRATION = 475.00. PET VER 4.00 INCLUDES AUTO STOCK-UPDATE = 575.00. PET VER 5.00 INCLUDES AUTO BANK UPDATE = £675.00. CPM VER 6.00 IN CORE, TRANSLATABLE PLUS DBMS = 775.00. CPM VER 7.00 AUTO STOCK-UPDATE = 875.00. CPM VER 8.00 AUTO BANK UPDATE = 975.00. CPM VER 9.00 INCLUDES OPTIONS 19, 20, 22, 23 (LATER RELEASE). +++ EACH LEVEL AUGMENTS LOWER ONE.

**WE EXPORT TO ALL COUNTRIES CALLERS ONLY BY APPOINTMENT
CONTACT TONY WINTER ON 01-636 8210
89 BEDFORD COURT MANSIONS, BEDFORD AVENUE, LONDON W.C.1.**

**NOTE!!! LEVEL 9.00 TOTALLY IN CORE PROGRAM LEAVES MASTER DRIVE FREE
(SAVING OF 200 POUNDS HARDWARE).**

**IMPORTANT!!! No computer hardware is ever of value without software, so we provide you with
a starting set of programs **** free **** at 10% of hardware purchased.
A Superbrain and NEC Spinwriter could give you up to 400 pounds of programs. See [].**

PET + PET + PET + PET + SOFTWARE + SOFTWARE + SUPERBRAIN + SUPERBRAIN

CBM 3032 32K	595.00	BUS VER 3.00	PET	475.00	SUPERBRAIN 320K	1795.00
CBM 3040 DISKS	595.00	BUS VER 4.00	PET	575.00	TWIN Z80 64K+CRT
CBM 3022 PRINTER	425.00	BUS VER 5.00	PET	675.00	+2 D'D-D'S DRIVE
CBM 8032 32K	875.00	BUS VER 6.00	CP'M	775.00	SUPERBRAIN 800K	2195.00
CBM 8050 1MEG DISKS	875.00	BUS VER 7.00	CP'M	875.00	TWIN Z80 64K+CRT
CBM EPSON PRINTER	395.00	BUS VER 8.00	CP'M	1000.00	+2 D'D-D'S DRIVE
CBM MULTI USER	650.00	BUS VER 9.00	CP'M	1075.00	SUPERBRAIN 2MEG	2795.00
CBM 3032 + EPSON +		CBM WORDPRO II		75.00	COMPUSTAR 10	1595.00
CBM 3040 + BUS V3	2215.00	CBM WORDPRO III		150.00	COMPUSTAR 15	1495.00
PRINTERS + PRINTERS +		CPM* WORD STAR		195.00	COMPUSTAR 20	2295.00
DIABLO 830 40CPS	1595.00	CPM* MBASIC 80		150.00	COMPUSTAR 30	2495.00
DOLPHIN BD80 125CPS	495.00	CPM* COBOL 80		320.00	COMPUSTAR 40	2795.00
NEC 5510 PRINTER	1695.00	CPM* PASCAL MT		150.00	INTERTUBE III	495.00
MICROLINE 80 120CPS	475.00	CPM* FORTRAN 80		200.00	EMULATOR	495.00
TELETYPE 43SR 30CPS	875.00	CPM* DATASTAR		175.00	10 MEG H'DISK	2950.00
DEC-LA34 TRACT 30CP	875.00	CPM* PASCAL-M		250.00	16 MEG (8'8)	3950.00
NEC-5530 PRINTER	1595.00	CPM* BYSTAM S'BRAIN		75.00	96 MEG (4DISK)	7950.00
QUME DAISY SPRINTS	1950.00	CPM* SUPERSORT		120.00	(ADDRESS'MAILER)	95.00
TEXAS 810 150CPS	1390.00	CPM* BASIC COMPILER		190.00	(STOCK CONTROL)	95.00
SPECIALS + SPECIALS +		CPM* DESPOOL		30.00	(DBMS DATABASE)	195.00
N'STAR QUAD .7 MEG	1200.00	CPM* BYSTAM IMS'N-STAR		75.00	IEEE TO PARALLEL	55.00
IMS 5000 48K D'D	1500.00	CPM* TEXTWRITER		75.00	IEEE'RS232 BI'DI	195.00
COMPUTHINK * 800K *	795.00	CPM* POSTMASTER		75.00	IEEE TO RS232	75.00
2 WAY CRDLESS PHONE	135.00	CPM* SELECTOR 3		180.00	S'HAND SWTP TERM	100.00
TELEPHONE ANSWER	230.00	CPM* CBASIC		75.00	WARRANTY	
SHUGART SA400 5" DR	135.00	CPM* MACRO 80		75.00	6 MONTH FULL REPAIR	***
SHUGART SA400 DRIVE 5 1/4"	135.00	CPM* W'STAR M'MERGE		245.00		
VER 3.00		BUS MANUAL *****		9.00		
		SUPERBRAIN 320K		1695.00		
		TWIN Z80 32K+CRT			
		+2 D'D-S'S DRIVE			

+++++++ SPECIAL INSTITUTION AND UNIVERSITY DISCOUNTS +++++++

MOST ITEMS IN STOCK. (ACCESS 'AMEXCO' BCLYCARD OTHERWISE CHEQUE WITH ORDER)

CONTACT TONY WINTER 01-636 8210
89 BEDFORD CT MANS, BEDFORD AVE W.C.1.

Alive...well... and very healthy

As a Nascom user I had enormous satisfaction and sensed an excitement about the future when told that I had Nascom.

I have been determined from the start of the troubles that Nascom would be revived and with several colleagues formed an association with sufficient finance to purchase and expand the new company.

Being a customer I am only too well aware of the frustrations caused by Nascom's supply problems. The root of these was cash and, as we will not have that problem, I am very confident that Nascom International can progress quickly and professionally into a normal supply situation.

While immediately supporting our traditional marketplace we intend to expand the company rapidly into the manufacturing of industrial Nascom products. The design of certain products is already under way and the first of these will be a Prestel users receiver which will be available at the start of 1981. This is a separate, stand alone unit having no connection with previous

Nascom products. We have several other projects under design or investigation that will give the new industrial division a good start next year.

We have the finance and facilities to exploit new ideas and would be very pleased to hear from any designer who has an idea based around Nascom products. Anyone with hardware or software please write to me at Pall Mall.

Nascom announced many products in the last year few of which arrived. Luckily during receivership many of these designs were completed and we will immediately be purchasing supplies to make these available a.s.a.p.

There are also other Nascom 2 products defined that we will quickly engineer and produce in the next few months.

The future for micros is undeniable and Nascom International intends to retain its rightful place at the head of European microcomputing.

Peter Mathews Chairman



Competition-best caption

2.

To allow the frustrated to vent their ire and the imaginative to vent their flair we invite your captions to the four cartoons that appear this month. A prize for each and the winners published. You can't win if you are too rude as we can't publish. Send to Chesham marked "Cartoon".

New Start With 20,000 users and a good deal of frustration and uncertainty mixed into the enthusiasm we invite everyone to write with their ideas and needs. The new home division will not be able to answer all the letters but policy decisions on direction can best be made on research into user needs.

Dealers We intend to continue the policy of sales through dealers and Nascom International will not be selling products direct to the public. Stocks we know are depleted and we would ask you to allow us time to restock our dealer network.

nascom

INTERNATIONAL

new company...new people...new start...

92 Broad Street, Chesham, Buckinghamshire. 02405 75151
46 Pall Mall, London SW1. 01-839 3143

Hard Core Software.

The new MCC Program line editor is one of the most powerful program editing tools now available anywhere.

Instant single character editing without the necessity to completely re-enter every line.

Editing many times faster, the more you use it the faster editing becomes.

Now lower case text can be inserted into print statements with just a simple command.

The package also includes a keyboard macro capability. You can assign common commands or convenient routines to a keyboard character. Thereafter all you need to do is press ESC and that character will cause the function to happen.

This uniquely powerful program is available on request.

Simply complete the form below and post it to us, or for further information telephone us direct on Wentworth 3246.

After a few days have passed you will be receiving a plain brown envelope addressed to you carrying some real "Hard Core Software."

MICRO COMPUTER CONNECTIONS LTD.

All your answers at the touch of a button.

Micro Computer Connections Ltd., 41 High Street, Egham, Surrey TW20 9DS.
Complete coupon and send together with your remittance for £35.00 p&p included, made payable to MICRO COMPUTER CONNECTIONS LTD.
Within 28 days of receipt you will receive the new MCC Program Line Editor, complete with instructions. (Credit Card facility available.)

NAME _____
COMPANY _____
POSITION _____
ADDRESS _____

I enclose my cheque/PO for £ _____ or debit my credit card No. _____

A GREAT DEAL FROM 6 NASCOM DEALERS

and guaranteed after-sales service

BUILT FLOPPY DISC SYSTEM FOR NASCOM 1/2 FROM £395+VAT

It's here at last. A floppy disc system and CP/M.

CP/M SYSTEM.

The disc unit comes fully assembled complete with one or two 5 $\frac{1}{4}$ " drives (FD250 double sided, single density) giving 160K per drive, controller card, power supply, interconnects from Nascom 1 or 2 to the FDC card and a second interconnect from the FDC card to two

drives, CP/M 1.4 on diskette plus manual, a BIOS EPROM and new N2MD PROM. All in a stylish enclosure.

Nascom 2 Single drive system. £450 + Vat
 Nascom 2 Double drive system £640 + Vat
 Nascom 1 Single drive system. £460 + Vat
 Nascom 1 Double drive system £650 + Vat
 Additional FD250 drives £205 + Vat

D-DOS SYSTEM

The disc unit is also available without CP/M to enable existing Nas-Sys software to be used. Simple read, write routines are supplied in EPROM. The unit plugs straight into the Nascom PIO.

Single drive system £395 + VAT
 (please state which Nascom the unit is for)

Certain parts of the CP/M and D-DOS disc systems are available in kit form. Details available on request.



ENCLOSURE FOR N2 + 5

The Kenilworth case is a professional case designed specifically for the Nascom 2 and up to five additional 8" x 8" cards. It has hardwood side panels and a plastic coated steel base and cover. A fully cut back panel will accept a fan, UHF and video connectors and up to 8 D-type connectors. The basic case accepts the N2 board, PSU and keyboard. Optional support kits are available for 2 and 5 card expansion.

Kenilworth case £49.50 + Vat
 2-card support kit £7.50 + Vat • 5-card support kit £19.50 + Vat



INTERFACE ENHANCING UNIT

The Castle interface is a built and tested add-on unit which lifts the Nascom 2 into the class of the fully professional computer. It mutes spurious output from cassette recorder switching, adds motor control facilities, automatically switches output between cassette and printer, simplifies 2400 baud cassette operating, and provides true RS232 handshake.

Castle Interface Unit .. £17.50 + Vat

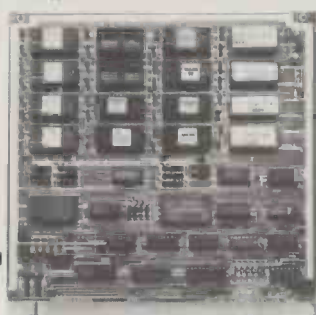

EPROM EXPANSION

The Nasbus compatible EPROM board accepts up to 32,2716 or 16,2708 EPROMs. It has a separate socket for the MK36271 8K BASIC ROM for the benefit of Nascom-1 users. And for Nascom-2 users, a wait state for slower EPROMs. The board also supports the Nascom Page Mode Scheme.

EPROM Board (kit) £55 + Vat
 EPROM Board (built & tested) £70 + Vat

A-D CONVERTER

For really interesting and useful interactions with the 'outside world' the Milham analogue to digital converter is a must. This 8-bit converter is multiplexed between four channels - all software selectable. Sampling rate is 4KHz. Sensitivity is adjustable.

Typical applications include temperature measurement, voice analysis, joystick tracking and voltage measurement. It is supplied built and tested with extensive software and easy connection to the Nascom PIO.

Milham A-D Converter (built and tested) £49.50 + Vat

PROGRAMMER'S AID.

For Nascom ROM BASIC running under Nas-Sys. Supplied in 2x2708 EPROMs. Features include: auto line numbering; intelligent renumbering; program appending; line deletion; hexadecimal conversion; recompression of reserved words; auto repeat; and printer handshake routines. Price £28 + Vat.

DUAL MONITOR BOARD. A piggy-back board that allows N1 users to switch rapidly between two separate operating systems. Price (kit): £6.50 + Vat.

BASIC PROGRAMMER'S AID.

Supplied on tape for N1/2 running Nas-Sys and Nascom ROM BASIC. Features include auto line number, full cross-reference listing, delete lines, find, compacting command, plus a comprehensive line re-numbering facility. Price: £13 + Vat.

PROM-PROG MKII.

2708 (multi-rail) and 2716 (single-rail) EPROM programmer kit controlled by N1/2 PIO. Supplied with comprehensive software for use with Nas-Sys. Price: £25.95 + Vat.

NASCOM-2 Microcomputer Kit £225 + Vat
 NASCOM-1 Microcomputer Kit £125 + Vat
 Built & tested £140 + Vat
 IMP Printer. Built & tested £325 + Vat

All prices are correct at time of going to press.

All the products are available while stocks last from the Nascom dealers below.
 (Mail order enquirers should telephone for delivery dates and post and packing costs.) Access & Barclaycard welcome.

BITS & PC'S
 4 Westgate, Wetherby, W. Yorks.
 Tel: (0937) 63774.

BUSINESS & LEISURE MICROCOMPUTERS
 16 The Square, Kenilworth, Warks.
 Tel: (0926) 512127.

ELECTROVALUE LTD.
 680 Burnage Lane, Burnage,
 Manchester M19 1NA.
 Tel: (061) 432 4945.
 28 St Judes, Englefield Green,
 Egham, Surrey TW20 0HB.
 Tel: (0784) 33603. Tlx: 264475.

TARGET ELECTRONICS
 16 Cherry Lane, Bristol BS1 3NG.
 Tel: (0272) 421196
INTERFACE COMPONENTS LTD.
 Oakfield Corner, Sycamore Road,
 Amersham, Bucks.
 Tel: (02403) 22307. Tlx: 837788.

HENRY'S RADIO
 404 Edgware Road, London W2.
 Tel: (01) 402 6822.
 Tlx: 262284 (quote ref: 1400)

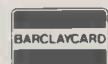
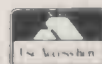

HEWLETT PACKARD

HP85

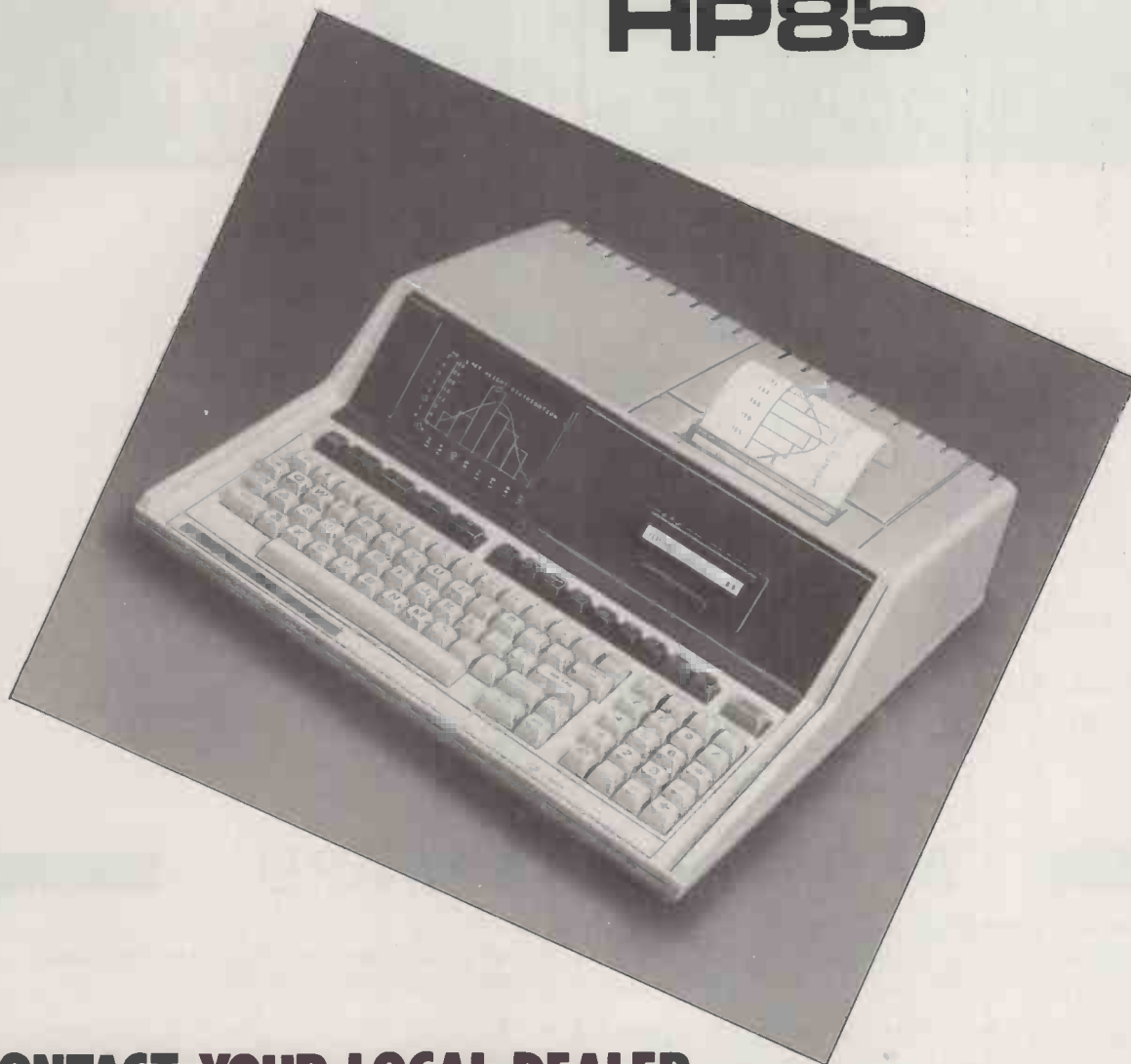

CONTACT YOUR LOCAL DEALER

Anglo-American Computing
9 Coventry Road
Coleshill
Warks
0675 65396

Automated Business Equipment
Mersey House
Heaton Mersey Industrial Estate
Battersea Road
Heaton Mersey
Stockport
Manchester (061 432) 0708

Cambridge Computer Store
1 Emmanuel Street
Cambridge CB1 1NE
0223 65334/68155

Cardiac Services
95a Finachy Road
Belfast BT10 DBY
Belfast 625566

Central Southern Calculators
12 Wokingham Road
Reading
Berks
Reading (0734) 61492

DBM Systems & Software
58 Victoria Street
Bristol BS1 6DE
0272 214093/4

D J Herriott Ltd
42 Camden Road
Tunbridge Wells
Kent TN1 1EE
(0892) 22443

Holdene Ltd
10 Blenheim Terrace
Leeds
Leeds (0532) 459459

Office Machinery Engineering
73 London Road
Brighton
E. Sussex
Brighton (0273) 689682

Petalect Ltd
32, Chertsey Road,
Woking,
Surrey,
04862 217766/63901

Robox Limited
Unit 4
Anderston Shopping Centre
Glasgow
Glasgow (041 221) 5401

Sumlock Bondain Ltd
15 Clerkenwell Close
London EC1
01-250 0505

Sumlock Services
Epic House
Charles Street
Leicester
Leicester (0533) 29673

This advertisement is organised by Personal Computer World and sponsored by the above Hewlett-Packard dealers. It is not a full list of all HP dealers, but only of those participating in this advertisement.

COMPUTECH for Apple

COMPUTECH for **ITT**

Well proven software for business applications on the
ITT 2020 and Apple microcomputers.

Prices excluding V.A.T. for cash with order, F.O.B. London NW3

PAYROLL	(300+ Employees, 100 Departments, hourly, weekly, monthly. Very powerful but easy to use).	£375
SALES LEDGER	(500+ Accounts, 100 Departments).	£295
PURCHASES LEDGER	(500+ Accounts, 100 Departments).	£295
GENERAL (OR NOMINAL) LEDGER	(1000 Accounts, 100 Analyses, multi-purpose package). Job costing etc.	£295
UTILITIES DISK 1	(Diskette patch, slot to slot copy, zap etc).	£20
APPLEWRITER	(Word Processing, see below for U/L case).	£42
VISICALC	(Financial Modelling, Costing, Analysis).	£95
CAI	(Converts Apple pictures for ITT display).	£10

Over 500 packages in use, fully supported by us.

AND NOW HARDWARE!

LOWER & UPPER CASE CHARACTER GENERATOR £50
Replaces character generator to display upper and lower case characters on screen, includes patches to work with Applewriter, supplies the missing link! Specify Apple or ITT.

COMPUTECH DIPLOMAT H/S SERIAL INTERFACE £80
This card has been designed and built to the same professional standards that have resulted in the success of our software. The DIPLOMAT observes the proper "handshaking" protocol so that you can drive fast printers and send and receive data from other peripherals at high speeds without loss of data. Switch (& software) selectable baud rates to 19200 and many other options. Plug compatible with 'terminal' or 'modem' wired peripherals. Guaranteed.

MICROLINE M80 PRINTER £425
This neat, reliable machine prints at 10 characters per inch, 80 characters on an 8 inch line, or 40 expanded characters, or 132 very readable characters, upper and lower case and graphics, 9 x 7 dot matrix, 6 or 8 lines per inch. Parallel interface is standard, serial optional. Both friction and sprocket feed are standard, tractor optional. We can also supply the parallel interface card for Apple System computers for £80 and a driver to enable both text and graphics to be used. Optional custom colour matching for Apple or ITT. Optional character sets. *Trade supplied at very generous discounts for modest quantities.*

THE FABULOUS MICROMUX 8000 from £800
This is a brand new product, an asynchronous serial multiplexor with up to 16 ports, any one of which may communicate with any other independently, like a 'telephone exchange' for data! Built in test function. Firmware may be customised for special applications. Available in multiples of 4 ports up to 16.

COMPUTECH SYSTEMS

168, Finchley Road, London NW3 6HP. Tel: 01-794 0202

AGENTS THROUGHOUT THE UK AND OVERSEAS

Almarc + Vector Graphic

The complete partnership
in Micro computers

DATA SYSTEMS LTD

906 Woodborough Road, Nottingham NG3 5QS.
Tel: (0602) 625035

System 2800.

- * S-100 bus.
- * Switch-selectable asynchronous baud rates between 110 and 9600 bits/second.
- * Vector-3 console chassis with 12-inch CRT (18" W x 12 1/2" H x 21" D).
- * Capacitance Keyboard 6 slot motherboard, and power supply.
- * Z-80 based single board computer with 1 serial port, 3 8 BIT parallel ports, 3 PROM slots, and

1K RAM. Flashwriter II. Video board, 64K dynamic memory board and disc controller. DUALSTOR enclosure with two 8-inch double density disc drives, total disc storage capacity 2.4 m bytes.

- * Version 4 extended systems monitor on PROM, Vector CP/M 2.2, SCOPE. Screen Oriented Program Editor, full screen dynamic simulating debugger, ZSM Z-80 assembler, Microsoft BASIC-80 Release 5.



System 3030.

- * Vector-3 console chassis with 12-inch CRT (18" W x 12 1/2" H x 21" D), capacitance keyboard, 6-slot S100 motherboard, and power supply.
- * ZCB Z-80 based single board computer with 1 serial port, 3 parallel ports, 3 PROM slots, and 1K RAM. Flashwriter II Video board, 64K dynamic memory board, floppy disc controller board, Winchester disc interface board, Megastor enclosure with 8-inch Winchester 3-platter hard disc drive, and

2 Micropolis Mod II quad density mini-floppy disc drives.

- * Capacity Hard Disc 32 M bytes.
- * 2 5 1/4" MICROP DISC DRIVES giving 630 Kbytes, Storage Capacity.
- * Version 4 extended systems monitor on PROM, Vector CP/M 2.2, SCOPE. Screen Oriented Program Editor, full screen dynamic simulating debugger, ZSM Z-80 assembler, Microsoft BASIC-80 Release 5.



System 'B'

- * 64K Bank Selectable Ram (56K available to user).
- * 3 Serial Ports, 2 Parallel Ports.
- * Twin Disc Drives, 630K Capacity.
- * Z-80 CPU, with Fast 4MHZ Clock.
- * Interrupt Handling on 1/0 Board.

- * 18 Slot Motherboard.
 - * Vector Mindless Terminal.
 - * Flashwriter II Video Board (24 x 80).
 - * CP/M 2.2 Operating System.
- Plus Microsoft Version 5 BASIC, SCOPE. Screen Oriented Program Editor, Full screen dynamic simulating debugger, ZSM Z-80 Assembler.



At Almarc Data Systems, when you buy Vector Graphic Micro-Computers, you are assured of Almarc's experience of over 430 systems installed throughout the U.K. — plus their back-up of full service facilities carried out by experienced staff.

Almarc are Specialists in Vector Graphic equipment which includes Micro-Computers for research, laboratory work, word

processing, business systems, schools, colleges, universities and industry. Plus an ever growing list of compatible software including Pascal, Fortran, Cobol, APL, Algol, Basic Compiler and others.

We will be pleased to demonstrate how Almarc + Vector Graphic Systems equates to The Complete Partnership in Micro-Computers.

MICROHIRE

FROM THE LEADING U.K. MICRO AND PROCESS CONTROL ENGINEERING COMPANY YOU CAN HIRE A WIDE RANGE OF MICRO'S, P.L.C's, M.P.C's AND PERIPHERALS FOR EITHER FAMILIARISATION PROGRAMME LAYOUTS OR SYSTEM EVALUATION BEFORE COMMITTING CAPITAL EXPENDITURE. WHATEVER YOUR COMMERCIAL OR INDUSTRIAL CONTROL APPLICATIONS ENJOY THE BENEFIT OF OUR EXPERTISE.

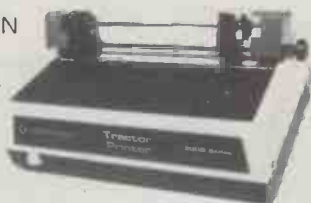

Hire, lease or buy

YOUR APPLE II, ACT 800 CBM 8032, 3032, 3016, 3022, 3040 AND OTHER POPULAR HARDWARE FROM STOCK! FULL RANGE OF ACCESSORIES AND SOFTWARE PACKAGES AVAILABLE NOW! TO DISCUSS YOUR DESIGN, REPAIR OR SERVICE REQUIREMENTS. CONTACT YOUR LOCAL ANALYST.



Why wait? Ring today!

AUGHTON MICRO SYSTEMS LIMITED



LIVERPOOL

Woodward Road, Kirkby, Liverpool L33 7UZ.
Telephone: 051-548 7788. Telex: 628681

PETERLEE

3 Davy Drive, North West Industrial Estate,
Peterlee, Co. Durham.
Telephone: 0783 865833/4. Telex: 537939

LONDON

210 Main Road, Sutton at Hone, Dartford, Kent.
Telephone: Farningham (0322) 862942
Telex: 896167

BITS & P.C.s

COMPUTER PRODUCTS LTD

The North's Leading Nascom Specialist

NEW PRODUCTS FROM NASCOM:

- Discs:**
Single drive £380.00
Double drive with CPM & EBASIC £640.00
Ask for details. Professionally designed for your NASCOM.
- Kenilworth Case:**
A high quality case made from stelvete coated steel and solid mahogany £49.50
Mounting kit for two cards £7.50
Mounting kit for five cards £19.50
- Sargon Chess Pack:**
This pack includes the book and a tape with Sargon prepared to run under NAS-SYS. Also included is a special graphics rom and a PCB giving your NASCOM the ability to switch between two graphics ROMs, your original and the chess ROM.
All the above for only £35.00
- Henelec EPROM Programmer:**
This unit allows the NASCOM user to program both 2708 and 2716 EPROMs and complete with operating software costs only £25.95
- Interface EPROM Board:**
Provides sockets for both 2708 and 2716 EPROMs (up to 16 EPROMs) and also provides a fully decoded socket for the NASCOM 8K BASIC ROM. This board is produced to full NASBUS specification and can be used in "page mode" together with the new NASCOM RAM B. Wait states may be generated on board to allow a NASCOM 1 to run at 4MHz in BASIC.
The complete kit at only £55.00
- Castle Interface:**
Gives the following features: Auto tape drive * Auto cassette muting * Auto serial printer muting * 2400/1200/300 BAUD cassette. This interface built and tested complete with documentation at only £17.50
- ASTECC 10" B/W Monitor:**
A professional cased 10-inch Monitor giving superb resolution, only £99.50
- Analogue to Digital Converter:**
This unit gives 4 channels with an Input Range of 0 to 120mV up to 0 to 24V. Conversion time (average) 0.5 mSec. Supplied built and tested at only £49.50
- Dual Monitor:**
This kit allows switching between two monitors on a NASCOM 1 e.g. T4 and NAS-SYS £6.50
- Port Probe:**
A very useful device for testing and evaluating ports and peripheral software with improved documentation £17.50
- HEX and Control Key Pads:**
Our popular range of add-on keyboards for the NASCOM micros.
HEX for NASCOM 2 £34.00
HEX & CONTROL KEYS for NASCOM 1 £40.50
- Cassette Machine:**
Will reliably record data at 2400bd and above, manufactured by SHARP £25.50
- Programmers' Aid:**
In 2 2708 EPROM gives the NASCOM rom BASIC many extra commands: AUTO, RENU, DELE, DUMP, FIND, HEX, APND, HELP. . . etc. £28.00
- HENELEC BASIC PROGRAMMERS AID on tape:**
Gives many extra facilities and in fact complements the BITS & P.C.s PROG: AID £14.95
- BITS & P.C.s Games Tape 1:**
Good value, ten excellent games £8.00
- Printers:**
We have a good range of printers, all of which will work on the NASCOM. RICH0, EPSON, IMP, QUME ANADEX.
- Books:**
Full range including INMC mags.
- Media:**
Paper, diskettes, ribbons, leaderless cassettes, VDU tables etc.
- Memories:**
4116, 4027, 2708, 2716.

BUILT SYSTEMS REPAIRS MAIL ORDER and ADVICE are our SPECIALITY.

BITS & P.C.s Computer Products Ltd.
4 Westgate, Wetherby, West Yorkshire.
Tel: 0937 63744.

SAE for details: prices exclude VAT and postage and package.

KGB MICROS LIMITED

THE PROFESSIONAL ORGANISATION OFFERING
HARDWARE AND SOFTWARE PLUS FULL CLIENT SUPPORT
WHO WISH TO MAKE YOUR BUSINESS OUR BUSINESS

SUPERBRAIN™



THE MICRO COMPUTER THAT HAS
THE BEST PRICE/PERFORMANCE
RATIO.

£1495 (64K RAM)

MICROLINE 80

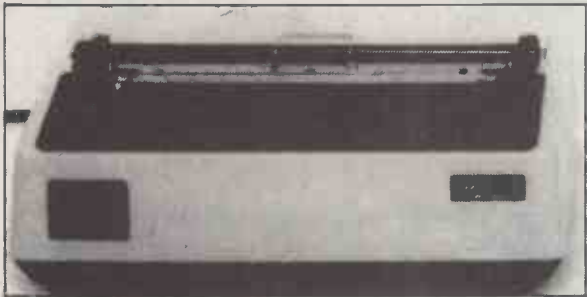

THE EFFICIENT BUSINESS SYSTEM
SUPERBRAIN

+

MICROLINE 80 PRINTER

£1795

INDIVIDUAL PRICE £500.00

DIABLO 630

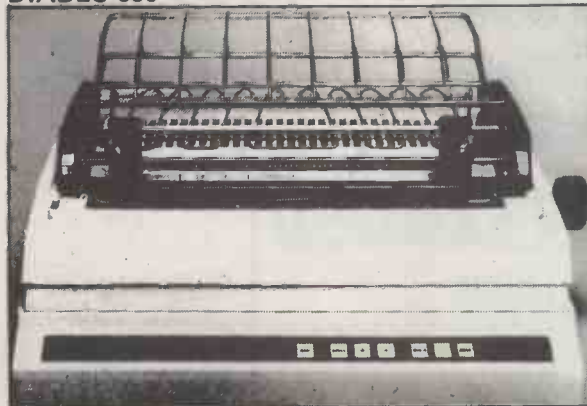

THE COMPLETE WORD PROCESSING
SYSTEM

SUPERBRAIN + DIABLO 630 PRINTER
THE PROVEN 'WORD STAR' PACKAGE

£2995

INDIVIDUAL PRICE £1675.00

SOFTWARE SUPPORT

- * KGB offer a wide range of standard software — FORTRAN, COBOL, BASIC, PASCAL.
- * KGB will customise our software packages to meet your unique requirements — Invoicing £95, Sales Ledger £235, Purchase Ledger £235, Nominal Ledger £235, Payroll £335.
- * KGB will design and implement software to suit your business needs.

**KGB Micros Ltd., 88 High Street, Slough, Berkshire.
Tel: Slough 38581/38319**

Superbrain is the registered trademark of Intertec Data Systems. Prices exc. VAT.

**WE HAVE ALL THE NEW ATARI®
VIDEO GAME PROGRAM™
CARTRIDGES.**

ATARI £86 + VAT

SILICA SHOP

TELEPHONE FOR FREE BROCHURES 01-301 1111

ELECTRONIC GAMES

ATARI



SPECIAL PRICE
£86 + VAT

INTELLIVISION MATTEL



£173.87 + VAT

Available August 1980
This is the most advanced TV
game in the world.
Expandable
next year into a full
microcomputer.
COLOUR CATALOGUE
AVAILABLE WITH
DETAILS ON ALL THE
CARTRIDGES

CHESS



Send for further details.

COMPUTERS

NEW RANGE
AVAILABLE
AUGUST 1980
We specialise in
computer chess
machines & stock
over 13 different
models from
£20 to £300

TELETEXT



RADOFIN
TELETEXT
Add on Adaptor

£173 + VAT

SPACE INVADERS



HAND HELDS + CARTRIDGES
ATARI - ACETRONIC
PRINZTRONIC
RADOFIN - DATABASE etc.
We keep a full range!
Send for cartridge lists stating which
machine you own.

BRIDGE

COMPUTER



- ★ Plays 1/2/3 or 4 Hands
- ★ Problem Mode
- ★ Audio Feedback
- ★ Instant Response
- ★ Auto scorekeeping

BACKGAMMON

COMPUTERS



OMAR 1
OMAR 2
CHALLENGER
GAMMONMASTER

From £38 to £108. Send for further details.

DRAUGHTS

COMPUTER



- ★ Solves Problems
- ★ Rejects illegal moves
- 2 level machine
£43 + VAT
- 4 level machine
£77.78 + VAT

LEISURE

- ★ CHEAP TV GAMES
- ★ TELEPHONE ANSWERING MACHINES
- ★ AUTO DIALERS
- ★ CALCULATORS
- ★ DIGITAL WATCHES
- ★ PRESTEL
- ★ HAND HELD GAMES

24 TUNE
DOOR
BELL
£13.65
+ VAT



FREE CATALOGUE

For a free copy
of our 32 page
catalogue, send
a 12p stamp to
Silica Shop Ltd
or Telephone
01-301 1111

MAIL ORDER SERVICE — Free postage & Packing

TELEPHONE & MAIL ORDERS - accepted on:
Access ★ Barclaycard ★ American Express ★ Diners Club

CALLERS WELCOME — at our shop in Welling — Demonstrations daily
Open from 9am-5pm Mon-Sat (9am-1pm Wed)

GUARANTEE — Full 12 months + After Sales Support!

We have comprehensive brochures on all products. Please let us know what you are interested in and we will send you detailed brochures AND our own 32 page catalogue covering most games on the market.

SILICA SHOP

SILICA SHOP LTD., Dept. PCW 12b
102 Bellegrave Road
Welling, Kent DA16 3QF
Tel: 01-301 1111

Get the latest on PET...



Dial 01-579 5845.

Adda make it their business to get in first on all that's best and new in PET hardware and software... and in finding out how to make the latest advances work more profitably for you.

All the advice, assistance and arrangement of demonstrations you could ask for are there for the taking. And that's just for starters. Long term Adda look after your future requirements with software, full engineering support and maintenance contracts that can include machine loan.

In addition to the 16k PET 3016 and 32k PET 3032, Adda offer you the new 32k PET 8032—with 80 columns, 12-inch screen and a keyboard that really gets down to business. Recent advances make possible some exciting applications for these mighty micros.

Link the 32k PET up to the Wordcraft word processing program and you have a very sophisticated word processing system for less than £4000. It's a word processor and more—because it can also be used as a small business machine.

The Wordcraft program comes on a mini floppy disc ready for use on a Commodore 3040 diskette drive. The whole system gives you word processing to standards achieved by expensive

purpose-built machines; and you can use a large selection of output printers including dot matrix, golfball and daisy wheel. So much for words—now for some action: phone 01-579 5845.

If you're looking for mainframe access, the Communicator 1 mainframe-PET link enables file transfer to be made in both directions... with a PET Communicator system configured with either dual floppy disc or cassette tape drive and a printer.

Files transferred from mainframe to PET can be manipulated locally and data transfer monitored on the PET screen. It's a fast way of cutting costs on bureau time share—and it also doubles up as a fast normal terminal. The Communicator 1 mainframe-PET link paves the way to big cost savings. Your first step is digital input to 01-579 5845.

More cost savings can be realised when you link up three to eight PETs to one Commodore disc drive and a printer using Mupet (Multi-User PET)—and you don't have to make any program changes. As a Mupet dealer, Adda can put you fully in the picture. Just phone 01-579 5845 for a demonstration of Mupet being put through its paces.



adda

we add up to a great deal.

Adda Computers
14 Broadway
West Ealing
London W13 0SR
Entrance in
Kirchen Road

NORTH STAR BUSINESS SYSTEM

WORD-PROCESSING
STOCK CONTROL
INVOICING
SALES & PURCHASE LEDGER
ETC. ETC.

FREE
CP/M &
WORDSTAR

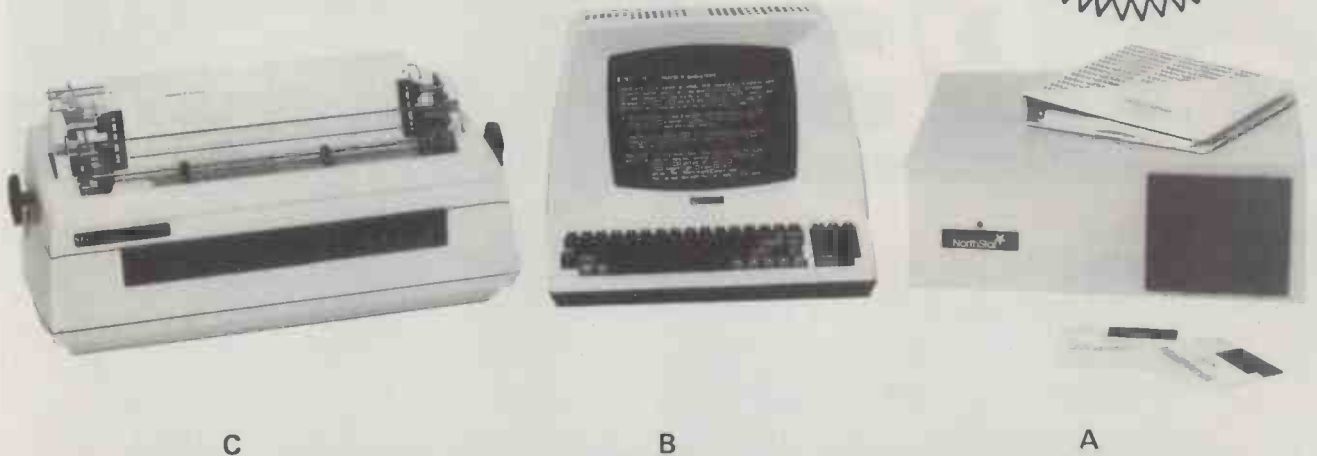

EX-STOCK

PROVEN RELIABILITY 1 YEAR GUARANTEE

SAMPLE RECOMMENDED SYSTEM (AS ABOVE):-

A	Horizon Computer (64K Ram 2 D/D Drives)	£2080.00
B	TVI-912C VDU, numerous features	£595.00
C	NEC RO Spinwriter (RS232) + tractors	£1775.00
COMPLETE SYSTEM PRICE (Includes cables)		£4450.00
ABOVE SYSTEM WITH DOUBLE-SIDED DRIVES		£4730.00

FREE !! WORDSTAR plus CP/M with above system.

INVENTORY Package - With Sales & Purchase Management System	£295.00
KDS Development System for North Star BASIC	£50.00
KDS Disk Despooler - North Star DOS despooler	£50.00
CP/M V2.2 - supports double-sided drives	£95.00
WORDSTAR V2.1 - Superb word processing package	£235.00
MAIL-MERGE - Adds form letter generation to WORDSTAR	£75.00
DATASTAR - CP/M compatible Database Management System	£195.00
North Star UCSD PASCAL-D/Q System	£105.00
Microsoft BASIC interpreter V5.1	£155.00
Microsoft BASIC compiler V5.1	£195.00
Microsoft FORTRAN-80	£205.00
Econoram IIa - 8K Static Memory	£100.00
Econoram XX - 32K Static Memory with bank switching	£355.00
DMB-6400 - 64K Dynamic RAM with bank switching	£545.00
Godbout Interfacer 1 - 2 full RS232 serial I/O card	£135.00
Switchboard - 2 Serial, 4 parallel I/O card	£155.00
OKI Microline-80 Printer - Lightweight, 80 cps, Graphics	£425.00
Paper Tiger Printer - 2K buffer, full graphics, form-feed	£595.00
Anadex DP9500 Printer - Fast, bi-directional, logic-seeking	£895.00
Morrow 26Mb Hard Disk Sys. + Timeshaver CP/M-North Star DOS	£3495.00
Morrow 26Mb Hard Disk - Add on hard disk	£2495.00

PLEASE WRITE OR PHONE FOR LATEST PRODUCT CATALOGUE

PHONE US OR CONTACT
YOUR NEAREST DEALER

CODAS LTD
Pontypridd Wales Tel: 0443-406450
CONQUEST COMPUTER SALES LTD
Benfleet Essex Tel: 03745-59861
DIGITAL DEVICES LTD
Southborough Kent Tel: 0892-37977/9
FYLDE MICROCOMPUTER SERVICES
Blackpool Lancs. Tel: 0253-692954
THE HARDWARE SOFTWARE CO.
London NW3 Tel: 01-722 6436
HOTEL MICROSYSTEMS LTD
Middlesex Tel: 01-890 9696
JAD INTEGRATED SERVICES
Plymouth Devon Tel: 0752-626164
KBS COMPUTER SERVICES
Liverpool Tel: 051-236 8333
KBS COMPUTER SERVICES
Cardiff Wales Tel: 0222-394313
KBS COMPUTER SERVICES
Coventry Warwicks. Tel: 0203-27266
LOVEDEN COMPUTER SERVICES LTD
Grantham Lincs. Tel: 0476-72000
MICRO FACILITIES LTD
Hampton Hill Middx. Tel: 01-979 4546
MICROSYS LTD
Prescot Merseyside Tel: 051-426 7271
MICROTECH COMPUTER SERVICES
Liverpool Tel: 051-236 2208/9
SAPPHIRE SYSTEMS
Billericay Essex Tel: 02774-57743
SPOT COMPUTER SYSTEMS LTD
Doncaster Yorks Tel: 0302 50833
S. SYSTEMS
Crawley Sussex Tel: 0293-515201
STAG TERMINALS LTD
Teddington Middx. Tel: 01-943 0777
SUMLOCK-BONDAIN LTD
London EC1 Tel: 01-250 0505
VIDEO VECTOR DYNAMICS LTD
Glasgow Scotland Tel: 041-226 3481/2

INTERAM

UK Distributor:
INTERAM Computer Systems Ltd.
59 Moreton Street,
Victoria, London SW1V 2NY
Tel: 01-834 0261/2733
Telex: 925859

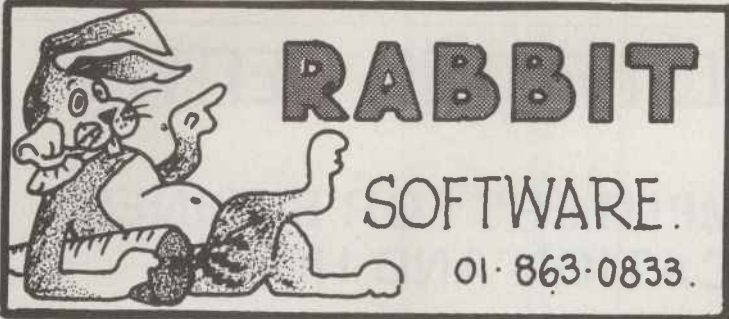

380. STATION ROAD.
HARROW.
MIDDX - HA1. 2DE.

A DIVISION OF CREAM COMPUTERS LTD

APPLE / IIT 2020 OUR DISCOUNT PRICE.

- APPLE WRITER. £ 35.00
- VISICALC. £115.00
- DESK TOP PLAN. £ 55.00
- MAILING LIST. £ 49.00
- MODIFIABLE DATA BASE. £ 49.00

PLEASE RING FOR FREE COMPREHENSIVE LIST OF OUR SOFTWARE.

PET.

OUR DISCOUNT PRICE

- VISICALC **NEW** £ 115.00
- DATABASE UTILITY. £ 15.00

★ PLUS COMPUTACOUNT PAYROLL £375.00

★ INTRODUCING THE POWERFUL CREAMWOOD BUSINESS MANAGER - COMPLETE ACCOUNTING PACKAGES FOR SALES & PURCHASE. EXTENSIVE INVOICING FEATURES. - £300.00 EACH.

SHARP PC 1211 **NEW**
Hand held computer - 1K Ram Basic language. Alpha-numeric keyboard - 24 character display
£ 79.95.

SHARP CE 121
Tape interface **£12.95.**

ADD 15% V.A.T. ALL MACHINES GUARANTEED 12 MONTHS

CREAMWOOD BUSINESS MANAGER & CONTROLLER DEMONSTRATION DISKS £35.00 EACH.

★ PLUS. **NEW**

FOR THE 8032 SUPERPET VISICALC. - £115.00
WORDCRAFT 80 £375.00
OZZ ADVANCED TOTALLY FLEXIBLE DATABASE PROGRAM - £300.00
CREAMWOOD BUSINESS CONTROLLER.
SALES PURCHASE GENERAL - £300.00 EACH.
COMMODORE SOFTWARE.

- APPLE. LEISURE. TRANQUILITY MOONBASE DISK £10.00
- RELOCATED INTEGER MK2. " £12.00
- SPACE INVADERS INT " £10.00
- BRIDGE " £10.00
- MICROCHESS " £13.00
- MICROGAMMON INT " £10.00

- STARWARS " DISK £10.00
- OTHELLO " DISK £10.00
- PINBALL " DISK £10.00
- SEVENS " DISK £10.00
- APPLE PACK 13 PROGRAMS £10.00

- PET. LEISURE. NEW ARCADE GAMES
- NIGHT DRIVE £6.00
- CAR RACE £6.00
- ACROBAT £6.00
- INVADERS £6.00
- 3D STARTREK £6.00
- BREAKTHROUGH £6.00

- NEW** TREASURE TROVE GAMES.
- NUMBER 11 £8.50
- NUMBER 12 £8.50
- NEW** PET MASTER SUPER CHIP £45.00

ALL BY SUPPLY

BUY RABBIT THIS CHRISTMAS!

PLEASE SEND FOR **FREE** BROCHURE BY RETURN.

Name

Address

QUANTITY	DESCRIPTION	PRICE.

I enclose my *cheque/charge my Access/Trustcard/Barclaycard/Visa No

Signature



CARD HOLDERS 'PHONE YOUR ORDER *Delete as applicable

ALL PRICES ARE EX. VAT.
PLEASE ADD 50p p&p ON SMALL ITEMS £2.50 ON LARGER ITEMS

ANGLIA COMPUTER CENTRE

MICROCOMPUTERS FOR BUSINESS,
EDUCATION AND HOME

FOR ALL YOUR BUSINESS, EDUCATION & LEISURE
COMPUTER REQUIREMENTS!!!

APPLE II & III

TRS-80

SHARP

NORTH STAR

HORIZON

TANGERINE

U.K. 101

NASCOM

VIDEO GENIE

+PRINTERS AND

OTHER PERIPHERALS

BOOKS**

SOFTWARE*

MAGAZINES**

STATIONERY***

BUSINESS +

INDUSTRIAL

CONTROL

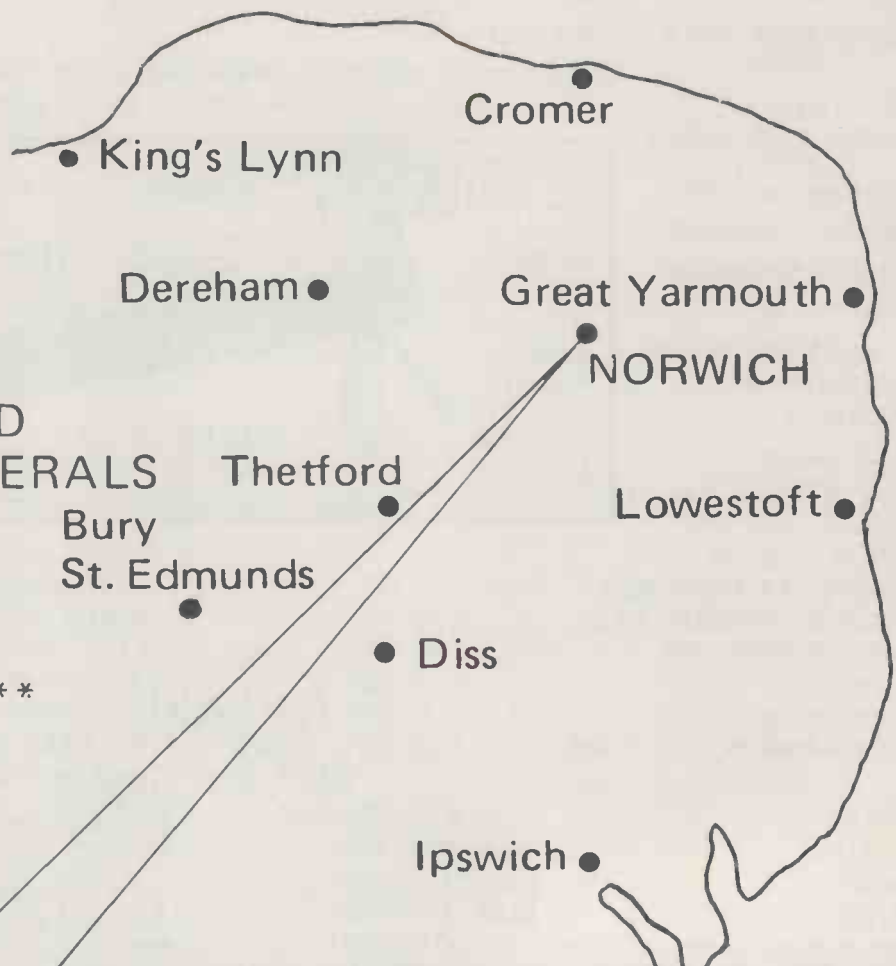

WE ARE HERE!!!

**88 St. Benedict's Street
NORWICH NR2 4AB**

Tel. (0603) 29652

24hr. Answering Service.

**Open on Sundays
during Dec.**

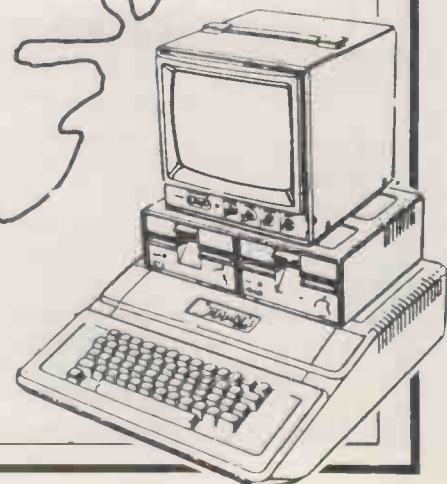

& Computers & Peripherals

Leading-make hardware
at hard-to-beat prices

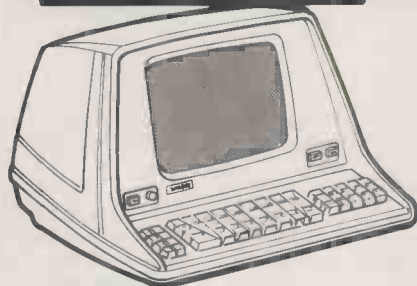
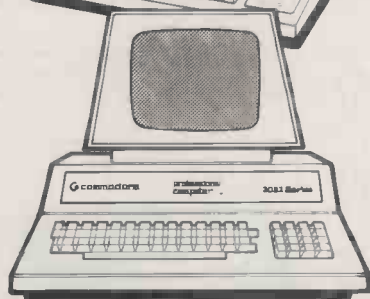
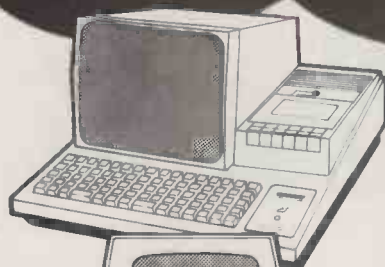

Model	User Ram	£
Sharp MZ80K		
20K	6K	380.00
36K	22K	423.00
48K	34K	475.00
MZ80FD	Twin floppy disk drive	650.00
MZ80P3	Matrix Printer	431.00
MZ801/0	Expansion Interface	83.00
PC1211	Pocket Computer	83.25
CE121	Cassette Interface for PC1211	11.75
Commodore		
2001-8	Integral Cassette/small keyboard	367.00
3008	8K with full size keyboard	389.00
3016	16K with full size keyboard	454.00
3032	32K with full size keyboard	600.00
3040	Twin 5¼" Disk drive	600.00
3022	80 Col. 93cps Tractor printer	367.00
3023	80 col. 93cps Friction printer	325.00
C2N	Add on cassette deck	48.00
	Computer to disk cable	18.00
	Disk to printer cable	22.00

For full retail price list and
Conditions of Sale relating to these
offers, contact

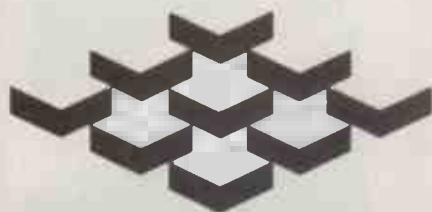

HB COMPUTERS

22 Newland Street
Kettering
Northamptonshire
Telephone 0536 520910
Telex 341297

ACT 800 Series

ACT 808	Computer and 800K disk system	2950.00
ACT 824	Computer and 2.4M disk system	3750.00
ACT 400	400K PET disk	625.00
ACT 800	800K PET disk	795.00
ACT 1.6	1.6M PET disk	995.00

Printers

Teletype 43 Pinfeed. 30cps	775.00
Decwriter LA34 Friction Feed. 30cps	775.00
Qume Sprint 5 45 RO	1518.00
Qume Sprint 5 55 RO	1605.00
Qume Sprint 5 45 SKR	1695.00
Qume Sprint 5 55 KSR	1810.00
Ricoh RP 1600 Daisywheel (PET interface)	1025.00
Ricoh RP 1600 Daisywheel (HITYPE interface)	900.00
Centronics 702	1300.00

CHROMASONIC electronics

48 JUNCTION ROAD, ARCHWAY, LONDON N19 5RD 50 yds from Archway Station & 9 bus routes
TELEPHONE 01-883 3705 01-883 2289

YOUR SOUNDEST CONNECTION IN THE WORLD OF COMPONENTS AND COMPUTERS

8N 8K RAM £399
16N 16K RAM £499
32N 32K RAM £599
CASSETTE DECK £55

343K Twin Floppy Disk £695

NEW 32K with 80 col Screen £825
Twin Disk Drive 950K £895

All with new keyboard
and green screen

Friction Feed Printer
£375

Tractor Feed Printer
£425



COMPLETE 32K SYSTEM £1789

MEMORY EXPANSION KIT

Suitable for UK101, Superboard expansion using 2114's each board has 16K ram capacity kit contains:

- ★ On board power supply
- ★ 4K Eprom expansion
- ★ Fully buffered for easy expansion via 40 pin socket
- ★ 8K kit £ 89.95
- ★ 16K kit £122.95
- ★ Printed Circuit Board £ 29.95
- ★ 40 pin-40 pin header plug £ 8.50

NEW SHOP

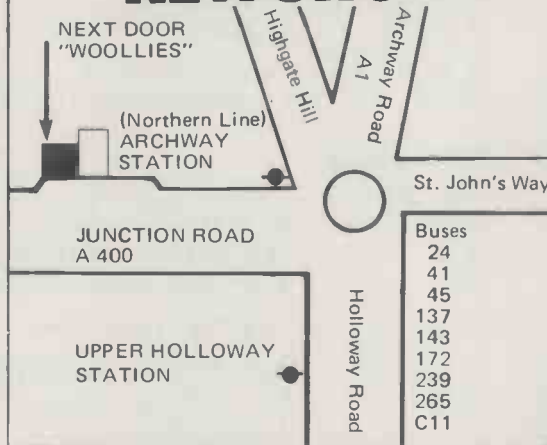

VIDEO GENIE

VIDEO GENIE based on TRS80



Utilises Z80, 12k level II Basic, Integral Cassette Deck, UHF O/P. 16k RAM

all TRS80 features £289

CASES

Available for U.K. 101, Superboard Nascom
Appx. DIM. 17" x 15"
435 x 384 mm

PRICE £24.50

Post & Packing £1.50

UK101 P.P.I.

BUILT & TESTED. INTERFACES TX80 PRINTER DIRECT, CAN BE PROGRAMMED TO OPERATE RELAYS, MOTORS, VARIOUS OTHER PERIPHERALS "CENTRONICS COMPATIBLE PLUGS INTO IC SOCKET. RED BINARY DISPLAY FULLY DOCUMENTED.

£29.95

UK101

£179 IN KIT FORM

£229 READY BUILT & TESTED

£255 COMPLETE IN CASE

4K EXPANSION (8 x 2114) NOW ONLY £18.00

No extras required

- ★ Free sampler tape
- ★ Full Qwerty keyboard
- ★ 8K basic
- ★ Ram expandable to 8K on board (4K inc)
- ★ Kansas City tape interface

★ NEW MONITOR ALLOWS FULL EDITING & CURSOR CONTROL

£22.00



PRINTERS

EPSON TX-80

£349

Dot-matrix printer with Pet graphics interface: Centronics parallel, options: PET, Apple and aerial.

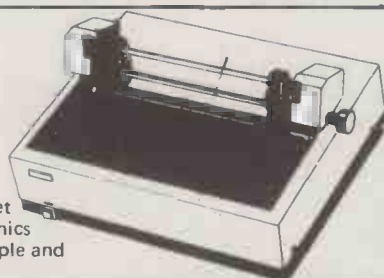

PLEASE ADD VAT 15% TO ALL PRICES. POSTAGE ON COMPUTERS, PRINTERS & CASSETTE DECKS CHARGED AT COST. ALL OTHER ITEMS P&P 30p. PLACE YOUR ORDER USING YOUR ACCESS OR BARCLAYCARD (Min. Tel. order £5.00). TRADE & EXPORT ENQUIRIES WELCOME, CREDIT FACILITIES ARRANGED.



NEW SHOP & SHOWROOM NOW OPEN

TELEPHONE
01-883 3705/01-883 2289

UK101 SOUND

SOUND GENERATOR
AND COMBINED
PARALLEL IN/OUT
PORT KIT
CONTAINING P.G.B.,
RY-3-8910, 6520 PIA,
FULLY DOCUMENTED
AND DEMO TAPE.

£29.95

AY-3-8910

£8.50

UK 101 SOFTWARE

SPACE INVADERS	6.50
REAL TIME CLOCK	5.00
CHEQUERS	3.00
OTHELLO	4.00
GAME PACK I	5.00
GAME PACK II	5.00
GAME PACK III	5.00
SCREEN MONITOR	4.00
ASSEMBLER EDITOR	14.90
10xC12 BLANK TAPES	4.00

CPUS

Z80 2.5 MEG	7.95
Z80A 4 MEG	9.95
6502	6.95
6800	6.50
8080	4.75
9900	25.95

SUPPORT CHIPS

Z80 CTC	5.95
Z80A CTC	6.95
Z80A PIO	5.95
Z80A PIO	6.95
6520	3.95
6522	6.85
6532	8.50
6821	4.25
6850	3.60
6852	4.35
8212	1.95
8216	1.95
8224	2.75
8228	3.75
8251	4.95
8253	9.75
8255	4.50
TM59901	13.16
TM59902	11.18
TM59904 (2465362)	4.21

MEMORY

D. RAMS	£	p
4027		2.75
4050 (350NS)		2.35
4060 (300NS)		2.39
4116		3.95
S. RAMS		
2102A		1.30
2102A2		1.69
2112A		2.75
2114/4045		2.75
4035		1.07
4044-5257		6.93
6810		3.50
BULK PURCHASE		
8x2114		18.00
8x4116		27.50
16x2114		34.00

EPROMS

2708	4.25
2716 (5v)	6.95
2532	29.95

ROM

2513 (UC)	5.95
-----------	------

I.C. SOCKETS

	DLL	W/W
8 pin	.09	.25
14 pin	.11	.35
16 pin	.12	.42
18 pin	.16	.50
20 pin	.20	.62
22 pin	.22	.65
24 pin	.24	.70
28 pin	.30	.80
36 pin	-	.99
40 pin	.40	1.10

BUFFERS

81LS95	1.25
81LS96	1.25
81LS97	1.25
81LS98	1.25
SN74365	.52
SN74366	.52
SN74367	.52
SN74368	.52
BT26	1.50
8T28	1.50
8T95	1.50
8T96	1.50
8T97	1.50
8T98	1.50

BAUD RATE GENS

MC14411	8.75
MM5307	8.75

UARTS

AY-5-1013	3.95
AY-3-1015	4.75
MM5303	4.75
TMS6011	3.55

SEND S.A.E. FOR COMPLETE
PRICE LIST OR PHONE 01 883 3705

Itancy... Systems... Analysis... Software... Hardware... Consultancy... Svst

MAP SOFTWARE FAST MAIL

SALES LEDGER - Open item, 350 accounts, 3500 transactions, includes sales invoicing, requires 64K and 2 floppy drives - £300

PURCHASE LEDGER - Ditto (no invoicing) - £300

NOMINAL LEDGER - 250 heads of analysis can be set by the user, 2500 transactions, P & L, Balance Sheet and Trading Account - £300

ACCOUNTS PRODUCTION - Allows production of accounts from the nominal, after allowing for accruals, prepayments and up to 20 closing stock values - £110

STOCK RECORDING - In - Out balance system, receipts, orders, costings, below re-order levels, etc. - £250

INCOMPLETE RECORDS - Designed for the professional accountant for production of accounts from Vouchers, Statements, Private Entry Documents etc. - £550

As above including word processing for customisation of clients accounts - £900

NEWSBOY - An aid for Newsagents, keeps records of newsrounds, customer accounts etc. - £425

JOB COSTING - Creation, Post Purchases, Invoices, Labour, Stock, Delivery Notes, Status and Profitability - £550

MAP HARDWARE

DOLPHIN BD 80 PRINTER - Full feature, serial or parallel interface (state which please) - £425 + cable

TEXAS OMNI 810 - Printer, very reliable, good for heavy duty utilisation, full 132 character width - £1450 + cable

ANADIX 9500 - Superb fast matrix printer with lots of features including 132 column, character etc., serial interface - £895 + cable

We also supply SUPERBRAIN & DYNABYTE Computers, Desks, Stands, Work-Stations, Stationery, Media etc., etc.

Please rush me the following SOFTWARE / HARDWARE:-

Name _____

Address _____

Please make cheques payable to MAP as address below. Please allow 7 days for delivery. Hardware orders add £15 packing/delivery.



BELGRAVE ESTATE
HONEYWELL LANE
OLDHAM, MANCHESTER
Tel: 061-633 3804/5

COMPUTER SYSTEMS LTD.
small enough to CARE - large enough to COPE

SOFTWARE

Software & Manual/Manual Only

Byrom Software	BSTAM—Utility to link one microcomputer to another also using BSTAM £70/5
Computer Plus	FMS 80 (File Management System) Demo Pack (includes manual and disc) £35 Complete System £395/25
Computer Services	Bidirectional driver for Diablo Hytype printers for use on CPM & CDOS systems £65/10
CP/M User Library	42 Volumes on 8" disc £4 42 Volumes on 5" disc £8
Creative Computing	For CP/M CS-9001 BASIC Games 1 £12 CS-9002 BASIC Games 2 £12 CS-9000 BASIC Games 1 and 2 £22 CS-9003 ADVENTURE I.O. £12 CS-9004 BILINGUAL Original Adventure £12 CS-9005 BASIC Games 3 £12 CS-9006 BASIC Games 4 £12 CS-9007 BASIC Games 3 and 4 £22 CS-9008 BASIC Games 1, 2, 3 and 4 £40
Digital Research	(Most formats now available) MPM 1.1 £175/18 CP/M 1.4 £65/18 CP/M 2.2 £90/18 SID £45/12 ZSID £55/12 MAC £55/12 TEX £45/12 DESPOOL £30/5 PL/1 £POA/25
Information Unlimited	WHATSIT (Database Management System) on North Star £59 on CP/M £75 on APPLE 2:48k (requires int Basic) £72 On APPLE 2:32k (requires int Basic) £59 on ITT 2020 (see Apple)
KLH Systems	Spooler for CPM systems £65/5
L.P. Enterprises	Diablo driver runs 110 to 9600 baud with autoloader for CP/M or CDOS £30/5 OMNIX—UNIX like multiuser, multitasking operating system for Z80 i.e. IMS, Cromemco, Horizon £250/30 Multiforth £65/20
MICAH Inc.	CP/M for CDOS Users: Program to Expand CP/M system to be compatible with Cromemco CDOS software £59/5 Disc Utilities: Pack one of CDOS users includes: Fast disc copy, Track test, Disc test, Compare files and others £30/5 Pack two for CP/M users includes same as pack one £30/5 Pack three for Cromemco users includes same as pack one and spool and print £65/5
Microsoft Inc.	BASIC-80 £175/17 BASIC Compiler 5.2 £195/17 FORTRAN-80 £220/17 COBOL-80 4.0 £355/17 EDIT-80 £45/11 MACRO-80 £80/11 MICROSEED £TBA/20 MULISP £TBA/20 MUMATH £TBA/20
Michael Shroyer Inc.	Electric Pencil Word Processor £100 SSII for tty etc £100 DSII for Diablo £105 TRS-80 Cassette/disc £50
Microfocus Ltd.	CIS COBOL version 4.2 £425/25 FORMS 2 £100/10
Micropro Inc.	WORD-MASTER 1.7 £70/20 TEX-WRITER 2.6 £35/15 WORD-STAR 2.1 £240/25 SUPER-SORT: Version 1 £120/20 Version 2 £100/20 Version 3 £75/20 WORD-STAR with MAIL-MERGE 2.1 £310/25 MAIL-MERGE 2.1 £70/10 DATASTAR 1.07 £165/20
MT Microsystems	Pascal MT £125/12

Software & Manual/Manual Only

Osborne & Associates	Accounts Payable & Accounts Receivable (disc only) £50 General Ledger (disc only) £50 Payroll with Cost Accounting (disc only) £50
Compiler Systems	CBASIC v2.06 £65/15
Structured Systems all Converted to UK Standard	Sales Ledger £275/15 Purchase Ledger £275/15 Nominal Ledger £325/15 Stock Control £275/15 Letterright £95/10 Analyst (File management Reporting System) £115/10 NAD (Name and Address selection system) £50/10 OSORT £50/10
TDL Software (Technical Design Labs)	Business Basic £80 ZTEL (Text Editing Lang.) £35 MACRO II (Z80 Macro Assembler) £35 LINKER £35 DEBUG II (for 8080/Z80) £45
Tiny-C Associates	Tiny-C language for 8080, 8085, Z80 systems £50/35
Supersoft Inc.	DIAGNOSTICS 1 £35/5 TERM £65/5
Software Works	Northstar Format only £50/10 Inventory-1 (Stock Control) £130/15 Inventory-2 with order entry, invoicing £50/15 Mailroom Housekeeper (Utilities, sorts) £35/10 Preventative Maintenance £75/15 Housekeeper-2 (Coming Soon) £TBA

ORDER INFORMATION

Software prices reflect distribution on 8" single density discs. If a format is requested which requires additional discs a surcharge of £4 per additional disc will be added.

Please add VAT and £2.50 for first class postage, packing and insurance.

If required, DATAPOST D service is available for an extra charge of £7.50.

All software on this Advertisement is available from stock and a 24-hour return service is thereby offered on all prepaid orders. When ordering CP/M software please specify the format you require otherwise software will be dispatched on an 8" single density disc.

For more information on any of these items, please phone, write or visit. (We are open during office hours).

All publications are published in the U.S.A. and are stocked in Britain by L.P. Enterprises.

We aim to keep all of these books in stock and as a result of this most mail orders are despatched by return of post.

OEM terms available

MAIL ORDER TELEPHONE ORDER VISIT

Send Cash, Cheque, Credit Card No., Postal Order, IMO to L.P. Enterprises, Room PCW, 8 Cambridge House, Cambridge Road, Barking, Essex IG11 8NT.

All Payment must be in sterling and drawn against a UK bank.

Subscriptions are processed to start with the next current issue, after the date of order.

These details are all current as of August 1980.

Prices are subject to change without notice, due to fluctuation in the dollar rate.

APPLE® II DISK DRIVES

DUAL DISK UNIT

£498

DISK CONTROLLER CARD

£ 49

- * Two Disks in one Cabinet
- * Has its own Power Supply Unit
- * Connects to standard Apple Disk Controller Card
- * Runs all Apple Software including Pascal
- * Japanese quality and reliability



APPLE DEALERS: Write or phone direct to Cumana and specifications plus dealer discounts will be mailed to you.

TRS-80® DISK DRIVES

DUAL DISK UNIT

2 x 40 Track Drives
2 x 80 Track Drives

£440
£645

SINGLE DISK UNIT

1 x 40 Track Drive
1 x 80 Track Drive

£236
£345

TRS 80 DISK CABLES

2 Drive Cable
4 Drive Cable

£20
£32.50



TRS-80 DEALERS: Write or phone direct to Cumana and specifications plus dealer discounts will be mailed to you.

EDUCATIONAL & QUANTITY DISCOUNTS

VERY GENEROUS EDUCATIONAL AND QUANTITY PURCHASE DISCOUNTS ARE NOW AVAILABLE ON CUMANA TRS 80 DISK DRIVES. OUR DEALERS WILL BE HAPPY TO SUPPLY PRICE QUOTATIONS

Call your nearest dealer for a demonstration:

RADIO SHACK LTD.,
188, Broadhurst Gardens,
London NW6
Tel 01-624-7174

COMP SHOP LTD., 14, Station
Road, New Barnet, Herts.
Tel 01-441-2922

COMP SHOP LTD.,
311, Edgware Road,
London W2, Tel 01-262-0387

MICRO CONTROL LTD.,
224, Edgware Road,
London W2, Tel 01-402-8842

**LONDON COMPUTER
CENTRE**, 43 Grafton Way,
London W1, Tel 01-388-5721

**TRANSAM COMPONENTS
LTD.**, 59-61, Theobalds Road,
London WC1
Tel 01-405-5240

N.I.C. 61, Broad Lane,
Tottenham, London N15
Tel 01-808-0377

**KATANNA MANAGEMENT
SERVICES**, 22, Roughtons,
Galleywood, Chelmsford,
Tel 0245-76127

I.C. ELECTRONICS,
Flagstones, Stede Quarter,
Biddenden, Kent,
Tel 0580-291816

**CAMBRIDGE COMPUTER
STORE**, 1, Emmanuel Street,
Cambridge, Tel 0223-65334

**PORTABLE MICRO-
SYSTEMS**, 18, Market Place,
Brackley, Northants
Tel 0280-702017

COMPUTERAMA LTD.,
5, Cleveland Place East,
London Road, Bath,
Tel 0225-333232

ENSIGN, 13-19, Milford
Street, Swindon, Wilts.
Tel 0793-42615

SEVET TRADING, 14, St.
Paul's Street, Bristol 2
Tel 0272-697757

PARWEST LTD., 58, Market
Place, Chippenham,
Tel 0249-2131

**HEWART MICRO-
ELECTRONICS**, 95, Blakelow
Road, Macclesfield,
Tel 0625-22030

HARDEN MICROSYSTEMS,
28-30, Back Lord Street,
Blackpool, Tel 0253-27590

MICRO CHIP SHOP,
197, Waterloo Road, Blackpool,
Tel 0253-403122

MICRO CHIP SHOP,
190, Lord Street, Fleetwood,
Lancs, Tel. 03917-79511

EWL COMPUTERS LTD.,
8, Royal Crescent, Glasgow,
Tel. 041-332-7642

**NORTH WEST COMPUTER
CONSULTANTS LTD.**,
241, Market Street, HYDE,
Cheshire
Tel: 061-366-8624

ZERO ONE ELECTRONICS,
36, Oaklands Avenue,
THORNTON HEATH,
Surrey
Tel: 01-689-7924

P & J EQUIPMENT LTD.,
3 Bridge Street,
GUILDFORD
Tel: 0483-504801

CUMANA LTD 35 Walnut Tree Close, Guildford, Surrey, GU1 4UN.
Telephone: (0483) 503121. Telex: 859680 (Input G).

*Please add VAT to all prices.
Delivery at cost will be advised
at time of order.*

What will you do with 12-year-old programmers when they reach 16?

Any microcomputer is a major investment for an educational establishment. Many potential users feel that a BASIC only computer is ample for their needs. That may be fine today, but with computer education starting so early you may in a surprisingly short time find you want more than current implementations of BASIC.

The 380Z is a computer that can grow to match your needs.

In the design of the 380Z our target user is the graduate research scientist. This ensures that the expandability and versatility needed tomorrow has been provided for in the computer you buy now.

approach will allow your students to advance.

380Z BASIC is not frozen in ROM. An enhanced BASIC could be loaded in mid 1980 and a BASIC with structured features sometime later.

On the 380Z the memory used by a BASIC interpreter can also be used for other software.

Does our research-oriented design pay off in classroom hardware?

Our scientific graphics was produced for the professional user. Interest in it for classroom use has been surprising.

The 380Z has the best graphics now available on a microcomputer,



freely mix upper and lower case text and diagrams.

Mains noise can cause system crashes which result in loss of programs and data. All current 380Zs include a mains filter which significantly reduces the chances of this happening.

Don't buy a 380Z on patriotic grounds.

Please only buy it if you would have bought it anyway. But remember, because it is designed and manufactured here you are bound to have better access to us for influence and help than if we were on the other side of an ocean.

Prices range from a 16K cassette 380Z @ £897 to a 56K Dual Full Floppy Disk 380Z @ £3322.



Might you want to add disc storage in the next few years?

If you do:

Given good hardware, software availability completely determines the flexibility and usefulness of your system. There is absolutely no question that a Z80 based micro-computer which uses the industry-standard CP/M* disk operating system has several times more software on the market available to it than non CP/M computers.

Today you can purchase a mature CP/M BASIC, FORTRAN, COBOL or Text Processor for the 380Z. Soon there will be CP/M Pascal and Database Management systems.

CP/M software is several years ahead of software available for non CP/M family machines.

If you don't:

Remember that professionals writing packages for your cassette system will themselves often use a disk 380Z, and the power of their tools will influence what they produce.

For many people a disk machine is too expensive - but at least the 380Z

allowing multiple resolutions, multiple paging, fading and accurate control over colour. All these features help bring excitement to efforts in computer assisted learning.

Our standard machine comes with low resolution graphics and support for this from BASIC allows you to plot a point directly with a plot command - useful for training and teaching.

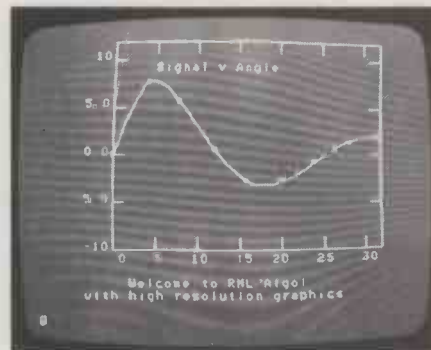

It is worth remembering too that neither our low resolution graphics nor our optional scientific (high resolution) graphics has any limiting effect on your memory usage, and in both you can

LOWER COSTS

LEA Discount

Local Education Authorities are eligible for a quantity discount scheme which makes it easier for them to benefit from quantity purchasing.

School and College Discount
Some schools and colleges can get a 5% discount on computer orders.

Please contact the Sales Office for details.

RESEARCH MACHINES

RESEARCH MACHINES Ltd,
PO. Box 75, Mill Street, Oxford, England.
Telephone: Oxford (0865) 49791/2/3.
Please send for full sales information.
Prices do not include shipping costs or VAT @ 15%.
* Trademark, Digital Research.



SORCERER

CP/M™
S100
Z80

For the serious user:
**Business
Education
Amateur**

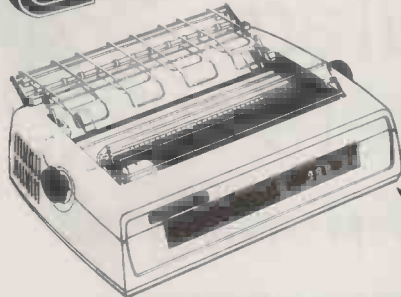

PIO + RS232/20ma serial O/P
Dual 1200 baud cassette O/P

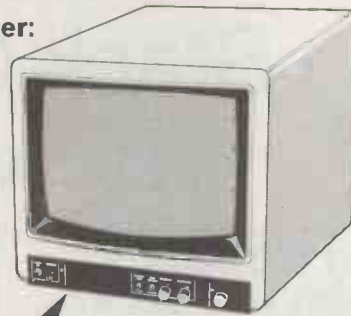

Memory mapped
30 lines x 64 characters
upper/lower case + 128
programmable graphics



SORCERER
16-48K internal RAM
Z80 CPU, 4K monitor

Video or UHF

6 slot S100 expansion
(not illustrated)

ROMPAC

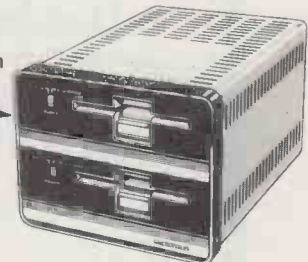

Micropolis 630K dual disk
CP/M or Micropolis MDOS

STANDARD SORCERER

- * Displays 30 lines of 64 characters - more than any other personal computer. 79 key stepped typewriter-style keyboard with separate numeric pad for fast data entry.
- * Plug in ROMPAC cartridges for programming languages, special applications (e.g. word processing) or creating a user's dedicated system. Sorcerer is supplied with 8K Microsoft BASIC ROMPAC
- * Composite video output for video monitor or UHF output for use with an unmodified TV set at nominal extra charge.
- * Z80 CPU with up to 48K RAM on-board.
- * 4K power-on monitor in ROM allowing machine code programming, batch processing, memory transfers and copying, alteration of memory locations, use of cassette files.
- * Dual 300 or 1200 baud cassette ports with motor control
- * Parallel I/O port and serial RS232 port for direct connection to printers or use as a terminal to a larger computer - no expensive 'extra' communications interfaces
- * Full upper/lower case ASCII characters plus 128 user programmable graphics (64 default to standard graphics symbols if undefined). Default graphics above ordinary characters on keytops.

16K £749.00 32K £799.00 48K £849.00

Expansion Capabilities

- * 6 slot S100 expansion for memory up to 56K RAM, disc drives (5 1/4" or 8") etc. Standard bus means that you are not dependent on equipment from a single manufacturer **£240.00**
- * Micropolis double density 5 1/4" drives with MDOS and Disc BASIC:
First drive (incl. controller card) single 315K **£690.00**
Additional drives (max 4 drives/controller) 315K **£390.00**
- * FDM 180 Disk Unit: Micropolis Disk Drive, plugs directly into Sorcerer, does not require S100 Unit:
Single 315K Disk Drive (c/w CP/M and Microsoft BASIC) **£599.00**
Single 315K Add-on Disk Drive. **£450.00**
- * CP/M industry standard disk operating system **£75.00**
- * Development ROMPAC - Z80 assembler, loader, editor, debugger **£70.00**
- * EPROM PAC for loading dedicated software up to 16K **£35.00**
- * Configuring programs allow Sorcerer to be used as a 'dumb' terminal or, with CP/M, as an intelligent terminal.

Programming Languages

The following programming languages are available for CP/M:

Microsoft Disk BASIC interpreter (BASIC 80 - compatible compiler), CBASIC2 (compiled BASIC), FORTRAN 80 and COBOL-80, ALGOL 60 - A Z80 system with graphics, string handling and random-access filehandling.

All Exidy products are covered by 12 months warranty.
CP/M™ is a trademark of Digital Research.
All prices exclusive of VAT

THE WORDPROCESSING WIZARD!

Sorcerer's upper/lower case typewriter keyboard and unusually large display (30 lines of text; approximately equivalent to one double-spaced typed page) makes it ideal for word processing applications. The Exidy word processor PAC is a sophisticated screen editor and text formatter with automatic text wrap-around, left and right justification, proportional letter spacing (on disk only with Spinwriter) and many other formatting facilities. It can also search for and replace strings, move and merge blocks of text and a macro facility allows specification of tasks such as mail-merge letter typing. Letters and texts can be stored on cassette or disks (one disk will store approximately 300,000 characters and costs less than five pounds. 32K or 48K RAM is recommended.

Word Processor PAC **£120.00** Disk Version: **£118.75**

C.Itoh 8300 dot matrix printer -40, 80 and 120 characters per line on 9 1/2" wide paper, 125 characters/second, upper/lower case, tractor feed, forms positioning **£499.00**

NEC Spinwriter solid font printer -variable horizontal and vertical spacing, proportional spacing, interchangeable fonts, carbon or fabric ribbon, 55 characters/second, paper up to 16" wide **£1,900.00**

Example system: 32K Sorcerer, video monitor, FDM 180 Disk Unit with CP/M and Microsoft BASIC, C.Itoh 8300 printer, Word Processor on disk and CP/M. **£2,225.00**

Business Software

Besides its word processing capabilities, Sorcerer can run a wide range of business software thanks to the widely used CP/M disk operating system available for the Micropolis disk drives. Programs available include:

Payroll: (requires CP/M and CBASIC2) **£250.00**
General Ledger, Job Costing, Accounts Receivable, **£335.00 each**
Accounts Payable: (all require CP/M and CBASIC2)

For further information and list of dealers,
please contact the sole U.K. distributors.

GEOFF WILKINSON, Dept. PCW.1

LIVEPORT

DATA PRODUCTS

The Ivory Works, St. Ives, Cornwall TR26 2HF
Telephone: (0736) 798157

PLEASE SEND DETAILS OF THE EXIDY RANGE/WORD PROCESSOR

NAME _____

ADDRESS _____

PCW/4



IDEAS FOR XMAS

Stack Computers Stocking Fillers



Pet Toolkits Down in Price!

NOW £25 for 32K
plus VAT **£37 for old 8K**

Features

AUTO Provides new line numbers when you are entering BASIC program lines.
RENUMBER Renumbers your BASIC program, including all GOTOs and GOSUBs.
DELETE Removes groups of BASIC program lines.
FIND Locates and displays the BASIC program lines that contain a specified string.
APPEND Adds a previously SAVEd program to the one currently in your PET.
DUMP Displays the names and values of all the variables used by your program (excluding arrays).
HELP If your program stops due to an error, HELP displays the offending line and where the PET detected the error.
TRACE As a program runs, the last six line numbers being executed are shown in the upper right corner of the PET's screen.
STEP Executes one BASIC line and stops. Pressing SHIFT executes the next line. The line number is displayed in the upper right hand corner of the screen.
OFF Turns TRACE or STEP off.

NEW PRODUCT

Toolkit on **Stack Rom Switch Board** complete with software. Allows both Toolkit and Computhink Disk to be used on the same Pet. Complete with Toolkit and all fittings.

£59 plus VAT

VERBATIM DISKETTES

5¼" Single Sided

Pet 3040, Computhink 400K, Apple, Horizon etc. all **£30 per box (10)** plus VAT.

5¼" Double Sided

Computhink 800K & 1.6 meg. etc. **£40 per box (10)** plus VAT.

8" Disks

Ring us for your requirements.

Consumables

PAPER
(Add £2.50 securicor per box)

(All prices exclude VAT)

RIBBONS

Anadex DP8000 2.50
 Pet 3022 2.50
 Anadex DP9500 10.00
 TTY 43 7.50
 Qume Sprint 5 Multistrike Black 4.00
 Qume Sprint 5 Multistrike Green, Blue, Red, Brown 5.00

9½" x 11" per box of 2000 sheets 15.00
 (Delivered 17.50 plus VAT)
 12" x 11" per box of 2000 sheets 15.00
 (Delivered 17.50 plus VAT)
 14½" x 11" per box of 2000 sheets 15.00
 (Delivered 17.50 plus VAT)
 8½" rolls (12 x 3½" dia 'A' Quality) 18.00
 (Delivered 20.50 plus VAT)
 8½" rolls (12 x 3½" dia 'B' Quality) 15.00
 (Delivered 17.50 plus VAT)

CASSETTES

C15 x 10s 4.40

Trendcom 100 40 col Paper (per roll) 1.50
 Trendcom 200 80 col Paper (per roll) 2.25
 SWT PR40 Paper (per roll) 1.00

PET CONNECTORS

User Port 1.20
 Cassette Port 0.95
 Hoods for User Port 2.25

EX STOCK EXPRESS DELIVERY

KINGSTON

KC NETKIT £135 plus vat.

A new concept in PET communication. Allows, Link to another PET for data transmission and file transfer. Free from the limitations of IEEE Bus. Transforms the PET into a smart or dumb terminal. No complicated machine code for input. Gives full character conversion. Share processing and programming. Reads ASCII files into PET BASIC. Transforms your PET into a more powerful yet controllable unit at a low cost. Available ex-stock

KRK KEYNOTE £55 plus vat.

Incorporating FOUR big features in an impressive hardware/software package. 1. REPEAT FUNCTION ON ALL KEYS. 2. RESET FUNCTION. 3. KEY CLICK/TONE, ALLOWING: Full flexibility on pitch, tone etc. and visual display. The KEYNOTE is easy to install and operate and includes a speaker programme tape and full illustrated manuals.

KRK KEY £20 plus vat.

Repeat function on number pad including cursor movement, an inexperienced aid to the busy programmer at a very low cost

BOOKS

Pet Revealed £10
 Pet Hardware Manual £5
 Programming Manual £5
 User Manual £5
 Disk Manual £5
 Printer Manual £5
 Programming the 6502 — Zaks £7.95
 Understanding your Pet £15



Subjects of interest **FOR MORE INFORMATION CUT OUT THIS COUPON**

Pet
 Industrial
 Educational
 Consumables
 Apple
 Commercial
 Printers

Please supply / send details of _____

Put us on your mailing list

Name _____
 Address _____

Please send to **STACK COMPUTER SERVICES LTD**
290-298 Derby Road, Bootle, Liverpool 20.
Telephone 051-933 5511 for all your enquiries.

**S
T
A
C
K**

COMPUTER SERVICES LTD

Video Genie

**BRITAINS' BEST BUY
IN PERSONAL COMPUTERS?**

— It Only Needs A Plug

**£299
+ VAT**



- 16K Ram, + 12k Microsoft Basic in Rom
- TRS-80 Level II Compatible 100's of Programs Available
- Self-Contained Power Supply
- Integral Cassette, Plugs into TV or Monitor
- Ideal for Business, Education, + Leisure
- Includes Demo Cassette with 5 Programs, + 3 Manuals, and Leads

Options:

Sound Unit, fitted when ordering £15 + VAT
Lower Case Characters fitted when ordering £55 + VAT

VG System Expansion

Expansion Box	£150	Epson TX-80B Printer	£349
Floppy Tape	£165	Printer Interface	£ 35
Disc Drive	£250	S100 Ram Card 16K	£135
Sound Synthesiser	£ 55	S100 Ram Card 32K	£175
Colour Graphics	TBA	Monitor 9" B/W Screen	£ 69
		Monitor 12" B/W "	£ 70
		All + VAT	

Programs

Space Invaders (Cassette) with Sound	£13.00
Othello (Game) (Cassette)	£ 9.25
Music Master (Cassette)	£14.95
Stock Control	£17.00
Text Edit/Word Processor (Cassette)	£15.00
All + VAT	

Books

TRS-80 Machine Language from the ground up	£ 8.50
The Easy Way to Programming in Basic	£ 5.00

Memory Bargains

2708 Eproms	£ 3.50
2716 Eproms	£ 7.95
2732 Eproms	£18.50
2532 Eproms	£18.50
2114 Rams 300ns	£ 2.70
4116 Rams 200ns	£ 2.95
All + VAT	

Q-Tek Systems Ltd

2, Daltry Close, Old Town, Stevenage, Herts
Tel: (0438) 65385

24-hour Despatch
Stock Permitting

**Almarc
would like
you to meet
their new
VIP**

Enter the Computer Age video genie system



12K MICROSOFT BASIC
16K RAM, UHF MODULATOR
INTERNAL CASSETTE
SECOND CASSETTE INTERFACE

80 COLUMNS
70 LINES PER MINUTE
GRAPHICS CHARACTERS
INTERFACES TO MOST MACHINES



100's OF PROGRAMS AVAILABLE
TRS-80 LEVEL II SOFTWARE COMPATIBLE

EIRON

Eiron House, Park Rd, Dun Laoghaire,
County Dublin, Ireland

ComServe

COMPUTER SHOP PRESENTS

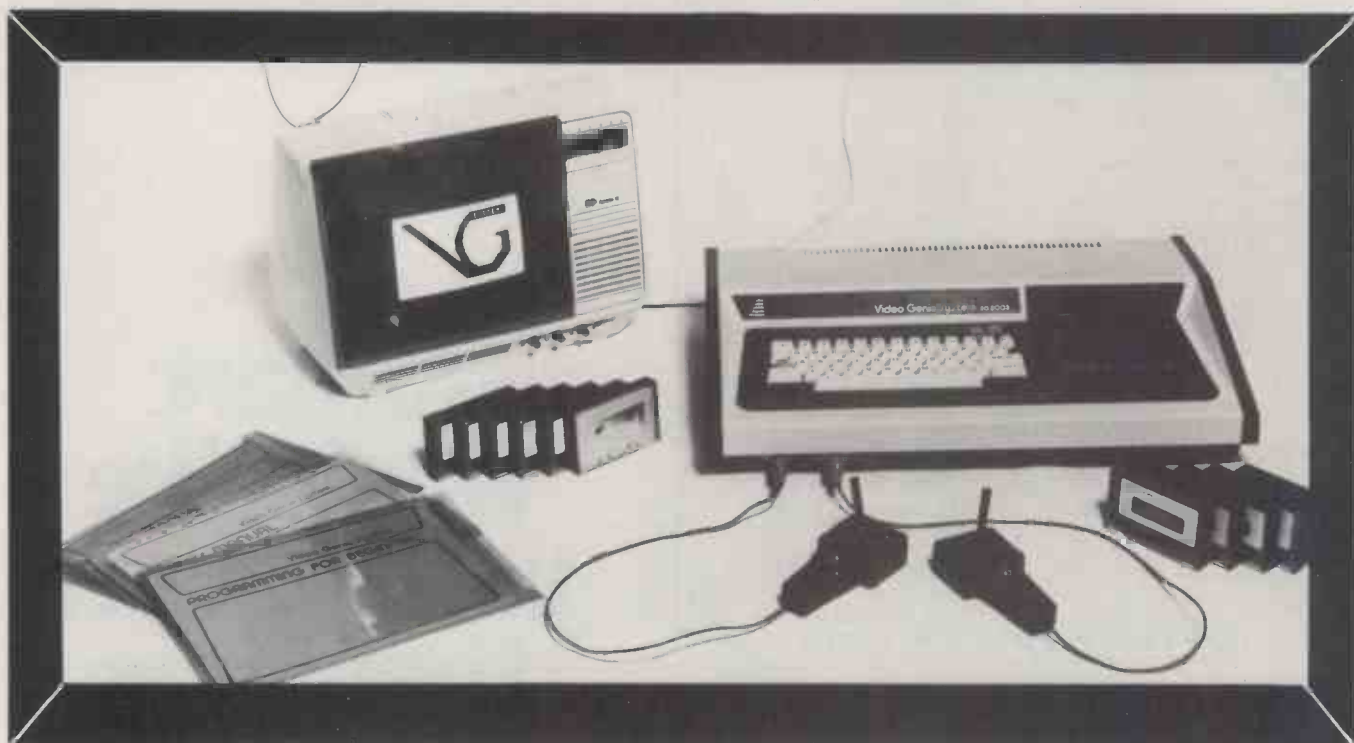

THE ELEGANT, EXPANDABLE

video genie system

£364 inc VAT. Postage. Requires T.V. or monitor — £70 if bought with Genie

Comprises standard 16K computer. 3 manuals. Demonstration tape. Lead for additional cassette player. Lead for monitor.

- FREE** Standard cover. Head cleaning/demangetising tape.
- FREE** Programs: Games. Utilities. Subroutines.
- FREE** Standard soundkit if wanted (installation £5 extra)
- FREE** Comserve joysticks if wanted (installation £7 extra)
- FREE** Coloured plastic folders for manuals or screen overlays.

CWO to

ComServe

98 TAVISTOCK STREET,
BEDFORD, BEDFORDSHIRE
TELEPHONE (0234) 216749

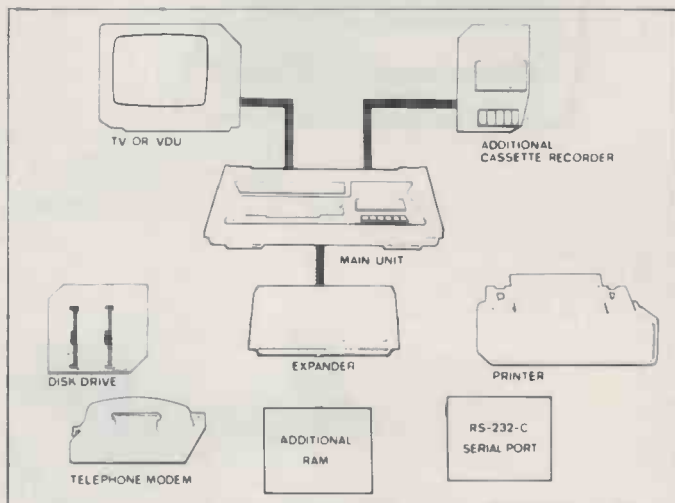

We supply various printers. We will supply S100 expansion box, colour boards, disk drive, fast tape drives, RS232 interfaces as available. We supply some '80, Genie and CP/M programs at 20% discount. We buy some secondhand programs (in manufacturers' original pack and with original documentation only)

S.A.E. for further information. Items and prices are as at time of going to press and are subject to alteration.



Pete & Pam Computers

Microcomputer hardware & software
Specialists in Applefare

Products for APPLE (A) PET (P) and TRS-80 (T) at a
FAIR PRICE!

MICROSOFT

Z-80 SOFTCARD (A) £175.00
A true Z-80 microprocessor including CP/M and Micro-
soft BASIC.

ASSEMBLY LANGUAGE (A + Softcard) £62.95
(T) £49.95

BASIC COMPILER (A + Softcard) £192.95
(T) £99.95

COBOL (A + Softcard) £359.95

EDITOR/ASSEMBLER PLUS (T) £15.95

FORTRAN (sen, true mach.code) (A + Soft card) £99.95

(T) £49.95

LEVEL III BASIC (T) £26.95

ADVENTURE (A + T) (disk int or fp) £14.95

TYPING TUTOR (int. tape) (A) £7.95 (T) £8.95

OLYMPIC DECATHLON (A + T) £14.95

Test your reflexes in 10 events — uses High Res graphics!

PERSONAL SOFTWARE

VISICALC (P) £96.95 (A) £75.00

CCA DATA BASE MANAGEMENT (T) £37.95

(P) £49.95

6502 BASIC ASSEMBLER (P) £12.95

GAMES — all on tape (int of fp)

CHECKER KING (A, P + T) 10.95

BRIDGE PARTNER (P + T) £8.95

GRAPHICS PACKAGE (P) 8.95

ELECTRONIC PAINTBRUSH (T) £8.95

PERIPHERALS PLUS

VERSAWRITER (A 32K) £124.95

Drawing tablet — allows colour, hi-resolution graphics to
be drawn free-hand or traced. Enlarge, shrink, rotate
images. Includes applicatins software — calculate
distances, add electronics symbols, 5 sizes of U & L case
text, & much more!

HIGH TECHNOLOGY

INFORMATION MASTER (A) £73.95

The most flexible and reliable data manager available,
written by the authors of "The Cashier" and "DBMS".
Performs mathematical calculations, Powerful, but easy
to use.

DATA BASE MANAGEMENT SYSTEM (A) £49.95

Design your own system for manipulation of large
amounts of data, and print formatted reports arranged as
you choose.

DATA MASTER (A) £49.95

NEW! A powerful accessory to use with either "Infor-
mation Master" or "DBMS", adds immense versatility to
both. Re-define files, merge data, enter new calculations,
and more!

ORDER SCHEDULER (A) £73.95

Helps you to maintain records and schedule shipment of
orders from your stock. Makes sales accounting easy.
Written by the author of "The Cashier", optional inter-
action with "The Cashier" produces reports of projected
sales and demand. Remarkable!

MOUNTAIN HARDWARE

EXPANSION CHASSIS (A) £319.95

8 more slots for your APPLE with separate power
supply to allow optimum use. This long-awaited product
is made to Mountain Hardware's high standards. Com-
patible with all peripherals.

MUSIC SYSTEM (A) £259.95

Generates the sound of any musical instrument — real or
imagined! Digital synthesizer with sixteen voices —
sophistication previously only available on mainframe.
Graphical input using light pen (provided) paddles or
keyboard. Includes membership of User's Club.

M & R ENTERPRISES

SUP-R-TERMINAL (A + video monitor) £195.00

The best of 80 x 24 video cards/ Shift/lock mod. 128 U
& L case 5 x 8 dot matrix ASCII characters & user
definable char. sets.

UTILITIES

MACRO SCREEN EDITOR (A Int or FP disk) £19.95

PASCAL PAPER TIGER GRAPHICS (A) £22.95

ENHANCED TIGER GRAPHICS (PAGE

1 OR 2) (A disk) £22.95

VISILIST (A) (formula/grid location of

Visicalc files) £10.95

APPLE-DOC (A) (change any listed element) £12.95

PROGRAM LINE EDITOR (A disk Int or FP) £18.95

HIGHER TEXT (A disk Int or FP) (def.

own colour text) £16.95

PLEASE ADD 15% V.A.T. TO YOUR ORDER —
POSTAGE IS FREE

ASK US FOR OUR FULL CATALOG

BUSINESS — GAMES — UTILITIES — FIRMWARE

We want to be your mailorder supplier. If you know
what you want — and don't want to pay an inflated
price — gives us a call. We'll try our best!

Tel. 01-677 2052 (24 hours) 7 days a week.

98 Moyser Road, London SW16 6SH

Post Office Giro A/c No. 585 6450

Almarc would like you to meet the Vector Graphic VIP



High performance at an astonishingly low price.
Compare this specification:

*The Vector 3 terminal, with 6 slot industry standard
S100 bus.

*Z80 Processor.

*56K of user RAM.

*1 serial RS232 port, 3 8-bit parallel ports.

*80 x 24 characters video display with 8 x 10
character matrix.

*Typewriter style keyboard with a separate numeric
key pad and capacitance keys.

*Unistor disc drive module giving 315 Kbytes of
storage capacity.

PLUS CP/M2, Microsoft BASIC 80, SCOPE (text
editor) and RAID (simulator debugger).

PLUS Almarc's 12 month warranty.

Almarc are Specialists in Vector Graphic equipment
which includes Micro-Computers for research,
laboratory work, word processing, business systems,
schools, colleges, universities and industry. Plus an ever
growing list of compatible software including Pascal,
Fortran, Cobol, APL, Algol, Basic Compiler and others.

We will be pleased to demonstrate how
Almarc + Vector Graphic Systems equates to The
Complete Partnership in Micro-Computers.



DATA SYSTEMS LTD

906 Woodborough Road, Nottingham NG3 5QS.

Telephone: (0602) 625035

Guy Kewney, Editor of Datalink, delivers his usual idiosyncratic rendering of all the latest happenings.

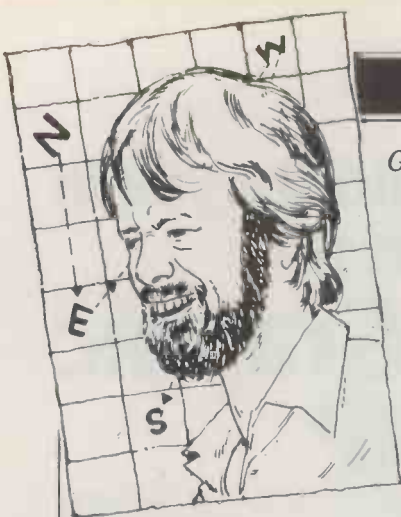

Playing with an Atom Health conf.

For the last month or so, I have been happily playing with an Acorn Atom, at the earnest request of Acorn's partners, Chris Curry and Hermann Hauser. In a way all this happy playing is designed to settle a bet: is the Atom a nice machine, or not?

Readers whose memories go back to March/April will recall that I got quite excited about the Atom when it was arriving, but that a couple of months later, when it arrived, Mike Dennis did a Benchtest and thought it was nowhere near as nice as its photograph.

Shrewdly spotting which of us was most likely to be responsive to a prolonged test, Acorn accordingly despatched a fully-equipped Atom to me, with the request that I see whether I agreed with Mike.

On two points, I do. The Basic supplied is non-standard. And the video output to a TV does require an adjustment of the vertical hold. And one anti-Atom point worth making straight away is that the video display has a silly fault — a 'flicker' when using graphics software.

Apart from that, I still think it is a worthwhile machine. The Basic is the thing I like most about the Atom. It is definitely a Basic for the programmer, not for the copyist, though the 'improvements' that its designer has put into it are irritating at first because you expect it to do things, and it doesn't.

For instance, in most Basics, a PRINT statement starts its output onto a screen at the beginning of a line, unless the previous PRINT ended in a semicolon. On this, it works the other way: if you want it to print on a new line, you have to end your PRINT by outputting a single quote (') or start the next line with one, of course.

Similarly, the Basic is integer, even when you have the full floating point option, so that a statement PRINT 3/4 will produce 0; you have to say FPRINT 3/4 if you want 0.750000. This means that all programs

written before installing the arithmetic option will continue to work afterwards, an important point.

Now that the Atom has passed its first 1000 sales, we have to start looking forward to the time when it becomes acceptable. Acceptable, as defined in my Rules of Thumb for selecting a system, means having more than 5000 users because that is the sort of figure that attracts software writers to start selling programs. And, right on cue, Bug Byte of Coventry write in with the news that the company is the first to offer Atom programs.

Bug Byte is a partnership of three — Baden, Fitzgerald, and Milner — the last of whom has written to complain that his company, not Econsoft, was the first to offer software for the Sinclair ZX80. For details of their products, Milner says, I should look in the advertisement which he recently sent for inclusion in the December issue of this magazine.

Oh, good; that saves me having to find out what they are and write about them.

You may (if our printers have really pushed themselves getting this issue out) be in time to get over to Loughborough on 11 December, to find out whether video displays are hazardous to health.

A conference is organised by HUSAT (Human Sciences and Advanced Technology) research group at Loughborough University, with medical experts on skin disease, plus ergonomic experts on people shape, and even experts on radioactivity — which should cover all aspects of the problems caused by looking at flickering screens — apart, that is, from the problem of how to debug the flickering program. Details on (0509) 63171.

Coming soon

We are all dying to know what the industry can produce to overtrump Uncle Clive Sinclair's ZX80.

The answer looks like being either the new Nascom Microcomputers machine (see elsewhere) or, more likely, a development of a less-known micro kit, the Tangerine

Micro-Tan.

The makers of the new machine deny that it will be a computer. It will, they say, be a Prestel adaptor, for £100 or less. All it will do, they say, is convert your television set into something that can be connected to the telephone lines, and can receive Prestel's database of news and rubbish pages. It will be called Tan Tel and it will be available early next year.

What makes it special, they hint, is the way it can be expanded (unlike the ZX80 which, nice though it is, isn't really worth expanding — you give it to your baby brother instead). It will be compatible with the expanded MicroTan, which is expandable to an enormous extent.

For example, the Tanel can have, for an extra £50 or so, a very good full-typewriter keyboard. For the cost of extra MicroTan memory and disk controller boards, it can have expanded memory and disks. It can have a great deal more memory than standard micros — despite being based on the well-known 6502 chip (in the PET, Apple, Acorn, etc) it can handle over 400 kbytes.

In other words, it can be expanded into a very office-acceptable data processing machine, with the ability to contact remote databases built in. The only real drawback, so far, is that the circuit it uses for talking down a phone line is the modem that the PO specified for Prestel — a modem which cannot talk to another one like itself. So Tanel users can't (initially) talk to each other.

Tangerine hints that this would be quickly cured but won't give details. Impressively, however, it claims that something like 40,000 Tanel units will be made and sold in 1981 — which is enough to attract software writers. Even PET is only up to 35,000-odd in the UK so far.

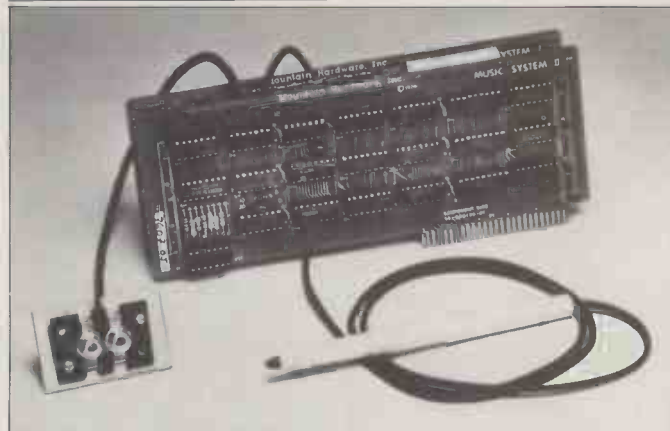

The only way of deciding whether a music synthesiser is any good is to listen to it. This one is not the Apple synthesiser but is available through all 250 Apple dealers in the UK, being imported by the Apple distributor Microsense. Without having listened to it myself, I can't be sure, but I think the 'special' feature about this one is stereo. "Stereo output is to users' stereo amplifier and speakers, or directly off card with stereo headphones," says the announcement. It sounds (sorry) quite exciting. More on (0442) 48151.

Postponed

Here's how to send a letter to Granny in Canada. You write it at your computer terminal, transmit it to the



The MSC mini-Winnie controller (centre). See 'Disk hook-up'.

IP Sharp timesharing computer locally. That computer instantly transmits it to the computer in Toronto, also owned by IP Sharp. In its turn, the Toronto machine gets on the line, dials Granny's terminal and tells it to print out pronto, Toronto — and Granny is woken from her slumbers by the chattering of the printer. Takes seconds.

It's called electronic mail and the advantages over people running around with bags over their shoulders are obvious. So, naturally, the European postal authorities (mainly the German Bundespost) are anti, and Sharp has been forced to cancel the service.

Of course, the CEPT will provide an alternative service. One day. When they can agree on how it's to be organised.

In the meantime, can we please carry on using the IP Sharp mailbag?

No.

Nice people, the CEPT.

Disk hook-up

Elsewhere on this page you'll find a photo of a computer joined to a little black box joined to a mini-Winnie hard disk. The black box (why are they always black?) is a low-cost (\$700) controller, which could give your PET a vast storage capacity.

Two intriguing things are not said in the large amount of information provided by the supplier, Microcomputer Systems Corporation. The first is: why show the controller being driven by the Hewlett-Packard HP-85, and not the PET? And secondly, what is the supplier going to do with it?

The magic part of this little black box is the fact that it uses an HP-patented method of connecting a computer to a device — the general purpose interface bus (GP-IB) — which also occurs (with minor variations) in the PET. In fact, the PET had it first — the HP-85 didn't get its own GP-IB until a couple of months ago.

The minor differences between the full GP-IB, as specified under the IEEE and IEC as the 488 standard, and the PET interface, should not affect this device. A disk

drive doesn't have subsidiary devices to control, and it is only in the area of subsidiary devices that the PET can need watching. So it's a safe bet that PET will drive the disk (a Shugart ST-506 drive) with this interface. So why didn't Microcomputer Systems say so? Intriguing.

Secondly, the question of why. Microcomputer Systems specialises in hardware interfaces, but is believed to have an interest in promoting products which it knows will be in high demand. Sources in California say that the choice of this drive is linked to Hewlett-Packard's plans to launch a database manager — software for controlling and searching through large volumes of stored data files — soon.

Incidentally, the controller can be used with the PET — and, "with a minimum of cost and design effort," with Apple, Prolog and systems using Intel's Multibus. But on the face of it, stay with PET and HP systems until we know just how 'minimum' this effort is. Details on (0101 408) 733 4200.

Secondhand I/Os

Secondhand input/output devices, remarks the new Computer Junk Shop, "are so necessary to make a relatively cheap micro-processor into a useful system." Too true.

To get cheap peripherals from the Junk Shop, however, you have to live near Widnes in Cheshire. The shop "will offer components, cables, power supplies, computer peripherals (both new and second-hand) together with more usual items such as lamps and batteries."

The company says it is getting its components from "the inevitable obsolescence that the changing technological age of the micro revolution is bringing."

The items on sale will be mainly unused surplus stock, acquired from major electronic manufacturers, and secondhand items, reclaimed from obsolete computer and electronic systems. Now you know what to do with your Science of Cambridge Mk 14 when you've finished jumping

on it. Details from Nigel Armitt on 051-420 4590.

Colour display

Real computer users, naturally, use real VDUs, not grotty television sets like imitation computer users have to put up with on their grotty little micros. That, of course, is why real computers have never been able to give their users the benefits of good colour output at less than extortionate prices, while we imitation computer users have had good colour for the price of an ordinary TV.

Ah well, somebody was bound to spot it; Rapid Recall has made the breakthrough, and produced a display system which allows any 'proper' Digital Equipment Corporation micro (the LSI-11 family of single-board minis) to drive a standard colour TV set.

The system is the VTU 30 J, and it is sold with the idea of allowing engineers to generate colour pictures mimicking the process in the process control system that the computer is controlling. The system takes up two printed circuit boards, and generates pictures by itself, once the computer has transmitted them — just like a real microcomputer. Clever, isn't it? Details on (0494) 26271.

Help from MUSE

Teachers needing national information and advice on micros, can now ask MUSE.

MUSE is Mini and micro-computer Users in Secondary Education, and it has set up a centre in Birmingham with a

full-time teacher in charge — Bob Trigger — who has been seconded from Birmingham's Marsh Hill Comprehensive School, and starts work on the first day of the New Year. Muse claims that Trigger has many years' experience of teaching computer studies, so can presumably advise relative beginners when they get stuck.

Funding for the centre has been provided as part of the government's £9 million microelectronics development programme for schools and colleges.

Anyone who feels that the Centre should know of their work in computers or in education or both, should contact the centre. Bob Trigger's phone number is 0527 76074.

New software

People who use operating systems tend not to like working with the nitty-gritty detail of getting binary codes in and out of disk storage — they like having it done for them. This provides a neat trap for some software publishers who wish to 'protect' their programs. They include disk storage in their programs and let the program fetch its data in a non-standard way. So, when you try to copy the data, you find that sector three under CP/M isn't sector three on this disk.

Annoying. Therefore let the computer tackle it. Get a program like PROZAP from A J Harding (Molimerx). This enables disk users to get into their disk and carry out examinations and modifications, Harding points out. Alternatively, try DISKAID — another 'zap' program designed to get round the

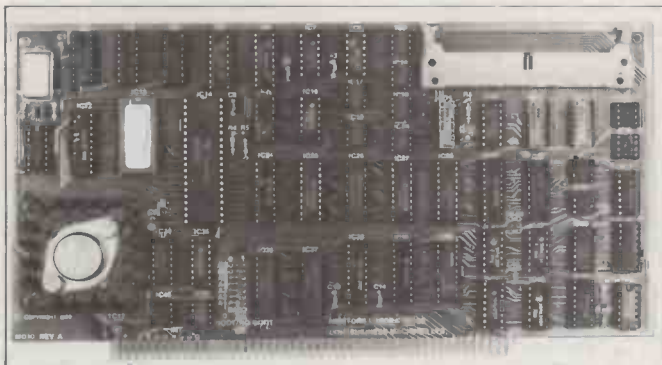

The newest "mini winchester" big-capacity storage systems are not yet available in removable cartridges — which means that micro users wanting removable big-storage devices either have to keep tape copies of their disks, or they have to use the older (and rather costly) cartridge disk drives.

An interface to connect \$100-based computers to one of these cartridge drives is available from Newtons Laboratories. As shown, it includes operating software to run under the CP/M operating system (version 2.2) with a "rewritten BIOS which will allow the user to boot from either his floppies, or from the cartridge disk drive."

If the hard disk is used in this way to start the system, then the floppy disk storage units can be used as peripheral storage — and vice versa, says Newtons.

Details from Theo Van Dort or Mike Osler on 01-874 6511.

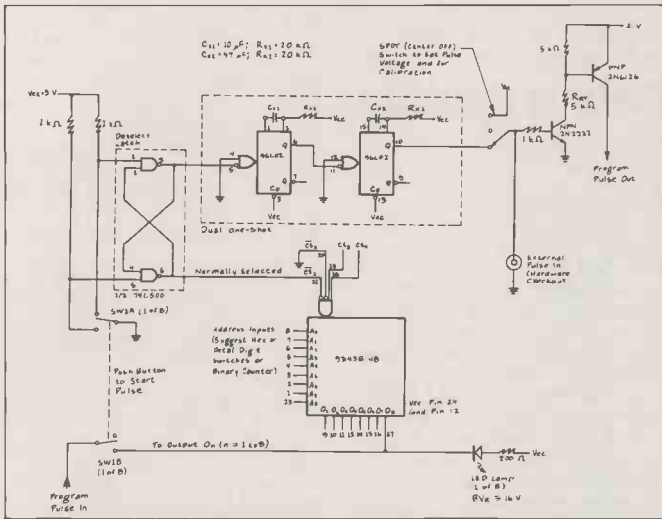

Politely, the giant chip-making company Fairchild has refrained from saying, in so many words, that people sell devices for loading programs into permanent memory at overhigh prices. Instead, the company has published this circuit, which it suggests can be built quickly, with a minimum number of parts, at low cost.

It is designed for the permanent programmable memories, not the ultraviolet erasable and reprogrammable EPROMs.

It blows the fuses on the memory chip, producing LOW outputs from the required memory cells (when made, they are all HIGH; must be nice being a cell. . .).

Details from Fairchild on (0707) 51111.

same nasty problem.

"It is fair to say that Prozap contains more commands and features than Diskaid," comments Harding, in the latest addition to its catalogue. "On the other hand, Diskaid costs a little less than Prozap."

The machine catered for is primarily the Tandy TRS-80 in its many guises.

There is a new NEWDOS called Newdos80 — better than NEWDOS+, says Harding, and much better documented; "it is not an upgrade but an entirely new piece of software. Unfortunately, therefore, we are not permitted to upgrade existing NEWDOS+ customers."

There is a touch-typing course, a board game called Dark Void (locating atoms in the void by shooting rays into it), Farmer Brown (strictly for the children), Hannibal and lots more. Details on (0424) 220391, or write to 28 Collington Avenue, Bexhill-on-Sea, E Sussex.

School scheme

"As a ZX80 owner," writes a teacher from St Ives, Cambridgeshire, "I have been extremely impressed with the cheapness and versatility of the machine, and have used it extensively in my profession as a primary school teacher. As there appeared to be a complete lack of educational programs on the market, I had to write my own to fit the particular needs of the junior school age range."

The correspondent earns

this free printing of his letter here because of the low price for his software: he is asking a mere £3.50 per cassette. So let him continue, unadulterated: "I feel that there is a definite need for good, reliable and above all tried and tested educational programs, so have decided to market my products. "Junior ZX80 Education Enterprises' aim is to produce reliable programs dealing with specific needs, as cheaply as possible. The information sheet will be sent to anyone interested."

It includes programs which could be used as games, but which are meant to be used in lessons. There is also a list of future projects, including a spelling game comprising the 300 words that comprise some 55 per cent of all written material and an offer to market any software supplied by others.

"We would like to point out, however, that every cassette has to be checked and tried with children, so the emphasis is on quality, rather than quantity."

Send stamped envelopes to Mr Squibgle, Junior ZX80 Education Enterprises, 38 Bedford Cres, St Ives, Cambs PE17 6DE.

It's all a moustake

There was no end of bitterness over the mouse competition.

The mouse competition? (you ask?)

Yes, the mouse competition. It was the idea of John Billingsley, of Euromicro exhibition fame,

to create a maze that could be solved by clever robot mice.

A micromouse with an RCA 1802 micro in it, devised by Geoff Pikes and Nick Smith, was the first into the centre of the maze on the day. Loud cheers, because they built it with less than £200 and no sponsorship and beat a great many sophisticated beasts from heavily sponsored entrants.

Well, having done the loud cheers, it remains to be admitted that the event wasn't an unqualified success. First, the maze itself was made of rather flimsy material, and many of the mice pushed it over. Second, most of the entered mice never actually found their way into the centre. In fact the winner, Sterling Mouse, was the only one that made it. And there were strong feelings that this was luck rather than judgement, because in the course of trying to map out the maze, preparatory to running, Sterling got lost and crashed.

In other words, Sterling couldn't build up a picture of the twists and turnings and gaps, but he (she?) still got to the centre — hmmm.

Prizes were awarded, however. Sterling got \$1000 in nice new notes, a Finnish entry, Midnight Sun, tied with the UK version, Fred Mouse, and each got the Computabits £100, which was nice of Nick Hampshire: and Brainy Bricks got a clock barometer plus £20 from the Computer Bookshop for the best performance in plotting the map (with which it still couldn't find its way to the centre, but never mind).

The remaining entries, Meryl, Pascal Mouse Engine, Amcomical and Yamohick 4 (!) were awarded consolation prizes. Nothing will persuade me to reveal what these were, or you will think me an utter sadist. I

have my own ideas of what the word 'consolation' means, and these prizes could not qualify.

Commodore, however, decided that the terms under which it had originally agreed to provided a trip to its US plant, had not been complied with. The entrants all grumbled about this, but I must confess that for once, my sympathies are with Commodore. Other prize sponsors decided to be magnanimous (sorry), and so much the better. But Commodore said that nobody actually qualified for the prize — and you really can't argue with that.

Copmstof

Compsoft is too busy using its computer to write useful PET software to let it be distracted by mundane tasks such as running word processing programs.

I know, because the company has just announced a data management system, DMS, which is used to keep track of such things as stock records, agency personnel records, financial and scientific analysis, patient or student records, sales analysis, maintenance contracts, and so on. The program is not restricted to PET users. It runs on all 32 kbyte PETs, plus Computabits machines, plus CP/M machines.

How on earth, you ask, can anyone tell from all that, that Compsoft doesn't use its computer for word processing? Because, I answer, the announcement includes such interesting words as student instead of student, thanm instead of than, CP/m instead of CP/M and cannon instead of cannot.

I only hope the telephone number (0483 39665/39665) is not similarly mistyped.



The important feature of this photograph is not the train set. Nor, surprisingly, is it the Sol computer (I think it's a Sol, but it's not clear in the photo) on the little table. No, it's the pneumatic drive — the bank of air cylinders — in the background.

It is an electronic switching box connected to the bank of air cylinders which Teddy Wright (left) developed, and was here using to drive the trains.

No, I don't understand it either, but ask Thomas Wright (Bradford) Ltd yourself on (0274) 663471 if you want details. Let me know what you have in mind — there must be things that really call for pneumatic control but I can't think what they are.

Commodore approval is your guarantee of quality.

As well as manufacturing Europe's number one micro-

computer, Commodore have officially approved a range of PET compatible products, a selection of which is featured below.

Post the coupon for our comprehensive brochure of approved products, or contact the supplier direct.



IJJ are the sole distributors in the UK for the outstanding MTU High Resolution Graphics system for the PET. This provides the following features.
320 x 200 dot matrix, fully addressable
Advanced machine code handler included (disk or cassette)
Straightforward to use, with 19 extra BASIC keywords.
8K extra memory when graphics not in use.
5 extra ROM sockets for firmware (e.g. Toolkit, guard chips, etc.)

Simple fitting within the PET using mounting bracket supplied
Plugs into memory expansion socket.
Only 3 wires to be soldered for raw do. supply.
All-inclusive price £320 (+VAT)



IJJ DESIGN LIMITED.
37 London Road, Marlborough,
Wilts SN8 2AA. Tel. (0672) 54487

Mitrelynn have produced an Acoustic Cover specifically designed to reduce the noise level of the Commodore Tractor Printer by some 80%.

Made of fire retardant styrene plastic with a leather-grained finish, the cover is lined internally with acoustically absorbent polyurethane foam treated to minimise dust.

All printer functions are easily accessible.



MITRELYNN Mitrelynn Limited,
159/161 High Street, Sawston, Cambridge.
Tel: 0223 835792 Telex 817855

FILEPROG, a disk based visual search and display filing system of up to 3000 records showing name, address, telephone number, notes, product and area codes.

Seven print facilities for mailing list, company list, self-adhesive labels or area list.
Full self checking back up routines ensure data cannot be accidentally lost.

AMPLICON MICRO SYSTEMS LIMITED
143 Ditchling Road, Brighton,
E. Sussex, BN1 6JA.
Tel: (0273) 562163



Stephenson Way, Three Bridges, Crawley,
W. Sussex, RH10 1TN. Tel: (0293) 26493.

The only manufacturer of approved interfaces for the Commodore PET * Type C: PET to RS232 * Type B: PET to RS232 bidirectional * TV monitor interface * A.P. PET to parallel * G.P.I. micro based interface programmed for your interface requirements

* Complete word processing systems
* Custom interfacing * Full range of CBM equipment * Ricoh RP1600 daisy wheel printers complete with integral addressable interface Ex. Stock.

Small Systems Engineering Limited,
2-4 Canfield Place, London NW6 3BT.
Tel: 01-328 7145/6 Telex 8813085 (Abacus)



8000 + 3000 Series Products for both the Businessman and Accountant in Practice. Incomplete Records Accounting, Sales, Purchase and Nominal Ledgers, Time Records Costing, VAT Special Retailers Schemes, Backed by around 200 live installations in Accountants' Practices throughout the U.K.

C.S.M. set the standard for Accounting Software. Computer Services Midlands Limited,

Refuge Assurance House,
Sutton New Road, Erdington,
Birmingham B23 6QX.
021-382 4171 (4 lines).



KRAM (Keyed Random Access Method) adds 10 functions to Basic in the 40/80 column PET, to give complete and easy control of disk data. KRAM is based on state-of-the-art VSAM mainframe techniques, giving fast keyed access to the 3040/8050 disks and maximizing disk capacity. Essential for business users. £100.00 + VAT.

Calco Software

Lakeside House, Kingston Hill,
Surrey KT2 7QT. Tel: 01-546 7256

MUPET is very good news if you require a multi-user word-processing system but up until now have run up against a budgetary brick wall.

MUPET makes the most of WORD CRAFT or WORDPRO IV by linking 2 or more PETS to a single disk-drive and your choice of quality printer.

Priced from £495 + VAT.
KOBRA MICROSYSTEMS



14 Broadway, West Ealing,
London W13 0SR.
01-579 5845.

Constructional Software is a library of programs for the construction industry with applications for Engineers, Architects, Quantity Surveyors and Contractors. Frame analysis, heat loss, drainage design, specification preparation, critical path analysis and resource allocation on 40 and 80 column PETS.



Claremont Controls Ltd.,
Chimney Mill, Newcastle upon
Tyne, NE2 4AL.
Telephone (0632) 610210.

To: Commodore Information Centre,
360 Euston Road, London NW1 3BL.
01-388 5702.

Please send me further information about the Commodore PET Approved Products range.

Name _____

Position _____

Address _____

Intended application _____

Do you own a PET? YES NO

commodore

PCW 1

Apples get together with Nestar

Painstakingly, you type out a screen of letters, four inches high, on the display of your Apple. The letter G is made up of forty Gs, the big U is made up of equally strategically placed Us, and the Y is a masterpiece of collated Ys.

Then you transmit the screen through a network to your mate Gonzo who is sitting at the console of a Tandy. Instantly the last letters of Y are transferred onto the next line, screwing up the whole display with unwanted line feeds.

This is the reason Zynar has brought Nestar to Britain, but has dropped the idea of putting anything other than Apple computers into the network.

Nestar was first demonstrated publicly at the West Coast Faire this year in San Francisco, where it took quite a long time to find your message (if there was one) but then lost it forever.

It now works quite a lot better and Harry Saal, the head of Nestar, came to Britain with it, to give UK rights to the new firm, Zynar.

The product is almost enough to make you take it seriously by itself. What makes it even more impressive is the man at the head of Zynar: Colin Crook.

Crook it was who forced Motorola to design the 6800,

the biggest 16-bit micro-processor in the world (until IBM releases details of its System/370 chip). Crook was virtually head of Motorola's world-wide micro operations, when he suddenly got out of America to bring his children back to where they could learn to speak properly — and for all the other things that make this country a nice place in which to grow up.

Now he has got the micro-system bug and is scathing in his scorn for those who don't see the future as a networking one. "There are people trying to design multi-user software systems, and they're absolutely mad," Crook confided at the Zynar launch in September. "The way to give extra power is to give extra computers, not to slice up cheap ones into things driving terminal teleprinters. Who for (...) 's sake wants a terminal on the end of a 300 baud line?" Who indeed.

Mind you, you can have fun with the Nestar net. Type in a buffer full of Control G characters, then transmit, and listen as everybody else's computers seize up, bleeping. No, don't do that; it would be irresponsible.

Details from Zynar, on Uxbridge (0895) 59831. They may even let you have some Apples to run the cluster network on.

Cheap printer

As long as the printer on a system isn't going to pretend



It wasn't fair to print a picture of this printer in its version that has no keyboard. Now that Weyfringe has produced one with keys, I happily display it here; this time as a terminal, not just as a printer. Details on Middlesbrough 210587. See the August PCW for the original mischief. (Hee! Hee! — Ed.)

it is an electric typewriter, it can cost £200 and still offer full width (80 characters per line) and 30 characters per second speed. The device that gives print at this price is the 'unihammer' dot matrix printer made by Seiko and marketed in the UK by Mitrecrest of Basingstoke.

Normal matrix printers can, theoretically, be stopped as soon as they have printed one character, because they print lines of dots, seven or nine lines at a time. This one only produces one line of dots. Rather like a TV screen scan, it runs down the paper dot-line by dot-line until it has built up the characters. That makes it a bit slow, but cheap. Details from Ian Jones on (0256) 56468.

CP/M. If Digital Research can do it again then we can expect good things of the 8086 and any other micros that run the same programs. At the moment, that is none; put your money on imitations for the future, however.

Digital Research is represented in Europe by the Belgian firm Vector International, tel 32 (016) 202496.

From the man who gave us Nascom...

The man who started Nascom by saying "What can we offer for £200?" has been asking himself "What can we build for under £1000?" And he has come up with Gemini.

Gemini, from John Marshall, will have a full 64 kbytes of memory, a small disk, a keyboard and some software (Basic, maybe APL) in a case oddly reminiscent of the Apple III (whatever happened to the Apple III?).

The disk drives will be available as add-ons for Nascom systems, by the way, but the future for Gemini and Marshall lies in the new machine.

It will run CP/M and eventually it will allow expansion on the S100 bus, Marshall says. The micro is, once again, the Z80. More details soon, says Marshall.

Moved

Last time your favourite electronics magazine published a sneaky little circuit to make your computer turn itself on, or to wipe your feet, or to imitate your boyfriend's voice when your parents' phone, you probably had trouble finding the compo-



This briefcase has a computer in it. Not for you to use but to keep the case shut until you type in the right combination code. Only one small point: if the battery runs down, the lock won't open. Nasty. Details on 01-882 2992.

Biggies grow up

The first sign of the future, the first indication that 16-bit 'big micros' are coming must be the announcement of a version of CP/M for the Intel 8086 micro.

At the moment there aren't a whole lot of 8086 systems around. The very first was the British Elite system from Modular Business Systems in Leeds. Since then, there have been a few others, mainly from people like Burroughs, and IBM. (Yes, IBM. Its latest word processor, the Displaywriter, turns out to be an Intel 8086 with floppy disks. Only one snag: IBM won't let your nasty little fingers in to program the machine. And it does have a lovely spelling program, which shows you which words have been spelled wrongly.)

Digital Research produced CP/M before the 8080 and Z80 micros had become as popular with micro users as they are now. In fact a major cause of that popularity was

Outstanding value. Superb support.



Commodore produce Britain's number one microcomputer. But we don't stop there. We also insist on providing comprehensive support throughout our national dealer network.

Our dealers can examine your needs and demonstrate which hardware and software will suit you best. Their trained engineers are always at hand and a 24-hour field maintenance service is available. Your local dealer can tell you more about the following Commodore Services.

Commodore PET

The Commodore PET computer range covers everything from the self-contained unit at under £500 to complete business systems at under £2,500.

Commodore Business Software and Petpacks

Our software range covers hundreds of applications. Business software includes Sales and Purchase Ledgers, Accounting, Stock Control, Payroll, Word Processing and more. In addition over 50 Petpacks are available covering such titles as Strathclyde Basic Tutorial, Assembler Development System, Statistics, plus our Treasure Trove and Arcade series of games.

Commodore Approved Products

Compatible products of other manufacturers with Commodore's mark of approval are also available.

Commodore Courses

Commodore offer a range of residential training courses and one day seminars. An excellent start. And when you have installed your system the PET User's Club Newsletter can keep you informed of new ideas and latest developments.

LONDON AREA

Adda Computers Ltd,
W5, 01-579 5845
Advanced Management Systems,
EC2, 01-638 9319
Byteshop Computerland,
W1, 01-638 0647
C.S.S. (Business Equipment) Ltd,
E8, 01-254 9293
Capital Computer Systems,
W1, 01-636 3863
Centrex-London Ltd,
SE13, 01-318 4213
Cream Microcomputer Shop,
HARROW, 01-863 0833
Da Vinci Computer Shop,
EDGWARE, 01-952 0526
L & J Computers,
NW9, 01-204 7525
Home and Business Computers,
E12, 01-472 5107
Merchant Systems Limited,
EC4, 01-383 1464
Metyclean Ltd,
SW1, 01-828 2511
Micro Computation,
N14, 01-882 5104
Micro Computer Centre,
SW14, 01-878 3206
Sumlock Bondain Ltd,
EC1, 01-250 0505
Sumlock Bondain Ltd,
EC4, 01-626 0487
T.L.C. World Trading Ltd,
WC2, 01-839 3894
TOPS TV Ltd,
SW1, 01-730 1795

HOME COUNTIES

G. M. Marketing,
ANDOVER, 790922
HSV Microcomputers,
BASINGSTOKE, 62444
MMS Ltd,
BEDFORD, 40601
Elex Systems Ltd,
BRACKNELL, 52929
DDM Direct Data Marketing Ltd,
BRENTWOOD, 229379
Amplicon Micro Systems Ltd,
BRIGHTON, 562163
RUF Computers (UK) Ltd,
BURGESS HILL, 45211
T & V Johnson (Microcomputers
Etc) Ltd, CAMBERLEY, 20446
Cambridge Computer Store,
CAMBRIDGE, 65334
Wego Computers Ltd,
CATERHAM, 49235
Dataview Ltd,
COLCHESTER, 78811-
South East Computers Ltd,
HASTINGS, 426844
Alpha Business Systems,
HERTFORD, 57423
Brent Computer Systems,
KINGS LANGLEY, 65056
Isher-Woods Business Systems,
LUTON, 416202
South East Computers Ltd,
MAIDSTONE, 681263
Micro Facilities Ltd,
MIDDLESEX, 01-979 4546
J. R. Ward Computers Ltd,
MILTON KEYNES 562850
Sumlock Bondain (East Anglia) Ltd,
NORWICH, 26259
T & V Johnson (Microcomputers
Etc) Ltd, OXFORD, 721461
H.S. Microcomputers,
SOUTHAMPTON, 22131
Super-Vision,
SOUTHAMPTON, 774023
Xitan Systems Ltd,
SOUTHAMPTON, 38740
Stuart R Dean Ltd,
SOUTHEND-ON-SEA, 62707
The Computer Shop,
TUNBRIDGE WELLS, 41645
Orchard Electronics,
WALLINGFORD 35529

Petalact Ltd,
WOKING, 63901
Oxford Computer Systems,
WOODSTOCK, 811976

MIDLANDS AND SOUTH HUMBERSIDE

Allen Computers,
GRIMSBY, 40568
Byteshop Computerland,
BIRMINGHAM, 622 7149
CPS (Data Systems) Ltd,
BIRMINGHAM, 707 3866
Camden Electronics,
BIRMINGHAM, 773 8240
Computer Services Midlands Ltd,
BIRMINGHAM, 382 4171
Catlands (Computers) Ltd,
BURTON-ON-TRENT, 812380
Ibek Systems,
COVENTRY, 86449
Jondane Associates Ltd,
COVENTRY, 664400
Davidson-Richards Ltd,
DERBY, 366803
Caddis Computer Systems Ltd,
HINCKLEY, 613544
H.B. Computers,
KETERING, 83922
Taylor-Wilson Systems Ltd,
KNOWLE, 6192
Machsize Ltd,
LEAMINGTON SPA, 312542
Office Computer Techniques Ltd,
LEICESTER, 28631
Lowe Electronics,
MATLOCK, 2817
Betos (Systems) Ltd,
NOTTINGHAM, 48108
Byteshop Computerland,
NOTTINGHAM, 40576
Keen Computers Ltd,
NOTTINGHAM, 583254
Tekdata Computing,
STOKE-ON-TRENT, 813631
Systems Micros,
TELFORD, 460214
McDowell Knagg & Associates,
WORCESTER, 427077

YORKSHIRE AND NORTH HUMBERSIDE

Ackroyd Typewriter & Adding
Machine Co. Ltd, BRADFORD, 31835
Microware Computers Ltd,
HULL, 562107
Microprocessor Services,
HULL, 23146
Holdene Ltd,
LEEDS, 459459

South Midlands Communications Ltd,
LEEDS, 782326
Yorkshire Electronics Services Ltd,
MORLEY, 522181
Computer Centre (Sheffield) Ltd,
SHEFFIELD, 53519
Electronic Services,
SHEFFIELD, 668767
Hallam Computer Systems Ltd,
SHEFFIELD, 663125

NORTH EAST

Dyson Instruments,
DURHAM, 66937
Currie & Maughan,
GATESHEAD, 774540
Wards (Office Supplies) Group,
GATESHEAD, 605915
Elton Ltd,
HARTLEPOOL, 61770
Fiddes Marketing Limited,
NEWCASTLE, 815157
Newcastle Computer Services,
NEWCASTLE, 615325
Format Micro Centre,
NEWCASTLE, 21093
Tripont Associated Systems
Consultants Ltd,
SUNDERLAND, 73310

SOUTH WALES AND WEST COUNTRY

Radan Computational Ltd,
BATH, 318483
Computer Corner,
SHREWSBURY, 59788
Bristol Computer Centre,
BRISTOL, 23430
C.S.S. (Bristol) Ltd,
BRISTOL, 779452
T & V Johnson (Microcomputers
Etc) Ltd, BRISTOL, 422061
Sumlock Tabdown Ltd,
BRISTOL, 26685
Sigma Systems,
CARDIFF, 34869
Office and Business Equipment
(Chester) Ltd, DEESIDE, 817277
A.C. Systems,
EXETER, 71718
Micro Media Systems,
NEWPORT, 59276
J.M. Computer Services Ltd,
NEWQUAY, 2863
Devon Computers,
PAIGNTON, 526303
J.A.D. Integrated Services,
PLYMOUTH 62616
Business Electronics,
SOUTHAMPTON, 738248
Computer Supplies (Swansea),
SWANSEA, 290047

NORTH WEST AND NORTH WALES

Tharstern Ltd,
BURNLEY, 38481
B+B (Computers) Ltd,
BOLTON, 26644
Preston Computer Centre,
PRESTON, 57684
Catlands (Computers) Ltd,
WILMSLOW, 527166

LIVERPOOL

Aughton Microsystems Ltd,
LIVERPOOL, 548 7788
B.E.C. Computers,
LIVERPOOL, 263 5738
Rockcliff Brothers Ltd,
LIVERPOOL, 521 5830

MANCHESTER AREA

Byteshop Computerland,
MANCHESTER, 236 4737
Computastore Ltd,
MANCHESTER, 832 4761
Cytek (U.K.) Ltd,
MANCHESTER, 872 4682
Executive Reprographic Ltd,
MANCHESTER, 228 1637
N.S.C. Computer Shops Ltd,
MANCHESTER, 832 2269
Sumlock Electronic Services
(Manchester) Ltd,
MANCHESTER, 834 4233
Professional Computer Services Ltd,
OLDHAM, 624 4065
D. Kipping Ltd,
SALFORD, 834 6367
Automated Business Equipment Ltd,
STOCKPORT, 061-432 0708

SCOTLAND

Holdene Microsystems Ltd,
EDINBURGH, 668 2727
Microcentre,
EDINBURGH, 556 7354
Aethorol Consultancy Services,
GLASGOW, 641 7758
Byteshop Computerland,
GLASGOW, 221 7409
Robox Ltd,
GLASGOW, 221 5401
Mac Micro,
INVERNESS, 712203
Thistle Computers,
KIRKWALL, 3140

IRELAND

Softech Ltd,
DUBLIN, 784739
Medical & Scientific Computer
Services Ltd, LISBURN, 77533

To: Commodore Information Centre,
360 Euston Road, London W1 3BL. 01-388 5702

PCW D6

Please send me further information about the Commodore PET.

Name

Position

Address

Intended application

Do you own a PET? YES NO

Commodore

This list covers dealers participating in our advertising.

ANOTHER ROXBURGH PRINTER?

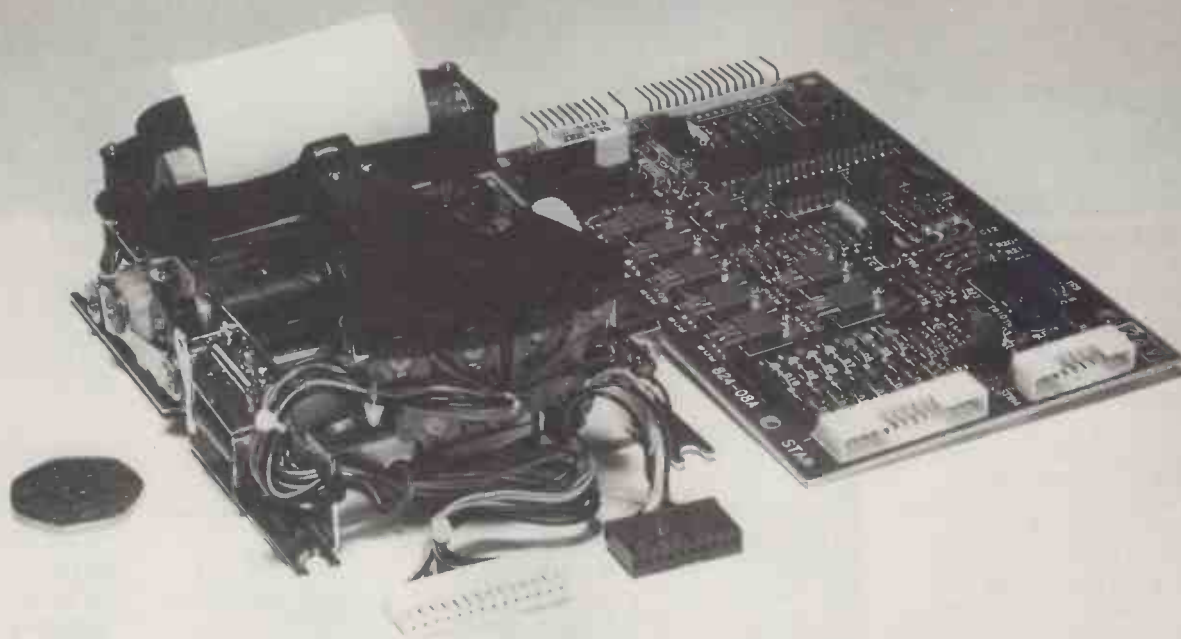

WELL, WE'RE A BIG FAMILY!

MEET THE DP BRANCH OF THE FAMILY

The DP 824 40 column for instance. It's complete with interface, 12 or 24 volt 8 bit parallel or serial input, friction or pin feed, mating connectors, ink ribbon and technical manual. The printer plugs directly into the interface board and, like all our printers, it's high reliability and low cost—£120.00 + VAT (one off).

LOOK AT THESE OTHER OPTIONS TOO!

- DP 822 12V 21 COL. FRICTION FEED PLUS 822-08-B INTERFACE (Pictured above) £95.00 + VAT (one off)
- DP 822 S 12V 21 COL. PIN FEED PLUS 822-08-B INTERFACE £97.30 + VAT (one off)
- DP 824 12V 40 COL. FRICTION FEED PLUS 824-08A-12 INTERFACE £120.00 + VAT (one off)
- DP 824 24V 40 COL. FRICTION FEED PLUS 824-08A-12 INTERFACE £120.00 + VAT (one off)
- DP 824 S 12V 40 COL. FRICTION FEED PLUS 824-08-12 INTERFACE £123.50 + VAT (one off)
- DP 824 S 24V 40 COL. PIN FEED PLUS 824-08A-24 INTERFACE £123.50 + VAT (one off)

WHY NOT CONTACT US TO FIND OUT ABOUT THE REST OF THE FAMILY?

PHONE KEITH EVANS, RYE (07973) 3777
OR SEE US AT COMPEC STAND 7112

ROXBURGH PRINTERS LTD.

22 WINCHELSEA RD., RYE, E. SUSSEX



A MEMBER OF THE ROXBURGH GROUP OF COMPANIES

Jon Baldachin on 01-580 6361 for details, or write to Suite 504, Albany House, Regent St, London W1.

costs £75, but you have to configure it to your own RML 380Z — which might cost you some effort. Details on Durham 47325.

Graftless graphics

It is very easy to draw pictures with the graphics command of microcomputers.

That's one of those statements that needs elaboration. It is easy, in the same way that it's easy to program a computer in hex code. It's a lot easier than doing the job that the computer is meant to do, by hand, but it still isn't actually easy.

A program to help with graphics on the Research Machines RML 380Z was developed during the course of a project at New College, Durham. The project, (the Durham Microcomputer Project) became quite famous at the time for showing a great many things that could and could not be done with computers in education. This bit of software is one of the good results that can be used by those of us not in education. Details of the product, called BASPIC, are given in a Users' Guide, published by Duncan Sledge.

It isn't as easy as it might be, because Sledge and Research Machines have failed to agree on a way of licensing Durham College to sell the Basic that BASPIC needs to run. BASPIC itself

Bandwagon time

You thought it was bad enough having two users groups for the Sinclair ZX80, didn't you? How about a third — based on Morris Plains?

Yup, that's in New Jersey, USA. They're even putting together a magazine, called Sync, and (here's the cheeky bit) are hoping to sell it to UK users. So we now have David Blagden's Users' Club, Tim Hartnell's National User Club, and Sync, from... oh thank God, it's available from Nuneaton, England. It may not be a British mag, but at least you don't have to write out dollar cheques.

Details (including games with a huckle in them) from Sync at 27 Andrew Close, Stoke Golding CV13 6EL. Send £10 for a year's subscription (six issues).

Incidentally, don't hold your breath waiting for Uncle Clive's latest addition, a big new Basic. He's had to cancel it. He says this is so that when he releases his cheap printer, he won't have to release another new memory chip but I'm afraid I suspect a bug. I'd be quite happy to have my full Basic now and buy a printer driving Basic when I get my printer.



Look carefully: it isn't an Apple III, it's a Transam Tuscan. And its price has been cut.

The very cheapest version is £235. You need a terminal to do anything at all with that, so you will be more interested in the £370 you have to spend to get a 16 kbytes system going with a video driver and keyboard, and Basic. A full 48 kbyte system, with twin disk drives, is £1481. That's assembled and tested, that last price. The other two are kit prices and the kit turns out to be quite nice to build and quite good at running when built. I've been watching a colleague at Datalink build it — his first ever venture with solder and clippers — and it worked first time, which is about as thorough a recommendation as anyone could give a single board system, especially one that offers a place to plug in five S100 cards.

Details (and details of a planned colour card, to interface to Prestel) on 01-405 5240.

nents to build it. You may have found that Ace Mailtronix in Batley, Yorks, were the people who eventually helped you out.

You will now be wondering where the heck Ace Mailtronix has gone. They've moved. The address is 3A Commercial Street, Batley WF17 5HJ, and the number is (0924) 441129.

CP/M for MZ-80K

The nice thing about the Japanese Sharp computer was the fact that it was like a PET in size, price and appearance but used the well-known Z80 micro.

Unfortunately, the reason the Z80 is 'the nice thing' about the Sharp is the fact that you can load the CP/M operating software and then get into that huge heap of very cheap software in the CP/M user library. And the Sharp MZ80K didn't have CP/M.

Until now, that is. The benefactor is Crystal Electronics, well known as the company which did both Nascom and Tandy a lot of favours by helping users. It has now added a CP/M for the machine to the 9 kbyte

Basic it already supplies (leaving more internal memory free). The software to run CP/M costs £200, and the price includes a "small, easily fitted circuit board."

Crystal reports that the 9k Basic is even being sold in Japan, and that Sharp dealers have accepted the CP/M addition. If you want info from the horse's mouth contact Crystal at 40 Magdalene Road, Torquay, Devon, tel 0803 22699.

Clever guys

After their first successful year marketing teach-yourself-computing courses to run on computers, Little Genius says it is improving the courses. As before, it is starting with the Apple II computer on which it launched the first Little Genius program. Versions of the improved course, covering the ITT/2020, the PET and the Research Machines RML 380Z, will be available "in the near future".

For past users, the main improvements appear to be in the analysis of answers and in the skill assessment abilities of the training program. The improved versions cost £40 each, or £90 for the three courses in the series. Talk to

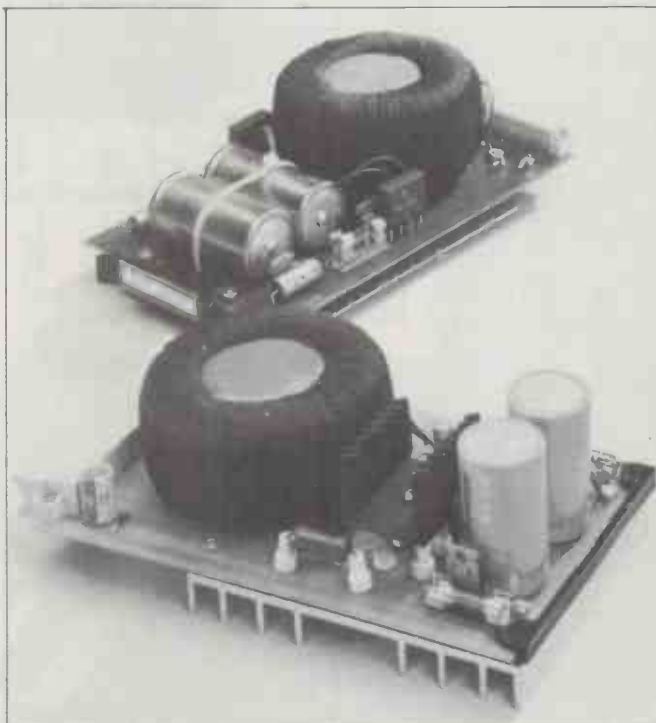

A big power punch on a little circuit card — 5 V at 5 amps, from Vero. What makes it special is the provision of an F-type connector which, says Vero, will give higher current-carrying capacity and will prevent the power supply being inadvertently plugged into the wrong position.

Details on (04215) 66330.

COMPETITION

Modern microcomputer technology has many applications, but one where it has so far had little impact is in reducing the problems of disability.

To mark the designation by the United Nations of 1981 as "The International Year of Disabled People", *PCW*, in conjunction with the IYDP Technology Working Group, is holding a competition for the best article on the subject:

"The application of micro-computer technology to the problems of disability".

There must be many possible applications for microtechnology in the fields of physical and sensory disabilities — remember, these include handicaps such as deafness, blindness, diabetes and epilepsy, as well as the more obvious physical impediments.

£100

We are offering a prize of £100 for the best article of around 2,500 words, which can be either theoretical or a description of an actual application (with photographs, if possible), and which we will print in *PCW* later in the year.

Entries will be judged by *PCW*'s Editor, David Tebbutt, and Adrian V Stokes, Chairman of the IYDP Technology Working Group. A third judge will be announced soon.

Please send your entry to IYDP Competition, 14 Rathbone Place, London W1P 1DE; to arrive not later than 30 April 1981, enclosing a suitable SAE if you would like it returned.

Personal Computer World



International Year of
Disabled People



YANKEE DOODLES

While Britain wallows in a depression, business is booming in Silicon Gulch, as Tom Williams reports.

The boom rolls on. Apple Computer has gotten big enough to cause something of a furore on that citadel of American capitalism, Wall Street. After Apple announced that it was about to launch its first public sale of stock, it rapidly became one of the hottest offerings ever. The company has been forced to ration shares to various brokers who, in turn, are giving only their best accounts first crack at buying Apple stock.

Apple is truly a business success story and is predicted to double its earnings over last year's to a whopping \$300 million — up from the paltry \$150 million of a year ago. What all this appears to mean for the personal computer market is that we will be seeing even more Apples and Apple-related products than the veritable flood to which we have become accustomed. The sale of stock will, for one thing, provide good revenue for continued expansion and the attention Apple has gained in the business world may well put it in a position to challenge Tandy for the title of top dog. There has even been a series of radio commercials by Dick Cavett (*not the Dick Cavett, surely?* — Ed) promoting Apple computers.

All, however, is not well in Apple Land. The long-awaited Apple III, which was debuted last May at NCC, has still not shown up on dealers' shelves. There were rumours about soldering problems in the power supply that forced the company to delay volume production for a while.

“All...is not well in Apple Land.”

On the forefront of new technology we once more find Zilog. After having overcome what appears to be the last hurdles for the Z-8001 (the Z-8000 version with segmented addressing that accesses eight megabytes), Zilog is reported to be working on a Z-9000. The Z-9000 will not have a new 32-bit architecture but will combine the Z-8000 16-bit architecture with virtual memory support on a single chip.

Virtual memory is a tech-

nique whereby the CPU creates 'virtual addresses' for all data, which it treats as if they were all a part of one continuous memory. It then sends these virtual addresses to a memory management unit (MMU) which converts them into physical addresses, which may exist in RAM or on disk. National Semiconductor had earlier presented its 16000 family of 16-bit CPUs, one member of which combined with an MMU chip to support virtual memory. If Zilog does come out with the Z-9000, it will be the first to combine CPU and MMU on a single chip.

The reason for all this activity in the area of greater and greater memory is the demand of the market for multi-user systems and distributed computing. Manufacturers are pursuing all approaches, but three watchwords are: modularity, expandability, and compatibility. These are sometimes, but not always, satisfied by massive amounts of RAM under a single CPU. At the low end (one to four users) which is admirably served by such manufacturers as Altos, a moderate amount of RAM supports the users and the systems offer expandability in the direction of disk storage.

A new entry has just joined this area in the shape of Morrow Designs' Decision 1 System. Morrow has combined a long experience in \$100 systems with a range of Winchester disk technology to produce a line of computers that are almost continuously expandable

from single-user floppy based configurations with between 200k and 2 Mbytes of disk storage up to a multi-user system with 256k of RAM and 28Mb of hard disk, priced at just over \$14,000.

The Z80-based Morrow system offers memory management hardware (not to be confused with virtual memory above) that has a memory map to support up to 16 tasks with complete memory protection and automatic memory allocation. In addition, a UNIX-like operating system, uNIX, and CP/M are offered such that the new uNIX can communicate with CP/M.

Another new entry which showed up at the recent Wescon show held in Anaheim, California in September is a rather novel machine by Piiceon Corp. of San Jose. The Sword computer (not to be confused with the long defunct Japanese Sord) is one of the first stand-alone systems to use the Intel 8086. The most striking thing about the Sword-100 is its CRT display, which is a 15-inch tube mounted 'on its side'. With this arrangement, the machine can display up to 66 lines of 80 characters each, a particularly nice feature for word processing. Memory consists of up to 8 kbytes of ROM and 64 kbytes of RAM. Disk storage consists of two Qume double-sided, double-density drives giving a total of 2 Mbytes.

But — and here is a point once again indicative of the trend in the industry — it is

designed to be an intelligent terminal workstation which can also fit into a distributed processing local network.

These local networks — individual processors sharing more expensive resources such as disks and printers — are starting to show up everywhere. The Bank of America has recently purchased a Nestar Cluster/One with 56 Apples for use as a preprocessor for entering cheques. The results are of course then fed into the bank's IBM behemoth for further digestion. According to Nestar's president, Harry Saal, the long touted 'office of the future' is not just around the corner — it's already here with a venge-

“...who's using those 64k RAM chips...”

ance, and almost without anyone noticing.

Everyone is asking "who's using those 64k RAM chips in a real product?" The answer is Hewlett-Packard. To be sure, the HP-1000 L Series is not exactly your garden variety personal computer but it should not take long for the technology to spread to personal computers, especially when the results of some of HP's tests become better known, and prices come down with volume sales.

HP recently introduced a 312k RAM board using the new 64 kbit chips. During reliability tests, technicians found the 64k chips to be more reliable than conventional 16 kbit memory chips. This obviated the need to incorporate costly error-correcting circuitry into the new memory system. Until recently, one of the most important problems with memories of this density was soft errors introduced when random alpha particles strike memory cells. Newer techniques in IC fabrication and technology are reducing these errors by a factor of ten over their previous rate. As a result memories should continue to become denser, and faster with a per-bit cost rollback of 20% to 30% per year. (*I think he means they'll get cheaper* — Ed.)

The boom rolls on!



“And she threw everything at me — including the computer aimed at the home user!”

PCW welcomes correspondence from its readers but we must warn that it tends to be one way! Please be as brief as possible and add "not for publication" if your letter is to be kept private. Please note that we are unable to give advice about the purchase of computers or other hardware/software — these questions must be addressed to Sheridan Williams (see 'Computer Answers' page). Address letters to: 'Communications', Personal Computer World, 14 Rathbone Place, London W1P 1DE.

Superboard query

I read your magazine every month, and have actually sacrificed ***** for it! I am at present using a Superboard and I would appreciate your help. When I bought it, I used it on an ancient Baird television which merrily displayed 23 x 23 characters. So that I could have the TV nearer, and as the Baird was on its way to the scrap heap, I rushed out with £69.95 and purchased a little 12in portable, made by NEC. Great picture on normal TV but when I plugged the Superboard in I couldn't see the first two characters on each line, except by adjusting the horizontal hold which causes the top five rows to 'bend up'. Can you help?

By the way, I thought the PCW show was really excellent. I came to London specially for it, and it was well worth the trip. G Monro, Woodbridge, Suffolk

We can think of a couple of ways of tackling your display problem. One would be to contact Steve Hanlan at Beaver Systems on 084421 5020. He apparently sells a device which should help. The other would be to join the OSI user's group and ask for issue four of their newsletter. This contains details of a DIY hardware solution. Apart from the cost of components, this approach will cost you £10 pa for membership of this excellent club. Contact George Chkiantz at 12 Benerly Road, London SW11 6DS, or phone 01-228 4839 — Ed.

ZX80memory

I noticed in one of your recent issues a letter asking how to find the amount of memory left in a ZX80. The answer you suggested was in fact wrong, measuring the amount of working space being used by the computer.

The unused memory is the part marked 'spare' on p106 of the ZX80 manual. The address of the bottom of this area is held in RAM locations 16400 and 16401 which can be PEEKed. The address of the top is held in the SP register of the Z80 CPU chip and cannot be PEEKed (although you could

use a USR routine to read it); in practice, however, it will be close to the physical top of RAM — 17408 for the basic 1k RAM, or with 1024 added for each extra 1k in an extension. Thus for 1k of RAM, PRINT 17408 — PEEK(16400)—256*PEEK(16401) will give you about half a dozen more than the number of bytes of memory left.

S J Vickers, Waterbeach, Cambs

Acorn Atom

A number of readers have contacted PCW regarding long delivery times for the Acorn Atom, certainly much longer than the 28 days promised in the advertisements. To clear the air, we wrote an open letter to Acorn Computer, the text of which is reproduced below, together with Acorn's reply:

We are currently receiving several enquiries per week about the delivery delays on the Atom.

We would be grateful if you would let our readers know what the backlog situation is and when orders placed now will be delivered. Please also let us know if the situation varies depending on whether the machine ordered is in kit form or assembled.

We received the following reply:

Thank you for your letter regarding delivery times for the Atom. Our original production plan was delayed by nearly six weeks because of last minute problems with the case moulding and this caused a backlog of orders which is taking some time to overcome. However we are now despatching in sufficient quantities to allow an order placed at the beginning of October to be delivered within six weeks, halfway through October within four weeks and halfway through November delivery should be ex-stock. We must point out that orders that include any of the later optional extras or that require special configuration may be subject to different delivery times.

If at any time a customer wishes to cancel we always give a refund and the option to re-order in the future on a high priority allocation. C J Curry, Director, Acorn Computers Ltd, Cambridge

Superbrain waver

I have just been reading your review of the Superbrain in August 1980 issue.

In one paragraph you erroneously explain that the reason there is no screen waver on the Superbrain is because the 240 V transformer is fitted behind the disk drives. I would like to point out that, with the chassis constructed from aluminium, the transformer is still much too close to the tube for it to have no effect on the screen. Screen waver on American computers is due to beating (or heterodynes) between the 60 Hz screen scan rate and 50 Hz stray field from the transformer(s). The cooling fan situated under the drives is another substantial source of 50 Hz field.

The real reason why you experienced no screen waver is that the screen scan rate is programmable, with the appropriate parameter combined in the DOS. Your machine must have been reprogrammed for 50 Hz before you got it. In our Superbrains the program CONFIGUR asks you which frequency you have and records the DOS.

David N Sands, Intelligent Artefacts Limited, Royston

DDE for me

I would like to add some comments about the DDE SPC/1 computer to those of your reviewer, Sue Eisenbach (PCW, July).

Firstly, my reasons for buying the SPC/1 early this year were that it has Comal and Pascal, supports large disk systems and has a modern multi-user facility with memory bank-switching. I did my homework properly by contacting Danish users on the questions of general quality, reliability and support. I also compared it with multi-user systems like Cromemco and LSI-11-based machines.

There are a few quirks and the documentation needs to be improved (I am producing my own teaching booklet and other materials) but my system has performed reliably and is a joy to use. This is because Comal and Pascal are a new world to someone brought up on outdated languages like Basic, Fortran and Algol, but also because the system is inherently well-

designed and constructed to high technical standards.

I think the final sentence of Sue Eisenbach's review: "I certainly prefer it (Comal) as both a teaching and as a programming language to Basic" is the crucial one. As a teacher deeply involved with schools and teacher education I deplore the failure of Basic to encourage good programming and problem analysis skills. Comal solves the problem beautifully by combining the simplicity and easy operating environment of Basic with the educationally sound and highly practical control structures of Pascal. For these reasons I regard the SPC/1 and the RC702 'Piccolo' (shortly to be released here) as valuable contributions to the UK market. Roy Atherton, Bulmershe College, Earley, Reading

Flowcharting standards

Derrick Daines, in his article 'Gateways to Logic' uses incorrect flowchart symbols. In fact the symbols he lists as 'Additions and Alternatives' are more correct than those he lists as 'Basic Flowchart Symbols'.

As Chairman of the British Standards Committee DPS/15, which is responsible (among other things) for the Standard on flowcharting symbols, I have a vested interest in seeing that the correct symbols are used. The current British Standard is: BS4058:1973 "Specification for Data Processing flow chart symbols, rules and conventions". Copies of this can be obtained from BSI at 101 Pentonville Road, London N1 9ND. For the benefit of non-UK readers the International Standards ISO 1028 and ISO 2636 cover the same ground as BS4058. These symbols have international agreement and most nations have their national equivalents of the ISO standards, eg Germany has issued standards under the references DIN 66 001 and 66 220 which cover much the same ground as the ISO standards but, like the BS standard, give more practical examples of the use of the flowchart symbols.

Finally, a new International Standard is being prepared by a committee, of which I am a Convenor, which will eventually replace ISO 1028 and 2636 and on

which many national standards will be based. This revised standard will cover flowchart symbols for program and data flowcharts, system flowcharts, program network charts and configuration charts. This revised standard is not, however, likely to appear in under two years, but as it does not introduce any drastic changes, it will be possible to continue to use the existing standards without fear of the symbols becoming obsolete.

V J Day, Malvern Wells

Survey wanted

In the name of sanity, can someone — and I suggest Guy Kewney as he seems the most sensible, and is definitely the most readable of all the computer magazine columnists — help me and no doubt a few thousand other poor souls, by doing a comparison of micros for gaming and hobby purposes. Without being too big-headed, I consider that I am above average intelligence with a minimum knowledge of micros but the microworld is slowly driving me nuts. Every manufacturer advertises his product as being excellent for business/games/education/hobbies/data processing/scientific applications et cetera... ad nauseum. Now this is categorically impossible! I am your ordinary average amateur computerist who wants to play with a micro at home.

I have a 4k ZX80 and it's an excellent little toy. But it is no more than that and Clive Sinclair's new upgraded language and 16k RAM will only make it an excellent little supertoy. Until he brings out Disk and Printing systems it will remain little else. Even if/and/or (delete as applicable) when he does this, should he approach the change with the same built in obsolescence, by the time we arrive at a 32k MPU + Disk + Printer we might well be

spending more (overall) than by buying a PET, TRS-80 or any other presently available system.

Now, I have just sent off my money to Science of Cambridge to upgrade my ZX80, but thus far and no further. I shall let my two boys have it when I purchase a more suitable system. The system I require will be used primarily for monitoring the play of a fantasy role playing game of the Dungeons & Dragons genus; specifically Chivalry & Sorcery. It will be required to present at any given time the rules and regulations and perform any of the calculations required in the playing of the game. Also I shall require it to act as a Real Time Monitor.

Can someone, somewhere do a comparison of micros for such a purpose?
Brian R Timmins, Portsmouth

Fast Apple copy

Have you got an APPLE II computer running DOS 3.2? Do you need to copy disks from slot-to-slot? Are you annoyed at the inordinately slow speed of the standard Apple Copy Program?

If your answer to any of the above questions is yes, the following will be of interest to you.

The standard Applesoft Copy Program, supplied on the DOS 3.2 Master Diskette, may be converted to a fast slot-to-slot Copy Program by entering:

```
| LOAD COPY
| 140 LM = 2
| SAVE FASTCOPY (or
| another filename of your
| choice)
| RUN
```

The program will ask you for the destination Slot and Drive, instead of automatically defaulting.

If you use the modified

Copy Program to copy from slot to slot, you will find that it takes about 30 seconds to format and copy a disk, against two-and-a-half minutes when using a single disk controller card.
Paul Smith, Vlasak Computer Systems

Cobollers

I have just read the latest (Sept) issue of your excellent magazine. For the last two years I've taken PCW and the other (unmentionable) magazine. Due to 'recession' one must go and I have no hesitation in keeping my order for PCW. The reason? — it's produced with the 'hobbyist' in mind and caters very well for us.

But do I detect a hint of 'snootiness' in Malcolm's 'Bookfare' column? Especially in his recent article on the Basic language?

I have a relation who is a professional programmer. From information received and the gift of an obsolete System 4 ANSI Cobol manual (weight 3.5 lb!) and having just built a Nascom II (an excellent instrument) and received their Basic manual (15 double pages), I am now in the happy position of being able to do simple programming and to understand the majority of programs printed in PCW. What would the situation be if Basic didn't exist? We would be committed to Cobol or Fortran or some other language and I would still be struggling with chapter two of the manual, having suffered a hernia due to carting it about!

Do professional programmers really have to take so many man/woman hours to get questionable results or is it one big con trick? Before Malcolm and others start cocking a snoot at the amateur, let them remember that it's the amateur that gives computing its lifeblood.

as it is in electronics and other sports and sciences. Is the professional worried that the amateur and Basic can do more for computing in quicker time (and therefore cheaper) than the professional?

I suggest that "Malcolm" gets down off his high horse and writes for the good of both sectors of the industry and PCW, or moves on to one of the professional papers (*Steady on — Ed*) and makes way for an enthusiast.
D McFarlane, Histon, Cambs

Off beam

As you may be aware, we advertised in the August issue of PCW, offering software and books under the name Beam Software.

Our advertisement attracted not only useful business but an objection from Beam Office Equipment who have established extensive trademarks and other rights in the Beam name.

As you know, we have discontinued use of the name Beam Software, and apologised to Beam Office Equipment for the inadvertent infringement of their right.

We will be continuing our business in software and books under our registered name, Melbourne House Publishers.
Alfred Milgrom, Leighton Buzzard

Answers back

With respect to S Withers' response to my 'Computer Answer' regarding 'GETting' a character from the keyboard of a North Star Horizon using DOS v5, I am afraid he is mistaken. I hadn't forgotten INCHAR\$ at all. My routine does something that the INCHAR\$ is incapable of — that is, return if no key is depressed, an essential element in interactive games.
Sheridan Williams, St Albans

Gun fun

I had great fun with the UK101 'Gunfight' program published in the October PCW. The right hand player would appear to have a couple of slight advantages: for example, he can kill the left hand player without hitting him! Also, once the branches are removed from the cactii then the bullets lodge in the cactus but the left hand man is killed anyway. Perhaps the impact of the bullet on the cactus generates some sort of death ray. The cure to these problems is to modify lines 15 and 23 of the program making PR = 53880 (instead of 53878) and POKE 53256 (instead of 53257) respectively.
John Bass, Grays, Essex



"Sure I believe it's the third malfunction today. Just try telling those 2,000 warheads that set off after the second malfunction."

RAANND SP1

PASCAL MICROENGINE



At last Sue Eisenbach has got her hands on a British-built system based around the Pascal Microengine!

UCSD Pascal is an operating system with a language compiler written at the Institute for Information Systems at the University of California at San Diego. It was devised to run on as large a range of microprocessors as possible and was therefore written for an imaginary machine whose machine code is called pseudo-code (or p-code). To implement Pascal on a new machine, all that is needed is a written interpreter to translate p-code to the new machine's target code. Of course, p-code executes more slowly than native code since every statement has to be interpreted. It was only a matter of time before the p-code stopped being just an imaginary code and someone designed a real p-code processor.

At Western Digital a processor — the Pascal Microengine (or WD/9000) — was designed to execute p-code directly. WD then built a single board computer (the WD/900), based on the new processor, and a boxed computer (the WD/90), based on the single board. Raannd, a Scottish company, has built an all-in-one computer, the Raannd SP1, by enclosing the Western Digital board in a case that also contains a VDU and disk drives. The review machine was a prototype version of the Raannd SP1.

Hardware

The Raannd SP1 comes in an IBM blue and cream steel case. With dimensions of 600 mm by 600 mm by 350 mm and a weight of 30kg (66lb), it is semi-portable. (That is, I can't lift it but for someone who can, it can be moved in one trip.) A couple of screws hold the top of the box; when it is removed, the CRT, disk drives, fan and PSU are revealed.

The single board computer requires further dismantling as it is contained in the bottom section of the case. The WD 900, the single board computer, contains the processor, 54k of RAM, two serial ports, two parallel ports, a DMA controller and a floppy disk controller.

The heart of the SP1 is a 16-bit stack oriented processor, the WD/9000. Western Digital second source LSI 11s for Digital Equipment and the WD/9000 seems to be based on the LSI 11 design, with different microcode. The processor comprises five LSI/MOS circuits each contained in a 40-pin package. These consist of a data chip containing the ALU, registers and microinstruction decoder, the control chip, containing the macroinstruction

decoder, portions of the control circuitry, the microinstruction counter and the I/O control logic and three 22 by 512-bit MICROM chips, containing processor microinstructions. The processor requires four power supplies (+5 V, +12 V, -5 V and -12 V).

The memory consists of 32k 16-bit words (that is 64 kbytes) provided in 32 16k dynamic RAM ICs where each chip is organised as 16k words by one bit. The processor communicates with the memory, peripheral ports and controllers via a 16-bit data bus, a 16-bit address bus and several control lines.

The WD/900 board contains two RS232 asynchronous serial ports. One is used by the SP1 VDU (9600 baud), leaving the other for a serial printer. Both ports have switch selectable baud rates (which are not that easy to reach as they are on the board rather than on the back of the case). All devices (printer, console, disks) are accessed via a name and the software is configured so that the second serial port can be accessed by reading from or writing to REMOTE (assuming all the necessary wires have been connected and the baud rate switch properly set). This port is bi-directional and so can be used for either a serial printer or a teletype device. The review machine had an LA34 connected to it for a while, which appeared to work satisfactorily.

I felt that the SP1 VDU showed room for improvement. Dr Gordon Rankin of Raannd said that changes will be made in the production models. The CRT display characters were rather small and were not perfectly steady on the screen. The screen was behind a polarising filter which left it rather dark in my flat. Perhaps in an office environment with bright light it would be better although I prefer a glare-free screen which is usable under variable lighting conditions. The keyboard lacked cursor keys and so cursor movement (needed in the editor) requires two keystrokes. Dr Rankin said that machines delivered in 1981 would probably have a cursor and numeric pad; I hope so.

The serial ports are implemented with two UC1931A/B ICs, which are programmable (synchronous or asynchronous). The operating system automatically programs these on loading, but according to the manual they can be reprogrammed.

An 8255A programmable peripheral interface with 24 programmable pins provides the parallel I/O. When the operating system is loaded, it programs the 8255A to provide an 8-bit input port (port A), an 8-bit output port (port B), suitable for a parallel printer, and an 8-bit control port (port C). The control port can generate and receive handshaking signals. Assuming the appropriate wires are connected, port B should be accessible by transferring files to the named device PRINTER. This was not tested on the review machine.

There are four switches on the key-

board under the disks. Only one switch, the reset button, was connected. It had to be held down for several seconds to boot the system up. Dr Rankin said that the other switches would be used in the production model to provide write protection for each of the drives and to allow the user choice over which drive to boot from.

The FD1791/2 floppy disk controller provided is switch selectable for single or double density five inch or eight inch disks and can handle up to four drives of the same type. It operates under the control of the DM1883A/B DMA controller which allows data transfers between the floppy disks and memory without intervention by the processor.

The drives in the review machine were MFE 700 double sided, double density drives. Each disk holds 1600 kbytes unformatted or 1976 blocks ($\frac{1}{2}$ kbyte each) formatted, which is accessed as two logical volumes. I found the disks noisy but reliable. The production model will probably have MFE 750 drives instead, which are said to be lighter, quieter, more reliable and use half the power of the 700s.

Software

In common with all microcomputers based on the Western Digital chip set, the Raand SP1 runs under the UCSD operating system. UCSD is a two-level operating system. At the first level it gives the user the option to E(edit, F(file, R(un, C(omp, L(ink, X(ecute, D(ebug, U(ser restart, I(nitialise, or H(alt.

At this level the user must type a letter to reach one of the second-level system programs (except H which crashes the system and requires the user to switch the machine off then on to set it to work again). Anything other than one of the prompt characters is ignored.

Fundamental to the philosophy of the operating system is the concept of a default workfile, which is created by typing a program into the editor. After it has been saved, unless the user takes specific steps to avoid it, all operations take place on this workfile. The editor reads it in automatically and, upon completion of the edit, writes it to SYSTEM.WRK.TEXT. The compiler places object code in SYSTEM.WRK.CODE which can be executed by typing R. If it doesn't exist, the compiler is automatically initiated to compile SYSTEM.WRK.TEXT into SYSTEM.WRK.CODE. This is linked to any library routines needed and then executed. If SYSTEM.WRK.TEXT doesn't exist when the compiler is called then the user is asked for a file to compile. The resulting machine code is put into SYSTEM.WRK.CODE. As soon as a SYSTEM.WRK.TEXT is altered in the editor, the operating system removes the old SYSTEM.WRK.CODE. The linker allows the user to combine several CODE files into SYSTEM.WRK.CODE. Typing X enables the user to execute any code file. D invokes the compiler, as the Debugger was never released.

The concept of a workfile is convenient if one is developing a single program, but quite irritating when switching regularly between files (eg entering and compiling the benchmarks). I personally don't like it. To change the workfile the user has to enter the File Handler (with F) giving the user the op-

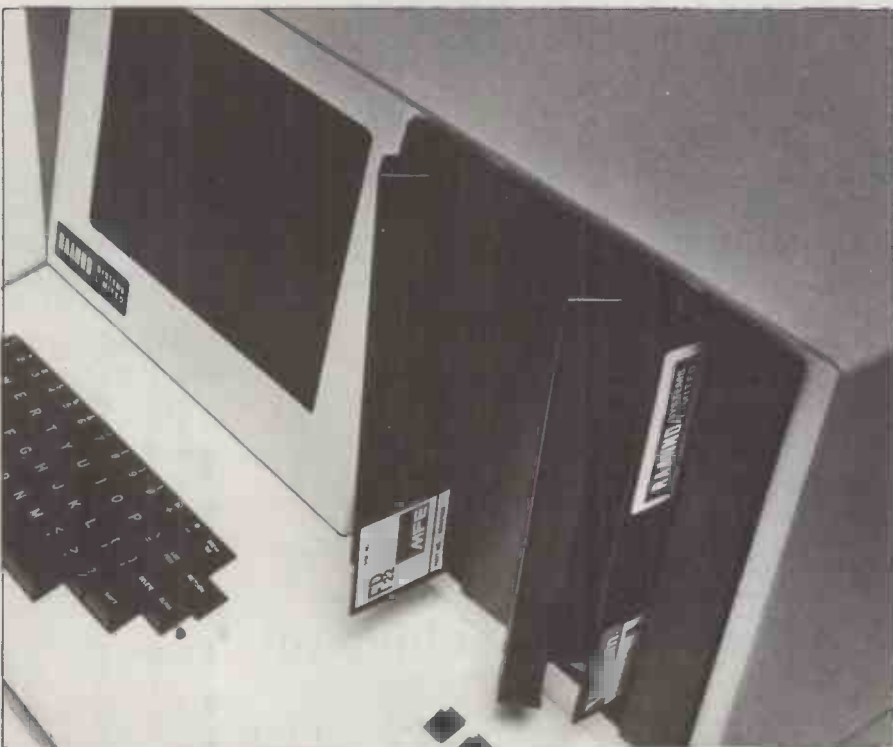
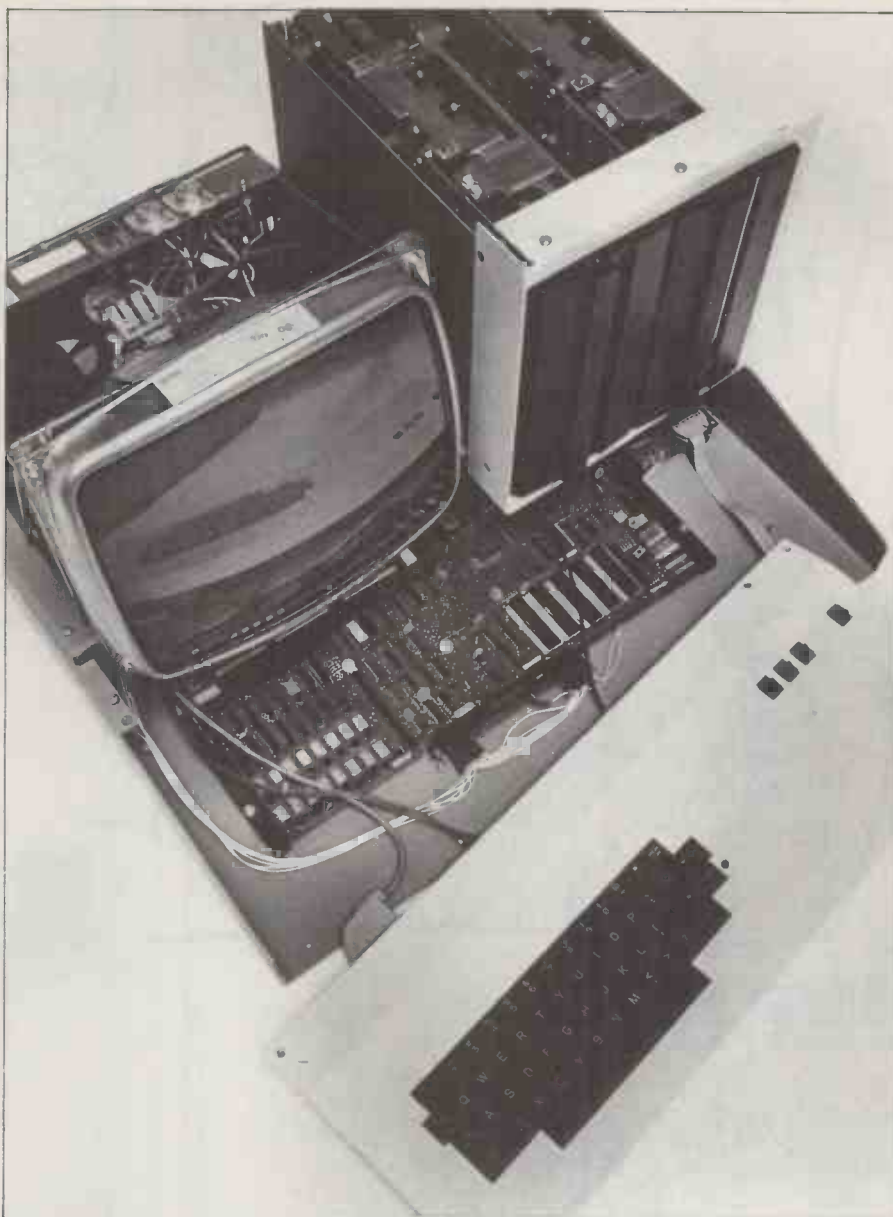



Our new tiger's got more stripes

Paper Tiger, already the recognised leader in low-cost impact matrix printers, has been even further improved. The new Paper Tiger Model 460 carries no less than ten extra features:

- Staggered 9 wire matrix head
- Bidirectional logic-seeking print technique
- Correspondence quality print in a 24 x 9 matrix cell
- Selectable mono or proportional spacing
- Selectable auto text justification
- Programmable horizontal and vertical tabbing

- 'Fine' positioning for word processing
- RS-232C (up to 9600 baud) with selectable XON/XOFF protocol
- Alterable function codes, fonts and characters
- Graphics capability

When the best gets better, you need to know all about it. Just clip and mail the coupon for the full story.



Teleprinter Equipment Limited —
the peripheral people

70-82 Akeman Street, Tring, Herts. HP23 6AJ. U.K.
Tel: Tring (0442 82) 4011/9 & 5551/9.
Telex: 82362 BATECO G.

Please send full details of Paper Tiger to:

Name _____

Company _____

Address _____

Tel: _____

See us at the
WINCH COMPUTER?
Stand Show
630

tion to call the following functions: G(et, S(ave, W(hat, N(ew, L(dir, R(em, C(hng, T(rans, D(ate, Q(uit; Filer: G(et, S(ave, W(hat, N(ew, L(dir, R(em, C(hng, T(rans, D(ate, Q(uit; Typing? gets the user; Filer: B(ad blks, E(xt-dir, K(runch, M(ake, P(refix, V(ols, X(amine; Z(ero.

The File Handler or Filer provides a comprehensive set of routines to manipulate files and disks. The filing system uses two wild cards '=' and '?'. The question mark requests verification for each file whereas the equals sign doesn't. In general the user is requested to confirm that an action should be undertaken before any action takes place. The Filer's routines are described in the table below.

The filer is comprehensive and easy to use for the first time user. The prompts mean there is no need to memorise commands. The major disadvantage of the Filer is that many of these commands are not in the outer level of the operating system. When one wants a directory listing, it is irritating to have to load the Filer (several seconds), type L, then answer the question 'Dir listing of what vol?' (volumes have both user given and number names and can be accessed by either) before the directory is read from the disk and written to the screen.

The user bears more responsibility for disk maintenance than he would under CP/M. Whenever a file is written to disk it is written to the largest free space available. If the file doesn't fit then the writing is unsuccessful. (No linking up of free spaces as in CP/M.) If the filename already exists, then the file is still written to the first free space and upon successful writing the original file is removed. This process has the tendency to fragment the free space on a disk and hence to require frequent file compression using Krunch (which takes several seconds). Fortunately krunching does not move BAD files forward.

Three editors (YALOE, SCREEN and L2) come with the system. Which ever is renamed SYSTEM.EDITOR is invoked when a user types E in response to the outer lever prompt. The review machine came with SCREEN.EDITOR as the system editor. It is a screen orientated editor designed for convenient entry of both programs and text. The cursor can be moved to anywhere in the file for insertion or deletion of characters. The editor is set up for entering programs; It has an auto indent feature which causes the cursor to start the next line with an indentation equal to that of the last. The editor can be altered for ordinary text — the auto indent can be turned off and filling turned on. Filling allows the user to type between user set margins without pressing return. (Not quite as nice as WORDSTAR as there isn't automatic right justification, but still quite nice.) SCREEN has a few bugs in it — sometimes it doesn't clear the screen before it overwrites its next screen full and occasionally it shows you the cursor one line above or below its actual position (so insertion or deletion takes place on the wrong line), but these can be avoided. As a whole, SCREEN is powerful, easy to learn and a pleasure to use.

YALOE (Yet Another Line Oriented Editor) appears identical to DEC's TECO type line editor. It is designed

for use on a slow console device or one that doesn't have cursor addressing and it seems bug free. Both SCREEN and YALOE only allow the user to edit a file that can fit into memory. (SCREEN can hold a 26k file whereas YALOE can hold 42k.) This limitation is overcome in the third editor Ls. Ls is supposed to be just like SCREEN except that it uses a memory buffer so that files of any size can be edited. Unfortunately it's filled with bugs. It crashes the whole system (the system didn't crash when I was using other software so it is unlikely that hardware was at fault). After a crash SYSTEM.WRK.TEXT occupies all the free space on the disk (eg 300k). Fortunately L2 makes a backup so this file can have its name changed to SYSTEM.WRK.TEXT and editing can continue.

The operating system comes with a variety of utilities in code form (so they can be Xecuted). These include a disassembler (which produces a listing with P-code mnemonics, hex, and any input or output calls), a librarian (for altering the SYSTEM.LIBRARY), a simple calculator, a library map and a bootstrap copier.

UCSD is quite a powerful operating system, although being written by students at University of California at San Diego it has a somewhat amateurish feel. The system lacks consistency in its user interface. In particular some of the programs in the operating system require a suffix, some require no suffix and some don't care whether the suffix is included or not. This can be quite frustrating to a new user but an experienced UCSD user probably doesn't think twice about it.

Languages

The UCSD operating system supports four language translators: compilers for Pascal, Basic and Fortran 77 and an adaptable assembler for the machine that UCSD is running on. The review machine came with just the Pascal compiler. There is no P-code macro assembler available but the Basic and Fortran 77 compilers (both written in Pascal) should be available if desired. The Pascal compiler was the first written for microcomputers and has become an

industry standard. Other Pascal compilers written for microcomputers tend to show the influence of the UCSD version.

UCSD Pascal is quite close to that described in Jensen and Wirth. The major alterations were implemented to take advantage of the interactive nature of the system. In particular input and output default to the terminal rather than a file, and a file type of 'interactive' exists so that interactive input doesn't hang the system (as it would in standard Pascal). It has an additional data type 'STRING' and an appropriate set of intrinsic functions and procedures. In order to take advantage of the random access capabilities of disks, UCSD Pascal provides random access files as well as standard sequential access files.

Other additions to the language include the ability to segment a program into up to seven overlays, long integers (up to 36 digits) and CASE statements that don't crash if there isn't a label to match the CASE selector (control just drops through to the first statement after the CASE statement).

Potential

The SP1 is aimed at software houses who have, or are planning to develop, business software on a UCSD system (probably an Apple) and want a larger system for customers who want an upgrade. Programs should transfer directly from an Apple onto the SP1, with its substantially faster processor (I haven't benchmarked Apple Pascal but after it has been compiled into p-code it still must be interpreted for the 6502) and much larger disks (2 Mb). Its case has been designed to look at home in a business environment.

The other market at which the SP1 is aimed is the academic one. Lack of interpreted Basic and graphics rules it out as a machine for schools but it is quite a nice machine for teaching Pascal. Regrettably, UCSD turtle graphics are not supported by the Raand hardware.

Documentation

Documentation tends to be the last item any manufacturer gets around to producing. Since the review system was a

File command table

Get-Get a new file for the workfile.
Save-Save the workfile under another name.
What-Find out what the workfile is.
New-Clear the workfile.
Ldir-List a directory.
Rem-Remove a file from the directory.
Chng-Change the name of a file.
Trans-Transfer a file (or disk) to another place. A transfer can occur to another disk, the printer or the screen.
Data-Allows the date to be changed. All directory listings include dates.
Quit>Returns the user to the outer level of the operating system.
Bad blks-Checks a disk for bad blocks.
Ext-dir-Lists a directory with information about file types and space usage of disk.
Krunch-Compresses all the files on a disk.
Make-Makes a disk file with the specified name.
Prefix-Allows the user to change the default disk. The default disk can be different from the system disk in which case the operating system will look on one disk for the system (and SYSTEM.WRK.=) and another for all other files.
Vols-Allows the user to see which volumes are on line. On the review machine these included four disks (each side of a disk is a different volume), the console and a remote port.
Xamine-Allows the user to examine possible bad blocks and to create files with suffix .BAD to contain them.
Zero-Reformats a disk.

mikro and makro

- TWO GREAT BRITISH ASSEMBLERS FOR THE CBM PET

Whether you are an experienced 6502 programmer or just getting to grips with machine language, one of these assemblers is right for you!

MIKRO ASSEMBLER makes full use of PET's Basic editor to pack a full-featured assembler into a single 4k chip which plugs into one of the 3 spare sockets. When you power up you will be just a SYS command away from being able to program in Assembler, Basic, or even both at once! There are just three new commands to learn because source code is written just like a Basic program - and if the Programmer's Toolkit is fitted you can use functions like FIND,DELETE,RENUMBER,APPEND and HELP to edit and debug your code. For any PET, tape or disk, MIKRO costs £50 plus VAT.

MAKRO ASSEMBLER really needs a 32k machine, though a 16k version is available. You can define macros with up to 9 parameters, and they may be nested to a depth of five! As source files can be appended you could build up a library of useful macro definitions - then bring them into your programs at will. MAKRO has all the standard assembler features plus a user-friendly editor - all for £50 plus VAT.

THE PETMASTER SUPERCHIP (£45 + VAT) gives owners of standard 40 column PETs many of the features of the new 8032 SuperPET - and much more besides. Single key entry of Basic and an auto-repeat facility are popular features, but the advanced programmer will find the User Definable Function Keys innovative and invaluable! Fully compatible with the PROGRAMMER'S TOOLKIT (£29 + VAT).

80 PET programs in our FREE catalogue!

LOOK OUT for our BASIC 4 compatible SUPERCHIP and TOOLKIT available soon!

SUPERSOFT

28 Burwood Avenue, Eastcote, Pinner, Middlesex
Telephone: 01-866 3326



SUPER STARTREK(B/16K) - the final Frontier! Your mission is to destroy the Klingon fleet in time to save the Federation. Phaser banks, photon torpedoes and on-board computer are operational. **£9.95**

INVASION EARTH!(MC/G) - fast version of the popular arcade game. 4 Invader types/intelligent homing, exploding, angled, direct, multiple warhead & radio-jamming missiles/40 skill levels. **Only £9.95**

Super LIFE(MC/G) - the BEST! - Evolution of a biological colony with 100 by 125 cell array (2/3 or 3/4 options). Use the 21 standard patterns or set individual pixels. Rotate & reflect any pattern. Select from 10 speeds. Evolution can be halted, patterns modified & new speed set. Extensive instructions-overlay technique keeps program within 8K. **SIMPLY FASCINATING!**

DEMONOES (B) - another arcade game! Played against the computer or other player. Make your opponent crash into the wall or his own or your tracks. Fast & competitive. **£8.95**

ALIEN LABYRINTH (B/G/min 16K) - you are trapped in a maze with an invisible alien creature. Find the exit before being eaten. Proximity & direction of alien reported each move. Superb 3D graphics. **£7.95**

MINI-TOOLBOX (MC) - aid to BASIC programming. Features are:- REPEAT KEY, AUTO line numbering, Decimal to HEX & HEX to Decimal conversions, RECOVER (from CLOAD error) & Multiple USR(X) routines. Resides in spare memory from 0C80HEX. **£7.95**

NASCOM 1 & 2

Spacefighter (B/G)	£7.95
Death Run (B/G)	£6.95
Driver (B/G)	£6.95
Sheepdog Trial	£5.95
Secret Agent (B/G)	£5.95
Slalom (B/G)	£5.95
Submarine Chase (B/G)	£5.45

Renumber (MC)	£6.95
Stock Market (B)	£6.45
Scramble (B)	£5.45
Hammurabi (B)	£6.45
Biorhythm (B/G)	£4.45
Code-Breaker (B)	£4.95
Labyrinth (B/G)	£5.45

PROGRAMS WANTED
BRIDGE, DRAUGHTS, BUSINESS APPLICATIONS, SPACE GAMES with GRAPHICS, C.A.L. & other original ideas.

WRITTEN ANY PROGRAMS ?
WE PAY HANDSOME ROYALTIES !
PROGRAM COMPETITION - 3 XTAL BASICS TO BE WON - Send SAE marked "Competition" for details. (Closing Date 10th January 1981)

****NASCOM 1** - Cottis Blandford Cassette Interface for N2 format, reliability & fast load. £16.30 or £13.30 with program.
All programs supplied on cassettes. B = BASIC. MC = Machine Code. G = Graphics 8K RAM required unless otherwise stated. **PLEASE GIVE FULL DETAILS OF YOUR NASCOM.**

MUSIC BOX

Now you can make music with NASCOM. Easy to follow program allows you to key in old favourites or have fun composing your own tunes. 7 octave range with staccato option. 9 tempos. Set note duration or tap in rhythm as required.

Comprehensive editing. Delete, insert or amend notes. Single-step forwards & backwards through tune. Add new lines within declared array size. The program includes tape generating & play-back routines & is supplied with 2 demonstration melodies & instructions for connecting your Nascom to an amplifier/speaker such as our unit below. Min.16K required - please state T4 or Nas-sys/2 or 4 MHz/with or without graphics. **Only £13.95**
AUDIO INTERFACE BOARD & SPEAKER - Compact & ready assembled, suitable for use with 'MUSIC BOX' & other 'sound effects' programs. 3 simple connections. Complete with instructions on programming for sounds. **£9.75**

C.A.L.

BUTTERFLY (B/G) - enjoy mental arithmetic! Race caterpillars across the screen by answering + - x + questions. Large, easy to read numerals, stunning graphics. Special features include hand-caps & demonstration of tables. Ages 5-11 approx **£7.95**
READING TEST CARDS (B/G) - help 3-6 year olds to read. Random words from specified groups displayed in characters 4 lines high, or input your own choice of words. **£5.95**

Send Ch1/PO + 45p/order P & P or SAE for FULL catalogue to
PROGRAM POWER, 5 Wensley Road., Leeds LS7 2LX
Telephone: (0532) 683186.

prototype, it did not contain the final version of the documentation. Instead, I was provided with the Western Digital WD/90 Pascal Microengine Reference Manual and a one page advertising blurb for the Raand SP1. The manual is really two books with a manila paper separator between them. The first is called the User's Manual while the second is called the Pascal Operations Manual. Actually the first is a hardware manual and the second an amended version of the standard UCSD Pascal operating system manual.

Raand says that the SP1 will be supplied with the following: a hardware manual based on the Western Digital User Manual altered to describe the SP1; a software manual based on the Western Digital Pascal Operations Manual; the *Pascal User's Manual and Report* by Jensen and Wirth; and *Microcomputer Problem Solving Using Pascal* by Ken Bowles.

I hope that the Raand manuals are slightly more accurate than their advertising blurb, which is filled with com-

parisons between this and other UCSD Pascal systems (both speed and memory usage) that don't check out.

The Bowles book is a very good textbook for learning UCSD Pascal. It places a strong emphasis on Turtle graphics, which unfortunately aren't supported on the SP1. Although Bowles produced a very readable introductory text it doesn't cover the full language (among the omissions are files and pointer types) and makes a rather poor reference work (it's too chatty and not indexed). The Jensen and Wirth book on the other hand is quite easy to use as a reference but probably too concise to be used as a text. Of course it is a reference for standard Pascal rather than UCSD Pascal and so it doesn't accurately describe the language implemented on the SP1. The Pascal Operations Manual contains a list of differences between UCSD Pascal and standard Pascal and so it needs to be used in conjunction with the *User Manual and Report*.

I thought that the Western Digital hardware manual was quite reasonable. Although it doesn't contain an index, the table of contents is quite comprehensive, including an overview, installation, operating and troubleshooting procedures, plus the theory of operations. The manual contains a large number of illustrations and tables.

The Pascal Operations Manual isn't quite so good. Firstly, it seems to describe a later release of software than I had. (Who knows — maybe the production model's software will fit the manual.) Secondly and more importantly, it is confusing — emphasis isn't placed on the important points. For example, in the file handling section a command M(ake is described for creating a file entry in the directory and reserving space on the disk for it. Unfortunately it doesn't say how to get anything onto that disk space or when the command might be used. It is an improvement, though, when compared to the UCSD standard manual. There are no pages out of order and explanations are somewhat lengthier, especially concerning P-code.

I doubt that the Raand manuals will be markedly better, as alteration to the Western Digital manual had not been started at the time of the review.

Expansion

The Raand SP1 will be sold as a fully expanded system only. There is no current plan for adding any optional extras to the system.

Prices

Raand is not planning to sell its computer on a one-off basis. Their



pricing structure reflects this policy and is as follows:

1 off	£5500
2-4	£5000
5-9	£4500
10-19	£4000
20+	£3500

It will be up to any dealer to fix a price. At the time of this review, Dicoll and Pronto have decided to carry the machine.

Conclusion

The Western Digital Microengine is a computer whose hardware was designed to execute UCSD Pascal efficiently. If one wants to work in this software environment there can be no faster implementation than this. The Raand single-unit computer is based on the Microengine. I found the review machine robust, reliable and attractive and, assuming its preproduction teething problems are solved (in particular a more stable display, a cursor pad and documentation), it should be quite a nice machine. Since this particular system contains quite a large amount of disk space and doesn't contain the hardware necessary to run UCSD graphics software, its primary potential market must be commercial software houses.

At a glance

FIRST IMPRESSIONS

Looks	****
Setting Up	****
Ease of Use	**

HIGH LEVEL LANGUAGES

Basic	n/a
Cobol	n/a
Fortran	n/a
Pascal	****
System Software	***

PACKAGES

	n/a
--	-----

PERFORMANCE

Processor	*****
Cassette	n/a
Disks	****
Bus	n/a

EXPANDABILITY

Memory	n/a
Cassettes	n/a
Disks	n/a

COMPATIBILITY

Hardware	**
Software	****

DOCUMENTATION

	**
--	----

VALUE FOR MONEY

--	-----

***** excellent, **** V. good, *** good, ** fair, * poor.

Benchmark Timings (in seconds)

Program Name	Timing
Magnifier	0.85
Forloop	9.52
Whileloop	9.29
Repeatloop	9.09
Literalassign	11.02
Memoryaccess	11.45
Vector	26.40
Equalif	15.96
Unequalif	15.78
Real algebra	6.79
Real arithmetic	8.75
Noparameter	4.55
Value	4.96
Reference	4.98
Maths	7.00

Technical Data

CPU:	WD/9000 Pascal MICROENGINE chip set (16-bit micro)
Memory:	64 kbytes dynamic RAM
Keyboard:	54 keys
Screen:	White P4 phosphor with polarised filter
Cassette:	N/A
Disks:	8in, double density, double sided
Ports:	1 serial, 2 parallel
System Software:	UCSD Pascal Operating System
Languages:	Pascal

Personal Computer

BINDERS KEEPERS LOSERS WEEPERS

Half the people you meet today are not preoccupied with pollution, perversion or persecution. It's worse than that — they've lost a copy or two of PCW and don't know where to find replacements.

So keep *your* copies of PCW in a beautiful bright yellow binder. £2.95 worth of smart security.

Just check the coupon at the foot of the page.

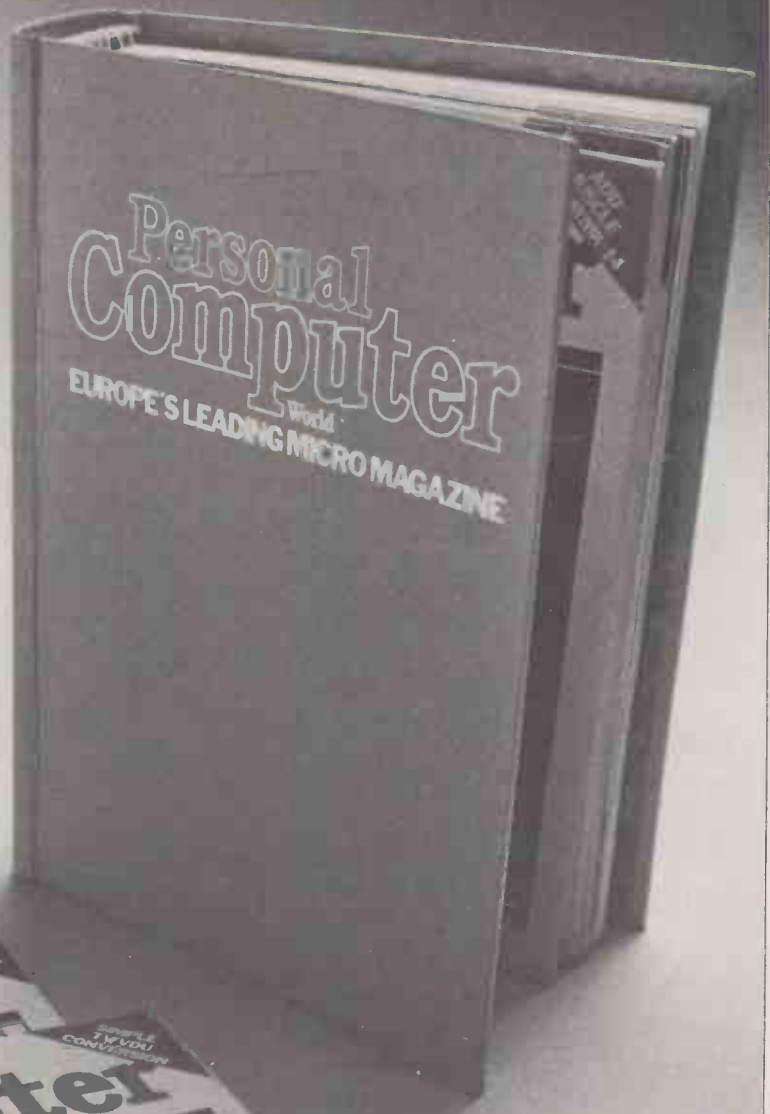

Please send me _____ PCW Binders at £2.95 each

NAME _____

ADDRESS _____

(Block capitals please)

I enclose cheque/P.O. for £ _____ made payable to
Sportscene Publishers Ltd.
Send coupon to PCW (Binders),
14 Rathbone Place, London
W1P 1DE. Allow at least
14 days for processing.

PASCAL BENCHMARKING

A suite of standard Benchmark programs have long been a feature of PCW's Benchtests but as they're written in Basic they were obviously unsuitable for this month's Benchtest of the Pascal Microengine-based Raannd SPI. Chris Sadler and Sue Eisenbach — authors of our Pascal series — have therefore devised a set of Pascal Benchmarks, which will be used in all future PCW Benchtests of machines which run Pascal.

When comparing the performance of different microcomputer systems, it is helpful to try to identify the different elements which contribute to that performance. Firstly, however, it is important to categorize those properties which characterize 'high' performance and, for the purpose of this discussion, the following definition will be adopted: a system will be considered to have demonstrated high performance if its operation (relative to competing systems) is fast, efficient and reliable; and if it can produce correct results with convenience of operation. These terms take on varying degrees of relevance when considered in relation to the different components of a system. It is therefore necessary to separate out those factors which may contribute to, or detract from, these qualities in different contexts.

Starting with the hardware, it is clear that the speed of execution will depend on the particular processor used and on the design of the outlying system — eg width of the bus, I/O cycles, etc. Likewise, reliability in this context, together with the correctness of results, will depend on decisions made by the designers of the entire configuration — have they cut corners on the quality of various system components for instance? The next major element to consider is the operating system and here reliability can be interpreted as consistent behaviour (eg does it always give the same error message when the same condition arises under different circumstances? Do default values apply globally or only for specific commands?). Convenience of use implies that interaction with the user is unambiguous, flexible and 'friendly'. Finally, the speed of operation at system level depends crucially on the efficiency of the system routines and utilities, particularly those that deal with disk access and other I/O activity.

The third element is the language translator which, for the purposes of this article, is a Pascal compiler. Once again, it is the competence of the designer which is being judged. An efficient compiler will produce code

which executes rapidly, while reliability and correctness here refer to the legality of the source code which the compiler will accept. (For Pascal, a suite of programs exists which fully tests these aspects of a compiler — details can be had from Dr Brian Wichman of the National Physical Laboratory.) Convenience of operation might imply, for instance, that effectual error messages and supporting diagnostics are provided.

The above discussion (summarised in Table 1) should place into perspective the role of the Benchmarks to be analysed in the next section. These don't cover everything one needs to know about a system — instead, they concentrate specifically on the skill with which the compiler writer has implemented certain features of the language, with particular reference to the execution speed of the ensuing object code and, additionally (inevitably), on the performance of the processor in handling that code. They are perhaps analogous to the petrol consumption tests given in car advertisements — a necessary (and objective) set of statistics, but by no means enough information with which to judge the whole car.

The Benchmarks

The idea behind these Benchmarks has been to try to isolate specific features of the language (ie instructions) so that the performance of any particular compiler in dealing with these features can be measured. Every attempt has been made to eliminate extraneous system-specific

factors (like disk transfers) so that it is only the effect of the processor executing the compiled code that will be detected. In each case execution begins with the letter S (for start) and finishes with E (for end). These characters indicate when the stopwatch button should be pressed and are inevitable overheads in the process — a system with slow I/O will fare relatively worse than a speedier system, regardless of the quality of the compiler.

In addition, in order to give meaningful intervals for timing, each process is embedded in a loop (1...10000 in most cases as opposed to the smaller loop in PCW's Basic Benchmarks). The first test is called MAGNIFIER and consists solely of the S and E signals and the loop. By subtracting its time from those of the ensuing Benchmarks, the timing for 10,000 instances of the single instruction or feature under consideration can be calculated. The specific features can be grouped under broader 'construct' headings as in Table 2. The individual Benchmark names are intended to be self-explanatory.

Figure 3 contains a listing of the Benchmark which can be input as individual programs and 'run by hand'.

Compiler design

Now that the goals of the Benchmarks have been fully declared, it would be as well to review some of the features of compiler design which may affect the results produced. It is worth noting that no account has been taken of the speed with which the compiler performs, al-

	Hardware	Operating System	Compiler
Speed	processor and bus	efficient utilities	—
Efficiency	processor and bus	efficient utilities	Benchmarks
Reliability	good design, high quality components	consistent structure	good design
Correctness of Results	good design, high quality components	consistent structure	legality of syntax
Convenience of Operation	packaging and finish	friendly and flexible	effective diagnostics

Table 1

Category	Benchmark name	Function
Overheads	MAGNIFIER	Measure of overhead involved in timing other benchmarks.
Loops	FORLOOP	10 iterations of FOR-DO loop.
	WHILELOOP	10 iterations of WHILE-DO loop.
	REPEATLOOP	10 iterations of REPEAT-UNTIL loop.
Assignments	LITERALASSIGN	10 assignments of constant value.
	MEMORYACCESS	10 assignments of a stored value.
	REALARITHMETIC	Single assignment of expression in which all arithmetic operations occur on constant values.
	REALALGEBRA	Single assignment of expression in which all operations occur on symbolic values.
Branches	VECTOR	10 assignments involving array element access.
	EQUALIF	10 operations of IF-THEN-ELSE in which each branch is executed with equal frequency.
	UNEQUALIF	10 operations of IF-THEN-ELSE in which the THEN branch is executed only once.
Procedures	NOPARAMETERS	5 nested procedure calls with no parameters.
	VALUE	5 nested procedure calls with call-by-value parameters.
	REFERENCE	5 nested procedure calls with call-by reference parameters.
Library calls	MATHS	2 calls to library functions.

Notes:

- 1 All timings can be offset by the MAGNIFIER measurement which takes account of the common overheads.
- 2 In MATHS, the MAGNIFIER loop has been reduced to 1000 to give a more reasonable figure.
- 3 The assignment and branch Benchmarks are all embedded in FORLOOP so an additional adjustment is necessary.
- 4 IF-THEN-ELSE has been given two tests because it is often faster to place the more frequently accessed segment in one branch or the other.
- 5 The procedure calls have been nested in order to investigate the build-up of the stack (and its effect on processing).
- 6 In VECTOR, matrix elements are employed on both sides of the assignment to investigate index addressing - compare with MEMORYACCESS. The initial assignment occurs only once so should be too short to affect the measurement.

Table 2

though this is a significant factor, especially to someone doing a large amount of development work. Instead, the Benchmarks investigate the performance of the target (object) code, but it is not only speed that needs to be reckoned with. Some compilers are written to produce p-code - the machine code of a (hypothetical) pseudo-machine. To run these objects on a real machine, a p-code interpreter is required which dynamically translates the p-code instructions into the native code of the host machine at run-time. Clearly, these compilers can be expected to produce slower times (all else being equal) than their alternatives which translate directly into native code, cutting out the overhead of the p-machine. As a variation of the latter approach, some compilers generate assembler language macros which are subsequently submitted to a macro-assembler which, in turn, produces the object code. This extra step lengthens the time taken to prepare a

program for each execution but offers great flexibility during overall development, particularly for optimisation and 'system' work. Finally, the Pascal Micro-engine (reviewed elsewhere in this issue) is a real implementation of the pseudo-machine, so its native code is p-code.

The second point has more to do with those language features whose implementation is open to a much freer interpretation on the part of the designer. In particular, the idea of sets and set manipulation, packing and unpacking, dynamic allocation of space (the heap) and garbage collection have not been incorporated into Benchmarks because it was felt that the variations in implementation were likely to be so wide as to defy comparison. Additionally, these are among the features most frequently left out of certain compilers which would not, in consequence, be comparable at all. The arithmetic operators are looked at in REALARITHMETIC and REALALGEBRA and some typical library functions are

referred to in MATHS. Considerably more could be made of the mathematical facilities available, but only at the expense of a substantial increase in the total number of Benchmarks could such features as the precision and speed of different modes of data representation, the accuracy of the function results and the performance of any floating point hardware be investigated.

Thirdly, certain features have not been considered suitable for Benchmarks because they tend to be intrinsically non-standard. In particular, the issue of disk-file access has been passed over because there are too many contributory variables to allow any meaningful measurements. This is not to say that non-standard features (like random access facilities) are necessarily a bad thing. In fact, they are usually more of a help than a hindrance - provided the user sticks to a single system. The compiler designer would not go to the trouble of implementing them if this were not the case. However, it is not possible to design 'objective' tests to compare such variable features.

Finally, compilers may differ widely in terms of the types and sizes of the source programs which they will accept, and these are not investigated in much detail in the Benchmarks. Legality can be checked for with Dr Wichman's suite, but this will give no indication of what size program will bring the compiler to a standstill. The compiler writer will have had to have made a number of decisions about how to apportion the compiler's work-space into stack space, variable lists and tables, etc, and these parameters, although crucial to a consideration of the development environment which a system offers (how deep can procedure nesting go? How big can an array be? ... etc), are not easily accessible to tests of this nature. Perhaps a future set of tests could be devised which investigates the space-utilisation of compilers as opposed to their time-efficiency as measured here.

Conclusion

In the meantime, the Benchmarks are offered as a means of testing some aspects of a compiler's performance against those of other compilers. Below are the measurements for our Heathkit H-11A (LSI 11/2) under UCSD and with the EIS chip in. Any figures for other systems would be welcome. Send them to Pascal Benchtests, PCW, 14 Rathbone Place, London W1P 1DE.

H-11A Benchmarks

MAGNIFIER	3.88
FORLOOP	42.76
WHILELOOP	40.11
REPEATLOOP	35.00
LITERALASSIGN	49.95
MEMORYACCESS	52.04
REALARITHMETIC	61.74
REALALGEBRA	40.61
VECTOR	102.89
EQUALIF	66.79
UNEQUALIF	65.79
NOPARAMETERS	26.40
VALUE	29.31
REFERENCE	29.69
MATHS	25.30

(All times in seconds)

Pascal Benchmarks

```

program magnifier ;
var k : integer ;
begin
  writeln ('s') ;
  for k := 1 to 10000 do ;
    writeln ('e')
  end .

```

```

program forloop ;
var j, k : integer ;
begin
  writeln ('s') ;
  for k := 1 to 10000 do
    for j := 1 to 10 do ;
      writeln ('e')
    end .
end .

```

```

program whileloop ;
var j, k : integer ;
begin
  writeln ('s') ;
  for k := 1 to 10000 do
    begin
      j := 1 ;
      while j <= 10 do j := j + 1
    end ;
    writeln ('e')
  end .

```

```

program repeatloop ;
var j, k : integer ;
begin
  writeln ('s') ;
  for k := 1 to 10000 do
    begin
      j := 1 ;
      repeat
        j := j + 1
      until j > 10 ;
    end ;
    writeln ('e')
  end .

```

```

program literalassign ;
var j, k, l : integer ;
begin
  writeln ('s') ;
  for k := 1 to 10000 do
    for j := 1 to 10 do l := 0 ;
    writeln ('e')
  end .

```

```

program memoryaccess ;
var j, k, l : integer ;
begin
  writeln ('s') ;
  for k := 1 to 10000 do
    for j := 1 to 10 do l := j ;
    writeln ('e')
  end .

```

```

program rearithmic ;
var k : integer ;
  x : real ;
begin
  for k := 1 to 10000 do
    x := k/2*3 + 4 - 5 ;
    writeln ('e')
  end .

```

```

program realalgebra ;
var k : integer ;
  x : real ;
begin
  writeln ('s') ;
  for k := 1 to 10000 do
    x := k/k*k + k - k ;
    writeln ('e')
  end .

```

```

program vector ;
var k, j : integer ;
  matrix : array [0..10] of integer ;
begin
  writeln ('s') ;
  matrix[0] := 1 ;
  for k := 1 to 10000 do
    for j := 1 to 10 do
      matrix[j] := matrix[j-1] ;
    end ;
    writeln ('e')
  end .

```

```

program equalif ;
var j, k, l : integer ;
begin
  writeln ('s') ;
  for k := 1 to 10000 do
    for j := 1 to 10 do
      if j < 6 then l := 1
      else l := 0 ;
    end ;
    writeln ('e')
  end .

```

```

program unequalif ;
var j, k, l : integer ;
begin
  writeln ('s') ;
  for k := 1 to 10000 do
    for j := 1 to 10 do
      if j < 2 then l := 1
      else l := 0 ;
    end ;
    writeln ('e')
  end .

```

```

program noparameters ;
var j, k : integer ;
procedure none5
begin
  j := 1
end ;
procedure none4 ;
begin
  none5
end ;
procedure none3 ;
begin
  none4
end ;
procedure none2 ;
begin
  none3
end ;
procedure none1 ;
begin
  none2
end ;
begin
  writeln ('s') ;
  j := 0 ;
  for k := 1 to 10000 do
    none1 ;
    writeln ('e')
  end .

```

```

program value ;
var j, k : integer ;
procedure value5 (i : integer) ;
begin
  i = 1
end ;
procedure value4 (i : integer) ;
begin
  value5 (i)
end ;
procedure value3 (i : integer) ;
begin
  value4 (i)
end ;
procedure value2 (i : integer) ;
begin
  value3 (i)
end ;
procedure value1 (i : integer) ;
begin
  value2 (i)
end ;
begin
  writeln ('s') ;
  j := 0 ;
  for k := 1 to 10000 do
    value1 (j) ;
    writeln ('e')
  end .

```

```

program reference ;
var j, k : integer ;
procedure refer5 (var i : integer) ;
begin
  i := 1
end ;
procedure refer4 (var i : integer) ;
begin
  refer5 (i)
end ;
procedure refer3 (var i : integer) ;
begin
  refer4 (i)
end ;
procedure refer2 (var i : integer) ;
begin
  refer3 (i)
end ;
procedure refer1 (var i : integer) ;
begin
  refer2 (i)
end ;
begin
  writeln ('s') ;
  j := 0 ;
  for k := 1 to 10000 do
    refer1 (j) ;
    writeln ('e')
  end .

```

```

program maths ;
var k : integer ;
  x, y : real ;
begin
  writeln ('s') ;
  for k := 1 to 10000 do
    begin
      x := exp(k) ;
      y := sin(k)
    end ;
    writeln ('e')
  end .

```

THE WORLD'S FINEST

AVAILABLE NOW! MICROTAN SOFTWARE
and **CEGMON**, the ultimate CompuKit Monitor ROM!
Amazing features many £3000 Computers can't match!

HOBBY COMPUTING SOFTWARE

MASTER
PACK

MASTER
PACK

UTILITIES PACK for
CompuKit UK101,
Ohio Superboard
(all screen formats)
and Microtan

Sixteen utility programs that will revolutionise your programming techniques. All programs feature NEW logical screen address system (line 1 column 1 is address 101) with full protection against under/over poking.

- * Simple and complex graphics created with single GOSUB calls
- * Inputs displayed at any screen address without scrolling
- * Full page of strings displayed by defining just one variable
- * EXTRA text display - a full screenful of text displayed direct from the keyboard
- * Graphics Design Toolkit - 'Graphics Underlay' and 'Screen Address Indicator' to speed your graphics design
- * Precision Random Number Generator - a great improvement on Microsoft's RND
- * Instant clear and fill screen and other invaluable routines
- * Modular design to minimise RAM needed (full pack 1300 bytes - 500 - 600 bytes in typical applications)
- * Written entirely in BASIC for easy customisation
- * Comprehensive operating instructions and demonstration program

Our best-selling program pack! NOW ONLY £14.95 including VAT

for the
TRS 80 Level II
COMPUKIT UK 101
SHARP MZ-80K
OHIO SUPERBOARD
VIDEO GENIE
MICROTAN
CASIO 501/502P

CHRISTMAS GAMES PACK
for TRS 80 (16K), Video Genie,
CompuKit UK101 (8K),
Ohio Superboard
(standard screen, 8K),
Sharp MZ-80K
and Microtan

Computer Christmas fun from PREMIER!
Three games full of seasonal flavour,
and featuring multiple skill levels to
entertain youngsters and challenge adults.

- * **REINDEER ROUNDUP** - Can you catch Santa's reindeer in time for him to make his Christmas deliveries? It's not as easy as it looks, and at the higher levels of play, it's downright difficult, especially after a few tipples of Christmas spirit!
- * **SUPER SANTA** - Now you've caught the reindeer, it's time to pop the presents down the chimneys, or at least, it's time to try to! Once again, great graphics, some neat twists, and a deceptively simple game to enthrall youngsters of all ages.
- * **TOBOGGAN RUN** - Can you steer your way down the toboggan run, avoiding the Abominable Snowmen, and without breaking the odd arm or leg? If not, don't worry, you're in good company - our Managing Director managed to break his neck, both arms and both legs when he tried his hand at TOBOGGAN RUN. Get well soon!

Three fun-packed, light-hearted games at a Christmas gift price - only £8.95 including VAT

TO ORDER: Enjoy the ultimate demonstration of program quality - in your own home on your own computer, with the security of our 10-day money-back guarantee of satisfaction

UK: Just send cheque/PO to include 50p to cover post, packing and insurance, quoting CT/12 on your order please.

OVERSEAS: Please deduct VAT (divide price by 1.15) and add postage for 200 grams weight OR send two International Reply Coupons for quotation/program details.

Orders normally despatched within five working days
PLEASE SPECIFY YOUR COMPUTER WHEN ORDERING

PREMIER software is available ONLY direct from PREMIER PUBLICATIONS
We will be pleased to send you details of our software range for your computer - phone or write today

from Premier Publications

12 Kingscote Road Addiscombe Croydon Surrey Telephone 01-656 6156

Britain's biggest hobby software specialist - over 100 000 programs sold to date!

YES, BUT IS IT ART?

Malcolm Banthorpe is already well known to PCW readers for his articles on colour and three dimensional plotting. This month he ponders the true nature of computer art, illustrating his theme with a bumper selection of pictures from his scrapbook.

Mention 'art' and 'computer' in the same breath and someone is bound to question whether the two words -- generally considered to be mutually exclusive -- can have any sort of valid connection. Yet almost since their inception, attempts have been made to use computers for aesthetic purposes, to generate music and poetry as well as graphic art -- the subject of this article.

Computer art is still far from gaining critical acceptance, placing it in a similar position to that suffered by photography for many years. A wider acceptance of computer art may occur when, as is starting to happen, computers are held in less awe and silicon chips cease being the subjects of sensational media reports.

Critics find computer art hard to accept because it requires no animal skills like those of painting or sculpting. Although it possesses many of the attributes of conventional art, it cannot be judged by the same criteria. What it *does* require of its practitioners is some appreciation of computer science and programming, and it therefore appeals to both artists and technologists, some of whom have welcomed it as a unique fusion of the disciplines.

A common stumbling block to public acceptance is the belief that "if it's produced by a machine, then it can't be art," an attitude that is widespread, but which misses the point that the computer is merely being used as a tool and, as such, is similar in principle to the painter's brush. The computer is commonly regarded as a sort of autonomous being, responsible for its own output: few realise that the computer can do nothing at all without programming. Politicians and bureaucrats are fond of this image because it allows them to attribute mistakes to 'computer error' when it would be more honest to blame the programmer or the person who supplied the faulty data.

The use of the term 'artificial intelligence', though not always apposite in the context of computer art, may partially be responsible for the misconception that the computer has somehow created the work. Another factor is the considerable random element of much computer art, which removes some of the detail of the work from the direct control of the programmer. It is nevertheless the set of instructions (ie the program) that the programmer feeds into the computer -- including which parameters will be randomly determined and within what limits -- which is entirely responsible for the computer's output.

As for the examples accompanying this article, I'll just say that they're designs and patterns produced for their own sake, on a computer. Some of them involve the plotting of mathematical functions (though nothing more complex than a few sines and cosines), but their purpose is not to illustrate those functions, merely to produce an aesthetically pleasing visual effect. As it's quite possible that someone will now object to my use of the expression 'aesthetically pleasing' to describe computer output, I'll stop trying to justify the title before my arguments become completely circular.

The sort of computer art that I'm writing about here covers a wide variety of graphics programs. Sometimes the results are similar in appearance to work which could have been produced by more conventional means. Other examples suggest the means of their generation. In all cases, however, the aim is to produce a design which exploits those characteristics unique to the computer. There is little point in using a computer to emulate a design which could have been more easily produced manually: one of the useful characteristics of the computer is its ability to repeatedly perform complex instruc-

tions, without error or fatigue; hence its effectiveness in generating patterns which would otherwise require an unreasonable amount of time and effort.

Computer graphic designs differ from their manually produced counterparts in the way in which they are initially conceived. Generally, if one were producing a design manually, one would start with a mental picture of the design and then set about achieving it in practice. In computer art, a more usual starting point is an idea for a programming technique which is then tried, with only a vague idea of what the outcome will be. Often two or more techniques, of known effect, will be combined to "see what happens". This is, of course, a broad generalisation and it is not possible to categorise all computer and conventional art so simply. There are times when, with a knowledge of techniques and their effects on a particular machine, it is possible to visualise a result and then set about achieving it.

An important aspect of computer art is the balance between explicit rules and random decisions. A program which is totally explicit will produce the same output each time it is run. Provision may be made to vary some of the parameters via user inputs such as the keyboard but the results will still be repeatable for any given input and will be totally in the control of the programmer. Alternatively, some or all of the program parameters may be determined by a random number generator.

One of the joys of computer art is the production of results which cannot be entirely predicted (and are occasionally unpredictably awful), by virtue of this random element. The range of random values which may be generated for a given parameter needs to be carefully controlled, otherwise the design can easily degenerate into visual 'noise' or chaos. A suitable range for each parameter can only be determined empirically. There is also the question of which parameters should have a random element and which should be fully predetermined. Again only trial and error can suggest the correct balance for a particular program. When initially experimenting with a program, it is a good idea to manually vary just one parameter at a time, so that the effect can be observed and a useful range of values found. The best results are often obtained by making a parameter partially predetermined and partially random. For instance, a horizontal co-ordinate may be calculated as a function of the vertical coordinate plus a random number, eg:

$$H = V * 1.5 + \text{RND}(1) * 4$$

Interactive computer art offers some interesting possibilities in the way that the progress of a program may be controlled. As well as the more obvious human interfaces such as the keyboard and joystick controls, it is possible to communicate with the computer by means of sound and light. Richard Lawrence has shown (*PCW* March 1980) how, by means of a simple machine code routine and a microphone connected via an amplifier to the cassette port of an ITT or Apple computer, it was possible to control the program with sound. A method of changing the colour of the display by whistling notes of different pitches was shown. A trivial example, perhaps, but it gives a good idea of what can be achieved with a

YES, BUT IS IT ART?

little imagination. A further level of sophistication would be to use a voice recognition program. It would also be easy to interface a photosensitive element so that a program is initiated or changed by, for instance, the shadow of someone standing in front of the computer.

In all the examples shown on page 65, the graphics were designed to be displayed directly on a cathode ray tube — a video monitor or TV. Other programs may be designed to produce an output to a printer or plotter. The advantages of a CRT output are that it is generally cheaper and faster than hard copy, it can display dynamic as well as static images, and is clearly superior where a colour display is involved. A printer or plotter can provide an instant permanent record of the computer output and a plotter has an added advantage when greater detail is required. Where a permanent record of a CRT display is required, it is a fairly simple matter to photograph the screen. Where moving images are involved, film can be used, although because of the problems of synchronising the camera shutter with the television frame rate, it is easier to photograph one frame at a time. This frame-by-frame technique has the advantage that it can allow designs whose plotting time is slow to be animated. Video tape would provide a more convenient medium for the direct storage of moving images, but hasn't, to my knowledge, been used to any extent in this context. Some computers provide a video signal which is sufficiently standard to be recorded on a domestic video cassette recorder, but those which generate a 525 line, 30 frame per second American standard signal are unlikely to be successful in this respect unless you have a dual standard VCR.

The computer I used was an ITT 2020 and the photographs taken directly from the screen of a 13" portable colour TV set. The ITT 2020 can generate genuine high resolution graphics in four colours, plus black and white. The colour system used, like that on the Apple, has some limitations, but these can be largely overcome (see last month's *PCW*). In fact, I've exploited some of the quirks of the system to produce specific effects. The fact that each screen point can only appear in one colour permits some interesting textures. Although only four colours are directly available, programming allows additional colours to be effectively displayed through a form of mixing.

Genuine high resolution graphics (ie with each point on the screen individually addressable, as opposed to the pixel graphics which some manufacturers still persist in describing as high resolution) is the most versatile system for computer art and most other graphics applications. It is, however, essential, and the lower resolution pixel

graphics (typically 40 x 25 or 48 x 16) can be used to experiment with various design concepts, though they allow less freedom as one is restricted to using the predefined graphics characters as building blocks. A machine such as the Sorcerer, which permits a number of user-defined pixels, offers a step in the direction of the versatility of bit-mapped high resolution graphics.

The ability of the cathode ray tube to display moving images can be exploited by some graphics programs such as those which use line-drawing commands. For example, Palssoft Basic on the ITT 2020 permits a line to be drawn between any two points on the screen almost as speedily as plotting a single point. This means that fairly complex images can be drawn and modified quickly enough to give the illusion of movement. Programs which involve curves generally require the coordinates of each point to be evaluated separately and the execution of these programs is consequently slower, taking perhaps several minutes to complete a single image. This was the case with the program used to generate Figures 5, 6 and 7.

On the other hand, Figure 9 was photographed from a program which generates a continually changing pattern. It makes use of an 'exclusive-OR' line-drawing technique to generate a design which at any stage is dependent on all that has previously been plotted. Palssoft Basic has a command called XDRAW which is used in conjunction with its shape table facility. The shape table allows a number of shapes to be predefined in line form and subsequently drawn anywhere on the screen with variable scale and rotation. Using the XDRAW command, as opposed to the more straightforward DRAW command, allows the lines of the shape plotted to be exclusive-ORed with whatever is already on the screen. Its most common use is as a convenient way of erasing a shape without clearing the whole screen. Experiment showed that the command could be used to give some interesting colour effects. Normally, it would be used with the plotting colour set to white: a white line crossing a second white line would result in black being displayed where the two lines overlapped. More interestingly, a coloured line crossing a white line was found to generate the complementary colour at the point of intersection. For example, a blue line crossing a white line would result in yellow at the intersection. Other combinations of line colours produced similarly useful effects.

To make use of the phenomenon, the simple shape of a square was used. By re-drawing the square several times at the same coordinates, with the scale incremented each time, a solid square can be formed rather than just a bare outline. The pattern program uses four such incremented squares which overlap to bring the exclusive-OR effect into action. The increment and the plotting colour are determined randomly for each group of four squares. The degree of randomness in the increment was fairly critical: too great a degree caused the pattern to become over complex and chaotic — too little caused it to repeat and become predictable. The final program used is very simple

(just 13 lines of Basic) and produces a constantly changing pattern of almost infinite variety, which, incidentally, shows little evidence of the square shapes from which it is built.

Figures 1, 2 and 4 were photographed from programs which generate moire patterns. A moire pattern could be described as a perceptual effect resulting from the superimposition of two sets of parallel or near-parallel lines, with a slight angular displacement or variation in line spacing between the two sets. This is the sort of repetitive task to which a computer is well suited. Here, the two sets of lines are of different colours.

Figures 5, 6 and 7 are drawn using a three-dimensional plotting technique as described in *PCW* last month. The final program draws a rectangular plane in perspective with raised contours and employs a hidden-line removal algorithm which would theoretically be hidden by the foreground.

The design of Figures 3, 8 and 10 are based on the well-known Lissajous patterns which will be familiar to most readers. They are usually plotted as a series of points, whose coordinates are calculated as:

$$X = K * \sin(P * A)$$

$$Y = K * \cos(Q * A)$$

where A is an angle in radians and K, P and Q are constants. In this case, I've calculated two sets of coordinates using different constants and then joined pairs of points with straight lines. Additional interest is generated by making the centre section of each line a different colour from the rest.

Each of the techniques used is, in itself, very simple, though some have undergone considerable development to achieve just the right effect. I hope that I've been able to show how design-generating programs can be developed from a few simple ideas.

As a postscript, it would perhaps be helpful to give a few guidelines on taking photographs directly from a video monitor or television set, as the results can otherwise be disappointing.

The first and most important requirement is to use a suitable camera shutter speed. The normal television frame rate is 25 pictures per second. This means that if the camera shutter speed is less than 1/25 of a second, then part of the screen image will not appear on the film, as only part of the screen will have been scanned while the shutter is open. A speed of 1/15 of a second or more is preferable, to eliminate any possible shading of the picture. A tripod or some other means of supporting the camera will be required if camera shake is to be avoided.

The camera must be aimed squarely at the screen face to avoid distortion of the image and to minimise the effects of the curvature of the screen. If you're using a camera with a non-reflex viewfinder, beware of parallax errors caused by the close focussing distance.

Reflections on the tube face are a common source of problems but are easily overlooked. Perhaps because we're accustomed to viewing television sets in lit rooms, it seems that the human brain contains a neat subroutine to filter screen reflections out. Even when looking at the screen through a camera viewfinder, it's easy not to

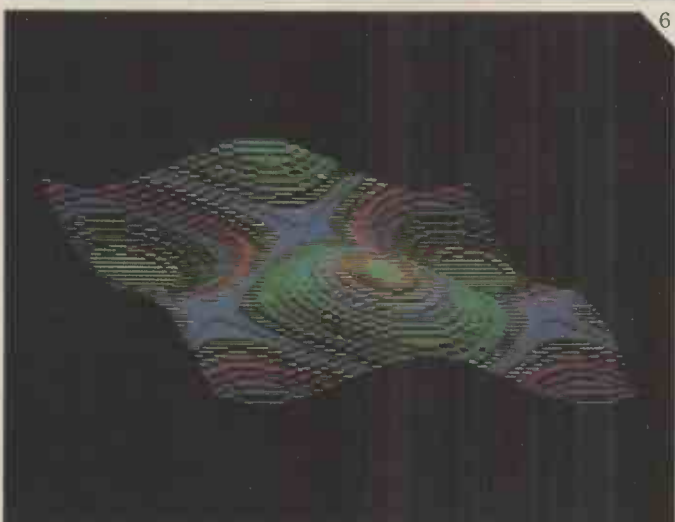
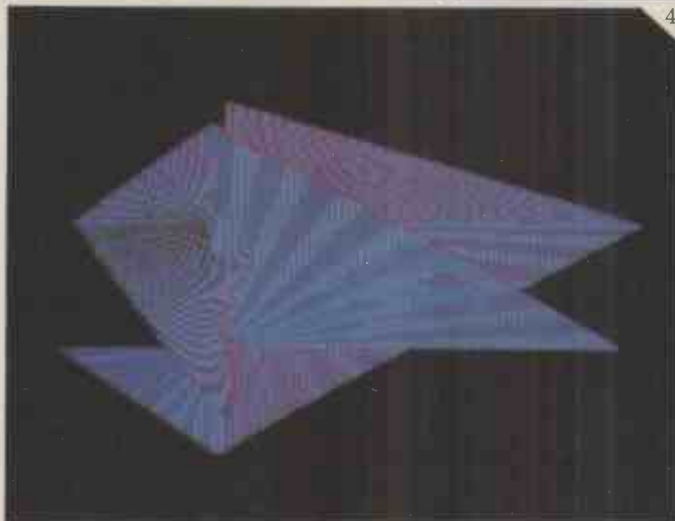
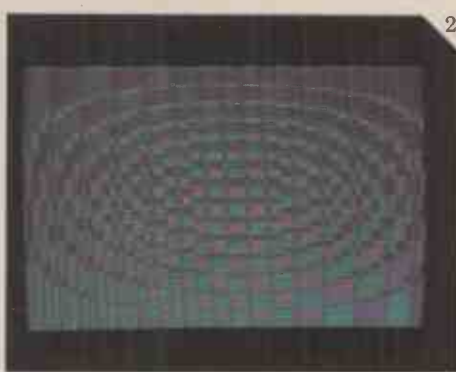

notice them. Unfortunately they still register on the film and the only real solution is to keep the room as dark as possible.

For black and white photographs the exposure is not too critical and an automatic camera will generally give acceptable results. If the shutter speed is set automatically by the camera, make sure it's slow enough. For colour film the

exposure is more critical and the approach that I've taken for both colour and black and white is as follows: first, devise a simple program to fill the screen with white dots or lines, evenly distributed, such that the screen area is effectively divided into half white and half black. The screen will now be emitting half its theoretical maximum amount of light. Set the exposure on

this and maintain it regardless of the meter readings given by the images to be photographed. This only needs to be done once, as the same exposure setting can be used on future occasions, as long as the brightness and contrast controls of the set are in the same positions. Adjustment will still be needed, of course, to allow for different film speeds.

YOU WILL FIND WHAT WE DID!!

Specifications BM-12E

Input Signal: 1.0±0.2V P-P
composite Video sync,
negative, fully compatible.
Input Impedance: 75 ohms
CRT: 12", 90° deflection
CRT Color: Green P31 phosphor
Video Amplifier Bandwidth: 18 MHz
Display Format: 25 lines of 80 characters
Scan Frequency: Horizontal-15.75KHz Vertical -60 Hz
Power Requirement: AC 117/230 volts 50/60 Hz
Size: 11½" high x 12½" wide x 12" deep
Weight: 16 Lbs



BMC ELEKTRONIK

CAPIM CENTER, ROßMARKT 15,
6000 FRANKFURT AM MAIN 1, F.R. OF GERMANY.
TELEFON (0611) 20516 TELEX 412889 CAPIM D.

BMC INTERNATIONAL

3F NO. 27, 5-CHOME, TANIMACHI, HIGASHI-KU,
OSAKA 540, JAPAN CABLE "BMCINT" OSAKA
PHONE: OSAKA 768-7791 TELEX: 64930 NISEMIC

Unique in concept—the home computer that grows as you do!

The Acorn Atom

£120

plus VAT and p&p

Special features include

- * FULL SIZED KEYBOARD
- * ASSEMBLER AND BASIC
- * TOP QUALITY MOULDED CASE
- * HIGH RESOLUTION COLOUR GRAPHICS*

* optional



Also available ready-built
£150
plus VAT and p&p

● The picture shows mixed graphics and characters in three colours

The Acorn Atom is a definitive personal computer. Simple to build, simple to operate. A powerful, full facility computer with all the features you would expect. Just connect the assembled computer to any domestic TV and power source and you are ready to begin. (Power requirement: 8V at 800mA). There is an ATOM power unit available – see the coupon below.

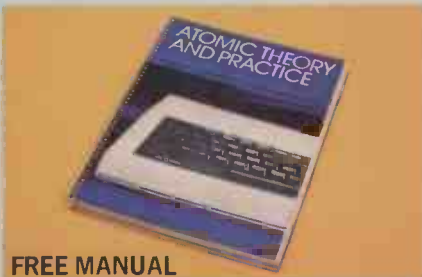

FREE MANUAL

Free with every ATOM, kit or built, is a computer manual. The first section explains and teaches you BASIC, the language that most personal computers and the ATOM operate in. The instructions are simple and learning quickly becomes a pleasure. You'll soon be writing your own programs. The second section is a reference

manual giving a full description of the ATOM's facilities and how to use them. Both sections are fully illustrated with example programs.

The standard ATOM includes:

- HARDWARE**
- Full-sized QWERTY keyboard
 - 6502 Microprocessor
 - Rugged injection-moulded case
 - 2K RAM
 - 8K HYPER-ROM
 - 23 integrated circuits and sockets
 - Audio cassette interface
 - UHF TV output
 - Full assembly instructions
- SOFTWARE**
- 32-bit arithmetic ($\pm 2,000,000,000$)
 - High speed execution
 - 43 standard/extended BASIC commands
 - Variable length strings (up to 256 characters)
 - String manipulation functions
 - 27 x 32 bit integer variables
 - 27 additional arrays
 - Random number function
 - PUT and GET byte
 - WAIT command for timing
 - DO-UNTIL construction
 - Logical operators (AND, OR, EX-OR)
 - Link to machine – code routines
 - PLOT commands, DRAW and MOVE

The ATOM modular concept

The ATOM has been designed to grow with you. As you build confidence and knowledge you can add more components. For instance the next stage might be to increase the ROM and RAM on the basic ATOM from 8K + 2K to 12K + 12K respectively. This will give you a direct printer drive, floating point mathematics, scientific and trigonometric functions, high resolution graphics.

From there you can expand indefinitely. Acorn have produced an enormous range of compatible PCB's which can be added to your original computer. For instance:

- A module to give red, green and blue colour signals
 - Teletext VDU card (for Prestel and Ceefax information)
 - An in-board connector for a communications loop interface – any number of ATOMs may be linked to each other – or to a master system with mass storage/hard copy facility
 - Floppy disk controller card.
- For details of these and other additions write to the address below.



ACORN COMPUTER 4a Market Hill, CAMBRIDGE CB2 3NJ

Your ACORN ATOM may qualify as a business expense. To order complete the coupon below and post to Acorn Computer for delivery within 28 days. Return as received within 14 days for full money refund if not completely satisfied. **All components are guaranteed with full service/repair facility available.**

Please send me the following items:

Quantity	Item	Item price inc. VAT+p&p	TOTALS
	ATOM KIT – 8K ROM + 2K RAM (MIN)	@ £140.00	
	ATOM ASSEMBLED – 8K ROM + 2K RAM (MIN)	@ £174.50	
	ATOM KIT – 12K ROM + 12K RAM (MAX)	@ £255.00	
	ATOM ASSEMBLED – 12K ROM + 12K RAM (MAX)	@ £289.50	
	1K RAM SETS	@ £11.22	
	4K FLOATING POINT ROM (inc in 12K Version)	@ £23.30	
	PRINTER DRIVE	6522 VIA @ £10.35	
	(inc in 12K version)	LS244 Buffer @ £3.17	
	MAINS POWER SUPPLY (1.3 amps)	@ £10.20	
		TOTAL	

To: Acorn Computer Ltd., 4a Market Hill, CAMBRIDGE CB2 3NJ

I enclose cheque/postal order for £ _____

Please debit my Access/Barclaycard No. _____

Signature _____

Name (Please print) _____

Address _____

Telephone No. _____

Registered No: 1403810. VAT No: 215 400 220



Make your micro

MICRO



Get the most out of your microcomputer with Graham-Dorian Business software.

At any given time, your hardware is only as useful as the software you run in it. Our programs let you realise the full potential of your hardware

Graham-Dorian provides highly detailed and well documented programs. All pretested on the job. Each so comprehensive that it takes little time to learn to run a program — even for someone who's never operated a computer before.

Graham-Dorian programs are on-line now working for us and others around the world. They are ready to go to work immediately or to be tailored for your more specific needs. Each package contains a software program in BAS and INT film form plus a user's manual and hard copy SOURCE LISTING.

Programs are compatible with most major computers using CP/M disk operating systems, and come in standard 8" or on various mini-floppy disks.

Graham-Dorian stand behind dealers with technical advice.

Yes, there's a world of difference in business software. Graham-Dorian has more per-package capabilities and more packages (with new ones added every few months).

Distributors for Micropro:- Wordstar, Datastar & Mailmerge. CP/M for Tandy Model I & II

†GDSS are appointing UK Dealers and European Distributors. Enquiries and applications invited.

*CBASIC-2 is a trade mark (copyright 1980) of Compiler Systems, Inc. GDSS are the European Distributor for CBASIC-2.

The Graham-Dorian PC now includes these packages:

- Nominal Ledger
- Purchase Ledger
- Sales Ledger
- Job Costing
- Order Entry & Invoicing
- Payroll
- Manufacturing Inventory
- Manufacturing Job Costing
- Wholesaler Inventory
- Retailer Inventory
- Cash Register
- Apartment
- Surveying
- Dental

CBASIC-2*

Ask your dealer for a demonstration soon.



Graham-Dorian Software Systems

A division of Graham-Dorian Enterprises & Terodec (Micro Systems) Ltd.
Unit 58, Suttons Park Avenue, Earley
Reading, Berks RG6 1AZ
Tel (0734) 664345/6 GDSS



NEWS

ComputerTown UK! - a nationwide computer literacy project -- is under way with centres already opened in Nottingham and Hillingdon and lots of interest being shown in other parts of the country. To contact CTUK! write c/o PCW, 14 Rathbone Place, London, W1P 1DE, enclosing an SAE if you want a reply. Please don't try to ring the PCW office as this project is carried out in our spare time.

The ComputerTown issue of *PCW* hit the news stands just as we were putting this one to bed so it is still too early to gauge reaction to the announcement. In the meantime we can tell you that, following a very low-key launch at the *PCW* show, quite a few people have shown interest and several have already set the wheels in motion in their own communities. A number of businesses have pledged software and machines to the project and, if these initial reactions are anything to go by, then CTUK! promises to be a huge success.

One interesting — but not very surprising — reaction has been the almost universal dislike of the name ComputerTown UK! Some say it's too American, some say it's meaningless, while others just can't put their fingers on the reason. We all know that the name is utterly irrelevant; it's what we're doing that's important. But if someone out there would like to donate a name which reflects the theme of 'taking computers out into your local community in order to promote computer awareness and remove fear,' then we'd love to hear from you. Write to us at the above address.

Now let's look at what's happened so far. First of all, Sutton-in-Ashfield and Eastcote will have CTUK!s running by the time you read this article. In each case, the local library is being used with a great deal of enthusiasm and commitment from the library staffs themselves.

Sutton-in-Ashfield is starting off in a big way with several machines, including at least one Atom, Sharp, PET, ZX80, Apple, Microtan and maybe a TRS-80 as well. They have managed this by making CTUK! an adjunct to their already thriving Sutton-in-Ashfield Computer Club (other clubs please note!). Graham Handley and Roy Griffin of Leasalink Viewdata have kindly provided them with an Atom on 'permanent loan'.

Sutton-in-Ashfield is getting its software either by developing it in-house or by scrounging. Anyone wanting to get involved should contact Deric Ellerby on Mansfield (0623) 753576. You may be interested to learn that Deric is aided and abetted in this venture by our very own Derrick Daines.

Eastcote CTUK! is starting rather less spectacularly in the (very small) local library. In fact there's only room for two machines. Contingency plans have been

made for the time when interest (and the number of volunteers) grows. Three other local libraries have been offered as potential CTUK! sites: Ruislip, South Ruislip and Ruislip Manor. Mr P Colahan, the Hillingdon borough librarian, is very sympathetic to CTUK! so, if anyone else in the borough wants to start up, you'll find him a most approachable man.

As with Sutton-in-Ashfield, software is being developed or scrounged. In fact, Eastcote-based software house, Supersoft has kindly given the project a number of programs from its catalogue. Thank you Supersoft. The people responsible for CTUK! Eastcote are Martin Baldwin and *PCW*'s editor, David Tebbutt. David can be contacted (but not by phone) at the main CTUK! address.

Hammersmith looks like being a lively area when it comes to CTUK! We've already heard from three people who'd like to set up there. We've put them in touch with each other but if anyone else would like to join in ring either Jo Gedrych on 01-602 1269 or our very own Malcolm Peltu on 01-995 1548. We can't yet give the third person's name because we're still waiting for permission. Jo and Malcolm see their project as CTUK! West London, although this doesn't mean that West London can now be considered covered! Good luck lads — we hope to hear some more news soon.

We had a nice letter from another West London man. His name is Mike Baker and he lives in Hanwell, W7. He'd like to hear from other people in his locality who'd be interested in starting a CTUK! there. Mike can be contacted on 01-840 0030.

Exciting news comes from Ingersoll, UK distributors of the Atari computer systems. Marketing manager, Steve

Bernard, strongly believes in CTUK! to the extent that he has pledged a number of machines to the project. We welcome his support and look forward to installing his computers in permanent CTUK! locations.

We also had a letter from David Payne, who works for Tandy. Although he's not in a position to scrounge free machines, he'd love to help in any way possible. He lives in South West London but any letter should be sent to the main CTUK! address for the moment and we'll forward them.

Edward Teague, until recently Sharp's PR man, popped in the other day and went away to propose a CTUK! in his home town of Romiley in Cheshire. For the moment contact Edward through the main CTUK! address.

While typing this report I had a phone call from Lyn Antill, author of our Systems series. Guess what? — she'd like to get a CTUK! going in the City of London. Anyone interested in joining in should write to her at 1 Defoe House, Barbican, London EC2Y 8DN.

Well that's it for this month. Our thanks to all those people mentioned; we really appreciate what you're doing. Next month we hope to bring you news of several more developments. Remember CTUK! should eventually cover the entire country, so it still needs plenty more volunteers. Anyone needing further information about CTUK! write to the main address enclosing an SAE. Once again, *please don't phone the PCW offices*, because CTUK! is a spare time activity.

We look forward to hearing from you, especially if you have news of your own local CTUK! progress. All news received by the middle of the month will appear in *PCW* a month later (or thereabouts).

ComputerTown UK! in brief

ComputerTown UK! is a voluntary, nationwide, community-based activity which aims to promote computer literacy by making microcomputers freely accessible to anyone interested. In particular it recognises the need for our future leaders, especially today's children, to feel completely at ease with the new technology. In ComputerTown the keywords are *fun* and *enjoyment*

with the emphasis on learning through discovery at the keyboard.

ComputerTown UK! *isn't* just a passing craze any more than are microcomputers themselves. It's not a plot to turn Britain into a nation of programmers nor is it a sneaky way to sell computers — in fact ComputerTown represents no commercial interests at all and is not a profit-making activity.

In the microcomputer jungle The Sharp MZ-80 system now with



Since its introduction, the Sharp MZ-80 system has proved to be one of the most versatile systems in the micro jungle, for commerce, industry and enthusiasts alike.

Now the MZ-80 Computer system has even more versatility thanks to CP/M[™] giving greater adaptability to face the future. After all look what happened to the Dinosaur.



The MZ-80 system is made up of the MZ-80K computer with the powerful Z-80 microprocessor. MZ-80FD Floppy Disc storage unit, now with CP/M[™] for even greater versatility. MZ-80P3 dot printer producing ultra Sharp print out copy.

survival depends on adaptability. CP/MTM has even greater versatility.



Your Sharp Microcomputer Dealers



AVON
BCG SHOP EQUIPMENT LTD · BRISTOL · TEL: 0272 425338
DECIMAL BUSINESS M/CS LTD · BRISTOL · TEL: 0272 294591
BEDFORDSHIRE
ISHERWOODS (H.B. COMPUTERS) LTD · LUTON · TEL: 0582 416202

BERKSHIRE
BCG SHOP EQUIPMENT LTD · READING · TEL: 0734 54015
NEWBEAR COMPUTING STORE LTD · NEWBURY · TEL: 0635 30505
BUCKINGHAMSHIRE
INTERFACE COMPONENTS LTD · AMERSHAM · TEL: 02403 22307
CHESHIRE
CASH REGISTER SERVICES · CHESTER · TEL: 0244 317549
FLETCHER WORTHINGTON LTD · HAILE · TEL: 061-928 8928
NEWBEAR COMPUTING STORE LTD · CHEADLE HEATH, STOCKPORT · TEL: 061-491 2290
DEVON
BCG SHOP EQUIPMENT LTD · PAIGNTON · TEL: 0803 557711
CRYSTAL ELECTRONICS LTD · TORQUAY · TEL: 0803 22699
PETER SCOTT (EXETER) LTD · EXETER · TEL: EXETER 73309
DORSET
SOUTH COAST BUSINESS M/CS · FERNDOWN, DORSET · TEL: 0202 893040
ESSEX
PROROLE LTD · WESTCLIFFE ON SEA · TEL: 0702 335298
LANCASHIRE
MICRODIGITAL LTD · LIVERPOOL · TEL: 051-227 2535
SUMITA ELECTRONICS LTD · PRESTON · TEL: 0772 55065
SUMLOCK SOFTWARE LTD · MANCHESTER · TEL: 061-228 3502
SOUND SERVICES · BURNLEY · TEL: 0282 38481
LEICESTERSHIRE
ARDEN DATA PROCESSING · LEICESTER · TEL: 0533 22255
GILBERT COMPUTERS · LUBENHAM · TEL: 0858 65894
LINCOLNSHIRE
HOWES ELECT. & AUTOM. SERVS. WASHINGTON · TEL: LINC OLIN 32379
LONDON
C.S.S. BUSINESS EQUIPT LTD · LONDON · E8 · TEL: 01-836 1176
CENTRAL CALCULATORS LTD · LONDON · EC2 · TEL: 01-729 5588

DIGITAL DESIGN & DEVELOPMENT · LONDON · W1 · TEL: 01-387 7388
EURO-CALC LTD · LONDON E.C.2 · TEL: 01-729 4555
EURO-CALC LTD · LONDON W.1 · TEL: 01-636 5560
EURO-CALC LTD · LONDON W.C.1 · TEL: 01-405 3113
JAXREST LTD · LONDON EC1 · TEL: 01-403 1801
LION COMPUTER SHOPS LTD · LONDON W.1 · TEL: 01-637 1601
PERSONAL COMPUTERS LTD · LONDON · TEL: 01-626 8121
SCOPE · LONDON EC2/M4HX · TEL: 01-247 8506
SUMLOCK BONDAIN LTD · LONDON EC1R 0AA · TEL: 01-253 2447
VIDEO SERVICES (BROMLEY) · TEL: 01-460 8833
CREAM COMPUTER SHOP · HARROW · TEL: 01-380 0833
NORFOLK
SUMLOCK BONDAIN (EAST ANGLIA) LTD · NORWICH · TEL: 0603 26259
NORTHAMPTONSHIRE
HB COMPUTERS LTD · KETTERING · TEL: 0536 83922
NOTTINGHAMSHIRE
KEEN COMPUTERS · NOTTINGHAM · TEL: 0602 583254
MANSFIELD BUSINESS M/CS LTD · MANSFIELD · TEL: 0623 26510
SALOP
COMPUTER CORNER · SHREWSBURY · TEL: 0743 55166
SOMERSET
NORSETT OFFICE SUPPLIES LTD · CHEDDAR · TEL: 0934 742184
SUFFOLK
MICROTEK · IPSWICH · TEL: 0473 50152
SURREY
PETALECT ELECTRONIC SERVICES WOKING · TEL: 04862 69032
R.B.M. DATA SERVICES · CROYDON · TEL: 01-684 1134
SUSSEX
M & H OFFICE EQUIPMENT · BRIGHTON · TEL: 0273 697231

TYNE & WEAR
P.M.S. LTD · SUNDERLAND · TEL: 0783 480009
WALES
CITY RADIO · CARDIFF · TEL: 0222 28169
SIGMA SYSTEMS LTD · CARDIFF · TEL: 0222 21515
WARWICKSHIRE
CAMDEN ELECTRONICS · SMALL HEATH (BIRMINGHAM) · TEL: 021-773 8240
E.B.S. LTD · BIRMINGHAM · TEL: 021-233 3045
JAXREST LTD · BIRMINGHAM · TEL: 021-328 4908
NEWBEAR COMPUTING STORE LTD · BIRMINGHAM · TEL: 021-707 7170
POINTCRAFT · BIRMINGHAM · TEL: 021-233 2325
YORKSHIRE
DATRON INTERFORM LTD · SHEFFIELD · TEL: 0742 585490
BITS & P.C.S. · WETHERBY, W YORKSHIRE · TEL: 0937 63744
SCOTLAND
A & G KNIGHT · ABERDEEN · TEL: 0224 630526
BUSINESS & ELECTRONIC M/CS · EDINGURGH · TEL: 031-226 5454
FORTRONIC LTD · DUNFERMLINE · TEL: 0383 823121
STRATHAND LTD · GLASGOW · TEL: 041-552 6731
NORTHERN IRELAND
O & M SYSTEMS · BELFAST 49440
IRE
TOMORROWS WORLD LTD · DUBLIN 2 · TEL: 00001 776861
ISLE OF MAN
DELTA SYSTEMS LTD · DOUGLAS · TEL: 0624 4586



COMPUTER APPLICATIONS

Malcolm Peltu reviews two new books on the impact of micros in communications and in industry in general and takes a look at some recent fiction.

The message medium-or, on the eighth day

Something funny happened to me on the way to reviewing *Goodbye Gutenberg*. Anthony Smith's tome on the 'newspaper revolution' which formed the basis of a recent *Horizon* programme. I couldn't get hold of a copy of the book.

Following exposure on *Horizon*, the publishers had run out of review copies. So I set off on a search which in itself is relevant to the meat of this review. I started out at my local WH Smith, then successively through a chain of bigger WH Smith's. But it seems that the limited space given over to hardback books is filled with autobiographies of TV frontmen and sports personalities and hundreds of Books Of Lists Of Books of Lists. I even found it difficult to find out whether or not *Gutenberg* was in stock in the shops.

Eventually I went to Foyles, the 'world's biggest bookshop'. I tried the technology section without finding *Gutenberg*. I asked a polite assistant who stared at me blankly and asked what it was about. I tried to explain that it was about the application of information technology to the newspaper industry. He stared blankly and took me to a more senior person. Instantly he knew where to find it in the Commerce department.

This scenario seems to be some kind of physical enactment of Marshall McLuhan's principle that the "Medium is the Message". One of Smith's arguments is that electronic information technology will turn the librarian into a "sentinel at the gateway of information and knowledge and society may come to find itself demanding to see his (sic) credentials." In other words, access to, and organisation of the database becomes crucial.

By walking between bookstores I found what I wanted. In order to do so, I had to guess at the way the book was classified and in the end was dependent on dialogue with an intelligent human being to explain my meaning.

Having found it, however, I was disappointed. A few years ago, I read an article by Smith which seemed to me to get to the heart of the way information technology is radically changing the nature of the news and entertainment media.

In that article, he pointed out that one of the virtues of current newspaper for-

mat is that they contain more than the specialist interests of any one reader. Even if the prime reason for buying a paper is the boobs on page 3, or the crossword, or Clive James' TV review, or the business section, the purchaser gets the whole paper. The *Sun* reader might therefore learn something about political developments after looking at page 3 and something on the arts page might capture the eye of the businessman. With the help of computerised technology in the US, however, papers are already getting more and more sectionalised. They become a collection of supplements, so that you can throw away the ones you don't want.

With electronic information media like Prestel, he commented, the process was taken further so that the 'reader' selects just the information needed and no more. In order to do this, a certain degree of skill will be needed to interact with the system, to scan and search the database. Smith warned that this could harm democracy because it would make the informed better informed but would remove even the incidental educational and informative effect gained from the words on pages 1 and 2 when looking for the girl on page 3.

In over 300 pages, *Goodbye Gutenberg* provides no fresh insights or even a real development of this important theme. Instead of providing what I thought would be a critical analysis of new technology, it is a technology-obsessed promotion of the wonders of technology.

Actually that is unfair. The bulk of the book is a very good, detailed study of the American newspaper industry and the impact on it of computer technology. It also has good background on the nature of electronic

news media like viewdata and the history of printing and libraries. But this well-researched core is wrapped around with flimsy and pretentious philosophising which I found hard work to digest and not worth the effort once I had. He seems so in love with the electronic medium that he fails to really question the nature of the message. By the end, information technology becomes an electronic message medium, smoothing down poetry and loveletters, timetables and invoices, births, marriages and wars into a passionless bit-stream.

Here is a typical chunk of his philosophising, full of sinewy, hard to swallow sentences and clever-sounding phrases: "Words have lost their hard edges in the age of the audio-visual. A world of facts is dissolving into a factless world overloaded with information, dominated by images. The provision of information has become the privilege of great feudalities, vast corporations that collect and disseminate material through a multiplicity of media; but at the same time the very abundance has made the receiver, the consumer, more powerful in the process of communication. The greater the profusion and the wiser the choice, the more dangerous is the fact that very few control it; but the danger is set against the greater freedom of the reader and the viewer." Phew, What a Scorcher!

His assertions are dubious. Words have *not* lost their edge. If they had, why would Smith spend so much time sculpting them? Words have weight and colour; poetry and literature are not dead — Shakespeare did not need a VDU; an abundance of information gives no power to the recipient. These are my beliefs, my assertions and I find it dangerous when

people like Smith diminish the values of wisdom, creativity, wordcraft, etc, in the flush of electro-love.

The words of Hazel O'Connor's song *On The Eighth Day* should be imprinted like a government health warning on every book about the wonders of technology. Her refrain: "Nobody laughed, nobody cried" in the world of machines could become the epitaph of the 'micro revolution'.

Although Smith makes an important point about the power of the database organiser and computer librarian, he again takes an enthusiastic step towards the Eighth Day: "Within the creative process it is becoming clear that the talent lies in the refining of past knowledge, in reformulation, in recirculation, in reordering the vast human storage of information that springs from the collective intellectual activity of the species, an unencompassable totality of versions and facts. The creative task lies in being able to manipulate this ever-expanding totality."

To support this, he quotes T S Eliot, who said that the most individual parts of a poet's work may be those in which "the dead poets, his ancestors, assert their immortality most vigorously." Smith's interpretation seems a travesty. The *human* process of *creation* does build on conscious and subconscious stimuli from the past and present and on the individual's own intelligence, emotions and creativity. This is a million bytes away from organising databases and sifting through them.

Smith also states that 'we' have passed a turning point in information development, equivalent to the creation of a diverse range of food and consumer goods, once basic physical needs have been catered for. He claims that "we" have changed "from the basic diet of mass entertainment for the work-weary to the profusion of choice required by societies where individual interests can be indulged." Perhaps too much American TV has dulled his senses.

Anyone seeing the 'profusion of choice' on American TV and most American newspapers will realise there is little choice at all — just a homogeneous wedge of blandness. More information does not mean better. More technical virtuosity does not mean more creativity.

Smith was on the original team of the original *Tonight* programme on BBC. Made in black and white, without the advantages of modern electronic technology, using jour-

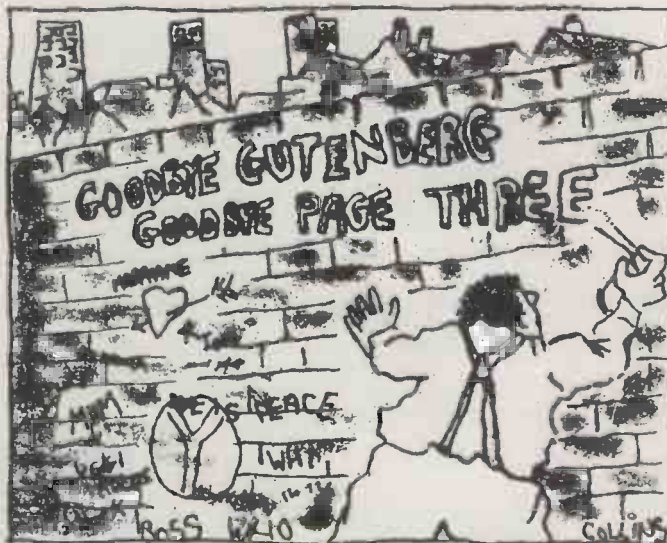



nalists with an edge to their words, this was one of the best current affairs programmes ever produced.

Perhaps he should take time out at his current job, as director of the British Film Institute, to look back at some old silent movies. In just a single reel of a Buster Keaton film, say, he will find more creativity, beauty, humour and humanity than any modern billion-dollar multi-media super-technology film.

But, despite my criticism of the book's philosophical trappings, I would recommend it strongly for anyone interested in newspaper technology, ancient and modern. Just skip the beginning and end.

Need for skills

For too long, the analysis of the employment effects of information technology was regarded as a numbers game — how many would be made employed/unemployed. Now it is being realised that there are other important issues to consider, more practical and concrete than guesstimating numbers.

One of the most important problems is ensuring that there are sufficient skilled people available to apply the technology, otherwise money will be wasted in investments in technology that prove inefficient and ineffective, or just be idle. There is no easy, flip answer to the problem. Clearly, money should be spent on training. But training who and in what skills? What order of priorities should be set? Which skills are becoming redundant and which new skills are likely to be needed?

An outline of how these training needs could be met is provided in an important new book, *Microelectronics and the Engineering Industry*, edited by Nuala Swords-Isherwood and Peter Senker of the Science Policy Research Unit (SPRU) at Sussex University.

It is based on detailed research work carried out by SPRU for the Engineering Industry Training Board and provides a detailed analysis of the skills needs in a variety of engineering processes and industries. There are chapters on assembly skills and welding, vehicle and mechanical industries, the electronics industry and offices.

Strong messages come through the book which pinpoint some of the basic reasons why British industry is melting away. In comparing attitudes in West Germany and the UK, based on a study of a number of companies, Senker comments: "It was in the area of attitudes to graduate engineers, their recruitment and deployment that the greatest difference

was found between West Germany and the UK." In West Germany, graduate engineers and technologists were recruited as a matter of routine because companies recognise the need for people with skills and innovative ideas. In the UK, however, Senker found that graduates were regarded as a 'luxury'. British management, he says, has relied on traditional apprenticeship schemes and part-time training to produce engineers. Although he believes this method has developed many good engineers in the past, it is totally inadequate when introducing new technology for which there is no existing base of experience in the company or where a broad systems approach needs to be taken.

On manpower planning, the editors conclude: "Manpower planning in even its simplest form is less practised by indigenous British companies than in foreign multinationals based in Britain." One British computer manufacturer, they say, even kept the little manpower information it had by manual methods rather than on a computer!

Inadequate manpower information can lead, for example, to a company having an ageing group of essential workers with insufficient time to recruit and train replacements. The failure to give attention to manpower planning also indicates that issues such as career development and training are regarded as peripheral to the main objectives to the enterprise.

"This contrasts most markedly with the approach of Japanese companies in particular, which integrate all aspects of the planning exercise," they say. The editors aptly summarise a crucial challenge facing British industry: "The prime requirement for competitive success and for coping with microelectronics is to have a highly educated, trained and skilled workforce at all levels. Those countries and firms which recognise this and implement appropriate policies will be successful in the microelectronics age." Their book indicates the way forward.

Unmarvellous fiction

"Time for a little light fictional relief," I thought, settling down with the latest book of *Creative Computing* stories, *Tales Of The Marvellous Machine*. But I found it heavy-going and would have given up at an early stage if I was reading it for pleasure rather than to review it.

Most of the stories could have been written by a computer, as their style generally lacks individuality or

character, although there are over 30 authors. Typically, they seem to be based on 'terminal musings', the kind of thing that a programmer might imagine while sitting at a computer terminal or personal computer. Like, "What if the computer was programmed with a human personality. . ."; "What if aliens from space used the computer to communicate. . ."; etc. Boringly etc.

The best story is the longest one, *Entelechy*, by David Sosnowski. It creates a genuine sense of mystery, of driving the reader to want to know what is happening and will happen. It has elements of mysticism, is full of poetic images and is a vivid and interesting re-working of what is basically a well-worn sci-fi idea.

Most of the others, however, would provide as much interest (or lack of it) if they were reduced to two-paragraph summaries. The first paragraph would explain the idea behind the story, such as: "Will people care about intelligent robots as if they were friends? What will happen when such a robot is being traded in at a second-hand robot store?" The second paragraph will give the punch line. (I won't in this example, which is *The Used Computer Dealer* by Stephen Kimmel, in case you want to find out for yourself.)

Even the well-known sci-fi writer Frederik Pohl falls into the dull mode of the rest of the book. Besides Sosnowski, only two authors display a strong literary style — and these are parodies of other authors'. Dick Hoover's *Legend of Jimmy The Green* is an uninteresting story made enjoyable by being written in the style of Damon Runyon. And Ian Malcolm Earls produces a numerical puzzle which would have been interesting as such but is boring in the guise of a wearisome mimicry of Conan Doyle in Sherlock Holmes and Charles Babbage (would you believe?).

But I would like to claim a place in the *Guinness Book Of Records* as the first book critic to find a numerical fault in a literary work.

To prove that *Creative Computing* knows how to sort lists, the book has 14 different indices, such as alphabetical lists of titles, physical locations, those stories which are about 'improving the human lot' and those about 'computers as they are now'. One list is by length of words — and I am sure that the story *Pulling the Plug* is nowhere near its claimed 3740 words.

If the *Creative Computing* book is largely based on the fantasies of frustrated programmers, *Programme for a Puppet* reads like the fantasy of an Australian journalist who has dabbled

with writing about computers, has lived in Earls Court and dreamed of living in Strand-on-the-Green (in-joke for those who know London) and has realised that topical adventure yarns which interweave politics, spying and screwing have a good chance of selling well.

The author, Roland Perry, wrote about computers, economics and politics on the *Melbourne Age* for five years and lived in London and New York. The hero of the book is an Australian journalist in Europe.

Its plot combines big business corruption, spying, killer thugs, computer smuggling to Russia, thrusting buttocks and undulating curves. The hero fights a battle against Lasercomp, a giant computer manufacturer — clearly with a satirical hint of IBM — which develops a programme to install a puppet president in the US to carry out its will.

If this sounds like your can of Fosters, you will probably enjoy it. But once again, I read this one for business reasons, not pleasure.

Sounds goods

Here is a book which sounds interesting, has lots of interesting and witty drawings, chapter titles and section headings but is still searching for the appropriate text to fit the packaging.

Computer Consciousness — Surviving in the Automated 80s sounds intriguing, doesn't it? And how about chapter titles like *Fauna of the Solid-State Age*?

In fact, this book is nothing more than yet another introduction to basic computing concepts. As such it is a rather mundane and workmanlike description, ranging from hardware to the human factor in applications. The illustrations are the best part but the overblown title and packaging make it all seem a bit silly.

Reviewed in this month's Bookfare were:

Goodbye Gutenberg by Anthony Smith (Oxford University Press, £8.50). *Microelectronics and the Engineering Industry* edited by Nuala Swords-Isherwood and Peter Senker (Frances Pinter, £10.00). *Tales of the Marvellous Machine* edited by Robert Taylor and Burchenal Green (Creative Computing Press). *Programme for a Puppet* by Roland Perry (Hamlyn Paperbacks, £1.25). *Computer Consciousness* by H Dominic Covey and Neil Harding McAlister (Addison-Wesley, £3.85).

15 good reasons for visiting Cambridge

1. Sharp Pocket Computer
2. TRS-80 Model I & II
3. Apple II & III
4. CBM (PET) 3000
5. North-Star Horizon
6. Cromemco
7. Hewlett-Packard HP-85
8. Acorn Atom
9. UK-101
10. X-Y Plotters
11. Qume
12. Farm Systems
13. Word Processing
14. Computer Books

With a uniquely comprehensive selection like this — all generally on demonstration and available from stock with full support by our team of computer professionals — you'll have the ideal chance of finding precisely the right system for your application.

Looking for a microcomputer? — then visit us at:

Cambridge Computer Store

1 Emmanuel Street Cambridge CB1 1NE
Telephone: (0223) 65334/68155



New Seikosha GP 80 Printer for educational and home use.

Smallest, plain paper 80 column printer on the market.

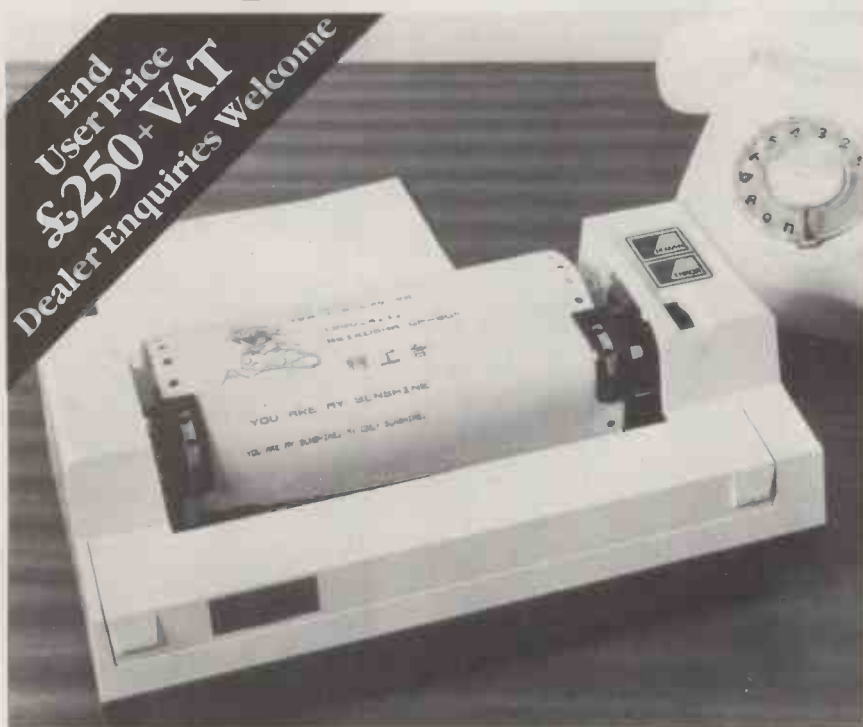

Features:

Plain paper
80 column width
30 cps
Full ASCII character set
Graphics facility
5 × 7 dot matrix
Double width characters
Pin feed
Centronics interface standard

Other Interfaces and cables available:

IEEE/488, PET, TANDY,
APPLE, RS/232C.

Ring DRG Systems Supplies for your nearest dealer.
13/14 Lynx Crescent, Winterstoke Rd.,
Weston-super-Mare, Avon B24 9DN.
Tel: (0934) 416392

(DRG) A Dickinson Robinson Group Company.

Personal Computer

World

FEATURE INDEX

Index to current volume, up to, and including, last month. (Previous volumes were indexed in March and April 1980 issues)

Hardware Projects

Z80 Homebrew	3-1
Selective PROM copier	3-3
TV to Monitor conversion	3-3
MK-14 Expansion	3-4
Teletypewriter conversion	3-5
Adding a Z80 to a 6800 system	3-7
VCR to PET interface	3-8
MK14 large LEDs	3-9
Sound Advice	3-10
Int IMP printer to TRS-80	3-11

Benchtest

Luxor ABC 80	3-1
WH 89	3-2
ACT System 800	3-2
Panasonic JD 700 U	3-3
Sinclair ZX-80	3-4
Challenger C2 4P	3-4
Texas Ti 99/4	3-5
Altos ACS 8000-2	3-5
Hewlett Packard HP-85	3-5
Benchmark Timings summary	3-5
TRS-80 Model II	3-6
Sintrom Periflex 630/48	3-6
Acorn Atom	3-7
DDE SPC/1	3-7
Super Brain	3-8
BASF 7120	3-9
CBM 8032	3-9
DAI Personal Computer	3-10
Atari 400 & 800	3-10
Benchmarks explained	3-10
SBS-8000	3-11

Series

PASCAL	3-1, 2, 3, 4, 5
David Levy's Games	3-1, 2, 3, 4, 5, 6, 7, 8, 9, 10, 11
On the line	3-1, 2, 3
Viewdata	3-4, 5, 6
Pascal Part 10 — Concluded	3-6
IEEE interface — Part 2	3-6
Chess	3-7, 8, 9, 10, 11
Gateways to Logic	3-7, 8, 9, 10, 11
Face to Face — the man/machine interface	3-7, 8, 9, 10, 11
Network Notes	3-7, 9
Secrets of Systems Analysis	3-9, 10, 11
PCW Sub Set	3-9, 10, 11

Fact Sheets

6800 opcodes	3-1
6502 opcodes	3-2

Personal Opinion

The end of work? Lord Avebury	3-1
Protest against technological determinism	3-3
Who needs the CRA?	3-4
Schools computing — David Firnberg	3-4
Stating the obvious	3-5
Micros in big businesses	3-5
Animistics — a look at 'friendly' computers	3-7
Computer/Information technology & the law	3-8

Evaluations (Checkout)

Video Genie	3-2
Vector Graphic Flashwriter II	3-2
Apple II Symtec light pen	3-3
Microdata UV8 EPROM eraser	3-5
Softy intelligent EPROM programmer	3-6
Exatron stirngy floppy 380Z High	3-6
Resolution Graphics	3-7
ROMPLUS+ for Apple II	3-8
Hi-Tech VDU board	3-9

Calculator Corner

TI 58/9 Pseudo opcodes	3-1
Casio Fx 502P Brag	3-1
Casio Fx 501/2P Master Pack	3-2
TI 58/9 Economics Simulations	3-2
Programming efficiency	3-3
Casio random number generator	3-3
HP 41C review	3-4
Artificial Intelligence	3-5
Accounts on TI-59	3-5
Data Packing	3-6
Sharp PC1211 evaluation	3-7
Pentathlon program	3-8
Aid for the blind	3-9
Godel, Escher, Bach	3-10
Casio Quirks & Data Packing	3-11

Indexes

Back Issues 1-1 to 2-4	3-2,3
Back Issues 2-5 to 2-8	3-4

Special Features

Computer Retailers' Association	3-1
Christopher Evans tribute	3-1
Show chess results	3-1
The British Computer Society	3-2
Astrology — case study	3-2
IEEE-488 bus explained	3-2
Economic simulation	3-3
Modern evaluations	3-5
5th West Coast Faire report	3-5
Wave Synthesis on Nascom 1	3-5
Overcoming PET printer problems	3-5
Random numbers	3-5
Sound to colour conversion	3-3
American report	3-3
Simple approach to programming	3-3
Communication aid for disabled	3-4
Imphex — intelligent game PET	3-4
House of Commons report	3-4, 9
Interrupt handling	3-6
Case Study — CompuColor installation	3-6
Poem	3-6
Power supplies explained	3-6
Power supply design	3-6
Program structuring in Basic	3-6
Sandbach school system	3-6
M68000 preview	3-7
Case Study — Apple Installation	3-7
3-D Plotting	3-7
Cassette files	3-8
Printer survey	3-8
Basic Basic	3-9
Worl Micromcomputer Chess Championship	3-9
Portable Basic	3-9
Parkinson's Pep-up	3-10
Bare Bones of Robotics	3-10
Helping the Handicapped	3-10
Another Dimension	3-10
Computertown UK	3-11
Apple/ITT colour graphics	3-11
Reader Survey	3-11
Forecasting	3-11
PCW Show round-up	3-11

Package evaluations

Sales Ledger	3-1,8
Purchase Ledger	3-2
Payroll	3-3
Word Processing	3-4
Information retrieval & databases	3-5

Integrated accounts packages	3-6
Stock Control	3-7

Programs

BASIC Star Wars	3-1
PET Alien Attack	3-1
Revas (conclusion) REverse assembler for Z80	3-1
Planet name generator	3-1
6800	3-1
MK-14 scrolled messages	3-3
6800 Keyword retrieval system	3-3
PET Kaleidoscope	3-3
Efficient character storage	3-3
Z80 Assembler	3-3
UK101 Dodgems	3-4
TRS-80 Fox and hounds	3-4
MZ 80K Sine wave addition	3-4
PET Backgammon	3-5
UK101 Nedge	3-6
PET Horse race	3-6
BASIC Renumber	3-6
Naming Nascom files	3-2
380Z Pictures	3-2
Fuel tank calculations — PET	3-2
PET large numeral generator	3-2
PET tank battle	3-2
BASIC string handling routines	3-2
UK101 Dogfight	3-6
MK 14 Frequency counter	3-6
North Star Maths test	3-6
PET Sweeper	3-6
PET Delete/Renumber	3-6
PET Cat and Mouse	3-7
UK 101 Graph Plotter	3-7
UK 101 Black Box	3-7
TRS-80 Graphics	3-7
PET Robot Nim	3-7
PET Golf	3-7
PET Nightmare Park	3-8
PET Dots & boxes	3-9
PET Bloobers	3-9
PET Demolition	3-9
Apple Showpiece	3-9
PEEK & POKE for Apple Pascal	3-9
PET Giant Slalom	3-9
Speed & Acceleration	3-9
PET Racer	3-10
PET Fighter Pilot	3-10
UK101 Graphics	3-10
Apple Plotting	3-10
UK101 Gunfight	3-10
PET Algebraic evaluation	3-10
ZX80 Breakout	3-10
PET Ski	3-11
MZ-80K Bouncing ball	3-11
Superboard/UK101 Bug bypass	3-11
PET Replace	3-11



Wiley

Two Important New Books
From Wiley

USING CP/M

by Judi M. Fernandez and Ruth Ashley
Duotech, San Diego

Here is the first complete, detailed self-paced introduction to CP/M (Control Program/Micro Computers), the most widely used microcomputer operating system. By fully understanding how the CP/M software package works, you can operate your computer at its full potential, performing routine work functions and sophisticated tasks with maximum flexibility and efficiency. The book can be used with any hardware that uses CP/M.

Two best-selling Wiley computer authors explain in logical sequence how to implement all the functional programs provided by CP/M. Shows how to create, erase and copy files, run other programs, translate and test 8080 assembler language programs, print data from files, displays the directory of a disk and more. This clear, comprehensive guide assumes no prior computer experience.

A Wiley Self Teaching Guide

November 1980
0471 08011 X

approx. 300 pages
(paper) £5.95

PASCAL PROGRAMMING

by Lawrence Atkinson
Dept. of Computer Science
University of Sheffield

A first course on Pascal Programming which can be used as an introductory text for those with no previous knowledge of programming or as a conversion text for those with experience of some higher level programming language other than Pascal. Topics are introduced in an order which has the learner in mind but each topic, once introduced, is covered fully which will make it useful as a reference text.

Top-down design is applied throughout and top-down testing is stressed as an integral part of the refinement process. Complete programs are introduced in the first chapter and throughout the book, points are illustrated by examples taken from a variety of applications.

Wiley Series in Computing

October 1980
0471 27773 8
0471 27774 6

438 pages
(cloth) \$16.50
(paper) \$6.95

John Wiley & Sons Limited

Baffins Lane · Chichester · Sussex · England

MICRODIGITAL



COMPUTER VOUCHER

Valid until 31/1/81 on any purchase over £100 –
one voucher per sale . . .

CALL IN TODAY for Sharp, Apple,
Video Genie, Atom, Printers, Software, Books.

MICRODIGITAL



Retail Premises at:
25 BRUNSWICK STREET,
LIVERPOOL L2 0PJ.
Tel: 051-227 2535/6/7

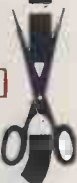

CHRISTMAS OFFER

THE SHARP MZ-80 COMPUTER SYSTEM



20% DISCOUNT (CASH, COLLECT)
+ 5 FREE GAMES OF YOUR CHOICE

Sharp's largest
dealers we supply complete MZ-80
systems including FLOPPY DISCS and PRINTERS.

We have considerable experience in
implementing SALES, PURCHASE and NOMINAL
LEDGERS, PAYROLL, STOCK CONTROL,
FOREIGN EXCHANGE and FINANCIAL
PROGRAMMES.

Contact us now for details on 01-247 8506.



Stone House, Houndsditch Entrance
128-140 Bishopsgate
London EC 2M 4HX



MICROWRITER



The Microwriter attracted much publicity when it appeared a couple of years ago, along with some scepticism as to its practicality. Can you learn to type with just one hand? Peter Rodwell reports.

About six years ago, writer and word-games addict Cy Endfield, an expatriate American living in London, bought one of the early pocket calculators. It struck him that a calculator-sized device with an alphanumeric keyboard and display would make the ideal basis for a word-game he'd invented — but he didn't like the idea of a full keyboard with one key for each letter of the alphabet. It would be too fiddly, he thought.

Thus was born the idea for the Microwriter, a device which would allow you to type alphanumerics using just one key for each finger and pressing them in various combinations to produce the required characters.

There was a problem, though. To do this you'd have to memorise the key combinations, and that seemed an almost impossible task to ask of anyone. Also, decoding the key combinations and producing characters from them seemed rather complicated.

Two innovations changed this. Firstly, the development of micro-electronics — and, in particular, the availability of low-cost CMOS chips —

made the decoding task easy. And Cy himself solved the key combinations problem by hitting on the idea of using the shapes of the letters themselves as mnemonics.

These two innovations made the Microwriter not only a possibility but a practicable reality and Cy quickly developed the idea beyond the stage of a word-game to that of a fully-fledged text inputting and storage device, which is the stage the Microwriter is at now.

Getting the Microwriter into production wasn't easy, and Cy Endfield has quite a horror story to tell about his experiences when trying to get backing. His big break came when his invention was shown on *Tomorrow's World* and caught the eye of a director of Hambros Life Assurance Ltd. The result was Microwriter Ltd, owned jointly by Cy Endfield and Hambros, which has been producing Microwriters for the last two

Above — the Microwriter with some of its interfaces: at the back is the TV interface with a sample display; centre left is the printer interface and to its right, the cassette interface and recorder.

years or so and has already sold some 500 of them.

Hardware

The Microwriter comes in a rugged, well-made plastic casing and has a 12-character alphanumeric display formed with 16-segment LEDs. The device is operated by six keys, one for each finger and two for the thumb; on the front edge are the on/off switch, battery charger socket and a nine-pin socket for the tape, TV and printer interfaces. The unit comes with a neat zip-up carry case and a battery charger; at about 11 cm wide, 22 cm long and 6.5 cm high, it's not pocket-sized but will fit into a large briefcase.

Inside, an RCA 1802 CPU does all the hard work, aided by assorted CMOS chipperies with 2k of EPROMs to hold the firmware and 8k of RAM in which the text is stored; throughout, the standard of construction is neat and professional. Under the frontal 'hump' on which you rest the palm of your hand is a set of rechargeable batteries which permanently powers the RAM so that its contents are preserved

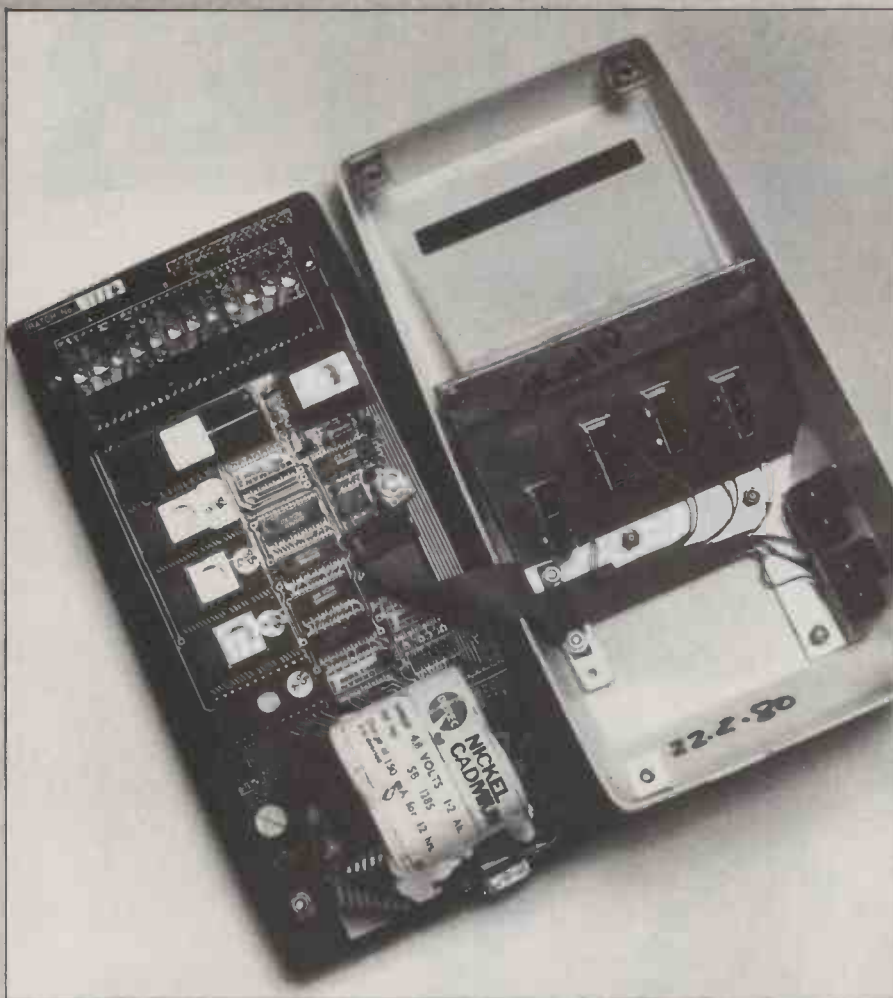

Inside the Microwriter. The RAM lives on a second PCB under the board you see here.

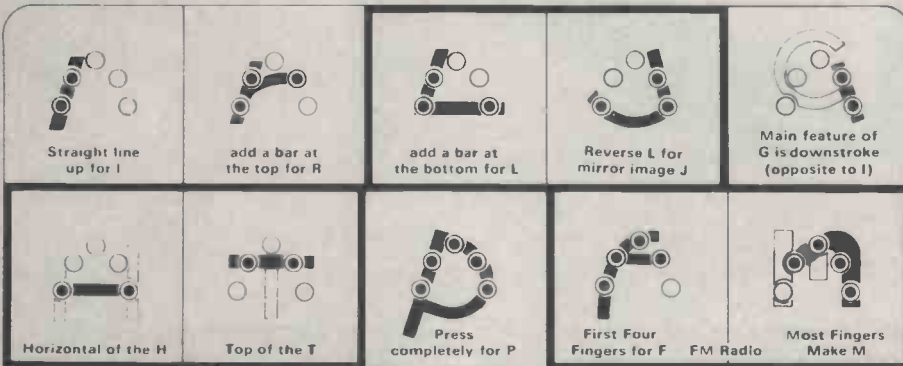

Fig 1 Part of the alphabet learning card.

while the main power switch is off — for up to six months, claims Microwriter, if the unit is unused. The batteries are good for about five hours' continuous use and the device can be used while being recharged. A flashing '!' on the display warns when the battery charge is getting low and if this is ignored the unit will eventually shut itself off to preserve the memory contents.

I had only two dislikes on the hardware side. I would prefer an LCD display — perhaps with more than 12 characters — to the LEDs and I found the keys too sensitive; Microwriter claims this is deliberate to allow faster use but I still think they're a mite too easily triggered accidentally.

In use

On power-up, the Microwriter displays its name; pressing the upper thumb key (actually the 'space' character), replaces this with 'START' on the left side of the display and the unit is then ready

for use.

All letters, numbers, punctuation marks and other characters are typed in by pressing the four finger and upper thumb keys either singly or in combination. The lower thumb key is roughly equivalent to a computer's control key — I'll expand on its use later. Each letter only appears on the display when the keys are released so you don't have to try to press or release them absolutely simultaneously.

On the version I used, I counted 59 key combinations which displayed characters, with a further 26 control combinations, some of which involved entering two characters. An enhanced version of the software will shortly be available with further characters and commands.

Earlier, I mentioned Cy Endfield's system for memorising the key combinations, without which the Microwriter would be virtually unusable. It involves visualising the shape of each

letter or symbol and pressing those keys which form the outline or salient points of that shape. Figure 1, taken from one of the handy learning cards supplied with the machine, gives a far better idea of how this works than I could explain in words. Note the little mnemonic phrases that go with each letter: although one or two of these are a little contrived, they really do help with the learning process.

The Microwriter has two 'registers' (as the manual calls them): 'alpha' and 'punctuation'. At power-on the machine is automatically in the alpha register, in which all letters of the alphabet plus the most commonly-used punctuation marks — full stop, comma, hyphen and apostrophe — are available. Pressing the control key by itself latches the device into the punctuation register (denoted by a Union Jack-like symbol on the display) where numerics and other punctuation marks are available together with symbols such as '@' and '%'; in fact all the symbols you normally find on a typewriter are available on the Microwriter except for fractions. In this mode, the control key has a toggle action — pressing it again puts you back into the alpha register.

There are separate learning cards for punctuation and numerics and, again, a lot of thought has gone into making the learning process easy. The '£' sign requires the same key combination in the numeric register as that which, in the alpha register, produces 'L', for example (although the resulting display character looks a little odd); similarly, '?' uses the same key combination as 'Y' (mnemonic 'why?'); and numeric '0' is the same key as letter 'O'.

The control key also functions in combination with other keys to allow a range of commands to be executed. This is mostly achieved using letters whose key combinations normally include the thumb key, except that the control key is used instead. Again care has been taken to make them easy to remember: you press CTRL-J to Jump back through text, CTRL-I to Insert text, for example. Many commands can be extended by first typing CTRL-Y; so while CTRL-F moves the display Forwards by one character, the sequence CTRL-Y, CTRL-F gives continuous forward scrolling — which you can Halt by hitting CTRL-H.

Text can be divided into separate blocks by inserting special block start and end symbols. This is necessary for printing or recording on cassette, as I'll explain later. It's also useful for deleting sections of text — you simply insert markers around the unwanted section, position the display anywhere within that section and type CTRL-W twice to Wipe it out.

The LED display shows all characters in upper case but the Microwriter stores them — and sends them to the printer — as lower case. Upper case characters can be defined single by typing CTRL-Y before you type the character, and the equivalent of a shift lock is available by pressing CTRL-P (for Permanent capitals). Upper case characters are denoted on the display simply by their flashing quickly, which I found slightly irritating.

As I said earlier, the Microwriter has an 8 kbyte text buffer, enough for about 1500 average-length words. When the buffer is full, the words 'MEMORY FULL' appear on the display; unfortunately this crashes the machine and you have to switch off then on again before you can do anything more, such as save what you've just written onto cassette. The next software release will contain a 'Memory full' early warning to eliminate this.

Learning

Learning the key combinations is, of course, the whole key to using the Microwriter and it's remarkably easy. It took me about half an hour to learn the alphabet and about the same period to learn the numerics, punctuation marks and assorted symbols.

Once the key combinations have been learnt, the rest is a matter of practice to build up speed. At first I found it quite frustrating — although I *knew* the combinations I still had to think before pressing the right keys.

too, had been overcome, although I still needed to refer to the learning cards occasionally for some of the lesser-used symbols such as '*' or '&'.

From what Microwriter tells me, this seems a reasonably typical learning curve; unfortunately I didn't have time to contact Microwriter users and compare notes — I'd be interested to hear from any Microwriting *PCW* readers.

Microwriter claims that speeds in the region of around 45 words a minute are possible. This is far faster than handwriting but slower than the faster typists. Although I've yet to reach this level of proficiency, I've certainly passed handwriting speed — it's now actually quicker and easier to use the Microwriter than to write in longhand. Despite several attempts to learn touch-typing, my typing still follows the Biblical method ('Seek and ye shall find. . .') so the Microwriter wins hands (or, rather, hand) down in this respect for me. (It occurs to me that you might be able to reach dictation speed using Speedwriting-style abbreviations on the Microwriter — then, if you were really clever, you could play it back into a word processor equipped with suitable

translation software! If anyone does this, I want a royalty.)

So I found learning to use the Microwriter quite easy — far easier than learning to type. This review was written entirely by Microwriter, in fact.

An interesting aside: I'm left-handed and the Microwriter is designed for use with the right hand yet, apart from an initial clumsiness which soon vanished, I had no difficulties. Microwriter is contemplating a left-handed version, aimed primarily at disabled users, but which some non-disabled sinistrals might prefer; I'm not sure how the key combinations would work, though.

A user's handbook comes with the Microwriter and explains every detail of its operation as well as reproducing the charts of key combinations. It is clearly written and logically laid out, although I spotted a couple of spelling mistakes. It was, of course, written using a Microwriter.

Interfaces

The Microwriter can be interfaced to a cassette recorder, a monitor or TV set and a printer. So you can save text, retrieve it, edit it, format it for printing on a screen, and print it.

The cassette interface is a calculator-

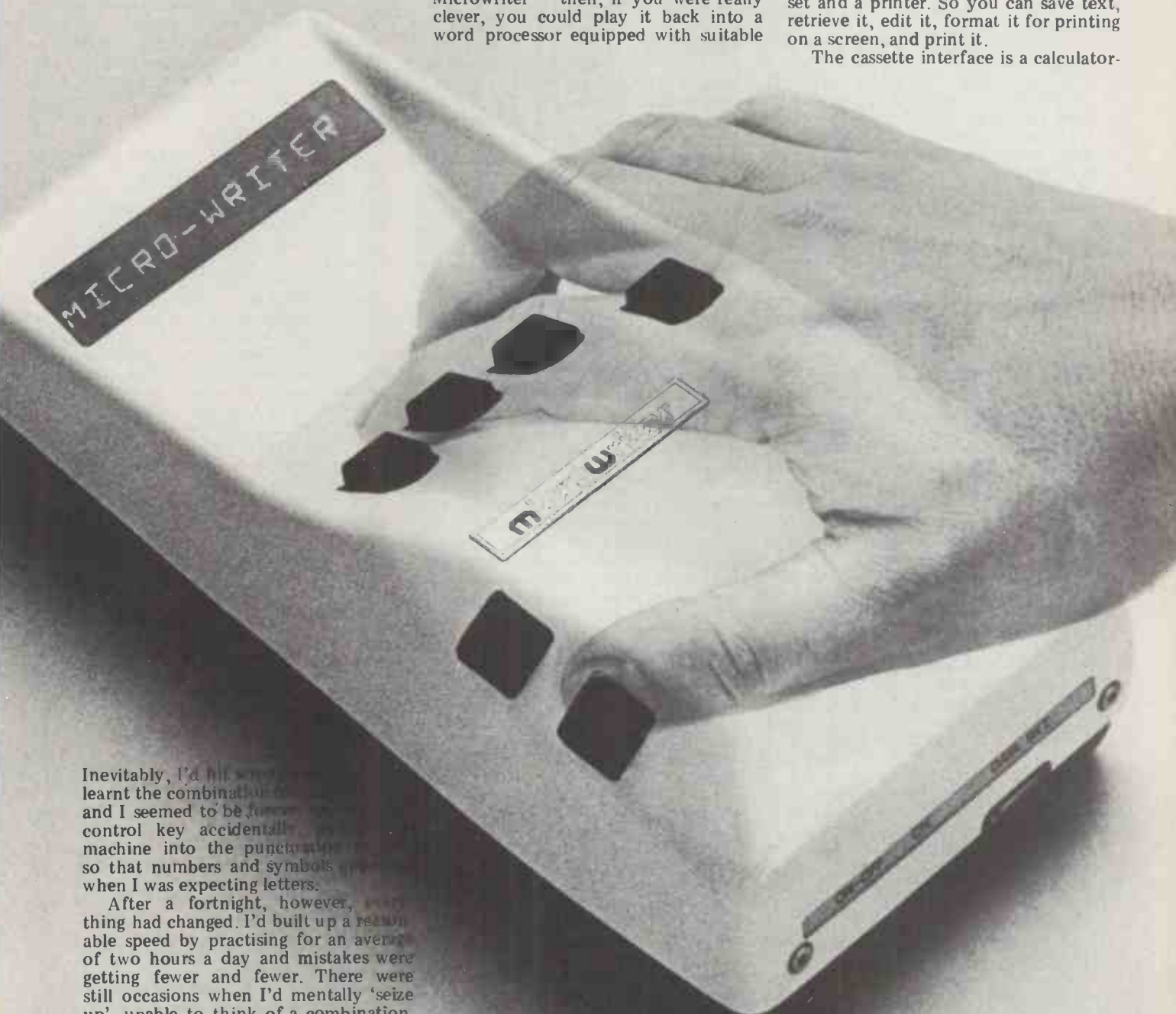

Inevitably, I'd hit some of the control key accidentally and I seemed to be turning the machine into the punctuation key so that numbers and symbols appeared when I was expecting letters.

After a fortnight, however, something had changed. I'd built up a reasonable speed by practising for an average of two hours a day and mistakes were getting fewer and fewer. There were still occasions when I'd mentally 'seize up', unable to think of a combination, but by the end of the third week this,

sized black box which plugs into the Microwriter and a recorder, and it takes its power from the Microwriter. Having found the text block you want to save, and positioned the display anywhere between the start and end markers, you just type CTRL-Y, CTRL-W. The words "TAPE WRITE" appear on the display until the block has been saved. At 1200 baud it takes about a minute to save an entire memory-full of text and each cassette holds up to ten loads per side. However, the user's manual sensibly warns against putting too many blocks onto one tape without recording verbal leaders to identify each one. Foolishly I ignored this advice and managed to overwrite a hefty portion of this review — the fault was entirely mine, not the machine's.

Microwriter supplies a Lanier micro cassette recorder with the interface, which is set up to operate specifically with this recorder. I tried three other recorders without success, despite much fiddling with volume controls. However, if you already have a recorder, Microwriter will sell you the interface by itself and set it up to work with your machine.

Retrieving text from tape is similarly straightforward — plug in, switch to play, and type CTRL-Y, CTRL-R. "TAPE READ" pops up on the display until the block has been read in. Using markers to define text blocks, you can add text to whatever's already in memory and concatenate them afterwards by removing the markers. Using the Lanier, I found the whole process reliable and trouble free, but if the Microwriter encounters garbage during the read process, it aborts the read and flashes a symbol to warn you.

The TV interface is housed in a largish Verobox, is mains-powered and has both monitor and UHF outputs. Using simple commands, you can display up to 16 lines of text on screen; the characters appear in black on a grey background with upper case characters in white. I tried a monitor and both black and white and colour TVs, which gave respectively excellent, good and slightly fuzzy displays, although all three were rock steady.

If you're working on a long text block, the video interface is almost essential. A 12-character 'window' into the Microwriter's memory just isn't enough for editing, particularly as the scrolling speed is rather slow — again, Microwriter intends to remedy this in the next software release, which will have two scrolling speeds.

Using the screen, you can format text for printing, as the text appears exactly as it would when printed. Formatting is a little rudimentary — you can set the left hand margin and insert tab characters; both work in five-character units. On both screen and printer, a line of 55 characters is output and a carriage return performed at the next space character in the text stream. You can, however, insert a special character to force a CR whenever you want one. Right-hand justification isn't available.

On-screen editing or writing isn't possible... yet. On the machine I used you could only dump to the screen; if you didn't like what you saw you could edit the text in the Microwriter but you then had to re-dump it to check

that you'd got it right. Again, this is to be remedied soon, with on-screen writing and editing facilities.

The printer interface is identical in appearance to the cassette interface and is also Microwriter-powered. There are two print commands, one giving single line spacing and the other giving double spacing. Printing can be stopped at any time with CTRL-H. Microwriter sells two printers, a typewriter-quality Ricoh daisywheel and a cheaper, dot matrix Centronics unit.

Although the interfaces were easy to use they didn't seem to have been given the same degree of thought which has gone into the Microwriter itself. You can only plug in one at a time to the Microwriter, so if you're involved in a long taping, editing and printing session, you're continually swapping plugs around. You also end up with quite a tangle of wires when using the three interfaces together; I'd have preferred a cradle-type arrangement to house both printer and cassette interfaces, into or onto which the Microwriter could fit, with three output sockets to eliminate all that plug-swapping.

Users

So who's going to use a Microwriter? Well, just about anyone who needs to put words onto paper. Cy Endfield sees it as much, much more than a replacement for the typewriter keyboard — he considers it as a pencil and paper replacement.

Personally, I can see a big sales potential for executives in the much-heralded office of the future. Few executives are likely to have either the time or inclination to learn touch-typing but most could Microwrite with ease. Interestingly, Government departments are keen Microwriter users; apparently there's a Home Office section which uses them to produce neatly-typed documents on subjects too hush-hush to be entrusted to typists.

PCW readers will be particularly interested to hear that software upgrades coming soon will turn the Microwriter into a full RS232 terminal with an ASCII character set. As personal computers become even more widespread, Microwriter terminals could make life easier for people who have difficulty with typewriter-format keyboards. It can also be linked to a voice synthesiser, which could be good news for the blind.

Even more interesting is the possibility of giving the Microwriter intelligence. Thus you would be able to link up to a computer through an RS232 interface or by telephone using an acoustic coupler. You could then download a program and run it locally; apparently this is already being experimented with.

Cy Endfield is particularly keen to see children using the Microwriter and, having seen how quickly kids pick up the basics of computing, I think they'd take to it very quickly. This conjures up a vision of some future society in which handwriting becomes a totally forgotten art and paper becomes just a wrapping material, as everyone Microwrites onto TV screens — unlikely, I'll grant you, but I'm certain that a great many people would find the Microwriter an extremely useful device. Its potential is enormous.

Conclusion

I found the Microwriter easy to both learn and use and, as my expertise with it increased, so did my enthusiasm. It's an addictive device, in fact, and I'm now starting to wonder how I ever managed without one.

There are several small points which need refining. The next software release will cover these and a few more — some of the control sequences will be simplified, there'll be a two-way communications facility for use with other equipment, such as computers, and jumping about within the text block will be refined, to mention only a few of the proposed enhancements. All the points I put to Microwriter were, in fact, answered with: "We're doing that in the next release," and I'm looking forward to trying the enhanced version.

On the hardware side, the interfaces certainly need tidying up. Trailing wires are dangerous as well as messy and constant plug-swapping is annoying.

On the whole, though, I was thoroughly impressed with the amount of careful, logical thought which has been put into the Microwriter to make it easy to learn and simple to use. Microwriter likes to maintain close links with its customers and encourages feedback; many suggestions from real users have been — or will be — incorporated into the device.

But there's a snag — it's not a cheap device, as you can see from the price list printed elsewhere in this review. In fact, I think it's very overpriced, especially when you consider that you can buy, for example, a 16k TRS-80 Level II — a machine of far greater complexity than the Microwriter — for nearly £100 less. The reason is, of course, that Tandy churns out TRS-80s in far greater volume than Microwriters; hopefully, if/when the Microwriter catches on and gets into high volume production, its price will drop. There's a nested snag here, of course, in that some may say that the Microwriter requires a careful learning period before you can use it, and thus isn't suited to volume sales. But this really doesn't hold water — a personal computer requires a lot more effort to learn to use, and in use requires continual mental effort; once you've learnt to use a Microwriter the only skill required in its continued use is a small degree of manual dexterity. In short, volume sales and volume production should be no problem, especially as Microwriter's user manual and teaching cards are far clearer and easier to follow than many personal computer manuals.

Prices

Microwriter with carry case & battery charger	£485
Cassette system	
Interface only	£60
Interface with Lanier recorder	£165
RS232 interface	£60
TV system	
Interface	£165
12-inch monitor	£130
Printers	
Ricoh RP40 daisywheel	£1100
Centronics dot matrix	£550

These prices are one-off end user prices — quantity discounts are available on the Microwriter itself. Prices exclude VAT.

SECRETS OF SYSTEMS ANALYSIS

PART 4

The pace hots up as Lyn Antill relates the user's needs to the various elements of hardware and software.

Do you need a computer?

I almost made the mistake of giving this section the title "Do you *want* a computer?", but that's a silly question — of course you want one, because they're such fun. In serious systems analysis you cannot totally ignore what the user fancies (if only because it provides good motivation to get over the effort of installing a new system) but you do have to put such things into perspective. So, back to the serious business.

Once the user's requirements have been established, there is one question which must be honestly faced: "Will these requirements best be met by a micro?" Some uses will be too small, others too large, some again will be impractical. The Bakery Dept at a London Polytechnic was faced with new EEC regulations that demanded that loaves of bread should have a certain average weight (rather than the minimum weight of UK regulations). To find out whether a lightweight loaf is acceptable some statistical calculations are necessary. To give the students practice in these calculations the teacher needed to generate random numbers to simulate the weights of imaginary loaves. The department wanted to buy a PET for this even though it was pointed out to them that random number tables cost 50p. In this case the computerised solution was 1000 times more expensive. (To be fair, though, the secondary benefit of exposing bakery students to microcomputers more than justified that expense, and the *real* reason is not always the one that is officially given.)

The sorts of factors which indicate that a computerised solution would be appropriate are:

- lots of routine work all to be done in the same way, or at least in a limited number of clearly defined ways;
- repeated calculations using a pre-determined formula;

- storage and retrieval of clearly defined data (ie where each record can have the same fields);
 - results are wanted quickly (for long calculations or searches through data files);
 - special machine features are required.
- Factors against a computerised solution are:

- lots of exceptions and one-offs;
- rapidly changing work (it takes time to write programs);
- the effort and expense of creating the computer system and the disruption of implementing it aren't justified by significant improvements in performance.

What size of computer?

It is an underlying assumption of this series that a microcomputer will be required but there is obviously an overlap between what can be done on the largest micros and the smallest minis. (The LSI 11 is designed to imitate the PDP 11, and Superbrains can be linked together to create a distributed network). Also a fairly wide range of sizes and speeds of micro cater for different requirements.

You will need a fast machine with a large memory if:

- you want to program in structured high level languages (eg Pascal or Cobol rather than Basic);
- you want to do regular word processing (this gets much slower if text is continually being stored on disk rather than holding large chunks of it in RAM);
- you want to do hefty calculations on large matrices;
- you want to do file sorting (ie you want to resequence your data).

You can get away with a smaller machine if:—

- you only need short Basic (or assembler) programs;
- you intend buying existing short

- programs which do not have large storage requirements;
- you wish to play around with the basic model now and expand it later (some micros are readily expandable with plug-in memory and peripherals);
- you're an educational establishment troubled by spending cuts and anything is better than nothing.

With experience a programmer can look at a problem and estimate the size of the program required to solve it. Comparison with showroom samples of which the size is known would also help to give an idea of the sort of size involved. Sizes are measured in k, which stands for 1024. On a micro this is normally a measure of the numbers of characters which can be stored. On an 8k PET the user has 8000-odd characters to allocate between programs and data, with another 8k of ROM holding the Basic interpreter. Other machines don't have Basic in ROM and so require 16k to run the same programs. At the very bottom of the scale, process control programs in assembler or Forth can be fitted into 2k. An 8k machine will serve as well as a large calculator. Business software will range between 16k and 64k, depending on two things — the number of checks and safeguards built into the program and the amount of data held in store at one time (small machines spend more time shuffling data on and off disk). For word processing — Wordstar, for example — 32k is possible but it will work much faster with 48k or 64k.

Different micros actually do their processing at different speeds. This is referred to as the clock speed and is measured in MHz (megahertz). It's the frequency of the clock pulse that determines the speed of the micro; 2 MHz and 4 MHz are common values, 4 MHz being the faster. The 68000 processor promises speeds up to 10 MHz.

If you are going to be doing much searching through data tables, re-arranging word processor text, or repeated calculation, then you could

be spending a lot of time waiting for answers. If that time is expensive then a faster machine could be cost-justified. But if your speed of operation is governed by the speed of a two-finger typist, then faster computing isn't going to help.

Tapes or floppies?

If your computer is going to do the same job all the time, or at any rate for long periods, then you want to start thinking about getting the program burnt into ROM (ie getting it put permanently into Read Only Memory and plugged directly onto the board). To store programs for more general use, however, or to store data for use on another occasion, the most common choice is between cassette tapes and floppy disks, with disk drives costing a good £500 more than tape decks.

The simplest machines, such as those at the bottom of the PET and Tandy ranges, have a single tape drive. This can be used for storing — and later reloading — programs, and also for storing data from one run to the next. The limitation on the data storage is that it all has to be read in from the input tape, stored in the machine, updated and written out onto a new output tape. This can be perfectly successful where the amount of data is strictly limited so that it can fit into whatever memory space isn't taken up by the program.

One City bank reckons to have stolen a lead over its competitors with such a system. The data in this case are a list of all the interest rates and exchange rates of different currencies against the dollar, perhaps 400 items in all. Now the bank can quickly work out exchange rates and interest rates for trading what it calls 'cocktail' currencies (where a single sum may be composed of several different currencies, such as Special Drawing Rights). Before the bank bought the PET, that information would have been written down on N sheets of paper, or taken from rates chalked up on a blackboard at the end of the dealing room, and the bankers wouldn't have had time to work out all the figures and do the deals before the market shifted and the rates for the individual currencies changed, requiring them to start their calculations all over again (or take an inspired guess).

A dual tape system allows a more general approach. Here, one tape provides the input while the other collects the output. This forms the basis of 'batch processing' which was once the normal thing on mainframes. Files have to be stored in sequence on the tapes with one field being used as a key to determine that sequence (eg, all customers in account number order). The files have to be processed in sequence on that same key. The program reads in the first record, you alter it if necessary (recording such things as a customer paying his bills or ordering more goods) and then you write the record onto the output tape. The limitations of this system are obvious. Even if only one record has to be changed, the whole tape has to be rewritten and you have to collect all the updates and sort them into the right order before running the program to

get anything like efficient processing. This system is perfectly suitable for keeping a record of things after they have happened and is probably quicker and more accurate than the corresponding manual record-keeping system. What it won't do for you is allow you to look up and alter records as you go along. Ten years ago people were amazed that a mini could give them figures that were accurate as of close of business the previous night, yet such a system seems really rather inadequate beside the direct access systems now readily available.

Dual floppies?

The most popular and versatile system for business use is based on twin floppy disks. Several files can be stored on one disk, so you can have input and output on just one drive if the files are small enough. The reason for having two drives is that this gives you the chance to copy both programs and data on to spare disks. This 'security copy' means that ruining a disk is not a disaster — you start again with the copy. It also means that there is no particular limitation on the size of the files — one file could, if necessary, run over several floppy disks. (Floppies are also sometimes known as diskettes.)

You can also get triple and even quadruple drives. I rather like the idea of triples myself, because you can have them permanently labelled 'INPUT', 'OUTPUT' and 'PROGRAM'. This makes life much less confusing for the novice operator. (Floppy disk shuffling is an art which takes a bit of mastering.)

Floppies are essential for word processing or for any information storage and retrieval system.

Printers

A printer is likely to cost as much again as the micro. Therefore it's not something to be purchased lightly. So, do you really need one, and if so, do you really need a high quality one?

Most of us are in the habit of writing things down on pieces of paper if we want to remember them or show them to someone else. This leads us to feel that if we want to be sure about something it has to be on paper and, thus, that we have to be able to get printouts of anything in the computer. A lot of the time this isn't really necessary because we can get the same information displayed on the screen. It may be handy to get them printed as well but may not be cost-effective. In the banking example quoted earlier, the dealers had to copy the results of the calculations on to their traditional 'dealing slips' for the deals to be typed up in the normal way but this is no way detracted from the usefulness of the system.

If you decide that you must have information printed, the next question is what quality printing do you need. If you just want an occasional copy of the stock file to check against what's actually in the store room, then your only requirement is that it be legible. If you're producing lots of printout for internal consumption then the printer must be fast as well and possibly more robust. If, however, you are producing documents to send to customers then a clear bold typeface enhances your company image. You may also want to

take carbon or Xerox copies of documents and many matrix printers are unsuitable for this.

If you only want occasional copies, it is much cheaper to get a Polaroid camera and photograph the screen; they even make screen hoods for the purpose.

Hard disks

These are also known as Winchester disks (rather in the way that vacuum cleaners are known as Hoovers). One of these will hold up to 10Mb (10 million bytes) compared with between 70, and 500,000 bytes on a floppy. Obviously you will only go in for one of these if you really do have a lot of data that needs to be accessed quickly. For instance, British Relay's Hotelmaster programs use one to hold all the information on every room in a large hotel, including names and addresses of all the guests who have booked, up to three years in advance. They need to have this information permanently available because, at any moment, someone might ring from the States to book a room for next year and they won't hold on while the receptionist goes to find the right floppy, load it, etc.

Since a hard disk is likely to cost you £5,000, you don't buy one if you do have time to retrieve a carefully-labelled floppy from the rack and load the data along with the program.

Turnkey systems and packages

This is where you buy a micro with the programs already in it and you have only to read the instructions, switch it on and go (well that's the theory, anyway). For some common and well defined applications turnkey systems are available: Hotelmaster, mentioned above, is one such. The machine is then dedicated to running that one program and you never have to bother about how it does so. Your operators never have to learn how to find their way round the operating system (for which they are usually grateful) and you don't have the hassle and uncertainty of trying to get your own system working. However, you could find that it's not easy to get alterations to the program, or to use the machine for another application.

The more common solution is to buy a package to run on a specified make of machine, or on any machine using a specified operating system (usually CP/M). There are all sorts of programs and packages available at all sorts of prices. The very best cost as much as £500 while others go for a fiver. How do you know if someone has written a package which does just the job you want? Well, the chances are that they haven't, although there may well be something which satisfies your basic requirements and which is available now rather than in six months when your programmer's finished debugging your custom-made version. I'll be devoting article six to finding and evaluating packages but the one thing to bear in mind is that it is still rather like buying an off-the-peg suit in the days before Marks & Spencer revolutionised that particular market — all right if you fit the pattern, like the style and know how to detect bad workmanship before you part with your money. But beware,

there aren't many people making suits who aren't professional tailors, but there are plenty of hams trying to make a fast buck out of writing and selling programs.

Tailor made programs

This is what we all want, at least in our dreams, but it is a solution that can easily turn out to be a nightmare. There are several pitfalls to be overcome over and above those already mentioned in the series. Not only do you have to analyse the problem and your requirements (which you have to do anyway) but you also have to turn those into a specification that a programmer can understand (and get right) or you have to program the machine yourself. Perhaps the greatest problem is that there's no way of trying out the proposed solution to see what it looks and feels like. For many people, the effort of setting it all up in their minds and imagining it in action is just too much. They would really rather wait until it's in front of them. Unfortunately, by that time they have run up several weeks work, so if they don't like it they've either wasted quite a bit of their own time, or someone else's, and that someone else is going to want paying.

So, don't go for custom-written programs unless:

- you've got the time and enthusiasm to develop them yourself (and the willingness to change them if you don't like something);
- you're prepared to spend time and mental effort going through the designs with your programmer before he starts and in supervising him as he gets on with it; or
- you've got money to burn.

Even if you think your application is sufficiently unusual that it is going to need custom-written programs, it is still worth while having a look at packages in the same general area because they will help you get an idea of what is possible and what features you do and don't like. It will also help you to get a feel for the different machines and to get on terms with your local salesman.

Programs and program suites

Whether you go for a package or have your programs specially written, it's as well to have some idea of the way that the job you want to get done *might* be programmed. I stress the word 'might' because you sometimes find that what seems to you like an unconventional solution actually gives better results. While you don't want to go into things with your eyes shut to other possibilities, neither do you want to have your mind empty of all ideas on the subject. A mental sketch of a possible solution at least gives you a starting point in your conversation with salesman or programmer. You must be firm over the user requirements but flexible over possible computerised solutions.

One question you ought to ask yourself is whether you are looking for a program or a suite. Do you have one clearly-defined job to be done, or are there several different things to do with the same data? My banking friend simply wanted a micro to do some

calculations. He could have gone in for a more sophisticated suite of programs that did all the book-keeping on the deals as well, but decided against it. He wasn't having book-keeping problems so he left well enough alone. When I was working in a different City bank we took the opposite view of our particular situation and worked slowly through the whole set-up, computerising each function in turn but they had to take me on to their full time staff in order to see the job through. They were having book-keeping problems and it took something like ten different programs to automate the work sufficiently to alleviate them.

Sometimes it is quite arbitrary whether separate functions are written as separate programs or as different aspects of the same program. Many programs are written on the 'menu' principle — you start the program and are then given the choice between

Invoicing program	
Current date	15.09.80
Menu	
Start of day	1
Invoices	2
Credit notes	3
Posting	4
End of day	5
Your choice	—

Fig 1 Program menu.

Invoices	
Menu	
Start new batch	1
Continue batch	2
End batch	3
Your choice	—

Fig 2 Menu for the invoice routine

several different possibilities, each of these leading to another set of secondary (or lower level) choices until you get into the actual program routines. Figure 1 gives an example of an imaginary menu for an invoicing program, and Figure 2 gives the menu for the 'Create Invoices' option. There is a great advantage to writing all the parts of a job into one program, apart from the fact that you only have one disk and program name to bother about and that is that the program can check that you have done everything in the right sequence — you don't try to post invoices that you haven't corrected, or close the day's work without having taken security copies of your data, or printed totals for your audit records.

Data files

One other thing to think about is the way in which your data *might* be arranged into files. Again I stress the word 'might'. The Basic language rather encourages the programmer to store lots of things as DATA statements in programs and many versions

of Basic have limited file handling, but if you are going for something written in an extended Basic or in Cobol (or indeed Pascal) you can be very much more demanding about what is stored in your files and how that data is arranged. For example, in Pascal you can (and in Cobol you have to) specify the maximum number of characters in a field. So what happens if you currently have seven-figure account numbers and your Cobol package has only allowed for six?

A more general point is how to divide your data between physical files. For example, a college keeping records on its students has basically two types of data — static information such as name, date of birth, address, course of study, and information which is being updated regularly such as marks for essays and tests, attendance, etc. If there are only a few students there would be room to lump all this into one file, but if there are lots of students on lots of courses then perhaps we would be better subdividing it either into two files — one for name and address, etc. and one for marks — or into one name and address file and several small class files for the marks. Alternatively, we may want it in a data base with a variety of different keys so that we can get at the information in different ways; we might need to know how many students we had over 30, or doing HND Computer Studies, or who hadn't yet handed in their third piece of coursework. Indeed we may want to pick out combinations of things — how many women were studying Mechanical Engineering and getting good results in their exams.

A database like this can be very versatile and useful for data which is not changing too much, but inserting and deleting records and changing key fields all require that the program change not only the file itself but also all the index files that it uses to retrieve the data and this inevitably slows down operation. So "you pays yer money and takes yer choice" — either sophisticated retrieval and slow processing, or fast processing and limited retrieval.

Conclusion

It has not been my intention with this article to encourage you to jump to any conclusions about either the machine or the program that you want. Far from it! But the range of products and possibilities is so vast that you need to narrow it down a bit before you start. You should be armed now with enough ideas to be able to start a sensible conversation with a salesman or programmer, aware that they will not understand your requirements unless you spell them out, and able to start them going through their sales pitch on the right sorts of products.

Next month

It's really rather difficult to separate talk about the machine and the programs because you need both together to make the system. Nevertheless for reasons of space and in the hope of reducing confusion I shall be doing just that — asking readers to bear in mind that article five, "Choosing a machine", is closely related to number six on packages and seven and eight on designing program suites.

Now available on Earth



THE SHARP MZ-80 COMPUTER SYSTEM

The Sharp MZ-80 System is a new approach to computer applications and their efficient use. Our aim is to make computers relatively simple and therefore better

understood and better used by those they are designed to serve. Take a look at the Sharp range - it will change the way you think about computers.

BCG Computer Systems Ltd
The Promenade
20 Gloucester Road
Bristol BS7 8AE
0272 425338/41979

The Computerist
642 London Road
Westcliff on Sea
Essex
0702 335298

Crystal Electronics Ltd
40 Magdelene Road
Torquay
Devon
0803 22699

Datron Micro Centre
Latham House
2 Abbeydale Road
Highfield
Sheffield
0742 585490

Digital Design & Development
Duchess House
18-19 Warren Street
London W1P 5DB
01-387 7388

Electronic Business Systems Ltd
54 Clement Street
Birmingham B1 2SW
021-233 3045

Euro-Calc Ltd
Euroc House
128/132 Curtain Road
London EC2
01-405 3223

Gilbert Computers
Old Hall Lane
Lubenham
Leics
0858 65894

HB Computers
22 Newland Street
Kettering
Northants
0536 83922

Howes Elect.
Microcomputer Centre
Newton Street
Lincs
0522 32379/791088

Newbear Computing
40 Bartholomew Street
Newbury
Berks
0635 30505

Norset Office Supplies Ltd
Myrtle House
Bath Street
Cheddar
Somerset
0934 742184

Personal Computers Ltd
194-200 Bishopsgate
London
EC2M 4NR
01-626 8121

PMS (Print Marketing) Ltd
82 Sea Road
Sunderland
Tyne & Wear
0783 480009

Scope
Stone House
Houndsditch Entrance
128/140 Bishopsgate
London EC2m 4HX
01-247 8506

Sigma Systems Ltd
54 Park Place
Cardiff
S. Wales
0222 21515

South Coast Business Machines Ltd
South Coast House
Wimborne Road
Ferndown
Dorset
0202 893040

Sumlock Bondain Ltd
263-9 City Road
London EC1V 1JX
01-250 0505

Sumlock Bondain (East Anglia) Ltd
32 Prince of Wales Road
Norwich NR1 1LG
0603 26259

Tomorrow's World Ltd
Grafton Arcade
Dublin 2
Dublin 776861

This is a list of dealers participating in associated advertising and not a full list.



COMPUTER APPLICATIONS



PRINTERFACING

Hard copy is an expensive luxury for most hobby computerists while the price of commercial printers remains so high. But with a little work you can interface a basic printer mechanism to most micros, as Peter Faff — in the first part of a series — explains.

Over the past few years a great many ready-built matrix printers have found their way onto the open market. Many of these units give excellent performance and they generally come with an equally amazing price tag. Now, for an industrial user this is no problem since he can usually call it capital equipment and gain tax advantages from it, but the average computerist in the street is not so fortunate. It is with him in mind that I have written this article.

There are two basic printer technologies, which we will call 'digital' and matrix. The main difference between the two is that 'digital' printers use cast type in the form of wheels, drums, bands, daisywheels or golfballs, while matrix printers build up characters and symbols by using an array of dots. Unfortunately the print quality of a matrix printer leaves a lot to be desired when compared with, say, a daisywheel printer but for the average micro-nut who just wants a simple hard copy device this is no problem; anyway it must be difficult to plot high resolution graphs on a daisywheel printer. In this article I will concentrate on matrix printers since I am limited by space, although if sufficient interest is shown I may write a follow-up article that looks at cheap digital printers of the type that can be found living in any recent printing calculator.

There is a fairly large number of matrix printers available. These can be divided into three basic types on the basis of how the print is formed on the paper: thermal, electrosensitive and impact. The operating principle of each type will be explained later in this article.

First, for those of you that have been living in the wilds for the past decade or so, I will give a basic explanation of how matrix printing works and I will also explain the various methods used to build up a line of printed characters. A matrix printer builds up a character or symbol in a

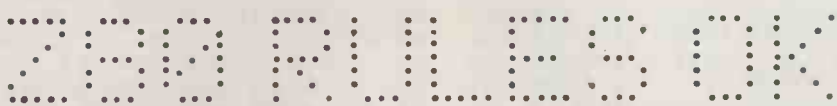
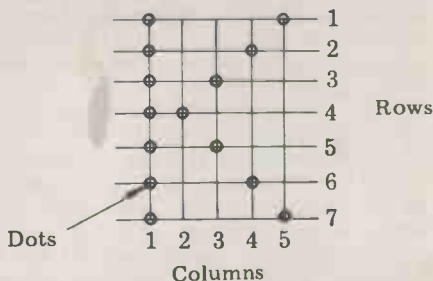

Fig 1

rectangular array of cells by leaving some cells empty while printing a dot in others — this is shown in Figure 1. As can be seen, the various letters are built up of a matrix of 5 x 7 individual dots; by printing or not printing the various dots, a whole range of characters and symbols can easily be built up. The 5 x 7 matrix is about the minimum size that gives a legible character shape and vast improvements can be made by using a larger matrix cell, such as 7 x 12 or 12 x 16. These larger matrix sizes mean that the resultant characters are much more legible; they also make it easier to design characters such as 'p' or 'q' with a descender that falls below the line of print. In this article, I will concentrate on 5 x 7 matrix printers, since these

of the print head. This method is used with all three types of matrix printers and it also crops up when driving dot matrix LED displays.

Figure 2 (iii) shows how a line of print is built up one character at a time, before stepping the print head over the paper to form the next character. In the case of a 5 x 7 matrix, the print head will have 35 individual dots but in practice the dots are connected as five rows and seven columns and the character is formed as in Figure 2 (ii). This is done to reduce the number of connections required from 36 to 12 but it does slow things down a little. A variation of this method uses a print head that looks like a standard seven-segment display but the segments emit heat instead of light, thus producing a format similar to a

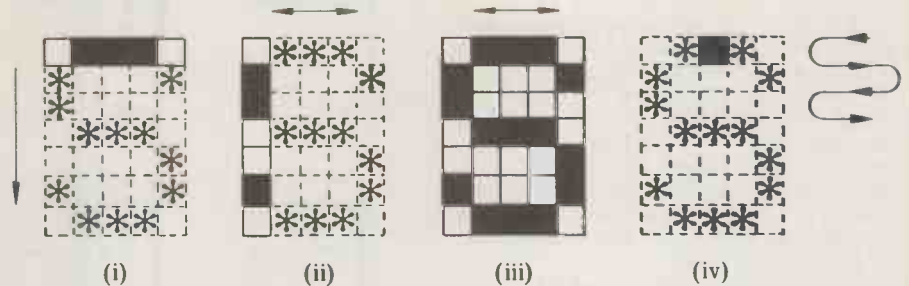

Fig 2

are the types that commonly are available.

There are several ways that a matrix printer can print dots to form a character and Figure 2 illustrates the four most common methods.

Figure 2 (i) shows a parallel print head. This type of print head generally covers the entire width of the paper and has a separate print element for each individual dot. In use, this type of print head will print an entire line of character dot rows, the paper will then move up and another line of dots will be printed; this continues until the characters are built up. This type of print mechanism is generally very fast — and one unit is theoretically capable of printing at a rate of 40,000 characters per second! Parallel print heads are employed on some types of thermal and electrosensitive printers.

Figure 2 (ii) shows how a character is built up by printing an entire dot column at a time and then moving across to print another column and so on; this is achieved by moving the print head backwards and forwards across the paper. To speed things up, printing is generally carried out on both strokes

seven-segment LED display. This method of printing is used only with thermal printers.

Finally, Figure 2 (iv) shows how a character is built up one dot at a time. There is usually one dot mechanism per character or group of characters and again the dots are printed bidirectionally in order to speed printing up. This method is a variation of that used by a normal VDU and is used with several types of thermal and impact printers.

To complicate matters even further there are three different ways of making a visible impression on paper: thermal, electrosensitive and impact. The first and probably the simplest method is thermal printing. This method uses paper that has a special heat-sensitive coat on one side which changes from white to blue when it is heated — the print heads therefore have to generate heat. To do this, small areas of a hard-wearing resistive compound are bonded to a ceramic substrate; these heating elements are interconnected by thin metal tracks. In some cases diodes are also bonded to the substrate and connected up to cut down problems when the elements are multiplexed. To heat an element it is necessary to pass a short pulse of current through it, thus printing a dot on the paper. The only noise that thermal printers make is generated by the paper feed mechanism and they are therefore suited to work in

a quiet environment. The thermal elements are arranged in groups and the most common interconnection patterns are shown in Figure 3. Figure 3 (i) also gives a graphic representation of a thermal print element.

Figure 3 (ii) shows a parallel print head which can print an entire line of dots at one go. Some types have the heating elements arranged in groups of five while others that are intended for graphics use have the elements on a uniform pitch. The ceramic heads can usually be butted together to build up a longer line of print and common sizes have between ten and 20 character groups; as always the elements are multiplexed to cut down the number of connections required.

Figure 3 (iii) shows a serial head that builds up characters by printing an entire column of dots at one go. In use, the head moves across the paper and prints bidirectionally.

Figure 3 (iv) shows a serial print head that builds up a line of characters by printing one character at one go. To cut down the number of connections required, the elements are connected into rows and columns which are strobed during printing to energise the elements; this is faster than moving the print head across the paper to print each column.

Figure 3 (v) shows a serial-parallel print head that has one element per character or group of characters. In use the heads zig-zag down the paper to build up the characters in a similar fashion to a VDU, where, of course, only one dot is used. One readily-available printer of this type uses ten elements to print 20 characters and could possibly be picked up for nothing out of a dead calculator.

In its simplest form a thermal printer consists of a rubber roller that both drives the paper up and also provides a firm surface for the ceramic head to rest on. The paper passes between the roller and the head and is often driven by a stepper motor. A thermal printer with a parallel head is very simple mechanically and could probably be home-made; mechanisms that use serial print heads are much more complex and should be purchased as a ready-built unit. Also, a parallel thermal printer does not generate any timing signals and so the logic required to drive them is generally very simple when compared with a serial type. With a serial printer there is also more to go wrong but, provided that they are not abused, they will give years of trouble-free service.

The second category of matrix printers is the electro-sensitive type. These units are not for the faint-hearted and anyone brought up on good old 5 V TTL should skip the next few paragraphs since electro-sensitive printers require around 60 V to operate — so watch where you put your fingers. On the other hand, electro-sensitive printers are relatively foolproof and, during development, nothing short of a 20 lb hammer will cause much damage to the mechanism. As with thermal printers, electro-sensitive units require special paper which can be expensive. The output from an electro-sensitive printer is black on a silver background. The silver colour is provided by an extremely thin coating of aluminium deposited over a base of black paper and, in order to expose the black, it is necessary to

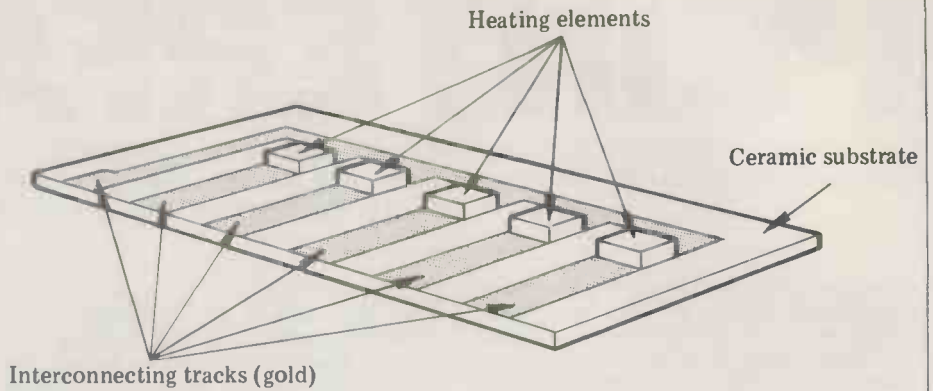

Fig 3 (i)

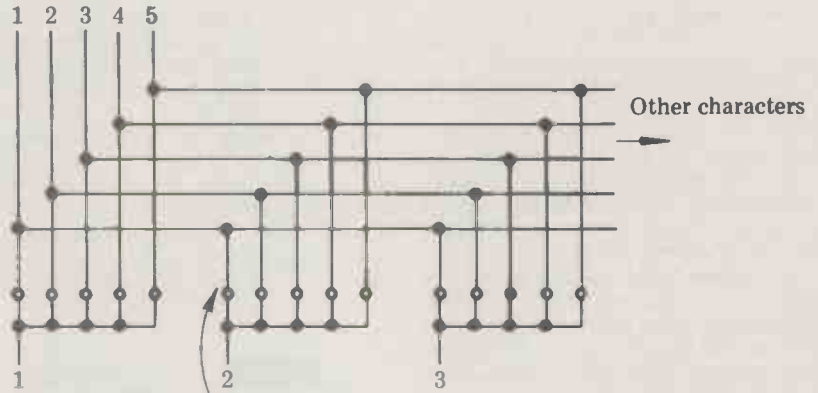

Fig 3 (ii)

Thermal elements

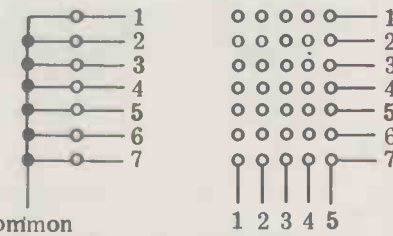

Fig 3 (iii)

common

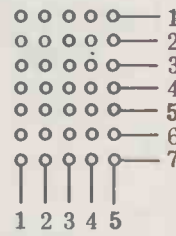

Fig 3 (iv)

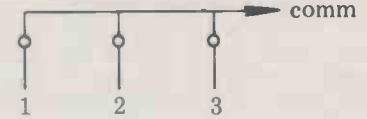

Fig 3 (v)

melt a hole in the aluminium layer. If any of you have ever shorted your favourite screwdriver across a fully charged-up smoothing capacitor you will have a shrewd idea of how this is achieved. By grounding the bulk of the paper roll and putting a high voltage on selected print electrodes a hole is melted in the metal layer, thus exposing the black backing; see Figure 4 (i) and (ii).

As with thermal printers there are several ways in which an electro-sensitive printer can build up characters and the two most common ways are also illustrated in Figure 4.

Figure 4 (iii) shows a serial print head where a vertical array of seven electrodes is moved backwards and forwards across the paper printing characters one column at a time. When a full line is printed the paper spaces up for the next line and the print head reverses direction. This method is reasonably fast but it does call for some exotic mechanics to control the movement of the print head and paper feed; these printers also generate several timing signals which must be taken into account when driving the thing. The timing signals ensure that everything prints in the right place.

Figure 4 (iv) shows a parallel print head which has a line of electrodes stretching across the paper. This head prints one dot line at a time and can easily be used to plot graphs, etc. The mechanism I will describe consists of a fixed electrode head, a motor and a drive roller. No timing signals are generated and the unit is very easy to use, since the group of 100 electrodes is reduced to ten groups of ten by a multiplexed drive circuit incorporated into the printer itself. This unit can also be found in dead calculators.

Finally the third category of matrix printers is the impact type. As the name implies, these use a mechanical impact to print on plain paper using a ribbon; they can also produce copies when used with pressure-sensitive paper. Since impact printers use plain paper they are much cheaper to feed than either of the other types and this may be an important consideration if you intend to do a lot of printing. Apart from the noise, impact printers are very good.

The dots are usually printed by a hardened needle that hits the paper at a rate of knots; the paper is supported by a solid backing roller. There are several ways to accelerate the needles and common methods include a solenoid pulling a plunger, magnetic plungers with spring assistance and a lever rotating cam system; all give similar results and I will look at several exam-

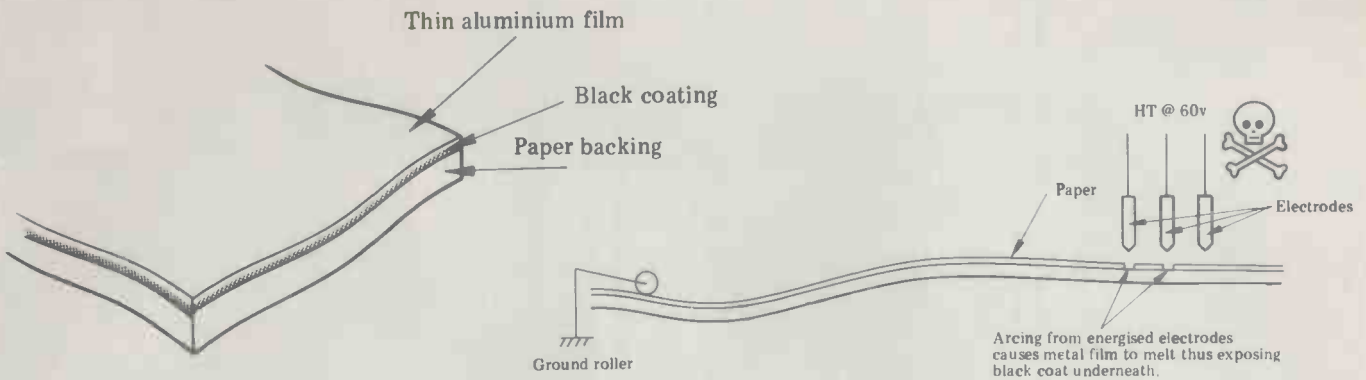

Fig 4 (i)

Fig 4 (ii)

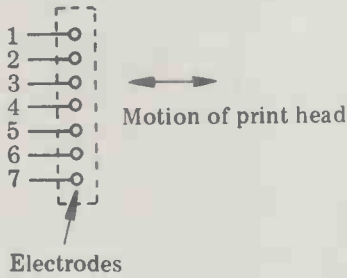

Fig 4 (iii)

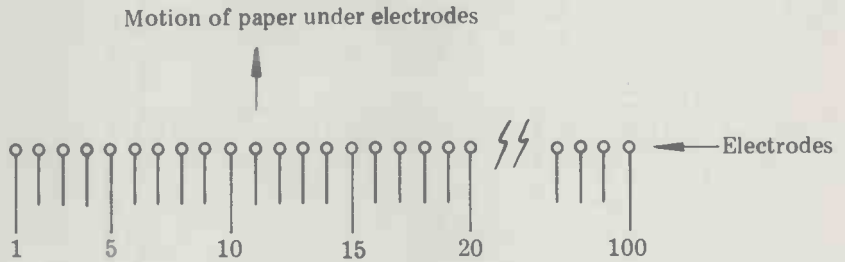

Fig 4 (iv)

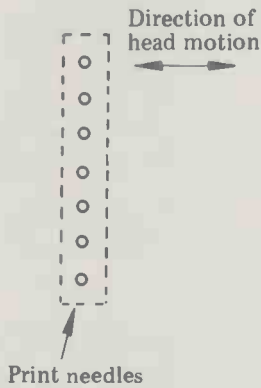

Fig 5 (i)

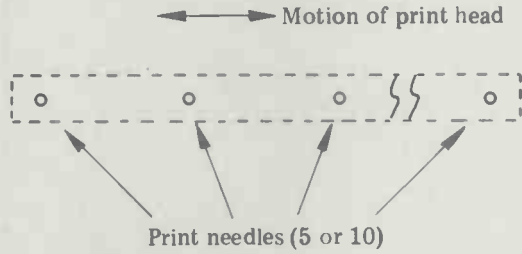

Fig 5 (ii)

ples of impact printers. As with thermal and electro-sensitive printers, there are several configurations of print needles that are used and two of the most common are illustrated in Figure 5.

Figure 5 (i) shows a serial print head that moves across the paper and prints characters one dot column at a time. This is the most common method used by impact printers and I will look at one or two units of this type.

Secondly, in Figure 5 (ii), we have a

serial parallel print head which uses one needle to build up a group of several characters one dot at a time; the print head moves backwards and forwards across the paper. I will look at two units that have five and ten print needles respectively. Both types of impact printers generate a variety of timing although this can be reduced to a minimum by letting your micro do all the hard bits.

Now that I have outlined the basic principles of operation of the three types of matrix printers, I will begin to look at several examples of commercial

units in greater depth. To aid the DIY person as much as possible, I will give details of the timing signals that the units generate and, with the aid of block diagrams and flowcharts, I will suggest ways that the printer mechanisms can be made to do their thing. The fine details of the interface electronics will be left to the individual constructor, and I will only give suggestions. I hope that what follows will be of use to anybody who requires a printer and has a limited budget. Anybody requiring further information, or even somebody to talk to, can contact me via the Editor.



FOR £375* CENTR PRINTERS TUR BUSINESS SYS

A microcomputer in the home is fun. But a microcomputer in the office is serious business. The quality of its output reflects your professionalism.

Reports, letters, invoices and other business correspondence need to be presented in a business-like way. At home you wouldn't spoil a good hi-fi system with second-rate speakers—so why accept less than clear, high quality print-out in the office?

Now, you don't have to. Centronics, the world's leading independent printer manufacturer, is making high quality printers available direct to you the user, at a price previously only obtainable within the computer industry for large quantity purchases.

The Centronics 730 and 737 are dot matrix printers which connect to all well-known makes of microcomputer. You'll no doubt recognise the phrase "Centronics compatible" from our competitors' advertising.

A wide choice of speeds and print styles, and the ability to handle single sheet and continuous stationery are provided by both printers.

In addition the 737 offers word processing quality print with proportional spacing. Both machines carry the Centronics manufacturer's warranty, and local maintenance is obviously available from the world's leading supplier of matrix printers.

For sample print-outs and further information send the coupon below. Centronics Data Computer (UK) Limited, Victoria Way, Burgess Hill, Sussex, RH15 9NU. Telephone: 04446 45011.

CENTRONICS®

Simply Better

Centronics, please send me a sample print-out and the name of my local stockist.
I am a (delete as appropriate): User/OEM/Shop

Name:..... Position:.....

Organisation:..... Tel. No:.....

Address:.....

PCW

Centronics Data Computer (UK) Limited, Victoria Way, Burgess Hill, Sussex, RH15 9NU.

TRONICS N MICROS INTO TEMS.

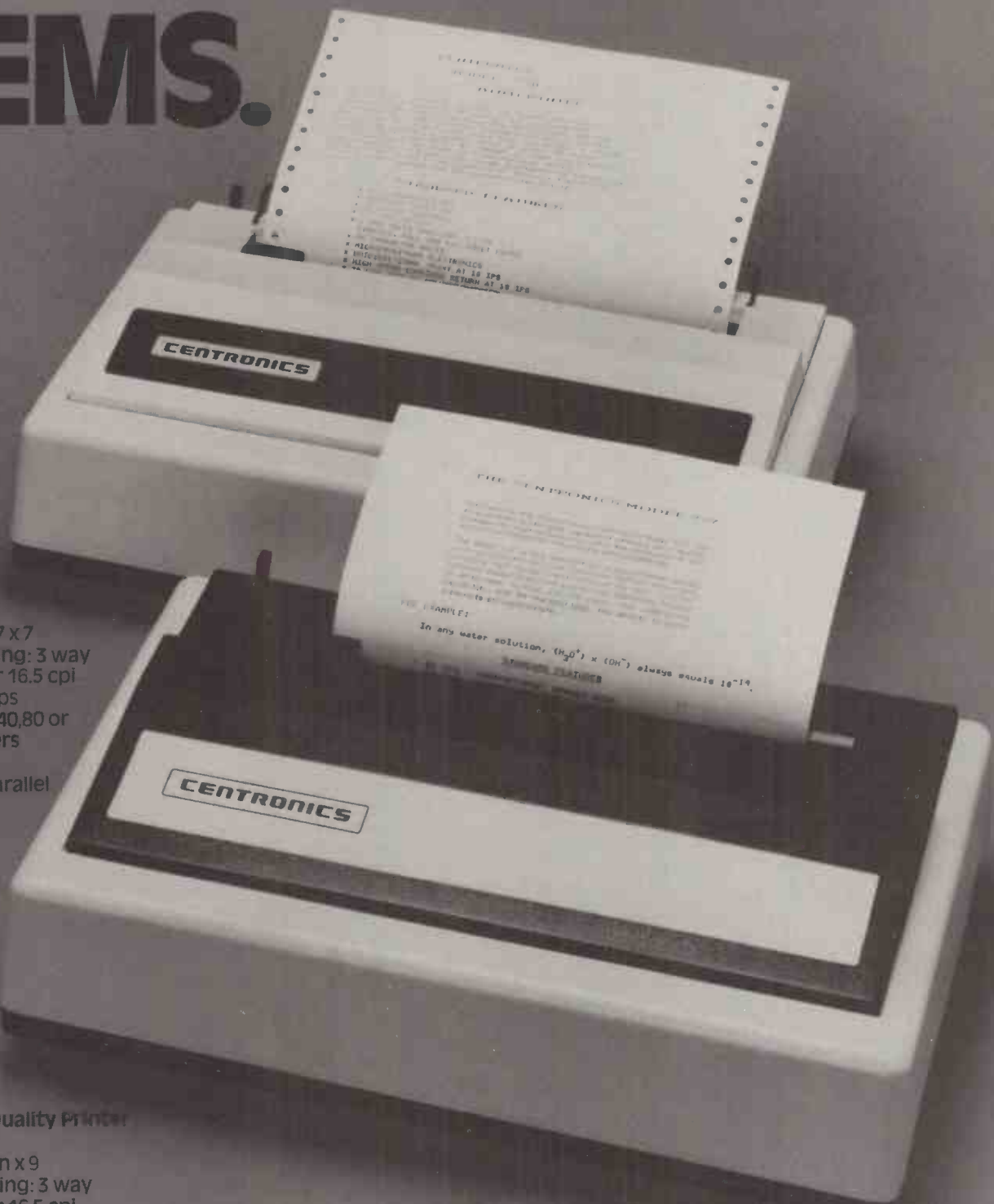

730 Printer:
Price: £375*
Dot matrix: 7 x 7
Paper handling: 3 way
Pitch: 5,10 or 16.5 cpi
Speed: 100 cps
Line length: 40,80 or
132 characters
Standard
interface: Parallel

737 Letter Quality Printer:
Price: £425*
Dot matrix: n x 9
Paper handling: 3 way
Pitch: 5,10 or 16.5 cpi
Speed: 80 cps proportional/50 cps monospaced
Line length: 40,80 or 132 characters
Standard interface: Parallel
*Excluding VAT

OPTIMIZING PC1211 EXECUTION TIME

When Dick Pountain tested the Sharp PC1211 last July, his main criticism of the machine was its very slow execution speed. This month Dick hands over to reader Denis Andrews who offers some ways of overcoming this handicap.

The PC1211 stands alone in its professional role, having the flexibility of a computer with the size, immediacy and accuracy of a calculator. However, there will be many others like myself who will wish to explore its full power for satisfaction and amusement.

For programs of more than a few lines, one is likely to encounter unexpected delays much longer than the time required for calculation. The handbooks — which are excellent in most respects — give little guidance about this and are even misleading. This article sets out to provide the missing information.

One program is given to illustrate the points. The chosen problem is fun in its own right — to have the machine play noughts and crosses with variety and skill. This task stretches the machine's logical and memory capacity to the full (and stretched the author too). My first solution took around 70 seconds per move: opponents became impatient! The program below responds in five to 19 seconds, similar to a human player. This has the same logical structure as the first idea, but is now geared to the strengths and weaknesses of the PC1211.

Strengths and weaknesses

These terms are used in respect to timing. The machine is remarkably powerful and easy to program, but execution is slow. The programmer's staple control devices — FOR loop and GOTO — are the slowest to execute. The less familiar logic functions and arithmetic GOSUB provide faster control. The PC1211 allows the construction of logic functions using the logic operators \Rightarrow , \leftarrow , \Rightarrow , \leftarrow and $\langle \rangle$. Such functions take the value 1 when true and 0 when false. The AND and OR operators don't exist in PC1211 Basic but their function is performed by * and +. So

$(B>2)*(B<5)$ takes the value 1 if B lies between 2 and 5, otherwise it's 0. The familiar devices INT, ABS and SGN are extremely fast.

Table 1 shows the execution time for most logical and arithmetic operations. These were calculated using a FOR loop and stopwatch, adding instructions in various combinations. The values are approximate and disguise marginal interdependencies. (Some are given below.) Times are given both in msec and 25 msec units (bracketed). The latter unit aids rapid calculation of execution times, as the most frequently used words or word-pairs then have unit time.

To calculate actual execution times, you need two further facts:

- Addresses are accessed by upward search through memory, starting either at the current line or at the first line in memory; the address defines which of these searches is made. GOTO is not costly if it names a current or following line, or line 1. The cost accrues if you have to jump back and thereby search through most of the program. Address searches run at about 450 words per second. FOR and GOSUB work differently: they leave an explicit address in an internal stack and no search is required for the return jump.
- Variables are also accessed serially but in a complex way. On the right of an assignment (fetch) A is fast and Z slow; on the left (store) the reverse is true. Trading A for Z makes a 16 msec difference. For subscripted variables on the right, there are two fetches (symbol and its reference); the time differences add. On the left, there are two fetches and one store; two cancel, leaving just the symbol, so (A) is fast and (Z) is slow. For practical calculation, reckon each symbol reference one unit, and brackets one or 1/2 each (left and right of '='). The choice of variable name only matters if frequencies of fetch and store are markedly different. The 'flexible' variables take no longer than the fixed

ones: A(26) and A(27) take about the same time in any role.

The time required to jump over most code is around 1/8 to 1/4 of the time needed to execute it! This makes the layout of long programs and their sub-routines absolutely crucial. All jumps should be forwards or to early addresses. If you need to jump backwards, create a logically unnecessary GOSUB — for the sake of its stacked address (eg L47 in the program).

Stacked functions seem to occupy a fixed time; the fourth level GOSUB takes no longer than the first, and does not slow the earlier orders either. Likewise for FOR loops. Unexpectedly, GOTO D, GOSUB D, A(D) are not observably slower than GOTO 7, GOSUB 7, A(7), etc., when letter and digit correspond. One letter can be faster than two digits. There is no measurable time added in respect of LET, STEP N or addresses, though presumably they must use some.

The programs provided in the applications manual have not been optimised in either space or time. Most of them have long jumps and make no use of the economical logic functions, the equivalence $C=A(3)$, or the implied '*' (which often saves a pair of brackets as well).

In particular, subroutines are commonly placed at the end, so that the whole program must be jumped to access them. The only references to layout (note 7 on the introductory page) gives the wrong reason for putting sub-routines at the start! It would of course be easy to rewrite the programs optimally if one used them often.

Useful devices

- If a result is needed in two forms, store it twice. Transformations of arrays are slow. (In the program A-1, J-R and T (by itself) represent the entire game. Two of these are redundant images, but transformation would be expensive in time and space.)
- Data can be packed (L.7, L.70) or unpacked (L.3) in one variable. Decoding is slow, but the device allows much data to be preset. (L.71 is equivalent to 19 assignments + five IF statements.)
- Multiply rather than divide (L.3, L.59), saving 50 msec.
- Use IF X. . rather than IF X>5. . , saving 30 msec or more.
- Make use of the logic functions rather than IF when you can. This generally saves one address and one assignment. (L.70 and 71 would be twice the size and run at half speed using IF state-

	6 (1/4)	12 (1/2)	25 (1)	36 (1.5)	60 (2.5)	75 (3)	250 (10)
SGN	+!	*	implied*	IF	GOSUB N	/	FOR-NEXT
ABS	-			GOTO N	GOSUB 1		(each cycle)
INT	E	()	GOTO 1	(all 4 levels)		
\$	"	=		RETURN			
string char.	1st digit)		THEN		FUNCTIONS:	
	on LEFT of ASSIGNMENT	Z	N	A	(11)	DMS (4)	SIN (24)
)	((25)	DEG (5)	ASN (20)
		()		LOG (20)		COS (24)
)	(EXP (11)		ACS (23)
	A	N	Z		LN (25)		TAN (10)
	on RIGHT of ASSIGNMENT						ATN (10)

Table 1 Approximate execution times, msec (bracketed, 25 msec units).

ments.)

6. Space saving also saves time; there being less code to jump over.

7. Place subroutines so that they are passed over as seldom as possible.

8. Loop structure is slow however accomplished. Write the inner loop(s) in full if you have space (ends of L.9-17).

9. A fixed string of GOSUBs is appreciably faster than a FOR...NEXT loop (and may use less space, too, up to three cycles).

10. Use flexible variables for the ones that must be subscripted anyway. Avoid them if you can.

11. A computation conceived as several successive loops can sometimes be restructured as a single loop with branches (L.9-17 with L.1).

12. Save the early addresses for the most-used subroutines and those which are called from diverse places.

Noughts and crosses

Space is too precious for REM statements in the PC1211! The following remarks stand in lieu and indicate very briefly how the program works. L.34 - 47 Set arrays to +1 (no move), mirrored "." for display. Decide who starts. Register first move.

L.4 - 7 Make random choice in range 1-Y. Select 1 of Y digits A(27)+. Record move: machine coded -4, "0"; player -1, "X". S = move no. L.50 - 63 Display position and machine's response. Read player's move. Transpose first move? Traps are coded only for one of eight symmetries.

L.64-71, L.81, L.84-88 Test for pre-coded traps at machine's second response, (too far from victory or defeat for serial calculation). All wins, losses, alternatives are coded, equivalents played equally often.

L.78 Test for immediate win; enter if any.

L.79 Test for direct threat by player; counter if any.

L.82 Test for empty squares, threats, double threats; select randomly within the highest level registered.

L.9 - 18 Test each remaining move in the rows which contain it; X is criterion: -8(two "0") for win, -2(two "X") to counter, -3("0"+".") for threat.

L.1 The inner routine - only successful tests enter. Hits listed at A(27)+. If higher-level hit found, restart list and reset level.

This program is capable of further speed optimising, eg by swapping variables. A quite different approach might be better of course. The hybrid of pre-set and search seems necessary: a fully intelligent program could easily be written but would run extremely slowly. It also seems necessary to avoid duplicating symmetries. One refinement perhaps worth pursuing is to transpose the display instead of the move. My attempts to do this ran out of space, but only just. The listing here includes some 50 redundant words, expended to buy a little speed when the more elegant solution seemed out of reach. A further 70 words would secure the improvement. Any ideas?

```

1:Z=Z+1:A(Z)=Y:IF U>WLET Z=26:W=U:GOTO 1
2:RETURN
4:V=V+9/8-50*(V>200):Z=V-INT(V/Y)*Y+1:RETURN
5:Y=1+INT LOG W:GOSUB 4:W=W+10^(-INT Z):Y=INT((W-INT W)*10)
6:A$(Y)="0":X=-4
7:T=10T+Y:A(Y+9)=X:S=S+1:RETURN
9:Z=26:IF JLET U=(X=K+L)+(X=M+P)+(X=N+R):IF U>WLET Y=1:GOSUB 1
10:IF LLET U=(X=J+K)+(X=O+R)+(X=N+P):IF U>WLET Y=3:GOSUB 1
11:IF MLET U=(X=J+R)+(X=K+O)+(X=L+P)+(X=M+Q):IF U>WLET Y=5:GOSUB 1
12:IF PLET U=(X=J+M)+(X=N+L)+(X=O+R):IF U>WLET Y=7:GOSUB 1
13:IF RLET U=(X=P+Q)+(X=L+O)+(X=N+J):IF U>WLET Y=9:GOSUB 1
14:IF KLET U=(X=J+L)+(X=N+O):IF U>WLET Y=2:GOSUB 1
15:IF MLET U=(X=J+P)+(X=N+O):IF U>WLET Y=4:GOSUB 1
16:IF OLET U=(X=M+N)+(X=L+R):IF U>WLET Y=6:GOSUB 1
17:IF QLET U=(X=K+N)+(X=P+R):IF U>WLET Y=8:GOSUB 1
18:RETURN
34:"G":S=1:T=0:A$(31)=" I GO:"
35:FOR Z=1 TO 9:A(Z+9)=1:A$(Z)=".":NEXT Z:INPUT "TOSS (0=YOU START):"
:X:IF XLET W=125:GOSUB 5:GOTO 47
44:GOSUB 56:A$(Y)="X":X=-1:GOSUB 7:W=5*(1=T)+158*(2=T)+1379*(5=T)
:GOSUB 5
47:GOSUB 50:GOTO 47
50:PRINT A$:B$:C$:"/":D$:E$:F$:"/":G$:H$:I$:A$(31):Y:IF -SEND
52:IF S>8 BEEP 3:PRINT "DRAW!":END
54:GOSUB 56:A$(Y)="X":X=-1:GOSUB 7:GOTO 64
56:INPUT "YOUR X:":Y:IF -A(Y+9)PAUSE "FULL":GOTO 56
57:IF T>9RETURN
58:IF (Y=5)+(Y<3)RETURN
59:IF T=5LET Y=Y-2*INT(.5Y-.5):GOTO 63
60:Z=Y/(5-T):IF Z=INT ZLET Y=Y-2:GOTO 63
61:IF T+Y<8RETURN
62:Y=3
63:BEEP 1:PAUSE "TRANPOSED..":Y:RETURN
64:IF S=3GOSUB 73-.1T:IF W<GOSUB 5:RETURN
65:GOTO 78
67:W=9745-7Y:RETURN
70:W=15*(4=Y)+(7=Y)+4679*(1=Y)+79*(8=Y)+367*(5=Y):RETURN
71:W=37*(9=Y)+457*(2=Y)+479*(3=Y)+357*(6=Y)+349*(5=Y):RETURN
78:IF S>4LET X=-8:W=1:GOSUB 9:IF Z>26GOSUB 6:S=0:A$(31)=" I WIN:"
:RETURN
79:X=-2:W=1:GOSUB 9:IF Z>26GOSUB 6:RETURN
81:IF S=46GOSUB 90-.01T:IF W<GOSUB 5:RETURN
82:X=-3:W=-1:GOSUB 9:Y=Z-26:GOSUB 4:Y=A(Z+26):GOSUB 6:RETURN
84:W=37*(J+R=-5)+19*(L+P=-5):RETURN
87:W=13*((289=T)+(287=T))+1346*((256=T)*(260=T))+47*(213=T):RETURN
88:W=476*(158=T)+238*(156=T)+2468*(159=T):RETURN
90:INPUT V:END:REM -- DELETE LINE AFTER SETTING RANDOM SEED --
    
```

Casio Multiple Regression

If you use a Casio fx502p for statistical work and you're not too happy with the Casio stats pack's regression program, then you might be interested in what's claimed to be a better version now on the market. It's produced by Colin Buchanan and Partners and the following is an extract from a letter they recently sent me:

"The Casio program library contains a rather weak simple regression program (for fitting a line between observations of X and Y). Much more interesting and useful is Multiple Regression for estimating relationships between X and more than one other variable. It is a difficult job to do this with only 256 program steps and 22 memories. The program we have written not only does this (for two

independent variables), but does so rather elegantly from the user's point of view, with standard errors, t ratios, R^2 and \sqrt{yz} all computed. Moreover, transformations and weighting of the observations can be very simply achieved. In short, we believe the program is ingenious, useful and likely to interest some of your readers, especially college students learning statistics and practitioners in such disciplines as economics, biology, geography, etc, where regression analysis is in common use."

From the documentation which came with the letter (they didn't send a full listing) and program looks quite good. For further details contact Colin Buchanan and Partners at 47 Princes Gate, London SW7 2QE, Tel: 01-589 8841.
Dick Pountain

IF YOU'RE WAITING FOR THE PRICE OF WORD PROCESSORS TO FALL WITHIN REASON,

IT JUST DID.



Everyone expected it would happen sooner or later... with WordPro PLUS™ it already has! Now all the marvelous benefits of expensive and advanced word processing systems are available on Commodore computers, the U.K.'s largest selling computer line. WordPro PLUS, when combined with the new 80 column CBM 8032, creates a word processing system comparable to virtually any other top quality word processor available—but at savings of thousands of pounds!

New, low cost computer technology is now available at a fraction of what you would expect to pay. This technology allowed Commodore to introduce the new and revolutionary CBM 8032 Computer.

WordPro PLUS turns this new CBM 8032 Computer into a sophisticated, time saving word processing tool. With WordPro PLUS, documents are displayed on the computer's screen. Editing and last minute revisions are simple and easy. No more lengthy re-typing sessions. Letters and documents are easily re-called from memory storage for editing or printing with final drafts printed perfectly at over five hundred words per minute!

Our nationwide team of professional dealers will show you how your office will benefit by using WordPro PLUS. At a price far less than you realize.

Invest in your office's future...
Invest in WordPro PLUS...
Call us today for the name of the
WordPro PLUS dealer nearest you.

Professional Software Ltd.
25 Station Road
New Barnet
Hertfordshire ENS 1PH
Telephone: 01-441 2397

CBM is a registered trademark of
Commodore Business Machines.

GATEWAYS TO LOGIC

Chapter 5 part 2: Electronic logic

Derrick Daines continues his series on teaching microcomputing to others

Gates and logic

Having given our students a taste of the practicalities, we can now demonstrate their use in principle. It's wisest to start off by presenting this work in the form of a few simple problems. Example 1. If a boy steals money or smacks a girl and makes her cry, then he will be punished (Figure 20). Having demonstrated this on the blackboard, the children can try their hand at the next.

Example 2. Mum will fetch the baby in from the garden if it starts to rain, if the baby cries, or if mum has to go to the shops. In any case, she will fetch him in if it's 12 o'clock and she has his dinner ready (Figures 21 and 22).

Example 3. A Ruritanian passport will be granted to those people who have at least one Ruritanian parent, or whose father's parents were Ruritanian. In no case will a passport be granted to those who have lived for any length of time in Agrophobia, Ruritania's deadliest enemy (Figure 23).

Many other problems of this type will be found in abundance on any government form or any insurance policy! At the teacher's discretion such problems may be presented solely as above — or else students may also be provided with the gate outline drawing and be required to fill in the details. The more advanced may be given problems couched in Boolean — for instance to decide on the gate configuration that will produce a certain Boolean output. Alternatively, they can simply work through a given gate configuration (Figure 24).

Bistables and clocks

I have repeatedly said that a computer is nothing but a bunch of gates but now I must qualify this as being only 95 per cent true. Chief amongst the remaining five per cent are register memories and clocks.

The very earliest computers used a type of memory called a bistable (Figure 25). Now, although modern computers use a wholly different technique (and even better ones are still being researched), the bistable offers an extremely good way of demonstrating computer memory — in particular,

the type of short-term memory that's still in use inside the microprocessor. What's more, it's extremely easy to assemble.

When the circuit of Figure 25 is wired up and power is applied, one LED will light up while the other remains unlit. Label one of them as output — it doesn't matter which. If you like, the other can be masked with a

bit of paper. Now, taking the wander lead shown, touch in turn the bases of the two transistors; the condition of the two lamps changes — that is, the one that was off will come on, and vice versa. What's more, the two lamps will remain as they are, however long we leave them. The circuit is therefore totally stable in either condition — hence its name, bistable.

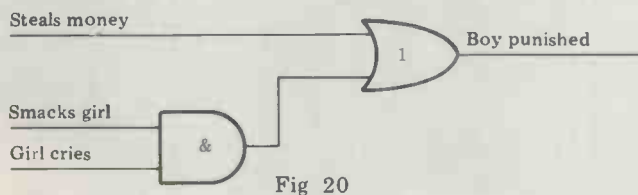

Fig 20

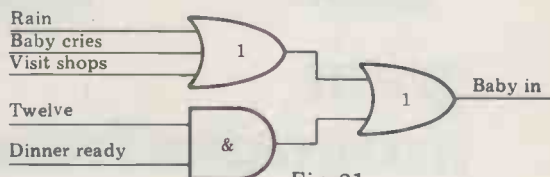

Fig 21

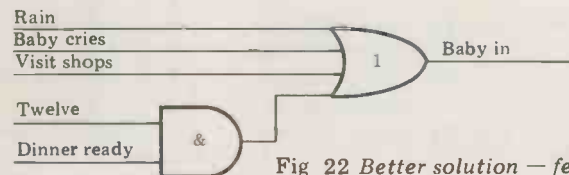

Fig 22 Better solution — fewer gates

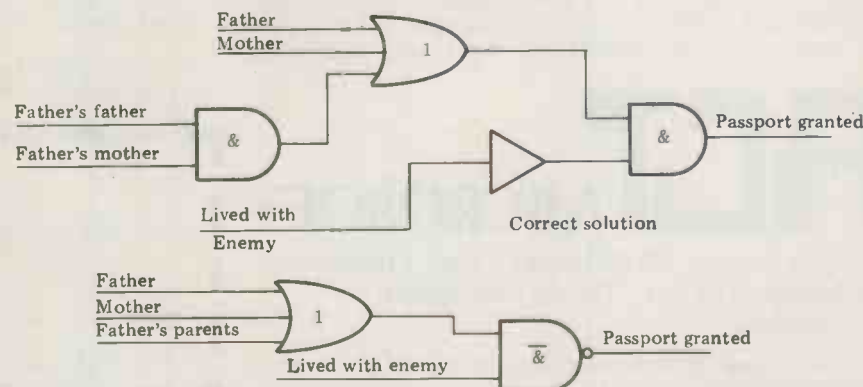

Fig 23 Can you spot two errors in the logic of this solution? The answer is given at the end of this month's chapter.

Why not the best?



great
programs from

Petsoft and Appleware

ACT Microsoft bring you America's best — programs for your PET or Apple by Personal Software Inc. Programs like VISICALC II, the latest version of the award winning problem-solving software that handles mathematical and financial forecasting — and solves just about any problem that can be represented in tabular form, (£125)

GAMMON GAMBLER is an exciting new backgammon program which lets you play the computer. Watch out also for CHECKER KING — it plays a mean game of draughts! And then there is MICROCHESS, the world's best-selling

computer chess program. Need we say more? *All the above cost £14 on cassette for PET or £17.50 on disk for Apple.*

CCA DATA MANAGEMENT SYSTEM is a superb new database program that turns your Apple into an electronic filing cabinet. You will find it surprisingly easy to store, sort and update every kind of information. *The price is £75.*

They call DESKTOP PLANNER the 'businessman's friend'. And no wonder; it brings real computing power to your fingertips for just £75 (*Apple only*).

For more information about this exciting software, send today for your copy of the ACT Microsoft catalogue — it is FREE!

ACT MICROSOFT

Radclyffe House, 66/68 Hagley Road, Edgbaston,
Birmingham B16 8PF. Tel. 021-455-8585
Telex 339396

PET is the trademark of Commodore Systems. Apple is the trademark of Apple Computers.

Prices exclude VAT and were correct at time of going to press.

NAME _____

ADDRESS _____

POSTCODE _____

I have a PET / APPLE / NEITHER (Please delete)



And here we have a unit of memory. If the output lamp is lit, we can say that it represents a binary '1', while if it is unlit, then of course it represents a binary '0'. This is a very important concept for students to grasp. Computer memory is a term that will not, of itself, convey very much to them, and the uninitiated have some very weird and wonderful ideas about how computers remember anything. Try asking them! They'll doubtless be astonished to learn that computer memory is simply the difference between high and low-voltage states.

In the average home computer, eight such bistables are (or were) needed for each and every computer word — either in the processing unit or in memory; students should begin to appreciate why the bulk of the early computers loomed so large, why they produced so much heat (two valves instead of transistors per binary bit) and why they spent so much time under repair.

It's very important to demonstrate at least one transistorised bistable. Figure 26 is very easily adapted from Figure 25; it simply arranges for the output of the first transistor to change the state of the second, which changes the state of the first, which changes the state. . . The values of the capacitors as well as some of the resistors can be changed within quite wide limits, to affect the rate of oscillation. At the slowest rate, oscillation cycles may take minutes, while at the faster rates the lamps barely seem to flicker.

Technically, the circuit is termed an astable, meaning simply 'not stable', but in computer circles it's universally known as a clock. The clock (or clocks — there can be several) is vital to the computer for it triggers events round the circuitry. For accuracy it often includes a crystal but in our case this is not necessary as the demonstration model which works very much slower. Sometimes it's convenient to use both halves of the clock for triggering different events — it all depends upon the design or architecture of the computer.

I find children, in particular are fascinated by the clock circuit (and there's no reason why it should not be run for hours at a time — battery drain is very light). And not only is it a great attention grabber — there are hundreds of applications where such a handy little circuit will come in useful.

Computer control

We now have all the building bricks of the computer and can therefore begin to put them together to evolve the finished product. No new devices are to be considered in this section; just new or improved ways of utilising those the students have already been shown. There's at least one kit on the market that's designed to teach how a computer is constructed and controlled and no doubt others are on the way; indeed, readers may like to assess their value after reading this section. For some it could be that what is written here will be considered sufficient; other readers (perhaps those with a slightly more specialised interest) will consider the learning experiences offered by such a kit to be well worth the rather heavy outlay.

Figure 27 is part of a hypothetical

computer and it adequately illustrates how the earliest of them were controlled. Personally, I've always found a blackboard illustration sufficient — see also Figure 28. Figure 27 shows the basic principle in detail. The data lines run all over the computer, carrying information here, there and everywhere; they may be likened to railway tracks, the gates representing the track points. Inevitably, numerous loops are formed and the clock is necessary so as to keep all the operations in step with one another — rather like a number of trains running on the same railway line loop but without collisions.

Examination of Figure 27 will show that data cannot flow anywhere unless the manual switches are closed — because the AND gates require that all inputs should be high. If switch 1 is

closed and data is present, then each time the clock pulses high, one bit of information is passed through the first gate. This is fairly straightforward and nearly all students grasp the idea very quickly, provided the previous work has been carefully covered.

The analogy of the model railway is very apt, for the very earliest computers were entirely controlled by manual switches — indeed the writer built one himself. Of necessity the control panel looked much like the plan of a marshalling yard — something along the lines of Figure 28. A and B are the two temporary registers that we've already met in connection with the cardboard computer, while C to F are long-term memories; each have eight little boxes, each of these representing a bistable memory element of the type just discussed and

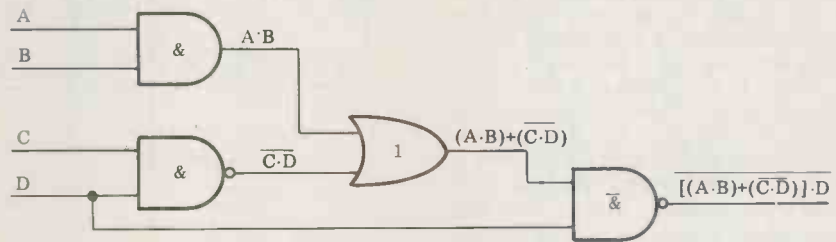

Fig 24

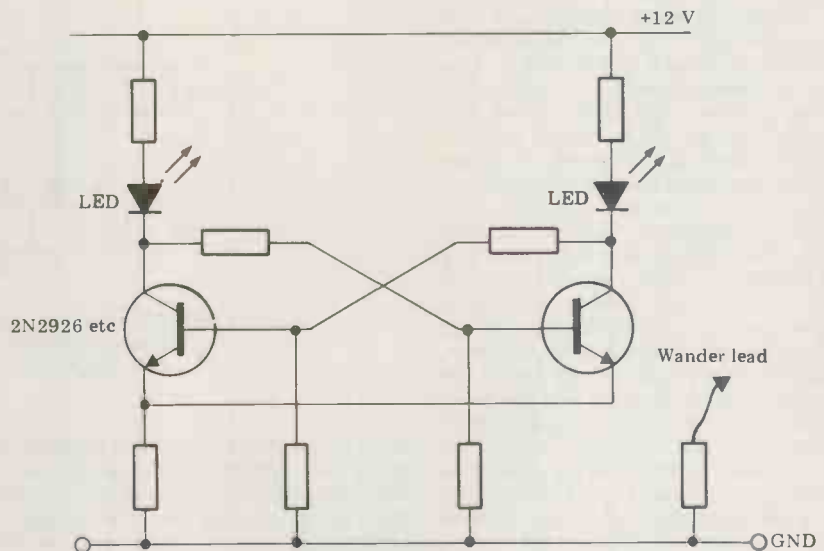

Fig 25 Bistable

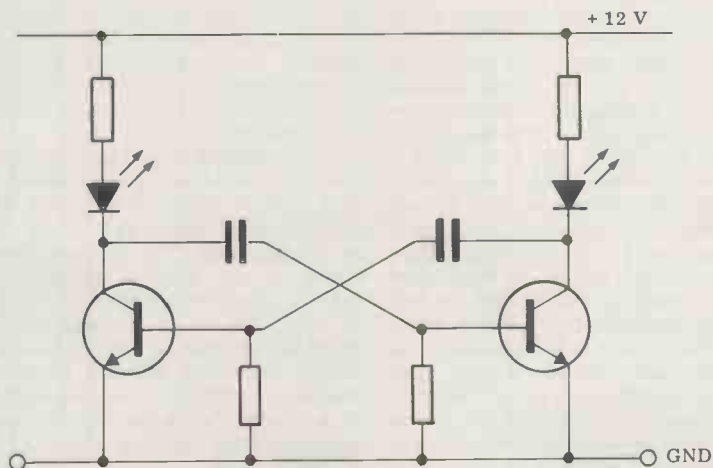

Fig 26 Astable

arranged in a linear fashion as shown. The interconnecting lines are data lines only, the clock and control lines having been omitted for the sake of clarity. AND gates are placed at every junction and each one is fed with synchronous clock pulses. They are numbered 1 - 12 and it's assumed that each one has a manually-operated switch for control, as in the previous diagram.

When explaining the diagram, we must also be careful to stress something that is not there - rather like the hole in the mint. The important thing to notice is that there are no memory elements other than those shown; no little resting-places for data exist along the main lines. . . they are for transfer only.

If we wish to store the contents of Register A in memory store C, then we must switch on gates 3 and 5 and ensure that all other gates are switched off. A train of pulses is applied from the clock and the data is transferred. Similarly, if we now wish to transfer data from store F to register B, we must switch off gates 3 and 5 before opening gates 12 and 2. In practice, operation of those earlier computers was a trifle more complicated than that and, for obvious reasons, laying out the control panel as shown in the Figure was the only way to minimise human error.

Students will have fun with the diagram if they are given starting and finishing conditions - eg, put the contents of A into C; C into B and B into A. This sort of problem allows us to made a few teaching points - especially if we stay with the analogy of the model railway.

Firstly, there is the question of one computer word (or train in our analogy) running into the back of another. Suppose for example we were to transfer a word into Register B where there is a word already - what happens to it? If it were a train, the result would be a mangled mess. . . a combination of the old and the new; in electronics however, the first is simply lost or erased as in the cardboard model. (I don't like the word 'overlaid' because in some minds that's analogous to the mangled mess.) The next question is, suppose we open gate 3 but forget to open any of the gates 5 - 8, what happens to the data shunted out of Register A? This is the reason we should have stressed the absence of any memory resting places other than those shown. In such circumstances, the data is again simply lost.

If they have not asked already, some students will now enquire how the computer knows that the whole word has been shifted. To put the point another way, when the leading bit of the word - or engine of the train - reaches point 'x' marked in Figure 28, why does it not continue blithely on and, as it were, 'crash' into the buffers or the closed gate 3? Well, it would but for a little device known as a counter. This gadget counts the clock pulses - analogous to counting wagons on a train - and when it has counted 8, it simply shuts off the clock. It's not necessary to model this very simple action and students generally accept it readily.

Combinations of gates under automatic and/or manual control can be strung together so as to provide parallel shift (as it is termed); that is, of course, very much faster than the serial shift of Fig-

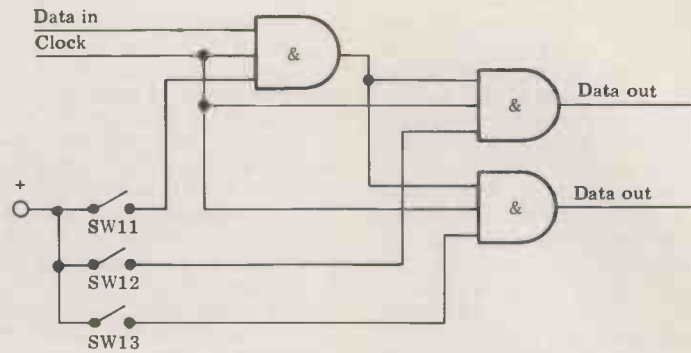

Fig 27

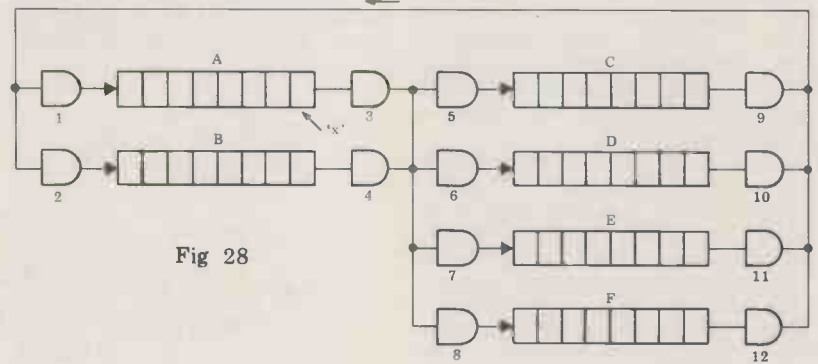

Fig 28

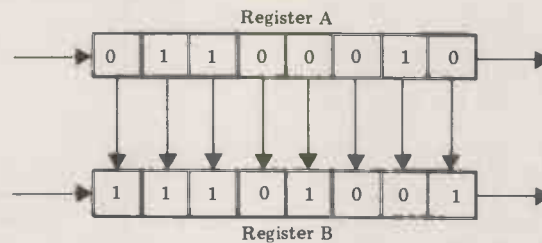

Fig 29 Simplified parallel-shift (compare with Figure 28). One clock pulse will transfer entire register A, deleting contents of Register B.

ure 28, but there is no need to stress the point for general students. Figure 29 illustrates the idea. Another combination of gates provides the adding or arithmetic circuit, while yet another gives comparison between two computer words. While they are, of course, enormously important to computer control study, generally speaking they are not necessary for the average student who is merely seeking background information. Such circuits are of necessity rather complex and therefore intimidating. Interested readers are referred to the literature.

A computer controlled by manually-operated switches in the manner described suffers from two major defects: (1) it's very slow and (2) it has no stored program. The slowness is due entirely to the human operator. It can take a considerable time to set a series of switches - a process that's also extremely prone to error. Once the GO button has been pressed, however, the machine is able to clock off eight pulses in a fraction of a second, so operation comprises an endless series of switch pushing, with constant reference to a series of written instructions. It's the absence of a stored program, however,

that classifies the machine as a crude calculator and not a crude computer.

Stored programs

The concept of the stored program goes back a very long way and one of the earliest contenders for the honour of original inventor is one Joseph Jacquard (1752-1834) - an entrepreneur and inventor of a weaving loom automation system. Readers with sufficient skill and patience can make a working model of Jacquard's system from Meccano. Leaflets are obtainable from M & W Models, Reading, which give full details of a machine that will weave cloth about 3 in wide, automatically reproducing a pattern over and over. Readers are warned however that this particular model is expensive and not easy to make. Simpler versions to illustrate the method only could be devised that would present a lot less trouble.

Jacquard's system used a series of punched cards that regulated a series of sensing rods. One card was in position at a time and as the rods descended, those opposite a hole were free to move through, while the others were stopped by the card. The difference was sensed and magnified by mechanical linkages,

BINARY				OUT
8	4	2	1	
0	0	0	1	1
0	0	1	0	2
0	0	1	1	3
0	1	0	0	4
0	1	0	1	5
0	1	1	0	6
0	1	1	1	7
1	0	0	0	8
1	0	0	1	9

Fig 30

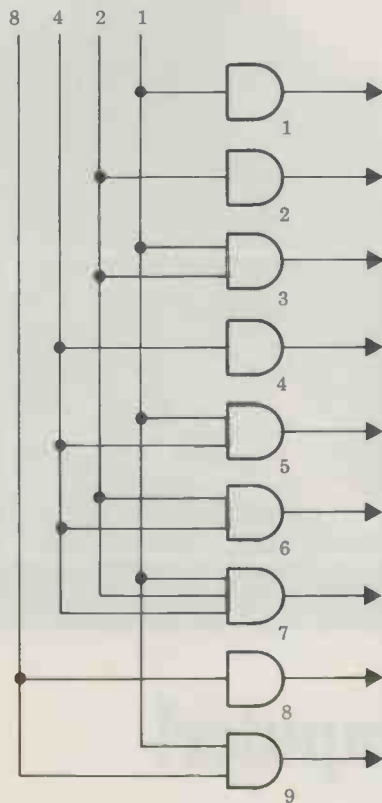

Fig 31

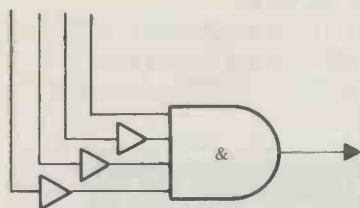

Fig 32

thus affecting the rise or fall of individual threads in the loom. A set number of warps was fed through the shuttle shed in this position before the sensing rods rose, the next card was fed into position, and the whole process was repeated. The cards were bound together in a large loop and thus the program was unending. Obviously, by inserting a different set of cards the machine would weave a different pattern. It was an interesting idea — especially at that time — and the great English mathematician Babbage was working on an adaptation of it to control his 'analytical engine' at the time

of his death in 1871.

The method is capable of wide variation and application. One is reminded of the frequently advertised charts that purport to teach the novice how to play the piano in an evening. Such charts are placed over the keyboard and various ingenious colour, numbering and lettering systems harmoniously link keys together. It was something like that which was required to turn the switch-operated calculator into a self-organising computer. What was wanted was some gadget to handle all the switching. The transistor makes a very fast switch and all that was needed was something — anything — to which we could say in effect, "Fred — take whatever you've got in Register A and shove it in memory C." The 'what's-it' would then switch the appropriate gates, the counter would count eight pulses, shifting the data, and the end of the count would signal back to the what's-it that the operation was complete. The what's-it would then fetch the next instruction and the cycle would be repeated, as with the programming already met in connection with the cardboard computer.

An intermediate stage came first, however.

Multiplexing

This is a big word that simply means controlling a lot of lines with a few. Let's imagine that we have 16 gates to control by hand. One way would be to have 16 switches — one for each gate — laid out schematically on a plan. The way forward, however, is to adopt a binary scheme.

Remember the grocer and his weights? When he wished to weigh 5 ounces, he used the 4 ounce weight and the 1 ounce weight, and you will remember that with just four binary bits we may therefore represent 16 numbers. So with switches. With just four switches — and thinking of their output as binary bits — we can control 16 gates. As with the grocer, when we wish to open gate 5, we flip switches 1 and 4.

The method is shown in Figure 31. If you follow the diagram carefully, you'll see that the switch marked 1 opens every other gate; the switch marked 8 opens the last two (only nine have been shown for clarity), and so on. Compare Figures 30 and 31.

Of course, it's not as simple as that! Suppose for example that, wishing to open gate 7, we flipped switches 1, 2 and 4. Doing that we'd find that in addition to gate 7, we'd also opened gates 1, 2, 3, 4, 5 and 6 — not a desirable state of affairs at all. But think back to a similar problem associated with sorting numbered cards in the binary selection box; the two problems are in fact different representations of the same thing. And the solution is the same — the realisation that (eg) decimal 3 is NOT 8 AND NOT 4 as well as 2 AND 1.

What's required therefore is an additional NOT output from each switch, to be taken to every gate not to be opened until the switch requires it — in other words, deliberately and permanently holding the output low until we equally deliberately switch it high.

The method is shown in Figure 32 and, clearly, all the extra lines could not have been drawn into Figure 31 without producing a very daunting diagram.

The next step came when it was realised that numbering individual gates was only a means to an end. What was *really* required was the switching of *sets* of gates, because it's these that perform different functions. The reader will see that an adaptation of Figures 31 and 32 will do this set-switching, while a glance back at Figure 28 will help him/her to realise the need.

We are now very close to the modern computer. The final step is for the *computer itself* to do the necessary switch selection — some means whereby it will in effect control itself. Consider — we have gates to take care of the manipulation of data and these are controlled by switches. The data and the control switching are binary, so can we somehow bring the two together.

In the event, it proves remarkably easy. First, we provide a special memory location called a Control Register (it's a memory, like any other). The outputs from this memory are paralleled as in Figure 29 and they are coded so as to operate the desired gates in the multiplex mode just described.

We also provide another special memory called a Program Counter, which keeps track of where the next instruction is coming from. The program Counter points to (say) memory location A07F and the computer fetches the contents of A07F and stores it in the Control Register. The counter is then incremented by 1. As a result of the contents now in the Control Register, gates are opened and the computer does something. When the clock has counted off eight bits, a signal is flashed and the cycle is repeated. The counter now is pointing at A080; the contents are fetched, put into the Control Register and the next operation performed. It really is that breathtakingly simple in concept. *Now* our students should be able to see why we brought in a study of Jacquard's loom, and all the other things!

Consider speed for one moment. The delays introduced by a human operator are totally eliminated; there are no errors of switching and no waiting. We can progressively increase clock speed until the transistors of the multifarious gates are switching as fast as they can go (typically a million times a second) and the whole series of operations can proceed at breakneck speed. Nevertheless, it must be stressed over and over again to our students that, despite the speed, every single thing about it is still proceeding logically and sequentially.

I often regret dismantling my early computers. One in particular was based on a design published by *Wireless World* in 1965 (how far we have come in so few years!) and it had the enormously useful facility of one being able to slow down the clock at will — in order to watch the transfer of binary digits as represented by little lamps. A modern version of this design would have much to commend it as a teaching aid.

The two errors in the second solution of Figure 23 are as follows: (a) no differentiation between father's mother and father's father, and (b) the first OR should be a NOR.

'TUSCAN' FROM TRANSAM



Take a step up to your next Computer!

THE CONCEPT

How many ways are there to build an S100 system? Not many, and all expensive. TUSCAN changes all that.

Five S100 boards on one single board—just for starters. Plus five extra slots for future expansion.

What a combination! Z80 and S100 with the TRANSAM total package of system and applications software.

How do we do it? Our prices start at £195 and you can build up in easy stages to a fully CP/M compatible disc based system. Something to think about!

THE HARDWARE

The first Z80 single board computer with integral S100 expansion. British designed to the new IEEE (8 BIT) S100 specification, the TUSCAN offers total system flexibility. A flexibility available now.

The board holds the equivalent of a Z80 cpu card, 8k ram, 8k rom video and I/O cards with 5 spare S100 expansion slots and offers a price/performance ratio which is hard to beat.

Just compare our price with a commercial S100 ten slot motherboard with this specification.

THE SOFTWARE

TUSCAN offers the user the choice of system monitor, editor, resident 8k basic, resident Pascal compiler or full CP/M disk operating system. All options are upwards

compatible and fully supported with applications software. Both 5¼" and 8" drives are supported in double density.

THE PACKAGE

TUSCAN is available in kit form or assembled. With several hardware and software options to suit your requirements and budget. Attractive desk top case also available holds 2 x 5¼" Drives.

TRANSAM

NOBODY DOES IT BETTER!

Send to Transam Components Ltd., 59/61 Theobald's Road, London WC1.

I am interested in the TUSCAN Z80 based single board computer with S100 expansion and enclose a S.A.E. for further details.

Name _____

Address _____

Telephone _____

MORE CHAMPIONSHIPS!

Kevin O'Connell examines the results of two recent major chess tournaments.

US championships

No sooner had the dust settled on the World Microcomputer Chess Championship at the PCW show than the results of the first US Microcomputer Chess Championship, played that same weekend, came through.

The North American tournament was played in San Jose, California, and co-sponsored by *Personal Computing*, the Mychess team, Applied Concepts and Motorola. Three of the competitors were also present in London at the same time — one of the advantages a micro has over a human.

The results achieved by Boris 2.5 and Chess Champion Super System III were particularly impressive — they have been commercially available for more than a year now. Of course, this is not to detract from the success of the Spracklens' new program in the Challenger hardware, but it will be interesting to see the new programs expected from Applied Concepts and SciSys.

World computer chess championship

After their own two special tournaments, the big guns of the micro world were trained on Linz in Austria, site of the third World Computer Chess Championship (25-29 September). Four 'micros' were among the 18 contestants. Advance 1.0 (UK) and Bebe (USA) were under microprocessor control but also availed themselves of some special chess hardware which, in each case, owed much to bit-slice technology. There were also two pure micros: Mychess (USA), running on a Cromemco, and the ubiquitous Champion Sensory Chal-

World CCC results

1.	BELLE (USA) Ken Thompson; Joe Condon PDP 11/70 with chess hardware	W8	D6	W4	W3	3½
2.	CHAOS (USA) Fred Swartz; Mike Alexander; Jack O'Keefe; Victor Berman Amdahl 470	W17	D4	W6	W7	3½
3.	DUCHESS (USA) Tom Truscott; Bruce Wright; Eric Jensen Amdahl V/8	W18	W12	W7	L1	3
4.	L'EXCENTRIQUE (Can) Claude Jarry Amdahl V/7	W5	D2	L1	W12	2½

GOTO page 135 for remaining results

lenger (USA), victor of both the US and the World Microcomputer Championships.

Advance 1.0, programmed by Mike Johnson and Dave Wilson, played in the World Micro Championship under the guise of Mike 3.0. In Linz only the name (and program!) had been changed. By defeating Sweden's Dark Horse, running on a Univac 1100/81 and programmed by Ulf Rathsman — whose Princess had competed in the World Micro where it had lost to Mike 3.0 — this was the only microcomputer to win a game. We reproduce that game here:

WHITE:	Advance 1.0	
BLACK:	Dark Horse	1.0
1	e2-e4	e7-e5
2	Ng1-f3	Nb8-c6
3	Bf1-b5	Ng8-f6
4	0-0 (Ke1-g1)	Bf8-e7
5	Rf1-e1	Be7-d6??
All beginners know that it is bad to move a piece twice in the opening.		
6	d2-d4	Nc6xd4

7 Nf3xd4 a7-a6
Why not? After all, if White has two pieces attacked then Black must be able to take one of them, so there is no rush to capture on d4.

8 Bb5-c4 b7-b5
White still has two pieces attacked.
9 Bc4-d5 Nf6xd5
10 e4xd5

Now Black wants, and needs, to take the knight on d4. That is what it was counting on, but White's last move cleared one more piece from the e-file and now e5xd4 is illegal. Oh well, back to the keyboard!

10... 0-0 (Ke8-g8)
11 Nd4-f5 Bc8-b7

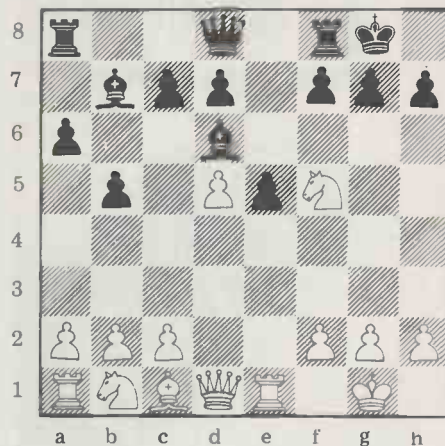

12 Bc1-h6! g7xh6?
Black was lost, but this makes matters worse.

13 Qd1-g4+ Black resigned

The trouble with 13...Qd8-g5 would have been that after 14 Nf5xh6+, Black would be at something of a loss to counter the follow-up 15 Qg4xg5.

The overall performance of the micros in Linz was quite good — of 14 games played against programs running on mainframes the micros scored +1 = 7 - 6 (32%).

See the score table for the full results of the tournament.

US results

1 (1)	CHAMPION SENSORY CHALLENGER (USA) Stand-alone device	W6	W5	W2	W4	4
2=(2)	BORIS 2.5 (USA) Stand-alone device	W10	W7	L1	D5	2½
2=(3)	BORIS EXPERIMENTAL (USA) Stand-alone device	W8	D4	L5	W9	2½
2=(4)	CHESS CHAMPION SUPER SYSTEM III (HK) Stand-alone device	W7	D3	W8	L1	2½
2=(5)	MYCHESS 'B' (USA) Cromemco	W9	L1	W3	D2	2½
6 (6)	ATARI 4k 'A' (USA) TV Interface Unit	L1	W10	D7	D8	2
7=(7)	MYCHESS 'A' (USA) Cromemco	L4	L2	D6	W10	1½
7=(8)	SFINKS (USA) TRS-80	L3	W9	L4	D6	1½
9 (9)	ATARI 4k 'B' (USA) TV Interface Unit	L5	L8	W10	L3	1
10(10)	LANE'S TC'86 (USA) Stand-alone device	L2	L6	L9	L7	0

FESTIVE FUN!

With Christmas fast approaching it seems like a good time to review the seasonal offerings of electronic goodies. This report is by PCW boffins David, Peter and Dick.

This year's review took us to that world famous toy emporium, Hamley's of Regent Street, to investigate the latest in truly electronic games. Dick Pountain specialised on the card games while editors David and Peter had a go at everything else. Of the 18 games offered only one was rejected, on the grounds that it was electro-mechanical. The remaining 17 were all electronic and most were intelligent, therefore qualifying for inclusion. We adopted a typical consumer's viewpoint, concentrating on questions like "Is it tough?", "What batteries are used?", "Is it fun?" and "Is it value for money?", rather than getting bogged down in technical details. We had a lot of fun and only one nasty moment when Peter sent a racing car on its preprogrammed route which just happened to take in a carefully-arranged toy display. Somehow our intrepid heroes managed to catch all the breakable toys before they hit the deck — phew!



SPACE LASER FIGHT and BOXING
Bambino Inc (Japan)
4 x HP11 batteries

We've grouped these two games together because, in most respects, they're identical. They have the same casing, which is extremely well-made and good to look at, the only difference between them being the colour. The keyboard control buttons are in the same places although they have different functions — in the one case combatants zap each other with laser guns and in the

other with boxing gloves. The action takes place on a vacuum fluorescent display and, to be quite honest, it's a bit of a disaster. In the boxing match, for example, if a boxer throws a punch it often involves his arm separating from his body — no way to win a fight really. The spacemen appear to be wearing mediaeval armour, although if the game was worth buying this detail would probably not be noticed.

The games give the option of two speeds and the opportunity to play a real opponent or the computer. We may be wrong but the machine seemed to respond quite randomly to the controls.

This game is claimed to be "the first with a microprocessor unit" — oh! really? The machine's strategy, if you can call it that, is to play only in response to the human input. Really, it wasn't very good. Beautifully made, but dreadful.



BLAST IT
Entex (Japan)
6 x HP7 batteries

This game simulates the well-known arcade (and personal computer) game 'Breakout', in which a brick wall has to be demolished with the aid of an iron ball. As with the arcade game only single bricks are removed from the ball's path. The player must catch the iron ball as it rebounds off the wall in order to send it back. Three balls are allowed in a game. The display is adequate and the sound effects are awful. Mercifully, there's a 'mute' switch which is a most sensible thing to incorporate — other game designers please note. Three controls handle the player's moves — left, right and return. The return button sends the ball forward instead of at an angle. Having hit a brick the ball then

resumes its normal diagonal progress. Two skill levels are provided — amateur and professional; professional takes some beating. All-in-all, this game is okay. Not one of the best, but okay.

RAISE THE DEVIL
Entex (Taiwan)
3 x HP7 batteries

Here's a quite reasonable machine, especially for pinball addicts. Yes, on reflection, addicts — the game's appeal might diminish after a while. It is, in fact, a simulation of a pinball using LEDs of all things to simulate ball and flipper movement. It sounds crazy but it does work. Raise The Devil is a hand-held game with instructions printed on the back for the forgetful types. It has four skill levels in addition to the expected flipper and shoot controls. Now and again the display got a bit confusing, but in the main it was pretty good. The only problem was that the horizontal bar of the score digits was a bit intermittent. It would be worth trying this one in the shop to see what you think of it before buying.

ELECTRONIC SOCCER
Entex (Taiwan)
3 x HP7 batteries

Well, the less said about this one the better. Frankly, we find our lunch hour games of blow football more entertaining, except when the Editor's been eating garlic, that is! In a hand-held game such as this it's impossible to get enough players on the field let alone cope with player and ball movement. LEDs are used to display the players and ball position, while larger (dim)

LEDs give the score. Controls for each player are forward, backward, left, right and kick. If you can't find an opponent then the computer will happily give you a very defensive and apparently random game. We weren't very happy with this one — in current parlance, we found it rather user-unfriendly. Try it and see what you think before buying.

DATACAR
Airfix (Hong Kong)
4 x HP11 and 2 x HP7 batteries

Now here's a real treat for children above about two years old. It's a programmable electric-powered car, and what a car — a BMW 3.5CSL in racing trim with rubber-shod wheels. The car is solidly made and should bash into things with little ill effect (to the car, that is). The only thing we didn't like



about the construction is the way that the PCB is clearly visible through the blue windows together with its inevitable mass of wires. 16 controls under the bonnet allows the operator (programmer?) to move the car in six different directions, hoot a horn and wail a siren. Each operation can be timed in seconds and a program can contain up to 48 such actions. When you consider that one function allows you to repeat the entire program then you'll have some idea of the car's potential.

The noises are superb but, sadly, there's no volume control. The car hurtles around so it's best not to have too many breakable objects in the room — see the comment earlier about Hamley's display. This has got to be one of the best items under review but you pay heavily for the privilege of owning it. We suspect that a lot of people out there won't be able to wait the year or two for the price to fall/inflation to catch up!

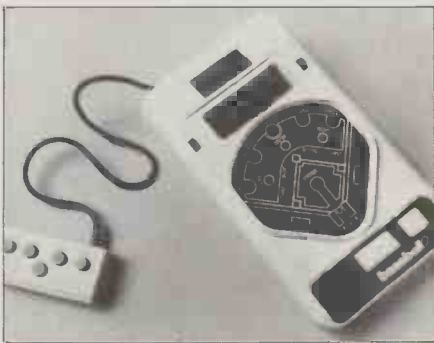

ELECTRONIC BASEBALL

Entex (Taiwan)
3 x HP7 batteries

Unless you're American or have an interest in baseball then you've got a bit of a hurdle to overcome before you can even begin to enjoy this game. Maybe the makers should produce a tame version and call it 'Rounders', but then again maybe they shouldn't. The instructions assume that you understand baseball so it's no good looking there for salvation. The game's for one or two players with one pitching and other hitting. Throws can be straight or curved and the hitter has to judge the timing of his hit just like in real life. If another player (rather than the computer) is pitching then he does it from a neat

little detachable keypad — a nice idea. This is, of course, still connected to the main game by a cable. The appeal of this game is limited in the UK but if they offered cricket in the same type of device then it could catch on. Electronic Baseball is one of the better thought-out games from Entex.



OTHELLO
Tsukuda Original (Japan)
4 x HP7 batteries or 6V input

This game was undoubtedly our personal favourite but — ouch! — the price. Ignoring that, this electronic Othello is surely an example of the way things must go in the toys and games business. Well made, this game has a liquid crystal board display which can be adjusted for contrast — much more restful on the eyes than some of the other games we've looked at.

It has a fair degree of intelligence with three levels of skill. We played several games at each level and only won one game. Apart from the fact that we're not brilliant Othello players, it does say something for the native intelligence of this machine. Controls comprise the keys A to H and 1 to 8, the skill selector, set, pass, auto, manual, score and on/off. The 'set' key is used when you've stopped messing about and wish to enter your move for real. It is possible to play around with various moves to gauge their effect. The 'pass' key is used when you can't move and it causes the machine to have hysterics: the machine stops you passing if there's a legal move on the board which you can still make and plays a gloating tune if there isn't.

Auto allows you to play against the machine while manual allows you to play a real live human. LEDs are used to indicate whose turn it is. It's a very good game but definitely overpriced.



SAFARI
Bambino Inc (Japan)
4 x HP11 batteries

Like all Bambino games, this is very well made in an attractive green plastic case. It is rugged and very easy to use. The instructions are simple and, just in case you forget them, they're printed on the back. The game is reminiscent of Peter Calver's 'Sweeper' which we pub-

lished in 'Programs' earlier this year. The idea of the game is to catch as many animals as possible in 90 seconds. Note, we said 'catch' not 'shoot', which we think is great — a significant move in the right direction. Animals appear at random on the display and four cursor control keys allow you to move a cage around the screen. Once you've caged an animal you've got to shut the door before it moves away. The three skill levels ensure that the machine keeps its interest for some time. It's an enjoyable game, well made, but like so many others of this type it's overpriced.



SPACE INVADERS
Entex (Japan)

6 x HP7 batteries

This is a hand-held version of the amazingly popular Space Invader pub game. It is also amazingly popular in Hamley's, where people exhibit severe withdrawal symptoms if the shop happens to run out of stock. Ah well, one man's meat. . . The display is quite faint, being covered by a garish bit of purple plastic with what looks like vacuum fluorescent invaders and so on underneath. Two speeds of play are offered — professional and amateur and, by gum, you don't half have to be quick to knock up a decent score at professional level. One very nice thing about this game is that the noises aren't very loud.

The controls comprise the aforementioned amateur/professional switch, a fire button and two controls to move the rocket launcher from left to right. These were mysteriously labelled "beam force controls". Odd. Mind you it looks impressive, embossed on the case like that. We found the game pretty boring but it clearly has a devout following, as Hamley's sales figures show.

NEW GENERATION COMPUTER ORGAN

Tensai (Singapore)
6 x HP2 batteries

Of the musical instruments reviewed, this was the best but, even so, it wasn't as enjoyable as some of the electro-mechanical organs which fall outside the scope of this survey.

In its hard red plastic case this organ looks tough. It has two octaves including black keys and each note is numbered to help the little ones. The pitch of the keys is smaller than on a piano and it's not possible to play chords. Three

tone control positions are provided — Hi sounds harsh and nasty, Lo sounds as if the loudspeaker is under a pillow and Med is, well, medium. A volume slider gives a progressive range from silence to very loud, while a neat little vibrato switch gives you that option as well.

It is possible to drive this machine from a mains adaptor and there's another socket on the back which isn't mentioned in the manual. It's either an earphone socket (good news) or a loudspeaker socket (bad news).



Now what sets this organ apart from the others in this survey is that it can record up to 48 notes of what you play. You can get instant replay at any of six speeds and if you're not sure of what speed you're at then a metronome has thoughtfully been provided. The only (and in our view serious) problem with the playback is that consecutive notes of the same pitch are played continuously. Try whistling *Jingle Bells* without the proper pauses between notes and you'll see what we mean. Two tunes: also tucked away in ROM inside the machine so it's possible to get a tune without any effort. One is *It's a Small, Small World* as reviewed in 'Bookfare' recently and we've forgotten the other one.

Conclusion — good for kids but not for parents.

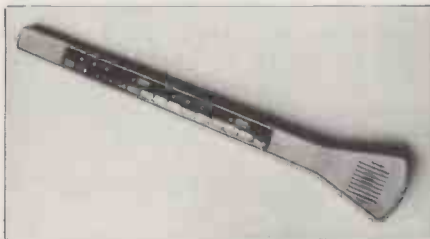

MAGICAL MUSICAL THING

Mattel (USA)

1 x PP3 battery

We really weren't sure whether to include this in the review but it's so weird we thought you ought to be warned. It all starts with the name — whose marketing men really got stuck for an idea then? And if they didn't, have they got any highly paid vacancies? Joking aside, this is a very odd plaything. It has a fun appearance,

being sort of long and thin with a multicoloured strip of plastic running almost its entire length. The remaining bits have to be covered with bits of sticky paper kindly supplied with the machine. 25 notes can be played by pressing the touch-sensitive multicoloured piece of plastic in the right places. These are considerably marked rather like a piano keyboard but at a different pitch. The device is about two feet long and can be played (according to the instructions) with elbows, feet or, indeed, any other part of your body. The Editor performed a passable version of 'Greensleeves' with his nose (on the Musical Thing, that is!)

Ah well, it takes all sorts. The 'music' produced has a nasty tone and it's only possible to play single notes — chords can only be achieved by playing more than one of these instruments simultaneously. Please don't do it near the PCW offices though! The only thing that commends it is that it's the cheapest toy in the review.



SINDY COOKER

Sindy

6 x HP7 batteries

If you ignore the price, here's a lovely toy for all those non-liberated little girls. You know, the ones who like to play with dolls and copy mummy. It's a cooker with interesting sound effects. Starting at the top there's a rotisserie with a light in it. It has to be rotated by hand from outside, which is a shame, seeing as there are batteries inside. Then we have the interesting bit — a four-ring hob onto which you may place a selection of pots and pans. And it doesn't matter which ring contains which pot — it makes the right noise! The frying pan sizzles, the saucepan bubbles, the pressure cooker hisses and the kettle whistles to the boil then goes off the boil. The kettle has the highest priority interrupt. . . oh, what are we saying? Just look at it and be mystified like we were, at first. The oven has a timing device which sounds an alarm a little while after anything is placed in it. All good fun, and six to ten year olds will love it.



LITE 'N' LEARN ELECTRONIC ORGAN

Concept 2000 (Hong Kong)

6 x HP7 batteries

Here's a cheap-looking but rugged musical instrument. In a bright red plastic case, the Lite 'n' Learn gives you the ability to learn a tune, listen to a tune or even play your own tune. These miracles (note the tongues in cheeks) are achieved through a ten-key keyboard topped with ten corresponding LEDs. To learn a tune (already in ROM in the machine) you press the learn button, whereupon a LED will glow. Press the appropriate key and another LED will glow, and so on until you've completed the tune. To just listen to the preprogrammed tune you press the auto button, select which of the 12 tunes you want and listen. A manual key allows you to do your own thing. It makes a nasty sound and doesn't allow chords. With these problems and only ten keys, its appeal is bound to be limited and in all probability interest would wane quickly.



STOP THIEF

Palitoy (France)

1 x PP3 battery

We have a small confession to make on this one — we didn't have time to learn the rules and actually play a proper game but we thought it warranted a mention anyway. It's probably the most expensive board game on the market if you ignore tarded-up backgammon and Mah Jong sets. Very similar to Cluedo, the idea is to catch a criminal at the scene of a crime. The board is laid out as a number of buildings and streets with each building having a number of rooms. Various temptations are sprinkled around the board. An Electronic Crime Scanner keeps track of where the criminal is. Cards are drawn which allow the player to do various things, while

the roll of the dice dictate the player's movements. Without getting too bogged down the player might find himself asking the calculator-like scanner for a tip or a clue. In the first case the scanner displays the criminal's location and if our memories serve us correctly the clue is a creaking door, breaking glass or one of the other sound clues telling what the criminal is up to. When the player thinks he knows where the criminal is, he keys this into the scanner then tries an arrest. The scanner makes a siren noise, followed by gunshots to warn the criminal. According to the next noise the arrest was either wrongful (a raspberry), a failure (na na-na na) or successful (a different siren). And so on. We'd love to play it some more because it looks like good fun — a new dimension in board games and something many others are sure to follow. The price, however, is just ridiculous — it should be at least half or maybe a third of the present level.

GIN RUMMY/BLACKJACK AND POKER

Entex Electronics (Japan)
4 x HP7 batteries or mains adaptor

As one who is fond of the rustle of pasteboard, I was quite excited at being offered the task of assessing two computer card games from Entex.

Both come in similar packages, like large pocket calculators, in cheap-looking — but tough — ABS cases. The buttons have a pleasantly positive action and, in both cases, large green fluorescent tube displays are used. A nice touch is that these tubes display the suit symbols in their corners, in addition to alphanumeric representation of the cards. It takes a bit of time to get used to 0 standing for ten, however.

Poker: I found this game very disappointing. Poker is not a game for two and the machine only plays as one opponent. In order to reinject some excitement into this two-player game, Entex has devised a non-standard version of poker which can definitely not



be found in Hoyle.

Based on Five-Card Draw, the betting is modified so that three rounds of betting are compulsory; you bet three rounds or drop — no seeing. You always open the betting and the dealer either calls you or doubles, and so on for two more rounds. On the second round, the dealer reveals two of his cards; on the third he reveals a third, introducing an element of stud in a rather disconcerting way. It seemed to me that the randomiser was rigged to provide better-than-average hands to both players; it is rare to pull less than a pair.

As to its skill, the machine plays a good hand quite well, bluffs hard, but is much too sloppy with bad hands, almost always going the distance instead of dropping. As a result I could beat it very soundly over ten or more hands.

To my shock, battery life is less than two hours, rendering it almost as expensive as the real thing! Not good value.

Gin Rummy/Blackjack: Blackjack is a pretty trivial and tedious game, to my mind. This machine plays it as well as a good croupier, playing the standard

casino rules, with splitting and doubling down permitted. As a bonus it pays extra on five card tricks.

Flipping a switch converts it to Gin Rummy (most of the non-numeric keys have double functions), which is very good indeed. Again the standard game is played, and it plays like the devil. You have a key to arrange your hand, another to form melds. The 11-digit display shows your hand, plus the machine's discard. A press of a key turns the discard into a card from stock. If the machine knocks first it will automatically lay-off your hand for you and, of course, it keeps all of the scores automatically, including bonuses. As a middling player, I found it consistently beating me; since its memory for my discards is infallible, this is hardly surprising!

The only gripe is that battery life is even lower than the Poker game: less than one-and-a-half hours solid play. This could be improved by using alkaline cells, but it's still insufficient for a long train journey. The adaptor would be a must. Nevertheless, at its price a reasonable buy.

Toy	Make	Batteries	Price*	Fun rating	Value for money
Space Laser Fight and Boxing	Bambino	4 x HP11	£35.00	**	*
Boxing	Bambino	4 x HP11	£35.00	*	*
Safari	Bambino	4 x HP11	£35.00	****	**
Raise the Devil	Entex	3 x HP7	£19.95	**	***
Space Invaders	Entex	6 x HP7	£19.95	**	***
Electronic Soccer	Entex	3 x HP7	£21.25	**	*
Electronic Baseball	Entex	3 x HP7	£31.95	**	**
Blast It	Entex	6 x HP7	£21.95	**	**
Poker	Entex	4 x HP7*	£22.75	**	*
Gin Rummy/Blackjack	Entex	4 x HP7*	£27.95	****	**
Datacar	Airfix	[2 x HP7 4 x HP11	£37.50	*****	***
Magical Musical Thing	Mattel	1 x PP3	£9.95	**	**
Lite 'n' Learn Electronic Organ	Concept 2000	6 x HP7	£19.95	**	*
New Generation Computer Organ	Tensai	6 x HP2*	£17.95	****	****
Sindy Cooker	Sindy	6 x HP7	£23.75	*****	***
Stop Thief	Palitoy	1 x PP3	£31.95	*****†	*
Othello	Tsukuda	4 x HP7*	£79.95	*****	**

* or mains adaptor

* prices will vary from store to store

***** Excellent
**** Very good
*** Good
** Fair
* Poor

† we think — see text

We would like to thank Hamleys of Regent Street and particularly Mrs Dawn Allen for making these games available to PCW.

COMPUTER ANSWERS

Questions for 'Computer Answers' should be sent to:
Sheridan Williams, 35 St Julian's Road, St Albans, Herts.

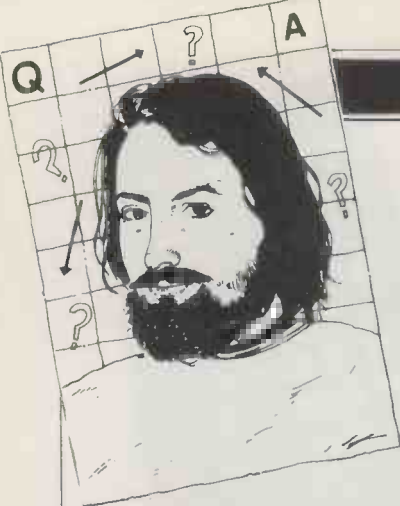

On the air

My interests include computer analysis of electronic circuits and using the computer as a teleprinter terminal for amateur radio transmission, the latter being the final hurdle before I go out and purchase. Do I have to take any precautions with electro-magnetic fields? The computer would sit next to the transmitter which has an output of 25 watts on frequencies in the 144 to 146 MHz band. Have any of your readers any experience with these problems?
B W Hepburn, NICS, COA, SHAPE, BFPO 26

I have put your full address above so that others interested may write directly to you.

The problems of shielding a microcomputer from interference and from causing interference are similar to shielding a radio or hi-fi set. The two main sources are RF and mains-borne. The former is suppressed by enclosing the components in a well grounded Faraday cage and screening all high speed data lines that leave the cage. Some manufacturers provide such screening as a matter of course but many later models have a plastic chassis which provides none. These would have to be modified by adding an internal wire mesh screen with a hole diameter of 1 cm or less. If you add a RTTY interface this should not produce many problems. It is important to provide good electrical contact at intervals wherever the mesh meets itself. Some indication of the efficiency of the screen can be made by putting an AM radio nearby with the unit in operation, on the principle that if you can't hear it then it can't hear you. Mains interference won't usually cause any problems; if it does then ferrite cores on the power cables where they enter the screen should help, as should extra bypass capacitors on the circuit boards themselves. With luck you should not have to resort to such devices; a well shielded transmitter feeding an external antenna through a good feed should not generate much RF near the computer in the first place.

However things are often less than perfect and I would suggest protecting the CPU anyway, as logic glitches are notoriously difficult to trap.

Finally, get in touch with the Radio Society of Great Britain, 35 Doughty Street, London WC1N 2AE, as there are many others with a common interest.
P A F Callow and Gareth Evans, RSGB

Conversion

I have a UK101 and would appreciate some help in converting the HPLLOT function used in 'Plotting in Three Dimensions' (PCW, July 1980) into a suitable subroutine.

A Katz, Edgware, Middx

The Compukit UK101 uses a 64 by 16 array of graphics pixels, each and any one of which can have placed in it any one of 255 alphanumeric or graphics characters, each made up from an eight by eight matrix of dots. The first six and last ten characters in each row of 64 are not displayed on a normal TV.

A sub-routine that will act as HPLLOT is:
10000 C = INT(X/8)
10010 C1 = X-C
10020 R = INT(Y/8)
10030 R1 = Y-R
10040 POKE 53248+C+64*R,
A(R1, C1)
10050 RETURN

At the start of the program you will need to set up the array A:
100 DATA x, y, z, a, ...
110 DIM A(8,8)
120 FOR R1 = 1 TO 8
130 FOR C1 = 1 TO 8
140 READ A(R1, C1)
150 NEXT C1
160 NEXT R1

The DATA items to go in line 100 are the codes for the graphics characters which correspond to the individual dots in each pixel. The instruction book (p 27) gives a program for displaying and identifying these.

In the sub-routine, line 10040 POKES into the correct pixel the graphics character most nearly corresponding to a single dot in the location defined by HPLLOT.

Instead of line 110 in the published program you will need to renumber so that line 1 becomes 200, and 130 becomes 370. Line 110 will then need to be replaced by:
350 X2 = X1-X
352 GOSUB 10000

354 X2 = X1+X
356 GOSUB 10000
Don't forget about not going too near the edges of the screen because of the characters you can't display!
P L McIlmoyle

RPN

I am thinking of buying a Powertran Z80 computer but am concerned about the Reverse Polish system used. As most of the programs printed in magazines are not of this type is it easy to convert? If so, how?
P W Stevens, Peterborough

You shouldn't have any real problems once you have understood the Reverse Polish notation, sometimes called postfix notation as opposed to infix notation which we normally use. I can't go into too much detail here so recommend that you buy a recently published book called *Computer Science* by C S French, D P Publications. You will find what you want on page 226.

Briefly, postfix requires no brackets and operation can be performed from left to right through the expression without worrying about operator precedence. Hewlett Packard calculators use Reverse Polish and they sell enough of them to show that people are not too worried about it.

Here are some expressions and their equivalents:

Infix	Postfix
A-B	AB-
(A-B)/C	AB-C/
2 + (A-B)/2	AB-2/2+

In brief, the operator operates on the two immediately preceding operands.
S W

PET replacement

I am considering replacing my two year old PET as it has been back four times for repair. What would you recommend for up to £1500? I require disks but no printer as yet. I wish to develop educational software and process examination results and pupils' records. Games are a secondary use. What about the Apple or Sharp? Are there any other machines worth considering?
P Denbigh, Leeds

You are the first person to

ask how to upgrade by changing machines — most people try to make the best of an existing system, which is usually a compromise as the system should be chosen around an application, not made to fit.

With £1500 to spend, you should seriously consider the Superbrain; read the review in a recent issue of PCW. Although the reviewer was not over the moon about it, it is certainly one of the best value systems on the market at present. It has either twin single-sided double-density 320k disks or twin double-sided double-density 720k disks; although the latter will take you over your budget, try and negotiate for them as an upgrade later will be extremely expensive. It has no graphics features as standard but does support CP/M, giving you a large range of extra software including word processors and other languages.

If you want to write educational software you ought to consider the Research Machines 380Z also; with two disks it is over your budget but you can buy it with single disks. Many local education authorities recommend it and over 1500 schools and colleges have them. It has superb graphics facilities as an extra but even the standard graphics are quite good. An increasing amount of educational software is being written for it. The 380Z is not very good for data processing as it has very limited disk capacity (single density) and, as yet, not very good DP software.

Finally, the Apple — worth considering for its graphics alone, but you should try and get an 80-character screen version. By the time you've bought the Apple, twin disks and screen, it will, however, have cost you over £1500.
S W

CP/M help

A year ago I purchased in board form an S100 32k 8-inch single disk computer with CP/M. I am having considerable difficulties with configuring CP/M and would like you to recommend a book for teaching me CP/M. Do you know the address of the CP/M Users' Group, who could surely help me?
P G Smart, Coventry

The only book I know of is

The CP/M Handbook with MP/M by Rodnay Zaks, published by Sybex. This book is very good but probably does not go as deeply as you would require into configuring CP/M to your particular system.

As you suggest, by far the most helpful would be the CP/M Users' Group whose address is: D Powys-Lybbe, MML, 11 Sun Street, Finsbury Square, London EC2. S W

ZX80printer

I have a ZX80 and have managed to get — very cheaply — an Olivetti TE 318 teleprinter which was previously used as a computer terminal. How do I hook it up to my ZX80?
Steve Dimond, Coulsdon, Surrey

The main hurdle is that Sinclair does not use the standard ASCII code which your printer requires. At the press conference in September for the launch of the new ROM, Clive Sinclair hinted that a ZX80 printer would be available sometime next year but he refused to be more specific. You could follow the lead of one club member who has built an intelligent printer interface using his Mk 14. Although intriguing, this seems an inconvenient and expensive route to follow. There are a number of 20 mA interface units on the market, but you'd need to write software to perform the conversion of letters and numbers to ASCII, plus provide a small lookup table to convert punctuation and special characters. Graphic symbols could not be included. This would enable use of the external device under program control only. To actually LIST programs, further software would be needed to POKE the appropriate locations in memory.

Olivetti says it would cost you £48 for the first hour, and £20 for each subsequent hour, for an engineer to visit you, inspect your Olivetti unit and, assuming it was working correctly, advise you on how to connect it to your ZX80!

Ken Macdonald and Tim Hartnell, National ZX80 Users' Club

Sharp1

I have recently bought a 20k Sharp MZ-80K computer. The PCB has eight empty sockets labelled RAM (III). I assume these are for expansion. Could you tell me what ICs to fit and what their working capacity would be. Also, two of the programs in the Basic manual don't work; would the expansion cure this problem?

B Wainwright, Wakefield, W Yorkshire

These sockets can indeed be used for expanding the memory. Use either 4027 (4k) or 4116 (16k) and you'll then have a capacity of 48k. Mind you, Sharp doesn't charge too much for its upgraded RAM anyway. This may cure your program errors but without further information I cannot answer this definitely. S W

Sharp2

I have just bought a Sharp micro. I cannot find out how to enter a program that has AND and OR in it. Can you help me?

P Stephens, Benfleet

Just replace AND by * and replace OR by +. S W

UK101queries

I have received several related questions about the UK101: In trying to choose between the UK101 and the Microtan I notice that a lot of games are advertised for the former, but not for the latter. As both use the 6502 processor, would UK101 programs run on the Microtan? What happens to the mains transformer of the UK101, as it is not attached to the PCB? What are the differences between the UK101 and the Ohio Superboard II, bearing in mind that the assembled UK101 is dearer than the Superboard? How does the Ohio Challenger 1 relate? Should I as a beginner consider buying the UK101 in kit form? Are there any better boards at around the same price?

A J Black, Wrexham; C Dorsman; S L Ward, Poulton-le-Fylde.

The Microtan as a single board operates only in machine code. It is not very likely that machine code programs written for the UK101 would run on it, due particularly to differences in handling I/O and character generation. However, by adding the Tanex board, Basic becomes available. This is a 10k Microsoft Basic and as such should be quite compatible with the 8k Microsoft Basic used by the UK101. That is not to say that you may not have to do

some alterations to UK101 programs to get them to run on the Microtan/Tanex but they should be fairly minor. You would probably have to enter the programs from the keyboard, as the cassettes for the UK101 may well not load.

The mains transformer for the UK101 is indeed not mounted on the PCB but is attached to it by leads which you can make of any reasonable length, so that you can put the transformer in a convenient place. This is not an unusual practice with uncased electronics kits. It does raise the question of safety and it would be wise to make sure the mains voltage terminals are well insulated. Even better, mount the transformer inside a plastic box.

There are not many differences between the UK101 and the Superboard, as the former was designed to be a British-made equivalent of the latter. The Superboard as originally imported was of the standard US design, intended to operate on 60 hertz mains rather than 50. The most obvious effect of this is that the standard Ohio Superboard will only display 25 characters per line on a UK TV set, compared with the UK101's 48.

Because of the frequency difference, the display may also not be as steady. However, an upgraded version of the Superboard is now available, fully converted to UK standards; this gives 48 characters per line. One of the other main differences is that the UK101 is intended primarily for sale as a kit. This is reflected in the pricing, with the UK101 kit being cheaper than the Superboard, but the Superboard being cheaper than an assembled UK101. No doubt this is related to the UK101 being assembled in the UK! As to whether a beginner should go for a kit, or a ready assembled board, this depends very much on the individual's skills, patience, and wealth!

If you're handy with a soldering iron and interested in the construction, by all means go for a kit. If you don't have these skills, or just want to get on with computing, go for the assembled product. The Challenger 1 is essentially a cased Superboard. Other single board computers that you might

like to think about include the Acorn Atom, the Rockwell Aim 65, the Nascom 1, and the Sinclair ZX80. P L McIlmoyle

Networking

Could you advise me on the possibility of setting up a system where a fairly powerful central microcomputer (such as a North Star Horizon) can process information stored on cassette by small units at remote locations and posted back to the centre? Bearing in mind the lack of compatibility between various Basics, would a special interface or data conversion program be needed? P M E Hazlehurst, Warley

The simplest, although perhaps not the cheapest, approach would be to select a manufacturer who offers systems in a variety of sizes which are compatible with each other. At the cheaper end of the market, both Acorn and Microtan offer small units suitable for the data collection work, which can be built up into larger systems for the more demanding central work.

Moving up to fully 'packaged' systems, the Tandy TRS-80 range immediately comes to mind. The data recording could be done using the Model 1, level 1 keyboard, while the central system could be a Model 1, level II with expansion interface and disk drives. The Ohio Challenger range also offers similar possibilities, with the C1 for data collecting and the Challenger C4P-MF (or even larger units) for the central work.

It is certainly possible to use special interfaces to allow data recorded in one format to be converted to another and these are indeed used for this purpose with mainframe computers. However, unless you build it yourself, such a unit could easily be as expensive as the central machine you have in mind. This would be the problem with the North Star Horizon. While this is popular for business use, it is very disk orientated, and inputting from cassettes would not be easy unless you could find an S100 card that provided this facility by slotting straight into the Horizon.

Whatever approach you take, it will be most important to check with your supplier that the various units really are compatible before making any commitment. Manufacturers can change their specifications at any time, or even supply what appear to be identical units with subtle differences (this has happened with both PET and TRS-80), perhaps because more than one factory can be involved. P L McIlmoyle

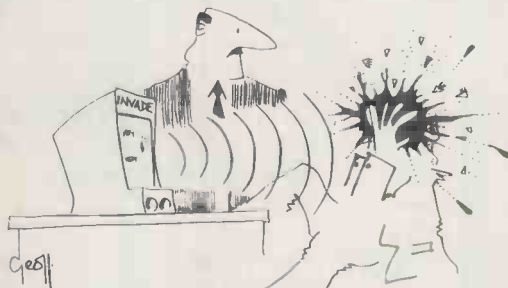

"As you see sir, the VDU facility is becoming more sophisticated all the time"

PCW SUBSET

Continuing PCW's unique series aimed at the serious programmer working in assembler language, Alan Tootill brings more examples of work sent in by readers.

The trouble with a series like this is that not everyone starts at the same time. Having read, in the September issue the rules and documentation for datasheets, Neil Imrie from Bedford writes:

1. Why this mania for abbreviation? Instead of the near meaningless 'level 0, class 1, I suggest 'This routine calls no other routines and follows such and such a standard.
2. If the level and class classification in 1 above is to be employed, why level 0 & 1, but class 1 & 2?
3. The ACTION section is really unnecessary if the routine is properly commented.
4. The SUBR DEPENDENCIES section is a repeat of the information in the level statement in 1.
5. In my opinion the very first statement for any routine is one indicating machine dependency and naming of the machine where appropriate. This is the general criticism of all program listings in magazines."

He also suggests that a time factor be given, as near as possible, for all routines, whether time critical or not and that the label at the routine entry point be given two colons (global symbol).

Concession

Neil puts some good points. In view of 4, we will dispose of 2 and part of 1 by dropping level and keeping SUBR DEPENDENCE. We will make it optional whether or not Time States, exact or maximum, are given for routines that are not time critical, because if you don't supply them, I'm not going to count them up. I am not convinced that two colons after a routine entry label is commonly understood to distinguish a routine generally available to any application. Will all of you who know it is and all who know it isn't please write in, so that we can sort this out? Meantime its use is optional.

Mania

I like a touch of mania, so will keep class 1 or 2. The technical dictionaries and glossaries should soon catch up with what a PCW Class 1 routine is - those who can't wait should go back to the September issue.

Perseverance

The ACTION section is proving difficult. It was proposed that the main actions of the routine be shown and you might have noticed that we have been experimenting a bit with

this. The idea is that the ACTION section should be independent of the listing, to help anyone to use the routine without needing to understand the code. The concept is a good one and we will persevere with it. Your ideas on strengthening this section will be particularly welcome.

Reshuffle

To me, the most important point about any routine is the job it will do in the real world. The processor on which the idea is executed is less important than the idea. So PROCESSOR stays last, where it is easy to find.

I want eventually to see the ideas of our best routines documented for execution on Z80, 8080, 6800 and 6502 processors. With this in view, a minor reshuffle of the documentation is called for, to put that which is common to all processors first and that which is variable last.

The second part of the documentation is now revised to:

Section 1 gives the class of the routine. Class 1 routines are re-entrant, relocatable and not self-modifying; others are class 2.

Section 5 is the old section 10.

Section 6 is the old section 11.

Sections 7-11 are the old sections 5-9.

Section 12 is optional for routines not time critical and gives the exact total or maximum number of Time States.

Section 13 gives the processor or processors that will run the machine code.

We can't get any better than that. Or can we?

Something different

Look at the graph in Figure 1. Suppose we know the values of X1 and Y1 (500 and 5000 in this illustration) and X2 and Y2 (2000 and 32000) and that the other co-ordinates we might use fall on a straight line between them. For any given value of X, between X1 and X2, we can then read off the corresponding value of Y.

If your microcomputer doesn't draw and read graphs, it can use INTPL, the subject of our first Datasheet this month, sent in by Jim Chance of Birmingham. The virtue of this routine

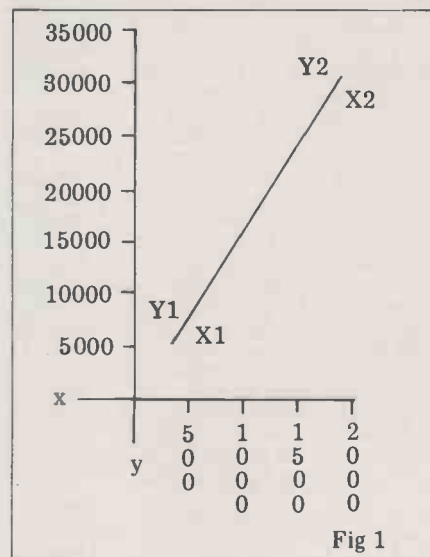

Fig 1

```

LD      IX,TAB      ; point to fixed co-ordinates
LD      BC,+1200    ; X value input
CALL    INTPL       ; get corresponding Y in DE
RST     20H         ; NAS SYS 1 restart to
                    ; display registers &
                    ; return to monitor
                    ; X1 held as F4 01
                    ; Y1 held as 88 13
TAB:    DEFW +500    ; X2 held as DO 07
        DEFW +5000   ; Y2 held as 00 7D
        DEFW +2000
        DEFW +32000
    
```

Fig 2

```

LD      (SAVE+1),SP ; save return
LD      SP,HL       ; set SP to params
(Main part of subroutine)
JP      SAVE

SAVE:   LD      SP,-- ; recover return
        RET     ; to main prog
    
```

Fig 3

is in its speed, so no 'improvements' that take more than 9000 Time States for the worst possible case are allowed.

In this bit of code I used to try out the routine in Figure 2.

Note how the fixed co-ordinates are held in TAB, with the most significant part of a double-byte binary number in the higher addressed byte and the least significant part in the lower. Note, too, that the routine changes the values in TAB, so that TAB has to be restored to its original state each time the routine is run like this.

Now that you have the routine, write in and tell us what you are doing with it. Jim used it to drive a digital to analogue converter, when the X axis was time and the Y was digital values.

Calling all learners

PCW has referred to this series as being for the serious programmer. It certainly, is, in the sense that everyone working in machine code must be keen on programming. But don't let this mislead you into thinking that only the expert can join in. Z80 machine code has not been around all that long and most of us are still learning.

I told you in November about David Yeomans from Halifax. He is not, and has not been, a programmer by occupation. He hasn't even got a microcomputer yet, being short of some parts for the one he is building. But he writes machine code that works and he sends it in to share it with other and to learn what the think about it.

David was taken with the idea we discussed in September of supplying parameters to subroutines, in the main program following the CALL and was already working along these lines. He sends our second Datasheet of a routine, ALRET, to alter the return address from a subroutine, to skip over parameters in the main program. The call to ALRET becomes the first instruction of the subroutine using parameters from the main program.

Don't interrupt

ALRET is strictly non-interruptable, as it takes the stack pointer above data that must be saved (the return address from ALRET). This further interesting suggestion of David's makes it even more so:

If a four-byte area of RAM called SAVE is dedicated to this procedure and the call to ALRET in the subroutine is followed immediately by the code in Figure 3, you can get the parameters in the main program area simply by popping them off the stack.

Not just a critic

Neil Imrie, who started us off this month by criticising and improving our documentation, sent converse routines in September's SBNF, better than the BFSN we printed in November. He sent BFSR, leaving the ASCII field right justified and BFSL, leaving it left justified.

BFSR is the subject of our third Datasheet. To get the result left justified, simply alter the machine code given for BFSR as follows:-

1. delete the 1st two bytes
2. alter the 10th byte from F6 to F8
3. alter the 15th byte from 07 to 08.

Datasheet

```
; = INTPL -Linear interpolation
;/ CLASS: 2
;/ TIME CRITICAL?: Not strictly but speed is important
;/ DESCRIPTION: Produces linear interpolation by the successive
;/                approximation method
;/ ACTION: algorithm follows:
;/ REPEAT
;/ BEGIN
;/ NEWY: = (Y2 - Y1) DIV 2 + Y1;
;/ NEWX: = (X2 - X1) DIV 2 + X1;
;/ IF X < NEWX
;/ THEN BEGIN X2: = NEWX; Y2: = NEWY END
;/ ELSE BEGIN X1: = NEWX; Y1: = NEWY END
;/ END;
;/ UNTIL (X2 - X1) DIV 2 = 0:
;/ Y: = NEWY;
;/ SUBr DEPENDENCE: Local
;/ INTERFACES: None
;/ INPUT: IX points to an eight-byte table in RAM holding the fixed co-
;/        ordinates X1, Y1, X2 and Y2 as double-byte binary numbers,
;/        with the most significant part of the number in the higher
;/        addressed byte and the least significant part in the lower
;/ OUTPUT: DE = corresponding value of Y
;/        Values in the table pointed to by IX, (IX) to (IX + 7),
;/        are altered
;/ REGs USED: AF, BC, DE, HL and IX
;/ STACK USE: 6
;/ LENGTH: 70
;/ TIME STATES: < 9000 in worst case
;/ PROCESSOR: Z80
```

```
INTPL: PUSH IX      ; save variable base      DD E5
        PUSH BC     ; save X                  C5
        CALL GTNEW  ; get HL = new Y          CD YY YY
        DEC IX      ;                        DD 2B
        DEC IX      ; IX → Y1                 DD 2B
        EX DE, HL   ; save new Y in DE       EB
        CALL GTNEW  ; get new X              CD YY YY
        POP BC      ; BC = X                  C1
        PUSH AF     ; save z flag             F5
        LD A,L      ;                        7D
        SUB C       ;                        91
        LD A,H      ;                        7C
        SBC A,B     ; compare HL, BC         98
        JR C,IP1    ; for X1, Y1             38 08
        INC IX      ;                        DD 23
        INC IX      ;                        DD 23
        INC IX      ;                        DD 23
        INC IX      ; IX → X2, Y2            DD 23
IP1:    LD (IX+4),E  ;                        DD 73 04
        LD (IX+5),D ; update Y1 or Y2        DD 72 05
        LD (IX+2),L ;                        DD 75 02
        LD (IX+3),H ; update X1 or X2        DD 74 03
        POP AF      ; z = finished            F1
        POP IX      ; restore variable base   DD E1
        JR NZ,INTPL ;                       20 D1
        RET        ;                         C9
; GTNEW does the average of Y1, Y2 or X1, X2 which
; it returns in HL, z = set if (2-1)/2 = zero
GTNEW: LD L,(IX+6) ;                        DD 6E 06
        LD H,(IX+7) ; HL = X2 or Y2          DD 66 07
        LD C,(IX+2) ;                        DD 4E 02
        LD B,(IX+3) ; BC = X1 or Y1          DD 46 03
        OR A       ; reset carry             B7
        SBC HL,BC  ; ED 42
        SRA H      ; CB 2C
        RR L       ; HL = HL/2              CB 1D
        LD A,H     ; 7C
        OR L       ; test z = finished       B5
        ADD HL,BC  ; HL = mean              09
        RET        ;                         C9
```

GOTO page 134

Your favourite

If your favourite routine hasn't been printed yet, why the heck don't you send it in?

Send your contributions to: PCW Sub Set, PCW, 14 Rathbone Place, London W1P 1DE.

FUTURE PERFECT?

Having explained the theory of forecasting last month, Alan Green now examines the dream of every micro owner -- using a computer to help win the football pools.

All of us at one time or another have dreamed of a jackpot win on the football pools. The problem, naturally, is to find those elusive eight draws from the 55 matches on the coupon. Picking match numbers at random means relying entirely on chance and hoping that, of the 1,217,566,352 possible choices of eight from 55, yours will be the winning one. Even entering a perm (it is really a combination not a permutation) of eight from 11 means that you are doing 165 lines and the chances are still only one in 7,379,190 that you will win.

In order to increase the chances of winning it is necessary to do an analysis of form and make the selections on a basis of informed assessment. With 130 teams in the English and Scottish leagues, this is a problem which is beyond the powers of the mind to handle but is simple for your micro, provided you tell it what type of analysis to perform. In my previous article on forecasting future events I said that any forecasting system needs a base of statistical analysis coupled with an ability on the part of the user to exercise his discretion and intuition. I also explained the principles of exponential smoothing designed to reduce data storage to a minimum and to analyse trends in results. The program Drawmaster listed with this article is a pools forecasting program which applies this technique to the special case of football results and presents a great deal of additional information to allow subjective interpretation to be done if required.

Program structure

The program (written for a PET) contains six main elements which will be dealt with separately, in detail. The initial provision is for the entry of all seven league tables either at the start or at some other time through the season. Match results are entered as and when they occur and the league tables are automatically updated precisely as they are in the Sunday newspapers. Forecasts can be made for any match between any of the 130 teams and this forecast contains four elements as detailed below. Provision exists to file and recall the league tables so that you are always working with the latest information when making forecasts. Finally all league tables can be displayed in order to check that your entries are correct and that you have not missed out any results.

Enter league table

For all teams you need to enter the name, win, draw, lose, goals for and goals against for both home and away performances and finally total points. Team names should be limited to 11 characters to allow for better formatting of subsequent displays. The crucial point to watch is that a part of the name to the left must be unique to that team. When forecasting it is not necessary to enter the complete team name, merely a string sufficient to identify it. Team searches are based on substring matching using the LEFT\$ statement. So if CLY is entered when forecasting, it would find either CLYDE or CLYDEBANK if the team names have been entered thus at the start of the program. It would be better to use CLYDE and CL'DEBANK, then CLY will only find Clyde and CL' will only find Clydebank. Chester and Chesterfield, Queens Park Rangers, Queens Park and Queen of the South present similar problems. Care at this stage can save time and reduce problems later.

To save on memory space a certain amount of information condensing has been done. When win, lose or draw records are entered they are combined into one number by subroutine 20110. Therefore a record of 12 wins, three draws and eight losses is stored as 120308. The number is broken down again when needed by subroutine 20210.

Similar procedures are adopted for and against in subroutines 20310 and 20410.

When all leagues are entered, an initial forecast performance for each team at home and away is required for exponentially smoothing stages of the forecasting routine. These forecasts must have a value between 0 and 2 and may be decided on subjectively or calculated based on the previous season's results. My own solution was to write a short program to do the following: $(2 \times \text{proportion of matches won}) + (\text{proportion of matches drawn})$. This gives a forecast based on points scored in matches, the approach used in the program.

For instance, if Norwich City had a home record of seven wins, ten draws and four losses, their forecast home performance would be $(2 \times \frac{7}{21}) + \frac{10}{21} = 1.14$

Enter match results

The identification strings for both teams in the match are entered (lines 11010-11310). It is not necessary to type the whole team name because the search through the tables is done using the LEFT\$ statements in lines 11080 and 11090 and, providing the input string is unique to one team, that team will be found. For example, EV would find Everton and CRY would find Crystal Palace. However, to find Bristol City as opposed to Bristol Rovers it would be necessary to enter BRISTOL C. When

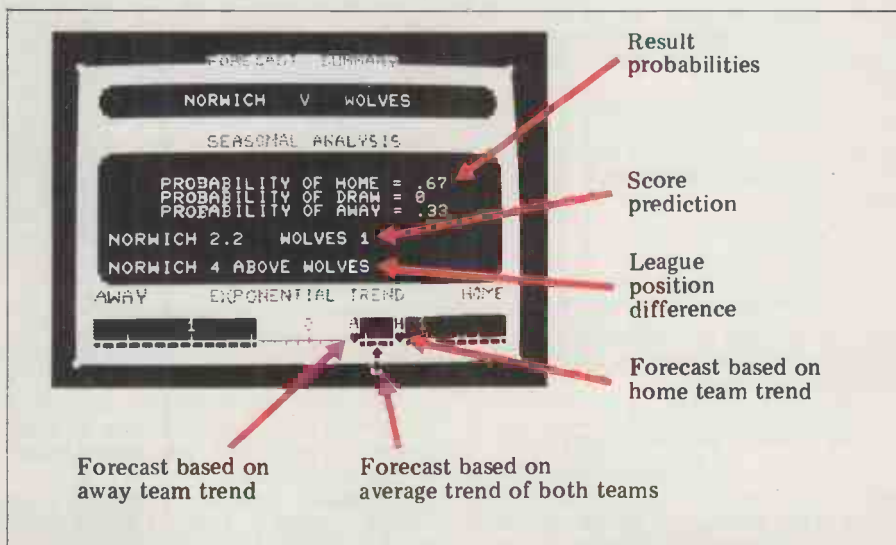

Fig 1 All forecasts are for a home win except away team trend, which marginally favours a draw.

the teams have been found the program prompts for the match result and gives the option to modify any details before final acceptance of the result. On final acceptance the league table details in terms of Win, Draw, Lose, Goals For, Goals Against and Total Points for both teams are adjusted accordingly. When all entries are complete the "*" is typed in place of the home team name and the program moves to the league sort routine in lines 11510-11590. The sorting is done with a standard ripple sort initially by total points but if two or more teams have the same number of points the sort is by goal difference.

File and recall league table

Lines 13010-14150 are standard filing routines but with the addition of a password facility to protect your data files. The program is designed to use a five-letter password but this was only to enable me to use my surname. If a different length password is required then the loop size in line 21220 must be changed accordingly. If, when recalling the league tables, the wrong password is given, the file is closed and the program returns to the option menu. At no time is the password visible on screen and it is only stored as a string variable for enough time to be checked.

League table display

All seven leagues are displayed sequentially and paging to the next one is achieved by pressing the space bar (lines 15010-15120). The details are displayed in condensed form in order to fit a complete table onto the PET's screen. Consequently a number under the WDL column, such as 20104, is interpreted as won 2, drawn 1, lost 4, and a number under the FA column such as 806 is interpreted as Goals For 8, Goals Against 6.

Forecast results

To forecast the result of a match the identification strings for both teams must be entered, eg 'LEE' and 'ARS' are required for the match Leeds United v Arsenal (lines 12010-12510). Having searched for and found the two teams, the forecast is presented as in Figure 1. Four sets of information are presented, three based on total performance for the season to date and one based on the recent trends of both teams. Details of the analyses are:

1. Result probability (lines 12150-12207). The home team's empirical probability of winning at home is based on its previous performances at home, thus:

Probability of win =

No of home wins

No of home matches played

The away team's empirical probability of losing away from home is similarly:

Probability of loss =

No of away losses

No of away matches played

In order for the result to be a home win the home team must win and the away team must lose. As we can calculate two separate probabilities for these events, the overall probability is taken as the average of the two individual

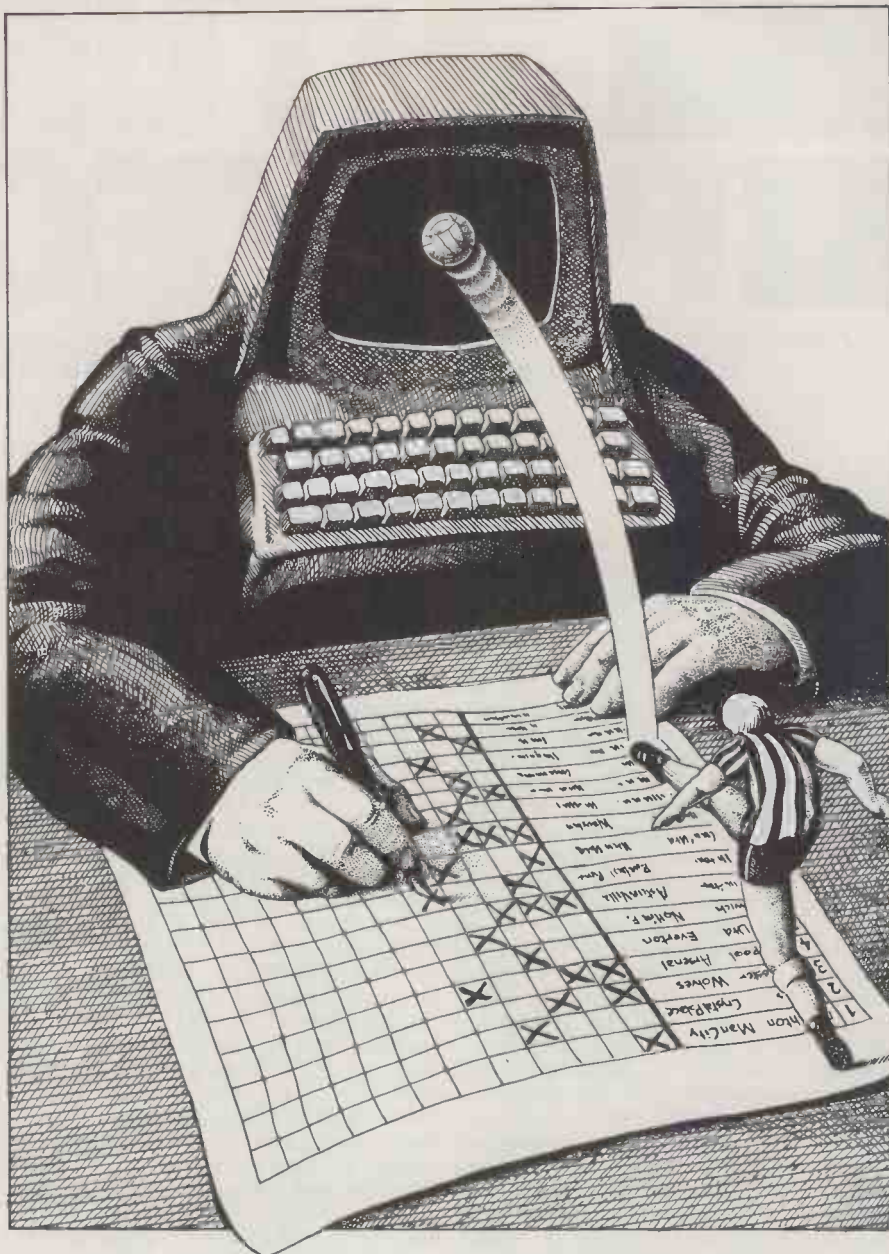

Illustration by Ingram Pinn

probabilities ie:

Prob'y of home result =

Prob'y of home team win +
Prob'y of away team lose

2

By similar arguments the draw and away win probabilities are calculated.

2. Match score (lines 12240 - 12350). The number of goals scored by the home team is related to its own scoring performance at home but also to the away team's record of conceding goals away from home. Therefore, the home team score is taken as the average of what it scores at home on average and what the away team concedes away on average.

Home team goals =

Home team ave home score +
Away team ave away concede

2

The away team's score is calculated by similar logic but involving its away scoring record and the home team's record of conceding.

3. Relative league position (lines 12380 - 12410). This is a simple statement of how much higher up the league one team is over the other.

4. Exponential trend (lines 12444 -

12462 and lines 22100 - 22230). This is the most powerful and probably the most useful part of the forecast. It is based on the double exponential smoothing (see my earlier article) of both home and away performance of every team in the leagues. The values of α and β are set at the beginning of the program in line 150. Variable XP corresponds to α and is set at 0.2. XT corresponds to β and is set at 0.07. These settings should not be taken as optimum values but are my personal initial values and should be adjusted in the light of experience. The exponential smoothing is done on the basis of points scored in each match so that if a team has a home record which averages out at a draw, its forecast of points for the next match is one point. If it wins that next match it scores two points and the forecast for the following match is correspondingly higher, say 1.2 points (depending on the values of α and β). That is, it is seen as more likely to win.

Obviously if a sequence of wins occurs the forecast approaches nearer to two, whereas a sequence of losses pushes the forecast towards zero. A run of draws maintains the forecast around one. The actual calculation of forecasts is done immediately following a match

result entry in that section of the program (lines 11290 - 1299). A check is incorporated to ensure that the forecast does not go below 0 or above two. Two separate forecasts are given for the match result based on the home team's home trend and the away team's away trend.

Finally, an average of the two predictions is given. The individual predictions based on trend are given by the two hearts on the scale in Figure 1 and the average trend prediction is shown by the double spade symbol. If only one heart symbol shows on the scale this is because both individual predictions are identical and one symbol overlays the other. The scale on the display is not intended to represent any actual calculation but is there as an indication of the strength of the forecast. The white area is intended to represent the draw prediction. If you want to increase or reduce this area for your own needs the appropriate lines to be modified are 21130 and 21135.

Interpreting the information

This is obviously a matter of personal opinion but I have checked this program over a number of weeks of the 1979/80 season and my preliminary conclusions are as follows. The individual trend figures are the most important with the away team's trend being slightly more significant. If these predictions are in gross conflict then the average trend figure in conjunction with the total season's analysis is used. Which elements of the season's analysis are more important than others I have not yet determined but careful monitoring should enable you to make a decision on this.

Referring to the match in the photograph, Leeds United's recent home performances indicate a draw bordering on a home win. Arsenal's away record recently indicates a home win. I would see this match as a marginal home win in spite of the seasonal analysis which in my opinion is not strongly against this. On its own the seasonal analysis suggests a draw.

This program will not guarantee eight draws but it will eliminate the majority of the non-draws. Remember, however, that chance and random events such as injury and the weather do play their part.

Finally, I shall be using this program this season and I hope to win. I hope you do too!

Note: as designed, the program requires approximately 14k of RAM. This is mainly because of ten arrays each of 130 elements. If you have a PET with only 8k of RAM then the best approach is to modify the program to handle one league display routine (15010 to 15120) arrays are redimensioned at 24 and the league display routine 15010 to 15120) dispensed with it should fit 8k. Don't forget to adjust all loops which are currently set at 130 cycles.

Disclaimer: Neither PCW nor the author will accept any responsibility if, by using this program, you fail to win your fortune - as the author points out, a great many unforeseeable factors can influence the result of a football game. Of course, if you do win a fortune, we hope you'll remember PCW...

```

● 1 IFST<>0THENPRINT"LOADING ERROR" ST="":ST=END
100 PRINT"J"
105 DIM#(130),HR(130),HG(130)
110 DIM#R(130),AG(130),FP(130)
115 DIM#FH(130),FA(130),TH(130),TA(130)
150 XP=.2:X0=1-XP:XT=.07:XS=1-XT:TL=((2/XP)-1)/2)+1
1001 GOSUB21011:GOSUB23000:GOSUB23001
1002 PRINT"FOOTBALL RESULT FORECASTER"
1004 PRINT"OPTION MENU" GOSUB23001:GOSUB23002
1010 PRINTTAB(7);"1" ENTER LEAGUE TABLES"
1015 PRINTTAB(7);"2" ENTER MATCH RESULTS"
1020 PRINTTAB(7);"3" FORECAST RESULTS"
1025 PRINTTAB(7);"4" FILE LEAGUE TABLES"
1030 PRINTTAB(7);"5" RECALL LEAGUE TABLES"
1035 PRINTTAB(7);"6" DISPLAY LEAGUE TABLES":IFEN=0THEN1045
1040 PRINTTAB(10);"LEAGUE TABLES LOADED"
1045 PRINT"ALAN GREEN 1980" GOSUB23003:GOSUB23001:GOSUB23004
1048 PRINT"ALAN GREEN 1980"
1050 GOSUB20620:OP=ASC(Z):IFOP>48ANDOP<55THEN1070
1065 GOTO1050
1070 ONOP-48GOSUB10010,11010,12010,13010,14010,15010
1099 GOTO1001
10010 IFEN=1THEN10620
10020 FORI=1TO130:PRINT" ":GOSUB20510
10040 PRINT"TEAMS";LS;"-";LF
10050 PRINT"TEAM";I:INPUT"("11 LETTER MAX)";N$(I):IFLEN(N$(I))<12THEN10060
10054 PRINT"TT":GOTO10050
10060 PRINT"HOME RESULTS":GOSUB20710:HR(I)=X:HG(I)=Y
10080 PRINT"AWAY RESULTS":GOSUB20710:AR(I)=X:AG(I)=Y
10100 INPUT"TOTAL POINTS";FP(I):PRINT
10110 GOSUB20810
10120 IFZ$="Y"THEN10150
10130 IFZ$="N"THEN10040
10140 GOTO10110
10150 NEXTI EN=1
10510 PRINT"FORECASTS FOR EXPONENTIAL SMOOTHING" GOSUB23005
10520 PRINT" ENTER HOME AND AWAY FORECASTS" GOSUB23005
10530 PRINT"1=SURE TO LOSE 1=DRAW 2=SURE TO WIN" GOSUB23005
10540 PRINT"
10550 PRINT"TEAM HOME AWAY"
10560 FORI=1TO130:PRINT" ":GOSUB23001
10580 PRINT" ";I:TAB(6);N$(I)
10590 INPUT" ";FH(I)
10600 INPUT" ";FA(I)
10610 NEXTI RETURN
101010 PRINT" ":GOSUB23000:GOSUB23001
101015 PRINT" ENTER MATCH RESULTS"
101016 PRINT"
101020 PRINT" TO FINISH TYPE '*' GOSUB23001:GOSUB23004
101040 HT=0:INPUT" HOME TEAM";H$:HL=LEN(H$)
101050 IFH$=" "THEN11510
101060 AT=0:INPUT" AWAY TEAM";A$:AL=LEN(A$)
101070 FORI=1TO130
101080 IFH$=LEFT$(N$(I),HL)THENHT=I
101090 IFA$=LEFT$(N$(I),AL)THENHT=I
101100 IFHT=0ANDAT>0THEN11140
101130 NEXTI PRINT"TEAM NAME ERROR...RE-ENTER" T":GOTO11040
101140 PRINT" ENTER THE MATCH SCORE"
101150 PRINT" ";HT):INPUTHG:PRINT" ";N$(AT):INPUTAG:PRINT
101170 GOSUB20810:IFZ$="Y"THEN11210
101190 IFZ$="N"THENPRINT" EDIT ALL MATCH DETAILS" T":GOTO11040
101200 GOTO11170
101210 HG(HT)=HG(HT)+HG*100+AG-AG(AT)=AG(AT)+AG*100+HG
101230 IFHG>AGTHENHM=10000:AM=1:Q1=2:Q2=0:GOTO11260
101240 IFAG>HGTHENHM=1:AM=10000:Q1=0:Q2=2:GOTO11260
101250 HM=100:AM=100:Q1=1:Q2=1
101260 HR(HT)=HR(HT)+HM:AR(AT)=AR(AT)+AM:FP(HT)=PP(HT)+Q1:PP(AT)=PP(AT)+Q2
101290 FX=FH(HT)-FH(AT):FX=X0+Q1*XP
101291 TX=TH(HT)-TH(AT):TX=X0+Q1*XP
101292 FH(HT)=FH(HT)+(TL*TH(HT))
101293 IFFH(HT)>2THENFH(HT)=2
101294 IFFH(HT)<0THENFH(HT)=0
101295 FX=FA(AT)-FA(HT):FX=X0+Q2*XP
101296 TX=TA(AT)-TA(HT):TX=X0+Q2*XP
101297 FA(AT)=FA(AT)+(TL*TA(AT))
101298 IFFA(AT)>2THENFA(AT)=2
101299 IFFA(AT)<0THENFA(AT)=0
101310 PRINT"THIS RESULT ADDED TO LEAGUE TABLES" GOSUB20910:GOTO11010
101510 GOSUB21011
101511 GOSUB23000:GOSUB23001
101515 PRINT" ADJUSTING ALL LEAGUE TABLES"
101516 PRINT"
101517 PRINT" FOLLOWING LATEST RESULTS" GOSUB23001
101521 PRINT"
101522 GOSUB23003:GOSUB23001:GOSUB23004
101525 PRINT"
101530 FORI=1TO130:LS=0:GOSUB20510
101560 IFLS=0THEN11780
101565 PRINT" ";TAB(8);D#
101570 FORK=1TO(LF-LS):PRINTTAB(22);"TRIPPLE";K:M=0
101590 FORJ=LSTOLF-K
101600 IFPP(J)>PP(J+1)THEN11750
101605 IFPP(J)<PP(J+1)THEN11660
101610 V=HG(J)+AG(J):GOSUB20410:G1=F-A:Y=HG(J+1)+AG(J+1):GOSUB20410:G2=F-A
101650 IFG1>G2THEN11750
101660 N$(J)=N$(J):X1=PP(J):X2=HR(J):X3=HG(J):X4=AR(J):X5=AG(J):X6=FH(J):X7=FA(J)
101680 N$(J)=N$(J+1):N$(J+1)=X#
101690 FP(J)=PP(J+1):FP(J+1)=X1
101700 HR(J)=HR(J+1):HR(J+1)=X2
101710 HG(J)=HG(J+1):HG(J+1)=X3
101720 AR(J)=AR(J+1):AR(J+1)=X4
101730 AG(J)=AG(J+1):AG(J+1)=X5
101734 FH(J)=FH(J+1):FH(J+1)=X6
101736 FA(J)=FA(J+1):FA(J+1)=X7:M=1
101750 NEXTJ
101760 IFM=0THEN11775
101770 NEXTK
101775 PRINTTAB(22);"SORTED"
101780 NEXTI RETURN
12010 PRINT" ":GOSUB23000:GOSUB23001
12015 PRINT" RESULTS FORECASTER"
12016 PRINT"
12020 PRINT" TO FINISH TYPE '*' GOSUB23001:GOSUB23004
12040 HT=0:INPUT" HOME TEAM";H$:HL=LEN(H$)
12050 IFH$=" "THEN12510
12060 AT=0:INPUT" AWAY TEAM";A$:AL=LEN(A$)
12065 PRINT" SEARCH FOR TERMS"
12070 FORI=1TO130:PRINT" ";TAB(18);I
12080 IFH$=LEFT$(N$(I),HL)THENHT=I
12090 IFA$=LEFT$(N$(I),AL)THENAT=I

```

interface components

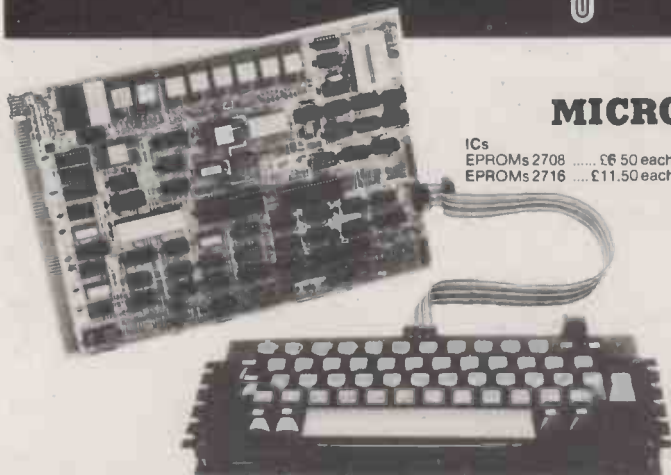

MICRO MART

ICs
EPROMs 2708 £6.50 each
EPROMs 2716 £11.50 each

MEMORIES
21L02 £0.80 each
4027 £1.50 each
4116 £3.95 each
2114 £3.00 each

Z80 DEVICES
MK3880 £9.50 each
MK3881 (P10) £6.25 each
MK3882 (CTC) £6.25 each

VOLTAGE REGULATORS
7805 80p each
7812 80p each
7815 80p each
7824 80p each
7905 65p each
7912 65p each
7915 65p each
7918 65p each
7924 65p each
Add VAT and 30p P&P to all orders

SHARP'S DESK-TOP BRAIN. MZ-80K FROM £480

Plus VAT
An amazing Z-80 controlled personal computer supplied with 78-key ASCII keyboard; 14K extended BASIC; VDU (40 characters x 25 lines); fast cassette facility; 4K monitor ROM; 80 x 50HR Graphics; and a choice of 20K, 32K or 48K of internal random access memory.

A 50-pin universal BUS connector allows the addition of printer, floppy discs, etc. There is also a built-in 3-octave music function.

20K System £480 + VAT
32K System £529 + VAT
MZ80FD (twin floppies with 208K) £780 + VAT
MZ80P3 Printer £517 + VAT
MZ80 I/O Interface £99 + VAT
Stock control & Sales/Purchase ledger software now available.

NASCOM-2

MEMORY ● 8K Microsoft BASIC ● 2K NAS-SYS 1 monitor ● 1K Video RAM ● 1K Workspace/User RAM ● On-board 8 sockets provided for memory expansion using standard 24-pin devices: 2708 EPROMs and MK4118 static RAM. MICROPROCESSOR ● Z80A which will run at 4MHz but is selectable between 2/4 MHz. HARDWARE ● Industrial standard 12" x 8" PCB, through hole plated, masked and screen printed. All bus lines are fully buffered on-board. INTERFACES ● Lcon 57 key solid state keyboard (included) ● Monitor/domestic TV interface ● Kansas City cassette interface (300/1200 baud) or RS232/20mA teletype interface.

The Nascom 2 kit is supplied complete with construction article and extensive software manual for the monitor and BASIC.

EXPANSION OPTIONS

● MK4118 £10 + VAT each
16K RAM B Board £140 + VAT
32K RAM B Board £170 + VAT
48K RAM B Board £200 + VAT
16K RAM A Board £140 + VAT

£345
Built & tested incl. 16K Ram A - VAT - £2.00 P&P
£295
- VAT (Kit)

NASCOM IMP PLAIN PAPER PRINTER

The Nascom IMP (Impact Matrix Printer) features:
● 60 lines per minute ● 80 characters per line ● Bi-directional printing ● 10 line print buffer ● Automatic CR/LF ● 96 characters ASCII set (includes upper/lower case. \$, £) ● Accepts 8 1/2" paper (pressure feed)
● Accepts 9 1/2" paper (tractor feed)
● Tractor/pressure feed ● Baud rate from 110 to 9600 ● External signal for optional synchronisation of baud rate
● Serial RS232 interface
● Ribbon cartridge £6.60 + VAT + 50p P&P
● 2000 sheets Fan Fold paper
£18.00 + VAT + £2.50 P&P

Nascom Imp
£325
Plus VAT + £2.75 P&P



48K SYSTEM
SPECIAL OFFER
OCT/NOV
£545
+ VAT

NASCOM-1

12" x 8" PCB carrying 5LSI MOS packages, 16 1K MOS memory packages and 33 TTL packages. There is on-board interface for UHF or unmodulated video and cassette or teletype. The 4K memory block is assigned to the operating system and video display leaving a 1K user RAM. The MPU is the standard Z80 which is capable of executing 158 instructions including all 8080 code. Built price £140 + VAT.

Nascom-1 Kit Price
£125 Plus VAT
+ P&P £1.50



NEW POCKET COMPUTER FOR UNDER £100 + VAT. SHARP PC-1211

It's true! A real computer that employs the BASIC programming language and fits into a pocket!
The PC-1211 measures only 175mm wide by 70mm deep by 15mm high and weighs a mere 170g (less than 6 ounces) yet look at its features! Up to 1424 program steps, 80 character input line with full editing features, 18 user definable keys, 24 character alpha-numeric LCD display and built-in tone function are included.

An optional cassette interface is available for loading or dumping programs or data. The PC-1211 is battery operated, has an auto power off function, and maintains all programs and data in its memory even after the power has been turned off.

£91.26
Plus VAT + P&P £1.00
(cassette interface £13.00 plus VAT + P&P 50p)

NASCOM FIRMWARE IN EPROM

NASPEN £30.00 + VAT + 35p P&P
ZEAP 2 £50.00 + VAT + 50p P&P
NAS-SYS 1 £25.00 + VAT + 35p P&P
NAS-DIS £37.50 + VAT + 35p P&P
NAS-DEBUG £15.00 + VAT + 35p P&P
NAS-SYS3 £40.00 + VAT + 35p P&P

NASCOM HARDWARE

Motherboard £5.50 + VAT + 50p P&P
Mini Motherboard £2.90 + VAT + 50p P&P
3 amp PSU £29.50 + VAT + £1.50 P&P
VERO DIP board £12.50 + VAT + 50p P&P
FRAME £32.50 + VAT + £2.00 P&P
8 Amp PSU Built £145.00 + VAT + £2.75 P&P
I/O Board £45.00 + VAT + £1.00 P&P
Buffer Board £32.50 + VAT + 50p P&P

NASCOM SOFTWARE ON TAPE

8K BASIC £15.00 + VAT + 50p P&P
ZEAP 2 £30.00 + VAT + 50p P&P

Microtype
Model 3 Case £24.50 + VAT + £1.50 P&P

NASBUS EPROM BOARD

Expands Nascoms 1 & 2 with up to 32K of Eprom. Accepts 2708s or 2716s. Also 24 pin socket for 8K ROM. Wait-state fitted for M2 users. Board can also support Nascom Page Mode Scheme.

£55 + VAT (Kit) | **£70** (Built & tested) Plus £1.00 P&P + VAT

INTERFACE COMPONENTS LTD.

OAKFIELD CORNER, SYCAMORE ROAD, AMERSHAM, BUCKS HP6 6SU
TELEPHONE: 02403 22307. TELEX 837788

Prices correct at time of going to press



BACKGAMMON

Lady Luck poses more than a few problems for David Levy in this month's look at Backgammon

The game of backgammon introduces special problems into the tree search. Some of these problems are caused by the fact that, before s/he decides what move to make, a player must throw a pair of dice and only then will s/he know which 'moves' are legal. The very fact that two dice can be thrown in 21 different ways gives rise to an enormous branching factor and this is the source of the second major problem. In this month's article we consider how these problems might best be approached. We also examine a strategy for determining when to make or accept a double.

The opening move of a backgammon game is easy for a computer program. Depending on how the dice appear, there are set moves which have been shown by experience to be best. The program merely stores these moves in a table and makes the move corresponding to the particular fall of each die. It is what happens after the first move that is interesting. Let us first consider a program which performs only a one-ply search.

The program need not begin to 'think' until after the dice have been thrown, since it is only then that its possible moves are known. For a one-ply search there is little difference between a backgammon program and a chess program — an evaluation function provides a score for the terminal nodes and the program chooses the move which leads to the highest scored terminal node. We shall discuss the evaluation process in more detail later in this article. Here it is only necessary to comment on the fact that when one player throws a double (1,1) or (2,2), etc, he makes two sets of moves, as though he had thrown four individual dice. This can be accounted for easily enough by calculating every possible way of playing the double throw, and making each of these ways into one branch of the tree.

Probabilistic trees

Once the search extends beyond one ply, the trees become probabilistic. We have already encountered such

trees in another form, earlier in this series. The tree in Figure 1 will enable the reader to understand the problem.

Let us assume that it is the program's turn to move from the root of the tree after the dice have been thrown. Berliner has calculated that in an average board position there are roughly 40 possible ways of making each move but that in typical game positions (assuming sensible play) the number drops to around 17. So from the root of the tree the program can choose from the moves M_1, M_2, \dots, M_{17} . Let us assume that we first examine move M_1 . In a one-ply search we would apply the evaluation function to the resulting position and back up the score S_1 to the root of the tree, assigning to S the value of the best score found so far.

After the program makes move M_1 , its opponent throws the dice. The move $M_{1,(11)}$ corresponds to the opponent throwing double 1 after the program has played M_1 . The move $M_{1,(12)}$ corresponds to the opponent throwing a 1 and a 2 after the program makes the move M_1 . Thus, there are 21 possibilities to consider after the program makes the move M_1 . Associated with each of these possibilities there is a probability measure. $P_{(11)}$ corresponds to the probability of the opponent throwing a double 1 (which is $1/36$). $P_{(12)}$ is the probability of throwing a 1 and a 2 (which is $1/18$). In fact the probability of throwing each particular double is $1/36$ and the probability of each of the other possible combinations of the die is $1/18$.

Let us see what happens if the program's opponent throws a double 1. He then has the choice of the (roughly) 17 moves which we denote by $M_{1,(11),1}, M_{1,(11),2} \dots M_{1,(11),17}$. For each of these 17 moves the program applies its evaluation function to the resulting position, and the best of the 17 scores is backed-up to $S_{1,(11)}$. Corresponding to the opponent's throw of a 1 and a 2 there are once again some 17 moves: $M_{1,(12),1}, M_{1,(12),2} \dots M_{1,(12),17}$, each of which has its own associated score. The best of these scores is backed-up to $S_{1,(12)}$.

Once we know the values of the scores $S_{1,(11)}, S_{1,(12)}, \dots, S_{1,(66)}$, we would like to back-up these scores to S_1 so that S_1 represents the best of these scores. But the program's opponent cannot choose how the die will fall and so he is unable to choose whether S_1 has the value of $S_{1,(11)}$ or some other backed-up value. The actual merit of the node at a depth of one ply is, therefore, not the merit of the best node at two ply, but a weighted sum of the two ply scores — the weightings corresponding to the probabilities of the various throws of the die. Thus, there is a probability of $1/36$ that the program's opponent will be able to choose for his value of S_1 and backed up score $S_{1,(11)}$. There is a probability of $1/18$ that the program's opponent will be able to choose for S_1 the value of $S_{1,(12)}$. And so on. The actual score which should be assigned to S_1 is therefore:

$$S_1 = (1/36 \times S_{1,(11)}) + (1/18 \times S_{1,(12)}) + (1/18 \times S_{1,(13)}) + \dots$$

The size of tree and how to cope with it

It will already be clear that, in order to perform the equivalent of a two-ply search, the program must do a lot of three-ply work. Some of this work is very fast: the moves at the second ply are nothing more than the throw of the die and these remain fixed for the whole game, as do their probabilities; they can be stored in a simple table. But the choice that arises after the throw requires a legal move generator, which may also be table driven but which increases the branching factor to approximately 17×21 , or 357, though this number can rise to over 800. Since it is impossible to choose how the dice will fall, the alpha-beta algorithm has no place in the tree search. The program must examine every possibility from a node before backing-up. There is, however, another method of pruning the tree, which in some ways is analogous to alpha-beta pruning.

Let us assume that M_1 is, in fact, the best move that the program can make. After calculating the scores and backing-up to S_1 , the program knows the value of making the move M_1 . It then begins to look at the move M_2 , and it calculates the score S_2 by adding: $(1/36 \times S_{2,(11)}) + (1/18 \times S_{2,(12)}) + (1/18 \times S_{2,(13)}) + \dots$ and since M_1 is better than M_2 , the score S_1 will be higher than S_2 (I have assumed that we are following the normal convention under which high scores are good for the program and low, or negative, scores are good for its opponent).

To determine that S_1 will be higher than S_2 , if we examine M_1 before M_2 it will be necessary to sum all 21 terms in the expression for S_2 . But what happens if we examine the moves in the reverse order, with the worst move being examined first? To show that M_{16} is better than M_{17} it will not necessarily, be essential to add all 21 terms in the expression for S_{16} . It might be the case that after adding only 18 of the terms, the score would already be better than that of S_{17} . From that point on it is no longer important in the relationship between M_{16} and M_{17} whether the three remaining terms

in the expression for S_{16} add up to a relatively small or large number. We know for certain that S_{16} is larger than S_{17} . Unfortunately, the whole of the pruning process is not this simple. In order to know that S_{15} is greater than S_{16} we *do* need to know the exact total of the 21 terms in S_{16} . So how can we afford to prune certain parts of the tree?

The answer lies in an analogy argument, which involves some approximation and hence some risk. But I doubt that it will give rise to serious errors.

It seems reasonable to argue that if, in position A, the results of n of the 21 possible throws add up to something better than the results of the same n throws in position B, then position A is better than position B. This is certainly true when $n=21$, and it is least likely to be true when $n=1$. Readers can experiment to see how low n can become without producing large errors in comparing two nodes. The important thing to remember is that we choose a 'cross section' of possible throws — at least one throw with a 1, one throw with a 2, and so on. The absolute minimum number of throws to be compared is three, for example 1 and 2, 3 and 4, 5 and 6. I would expect it to be true that if

$S_{1,(12)} + S_{1,(34)} + S_{1,(56)} > S_{2,(12)} + S_{2,(34)} + S_{2,(56)}$, then $S_1 > S_2$.

Of course there would be exceptions to this generalisation, but the number of exceptions ought to be a small price to pay for cutting down the possible throws of the dice from 21 to only 3.

When we consider a deeper tree, which takes into account the first two moves by the program and the first reply by its opponent, instead of examining a three-ply sequence we are, in fact, looking at a five-ply probabilistic tree. The number of nodes on this tree will already be so large that, without alpha-beta pruning, it is very doubtful whether a micro-program can search it within an acceptable time span, and alpha-beta pruning is not possible because of the nature of the tree — a player does not have complete freedom of choice because of the dice. The tree in Figure 2 will illustrate the magnitude of the problem. Since none of the scores at any ply can be known until *all* successor moves from that node have been examined, there is no way that alpha-beta can be employed. Of course forward pruning is always possible, using either the apparent merit of a node as measured by the evaluation function or the backed-up merit as determined from an extra ply of look-ahead (which would be slow) but this is all that one can do.

The Evaluation function

Backgammon can be divided into two distinct stages. For most of a game the two sides are 'engaged'. That is to say, there are one or more opposing men standing between one or more men and the inner table. Once this stage is over the two sides are 'disengaged', and the game becomes a race to 'bear off' all of one's men; the first player to do this is the winner.

During the engaged stage there are two features of paramount importance.

Berliner, who as well as being a former World Champion at correspondence chess is also the world's leading backgammon programmer, calls these features 'Blot Danger' and 'Blockading Factor'. A blot is a single man on a point, which is liable to be 'hit' by an opposing man landing on the same point. The blot is then sent off the board until that player throws a dice in such a way as to allow the man on the bar to move to a point which is not blockaded by the opponent. By hitting many of your opponent's blots you force many of his men onto the bar and thereby slow down his progress around the board. Berliner's blot danger feature finds the optimal way to play every potential roll of the dice so as to hit the greatest number of blots, or to hit the most advanced blot(s) if there is a choice of equally powerful plays.

It is a relatively easy matter for the program to compute the probability of one side or the other landing on a point where his opponent has a blot. Clearly the blot danger feature must use such a calculation in order to arrive at an accurate estimate of danger, which in turn will discourage the program from making moves which leave vulnerable blots. In any game where chance plays a part it is impossible to be sure that a particular strategy will be fool-proof, but it makes good sense to play with the odds.

The notion of a blockade is very important in impeding the progress of your opponent's men, since an enemy man cannot land on a blocked point (ie a point with two or more of your own men on it). Setting up a succession of adjacent blockades is a particularly powerful strategy if it can be successively adopted because it prevents the opponent from moving unless he is lucky enough to roll high numbers from a point just on one side of the blockade. Berliner's program considers every combination of from zero to seven blockading points (seven

is the maximum number possible, since each side has only 15 men), at a distance of from one to 12 points in front of each man. It employs a table of these blockading patterns to store the number of rolls of the dice that could legally be played by the side who is trying to pass the blockade. This number indicates the extent to which each man is blockaded.

When the two sides' men become disengaged, the 'running game' begins, so called because each player's men run as fast as possible towards the inner (or home) table. At this stage of the game it is possible to estimate fairly accurately the probability that a particular player will win the game by bearing off all his men before his opponent is able to do so. One method of doing this is to 'count' the position — simply add up the number of steps each man must take before he can bear off, assuming no wasted motion. This count can be employed in a simple table to determine the odds of winning, and such tables are found in most backgammon books. For example, the books will tell you that if your count is 60 and your lead over your opponent is four when it is your turn to roll, the odds are eight to five in your favour. Until the last few moves of the game, when special heuristics apply, it is relatively simple for the program to decide which men to move and in many situations it will make no difference. But it is just in this stage of the game that the complication of the doubling cube becomes of paramount importance.

Backgammon is traditionally played for stakes. One of the essential elements of a backgammon set is a cube with the numbers 2, 4, 8, 16, 32 and 64 on the faces. If a player feels that he has a good chance of winning he may put the cube with the 2 face uppermost, at which point his opponent must either resign or agree to play the game for double the usual stake. Having accepted a double a player may, later in the game, double again, by turning the 4 face uppermost.

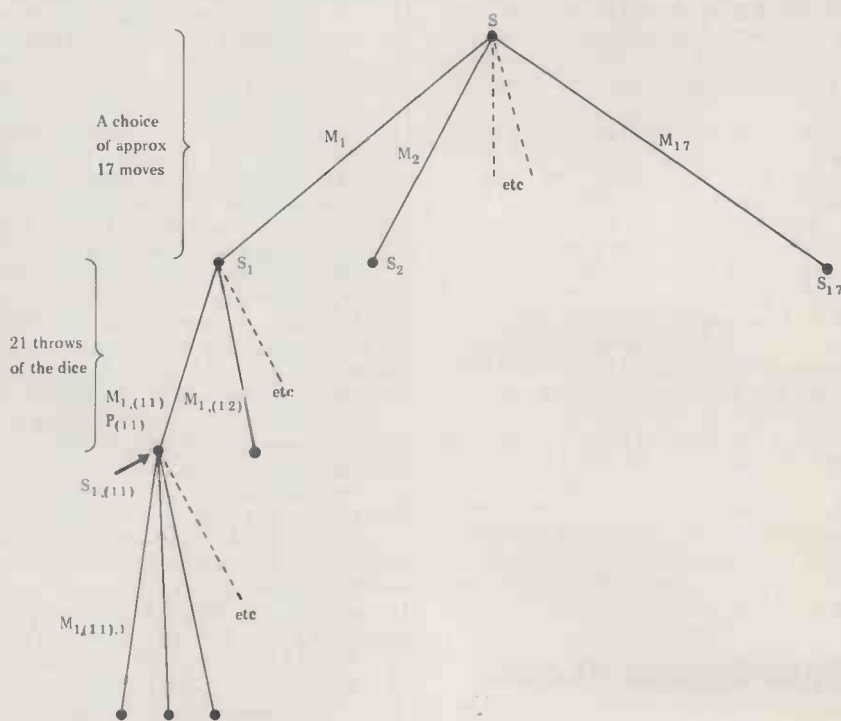

Fig 1 One move by the program and one by its opponent

This process may continue until the players are wagering 64 times the original stake — people have won and lost fortunes through the doubling cube.

Not surprisingly, statisticians have calculated formulae which indicate when a player should double and when a double should be accepted and these formulae are obviously easier for a program to apply than for a human. There is, however, an important psychological aspect to doubling. If most players double when their probability of winning is around 0.6, it will be better to double at 0.7 and keep your opponent in the game (if he assumes that he still has some chance he will be less likely to resign, and you will win twice as much). Of course if both players can calculate perfectly one will always resign when the other doubles, and neither will double until the 'correct' moment.

Backgammon books give quite a lot of useful information on when a player should double and when a double should be accepted. This makes the programmer's task easier, and helps to reduce the element of skill in the game below its normally tiny amount. My own view of the game is that it is rather shallow, with virtually no scope for brilliant or imaginative play but with features that allow a fast mind to score a steady though slight advantage against a player with a lesser facility for calculation. It can be a fun game to program, with plenty of scope for neat graphics work and the problem of coping with the enormous trees certainly makes it a challenge to the serious games programmer.

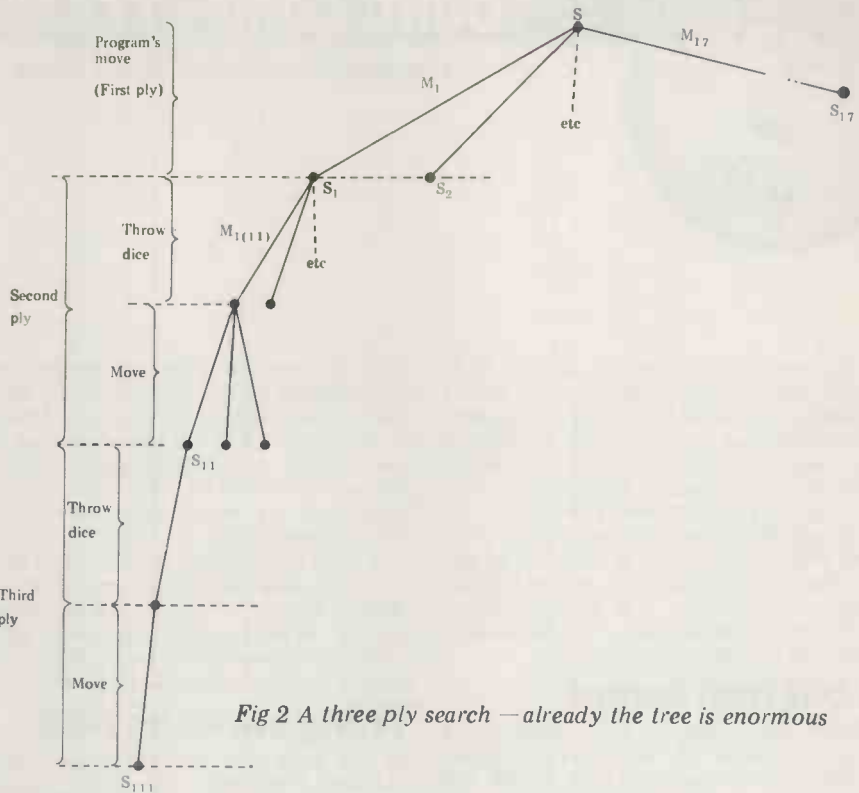

Fig 2 A three ply search — already the tree is enormous

Bibliography

Berliner, H. *Experiences in Evaluation with BKG — A Program that plays Backgammon. Proceedings of the fifth International Joint Conference on Artificial Intelligence 1977*, pp.

428-433. Keeler, E.B., & Spencer, J. *Optimal Doubling in Backgammon. Operations Research, Vol. 23, No. 6, Nov-Dec 1975*, pp. 1063-1071.

COMPUTER FAIRE

(Conference & Exposition)

on

Intelligent Machines

for

Home, Business, & Industry

Personal
Computer
World



Spring in San Francisco from £440

Enjoy a two-centre holiday in sunny California, 1 — 9 April, 1981
just in time for the 6th West Coast Computer Faire.

Lounge on Santa Monica beach, visit the first ever computer store or maybe even take a peek at Hollywood. Follow this with a few days in San Francisco visiting the Computer Faire and possibly pop down El Camino Real to Silicon Valley.

All this, and much more can be yours if you take advantage of Meridian Tours' special offer to PCW readers, details of which are now being finalised.

Three holidays are planned, each of which ensures that you are in San Francisco for the duration of the Faire, which must be the biggest micro-dedicated show in the world. The first holiday comprises one night in Los Angeles at the first-class Sheraton Miramar at Santa Monica Beach followed by six nights in San Francisco at the Civic Centre Holiday Inn, just round the corner from the Faire. The second holiday provides the chance to spend three nights in Los Angeles and four in San Francisco while the third allows you to 'do your own thing' for a week following one of the above holidays, simply returning to base for the journey home.

The holiday price includes all flights, hotel accommodation, supervised transfers between airports and hotels, entrance to the Faire, a copy of the conference proceedings and compulsory insurance. The cost does not include transport to and from Gatwick, meals abroad or additional accommodation for those wishing to stay an extra week.

Car hire can be arranged at special rates by Meridian before departure and special excursions may be booked with their local representatives while abroad.

Having said all that, this promises to become quite an event in the PCW year; it's bound to be fun — even for those who aren't too interested in computers. They can make the most of San Francisco with its Golden Gate Bridge, cable cars, Chinatown, Fisherman's Wharf — not to mention a more recent phenomenon, lobby watching in the Hyatt Regency.

For further information and a booking form write to West Coast Trip, PCW, 14 Rathbone Place, London W1P 1DE.

This holiday is being organised by Meridian Tours Midlands Ltd who are bonded tour operators
(Air Tour Operator's Licence No. 700B)



I enjoyed my appearance at the PCW show immensely, feeling very proud standing beneath a Young Computer World banner and an artist's blow-up of Abigail's 'Computer Kid' design which we adopted. It was great to meet so many readers and contributors — it would take this entire issue of PCW to tell you about them, but as the editor is already beginning to mutter darkly about a take-over bid from YCW, I can't be so ambitious. I'll do what I can over the next few months.

Lost and found

Would the character who strolled off with a couple of books please return them? They were on the stand for discussion, not as handouts! They're *Computer Bits And Pieces* and *Man Meets The Computer* and are stamped inside with our school name. We need 'em!

It was very late when I left the Cunard Hotel after the Show closed. The loading bay at the back was deserted and there I met a very lonely computer looking for its owner. If anyone reading this thinks that it's theirs and can provide the type and serial number, I'll be glad to return it.

Superman

One gentleman went out of his way at the Show to give me a comic. I was surprised at first — how young did he think I was? — but he pointed out that the cover burred about "a complete 28 page bonus Superman story". When you turned to the extra pages, it proved to be true — 28 pages of Superman, daringly doing his duty and devotedly undoing the dastardly deeds of Major Disaster. Wow! But — what's this? — aided by two primary school kids and their TRS-80?????!!

My first reaction was disapproval. Disguising advertising as a bonus story struck me as being rather underhand. However, the advertising was open enough, so I revised my opinion and read it for enjoyment. (Yes — I sometimes pinch my kids' comics!) I finished it feeling only mild disapproval.

Firstly, although the writers had got in some very good teaching points about computers, with Superman doing the explaining, the comic is American — and Americans share with the Russians the conviction that they have invented everything. This comes out in the storyline, which is otherwise quite innocuous.

Secondly, here is Superman saving a plunging airliner and he needs to know acceleration, speed, gravity, kinetic energy, etc, which the kids supply in seconds, aided by their TRS-80. Stirring stuff — but stupid. The punch line is: "Think as fast as Superman with a TRS-

80!" No mention of programming time. No mention of the need to know what you're doing before you get a computer to do it. No mention of a data-base on disk or tape — or even printed. There is not even any hint of the time needed to learn how to handle the computer — the kids just grab the thing and do it!

I can't help thinking that if any sales are made because of this form of advertising — which I doubt — the advantage will be offset by disappointment. Still, a 28 page advertisement may earn them a place in the *Guinness Book Of Records*.

Things are moving

By the time that this appears in print, Richard Fothergill will have started work at his new job as the first Director of the £9 million micro-electronics in schools programme. He's got a lot of work to do and just about everything that he does will affect education, the computer manufacturing industry and, eventually, society at large. That's a king-sized job, but judging by his past record, Fothergill is just the man to do it. We wish him luck. We mustn't, however, expect too much too soon. It's extremely difficult to overcome entrenched attitudes and time-consuming to call vital meetings. We must also face the fact that £9 million is not much in view of the need. Perhaps one of Fothergill's first tasks should be to prepare a case for more lolly.

Programs received

Multiplication Spaceships by Ian Dickinson (15) of Whitby.
Racetrack by MN Darby (16), of Dudley.

Compukit Derby by Richard Freeman (14), of Welwyn Garden City.

Track Race and Blockade by Torstein Kongsheim of Oslo.

Bank Account Reminder, History Quiz and Electronics Calculator by Simon Meldrum (8), of Ipswich. (Isn't he too young to have a cheque book of his own?)

Gomoku by Christopher Burrows (15), of Maldon.

May I make a point here? You will see that three of our readers have sent in very similar games, which underlines what I wrote last month — devising new games or applications is extremely difficult. Don't get me wrong — I love getting all these programs, but if you can manage something new, you have a much greater chance of your program being published and paid for.

Finally for this month, several people at the PCW Show asked me if it was possible to obtain listings of programs which we have mentioned but not published. This is not possible for a number of reasons, chief among them being the sheer size of the administrative task this would entail. Besides, it would be illegal for us to distribute copies of listings that we have not paid for!

What I can do is to put enquirers in touch with authors, so starting from this month I shall compile a book of names and addresses of young authors. If you would like to get in touch with them, send me a stamped addressed envelope and I will let you have the address of the youngster concerned. Conversely, if any of my young correspondents do not wish to be bothered by other mail, they can let me know and I will respect their privacy.

PET Simon

by Jonathan J Dick

```

190 DIM A(4),B(4),C(4),S(4),W(4),KY(9),SQ(50)
200 POKE59463,12:REM#GRAPHICS MODE#
210 PRINT"7":REM#CLEAR SCREEN#
220 A(1)=0:B(1)=128:A(2)=20:B(2)=128:A(3)=224:B(3)=129:A(4)=244:B(4)=129
230 C(1)=160:C(2)=127:C(3)=102:C(4)=81
240 REM
250 REM POKE IN MACHINE-CODE SUBROUTINE
260 REM
270 FOR I=826TO855:READA,POKEI,A:NEXT
280 REM
290 REM
300 REM
310 REM DATA FOR MACHINE-CODE SUBROUTINE WHICH INSTANTLY FILLS A QUARTER
320 REM OF THE SCREEN WITH A SPECIFIED CHARACTER
330 REM
340 REM
350 DATA 162,12,160,0,165,180,145,177,200,192,20,208,249,24,169,40,101,177,133
360 DATA 177,169,0,101,178,133,178,202,208,229,96
370 REM
380 REM
390 REM
400 REM A() AND B() ARE SCREEN POSITION ARRAYS
410 REM C() HOLDS THE CHARACTERS FOR EACH QUARTER
420 REM S() HOLDS THE SOUND FOR EACH QUARTER
430 REM W() HOLDS THE VALUES FOR THE DEMO OF GAME
440 REM KY() HOLDS THE DECODING VALUES FOR THE NUMBER KEYS
450 REM W() HOLDS THE PATTERN FOR THE SCREEN CLEAR OF THE TITLE
460 REM SQ() HOLDS THE SEQUENCE SO FAP
470 REM "SQ" IS ADDRESS TO POKE SOUND NOTE TO

```

The DAI Personal Computer is Here!

* High Performance *

* High Value *

48k RAM

£795

COLOUR

SOUND



Standard Features

- * 24k Resident High-Speed Basic
- * 16 Colour High-Resolution Graphics (255 × 335)
- * Scrolling Screen Editor
- * Sound Commands for Music Generation
- * Very High Speed Hardware Maths Option
- * Resident Monitor for Machine Language Programming
- * 3 Programmable Parallel Ports
- * Standard TV Interface via Aerial Socket
- * RS232 Serial Port and Dual Cassette Interfaces

Manufactured by:

DAI

THE
MICROCOMPUTER
ENGINEERING
COMPANY

Brussels, Belgium.

Available from:

Data Applications (UK) Ltd.

Personal Computer Division
16b Dyer Street
Cirencester
Gloucestershire
GL7 2PF

Tel: Cirencester
(0285) 61902

For further information please complete and post to:
Data Applications (UK) Ltd, 16b Dyer Street, Cirencester, Glos GL7 2PF

NAME.....

ADDRESS.....

MY INTEREST IS:.....

Britain's first com puter kit.

The Sinclair ZX80.

£79.95

Price breakdown
ZX80 and manual: £69.52
VAT: £10.43
Post and Packing FREE

Please note: many kit makers quote VAT-exclusive prices.

You've seen the reviews... you've heard the excitement... now make the kit!

This is the ZX80. 'Personal Computer World' gave it 5 stars for 'excellent value.' Benchmark tests say it's faster than all previous personal computers. And the response from kit enthusiasts has been tremendous.

To help you appreciate its value, the price is shown above with and without VAT. This is so you can compare the ZX80 with competitive kits that don't appear with inclusive prices.

'Excellent value' indeed!

For just £79.95 (including VAT and p&p) you get everything you need to build a personal computer at home... PCB, with IC sockets for all ICs; case; leads for direct connection to a cassette recorder and television (black and white or colour); everything!

Yet the ZX80 really is a complete, powerful, full-facility computer, matching or surpassing other personal computers at several times the price.

The ZX80 is programmed in BASIC, the world's most popular computer language for beginners and experts alike.

The ZX80 is pleasantly straightforward to assemble, using a fine-tipped soldering iron. It immediately proves what a good job you've done: connect it to your TV... link it to an appropriate power source... and you're ready to go.

Your ZX80 kit contains...

- Printed circuit board, with IC sockets for all ICs.
- Complete components set, including all ICs - all manufactured by selected world-leading suppliers.
- New rugged Sinclair keyboard, touch-sensitive, wipe-clean.
- Ready-moulded case.
- Leads and plugs for connection to domestic TV and cassette recorder. (Programs can be **SAVED** and **LOADED** on to a portable cassette recorder.)
- FREE course in BASIC programming and user manual.

Optional extras

- Mains adaptor of 600 mA at 9 V DC nominal unregulated (available separately - see coupon).
- Additional memory expansion boards allowing up to 16K bytes RAM. (Extra RAM chips also available - see coupon).

*Use a 600 mA at 9 V DC nominal unregulated mains adaptor. Available from Sinclair if desired (see coupon).

The unique and valuable components of the Sinclair ZX80.

The Sinclair ZX80 is not just another personal computer. Quite apart from its exceptionally low price, the ZX80 has two uniquely advanced components: the Sinclair BASIC interpreter; and the Sinclair teach-yourself BASIC manual.

The unique Sinclair BASIC interpreter offers remarkable programming advantages:

- Unique 'one-touch' key word entry: the ZX80 eliminates a great deal of tiresome typing. Key words (**RUN**, **PRINT**, **LIST**, etc.) have their own single-key entry.
- Unique syntax check. Only lines with correct syntax are accepted into programs. A cursor identifies errors immediately. This prevents entry of long and complicated programs with faults only discovered when you try to run them.
- Excellent string-handling capability - takes up to 26 string variables of any length. All strings can undergo all relational tests (e.g. comparison). The ZX80 also has string input-to request a line of text when necessary. Strings do not need to be dimensioned.
- Up to 26 single dimension arrays.
- FOR/NEXT loops nested up to 26.
- Variable names of any length.
- BASIC language also handles full Boolean arithmetic, conditional expressions, etc.
- Exceptionally powerful edit facilities, allows modification of existing program lines.
- Randomise function, useful for games and secret codes, as well as more serious applications.
- Timer under program control.
- PEEK and POKE enable entry of machine code instructions,USR causes jump to a user's machine language sub-routine.
- High-resolution graphics with 22 standard graphic symbols.
- All characters printable in reverse under program control.
- Lines of unlimited length.

Fewer chips, compact design, volume production - more power per pound!

The ZX80 owes its remarkable low price to its remarkable design: the whole system is packed on to fewer, newer, more powerful and advanced LSI chips. A single SUPER ROM, for instance, contains the BASIC interpreter, the character set, operating system, and monitor. And the ZX80's 1K byte RAM is roughly equivalent to 4K bytes in a conventional computer - typically storing 100 lines of BASIC. (Key words occupy only a single byte.)

The display shows 32 characters by 24 lines. And Benchmark tests show that the ZX80 is faster than all other personal computers.

No other personal computer offers this unique combination of high capability and low price.

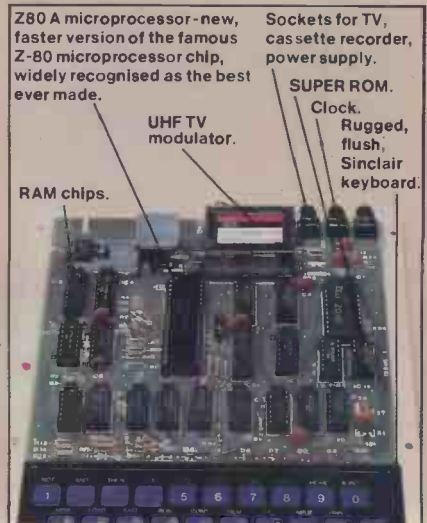

plete

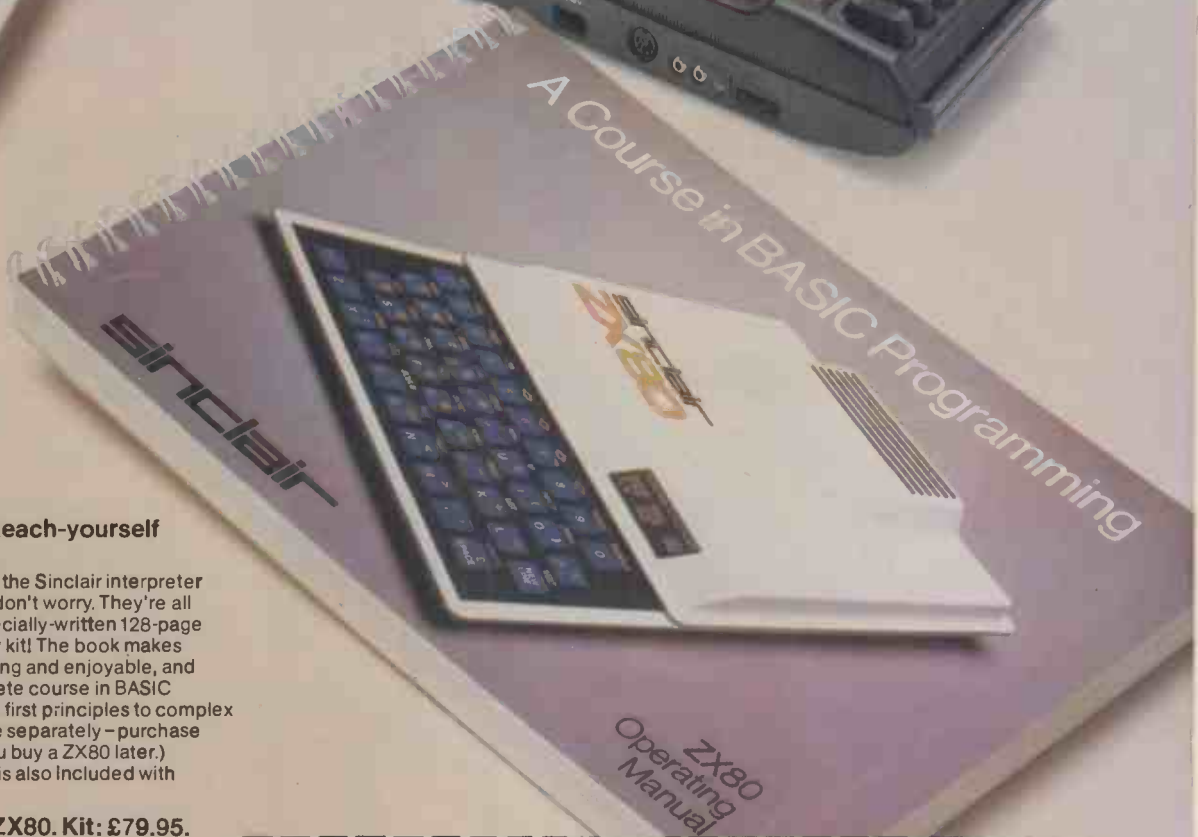
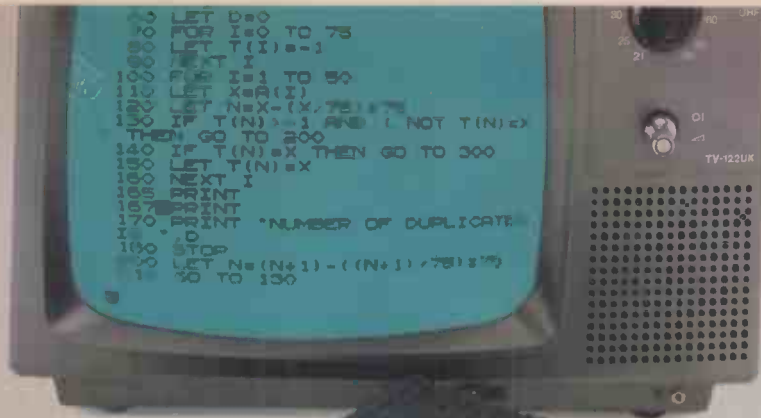

The Sinclair teach-yourself BASIC manual.

If the features of the Sinclair interpreter mean little to you - don't worry. They're all explained in the specially-written 128-page book free with every kit! The book makes learning easy, exciting and enjoyable, and represents a complete course in BASIC programming - from first principles to complex programs. (Available separately - purchase price refunded if you buy a ZX80 later.) A hardware manual is also included with every kit.

The Sinclair ZX80. Kit: £79.95. Assembled: £99.95. Complete!

The ZX80 kit costs a mere £79.95. Can't wait to have a ZX80 up and running? No problem! It's also available, ready assembled and complete with mains adaptor, for only £99.95.

Demand for the ZX80 is very high: use the coupon to order today for the earliest possible delivery. All orders will be despatched in strict rotation. We'll acknowledge each order by return, and tell you exactly when your ZX80 will be delivered. If you choose not to wait, you can cancel your order immediately, and your money will be refunded at once. Again, of course, you may return your ZX80 as received within 14 days for a full refund. We want you to be satisfied beyond all doubt - and we have no doubt that you will be.

sinclair
ZX80
Science of Cambridge Ltd

6 Kings Parade, Cambridge, Cambs., CB2 1SN
Tel: 0223 311488.

ORDER FORM

To: Science of Cambridge Ltd, 6 Kings Parade, Cambridge, Cambs., CB2 1SN.
Remember: all prices shown include VAT, postage and packing. No hidden extras.
Please send me:

Quantity	Item	Item price £	Total £
	Sinclair ZX80 Personal Computer kit(s). Price includes ZX80 BASIC manual, excludes mains adaptor.	£79.95	
	Ready-assembled Sinclair ZX80 Personal Computer(s). Price includes ZX80 BASIC manual and mains adaptor.	£99.95	
	Mains Adaptor(s) (600 mA at 9 VDC nominal unregulated).	8.95	
	Memory Expansion Board(s) (each one takes up to 3K bytes).	12.00	
	RAM Memory chips - standard 1K bytes capacity.	16.00	
	Sinclair ZX80 Manual(s) (manual free with every ZX80 kit or ready-made computer).	5.00	
		TOTAL	£

NB. Your Sinclair ZX80 may qualify as a business expense.

I enclose a cheque/postal order payable to Science of Cambridge Ltd for £ _____
Please print
Name: Mr/Mrs/Miss _____
Address _____

Comart Approved Dealers

Belfast
O & M Systems
95 Dublin Road
Tel: 0232 49440

Birmingham
Byteshop Computerland Ltd
94/96 Hurst St, B5 4TD
Tel: 021 622 7149

Cambridge
Cambridge Computer Stores
1 Emmanuel St, CB1 1NE
Tel: 0223 68155

Cornwall
Benchmark Computer
Systems Ltd
Tremena Manor
Tremena Road
St Austell, PL25 5GG
Tel: 0726 610000

Dublin
Lendac Data Systems Ltd
8 Dawson St
Tel: 0001 372052

Glasgow
Byteshop Computerland Ltd
Magnet House
61 Waterloo St, G2 7BP
Tel: 041 221 7409

Leeds
Holdene Ltd
Manchester Unity House
11/12 Rampart Road
Woodhouse St
Tel: 0532 459459

London
Byteshop Computerland Ltd
48 Tottenham Court Road,
W1R5 4TD
Tel: 01 636 0647

Digitus
9 Macklin Street
Covent Garden WC2
Tel: 01 405 6761

Jarrogate
67 Tulsemere Road,
West Norwood,
London SE17
Tel: 01-670 3674

Manchester
Byteshop Computerland Ltd
11 Gateway House
Piccadilly Station Approach
Tel: 061 236 4737

NSC Computers
29 Hanging Ditch
Tel: 061 832 2269

Newbury
Newbear Computing Store
40 Bartholomew St
Tel: 0635 30505

Nottingham
Byteshop Computerland Ltd
92A Upper Parliament St,
NG1 6LF
Tel: 0602 40576

Sheffield
Hallam Computer Systems
451 Eccleshall Road, S11 9PN
Tel: 0742 663125

Southampton
Xitan Systems
23 Cumberland Place,
SO1 2BB
Tel: 0703 38740

Sudbury
Eurotec Consultants
Holbrook Hall
Little Walsingham
Tel: 0206 262319

Warwicks
Business & Leisure
Microcomputers
16 The Square
Kenilworth
Tel: 0926 512127

Watford
Lux Computer Services
108 The Parade
High Street
Watford WD11 2AW
Tel: 0923 29513

Comart Microcomputer dealers are located strategically throughout the country to give support, guidance and assistance. In the event of difficulty contact Comart direct.

comart communicator

The clean simplicity outside...



...conceals the pedigree inside.

Comart's CP100 Communicator is the new British designed, British made Microcomputer from Comart. It is the result of a carefully conceived development programme. It exploits Comart's first hand experience of the British computer market, and their growing strength as a manufacturer.

CP100 is the first of a new generation of flexible, expandable micros specifically developed to suit British operating conditions and communication requirements.

The clean lines outside, conceal the power within; its S-100 bus means wide ranging peripheral support, and simple after sales care. And, that's not all. Communicator is built to keep your future options open. It's ready for Prestel, asynchronous, and synchronous operation. It has expandable memory capability and yet it's price competitive as a stand-alone system with its CP/M™ operating system, and support software.

Find out more about Communicator today.

The U.K. Leaders in Microcomputer
Development, Application and Support.

comart

St Neots HUNTINGDON Cambs PE19 2AF
Tel (0480) 215005 Telex: 32514 Comart G.

CRAM

Followers of our series 'Gateways to Logic' may remember a passing reference to Granny's red flannel nightie. This reminded David Tebbutt of a fearsome device he encountered many years ago. . .

Derrick Daine's description of a binary selection box ('Gateways to Logic', PCW Oct 1980) reminded me of a similar technique used in the early sixties on large mainframe computers. In those days mass data storage tended to be on magnetic drums or magnetic tape. The disadvantage of a drum was that it couldn't be exchanged, so as the database grew the only option was to increase the number of drums. The advantage of a drum was that each track possessed its own read/write heads so access to data was never more than the time taken for a single drum revolution. The disadvantage of a magnetic tape was that to access a single record it was necessary to pass over all the records between the previous position and the new record. Many system design courses spent a large proportion of their time describing how files should be designed and manipulated to minimise the effect of this problem. In the end the answer was to sort records into the same sequence for each of the tapes being processed and then to run the program, pulling the records in order and skipping over those not required. Effective but slow and tedious.

In the late fifties someone in NCR had the bright idea of a card-based Random Access Memory device (CRAM) which combined the rapid access of the drum with the high volume, exchangeable storage offered by tape. The 6cwt CRAM unit simulated a drum by wrapping a sheet of magnetic material around a revolving capstan and exchanging one sheet for another under program control. The sheets, or cards as they were called, were made of mylar material coated on one side with carbon to help dissipate static electricity and on the other with a magnetic oxide covered with wax. Each card measured about 3 1/4 in x 14 in x .005 in and was supplied in a 'deck' varying in content between 128 and 384 cards. Each card could be imagined as a number of strips of magnetic tape laid side by side along the length of the card. The number of tracks varied according to the method of data recording, parallel encoding having seven tracks and serial either 56 or 144.

At the top of each card was a series of notches which, according to their shape, represented a binary 0 or 1. In this way a card containing eight notches could be made to represent any value between 0 and 255 — a familiar fact to most PCW readers. This then gave the programmer the ability to address any individual card regardless of its physical location within the pack. Some later packs contained 384 cards, achieved by having nine slots but only using eight of

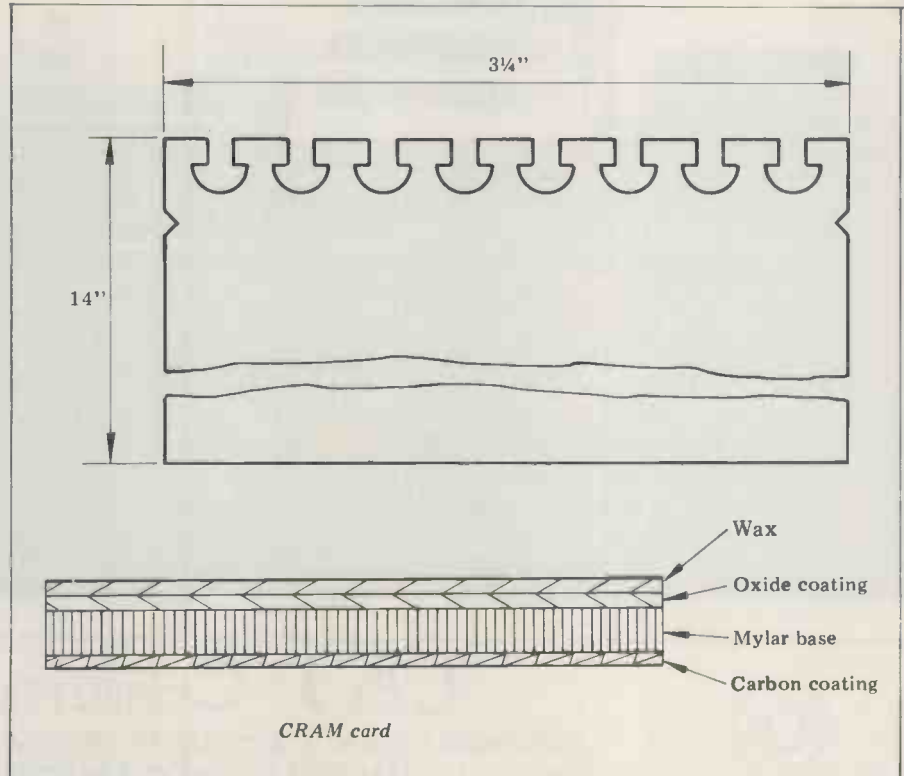

CRAM card

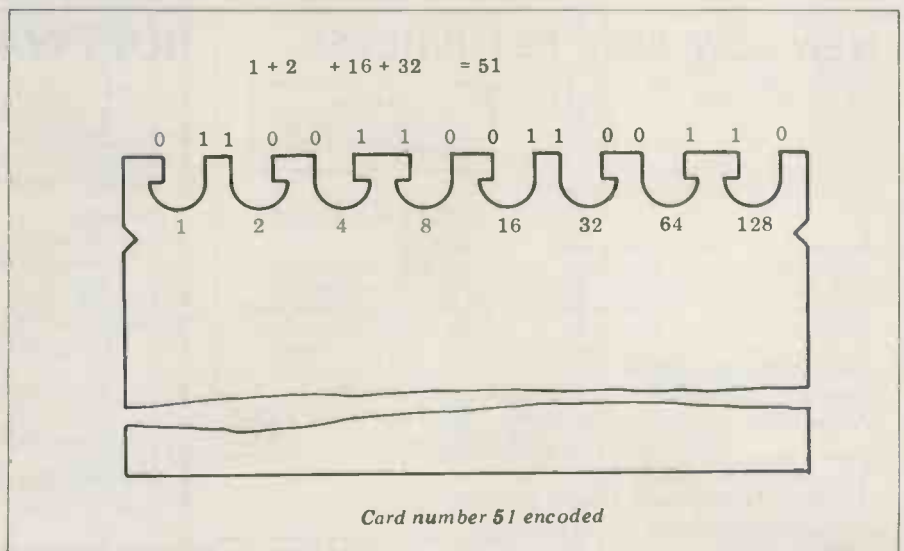

Card number 51 encoded

them — slot eight being zero whenever slot nine had a value of 1.

As mentioned earlier, the data were arranged in either serial or parallel form on the face of the card depending on the particular CRAM model concerned. In the early days data were held on eight bit wide tracks, six bits for data, one for parity and one for 'clocking' and each card contained seven such tracks. Later models recorded data on 56 or 144 single bit tracks in 14-bit

'words'. Clocking on these models was automatic and parity was taken care of by two of the 14 bits — ie six bits plus one parity bit, twice.

In this way the largest and most recent CRAM deck was capable of holding 145,041,408 data characters. Not bad for an exchangeable fast access device, huh?

It worked through an amazing combination of rotating rods, revolving drums, raceways and vacuums. The deck

BYTE SHOP COMPUTERLAND

your specialist Computerstore.

Commodore Business System



Well-proven systems for the serious user. Our computer stores are staffed by business experts, backed by first class maintenance support.

The Commodore is a complete computerized business system, ideal for first time users. Based on the world famous PET computer, it is easy to use and extremely cost-effective. The system includes large capacity disks

and an excellent quality printer thus bringing many applications within the reach of the small business.

Find out why the Commodore Business System is so popular – call in to any of our shops for advice and a demonstration of this and other systems.

London

48 Tottenham Court Road
London W185 4TD
Tel. 01-636 0647

Nottingham

92a Upper Parliament Street
Nottingham NG1 6LF
Tel. 0602 40576 Telex. 377389

Manchester

11 Gateway House
Piccadilly Station Approach
Manchester
Tel. 061-236 4737 Telex. 666168

Birmingham

94-96 Hurst Street
Birmingham B5 4TD
Tel. 021-622 7149 Telex. 336186

Glasgow

Magnet House
Waterloo Street
Glasgow Tel. 041-221 7409
Telex. 779263

BYTE SHOP
COMPUTERLAND
– your specialist Computerstore.



L&J COMPUTERS

3 CRUNDALE AVENUE, KINGSBURY NW9 9PJ 01-204 7525

THE "PET" SPECIALISTS



NEW LOW, LOW 'PET' PRICES!!

AVAILABLE FROM STOCK

Pet 8K (large keys) £420 *
Pet 16K £499 *
Pet 32K £630 *

Ext. cassette decks (+ counter) £55 *
8032 (80 col. screen: new keyboard)

TRY US!
YOU WILL NOT BE
DISAPPOINTED

SUPERPETS NOW EX-STOCK!

Printers	Disc Drives	Sundries
PET 3023	PET 3040	Tool kits: library cases
PET 3022	Compu 400K	Disks: C12 cassettes
Centronic 779	Compu 800K	Paper (roll & tractor feed)
Spinwriter	Interfaces	Labels: Dust covers

Specials for this month:

Petmaster Superchips – upgrade your pet even more!
A few Only: Brand New Centronic 779 t/f printers at £590*
Brand New Pet 2023 f/ printers £320*

The "MUPETS" are HERE!

3 to 8 PETs only need 1 DISK DRIVE . . .
Daily demonstrations: Ring for details.



COMPLETE SYSTEMS
FROM £1700!!

THE ESTIMATES WE SUPPLY & INSTALL ARE COMPLETE
ESTIMATES GIVEN FREE WITH NO HIDDEN EXTRAS:
FULL BACK-UP: GUARANTEED EXPERTISE.

* PRICES DO NOT INCLUDE VAT

SOFTWARE

As well as a full range of Petsoft and Commodore Software, we have some highly reliable "Home-Brewed" programs available.

STOCK CONTROL & INVOICING £60
(Handles up to 500 items – 32k) (80 on 16K). Stock depleted on invoicing, search etc. Cassette, disk (& colour print option).

CASH BOOK £90
Enter daily/weekly amounts – printout and totals, weekly monthly analysis, totals and balances.

MACHINE HIRE Typewriter & Plant Hire £420
STOCK TAKING Cuts out all the hard work £230
OUTSIDE SERVICES (For Mini-Cabs etc.) £220

Sae for free software booklet

SPECIALISTS IN:

Commodore Business Programs: Superpay;
Bristol Trader, Item & Monitor: Word Processing

SPECIALISED SOFTWARE APPLICATIONS
UNDERTAKEN. RING FOR DETAILS

2 FOR JUST OVER THE PRICE OF 1!

We now have limited stock of new cassette decks with a built-in counter soundbox for PETS!
At ONLY £65*
Orders dealt with in strict rotation.

PERSONAL SHOPPERS WELCOME
Phone & Mail Orders accepted.

ALL GOODS SENT SAME DAY WHEREVER POSSIBLE
LARGE S.A.E. FOR LISTS ETC.



of cards was held at its edges by a pair of rods called gating rods. These fitted nicely into notches cut into the sides of each card. While the deck was held thus, a series of selection rods were rotated in the notches at the top of the card deck. Each slot contained a single rod which positioned itself either to the slot's left or right. Perhaps I should digress slightly at this point to explain that every slot started off life with two flanges. In the card number encoding process one of these flanges was removed, depending on whether a binary 0 or 1 was to be coded. This left one flange either to the right or the left of the slot.

Now, returning to the selection rods, once these had positioned themselves then the gating rods were released, allowing any cards to fall which were not supported by at least one of the selection rods. With any luck only one card could be released — the card called for by the programmer. It wasn't unknown for people to make mistakes when punching up the slots, or for flanges to tear, in which case a 'double drop' would occur, causing much aggravation for all concerned. A 'hanger' alarm would sound if a card failed to reach the capstan within a reasonable time. This could be the result of a jam or a missing card.

On a good day, though, only one card would drop, thus beginning a very interesting journey. It would fall (courtesy of gravity in the earlier models but assisted by 'accelerator rollers' in later models) into the drop ramp which would guide the leading edge of the card to the rapidly spinning aluminium capstan. Now the capstan was a curious affair because it revolved around a series of fixed internal chambers which either contained a vacuum or ambient air pressure. To enable these chambers to operate on the card the capstan was perforated.

The card was sucked to the capstan at the foot of the drop ramp, thus enabling it to pick up to the capstan's rotational speed of 380in per second. When the card reached the read/write head area the chamber was at ambient pressure but the read/write head assembly contained its own vacuum chamber thus pulling the card away from the capstan and into contact with the heads. Having passed the heads and the influence of their vacuum, the next chamber was once again a vacuum thus pulling the card back to the capstan. The choice left now was either to allow the card to continue for another revolution with the capstan, or for it to be replaced on the selection rods. This was easily accomplished by making the next chamber either a vacuum or ambient pressure. A vacuum caused the card to stick to the capstan while ambient pressure caused the card to fly off up the 'raceway' over the top of the entire assembly and back onto the selection rods. The card was always replaced at the right hand side of the deck which didn't cause any selection problems — it just meant that the cards were never in any particular physical sequence.

As time went by the design changed but the basic principles remained the same. Things like movable read/write heads allowed more data to be packed on the cards but without significantly increasing access times. This was because the heads could be moved while

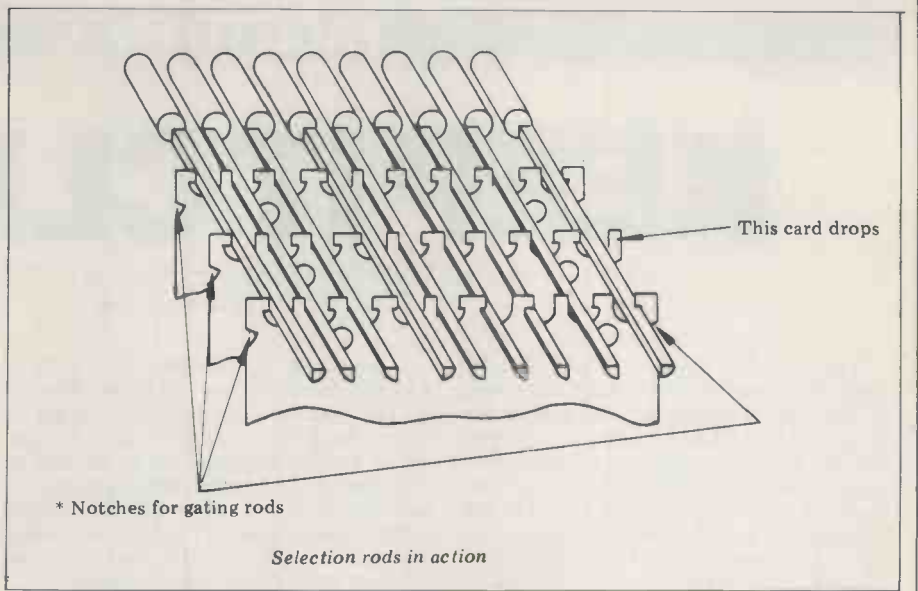

the card was dropping. On that particular model 36 heads could be moved to four different positions, allowing 144 tracks per card.

Anyone who ever worked with CRAM remembers it with affection and tall stories abound. My particular favourite is that NCR was so keen to prevent imitations that it tried to patent the use of gravity to feed cards to the drum. Whether this is true or not, the fact is that the like of CRAM hasn't been seen anywhere else and it was soon overtaken by disk storage. In its time, though, it had much to offer and was an ingenious solution to the problems of its day.

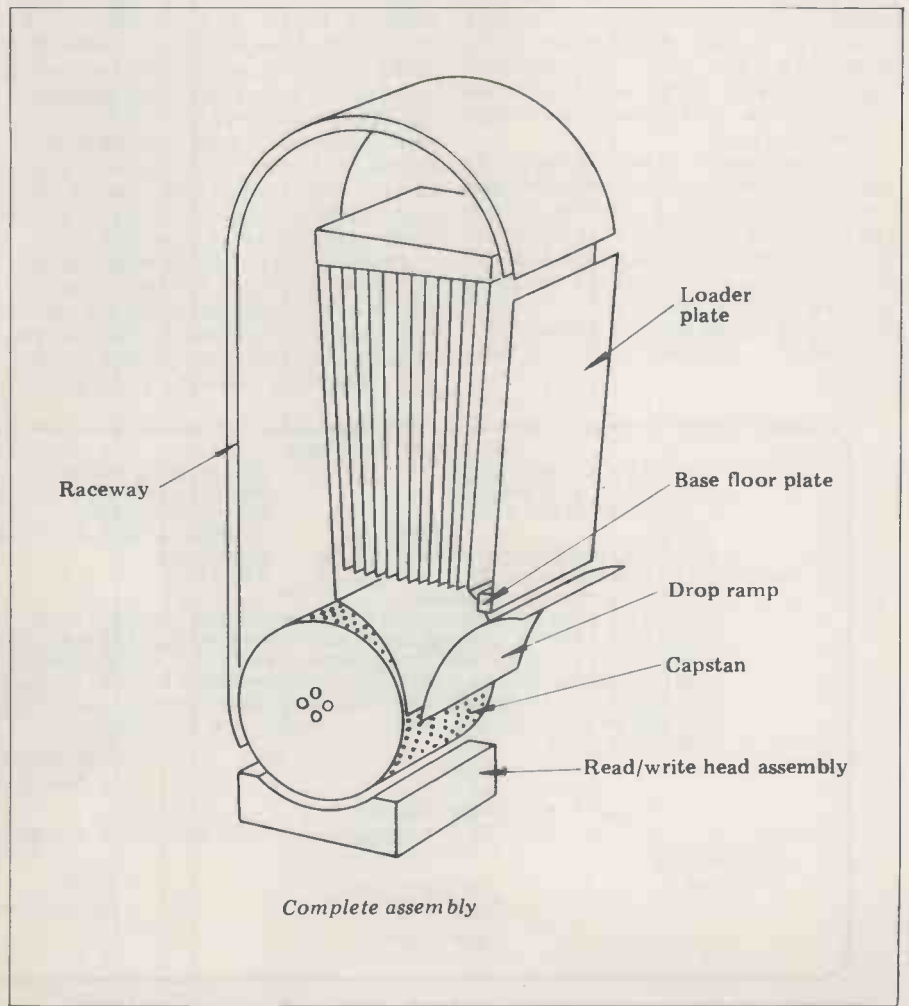
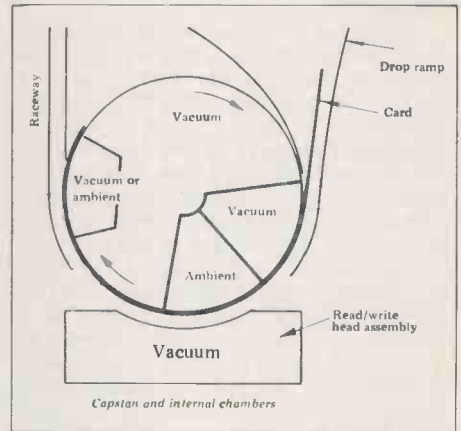

KEEP IT CLEAN!

This month David Hebditch looks at a typical VDU screen layout and doesn't like what he sees.

The last two 'Face-to-Face' articles were concerned with the basic concepts of formatted dialogues and with some of the programming techniques which can be used to implement them. This month we shall discuss some of the essential principles of design which will contribute to the effectiveness and user-friendliness of this important method of interacting with computer systems.

Designing a screen format (for input or output) is much more difficult than designing, say, a file record or the layout of a punched card. The essential difference, of course, is that real live end-users don't get to see file formats. Symptoms of this problem may be the overcrowding of screens, unnecessary coding of information and so on. Perhaps the key to this is the fact that screen design does involve a large element of 'graphic design' and that this 'artistic' element is not taught as a specific subject on system courses. It is therefore, perhaps, somewhat ambitious to attempt to teach these rather nebulous skills in the space of one article. The most I can probably achieve is to increase the reader's sensitivity to the problem and then hope that the 'new consciousness' will perpetuate more and more new ideas on how to approach the design of screen layouts.

The approach I plan to adopt is to take a 'before-and-after' situation and use that to highlight a checklist of pros and cons. Now just so that I am not accused of making things too easy for myself (perish the thought) I am going to take an example which is by no means easy to fit into a standard 80 x 24 screen — especially if it is to look good.

Let's start by looking at Figure 1 which must be an all-time disaster in the history of dialogue design. I don't seriously believe that anyone could design anything quite as bad as this, but it does have the advantage of embodying a lot of 'nasties' in quite a little space. Most of these are already marked on the figure, but let's go through them fairly systematically.

From an overall view, the screen looks *unbalanced*; some parts are overcrowded and other areas completely clear of text. The overall effect is that the screen is 'top heavy'. From the user's view, finding a particular item of data among all the clutter in the middle must be quite difficult. There is no obvious and clear grouping of data according to its meaning and/or use. Furthermore, the sequence does not have any apparent logic and in one case actually appears to be wrong (in the list of invoice numbers).

Another omission is the absence of any lower-case text. Lower-case looks a lot neater than upper-case and is actually easier to read (because of the greater variety of shapes rather than anything to do with the size of the characters). It is also a convenient way of distinguishing between the formatting text and the actual data being displayed. The absence of lower-case on your VDU or in your micro does not count as an excuse as far as I'm concerned. There are no longer any cost reasons why every system should not have a full upper- and lower-case capability.

Looking at the screen more closely, a number of other problems come to light. For example, the dates are not in a consistent format and in two cases the format lacks delimiters: 230680. Even with delimiters, I would argue that this

type of date format is unclear because it involves unnecessary coding — 1 for January, 2 for February and so on. I think that 23Jun80 is more legible (and requires one less character).

A perennial problem with screens in general (and this one in particular) is the *unnecessary use of coding*. In interactive dialogues, coding should only exist for the efficient and convenient input of data by users through the keyboard. The use of coding on output displays is an admission of failure except where the complexity of the encoded data is such that more explicit representation is not really practical. If you have the space to do it then the use of a code as well as the expanded meaning may well help to familiarise the users with the codes in general.

In some cases, data is shown with hardly any explanatory legend (eg ageing) or with no units (eg P/Class Sales). The use of the equals signs (=) is not recommended (the resulting 'algebra' can be intimidating) and the designer should also take care to avoid the use of computer jargon. For the average user a 'character' is someone like Steptoe's dad and a 'field' is where cows masticate grass. So the message is: *avoid jargon, unless it is the user's own*.

The screen doesn't have a title and, whereas this might not be a problem in this case, it could be if the application has a lot of fairly similar screens. Any screen should always *make clear the next actions* available to the user. The '???' in the bottom left corner is inexcusably sloppy.

So much for the bad news. Figure 2 shows essentially the same thing done in a much more tidy and effective

Fig 1 A screen layout incorporating some undesirable features

FACE TO FACE

Next action: —	Customer Information Display			16:55 11SEP80	
Customer Number 432567	Customer Class MULTIPLE RETAIL	Territory 12	Sales Representative D G TOMLINSON		
Statement Name & Address J. G. BROWN & CO LTD. UNIT 5, TANBOW INDUSTRIAL ESTATE, GREATER MENS HOLM, WEST YORKSHIRE LS34 2MQ.		Delivery Name & Address BROWN'S OFFICE SUPPLIES 29 HIGH STREET PUDDLETWITCH NEW TOWN, RUTLAND, RU12 9TR.			
Delivery Instructions: CLOSED WEDNESDAY AFTERNOONS/BEWARE OF FIERCE DOG. Contact: MRS CLAIRE HARVEY		Telephone Number: 0234 6543			
Date Account Opened: 2FEB66	Date Last Payment: 12MAY80	!	Last	34231	
Date of Last Invoice: 23JUN80	Outstanding Orders: YES	!	Five	35807	
Normal Credit Limit: 1000	Discount for invoices up to	!	Invoice	35671	
High Season C/Limit: 1500	500,1000,2000,5000 & above	!	Numbers	35992	
Limits Last Reviewed: 15MAR79	5% 7.5% 10% 12.5% 15%	!		36108	
Ageing of Invoices:					
Current Balance	One Month	Two Months	Three Months	More than 3 Months	
750.50	195.50	225.50	330.00	0.00	
Next Action: Type 'M' for Main Menu, 'C' for Customer Information again.					

Fig 2 Some improvements made to the screen in Fig 1

manner. However, the screen is still somewhat crowded but I have assumed that the user is (as they often do) insisting on a certain minimum amount of data appearing on each display. So it is still not a simple layout, but I would be pleased to publish any improvements on this that readers may like to try. (Not just suggestions — I would want the whole screen re-drafted please.)

The screen now looks more balanced and tidy. It has a title and a clear indication of what the user may do next. Note that the 'next action' character is entered in the top left corner of the screen. It is a good idea always to have this 'next action' and for it always to appear in the same place. I prefer the top left because, in the case

of data entry dialogues, it is the easiest place to get to from any other part of the screen (by pressing HOME or whatever). The layout is now more clearly segmented into logical areas and lines of hyphens have been employed to augment this. Obviously this would look much better if the display had a simple line-drawing extension to its character set. This would also make a much better job of the vertical lines than columns of exclamation marks!

Lower case has been used to differentiate the formatting text from the data and this may be improved even further through the use of a screen facility such as half-intensity. But don't overdo it! Inverse video and blink can have a negative effect, so use

'attention-attracting' devices sparingly. In the example shown in Figure 2, I have omitted completely the P/Class Sales figures on the grounds that the screen is already over-crowded. Arguably, even more should be left out and placed on a second display which the user could 'flip' to if required. Where information was previously coded (eg discounts and ageing) this is now shown in clear. All the dates are shown in a standard format. In the case of input screens, it is a good idea to reserve a line or two (always in the same place, of course) for error messages.

Next month, we will look at natural language dialogues and consider how easy it is to get these wrong as well as the benefits of getting them right.

BACK NUMBERS

Volume 1 No. 1 May 1978
Nascom 1/77-68: The Mighty Micromite/A charity system

Volume 1 No. 2 June 1978
Research Machines 380Z/
Computer in the classroom/
The Europa Bus.

Volume 1 No. 3 July 1978
Buzzwords — A to Z of
computer terms/Pattern re-
cognition/Micro music

Volume 1 No. 8 December
1978 Computers and Art/3-D
Noughts and Crosses/Mickie
— the interviewing micro.

Volume 2 No. 1 May 1979
Small computers for small
organisations/Sorcerer graph-
ics/Chess Programming Hints/
Parkinsons Revas.

Volume 2 No. 2 June 1979
MSI 6800/Witbit — disassem-
ble your programs/The Multi-
lingual Machine/Polytechnical
Processing.

Volume 2 No. 3 July 1979
Vision link: Interfacing and
Software for the Superscamp
VDU/Pet Preening/Extended
cursor graphics for the TRS-
80.

Volume 2 No. 4 August 1979
The North Star Horizon/High
Speed Cassette Interface for
the SWTP 6800/Garage Acco-
unting program/Apple Medi-
cal Application.

Volume 2 No. 7 November
1979 PCW Show issue/6800
Bug/Hard disc security/
Detecting literary forgeries/
Benchtest — the Challenger
C3

PLEASE NOTE THAT THE FOLLOWING
ISSUES ARE SOLD OUT

VOLUME 1 Nos. 4, 5, 6, 7, 9, 10, 11, 12

VOLUME 2 Nos. 5, 6, 8

VOLUME 3 Nos. 1, 2, 3, 4,
ALL OTHER ISSUES MAY BE
ORDERED USING THIS FORM.

Any one issue 95p; Any two issues £1.75; Any three issues £2.50; Any four issues £3.00. All additional issues @ 50p each. Binders @ £2.95. All prices include post and packing. Cheque or P.O. payable to (PCW) SportsScene Publishers Ltd., 14 Rathbone Place, London W1P 1DE. Please allow up to 3 weeks for delivery and don't forget to state clearly your name and full address with your order. Please send me the following copies of PCW. I enclose a cheque/P.O. for £

Volume 1	Volume 2	Volume 3
1 2 3 7 8	1 2 3 4 7 5	6 7 8 9 10
<input type="checkbox"/> <input type="checkbox"/> <input type="checkbox"/> <input type="checkbox"/> <input type="checkbox"/>	<input type="checkbox"/> <input type="checkbox"/> <input type="checkbox"/> <input type="checkbox"/> <input type="checkbox"/> <input type="checkbox"/>	<input type="checkbox"/> <input type="checkbox"/> <input type="checkbox"/> <input type="checkbox"/> <input type="checkbox"/> <input type="checkbox"/>

Name _____

Address _____

*Tick appropriate boxes

NEWCOMERS-START HERE

This is our unique quick-reference guide, reprinted every month to help our new readers pick their way through the most important pieces of (necessary) jargon found in PCW. While it's in no way totally comprehensive, we trust you'll find it a useful introduction. Happy microcomputing!

Welcome to the confusing world of the microcomputer. First of all, don't be fooled; there's nothing complicated about this business, it's just that we're surrounded by an immense amount of necessary jargon. Imagine if we had to continually say "numbering system with a radix of sixteen in which the letters A to F represent the values 10 to 15" when instead we can simply say "hex". No doubt soon many of the words and phrases we are about to explain will eventually fall into common English usage. Until that time, PCW will be publishing this guide — every month.

We'll start by considering a microcomputer's functions and then examine the physical components necessary to implement these functions.

The microcomputer is capable of receiving information, processing it, storing the results or sending them somewhere else. All this information is called data and it comprises numbers, letters and special symbols which can be read by humans. Although the data are (yes, it's plural) accepted and output by the computer in 'human' form, inside it's a different story — they must be held in the form of an electronic code. This code is called binary — a system of numbering which uses only 0s and 1s. Thus in most micros each character, number or symbol is represented by eight binary digits or bits as they are called, ranging from 00000000 to 11111111.

To simplify communication between computers, several standard coding systems exist, the most common being ASCII (American Standard Code for Information Interchange). As an example of this standard, the number five is represented as 00110101 — complicated for humans, but easy for the computer! This collection of eight bits is called a byte and computer freaks who spend a lot of time messing around with bits and bytes use a half-way human representation called hex. The hex equivalent of a byte is obtained by giving each half a single character code (0-9, A-F): 0=0000, 1=0001, 2=0010, 3=0011, 4=0100, 5=0101, E=1110 and F=1111. Our example of 5 is therefore 35 in hex. This makes it easier for humans to handle complicated collections of 0s and 1s. The machine detects these 0s and 1s by recognising different voltage levels.

The computer processes data by reshuffling, per-

forming arithmetic on, or by comparing them with other data. It's the latter function that gives a computer its apparent 'intelligence' — the ability to make decisions and to act upon them. It has to be given a set of rules in order to do this and, once again, these rules are stored in memory as bytes. The rules are called programs and while they can be input in binary or hex (machine code programming), the usual method is to have a special program which translates English or near-English into machine code. This speeds programming considerably; the nearer the programming language is to English, the faster the programming time. On the other hand, program execution speed tends to be slower.

The most common microcomputer language is Basic. Program instructions are typed in at the keyboard, to be coded and stored in the computer's memory. To run such a program the computer uses an interpreter which picks up each English-type instruction, translates it into machine code and then feeds it into the processor for execution. It has to do this each time the same instruction has to be executed.

Two strange words you will hear in connection with Basic are PEEK and POKE. They give the programmer access to the memory of the machine. It's possible to read (PEEK) the contents of a byte in the computer and to modify a byte (POKE).

Moving on to hardware, this means the physical components of a computer system as opposed to software — the programs needed to make the system work.

At the heart of a microcomputer system is the central processing unit (CPU), a single microprocessor chip with supporting devices such as buffers, which 'amplify' the CPU's signals for use by other components in the system. The packaged chips are either soldered directly to a printed circuit board (PCB) or are mounted in sockets.

In some microcomputers, the entire system is mounted on a single, large, PCB; in others a bus system is used, comprising a long PCB holding a number of interconnected sockets. Plugged into these are several smaller PCBs, each with a specific function — for instance, one card would hold the CPU and its support chips. The most widely-used bus system is called the S100.

The CPU needs memory in which to keep programs

and data. Microcomputers generally have two types of memory, RAM (Random Access Memory) and ROM (Read Only Memory). The CPU can read information stored in RAM — and also put information into RAM. Two types of RAM exist — static and dynamic; all you really need know is that dynamic RAM uses less power and is less expensive than static, but it requires additional, complex, circuitry to make it work. Both types of RAM lose their contents when power is switched off, whereas ROM retains its contents permanently. Not surprisingly, manufacturers often store interpreters and the like in ROM. The CPU can only read the ROM's contents and cannot alter them in any way. You can buy special ROMs called PROMs (Programmable ROMs) and EPROMs (Erasable PROMs) which can be programmed using a special device; EPROMs can be erased using ultra-violet light.

Because RAM loses its contents when power is switched off, cassettes and floppy disks are used to save programs and data for later use. Audio-type tape recorders are often used by converting data to a series of audio tones and recording them; later the computer can listen to these same tones and re-convert them into data. Various methods are used for this, so a cassette recorded by one make of computer won't necessarily work on another make. It takes a long time to record and play back information and it's difficult to locate one specific item among a whole mass of information on a cassette; therefore, to overcome these problems, floppy disks are used on more sophisticated systems.

A floppy disk is made of thin plastic, coated with a magnetic recording surface rather like that used on tape. The disk, in its protective envelope, is placed in a disk drive which rotates it and moves a read/write head across the disk's surface. The disk is divided into concentric rings called tracks, each of which is in turn subdivided into sectors. Using a program called a disk operating system, the computer keeps track of exactly where information is on the disk and it can get to any item of data by moving the head to the appropriate track and then waiting for the right sector to come round. Two methods are used to tell the computer where on a track each sector starts: soft sectoring

where special signals are recorded on the surface and hard sectoring where holes are punched through the disk around the central hole, one per sector.

Half-way between cassettes and disks is the stringy floppy — a miniature continuous loop tape cartridge, faster than a cassette but cheaper than a disk system. Hard disk systems are also available for microcomputers; they store more information than floppy disks, are more reliable and information can be transferred to and from them much more quickly.

You, the user, must be able to communicate with the computer and the generally accepted minimum for this is the visual display unit (VDU), which looks like a TV screen with a typewriter-style keyboard; sometimes these are built into the system, sometimes they're separate. If you want a written record (hard copy) of the computer's output, you'll need a printer.

The computer can send out and receive information in two forms — parallel and serial. Parallel input/output (I/O) requires a series of wires to connect the computer to another device, such as a printer, and it sends out data a byte at a time, with a separate wire carrying each bit. Serial I/O involves sending data one bit at a time along a single piece of wire, with extra bits added to tell the receiving device when a byte is about to start and when it has finished. The speed that data is transmitted is referred to as the baud rate and, very roughly, the baud rate divided by 10 equals the number of bytes being sent per second.

To ensure that both receiver and transmitter link up without any electrical horrors, standards exist for serial interfaces; the most common is RS232 (or V24) while, for parallel interfaces to printers, the Centronics standard is popular.

Finally, a modem connects a computer, via a serial interface, to the telephone system allowing two computers with modems to exchange information. A modem must be wired into the telephone system and you need British Telecom's permission; instead you could use an acoustic coupler, which has two obscene-looking rubber cups into which the handset fits, and which has no electrical connection with the phone system — British Telecom isn't so uppity about the use of these.

IN STORE

DIRECT ACCESS

The British-made Newbrain is one of the three new entries this month. A low-priced dual cassette machine, it gives users the choice between a battery-operated system with 2-4k static RAM and a mains system with 16k RAM. I'm told that all current orders will be fulfilled before Christmas and that full production is scheduled for March next year. Also new is the Macro; MicroAPL is promoting this as an alternative to commercial timesharing, based on the APL language. The third newcomer is the 79/09 single board from Newbear, a 6809 upgrade for the 77/68. By popular demand, 'In Store' now gives the month and year in which machines have been Benchtested by PCW (indicated by BT in the misc. column). Finally, note that both the Attache and Megamicro now boast a full range of business software. Send updates for In Store to me, Dick Olney, at PCW, 14 Rathbone Place, London W1P 1DE.

Machine (Price from)	Main Distributor/s (No. of Dealers)	Hardware	Software	Miscellaneous (Documentation)
ABC 80 (£738)	Datormark Ltd: 09322 44896	16-40k RAM; Z80A; C; 12"; 16x40 b&w VDU; 4680 bus; IEEE 488; RS232 port.	DOS; Basic (16k ROM); <i>Fortran</i> ; <i>Pascal</i> ; <i>A</i> ; <i>Multi user Basic</i> .	Colour video graphics with UHF output. Viewdata compatible. Loudspeaker. Numeric keypad. Options: dual 5 1/4" F/D (160k) £895; dual 8" F/D (2 Mb). BT 1/80. (I)
ACT System 800 (£3950)	ACT: 021-455 9898 (50)	48k RAM; 6502; dual 5 1/4" F/D (800k); 12"; 30x64 VDU; 1 S/P; 1 P/P; Multi-screen int.	MDOS; Basic; <i>A</i> ; <i>CBasic</i> ; <i>PL/M</i> ; <i>Forth</i> ; <i>Fifth</i> ; <i>Cesil</i> ; <i>Pilot</i> ; <i>Fortran</i> .	IBM compatible K/B. High resolution graphics. Available with dual 8" F/D (2.4 Mb) £4950 - 4.8 Mb maximum. BT 2/80 (E).
Alpha Micro (£5650)	Alpha Micro (UK) Ltd: 01-250 1616 (TBA)	64k - 1 Mb RAM; 16 bit; dual 8" F/D (2.4 Mb); 6 S/P.	Multi-user OS; Basic; <i>M/A</i> ; <i>Pascal</i> ; <i>U</i> .	Modular. Expands to 1200 Mb, 24 terminals or multiprocessor system. (E)
Altos ACS 8000 (£3398)	Logitek: 02572 66803 (33)	64k RAM; Z80; 1k EPROM; dual 8" F/D (1Mb); 2xRS232 ports; 1 P/P.	<i>CP/M</i> ; <i>Basic</i> ; <i>CBasic</i> ; <i>Cobol</i> ; <i>Pascal</i> ; <i>Fortran</i> .	Expandable to 4-user system with 58Mb H/D. Maintenance contracts avail; BT 5/80 (S&H).
Apple II (£695)	Microsense: 0442 41191 (190)	16-48k RAM; 6502; 8 I/O slots.	<i>O/S</i> ; <i>Basic</i> ; <i>Pascal</i> ; <i>Fortran</i> .	280x192 high resolution graphics; Integer Basic in 6k ROM; Option: single 5 1/4" F/D (116k) £349.
Athena 8285 (£5694)	Butel-Comco Ltd: 0703 39890 (TBA)	64k RAM; 8085A; dual 5 1/4" F/D (644k); 12"; 25x80 VDU; 150 cps printer; RS232 port.	AMOS; T/E; <i>Basic</i> ; <i>Cobol</i> ; <i>Fortran</i> ; <i>Pascal</i> ; <i>APL</i> ; <i>M/A</i> .	Extended ASCII K/B with numeric pad; graphics. Options: dual 8" F/D (2Mb); up to 1200 Mb H/D
Atom (£120)	Acorn: 0223 312772 (N/A)	2-11k RAM; 6502; Full K/B; C int; TV int; 20 I/O lines; 1 P/P.	Basic in 8k ROM; <i>A</i> ; Cass <i>O/S</i> .	High resolution graphics on bigger model; colour monitor <i>O/P</i> . Loudspeaker. Note also, systems based on Acorn SBC. BT 7/80 (B).
Attache System II (£8000)	Friargrove Systems Ltd: 01-572 3784 (10)	64k RAM; Z80; dual 8" F/D (1.2Mb); 12"; 24x80 VDU; 180 cps printer.	Basic; <i>Fortran</i> ; <i>Cobol</i> .	Upgradable to multiuser system with 34Mb H/D. Full range of business packages included software dealers TBA. (S).
Billings BC-12 FD: (£3995)	Mitech: 04862 23131 (TBA)	64k RAM; Z80A; dual 5 1/4" F/D (640k); 12"; 24x80 b&w (or b&g) VDU.	DOS; Basic; <i>Fortran</i> ; <i>Cobol</i> ; <i>A</i> .	With dual 8" F/D (2Mb) £5995. Additional dual 8" F/D £3000. (S).
C/09 (£3975)	SWTP Ltd: 01-491 7507 (16)	56k RAM; 6809; dual 8" F/D (2Mb); 8"; 16x80 VDU; 1 S/P.	TSC FLEX; <i>Basic</i> ; <i>Pascal</i> ; <i>A</i> ; <i>Dis A</i> ; <i>T/E</i> ; <i>U</i> .	VDU is intelligent. Option: 15Mb H/D £3575; with dual 5 1/4" F/D (350k) instead of 8", £3000. (H)
Challenger 1P & C4P (£220 & £395)	CTS: 0706 79332. Millbank Computing: 01-549 7262. Mutek: 0225 743289. U-Microcomputers: 0925 54117 (18)	4-32k RAM; 6502; C int; RS232 port. Options: dual 5 1/4" F/D (160k) £550; for C4P dual 8" F/D (1.15Mb) and 20MB H/D.	<i>O/S</i> ; Basic (8k ROM) <i>Ex Basic</i> ; <i>A</i> .	D/A conv. colour capability. Runs OSI business software on 8" F/D Plato educational software avail. soon. BT 4/80. (S).
Challenger 2 (£1500)	As above	48k RAM; 6502; dual 8" F/D (0.5Mb); RS232 port.	OS65U; <i>Ex Basic</i> ; <i>A</i> .	Designed as low cost business system (S).
Challenger C3 (£2334)	As above	32-56k RAM; 6502; 6800; Z80; dual 8" F/D (1.15Mb); 2-16 S/P.	OS65U; Basic; <i>CP/M</i> ; <i>Fortran</i> ; <i>Cobol</i> .	Expandable to multi-user (8) system. Options: C3B & C3C H/D units, 74Mb for about £8500. (S&H).
Clenlo Conqueror System B (£1950)	Clenlo Computing Systems Ltd: 01-670 4202 (TBA)	64k RAM; Z80; dual 8" F/D (1Mb); 3 S/P; 2 P/P.	<i>CP/M</i> ; <i>CBasic-2</i> ; Pearl 1; <i>U</i> .	With four 8" F/D £2850. (S&H)
Clenlo Conqueror System D (£5150)	As above	64k RAM; single 8" F/D (500k); 10Mb H/D; 3 S/P; 2 P/P.	<i>CP/M</i> ; <i>CBasic-2</i> ; Pearl 11; <i>U</i> .	With 26Mb H/D and no F/D £5950.
Compucolor II (£995)	Dyad Developments: 08446 729 (TBA)	8-32k RAM; 8080; 13" 32x64 8-colour VDU; single 5 1/4" F/D (51k); RS232 port.	DOS (ROM); <i>Ex-Basic</i> (ROM); <i>A</i> .	16k version £1078, 32k £1198. High resolution graphics. 6-month subscription to user magazine inclusive BT 9/79. (S)
Compucorp 625 (£6000)	Compucorp: 01-952 7860 (17)	60k RAM; dual 5 1/4" F/D (630k); 9"; 16x80 VDU; 40 col printer; RS232 port.	Basic; <i>A</i> ; <i>Fortran</i> ; <i>Pascal</i> ; <i>U</i> .	Various systems available with 320k - 2.4Mb F/D and 9", 12" or 20" VDU.
Computermart 2000 DS (£1500)	Computermart: 0603 615089	32-256k RAM; 8085; dual 8" F/D (1-2Mb); S/P; P/P.	<i>CP/M</i> ; <i>Cis Cobol</i> ; <i>Basic</i> ; <i>Fortran</i> .	Expandable to multi-user, multi-tasking, multi-processor 96Mb H/D system (around £15000).
Cromemco System 2, System 3, System Z2H, (£2100/£3730/£5340)	Datron: 0742 585490. Comart: 0480 215005. MicroCentre: 031 556 7354 (18)	64k RAM; Z80; dual 5 1/4" F/D (346k) on System 2 & Z2H; dual 8" F/D (1.2Mb) on Sys 3; 10Mb H/D on Z2H; S/P; P/P.	CDOS; <i>Basic</i> ; <i>Cobol</i> ; <i>Fortran</i> ; <i>RPG II</i> ; <i>Lisp</i> ; <i>A</i> ; <i>W/P</i> ; <i>Multi-user Basic</i> .	All systems expandable to multi-user (max 7) £6408 Sys 2, £8304 Sys 3. Options: dual 8" F/D (996k); 11-22Mb H/D. BT 10/79 (E).

List of Abbreviations

A Assembler
BT Bench Tested
C Cassette
E Extensive

F/D Floppy disk
G/C Graphics card
H Hardware
H/D Hard disk
I Introductory
Int Interface

M/A Macro assembler
N/A Not available
N/P Numeric pad
O/S Operating system
P/P Parallel port
S Software

S/P Serial port
T/E Text editor
TBA To be announced
U Utility

Please note: Software items listed in *italic* are not included in the basic price of the equipment. All prices are exclusive of VAT.

**DIRECT
ACCESS**

IN STORE

Machine (Price from)	Main Distributor/s (No. of Dealers)	Hardware	Software	Miscellaneous (Documentation)
DAI (£998-48k)	Data Applications (UK): 0285 2588 (TBA)	12-48k RAM; 8080; C int; 24x 60 VDU int; RS232 port; over 20 industrial ints.	Basic (ROM); U.	Colour graphics up to 255x 335; 3 notes & noise generator; PAL O/P to TV; Paddle int; H maths option. (I), BT 10/80
Diablo 3000 (£8950)	Business Computers Ltd: 01-207 3344 (TBA)	32k RAM; 8085; dual 8" F/D (1.2Mb); 12", 24x80 b&w VDU; 45cps printer.	DOS; Basic; DA CL; A; U.	Selection of business packages included (S).
Digital Micro- systems DSC-2 (£3525)	Modata: 0892 41555 (10)	64k RAM; Z80; dual 8" F/D (1.14Mb); 4xRS232 ports; EIA port.	CP/M; Basic-E; CBasic; Cobol; Fortran; Pascal.	14 or 28Mb H/D available or additional F/D units (H).
Digital Micro- systems DSC-4 (£6045)	As above	128k RAM; Z80A; single 8" F/D (500k); 11Mb H/D; 4x RS232 ports; 2 P/P.	CP/M; Basic-E; CBasic; Cobol; Fortran; Pascal.	Also DSC-3 with 64k RAM. Options: 128k RAM £1295; up to 4Mb F/D and 29Mb H/D. (H).
Durango F-85 (£7500)	Comp Ancillaries: 0784 36455 (12)	64k RAM; 8085; dual 5 1/4" F/D (1Mb); 9", 16x64 green VDU; 132 col 165 cps printer; N/P.	O/S; DBasic; CP/M; CBasic; Micro Cobol.	Up to 5 work stations; fully integrated system. Options: additional dual 5 1/4" F/D (1Mb); 12-24Mb H/D. (S).
Dynabyte DB8/1 (£1500)	Dynabyte UK/ Europe Ltd: 0723 65559 (6)	32-64k RAM; Z80; S100 bus; 2xRS232 ports; 1 P/P.	CP/M; Basic; Cobol; Pascal.	Expands to multi-user system. Options: dual 8" F/D (1Mb) £2000; Also DB8/2 with dual 5 1/4" F/D (400k) £3000. (E).
Equinox 200 (£7500)	Equinox: 01-739 2387 (N/A)	64-256k RAM; Z80; 10Mb H/D; 1 S/P; 1 P/P.	CP/M; CBasic; Cobol; Fortran.	Multi-user MVT/FAMOS available in place of CP/M. (S&H).
Euroc (£7995)	Euroc: 01-729 4555 (TBA)	64k RAM; 8080A; dual 8" F/D (1Mb); 15", 25x80 b&w VDU; 132 col 140 cps printer.	CP/M; CBasic; A; U.	Financial software available. Supply of stationary included.
Executive Mini- computer (£378)	Binatone Int: 01-903 5211 (N/A)	16k RAM; Z80; 500 bps C; 32x64 TV int; extra C int; 1 P/P.	Basic (12k ROM); M/A; Fortran.	Graphics avail. F/D under development. Also 4k version called 'Oxford minicomputer'.
Exidy Sorcerer (£749)	Liveport Data Products: 0736 798157 (27)	16-48k RAM; Z80; RS232 port; 1 P/P; S100 connector; 30x64 VDU int.	O/S: Basic (ROM); T/E; A; CP/M; Algol; Fortran; Basic; 80.	High resolution graphics capa- bility; user programmable character set. 32k version £799; 48k £849. Option: single 5 1/4" F/D (315k) £600.
HP 85 (£1830)	Hewlett Packard Ltd: 0734 784774 (16)	16-32k RAM; C.P.U.; 5", 16x32 VDU; C (200k); 64 cps printer; 4 P/P. Options: dual 5 1/4" F/D (540k) £1408; dual 8" F/D (2.4Mb) £3744.	Basic (ROM)	Full dot matrix graphics. Complete range of interfaces, peripherals and ap- plication packages avail. 16k RAM £222. (S).
IMS 5000 (£1935)	Equinox: 01-739 2387 (20)	32-64k RAM; Z80; dual 5 1/4" F/D (320k)	CP/M; CBasic; Cobol; Fortran.	3 drives option: (S&H).
IMS 8000 (£3515)	As above	64-256k RAM; Z80; dual 8" F/D (1Mb).	CP/M; CBasic; Cobol; Fortran; MicroCobol.	Multi-user MVT/FAMOS avail- able in place of CP/M. (S&H).
ITT 2020 (£867)	ITT: 0268 3040 (15)	16-48k RAM; 6502	Monitor; A; Ex Basic; Dis A.	360x192 high res graphics. Ex- Basic in 6k ROM: Options — single 5 1/4" F/D (116k), £425; 16k RAM, £110; RS232 port, £96; 32k system, £931; 48k sys- tem. £995. (B).
LX-500 (£3500)	Logabax Ltd: 01-965 0061 (13)	32k RAM; Z80; dual 5 1/4" F/D (180k); 12" 25x80 b&w VDU; 100cps printer.	DOS; Basic; A.	Other printers available. (S).
LSI M-One (£5995)	LSI Computers 04862 23411 (20)	8k RAM; 8080; dual 8" F/D (1.2Mb); 12", 24x80 b&w VDU.	FMOS; A.	Choice of standard business packages included in price. (S).
LSI M-One Model 5, (£9900)	As above	16k RAM; 8080; dual 8" F/D (2.4Mb); 2x12", 24x80 VDUs; 120 cps bidirectional printer.	FMOS; A.	One VDU is for inquiry only. (S).
Macro 1 & 2 (£3750 or £280 pm)	Micro APL Ltd. 01-834 2687 (TBA)	64k RAM; Z80; dual 8" F/D (1 Mb); 4xRS232 ports.	CP/M; APL; U; Basic; Fortran; Cobol; Word- star Algol; Pascal; Forth.	Designed as timesharing replace- ment. (S).
Megamicro (£6080)	Bytronix: 0252 726814 (5)	56k RAM; Z80; dual 8" F/D (500k); 12", 20x80 green VDU; 180 cps printer; 2 S/P; 2 P/P.	CP/M; U; Basic; A; M/A.	Range of bus. packages now avail. from Ludhose of Streatham. (H&B).
Mikro 1000 (£3950)	Airamco: 0294 57755 (TBA)	64k RAM; Z80; dual 8" F/D (1Mb); 12", 24x80 VDU; S100; RS232; 1 P/P.	CP/M; Basic; Cobol; Fortran.	Also word processor with 44 special function keys & NEC Spinwriter printer £4450. (S&H)
Microstar 45 Plus (£4800)	Data Efficiency Ltd: 0442 63561 (30)	64k RAM; 8085; dual 8" F/D (1.2Mb); 3 S/P; RS232 port.	Stardos; CP/M; Basic; Cobol; Fortran.	(E).
Microtan 65 (£69)	Tangerine: 0353 3633 (6)	1k RAM; 6502; TV int; Exp up to 277k RAM.	1k TANBUG monitor; 2k A, disassembler, cassette firmware; 10k Microsoft ExBasic.	Options: bulk I/O modules, hi- def colour graphics, DOS, system racking, ASCII keyboard. (S&H)
MS5001 (£8250)	BMG Ltd: 0793 37813 (N/A)	64k RAM; 8085; dual 8" F/D (1Mb); 12", 80x24 VDU; 160 cps printer; RS232.	CP/M; Basic; Cobol; Fortran; MP/M.	Price includes desk mounting and one computer. Hardware & software support. Leasing arrangements available. (E)
MSI 6816 (£1200)	Strumech: 05433 4321 (5)	16-56k RAM; 6800; 9" 16x64 b&w VDU; C int; 1 S/P; 1 P/P.	Basic; A.	Graphics & PROM programmer available. (S&H).
MSI System 7 (£3500)	As above	56k RAM; 6800; dual 5 1/4" F/D (160k); 9", 16x64 VDU; 1 S/P; 1 P/P.	FDOS; Basic; A; U.	As above. Multi-user O/S avail. Options: 10Mb H/D.

List of Abbreviations

A Assembler	F/D Floppy disk	M/A Macro assembler	S/P Serial port
BT Benchtested	G/C Graphics card	N/A Not available	T/E Text editor
C Cassette	H Hardware	N/P Numeric pad	TBA To be announced
E Extensive	H/D Hard disk	O/S Operating system	U Utility
	I Introductory	P/P Parallel port	
	Int Interface	S Software	

Please note: Software items listed in *italic* are not included in the basic price of the equipment. All prices are *exclusive* of VAT.

IN STORE



Machine (Price from)	Main Distributor/s (No. of Dealers)	Hardware	Software	Miscellaneous (Documentation)
MSI System 12 (£8000)	As above	56-184k RAM; 6800; 10Mb H/D; 9", 16x24 VDU; 1 S/P; 1 P/P.	SDOS; Basic; CBasic; U.	As above. Business packages avail. (H & S).
Nanocomputer NBZ80S (£420)	Midwich: 0284 701321	4k RAM; 2k ROM; Z80; C int; 8 digit LED; Calc K/B; RS232 port; 2 P/P.	Machine language; Basic; A; T/E.	Designed for hardware education. Full training manuals included. Fully expandable. (E).
Newbrain MB £219	Newbury Labs. 021-707 7170. Newbear. 0635 30505 (N/A)	2-4k RAM; Z80A; Nat 420; 14x 16 VDU; 2xC int; TV int; V24 port. Option: C (50k) £60.	C Basic (16k ROM)	Graphics. Battery or mains. Mains only with 16k RAM £269. (low power battery version £299). (I).
North Star Horizon (£2230)	Comart: (7) 0480 215005. Comma: 0277 811131. Equinox: 01-739 2387 (20)	48-56k RAM; Z80A; dual 5¼" F/D (360k); 15", 24x80 VDU; 150cps printer; 2 S/P; 1 P/P.	DOS; Basic; CP/M; Cobol; Fortran; Pascal.	With 32k and single F/D £1495. Options: 18Mb H/D.
Panasonic JD 800U, JD 840U (£4275, £4950)	Panasonic Business Equipment: 01-262 3121 (10 regional dist)	56k RAM; 8085A; 2-4k PROM; dual 8" F/D, JD800 U (500k), JD840U (2Mb); 12", 24x80 green VDU; 3xRS232 ports.	CP/M; Basic; Micro-Cobol.	Also available with 5¼" F/D; JD740U (570k) £4095. BT 3/80 (S).
Pascal Microengine (£2295)	Pronto Electronic Systems Ltd: 01-554 6222	64k RAM; MCP 1600; 2x RS232 ports; 2 P/P.	Pascal.	CPU instruction set is P-code; no interpreter needed. Available with dual 8" F/D (2Mb) £3900.
Periflex 630/48 (£2500)	Sintrom: 0734 85464 (5)	48k RAM; Z80; dual 5¼" F/D (630k); 2xRS232 ports; 1 P/P.	CP/M; Basic; Fortran; Cobol; A.	One-day installation training on site included in price. Option: dual 5¼" F/D (630k) £859; dual 8¼" F/D (1Mb) £1025. BT 6/80 (S&H).
Periflex 1024/64 (£3300)	As above	64k RAM; Z80; dual 8" F/D (1Mb); 2xRS232 ports; 1 P/P.	As above.	As above.
PET 8k, 16k, & 32k (£450, £550, £695)	Commodore: 01-388 5702 (150)	8-32k RAM; 6502; C; 9"; 25x40 VDU; IEEE-488 port; Options: dual 5¼" F/D (353k) £695; same but (950k) £895.	O/S; Basic (in 8k ROM); Forth; Pilot; Pascal.	Disk controller for 8k version £30. New 8032 with 80-col screen (32k) £895.(I).
Powerhouse 2 (£1125)	Powerhouse Micros: 0422 48422 (TBA)	32-64k RAM; Z80A; 5"; 29x96 VDU; RS232 port; external bus.	4k Monitor; FDOS; Basic; ExBasic (14k EPROM)	VDU has flexible screen logic. Options: FDOS & Basic £210; graphics card £200. (H)
Powerhouse 3 (£2600)	As above	32-64k RAM; Z80A; dual 5¼" F/D (350k); 5"; 29x96 VDU; RS232 port; external bus.	As above.	VDU as above. With 1.2Mb F/D £3500. ExBasic & FDOS in 14k EPROMs £300. (H)
Rair Black Box (£2250)	Rair: 01-836 4663 (N/A)	32-64k RAM; 8085; dual 5¼" F/D (260k); 2x RS232 ports.	CP/M; Basic; Cobol; Fortran; M/A.	16k RAM expansion £250 10Mb H/D £2500.
Research Machines 380Z (£1123)	Research Machines 0865 49791 (N/A)	16-56k RAM; Z80A; 2xC; RS232 port.	ExBasic; A; T/E; U; CP/M; Fortran; Cobol; Algol; Cesil.	Limited graphics. Many possible systems. With 48k RAM & dual 8" FD (1Mb) £3394.
S/09 (£5350)	SWTP Ltd: 01-491 7507 (16)	128k RAM; 6809; dual 8" F/D (2Mb); 8"; 21x92 VDU; 2xS/P; 1 P/P.	TSC FLEX; Basic; Pascal; A; Dis A; T/E; U.	VDU is intelligent. Expands to 60Mb H/D multi-user system. Option: 15Mb H/D £3575. Maintenance contracts. (S&H)
SBS 8000 (£1449)	Manhattan Skyline Ltd: 08012 3442 (TBA)	64k RAM; Z80A; 12"; 16x64 VDU; 1 P/P; RS232 port (extra £133).	ExBasic (24k ROM); DOS.	Options: disk control card £237; dual 5¼" F/D (368k) £795; dual 8" F/D (2Mb) £1400. (S)
SEED System 1 (£2000)	Strumech: 05433 4321 (4)	32-64k RAM; 6800; dual 5¼" F/D (160k); 9"; 16x24 VDU; RS232 port.	DOS; Basic; U; Fortran; A; Pilot; Strubal; T/E.	Several F/D options. With 64k RAM & dual 8" F/D (1.2Mb) about £3000. (E).
Sharp MZ-80k (£480) (22)	Sharp electronics (UK) Ltd: 061-205 2333	6-34k RAM; Z80; C; 10"; 24x 40 VDU; Option: dual 5¼" F/D (280k) £780.	Basic (14k ROM); A.	Graphics; loudspeaker. 18k RAM version £529; 22k £549; 34k £599. BT 10/79 (B).
Sinclair ZX80 (£100)	Science of Cambridge: 0223 311488 (N/A)	1-16k RAM; Z80A; C int; TV int; full K/B; 44-pin expansion port.	Basic (4k ROM).	Kit £80. Mains adaptor £9. (S).
Smoke Signal Chieftan (£1807)	Systems Implementation Ltd: 06924 5666 (TBA)	32-64k RAM; 6800; dual 5¼" F/D (160k); 12"; 24x80 VDU; RS232 port.	DOS; 68/FLEX; Basic; Fortran; Cobol; U.	With dual 8" F/D (2Mb) £2712. Designed as development system for industrial control. (H)
Solitaire WP & BS200 (£6750 & £8200)	Solitaire KPG: 01-995 3573 (TBA)	64k RAM; 8085; 14" VDU (with own CPU); 45 cps printer; CPU port; dual 5¼" F/D (700k) 8" F/D (1.02Mb) with BS200.	DOS; Basic.. dual	All solitaire systems are compatible; graphics on 11x13 dot matrix.(S).
Sord M100 (£795)	Midas Computer Services Ltd: 0903 814523 Exleigh Bus. Mach. 0736-66577. (8)	48k RAM; Z80; 8k ROM; 12"; 24x64 green VDU; RS232 port; S100 bus; N/P.	O/S; Basic; A; Fortran; Pascal.	M100 ACE with single 5¼" F/D (143k) £1850. Up to 3 drives possible. Colour graphics avail. (I).
Sord M223 Mk II-VI (£3950)	As above	64k RAM; Z80; 8k ROM; single 5¼" F/D (350k); 12"; 24x80 green VDU; RS232 ports; S100 bus; N/P.	O/S; ExBasic; CBasic; Multi-User Basic; Fortran; Pascal; Cobol.	Expandable to 4Mb F/D, 32Mb H/D, 5 screens, 2 printers, M243 with 192k RAM & dual 8" F/D £7000.
SPC/1 (£3770) (TBA)	Digital Data: 01-573 8854	64-1024k RAM; 8085A-2; dual 5¼" F/D (90k); 12"; 24x80 VDU; 2xRS232 ports; Option: single 8" F/D (1Mb) £1090; 20Mb H/D £7000.	Mikados; Comal; Pascal; A.	With 32k RAM and single F/D (Comal only) £1995. Expandable to multi-user system (8 users). BT 7/80 (S).
Superbrain (£1995)	Icarus: 0632 29593 (TBA)	64k RAM; 2xZ80; dual 5¼" F/D (320k); 12"; 25x80 VDU; S100 bus; RS232 port.	CP/M; A; Basic; Cobol; Fortran; APL; Pascal.	Limited graphics. Mainframe int avail. Options: dual 5¼" F/D (320k); dual 8" F/D (2.4 Mb); 8-120Mb H/D. BT 8/80 (S&H).

List of Abbreviations	F/D Floppy disk	M/A Macro assembler	S/P Serial port
A Assembler	G/C Graphics card	N/A Not available	T/E Text editor
BT Benchtested	H Hardware	N/P Numeric pad	TBA To be announced
C Cassette	H/D Hard disk	O/S Operating system	U Utility
E Extensive	I Introductory	P/P Parallel port	
	Int Interface	S Software	

Please note: Software items listed in *italics* are not included in the basic price of the equipment. All prices are *exclusive* of VAT.

DIRECT ACCESS

IN STORE

Machine (Price from)	Main Distributor/s (No. of Dealers)	Hardware	Software	Miscellaneous (Documentation)
System 80 (£1355-48k)	Nascom: 02405 75155 (32)	16-48k RAM; Z80A; dual 5¼" F/D (560k); TV int; RS232 port.	CP/M; Basic (8k ROM)	EPROM firmware avail. Colour graphics card £165. Many configurations possible. (S&H).
Tandberg EC10 (£4000)	Tandberg: 0532 35111 (N/A)	64k RAM; 8080A; single 8" F/D (250k); 12", 25x80 VDU; 7x RS232 ports; printer int.	CP/M; ExBasic (24k) Multi-user Basic; Pascal; Cobol; A; U;	Up to 7 terminals. Includes V28 comms port. (S & H).
Tandy TRS80 Level I (£335)	Tandy: 021 556 6101 (200)	4-16k RAM; Z80; C; 12", 16x64 VDU.	Basic (4k ROM); A.	Expandable to Level II. Many extras available. (I).
Tandy TRS80 Level II (£408)	As above	4-48k RAM; Z80; C; 12", 16x 64 VDU; RS232 port; 1 P/P.	Basic (4k ROM); M/A; Fortran.	16k machine includes N/P. 4-16k upgrade £87, 48k system £620; Option: single 5¼" F/D (78k) £295, (subsequent £277; up to 4. BT 6/80 (I).
Tandy TRS80 Model 2 (£1999)	As above	32-64k RAM; Z80A; single 8" F/D (500k); 12", 24x80 VDU; 2 S/P; 1 P/P; N/P.	DOS; Basic.	64k version £2249. Expandable to four F/D drives, single drive expansion £799; three drive £1589.
TECS (£1200)	Technalogs Computing Ltd: 061-793 5293 B&B Computers Ltd 0204 26644 (TBA)	4-56k RAM; 8k PROM; 6800/6809; 2xC; TV int; 2xRS232 ports; internal viewdata modem & printer port.	FLEX; Basic; Pascal; TDOS; A; T/E; Pilot; Fortran; Cobol.	Fully viewdata compatible. Options — dual 5¼" F/D (320k) £850; dual 8" F/D £120 £1200. (S&H).
Terodec DPS 64/1 (£3099)	Terodec (Micosystems) Ltd: 0734 664343 (8)	64k RAM; Z80; dual 8" F/D (1Mb); 12", 24x80 VDU; 2 S/P; 3 P/P. Options: dual 8" F/D (1Mb) £1150; with 2Mb £1455.	CP/M; Basic; Cobol; CBasic; Fortran; Algol; Pascal.	TMZ 80 enhanced model in integral workstation £5595 (with 4Mb F/D). DPS 64/2 with 2Mb F/D £3404. (S&H).
TI 99/4 (£750)	TI: 0234 67466 (TBA)	16k RAM; 26k ROM; 9900; 24x32 VDU; 2x C int; TV int; RS232 port.	OS; Basic.	Can run 16-colour TV screen. BT 5/80 (S).
Triton L8.2 (£611)	Transam: 01-405 5240 (N/A)	32k RAM; 8080; C int; 16x64 VDU int; 1 S/P; 1 P/P.	4k monitor; Pascal (20k ROM); CP/M; Pascal.	Graphics; 5¼" or 8" F/D are available; L7.2 with 2k monitor and Basic (no Pascal) £409. (S&H).
Vector MZ (£2595)	Almarc: 0602 62503 (3)	56k RAM; Z80A; dual 5¼" F/D (630k); 3 S/P; 2 P/P.	CP/M; Basic; Algol; Cobol; Pascal; Fortran; Coral; CBasic; A.	High resolution graphics. Also system B with video board & terminal £3195. (E).
Vector System 2800 (£4195)	As above	56k RAM; Z80A; dual 8" F/D (2.4Mb); 3 S/P; 2 P/P.	As above.	High-res graphics. Also System 3030 with 32Mb H/D and single 5¼" F/D £7500. (E)
Video Genie EG3003 (£330)	Lowe Electronics: 0629 2817 (N/A)	16k RAM; Z80; 500bps C; 32x64 TV int; extra C int; 1 P/P.	Basic (12k ROM); M/A; Fortran.	Graphics available.
WH8 (£352)	Heath 0452 29451 (N/A).	16-64k RAM; 8080A (or Z80); 4 S/P. Option: single 5¼" F/D (102k) £241.	OS; HDOS; CP/M; Fortran; Pascal; Basic	Kit. 3 drives max. Colour graphics avail. (S&H) BT 2/80.
Zentec (£4838)	Zygal Dynamics: 02405 75681 (TBA)	32-64k RAM; 2x8080; dual 5¼" F/D (256k); 15", 25x80 VDU; RS232 port.	O/S; A; U; Basic; Cis Cobol.	User programmable character set set. Option: dual 8" F/D (1Mb). (S).
Zenith WH-11A (£2673)	Heath Ltd: 0452 29451 & 01-636 7349 (N/A)	LSI 11; 16-32k RAM; 25x80 VDU; S/P; P/P.	O/S; Basic; Fortran; A; U.	PDP 11-compat. Option: 2x8" F/D 2.2Mb. £1717 (S&H).
Zenith Z89 £1570-£1710	As above	16-48k RAM; Z80; single 5¼" F/D (102k); 12" 25x80 b&g VDU; RS232.	Basic; A; HDOS; CP/M; MBasic; CBasic; Fortran.	3 x 5¼" F/D possible. Options: dual 8" F/D (2.2Mb) £1717, 20Mb H/D.
Zilog MCZ 1/05 (portable); MCZ 1/20A (£3250)	Micropower: 0256 54121. Memec: 084421 5471 (N/A)	64k RAM; Z80; dual 8" F/D (600k); RS232 port; MCZ 1/20A only 1 P/P; Option: 10Mb H/D £7100	RIO; O/S; Cobol; Basic; Fortran; Pascal; M/A; U.	Available desk top or rack mounted. Debug in 3k PROM. 1/20A runs multi user Cobol, up to 5 terminals with 40Mb H/D.(S&H).
Z-Plus (£3950)	Rostronics Ltd: 01-874 1171 (16).	64k RAM; Z80; dual 8" F/D (1Mb); 4 S/P; 2 P/P.	CP/M; A; U; Basic; Cobol; Fortran; Pascal; APL; PL/1; Algol.	Available with 2Mb F/D. Option: 20Mb H/D £4000. BT 12/79 (S&H).

SINGLE BOARDS

Machine (Price from)	Main Distributor/s (No. of Dealers)	Hardware	Software/Firmware	Miscellaneous (Documentation)
Acorn System 1 (£65)	Acorn: 0223 312772 (10)	11/8k RAM; 6502; EPROM socket; Hex K/B; C int; 8-digit LED display; up to 16 ports. Options: Eurocard 64-way connector; VDU card; full K/B card.	¼k monitor; Basic.	Kit. Programmable address linking. On-board 5 V regulator. Available assembled £79. Can be expanded to disk-based system. (S&H).
Aim 65C (£285)	Pelco: 0273 722155 (7)	1-4k RAM; 6502; 4-20k ROM; Full K/B; 2xC; 20 char LED; 20 char thermal printer; RS232 port.	A. Dis A; T/E; 8k monitor; Basic (8k ROM); PL65.	Power supplies and two types of case avail. Can be expanded to disk system. (E).
Cromemco SC (£260)	Comart: 0480 215005 (17)	1k RAM; Z80A; 8k EPROM sockets; RS232 port; 3 P/P. Option: S100 bus.	Monitor; Basic.	5 program interval timers. Can put own Basic programs in EPROM.(E).
Elf II (£60)	Newtronics: 01-348 3325 (N/A)	¼-64k RAM; RCA 1802; Hex K/B; 2-digit LED; TV int; C int; RS232. Options: Full K/B; VDU card.	1k monitor; A; Dis A; T/E; Elf-bug; Tiny Basic; Basic.	TTY, N-line decoders. Low resolution graphics (high res avail). Kits or built. (H).
Explorer (£82)	As above	4-64k RAM; 8085; Hex K/B; RS232 port; S100 bus; C int; 1k video RAM.	2k monitor; Basic; CP/M.	Supplied in kit or built. Full range of peripherals including F/D. (H).

List of Abbreviations

A Assembler	F/D Floppy disk	M/A Macro assembler	S/P Serial port
BT Bench Tested	G/C Graphics card	N/A Not available	T/E Text editor
C Cassette	H Hardware	N/P Numeric pad	TBA To be announced
E Extensive	H/D Hard disk	O/S Operating system	U Utility
	I Introductory	P/P Parallel port	
	Int Interface	S Software	

Please note: Software items listed in *italic* are not included in the basic price of the equipment. All prices are *exclusive* of VAT.

DIRECT ACCESS

SINGLE BOARDS

Hewlett 6800S (£299)	Hewlett: 0625 22030 (N/A)	16k RAM; 6800; full K/B; VDU int; 2xC int; 1 S/P; 2 P/P; Option: 16k RAM £90.	1k monitor; A; T/E.	Can be upgraded with 6809. (H).
Hewlett 6800 Mk III (£152)	As above	1k RAM; 6800; VDU board.	1k monitor.	Options: single 5¼" F/D (75k) £350; PROM programmer £32. (H).
Microtan 65 (£69)	Tangerine: 0353 3633 (6)	1k RAM; 6502; 16x32 TV int; Options: 64x64 Pixel graphics £6.50; 16k RAM £56.	1k monitor; Basic.	TANEX expansion kit with 7k RAM; 4k EPROM sockets; 10k Basic; 4 S/P; 32 P/P £145. (E).
Nascom 1 (£125)	Nascom: 02405 75155 (20)	4k RAM; Z80; Full K/B; TV int; 2 P/P; 1 S/P. Options: 16k RAM £140; single 5¼" F/D (250k) £240 (4 disk controller £127).	2k monitor; BBasic; Tiny Basic; A; T/E; U.	Kit. Built version £140. Also Nascom 2 with 8k Microsoft Basic in ROM £225 (no RAM). (S&H).
77/68 (£90)	Newbear: 0635 30505 (N/A)	4k RAM; 6800; LED; C int; VDU int.	1k monitor; Basic.	Expandable to 64k RAM with F/D. (B).
79/09 (£65)	As above	1k RAM; 6809; P/P; S/P.	2k Monitor.	Designed to upgrade 77/68. (H).
SBC 100 (£135)	Airamco: 0294 57755 (TBA)	1k RAM; Z80; 8k ROM; S100; 1 S/P; 1 P/P.	1k monitor; DOS in ROM.	Kit. Available assembled £196. (E).
Superboard (£188)	(as Challenger)	4-8k RAM; 6502; 10k ROM; full K/B; VDU int; C int.	Basic (8k ROM).	Options: RS232 port; single 5¼" F/D (100k) £316; 8k RAM £188. (S&H).
Smoke Signal SCB 68 (£174)	Systems Implementation Ltd: 06924 5666 (TBA)	1k RAM; 6800/6809; 10-20k EPROM; 1 S/P.	2k monitor.	Many expansion boards available including F/D. (H)
SYM-1 (£160)	Newbear: 0635 30505 (N/A)	1-4k RAM; 6502; C int; VDU int; 2x6522 ports. Option: TV int.	4k monitor; Basic; A.	Expandable to 64k RAM with F/D. (B).
Triton L5.2 (£294)	Transam: 01-405 5240 (N/A).	1-3k RAM; 8080; 1k VDU RAM full K/B; 16x64 VDU or TV int; C int; 1 S/P.	1½k monitor; 2½k Basic.	64-char graphics. Disk int running CP/M about £200. (S&H).
Tuscan (£195)	As above	8k RAM; 8k ROM; Z80A; 5xS100 slots; RS232 port; TV int; C int; 1 P/P.	2k monitor; 8k Basic; CP/M; Pascal.	High res graphics available. Can be expanded to F/D system. (S&H).
UK101 (£179)	Comp Shop: 01-440 7033 (4)	4k RAM; 6502; full K/B; 16x48 VDU or TV int; C int; RS232 port. Options: 4k RAM £29.	1k monitor; 8k Basic; Dis A; U.	Graphics. Will run Superboard software. New monitor EPROM with enhanced U £22. (S&H).
ZCB (£260)	Almarc: 0602 625035 (3)	1k RAM; Z80A; 3 PROM sockets; RS232 port; 3 P/P.	Will take any 2708/16/32 software.	S100 bus compatible. Expandable to full system. (E).

DIARY DATA

Birmingham, England	(NEC) Which Computer? Show. Contact Clapp & Poliak Europe Ltd., 01-995 4806	25 - 28 Nov
Brighton, England	(Metropole Exhib. Hall) Semiconductor Int. Exhib. Contact: Kiver Communications SA, 171/185 Ewell Rd., Surbiton, Surrey KT6 6AX	25 - 27 Nov
London, England	(Royal Hort. Hall) Breadboard. Contact: Modmags Ltd., 145 Charing Cross Road, London WC2H 0EE	26 - 30 Nov
Nottingham, England	(Novotel) Electronic Business Equip. Exbn - BIZTRONIC. Contact: Groundrule Exbn Co, 7 Market St, Altrincham, Cheshire. 061-928 0406	2 - 3 Dec
Birmingham, England	(Edgbaston Cricket Ground) Electronic Business Equip. Exbn - BIZTRONIC. Contact: (as above)	27 - 29 Jan
Bahrain	Middle East Electronic Comms. Show & Conf - MECOM. Contact: Arabian Exbn. Management, 49-50 Calthorpe Rd., Edgbaston, Birmingham. 021-454 4416	2 - 5 Feb
Eindhoven, Holland	Int. Microelectronics Sub. Systems Trade Fair - Microelectronica. Contact: Golden Gate Exbns Inc, PO Box 428, Los Altos, CA94022, USA	4 - 6 Feb
Glasgow, Scotland	(Albany Hotel) Computermarket. Contact: Couchmead Ltd., 42 Gt Windmill Street, London W1. 01-437 4187	17 - 19 Mar

USER GROUPS INDEX

Here are the details of additions and changes recently notified. If we have failed to include YOUR group (or have published incorrect information) either here or in the complete listing, then please address changes/additions to: PCW (User Groups Index), 14 Rathbone Place, London W1P 1DE. Finally, the next complete listing will appear in our February issue.

NATIONAL

Anyone interested in forming a Texas TI99/4 Users' Club with a magazine and a software library, should contact Mr P Dicks, Data Processing Manager, Pershke Price Service Organisation Ltd, Dover House, 141 Morden Rd, Mitcham, Surrey CR4 4XB, tel. 01-648 7090

Sharp PC-1211 Users' Club. Also open to TRS-80 Pocket Computer owners and anyone else with or without a computer. Membership costs £5 p/a which includes a newsletter containing programs etc. Contact: Jonathan Dakeyne, 281 Lidgett Lane, Leeds LS17 6PD.

Apple/ITT2020 Users' Group. Just started up, with plans to hold monthly meetings on Sunday afternoons. Contact: John Sharp, 20 The Glebe, Garston, Watford WD2 6LR, tel. Garston 75093.

A user group specifically for Level 1 TRS-80 owners has recently been set up. We've no further details, other than that a newsletter is planned. Contact: N Rushton, 123 Roughwood Drive, Northwood, Kirkby, Merseyside L33 9UG.

SOUTH

IPUG South East Regional Group. Meets third Thursday each month, 7.30 pm at Charles Darwin School, Jail Lane, Biggin Hill. Bi-monthly newsletter. Contact: W Cdr M Ryan, 164 Chesterfield Drive, Sevenoaks, Kent TN13 2EH, tel (0732) 53530.

CAMBRIDGESHIRE

Peterborough Computer Club. Recently formed, meets on first and third Mondays each month at

Adult Education Centre, Brook Street, Peterborough. Contact: T Marchant, tel Peterborough 76681 after 6 weekdays, anytime weekends.

EAST MIDLANDS

East Midlands TRS-80 Users' Group. For owners/would-be owners of TRS-80s or Video Genies. For free newsletter and further details contact: Mike Costello, 17 Langbank Avenue, Rise Park, Nottingham NG5 5BU.

LANCASHIRE

PET Users' in West Lancs. Meets monthly on third Thursday each month at Arnold School Blackpool. Contact: David Jowett, 197 Victoria Road East, Thornton, Blackpool FY5 3ST, tel Cleveleys 869108.

SCOTLAND

Central Scotland Computer Club. Meets first and third Thursdays each month at Falkirk College of Technology, Grangemouth Rd., Falkirk. Contact J Lyon, 78 Slamannan Rd, Falkirk FK1 5NF, tel. 22430.

Grampian Amateur Computer Society. Meets second Monday monthly at local hotel, looking for own premises. Sub £4 p/a (£1 for junior members), monthly. About 50 members. Club owns an ICL 1902! Contact: Alan Hird, 20 Harcourt Rd, Aberdeen, Grampian, tel (0224) 33102.

SUFFOLK

Anyone interested in forming a Suffolk Computer Users' Club should contact Ian on Ipswich 831353 eves/weekends.

The classified service that's free to non-commercial readers. Advertisements (50 words max) to:
PCW Transaction File, 14 Rathbone Place, London W1P 1DE.

For sale

Litton/Monroe VRC... serial printer, tape read/write progs & manuals, large quant paper tape & paper rolls, all working, suitable for invoicing, ledgers, stock control, £500 the lot or swap for Apple, TRS-80, PET with disks. Ward, 01-486 9893 day.

PET 2001... 8k, exc cond, dust cover, games progs & doc, £350. Tel: Chipping Sodbury 311779 eves.

Sorcerer... 32k, S100 exp unit, monitor, dual Micropolis disks (630k total), Basic & Word Processing pacs, CP/M software & manuals, can split, reasonable offers. Tel: 061-928 8507 eves or w/ends.

T159... as new, with marine nav module & spare cards, £160. Tel: Chesterfield (0246) 34898.

Eight inch... disk drive (GSI FDD110), 220/50 mains motor, S100 s/dens controller (Wameco FDC1), inc onboard 2708 firmware, spare drive PCB, hard/software doc inc, untried, so £240 the lot inc carriage. Andrews, Templecombe (Somerset) 70587 eves.

Kim 1... 1k RAM, 2k ROM, monitor, tape, cassette int, 2 8-bit I/O ports, hex keypad, 6-digit 7-seg display, user manual & connector, fully expandable, £60. N Brazier, Trilleck, Cliff Road, North Patherton, Bridgewater, Somerset. Tel: 0278 662244 eves.

TRS-80 L2... 16k, VDU, c/recorder, Tbug, debounce & renumber tapes, Z80 assembler lang, Intro to Basic, Tandy instruction manuals, £400 ovno. Tel: 0273 733774 day, 0273 35627 eves.

Sorcerer 32k... 8k Basic, development pac, manuals, much software, £650 ono. A Wood, 47-Crick Rd., Hillmorton, Rugby CV21 4DU. Tel: 0788 846220 after 4.30.

Brand new... ZX80, bought assembled, with PSU, unused, boxed, cost £108, accept £80. Tel: Leatherhead 74674.

ZX80... inc leads, mains adaptor, etc, 2 months old, £70. Tel: Welwyn Garden City 33485.

New TRS-80... 16k level 2. Good reason for selling. Tel: Bilston 042869 after 7pm not Thursday or Sunday. Ask for Dave.

Teletype 33 KSR... ASCII coded, RS 232 I/O, With stand. Good condition, £180 ono. Tel: 0629 834426 (Darleydale) evenings.

ZX80... plus 3k RAM, circuit diagram, manuals, mains adaptor and 44 programs on tape + other literature. Tel: Witham (Essex) 516335.

Nascom 2... 32k RAM, 8k Basic, 4k ZEAP in EPROM, 4k Toolkit, 2400 Baud cassette interface, manuals tapes and programs. £470. Tel: 0326 72207 evenings/weekends. Can deliver West Country & London.

PET... 32k, Large Keyboard, new ROMs, Green Screen, 7 months old with cassette deck and spare tapes, manuals and books. Offers around £625. Tel: Saffron Walden (0799) 24244

Acorn System One... Excellent introduction to microprocessing and machine code programming. £55. Contact James Movercroft, 107, Fulham Palace Road London W6.

MK14... Issue 4, extra RAM, I/O, new keyboard, cassette interface, working £40. Tel: 01-542 0089 after 5pm. weekdays (Wimbledon Chase)

UK 101... New, cased and working plus new monitor, 5k RAM, 8k ROM. All cables attached. New monitor allows on screen editing. Several programs (including Invaders) thrown in. £275 ono. Tel: 01-690 6085 between 9.30 and 10.30 any evening.

Sinclair ZX-80... inc leads, mains adaptor and Basic manual. Tel: 01-572 5582 ask for Dave.

SYM 1... 4k, 8k Basic in ROM, alphanumeric keyboard (v. good quality), Tangerine 1648 VDU. Full set of manuals, 6 amp psu. Cash crisis forces sale. First £260 takes the lot. (cost around £700). Tel: Millom 3591

TRS-80... Level 2, 16k CUP plus adaptors for mains, video and cassette. Also some cassettes (inc Invaders) and manuals. Only 2 months old, £380 or swap for 8k PET. David Watson — Tel: Hatfield Heath (027977) 292.

Boris... Walnut cased master chess computer. Unwanted gift from USA. Different from UK model. Extra features—rechargeable batteries, memory switch for saving board position. vhf/uhf 3" TV, ideal for micros —£60 or exchange one/both for good oscilloscope. Tel: Radnage (024026) 3765.

PET 2001 8k... small keyboard, integral cassette, usual extras inc games, manual, sound box etc. Offers around £399 to Kevin Pretorius, tel 01-360 9576 (Enfield)

Superboard II... perfect working order, 8k RAM, wood case, PSU, TV modulator, leads, manuals, software inc screen editor, galactic warfare, man many other progs, £220. Tel R. Staerck, Ingrebourne 70681 after 4

Softy... EPROM programmer & development board, built & working with PSU & details of mods to program; for single rail EPROMs, £93. Tel 0325 313853

PET 2001 8k... 10 months old, as new, £450. Inc toolkit, green screen, sound box, TIS workbooks, manual, u utilities, games (Microchess) etc. Tel Bradford 675775 after 6.

PET 2001 8k... green screen, sound box, TIS workbooks, tapes, collection of magazines, little used, 11 months old, £330 ono. Tel 01-597 4364

S100... system with Z80, 104, ROM board, 16 x 64 VDU board, 64k DRAM board, full RS232 keyboard, 9-slot motherboard, PSU, cased, Tel Geoff 0632 651707

UK101... new monitor, used cond with all doc, £18. Tel 0535 607525, ask for David Exchange... Panasonic video recorder with 11 tapes (24 hours) & cabinet for TRS-80 (16k) L2 or PET 16k. Marin Cook, 16 Reynolds Court, Kingsway, Oldbury, Warley, W Midlands, or tel 021-422 6019 & leave phone no. to contact.

77-68 CPU... (ex switches/LEDs) £20. VDU, £20 Mon-2 (with T-Bug), £20; 4k RAM (with 2k), £20 all 4 boards £50. Tel Denis Field, St. Albans 60432 eve, 01-950-4030 ect 219 day.

MSI 6800... computer, 8k RAM, par & serial cassette ints, SWTP CT6155 graphics board, SWTP CT64 terminal, V/C case, 2 pages memory, TV modulator, £595. Tel 092 82 2929

Diablo 1550... daisy wheel printer/typewriter, RS232, friction/tractor feed, paper tray, integral stand, £595 ono. Tel 01-989 0430

Apple II Plus... 38k, single disk drive, wide range of software, unemployment forces sale, £850 Tel Hitchin 31761

Cassette storage... RDL recorder model GED460, tech & op manuals, needs new EOT lamp otherwise perfect, elaborate data & control logic in desktop steel case, unusual item £60. Tel. 01-977 4389 eves.

UK101... 8k RAM, 8k Microsoft Basic, assembled & cased, manual, games, extended monitor, assembler/editor, working, Tel Lee, 01-328 2444 or call 18 Plympton Rd. London NW6 eves

TRS-80 Level II... 16k VDU, cassette, 2 speed switchable processor (1.77 MHz/2.66 MHz), manuals, dust covers, books, tapes inc Space Invaders, Adventure games, chess, spare tapes & case, £550 ono. Tel Chester 672961 day or 051-336 6446 after 7, ask for Phil

TI PC100B... print cradle for T159/58, £110. Interface for old style 8k PET to MTU hi-res graphics board as sold by IJJ Design. £50. Tel Burton-on-Trent (0283) 217373

PET 2001 32k... large keyboard, new ROMs, ext cassette, some progs, 9 months old, impulse buy, rarely used, £450 ono for quick sale, buyer collects. Tel. Littlehampton (09064) 4477 ext 4 day, 09064 6591 eves.

63-key ASCII... keyboard, cased with Newbear Petitevid CRT ctrlr board & PSU; add monitor/TV for self-cont'd ASCII terminal. UHF modulator free if req. Prefer buyer inspects & collects, £90 ono. S. Hunt, 21 Green St., Milton Malsor, Northampton NN7 3AT

Nascom 2... 32k RAM, video monitor, large PSU, PIO board (up to 10 PIOs + CTC), 16 channel ADC, ICL 7075 printer, Zeap 2, Nasdis, Debug, Basic + Toolkit all in ROM, 4 1/2 digit DVM, all in 19" rack, working with full doc & many extras, best offer over £1000, buyer collects. Tel John. 01-351 3044 eves.

PET 2001 8k... £400 Tel 0494 33164

Nascom 1... T2 monitor, PSU all doc, cassettes & progs, ideal for beginner or exp person, £90 ono. Tel Chris (0782) 622164 after 5

Sorcerer... 48k, almost new, working, with 10 months warranty left, owner decided to buy video game machine due to lack of serious use; inc TV modulator, software manual & other extras, £536 ono. Also Chess Challenger 7, around £35. Tel P Koh 01-205 3521

TRS-80 Level II... 16k + cass rec (CTR-80), numeric keypad, latest video monitor, some software (eg games, Tbug, Edtsam, Micromusic etc), almost new, perfect cond, only £500 inc packing — unwanted birthday present. Tel G. Kilpatrick (0772) 73 2169

PET 2001-8... vgc, 8k old ROM, software, manuals, PETsoft soundbox, £400 ono. Tel Brege, Newcastle 744299 after 4

SWTP 6800... comprising 6800 processor, par & serialints, SWTP Bug, 40k RAM, CT64 terminal, AC30 cassette int, MF68 twin minifloppy drive unit (170k), PR40 40-col printer, system may be seen working, £1350. Tel Ware 2864 day, Ware 870300 eves

MZ-80K... 24k RAM, perfect cond, bought 15 Aug this year, inc Basic tape, manual, 50 progs (Othello, music, Space Invaders etc), £500 A. Mewes, 11 Barid Gdns, London SE19, Tel 01-670 1828

Nascom 1... 40k RAM (2 boards) control + hex keyboard (Bits PCs), hi-res graphics card (Bits PCs), EPROM programmer for 2708s, dual monitor board (NasSys + T4), case unit has fitted VDU & keyboards, interfaced to Creed 7B teleprinter, CUTS 300, 600, 1200 & 2400 baud, software inc Naspen, Zeap, toolkit, Naschess, Nasdis, Revas C, all for £600, possible split. Tel. Mountain Ash (Glamorgan) 476040 ask for Paul

UK101... new monitor ROM, 8k RAM, assembler editor tape, Microcase, cased transformer, fully tested, full doc & 6502 assembler & applications books £200. Tel Steve Griffiths, 01-997 3311 ext 2087 day

UK101... prof built, 8k RAM, cased with cooling fan & mains switch, TV monitor & cass output skets, 2 mini mains skets on rear panel, £300 ono. Mr C Bevis, 136 Talbot Rd, Southsea, Hants or tel Portsmouth 731151 after 7.30

T159... prog clac & PC100C printer, maths, stats, master & leisure modules, many mag cards & spare rolls pinter paper, 7 TI books, instruction manuals, perfect con, £250. Tel Wokingham (0734) 788023

Datem modem... ex GPO model 2A, working Yhas been used as am RTTY terminal) with literature & spare boards, £48. 9 channel tape data recorder, mechanics working + int boards (Singer), £35, no literature. Tel Dr. Bulger. 01-985 1314.

ZX80... full working order, assembled, inc all leads, PSU & manual, vgc, £75. Timothy Place, The Coppice, Green, Thornborough, Nr. Buckingham, tel Buckingham 3796

Nascom 2... 16k memory exp, built & working, tape recorder & leads, 110, 300, 1200 or 2400 baud, Zeap 2 & some games inc 12k m/c code Sargon Chess, offers. Tel Peterborough (0733) 222588.

UK101... 5 months old, vgc, cased with 8k RAM & dis-assembler oncass, £240 ono. Tel West Drayton 21197 after 6.30 or w/ends.

Triton... motherboard with PSU & connectors fitted, 8k RAM card 8k EPROM card, 2 spare card connectors, 2 x 2114L RAM chips (board minus memory chips), £110 ono. Tel Mr Rees, 01-802 8502 eves, 01-580 4468 ext 2172 day

PET 8k... old ROM, internal cassette, owner getting 32k, £370 Tel 01-449 7812
Genuine reason... for give-away price of £400 for new TRS-80 Level II, 16k inc VDU & cassette, all manuals & software. Will offer some basic instruction if required. Tel 021-455 7413 after 5.30 or w/ends.

Wanted

Toolkit for PET 2001 (old ROM) Shafe, Apartamento 411, Edificio Cap Negret, 27 Altea (Alicante), Spain.

PET, TRS-80 level II or Sinclair, with cassette and manuals. Large keyboard essential. Telephone 0492 67288 after 8pm.

ELCOMP Books

Care and Feeding of the Commodore PET
 Eight chapters exploring PET hardware. Includes repair and interfacing information. Programming tricks and schematics.
 Order No. 150 \$11.00

8K Microsoft BASIC Reference Manual
 Authoritative reference manual for the original Microsoft 4K and 8K BASIC developed for Altair and later computers including PET, TRS 80, and OSI. OS/1 owners please take note!
 Order No. 151 \$ 9.95

Expansion Handbook for 6502 and 6802
 (S 44 Card Manual) Describes all of the 4 5 x 6 5 44 pin S 44 cards incl RAM, ROM, dig I/O, MUX to D, EPROM Prog, etc. With schematics and funct. descriptions. A must for every KIM, SYM and AIM owner.
 Order No. 152 \$ 9.95

Microcomputer Application Notes
 Reprint of Intel's most important application notes including 2708, 8085, 8255, 8251 chips. Very necessary for the hardware buff.
 Order No. 153 \$ 9.95

Complex Sound Generation
 New, revised applications manual for the Texas Instruments SN 76477 Complex Sound Generator. Circuit board available (\$8.95).
 Order No. 154 \$ 6.95

Small Business Programs
 Complete programs for the business user. Mailing List, Inventory, Invoice Writing and much more. Introduction into Business Applications. Many listings.
 Order No. 156 \$14.90

The First Book of Ohio Scientific, Vol. I
 Contains an introduction to personal computers and describes the Ohio Scientific Line. Contains explanatory diagrams, block, hook up expansion tricks, hints and many interesting listings. Hardware and software information not previously available in one compact source. 192 pages.
 Order No. 157 \$ 7.95

The First Book of Ohio Scientific, Vol. II
 Vol. II contains very valuable information about Ohio Scientific microcomputer systems. Introduction to OS 650 and OS65 U, networking and distributed processing, systems specifications, business applications, hard and software hints and tips.
 Order No. 158 \$ 7.95

Mailing List Program for Challenger C1/C2 8K
 Order No. 2004 - Personal Version \$ 9.95
 Order No. 2005 - Business Version \$ 9.95

Ohio Scientific Expansion Information
 Conversion of CIP (Cassette) to 52x26 display. Detailed step by step instructions for doubling the CIP speed and display size!
 Order No. 1105 \$12.00

Important Software for CBM 16K/32K
 Most powerful Editor/Assembler for Commodore CBM 16/32K on cassette. Very fast—Editor divides screen into 3 parts. Scrolling text window, 24 direct commands, 19 serial commands, status and error messages. Assembler can be started directly from the editor or from the TIM monitor. Translates in three passes. If an error is encountered automatic return to the editor. Cassette with DEMO.
 Order No. 3276 \$69.00

ATTENTION APPLE USERS
 Same as above for Apple II or Apple II plus.
 Order No. 3500 \$89.00

MONJANA/1 makes Machine Language Programming easy!
 In every Commodore CBM there is a spare ROM socket waiting for its MONJANA/1. The new MONJANA/1 Machine Language Monitor in ROM offers more user guidance and debugging aids than any other monitor available today. It is indispensable for anyone intending to take full advantage of the computers features. Trace link disassemble dump relocate, line assemble and much more. Every command function has demand printout option. Price includes extensive manual.
 Order No. 2001 \$98.00

JANA-Monitor on cassette for the PET
 Similar to MONJANA/1, very powerful.
 Order No. 2002 \$29.00

ELCOMP PUBLISHING Inc.
 3873-L Schaefer Ave., Chino CA 91710 (714) 591-3130

Please send me the books/software indicated below

I enclose \$_____ send postpaid

Send COD (\$5 extra)

Charge my Visa Mastercharge

Acct No _____

Expir date _____ signature _____

Book No _____ Book No _____ Software No _____

1 Year subscription to ELCOMP Newsletter \$9.80

Name _____ Phone _____

Address _____

City _____ State _____ Zip _____

CA add 6% sales tax, We also accept Eurocheck. All orders outside USA must add 15% shipping.

```

12100 IFHT>0ANDDAT>0THEN12130
12110 NEXTI
12115 PRINT" "
12120 PRINT"***** TEAM NAME ERROR...RE-ENTER" :HT=0:AT=0:GOTO12040
12130 GOSUB21011:GOSUB21050
12135 PRINT"*****";TAB(16-LEN(N$(HT>>)),N$(HT);TAB(18);" V ";TAB(23);N$(AT)
12150 PRINT X=HR(HT):GOSUB20210
12160 HW=N:HL=L:HD=D:HS=W+L+D:IFHS=0THENHS=1
12170 X=AR(AT):GOSUB20210
12180 AW=N:AL=L:AD=D:AS=W+L+D:IFAS=0THENAS=1
12190 PH=(HM/HS)+(AL/AS)/2
12195 PRINTTAB(7);"*****PROBABILITY OF HOME =";INT(PH*100+.5)/100
12200 PD=(HD/HS)+(AD/AS)/2
12202 PRINTTAB(7);"*****PROBABILITY OF DRAW =";INT(PD*100+.5)/100
12205 PA=(HL/HS)+(AN/AS)/2
12207 PRINTTAB(7);"*****PROBABILITY OF AWAY =";INT(PA*100+.5)/100
12240 FRINT:Y=HG(HT):GOSUB20410:F1=F:F2=A:Y=AG(AT):GOSUB20410:F3=F:F4=A
12300 SH=(F1/HS)+(F4/AS)/2:SA=(F2/HS)+(F3/AS)/2
12350 PRINTTAB(3);N$(HT);INT(SH*10+.5)/10;" ";N$(AT);INT(SA*10+.5)/10:PRINT
12380 IFHT<0ANDAT<0THEN12410
12390 PRINTTAB(3);N$(AT);HT-AT;"ABOVE ";N$(HT):GOTO12444
12410 PRINTTAB(3);N$(HT);AT-HT;"ABOVE ";N$(AT)
12444 GOSUB22100
12445 TT=INT((2-FA(AT)+FH(HT))/2)*20+.5)-1
12447 IFTT<36THEHTT=36
12448 IFTT<2THEHTT=2
12462 PRINTTAB(11);"*****";GOSUB20620:GOTO12010
12510 RETURN
13010 PRINT"*****LOAD XEXPO-LEAGUES TAPE*****";GOSUB20615:PRINT" "
13030 OPEN1,1,1,"XPO-LEAGUES"
13040 PRINT"*****LEAGUE TABLES FILE OPENED*****";GOSUB21210
13045 PRINT#1,0$;" "
13050 FORI=1TO130
13060 PRINT#1,N$(I)
13070 PRINT#1,HR(I)
13080 PRINT#1,HG(I)
13090 PRINT#1,AR(I)
13100 PRINT#1,AG(I)
13110 PRINT#1,PP(I)
13114 PRINT#1,FK(I)
13116 PRINT#1,FA(I)
13117 PRINT#1,TH(I)
13118 PRINT#1,TA(I)
13120 PRINT"*****TEAMS FILED =";I:NEXTI
13150 CLOSE1:PRINT"*****ALL TEAMS FILED*****";GOSUB20615:RETURN
14010 IFEN=1THEN14170
14015 PRINT"*****LOAD XEXPO-LEAGUES TAPE*****";GOSUB20615:PRINT"*****PASSWORD ?"
14023 GOSUB21215
14030 OPEN1,1,0,"XPO-LEAGUES"
14040 PRINT"*****LEAGUE TABLES FILE OPENED*****"
14042 INPUT#1,0$:IF0$=0THEN14050
14046 PRINT"*****WRONG PASSWORD GIVEN !";0$;" "":00$=" "
14048 CLOSE1:PRINT"*****FILE CLOSED*****":RETURN
14050 0$=" "":00$=" "":FORI=1TO130
14060 INPUT#1,N$(I)
14070 INPUT#1,HR(I)
14080 INPUT#1,HG(I)
14090 INPUT#1,AR(I)
14100 INPUT#1,AG(I)
14110 INPUT#1,PP(I)
14114 INPUT#1,FK(I)
14116 INPUT#1,FA(I)
14117 INPUT#1,TH(I)
14118 INPUT#1,TA(I)
14120 PRINT"*****TEAMS RECALLED";I:NEXTI
14140 CLOSE1
14150 PRINT"*****ALL TEAMS RECALLED*****";EN=1:GOSUB20615:RETURN
15010 PRINT"*****DIVISION 1*****";TAB(12);"*****W D L F A W D L F A P T"
15030 FORI=1TO130:GOSUB20510:IFLS<2THEN15080
15060 GOSUB20620:PRINT"*****";D$;TAB(12);"*****W D L F A W D L F A P T"
15080 PRINTN$(I);
15085 Y$=STR$(HR(I)):PRINTTAB(18-LEN(Y$));Y$;
15090 Y$=STR$(HG(I)):PRINTTAB(23-LEN(Y$));Y$;
15095 Y$=STR$(AR(I)):PRINTTAB(30-LEN(Y$));Y$;
15100 Y$=STR$(AG(I)):PRINTTAB(35-LEN(Y$));Y$;
15110 PRINTTAB(35);PP(I)
15120 LS=0:NEXTI:GOSUB20620:RETURN
20210 X=L+D*100+W*10000:RETURN
20210 W=INT(X/10000):D=INT(X/100)-W*100:X=L+D*100+W*10000:RETURN
20310 Y=F*100+A:RETURN
20410 F=INT(Y/100):A=Y-F*100:RETURN
20510 IF1=1THEND$="DIVISION 1":LS=1:LF=22:RETURN
20520 IF1=23THEND$="DIVISION 2":LS=23:LF=44:RETURN
20530 IF1=45THEND$="DIVISION 3":LS=45:LF=68:RETURN
20540 IF1=69THEND$="DIVISION 4":LS=69:LF=92:RETURN
20550 IF1=93THEND$="SCOTS PREM":LS=93:LF=102:RETURN
20560 IF1=103THEND$="SCOT DIV 1":LS=103:LF=116:RETURN
20570 IF1=117THEND$="SCOT DIV 2":LS=117:LF=130:RETURN
20580 RETURN
20610 PRINT"*****"
20615 PRINT"*****TO CONTINUE PRESS 'SPACE' BAR"
20620 GETZ$:IFZ$=" "THEN20620
20630 RETURN
20710 INPUT"*****MATCHES WON *****";W:INPUT"*****MATCHES DRAWN*****";D:INPUT"*****MATCHES LOST *****";L
20740 GOSUB20110:INPUT"*****GOALS FOR *****";F:INPUT"*****GOALS AGAINST*****";A
20770 GOSUB20310:RETURN
20810 PRINT"*****ARE DETAILS CORRECT ?" :GOSUB20620:RETURN
20910 FORN=1TO25:Z$=SOR(7):NEXTN:RETURN
21011 PRINT"*****"
21030 FORJ=1TO20:PRINT"*****";J:NEXTJ:RETURN
21050 PRINT"*****";FORECAST SUMMARY*****":GOSUB23001:GOSUB2300.
21070 PRINT GOSUB23003:GOSUB23001
21081 PRINT"*****";SEASONAL ANALYSIS*****":GOSUB23002
21100 PRINT"*****";GOSUB23003
21110 PRINT"*****";EXPONENTIAL TREND*****;HOME*****":GOSUB23001
21130 PRINT"*****";1 2 0 1*****":GOSUB23001:GOSUB23004
21135 PRINT"*****";GOSUB23001:GOSUB23004
21150 RETURN
21210 PRINT"*****WHAT IS PASSWORD TO BE (S) AND"
21215 0$=" "
21220 FORJ=1TO5:GOSUB20620:0$=0$+Z$:NEXTJ:RETURN
22100 TT=FK(HT):GOSUB22200:PRINTTAB(11);"*****";
22120 TT=2-FA(AT):GOSUB22200:PRINTTAB(11);"*****";
22200 TT=INT(TT*20+.5)-1
22210 IFTT<36THEHTT=36
22220 IFTT<2THEHTT=2
22230 RETURN
    
```

WE'RE WARNING YOU

If
you don't
have a Superboard
or UK101 you're going
to regret not being
able to buy these
amazing add-ons!

CEGMON

The new monitor for all OSI and UK101 systems, with the *right* range of features!

- ★ Twin-cursor screen editor ★
- ★ Improved keyboard routine ★
- ★ New screen-handler ★
*with fully programmable protected areas,
screen and 'window' clear, cursor controls*
- ★ New machine-code monitor ★
*with load save, tabular display,
'modify' entry for text and hexadecimal,
breakpoint handler, block move,
and much more*
- ★ Disc bootstrap ★
- ★ Full compatibility ★

Complete with full manual and card for
only £29.50

HIGH-SPEED CASSETTE INTERFACE

Really fast cassette loading at 4800 baud:
loads an 8K BASIC program *reliably*
in under half a minute!

Switchable to standard 300 baud
for compatibility with existing software.

Ready built interface unit for
a mere £22.50

All prices quoted exclude VAT

MUTEK Quarry Hill, Box, Wilts
Tel: Bath (0225) 743289

```

• 23000 PRINT " " : RETURN
23001 PRINT " " : RETURN
• 23002 PRINT " " : RETURN
23003 PRINT " " : RETURN
• 23004 PRINT " " : RETURN
23005 PRINT " " : RETURN
• READY.

```

PCW Sub Set continued from page 107

Datasheet

```

; = ALRET — Skip parameters
;/ CLASS: 2
;/ TIME CRITICAL?: No
;/ DESCRIPTION: Alters the return address from a subroutine to skip
;/                over parameters in the main program and leaves
;/                HL pointing to the lowest addressed parameter
;/ ACTION: HL ← (SP + 2)
;/                (SP + 2) ← (SP + 2) + (DE)
;/ SUBr DEPENDENCE: None
;/ INTERFACES: None
;/ INPUT: The DE register must have been set in the main program to
;/         the number of bytes to be jumped over
;/ OUTPUT: HL points to the location following the main program call,
;/         which is the first of the parameters.
;/         The return from subroutine address on the stack has been
;/         increased by the value in DE on input.
;/ REGs USED: DE and HL
;/ STACK USE: 0
;/ LENGTH: 10
;/ TIME STATES: 91
;/ PROCESSOR: Z80 and 8080
ALRET: INC SP ; bypass return address 33
        INC SP ; to calling subroutine 33
        EX (SP),HL ; HL = initial SP contents E3
        EX DE,HL EB
        ADD HL,DE ; HL = new return address 19
        EX (SP),HL ; SP = new return address E3
        EX DE,HL ; HL = initial SP contents EB
        DEC SP ; reset SP for return 3B
        DEC SP : from this routine 3B
        RET : to calling subroutine C9

```

Datasheet

```

; = BFSR — Packed BCD/ASCII
;/ CLASS: 1
;/ TIME CRITICAL?: No
;/ DESCRIPTION: Converts packed BCD digits into ASCII decimal
;/                bytes; leaves the BCD field unchanged;
;/                suppresses leading zeros, but not the least significant
;/                nibble of an all zero field.
;/ ACTION: Not given, as not helpful
;/ SUBr DEPENDENCE: None
;/ INTERFACES: None
;/ INPUT: DE contains the address of the most significant ASCII byte
;/         HL contains the address of the most significant packed
;/         BCD byte
;/         B contains the number of BCD bytes to be converted
;/ OUTPUT: The ASCII field is created and the BCD field is unaffected
;/ REGs USED: A,B,DE,HL
;/ STACK USE: 0
;/ LENGTH: 35
;/ TIME STATES: Approximately 200 per packed BCD byte
;/ PROCESSOR: Z80
BFSR1: INC DE ; increment DE 13
        INC DE ; increment DE 13
        INC HL ; bump packed byte pointer 23
BFSR: LD A,(HL) ; pick up packed byte 7E
        AND FFH ; is it = 0? E6 FF
        JRNZ BGSr2 ; if not go to convert it 20 03
        DJNZ BFSR1 ; cont if not end BCD field 10 F6
        INC B ; bump byte counter 04
BFSR2: AND FOH ; upper nibble = 0? E6 F0
        JR Z,BFSR4 ; jump if yes 28 07
        LD A,30H ; load A with 30 hex 3E 30
BFSR3: RLD ; get high nibble ED 6F
        LD (DE),A ; store ASCII 12
        RRD ; restore packed byte ED 67
BFSR4: INC DE ; bump ASCII pointer 13
        LD A,30H ; load A with 30 hex 3E 30

```

RRD		; get low nibble	ED 67
LD	(DE),A	; store ASCII	12
RLD		; restore packed byte	ED 6F
INC	HL	; bump packed byte pointer	23
INC	DE	; bump ASCII pointer	13
DJNZ	BFSR3	; decr B & continue if not 0	10 EF
RET		; return	C9

Microchess continued from page 69

5.	CHES 4.9 (USA) Lawrence Atkin; David Cahlander CDC Cyber 176	L4	D9	W11	W10	2½
6.	NUCHES (USA) David Slate; William Blanchard CDC Cyber 176	W16	D1	L2	D9	2
7.	KAISSA (USSR) V L Arlazarov; M V Donskoy IBM 370/168	W14	W13	L3	L2	2
8.	BCP (UK) Don Beal PDP 11/70	L1	D10	D14	W15	2
9.	BEBE (USA) Tony Scherzer Bebe chess machine	D10	D5	D12	D6	2
10.	SCHACH 2.3 (BRD) Matthias Engelbach Burroughs 7800	D9	D8	W13	L5	2
11.	AWIT (Can) T A Marsland Amdahl 470 V/7	L13	W17	L5	W18	2
12.	MASTER (UK) Peter Kent; John Birmingham IBM 3033	W15	L3	D9	L4	1½
13.	OSTRICH (Can) Monroe Newborn Data General Nova 4	W11	L7	L10	D14	1½
14.	MYCHES (USA) David Kittinger Cromemco	L7	D15	D8	D13	1½
15.	PARWELL (BRD) Thomas Nitsche; Elmar Henne; Wolfram Wolff Siemens SMS 2 plus 128 8080s in parallel	L12	D14	W16	L8	1½
16.	ADVANCE 1.0 (UK) Mike Johnson; Dave Wilson 6502 plus chess hardware	L6	D18	L15	W17	1½
17.	DARK HORSE (SWE) Ulf Rathsman Univac 1100/81	L2	L11	W18	L16	1
18.	CSC (USA) Dan & Kathe Spracklen; Ron Nelson; Frank Duason; Ed English Champion Sensory Challenger	L3	D16	L17	L11	½

Belle defeated Chaos in the play-off for the title

YCW program continued from page 116

```

480 REM
490 REM
500 FOR Y=1 TO 10 READ R(NY):NEXT
510 DATA 1,4,3,2,4,4,1,2,3,1
520 REM
530 W(1)=1 W(2)=4 W(3)=2:W(4)=3
540 REM
550 S(1)=50 S(2)=100:S(3)=150 S(4)=200 S0=59464
560 REM KEY CONVERSION TABLE
570 FOR Y=1 TO 9:READ K(Y):NEXT
580 DATA 3,0,4,0,0,0,1,0,2
590 REM ENABLE SOUND O/P
600 POKE59467,16:POKE59466,15
610 REM PRINT TITLE
620 PRINT"....."
630 PRINT"  "
640 PRINT" 3  "
650 PRINT"  "
660 PRINT"....."
670 PRINT"  "
680 PRINT"....."
690 PRINT"    WRITTEN BY JONATHAN J DICK"
700 PRINT"    SOUND ON PINS 'M' AND 'N' ON USER PORT"
710 FORU=1TO3000:NEXT
720 REM CLEAR SCREEN IN QUARTERS
730 FORI=1TO4:POKE177,ACW(I):POKE178,B(W(I)):POKE180,32 SVS826 FORU=1TO500
740 NEXT:NEXT
750 FOR U=1 TO 500:NEXT:PRINT"@"
760 FORI=1TO2:POKE50,100:FORU=1TO50:NEXT:POKE50,0:FORU=1TO50:NEXT:NEXT
770 PRINT"    DO YOU WANT INSTRUCTIONS?"
780 GETW$:IFW$=""THEN780
790 IFW$="Y"THENPRINT"J".GOTO830
800 IFW$="N"THEN1140
810 GOTO780
820 REM INSTRUCTIONS

```

MICROMART

µHex EPROM PROGRAMMERS

426 2508/2708/2758/2516/2716
Dual and Single supply Eproms. £95

416 2704/2708/2716 Dual only. £65

480 2704/2708 Kit £35. Built £40.

All programmers require only standard power supplies.
The 426 & 416 are cased and have push-button selection.
Program any length block into the Eprom. Software included. Range covers 280, 8080, 6800 and 6500. State machine.

PIO, PIA INTERFACE MODULES

Available for 280/8080 and 6800/6500.

Prices include carriage. Please add VAT SAE for further product information.

MICROHEX COMPUTERS

UNION STREET, TROWBRIDGE, WILTS.

MICROTYPE



READY CUT CASE FOR SUPERBOARD.
UK101, NASCOM 2.
ALSO AVAILABLE WITH BLANK KEYBOARD FOR HUMBERNUT, NASCOM 1, ETC 1

PRODUCED IN BLACK ABS PLASTIC, COMPLETE WITH SCREWS AND INSTRUCTIONS.
SPACE FOR EXPANSION; FORCE FEED FAN, NUMERIC PAD AND ADDITIONAL KEYS.
ONLY £29.50 - £139 P.P.P. - VAT
SEND CHEQUES OR P.O.'S FOR £29.50 TO
MICROTYPE, P.O. BOX 104, HEMEL HEMPSTEAD, HERTS. HP2 7JZ
SEE FOR DETAILS DEALER & DEM ENQUIRIES WELCOME

CARDIFF MICRO CENTRE

COMMODORE PETS

+

PETSOFT PROGRAMS

+

HEWLETT PACKARD

+

COMPUTER BOOKS

SIGMA SYSTEMS

54 Park Place

Cardiff 21515/34869

CONFUSED?

DO YOU FIND IT ALL TOO COMPLICATED? ARE THERE TOO MANY TECHNICAL TERMS? WE DON'T JUST SELL MICROS. WE LIVE AND WORK WITH THEM, WE TEACH ALL OUR CUSTOMERS TO USE THEM. BUY A MICRO FROM US AND GET AS MUCH HELP AS YOU NEED!

MICROTEK

PHONE CHRIS ROBINSON ON IPSWICH (0473) 50152

MICROMART

MINE OF INFORMATION LTD

1 FRANCIS AVENUE,
ST ALBANS AL3 6BL
ENGLAND

Phone: 0727 52801
Telex: 925 859

MICROCOMPUTER CONSULTANCY & BOOK SELLERS

TRS-80, NASCOM, OTHER Z80 SYSTEMS

RS232C SERIAL INTERFACE — crystal controlled, baud rates up to 19200, bi-directional, full handshake, etc. Suitable for connecting to modem, serial printer (4 additional signals available); CSR, DSR, CD, RI), other computers. Port addresses selectable, TRS-80. Expansion interface NOT required. Complete kit £68, including cable and plus for keyboard unit and upper/lower case video modification details.

PRINTER INTERFACE BOARD — run the Nascom Micro Imp printer from the TRS-80 (Expansion Interface not necessary). Handshake capability, run up to 9600 baud. The cheapest dot matrix, plain paper, 80 col. printer for the TRS-80. Interface board ready built £30. Including cable and plus for keyboard unit and upper/lower case video mod details.

LOGIC PROBE — build yourself a really good logic probe. Complete kit £12.

For further details of the above, send a large stamped addressed envelope to:
SCALE ENGINEERING, 6 GOSS
BARTON, MAILSEA, AVON BS19 2XD
N.B. Prices include VAT & postage

sinclair ZX80 SOFTWARE

Battleship	Mastermind
NIM	Dallas
Simon	Hangman
Hurkle	Bandit
Lunar Land	Maths Test
Water Bill	Dice Throw
Wordpuzzle	Big Ben
Money Loan	Tank

All the above programs are available for the 1K ZX80. Each program is supplied on its own C12 microprocessor cassette with full documentation and listing. £5.00 each, 3 for £12.00 or send £2.50 for a sample program and catalogue. Cheques to:

CDS Micro Systems, 10 Estfield Close,
Tickhill, Doncaster, DN11 9LA.
Mail Order Only

OKI

MICROLINE 80

£359*

NORTHAMBER LTD
Great Oak House, Esher, Surrey
KT10 9BR Tel: 0372 62071
*plus VAT and delivery

```

830 PRINT"SIMON IS A GAME OF MEMORY. TO PLAY,"
840 PRINT"YOU WATCH THE SCREEN WHILE GRAPHIC"
850 PRINT"BLOCKS FLASH IN A SEQUENCE IN ANY OF THE"
860 PRINT"FOUR CORNERS OF THE SCREEN, CHOSEN AT"
870 PRINT"RANDOM. THIS IS HOW THEY APPEAR....."
880 FOR U=1 TO 8000:NEXT
890 PRINT"J"
900 FOR T=1 TO 10:SQ=RN(T):D=300:GOSUB1730
910 FOR U=1 TO 150:NEXT:NEXT
920 PRINT"THEN YOU HAVE TO REPRODUCE THE SEQUENCE"
930 PRINT"USING THE NUMERIC KEY PAD FOR THE FOUR"
940 PRINT"QUARTERS LIKE THIS -"
950 PRINT"
960 PRINT"   QUARTER----- 7 1 9 "
970 PRINT"   |                         | "
980 PRINT"   |                         | "
990 PRINT"   |                         | "
1000 PRINT"   KEY----- 1 1 3 "
1010 PRINT"
1020 PRINT"NOW YOU ARE KEYING IN WHAT YOU THINK"
1030 PRINT"THE SEQUENCE IN, DON'T TAKE TOO LONG"
1040 PRINT"THINKING OR YOU WILL LOSE!!!"
1050 PRINT"YOU START WITH ONLY FIVE FLASHES IN A"
1060 PRINT"SEQUENCE, BUT IF YOU WIN THEY INCREASE"
1070 PRINT"BY TWO EVERY TIME UNTIL YOU LOSE OR YOU"
1080 PRINT"MANAGE TO REMEMBER A SEQUENCE OF 50!!!"
1090 PRINT"YOU CAN SET THE DIFFICULTY OF THE GAME"
1100 PRINT"FROM 1-20. THIS MAKES THE GAME SLOW OR"
1110 PRINT"FAST. 1 IS SLOW 20 IS FAST."
1120 GOSUB1590
1130 PRINT"J"
1140 INPUT"HOW DIFFICULT (1-20)   ||||";D$:IFD$="" THENPRINT"J":GOTO1140
1150 D=VAL(D$):D1=INT(D)
1160 IF(D1ORD120ORD130)D1THENPRINT"MUST BE INTEGER BETWEEN 1 AND 20":GOTO1140
1170 FOR T=1 TO 5:SQ(T)=INT(RND(1)*4)+1:NEXT:REM*SETUP FIVE FLASHES*
1180 D=(21-D)*50:NS=5:REM*NUMBER OF FLASHES AFTER 5*
1190 REM DO RANDOM SEQUENCE
1200 PRINT"GET READY.....":FORU=1 TO 2000:NEXT:PRINT"J"
1210 FOR V=1 TO NS:SQ=SQ(V)
1220 GOSUB1730
1230 NEXT
1240 PRINT"NOW REPEAT THE SEQUENCE WHEN THE SCREEN"
1250 PRINT"   CLEARS"
1260 FOR T=1 TO 100:NEXT:PRINT"J":CO=1
1270 POKE158,0:REM*CLEAR BUFFER*
1280 TI$="000000"
1290 POKE158,0:REM*CLEAR BUFFER*
1300 GETW$:IFW$="" THEN1400
1310 KY=VAL(W$):IFKY=0 THEN1300
1320 SQ=KY(KY):IFSQ=0 THEN1300
1330 IFSQ<SQ(CO) THEN1440
1340 GOSUB1730
1350 CO=CO+1:IFCO=NS+1 THEN1400
1360 GOTO1280
1370 PRINT"YOU HAVE COMPLETED THE GAME BY MANAGING"
1380 PRINT"TO REMEMBER 50 FLASHES. THAT IS AMAZING!"
1390 GOTO1650
1400 IFTI$<"000004" THEN1300
1410 FOR I=1 TO 320:POKES0,20:POKES0,30:NEXT:POKES0,0
1420 PRINT"YOU TOOK TOO LONG THINKING!!":GOTO1650
1430 REM LOSE GAME
1440 POKE177,A(SQ):POKE178,B(SQ):POKE180,C(SQ):SYS826:FORU=1 TO 100:POKES0,250
1450 POKES0,100:NEXT:POKE177,A(SQ):POKE178,B(SQ):POKE180,C(SQ):POKES0,0:SYS826
1460 POKE158,0:REM*CLEAR BUFFER*
1470 PRINT"YOU LOSE THAT ONE":GOTO1650
1480 FORA=1 TO 10:FORU=50 TO 100:POKES0,U:NEXT:NEXT:POKES0,0
1490 PRINT"OKAY!! YOU HAVE REMEMBERED "NS"FLASHES":NS=NS+2:IFNS=52 THEN1370
1500 PRINT"PRESS ANY KEY TO QUIT. OTHERWISE GAME"
1510 SQ(NS-1)=INT(RND(1)*4)+1:SQ(NS)=INT(RND(1)*4)+1:REM*SET UP NEXT 2 FLASHES*
1520 PRINT"CONTINUES IN FIVE SECONDS."
1530 TI$="000000":POKE158,0
1540 GETW$:IFW$="" ANDTI$<"000005" THEN1540
1550 IFW$="" THEN1200
1560 POKE59467,0:END
1570 REM
1580 REM SUBROUTINE TO WAIT FOR KEY PRESS
1590 PRINT"
1600 PRINT"PRESS ANY KEY TO CONTINUE "
1610 POKE158,0
1620 GETQQ$:IFQQ$="" THEN1620
1630 RETURN
1640 REM SUBROUTINE TO ASK WHETHER YOU WANT ANOTHER GAME
1650 PRINT"
1660 PRINT"DO YOU WANT TO PLAY AGAIN? "
1670 GETW$:IFW$="" THEN1670
1680 IFW$="Y" THEN1140
1690 IFW$="N" THENPOKE59467,0:END
1700 GOTO1670
1710 REM
1720 REM SUBROUTINE TO FILL A QUARTER OF THE SCREEN
1730 POKE177,A(SQ):POKE178,B(SQ):POKE180,C(SQ):POKES0,S(SQ):SYS826:FORU=1 TO D
1740 NEXT
1750 POKE177,A(SQ):POKE178,B(SQ):POKE180,32:POKES0,0:SYS826:FORU=1 TO 150:NEXT
1760 RETURN

```

Submitting programs to PCW

Our programs section thrives on contributions from you, the readers. In particular we're looking for original ideas (no more Nim, decimal-hex conversions, Masterminds, digital clocks, etc please!) and we're not just interested in games — if you've a handy business/scientific/educational program then we'd be interested to hear from you.

Once you've written and thoroughly debugged your program, send it to us on cassette or disk with, if possible, a

clear printout made with a new ribbon on plain (not lined) paper. Write a covering letter stating briefly what the program is, *exactly* which machine it's for (ie old/new ROM PET, or TRS-80 Level I or II) and how much memory it requires. On a separate sheet list any special instructions which aren't included in the program and write your name and address on each piece of paper you send us as well as on the cassette/disk. If you'd like your cassette/disk returned then enclose a suitable SAE.

Send your programs to: PCW Programs, Personal Computer World, 14 Rathbone Place, London W1P 1DE.

PROGRAMS

TRS-80 Tarot

by Simon Williams

This interesting program runs on a 16k machine.

```
10 RANDOM:CLEARR140:GOSUB530
20 DIML(2,10):FORN=0TO9:READL(0,N),L(1,N):NEXT
30 '***INFORMATION/INSTRUCTIONS
40 CLS:PRINT@465,"COPYRIGHT 1980, SIMON WILLIAMS":FORN=1TO1000:NEXT
50 CLS:PRINT"THE TAROT IS AN ANCIENT METHOD OF FORTUNE TELLING WHICH MAKES USE
OF A PACK OF 78 CARDS. THESE ARE DIVIDED INTO TWO SECTIONS, THE MAJOR & MINOR
ARCANA". THE MAJOR ARCANA IS A SET OF 22"
60 PRINT"PICTORIAL CARDS DEPICTING PEOPLE AND OBJECTS. THE MINOR ARCANA IS SIMI
LAR TO AN ORDINARY PACK OF PLAYING CARDS WITH AN EXTRA CARD IN EACH SUIT, THE
'PAGE'. THE FOUR SUITS ARE NAMED WANDS,"
70 PRINT"CUPS, SWORDS AND PENTACLES. THE MAJOR AND MINOR ARCANAS ARE SHUFFLE
D TOGETHER AND DEALT OUT, FACE DOWN, IN ANY OF SEVERAL ARRANGEMENTS KNOWN AS
'LAYS'. THE CARDS ARE THEN REVEALED, ONE"
80 PRINT"AT A TIME, AND READ ACCORDING TO THEIR INDIVIDUAL MEANINGS AND THEIR P
OSITIONS IN RELATION TO THE OTHER CARDS. I SHALL READ FROM THE TEN CARD OR 'C
ELTIC CROSS' LAY."
90 PRINT"BEFORE WE START, I NEED TO KNOW SOME THINGS ABOUT YOU, IN ORDER TO ASSI
GN YOU ONE OF THE COURT CARDS AS YOUR 'SIGNIFICATOR'. ARE YOU MALE OR FEMALE?
ANSWER M OR F."
100 S$=INKEY$:IFS$(0)"M"ANDS$(0)"F"=GOTO100
110 PRINT@896,"ARE YOU OVER 40? ANSWER Y OR N - PLEASE BE HONEST."
120 AS=INKEY$:IFA$(0)"Y"ANDAS$(0)"N"=GOTO120
130 PRINT@896,"WHAT COLOUR IS YOUR HAIR? A = VERY FAIR, B = GRAY, C = LIGHT B
ROWN, D = DARK BROWN, E = BLACK"
140 HS=INKEY$:IFH$(0)"A"ANDH$(0)"B"ANDH$(0)"C"ANDH$(0)"D"ANDH$(0)"E"=GOTO140
150 AS=5$+AS:IFA$="M"THENAS="KING OF ":A=14:GOTO180
160 IFA$="F"THENAS="QUEEN OF ":A=13:GOTO180
170 IFA$="M"THENAS="KNIGHT OF ":A=12:GOTO180
180 IFA$="A"ORH$="B"THENAS="WANDS":H=64:GOTO210
190 IFA$="C"THENAS="CUPS":H=50:GOTO210
200 IFA$="D"THENAS="SWORDS":H=36:ELSENH$="PENTACLES":H=22
210 CD(0)=A+H:CLS:PRINT@320,"THANK YOU. YOUR SIGNIFICATOR IS THE "A$+H$"."
220 PRINT"THIS CARD IS PLACED FACE UP ON THE TABLE AND THE FIRST TWO CARDS OF
THE LAY ARE PLACED ON TOP OF IT AS THEY ARE DEALT."
230 PRINT@896,"PLEASE CONCENTRATE ON ANY MATTER OF CONCERN BEFORE PRESSING THE S
PACE BAR TO BEGIN THE READING.":
240 IFINKEY$(0)" "THENR=RND(0):GOTO240
250 '***READING
260 CLS:PRINT@320,"THE FIRST CARD IS LAID ON TOP OF THE SIGNIFICATOR AND SHOWS T
HE GENERAL SURROUNDINGS OF YOUR ENQUIRY. THE CARD I TURN UP IS ":GOSUB380
270 CLS:PRINT@320,"THE SECOND CARD IS PLACED ACROSS THE FIRST AND INDICATES ANY
CURRENT PROBLEMS. FAVOURABLE CARDS MEAN SMALL PROBLEMS. I DRAW ":GOSUB380
280 CLS:PRINT@320,"THE THIRD CARD, WHICH INDICATES YOUR AIMS AND IDEALS, IS PLAC
ED ABOVE THE SIGNIFICATOR. IN THIS CASE THE CARD IS ":GOSUB380
290 CLS:PRINT@320,"THE FOURTH CARD, PLACED BELOW THE SIGNIFICATOR, SHOWS THE BAC
K- GROUND TO THE PRESENT SITUATION - WHAT LED UP TO IT. I TURN UP ":GOSUB380
300 CLS:PRINT@320,"LEFT OF THE SIGNIFICATOR, THE FIFTH CARD SHOWS THE IMMEDIATE
PAST - WHAT IS BEHIND YOU. THIS CARD IS ":GOSUB380
310 CLS:PRINT@320,"THE SIXTH CARD, LAID TO THE RIGHT OF THE SIGNIFICATOR, SHOWS
THE IMMEDIATE FUTURE - WHAT IS 'BEFORE' YOU. THE CARD DRAWN IS ":GOSUB380
320 CLS:PRINT@320,"THE SEVENTH CARD, PLACED TO THE RIGHT OF THE SIXTH, SHOWS YOU
R ATTITUDE TO THE MATTER. IF A COURT CARD IS DRAWN, YOU ARE SHOW- ING SOME OF T
HE FEATURES OF THAT CHARACTER. I TURN UP ":GOSUB380
330 CLS:PRINT@320,"THE EIGHTH CARD, WHICH INDICATES THE ENVIRONMENT IN WHICH YOU
'REWORKING, IS LAID ABOVE THE SEVENTH. I DRAW ":GOSUB380
340 CLS:PRINT@320,"THE NINTH CARD SHOWS YOUR HOPES AND FEARS AND IS PLACED ABOVE
THE EIGHTH. THIS CARD IS ":GOSUB380
350 CLS:PRINT@320,"THE LAST CARD, THE TENTH, INDICATES THE FINAL OUTCOME OF THE
MATTER - WHAT WILL BE - AND IS LAID ABOVE THE NINTH. IT IS ":GOSUB380
360 CLS:PRINT@454,"THIS COMPLETES THE READING. I WISH YOU GOOD FORTUNE.":FORN=1T
O2000:NEXT
370 RESTORE:GOSUB530:PRINT@832,:END
380 '***CARD/MESSAGE SELECTION & PRINT
390 R=RND(156):IFR(78)THENR$=" REVERSED":R1=R-78:ELSEN$="":R1=R
400 IFR(1)64THENR2=R1-64:N$=" OF WANDS"+N$:GOTO450
410 IFR(1)50THENR2=R1-50:N$=" OF CUPS"+N$:GOTO450
420 IFR(1)36THENR2=R1-36:N$=" OF SWORDS"+N$:GOTO450
430 IFR(1)22THENR2=R1-22:N$=" OF PENTACLES"+N$:GOTO450
440 RESTORE:FORN=1TOR1+194:READNM$:NEXT:N$=NM$+N$:MM$="MAJOR":GOTO460
450 RESTORE:FORN=1TOR2+216:READNM$:NEXT:N$="THE "+N$+N$:MM$="MINOR"
460 IFR(11)THENIFR=CD(N1)THENN1=0:GOTO380:ELSEN1=N1+1:GOTO460:ELSEN1=0
470 CD(CN+1)=R:RESTORE:FORN=1TOR+230:READT$:NEXT
480 PRINTNM$:PRINT"THIS CARD IS OF THE "MM$" ARCANA & IMPLIES "T$
490 FORN=0TO9:SET(L(0,N),L(1,N)):NEXT:PRINT@960,"PLEASE PRESS SPACE BAR TO CONTI
NUE READING":
500 F=F+1:IFF(15)=INT(F/15)GOSUB520
510 IFINKEY$(0)" "THENCN=CN+1:RETURNELSE500
520 IFPDINT(L(0,CN),L(1,CN)):RESET(L(0,CN),L(1,CN)):RETURNELSESET(L(0,CN),L(1,CN
)):RETURN
530 '***TITLE GRAPHICS
540 CLS:FORN=1TO10:READC0,C1,C2,C3,C4,C5
550 FORI=C0TOC1:SET(I,C2):NEXTI:FORI=C3TOC4:SET(I,C5):NEXTI:N
560 FORN=1TO6:READC0,C1,C2,C3:FORJ=C0TOC1:SET(C2,J):SET(C3,J):NEXTJ:N
570 FORN=1TO6:READC0,C1,C2,C3,C4
580 FORJ=C0TOC1:SET(C2,J):SET(C3,J):SET(C4,J):NEXTJ:N
590 FORN=1TO5:READC0,C1,C2,C3,C4,C5,C6,C7,C8,C9,CA,CB
600 SET(C0,C1):SET(C2,C3):SET(C4,C5):SET(C6,C7):SET(C8,C9):SET(CA,CB):NEXT
610 FORI=36TO89:SET(I,30):SET(I,35):NEXT:FORI=82TO89:SET(I,25):SET(I,36):NEXT
620 FORJ=11TO13:SET(4,J):SET(5,J):SET(30,J):SET(31,J):NEXT
630 FORI=71TO75:SET(I,25):NEXT:SET(91,16):FORN=1TO1500:NEXT:RETURN
640 DATA0,59,9,6,27,10,46,49,10,32,47,11,16,17,13,6,15,14,46,52,25,44,47,26,38,
53,36,56,57,36,76,79,34,92,95,34,78,81,35,90,93,35,92,99,15,98,101,16,105,111,17
,105,106,35,113,117,35,103,113,36
650 DATA10,15,28,29,14,30,26,27,17,33,24,25,32,34,22,23,33,35,20,21,35,36,18,19
660 DATA31,34,35,36,37,24,35,53,54,55,24,36,62,63,64,29,33,74,75,76,29,33,95,96,
97,9,35,102,103,104
670 DATA38,29,39,29,40,28,41,28,42,27,43,27,65,28,66,28,67,27,68,27,69,26,70,26,
76,28,77,28,78,27,79,27,80,26,81,26,90,26,91,26,92,27,93,27,94,28,95,28,80,36,81
,36,90,36,91,36,112,16,113,16
680 DATA6,7,62,7,62,5,62,9,58,7,66,7,72,7,72,5,72,3,72,1
690 DATA THE MAGICIAN, THE HIGH PRIESTESS, THE EMPRESS, THE EMPEROR, THE HERIOPHANT, T
HE LOVERS, THE CHARIOT, JUSTICE, THE HERMIT, THE WHEEL OF FORTUNE
700 DATA STRENGTH, THE HANGED MAN, DEATH, TEMPERANCE, THE DEVIL, THE TOWER, THE STAR, TH
E MOON, THE SUN, JUDGEMENT, THE WORLD, THE FOOL
710 DATAACE, 2,3,4,5,6,7,8,9,10, PAGE, KNIGHT, QUEEN, KING
720 DATA EITHER THE NEED FOR OR THE SKILLS OF DIPLOMACY., MYSTERY & THE FUTURE OR
A WOMAN WITH PSYCHIC POWERS., FRUITFULNESS IN ALL ITS ASSOCIATIONS., INITIATIVE.,
STABILITY IN LIFE. THE AID OF A POWERFUL PERSON.
730 DATA ASSOCIATIONS WITH OTHERS AND PARTICULARLY MARRIAGE., ALL FORMS OF LOVE
AND ATTRACTION TO BEAUTIFUL THINGS., TRIUMPH ONLY THROUGH PERSEVERANCE AND DOGGEDN
ESS. THE JUST OUTCOME OF PROBLEMS.
740 DATA CORRUPTION. OTHERS MAY TRY TO BETRAY YOU., THE FORCES OF LUCK AND THE
REFUSE SUCCESS., A TIME FOR TAKING COURAGE AND ACTING ENERGETICALLY., INTUITION
. YOUR OWN OR ADVICE FROM ONE WHO HAS.
750 DATA THE END OF A CYCLE OF EVENTS. CHANGE AND RENEWAL., A NEED FOR ECONOMY & GO
OD MANAGEMENT., THE EFFECT OF EXTRA EFFORT. POSSIBLY VIOLENCE., ADVERSITY & DISTR
ESS. MISERY CAUSED BY CONFLICT.
760 DATA LOSS BY THEFT OF MATERIAL OR SPIRITUAL THINGS., A WARNING OF HIDDEN EN
```

MICROMART

**MORRISTON
COMPUTER
CENTRE**

46 CROWN ST
MORRISTON
Tel: 795817 SWANSEA

SHARP MZ80 VIDEO
PC1211 GENIE

OHIO SUPERBOARD £159

SUPERBOARD II (48x32 format) £189
POWER SUPPLY 5 V. 3 AMP. £18 (24)
METAL CHALLENGER CASE £18 (24)
48 x 32 ENHANCEMENT SERVICE £33
48 x 32 KIT & DETAILED PLANS £12 (20)
CHALLENGER 1P (uses S/BOARD) £205
CHALLENGER 1P (48x32 format) £238

prices in brackets apply if not bought with S Board

NEW MONITOR FOR OHIO & UK101 £29.50

Software for both enhanced & standard S/Boards
SPACE INVADERS (fast 4k mac code) £4
TABULAR EXTENDED MAC CODE MONITOR £3
SINGLE KEYCOMMANDS/SCN EDITOR IN ONE £3

ZX80 TRADE IN

we offer top P Exchange rates

ZX80 S/HAND, WORKING FROM £60

NORTHERN MICRO

add 15% VAT
29 Moorcroft Park TEL HOLMFIRTH
New Mill (048489) 2062
Huddersfield 10am-8pm Mon-Sat
HD7 7NS

SOFTWARE FOR THE PET, APPLE, TRS-80, SORCERER

Cash book	£15
Discounted cash flow	£8
Macro-economic game	£5
Basic statistics	£5
Regression	£5
Chi-square (N x 1 equal expts; N x 1 unequal expts.)	£5 each
T-test (independent samples; correlated samples)	£5 each
Pearson correlation	£5
ESP tester	£5
Hex loader (TRS-80 only)	£5

Programs are available for Sorcer, Pet (new ROMs), TRS-80 (Level II) and Apple (AppleSoft). All programs require 16K RAM (minimum) and are cassette based.

Data preparation on cassettes for above machines @ 30p per 1000 key depressions. Send copy of data to be encoded, format required and cheque.

Custom programming for above machines and IMS 5000. Write with details of your requirements.

Coming soon - tiny Pascal (cassette-based) for Pet @ £25

Mail order only. Prices are all-inclusive. When ordering please state machine configuration. Send orders and requests for catalogues to Dept. C1, Sapphire Software Ltd 95 Risborough Rd, Bedford MK41 9OR

TRS 80 LIGHT PEN

Give sight to your micro!

With only a few lines of BASIC, any program can accept inputs by pointing the Light Pen at the TV screen. Hundreds of applications! Plugs into the MIC input of your cassette recorder.

Included with the Light Pen is a demonstration tape, plus full instructions on how to write your own software.

The only extra required is a PP3 battery!

MICROVISION LIGHT PEN - ONLY £12.00

Also available is a Light Pen amplifier, enabling direct connection to the TRS 80 tape port £4.50.

Please add 50p to cover P&P

MICROVISION, 15 ELMSHAW RD, PUTNEY, LONDON SW15 5EL

MAIL ORDER ONLY

SPECIALS for PET

Programmer's toolkit	£39
Light Pen (+ software)	£25
Word Processor (M/code)	£35
Music system complete	£37
Adventures 1 & 2	£ 7
(All + VAT but incl. postage)	
Send for details - state model.	



MICROCASE "turns a board into a real computer"
 NASCOM 1 & 2
 COMPUKIT
 SUPERBOARD
 ALSO UNCUT KEYBOARD MODEL
 Direct from us or from your dealer - but make sure you see a GENUINE MICROCASE - About £30

Simple Software Ltd
 15 Havelock Road
 Brighton Sussex BN1 6GL
 (0273) 504879



UK101

NASCOM 1 & 2

ADD-ON COLOUR SYSTEM



DAZZLING COLOUR GRAPHICS FOR UK101 & NASCOM

- Professional bit-addressable 'pixel' system
- 3072 colour cell definition
- 8 Colours foreground + 8 background
- FREE SOFTWARE: Plot, Line, Circle (Basic & Z80)
- Animated Demonstration Program
- Modulator Included for use with normal TV

KIT: only **£45** Built & Tested: only **£60**

Also available separately:

COLOUR MODULATOR

- R G B inputs, PAL/UFH output
- Unlimited colour combinations
- TTL etc interface details supplied
- 1000's already in use!

KIT: only **£12** Built & Tested: only **£18**

- please add VAT at 15% to all prices
 - Barclay/Access orders accepted by telephone

WILLIAM STUART SYSTEMS Ltd

Down House, Billerway Road, Broomfield, Broomfield, Essex, CM13 3SD
 Telephone Broomfield (0277) 810244

GAMES FOR YOU AND YOUR

- STARFIGHTER** - Watch out Buck Rodgers!
- LUNAR LANDER** - More difficult than it looks.
- SEA BATTLE** - Makes sinking the British look easy.
 On cassette £3.00 each or 3 for £7.50
 Program listings £1.50 each.
- ONE ARM BANDIT** - A few cans of beer and you would never have known you had left the pub.
- FUNCTION PLOTTER** - Plots almost any mathematical function, great help with the homework.
 On cassette £2.00 each both for £3.25.
 Program listings £1.00 each.
 Full instructions supplied with each other.
 Programs suitable for 8K PET and above.
 Prices inclusive VAT, P&P, Cheque/P.O.
 to GRAD.80 Systems, Hartfield Farm, Frensham Lane, Headley, Hants.

PROGRAMS

- MIES WHO WILL DECEIVE. MATERIAL HAPPINESS. CONTENTMENT THROUGH GOOD MARRIAGE. 770 DATACHANGE OF POSITION. RENEWAL AND REBIRTH. ASSURED SUCCESS VIA AVIAGE OR CHANGE OF PLACE. A TIME TO CONSIDER YOUR CAREER. CONSOLIDATION.
- 780 DATAPERFECT CONTENTMENT. ALSO FINANCIAL REWARD. A TIME FOR GAITY AND RECREATION. PERHAPS GOOD NEWS. CRAFTSMANSHIP AND THE NEED TO USE PRACTICAL GIFTS. GIFT OR LEGACY. THE ACQUISITION OF NEW POSSESSIONS.
- 790 DATAMATERIAL DIFFICULTIES BUT LOVE IS WELL LOOKED ON. GRATIFICATION THROUGH GIFTS OR OTHER PLEASURES. INGENUITY IN BUSINESS AND MONEY MATTERS. A CREATIVE PERIOD IN CRAFT OR BUSINESS.
- 800 DATAPRUDENCE. SAFETY AND ACCOMPLISHMENT FROM THIS. GAIN IN MONETARY OR FAMILY MATTERS. A TIME FOR SCHOLARSHIP OR REFLECTION. LOOK TO YOUR AFFAIRS. THE EFFECT OF SOMEONE WITH YOUR AFFAIRS AT HEART.
- 810 DATATHE EFFECTS OF AN OPULENT THOUGH GENEROUS WOMAN. SECURITY. INTELLECT AND PARTICULARLY MATHEMATICS. LOOK TO BUSINESS.
- 820 DATAGREAT FORCE IN LOVE OR HATE. TRIUMPH THROUGH THIS. CONFORMITY AND THE STABILITY THIS MAY BRING. A FEELING OF LOSS OF SOMEONE OR SOMETHING. THE NEED FOR SOLITUDE. A TIME FOR CONTEMPLATION.
- 830 DATALOSS OR DESTRUCTION OF SOMETHING CLOSE TO YOU. A JOURNEY WHICH MAY INCLUDE TRAVEL BY OR OVER WATER. ANNOYANCE AT THE FAILURE OF A PLAN THROUGH DISAGREEMENT. BAD NEWS OF AN ILLNESS OR OTHER CRISIS.
- 840 DATADEEP DISAPPOINTMENT POSSIBLY THROUGH DEATH. PAIN AND SADNESS. ALL IS NOT WELL. EXAMINATION. THE ABILITY TO STUDY DETAILS NORMALLY MISSED. SKILL AND BRAVERY. THE TIME TO USE SUCH VIRTUES.
- 850 DATASADNESS OR EMBARRASSMENT FOR YOU (IF FEMALE) OR A WOMAN CLOSE TO YOU. THE EFFECTS OF ONE WITH AUTHORITY TO MAKE DECISIONS.
- 860 DATACONTENTMENT WITH ALL RELATIONSHIPS. LOVE AND PASSION. THE INTER-RELATION OF THE SEXES. A HAPPY CONCLUSION. MERRIMENT AND FULFILLMENT. TIREDNESS AND IMAGINARY WORRIES CAUSED BY A STRICT ROUTINE.
- 870 DATARECEIPT OF A GIFT. THIS RESULTS IN ANOTHER LOSS. REFLECTIONS ON THE PAST AND CHILDHOOD. IMAGINATION. A GOOD TIME FOR CREATIVE WORK THOUGH TRANSITORY. DEJECTION OVER THINGS AS THEY ARE. THIS WILL PASS.
- 880 DATAA VICTORY IN SOMETHING YOU DESIRE. CONTENTMENT WITH YOUR PRESENT SURROUNDINGS AND THINGS AS THEY ARE. THE EFFECTS OF A FAIR AND STUDIOUS YOUNG MAN. HE MAY HELP YOU. A PROPOSITION OR INVITATION.
- 890 DATATHE EFFECTS OF A FAIR WOMAN. SHE IS DREAMY BUT VISIONARY. "THE EFFECTS OF A CREATIVE MAN IN BUSINESS, LAW OR THE CHURCH."
- 900 DATATHE BEGINNING OF NEW THINGS - CREATION. POSSIBLY A BIRTH. PHYSICAL SUFFERING OR SADNESS. DISSATISFACTION WITH POSSESSIONS. STRENGTH IN TRADE AND DEALINGS WITH PEOPLE. A HAPPY LIFE. PEACE AND PROSPERITY.
- 910 DATALIMITATION OR SHAM. A SUPERFICIAL VIEW. SUCCESS IN UNDERTAKINGS OR GREAT NEWS. A NEED TO WORK BY DISCUSSION AND NEGOTIATION. FINAL SUCCESS. HASTE TOWARDS A FAVORABLE OUTCOME. CHANGE.
- 920 DATADelay CAUSED BY OPPOSITION TO YOUR IDEAS. FINANCIAL GAIN BUT OPPOSITION IN LAW. THE INFLUENCE OF A DARK YOUNG MAN. HE MAY BRING NEWS. DEPARTURE OR ABSENCE. A MOVE OR EMIGRATION.
- 930 DATATHE INFLUENCE OF A COUNTRY WOMAN WHO IS LOVING AND HONOURABLE. THE INFLUENCE OF A FRIENDLY COUNTRYMAN WHO IS HONEST AND CONSCIENTIOUS.
- 940 DATADISQUIET & A FEELING THAT ALL IS NOT RIGHT. THE PHYSICAL SIDE OF LOVE. PASSION. A VERY STRONG CARD. LIGHT AND TRUTH IN MATTERS. COMPLEX PROBLEMS REVEALED. BENEVOLENCE OF OTHERS TOWARDS YOU.
- 950 DATAN INCREASE IN YOUR UNDERSTANDING OF SOCIETY. CERTAIN PROJECTS MAY BE FOOLISHLY THOUGHT OUT. A DISPUTE. POSSIBLE LITIGATION. A TENDENCY TO BIAS. WATCH AGAINST BIGOTRY.
- 960 DATAN OVERCAUTIOUS ATTITUDE. THINK THINGS OUT - THEN ACT. ABUNDANCE OF THE GOOD THINGS IN LIFE. ENJOY THEM. AN ABUSE OF POWER THROUGH WEAKNESS. OBSTRUCTION THROUGH SELFISHNESS. TAKE HEED.
- 970 DATARELIGIOUS INACTION. COULD CAUSE PROBLEMS. CONNECTIONS WITH THE CHURCH OR RELIGION LOOK WELL. BLINDNESS TO WHAT IS RIGHT. PETTINESS. PROBLEMS CAUSED BY ARGUMENT OR DISAGREEMENT.
- 980 DATAA TENDENCY TO ARRANGANCE WHICH MAY CAUSE ALIENATION. INSTABILITY AND INCONSTANCY OF THOSE ABOUT YOU. CONTENTMENT ON MATERIAL AND SPIRITUAL PLANES.
- 990 DATAWEAKNESS THROUGH AN OVERSIMPLIFICATION OF EVENTS. INERTIA OR FIATY MAY CAUSE STAGNATION. FOLLY THROUGH EXTRA VAGANCE OR PLEASURE-SEEKING.
- 1000 DATABAD INTELLIGENCE. THE EVIL SIDE OF WEALTH. A FACADE OF ENJOYMENT TO KEEP OTHERS HAPPY. MEDIOCRITY IN WORK. A TENDENCY TO PETTINESS. DELAY TO SOME PROJECT DUE TO OTHERS' OPPOSITION.
- 1010 DATADISORDER OR CHAOS. IT MAY SPELL RUIN FOR SOME PROJECT. ENVY AND JEALOUSY WHICH LEAD TO ILLUSORY DESIRES. QUARRELS OVER MONEY OR POSSESSIONS. A TENDENCY TO VANITY. THIS MAY STAND AGAINST AMBITION.
- 1020 DATADECEPTION. BEWARE OF OTHERS KEEPING BAD FAITH. MONETARY LOSS THROUGH GAMBLING OR ROBBERY. TAKE NO CHANCES. UNFAVOURABLE NEWS CAUSING WORRY. IDLENESS AND LACK OF ENERGY. STAGNATION.
- 1030 DATASUSPICION AND MISTRUST MAY EFFECT YOUR REASONING. THE TEMPTATION OF VICE. WATCH FOR WEAKNESS.
- 1040 DATAGREAT FORCE IN LOVE OR HATE. NOT TO THE GOOD. LIES AND DISLOYALTY. BEWARE UNTRUTHS. CONFUSION AND A FEELING OF INTELLECTUAL ISOLATION. PRECAUTION. BE CAREFUL WHAT YOU DO.
- 1050 DATALOSS OR DESTRUCTION OF SOMETHING CLOSE TO YOU. A PROPOSAL OF LOVE OR HER DECLARATION. PUBLICITY. GOOD ADVICE FROM A WISE PERSON. TAKE HEED. DIFFICULTIES AND OPPOSITION. TREACHERY.
- 1060 DATASUSPICION CAST ON YOUR A FEELING OF SHAME. TRANSITORY PROFIT OR ADVANTAGE. MAKE HAY... THE USE OF OBSERVATION TO BAD ENDS. SPYING. FOOLISHNESS. THE INABILITY TO THINK SOUNDLY.
- 1070 DATAA CLOSED MIND. WATCH AGAINST BIGOTRY OR DECEIT. A TENDENCY TO CRUELTY OR PERVERSITY. WATCH THIS.
- 1080 DATADISCONTENT. THE DESIRE TO PUT RIGHT YOUR PROBLEMS. LOVE AND PASSION. THE INTER-RELATION OF THE SEXES. A NEW VENTURE OR HOLIDAY. ACHIEVEMENT FROM THIS. NEW RELATIONSHIPS AND DELIGHT IN NOVELTY.
- 1090 DATATHE CHANGE OF NEW ALLIANCES. BUSINESS LOOKS WELL. THE CHANGE OF FRESH EXCITEMENTS. RENEWAL. A DESIRE TO SUCCEED. YOUR FORCE OF WILL. GREAT JOY AND HAPPINESS. A CELEBRATION.
- 1100 DATALYALTY OF OTHERS TO YOU. HONESTY AND GOOD ADVICE. INDIGNATION AT AN AFFRONT IN LOVE. A VIOLENT RESPONSE. A TASTE FOR RISK COULD LEAD TO DECEPTION. A TRICK OR FRAUD. BE ON YOUR GUARD.
- 1110 DATATHE INFLUENCE OF A DISTINGUISHED WOMAN. DON'T TRUST HER. THE EFFECT OF A ROGUE OR SCANDAL-MONGER. HE IS DISHONEST.
- 1120 DATAA FALL IN FORTUNE. RUIN OF SOMETHING ESTABLISHED. SURPRISE AND WONDER LEADING TO DISQUIET. THE END OF TROUBLES. ADVERSITY IS OVER. PROSPERITY AND INCREASE. AN APPRECIATION OF BEAUTY.
- 1130 DATA CONTRADICTION AND THE TENDENCY OF OTHERS TO TRICK YOU. APPREHENSION AND THE FEAR OF DEFEAT. PERPLEXITY. EMBARRASMENTS AND WORRIES. QUARRELS ARISING FROM JEALOUSY OR ENVY.
- 1140 DATA OBSTACLES TO YOUR IDEAS. POSSIBLE CALAMITY. DIFFICULTIES AND THE INTERREGUE OF OTHERS AGAINST YOU. BAD NEWS OR ANNOUNCEMENTS. INDECISION. DISCORD. INTERRUPTION OF THE PRESENT STATUS QUO.
- 1150 DATAPROBLEMS OF JEALOUSY - DECEIT OR INFIDELITY. "THE INFLUENCE OF A GOOD BUT SEVERE MAN. HE IS AUSTERE, YET TOLERANT."

Listing courtesy London Computer Centre

PET Rebound

by Angus Watkinson

This version of the board game runs on a new ROM, 8k PET.

```

4 GOSUB1500
5 PRINT "O": T1=0: T2=0
6 P=INT(2*RND(1))+1: V2=0: F1=0: F2=0: TV=0: TH=0
10 O$="XXXXXXXXXXXXXXXXXXXXXXXXXXXXXXXXXXXXXXXXXXXXXXXXXXXX"
12 F$="XXXXXXXXXXXXXXXXXXXXXXXXXXXXXXXXXXXXXXXXXXXXXXXXXXXX"
    
```

PROGRAMS

```

15 PRINT"JN REBOUND ■"
20 PRINT"
30 PRINT"1"
40 PRINT"2"
50 PRINT"3"
60 PRINT"4"
70 PRINT"5"
80 PRINT"
85 PRINT"
90 PRINT"
100 PRINT"
110 PRINT"
120 PRINT"
130 PRINT"
140 PRINT"
150 PRINT" | | | | |
160 PRINT"0 100 80 60 40
162 P0(1)=33391:P0(2)=33393:P0(3)=33432:P0(4)=33471:P0(5)=33473
165 FORN=1T05:POKEP0(N),81:NEXT
167 FORN=1T05:POKEP0(N)+6,87:NEXT
170 PRINT"*****PLAYER 1'S SCORE:P1:*****TOTAL":T1
172 PRINT"*****PLAYER 2'S SCORE:P2:*****TOTAL":T2
190 FORQ=1T010
200 PRINT"*****PLAYER 1'S P:*****ROW ?":
234 IFF=1THENR=81:TH=TH+1:GOTO236
235 TY=TY+1:R=87
236 POKE158,0:D=0:H=0
240 GETA$:IFA$=""THEN240
242 IFVAL(A$)=V2THEN240
250 S=VAL(A$):IFS>50RS<1THEN240
257 V2=S
258 IFR=81THENPOKEP0(TH),209:GOTO260
259 POKEP0(TY)+6,215
260 PRINTS:C=0:F=32810
270 D=S*40:D=D+F:POKED,R
280 PRINT"*****PRESS THE '='S KEY"
288 Y=PEEK(155)-255:IFY=0THEN268
300 PRINT"*****"
310 Y=PEEK(155)-255
314 IFY=-128THENC=C+1:GOTO310
315 IFC=0THENG=0:GOTO400
320 IFY=0THENC=INT(C/3):G=1
321 H=H+1:J=1
323 IFPEEK(D+G)=102THENH=C:POKED,32:POKED+G,81:POKED+G,102:GOTO335
324 IFPEEK(D+G)=81THENR=81:C=INT(C/4):H=0:GOTO334
325 IFPEEK(D+G)=87THENR=87:C=INT(C/4):H=0:GOTO334
327 IFPEEK(D+G)=77THENG=40:GOTO324
328 IFPEEK(D+J)=78THENG=-1:J=0:GOTO324
329 IFPEEK(D)=77THENG=40:GOTO334
330 IFPEEK(D)=78THENG=-1:GOTO334
333 POKED,32:POKEI+G,R
334 IFPEEK(D)=102THENPOKED+2,R:POKED,102
335 D=D+G
337 IFH<0THEN321
405 IFF=2THENP=0
410 P=P+1:POKE33551,32:C=0:H=0
420 X=0:J=33128:B=100:P1=0:P2=0
430 FORN=1T016
440 H=J+H
445 X=X+1
450 FORM=1T05
460 IFPEEK(H)=81THENP1=P1+B:GOTO500
470 IFPEEK(H)=87THENP2=P2+B:GOTO500
500 H=H+40
510 NEXTM
515 IFX=4THENX=0:B=B-20
520 NEXTH
530 GOSUB1040
540 NEXT
550 T1=T1+P1:T2=T2+P2:GOSUB1040
560 PRINT"*****":FORN=1T01000:NEXT
570 PRINT"*****CARRY ON ? ■":
580 GETA$:IFA$=""THENS80
590 IFA$="Y"THENG
600 IFA$="N"THEN620
610 GOTO580
620 PRINT"J"
630 IFT1>T2THENPRINT"*****PLAYER 1 BEAT PLAYER 2":END
640 IFT1=T2THENPRINT"*****PLAYER 1 DREW WITH PLAYER 2":END
650 PRINT"*****PLAYER 2 BEAT PLAYER 1":END
1040 PRINTQ$P1;"|";R$T1
1050 PRINTQ$P2;"|";R$T2
1060 RETURN
1500 PRINT"JN REBOUND ■"
1510 PRINT"*****PROGRAMMED BY MR.WATKINSON"
1520 PRINT"*****"
1530 PRINT"*****FOR AN 8K PET"
1540 PRINT"*****TAKING UP 3492 BYTES"
1570 FORN=1T04000:NEXT
1600 PRINT"JN INSTRUCTIONS ■"
1610 PRINT"*****THIS IS A GAME FOR TWO PLAYERS."
1620 PRINT"*****THEY EACH HAVE FIVE SHAPES-"
1630 PRINT"*****PLAYER '1' HAS THE 'O' SHAPES."
1640 PRINT"*****PLAYER '2' HAS THE 'O' SHAPES."
1650 PRINT"*****THE PET WILL ASK A PLAYER FOR THE "
1660 PRINT"*****ROW IN WHICH ONE SHAPE IS TO BE PLACED."
1670 PRINT"*****THEN, YOU PRESS THE '='S KEY AND"
1680 PRINT"*****YOU'LL BE TIMED FOR HOW LONG YOU HOLD"
1690 PRINT"*****IT DOWN .THE SHAPE WILL THEN"
1700 PRINT"*****MOVE THAT DISTANCE."
1710 PRINT"***** PRESS ANY KEY TO CONTINUE ■"

```

MICROMART

topmark

computers

NEW! NEW! NEW!



APPLE FORTRAN
(Needs language card)

Send only £120 + VAT £18 (Fortran only)
or £419 + VAT £62.85 (complete
system, includes Pascal and language card)

NEW! NEW! NEW!

NEW! DOS 3.3 - much improved
capacity £40 + VAT £6.

NEW! Eurocolour card - vastly
superior to previous versions £113 + VAT
£16.95

Official Government and Educational
orders accepted.

Contact Tom Piercy at
Topmark Computers, 77 Wilkinson Close,
Eaton Socon, St Neots, Cambs. PE19 3HJ
Huntingdon (0480) 212563

VETS FOR PETS

Anita Electronic Services (London) Ltd.
are specialists in the repair and service of
Commodore Pets.

We offer a fast on-site service, or alter-
natively repairs can be carried out at our
workshops should you wish to bring in
your Pet.

Pet maintenance contracts are available
at very competitive prices. Trade inquiries
welcomed.

For further information, tel or write to:

John Meade
Anita Electronic Services
15 Clerkenwell Close, London EC1
01-253 2444

We also specialise in the repair of all
makes of office equipment.

OSI/UK User Group

Support for

OHIO SCIENTIFIC

the independent user group
for all users of Ohio Scientific
small computers (Superboard C3)
and UK101

professionally-produced
A5-format bi-monthly Newsletter
development and documentation
programming and planning aids
and much more!

£10.00
for six-issue membership/subscription

contact: George Chkiantz
12 Bennerley Road, London SW11 6DS

PROGRAMS

```
10110 PRINT"BSIf you fall into the swamp,you"
10120 PRINT"BSshould look out for the ALLIGATORS !!!"
10130 PRINT"BPPress any key to Start"
10140 GET Z$:IF Z$="" THEN 10140
10150 PRINT"BS": RETURN
```

Listing courtesy Sharp Electronics

PET Connect

by T Bell (YCW)

```
100 PRINT"IN THE GAME OF CONNECT 4":PRINT"
110 REM *****CONNECT 4*****
120 REM *PROGRAMMED BY T.BELL*
130 REM *****CONNECT 4*****
140 PRINT:PRINT"DO YOU WANT INSTRUCTIONS (Y/N)? ":GOSUB620
150 IFA$<"Y"&ANDAS$<"N"&THEN140
160 PRINTAS$:IFA$<"Y"&THEN230
170 PRINT"IN THE OBJECT OF THE GAME IS TO GET A ROW"
180 PRINT"IN ANY DIRECTION OF FOUR PIECES."
190 PRINT"WHEN ASKED 'MOVE FOR ',TYPE THE COLUMN "
200 PRINT"INTO WHICH YOU WANT TO PLACE YOUR PIECE."
210 PRINT"THE PIECE WILL DROP TO THE BOTTOM OF "
220 PRINT"THE COLUMN."
230 FORI=1TO2:PRINT"NAME OF PLAYER "I"<">:CHR$(203+6*I)"? ":
240 GOSUB620:IFA$="M"&ORAS$="N"&ORAS$="T"&ORAS$="B"&ORAS$="R"&THEN240
250 IFA$<CHR$(13)&ANDAS$<CHR$(20)&THENPRINTAS$:AS$(I)=AS$(I)+I:GOTO240
260 IFA$<CHR$(20)&ANDLEN(AS$(I))>0THENAS$(I)=LEFT$(AS$(I),LEN(AS$(I))-1):PRINTAS$:
270 IFA$C(AS$)=200RLEN(AS$(I))=0THEN240
280 PRINT" ":NEXT:C(1)=81:C(2)=87:PRINT"JUNK":FORI=1TO7:POKE32852+4*I,I:NEXT
290 AS$="
300 BS$="
310 DS$="
320 CS$="
330 T=2:FORI=1TO9:IFI=1THENPRINTAS$:PRINTDS$:NEXT
340 IFI=9THENPRINTBS$:NEXT:GOTO360
350 PRINTCS$:PRINTDS$:NEXT
360 C=C+1:T=3-T:POKE32887,C(T):IFC>56GOTO540
370 PRINT"MOVE FOR "AS$(T)"
380 IFA$C(ORB)>8THEN370
390 IFA$(B)>7THEN370
400 PRINTAS$:A(B)=A(B)+1:B(A(B),B)=C(T):GOSUB650:POKE32887,32
410 E=0:FORI=B-3TOB+3:IFI<1ORI>8THENE=0:GOTO440
420 IFA$(B,I)>C(T)THENE=0:GOTO440
430 E(E,1)=A(B):E(E,2)=I:E=E+1:IFE>3GOTO560
440 NEXT:E=0:FORI=A(B)-3TOA(B)+3:IFI<1ORI>8THENE=0:GOTO470
450 IFA$(I,B)>C(T)THENE=0:GOTO470
460 E(E,1)=I:E(E,2)=B:E=E+1:IFE>3GOTO560
470 NEXT:E=0:J=B-4:FORI=A(B)-3TOA(B)+3:J=J+1:IFI<1ORJ>8ORJ>8GOTO580
480 IFA$(I,J)>C(T)THENE=0:GOTO580
490 E(E,1)=I:E(E,2)=J:E=E+1:IFE>3GOTO560
500 NEXTI:E=0:J=B+4:FORI=A(B)-3TOA(B)+3:J=J-1:IFJ<1ORJ>8ORJ<1ORJ>8GOTO530
510 IFA$(I,J)>C(T)THENE=0:GOTO530
520 E(E,1)=I:E(E,2)=J:E=E+1:IFE>3GOTO560
530 NEXTI:E=0:FORI=1TO10:GETAS$:NEXT:GOTO360
540 PRINT"IS A DRAW!":GOSUB610:RUN
550 PRINT"NON!":GOSUB610:RUN
560 J=0
570 J=J+1:FORI=0TO3:POKE33572-E(I,1)*80+E(I,2)*4,C(T)+128:NEXT
580 FORK=1TO50:NEXT
590 FORI=0TO3:POKE33572-E(I,1)*80+E(I,2)*4,C(T):NEXT:IFJ>190GOTO550
600 FORK=1TO50:NEXT:GOTO570
610 FORI=1TO1000:NEXT:RETURN
620 PRINT"FORK=1TO110:GETAS$:IFA$<"&THENRETURN
630 NEXT:PRINT"FORK=1TO110:GETAS$:IFA$<"&THENRETURN
640 NEXT:GOTO620
650 FORI=0TOA(B)STEP-1:IFI<8THENPOKE33492-80*I+4*B,32
660 POKE33572-80*I+4*B,C(T):FORK=1TO10:NEXTK,I:RETURN
```

Listing courtesy Euro-Calc

UK 101 Minefield

by Deric Ellerby

The program draws a map on which 20 mines are hidden. You have to move from the South West corner to your base in the North East. To help you, you have a mine detector which

looks at all eight squares around you but be warned — the detector 'fails' after 20 moves and then you're on your own!

```
10 DIMA(11,11):M=181:C=187:T=11:V=29:IN=57088:TR=53400
20 E=0:F1=128:F2=135:F3=147:POKE530,1:GOSUB980
30 INPUT"Instructions needed";H$:IFLEFT$(H$,1)>"N"&THEN700
40 INPUT"Are you an expert";H$:IFLEFT$(H$,1)=""&THEN1
50 GS=INT(RND(T)*4+1):GOSUB980
60 H$="MINEFIELD - by Deric Ellerby.":FORA=1TOLEN(H$)
70 POKE53333+A.ASC(MID$(H$,A,1)):NEXT
75 REM*****MNF
80 FORI=2TO32:POKETR+I,F1:POKETR+I+704,F2:NEXT
90 FORI=65TO704STEP64:POKETR+I,F3:POKETR+I+31,F3:NEXT
100 POKETR+122,46:POKETR+C-1,29:POKETR+C,92:POKETR+C+1,F1
110 POKE54043,29:POKE53494,15:POKE53775,85:POKE53777,68
120 POKE53779,76:POKE53781,82:POKE53783,63
125 REM*****MINES
130 FORH=1TO20:A=RND(V)
140 J=INT(RND(T)*10+1):K=INT(RND(M)*10+1)
150 IFA(J,K)>0THEN140
160 IFJ=10ANDK=1THEN140
170 IFJ=10ANDK=2THEN140
```

MICROMART

UK101 and SUPERBOARD SOFTWARE

The top ten from the guy who wrote "LE PASSE-TEMPS"

1. GALACTIC HITCHHIKER (8k) An Adventure, all in Machine Code, A' beauty!
 2. STARTREK (8k) The old favourite but no scrolling! All the info. on display all the time.
 3. SUPERTREK (8k) A graphics version. Sail boldly through the universe, zapping moving Klingons in real time.
 4. PIRANHA* A fun, real time graphics game.
 5. BREAKOUT* A smashing version with machine-code to move the paddle.
 6. STUD POKER (8k) You against the mean machine.
 7. LUNAR LANDER A real challenge. You won't get down in less than 3 hours.
 8. STOCKMARKET (8k) A realistic simulation for would-be millionaires.
 9. LE PASSE-TEMPS* You need this one, if you haven't got it.
 10. HANGMAN* Excellent graphics (P.E. said so!). Others available include a BASIC TUTOR @ £10. (comprises 8x4k programs.) and lots more games. Note that these are ORIGINAL PROGRAMS, NOT 101 VERSIONS of PRINT!
- PRICES: 8k £4, 4k £2 all inclusive from: Mr A Knight, 28 Simonside Walk, Ormesby, Cleveland. Phone (0642) 321266

LOOK!

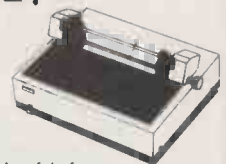

The latest version of the famous
EPSON TX-80
The TOPPER with GRAFTRAX

This unique option from DATAPLUS gives the TX-80 a FULL HI-DEF GRAPHICS capability. When the bit plot mode is invoked, each bit arriving via the parallel interface individually controls one of the 7 print head needles.

Additional facilities include software control of line feeds in .007" increments, and many others.

You have NEVER been offered a better deal than this.

TX-80 with parallel interface -- £355 + VAT
GRAFTRAX option -- £ 40. + VAT
Apple, PET, Sharp, Tandy
RS.232 Interfaces -- £ 40. + VAT
Cash or Credit Cards accepted

DATAPLUS LTD
39.49 Roman Road, Cottenham.
0242-30030 or 37373

PET HIRE OR BUY

Southampton

Weekly charges

- 8K large keyboard £23, 16K £26, 32K £30
- £5 surcharge for Xmas week
- Tractor Printer £30, Floppy Disk Unit £30
- Manuals, Tutorials, Games etc, Included
- 2 weeks max hire charge refunded on purchase
- All Commodore Models stocked
- 8KS (small keyboard, integral cassette) £425
- 8KN (large keyboard, no cassette) £450
- £50 free software with above
- 16K from £475, 32K from £575, Printers £405
- Floppy Disk Unit £675, C2N Cassette Deck £55
- Some ex-hire machines also available
- TENSAI Cassette Deck with counter and CB2 sound (Invaders etc) £70 inc all connectors
- TOOLKIT £45 or £35 with purchase of PET
- High quality beige plastic dustcovers for PET, 3022 Tractor Printer, 3040 Disk Unit £4 (including VAT and p&p)

Sundry items, books, software etc stocked
All prices exclude VAT
Official Commodore Dealer

SUPER-VISION

13 St James Road, Shirley, Southampton
Telephone (0703) 774023
After hours (0703) 654488

To advertise in
MICROMART
Please ring Jacquie Hancock
on 01-631 1682

MICROMART

EPROMPT ERASER



- CLEARS UP TO 32 CHIPS IN 30 MINS ON 200-250 V.A.C.
- CONTINUOUS 253 NM BEAM, SAFE & SIMPLE, GUARANTEED
- £39 C.W.O. £40 C.O.D. • P&P+VAT INCLUSIVE!
- TRADE ENQUIRIES INVITED FOR SUBSTANTIAL DISCOUNTS
- ALL ORDERS AND ENQUIRIES POST-FREE TO

TEX MICROSYSTEMS LTD.

ST. ALBANS, HERTS, AL1 1BR
TRING 4797/ST. ALBANS 64077 ANYTIME

6800

Software at reasonable prices ... ones you can afford!!!
We can offer refurbished systems or SS50 boards with a warranty to boot and at vastly reduced prices. This could be your chance to enhance your system, or to cash in on your surplus equipment.

Interested? then contact:—
COMPUSENSE LTD.
P.O. Box 169

London N13 4HT tel. 01-882 0681
P.S. We have a home for old pets or rotten apples too!!

SUPERBOARD II

STILL the best value in Home Computers. Just compare the features:

- * 8K floating point BASIC in ROM
- * Full ASC11 keyboard
- * Standard cassette/TV interface
- * RS232 printer interface
- * 4K user RAM
- * Expandable to 32K and dual mini-floppy
- * Full range of OHIO Computers carried.

AVAILABLE NOW FROM:

C.T.S.,
31/33 Church Street
Littleborough
Lancs OL15 8DA

PLEASE RING OR WRITE FOR LATEST PRICES.

TEL: LITTLEBOROUGH (0706) 74342 or 79332 ANYTIME

NEW MICROSHOP NOW OPEN

COMMODORE PET

Supérpet, Printers, Wordpro, Compu-think, Mupet, Petsoft.

TRS80

Models I and II Harding + Tridata Software.

APPLE

See VISICALC and CASHIER demonstrated.

COMPUTER SUPPLIES
82 GOWER RD, SKETTY
TEL: SWANSEA 290047

PROGRAMS

```

180 IFJ=9ANDK=1THEN140
190 IFJ=1ANDK=10THEN140
200 IFJ=1ANDK=9THEN140
210 IFJ=2ANDK=10THEN140
220 A(J,K)=N:IFA>.5THENA(J,K)=C:GOSUB960
230 IFA(J,K)=CTHENPOKEF-1,C-1:POKEF,C:POKEF+1,C-2
240 NEXTJ:J=1:K=10
245 REM*****MINE DETECTOR
250 N1=0:G1=0:G=53443+64*K:IFN>20THENPOKETR+190,N:GOTO300
260 FORJ=J-1TOJ+1:IFJ<1THENJ1=1
270 FORK1=K-1TOK+1:IFK1<1THENK1=1
280 IFA(J1,K1)=MTHENM1=M1+1
290 NEXTK1,J1:POKETR+190,M1+48
295 REM*****KEY IN
300 POKEIN,239:G1=G1+1:IFPEEK(IN)=223THEN380
310 IFPEEK(IN)=251THEN410
320 POKEIN,223:IFPEEK(IN)=191THEN440
330 POKEIN,247:IFPEEK(IN)=191THEN470
340 IFEK1ORINT(G1/G5)<>G1/G5THEN300
345 REM*****GUN
350 G=G-1:G2=PEEK(G):POKEG,22:FORA=1TO60:NEXT:POKEG,G2
360 IFPEEK(G-1)=VTHENL=2:GOTO530
370 GOTO300
375 REM*****RIGHT
380 J=J+1:IFJ<=10ANDK(J,K)<>CTHEN400
390 J=J-1:GOTO300
400 POKETR+3*(J-1)+64*K,T:GOTO500
405 REM*****UP
410 K=K-1:IFK>=1ANDK(J,K)<>CTHEN430
420 K=K+1:GOTO300
430 POKETR+3*J+64*(K+1),T:GOTO500
435 REM*****LEFT
440 J=J-1:IFJ>=1ANDK(J,K)<>CTHEN460
450 J=J+1:GOTO300
460 POKETR+3*(J+1)+64*K,T:GOTO500
465 REM*****DOWN
470 K=K+1:IFK<=10ANDK(J,K)<>CTHEN490
480 K=K-1:GOTO300
490 POKETR+3*J+64*(K-1),T
500 IFA(J,K)=MTHENL=INT(RND(T)*4+3):GOTO530
510 IFJ=10ANDK=1THENL=1:GOTO530
520 POKETR+3*J+64*K,V:N=N+1:GOTO250
530 ONLGO540,570,590,590,600,610
540 FORA=1TO10:POKE53494,161:GOSUB970
550 POKE53494,15:GOSUB970
560 NEXT:H$="SAFE IN YOUR BASE!...well done!":GOTO650
570 H$="Missile strike!...you're wiped out!":GOTO620
580 H$="BOOM!!! YOU'RE DEAD!!!":GOTO620
590 H$="WHAT HEAVY FEET YOU HAD!!!":GOTO620
600 H$="GOODBYE, DAISY PUSHER!!!":GOTO620
610 H$="IT'S NOT YOUR LUCKY DAY!!!"
620 GOSUB960
630 FORA=1TOS:POKEF,15+A:GOSUB970
640 NEXT:POKEF,219
650 FORA=1TOLEN(H$):POKE54160+A,ASC(MID$(H$,A,1)):NEXT
660 FORJ=1TO10:FORK=1TO10:IFA(J,K)<>MTHEN690
670 GOSUB960
680 IFPEEK(F)<>219THENPOKEF,M
690 NEXTK,J:END
700 PRINT:PRINT"YOUR MISSION - to cross a dangerous minefield!!"
710 PRINT:PRINT"You are symbol ";CHR$(V);" and your objective ";
720 PRINTCHR$(15);" . Avoid"
730 PRINT"the flooded craters ";CHR$(C-1);CHR$(C);CHR$(C-2);
740 PRINT" where previous"
750 PRINT"contestants perished. Your mine detector ";
760 PRINTCHR$(92);CHR$(F1)
770 PRINT"will tell you how many mines are immediately"
780 PRINT"around you, but cannot indicate direction."
790 PRINT"Also its batteries do not last forever!!"
800 PRINT"You may move UP, DOWN, LEFT or RIGHT by keys"
810 PRINT"U, D, L or R."
820 PRINT:PRINT" ....Good luck!!":PRINT
830 PRINT:INPUT" Ready";H$:IFLEFT$(H$,1)<>"V"THEN830
840 GOSUB980
850 GOTO40
960 F=TR+3*J+64*K:RETURN
970 FORX=1TO60:NEXT:RETURN
980 FORA=1TO16:PRINT:NEXT:RETURN
    
```

PET Cat and mouse

by Richard Warner

This program is written for new ROM PETs but can easily be converted for old ROMs — see line 121.

```

100 F=RND(-TI):PC=0:MC=0:D=0:M=0:T=0:S=0
110 SP=32:SS=96:WC=160
120 IN=166
121 REM FOR OLD ROM'S, IN=515
130 CC=102:C=81
140 TP=32768
150 C$="M"
160 DEFNFX(X)=TF+V#80+H#2
180 DIM(C),M(200)
190 GOSUB2000
200 GOSUB1000
210 PRINT"COUNTDOWN-5":TT=TI:D=5
    
```

PROGRAMS

```

220 IFTI-TT<60THEN220
230 PRINT"II";:IFD=0THEN250
240 D=D-1:POKETP+18,D+48:TT=TI:GOTO220
250 PRINTC$
260 T=0:M=0
300 IFTHENT=0:GOTO360
310 T=1:MC=MC-1:IFMC<0THENMC=3
320 D=PEEK(PC+T(MC))
330 IFD=SPORD=S1ORD=CTHEN360
340 IFMC<3THENMC=MC+1:GOTO320
350 MC=0:GOTO320
360 POKEPC,SP:PC=PC+T(MC):POKEFC,CC
370 IFP=PCTHEN700
400 FORF=1TOS:GOSUB500:NEXT
410 POKEP,SP:P=P+M:IFPEEK(P)=WCORP=BETHENP=P-M:M=0
420 IFP=PCTHEN700
430 POKEP,C
440 IFP<>H0THEN300
450 GOTO600
500 D=PEEK(IN)
510 IFD=255THENM=0:RETURN
520 IFD=18THENM=40:RETURN
530 IFD=42THENM=-1:RETURN
540 IFD=41THENM=1:RETURN
550 IFD=50THENM=-40:RETURN
560 RETURN
600 T(0)=1:T(2)=-1:T=0:S=1
610 FORF=0T029:NEXT:POKEP,32
620 IFPEEK(P+T(S))=WCTHEN660
630 IFP+T(S)=BETHEN660
640 IFT=3THENZ$="0":GOTO800
650 T=T+1:S=S+1:IFS=4THENS=0
660 P=P+T(T):POKEP,C:GOTO610
700 PRINT"0";TAB(HM);"YUM YUM"
710 FORF=0T0300:POKEP,C:POKEP,CC:NEXT
720 PRINTC$:PRINTTAB(HM);"BERP"
730 IFMT=1THENFORF=0T0799:NEXT:GOTO760
740 FORF=TPT033685:IFPEEK(F)=S1THENPOKEF,SP
750 NEXT
760 PRINTC$:Z$="0"
770 POKEPC,SP
800 FORF=0T09:GETT$:NEXT:PRINT"0";
810 N$=" NEW GAME? "
820 FORF=1T0LEN(N$)
830 PRINTMID$(N$,F,1);Z$;"II";
840 FORD=0T029:NEXT:NEXT
850 PRINT:PRINT"XXXXXXXXXXXXXXXXXXXXXXXXXXXX"
860 PRINT"< PRESS RETURN FOR NEW MAZE TYPE >"
870 PRINT"0";N$;
900 T=0
910 GETT$:IFT$<>" "THEN960
920 IFT=0THENPRINT" ";:GOTO940
930 PRINTZ$;
940 PRINT"II";:T=1-T
950 FORF=0T0199:NEXT:GOTO910
960 IFT$="N"THENPRINT"0":END
970 IFT$="CHR$(13)THENGOSUB2500:GOTO2000
980 IFT$="Y"THEN200
990 GOTO920
1000 REM DESIGN MAZE
1200 PRINT"0":FORF=0T02*VM
1210 PRINTLEFT$( " ",2*HM+3):NEXT
1211 REM 01234567890123456789012345678901234567
1220 H=INT(HM*VRND(1)+1):V=INT(VM*VRND(1)+1)
1230 P=FNP(X):M=0
1300 POKEP,S2:T=0
1310 IFPEEK(P-80)=WCTHENT(T)=-40:T=T+1
1320 IFPEEK(P-2)=WCTHENT(T)=-1:T=T+1
1330 IFPEEK(P+80)=WCTHENT(T)=40:T=T+1
1340 IFPEEK(P+2)=WCTHENT(T)=1:T=T+1
1350 IFT>1THEND=TCT*VRND(1)):M(M)=P:M=M+1:POKEP+D,S1:P=P+2*D:GOTO1300
1360 IFT=1THEND=T(0):POKEP+D,S1:P=P+2*D:GOTO1300
1400 IFM=0THEN1500
1410 M=M-1:P=M(M)
1420 IFPEEK(P-80)+PEEK(P-2)+PEEK(P+80)+PEEK(P+2)=ASTHEN1400
1440 GOTO1300
1500 V=INT(VM*VRND(1))+1:H=HM:HO=FNP(0)+1:POKEHO,SS
1510 V=INT(VM*VRND(1))+1:H=1:BE=FNP(0)-1:POKEBE,SS
1520 P=BE+1:POKEP,C
1530 PC=HO-1:POKEPC,CC:MC=INT(RND(1))*4
1540 T(0)=1+(RND(1)<.5)*2
1550 T(1)=40:T(3)=-40:T(2)=T(0)*-1
1599 RETURN
2000 PRINT"0" CAT AND MOUSE"
2010 PRINT"THE OBJECT OF THE GAME IS TO GET THE"
2020 PRINT"MOUSE OUT OF THE MAZE, WITHOUT BEING"
2030 PRINT"EATEN BY THE CAT."
2040 PRINT"WHAT MOVE THE MOUSE USE"
2050 PRINT" 4 - TO MOVE LEFT"
2060 PRINT" 6 - TO MOVE RIGHT"
2070 PRINT" 8 - TO MOVE UP"
2080 PRINT" 2 - TO MOVE DOWN"
2090 PRINT"KEEP YOUR FINGER ON THE KEY."
2100 PRINT"THE CAT IS SHOWN AS 'X'."
2110 PRINT"THE MOUSE IS SHOWN AS 'O'."
2200 PRINT"PLEASE PRESS ANY KEY TO CONTINUE"
2210 GETZ$:IFZ$=" "THEN2210
2500 PRINT"PLEASE SPECIFY TYPE OF MAZE:"
2510 PRINT" 1:ORDINARY"
2520 PRINT" 2:JAILBREAK"
2530 PRINT" 3:HAYFIELD"
2540 PRINT"MAZE TYPE";:T=3:GOSUB2900
2550 HT=T:ONHTGOTO2560,2570,2580
2560 S1=SP:S2=SP:GOTO2590
2570 S1=224:S2=SP:GOTO2590
2580 S1=224:S2=224:GOTO2590
2590 AS=4*S2
2600 PRINT"PLEASE SPECIFY SPEED:"

```

MICROMART

Surplus to Requirements.
New Unused Apple 48K
£780.00
Master Disc Drive
£365.00
Slave Disc
£305.00
Phone Charles Kennard
after 8pm on 01-883 0874

380Z SOFTWARE
 (Supplied on Cassette)
 Machine Language Programs:
DISSASSEMBLER — a fast reverse assembler for machine language programs. A must for program modification when listings are not available. £16. Also on disk.
WORD PROCESSOR — a powerful 4k program for writing and modifying text. Cassette storage of text, limited only by memory size. Printer output. £19. Also on disk.
COS 2 3 and COS 3 0 versions available
Basic Programs
CURSOR — gives good control of cursor for drawing diagrams in graphics mode. £5.
ROULETTE — the gambling game £5.
FOX INDUSTRIES
 (COMPUTER DIVISION)
DONCASTER AIRFIELD S. YORKS
 (0302 57695)

In our CHRISTMAS catalogue for the

ZX80

MASTERMIND* KALA* MORTGAGE
MORSE BATTLESHIPS TARGET
HANGMAN SPIDER TRIANGLES*
MATHS TEST* DIAR REGRESSION
 plus many more
 *Coupon worth £2.00 with these programmes, one only per order.
 *£2.75, all others £3.75
 Hints and Tips for the ZX80 £3.50
 Hewson Consultants 7 Grahame Close
 Blewbury Oxon OX11 9QE
 0235 850075

NEW Get your
Programs
up & running
FAST For **£3-10** inc.
 Only p&p
 Send now for the very latest easy to use, multi-rule/flowchart template—for the fast design of program/system logic diagrams. Complete with special 'Clearview' window to make Printout checking and reading fast and accurate every time! Built in dual rule, calibrated in both 1/10 of an inch and millimetres—absolutely invaluable!
 You'll wonder how you managed without one!
HURRY WHILEST STOCKS LAST!
 Send cheques/PO. now to:
 Executive Office Products
 Dept. No. A/1
 292 Hale Road, Hale Barns,
 Altrincham, Cheshire WA15 8ST.

MICROMART

The ZX80 Magic Box £4.75

Edition 2. 15 plus programs for 1-4K byte RAM machines, including Music, Othello, Animals, Moon Lander & Hex-pawn. Programming tips. Using USR. Hardware notes.
TIMEDATA Ltd. 57 Swallowdale, Basildon, Essex

ZX80

National ZX80 Users Club.

For free membership and a copy of the latest club magazine, send SAE to 44-46 Earls Court Road, LONDON W8 6EJ, UK.

To advertise in
MICROMART
Please ring Jacquie Hancock
on 01-631 1682

BIAS POWER SUPPLIES FOR SYSTEM EXPANSION TO 64K

BIAS 1 for general micro use
+5 @ 10 amps ±12v @ 2 amps
-5 @ 1 amp KIT £42.50

BIAS 3 for S100 systems
+8v @ 10amps
±18v @ 3.5amps KIT £40.20

Over Voltage Protection
- optional B1 - £12;

HEAVY ALLOY CASE
150 x 150 x 200
includes switches, connectors,
predrilled £12

Assembled & Guaranteed add £15

Mail order to:

ONUSTECH ENG LTD

474 CHISWICK HIGH RD
LONDON W4
01-995 0160

p&p £3.50
Prices excluding VAT.

PROGRAMS

```

2610 PRINT " 1 (SLOW) - 5 (FAST)"
2620 PRINT "SPEED"; T=5:GOSUB2900
2630 S=(5-T)*2+1
2700 PRINT "PLEASE SPECIFY MAZE SIZE:"
2710 PRINT " 1 (SMALL) - 3 (LARGE)"
2720 PRINT "MAZE SIZE"; T=3:GOSUB2900
2730 RESTORE:FORF=1TOT:READM1,VM:NEXT
2740 FORF=0T099:NEXT:RETURN
2800 DATA 10,7
2810 DATA 14,9
2820 DATA 18,11
2900 PRINT "? "; :FORF=0T09:GETZ$:NEXT:R=0:T$=""
2910 TT=TI+45:R=1-R
2920 IFRTHENPRINTT$;"!!":GOTO2940
2930 PRINT "!!";
2940 GETZ$:IFZ$>" "THEN2970
2950 IFTI<TTTHEN2940
2960 GOTO2910
2970 F=ASC(Z$)-48:IFF<10RF>TTTHENF="?":R=0:GOTO2910
2980 T=F:PRINTZ$:RETURN
    
```

LEISURE LINES

Well, we had a really mediocre response to Puzzle No 13. I suppose everyone was on holiday because I can't believe it was too difficult. Anyway, 25 out of the 27 entries received were correct and, just for a change, the winner turned out to be a foreign competitor, Karl Veverka of Vienna, Austria. Well done, Karl - we'll be sending your prize in due course.

There were several possible solutions, and the winning one was:

1600	000	000
1101	111	489
1254	222	225
3333	330	225
4434	494	464
4555	575	025
4666	665	969
7907	477	776
3828	886	884
2909	199	969

Quickie

As usual, no prizes for this one so no answers required. If a hen and a half lay an egg and a half in a day and a half, how long will it take 12 hens to lay 12 eggs?

Prize puzzle

This month's problem is all about check digits, so we'd better make sure we all agree on the definition first.

To find the check digit of modulo 97 for a six-digit number, proceed as follows:

- multiply the first digit of the number by the first weight, W1;
- multiply the second digit of the number by the second weight, W2;
- etc;
- add the six products so formed to give a single total;
- divide this total by 97 and the remainder is the required check digit.

For example, suppose our weights are 10, 20, 30, 40, 50 and 60 respectively, and suppose we wish to find a check digit for the number 987654. Then we calculate $9 \times 10 + 8 \times 20 + 7 \times 30 + 6 \times 40 + 5 \times 50 + 4 \times 60 = 1190$, which leaves a remainder of 27 when divided by 97. Hence the required check digit is 27.

Right, now for the problem. We are given eight numbers and their respective check digits. You have merely to calculate the check digit for the ninth number.

So here are the numbers, with their check digits in brackets:

1. 693847 (16)
2. 264315 (27)
3. 927064 (32)
4. 472289 (14)
5. 838521 (73)
6. 741318 (69)
7. 553846 (14)
8. 385132 (10)
9. 123456 (??)

I'll give you a little more information, however. All weights are positive integers between 0 and 99 inclusive; and from left to right across the six digits, the weights are multiples of successive prime numbers (unity is not considered 'prime' for this purpose). For example, if weight W1 is five then W2 is a multiple of seven, W3 is a multiple of 11, W4 is a multiple of 13 and so on. This information should render the problem almost trivial.

I want to know the check digit of the ninth number, then, together with the weights W1 to W6. Answers on a postcard (letters are filed in the bin) to Puzzle No 16, PCW, 14 Rathbone Place, London W1P 1DE, to arrive no later than 31 December. Prize (yawn) is a book token, as usual.

BLUDNERS

Quite a few readers were thrown into confusion by the ZX80 Breakout program. The problem lies in line 130, at the end, in fact; instead of a space

between the inverted commas there should be a shaded square. And in lines 140 and 320, there's only a single space between the inverted commas.

COMPUTERAMA

All we discount is the price!

Computers

Pet, 40 col, new RDMS green screen, large keyboard	8K	£399
	16K	£499
	32K	£599
Pet, 80 col, new DDS	32K	£840
	64K	PDA
	4KLI	£320
TRS-80 system, includes VDU, cassette recorder & P.S.U.	16KLI	£475
	4KLI	£250
	16KLI	£375
TRS-80 CPU, includes UHF TV modulator & P.S.U.		
TRS-80 expansion interface	32K	£275
Apple II includes BASIC interpreter	16K	£599
	32K	£625
	48K	£649
Colour monitor system		£399
Video Genie includes on-board cassette recorder, output to VDU or UHF TV (TRS-80 BASIC)	16K	£299
Video Genie expansion bus box	S100	£245



Dear Customer,

Our computer products are the best possible value for money. The price you pay is low because we import direct, and sell direct, thus cutting out the retailer. We look after you, our customer with a full year guarantee and after-guarantee servicing. We can give you unbiased advice and take orders with most credit cards over the telephone for despatch the same day. We also do personal financing and company leasing or lease-purchase. You can't get a better deal elsewhere — scan the pages of this magazine and see. Why not order from us now — you'll be glad you did, I promise you.

*Alan Brook
Computerama*

Disc drives

Pet compatible	
Commodore Dual	£655
Computhink 400K	£595
Dual 800K	£795
1.6Mb	£1195
TRS-80 compatible, all with case & P.S.U.	
Teac 40 track single	£225
Dual	£399
Quad	£775
77 track single	£325
Dual	£595
Quad	£1155
Shugart SA 400 Single	£229
Apple 11 twin-drive	£456
Controller card	£49

Diskettes 5 1/4" double sided double density £32 for 10
8 1/2" " " " " £36 for 10



Printers

Electrosensitive Type	
Quick Printer II (33 col) (TRS-80, serial & parallel inputs)	£129
Thermal Type	
Phantom 400 (40 col) (with dot graphics)	£229
800 (80 col)	£329
Impact Dot-Matrix	
Commodore Tractor 80 col (for Pet) all Pet graphics	£375
Epson Tractor 80 col Pet graphics	£325
Epson Tractor 80 col High Res. graphics	£399
Anadex DP8000	£425
Anadex DP9500	£825
Paper Tiger with 8 char. sizes & High Res. graphics	£595



List of programmes
available on request.

Monitors

12"	£69
12" (green screen)	£79

Cables

Pet/IEEE	£20	C12	
IEEE/IEEE	£25	Blank	
RS232 Plug to socket	£25	Cassettes	
RS232 Plug to plug	£25	10 for £4	
For others please ring		100 for £35	

Paper

Electrosensitive for QPII	£3.50 per 2 roll pack
Thermal for Phantom 400, TCM 100	£4.10 per 2 roll pack
Phantom 800, TCM 200	£3.90 per roll pack
Impact, single part sprocket punched	
9 1/2 x 11 for Commodore, Epson, Anadex	
Dolphin & Paper Tiger, fanfold	
strippable	£9.50 per box 2000 sheets

Interfaces

Pet/TRS-80 to UHF TV	£25
Pet/TRS-80 to RS232 output	£65
Pet to RS232 in/out	£90
Pet to RS232 decoded output	£150
Pet to RS232 decoded in/out	£175
Pet multiplexer for networking up to 20 Pets	£350
Pet/TRS-80 to S100, 4 slot	£112
Pet/TRS-80 to Centronics	£45
Pet to Centronics decoded	£69



TEL: BATH (0225)
333232

- Personal credit (same day)
- Company credit
- Full year guarantee
- After-sales service
- Mail order
- Export (most countries)

Please add £10 Securicor delivery
on computers etc.
Plus 15% V.A.T. on all prices.



Computerama Ltd.
5 Cleveland Place East,
London Road, Bath, BA1 5DJ



COMPUTER WAREHOUSE

NOW OPEN
MONDAY-SATURDAY
9.30-5.30

★ RAM AND EPROM STAR OFFERS ★

2716 Single 5v rail EPROMS	£10.25
2716 Three rail EPROMS	£ 8.50
2708 EPROMS	£ 4.95
4116 16k x 1 200 ns RAMS 8 for	£28.50

In stock now test equipment, microprocessors, teletypes, transformers, power supplies, scopes, sig. gen's, motors, peripheral equipment, I.C.'s, tools, components, variacs, keyboards, transistors, microswitches, V.D.U.'s sub-assemblies + thousands of other stock lines. Just a mere fraction of our vast range, is displayed below: 100's of bargains for callers.

TELETYPE ASR33 I/O TERMINALS



£235 + CAR + VAT

Fully fledged industry standard ASR33 data terminal. Many features including: ASCII keyboard and printer for data I/O, auto data detect circuitry, RS232 serial interface, 110 baud, 8 bit paper tape punch and reader for off line data preparation and ridiculously cheap and reliable data storage. Supplied in good condition and in working order. Options: Floor stand £12.50 + VAT Sound proof enclosure £25.00 + VAT

ICL TERMIPRINTER 300 BAUD TERMINALS



£325 + CAR + VAT

Made under licence from the world famous GE Co. The ICL Termiprinter is a small attractive unit with so many features it is impossible to list them in the space available! Brief spec. as follows: RS232 serial interface, switchable baud rates 110, 150, 300, (30 cps), upper and lower case correspondence type face, standard paper, almost silent running, form feed, electronic tab settings, suited for word processor applications plus many more features. Supplied in good condition and in working order. Limited quantity.

SCOOP PURCHASE 9" VIDEO MONITORS

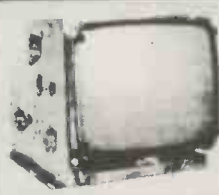

ONLY £57.50 + VAT

Made by the famous MOTOROLA CO. The 9" video monitor type XM226 16 is a self contained unit featuring a quoted bandwidth of 10Hz to 10MHz with 800 lines resolution at the screen centre. The printed circuit board and power transistors are both plug-in for ease of servicing. All controls are easily accessible from the rear. By connection of any 75Ω composite video signal and 12v D.C. you have a professional monitor to do any MPU/CCTV system proud! Supplied BRAND NEW complete with circuits at only £57.50 + VAT Specialist carriage and insurance £7.50 + VAT.

EX STOCK SOFTY

SOFTWARE DEVELOPMENT SYSTEM, INVALUABLE TOOL FOR DESIGNERS, HOBBYISTS ETC. Enables "open heart surgery" on 2708, 2716, etc, Blows, Copies, Reads EPROMS or emulates EPROM/ROM IN-SITU whilst displaying contents off ROM/RAM on a domestic TV receiver. A host of other features. Write or phone for more details. £115 + VAT & CARR PSU £20 + VAT You'll never regret buying a SOFTY!

EQUIPMENT CASES



GIVE YOUR M.P.U. A HOME ONLY £9.95 + 1.85 pp

Superb professional fully enclosed, made for the G.P.O. to the highest standard, offered at a fraction of their original cost they feature aluminium sides, hinged removable front panel, which can be secured by 2 screws to prevent prying fingers. All are finished in two tone G.P.O. grey and although believed brand new may have minor scuff marks/scratches due to bad storage. Dimensions 16" D x 6 1/4" H x 14 3/4" W

MAKE YOUR COMPUTER TALK!!! VIA OUR EX-GPO MODEM UNITS

Well, not exactly talk, but communicate over a standard dial-up G.P.O. line with any other modem. The modem unit 2A is housed in an attractive fibre glass case measuring only 15" w x 13" d x 5" h, inside are the electronics and mains power supply which enable serial duplex data communication between terminal/computer etc. at any speed up to and in excess of 250 baud (300 at a push). Made to the most stringent, exacting specification for the G.P.O. These units feature Modular plug in P.C.B.'s, internal test points, Standard tone frequencies. Configurable to terminal or computer end, Auto unattended answer, RS232/V24 interface on standard 25 way 'D' socket, etc. etc., supplied complete with diags., at a fraction of their original cost at only £55.00 + £4.50 CARR.

NOTE: Units believed working, but untested, unguaranteed. Permission may be required for connection to G.P.O. lines.

SEMICONDUCTOR 'GRAB BAGS'

Amazing value mixed semiconductor, include transistors, digital, linear I.C.'s, triacs, diodes, bridge recs. etc. etc. All devices guaranteed brand new, full spec. with manufacturers markings, fully guaranteed. 50 + BAG £2.95 100 + BAGS £5.15

MUFFIN FANS

Keep your equipment Cool and Reliable with our tested ex-equipment "Muffin Fans" almost silent running and easily mounted. Available in two voltages. 110 V.A.C. £5.05 + pp 90p OR 240v A.C. £6.15 + pp 90p DIMENSIONS 4 1/2" x 4 1/2" x 1 1/2"

ELECTRONIC COMPONENTS & EQUIPMENT

66% DISCOUNT

Due to our massive bulk purchasing programme which enables us to bring you the best possible bargains, we have thousands of I.C.'s, Transistors, Relays, Cap's., P.C.B.'s, Sub-assemblies, Switches, etc. etc. surplus to our requirements. Because we don't have sufficient stocks of any one item to include in our ads., we are packing all these items into the "BARGAIN PARCEL OF A LIFETIME" Thousands of components at giveaway prices! Guaranteed to be worth at least 3 times what you pay plus we always include something from our ads. for unbeatable value!! Sold by weight

2.5kds £ 4.75 + pp £1.25	5kds £ 6.75 + pp £1.80
10kds £11.75 + pp £2.25	20kds £19.99 + pp £4.75

LED DIGITAL ALARM CLOCK MODULE

★ 12 HOUR ★ 50/60 HZ ★ LARGE DISPLAY ★ 100's OF USES The same module, NATIONAL MA1012, used in most alarm clock/radios on the market today, the only difference is our price! GIANT 1/2" LED characters give extremely clear viewing and readability. All electronics are self-contained on a P.C.B. measuring only 3" x 1 1/2". By addition of a few switches and 5/16 volts A.C. you have a multi-function alarm clock at a mere fraction of cost. Dozens of functions include snooze timer, am-pm, alarm set, power fail indicators, flashing seconds cursor, modulated alarm output, dimmer control, etc, etc. Supplied brand new with full data at only £5.25

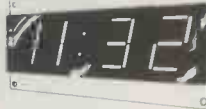

suitable transformer for mains operation £1.75

Save Over £1200!! Logabax DZM180 High Speed Matrix Printers

This must be one of our greatest bulk saving deals this year. This fabulous printer is listed at over £1800 and judging by the quality workmanship we are not surprised. The Logabax DZM180 Matrix printer, capable of printing up to 132 characters per line on any size (via variable tractor unit) sprocket fed fanfold paper. A precision matrix head utilising ruby bearings gives exceptionally clear uniform legible characters via standard ribbon. Many other features include internal buffer, for high throughput, in excess of 180 characters per second, software controllable form and tab functions, standard TTL parallel interface, etc. etc. Supplied brand new and boxed at only



£599.00 plus VAT* Optional extras: Floor stand (as picture) £30.00 plus VAT Paper handler £18.00 plus VAT *Carriage - please enquire for specific quote.

THE "MULTIVOLT" MULTI RAIL P.S.U.

This has got to be the power supply to end all your M.P.U./LAB supply requirements. Recently made by the famous "WVIER" Co Ltd to the highest professional specifications. With an original cost of over £200 the supply features every possible form of protection, full regulation, over voltage and current limit and just look at these outputs; it may have been made to your specifications!

+ 5 V at 12 Amps	+ 30 V at 2 Amps	+ 5 V at 4.5 Amps
+ 5 V at 4 Amps	- 12 V at 2.5 Amps	+ 12 V at 2.5 Amps
		- 9 V at 1 Amp

you agree then order now whilst stocks last. Supplied BRAND NEW at only complete with diagrams. £59.99 CARR & INSUR. £6.75

FULL RANGE OF COMPONENTS EX STOCK SEE SEPARATE ADVERT THIS MAGAZINE



Dept. P.C.W. 64-66 Melfort Rd., Thornton Heath, Croydon, Surrey. Tel: 01-689 7702 or 01-689 6800

MAIL ORDER INFORMATION

Unless otherwise stated all prices inclusive of V.A.T. Cash with order. Minimum order value £20.00. Prices and Postage quoted for UK only. Where post and packing not indicated please add 50p per order. Bona Fida account orders minimum £10.00. Export and trade enquiries welcome. Orders despatched same day where possible. Access and Barclaycard Visa welcome.

BRAND NEW 8" FLOPPY DISK DRIVES SHUGART SA800 £225.00 + carr + VAT SHUGART SA801 £245.00 + carr + VAT

5v D.C. POWER SUPPLIES

Following the recent "SELL OUT" demand for our 5v 3 amp P.S.U. we have managed to secure a large quantity of ex-computer systems P.S.U.'s with the following spec.: 240 or 110v A.C. input. Outputs of 5v @ 3.4 amps, 7.2v @ 3 amps and 6.5v @ 1 amp. The 5v and 7.2v outputs are fully regulated and adjustable with variable current limiting on the 5v supply. Unit is self contained on a P.C.B. measuring only 12" x 5" x 3". The 7.2v output is ideal for feeding "on board" regulators or a further 3 amp LM323K regulator to give an effective 5v @ 7 amp supply. Supplied complete with circuit at only £10.95 + £1.75 pp. Believed working but untested, unguaranteed.

KEYBOARDS

★ LOW PRICE CHASSIS ★



A special bulk purchase enables us to offer the above keyboard at a lowest ever price. 49 coded keys encoded into a direct TTL compatible 7 bit output. Features such as delayed strobe, 5 volt D.C. single rail operation and rollover protection make this an absolute must for the MPU constructor! Supplied complete with connection diagram and edge connector, at a secondhand price of only £20.00 + P.P. £1.60

SUPER CASED VERSION Same as above spec. but housed in attractive two tone moulded free standing case. Unit also includes an all TTL parallel to serial converter (no details) etc.

£27.50 + P.P. £1.85

TOROIDAL TRANSFORMERS

PR 240v pri. sec. 15 0 15 @ 2 amps dimensions 3" x 2 1/2" £4.95 - p.p. 90p TM 240v/110v pri. sec. 15 0 15 8vA dimensions 2 1/2" x 1" £1.95 - p.p. 30p All voltages measured off load

Plugs, Sockets & Connectors Cannon 'D' Range

Ways	Plug	Socket
9	£1.07	£1.26
15	£1.17	£2.01
25	£1.72	£2.58
37	£2.35	£4.14
50	£2.90	£5.46

25 way ex-equip. plug or socket £1.25

Edge connectors, gold plated

0.1" DS	40 way	£2.45
0.1" DS	85 way	£3.99
0.15" DS	56 way	£3.25
0.156DS	36 way	£2.00

All connectors easily cut to size 1000's of other connectors ex stock

NewBear

Computing Store Ltd

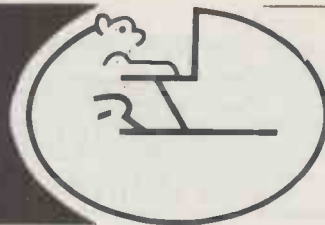

MZ-80K

NBMZ80K MONITOR LISTING	£15.00
NBMZ80K BASIC LISTING	£30.00
NBMZ80K ZEN EDITOR/ASSEMBLER TAPE & MANUAL	£19.50
MZ80K MACHINE CODE TAPE & MANUAL ...	£22.50
MZ80K ASSEMBLY LANGUAGE TAPE & MANUAL	£45.00
NBMZ80K V24/RS232 PRINTER INTERFACE ..	£49.50

DISKS & PRINTER NOW AVAILABLE

A COMPLETE BUSINESS SYSTEM FOR
LESS THAN £2000.

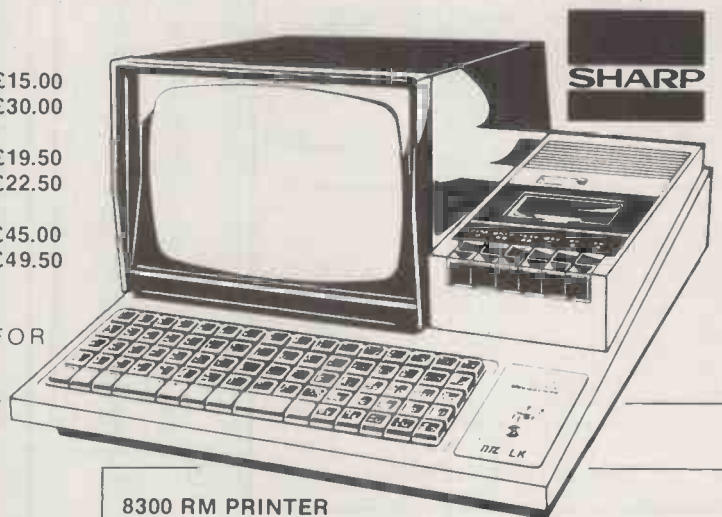

SHARP

MICROCOMPUTING I.C.'S

MC6800	£6.75
MC6802	£10.50
MC6809	£17.75
MC6810AP	£3.61
MC6821	£4.63
MC6840	£10.50
MC6850	£4.99
MC6852	£4.75
MC8062P	2.88
MC14536P	£2.50
MC3459	£2.43
Z8001	£142.50
Z80 CPU 2.5 Mhz	£8.99
Z80 CTC 2.5 Mhz	£7.99
Z80 P10 2.5 Mhz	£7.99
Z80 S10	£25.57
Z80A CPU 4 Mhz	£10.50
Z80A P10 4 Mhz	£10.00
Z80A CTC 4 Mhz	£10.00
SC MP 11 (INS8060N)	£11.30
INS8154N	£8.18
6502	£8.99
6522 VIA	£8.14
6532	£9.75
6545 CRT CONTROLLER	£18.50
6551 ACIA	£9.99
8080A	£5.50
8224	£2.95
8228	£3.00
DM 8835N	£1.35
8212	£2.25
8216	£2.50

NEW LOW PRICES!



NORTH STAR ★ HORIZON

8300 RM PRINTER

80/132 CH PER LINE (SWITCHABLE); 125 C.P.S: 2K BUFFER; V24 RS 232/ CURRENT LOOP INTERFACE; SPEED SWITCHABLE BETWEEN 110.9600 BAUD; VARIABLE WIDTH CHAR AVAILABLE UNDER SOFTWARE CONTROL: SPROCKET FEED; 4 x 9 DOT MATRIC; PAPER WIDTH 4.5" TO 9.5"

PRICE £499.00

SPECTRONICS U.V. EPROM — ERASING LAMPS

PE 14 ERASES UP TO 6 CHIPS, TAKES APPROX. 19 MINS.	£45.00
PE 14T ERASES UP TO 6 CHIPS, TAKES APPROX. 19 MINS.	£59.95
PE 24T ERASES UP TO 9 CHIPS, TAKES APPROX. 15 MINS.	£87.00
PR 12ST ERASES UP TO 16 CHIPS, TAKES APPROX. 7 MINS.	£186.24
PR 320T ERASES UP TO 36 CHIPS, TAKES APPROX. 7 MINS.	£302.00

U.V. EPROM ERASING CABINET

PC 1100 ERASES UP TO 72 CHIPS, TAKES APPROX. 7 MINS.	£693.00
PC 2200 ERASES UP TO 144 CHIPS, TAKES APPROX. 7 MINS.	£1142.00
PC 3300 ERASES UP TO 216 CHIPS, TAKES APPROX. 7 MINS.	£1595.00
PC 4400 ERASES UP TO 288 CHIPS, TAKES APPROX. 7 MINS.	£2047.00

DISC DRIVE

Shugart SA 400 5¼" single sided disc drive. £189

Tandon TM 100 5¼ double sided disc drive £250

Send for details of New Sharp add ons.

NewBear

for the widest selection of computing books

NEW BOOK LIST

MEMORIES

4116 (16K DYNAMIC)	£4.50
2716 (INTEL + 5V TYPE) - ...	£12.50
2708	£4.50

NEWBEAR COMPUTING STORE LTD, (HEAD OFFICE) 40 BARTHOLOMEW STREET, NEWBURY, BERKS
TELEX 848507 NCS (MAIL ORDER) TEL. (0635) 30505
FIRST FLOOR OFFICES, TIVOLI CENTRE, COVENTRY ROAD, BIRMINGHAM. TEL. 021 707 7170
220-222 STOCKPORT ROAD, CHEADLE HEATH, STOCKPORT. TEL. 061-4912290

PLEASE ADD V.A.T. TO ALL PRICES.

GET A SHARP DEAL
FROM NEWBEAR
SEND FOR OUR
FREE CATALOGUE

Greenbank

Greenbank Electronics
(Dept W12C) 92 New Chester Road, New Ferry
Wirral, Merseyside L62 5AG
(Tel: 051-645 3391)

UV EPROM ERASERS

UV 140, UV 141



Two easy to use units designed for both the professional and amateur UV-prom user

Features

- Can erase up to 14 proms
- Special short wave ultraviolet tube
- Erase time variable between 5 and 50 minutes in 5 minute steps (preventing over exposure which may shorten prom life)
- Sliding tray carries proms on conductive foam
- Safety interlock switch prevents the timing circuit from operating and switching on the tube with the tray open
- Mains On and Tube On indicators
- Smart textured case
- Complete instructions supplied

Supplied complete with mains plug and flex

Model UV141: Price £77.70

Also available without timer as

Model UV140: Price £61.20

Tex Microsystems

"EPROMPT" UV ERASER

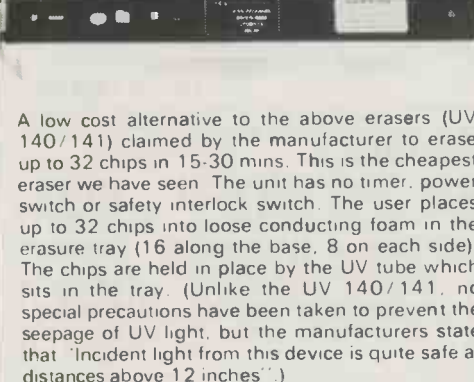

A low cost alternative to the above erasers (UV 140/141) claimed by the manufacturer to erase up to 32 chips in 15-30 mins. This is the cheapest eraser we have seen. The unit has no timer, power switch or safety interlock switch. The user places up to 32 chips into loose conducting foam in the erasure tray (16 along the base, 8 on each side). The chips are held in place by the UV tube which sits in the tray. (Unlike the UV 140/141, no special precautions have been taken to prevent the seepage of UV light, but the manufacturers state that "Incident light from this device is quite safe at distances above 12 inches")

(Dimensions - 325x64 x 38mm)

EPROMPT ERASER: Price £33.00

MICROPROCESSORS

COMPUTER BOARDS

- 114 x 203 mm fibreglass gold plated edge connector
- Butterfly SC-MP CPU £9.40
- SC MP Pre-board £9.40
- Z80 CPU card £9.40
- VDU A set £8.90
- VDU B £8.90
- VDU G three £8.90
- EPROM Programmer £27.00
- 1/4 PROM board £204.15
- 1/8 PROM board £270.85
- 2/8 PROM board £270.85
- 2/8 RAM board £270.85
- 2/8 CTC £270.85
- 8/8 RAM board £271.45
- 8/8 RAM board £271.45
- Tape interface £8.90
- Keyboard interface £8.90
- PSU 5v +12v -12v board £8.90
- PSU 5v -12v board £5.50
- ISBUS 11 slot back board £11.50
- 13" x 13" approx Epoxy Glass lined

Further details on request

NEW COMPUTER BOARDS

- The following computer boards have been added to the range for use with the Z80 (114x203mm fibreglass with gold plated edge connector)
- 1P2 B line opto isolated input board £9.40
- OP2 B line relay output board £9.40
- S10 RS232C serial interface board £9.40
- MX02 16K dynamic ram board £9.40
- Z80 £6.95
- Z80 CTC £270.85
- 8/8 RAM board £271.45
- 8/8 RAM board £271.45
- Tape interface £8.90
- Keyboard interface £8.90
- PSU 5v +12v -12v board £8.90
- 6800 MPU £6.55
- 6802 MPU £9.95
- 6809 £19.95
- 6810 £3.25
- 6810 (128 x 8 RAM) £3.75
- 6820 6821 PA £3.96
- 6845 £22.30
- 6850 ACIA £4.85
- MC6800 £2.64

TERMS (VAT, CMO, Cheques etc payable to Greenbank Electronics and crossed. Add VAT to all prices at 15% except where stated otherwise. Post etc: (UK 35p +5p VAT = 40p) per order. Export: NO VAT but add 35p (Eire), 75p (Europe) and £2.50 elsewhere. Access, Barclaycard, Visa, telephoned orders accepted. (Cash, universities, govt dept, etc can telephone their orders for immediate despatch on account)



CMOS

These cut prices for Amateur Users and Export. Note: industrial users - quantity prices available. Mostly Motorola, RCA

4000 18p	4042 80p	4095 £1.97	4410 £8.55	4531 £1.45
4001 25p	4043 90p	4096 £1.97	4411 £10.72	4532 £1.30
4002 25p	4044 90p	4097 £5.98	4412P £14.93	4534 £5.60
4006 95p	4045 £2.63	4098 £1.92	4415P £5.24	4536 £3.68
4007 18p	4046 £1.10	4099 £2.00	4422 £5.66	4537L £26.10
4008 80p	4047 £1.71	40100 £1.92	4433 £12.30	4538 £1.20
4009 40p	4048 77p	40101 £1.69	4435P £5.40	4539 97p
4010 50p	4049 45p	40102 £3.67	4450 £3.81	4541 £1.19
4011 25p	4050 49p	40103 £3.67	4451 £3.81	4543 £1.80
4012 18p	4051 80p	40104 £1.85	4451 £3.81	4549 £4.38
4013 50p	4052 80p	40105 £1.85	4452 £3.81	4552 £14.85
4014 84p	4053 80p	40106 92p	4490P £4.20	4553 £4.50
4015 84p	4054 £2.18	40107 £1.28	4490P £3.14	4554 £1.38
4016 45p	4055 £2.55	40108 £7.54	4500 £6.95	4555 78p
4017 80p	4056 £2.55	40109 £1.28	4501 29p	4556 72p
4018 89p	4059 £9.23	40110 £3.00	4502 1.20	4557 £3.86
4019 45p	4060 £2.10	40111 £1.77	4503 70p	4558 £1.25
4020 99p	4062P £10.00	40150 £1.54	4505 £5.71	4559 £4.38
4021 £1.10	4063 £1.90	40151 £1.54	4506 50p	4560 £2.50
4022 £1.00	4066 55p	40162 £1.54	4507 55p	4561 81p
4023 27p	4067 £7.21	40163 £1.54	4508 £2.90	4562 £5.60
4024 78p	4068 27p	40174 £1.54	4510 99p	4566 £1.59
4025 27p	4069 27p	40181 £5.03	4511 £1.50	4568 £2.38
4026 £3.25	4070 30p	40182 £1.90	4512 80p	4569 £2.50
4027 50p	4071 25p	40192 £2.41	4514 £2.65	4572 40p
4028 84p	4072 25p	40193 £2.41	4515 £3.00	4580 £4.77
4029 99p	4073 25p	40194 £2.27	4516 £1.10	4581 £2.62
4030 74p	4075 25p	40208 £7.54	4517 £4.46	4582 £1.14
4031 £4.31	4076 £1.07	40257 £2.31	4518 £1.60	4583 90p
4032 £1.31	4077 29p	4160 96p	4519 80p	4584 90p
4033 £2.63	4078 29p	4161 96p	4520 £1.00	4585 £1.27
4034 £2.00	4081 27p	4162 96p	4521 £2.50	4597 £2.44
4035 £1.10	4082 27p	4163 96p	4522 £1.11	4598 £2.98
4037 £1.99	4085 £1.35	4174 90p	4526 £1.00	4599 £6.95
4038 £1.20	4086 £1.35	4175 £1.15	4527 £1.50	4700 £1.75
4039 £2.70	4089 £2.91	4194 £1.16	4528 £1.20	
4040 £1.00	4093 80p	4408 £9.37	4529 £1.30	
4041 £1.59	4094 25p	4409 £9.37	4530 70p	

74C

74C00 28p	74C76 57p	74C163 £1.15	74C803 57p	74C925 £5.01
74C02 28p	74C85 1.34	74C164 £1.08	74C804 57p	74C926 £5.01
74C04 28p	74C86 67p	74C173 93p	74C806 57p	74C928 £5.01
74C08 28p	74C89 £4.62	74C174 93p	74C807 57p	74C929 £17.90
74C10 28p	74C90 89p	74C175 93p	74C808 1.00	74C930 £17.90
74C14 28p	74C93 89p	74C192 £1.15	74C809 £1.69	
74C20 28p	74C95 £1.08	74C193 £1.15	74C810 £1.69	
74C24 28p	74C107 29p	74C195 £1.08	74C811 £1.69	
74C30 28p	74C150 £3.81	74C200 £7.46	74C812 £1.69	
74C32 28p	74C151 £2.55	74C221 £1.41	74C814 £1.46	
74C42 95p	74C154 £3.81	74C225 £2.98	74C815 £1.15	
74C48 £1.43	74C157 £2.29	74C273 £1.79	74C819 £1.10	
74C73 57p	74C160 £1.49	74C374 £1.79	74C821 £1.07	
74C74 59p	74C162 £1.15	74C901 57p	74C822 £1.18	
		74C902 79p	74C923 £3.85	

74LS

74LS00 14p	74LS55 30p	74LS151 96p	74LS244 £1.70	74LS374 £1.95
74LS01 14p	74LS63 £1.50	74LS153 76p	74LS245 £3.50	74LS375 £1.60
74LS02 16p	74LS74 46p	74LS155 £1.70	74LS247 £1.90	74LS377 £2.12
74LS03 16p	74LS74 41p	74LS156 96p	74LS248 £1.90	74LS378 £1.84
74LS04 16p	74LS75 48p	74LS155 96p	74LS249 £1.90	74LS379 £2.15
74LS05 16p	74LS76 40p	74LS157 76p	74LS251 £1.34	74LS384 86p
74LS06 16p	74LS78 40p	74LS158 96p	74LS253 £1.42	74LS386 86p
74LS09 20p	74LS83 £1.15	74LS160 £1.28	74LS257 £1.10	74L 390 £2.30
74LS10 20p	74LS85 £1.16	74LS161 96p	74LS259 £1.60	74LS392 £2.18
74LS15 20p	74LS86 43p	74LS162 £1.38	74LS259 £1.60	74LS395 £2.18
74LS18 22p	74LS91 60p	74LS163 £1.18	74LS261 £4.50	74LS396 £2.15
74LS19 22p	74LS91 60p	74LS164 £1.14	74LS266 52p	74LS398 £2.76
74LS22 23p	74LS92 89p	74LS165 75p	74LS273 £2.44	74LS399 £2.30
74LS23 38p	74LS93 89p	74LS166 £2.26	74LS275 £2.50	74LS445 £1.50
74LS24 25p	74LS95 £1.16	74LS164 60p	74LS279 66p	74LS447 £4.44
74LS25 30p	74LS96 £1.16	74LS173 £1.05	74LS283 £1.92	74LS490 £1.80
74LS26 48p	74LS107 44p	74LS174 £1.06	74LS290 £1.28	74LS568 £1.82
74LS27 28p	74LS109 55p	74LS175 £1.10	74LS293 £1.10	74LS569 £1.82
74LS28 48p	74LS112 55p	74LS181 £3.98	74LS295 £1.85	
74LS30 22p	74LS113 50p	74LS183 £2.98	74LS298 £1.68	
74LS32 27p	74LS114 50p	74LS184 £1.40	74LS299 £2.40	
74LS33 39p	74LS122 70p	74LS189 £1.40	74LS325 £2.90	
74LS37 39p	74LS123 70p	74LS192 £1.30	74LS326 £2.94	
74LS38 39p	74LS124 £1.80	74LS193 £1.30	74LS327 £2.86	
74LS40 28p	74LS125 60p	74LS194 £1.66	74LS347 £1.48	
74LS42 96p	74LS132 95p	74LS195 £1.36	74LS348 £1.86	
74LS47 90p	74LS138 85p	74LS196 £1.00	74LS352 £2.78	
74LS48 £1.20	74LS139 85p	74LS197 £1.40	74LS353 £2.28	
74LS51 24p	74LS147 £1.70	74LS221 96p	74LS365 65p	
74LS54 28p	74LS148 £1.73	74LS240 £2.36	74LS366 65p	
		74LS241 £2.32	74LS367 65p	
		74LS242 £2.32	74LS368 66p	
		74LS243 £2.32	74LS373 £1.80	

UV ERASABLES

- 5204 (512 x 8) £11.50
- 2708 1K x 8 £3.95
- 2716-2516 2K x 8 single 5V £6.95
- 2532 4K x 8 (5v) £37.00
- PROWASHING each Prom 50p (+ 30p + VAT)

5204/2708/2516 Program- mng Service £7.50/£2.50/ £15.00 each prom. Price does not include prom, we accept handwritten/typed source code - must be hexadecimal.

UV PROM ERASER

- UV140 £61.20
- UV141 £77.70
- EPROMPT £33.00

INTERFACE

- 81LS95 6 7 8 £1.40
- 7549 LED driver 50p
- 75492 92p
- ZN425 £3.95
- 8128 8728 £2.64
- 8174 48p

CRT Controller: Uarts

- Thompson CSF SF 19634E £11.50
- AV 5 0113 UART 1R 1602 £4.00
- AV 5 1013A £4.70
- AV 3 1014A £5.60
- AV 3 1015 £5.60

CHAR. GEN. KEYBOARD ENCODER

- MCM 66760 £9.75
- MK 2302 £15.29
- RO-3-2513 (5v Uppercase) £6.00
- DM 0678 CAB/BWF £14.27
- AY-5-2376 £9.75

FIRMWARE

- ZMON for Z80 (1 x 2708) £14.95
- 2K Tiny BASIC for Z80 (2 x 2708) £19.95
- 4K NIBL for SC/MIP (4 x 2708) £49.95
- 4K NIBL-MM for SC/MIP (4 x 2708) £49.95
- 1K Various for SC/MIP (1 x 2708) £14.95

(Descriptive leaflet available on above Ref S.W. 5)

MODULATORS

- UM1111 E36 UMF Ch.36 Vision Modulator £2.50
- UM1231 UMF Ch.36 Vision Modulator wide bandwidth (for computers etc) £4.70
- 7505 75p
- 7505 £1.08
- 7517 97p
- 7512 £1.08
- 7805 £5.61

QUARTZ

32.768KHz £3.23	327.68KHz £3.92
60 KHz £9.95	355.0 KHz £4.95
100.0 KHz £1.62	1.000 MHz £3.62
200.0 KHz £3.92	1.008 MHz £3.92
204.8 KHz £3.92	1.280 MHz £3.92
262.144 KHz £3.92	1.6 MHz £4.25
307.2 KHz £3.92	1.8 MHz £4.25
312.5 KHz £3.92	1.8432 MHz £3.62
355.0 KHz £4.95	2.000 MHz £3.62
1.000 MHz £3.62	2.097152 MHz £3.23
1.008 MHz £3.92	2.4576 MHz £3.62
1.280 MHz £3.92	2.500 MHz £3.92
1.6 MHz £4.25	3.000 MHz £3.62
1.8 MHz £4.25	3.2768 MHz £3.23
1.8432 MHz £3.62	3.579545 MHz £1.95
2.000 MHz £3.62	3.93216 MHz £3.92
2.097152 MHz £3.23	4.000 MHz £2.90
2.4576 MHz £3.62	4.032 MHz £3.23
2.500 MHz £3.92	4.096 MHz £3.62
3.000 MHz £3.62	4.194304 MHz £3.23
3.2768 MHz £3.23	4.433619 MHz £1.25
3.579545 MHz £1.95	4.608 MHz £3.23
3.93216 MHz £3.92	4.800 MHz £3.23
4.000 MHz £2.90	4.9152 MHz £3.23
4.032 MHz £3.23	5.000 MHz £3.23
4.096 MHz £3.62	5.0688 MHz £3.23
4.194304 MHz £3.23	5.185 MHz £3.23
4.433619 MHz £1.25	6.000 MHz £3.23
4.608 MHz £3.2	

XITAN SYSTEMS LTD

The South's CROMEMCO experts

Need a Hard Disk System with FAST RELIABLE Backup?

Xitan now have the answer with the Z-2H plus DC300 Tape cartridge BACKUP system (S100 controller, drive, psu & software).

The Cartridge BACKUP system is available separately for existing Z-2H users (13.4 Megabyte capacity – 1 Megabyte per 5 minutes).



Utilities/Software for CROMEMCO Systems.

Tired of XFER – Use FCOPY or DFCOPY. Single sided 8" copy in 54 seconds, Double sided 8" copy in 104 seconds, £50.00 ea. Need to build Assembler libraries – try LIBR at £50.00.

CP/M 2.2 and MP/M 1.1 available for System 3 and Z-2H systems.

EASYFORM. For creation/editing of forms on the 3102 VDU with structured Basic. Forms useable from Cobol, Fortran etc. £160.00.

BUSINESS SOFTWARE

CROMEMCO systems – a complete Business system based on the system 3 from CAP-CPP. Phone for an appointment to see it running.

For the smaller customer, we have an integrated Sales, Purchase and Nominal system for the North Star Horizon.

Nothing fancy – but installed and running for over 7 months. IT WORKS!

WHATIF! Cash Flow, Accounts budgetting utility. Just released. Incredible value at £95.00.

Also available an Incomplete Records system for the Horizon.



SPECIALS.

Real Time Clock – S100 – 100 microseconds up to 99,999 days £155.00. Hi-Tech S100 PAL colour card, 24 x 40 Prestel format £295.00. Video Vector Fastlib £495.00. Dual Tandem Double/sided 40 track mini-floppy sybsytsem £625.00.

INTEGRATED SPECIALIST SYSTEMS.

MEDIDATA 32,000 patient Doctors' system. Installed & running. Prices from £7500.00.

RETURNED ALE. Run a brewery? Keep track of returned ale and reclaim Excise Duty. Track down production & storage problems. Copes with 10,000 + barrels. Prices from £8500.00.

Xitan Systems also supplies and stocks vdu's, printers, NORTH STAR HORIZON computers, Commodore Business Machines PETs, S100 boards, and books. We are here to demonstrate the range of quality microcomputer systems available for use today. Ring up for an appointment now! You'll not be disappointed. We have Osborne's Sales Ledger and Payable Ledger in source form for use on Cromemco System 3 with CBASIC2, and we can offer a customising service on these programs. Additional software includes Microsoft Basic Interpreter and Compilers, Cbasic, Macro80, and CP/M for the North Star Horizon.

Xitan Systems Ltd., 23 Cumberland Place, Southampton SO1 2BB.

Tel: (0703) 38740

Hours Tue-Sat 9.30 am to 5.30 pm

SOFTWARE DIRECT FROM WRITERS

QUALITY AT THE RIGHT PRICE!

PETSSETTE

20 PET PROGRAMS £20

- * PAYROLL
- * MAILING LIST
- * BANK ACCOUNT
- * LIBRARY INDEX
- * STOCK CONTROL
- * CASH REGISTER
- * LUNAR LANDER
- * SNOOKER
- * ASTRONOMY
- * STARTREK
- * JET FLIGHT
- * HANGMAN
- * SPACE ATTACK
- * KLINGON
- * LOST IN SPACE
- * STANDARD LETTER
- * SPACE DOGFIGHT
- * NOUGHT & CROSSES
- * SALES LEDGER
- * LUNAR INVADERS

All for £20

inc. Cassette & postage

PETMERGE

NOW YOU CAN SAVE LOTS OF TIME BY JOINING USEFUL GOSUBS TOGETHER - USING YOUR CBM DISK, AND OUR LONG AWAITED MERGER PROGRAM.

ONLY £40 inc:

DISK, INSTRUCTIONS & POSTAGE



BUSINESS-PACK

- * WORD PROCESSOR
- * PAYROLL
- * BANK ACCOUNT
- * STOCK CONTROL
- * MAILER/LETTER
- * CASH REGISTER
- * SALESMAN
- * LIBRARY INDEX

COMPLETE PACK (inc. DISKS, DOCUMENTATION & POSTAGE):

APPLE II / ITT 2020 / PET ONLY: £99

HARDWARE

- * ITT 2020 48K
- * PRINTER
- * DISK DRIVES
- * COLOUR MONITOR
- * FULL SOFTWARE

Complete system: £3000

TRY IT!

PHONE FOR A DEMONSTRATION NOW

NEW NEW

- * SUPER STOCK CONTROL £70
- * DOUBLE ENTRY LEDGER £70
- * INVOICER £60
- * FILING CABINET £50
- * YEAR PLANNER PRINTER £30

APPLE II & ITT 2020

Prices include: DISK, POSTAGE & DOCUMENTATION

BUSYLINK

★ A fully integrated business system for:

- * INVOICING
- * WORD PROCESSING
- * ADDRESSING

£250

inc. Disk, Documentation & post. APPLE II & ITT 2020

PROGRAM MART

- * Snooker
- * Crossword
- * Noughts & crosses
- * Space dogfight
- * Startrek
- * Phaser
- * Jet flight
- * Spaceship
- * Klingon
- * STOCK CONTROL
- * PAYROLL
- * BANK ACCOUNT
- * SALESMAN
- * CASH REGISTER
- * LIBRARY INDEX
- * STATISTICS
- * GRAPH PLOT
- * ASTRONOMY



£10 each OR any 5 £20 (inc. disk & postage)

APPLE II - ITT 2020 - PET

SPECIALS

THE VERY POPULAR:-

★ MAILER/LETTER & £50

★ Word processor £40

inc. Disk, postage.

Plus: * apple ITT PET

FREE - any 5 Program Mart programs.

66, Queens Road
Loughborough
Leicestershire LE11 1HD
0509 217671

DATABANK

Your computer ?

Please tick the boxes

Apple II ITT 2020 PET
CBM DISK

Name _____

Address _____

Postcode _____

- BUSINESS-PACK
- BUSYLINK
- PETSSETTE
- PETMERGE
- MAILER/LETTER
- WORD PROCESSOR
- SUP/STOCK CONTROL
- D/E LEDGER
- INVOICER
- FILING CABINET
- YEAR PNR. PTR.
- PROGRAM MART
- _____
- _____
- _____
- MORE DETAILS





ALTOS

The true multi user computer system

The ALTOS ACS 8000 range of business/scientific micro computers creates a new standard in quality and reliability in high technology micro computers.

Hard Disk / Multi User Systems

The Winchester hard disk / multi user systems are now available supporting up to 4 simultaneous users and providing a maximum of 58 Megabytes of hard disk data storage.

The systems are truly flexible and allow expansion of the ALTOS floppy disk system to keep pace with the users requirements.

Still single board, features include

- a high speed I/O section with up to six serial ports and one 8 bit Parallel port
- up to 208K of on board R.A.M.
- High speed (4 MHz.) D.M.A. control as standard.

Yes, mini power and at micro cost too.

Hard Disk Security Back-up

The 17.5 Megabyte funnel tape unit permits selective dumping from the Winchester at a rate of 1 Megabyte per minute.

Built-in Reliability

The ACS 8000 range are true single board micro computers making them extremely reliable and maintainable. All electronics are socketed for quick replacement. Complete diagnostic utility software for drives and memory is provided.

The board and Shugart floppy disk drives are easily accessible and can be removed in less than ten minutes.

Quality Software

Unlimited versatility. The ACS 8000 range support the widely accepted CP/M and MP/M operating systems plus basic (Microsoft and CBasic), Cobol, Pascal, and Fortran IV. All available now.

Logitek in conjunction with its own microsoftware house, Interface Software Ltd. of Camberley are able to supply a wide range of proven 'off-the-shelf' business software including general accounting, word processing, stock control, mailing list etc.

There are already over 1000 micro computer installations using this software. A track record which we consider speaks for itself. Why 're-invent the wheel' when there is standard software of this quality available now?

Communication Software

Two new custom software packages are now available for the Altos Computer System operating with CP/M to enable it to communicate with remote machines over ordinary telephone lines. ASYNC is an asynchronous package that operates with almost any remote machine. SYNCH is a synchronous package for use with the IBM 3780 protocols.

Custom Graphics & Scientific Software

A full graphics and scientific package is now available for use for the Altos with FPP.

GRAFLIB is a custom Altos software package containing a complete range of FORTRAN—callable graphics subroutines. It is designed with DRE RG—512 board, or a Tektronix 4000 series graphics terminal. Several multi-colour X-Y plotters are supported allowing hard copy in addition to screen graphics.

After Sales Support

Logitek are supported by DDT Maintenance Ltd. who provide a nationwide field maintenance service for Altos products and offer the option of maintenance contracts.

Availability

Logitek carry deep shelf stocks of Altos hardware and compatible peripherals.



LOGITEK

LOGITEK, E.I.C. Electronics Ltd.

All enquiries to

8-10 Fazakerley St., Chorley,
Lancs. Tel: 02572 67615/70206

also at

30 Kelvin Ave.,
Hillington Industrial Estate,
Glasgow G52 4LH

Logitek are now the exclusive distributors of
Altos Computer Products for the U.K. and Eire

NEW THE TUSCAN S100

A Z80 based S100 Computer System.

TUSCAN main board. The heart of the system with Z80, video, Ram, Rom, and I/O plus five S100 slots for expansion.

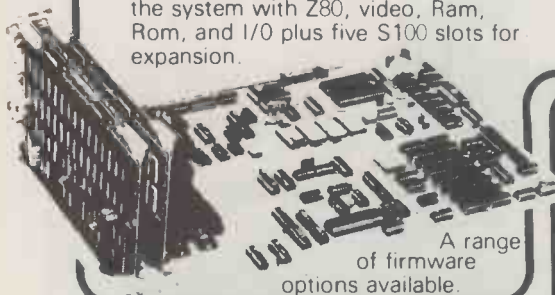

A range of firmware options available.

Available in Kit Form or Assembled. All components available separately.

- Houses two 5 1/4" drives for a compact business system
- Professional case will house the complete system
- Two keyboard options
- Hinged lid for easy access
- Stylish finish ideal for office or home.



On Demonstration NOW
KITS from £195 + VAT delivery Ex-Stock

NASCOM-2

MICRO-KIT COMPUTER WITH IMPROVED 16k B RAM Board



Ex-stock

only £335 + VAT

Full after sales service

Firmware & MOS ICs Software
Zeap Assembler (4, 1Kx8 EPROMS) £50
Nas Pen text editor (2, 1Kx8 EPROMS) £30
Expansion boards (in kit form)
48K RAM £210 ● 32K RAM £175.00
16K RAM £140
EPROM CARD (NASCOM compatible) KIT. Suitable for 16 x 2708 or 16 x 2716 or mixed 1 x NASCOM 8k BASIC ROM £56.00. BASIC programmers aid. Self locating tape £14.96.

POWER SUPPLY £29.50

NASCOM PRODUCT LIST + VAT

I/O board kit less I/O chips	45.00
UART + BAUD rate generator + crystal for I/O board	16.00
Econographics kit for additional 128 characters (N1 only)	30.00
2708/2716 Programmer suitable for N1 and N2 under NAS-SYS	£20.95
Nascom 19" rack mounting card frame for N1 and N2	32.50
Nas-DA disassembler 3 EPROM for Nas-sys	37.50
MK36271 8K BASIC in 8K x 8 ROM	30.00
Naspen VS in 2 EPROM	25.00
Nas-sys monitor in 2 EPROM	25.00
4 Games Tape	£8.50
Nasbug T4 2 x EPROM	25.00
Tiny Basic 2 x EPROM	25.00
Super Tiny Basic 3 x EPROM	37.50
Super Tiny Basic upgrade 1 x EPROM	12.50
Tape Software	
ZEAP 2 tape and documentation for Nas-sys	30.00
8K BASIC tape and documentation for N1	15.00

THE HENELEC DISK SYSTEM FOR NASCOM and any other Z80 8080 Microcomputer with an uncommitted P10

DISKS

- The Henelec controller card plugs direct into a Z80 P10 and controls up to 3 double-sided mini-floppy drives giving a maximum 480K system.
 - General Purpose FDC control software for simple DOS or for CPM.
 - Simple DOS software for NASCOM 1/2 under NAS-SYS
 - OR ROM CB10S for CPM on NASCOM 1/2 incorporating the major NAS SYS features. Maximum 60K CPM system
 - New MD prom supplied for N2/CPM
- TWO SYSTEMS**
- SIM-DOS "Floppy Tape Recorder" with 1 drive PSU firmware, etc. Double sided £380 plus VAT
 - CPM System with 1 drive, double sided PSU firmware, etc. £450 plus VAT
 - Additional Drives with PSU £205 plus VAT

COMPUTER KEYBOARDS

APPLE COMPUTER KEYBOARD

52 Key 7 Bit ASCII coded Positive Strobe + 5V - 12V Size 13x4 1/4" Sturdy Construction Sloping Keys Black/White print. Made in USA for Apple Inc. **Brand New £36 incl VAT.** Post £2.50 individually packed in ANTI-STATIC FOAM

71 KEY ASCII KEYBOARD INCLUDING NUMERIC KEYPAD. £49.00 plus £7.36 VAT TOTAL £56.36. Uses gold crosspoint keys. Includes keypad and ribbon cable. Only available as fully assembled and tested

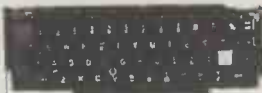

CARTER 57 key ASCII keyboard. Conventional key board. 128 ASCII characters including control keys. Parallel output with strobe. Shift lock. + 5V and -12V DC. 12" x 5.5" x 1.5" Black keys with white legends. 39.34 + VAT.

FERRANTI - "SIZE 14 x 6 x 3" SLOPING FRONT" 55 Key ASCII Coded in steel case. Complete with Plug and Cable with circuit to convert to T.T.L. levels. In good condition at only £19.95 + VAT. P/P £2.50

NASCOM-1

12" x 8" PCB carrying 5LSI MOS packages, 16 1K MOS memory packages and 33 TTL packages. There is on-board interface for UHF or unmodulated video and cassette or teletype. The 4K memory block is assigned to the operating system and video display leaving a 1K user RAM. The MPU is the standard Z80 which is capable of executing 158 instructions including all 8080 code. **Nascom-1 Kit Price £125 Plus VAT** Built price £140 + VAT + P&P £1.50



PLAIN PAPER £325 PRINTER

Fully built and housed in a stylish enclosure for just £325 plus VAT. INTERFACES WITH ALL MICRO COMPUTERS

The Nascom IMP (Impact Matrix Printer) features are

- 60 lines per minute. 80 characters per line.
 - Bi-directional printing. 10 line print buffer.
 - Automatic CR/LF. 96 character ASCII set (including upper/lower case, \$, £). Accepts 8 1/2" paper (pressure feed). Accepts 9 1/4" paper (tractor feed). Tractor/pressure feed. Baud rate from 110 to 9600. External signal for optional synchronisation of baud rate.
- IDEAL FOR WORD PROCESSING**

TANGERINE

COMPUTER SYSTEMS

"MICRON" the latest line in superb products on demonstration from your London stockist

EX-STOCK £395.00 inc. VAT BRITISH DESIGN

- 6502 based microcomputer
- VDU alpha numeric display
- Powerful monitor TANBUG
- 8K RAM
- 32 parallel I/O lines
- 2 serial I/O lines
- RS 232 C/20mA loop, with 16 programmable Baud rates
- Four 16 Bit counter timers
- CUTS cassette recorder interface
- Data bus buffering
- Memory mapping control
- 71 Key ASCII Keyboard, including numeric keypad and with auto repeat
- Including metal cabinets for both keyboard and modules
- Including power supply
- 10K Microsoft BASIC

CENTRONICS QUICK PRINTER



List Price £459 incl. VAT

OUR PRICE plus VAT

EXCLUSIVE TO HENRY'S 50% OFF MAKER'S PRICE £195

for: Software selectable 20, 40 and 80 column using 120mm aluminium-ised paper. 1 roll supplied. 150 lines per minute. **NASCOM** Centronics parallel data interface for Nascom, Tandy, etc. 240 volt mains input. ASCII character set Paper feed, and on/off select switches "BELL" signal Weight 10lbs Size: 13" x 10 1/2" x 4 1/2"

MONITORS
New and Reconditioned FROM £35

TANGERINE LONDON STOCKISTS

Microtan 65 kit	£69.00	Tanex assembled	53.00
Microtan 65 assembled	79.00	Tanex (expanded)kit	106.50
Lower case option	9.48	Tanex (expanded)lassmbld	116.50
Graphics option	6.52	Serial I/O option	12.87
20 way keypad	10.00	Tanram kit	34.00
Full ASCII keyboard	49.00	Tanram assembled	44.00
Tanex kit	43.00	Tanram (expanded)lassbld	190.00

MPS1 power supply	23.00
Mini Mother board	10.00
Mini Rack	43.00

10K extended Microsoft in ROM £39.00

10K extended Microsoft in EPROM 49.00

SEND FOR COMPLETE COMPUTER BROCHURE FREEPOST TO ADDRESS BELOW

MEMORIES Discounts 10% for 4, 15% for 8, 20% for 16

MK 3880 (NZ80)	7.50		
MK 3880-N4 (Z80A)	7.95	2708	5.95
MK 4116 16K x 1 dy RAM	6.50	2716	15.00
MK 4027 4K x 1 dy RAM	2.25	IM6402 UART	4.50
2102 1K x 1 static RAM	1.00	2114 1K x 4 static RAM	3.25
4118 1K x 8 static RAM	12.75	8080A	5.25

ADD VAT 15% TO YOUR ORDER EXCEPT WHERE STATED



HENRY'S

Computer Kit Division
404 Edgware Road, London, W2, England I.E.D.
01-402 6822

Official Export & Educational Orders Welcome
Our telx: 252284
Mono Ref. 1400 Transonics

INNOVATIVE

TRS-80 SOFTWARE

FROM THE PROFESSIONALS



**Animation
Animation
Animation**

Animate is a machine language program representing an entirely new breakthrough in the use of graphics on the TRS-80 or Video Genie microcomputers. As Walt Disney and others found to their profit some years ago, if you draw a number of separate pictures slightly different to each other, and then display them consecutively sufficiently fast, a moving picture is produced. This is precisely what Animate does. Pictures are built up as a sequence of frames, each one being as small or as large as you wish and composed using an easily used graphics cursor. The entire graphics content of a frame can be shifted in any direction so as to move objects without the need to redraw them in each new position. As each new frame is completed it is automatically stored in memory and given a number, so that it may be recalled and edited at will. The timing of the projection of each frame is definable up to a maximum of 100 seconds. When the picture is completed it may be viewed and edited as you wish. When the final picture is complete it may be stored on cassette as a SYSTEM program. Thereafter it may be loaded and accessed either by Animate or by any Basic program. Thus the same picture may be used in any number of different Basic programs, if you wish. Animate is available at present only on cassette for Level II or Genie machines of 16K and up. A disk version will be available shortly. A comprehensive manual is included.

£ 14.95

Plus VAT and 75p P & P = £17.94.

Send large SAE (38p) for our current Catalogue of TRS-80 software. Add £1.85 for a binder.



A.J.HARDING (MOLIMERX)

MOLIMERX LTD.

28 COLLINGTON AVENUE, BEXHILL-ON-SEA, E.SUSSEX.

TEL: (0424) 220391

TELEX 86736 SOTEX G



Euro-Calc Ltd

PRICES FOR
NOVEMBER/DECEMBER

Bring this ad. with you
for 2½% discount on cash
sales.

COMPUTERS

SHARP	Ex. VAT	Inc. VAT
MZ 80K 20K	£462.00	£531.30
MZ 80K 32K	£486.64	£559.64
MZ 80K 48K	£511.28	£587.97
MZ 80FD	£756.61	£870.10
MZ 80P3	£500.83	£575.96
MZ 80 I/O	£96.42	£110.88

COMMODORE		
8K	£410.00	£471.50
16K	£495.00	£569.25
32K	£595.00	£684.25
3022	£390.00	£448.50
3040	£635.00	£730.25
C2N	55.00	£63.25

HEWLETT PACKARD		
HP-85	£1830.00	£2104.50

CENTRONICS		
730	£449.37	£517.00
737	£565.22	£650.00

ODDS AND ENDS		
BOX 5¼" DISCS	£21.74	£25.00
BOX PAPER (2000 sheets)	£13.04	£15.00



TEXAS TI 99/4 SPECIAL OFFER

including Skantic dual-standard monitor (may be used as TV only)

£775.00 inc VAT

APPLE III ATARI 400 ATARI 800 Call for details

CALCULATORS

CASIO	
FX 501P	£45.95
FX502P	£64.95
FA1	£19.95

TEXAS	
51-III	£23.95
57	£25.95
58	£54.95
58C	£64.95
59	£159.95
PC100C	£139.95

HEWLETT - PACKARD	
HP-34C	£90.00
HP-33E	£52.00
HP-33C	£65.00
HP-41C	£178.95
Card Reader	£129.95
Memory Modules	£29.95
Printer	P.D.A.

SHARP	
PC 1211	£99.95
CE 121	£13.95

All prices include V.A.T.

Full range of Calculators & Watches

COMPUTER SALES 01-636 5560 (Mike Slaughter)

CALCULATOR SALES 01-636 8161

224 TOTTENHAM COURT ROAD
LONDON W.1

Euro-Calc Ltd

MICRO-FACILITIES

127 HIGH STREET
HAMPTON HILL
MIDDLESEX **01-979 4546**
01-941 1197

MIDDLESEX & S.W.LONDON

Approved Business Dealers for:

Commodore Computers & Business Packages
Apple II
North Star Horizon
IMS 5000/8000 Series

As fully authorised Dealers for the above equipment, and as experienced data processing professionals, we are the best people to help you.

Our complete package offers you:

Free initial discussion & advice
Systems Design & Programming
Software Packages
Supply & Installation of equipment
Leasing & Financing terms
Full Maintenance Contracts
Genuine After Sales Service

Contact us to discuss your problems and requirements, we offer you a lot more, but only charge the same. Our ability will give you peace of mind and confidence that the job will be done properly.

WEST MIDLANDS

If you want a computer
for business use
consult the experts!

PAYROLL
STOCK CONTROL
PURCHASE/SALES
STOCK/INVOICING
INSURANCE BROKERS
VISICALC
WORD PROCESSING
MAILING LIST
etc.

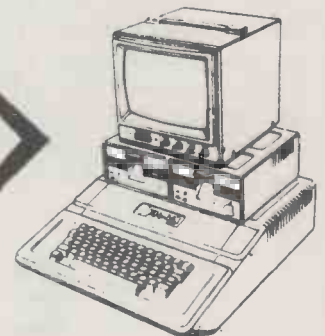

 **apple II** SALES AND LEASING

LEASE AN APPLE II 48K SYSTEM INCL.
TWIN DISK DRIVES, MONITOR AND PRINTER
From £11.50 per week!

MICRO BUSINESS CENTRE LTD.

Castle Bridge House, Lichfield Road
Wednesfield, Wolverhampton
Tel: 0902 725687 for Sales and Service

PRINTER SUPERMARKET

COMPLETE SYSTEMS

NEW LOW PRICE £1095

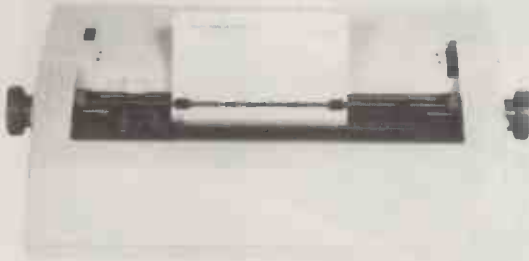

**60 CHARACTERS PER SECOND
RICOH RP-1600
THE FASTEST DAISY WHEEL PRINTER.**

FAST, heavy duty commercial DAISY WHEEL printer, with high quality printout, coupled with low noise necessary for office environment. Nationwide service by NEXOS. 90 day warranty provided at your premises.
124 char: upper/lower case. • 10/12 chars: per inch giving 126 or 163 columns. • 15 inch wide frintion platen. • /reverse Top of the form, BOLDING, underline, and host of other features. • Centronics type parallel interface as standard. options: serial interface 60 • PET interface 65 • APPLE interface 75.

NEW SUPER BRAIN DUAL DENSITY £1595/QUAD DENSITY £1995



NOW WITH CP/M 2.2, & INCREASED DISC STORAGE. TWIN Z80-A 1MHZ • 2 DISC DRIVES, DUAL DENSITY 320 K QUAD DENSITY 700 K STORAGE • 64 K RAM • HIGH RESOLUTION 12 INCH CRT. 80 x 24 LINES UPPER/LOWER CASE • 2 RS-232 PRINTER PORTS • CPM 2.2 OPERATING SYSTEM • MBASIC, COBOL, FORTRAN, PASCAL, WORD PROCESSING & ACCOUNTS PACKAGES AVAILABLE. DEALER ENQUIRIES INVITED

NEW LOW PRICE £1095



NEW TRS-80 MODEL 1 48K SYSTEM WITH DUAL DISC DRIVES.

NEW GREENSCREEN VDU, WITH ROCK STEADY DISPLAY, REDESIGNED 32K EXPANSION INTRFACE WITH TROUBLE FREE DISC OPERATION, TWO 40 TRACK TEAC DISC DRIVES, COMPLETE WITH CABLES. TRIDATA SALES, PURCHASE, INVOICING, PAYROLL PACKAGES AVAILABLE. WITH DESK AND EPSON PRINTER £1495

OKI MICROLINE 80/132. THE QUIET PRINTER YOU CAN LIVE WITH

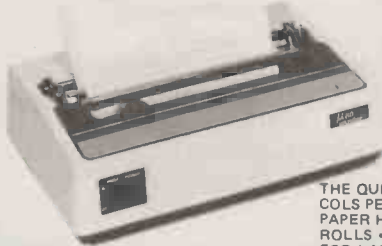

NOW WITH £ SIGN
NEW LOW PRICE
£399

THE QUIETEST DOT MATRIX AVAILABLE. 40, 80, OR 132 COLS PER LINE • EXCELLENT PRINT QUALITY • 3 WAY PAPER HANDLING: LETTERHEADS, FANFOLD, OR PAPER ROLLS • GRAPHICS • IDEAL FOR SOFTWARE WRITTEN FOR LARGE 132 COL PRINTERS • CONTINUOUS RATING PRINTING DAY IN AND DAY OUT • CENTRONICS PARALLEL STANDARD. OPTIONS: RS-232, PET, APPLE. DEALER ENQUIRIES INVITED

NEW MAXI ANADEX WITH GRAPHICS £895

Takes up to 13.5 inch wide paper • Upper/lower case with decenders • £ sign • 132 or 175 chrs/line with double width printing • Fast 150 CPS bi-directional logic seeking printing • Heavy duty print head giving 650 million chrs print life • serial, Parallel and Current Loop interfaces built in • Host of other features found on printers costing twice as much.



EPSON TX-80 £325



DOT-MATRIX PRINTER PET GRAPHICS. PRINTS 80 COLUMNS ON PLAIN PAPER AT 90 CHARACTERS/SECOND. ADJUSTABLE TRACTOR • UPPER/LOWER CASE • DOUBLE WIDTH PRINTING • MICRO CONTROLLED • SELF TEST • HEAVY DUTY PRINT HEAD USING JEWELL BEARINGS FOR LONG LIFE • MADE BY SHINSHU SEIKI AN AFFILIATE OF SEIKO WATCH CO OF JAPAN. INTERFACE: CENTRONICS PARALLEL. OPTIONS: PET, APPLE, AND SERIAL.

TRS-80 MODEL II



STATE OF THE ART SECOND GENERATION COMPUTER. OVER 10,000 ALREADY SOLD IN USA. 8 SLOT BUS ENSURES EXPANSION OF HARD DISCS & OTHER PERIPHERALS. 76 Key professional keyboard, self test on POWER UP. TRSDOS & LEVEL III BASIC STANDARD. CP/M AVAILABLE AS OPTION, making a wide range of accounting, educational, scientific & word processing packages instantly usable. NATIONWIDE SERVICE THROUGH 180 TANDY STORES & COMPUTER CENTRES.

NOW WITH CP/M 2.24
£1999

LOW COST WORD PROCESSOR I

BASED ON TRS-80 LEVEL 2 16K, CASSETTE RECORDER, ELECTRIC PENCIL SOFTWARE, UPPER/LOWER CASE MOD, PRINTER INTERFACE AND OKI DOT MATRIX PRINTER. COMPLETE READY TO GO £895 FREE MAILING LIST PROGRAM. WORD PROCESSOR II SAME AS ABOVE BUT WITH 48K, 2 DISC DRIVES AND RICOH DAISY WHEEL PRINTER £2195

WORD PROCESSOR III

BASED ON SUPERBRAIN COMPUTER SHOWN ABOVE. WITH RICOH PRINTER & "MAGIC WAND" THE ULTIMATE IN WORD PROCESSING. LETTERS AUTOMATICALLY FORMATTED WITH ADDRESSES FETCHED FROM SEPARATE FILE. COMPLETE SYSTEM £2950 INVOICING, STOCKCONTROL, SALES LEDGER, PURCHASE LEDGER, PAYROLL AVAILABLE FOR ABOVE COMPUTERS. FROM £250 PER PACKAGE.



ANADEX DP-8000 NEW LOW PRICE £449

FAST 112 CHARACTERS PER SECOND • BOTH RS-232, AND CENTRONICS PARALLEL INTERFACES BUILT IN • UPPER/LOWER CASE WITH £ SIGN

PRICES QUOTED ABOVE DO NOT INCLUDE VAT. PHONE OR CALL FOR FURTHER DETAILS OR DEMONSTRATIONS.

LONDON COMPUTER CENTRE LIMITED
43, GRAFTON WAY, OFF TOTTENHAM COURT ROAD, LONDON W1
TEL: 01-388 5721 OPENING HRS: 11-7 MON-FRI, 12-4 SATS.

INDEPENDENT COMPUTER ENGINEERING LTD

CROMEMCO Systems & Software

SYSTEM ZERO – the latest low cost computer from Cromemco,

CP/M 2.2 for Cromemco systems **£95**

10 Megabyte Cartridge Disk
(5 Megabyte fixed 5 removable)
and controller for the S100 Bus

£3,950 including installation
(London area)

We supply computer solutions to business problems

- * Software packages
- * Hardware maintenance
- * Hardware configuration and design

We also have an "Aladdin's Cave" of computer spares, power supplies, boards, chips, etc. etc.

For further details and information, please contact:

Independent Computer Engineering Limited,
16/18 Littleton Road, Ashford, Middlesex.

Tel: (07842) 47171/2

Telex: 8952042 (DPCUST G)



EPSON – MX80 DOT MATRIX PRINTER

The printer you have been waiting for

- * 9x9 matrix (true descenders in lower case)
- * 80cps bidirectional printing with logical seeking print head (maximises throughput)
- * 96 ASCII character set, plus 64 graphics incorporating 4 switch selectable European language options.
- * Programmable forms handling
- * 12 different print modes, up to 132 characters per line
- * Operator controls and indicators, including self test feature.
- * **£395** – with standard parallel interface (interface options – RS232, Pet, TRS80, MZ80 Apple).

ALL PRICES EXCLUDE VAT

CASSETTE SOFTWARE FROM ENERTECH

PASCAL-16/C

FOR

RML 380 Z

NASCOM 2

THIS IS AN INTERACTIVE INTERPRETER/COMPILER AND EDITOR AVAILABLE ON CASSETTE. PASCAL SOURCE PROGRAM MAY BE INTERPRETED, COMPILED AND EXECUTED IN A STEP-BY-STEP MODE. INDICATED ERRORS MAY BE RECOVERED AND EDITED. COMPILATION IS TO COMPACT, RELOCATABLE MAPPCODE AND THE MAPP 1.4Z FLOATING POINT PACKAGE IS INCLUDED. A MINIMUM 16K RAM PLUS VIDEO RAM IS REQUIRED. FULLY DOCUMENTED.

– IDEAL AS A TEACHING AID –

THE FOLLOWING SUBSET IS SUPPORTED:

Constants: numerical: ranges $\pm 1.469 \times 10^{-39}$ to $\pm 1.701 \times 10^{+38}$ character and character string: ASCII

Variables: integer: range ± 65535
real: ranges $\pm 1.469 \times 10^{-39}$ to $\pm 1.701 \times 10^{+38}$
character: ASCII

Operators: + - * DIV MOD
real: + - * /
real (non-standard): **
boolean: NOT = <> << >> <= >=

Functions: Integer: ABS SQR
inter/real: ROUND TRUNC
integer/char: ORD CHAR
real: ABS SQR SQRT SIN COS ARCTAN LN EXP
real (non-standard): RCPL SIND COSD ARCTAND
(degrees) LOG (to base ten)

Procedures: value and variable parameters

Controls: BEGIN – END REPEAT – UNTIL WHILE – DO
FOR – TO/DOWNTO – DO IF – THEN – ELSE

Input/output: READ READLN EOLN
WRITE WRITELN: expressions, character strings

Editor commands: NEXT, FIND, ERASE, INSERT, CANCEL,
LIST, INPUT DATA, EXECUTE, RESET.

Licensed for use on one system only.

PRICE £35.00 PLUS VAT, INCLUSIVE OF U.K. CARRIAGE, C.W.O.

RML versions in stock (please state whether COS 2 or
COS 3 is required)

NASCOM 2 version (Nas-syst) due early December.

Please send cheque or P.O. to:

ENERTECH LTD

32 GILDREDGE ROAD, EASTBOURNE, EAST SUSSEX, BN21 4SH

the software house

OUR NEW ILLUSTRATED
INFORMATIVE
CATALOGUE IS NOW
AVAILABLE
£1
(FULLY REFUNDABLE
AGAINST FIRST
PURCHASE)

146 Oxford Street, London, W1.

Dealer Enquiries welcomed:
Telephone 01-637 2108

SC

SIRTON COMPUTERS

76 Godstone Road, Kenley (Nr Croydon)

Surrey CR2 5AA

Tel: 01-668 0761/2

MIDAS S100 SYSTEMS

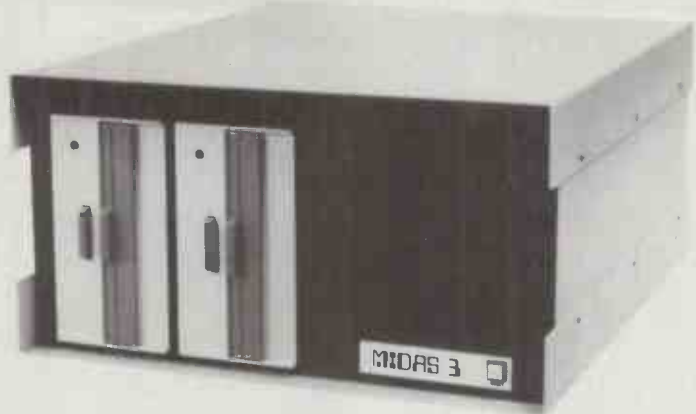
MIDAS 1 : From £750**MIDAS 2 : From £1580****MIDAS 3 : From £2150****MIDAS 4 : From £5900****ITHACA-DPS 1 : From £1075**

- Our versatile Z80 Microcomputers are available as standard units or custom configured to your exact specification from a comprehensive range of stocked S100 boards.
- Disc storage capacity of the MIDAS 3 can be 2M Bytes, expandable to over 20M Bytes with a Winchester Hard Disc Unit in our MIDAS 4 range.
- MIDAS runs CP/M and MP/M is also available. Other Software includes M-BASIC, C-BASIC, FORTRAN, COBOL, CIS-COBOL, PASCAL and Word Processing.
- A MIDAS 3, with 64K RAM and 2M Bytes storage on two 8" drives with two Serial I/O Ports and CP/M 2 only £2600.
- Printers, VDUs and other peripherals stocked to give complete package systems at keen prices.
- Business Packages include Accounts, Stock Control, Purchase Ledger etc etc.

Boards stocked from Ithaca, Godbout, SSM, S D Systems, Vector, Micromation Mullen, Mountain Hardware, Hi-Tech, Video Vector, Pickles & Trout, Central Data, Cromemco, Thinker Toys – Send for full Price List (many available in kit form).

PROCESSOR

Z80 Starter Kit	£188
SBC100	£208
SBC200	£237
Z80 CPU's4 MHz	from £130

EPROM

2708 EPROM (16K)	£60
2708/2716 Programmers from	£134

VIDEO

16 lines, 32/64 ch	from £104
24 Lines, 84 ch	from £265

DISC CONTROLLERS

Versafloppy S/D	£198
Doubler D/D	£280

SOFTWARE

CP/M 1 & 2, MP/M, PL/1, C-BASIC 2, M-BASIC V5, XYBASIC, FORTRAN 80, COBOL 80, CIS-COBAL, PASCAL/Z, PASCAL (UCSD), PASCAL M/T, Forth, MAC, ZSID, Disassembler, Wordstar, Datastar, Magic Wand, Wordmaster, Supersort etc etc.

RAM

Dynamic RAM 16K – 64K	from £205
Static RAM 8K – 64K	from £95
Memory Manager	£52

I/O

2S/4P prov 4K RAM/4K ROM	£169
2S/2P or 2S/4P or	
3P/1S or 4S/2P	from £135
Analogue 8 or 12 bit	from £287
Optically isolated I/O	£114
IEEE 488 Interface	£350

MISCELLANEOUS

Real Time Clock	£180
High Dens Graph/8K RAM	£333
Hi-Tech Colour	£295
Motherboards – various from	£34
Extender Board/logic probe	£39
Maths Board AMD 9511	£330

**WE ARE THE SOLE U.K. DISTRIBUTORS FOR INTEGRAND S100 MAINFRAME
DISC ENCLOSURES ETC.**

NEW

Introducing the incredible **BIGBOARD Z-80 CPU!** Single Board Computer Kit

64K RAM!
**FLOPPY DISK
CONTROLLER!**
24x80VDU!

AT ONLY

£395⁰⁰ plus
VAT

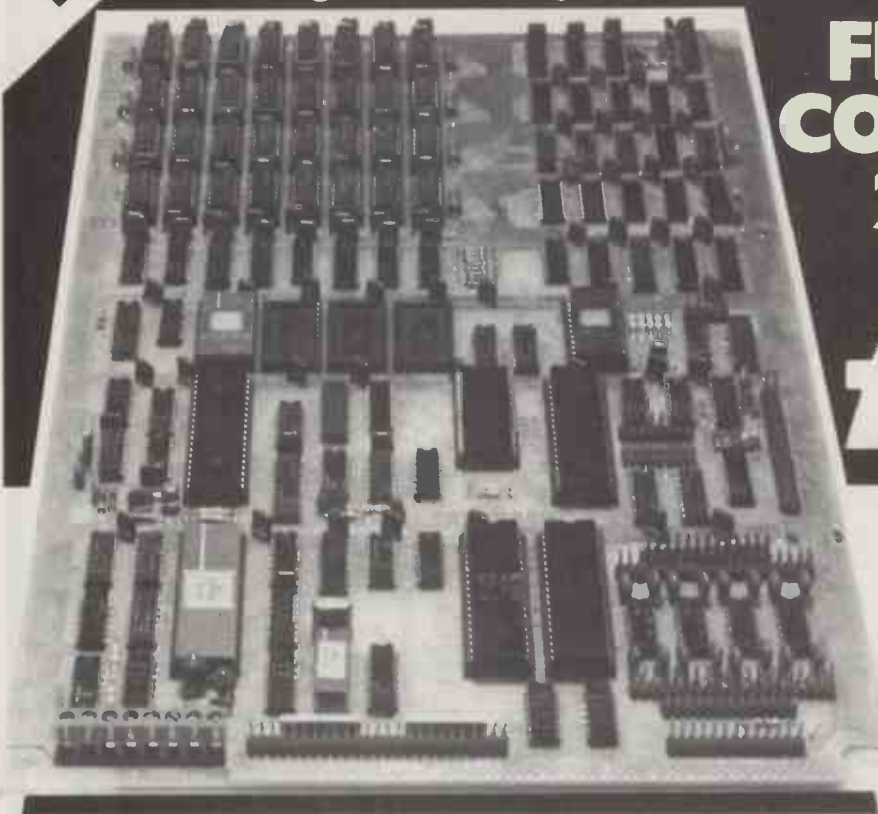

it packs twice as much
on **ONE BOARD** – at around
HALF THE PRICE!

It's taken three whole years to produce the BigBoard, designed from scratch to run the latest version of CP/M, so just imagine what software you could run **WITH NO MODS NEEDED!** In fact, add a couple of 8" Disk Drives, a Video Monitor and Keyboard, then an enclosure and connect a suitable Power Supply and you'll have a Total Business System for about **ONE THIRD** the cost! That's what you call BigBoard flexibility, power – and sheer operating value. Send for your BigBoard today!

Size 8½ x 13¾ inches. Requires + 5V @ 3 Amps +/- 12V @ 0.5 Amps.

YOU GET THESE FEATURES

64K RAM	That's 64K of usable RAM space using industry-standard 4116s. All 64K is available to the user, (video and EPROM sections do not make holes in it, for example), and extra special care has been taken to ensure that the RAM array PC layout eliminates potential noise and malfunction.	80 x 24 Character Video	Gives a crisp, flicker-free, sharp display even on the smallest monitors. Hardware scroll, full cursor controls, composite or split video and sync. The character set is supplied on a 2716 style ROM (makes customised fonts that much easier!), and sync. pulses can be any desired length or polarity. Video can be inverted or true.
Z-80 CPU	Handles all 4116 RAM refresh and supports all MODE 2 INTERRUPTS. Fully buffered, the Z-80 runs all 8080 software.	Basic I/O	A separate parallel port (Z80 P10) for use with an ASCII encoded keyboard for input. Output on the 80 x 24 character video display.
Floppy Disk Controller	Uses the WD1771 controller chip with TTL Data Separator for reliability. IBM 3740 compatible, it will support up to four 8" drives and is directly compatible with standard Sugart drives such as the SAB00 or SAB01. Drives can also be configured for remote AC off-on. Runs CP/M 2.2.	PFM 3.0 2K System Monitor	The on-board PFM 3.0 is the real power behind the BigBoard. PFM commands include Dump Memory, Boot CP/M, Copy, Examine, Fill Memory, Test Memory, Go To, Read and Write I/O Ports, Disk Read (Drive, Track, Sector) and Search. But, PFM occupies one of the four 2716 EPROMs, so it doesn't occupy any of the 64K of usable RAM!

PLUS THESE OPTIONS

Serial I/O	Full 2 channels using the Z-80 S10 and the SMC 8116 Baud Rate Generator. You get FULL RS232! For synchronous or asynchronous communication, and clocks can be transmitted or received by a modem in the former. Both channels can be set up for either data communication or data terminals. Supports mode 2 Int. PRICE JUST £60 !
Four Port Parallel I/O	Uses Z-80 P10 to give full 16 bits, fully buffered and bi-directional. User selectable hand-shake polarity, and set of all parts and connectors for parallel I/O ONLY £25 !
Real Time Clock	Uses Z-80 CTC and can be configured as a counter on Real Time Clock. Set of all parts ONLY £12 !
CP/M 2.2	The popular CP/M D.O.S. as modified by Micronix Systems to run on the BigBoard is just £99 !

Please send me _____ BigBoard/s at £460 (including £60 VAT and £5 INSURED DELIVERY) each, total

£ _____ And

_____ Serial I/O at £69 (inc. VAT) each, total £ _____

_____ Four Port Parallel I/O at £28.75 (inc. VAT) each, total £ _____

_____ Real Time Clock/s at £13.80 (inc. VAT) each, total £ _____

_____ CP/M 2.2 at £113.85 (inc. VAT) each, total £ _____

I enclose cheque for £ _____, or PAY BY ACCESS, giving card number and signature. Cheques payable to Maclin-Zand Electronics Ltd., please. Cash with order.

Name _____



ACCESS
NO _____

Address _____

Signature _____

Sole European Distributor.
Maclin-Zand Electronics Limited,
38 Mount Pleasant, London WC1X 0AP.
Tel: 01-278 7369/01-837 1165 Telex 8953084

PCWBB



Maclin-Zand

Making state-of-the-art affordable.



If you are puzzled by the lack of good application software for CP/M micros; then puzzle no longer. - Ask about

We are exclusive distributors for UK of SERENDIPITY SYSTEMS packages for Apple & CP/M; of MAGSAM index sequential access routines for CBASIC and MBASIC and IFO-Information File Organiser - the best data base package available for use with Apple.

DATAFLOW

The easy-to-use, fast and flexible Data Base Management and Information Retrieval package.

Also ask about; Inter-Stat, Advanced Maths and Video Message packages for Apple
Ask for leaflet on; Serendipity Ledgers and Stock Control for CP/M Professional
Client Billing for Accountants, Lawyers etc.



GREAT NORTHERN Computer Services Limited

55 East Parade, Harrogate, HG1 5LQ Telephone [0423]501131 Telex 57453 For Great Northern
116 Low Lane, Horsforth, Leeds LS18 8PX. Telephone (0532) 589980

3D

Digital Design and Development

18/19 Warrén Street · London W1P 5DB Tel: 01 387 7388

CBM PET SHARP MZ-80K

Specialist Suppliers of Complete Systems for Industrial and Laboratory Monitoring and Control.

Please note our new address. Callers welcomed for demonstration and/or discussion.

SHARP MZ-80K INTERFACES

- Parallel Printer Interface £110
- Serial Printer Interface £150
- Bi-Directional Serial Interface £210
- 16-Channel A/D Convertor Unit £280
- Fast Data Acquisition System - 40,000 readings/sec. 4 analog channels IN and 4 channels OUT. P.O.A.

PET INTERFACES

IEEE-488 Compatible Units

- 16 Channel 8-Bit A/D Convertor £300
- 8 Channel 8-Bit D/A Convertor £350
- 8 Channel 12-Bit A/D Convertor £600
- 12-Bit D/A Convertor P.O.A.
- X-Y Analog Plotter Interface £200
- Digital Data Input Unit, 64 Bits £400
- Digital Data Output Unit, 64 Bits £350
- 16 Channel Relay Unit £350

Also....

- USER Port Converter A/D plus D/A £200
- Fast Data Acquisition System 40,000 readings per sec. 4 A/D + 4 D/A P.O.A.

All units boxed complete with IEEE-488 address internally selectable, with integral power supply, cables, switch, fuse, indicators and illustrative BASIC software.

TERMS: All prices EX-VAT. P&P extra. Cheques should be made payable to 3D Digital Design & Development. All goods supplied under 90 days warranty. CUSTOM DESIGN UNDERTAKEN



New and exciting Applesoft programs

NEW! the correspondent

By Roger Wagner

by R. Wagner

THE CORRESPONDENT is sure to be one of the most versatile programs in your library! It can be used as:

A Text Processor: Upper/lower case, 1-80 cols. (4-way scrolling). Text move/copy/insert/delete, tabbing, justify text, auto-centering and more!

A Database (with or without printer!) Extremely fast find routine and easy editing make it a natural for free-form data files. Create and fill out forms, access phone lists or index your magazines.

A Programming Utility: (printer or not). Examine, edit, transfer random or sequential text files. Create versatile exec. files. Even put bi-directional scrolling in your own programs!

Apple disk £29.95 + VAT

Roger's Easel

by R. Wagner

At last a program which allows you to draw colour pictures in lo-res graphics, and then permanently link them to your own Integer or Applesoft programs. Linked pictures can be displayed on either text/graphics page. (Integer basic).

Apple disk £14.95 + VAT

Apple-Doc By Roger Wagner

An Aid to the Development and Documentation of Applesoft Programs

This 3 program set is a must to anyone writing or using programs in Applesoft! It not only provides valuable info. on each of your programs, but allows you to change any element throughout the listing almost as easily as you would change a single line!!

With Apple-Doc you can produce a list of every variable in your program and the lines each is used on, each line called by a GOTO, GOSUB, etc., in fact, every occurrence of almost anything! You can rename variables, change constants and referenced line numbers or do local or global replacement editing on your listing.

Apple-Doc is a must for the serious Applesoft programmer.

Diskette complete with full documentation £24.95 + VAT

tridee

©Robin L. Frost

An exciting new addition to your Pascal library — enables you to create 3D graphics, viewable from any angle and distance. As easy to use as Turtlegraphics.

Procedures include Ortho, Perspec, Rotate, View, Move to-3, View-from.

Complete with comprehensive instructions £49.95 + VAT

Apple World

is here. The fast 3D graphics package that runs on your Apple II plus. Zoom, pan, tilt and scale your own designs on the Apple screen, at only £24.95 + VAT

Plus a complete range of "off the shelf" programs for finance, commercial, scientific and education. Keep yourself up to date, send for our "Fact Sheets" giving full program details.

Now available Apple FORTRAN, Dos 3.3, Apple Plot

LEICESTER computer centre limited

109 QUEENS ROAD LEICESTER LE2 1TT

Tel: 0533 709841

apple computer Sales and Service

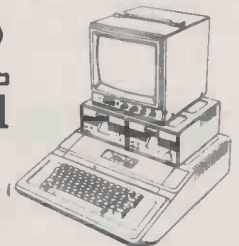

Color — at Black-and-White Prices

DYAD Developments

The Priory - Great Milton - Oxon - OX9 7PB - Tel (08446) 729

DEALER INQUIRIES WELCOMED

COMPUCOLOR II

- 19" COLOUR MONITOR for COLOUR GRAPHICS etc
- 11: in MINIFLOPPY DRIVE \$1.2K per side
- pressive EXTENDED BASIC on 16K ROM
- 43H RESOLUTION GRAPHICS 128x128
- RS232C port: simplified PRINTER or MODEM etc.

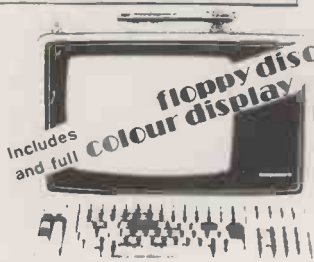

SYSTEMS/UTILITY	
ASSEMBLER (16K)	£15.00
TEXT EDITOR (16K)	£15.00
PERSONAL DATA BASE (16K)	£25.00
MONITOR (16K)	£12.50
SCREEN EDITOR (16K, 117KEY)	£20.00
FORMATTER	£20.00
DEBUGGER (16K)	£20.00
PILOT (16K)	£30.00
FORTRAN (32K)	£40.00
ALGEB (32K)	£25.00
EDUCATIONAL	
BASIC LANGUAGE VOL. 1	£15.00
MATH TUTOR	£12.50
HANGMAN	£12.50
ENGINEERING	
STATISTICS 1 (16K)	£15.00
STATISTICS 2 (16K)	£20.00
STATISTICS 3 (16K)	£20.00

GAMES

- Formatted Twin Pack Sampler
- Obello
- Chess
- Star Trip
- Blackjack
- Card's Tic Tac Toe
- Sharks
- Ali's Raid
- Star Trader
- Swarms
- Bounce
- Shoot
- Lunar Lander
- Solitaire
- Naze Master

Trendspotter - The Trendspotter software package is a "state-of-the-art" Management Information system which fully utilizes our products colorgraphic capabilities. Data is entered and stored on files created by the user. Trendspotter will automatically scale the data to fit within the graphic display. The display can be labeled according to the users needs and the various files plotted in any of the eight foreground or background colors for comparative analysis. Four graphic modes are available and data can be manipulated to account for lag and lead times, trend forecasting, exponential smoothing, simple linear regressions, moving averages, compound growth calculations, inflation and deflation compensation, detrending of data, and "trigger point" functions.

Compewriter - The Compewriter was designed specifically for the Compucolor II and the ISC 3621. This package includes the necessary keyboard conversions, documentation, and software to turn your computer into a powerful text editing machine. Compewriter incorporates the best features of the leading word-processing systems including single key command entry, full screen editing and print formatting on the screen.

The Color Advantage

Research studies chronicled in such professional publications as the *Journal of Applied Psychology* and the *Journal of Experimental Psychology* as well as extensive on-the-job experience have proven repeatedly that color displays convey information more quickly and more effectively than any other visual method. Color-

coded displays lead to easier data recognition, thus minimizing search time and permitting faster operator response. Color dramatically reduces operator fatigue and can cut costly error by as much as 80%.

NEW! in the

Intecolor 8000 Series Desktop Computers



Color Communicates Better

CP/M Compatible Desktop Computers

These Intecolor desktops are designed to give small businesses the advantages of both color graphics and an abundant selection of readily-available software. There are CP/M programs for virtually any business application, which minimizes the need for specially-prepared software.

Intecolor CP/M compatible desktops are available in the 13" contemporary case (model 8363), 19" contemporary case (model 8963) and 19" standard case (model 8063).

CP/M Operating System

The CP/M operating system is the latest version of CP/M, and is stored on Soft-Disk™. When loaded, it allows the user to run any CP/M program without modification, whether it's in BASIC, COBOL, FORTRAN IV or any other programming language.

Languages

A Soft-Disk containing ISC's color version of Microsoft® Business BASIC is also included. It provides 19 commands, 29 program statements, 15 input statements, 25 arithmetic functions, 15 string functions, and 9 input/output functions. In addition Microsoft COBOL and FORTRAN IV are available as options.

Memory and Mass Storage

CP/M compatible desktops are equipped with 32K of user RAM (expandable to 48K), and 8K of ROM. Two disk drives are available: the 591K dual 8" floppy disk drive and the 1182K double-headed drive.

COMPUCOLOR 11

prices excl. VAT

MODEL 3, 8K RAM	£ 995.00
MODEL 4, 16K RAM	£1078.00
MODEL 5, 32K RAM	£1198.00
COB 101 KEYBOARD	£ 80.00
COB 117 KEYBOARD	£ 120.00
MODEL 9, "TUTOR", 25"	£1580.00
COMPUCOLOR "EXECUTIVE" MODEL	TBA

MISCELLANEOUS HARDWARE

RS232C ADAPTOR CABLE	£ 25.00
LOWER CASE CHARACTERS	£ 85.00
ADD-ON RAM, 16K	£195.00
ADD-ON PROM BOARD	£ 45.00
SOFTWARE	£ 30.00
KEYBOARD UPGRADE 72-101	£ 95.00
KEYBOARD UPGRADE 72-117	£135.00
KEYBOARD UPGRADE 101-117	£ 55.00
MAINTENANCE MANUAL	£ 25.00

All systems include an Instruction Manual, Programming Manual, Sampler software Demo programs and six months free subscription of Colorous Users Newsletter.

Trident



£670.00



£2650.00

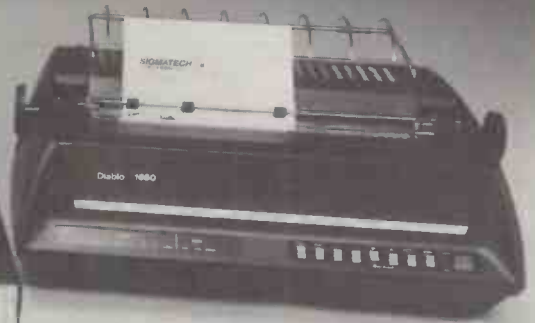

£2150.00

Configuration shown is for word processing including WORDSTAR £5450

- ★ Full Business Systems available
- ★ 64K 4MUZ Memory
- ★ Rack Mounting available
- ★ Interface to most VDUS and printers
- ★ Wide range of high level Languages available
- ★ Fastest CPM Machine
- ★ 6 slot S100 mother board
- ★ 2 or 4MBYTE Disc Storage

SIGMATECH LTD.
ELECTRONICS

For further information:- Tel: (0734) 587000
22, Portman Road, Battle Farm Estate, Reading, Berks.

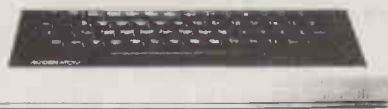

Acorn Atom

SOFTWARE ON QUALITY CASSETTES.

2K PROGRAMS: Moon-landing, Reaction test, Torpedo, Hangman. All four on one cassette for ONLY £5.00.

4K PROGRAMS: Alien destroy; Bio-rhythms; Battleships; Horse race; Pontoon; Minefield @ £3 EACH.

SPECIAL OFFER! All six on 2 cassettes for ONLY £15.

NOW AVAILABLE - ATOM BREAKOUT game (4K) @ £4.00
PINBALL (6K) - uses graphics mode 2 - £6.

sinclair

ZX80 software ONLY £3 PER CASSETTE OF PROGRAMS

- No.1 Moon-landing, Reaction-tester, Hangman, Code-breaker, Intercept.
- No.2 Bio-rhythms, Solitaire, Battleships, Dice.
- No.3 Remcard, Bingo, Sequences, Letter-shuffle.
- No.4 Sine & Cosine, Area of circle, Simultaneous equations, Simple differentiation, Averages.
- No.5 Guess & gamble, Number sort, Treasure hunt, Fruitmachine
- No.6 Horse race, Secret codes, Stopwatch.

SPECIAL OFFER ALL SIX CASSETTES FOR ONLY £15

ZX80 PROGRAMMING COURSE - book & cassette of programs deal with arrays, PEEK&POKE, machine code etc. £7.50.

NASCOM 2 SOFTWARE uses Nas-Sys & graphics. On cassette.

Football @ £3; Nascom Breakout @ £4; Squash @ £3.

ALL PRICES INCLUSIVE MAIL ORDER ONLY.

BUG-BYTE

251 HENLEY ROAD COVENTRY
CV2 1BX

COMPUTER KITS

TANGERINE

Microtan 65 kit £69.00
Tanex (min. Config.) £43.00
Tanex expanded kit £106.00
Keypad/full ASCII keyboard,
P.S. Mother board, cabinets
etc.

TUSCAN

Single Bd. 1K RAM
2K Monitor, incl. Video
£235.00

56 Keyboards for Tangerine and Tuscan £39.50
Video Genie 16K RAM with cassette £365.00 oncl. V.A.T.
Software available for the Video Genie

Wide selection of Books including:

By ZAKS:

Ref:

200 Programming the Z80	8.95	167 How to make money with your Micro-computer	5.75
60 Programming the 6502	6.95	168 Microsoft BASIC	6.75
155 6502 Applications	7.95	187 6502 Assembly Language	8.25
258 6502 Games	8.95	195 BASIC Handbook	11.00
279 CP/M Handbook	8.95	203 The Best of Micro Vol 1.	5.50
By others:		204 The Best of Micro Vol 2.	6.50
174 Programming in PASCAL	6.95	212 6502 Software Design	7.95
194 Learning Level 11 BASIC TRS80	11.00	224 BASIC cookbook	3.95
211 TRS80 Interfacing BK1	6.95	226 Beginners Guide to Computers and Micros	5.00
217 Z80 Micro Design Projects	9.15	243 Microprocessor Cookbook	4.65
261 TRS 80 Disk and Other Mysteries	11.95	280 Your First Computer	5.95
267 Introduction to T Bug	6.25	212 Crash Course in Micros	10.65
154 S-100 & Other Micro Buses	5.15	278 The Personal Computer Guide	5.15
264 PET Personal Computer Guide	10.50	212 Machine Language from the Ground up	8.50
29 Cheap Video Cookbook	4.95		
40 BASIC BASIC	6.50		
159 Z80 Assembly Language	8.15		

Other books available, why not send for list. VAT Extra (where applicable) Post and Packing extra

MICRO-PRINT LTD

59 Church Street, Stoke-on-Trent, Staffs ST4 1DQ
Tel: (0782) 48348

SOFTY Software Development System AND EPROM PROGRAMMER

EX-STOCK

SOFTY is intended for the development of programs which will eventually become software residing in ROM and forming part of a microsystem. During the development stage of a microsystem, SOFTY will be connected in place of the firmware ROM via a ribbon cable, terminated in a 24 pin DIL plug.

Data may be entered into the SOFTY RAM via the serial port, parallel port, direct memory access, or the keypad, and manipulated using the assembler key-functions. When the program has been entered, and the internal microprocessor can be 'turned off', and the external microsystem and its resident microprocessor allowed to access and run the program in SOFTY's RAM and/or programming socket. In this way, modification can be made until the required program is complete — the contents of the RAM being clearly visible as a 'page' on TV or monitor. 4 pages are available, 2 of the Data RAM and 2 of the programming socket.

In the end, when the program is complete and working, the DIL plus is removed and replaced by an EPROM device programmed by SOFTY. SOFTY is able to program the 2704/2708/2716 family which have 3 voltage rails —

To help in the process of program development SOFTY has various assembler key-functions, which include — block shift without overwriting, block store, cursor control, match byte and displacement calculations (for jumps etc). A high speed cassette interface is also provided for storing working programs and useful subroutines.

SOFTY kit of parts: (including zero insertion force socket for EPROM programmer) Price £100 + VAT (postage paid). SOFTY built & tested — £120 + VAT (postage paid). Built SOFTY power supply — £20 + VAT (postage paid). Write or telephone for full details.

NEW

SOFTY CONVERSION CARD — EX-STOCK
Enables SOFTY to program the single rail EPROMs 2508, 2758, 2516, (INTEL 2716), 2532.

Selection of device type and 1K block are by 4 way pcb slide switches. Programming socket is zero insertion force. Supplied ready built & tested with Dip jumper for connection to SOFTY, £40 + VAT (postage paid).

NEW

SOFTY PRINTER CARD — EX-STOCK

- 40 column electrosensitive printer • 5 x 7 dot matrix
- software selection of characters per line (1 to 16 bytes)
- push button printing of EPROM/RAM/Intercursor contents
- Connects to SOFTY card edge • Well documented • Supplied ready built & tested, including power supply, edge connector & paper roll for £145 + VAT (post paid), Spare paper rolls (28-30 metres/roll) — £6.96 + VAT

EX-STOCK EPROMS

	1-9	10-24	25-49	50up
2708 (450ns)	£4.80	£4.30	£3.90	£3.70
2716 (450ns)	£9.00	£8.00	£7.35	£6.60

Single rail
Deduct a further 5% for cash with order on these low EPROM prices.

Add VAT at 15%. Postage paid.

MODEL 14 EPROM ERASERS

EX-STOCK



MODEL UV 141 EPROM ERASER

- Fast erase times (typically 20 minutes for 2708 EPROM)
- 14 EPROM capacity
- Built-in 5 to 20 minute timer to cater for all EPROMs
- Safety interlocked to prevent eye and skin damage
- Convenient slide-tray loading of devices
- 'MAINS' and 'ERASE' indicators
- Rugged construction

Priced at only £78 + VAT post paid

MODEL UV 140 EPROM ERASER
Similar to Model UV141 but without timer
Low price at only £61.50 + VAT post paid
WRITE OR TELEPHONE FOR FULL DETAILS OR SEND CHEQUES/OFFICIAL COMPANY ORDERS TO:

GP Industrial Electronics Limited

Unit 6, Burke Road, Totnes Industrial Estate,
Totnes, Devon. Tel. Totnes (0803) 863360 Sales, 863380 Technical.
TRADE AND EXPORT ENQUIRIES WELCOME

Quality Compukit Software

SPACE INVADERS — 8K — £4.00. The ultimate game written especially for your compukit. Fantastic graphics are just one of the features of this excellent game.

STARTREK — 8K — £6.75. More exciting than games. Commands include L/R and S/R scans, phasers, photon torpedoes, warp drive and galactic map. Comes with full instructions.

BREAKOUT — 4K — £3.25. Our version of this popular cult pub game — it'll keep you amused for hours.

GUNFIGHT — 8K — £3.75. You v computer — and take it from us you won't find it that easy to beat!!

RAM TEST — £2.75. Test your "RAM" with this easy-to-use program. Comes with full instructions.

SOUND BOX SUITABLE FOR USE WITH UK101 AND SUPERBOARD II.

Now you can play tunes on your board with this easy to construct unit. It is easy to control in BASIC or M/C, with hardware volume control and tuning, and runs off the on-board power supply. The unit is complete in every way and comprehensive building, connecting and tuning instructions are supplied.

Every unit is supplied with a free game on tape.

KIT — £14.95

READY ASSEMBLED AND TESTED — £19.95
(please state UK101 or SII)

ALL OUR PROGRAMS ARE ON GOOD QUALITY TAPE AND PRICES ARE FULLY INCLUSIVE — NO HIDDEN EXTRAS WITH US!

For details of these and other products send large SAE to:

J.M. Electronics
PO Box 71, Norwich, NR6 7JE.

Floppy disc File



Easy reference filing system for your flexible computer discs, files 20 discs per binder. File sheets retain 4 discs, have reinforced binder edge and file reference tab. Leaves punched for 2 and 3 hole binders. Also available for 8" discs, files 10 discs per binder.

—Please state size when ordering

Binder complete with 5 leaves £4.95 + VAT

Pack of 5 leaves only £1.55 + VAT

BASF and Memorex mini discs £27 + VAT per box (10)

Clean your monitor screen with the revolutionary Quick Wipes, Anti-Static tissue. Removes dirt, dust and static in one wipe. £2.75 per can + VAT

LEICESTER
computer centre limited

109 QUEENS ROAD LEICESTER LE2 1TT Tel: 0533 709841

Erase Eproms in 8 minutes for under £100

£97 delivered in U.K.
+ V.A.T.

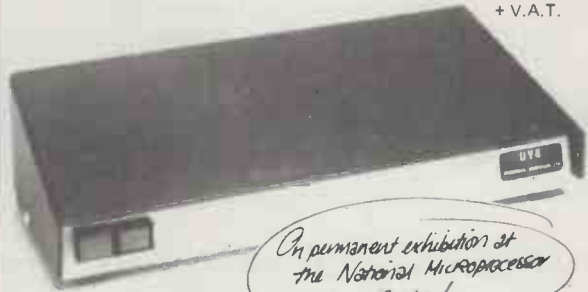

*An permanent exhibition at
the National Microprocessor
Centre!*

The high speed, high capacity model UV8 sets new performance and price standards.

- Cuts typical erasure times by a factor of 5
- 8 MINUTE SOLID STATE TIMER
- Capacity up to 14 EPROMS
- 2708 type erased in 4 to 7 minutes
- High intensity 254 NM UV source
- Safety interlock automatically starts timing sequence
- Audio tone signals erasure cycle complete
- Internal switch to extend erase time.

MICRODATA Computers Ltd, Belvedere Works, Bilton Way,
Pump Lane Industrial Estate, Hayes Middlesex.

Telephone (01) 848 9871 (6 lines)

Telex 934110

TRIDATA COMPLETE BUSINESS SOFTWARE PACKAGES

- | | |
|-------------------|-----------------------|
| * SALES INVOICING | for use on |
| * SALES LEDGER | * TANDY TRS 80 |
| * PURCHASE LEDGER | * TANDY TRS 80 Mk. II |
| * NOMINAL LEDGER | * SHARP MZ-80K |
| * PAYROLL | * PET AND SUPERPET |
| * STOCK CONTROL | * APPLE |

Our business packages are supplied with master diskettes, detailed operating manuals and training procedures. For small businesses and traders with up to 700 employees, 9,999 customers and 9,999 suppliers, our proven programs written by experienced DP professionals provide fast, simple control, with built in security routines for prevention of unauthorised use, abuse or mishandling. Over 550 Tridata business systems are now in use.

TRIDATA WARRANTY

Every Tridata program has a written 12 month warranty and can be automatically updated to conform to any legislation that may alter your accounting procedures.

SEND THE COUPON TODAY
OR TELEPHONE
021-622 6085

Tridata

TRIDATA MICROS LTD., Smithfield House, Digbeth, Birmingham

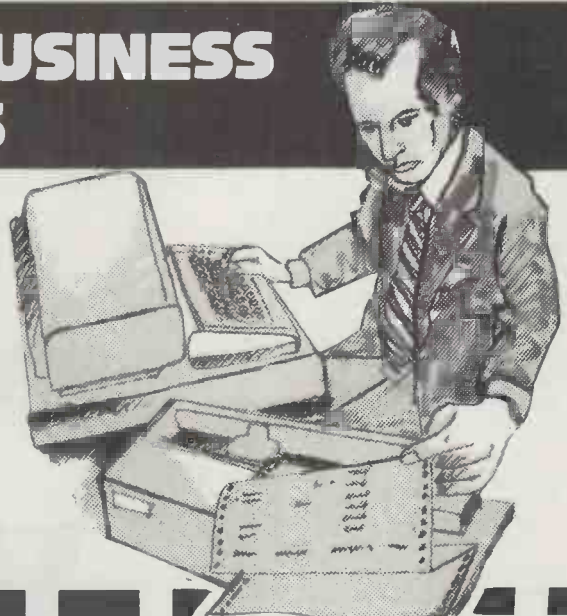

Send me details of the Tridata Business Software Systems. I am interested in

PURCHASE LEDGER	For	TANDY TRS 80
SALES LEDGER		TANDY TRS 80 Mk. II
PAYROLL		SHARP MZ-80K
NOMINAL LEDGER		PET
SALES INVOICING		SUPERPET
STOCK CONTROL		APPLE

Name _____
Company _____
Address _____

TRIDATA MICROS LTD., Smithfield House, Digbeth, Birmingham B5 6BS

IF

..... you want the best service
you need professional advice
years of experience impress you
you are trying to find the best computer equipment
as well as the finest software

MICROSOLVE

is the Company to contact

MICROSOLVE COMPUTER SERVICES LTD

3rd Floor (rear),
MIDDLESEX HOUSE,
29-45 High Street,
EDGWARE,
Middlesex.
(exit 4 M1/20 mins. West End).
(prices ex. VAT)

01-951 0218/9/0

We cover a full range of equipment including the APPLE II (from £695/16K); the MICROSTAR multi-user system (from £4,950) and the powerful ALPHA MICRO which will run 1 to 22 terminals — the most cost effective system available today.

WE OFFER A COMPLETE SERVICE which encompasses advice, systems design, sale and installation of computer and peripherals, as well as tailor-made software, where necessary. There are fully documented ACCOUNTING and WORD PROCESSING PACKAGES etc., for Accountants, Solicitors, Manufacturers, Retailers, Medical Practitioners in fact all business applications.

ALSO in stock are PRINTERS, VDUs, CONTINUOUS STATIONERY, DISKETTES, DISK BOXES, all from the best names in the computer world — TEXAS, LEAR SEIGLER, TALLY, QUME, PAPER TIGER etc.

So if you either wish to buy a computer to program yourself or take advantage of our service TELEPHONE NOW FOR AN APPOINTMENT.

MICROSOLVE MICROSOLVE

Master Your Micro FAST with...

Little Genius floppy diskette based courses will teach you, how to use your system and how to realise the full potential of the "Mighty Micro". These fully interactive computer lessons will guide you quickly to a high level of understanding and confidence in your ability to make the most of your microcomputer system.

Courses now available:

- Applesoft BASIC
- Advanced
- Applesoft BASIC
- Using your Apple
- PET BASIC
- Advanced PET BASIC
- Palsoft BASIC
- Advanced Palsoft BASIC
- Using your 2020



Little Genius

Each course, comprising a floppy diskette, and starting instructions, costs only £40.00 plus VAT.

SPECIAL "3 in one" OFFER for 3 courses covering the same system only £99.00 plus VAT.

Little Genius courses are available from most computer retail outlets, or direct mail order from:

LITTLE GENIUS

Suite 504, Albany House, 324 Regent Street, London W1R 5AA.
Telephone: 01-580 6361

Happy Memories

4116	200ns	£3.75	4116	150ns	£4.95
2114	450ns	£2.95	2114	200ns	£3.95
2708	450ns	£4.95	2716	5V	£9.95

Memorex soft-sectored mini-discs with free plastic library case £19.95 per 10.

Low profile I.C. sockets:

Pins: 8 14 16 18 20 22 24 28 40
Pence: 10 11 12 16 17 19 21 27 37

Euroconnectors:

64/96 Male (right angled) £2.39 64/96 Female £3.52

RS232 connectors (solder):

Male 25 way: £1.86 Female 25 way: £2.13
Hoods: 66p

ALL PRICES VAT INCLUSIVE

Please add 30p postage to orders under £10.
Government + Educational orders welcome
£10 minimum



Happy Memories
Gladestry
Kington
Herefordshire
HR5 3NY

Tel: (054 422) 618





Some new introductions by the Midlands Computer Centre...

We celebrate our first birthday with news of new introductions available from the Micro Computer Centre.

NEW HORIZON NEW CROMEMCO

In addition to Nascom and Commodore micro computers

PERIPHERALS

(Excluding printers)
Sharp Cassette Decks. Crofton 10" Cased Monitors.

PRINTERS

Nexos Ricoh RP 1600 Daisy Wheel Printer. Diablo Daisy Wheel Printer. Nascom Micro Imp. Dot Matrix Plain Paper Printer. Centronics Dot Matrix. Anadex Dot Matrix. Newbury Laboratories Dot Matrix Impact Printer.

ADD-ONS FOR NASCOM

Input/Output Board. PIO Kit. Counter Timer Kit. UART Kit. (Colour Board Programmable Character Generator Board. Floppy Disc System (Single Drive) available in September). Nas-Pen Text editor. ZEAP 2.0 in EPROM or on Tape. Nas-Sys 3 Enhanced version of Nas-Sys 1. Nas-Dis - Disassembler. Debug - Dynamic Debugger.

BITs & PCs

Tool Kit. Port Probe. Hex Key Pad.

WILLIAM STUART

Colour Graphics for Nascom 1 & 2.

MERSEYSIDE NASCOM USER GROUP

ROM/EPROM Board for Nasbus.

EXTRAS

Henry's EPROM Burner. Antex Soldering Irons & Bits.

SOFTWARE

Northstar. CAP-CPP. Cromemco. Petsoft. Supersoft. Nascom Games.

BOOKS

Very full range of books on 6502, Z80, Languages, Interfacing, Introductory books and games and General Programs.

MAGAZINES

Personal Computer World. Computing Today. Practical Computing. Educational Computing. Liverpool Software Gazette. Printout.

ASK ABOUT THE KENILWORTH CASE

The "Kenilworth" Case. Microtype Case. Veroframe.

BUSINESS & LEISURE MICROCOMPUTERS

Castle Interface.

Business & Leisure Micro Computers

16 The Square, Kenilworth, Warwickshire CV8 1EB. Tel: (0926) 512127

S100

Do You Have All These Facilities On Your S100 System, With Just Two Boards?

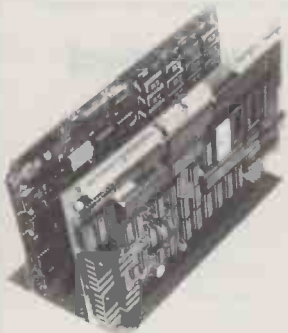

1. Z80A CPU-2 or 4MHz Operation.
2. Z80A CTC - 4 Channels.
3. Z80A S10-2 RS-232.
4. Z80A P10.
5. Disk controller; Takes up to 4 disk drives, single or double density operation.
6. 64k Bytes of memory.
7. EPROM Programmer.
8. Real time clock.
9. Software:
Standard 2k Monitor.
CP/M Cold Start Loader.
CP/M BIOS (1.4)

Prices:
FDC-1 Board £495.50
Expandoram £327.56
Mother Board £42.00
All prices exclude VAT.

Memories

2114-300ns	1k x 4 SRAM	2.25
4116-200ns	16k x 1 DRAM	2.61
2708-450ns	1k x 8 EPROM	3.60
2516-450ns	2k x 8 EPROM	7.92
2716-450ns	2k x 8 EPROM	7.92
2532-450ns	4k x 8 EPROM	23.40

Please add 50 pence for postage and VAT. Send SAE for price list.

SEMEL

MICROCOMPUTER - HARDWARE - SOFTWARE

3c, BARLEY MARKET ST., TAVISTOCK, DEVON. PL19 0JF.
Tel. TAVISTOCK (0822) 5247. Telex: 45263

STRUTT LTD

3c, BARLEY MARKET STREET,
TAVISTOCK,
DEVON, England, PL19 0JF.

Tel: TAVISTOCK (0822) 5439/5548
Telex: 45263

DATRON of SHEFFIELD

for

Cromemco the ultimate name in micros



DATRON import direct from Cromemco, California.
DATRON can supply Nationwide.
DATRON can provide maintenance nationally
DATRON can give you the realistic prices.
DATRON have in stock:-

SYSTEM 2 64 K £ 2147

SYSTEM 3 64 K £ 3398

Z-2H HARD DISC 10M £ 5373

DATRON can supply Systems 2 and 3 with Multi-Tasking facilities.

DATRON easily accessible - in the centre of the country.

Write or telephone for FREE colour brochure on System 3 or Z-2H.
We use Cromemco for our own business, why not call in for a demonstration.



DATRON MICRO CENTRE
DATRON INTERFORM LTD

2 Abbeydale Road, Sheffield S7 1FD.
Telephone 0742-585490. Telex 547151.

BUBBLE MEMORY and REAL TIME CLOCK for NASCOM

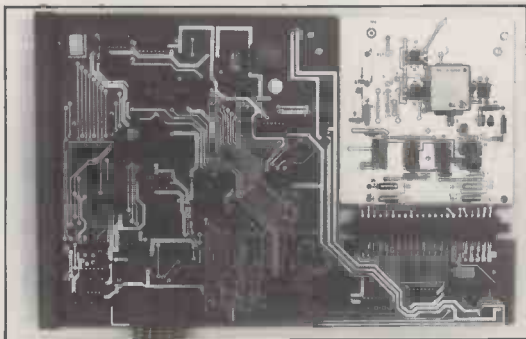

THE 8423 IS FULLY ASSEMBLED, BURNT IN AND PLUGS INTO THE 77 WAY NASBUS.

- * ADD A NON-VOLATILE MEMORY TO YOUR NASCOM I or II
- * MONITOR TRANSPARENT - USE IT WITH NAS-SYS, T2, T4 or B-BUG
- * UNAFFECTED BY DUST OR VIBRATION
- * 92,304 BIT CAPACITY ORGANISED AS 144 MINOR LOOPS OF 641 BITS
- * BATTERY SUPPORTED CHOS CLOCK GENERATES PERPETUAL DAY, DATE, TIME
- * DEALERS ENQUIRIES WELCOMED

Microdata Computers Ltd

BELVEDERE WORKS, BILTON WAY,
PUMP LANE INDUSTRIAL ESTATE, HAYES,
MIDDLESEX. UB3 3ND.

TELEPHONE (01) 848 9871 (6 LINES) TELEX 934110



You stand out in a crowd

Your business is not exactly the same as any other and neither are its problems. Any solutions are probably unique and must be tailored exactly for you.

You know your business better than anyone else and any system designed should use your knowledge. The micro-computer specialist should show you how to use the computer to meet your business requirements.

You should be able to get the micro-computer which best suits your business. It should be chosen after your requirements are specified.

You and your staff have a right to know all about YOUR system, including helping to program it if you want to. Training is your right - not an additional service.

If microcomputers cannot satisfy your business needs, you want to know - you don't want false promises.

67 Nova Road, Croydon, Surrey CR0 2TN.
Telephone: 01-688 6013

THE ROSE MICRO

INTEGRATED SMALL BUSINESS SOFTWARE ISBS

Professional Business Packages for Microcomputer systems include:

- PAYROLL
- STOCK CONTROL
- ORDER ENTRY & INVOICING
- COMPANY SALES
- COMPANY PURCHASES
- GENERAL ACCOUNTING
- NAME & ADDRESS SYSTEM

Available as individual modules or complete system to run on RAIR BLACK BOX, NORTHSTAR, HEATH, CROMEMCO, DYNABYTE, IMS 5000/8000, ALTOS, ALTAIR, SUPERBRAIN, MICROMATION and most other 8080 based systems.

Contact Lifeboat Associates, 32 Neal Street, London WC2 or your nearest dealer.

GRAFFCOM 52 SHAFTESBURY AVENUE
SYSTEMS GROUP LONDON W1 01-734 8862

OHIO SCIENTIFIC



SUPERBOARDS WITH 32 x 32 DISPLAY

Announcing the new 50Hz guard band models with 1.5 MHz clocks giving 50% more speed, a full 32 x 32 display and multi-speed tape interface.
BLACK AND WHITE £159 + 15% post free.
COLOUR VERSION £225 + 15% VAT.

THE UNIQUE SPECIAL OFFER YOU CANNOT RESIST

If bought with either Superboard these items are at the reduced prices shown first. Also sold separately at the bracketed prices. Add 15% VAT. Guard band kit £0 (£8). Modulator and power supply kit £7.95 (£25). 4K extra ram £20 (£24). Display expansion kit approx 30 lines x 54 characters £15 (£20). Case £23 (£26). Colour conversion board £65 (£65). Cassette recorder £14 (£16). CEGMON improved monitor rom poa. Extended monitor (tape) £20 (£20). Assembler/Editor £25 (£25). 610 Expansion board £159 (£159). MiniFloppy with psu and 2 copies DOS £275 (£275).

SHARP COMPUTERS



The brilliant new Japanese computer MZ-80-K which is beating the hell out of PET. 20K ram expandable to 48K. Built-in VDU screen, music function and cassette. Displays 40 characters x 25 lines and 80 x 50 on graphics. £438 + 15% VAT.
MZ80P3 Printer £499 + 15%.
MZ80FD Floppy disc £772 + 15%.
MZ80 I/O Interface £83 + 15%.
PC 1211 £83 + 15%. CE121 £12 + 15%.

OKI AND BASE 2 PRINTER



OKI Microline 80 Printer £399 + 15%.
BASE 2 Printer (illustrated) £359 + 15% VAT with free interface components and word processor program. 72, 80, 96, 120 or 132 chr/line. Tractor and friction feed. Graphics with user definable set in ram. RS-232, 20ma, IEEE488 and centronics interfaces.

SWANLEY ELECTRONICS

Dept. PC, 32 Goldsel Rd, Swanley, Kent BR8 8EZ.
Please add 35p postage. Telephone Swanley 64851.
Lists 27p post free. Overseas customers deduct 13%.
Official credit orders welcome.

TOMORROW TODAY

at
Birmingham Computer Centre

Commodore official distributors



3016, 3032, 3008 PETs

The reliable value for money system with after sales support, instruction and training facilities and a wide range of programmes.



48K
Disk
drive with
controller
£1,044
+ VAT

Apple authorised distributors

The sophisticated quality system with a reputation for advanced design and innovation.

SHARP
Z80K



The incredible computer system. Now available ex-stock including the new dual drive double sided floppy disk.

THE ULTIMATE IN DAISYWHEEL PRINTERS
RICOH RP 1600



THE BEST WORLD PROCESSOR
PRINTER AVAILABLE
DEALER ENQUIRIES WELCOME

STAND
200

See us at the
WHICH COMPUTER?
National
Exhibition
Centre
Birmingham
25-28 November 1980
Show

Camden Electronics, First Floor,
462 Coventry Road, Small Heath,
Birmingham B10 0UG.
Telephone 021 773 8240

Open Mon.-Sat. 9.30-6.00 p.m.

A MEMBER OF THE COMPUTER RETAILERS ASSOCIATION



centralex

A comprehensive range of Microcomputers Equipment, Peripherals, Software and Services for those who value Professional Standards, Guidance and Continuing Support for Hardware and Software.

APPLE
TEXAS
MICROPOLIS
DIABLO
MICROLINE

PET
OHIO SCIENTIFIC
CENTRONICS
QUME
HITACHI

ITT 2020
CROMEMCO
ANADEX
DEC
LEXICON

EXIDY
MICROSTAR
INTEGRAL
DATA GENERAL
ETC. ETC.

HORIZON
SHUGART
TELETYPE
EPSON

INFORMEX-80 Printer

£399+VAT



Special offer - for a limited period

For PET, APPLE, EXIDY, TRS80, ETC
A high quality, high speed printer
(125 cps) Upper and lower case letters
plus graphics as standard
Interface and cable for TRS80, PET,
APPLE or RS 232 £69 + VAT
Tractor feed option only £39

ALSO Training, Consultancy, Systems Design,
Programming and Software

PAYROLL - INVOICING - STOCK CONTROL -
SALES/PURCHASE LEDGER - VAT - MEDICAL
RECORDS - EDUCATIONAL & ENGINEERING
PROGRAMMES - HOTEL RESERVATION - ESTATE
AGENTS - BUILDING MAINTENANCE - COBOL -
FORTRAN - ETC.

Maintenance Contracts including stand-by equipment during repair
periods - Free Delivery Nationwide - Terms arranged - Credit Cards and
official orders accepted.



MICROLINK

The flexible interfacing
system for your Commodore
PET or HP 85.

The Microlink interface makes it easy to use your
Micro for tasks such as:

- * Replacing chart recordings by computer analysis
- * Automating experiments * Adding data
processing capability to monitoring instruments.

The MICROLINK interface consists of a
mainframe incorporating a power supply, an IEEE
488 interface and a cabinet holding up to 10
modules - this construction means that an interface
can be configured to your precise requirements.
Modules available include: * Analogue to digital
converters * Digital to analogue converters
* Analogue X-Y plotter driver * Analogue input
conditioning modules * Relay outputs * BCD
character inputs * Signal conditioning inputs
* High speed clock and multiplexer.

Write or telephone with details of your
application, and we will quote you for a
configuration to meet your needs.

For full information contact:
Biodata Ltd., 6 Lower Ormond St., Manchester M1 5QF. Tel: 061-236 1283

Biodata

it's soft at the top!

Business software at competitive
prices for CBM PETS - to keep you
on top of your business.

- Petaid Filing & Retrieval system
- All purpose program structure
- Incomplete records
- Planner
- Mailing
- General accounting
- Residential or part time courses
- Estate Agents

The sign of good software for
the small businessman

Send for our catalogue

STAGE ONE SOFTWARE

6 CRITERION ARCADE, Old Christchurch Road
Bournemouth. Tel: 0202 23570



INTELLIGENT ARTEFACTS LTD

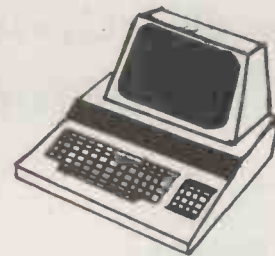

DISCOUNT PETS

	£
8K	425
16K	480
32K	580
DUAL DRIVE FLOPPY	590
SUPER PET	799
SUPER FLOPPY	825
CASSETTE	50
TOOLKIT	40

DISCOUNT PRINTERS

EPSON (with interface)	349
BASE 2	375

SOFTWARE

Blake 2 + Gamepack	20
Payroll	52
Accounts (North Star)	520

TEXAS

TI99/4 + 14" Skantic colour TV/monitor. . 499

NORTH STAR HORIZON

With 2 serial + parallel I/O
 4 MHZ Z-80 DOS + Basic 1450
 32k QD Density 1690
 48k DB Density 1690
 48k QD Density 1950

SUPER BRAIN

(Integral disk drive and VDU)
 32k RAM 320k Disk 1499
 64k RAM 320k Disk 1650
 64k RAM 788 Disk 1895

(PRICES EX VAT)

INTELLIGENT ARTEFACTS LIMITED
 Discount Hardware and Software

Cambridge Road, Orwell, Royston, Herts.
 Telephone: Arrington (022020) 689

INFORM80'S

PET PROGRAMS

SPECIAL OFFER SPECIAL OFFER SPECIAL

Our two most popular games programs are still only £10.00 each, buy one before Christmas and you receive a bonus: we will include a FREE GAMES PACKAGE on EVERY TAPE DISPATCHED DURING DECEMBER!

Startrek £10.00

Your PET becomes the shipboard computer of the famous Star Ship Enterprise, with you at the helm. You will need the guile of Capt Kirk or the cool logic of Mr Spock to rid the galaxy of the cunning Klingon Battlefleet in the time.

Space Invasion £10.00

The familiar pub and amusement arcade machine is not a game its an obsession! This is a full implementation for your PET with all the usual features except for the slot in the front that takes your money!

Every program is fully documented: when you tire of the games, you can practice your programming skills enhancing them.

INFORMATIES

31 Grove Dwellings,
 Adelina Grove
 LONDON
 E1

I enclose a cheque/PO for £ please
 send Startrek/Space-Invasion plus free
 games package. For a PET with
 8/16/32K & OLD/NEW ROM

CBM now down £300 +

NEW 4000 Series with 2.1 DOS and 4.0 BASIC

SUPER NEW DEAL £1699 ex. VAT.

For all this :

4032 Computer + 4040 Disc + 3022 tractor
 printer + 2 Cables + c2N cassette + PET
 Revealed.

* Commodore price for 3000 Series +2.1
 DOS and 4.0 Basic equivalent to above was
 £2001 ex. VAT.

Hurry! The PET is gone

GET ONE WHILST YOU CAN!

2008 (Old Keyboard) £365.00

3016N £385.00

(money with order price ex. VAT)

Our prices are lower than many unofficial
 sources but we ARE OFFICIAL DEALERS

CCS MICROHIRE

16K Microcomputer £89/month — 32/48K £99
 2 — Discs £89/month

CCS MICROHIRE/MICROSALES

7 The Arcade
 Letchworth
 Herts

Telephone (04626) 73301

Enter the Computer Age video genie system

12K MICROSOFT BASIC
16K RAM, UHF MODULATOR
INTERNAL CASSETTE
SECOND CASSETTE INTERFACE

**£330
PLUS VAT**



80 COLUMNS
70 LINES PER MINUTE
GRAPHICS CHARACTERS
INTERFACES TO MOST MACHINES

**£395
PLUS VAT**



100's OF PROGRAMS AVAILABLE
TRS-80 LEVEL II SOFTWARE COMPATIBLE

Dealer List

3 Line Computing Hull 445496
ABC Supplies Levenshulme
061-431-9265
Shipley 585333

Advance TV Services
Allen TV Services Stoke on Trent
616929
Huddersfield 20774

Amateur Radio Shop
Anglia Computer Centre Norwich 29652

Arden Data Processing
Beaver Computers Peterboro' 49577
Leicester 222 55
Littlehampton 22461

Blandford Computers
Briers Bookshop Middlesborough
242017

Bus Stop Watford 40698
Newport Pagnell 610625
Cambridge 314666

Cambridge Micro-computers
Catronics Wallington 01-669
6700/1

Cavern Electronics Milton Keynes
314925

Computer Business Systems
Computer and Chips Lytham 730033

Computerama
Computopia St Andrews 72569

Bath 333232
Leighton Buzzard 376600
Limerick 42733

D B Micro-computers
Derwent Radio Scarborough 65996
Eiron Computers Dublin 808575/
805045

Eley Electronics Dublin 808575/
805045

Eley Electronics Leicester 871522

East Midlands Computer Services Nottingham 267079

Emprise Ltd Colchester 865773
G B Organs & TV St Saviour Jersey
26788

Gemsoft Woking 22881
Kansas City Systems Chesterfield 850357

Kays Electronics Chesterfield 31696
Leisuronic Blackpool 27091
Marton Micro-computer Services Northampton
890661
Melton Mowbray 812888
Stoke on Trent 541743

Matrix Computer Systems Beckenham 01-658
7508/7551
Midland Micro-computers Nottingham 298281

Microdigital Liverpool 227-2535
Mighty Micro Basingsstoke 56417
Mighty Micro Burnley 32209/
53629

Morrison Computer Centre Swansea 795817

MRS Cardiff 616396/7
Communications
Optelco Rayleigh 774089
C Owens Peterlee 865871
Q Tek Systems Stevenage 65385
Radio Shack Ltd London NW6
01-624 7174

Rebval Computers Garboldisham 316

SMG Micro-computers Gravesend 55813

SMG Micro-computers Gravesend 55813
Tryfan Computers Bangor 52042
University Radio Stores Nottingham 45466

Ward Electronics Birmingham 021-
554-0708

Watford Electronics Watford 405888/
37774

commodore PET PACK software

DIRECT FROM

audiogenic

(WE MANUFACTURE THEM)

The Commodore range of Petpack Software is big and getting bigger! At the moment there are over 60 Petpacks and new programs are being added all the time. Here at Audiogenic we hold stocks of every Petpack and GD series disc, ready for immediate despatch.

For the Businessman we have programs for Stock Control, Filing, Accounts, Payroll, a very powerful Word Processor, and more!

For Educational applications we have programs to aid in the tuition of Languages, Physics, Maths, English, Pet Programming, Statistics, etc. For the Scientist or Engineer we have programs on Mechanics of Materials, Harmonic Analysis, Circuit Design, Drawing Load and Die Design, Statistical Analysis, Geometry and Algebra, to mention but a few. Then for the Programmer, there is a selection of Programming Aids on cassette and disc. And, of course, there are the Games Petpacks! Fun for all the Family! There are at present 12 cassettes in the Treasure Trove series, with over 40 different games in all. The Arcade series has 6 games which will be familiar to those of you who frequent pubs, clubs or amusement arcades. The games are PET versions of those popular pastimes like the addictive 'Space Invaders' or the universe-encompassing 3D Startrek.

Get out catalogue for the exciting details.

LATEST NEWS ORACLE PAGE 451

NEW RELEASES

Pascal (32k Pets Only) £138.00 Galaxy One-Combination of Treasure Troves 1 to 6 on Disk £46.00 Arcade Games — Breakthrough, Night Driver and Car Race £7.00 each 2 more Treasure Troves including Drive Bomber Dominos, L Game and Tower of Hanoi £10.00 each

Wordpro 1 (Old Rom Only) Cassette forerunner board pro 3: £25.00

Vegetable planner — Computing your garden £10.00
7 additions to our educational PETPACKS inc pilot and cesll @ £10.00 each

BOOKS

As well as PET releases and the 6500 hardware and Programming Manuals, we can offer from Osborne McGraw-Hill:-

"PETCBM Personal Computer Guide" £9.95
Everything you wanted to know about your "PET" — from "on" switch to the assembly language sub-routine

"Some common basic programmes PET Editor" £8.70

A collection of 76 practical BASIC programmes that address personal finance, with full PET listings, mathematical, statistical and general interest problems

"PET and the IEEE 488BUS (GPIB)" £9.95

This is the only complete guide available on interfacing PET to GPIB

"6502 Assembly Language Programming" £8.70

For the advanced programmer:- increase the capabilities and performance of PET

ACCESSORIES

"PETSET" to get you out of crashed conditions. Verbatim Disk £3 each 10 for £25.00 & Minkassette Disk Holders Blank Cassettes C10 5 for £2.75 and Printers Ribbons. Complete Range of Bib Cassette Accessories inc Head Demagnetiser @ £8.24

Post and Package 25p — Thereafter 10p for any additional items.

LOWE ELECTRONICS

BENTLEY BRIDGE
CHESTERFIELD RD
MATLOCK
DERBYSHIRE DE4 1LE

Trade Enquiries Welcome



P.O. Box 88 Reading, Berkshire,
Tel: (0734) 595269 24 Hour.

The AIRAMCO Mikro 1000

-The Scottish Solution.



The Mikro 1000 is a Scottish built micro-computer which combines State of Art technology with simplicity and durability to give a powerful small business system at a very competitive price.

Driven by a 2.5 MHz or 4 MHz Z80 processing unit constructed around Industry Standard S100 Bus, the Mikro 1000 is designed to provide the ease of expansion necessary in a modern growing business or industry - memory is expandable from 32K to 256K, with up to 4 Megabytes of on-line disk storage.

The integral VDU has an 80 cols. x 24 lines screen, and incorporates a green phosphor CRT, while the 117 key keyboard can be used remotely from the main body of the

machine, and may be programmed for user functions such as word processing commands.

As well as supporting all CP/M based languages, the Mikro 1000 has a full range of business software, including Sales, Purchase and Nominal Ledger, Inventory Control, and Payroll, as well as Word Processing (which is available at even lower cost as a separate system on the Mikro 1000 WP).

For further information on either Mikro 1000 system, please contact:



Unit A2, Longford Avenue, Kilwinning Ind. Est.,
Kilwinning, Ayrshire, KA22 8NP.
Tel: 0294 57755 Telex: 779808

COMPUTERS

From as little as £20 per week for your own business system with video screen, keyboard, twin floppy disk unit and printer. Choose any of the software programs available i.e.:

- ★ Word processing
- ★ Payroll
- ★ Invoicing
- ★ Stock control
- ★ Book-keeping
- ★ Incomplete records
- ★ Time recording
- ★ Information retrieval
- ★ Cash flow
- ★ Projection analysis

And when you've finished your easy days work we've got a few games for you to relax to including Space Invaders. We have first hand experience in dealing with businesses and can offer you expert advice in setting up your very first system. We can also offer installation, training and maintenance contracts.

NOW IS THE TIME

EXTRAS & OPTIONS
Floppy disks
Continuous Stationery
Dustcovers
Automatic sheet feeder
Tractor feed
Daisy wheels
Printer ribbons

Special desk work station
Lockable disk boxes
Payslips
Sound boxes
HARDWARE
CBM 3032 Computer
CBM 3040 Floppy
CBM 3022 Printer

CBM 8032 Computer (New model)
CBM 8050 Floppy (New model)
Game Springs Daisy Wheel Printer
SERVICES
Installation
Training
Maintenance
After Sales Service

Call into the

DA VINCI COMPUTER SHOP

65 High St., Edgware, Middx.

Tel. 952 0526

Open Mon-Fri. 9-5.30, Sat 9.30-5.00
or send for details



PLEASE SEND ME DETAILS:

Name
Company Position
Address
Tel. No.
I am interested in

FERGUSSON COMPUTER SERVICES

For All Your

 **apple & ITT 2020**
SALES AND SERVICE

Contract Maintenance:-

- * On-site repair contracts
- * Total system or only items required
- * 24hrs response to calls
- * Very competitive rates

Ad-hoc Repair Service:-

- * Ring for repair quotation
- * Same day service
- * Collection from Red Star if required

Hardware and Software Sales:-

- * 32K RAM free with each system purchased with this advertisement
- * Totally Integrated Ledger system complete for £3262.00

For further information ring
Byfleet (09323) 45330

Fergusson Computer Services
"Sharberry", Maitland Close, West Byfleet, Surrey

Buying Computers?

Commodore PET 32K
£675.75 plus VAT

Sharp MZ-80K
£480.00 plus VAT

ITT 20/20 16K
£607.00 plus VAT

ACT 808 inc dual disk drive
£3950.00 plus VAT

We'll give you more than a good deal

Under one roof in London's West End you can find:

HARDWARE:

A comprehensive range of hardware to meet most applications - and budgets, with terms to suit you.

SOFTWARE:

Probably the widest range of off-the-shelf software in the UK. Try out the packages and choose the one that suits you.

CONSULTANCY SERVICES:

To apply micro computer systems to business, education or the home, make an appointment with our trained professionals for friendly advice based on extensive experience of discussing problems with many others like you.

MAINTENANCE AND REPAIR CLUB:

that guarantees microcomputer users minimum downtime at very attractive premiums.

REFERENCE MATERIAL:

A library of publications covering all aspects of the microcomputer world, including back issues of this and other important periodicals.

DEMONSTRATIONS:

Regular, free demonstrations of business software - phone for details, times etc.

LION MICROCOMPUTER CENTRE

is the single source to meet all your requirements.

The above prices do not apply to account sales.



LION MICRO-COMPUTERS

Small Computers - to make your business bigger
Lion Computer Shops Ltd., Lion House, 227 Tottenham Court Road
London W1 (First Floor) Telephone 01-637 1601
Telex 28394 Lion G.
Open 9 to 6, Monday to Saturday (Thursday to 7)



Mini-Digital Cassette Recorder

An alternative to disc for program & data storage

FEATURES

- * The Philips MDCR 220 mechanism of proven reliability
- * Holds up to 120k Bytes/Cassette with fast data transfer
- * Extra memory board with RAM and ROM to hold operating software.
- * Will read & write (in blocks from 256 bytes to 60k Bytes), backspace & search for end of data on tape
- * Compatible with 6502 based systems ie PET, AIM65, OHIO, KIM, COMPUKIT ETC.



PRICES (INCLUDING MANUAL)

MINI RECORDER MECHANISM	£95.00
INTERFACING BOARD (TYPEA)	£42.50
MEMORY BOARD (WITH ROMS FOR 6502)	£55.00
CASSETTES (BOX OF 6)	£15.90
MANUALS (SEPARATE)	£10.00
CARRIAGE	£2.25
PRICES EXCLUSIVE OF VAT @ 15%	

CURRAH

COMPUTER COMPONENTS

Unit 7 Hartlepool Workshops, Sandgate Industrial Est.
Hartlepool, Cleveland



Scotland's Complete Microcomputer Service

now supply and support:

HARDWARE:

Apple II Systems and Peripherals
Commodore Business Systems
A wide range of VDUs, printers, etc.

SOFTWARE:

Incomplete Records Accounting
Sales Ledger
Purchase Ledger
Nominal Ledger
Stock Control
Payroll
Word Processing
Database

Software can be tailored to your requirements or written completely to your specifications.

Our service is comprehensive, ranging from advice on system selection through installation and implementation, to operator training and comprehensive Hardware and Software maintenance.

You don't have to take our word for it.

Call us and arrange a demonstration.

GATE MICROSYSTEMS LTD.,
THE NETHERGATE CENTRE,
66 NETHERGATE,
DUNDEE.
TEL: (0382) 28194.

Have fun and games this Christmastide- with Kansas

Games for the TRS-80 and Video Genie:

SWORDS AND SORCERY

An 'Adventure' type program, with much, much, much more — and graphics!

Meet the great oracle, nymph, trolls, maidens, yerb, farble warfer, slave girls, rats, snakes, spiders, dragons, goblins and the necromancer in the fight to save the princess — then get out quick!

A full 16K of superb entertainment needing skill, strategy and cunning. Only available from Kansas. **£9.50**

INFINITE STAR TREK

Upgraded yet again to give fast Warp and Impulse. It really is by far the best, requiring no little skill and awareness to destroy the Klingons before they destroy you. **£9.50**

PLAY THE MICRO

CHESSE Seven levels of skill and plays to correct rules. Far ahead ahead of Microchess in speed and play.

BRIDGE four hand and dummy contract bridge, with all the facilities to give a hard game.

PONTOON The micro plays a clever hand and you'll need your wits about you here.

BACKGAMMON Try to beat this one, you'll need all your skill.

DOMINOES It's not just luck as this program plays a clever game indeed.

Any of these at a remarkable **£8.50** each

DOUBLE GAMES PACKS

Maze Runner and Shatter. Pot Black and Breakthrough. Pin Ball Bounce and Robots. Build High and Knights Tour. Amazing Maze and Touchdown. Suicide Plane and Fire One.

All entertaining full graphic games at two for the price of one. **£6.50** per pack.

Prices are VAT paid post free. First class return post service. Telephone your Barclaycard or Trustcard number for same day despatch. (You can order after 6pm using our answering machine with programs sent the following morning). Despatch world-wide but add for postage in this case. Full catalogue sent free upon request.

Kansas

Kansas City Systems, Unit 3, Sulton Springs Wood Chesterfield, Derbyshire Tel 0246-850357

KNIGHT'S T.V. & COMPUTERS

108 Rosemount Place, Aberdeen.
Tel: (0224) 630526. Telex: 739169.



Dear Microfans,

Frankly we don't like cash and carry deals where you send cash, pay for delivery, and pay to take it back if it ever needs service. We have been giving personal service for 40 years and we intend to continue supporting and helping our customers. Our price for the 48K Sharp MZ-80K is £499 plus VAT. We include free Red Star next day delivery, one year's unconditional guarantee, our exclusive TOOLKIT, membership of the Sharp User Group, and 100 programs to get you off to a flying start. We use the Sharp every day in our own business and it is because we understand the capabilities of this Z80 based micro that we were able to write our exclusive TOOLKIT. Without taking any more memory than Sharp's Basic we have been able to add new commands including AUTO LINE NUMBERING, RENUMBER, APPEND, PRINT SCREEN, TRACE, etc. etc. thus greatly enhancing Sharp's excellent mathematically accurate Basic.

The free 100 programs include Bowling, Startrek, Cribbage, Backgammon, Poker, Brick out, Othello, Space Invaders, 3D Maze, Bio Rhythm, Kamikaze, Golf, Laser attack, customer receipts, reminders, customer files, mortgage, loan repayments, contract costing, inflation forecasting accounts, TV tests, CB Primer, Statistics - mean, variances, std deviation, co-variances, linear, exponential, log and power curves, transceiver, computer piano, Sharp organ keys, music library, teach tables, multiplication grid, number line, lissajous figures, equations of motion, quadratic equations, morse by sight and sound, morse sending, morse receiving, satellite orbit predictor, byte searcher, disassembler, memory dumper, etc, etc.

We are also giving these programs away with each Sharp printer or disk unit. Buy your floppies from us and we also give professionally written programs on disk for Stock control of 2,000 items, Sales and Purchase ledger, Inflation forecasting accounts, inflation forecasting accounts, mail list (up to 1500 names and addresses on one disk), and an excellent report generating program. Disk programs come complete with full documentation and 'hot-line' personal service from Alec and Graham Knight. Ring, write or telex for further details.

Happy computing, 73, 10 - 10 lets do it again,
Graham Knight (GM8FFX)

**100 Free
Programs
from
Sharps
big dealer**

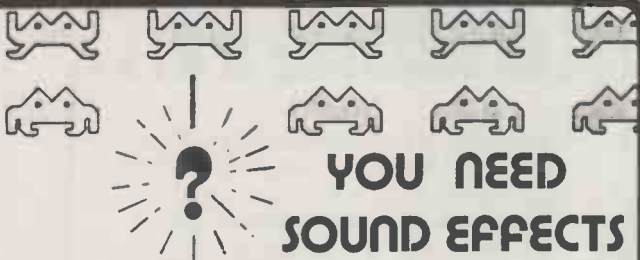

**YOU NEED
SOUND EFFECTS**

FOR PET, SUPERBOARD, UKIOI, NASCOM.

EXAMPLES: Lasers, explosions, whistling bombs, telephone tones, racing cars, sirens, musical instruments, wolf whistles, drums... almost any conceivable sound!!!

Entirely under program control, this polyphonic synthesizer unit adds a new dimension to games and other programs. Stereo output, doppler sweep & amplitude control give a truly dynamic depth to the sound.

By careful design of hardware the processor time used is minimal. Simply run by BASIC or Machine code.

Also includes two 8bit I/O ports that can be used for control and/or monitoring of various devices - switches, lamps, cassette motor etc. Will scan 64 key keyboard with no additional hardware.

Complete built and tested unit with onboard amplifier and speaker (included) + separate DIN output for stereo amplifier, demo program & full instructions.

Nascom version suits 77way Nasbus, Compukit & Superboard versions on 40 pin D.I.P. connector, Pet version with 24 pin DIP or 40 pin edge connector.

Before you buy any other Sound Generator consider these points:

No need for expensive extra I/O ports to drive the unit.
Full use of keyboard during programs.
No loss of system memory or problems with other expansions.
Channel, volume and noise independently programmable.

£43 + VAT
EX STOCK

**SOON
AVAILABLE!!**

PHONE, WRITE FOR DETAILS.

Low cost, 16k memory board
for Superboard/UK 101
Peripheral board 24 I/O lines
for relay driving etc., etc.

OHIO SCIENTIFIC

SUPERBOARD II 50 Hz £159 + VAT
610 EXPANSION £159 + VAT
CD3P FLOPPY DISC £285 + VAT
BASE 2 800MST PRINTER £359 + VAT

Microcasses £26. 2114L-300ns RAM 8 for £22. 5V 3A power supply for Superboard £15. Vision Modulator, high quality, £4.50. Sound Modulator to match £3.75. 40 pin ribbon cable, 40 pin DIP/40 pin PCB suit Breadboard £4.50. Prototype Breadboard for Superboard/UK 101 comprehensive, labeled bus £5.50. Bus extender to take 610 & peripherals £4.95. Header plugs, 40 pin £2.50. 40 pin sockets 40p. 8T28 buffers £1.50 each. AY-3-8910 sound chip £8.25. Joystick mechanisms £9.95. Blank DATA cassettes £5.25 for 10. Blank DATA cassettes £5.25 for 10. Blank discs 5 1/4" £3.25. 4116-200ns RAM 8 for £22.50.

Please add VAT to the above prices. Orders under £10 add 50p p.p. Trade enquiries welcome.

Easicomp

57 PARANA COURT SPROWSTON
NORWICH NR7 8BH 0603 416352



**CRYSTAL ELECTRONICS
CC ELECTRONICS**

SHARP MZ80K
**For the latest competitive
PRICE**
Contact us
Before you accept discounts elsewhere.
GIVE US A TRY
**CRYSTAL ELECTRONICS is the home of XTAL BASIC
ACCLAIMED BY MANY**

We KNOW the SHARP computers, we BACK the SHARP computers
What we give FREE is worth more than money.

**MZ80K owners - are you XTAL followers?
NO! Then please read on.
XTAL BASIC (SHARP)**

Takes 5K less memory, has all the features of SHARP BASIC PLUS Multi dim strings, error trapping, logical operators, machine code monitor, more flexible peripheral handling, improved screen control, increased list control, auto run, if.. then.. else - and it doesn't stop there - it grows. You can extend the commands and functions at will - 10K, 12K, 16K, BASIC?

SHARP to XTAL BASIC conversion program is included.
£40 plus VAT (Disc version on its way)
**DESIGNERS OF MICROCOMPUTER SYSTEMS + XTAL BASIC
IS WORTH CONSIDERING ON COST ALONE.**

Members of Computer Retailers Association & Apple Dealers Association

Shop open 0930-1730 except Saturday & Sunday
40 Magdalene Road, Torquay, Devon, England. Tel: 0803 22699
Telex 42507 XTAL G
Access and Barclaycard welcome.



aculab

floppy tape,

The tape that behaves like a disc,
For TRS-80 LEVEL II and Video Genie.

Connects directly to TRS-80 Level 2 Keyboard. Operating and file handling software in ROM. 8 commands add 12 powerful functions to Level 2 BASIC. No buttons, switches or volume controls. Full control of all functions from Keyboard or program. Daisy chain multiple drives. Certified digital tape in endless loop cartridges. Reads and writes in FM format at 9000 Baud. Soft sectored with parity and checksum error detection for highly reliable operation—just like discs. Maintains directory with up to 32 files on each tape, tapes may be write-protected. Supports Basic and machine-language program files, memory image and random access data files. 12 character filespecs—: "FILENAME/EXT:d" (d is drive no. 0-7). Automatic keyboard debounce. Full manual with programming examples and useful file-handling routines.

COMMANDS (usually followed with a filespec and possible parameter list).

@SAVE, @LOAD, @RUN —for BASIC programs, machine language programs and memory image files. @GET, @PUT —moves a 256-byte record between a random access file and BASIC's data buffer. @KILL —removes a file from the directory and releases tape sectors for immediate re-use. @LIST —displays file directory along with sector allocation and free sectors. @NEW —formats tape and creates a blank directory.

Master drive with PSU, Manual and a selection of tapes.

For TRS-80 £169-00, for Video Genie £174-00.

Slave drives £125-00. (add £2-00 p.p. + vat).

(Export orders pp charged at cost)



For further information,
Telephone
0525 371393

aculab Ltd.
24 Heath Road,
Leighton Buzzard,
Beds. LU7 8AB

SEE IT... PROGRAMME IT...

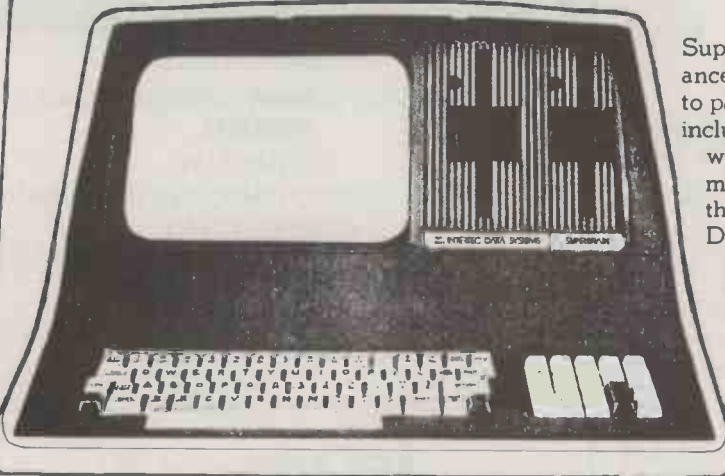

SuperBrain users get exceptional performance for just a fraction of what they'd expect to pay. Standard SuperBrain features include: two double density mini-floppies with 350K bytes of disk storage, 32K of ram memory (expandable to 64K) to handle even the most sophisticated programs, a CP/M^A Disk Operating System with a high powered text editor, assembler, debugger and a disk formator. And, with SuperBrain's S-100 bus adaptor, you can add all the programming power you will ever need...almost any type of S-100 compatible bus accessory.

Truly incredible performance. All in a single, smart looking, self-contained desktop unit.

SUPERBRAIN™
Intelligent Video Terminal Systems

£1595 ~ £2250 +vat

inc M basic & CP/M

MAINTENANCE CONTRACTS on SUPERBRAIN Equipment From £155pa.

BELIEVE IT!!

- ★ PERSONAL SERVICE
- ★ AFTER SALES SERVICE
- ★ EXPERIENCED PROGRAMMERS

S.M.G. MICROCOMPUTERS

39 Windmill St. Gravesend, Kent. Tel: 0474 55813

Intex DATALOG LTD COMPUTERS

STOCK CONTROL 3750

Stock Control 3750 is a complete stock control system designed and written to meet the needs of a small business.

It will accommodate up to 3747 stock items and runs on a COMMODORE PET microcomputer interfaced to a printer and COMPU/THINK disk drives.

The System incorporates programs to:

1. Set up a Supplier file.
2. Set up Stock files.
3. Copy Data files.
4. Insert/delete stock records.
5. Insert/delete supplier records.
6. Update/display stock file.
7. Update/display supplier file.
8. Print stock list.
9. Print supplier list.
10. Print reorder report.
11. Print stock movement report.
12. Print stock valuation report.

And perform other useful routines.

Stock Control 3750 is fully protected from misuse and can easily be used by someone with no knowledge of computers or their operation.

The System costs 195.00 + V.A.T. and this price includes a full back-up and advisory service from INTEX DATALOG.

For full specification write to:-

INTEX DATALOG LIMITED, Dept CA0980

Eaglescliffe Industrial Estate, Eaglescliffe, Cleveland TS16 0PN.

MICROPAY-200

Micropay-200 is a complete payroll System designed to run on a COMMODORE 32K PET microcomputer, interfaced to dual floppy disk drives and a printer.

The System provides:

1. Weekly/monthly payslips
2. Summary page of all payments and deductions that month
3. Summary page of all payments and deductions for the tax year to date
4. Weekly/monthly cash analysis slip for all cash payments made
5. Monthly summary of all payments and deductions
6. Year end summary of all payments and deductions

The System copes with:

1. Up to 200 current employees, plus end of the year details of up to a further 400 ex-employees who have left during the year.
2. Suffix L, H, P, V and T cumulative and Week 1 Codes
3. Prefix D and prefix F, BR and NT codes
4. All necessary alterations concerned with changes in income tax rates, band widths and personal allowances.
5. National Insurance Contributions at rates A, B and C for non-contracted out employees and at rates D and E for contracted out employees.
6. All necessary alterations concerned with changes in N.I. contribution rates and earnings limits.
7. Up to 5 user-definable wage rates for each employee, plus the normal hourly rate.
8. Holiday pay — including a check on the amount of holiday taken in the year
9. Up to a total of 5 user-definable additions/deductions to the before after tax pay
10. Changing an employee from one N.I. rate to another and backdating such a change
11. Job costing and analysis

THE SYSTEM COSTS 195.00 + VAT AND THIS PRICE INCLUDES A FULL BACK-UP AND ADVISORY SERVICE FROM INTEX DATALOG.

Intex

THE ZX80 COMPANION

Second edition

ISBN 0 907211 00 3 Price £10.00

This best-selling book on the Sinclair ZX80 has now been extended to include extra sections on the ZX80 monitor with entry addresses, new programs, and an amplified coverage of ZX80 BASIC. Send a £10.00 cheque (including P & P) to LINSAC.

Sinclair ZX80 Software

The new Autumn catalogue of Sinclair-tested educational and games programs is now available. Send SAE for your copy.

LINSAC

68 Barker Road, Middlesbrough
TS5 5ES

M&C BUSINESS SERVICES LTD

introduce

EUROCC

and

ATHENA

for further details write or phone

M & C BUSINESS SERVICES LTD
122 HAVELOCK STREET,
KETTERING, NORTHANTS
Tel: (0536) 86652



TAKE CONTROL

JSS

APPLE II

INTERFACE

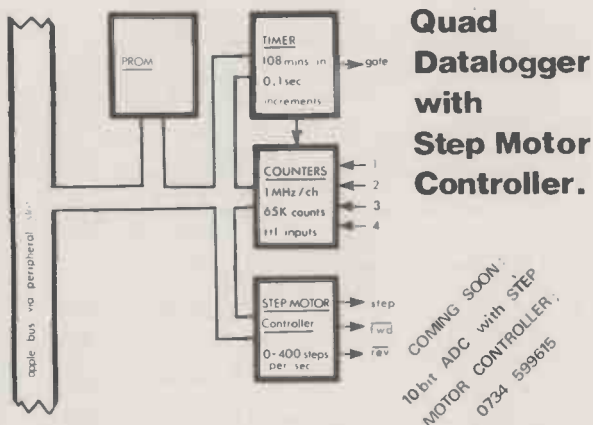

Quad Datalogger with Step Motor Controller.

COMING SOON!
10 bit ADC with STEP MOTOR CONTROLLER.
0734 599615

APPLE

Z80

LSI 11

Cost Effective Control from

J S SYSTEMS Ltd 18 PORTMAN Rd READING RG6 1JH

TEMPLEMAN SOFTWARE LIMITED

25-26 Greenhill Street, Stratford Upon Avon
Warwickshire CV37 8LR
Telephone: Stratford Upon Avon (0789) 66237

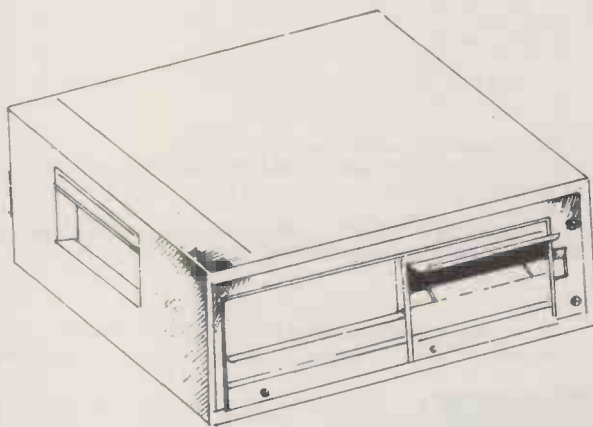

8" DOUBLE SIDED, SINGLE DENSITY FLOPPY DISC DRIVE.

*THEY HOLD FIVE TIMES AS MUCH INFORMATION AS 5" DRIVES, I.E. ONE MILLION CHARACTERS.

*TWO VERSIONS OF DOS ARE SUPPLIED; MAXIDOS AND NORMALDOS.

*PASCAL IS AVAILABLE.

*ITT SILVER OR APPLE CREAM CASING.

*R.R.P. £1550 (exc. VAT).

*DEALER ENQUIRIES WELCOME.

COMPUTERS FOR HOME BUSINESS EDUCATION

Exidy Sorcerer

16K - £860 32K - £918 48K - £976
S100 Expansion Box 6-slot - £276.00
Micropolis Dual Disc Drive - £1,380.00
NEC Spinwriter (receive only) - £2185

Z-89 ALL-IN-ONE COMPUTER

The new all-in-one computer from Zenith is the most versatile micro-computer available today.
* 'Intelligent' video terminal * two Z80 microprocessors * floppy disc storage system * expandable to 48K RAM
Easy to programme. Simple to operate. It is capable of a multitude of high-speed functions and speaks the language of today's most popular software. Price from £1805



The most advanced microcomputer yet.

WIDE RANGE OF ELECTRONIC GAMES

WH 14 SERIAL PRINTER
With a compact table-top configuration, the WH-14 is designed for a broad variety of uses in any computing environment.



Microprocessor based, it is compatible with any computer providing standard RS 232C or 20mA current loop interface connections. Price £585.00

video 100 12" BLACK & WHITE LOW COST VIDEO MONITOR
£90.00

RADAT 5" 10 MHz Scopes only £169.00
SELECTION OF SOFTWARE GAMES & BUSINESS

5 1/4" FLOPPY DISK for TRS 80
Team FD50A Single Drive £267.50
Dual Drive £506.00
Integral Power Supply



TRS80 LEVEL 2 16K only £440 KBD only expansion box 32K £340.00

Video Genie - £375

Large range of computers etc. books. Send for List
SAE with all enquiries - All prices inclusive.

SUPPLIERS TO BUSINESS, EDUCATION & HEALTH AUTHORITIES

N.I.C

BANCLAYCARD

VISA

Day 01-808 0377 - Eve 01-889 9736

(Unit 1), 61 Broad Lane, Tottenham, London N.15.

SOFTWARE IS OUR MIDDLE NAME

Can you afford to be less than excellent?

Whether you're in high vacuum technology, space research, brewing, computers or commerce, if you've got something to control, we've got something with which to control it.

Our top quality range of British designed and manufactured S100 products from INTERACTIVE DATA SYSTEMS are already used in all the above fields and others by many of the country's leading industries and universities etc.

They all chose IDS equipment for excellent reasons, i.e.; EXCELLENT SPECIFICATIONS,

EXCELLENT DESIGN,
EXCELLENT QUALITY,
EXCELLENT PRICES.



'High Vacuum Technology by SCANWEL Ltd, Bala, Gwynedd'

APPLY NOW FOR YOUR COPY OF OUR FREE CATALOGUE.

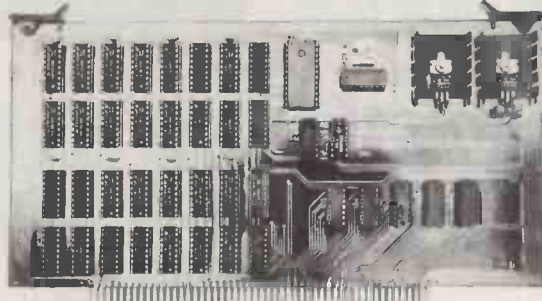

BRITISH S100 by INTERACTIVE DATA SYSTEMS

The MENDIP range includes:-

		£A&T*
IDS SBMC	4MHz Z80A Single Board Micro Computer, 1K RAM, sockets for up to 32K EPROM, 2 Serial Ports, 4 channel CTC etc.	235.00
IDS 16K SRAM	16K bytes Static RAM board (2114).	198.00
IDS 8K SRAM	8K bytes memory board.	114.00
IDS DFDC	Double/single density, double/single sided diskette controller.	198.00
IDS PCI 10	A mixture of input and output channels of various types to monitor and control external circuitry.	223.00
IDS Z80 CPU	A basic 4MHz Z80A processor board.	105.00
IDS TERM 40	Active Termination Board.	32.50
IDS SARACEN SERIES	A range of "ready-to-go" systems based on IDS components. (VDU and Printer extra)	from 1925.70 to 2676.45

* We also sell KIT versions, however we strongly recommend A&T (Assembled & Tested) equipment to all except very experienced constructors with adequate test equipment.

Please add VAT to all prices (standard rate 15%)

Mendip Computers...

57 BATH ROAD, WELLS, SOMERSET, BA5 3HS. TEL: WELLS (0749) 75249

MAIL ORDER ONLY.

MAGTRONICS

MAGTRONICS LTD
3 GOLDHUST TERRACE
LONDON
N.W.6.
TELE. 01-624-9847

74LS SERIES

74LS00	.18				
74LS01	.18				
74LS02	.18	74LS114	.35	74LS242	1.90
74LS03	.18	74LS122	.70	74LS243	1.90
74LS04	.22	74LS123	.75	74LS244	2.10
74LS05	.22	74LS124	1.40	74LS245	2.50
74LS08	.20	74LS125	.40	74LS247	1.20
74LS09	.22	74LS126	.40	74LS248	1.80
74LS10	.18	74LS132	.65	74LS249	1.25
74LS11	.22	74LS133	.40	74LS251	1.10
74LS12	.22	74LS136	.40	74LS253	1.10
74LS13	.40	74LS138	.70	74LS257	1.10
74LS14	.70	74LS139	.70	74LS258	0.95
74LS15	.22	74LS145	1.10	74LS259	1.65
74LS20	.20	74LS148	1.70	74LS260	.30
74LS21	.22	74LS151	.85	74LS261	3.50
74LS22	.22	74LS153	.55	74LS266	.40
74LS26	.22	74LS154	1.40	74LS273	1.75
74LS27	.22	74LS155	.75	74LS279	.65
74LS28	.22	74LS156	.75	74LS280	1.75
74LS30	.20	74LS157	.60	74LS283	1.00
74LS32	.26	74LS158	.65	74LS290	0.95
74LS33	.28	74LS160	1.10	74LS293	0.95
74LS37	.26	74LS161	.80	74LS295A	1.45
74LS38	.26	74LS162	1.10	74LS298	1.40
74LS40	.22	74LS163	.80	74LS324	1.80
74LS42	.65	74LS164	1.10	74LS325	2.55
74LS47	.85	74LS165	.80	74LS326	2.55
74LS48	.85	74LS166	1.70	74LS327	2.55
74LS49	1.00	74LS168	1.70	74LS352	1.35
74LS54	.20	74LS169	1.70	74LS353	1.35
74LS55	.20	74LS170	1.70	74LS365	.60
74LS56	1.50	74LS173	1.10	74LS366	.60
74LS73	.35	74LS174	.95	74LS367	.60
74LS74	.35	74LS175	.95	74LS368	.60
74LS75	.42	74LS181	2.75	74LS373	1.75
74LS76	.35	74LS190	1.20	74LS374	1.75
74LS78	.35	74LS191	1.20	74LS375	.75
74LS83A	.85	74LS192	1.10	74LS377	1.75
74LS85	1.00	74LS193	1.10	74LS378	1.30
74LS86	.35	74LS194A	1.00	74LS379	1.40
74LS90	.58	74LS195A	.90	74LS381	3.65
74LS91	.99	74LS196	.95	74LS386	.60
74LS92	.90	74LS199	.95	74LS390	1.75
74LS93A	.65	74LS197	.95	74LS393	1.50
74LS95A	1.00	74LS424	4.50	74LS395	1.80
74LS96	1.25	74LS445	1.25	74LS396	1.70
74LS107	.35	74LS447	1.25	74LS398	2.70
74LS109	.35	74LS490	1.95	74LS399	1.60
74LS112	.35	74LS221	1.20	74LS668	1.95
74LS113	.40	74LS240	2.10	74LS669	.95
		74LS241	1.90	74LS670	.95

DISKETTES

UNCONDITIONAL GUARANTEE

5.25" MINI-DISKETTES 1 SECTOR (SOFT)	SINGLE SIDED PER 10 £24.00
5.25" MINI-DISKETTE 10 SECTOR	SINGLE SIDED PER 10 £24.00
5.25" MINI-DISKETTE 16 SECTOR	SINGLE SIDED PER 10 £24.00
8" SINGLE SIDED 26 SECTOR	SINGLE DENSITY PER 10 £25.80
8" SINGLE SIDED 26 SECTOR	DOUBLE DENSITY PER 10 £32.00
8" DOUBLE SIDED 26 SECTOR	SINGLE DENSITY PER 10 £38.20
8" DOUBLE SIDED 26 SECTOR	DOUBLE DENSITY PER 10 £40.00

MEMORIES
C.P.U.s
SUPPORT DEVICES
C.MOS.
TRANSISTORS
DIODES
ALL STOCKED
PHONE FOR
QUOTATION

All orders under £50 add 50 p P&P. Add 15% VAT to total.

Many other types of hard and soft sector diskettes available. Phone for quotation.

Magnetic cards, data cartridges, digital cassettes are also stocked.

Official orders from schools, colleges, universities and Govt. Bodies accepted.

E. PROMS	MEMORIES	C. PUS.	SOCKETS
1702A	500p 2114L	400p 6502	800p L.P.
2708	450p 2114L-2	500p 6800	700p 8 PIN
2716(+5v)	900p 2114L-3	500p 6802	1200p 14 PIN
2532(+5v)	2700p 4116L-2	500p 8080A	450p 16 PIN
	6810	350p 8085A	1100p 24 PIN
			9p
			10p
			11p
			22p

The video genie system only needs a plug



£380 inc. VAT

**MATRIX
COMPUTER
SYSTEMS LIMITED**

- 16K RAM + 12K Microsoft BASIC in ROM
- TRS-80 Level II compatible ● Ideal for Business, Education + Leisure ● Integral Cassette + TV Output
- Customized Business Packages available
- Expansion to Disks + Printer

325, Upper Elmers End Road, Beckenham, Kent. Telephone 01-658 7508/7551



FOR THE SINCLAIR ZX-80

This unique book contains 30 programs, all designed to fit in the basic 1K version of the SINCLAIR ZX-80!!

Programs include **BLACKJACK**, **LUNAR LANDER**, (with spaceship display), **HANGMAN**, **NIM**, **LINE RENUMBER**, **MEMORY** (calculates how much memory is left using **USR** function), and **GOMOKU** (a Japanese board game on a 7 x 7 board).

Even more important than the programs themselves are the programming techniques these programs utilise, illustrating space compression, **PEEKs** and **POKEs**, **USR** function and use of the display section as memory!

available
by mail
order only

£6.95 (plus 50P p&p)

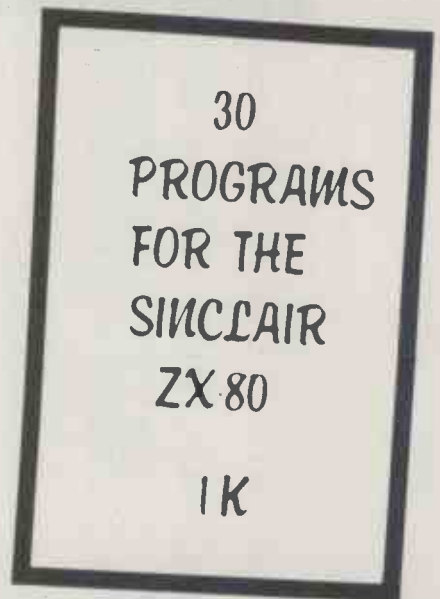

COMING SOON:

ZX-80 MACHINE LANGUAGE PROGRAMMING

**MELBOURNE HOUSE
PUBLISHERS**

Orders to: 131 Trafalgar Road, London SE10
Correspondence: Glebe Cottage, Glebe House, Station Road,
Cheddington, Leighton Buzzard, Bedfordshire.

NAME

ADDRESS

Please enclose cheque or P.O.
for £7.45 per copy.

FOR ALL YOUR MAIN REQUIREMENTS
FROM ONE SUPPLIER
JUST LIFT THE PHONE...

0252-518022/518717

Continuous Stationery — all types pre-printed including letterheads. Listing Paper — all sizes.
Continuous labels — plain and printed.

Printer ribbons, Pet etc., 3M Data Recording Products
ACCO Continuous Stationery filing systems

NOW AVAILABLE EX-STOCK

Plain listing paper in the following sizes:-

11 x 8½, 11 x 9, 11 x 9½, 11 x 9¾, 12 x 9¾

All best quality white bond, tear off sprockets

ONLY £14.00 per box of 2000 sheets

add carriage of £3.00 per box + VAT 5 or more carriage FREE.

WE CAN ALSO PRINT CONTINUOUS FORMS
WITH YOUR NAME & ADDRESS ETC
PLEASE RING FOR FREE QUOTE

3M Personal Digital Computing Cassettes. Individually boxed,
minimum order 10 10 min 47p each, 30 min 53p each,
5¼" Mini Diskettes, 100% error free

£2.25p each, minimum order 10

as above but in plastic library case

£2.46p each, minimum order 10

8" Diskettes, 100% error free, storage box,

From £2.60p each, minimum order 10

NEW LINE — Smart Diskette binder, anti static, holds 20.5¼"

£15.25 each

as above but for standard 8" Diskettes £17.25p each

*ACCO paper binders, a must for all stationery filed or
regularly used, from £1.96p each

Add VAT and 80p post & packing for each item ordered,
all despatched within 24 hours.

Clearsons Ltd.

Lynwood House 1 Camp Road Farnborough
Hampshire GU14 6EN

OHIO..
..24 hours a day!

Yes that's right, we are at your service 24 hours a day offering a complete OHIO SCIENTIFIC service, giving technical information, advice on hardware expansion and satisfying your requirements in any of the following:

OSI SYSTEMS-including the popular SUPERBOARD II and CHALLENGER 4P as either cassette or disk based systems.

OSI SOFTWARE-cassette and disk based software covering a broad spectrum of uses. Some of the cassette based software can be run on the UK101.

BEAVER SOFTWARE-business, educational and entertainment software professional programs with full listings and documentation. Also available for other programs especially the UK101.

BEAVER PROGRAMMING AIDS-including video workpads, BASIC workpads, machine code workpads, cassette Index cards, labels and blank cassettes, all available for OSI UK101 and TRS-80.

In addition to the above, we also have available cases for the SUPERBOARD II (and others).

Demonstrations of all the systems and software available can be arranged in your own home or business premises (within a 50 mile radius of Oxford).

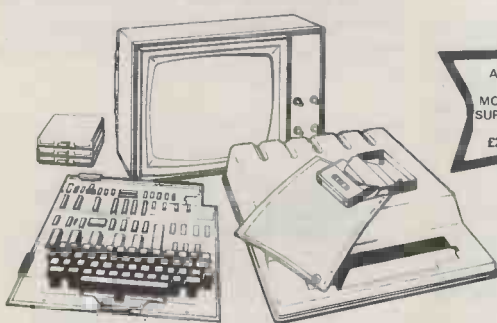

NOW AVAILABLE NEW MONITOR FOR SUPERBOARD & UK 101 £29.50 + VAT

BEAVER
SYSTEMS

Norlett House, Dormer Road, Thame, Oxon OX9 3UC
Telephone Thame (084421) 5020 (24hr)

CompUtopia
LIMITED

30 Lake Street, Leighton Buzzard, Bedfordshire
Tel: (0525) 376600 24 hour Answering Service

APPLE II

authorised dealers
from
£695
+
VAT

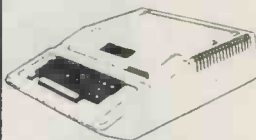

- * Choice of 16K, 32K, 48K user RAM
- * Huge range of software already available.
- * Simply plugs into video monitor or UHF TV.
- * High resolution graphics (5400 point array)
- * Eight Accessory expansion slots for disks, printer etc.

commodore

authorised dealers

- * Choice of 8K, 16K, 32K user RAM
- * Huge range of software already available
- * Self-contained monitor
- * Numeric keypad on keyboard.
- * Full expansion capability for cassette, disks and printer.



from
£445
+ VAT

PET 2001

- * 16k User RAM plus 12k Microsoft BASIC in ROM
- * Fully TRS 80 level II software compatible
- * Huge range of software already available
- * Self contained, cassette, PSU & UHF modulator
- * Simply plugs into video monitor or UHF TV
- * Full expansion capability for disks & printer

THE VIDEO GENIE SYSTEM EG 3003

£330 + VAT



PERIPHERALS

PRINTERS	
Texas Instruments Omni 810 Printer	£1450.00
Paper Tiger Printer with Graphics	£ 598.00
MONITORS	
VM 129 Hitachi 12" B&W Video Monitor	£ 187.00
VM910 9" B&W Video Monitor	£ 127.00

£395 + VAT complete with interface for APPLE, PET or VIDEO GENIE



THE MICROSOFT Z80 SOFTCARD OPENS UP IN HORIZONS FOR YOUR APPLE II

Plug the new Microsoft Z80 SoftCard into your APPLE II and start using *all* of the system and application software written for Z80 based computers.

Included with the board is the versatile CP/M; the most widely used microcomputer operating system, and Microsoft's 5.0 BASIC, the most powerful version to date of Microsoft's famous BASIC Interpreter. **£275+VAT Dealer enquiries welcome.**

WATCH YOUR APPLE GROW TO TWICE ITS SIZE!!

Add a twin 8" disk and give yourself up to 1.6 million characters of storage on line. **£1750+VAT Dealer enquiries welcome.**

Illustrating Basic	Alcock	3.25
Basic Handbook	Lien	11.00
Computer Programs that Work	Lee/Beech/Lee	3.95
Basic Computer Games	Ahl	4.25
More Computer Games	Ahl	4.25
C207 Microprocessor Interfacing	Lesea/	9.50
Techniques	Zaks	9.50
6502 Assembly Language Programming	Leventhal	7.95
C202 Programming the 6502	Zaks	7.95
G402 6502 Games Book	Zaks	8.20
The Pet Revealed	Hampshire	10.00
Z80 Assembly Language Programming	Leventhal	7.95
Z80 Microcomputer Handbook	Barden	6.80
Introduction to Microcomputers Vol 0	Osborne	5.00
Introduction to Microcomputers Vol 1	Osborne	7.50
The Personal Computer Book	Bradbeer	5.30

Please phone or write for complete book list and prices. Prices include P & P within the U.K.
Please send cheque or P.O., or if phoning your order, state Barclaycard number.

**The Sinclair ZX80 is innovative and powerful.
Now there's a magazine to help you get
the most out of it.**

Get in sync



SYNC magazine is different from other personal computing magazines. Not just different because it is about a unique computer, the Sinclair ZX80 (and kit version, the MicroAce). But different because of the creative and innovative philosophy of the editors.

A Fascinating Computer

The ZX80 doesn't have memory mapped video. Thus the screen goes blank when a key is pressed. To some reviewers this is a disadvantage: To our editors this is a challenge. One suggested that games could be written to take advantage of the screen blanking. For example, how about a game where characters and graphic symbols move around the screen while it is blanked? The object would be to crack the secret code governing the movements. Voila! A new game like Mastermind or Black Box uniquely for the ZX80.

We made some interesting discoveries soon after setting up the machine. For instance, the CHR\$ function is not limited to a value between 0 and 255, but cycles repeatedly through the code. CHR\$(9) and CHR\$(265) will produce identical values. In other words, CHR\$ operates in a MOD 256 fashion. We found that the "=" sign can be used several times on a single line, allowing the logical evaluation of variables. In the Sinclair, LET X=Y=Z=W is a valid expression.

Or consider the TL\$ function which strips a string of its initial character. At first, we wondered what practical value it had. Then someone suggested it would be perfect for removing the dollar sign from numerical inputs.

Breakthroughs? Hardly. But indicative of the hints and kinds you'll find in every issue of SYNC. We intend to take the Sinclair to its limits and then push beyond, finding new tricks and tips, new applications, new ways to do what couldn't be done before. SYNC functions

on many levels, with tutorials for the beginner and concepts that will keep the pros coming back for more. We'll show you how to duplicate commands available in other Basics. And, perhaps, how to do things that can't be done on other machines.

Many computer applications require that data be sorted. But did you realize there are over ten fundamentally different sorting algorithms? Many people settle for a simple bubble sort perhaps because it's described in so many programming manuals or because they've seen it in another program. However, sort routines such as heapsort or Shell-Metzner are over 100 times as fast as a bubble sort and may actually use less memory. Sure, 1K of memory isn't a lot to work with, but it can be stretched much further by using innovative, clever coding. You'll find this type of help in SYNC.

Lots of Games and Applications

Applications and software are the meat of SYNC. We recognize that along with useful, pragmatic applications, like financial analysis and graphing, you'll want games that are fun and challenging. In the charter issue of SYNC you'll find several games. Acey Ducey is a card game in which the dealer (the computer) deals two cards face up. You then have an option to bet depending upon whether you feel the next card dealt will have a value between the first two.

In Hurtle, another game in the charter issue, you have to find a happy little Hurtle who is hiding on a 10 X 10 grid. In response to your guesses, the Hurtle sends out a clue telling you in which direction to look next.

One of the most ancient forms of arithmetical puzzle is called a "boomerang." The oldest recorded example is that set down by Nicomachus in his *Arithmetica* around 100 A.D. You'll find a computer version of this puzzle in SYNC.

Hard-Hitting, Objective Evaluations

By selecting the ZX80 or MicroAce as your personal computer you've shown that you are an astute buyer looking for good performance, an innovative design and economical price. However, selecting software will not be easy. That's where SYNC comes in. SYNC evaluates software packages and other peripherals and doesn't just publish manufacturer descriptions. We put each package through its paces and give you an in-depth, objective report of its strengths and weaknesses.

SYNC is a Creative Computing publication. Creative Computing is the number 1 magazine of software and applications with nearly 100,000 circulation. The two most popular computer games books in the world, *Basic Computer Games* and *More Basic Computer Games* (combined sales over 500,000) are published by Creative Computing. Creative Computing Software manufactures over 150 software packages for six different personal computers.

Creative Computing, founded in 1974 by David Ahl, is a well-established firm committed to the future of personal computing. We expect the Sinclair ZX80 to be a highly successful computer and correspondingly, SYNC to be a respected and successful magazine.

Order SYNC Today

Right now we need all the help we can get. First of all, we'd like you to subscribe to SYNC. Subscriptions are posted by air directly from America and cost just £10 for one year (6 issues), £18 for two years (12 issues) or, if you really want to beat inflation, £25 for three years (18 issues). SYNC is available only by subscription; it is not on newstands. We guarantee your satisfaction or we will refund the unfulfilled portion of your subscription.

Needless to say, we can't fill up all the pages without your help. So send in your programs, articles, hints and tips. Remember, illustrations and screen photos make a piece much more interesting. Send in your reviews of peripherals and software too—but be warned: reviews must be in-depth and objective. We want you to respect what you read on the pages of SYNC so be honest and forthright in the material you send us. Of course we pay for contributions—just don't expect to retire on it.

The exploration has begun. Join us.

The magazine for Sinclair ZX80 users

SYNC

27 Under Close
Stoke Golding

Nuneaton CV13 6EL, England

ADVERTISERS INDEX

AJD Direct Supplies	24	Data Bank	150	Low Electronics	170	Personal Computers	OBC
Acorn Computers	67	Datomark	13	L&J Computers	22	Pete & Pam	
Aculab	176	Datron Microcentre	166	LP Enterprises	32	Computers	39
Adda	25	Davinci Comp	171	Leicester Comp		Petsoft	94
Airamco	171	Digital Design & Development	159	Centre	160/163	Plus Business	
Almarc Data Systems	21/37/39	Display Electronics	146	Linsak	177	Systems	23
Anglia Comp Centre	28	DYAD	160	Lion Hse	172	Portable Micro Systems	3
Audiogenic	170	Eagle Comps	8/9	Little Genius	164	Premier Publications	62
Aughton Micro Systems	22	Easi Comp	175	Liveport Data		Professional Software	92
BMC International	66	Enertech	156	Products	35	Program Power	56
Beaver Systems	181	Eurocalc	154	Logitek	151	Q-Tek Systems	37
Biodata	168	Ferguson Computers	171	London Computer		Research Machines	34
Bits & PC'S	22	Gate Microsystems	174	Store	156	Roxburgh	46
Bug Byte	161	GP Industrial	162	M&C Business		SMG Microcomps	176
Business & Leisure	165	Graffcom	167	Services	177	Science of	
Byte Shop	122	Graham Dorian	68	Macclin-Zand	158	Cambridge	118/119
CCS Microhire	169	Gramma Winter	14/15	Magtronics	179	Scope	76
Cambridge Comp Store	74	Greenbank Electronics	148	Map Computer		Sharp Co-Op	84
Camden Electronics	167	Gt. Northern		Systems	31	Sharp	70/71
Centralex	168	Computers	159	Matrix Computer		Sigma Technical Press	2
Centronics	88/89	Guestel	10	Systems	180	Sigmatex	161
Chromasonic	30	HP Computers	29	Melbourne House		Simon Computers	13
Clearsons	181	Happy Memories	164	Publishers	180	Sirton	157
Comart	120	AJ Harding	153	Mendip Computers	179	Software House	156
Commodore	43/45	Henry's	152	Microbusiness Centre	154	Stack	36
Comp Shop	184/IBC	Hewlett Packard	19	Microbyte	173	Stage One	168
Computech	20	Houghton	6	Micro Centre	IFC	Strutt	165
Computerama	145	Independent Computer		Microcomputer		Sumlock Boundain	12
Computopia	181	Engineering	156	Connections	17	Supersoft	56
Comserve	38	Infomaties	80/169	Microdata Comps	163/166	Swanley Electronics	167
Cream Microcomputer		Interam Computer		Microdigital	76	TVJ Micro Computers	7
Shop	27	Systems	26	Microfacilities	154	Talbot Rhys	2
Creative Computing	182	Interface	18/112	Micro-Print	161	Tandy	4/5
Crystal	175	Intelligent Artefacts	169	Microsolve	614	Tel Equipment	54
Cumana	33	Intex Datalog	177	Mighty Micro	2/108	Templeman Software	178
Currah	172	JM Electronics	162	Mike Rose Micros	166	Transam	98
DRG Business Machines	74	JS Systems	178	NIC	178	Tridata	163
Data Allplications		Kansas City	174	Nascom	16	John Wiley	76
International	117	Knights	175	Newbear Computing	147	Xitan Systems	149
				Newtons Laboratories	11		



"HHHHHHH, HHHHH, HHHHHHHHHHH, HHH, HHHHHHHHH - (HEAVY BREATHING)."

This was the text of a telex which arrived at our office the other day from, unbelievably, the States. Will the joker who sent this please identify him/herself, as our receptionist, the lovely Sara, is now scared to lift the lid on the machine each morning. Whatever next? Obscene letters by carrier pigeon, perhaps? . . .

Remember our moan last month about Commodore's persisting in billing us for the SuperPET we Bench-tested? Incredibly, despite long phone calls, the bills still pour in. Maybe somebody should sell them an improved invoicing package . . . On its way from Commodore, a 4000 series with Basic and disk-handling compatible with the 8000 series, correcting the RENAME bug and giving features like relative record handling; you'll be able to upgrade your 3000 series by buying new ROMs, one for the Basic and one for the disks, costing £38 each. Wonder if they'll invoice us if we decide to Benchtest the new machines? . . . Amiable Henry Budgett

had his holiday ruined this year. Seeking to escape the pressure of running *Computing Today*, he jetted to Athens, got a taxi to the port, hopped onto a passing fishing boat and ended up on a tiny Greek island with just one street and a handful of goats. His Hellenic idyll was ruined, however, when, coming across the only shop in the village, he saw a rack of magazines among which he found the latest editions of *PCW* and a certain other micro magazine but — horror! — no *Toady*!!! He instantly boated, taxied and jetted back to Charing Cross Road to berate his hapless circulation manager. . . Will Mr R M Yorston please contact us to hear something to his advantage. . . A semi-grovel to Ingersoll — thanks for lending us the Ataris to Benchtest; pity we forgot to say that Ingersoll is the sole UK distributor for Atari equipment. . . Have you booked for our West Coast Trip yet? Our budgeting department (sorry Henry) has worked out that two people sharing would save £100 each on the cost of doing it independently, so hurry now while stocks last (see page 115). . . Some friends of ours (yes,

we do have some) kept getting the engaged tone when ringing a local school. After a thorough investigation, British Telecom announced that the line was out of order. Subsequent investigation by our friends revealed that in fact the school had been on line to Prestel for one-and-a-half hours and then attached to a mainframe at Trent Poly via an acoustic coupler for two hours. . . Tandy rang us in response to our recent comments about their TRS-80 hand-held thing ('Newsprint', October), when we mentioned that we couldn't tell the difference between it and the Sharp PC-1211. "But it's got 1.9k of memory while the Sharp has only .9k!" said Tandy. Oh, well, yes, but everyone we spoke to is selling a 1.4k version of the Sharp. It's the PC-1210 which has .9k and it's not sold in Britain . . . On a recent visit to the Softwarehouse we came across a weird object in an unusual, hand-crafted case. Turned out it was Tim Hartnell's personal ZX80 which, for reasons best known to himself, he'd fitted into a case with a proper keyboard and a clever switch to un-reverse the reversed display, if you see what we mean (*I don't and I wrote it — Ed*). . . The new word processor from Nexos sports a 'bronze on black' display, because, they claim, this is

all the rage among ergonomically-conscious Scandinavians. But the Scands use orange on brown, we countered, at Nexos' recent launch. "We've adapted it slightly — pretty, innit?" came the reply. Actually it is, very pretty.



Some say they're elephants, some say they're Male Chauvinist Piglets, we say they're Space Invaders. Whatever they are, they belong on the tie of David Low, who's recently displaced Peter Oldershaw as MD of ACT Microsoft. Peter's still with the group, concentrating on setting up a countrywide maintenance organisation.

NEW REDUCED PRICES

8K **£399**
16K **£499** + VAT
32K **£599**
RRP £795 for 32K



EXTENDED WARRANTY BY COMPUKARE

The PEDIGREE PETS Very popular for home & business use 8K Microsoft Basic in ROM 8K Pet 32K & 16K with new improved keyboard. All with green screen. Cassette Deck £55 extra. Full range of software available.

- Interface PET IEEE — Centronics Parallel
- Not decoded £49.00 + VAT Decoded £77.00 + VAT

NOW IN STOCK SUPER 80 COLUMN PET only **£825** + VAT

SPECIAL SCOOP GET YOURSELF A PRINTER FOR YOUR PET AND SAVE A FORTUNE

only **£299** + VAT

Interface Cards £49

Full Pet Graphics including cables. Ready to go. **EX-STOCK.**

Interfaces with APPLE, PET, EXIDY, TRS80, COMPUKIT and NASCOM.



EXTENDED WARRANTY BY COMPUKARE

NASCOM 2 DISC DRIVES

Add a powerful, double density, mini floppy disc to your Nascom system.

- Disc Controller Card (includes Nasbus-6 S100 interface)
- Will control 4 Drives.
- CPM operating system.
- Extended Disc Basic Compiler.
- Power supply included

One Disc System — **£499** + VAT
Additional Disc Unit — **£299** + VAT



NASCOM 2 GAMES TAPE

featuring Space Invaders and Android Nim, Re-numbering program and other goodies!

£7.50 + VAT

NEC SPINWRITER

only **£1490** + VAT



NEC's high quality printer uses a print "thimble" that has less diameter and inertia than a daisy wheel, giving a quieter, faster, more reliable printer that can cope with plotting and printing (128 ASCII characters) with up to five copies, friction or tractor fed. The ribbon and thimble can be changed in seconds. 55 characters per second bidirectional printing — with red/black, bold, subscript, superscript, proportional spacing, tabbing, and much, much more.

TEAC DISK DRIVES

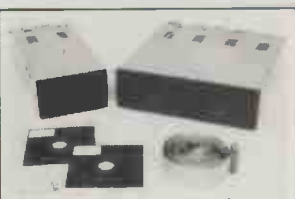

- TEAC FD-50A has 40 tracks giving 125K Bytes unformatted single density capacity.
- The FD-50A can be used in double density recording mode.
- The FD-50A is Shugart SA400 interface compatible.
- Directly compatible with Tandy TRS80 expansion interface.
- Also interfaces with Video Genie, SWTP, Heathkit, North Star Horizon, Superbrain, Nascom, etc., etc.
- Address selection for Daisy chaining up to 4 Disks.
- Disks plus power supply housed in an attractive grey case.

Single Disk Drive **£225** + VAT Double Disk Drive **£389** + VAT

COMP POCKET COMPUTER GREATEST BREAKTHROUGH YET

£99.90
+ VAT



COMPUTER POWER THAT ONCE FILLED A ROOM CAN NOW BE CARRIED IN YOUR POCKET!

- Programs in BASIC • "QWERTY" Alphabetic Keyboard • 1.9K Random Access Memory • Long Battery Life.

Computer power that once filled a room can now be carried in your pocket! It's easy to load with ready-to-run software from cassette tape (interface and recorder optional) or program it yourself in easy-to-learn BASIC. 24-character liquid crystal readout displays one line at a time. Special feature is advanced non-volatile memory allows you to power on and off without losing the contents of memory. Note: Memory must be transferred to tape before changing batteries. Automatic statement compaction squeezes every ounce of memory space. Features power-off retention of programs and data. Powerful resident BASIC language includes multiple statements, math functions, editing, strings, arrays and much more. Multiple program loading capability subject to RAM availability. Carrying case and batteries included.

Program	Each	Program	Each
Real Estate	£13.95	Games 1	£8.95
Civil Engineering	£13.95	Business Statistics	£10.95
Aviation	£13.95	Business Financial	£10.95
Math Drill	£8.95	Personal Financial	£10.95

EXTENDED WARRANTY BY COMPUKARE



EXATRON STRINGY FLOPPY FOR TRS80

(Expansion interface not needed)

only **£169** + VAT

High Speed storage medium that is cheap and reliable. Includes 20 wafers - M/C monitor - BUS EXPN cable. **£169**

COMMERCIAL • EXPANDABLE • COMPLETE TRS80 • MODEL II

This new unit from the world's most successful micro company is now available immediately with software. The basic unit comes complete with 64 thousand characters (bytes) of Memory. The built in 8" Floppy disc adds another 1/2 million extra characters including the disc operating system. More disc expansion is now available.

The Model II is a complete unit with a full keyboard including a numeric pad and 12" screen which gives 24 lines of 80 characters. The computer is supplied with both the disc operating system and the Level III Basic.

A full self test routine is written into the power up procedure to eliminate incorrect operation. Both serial and parallel expansion sockets are standard. A printer is a plug-in operation. Both hardware and software necessary to talk to a mainframe are included. Terminal usage is very possible. With the addition of CPM2 you can operate with COBOL, FORTRAN, MBASIC, CBASIC in which languages are many other applications packages i.e. accounting, payroll stock etc.

64K 1-Disk Model II **£1995.00** + VAT
RRP £2250.00

CP/M2 **£95.00** CBASIC **£75.00** FORTRAN **£220.00**
CIS COBOL **£400.00** MBASIC **£155.00** WORDSTAR **£255.00**

EPROM 2716 **£12.50** + VAT

only **£325** + VAT

EXTENDED WARRANTY BY COMPUKARE



TRS80 LEVEL 2 16K

Fully converted to UK T V Standard. Comes complete with easy to follow manuals. UK Power Supply — Cassettes Leads — Sample tapes. Special box to enable you to plug into your own TV. Recommended for first time-buyers. Just plug in and go. Full Range of Software Available.

Interface to Centronics Parallel for TRS80 **£75.00** + VAT

only **£295** + VAT
Expand your TRS80 by 32K

TRS80 EXPANSION INTERFACE

32K Memory on board Centronics parallel port Disk controller card Real time clock. Requires Level II Basic. Interface for 2 cassette decks complete with power supply.

YOU NEED NEVER MISS AN IMPORTANT CALL AGAIN TWO CORDLESS TELEPHONE SYSTEMS — DIRECT FROM USA

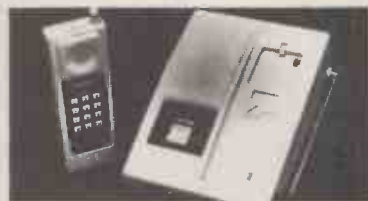

THE ALCOM only **£147** + VAT

Base station connects to your telephone line. Remote handset clips to your belt and gives you push-button dialling — Bleeps when call arriving — Nicad rechargeable batteries. Charger in base unit.

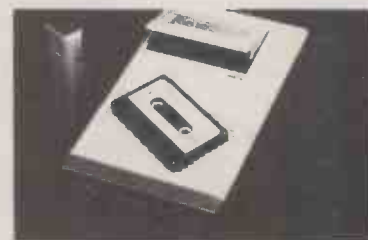

LOW COST TELEPHONE ANSWERING MACHINE only **£99.95** + VAT

Microprocessor controlled answering machine. Plug into your phone line. Records any phone call messages. Remote bleeper enables you to listen to your messages from anywhere in the world. Uses standard cassettes. Comes complete with mains adaptor, microphone, remote bleeper, base unit, cassette with 30 sample pre-recorded messages.

THE VIDEO GENIE SYSTEM EG3000 Series

16K **£289** + VAT

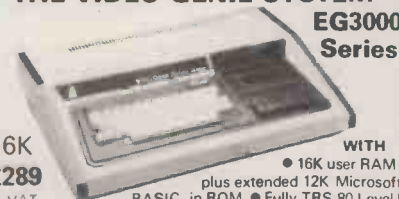

WITH 16K user RAM plus extended 12K Microsoft BASIC in ROM • Fully TRS-80 Level II software compatible • Huge range of software already available • Self contained, PSU, UHF modulator, and cassette • Simply plugs into video monitor or UHF TV • Full expansion to disks and printer • Absolutely complete — just fit into mains plug.

COMING SOON THE MARTELL TV GAME

RRP £540 only **£399** + VAT
ANADEX DP8000

Super Quality - Low cost printer Tractor Feed with full 96 ASCII character set. Accepts RS232C at baud rates between 100 and 9600 and Parallel Bit data.

Attaches either directly or through interfaces to Pet, Apple, TRS80, Sorcerer, Nascom, CompuKit etc.

THE NEW ANADEX DP9501

A PROFESSIONAL PRINTER



- Bi-directional printing
- Up to 220 chars/line with 4 print densities
- 500 char buffer
- RS232C and Centronics Parallel interface built in
- Full software control of matrix needles allowing graphics capability
- 200 chars/sec
- Adjustable width tractor feed.

All this for only **£895 + VAT.**

THE ATARI VIDEO COMPUTER GAMES SYSTEM

Atari's Video Computer System now offers more than 1300 different game variations and options in twenty Game Program™ cartridges!

Most Cartridges only **£13.90 + VAT**
 Prices may vary with special editions Basic Maths, Airsea Battle, Black Jack, Breakout, Surround, Spacewar, Video Olympics, Outlaw, Basketball, Hunt & Score*, Space War, Sky Diver, Air Sea Battle, Codebreaker*, Miniature Golf.

Extra Paddle Controllers - **£14.90 + VAT**
 Keyboard Controllers - **£16.90 + VAT**

SPACE INVADERS NOW IN STOCK £25

NEW TV GAME BREAK OUT

Has got to be one of the world's greatest TV games. You really get hooked. As featured in ETI. Has also 4 other pinball games and lots of options. Good kit for up-grading old amusement games.

MINI KIT - PCB, sound & vision modulator, memory chip and de-code chip. Very simple to construct. **£14.90 + VAT**
OR PCB £2.90 MAIN LSI £8.50 Both plus VAT

WE ARE NOW STOCKING THE APPLE II EUROPLUS AT REDUCED PRICES



16K **£599**
 32K **£649**
 48K **£659** + VAT

Getting Started APPLE II is faster, smaller, and more powerful than its predecessors. And it's more fun to use too because of built-in features like:

- BASIC - The Language that Makes Programming Fun.
- High-Resolution Graphics (in a 54,000-Point Array) for Finely-Detailed Displays.
- Sound Capability that Brings Programs to Life.
- Hand Controls for Games and Other Human-Input Applications.
- Internal Memory Capacity of 48K Bytes of RAM, 12K Bytes of ROM; for Big-System Performance in a Small Package.
- Eight Accessory Expansion Slots to let the System Grow With Your Needs.

You don't need to be an expert to enjoy APPLE II. It is a complete, ready-to-run computer. Just connect it to a video display and start using programs (or writing your own) the first day. You'll find that its tutorial manuals help you make it your own personal problem solver.



"Europe's Largest Discount Personal Computer Stores"

Please add VAT to all prices - including delivery. Please make cheques and postal orders payable to **COMP SHOP LTD.**, or phone your order quoting **BARCLAYCARD, ACCESS, DINERS CLUB** or **AMERICAN EXPRESS** number.

MAIL ORDER AND SHOP:

14 Station Road, New Barnet, Hertfordshire, EN5 1QW (Close to New Barnet BR Station - Moorgate Line).
 Telephone: 01-441 2922 (Sales) 01-449 6596 Telex: 298755 TELCOM G

NEW WEST END SHOWROOM:

311 Edgware Road, London W2. Telephone: 01-262 0387

OPEN - 10am - 7pm - Monday to Saturday

- ★ **IRELAND:** 80 Marlborough Street, Dublin 1. Telephone: Dublin 749933
- ★ **COMP SHOP USA,** 1348 East Edinger, Santa Ana, California, Zip Code 92705. Telephone: 0101 714 5472526



COMP COMPUTER COMPONENTS

(Part of the Compshop Ltd. Group)



EUROPE'S FASTEST SELLING ONE BOARD COMPUTER
COMPUKIT UK101

★ 6502 based system - best value for money on the market. ★ Powerful 8K Basic - Fastest around ★ Full Qwerty Keyboard ★ 4K RAM Expandable to 8K on board. ★ Power supply and RF Modulator on board. ★ No Extras needed - Plug-in and go. ★ Kansas City Tape Interface on board. ★ Free Sampler Tape including powerful Disassembler and Monitor with each Kit. ★ If you want to learn about Micros, but didn't know which machine to buy then this is the machine for you.

40 pin Expansion Jumper Cable for CompuKit expansion **£8.50 + VAT**

Build, Understand and Program your own Computer for only a small outlay

KIT ONLY £179 + VAT
NO EXTRAS NEEDED

Available ready assembled, tested & ready to go **£229 + VAT**

NEW MONITOR FOR COMPUKIT UK101

● In 2K Eprom 2716 ● Allows screen editing ● Saves data on tape ● Flashing cursor ● Text scrolls down **£22.00 + VAT**

FOR THE COMPUKIT

Assembler/Editor **£14.90**
 Screen Editor Tape **£5.90**

Game Packs

1. Four Games **£5.00**
 2. Four Games **£5.00**
 3. Three Games 8K only **£5.00**

Super Space Invaders (8K) **£6.50**
 Space Invaders **£5.00**
 Chequers **£3.00**
 Real Time Clock **£3.00**
 Case for CompuKit **£29.50**



HITACHI PROFESSIONAL MONITORS

9" - ~~£129~~ **£99.95**
 12" - ~~£199~~ **£149**

- **Reliability** Solid state circuitry using an IC and silicon transistors ensures high reliability.
- **500 lines horizontal resolution** Horizontal resolution in excess of 500 lines is achieved in picture center.
- **Stable picture** Even played back pictures of VTR can be displayed without filtering.
- **Looping video input** Video input can be looped through with built-in termination switch.
- **External sync operation** (available as option for U and C types)
- **Compact construction** Two monitors are mountable side by side in a standard 19-inch rack.

MEMORY UPGRADES

16K (8 x 4116) **£29.90 + VAT**
 4K CompuKit (8 x 2114) **£29.90 + VAT**

ENGLISH COLOUR TV/ AMERICAN NTSC COLOUR MONITOR

Suitable for Apple, Atari and Texas 99/4 **£295 + VAT**

8MHz Super Quality Modulators **£4.90**
 6MHz Standard Modulators **£2.90**
 C12 Computer Grade Cassettes 10 for **£4.00**
 Anadex Printer Paper - 2000 sheets **£25.00**
 Floppy Discs 5 1/4" Hard and Soft Sector **£3.50**
 Floppy Disc Library Case 5 1/4" **£3.50**
 Verocases for Nascom 1 & 2 etc. **£24.90**
 Keyboard Cases **£9.90**

SPECIAL OFFER

We will part exchange your Sinclair ZX80 for any of our products.

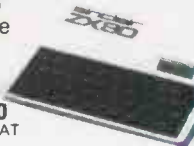

Refurbished ZX80's - fully guaranteed **£69.90 + VAT**
 (Supply dependant upon stocks).

We have one of the largest collections of Computer Books under one roof, along with racks of software for the PET and TRS80. **Come and see for yourself.**



We give a full one year's warranty on all our products.

SPECIAL - ONCE IN A LIFETIME OFFER!

RRP £740 + VAT

16K **£399**
 32K **£449**
 48K **£499** + VAT



EXIDY SORCERER

For Personal or Business Use.
 32K or 48K memory. 8K Microsoft Basic in ROM. Dual Cassette I/O, RS232 I/O. Parallel I/O (Centronics). Expansion available through optional extra \$100 Motherboard. 69 Key keyboard including 16 key numeric pad.

We are now entering our fourth financial year of dealing solely in the personal computer market — in fact, we started it! Over this period, Personal Computers Limited have formed a group of graduate specialists who will help you in the fields of word processing, financial planning, statistics, economic modelling, forecasting, accounting systems, foreign exchange, banking and oil exploration. We also do rather well with computer graphics and highly recommend the graphics tablets and our plotter for Apple.

We can also offer two excellent items of software — Format 40 and Visicalc — at a combined price of ONLY £189, and the Super Sound Generator for only £90! (excl. V.A.T.)



8" Disk Drive (above left)

Our 8" disks are still as popular as ever — 2 drives give you 1.2MB with all the reliable security of Shugart Technology. Easily interfaced to Apple, uses the same D.O.S.

A.I.O. Serial and Parallel Card (above centre)

Three hand-shake lines (R.T.S., C.T.S. and D.C.D.). Firmware for serial interfaces on-board, software for parallel printer available, 2 bi-directional 8 bit parallel ports, plus 4 additional interrupt and hand-shaking lines.

Light Pen (above right)

A much sought after product which we introduced to the U.K.

80 Character Card (below left)

... opens up the real commercial world for all Apple-owners.

Paper Tiger (Below centre)

132 character line, plus graphics, 8 character sizes, ordinary paper, multiple copy, upper and lower case 96 character, parallel/serial, form control.

Centronics 730 (Below right)

A substantial, robust printer from a major manufacturer. 3 way paper handling system, 100 character per second. Special low-cost including interface. 96 characters.



Items pictured

Sharp MZ — 80K

A new generation of personal computer, self contained, versatile and starting at only £570 (excl. VAT). Explore the Zilog Z80 now the easy way. Disks and printer available shortly.

Numeric Keypad

... with 8 function keys is a must in all financial applications.

TCM 100 & TCM 200

... both now have graphics as well as their own power supply, essential with this type of printer.

Qume Sprint 5

The quality word processing printer. Clean, clear executive reports the way you want them. Can print up to 5760 points per square inch — or even print in 2 colours.

This is what we do..

and we do it rather well!



Personal Computers Limited

104-200 Bishopsgate, London, E.C.2M 4NT. Tel: 01-692 0121

For further information, please complete this coupon and post to:
 Personal Computers Limited, 194-200 Bishopsgate, London EC2M 4NY

NAME _____ ADDRESS _____

* Now here details for APPLE III