

RA Rae

THE POST OFFICE
Cromwell Rd
ELECTRICAL ENGINEERS'
JOURNAL



Vol. 53 Part 3

OCTOBER 1960

CONTENTS

	Page
AN INSERTION-LOSS DISPLAY AND RECORDING EQUIPMENT FOR THE FREQUENCY RANGE 50 kc/s-8 Mc/s—A. E. Ford and J. S. Whyte, M.Sc.(Eng.), A.M.I.E.E.	145
THE BRITISH COMPUTER SOCIETY'S SECOND ANNUAL NATIONAL CONFERENCE, HARROGATE, JULY 1960	150
A CONTINUOUS-READING HARMONIC ANALYSER FOR COMPLEX 50 c/s WAVEFORMS T. Pilling, B.Sc.(Tech.), A.M.I.E.E., G. A. Bartlett, B.Sc.(Eng.), A.M.I.E.E., and W. J. B. Stephens	152
THE POST OFFICE TYPE 1 RATCHET RELAY D. J. Manning.....	154
EXTENSION OF ONGAR RADIO STATION R. Holden, B.Sc.(Eng.), A.M.I.E.E., and L. R. Meatyard, A.M.I.E.E.....	158
A SIGNAL GENERATOR FOR TESTING BAND 7 (H.F.) RADIO TRANSMITTERS E. G. Bronsdon.....	160
PLASTIC TELEPHONE CABLE CONSTRUCTION IN THE TROPICS Sir Norman Frome, C.I.E., D.F.C., M.Sc., M.I.E.E.....	162
THE ANGLO-SWEDISH SUBMARINE TELEPHONE CABLE.....	165
THE 4-WIRE EXTENSION PRINCIPLE FOR SMALL CORDLESS P.M.B.X. SWITCHBOARDS E. J. Lidbetter.....	167
A PROPOSED NEW CABLE SYSTEM DIRECT TO U.S.A.—TAT-3.....	169
NEW COAST RADIO STATIONS E. Briggs and B. Peters.....	170
VOLTAGE-MARGIN TESTING OF TELEGRAPH ELECTRONIC SWITCHING EQUIPMENT A. F. Harrison, Grad.I.E.E., A.M.Brit.I.R.E.....	173
THE USE OF MODERN MATERIALS FOR TELEPHONE CORDS.....	175
A LIGHT-WEIGHT HEADSET FOR TELEPHONE OPERATORS H. J. C. Spencer, A.M.I.E.E., and J. S. P. Robertson, B.Sc.(Eng.).....	177
SORTING TECHNIQUES FOR AUTOMATIC COMPUTERS J. B. Stringer, M.A.....	181
EFFECT OF RAILWAY ELECTRIFICATION ON POST OFFICE CIRCUITS D. W. R. Cobbe, A.M.I.E.E., and B. R. Horsfield, A.M.I.E.E.....	184
A TABLE TELEPHONE WITH FOUR PUSH-BUTTON KEYS—TELEPHONE No. 710 H. J. C. Spencer, A.M.I.E.E.....	190
CALIBRATION	192
AUTOMATIC CONTROL OF THE RUGBY RADIO (GBR) TIME SIGNALS BY AN ELECTRONIC CLOCK—J. S. McClements.....	193
A TESTER FOR OUTLETS FROM 2-MOTION SELECTOR BANKS.....	196
TIME ASSIGNMENT SPEECH INTERPOLATION (T.A.S.I.) C. E. E. Clinch, B.Sc.(Eng.), A.M.I.E.E., F.S.S.....	197
SIGNALLING ARRANGEMENTS FOR DIALLING OVER THE TRANSATLANTIC TELEPHONE CABLES—S. Welch, M.Eng., A.M.I.E.E.....	201
WHEATSTONE BRIDGE CIRCUIT FOR TEST-DESKS.....	205
NOTES AND COMMENTS.....	206
INSTITUTION OF POST OFFICE ELECTRICAL ENGINEERS.....	208
REGIONAL NOTES	209
ASSOCIATE SECTION NOTES.....	212
STAFF CHANGES	216
BOOK REVIEWS.....	151, 157, 159, 161, 166, 169, 172, 174, 195, 196, 207, 211, 215

Price 2s. 6d. (Post Paid 3s. 6d.)

Published in April, July, October and January by *The Post Office Electrical Engineers' Journal*,
G.P.O., 2-12 Gresham Street, London, E.C.2.

Annual Subscription (post paid): Home and Overseas, 14s. (Canada and U.S.A. 2 dollars 25 cents).

THE POST OFFICE ELECTRICAL ENGINEERS' JOURNAL

Vol. 53 Part 3

OCTOBER 1960

An Insertion-Loss Display and Recording Equipment for the Frequency Range 50 kc/s–8 Mc/s

A. E. FORD and J. S. WHYTE, M.Sc.(Eng.), A.M.I.E.E.†

U.D.C. 621.317.741.029.5:621.317.755

The equipment described enables insertion-loss/frequency measurements in the range 50 kc/s–8 Mc/s to be made with great rapidity. The insertion-loss/frequency characteristic of the system under test may be displayed on a cathode-ray tube, or, alternatively, it may be recorded on a pen-recorder chart. No connexion, other than that provided by the system under test, is needed between the sending and receiving portions of the equipment.

INTRODUCTION

ONE of the basic measurements that has to be made in connexion with high-frequency transmission equipment is that of insertion loss as a function of frequency. Such measurements are required at all stages in the design, manufacture, installation, maintenance and overhaul of transmission equipment. The traditional point-by-point methods are time consuming, and unless the measuring frequencies are very closely spaced there is a danger that significant irregularities may be overlooked. The need to obtain results more quickly and with greater accuracy has therefore led to the development of the equipment to be described.

The ability to carry out insertion-loss/frequency measurements more rapidly not only enables new plant to be brought into service more quickly, it can also lead to a reduction in the cost of high-frequency transmission equipment (since testing is estimated to account for approximately 10 per cent of the capital cost of such equipment) and to less time being required for maintenance measurements, which may require a high-frequency line to be taken out of service.

The contribution to faster testing made by sweep-frequency equipment arises mainly from the large quantity of information that it provides and the speed with which it can present such information. The latter feature is particularly advantageous when, for example, the characteristic being measured is changing with time. The existence and magnitude of such changes, even when they persist for periods as short as a few seconds, are clearly seen on sweep-frequency equipment, and they would be extremely difficult to measure in other ways.

The same feature may justify the adoption of circuit arrangements involving many variables, whose adjustment using point-by-point methods might take so long as to be impracticable. An example of this is offered by an

experimental variable equalizer with which the authors have recently been concerned. This equalizer has 27 variable controls, which may be considered as being interdependent. The adjustment of these controls to produce a desired result may require between 200 and 300 insertion-loss/frequency runs to be made. With the sweep-frequency type of measuring set the adjustments and all the frequency runs may easily be made in less than five minutes. This example has been chosen because, being an extreme case, it indicates how dramatic the contrast with traditional methods can be.

The equipment that has been developed comprises a sender and receiver which may be operated at localities remote from each other and having no interconnexion other than that provided by the system under test. The receiver provides a continuous display, on a cathode-ray tube, of the insertion-loss/frequency characteristic of the network or system connected between the sender and receiver. A frequency band of 50 kc/s–8 Mc/s, or any part of this band, may be displayed, and at maximum sensitivity a discrimination of better than 0.1 db is obtained.

As an alternative to the cathode-ray tube, records may be taken on the chart of a pen recorder, and in this way a permanent copy of the display is available in a period of one minute. This facility has shown itself to be extremely valuable, as it is cheap and free from several practical difficulties that arise with photographic methods.

Fig. 1 shows a complete equipment. The receiver may be identified by the cathode-ray tube seen on the right-hand side of its front panel; the sender is immediately below it. The other two units contain the power-supply equipment.

CIRCUIT ARRANGEMENT

Sender

The sender (Fig. 2) functions as a beat-frequency oscillator in which one of the primary oscillators operates at a fixed frequency of 25 Mc/s and the other primary oscillator is frequency modulated. The latter oscillator, which operates in the frequency range 25–33 Mc/s, makes use of the magnetic properties of ferrite material.

Fig. 3 shows how the h.f. coil of the oscillator is wound on a small ferrite core, which itself forms part of a closed magnetic circuit. When no current is flowing in the l.f.

† Post Office Research Station.



FIG. 1—INSERTION-LOSS DISPLAY AND RECORDING EQUIPMENT

energizing coil shown, there is no flux in the iron circuit, and the permeability of the ferrite, and hence the inductance of the h.f. coil, is at maximum. When current flows in the energizing coil, the flux produced in the ferrite core reduces its incremental permeability and hence also reduces the inductance of the h.f. coil. In the limit, if the ferrite core were saturated, the inductance of the h.f. coil would be equal to its inductance in air. Using this device, a sawtooth current in the energizing coil produces the desired repetitive frequency sweep, and a simple control of the sweep width is obtained by varying the sawtooth amplitude.

The difference-frequency output from the mixer stage is transmitted to line via a negative feedback amplifier, providing an output level of + 5 dbm* into a 75-ohm load. A direct-coupled automatic-gain-control circuit reduces the variations of output level with frequency to less than 0.1 db.

* dbm—decibels relative to 1 mW.

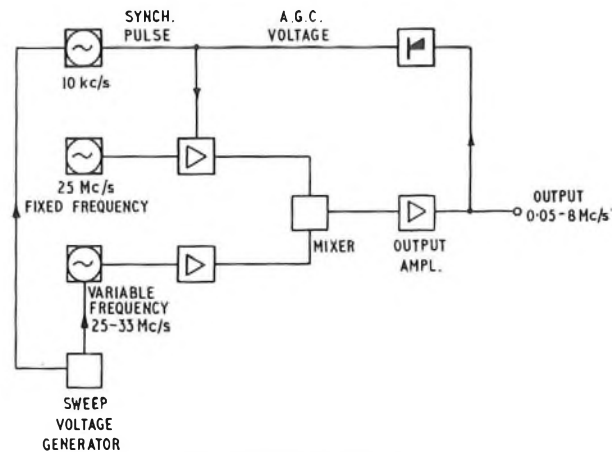

FIG. 2—BLOCK SCHEMATIC DIAGRAM OF SENDER

The sawtooth current required in the energizing coil is controlled in time and amplitude by two phantastron relaxation oscillators,¹ one controlling the forward sweep period and the other controlling the flyback period. A choice of two sweep rates is offered, one having a forward sweep period of 40 ms for use with the cathode-ray tube display, the other having a forward sweep period of 1 minute for use with the recorder. It is the provision of the very slow sweep rate which makes it necessary to use direct coupling for the automatic-gain-control circuits. Controlling the reverse-scan period by means of a separate phantastron ensures that the correct period of time is available for the synchronizing operations to take place. Pulses for synchronizing the receiver time-base are generated in the sender and transmitted over the system under test; the method employed is described more fully later.

Receiver

The receiver (Fig. 4) has an input impedance of 75 ohms with a return loss of better than 40 db and is designed to operate with a nominal input level of - 15 dbm. The input amplifier has three stages and, when the 27 db of negative feedback is applied, its gain does not vary by more than ± 0.1 db over the frequency range 50 kc/s-

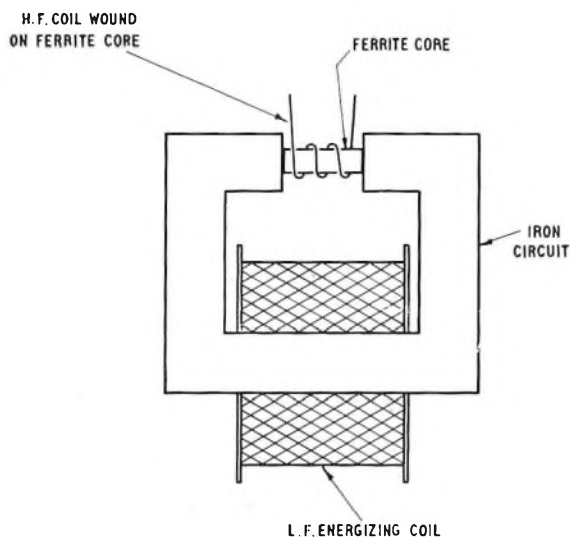

FIG. 3—ARRANGEMENT OF FERRITE MODULATOR

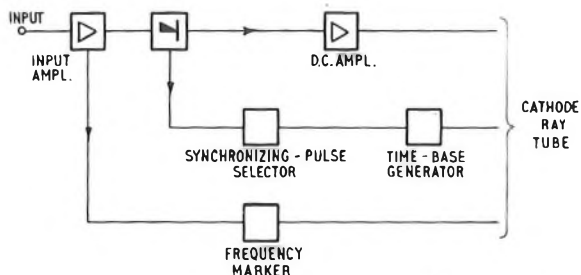

FIG. 4—BLOCK SCHEMATIC DIAGRAM OF RECEIVER

8 Mc/s. It will be appreciated that the requirements of the receiver input amplifier are more exacting than those of the sender output amplifier in respect of flatness of gain/frequency response because the shortcomings of the sender amplifier may to some extent be remedied by the automatic gain control, whereas no such remedial action is possible for the receiver amplifier.

Following the input amplifier is the diode detector; the steady component of the d.c. output due to the incoming signal is "backed-off" by potentials applied in the detector output stage, and the variations are amplified in the 2-stage direct-coupled amplifier which follows. A balanced output stage provides the Y deflecting potentials for the cathode-ray tube. Negative feedback reduces the zero drift and improves the stability of this amplifier. Direct coupling throughout confers several advantages, one being that the vertical axis may be calibrated by inserting known increments of loss on the input attenuator.

A second output from the detector is fed to the circuits which identify the occurrence of the synchronizing pulse; the manner in which these circuits operate is described in more detail in the next section. The receiver time-base generator uses a double-triode valve, and the linearity of the capacitor-charging current is improved by "bootstrap" action.¹ A balanced amplifier follows the waveform generator and feeds the deflexion voltage to both pairs of X deflexion plates of the double-gun cathode-ray tube.

One beam of this tube gives the signal display and the other, used for frequency marking, is arranged to be normally deflected to a position off the screen. The frequency-marking circuits measure the incoming frequency and, when this is equal to one of the internally generated frequencies, a pulse is produced. This pulse is used to deflect the marker beam completely across the screen; the frequency calibration therefore appears as a series of ordinates, and these can be seen in the photograph of a typical display given in Fig. 10(a).

When it is desired to use the recording facility there is no need to provide a slow-speed sweep generator at the receiver, so the synchronizing facilities are not required. The recorder employed uses a roller-type chart and has a synchronous electric-motor drive, so that in effect the motor drive provides the receiver slow-speed time base and the recordings are repeated along the chart at 1-minute intervals.

SYNCHRONIZATION AND FREQUENCY CALIBRATION

The descriptions given of the sender and receiver have necessarily been very much simplified. Two interesting examples of the circuit arrangements, the synchronization of the time-base generators at the sender and receiver and the frequency calibration arrangements at the receiver, will, however, be described more fully.

Synchronization

As already explained, the X deflexion of the display in the receiver is produced by a sawtooth generator running as a slave to that in the sender, synchronizing information having been transmitted over the system under test. D.C. synchronizing pulses of the type associated with a television video waveform cannot be transmitted because the networks to be tested will frequently have band-pass characteristics. The pulses are therefore sent as amplitude modulations of a carrier signal, and the sweep signal is used as the carrier during the flyback period.

At the end of each sweep the time-base generator in the sender produces a pulse of about 4 ms duration. A 10 kc/s oscillator (Fig. 2) is arranged so that oscillation is inhibited except during receipt of this pulse; hence a burst of 10 kc/s tone lasting 4 ms is produced, marking the end of each transmitted sweep. By feeding this burst of tone on to the automatic-gain-control line, amplitude modulation of the sent signal is achieved.

At the receiver it is necessary to avoid false time-base operation by incoming signals that imitate the synchronizing signal. For this purpose, the synchronizing signal is tested for frequency, duration and approximate pulse-repetition frequency before being accepted as valid.

Referring to Fig. 5, it will be seen that the burst of 10 kc/s synchronizing tone is selected by a 10 kc/s band-pass filter connected to the receiver detector output.

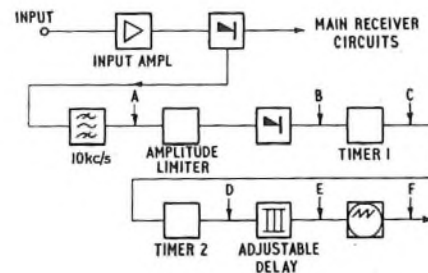

FIG. 5—BLOCK SCHEMATIC DIAGRAM OF SYNCHRONIZING-PULSE SELECTOR CIRCUITS

After amplitude limiting by a cathode-coupled pair, the 10 kc/s burst is rectified, so giving a d.c. pulse which is passed to the timing circuits. The first of these generates an output pulse after an input pulse has been present for 2 ms; the second provides a period of about 25 ms, following the transmission of a pulse, during which no further transmission can occur. The relative time relationships of the waveforms at the points lettered in Fig. 5 are illustrated in Fig. 6.

The pulse now available at point D of Fig. 5 occurs some milliseconds after the end of the forward sweep from the sender, but several milliseconds before the start of the next sweep. The exact number of milliseconds will depend on the characteristics of the particular sender and of the system under test, and to ensure that any sender can work to any receiver it is necessary to provide an adjustable delay at the receiver; this enables the new forward sweep in the receiver to be set to coincide with that in the sender. The pulse at point D (which is coincident with that at point C) is used to switch on the current in a valve. This current returns to its original state after a period determined by an adjustable time-constant circuit. The waveform shown in Fig. 6 for point E is thereby obtained. The leading edge of this waveform initiates the flyback in the receiver time-base generator, and there

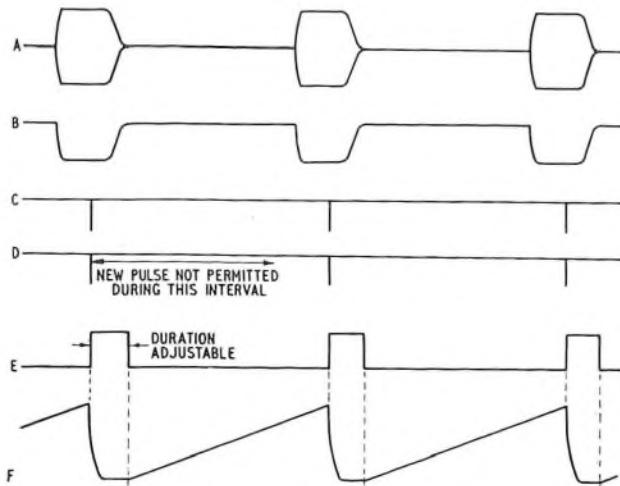

FIG. 6—TIME RELATIONSHIPS IN SYNCHRONIZING-PULSE SELECTOR CIRCUITS

follows a rest period until the trailing edge of this waveform arrives. When this happens, a new forward sweep can commence, as shown in Fig. 6 for point F.

Frequency Calibration

The frequency calibration of the display is produced by comparing the incoming sweep frequency with locally generated reference frequencies. When they are equal, a pulse is generated which is used to deflect one of the beams of the double-gun cathode-ray tube. In this way a calibration in the form of a series of ordinates is obtained, as illustrated in Fig. 10(a).

Fig. 7 shows the circuit arrangement. A harmonic series of frequencies, selected by a switch to have either 1, 0.5 or 0.25 Mc/s spacing, is generated by a blocking oscillator. These harmonics are compared with the incoming sweep signal in the mixer stage, the difference-frequency output of the stage being selected by the succeeding low-pass filter. For the purposes of explanation only, suppose the circuit were interrupted at the point X. A beat frequency would appear at the point Y whenever the incoming frequency had a frequency $nf \pm f_c$ where nf represents the various harmonics of the blocking oscillator whose fundamental frequency is f , and f_c is the cut-off frequency of the low-pass filter. The low-pass filter output during a portion of the sweep would be as represented in Fig. 8. The beat frequency starts at about 50 kc/s, falls linearly to zero and then rises again to 50 kc/s before the

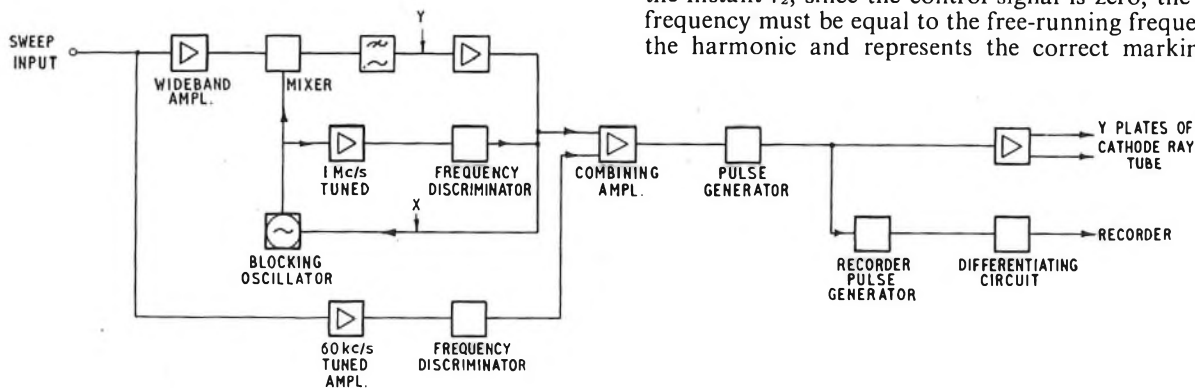

FIG. 7—BLOCK SCHEMATIC DIAGRAM OF FREQUENCY-MARKER CIRCUIT

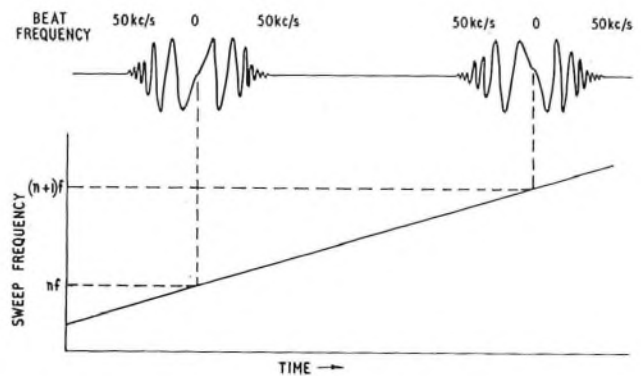

FIG. 8—BEAT-FREQUENCY RELATIONSHIPS IN FREQUENCY-MARKER CIRCUIT WHEN PHASE-LOCKING LOOP IS DISCONNECTED

output ceases until the region of the next harmonic is reached.

It might be supposed that it is only necessary to detect the envelope of this beat frequency to obtain a double pulse with which to identify the desired frequency. Such an arrangement gives unsatisfactory results. If a sweep width of 8 Mc/s occupies 100 mm of the screen, and if the marker pulse is to be not more than $\frac{1}{4}$ mm in width, the low-pass filter cut-off would have to be $1/800$ of the sweep width, i.e. 10 kc/s (allowing for the fact that a double pulse is received). Since the sweep is proceeding at the rate of 200 kc/s per millisecond, the beat frequency is within the filter pass-band for only 100 microseconds. During this time the beat frequency has to fall from 10 kc/s to zero and rise again to 10 kc/s. Remembering that the period of the initial beat frequency of 10 kc/s is 100 microseconds, it will be understood that a beat tone having a consistent envelope shape will not be obtained, and the actual waveform will depend on the phase relation existing between the two signals at the moment that their frequencies are identical; this phase relation will be random. The solution of this problem lies in the use of the phase-locking circuit² when the connexion is made at point X.

As the sweep frequency approaches one of the blocking-oscillator harmonics, a control signal is fed back to this oscillator and pulls it into synchronism with the sweep frequency. Once synchronism has been achieved, the control signal at X is a quasi-direct-current signal whose amplitude and sign are determined by the phase relationship of the two input signals to the mixer; the waveform at X now has the form shown in Fig. 9(a). Synchronism between the sweep frequency and the harmonic of the blocking oscillator is established at t_1 and lost at t_3 . At the instant t_2 , since the control signal is zero, the sweep frequency must be equal to the free-running frequency of the harmonic and represents the correct marking fre-

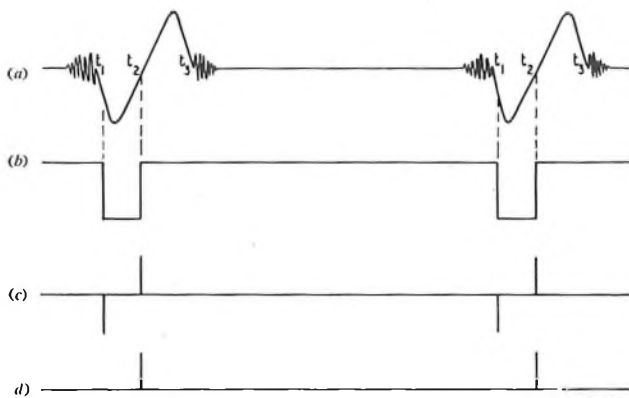

FIG. 9—FREQUENCY-MARKER CIRCUIT WAVEFORMS

quency. The low-frequency component of this waveform is used to trigger a pulse-generator circuit which gives an output of the form shown in Fig. 9(b). Differentiating this, and clamping to remove the negative-going pulse, gives the waveform of Fig. 9(d). It will be seen that a narrow pulse now occurs at the desired time instant. This pulse is then used to deflect the frequency-marker beam on the cathode-ray tube, so drawing the desired ordinate.

In the arrangement as described so far the accuracy of the frequency markers will be limited by the frequency stability of the blocking oscillator, and this is not inherently high. For this reason, automatic frequency control (a.f.c.) is required, and the 1 Mc/s component of the oscillator output is extracted and passed to a frequency discriminator centred on 1 Mc/s. The rectified output from this is fed back into the control circuit (as a form of a.f.c.), so that the overall frequency stability depends more on the frequency discriminator than on the oscillator. It is necessary to make the time constant of the frequency-discriminator output circuit long, so that it does not effectively oppose the wanted frequency changes associated with the frequency-locking feature.

The pulses which are fed to the cathode-ray tube are much too brief in duration to deflect the pen of the pen recorder, so they are used to produce a new pulse from a second pulse-generator. If a single-current pulse is supplied to the pen the resultant mark has a steep front but a slowly falling trailing edge because the restoring torque on the pen is small; hence an unacceptably wide mark results irrespective of the width of the pulse. This can be overcome by using a double-current pulse of suitable width and amplitude so that the pen is driven back towards its standing position by the reverse-current pulse. The neat, narrow markers obtained by this technique can be seen on the photograph of a section of actual recording in Fig. 10(b).

OPERATION AND TYPICAL RESULTS

A feature of the equipment is the ease of operation after the initial adjustment of the preset controls. Controls on the sender permit the sweep width, minimum frequency of the sweep, and the output level to be set as required. Other controls on the receiver give a choice of 0.5 db/cm, 1.0 db/cm or a coarse uncalibrated range as the sensitivity of the display, and a choice of frequency markers at intervals of 250 kc/s, 500 kc/s or 1 Mc/s plus an optional marker at 60 kc/s. Operating a switch on the sender and on the receiver prepares the equipment for recording.

An example of the type of display produced is shown in Fig. 10(a), which is reproduced from a photograph of the tube face. In this instance the insertion-loss/frequency characteristic typical of a long-distance coaxial-cable transmission system is displayed. The vertical ordinates, which are the frequency markers, are spaced at 500 kc/s in this example and the extreme left-hand ordinate corresponds to 0 Mc/s. The sensitivity is set so that the horizontal calibration lines are spaced at intervals corresponding to 0.5 db. The portion of chart produced by the recorder under the same conditions is reproduced in Fig. 10(b). In this instance the frequency markers appear as short vertical marks on the trace, and the loss calibration is printed on the chart.

Whenever sweep methods of measurement are used care has to be taken to ensure that the rate of change of frequency used is not too great, or distortions may occur. Because, in the present equipment, reduction of the sweep width also reduces the rate of change of frequency, there is no difficulty in meeting this requirement. Any doubt concerning the existence of this type of distortion is easily resolved by reducing the sweep width to see if the display amplitude changes.

The line amplifiers used on modern cable systems frequently have large slopes in their gain/frequency

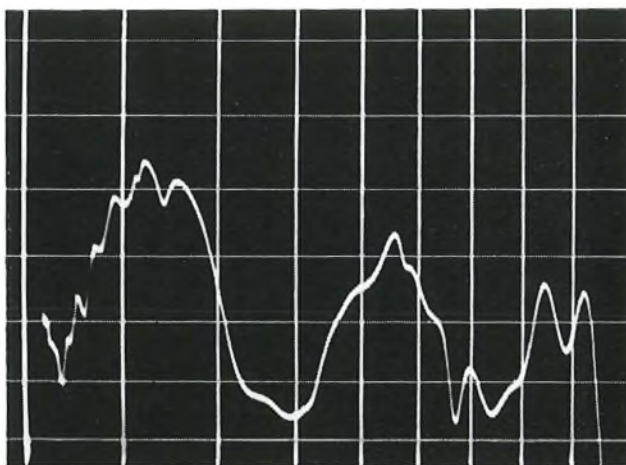

(a) Photograph of typical display

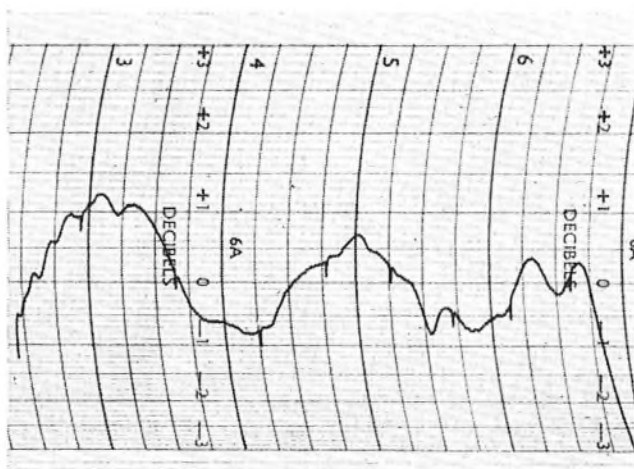

(b) Recorded curve corresponding to Fig. 10(a)

FIG. 10—MEASURED INSERTION-LOSS/FREQUENCY CHARACTERISTIC

characteristic to compensate for the cable characteristics. To test such amplifiers with this equipment they are connected in tandem with a cable simulation network, so that the overall nominal characteristic is flat, and small deviations of the amplifier characteristic from the desired slope are then readily apparent.

In conjunction with a return-loss bridge the equipment can display or record return loss as a function of frequency, and this facility is of great value in the adjustment of amplifiers.

Other less obvious applications of the apparatus that have proved useful during work on broadband transmission systems include indication of system pilot break-through, hum modulation and the level and frequency of interfering tones.

A slightly modified version of the equipment is proving of great value in the acceptance testing of frequency translating equipment, where the facility of speedily recording the results is of particular value. Another set

installed on H.M.T.S. *Monarch* was used during the laying of the Newfoundland–Nova Scotia section of the second transatlantic telephone cable in 1959. The application of sweep-frequency equipment to submarine cable work will probably become standard procedure for future important laying operations.

ACKNOWLEDGEMENT

The authors wish to acknowledge the contributions made to the development of this equipment by several of their colleagues, in particular Mr. R. A. Seymour, who invented the frequency-marking arrangement, and Mr. J. R. Jarvis, who contributed to other parts of the equipment.

References

¹ WILLIAMS, F. C., and MOODY, N. F. Ranging Circuits, Linear Time-base Generators and Associated Circuits. *Journal I.E.E.*, Part IIIa, Radiolocation, Vol. 93, No. 7, p. 1188, 1946.

² British Patent Application No. 29887/57.

The British Computer Society's Second Annual National Conference, Harrogate, July 1960

U.D.C. 061.3:681.14

THE British Computer Society, which was established in 1957, originated in the merger of the London Computer Group and university, scientific and engineering interests in computers. Previously, the London Computer Group, formed in 1956, had been principally concerned with accounting and management-control uses of computers. It was soon realized, however, that a body of wider interests was required and the Society was formed. The Society holds meetings and discussions about the application and design of computers and associated machines. It is a member of the British Conference on Automation and Computation, which also includes as members the professional engineering institutions.

The first annual conference of the Society was held at Cambridge University in 1959, and this year the second conference, at Harrogate, was held from 4–7 July. About 350 people attended, including visitors from France, Sweden, Holland and Canada. Several members of the Post Office Engineering Department attended, as well as representatives of H.M. Treasury Technical Support Unit.

On Monday evening the conference began with the presidential address given by Dr. Wilkes of Cambridge University. He referred to the establishment of the International Federation of Data Processing Societies (I.F.D.P.S.) which had been proposed at the UNESCO conference in Paris in June 1959.* The first council meeting of I.F.D.P.S. had been held in Rome in June 1960 and the British Computer Society had represented the United Kingdom. Amongst items agreed there were plans for the second International Conference on Information Processing to be held in Munich in September 1962.

Dr. Wilkes then referred in some detail to data trans-

mission and the need for error-correcting devices. He said that in the U.S.A. some difficulty had been experienced with automatic-repeat systems due to the presence of echo suppressors. This had resulted in further consideration of error-correcting codes. He mentioned the facilities available from the Post Office and compared the relative advantages of using a private circuit as against the use of the public network. He concluded by saying that the accurate transmission of coded data was important for computers and that, in the future, telecommunications transmission engineers might be less concerned than Shakespeare's Hamlet was with "words, words, words."

On Tuesday morning the first of the formal papers was read. This discussed the need for a linking language between that of the computer, which requires its instructions in a fixed form and in unambiguous minute terms, and human beings, who often give their instructions in varying forms and are less specific. The earlier computers were instructed by the programmer in a coded language arranged to make easier the design of the machine. The present move is to use problem oriented languages; examples of these are FORTRAN—Formula Translation Language, and ALGOL—Algorithmic Language. These two are oriented in the direction of mathematical problems, and instructions to the machine, instead of being coded in an unnatural way, can be written in a form resembling the original mathematical expressions of the problem. More difficult to devise are languages to represent data processing or business applications. An example of these is COBOL—Common Business Language. Here use is made of noise words which have no effect upon the computer. In the statement "If A is greater than B—", "if" and "is" are noise words and are merely used to give the orders a language structure more acceptable to the programmer. These techniques go under the general title of auto-codes, and in addition

* First International Conference on Information Processing at Paris, June 1959. *P.O.E.E.J.*, Vol. 52, p. 206, Oct. 1959.

to allowing the programmer to express his program in every-day language they also relieve him of the responsibility of designating storage positions within the computer and, consequently, facilitate subsequent changes to the program.

Other papers on Tuesday dealt with the use of computers for market research and also the use of small computers in science and industry. A particularly interesting part of this session, and also the session on Wednesday afternoon, was the use of computers for the solution of problems by simulation techniques. The problems considered concerned the actual operation of a hydroelectric system, a nuclear power station and a chemical plant. Variations in the size of the plant, the conditions of operation and the volume of the output all interact. To find the optimum conditions a test employing a large range of settings and conditions on the plant itself would provide a solution. This approach may not be practicable, e.g. the plant has to be kept working, or certain settings may be dangerous and in many instances, e.g. during the design stages, the plant may not even exist. An approximate solution by means of a computer can often be found by simulating the problem in terms of a mathematical analysis of the operation. Alternatively, an analogue of the operation but represented within the computer in digital terms is sometimes an easier approach. In the case of the hydroelectric-system simulation the program took into account the water

levels of an upper and a lower reservoir, the flow of water along a channel connecting them, the effect of sluice gates, the effective loss of power due to water overspilling the reservoir, and shortage of water in summer, etc. The whole previous life-cycle of 14 years of operation of the system was simulated in 45 minutes. Possible constructional changes to the reservoirs and the effect on the operation was also investigated.

On Wednesday morning a report was given by a member of a party, representing the Scientific Instrument Manufacturers Association (S.I.M.A.), of a recent visit to Moscow during an exhibition organized by the International Federation of Automatic Control. The Russians are particularly interested in machines for process control and a small British computer suitable for this purpose, which was on show there, attracted a good deal of attention.

A visit to the U.S.A. in connexion with a convention organized by the University of California on "Control and Exploitation of Giant Computers" was also described. A magnetic-tape unit for one of these machines with a maximum information rate of 9 million bits per second was mentioned.

Other papers included were on numerical analysis, data processing in government departments and accounting applications. A small exhibition of computing equipment and visits to computing centres were also arranged.

G. D. A.

Book Review

"Television Field Trials of 405-Line and 625-Line Systems in the U.H.F. and S.H.F. Bands, 1957-8." The British Broadcasting Corporation. 152 pp., 160 ill. 20s.

This report analyses the results of tests carried out on behalf of the Technical Sub-Committee of the Television Advisory Committee by the B.B.C., D.S.I.R., I.T.A., Mullard Research Laboratories and the Post Office, with the full co-operation of several receiver manufacturers. It is of particular interest in view of the recent report of the Television Advisory Committee.* The aim was to provide technical information for the Sub-Committee on 405-line and 625-line television standards and on the use of Band V (606-960 Mc/s) for television broadcasting.

The work was done in two parts. The first series of tests involved simultaneous transmissions from the B.B.C. Crystal Palace tower on 405-line standards in Band I (45 Mc/s vision carrier) and Band V (654.25 Mc/s vision carrier), and provided information on radio propagation and picture quality in the two bands. The second series included 625-line transmissions in Band V and simultaneous 405-line transmissions in Band I. The results, in conjunction with those from the first series of tests, enabled a comparison of the two standards operating in Band V to be made. The simultaneous transmission of 405-line and 625-line signals in Band V would have simplified this aspect of the study, but this would have involved two high-power Band V transmitters and only one was available.

Five mobile laboratories were fully deployed for the work; observations were made of field strengths and picture quality at more than 1,000 sites in the Greater London area, and of picture quality in the homes of selected viewers. The picture-quality observations involved subjective assessments of the various characteristics that contribute to, or detract from, the overall quality of a received picture, e.g. noise, interference, multiple images, smearing, fading, sharpness,

visibility of scanning lines, etc., and the results are analysed in detail in the report.

The broad conclusions were that the first-class and second-class service areas of the transmitters in Bands I and V, using 170 kW and 1,000 kW e.r.p., respectively, are broadly comparable, but the greater "shadow" effect experienced with the higher-frequency band results in much more pronounced screening effects from high intervening ground.

As the report states: "the limits of a Band V service area are somewhat more precisely defined than those of a Band I service area and the 'rural service' does not extend appreciably beyond the 'urban service.' It is therefore evident that a greater number of transmitters would be required to serve the United Kingdom than is at present used in Band I, particularly when the greater irregularity of the second-class service area of Band V is taken into account."

The service area of a Band V transmitter is substantially the same when operating on 625-line Western European C.C.I.R. standards as when operating on the British 405-line system.

The overall assessment of Band V 625-line pictures was not significantly different from that of Band V 405-line pictures, except in areas of high field strength where the higher definition pictures were slightly better, but in respect of visibility of line structure, 625-line pictures were generally significantly better than 405-line pictures. However, as pointed out by Sir Harold Bishop in the Foreword, the comparison is "based on the use of the Western European standard for the 625-line system, which employs a video bandwidth of 5 Mc/s and a channel width of 7 Mc/s. It is considered that, with further development of the system, and the use of receivers with improved noise factors, the 625-line pictures will show a definite superiority, particularly when viewed on the larger screens."

Without doubt the report is a very valuable contribution to the development of television using the higher frequency bands. It covers one of the most comprehensive series of tests which have been made in this field, at least in Europe, and perhaps in the world, and clearly demonstrates what can be achieved by a co-operative effort.

C. F. B.

* Report of the Television Advisory Committee (Her Majesty's Stationery Office, 1960).

A Continuous-Reading Harmonic Analyser for Complex 50 c/s Waveforms

T. PILLING, B.Sc.(Tech.), A.M.I.E.E., G. A. BARTLETT, B.Sc.(Eng.), A.M.I.E.E., and
W. J. B. STEPHENS†

U.D.C. 621.317.757.087.45

A brief description is given of a harmonic analyser which continuously presents, as meter readings, the r.m.s. values of the fundamental and 11 selected odd harmonics of a complex 50 c/s waveform. The analyser uses transistors and has a built-in calibration oscillator. Pen recorders can be connected into the circuit instead of the meters if it is desired to obtain a permanent record. The apparatus is transportable and battery-operated.

INTRODUCTION

THE need for harmonic analysis of complex 50 c/s waveforms is met in the study of inductive interference with telecommunication circuits arising from power lines and electrified railways.

Under steady test conditions a normal type of wave analyser, using the heterodyne and narrow band-pass filter principle, can be employed, although it takes considerable time and care to make the series of observations usually necessary in interference studies. If, however, in railway-electrification studies the conditions are not steady, because the effect of one or more moving trains is under observation, then the use of a normal wave analyser becomes impossible. A spectrum analyser of the type which displays the line spectrum of the waveform under test, on the screen of a cathode-ray tube, would appear a possibility. Spectrum analysers, however, do not usually have the amplitude range nor the accuracy required and, in addition, the cathode-ray tube display must be photographed in order to obtain a permanent record.

This article gives a brief description of a harmonic analyser that has been designed to obviate these difficulties. It uses straightforward filter methods and displays continuously, on meters, the r.m.s. values of the fundamental and eleven chosen odd harmonics of the complex 50 c/s waveform under investigation.

FACILITIES

The instrument, as designed, will not give accurate results on any 50 c/s waveform without restriction; the design is necessarily based on the type of spectrum usually encountered in the applications mentioned above, in which even harmonics are negligible and odd harmonics decrease in amplitude with increase in order.

The signal components selected for measurement are 50, 150, 250, 350, 450, 550, 650, 750, 950, 1150, 1350 and 1550 c/s.

Range-switching facilities are provided, enabling the sensitivity to be varied for all components simultaneously and for individual components separately. At the most sensitive settings, the input required for full-scale deflexion on the appropriate meter is 100 mV for the fundamental and 10 mV for each harmonic.

The input impedance of the analyser is 10,000 ohms for all range settings, so that the instrument is suitable for the measurement of longitudinal or transverse voltages on telephone circuits, and can be connected

† Post Office Research Station.

across the load impedance of a wideband current transformer for measurements on power systems.

CIRCUIT ARRANGEMENT

A block schematic diagram of the analyser is given in Fig. 1. An input attenuator provides a "range-switching" facility common to all the signal components to be measured, and is adjusted to give a convenient deflexion on the meter indicating the 50 c/s component.

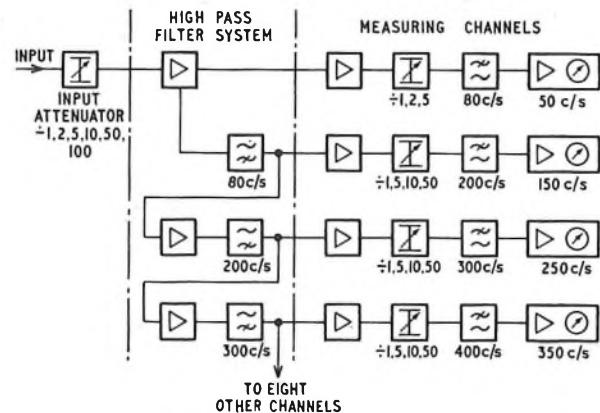

FIG. 1—BLOCK SCHEMATIC DIAGRAM OF HARMONIC ANALYSER

There are 12 measuring channels, one for each of the components to be measured; these channels are similar, each consisting of a buffer amplifier, a range-switching attenuator, a low-pass filter, a selective amplifier, a bridge rectifier and a meter. The low-pass filter is designed to give a high attenuation at the frequencies of the two odd harmonics immediately above the harmonic being selected, and some attenuation at still higher frequencies; at such frequencies the necessary additional attenuation is provided by the selective amplifier.

The remaining requirement, rejection of the harmonics below that being measured, is met by a system of high-pass filters preceding the measuring channels. These filters are arranged (see Fig. 1) so that the 150 c/s channel is fed through an 80 c/s high-pass filter, the 250 c/s channel is fed through the 80 c/s filter and also a 200 c/s filter, and so on. Thus, the lower-frequency components, which are of large relative amplitude, suffer increasing attenuation as the waveform progresses towards the higher-frequency measuring circuits.

Fig. 2 shows the way in which the preceding high-pass filters, the low-pass filter, and the selective amplifier combine to provide the necessary selectivity for one of the components (550 c/s).

All the amplifiers are transistor amplifiers and are d.c. stabilized by the well-known potential-divider and emitter-resistor method. In the selective-feedback path of the final amplifier in each channel there is a bridge-

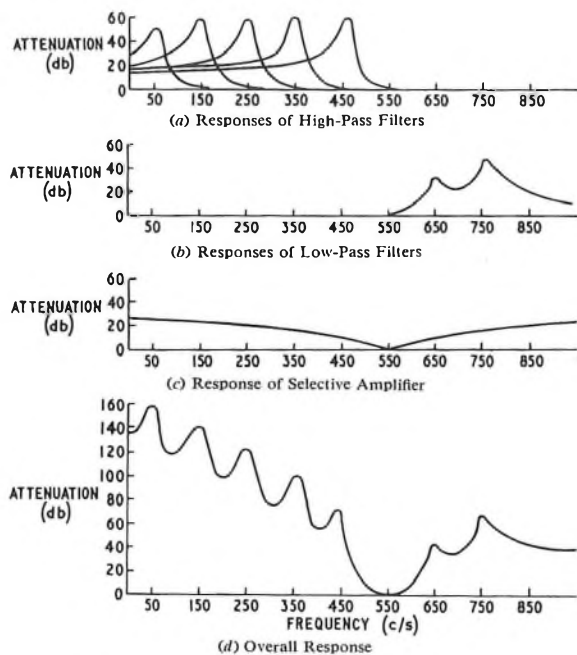

FIG. 2—RESPONSE OF A TYPICAL CHANNEL—550 c/s

rectifier circuit feeding a 1 mA meter, which is used for continuously indicating the r.m.s. value of the harmonic present. By means of a break-jack the meter can be removed from circuit, and the bridge rectifier can be used to operate an external pen-recorder such as the Decibel-meter No. 14A*; the final transistor in each selective amplifier is protected from the surge caused by the change-over by shunting it with a Zener diode.

Most of the high-Q filter inductors have cores of high-permeability nickel-iron laminations with air-gaps in them. Ferrite cores are used for some of the higher-harmonic filters.

CALIBRATION

Preset gain controls are provided in the channels so that the sensitivity can be adjusted over a small range. In the laboratory it is a simple matter to obtain suitable calibration voltages but, so that the equipment can be calibrated in the field, a calibration oscillator is incorporated. This is a two-stage, thermistor stabilized, resistance-capacitance oscillator using transistors, which provides a stable voltage at each harmonic frequency. The oscillator frequencies themselves can be checked on the apparatus, provided a 50 c/s supply is available. The 50 c/s is applied to a suitable harmonic-producing network and the distorted waveform is applied to the input of the analyser. The oscillator can be checked and adjusted, if necessary, by obtaining "zero beats" on all the harmonic meters in turn.

MECHANICAL LAYOUT

The mechanical layout of the analyser can be seen from Fig. 3. The equipment is mounted in two wooden carrying cases each of front dimensions 21 in. by 21 in., and 16 in. deep including front and rear covers. The working batteries are mounted in the lower rear cover, while the upper rear cover houses a spare battery set which is intermittently used for the calibration oscillator.

* PARSONS, A. P., and DIDCOCK, F. E. Recording Decibel-meters. *P.O.E.E.J.*, Vol. 51, p. 145, July 1958.

Each carrying case contains six measuring channels, each channel being a separate unit. The lower carrying case also contains, on a long narrow panel at the bottom, the master attenuator (on the left), the calibration oscillator (in the middle), and the on-off switch and battery-voltage meter (on the right). On the front of each channel unit is the channel attenuator and the meter used to indicate the amount of harmonic present. The size of the apparatus is largely dictated by the size of the inductors and capacitors required for the filters.

PERFORMANCE

The main possible causes of inaccuracy in the apparatus are overload in the amplifiers, harmonic production in the high-pass filters and variation of sensitivity with deviation of the repetition frequency of the complex wave from 50 c/s.

The design is such that, with the frequency spectrum normally encountered, overloading does not occur if the deflexion of the 50 c/s meter does not exceed full-scale. Care has been taken in the design of the filter inductors to ensure that unwanted third harmonics, which are produced by some of the filters, will have a negligible effect on the meter readings. To minimize the error arising from drift of the repetition frequency of the waveform under observation, the overall pass-bands of the filter system have been made as flat as possible in the neighbourhood of the nominal frequencies. For a frequency drift of ± 1 per cent, the measurement error does not exceed -1 per cent (0.1 db) at 50 c/s nor -10 per cent (1.0 db) at 1,550 c/s.

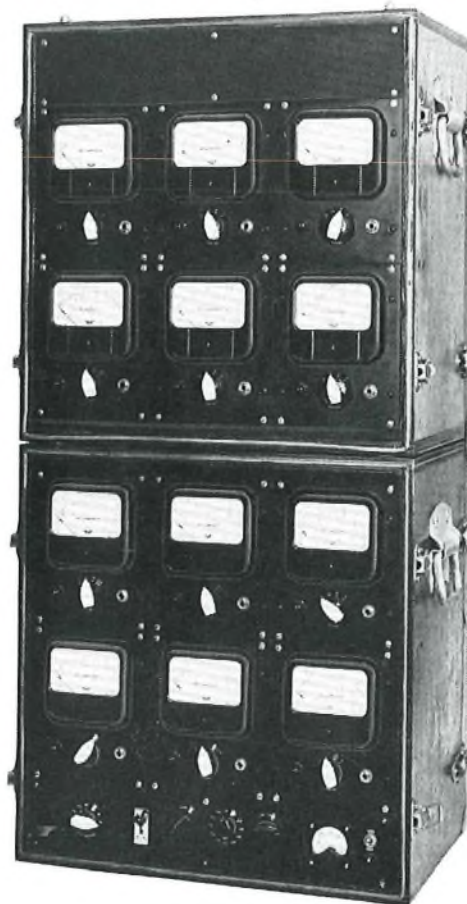

FIG. 3—THE CONTINUOUS-READING HARMONIC ANALYSER

The Post Office Type 1 Ratchet Relay

D. J. MANNING†

U.D.C. 621.395.6:621.318.56

A description is given of the constructional details and electrical performance of a new mechanism called the ratchet relay which is capable of transmitting an output pulse after absorbing a number of input pulses. A typical circuit element using a 33-step version of the relay is also given.

INTRODUCTION

CIRCUIT designers have often encountered the need for an electromechanical device which would transmit an output pulse after absorbing a given number of input pulses and, in the absence of such a device, have used a uniselector and relay or a train of pulse-counting relays. A cheaper and more compact means of giving the facility became urgent when periodic metering circuits for both local and trunk calls had to be devised for the introduction of subscriber trunk dialling. Subscribers' local calls, for instance, were to be metered so that the period between the metering pulse given when the call was answered and the second metering pulse would be between 1 and 1.1 times the nominal metering period.¹ This necessitated a circuit which would accept pulses at 10 times the metering rate and transmit pulses at the metering rate. The Post Office Type 1 ratchet relay has been developed to perform this and similar pulse-dividing functions. The relay can be mounted in a single standard 3,000-type relay drilling and will probably cost less than two 3,000-type relays. Its use therefore makes possible worthwhile savings in mounting space and capital cost. A general view of the new relay is given in Fig. 1.

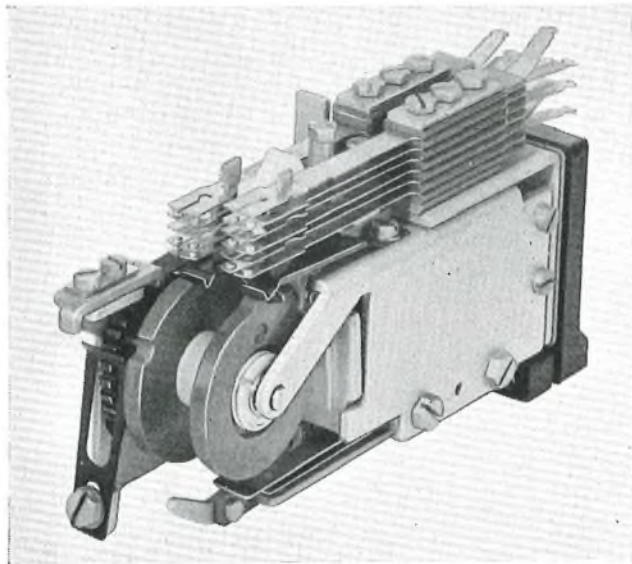

FIG. 1—GENERAL VIEW OF RATCHET RELAY

GENERAL DESCRIPTION

The ratchet relay consists essentially of an electromagnet having an armature to which are fixed a spring-steel driving pawl and an interrupter-spring-set operating-

†Telephone Exchange Standards and Maintenance Branch, E.-in-C.'s Office.

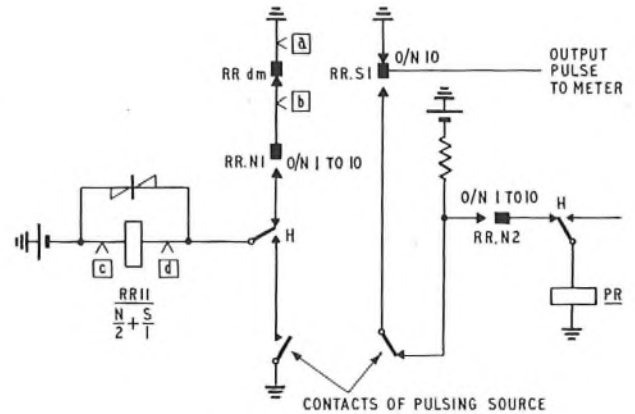

FIG. 2—TYPICAL CIRCUIT ELEMENT

arm, an assembly of a ratchet wheel and two cams which is driven forward one step by the pawl each time the armature releases, and two spring-sets each operated by one of the two cams. In a typical circuit, see Fig. 2 which shows the symbols and designations for the ratchet-relay coil and its contacts, one of the two cam-operated spring-sets, usually the left-hand one, is used to give "ratchet-relay off-normal" signals; the other transmits the required output pulses. Thus, in local-call periodic-metering circuits, the left-hand spring-set of the ratchet relay is off-normal on all steps from 1 to 10 (the normal step is designated 0) and the right-hand cam moves its spring-set off-normal in rotating from step 9 to step 10 at the end of the tenth input pulse (Fig. 3). During the eleventh pulse, whilst the ratchet relay remains on step 10 with the armature operated, the right-hand spring-set transmits the metering signal to the circuit. At the end of the eleventh pulse the ratchet relay takes a further step and both cams return their spring-sets to the normal condition, as on the initial step 0. If further pulses are received the cycle of spring-set operation is repeated. The ratchet wheel has 33 teeth and hence the eleven-step cycle from step 0 to step 10 is repeated three times in each revolution of the cams. At the conclusion of the call, if the ratchet relay is on a step other than 0, a circuit which includes the magnet and contacts of the "off-normal" spring-set and the inter-

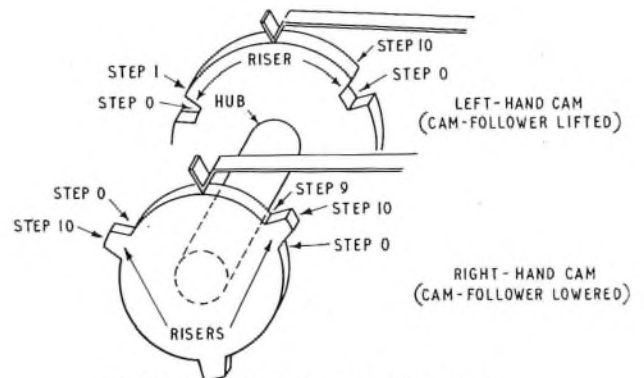

FIG. 3—CAMS OF TYPICAL RATCHET RELAY

rupter is closed and the ratchet relay self-drives to the next 0 position.

With a ratchet wheel which has 33 teeth the cams can be arranged for the desired cycle of spring-set operations to be repeated every 3, 11, or 33 steps of the relay. The relatively large number of relays required for local-call periodic-metering circuits justified the development of the 33-step relay. However, a ratchet wheel with 36 teeth is likely to be more generally useful, since the cams of a relay so equipped can be arranged to give 2, 3, 4, 6, 9, 12, 18, or 36 steps per cycle. Moreover, a 6-step cycle is required for periodic metering of trunk calls.¹ The ratchet relay has, therefore, been designed to work with ratchet wheels having either 33 or 36 teeth, the armature stroke being slightly shorter and the sensitivity thus slightly greater when a cam and ratchet assembly having a 36-tooth ratchet wheel is fitted.

The cam arrangement used for local-call periodic metering is relatively simple. Considerably more complex cam combinations are possible, giving any desired sequence of spring-set operation and release on the steps within the cycle. The cams and spring-sets can also be arranged to cause the relay to self-drive over a pre-determined number of steps per cycle so that it can be used to divide a train of pulses by a number which is not a factor of 33 or 36.

CONSTRUCTION

The frame of the ratchet relay is a mild-steel channel of U-section (Fig. 1). The open side of the channel is closed over part of its length by a second channel of similar, but shallower, U section. The front edge of the web of this second channel-piece is formed into a knife-edge, on which the armature pivots, and the rear part of the web is formed into a hook for the armature-restoring coil spring. The coil is fixed between the frame and the knife-edge plate by screws passing through holes in the rear of the frame flanges into the rear coil-cheek, which is a block of annealed steel suitably insulated from the coil winding (Fig. 4). The armature, frame, knife-edge plate and rear coil-cheek form almost a complete box structure and give a compact and efficient magnetic circuit which enables the relay to operate satisfactorily with less than 7 watts input.

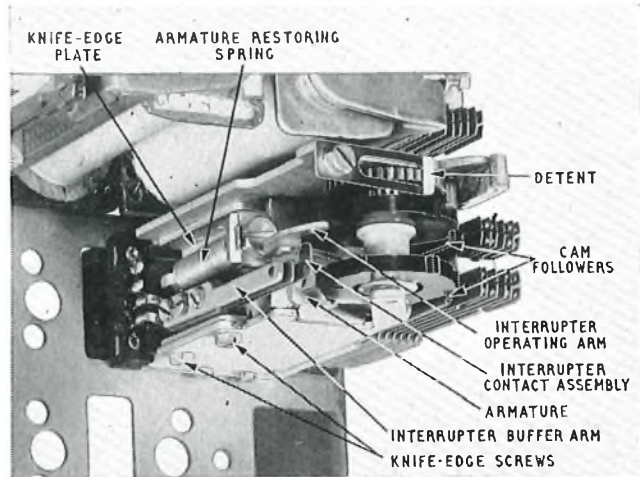

FIG. 5—RATCHET RELAY MOUNTED IN RELAY-SET

The left-hand flange of the frame is extended to carry the cam-and-ratchet assembly spindle, the pawl front-stop and the detent. The right-hand flange is extended to restrict sideways movement of the armature on the knife-edge, and to retain the cam and ratchet assembly on its spindle (Fig. 1). The frame channel-web is bent at right-angles to form a lug which carries the armature back-stop screw and its lock-nut; these are adjustable from the front of the relay.

The armature is extended beyond the knife-edge to form a lug on which the armature-restoring-spring adjusting-screw bears, and this permits adjustment of restoring-spring tension from the front of the relay (Fig. 5). The interrupter operating arm is accessible from the front of the relay and affords means for manually operating the armature when the relay is in position on its mounting plate.

The detent (see Fig. 1) is a steel spring the working edge of which is the square-cut end of a parallel-sided cut-out in the spring. The detent fixing screw is easily accessible for adjustment of the detent to the ratchet wheel teeth.

The interrupter-contact assembly is fixed to the knife-edge plate, as shown in Fig. 5. The interrupter

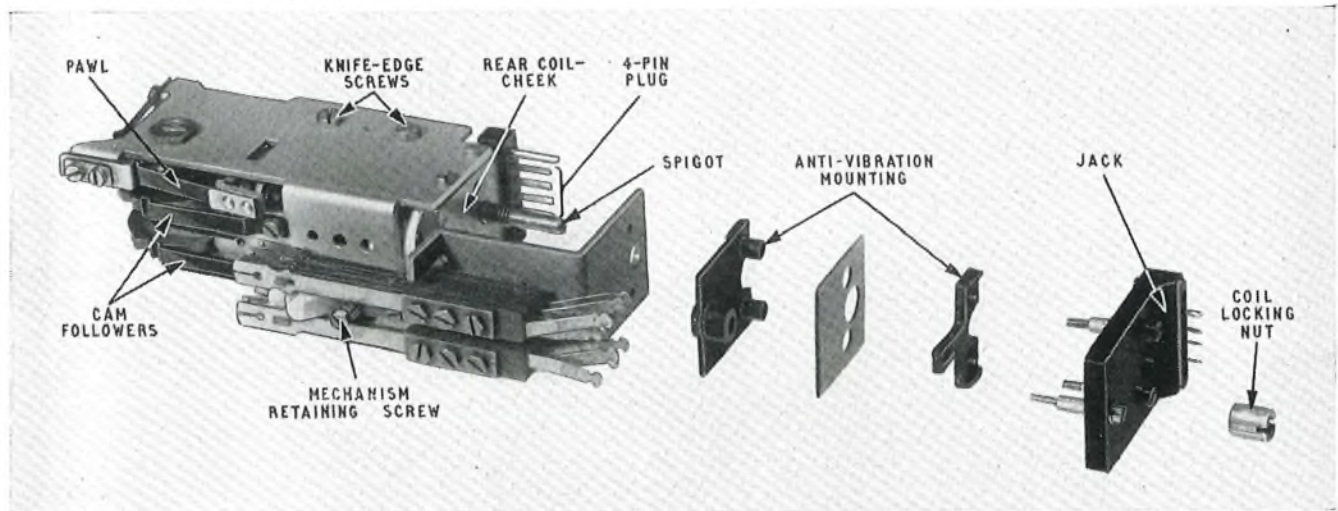

FIG. 4—MOUNTING DETAILS

break spring rests on an insulating buffer carried at the end of the buffer arm. The buffer arm is made of relatively soft steel so that it can be set to adjust the point in the travel of the armature at which the interrupter contacts open and close from the front of the relay and thus ensure smooth running. The interrupter contacts are of silver, and are capable of carrying the full coil current.

The two cam-followers (Fig. 1 and 4) are spring-steel members having V-shaped tips, each of which bears upon the periphery of its cam between risers and is lifted and lowered through approximately 0.040 in. by each cam riser (Fig. 3) as its cam rotates. These movements of the cam follower are transmitted to the spring-set lever springs by the spring-set operating comb. Each cam follower is fixed at its rear end to the web of the frame channel by a single screw. The hole in the cam follower through which the fixing screw passes is elongated so that the follower can be correctly positioned relative to the cam risers.

Ratchet and Cam Assembly

The ratchet and cam assembly is built up on a hollow brass hub which rotates on a stainless-steel spindle screwed into the left-hand side of the frame. The screwed portion of the spindle is of larger diameter than the part on which the hub revolves and as it is being screwed into the frame it reduces the side play of the hub between itself and the right-hand side of the frame. When the side play has been adjusted satisfactorily, the spindle is secured in position by a lock-nut (Fig. 4).

The aluminium-bronze ratchet wheel, having 33 or 36 teeth as required, is fixed to the hub, against the left-hand face of a flange on the hub. The left-hand cam, the spacing collar, and the right-hand cam are clamped against the right-hand face of this flange by a ring-nut engaging a screw thread cut on the right-hand end of the hub. Assembly of the parts requires a jig and they are, therefore, not separately replaceable in service.

The cams are phenolic-resin mouldings and require to be lubricated with grease. Wear of the cams and cam followers after several million operations of the relay is very slight.

The ratchet wheel has to be lubricated sparingly because the relay is mounted in relay-sets with other apparatus and excess lubricant could spread to other relay armatures and contacts.

Cam-Operated Spring-sets

The outer profile of the cam-operated springs is the same as that of the mechanically operated springs of the 2,000-type selector. The ratchet-relay springs are, however, slotted to take the operating comb. Comb-operation of the springs was decided upon as giving a longer life than pin-operation.² To ensure stability of the comb, each spring-set must be built up of not less than four contact springs. Space limits the maximum number of springs to six. Any combinations of make, break and change-over actions are permissible within these limits on the number of springs.

The transit time of the lever springs is very small, being no more than that of the lever spring of a high-speed relay. The speed of the ratchet-relay lever spring is considerably higher and because of this there is appreciable contact bounce, particularly on release, when the follower leaves a cam riser. This bounce may last for eight milliseconds.

The buffer block is of the type used for 600-type relays.

Plug-in Facility

Those adjustments which are likely to be necessary most frequently can be made when the relay is mounted, but adjustment of the knife-edge, armature, stroke, and cam-follower position cannot be so effected. The relay is, therefore, designed so that the mechanism can be withdrawn leaving the cam-operated spring-sets and buffer block attached to the mounting plate (Fig. 6). Thus, there are four connexions to be made by plug-and-socket, two to the coil and two to the interrupter springs. A four-pin plug is fixed to the rear coil-check (Fig. 4) and engages through the coil-tag hole in the mounting plate with four pincer-type sockets (Fig. 6) in a jack at the rear of the mounting plate. The plug body and jack body (Fig. 4) are phenolic-resin mouldings. The jack sockets, which are of the pattern developed for the 42-point jack of the Type 4 uniselectors,³ extend to the rear of the jack to form soldering tags. The plug body carries two spigots which, engaging in holes in the jack, help to guide the pins into their sockets and to protect the pins from damage when the mechanism is withdrawn from the jack.

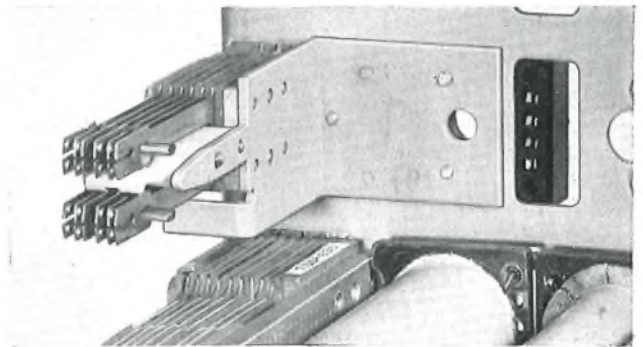

FIG. 6—SPRING-SETS WITH MECHANISM REMOVED

The jack is fixed by three screws passing through the mounting plate into the shorter leg of an L-section bracket (Fig. 4 and 6), to the longer leg of which are fixed the two cam-operated spring-sets and their buffer block. When the mechanism is plugged into the jack, it is clamped to the L-shaped spring-set mounting bracket by the front buffer-block screw, which passes through the buffer block and L-shaped bracket into the web of the mechanism frame.

To withdraw the mechanism it is necessary only to undo the mechanism retaining screw (it is trapped by the buffer-block clamp plate and so will not fall out) and pull the mechanism out of its jack. The rear coil-check carries a threaded spigot (Fig. 4) which helps to guide the mechanism into the jack. For additional security in transit a 3,000-type relay-coil nut can be screwed on to the spigot, clamping the mechanism to the spring-set bracket; this nut, if fitted, must be removed before the mechanism can be withdrawn.

Resilient Mounting

When used in a periodic-metering circuit the ratchet relay steps to input pulses throughout a call. There are relay, wiper, or plug-and-jack contacts in the speech path that can be vibrated by the operation and release of the ratchet relay armature. The resistance of these contacts may vary when vibrated and thus cause

microphonic noise. To reduce this noise the ratchet relay is provided with a resilient mounting by interposing rubber gaskets between the spring-set bracket and the front of the mounting plate and between the jack and the rear of the mounting plate (Fig. 4). Compression of the rubber is limited by three brass sleeves fitting over the jack-fixing screws between the screw heads and the spring-set bracket. Both gaskets are synthetic rubber (Neoprene) mouldings, which contain no sulphur so that there is little risk of contamination of adjacent relay contacts.

Coils

For 50-volt working, coils can be wound to a nominal resistance of 375, 310, or 235 ohms to meet different circuit requirements. The coil is quenched by means of a non-linear resistor connected across the coil soldering

tags at the rear of the jack. When the mechanism is withdrawn from the jack, therefore, there is no quench connected across the coil.

ACKNOWLEDGEMENTS

Development of the Type 1 ratchet relay was carried out by the General Electric Company on behalf of the British Telephone Technical Development Committee. The photograph for Fig. 1 was supplied by the General Electric Company.

References

- ¹WALKER, N. Periodic Metering. *P.O.E.E.J.*, Vol. 51, p. 320, Jan. 1959.
- ²ROGERS, B. H. E. The Post Office Type 10 Relay. *P.O.E.E.J.*, Vol. 51, p. 14, Apr. 1958.
- ³MANNING, D. J. The Post Office Type 4 Uniselect. *P.O.E.E.J.*, Vol. 52, p. 215, Oct. 1959.

Book Reviews

"Plastics Progress 1959." Papers and discussions at the International Plastics Convention held at Olympia. Edited by P. Morgan, M.A. Iliffe & Sons, Ltd. xii + 216 pp. 138 ill. 55s.

Previously called British Plastics Convention, this convention, the fifth of the series, has changed its name to International Plastics Convention in accordance with the wider origins of the contributions. For the benefit of those who have not seen previous numbers of "Plastics Progress" it may be mentioned that it is not a general textbook about all plastic materials but a collection of excellent technological papers in certain specific fields of current interest.

The first two papers give a thorough account of polypropylene (thus filling a gap to which the present reviewer drew attention when writing of the 1957 volume). They are "Physical and Mechanical Properties of Polypropylene" by J. M. Goppel and "The Moulding Characteristics of Polypropylene" by G. Campbell. Then follows a paper on "Some New Epoxide Resin Systems and their Properties" by R. N. Lewis.

The next paper, "The Crosslinking of Thermoplastics after Fabrication" by R. R. Smith, deals mainly with the crosslinking of the molecules of three thermoplastics, polythene, cellulose acetate, and p.v.c., after they have been fabricated, by means of ultra-violet light, high-energy electrons, or hot curing with reactive chemicals. By these means the softening point can be raised in many cases. Most of the other mechanical properties are also altered to some extent by these processes, which may be advantageous or the reverse, depending on the application.

"Some Theoretical and Experimental Aspects of Block and Graft Copolymers" by J. Benton and C. M. Thomas is a more fundamental paper. It will be remembered that copolymers are plastics whose molecules are built up from two or more kinds of unit. Most commercial copolymers have molecules with a random arrangement of the two or more types of unit. Block copolymers consist of molecules in which a complete segment is built up of only one kind of unit followed by another segment containing only the second type of unit, and so on. Graft copolymers consist, essentially, of branched molecules in which the (linear) backbone is of one kind of unit only while the branches are of another kind of unit.

Then follow three papers on the progress of glass-reinforced plastics in the Benelux countries, the United Kingdom, and U.S.A., respectively. The next section consists of two papers on expanded plastics, "U.S. Developments in Foamed Plastics and in particular in Foamed

Smokes" by Betty L. Raskin and "Bulk Density and Physical Properties of Expanded Polystyrene" by W. B. Brown.

Lastly, there are two papers on extrusion, "Extrusion Studies on Thermoplastics" by D. A. Lannon and G. C. Karas, and "The Extrusion of Acrylics" by L. Griffiths. The latter deals with polymethyl methacrylates (Perspex, Diakon, Transpex, etc.) for which the main application in extruded form, at present, is for diffusers for fluorescent-light fittings.

The book is well produced, and the plates, diagrams and curves are clear.

A. A. N.

"Telegraphs in Victorian London." J. Durham. The Golden Head Press, Ltd. 31 pp. 15s.

In this literary trifle, the author reviews somewhat superficially the fortunes and misfortunes of the London District Telegraph Co., Ltd., whose declared aim was to set up one hundred offices within a four-mile radius of Charing Cross for handling public telegrams; he also refers briefly to the operations of the more successful Universal Private Telegraph Co.

Economic stability depended upon a cheap form of over-house line construction to avoid the cost of excavating London's expensive streets. The minimum charge for a telegram fluctuated between 6d. and 1s. and it is clear that the District Co. followed a difficult career involving delays, deficits and near-disaster from storm damage. The Universal Co., which provided private circuits only, was on more profitable ground.

Technical information is sparse. The Universal Co. supplied Wheatstone's ABC Communicator, which avoided the cost of battery upkeep and was simple for the renter to operate. The District Co. used battery-energized double-needle instruments which required trained operators; delays and errors resulted from the need for re-transmission through a transit office.

At the time these London companies were formed (1859-60) inland telegraph services were already available, provided mainly by the Magnetic and Electric Companies—indeed the first transatlantic cable was already experiencing its brief life.

Closing the story with the transfer of the undertakings to the Post Office in 1870, this book spans only a small part of the Victorian era; nevertheless the account reveals, though under subdued gaslight, some of the problems which confronted the pioneers of commercial telegraphy.

I.P.O.E.E. Library No. 2601.

R. N. R.

Extension of Ongar Radio Station

R. HOLDEN, B.Sc.(Eng.), A.M.I.E.E., and L. R. MEATYARD, A.M.I.E.E.†

U.D.C. 621.396.61:621.396.71

Facilities afforded by Ongar radio station were improved in 1959 by the provision of new transmitters and the associated drive equipment in an unattended building, and the installation of new aerials and feeders. The new equipment is remotely controlled and selection of the operating frequency, type of emission and aerial to be used can be effected from the central, staffed, building.

INTRODUCTION

POST Office facilities for handling long-distance point-to-point radio-telegraph traffic to the Near East, Far East and North America were extended in 1959, when a building extension housing seven new high-power h.f. transmitters at Ongar radio station was formally opened by Lord Chesham.

The radio equipment at Ongar is divided among a central, staffed, building and two smaller, unattended, buildings some distance away. The new transmitters and associated drive equipment are accommodated in an extension of the unattended "D" building about three-quarters of a mile from the central station. This building was chosen for the extension because land suitable for the erection of new aerials was available nearby and relatively short transmission lines were required.

To preserve the unstaffed character of the D building, the new installation is designed for unattended operation with remote control from the central building.

DRIVE EQUIPMENT

Two types of drive equipment are provided: a general-purpose telegraph drive unit and an independent-sideband (i.s.b.) drive unit. The telegraph drive unit accepts double-current signals at its input and processes them to provide, at a nominal frequency of 3·1 Mc/s, an output that may take the form of an on/off, frequency-shift, or four-frequency diplex signal. The i.s.b. drive unit accepts two independent input signals, each of up to 6 kc/s band-width, and provides an output signal comprising two independent sidebands, one on each side of 3·1 Mc/s, together with a low level 3·1 Mc/s pilot carrier when required. The i.s.b. drive units are suitable for telephony but their main use at Ongar is for frequency-division-multiplex telegraphy and facsimile or phototelegraph emissions. Selection of the required type of drive equipment can be made from the central building by the operation of a change-over relay at the transmitter input. The figure shows the drive equipment with the transmitters in the background.

†Overseas Radio Planning and Provision Branch, E.-in-C.'s Office.

TRANSMITTERS

The transmitters are suitable for both telegraphy and telephony, providing 20 kW continuous output on C.W. or 30 kW peak envelope power on telephony or frequency-division-multiplex telegraphy. Six predetermined carrier-frequencies within the range of 4 to 27·5 Mc/s can be selected by press-button control. The time taken to change from one frequency to another is about 12 seconds.

The transmitters accept the modulated 3·1 Mc/s signal from the drive equipment and an unmodulated frequency in the range 3·45 to 7 Mc/s from a separate rack of crystal oscillators. The unmodulated frequency can be multiplied by two or four as required in the transmitter harmonic generators and the resulting frequency is combined with the drive signal in a linear, balanced modulator to produce the required modulated output at low level. This signal is then amplified to the output power levels mentioned earlier. Single-ended amplifiers are employed throughout the transmitters and good linearity is achieved by the use of r.f. negative feedback. The final amplifier comprises two grounded-grid valves, each of 15 kW anode dissipation, in parallel feeding a coupling circuit which delivers the output power into a balanced load of 195 ohms. A reflectometer monitors the voltage-standing-wave ratio of the load and the transmitter is shut down automatically if abnormal mismatch arises.

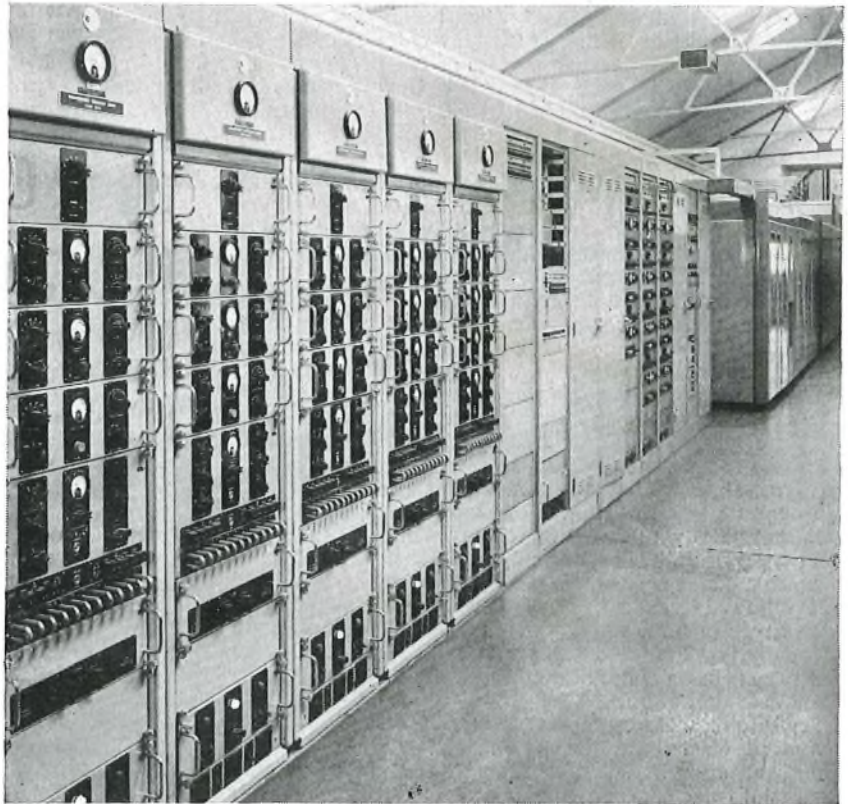

DRIVE EQUIPMENT WITH TRANSMITTERS IN THE BACKGROUND

The transmitters are air cooled, the associated fans and air filters being accommodated in separate rooms behind the transmitters, and all or part of the air warmed in passing through the equipment can be returned to the transmitter hall under thermostatic control to assist in heating the building. At the rear of each transmitter is a fire-proofed room containing the oil-filled power equipment. This room is equipped with automatically-operated carbon-dioxide fire-extinguishing apparatus, and the door is mechanically interlocked with the transmitter so that access to any equipment working at dangerous voltages cannot be obtained until power supplies have been disconnected and high-voltage points earthed.

FEEDERS AND AERIALS

Within the building twin coaxial feeders of rigid construction provide a 195-ohm balanced transmission path for the r.f. power. The earthed outer screens ensure freedom from crosstalk and safety for the operating staff. These twin feeders run from each transmitter to an aerial switchroom where they are connected to two-position solenoid-operated switches, the outlets of which can be manually connected to any two pairs of vertically-arranged telescopic feeders associated with the aerials. Final selection of one of a pair of aerials may be effected by remote control from the central building. The aerial feeders leave the building through a lantern head on the switchroom roof and are connected to exponential transforming lines which are about 130 ft long, suspended between the building parapet and gantries in the field. Each line is composed of four wires, between which the spacing is so tapered that the impedance increases exponentially with length. This arrangement provides an aperiodic impedance match between the 195-ohm feeders and the 565-ohm lines used for the main run to the aerials. The twin open-wire construction used for the main feeder-runs provides a relatively cheap means of conveying r.f. power to the aerials.

Seven new high-performance rhombic-aerial systems have been provided. Each system comprises two aerials designed to be complementary in covering the required ranges of frequency and vertical propagation angles. The aerials of each pair are suspended concentrically one below the other from four 150 ft stayed steel-lattice masts.

Use of these aerials is not confined to the seven new transmitters. A 76-ohm coaxial feeder linking the two buildings can be used to connect any transmitter in the central building to the D-building switchroom. Here an impedance transformation to 195-ohm balanced output is accomplished by a novel design of wideband

transmission-line transformer, the output of which can be routed to any one of the new aerials via the 195-ohm switching and patching frame. The transformer*, which is of Post Office design, will handle up to 30 kW of r.f. power and matches the impedances over the full range of 4 to 27.5 Mc/s with a maximum voltage-standing-wave ratio of 1.3 in the input line.

CONTROL AND MONITORING

Complete control of the new installation is provided locally at the D building. In addition, control of the more important operations is extended to the central building, and normal traffic requirements such as starting and stopping a transmitter, change of frequency and aerial, and selection of telegraph or telephone drive are all accomplished without visiting the remote building.

At the central building supervisory indications are given to check that the required functions have been correctly carried out and monitor lamps give warning of variations from normal of the i.s.b. pilot carrier and feeder-line voltage-standing-wave ratio. Meters indicate the level of the 3.1 Mc/s signal at the transmitter input and the peak voltage present on the coaxial feeders at the transmitter output.

Each transmitter is equipped with a monitor frequency-changer which samples the r.f. output from the final amplifier and translates it to 3.1 Mc/s. Monitor receivers associated with the i.s.b. and telegraph drive units accept this signal for local monitoring. For central monitoring, the 3.1 Mc/s monitor signal from any transmitter monitor can be selected by remote control, translated to audio frequency and returned to the central station for detailed measurement of the characteristics of the emission. A multi-purpose 0.375 in. coaxial cable between the two buildings is used for returning the 3.1 Mc/s monitor signal to the central building when an analysis of a radiated signal spectrum is desired.

EQUIPMENT RELIABILITY

Faults occurring at a remote unstaffed building may lead to appreciable lost traffic time and high reliability of equipment is therefore essential. The new installation at Ongar has been fully operational since March 1959. The fault rate, even during the initial period of operation, has been low and confirms that the equipment is sufficiently reliable for remote unattended operation. The suitability of this equipment for unattended operation and remote control has also been demonstrated by a similar installation of four transmitters in an unattended building at Dorchester radio station which was brought into operation shortly after the opening of the Ongar extension. The same type of transmitter is now being installed in place of a number of old transmitters at the original Rugby short-wave building.

* BROAD, E. R. High-Power Radio-Frequency Broad-Band Transformers. *P.O.E.E.J.*, Vol. 51, p. 8, Apr. 1958.

Book Received

"Electrical Who's Who, 1960-61." Sixth Edition. Electrical Review Publications, Ltd. Distributed by Iliffe & Sons, Ltd. 566 pp. 35s. (36s. 9d. by post).

This new edition contains about 9,000 entries, covering men and women in all branches of the electrical industry—supply, manufacturing, contracting, consulting, research, transport, mining and trade associations. Electrical

engineers in the Post Office, the Admiralty and other Government Departments are also included.

Brief biographies give particulars of education and careers. These are supplemented by an index to the entries, classified under the names of companies or other organizations, thus making it easy to ascertain the names of the principals of a particular concern and from there to refer to the biographical entries.

A Signal Generator for Testing Band 7 (H.F.) Radio Transmitters

E. G. BRONSDON†

U.D.C. 621.372.42:621.396.61.029.58

A simple narrow-band signal generator, which simulates the output from an independent-sideband drive unit under standard test conditions, has been developed for testing Band 7 (h.f.) radio transmitters. The generator employs crystal oscillators of established design.

INTRODUCTION

RADIO transmitters used for telephony or for frequency-division-multiplex telegraphy transmissions in Band 7 (the h.f. band, 3–30 Mc/s) require a substantially linear input/output amplitude relationship, and a method of assessing the degree of linearity is to measure the level of the third-order intermodulation components present in the output signal when two equal-level single-frequency signals are simultaneously applied to the input. The output from a conventional independent-sideband transmitter drive unit comprises a small band of frequencies centred on 3.1 Mc/s, and, hitherto, means for generating standard test signals at about this frequency and for distortion measurement have been included in the drive unit, which was generally situated reasonably near the transmitter.

In recent years a mobile h.f. spectrum analyser has been found to be most effective for determining transmitter performance. This instrument will display, on a calibrated cathode-ray tube, the relative amplitudes of individual components in a complex signal between 3 and 30 Mc/s occupying any frequency band up to 30 kc/s in width. Its introduction, together with the present practice of installing the drive unit at a con-

siderable distance from the transmitter, gave rise to the need for a mobile signal generator to replace the drive-unit test facilities. Tests showed that, with certain precautions, Oscillators No. 35 could be used to generate the required test signals. The Oscillator No. 35 is a compact and inexpensive crystal-controlled unit operating in the frequency range 3–7 Mc/s normally used for carrier-wave generation. It does not require the adjustment of tuned circuits, and has a frequency stability of better than 1 part in 10^6 per degree Celsius at room temperatures. This oscillator is in all respects suitable for incorporation in transportable equipment, and a signal generator (Signal Generator No. 3A) has been developed around it.

DESCRIPTION OF THE GENERATOR

The criterion of radio-transmitter linearity adopted is the level, relative to wanted signals, of intermodulation products present at the transmitter output, and the Post Office at present specifies that the third-order product shall not exceed -42 db relative to the peak envelope power (p.e.p.) output. The signal-generator output must, clearly, have a lower spurious content, particularly for its intermodulation components, than the transmitter if ambiguity of measurement is to be avoided, and a figure of -66 db relative to the p.e.p. output of the generator was specified.

The p.e.p. required from the generator is 250 mW in 75 ohms, derived from two equal-level sinusoidal signals in the frequency range 3.094–3.106 Mc/s. The r.m.s. power of such a signal is 125 mW and, thus, the power required from each signal is 62.5 mW ($+18$ dbm*). An Oscillator No. 35 will deliver $+20$ dbm into a 75-ohm load, but some 40 db separation is required between two oscillator outputs, which are in parallel, if intermodulation products are to be kept to an acceptable level. This is achieved simply in the present design by a 20 db attenuator in each oscillator output, which reduces the useful level to 0 dbm. The generator also provides for a pilot carrier signal, at

† Overseas Radio Planning and Provision Branch, E.-in-C.'s Office.

* dbm—decibels relative to 1 mW.

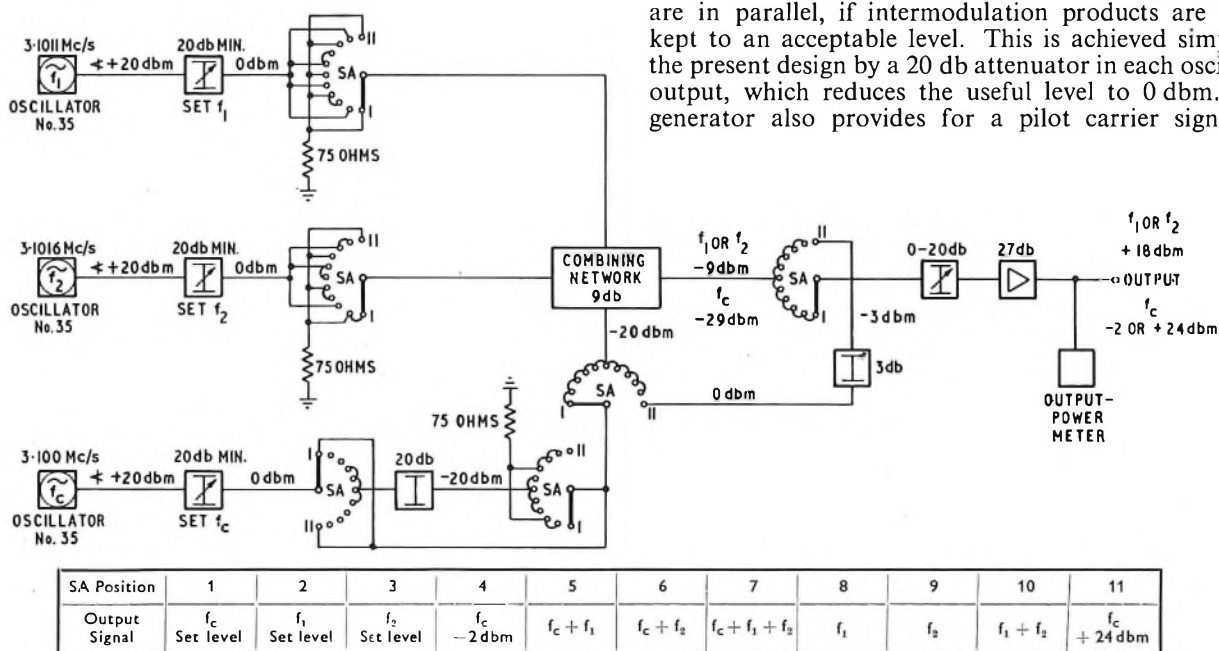

BLOCK SCHEMATIC DIAGRAM OF SIGNAL GENERATOR

3.1 Mc/s, to be injected in addition to the two test signals, and a combining network for the three signals, necessary to preserve the impedance matching to the attenuator which follows it, introduces a further 9 db loss. To achieve the required output-power with output-level stability and good intermodulation performance, a negative-feedback amplifier is included after the combining network and attenuator.

The actual frequencies chosen for the two signal oscillators follow previous practice. If the signals are separated by some 500 to 700 c/s from each other and by some 1,000 to 1,800 c/s from the pilot carrier frequency then the frequencies at which a number of significant intermodulation components arise will fall within one transmission sideband and lie within the sweep range of the spectrum analyser.

The generator circuit is shown, in block schematic form, in the figure. The outputs from two oscillators having frequencies f_1 and f_2 may be selected separately or in combination by means of the ganged switch SA, and the selected signal is then amplified to the required output-power level. If the levels for f_1 and f_2 are set individually to a particular calibration point on the output-power-meter scale then the p.e.p. of the composite signal is 250 mW. The output from the third oscillator, the pilot carrier frequency f_c , may also be selected

separately by means of switch SA, and if its level is set to the calibration point then, when combined with f_1 , f_2 , or f_1 and f_2 , its level will be -26 db relative to 250 mW and will be at the standard level for a pilot carrier in independent-sideband telephony transmission. One position of SA, however, allows f_c to be generated separately at an output level of 250 mW, a facility which is useful for initial transmitter adjustment. The output levels shown in the figure are those obtained for a zero-loss setting of the 0-20 db attenuator immediately preceding the output amplifier. This attenuator enables examination of transmitter performances to be made over a 20 db range up to the maximum rated p.e.p. output. The output amplifier passes a narrow band of frequencies centred, approximately, on 3.1 Mc/s, and employs some 20 db of negative feedback.

CONCLUSION

The generator, which is trolley mounted, is an almost essential complement to the spectrum analyser for transmitter testing. It is relatively inexpensive to produce and simple to operate, and its performance, which is much superior to that of equipment hitherto available, is likely to be adequate to meet, for many years, any requirement arising from higher performance standards for transmitters.

Book Review

"Electrical Circuit Analysis." K. Stephen, B.Sc., A.M.I.E.E. Cleaver-Hume Press, Ltd. 259 pp. 149 ill. 30s.

The purpose of this book is to provide "... sufficient material in electrical circuit analysis for the requirements of a general degree in electrical engineering and to serve as an introduction to the more specialized techniques required at a post-graduate level." Superficially, the book bears a remarkable resemblance to "Electric Circuit Theory," by Benson and Harrison, published only a few months earlier and reviewed in the July 1960 issue of this Journal. Both books are written for undergraduate study in electrical engineering and have a similar arrangement of subject matter. The present volume, however, covers a smaller variety of topics and is written for students at a slightly lower level of study.

The central theme of the book is the treatment of comparatively simple a.c. circuits using the j-operator and vector diagrams in the customary fashion. The introduction to this is effected quite gently over the first six chapters through discussions of d.c. circuits, the properties of inductors and capacitors, and the elements of complex numbers. A.C. circuits are developed to the point where a general mesh or nodal analysis becomes necessary and these latter procedures are briefly described, but not elaborated. At the end of the book two chapters are devoted to polyphase systems and one chapter to harmonic analysis. Practically all the applications of circuit analysis are discussed in a context of power engineering and no special attention is directed to the needs of the prospective communication and electronics engineer;

in this respect it presents a less balanced text than does the book by Benson and Harrison.

The approach to most of the subject matter is quite conventional and merits no comment. The explanations offered are well written, have an air of authority and make pleasant reading, but, nevertheless, they sometimes lack the technical precision that one expects in a textbook. An extreme example of this occurs when the author is attempting to contrast branch-current equations with loop-current equations: although, on a previous occasion, he has correctly given the rules for constructing the branch-current equations he fails to follow these rules in dealing with a six-branch network and can find only three such equations.

Some of the mathematics could, with advantage, be simplified, and occasionally there are mistakes which are presumably due to a misunderstanding of the mathematical process concerned. One inexplicable piece of complication appears at the critical stage where the student is first introduced to simple series a.c. circuits. Instead of giving a straightforward explanation of the steady-state solution for sinusoidal excitation, which is all that is required and which would follow naturally from the previous chapter on the j-operator, the author sets out the differential equation for the circuit and then works through the complete solution for a suddenly-applied sine wave of voltage. The nature of the steady-state solution gets hidden in four pages of inelegant mathematics and has to be rescued as an afterthought in a few lines at the end.

In spite of these flaws the book is soundly conceived and with a little polishing, which it could easily receive for another edition, would make an excellent book.

I.P.O.E.E. Library No. 2596.

H. J. O.

Plastic Telephone Cable Construction in the Tropics

Sir NORMAN FROME, C.I.E., D.F.C., M.Sc., M.I.E.E.†

U.D.C. 621.315.211.9:621.315.616

Plastic insulated and sheathed cables are being used increasingly in tropical countries. Special techniques are, however, necessary because of the climatic conditions and to cope with attacks by various insects. In addition, construction methods often need to be suited to the use of semi-skilled labour.

INTRODUCTION

DURING the past ten years or so increasing use has been made of plastic insulated and sheathed cables for local distribution purposes in the line and cable networks of telephone exchange systems in tropical countries. To withstand the severe climatic conditions and because of the limitations frequently imposed by the employment of semi-skilled staff, special techniques for this form of construction have been evolved.

The use of plastic distribution cables is proving attractive to overseas administrations since these cables are economical, light and easily handled; they need little skill in installation and can be supplied in very long lengths. When used to replace open wires, they are effective in reducing the incidence of line faults.

Initially, the use of plastic cable in the tropics was largely confined to aerial-cable schemes but, during recent years, more use has been made of cables buried direct in the ground, and many additional problems have arisen both from the jointing requirements and from insect and rodent attack.

For tropical work plastic telephone cables for external use have polythene-insulated conductors, the core is aluminium-tape screened, and the cable p.v.c.-sheathed* overall. The p.v.c. used for sheathing in such circumstances is normally of the dioctyl-phthalate plasticizer, basic-lead-carbonate stabilizer type and of a hard grade. P.V.C. sheathing is usually preferred to polythene as it has better resistance to abrasion, is not affected by common oils and is non-inflammable. Also, experience overseas indicates that in most instances p.v.c. appears to be less extensively damaged by insect attacks. Both dielectric and sheaths are used in thicknesses greater than normal in temperate climates to safeguard against high temperatures and to withstand rough handling.

Black or grey p.v.c. cable sheaths are specified for aerial-cable construction; only these two colours have been found capable of withstanding the ultra-violet radiation in the tropics. Grey cable is used where appearance has to be taken into consideration (e.g. for cabling along shop fronts), black being used in other circumstances and for all underground work.

The aluminium screening performs a triple function; it acts as a barrier between the polythene-insulated conductors and the p.v.c. sheath to prevent the migration of the p.v.c. plasticizer into the polythene, as a screen against inductive interference, and as a protection against some of the milder forms of insect attack.

Cables for internal work are usually both p.v.c. insulated and sheathed, without screening, and are supplied in a variety of colours.

† The author is with Messrs. Preece, Cardew & Rider, Consulting Engineers.

* p.v.c.—polyvinyl chloride.

‡ Seven strands of 20-gauge, 16-gauge or 14-gauge wire.

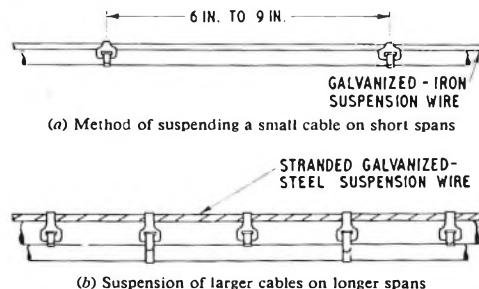

FIG. 1—SUSPENSION OF PLASTIC AERIAL CABLES WITH STRAP CLIPS

AERIAL-CABLE CONSTRUCTION

Suspension

A method of suspending plastic aerial cables which has been found very effective in overseas conditions is that illustrated in Fig. 1, which shows how the cable is closely clipped to a suspension wire, using tinned-brass strap clips. This form of construction has proved to be simple and economical; it avoids any abrasion difficulties and is very flexible in meeting the requirements for cables of various sizes in a distribution network. In erecting a cable, it is clipped to the suspension wire on the ground and both the cable and wire are then pulled up and fixed into position.

The suspension wire used for small cables on short terminating spans and on minor lines is 300 lb/mile galvanized-iron line wire but, for supporting larger cables, or where long spans are involved or damage from storms or falling tree branches may occur, the use of 7/20, 7/16 or 7/14‡ galvanized stranded-steel wire is necessary. On coastal routes which are liable to abnormal corrosion, p.v.c.-covered steel suspension wires have been employed with p.v.c.-covered strap clips.

Pole Fittings

In most tropical countries steel or concrete poles are necessary to withstand the climatic conditions and to avoid the damage from termites to which wooden poles are liable. Fig. 2 shows one of the types of aerial-cable suspension clamps for use with steel poles; other types are available with double suspension clamps and for fitting on cross-arms or under insulator spindles.

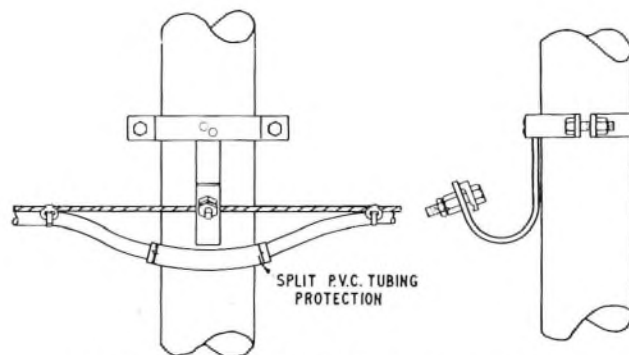

FIG. 2—AERIAL-CABLE SUSPENSION FROM STEEL POLES

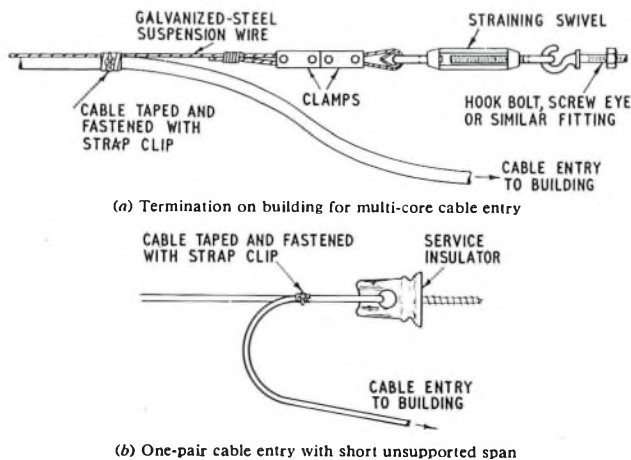

FIG. 3—PLASTIC CABLE TERMINATIONS ON BUILDINGS

The termination of aerial cables on buildings is arranged in a variety of ways to suit local circumstances. Fig. 3 illustrates two of the methods of leading-in large and small cables.

Jointing and Distribution Boxes

So far as possible, joints, other than at distribution points, are avoided in aerial-cable schemes. When it is necessary to make a through joint the bell type of expandable-plug joint-box shown in Fig. 4(a) has proved effective, whilst for combined jointing and distribution weatherproof galvanized-steel boxes, as shown in Fig. 4(b), are available in a series of sizes up to 100 pairs and meet most requirements.

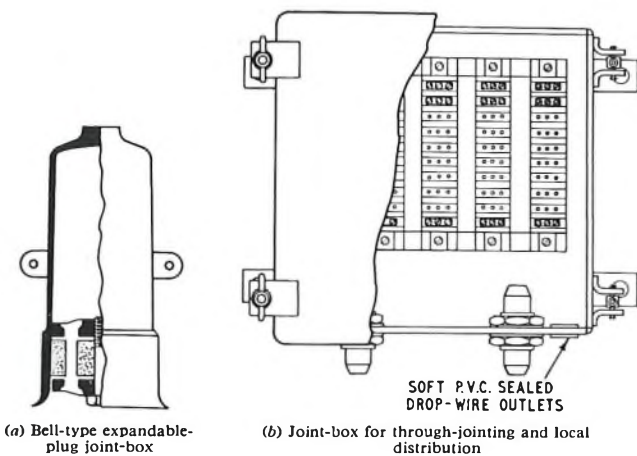

FIG. 4—JOINTING AND DISTRIBUTION BOXES

In congested city areas overseas where pole routes cannot be erected and cabling has to be fixed to the faces of buildings, usually under verandahs, it is frequently necessary to bring out a pair or pairs from a cable for subscribers' connexions, and the small moulded distribution box shown in Fig. 5 has proved to be useful for this work. The box enables up to three pairs to be taken out of the cable and, when fitted with a hood, it can be used in exposed situations. The drawing illustrates the method of use and indicates features of the design.

Aerial Cables in Service

The main factors affecting the service life of plastic

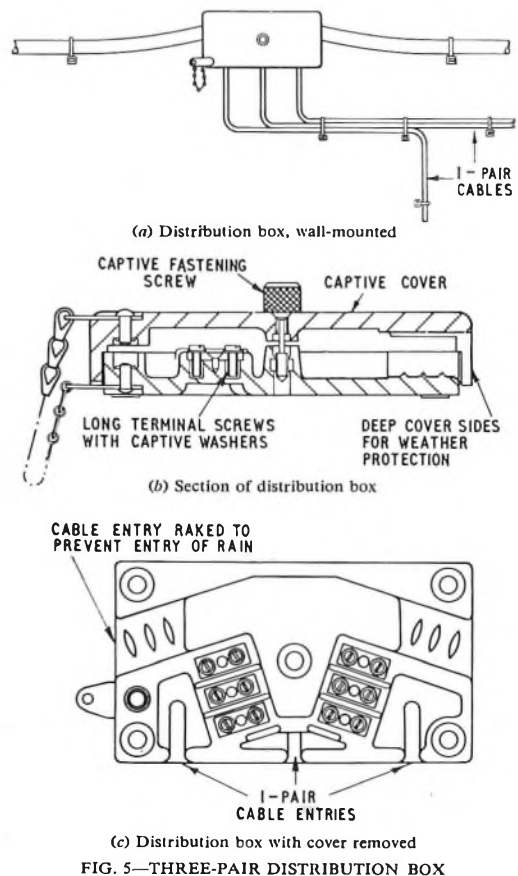

FIG. 5—THREE-PAIR DISTRIBUTION BOX

aerial cables under tropical conditions are the effects of ultra-violet radiation and high temperatures due to the sun. Aerial cables are not ordinarily subject to insect attack, and the permeation of water vapour is of no great importance since the cables are usually being dried more than they are being wetted. The effects of ultra-violet radiation can be controlled by the use of suitable sheath pigments, e.g. carbon black.

What the eventual service life of tropical p.v.c.-sheathed aerial cables will be is not yet known; cables which are known to have been in use for some eight years in very high sun temperatures and low humidities have so far shown no cracking or crazing of the sheath, and the insulation resistance of the cable conductors has remained unaffected. This service life has already greatly exceeded that previously obtained with rubber-insulated wires and cables under similar conditions, but how plastic cable will ultimately compare with lead-covered paper-core aerial cable remains to be seen.

UNDERGROUND CABLE CONSTRUCTION

The factors which most adversely affect plastic cables laid direct in the ground in the tropics are water-vapour permeation and insect attack. Water-vapour permeation particularly influences the form of construction of cable joints, and the forms of construction and protection of the cable itself are largely determined by the need to provide resistance to insect attacks.

Cables are normally laid from 1-2 ft underground, depending on the type of cable and on local conditions, although in areas where insect attacks are frequent, burying at a depth of 4 ft has sometimes been found to be necessary. Mechanical trenching tools have been

used to a limited extent; so also has the laying of plastic cables in ducts. The main problems have, however, arisen where cables are laid direct in the ground in the outlying areas of distribution networks.

Water-Vapour Permeation

Plastic cables are not completely "watertight" in the sense that lead sheaths are, and in some tropical countries cables may have to be laid in areas which are intermittently or continuously waterlogged. In these circumstances water vapour may eventually find its way into the cable or, in the event of mechanical damage to the sheath, water may enter the cable. So long as the polythene conductor-insulation remains perfect these conditions will cause no great difficulty in subscribers' distribution cables but, if water vapour finds its way into a cable joint where there are bare lengths of conductor under the jointing sleeves, low insulation will result. Water-barrier sleeves assist in overcoming such difficulties, whilst the use of silicone-grease-filled sleeves on the conductor joints will protect the cable against any imperfect barrier sealing or imperfectly fitted cable-joint assemblies.

Jointing

To meet overseas conditions, joints in a plastic cable should be of as simple a form as possible, require the minimum of skill in making and not involve the use of special tools or equipment; preferably they should be so constructed that when necessary they can readily be dismantled and re-made; such joints should have a long service life free from faults.

Expandable-plug forms of cable joint meet most of the requirements for joints capable of being readily dismantled, although care must be exercised to avoid leakage at the junctions between the plugs and the cable sheath. Oxidized brass, aluminium or plastic sleeves are preferred to the lead type reinforced with brass end-rings, since the presence of dissimilar metals in contact in saline or contaminated subsoil water is not desirable. In such subsoil conditions deterioration of the material of the plug has also occurred.

Joints in a form which can be readily dismantled are normally required for tee and branching-cable joints, but it has proved difficult to ensure that such joints can be made and kept water-vapour proof. For the permanent through-jointing of cables and for joints between lead-covered paper-core and plastic cables, resin-filled or wax-filled joints in a moulded casing have advantages in that complete sealing can be obtained, no water barriers or grease-filled sleeves are required, and the joint is not subject to insect attack. When such filled joints are used sufficient spare cable is coiled at the jointing point to re-make the joint if this becomes necessary.

Insect Attack

Although controlled field trials overseas have in the past resulted in p.v.c. being considered "termite proof" or "termite resistant," many instances have occurred in various territories of damage to cable sheaths by termites and some varieties of true ants; Fig. 6 and 7 illustrate the results of such attacks.

In the majority of instances such damage occurs where the cable happens to be in the way of a termite or ant "run." The insects endeavour to remove the cable, which forms an obstruction in their runway. Fig. 8, however, shows damage to a polythene insulated cable-

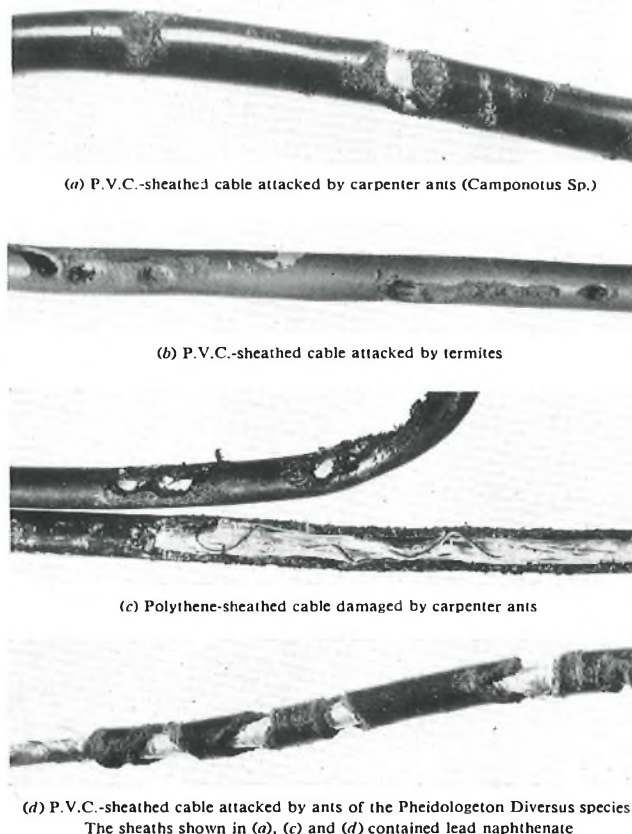

FIG. 6—EFFECTS OF INSECT ATTACKS ON PLASTIC-SHEATHED CABLES

form which was attacked although it did not form an obstruction. The ant concerned (*Monomorium Destructor*) appears either to be attracted to polythene as an article of food or to remove it for some domestic purpose.

Aluminium-tape screening is generally sufficient to prevent termites reaching the core of a cable, but true ants of the *Camponotus* and *Pheidologeton* species in particular appear to be more powerful biters and can remove the aluminium and then attack the conductor insulation. A copper, bronze or tinned-brass tape in place of aluminium will prevent the core being attacked, but this adds to the cost of the cable and makes it heavier and more difficult to handle. In most cases damage to polythene sheaths through insect attack is more extensive than to p.v.c. sheaths; it seems that the dioctyl-phthalate plasticizer used in tropical p.v.c. compounds has a slight repellent effect and insects appear to be able to bite more readily into polythene than into p.v.c.

The problem of preventing insect attacks is a difficult



FIG. 7—POLYTHENE-SHEATHED CARRIER-FREQUENCY CABLE ATTACKED BY TERMITES (*MACROTERMES BELlicosus*)

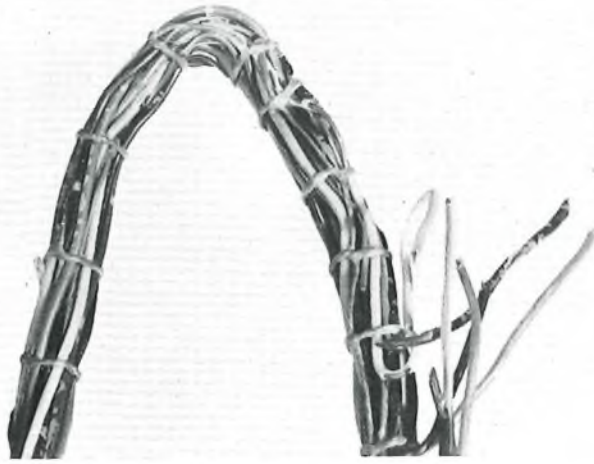

FIG. 8—POLYTHENE-INSULATED CABLE FORM ATTACKED BY MONOMORIUM DESTRUCTOR ANTS

one. The use of poisons in the sheath or the surrounding soil involves manufacturing, handling and other difficulties in the field, and, moreover, termites and ants are incapable of learning and continue to attack a cable forming an obstruction in spite of being poisoned in large numbers.

An alternative is the inclusion of an effective repellent in the sheath. Lead naphthenate has been used for such a purpose with partial success, but instances have occurred in which sheaths containing this repellent have been attacked. Experience also indicates that lead naphthenate only remains effective for a year or so under tropical conditions.

Investigations and field trials are in progress in an endeavour to find a long-life repellent or suitable poison but, until this problem of insect attack is finally solved, the use of plastic cables laid direct in the ground in the tropics will not be completely satisfactory.

INTERNAL CABLING AND WIRING

P.V.C. insulated and sheathed wires and cables have largely superseded the vulcanized indiarubber, lead-sheathed vulcanized indiarubber and textile-insulated wires and cables previously used overseas for wiring to telephone instruments and cabling in buildings. Two-conductor cables are supplied in twisted-pair or flat or dumbbell formation in a variety of sheath colours to meet local requirements, and are fixed with various types of pin, clip, or staple. The p.v.c. used for internal cables for both the conductor insulation and sheathing is of tropical grade. In some isolated instances internal cables fitted in old buildings have been attacked by termites and rodents but, in general, plastic wiring and cabling in subscribers' premises have proved to be very successful.

The Anglo-Swedish Submarine Telephone Cable

U.D.C. 621.395.51 (41+485):621.315.28

THE laying of the first direct submarine telephone cable between the United Kingdom and Sweden was completed on 17 June.

The new cable is the longest submarine cable in the world equipped with submerged repeaters for two-way operation and is a joint project by the United Kingdom Post Office and the Royal Board of Swedish Telecommunications. The cable, repeaters and terminal equipment are of British design and manufacture and will provide 60 telephone circuits of C.C.I.T.T. quality.

At the United Kingdom end the terminal equipment is installed in a new repeater station at Middlesbrough; in Sweden the terminal equipment is at Göteborg. The submarine cable route is from Marske, about 10 miles east of Middlesbrough, to Sandvik, some 10 miles from Göteborg. The submarine section is about 510 nautical miles (n.m.) long and the length of the whole system between the terminal stations at Middlesbrough and Göteborg is about 527 n.m.

The terminal equipment assembles the 60 circuits from five basic 12-circuit carrier groups (60–108 kc/s) into the frequency bands 60–300 kc/s for transmission in the Göteborg–Middlesbrough direction and 360–608 kc/s for the reverse direction. The 360–608 kc/s band includes an 8 kc/s portion used in the repeater monitoring system.

From Middlesbrough the circuits in the new cable are extended to London in carrier and coaxial cables while from Göteborg the circuits are extended to Stockholm by

coaxial cable. London–Stockholm 12-circuit groups are provided in this way without the necessity for translation to audio frequency at intermediate points.

The cable is fitted with 29 submerged repeaters of the latest British design. This type of repeater has been developed for use on the United Kingdom–Canada cable (CANTAT),¹ to be laid in 1961, which will be the first link in the Commonwealth "round-the-world" telephone cable system.² The same design of repeater will also be used on the Commonwealth Pacific cable from Canada to New Zealand and Australia, the next link in the Commonwealth cable system. Notable features of the repeaters are the use of new and improved long-life valves, which have enabled the repeater operating voltage to be reduced, and a new monitoring unit with which it is possible to locate not only all the usual types of fault but also, for the first time in a British repeater, a wideband noise fault.

The repeater characteristics have been designed to meet the requirements for the new British light-weight armoured cable³ to be used for the deep-water sections of the Commonwealth system. The cable on the United Kingdom–Sweden route is, however, conventionally armoured to provide the mechanical protection needed for a shallow-water route, but the internal construction of the cable has been modified so that its impedance and loss/frequency characteristics are similar to those of light-weight cable. This simulation of the characteristics of light-weight cable has been achieved by the use of a

composite centre conductor comprising a core of stranded-steel wires surrounded by an outer longitudinal copper tape. This tape is formed into a tube around the stranded core by means of a seam joint similar to that used for metal boxes. Conventional polythene-dielectric insulation with an outer diameter of 0.62 in. is used and the outer conductor consists of six helical copper tapes with an overlapped copper binding tape. Most of the cable is armoured with No. 2 S.W.G. mild-steel wires, but about 100 n.m. in deeper water is armoured with No. 6 S.W.G. mild-steel wires.

Power-feeding equipment maintains a constant direct current to the cable, regulated to within ± 1 per cent, to energize the repeaters. Since the cable is short relative to the design capabilities of the system, the whole of the power is fed from the Middlesbrough terminal, the total line voltage being about 3,500 volts.

The Post Office cable ship *Monarch* laid some 490 n.m. of the main cable, including 28 submerged repeaters,

between 10 June and 15 June. Shore ends at Marske and Sandvik had been laid in advance by the smaller Post Office cable ship *Ariel*. The cable was completed by *Ariel* laying some 16 n.m. of cable, including the 29th repeater, in shallow water at the Swedish end of the route and making the final splice on 17 June.

The new cable is another link in the extensive network of submarine cables between the United Kingdom and the Continent. It will provide a valuable direct route to meet the ever increasing demands for telephone and telegraph facilities between this country and Sweden, and neighbouring countries.

R. H. F.

References

¹ A Proposed New Telephone Cable between the United Kingdom and Canada. *P.O.E.E.J.*, Vol. 50, p. 104, July 1957.

² Proposed Commonwealth Pacific Telephone Cable System. *P.O.E.E.J.*, Vol. 53, p. 40, Apr. 1960.

³ BROCKBANK, R. A., and MEYERS, A. L. A New Deep-Sea Coaxial Cable. *P.O.E.E.J.*, Vol. 50, p. 7, Apr. 1957.

Book Reviews

"Electro-Technology for National Certificate Courses." Vol. III. H. Buckingham, M.Sc., Ph.D., A.M.I.E.E., and E. M. Price, M.Sc.Tech., A.M.I.E.E. The English Universities Press, Ltd. xiv + 361 pp. 295 ill. 16s.

Technical education has risen in status during the past 20 years from being an unpopular cinderella in the educational world to a princess on whom riches and attention are lavished. Industrial economics dictates that more electrical technologists are essential in industry; the technical colleges are, therefore, pressed to provide them, the teaching staffs expand, new teaching methods are introduced and the writing of text books is fostered. Many of the new books do not survive to a second edition but a few will become of value in our technical libraries.

Volume III of Electro-Technology for National Certificate Courses, by Dr. H. Buckingham, of Loughborough, and Mr. E. M. Price, of the Bradford Institute of Technology, is in the second category amongst the better text books. It is intended for the S3 course (O.N.C.) but its coverage is broader than is required for the Ordinary National Certificate and the book will be useful to students taking I.E.E. examinations or entering upon engineering degree courses.

Some telecommunication engineers might consider this book old fashioned in its outlook because it deals with fundamentals by fundamental methods; e.g. a.c. circuits are solved using vectors. However, in this case the authors use vectors and operator j together, the former illustrating the latter. The result is most satisfactory, and gives the student confidence in both methods of analysis.

This is the third volume of a series and to some extent it fills the gaps in the other two volumes. The first chapter is on armature windings—perhaps somewhat out of context; but the following chapters are in logical order—electric and magnetic fields, direct-current effects, single-phase circuits and polyphase systems. There are then more advanced chapters on rotating magnetic fields, advanced circuit theory using the classical theorems such as Thevenin's theorem, simple bridge circuits, conversion of a.c. to d.c., and a few thoughts on applications of electronics to electrical engineering. It is well known that colleges biased towards "heavy electrical engineering" seldom take electronics seriously and this chapter rather typifies this outlook.

The authors are to be congratulated on including a chapter on "some economic considerations." This important aspect of an engineer's work is too easily overlooked

during training.

The book is beautifully presented with clear print on good quality paper. The style of writing is smooth and clear and generally easy to follow.

C. F. F.

"Landesfernwahl" (Nationwide Dialling). Dr. Ing. R. Fuhrer. R. Oldenbourg, Munich, Germany. Vol. I: The Basic Problems. 250 pp. 116 ill. D.M.32. Vol. II: Technical Solutions. 296 pp. 190 ill. D.M.36.

These books form a comprehensive survey of German telephone switching and signalling practice. In particular, they deal with the problems, and the proposed technical solutions, associated with subscriber trunk dialling with reference to the German national network.

Dr. Fuhrer, head of the German Bundespost Telephone Switching and Signalling Development division at Munich when these books were written, writes with considerable authority on the subject as it was his responsibility to conduct the study and to formulate technical solutions to meet the conditions of the German network.

Volume I is divided into seven main sections:

Section 1 deals with area codes and national numbering. The usual problems of dividing the country into charge areas and main zones are developed. Details are given of the arrangements adopted by the Bundespost. As in the United Kingdom, the German administration proposes the prefix digit 0 for S.T.D.

Section 2 deals with the problems of interconnecting the line network. The various problems are posed and given rigorous treatment. The conclusion favours tandem working with "star" type line networks. The treatment develops the German transit network: endamt-knotenamt-hauptamt-zentralamt exchanges in ascending order of switching, which exchanges may be regarded as local-primary-secondary-tertiary switching exchanges. The transmission losses of the network are discussed under the various limited conditions of 4-wire switching on the network, and for complete 4-wire switching. The suggestion is that the normal condition for some time will be 4-wire switching down to the knotenamt, with the ultimate object of 4-wire switching down to the endamt exchanges.

Section 3 deals with charging rates and the general techniques of repeated metering and automatic ticketing. The problems of meter-pulse generation, timing, distribution and application are treated in general detail. Repeated metering is adopted for Germany.

Section 4 deals with the general outline of signalling and

(Continued on p. 168)

The 4-Wire Extension Principle for Small Cordless P.M.B.X. Switchboards

E. J. LIDBETTER†

U.D.C. 621.395.23

The conventional type of small cordless P.M.B.X. switchboard utilizes only two conductors for the connexion to each extension. By using a third conductor and by providing, in addition, an earth connexion to the extension, the design of the switchboard is simplified, its size may be reduced and additional facilities may more readily be provided.

INTRODUCTION

A NEW principle has been adopted for the circuit design of a range of small cordless private manual branch exchanges (P.M.B.X.s). This consists of separating the functions of transmission and supervision and involves running an additional wire and an earth lead to each extension.

It has been found that the cost of the additional wiring is more than offset by a reduction in the number and cost of components in the switchboard, and it is only at the relatively few installations at which external extensions are required that the economic advantage is lost. Furthermore, the new design permits additional facilities to be provided more readily.

Switchboards incorporating this new principle will be the subject of future articles in this Journal.

THE PRINCIPLE OF 4-WIRE EXTENSION WORKING

The present method of providing the calling signals on a parallel-feed type of cordless switchboard is to use an indicator in series with the extension line-circuit. This indicator is controlled by the extension loop and is disconnected when the connecting key is operated. Supervisory signals are then obtained by means of a relay in the connecting circuit, the contacts of the relay being used to control the indicator. This arrangement has certain inherent disadvantages in that it reduces the line signalling limits by the d.c. resistance of the relay and, due to sensitivity requirements, it is necessary to provide a relief relay to prevent operation of the supervisory device during dialling. If, however, control of the supervisory signals is made independent of the extension loop, it becomes possible to dispense with the line relay in the connecting circuit and a common indicating device can still be used for both calling and supervisory signals. This simplification is made by increasing the number of wires between the switchboard and the extension telephone instrument to three and by providing a signalling earth at the telephone.

The figure shows the circuit element for the 4-wire extension principle. Each extension telephone is provided with an additional switch-hook spring-set, SWA, to control supervisory clearing signals. When required, press-button recall can easily be provided by means of a press-button fitted on the telephone instrument and connected in parallel with the additional switch-hook spring-set.

With the extension-connecting key KE normal, a loop condition is applied to the A and B terminals to give a calling signal when the extension telephone

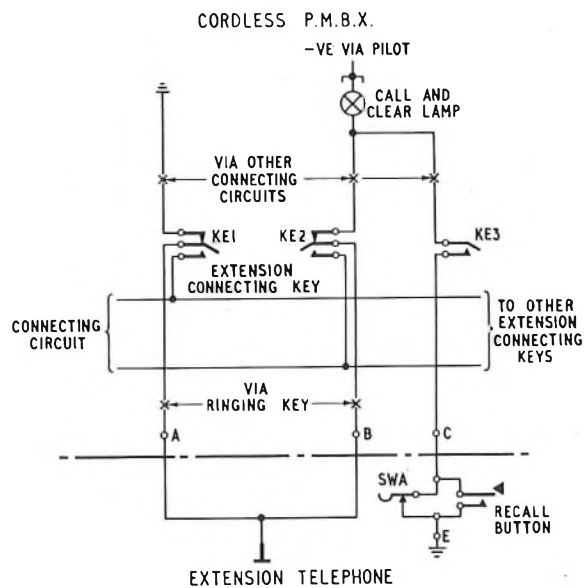

The extension earth is usually connected at the distribution case
4-WIRE EXTENSION CIRCUIT ELEMENT

handset is lifted. The operator answers the call by operating the extension-connecting key KE, the calling signal is extinguished and the battery and earth conditions are removed from the line by key contacts KE1 and KE2. The supervisory device is now connected via KE3 and the C terminal to the switch-hook and press-button spring-sets controlling the clearing and recall signals respectively. Hence, if the extension-connecting key KE is operated and the extension telephone handset is replaced, a clearing signal is given to the operator. This simple circuit arrangement gives full and improved supervisory facilities with the minimum provision of components.

ADVANTAGES AND DISADVANTAGES OF THE NEW PRINCIPLE

A cordless switchboard design based on the principle just described is simple, requires the use of fewer components than the conventional type of cordless switchboard and has a comprehensive and improved range of facilities. The overall size of the case is considerably reduced, resulting in a saving of materials and in decreased packaging and storage charges. On the other hand, when an external extension is required it may be uneconomic to use extra wires in the main exchange local-line network for signalling purposes, and in these circumstances a comparatively expensive relay-set for converting the extension from 4-wire to the conventional 2-wire working is fitted at the P.B.X. end of the extension. Special arrangements also have to be made if certain types of extension-plans are required at any of the P.B.X. extensions.

Nevertheless, it is estimated that these disadvantages are more than offset by the economic advantage to be gained at any average installation, even after taking

† Subscribers' Apparatus and Miscellaneous Services Branch, E.-in-C.'s Office.

into account the cost of providing the extra spring-set, the additional wiring to each extension telephone and, where an existing switchboard is changed for one of the new design, the labour charges incurred in providing the new wiring between the P.B.X. and extensions.

Further advantages of the design are that individual supervisory clearing signals are given on extension-to-extension calls and that the signalling limit on exchange-to-extension connexions is raised to that of a direct exchange line. Press-button recall can easily be provided as a function of the signalling wire, and therefore the difficulties encountered in arranging for this facility to be provided on the introduction of subscriber trunk dialling are avoided. These difficulties arise with the conventional 2-wire extension circuit because, with the introduction of subscriber trunk dialling, the exchange line polarity at the P.B.X. may be different on established outgoing local calls from that on trunk calls. This would necessitate the inclusion of a differentially connected relay in the line circuit at the P.B.X. to provide a press-button recall facility. The earthed loop used as the

recalling signal would offer a low-impedance earth path to longitudinally-connected 50 c/s metering signals.* This might prevent the meter registering correctly and cause a loud noise to be heard if the recall signal and metering signals occurred simultaneously. The signalling wire can also be used for other purposes such as the provision of automatic hold on exchange calls, a facility which has proved difficult and expensive to provide using the conventional 2-wire extension circuit.

CONCLUSION

Briefly, the principle is attractive in that it enables a simple and comparatively cheap P.M.B.X. to be provided which will meet the requirements of the majority of users. It requires more expensive auxiliary units to be provided in only comparatively few instances, thus effecting an overall saving in cost.

* GRESSWELL, F., BELK, J. L., and ALDERSON, G. A. Subscribers' Private Meter Equipment. *P.O.E.E.J.*, Vol. 51, p. 338, Jan. 1959.

Book Review

"Landesfernwahl"—*continued from p. 166*

dialling techniques, and includes general treatment of the C.C.I.T.T. international 2 v.f. 2,040 c/s and 2,400 c/s binary signalling system, and of the two-out-of-five multi-frequency digital signalling technique. General detail is given of the various signalling systems applied in Germany since 1930. It is interesting that 1 v.f. systems, a 3,000 c/s in-band and a 3,850 c/s out-band, are the present-day standard voice-frequency signalling systems in Germany.

Section 5 deals in circuit-element form with the problems of 2-wire and 4-wire switching with particular emphasis on the signalling problems of 4-wire switching.

Section 6 discusses the problems of controlling the routing of traffic on the transit network. The treatment covers originating-exchange control and the alternative of passing the complete call information from exchange to exchange as the call is extended.

Section 7 discusses methods of access to circuits from operators' positions, automatic access and direct (jack) access being treated.

The whole treatment in Volume I is based on general principles, the various aspects of the many problems being examined with extreme thoroughness and lucidity.

Volume II is divided into four main sections:

Section 1 is a general review of the technical solutions.

Section 2 deals in considerable detail with the various signalling and dialling techniques and includes local d.c. (single-wire earth return), 50 c/s dialling, and voice-frequency signalling. The author is a recognized expert on the subject of d.c. pulse correction and this technique is discussed in some detail. A basic treatment of signal imitation in relation to in-band voice-frequency signalling is given, and this develops the conclusion that a high signalling frequency has considerable advantages and, mainly because of this, a 1 v.f. 3,000 c/s voice-frequency signalling system has been adopted as standard. Considerable detail of this system, and of the 3,850 c/s out-band signalling system, is given. The design problems of voice-frequency signalling receivers are discussed. The standard German receiver is a conventional valve type with "difference" guard circuit. It is interesting to note that long-distance d.c. pulsing finds no application in the German network as the phantoms of 4-wire circuits are not available for the exclusive use of signalling; 50 c/s dialling covers this field.

Section 3 deals with equipment and components. It includes frequency generators, meters, subscribers' private meter, S.T.D. coin-box, pulse regenerator, the precious-metal-contact motor switch (now the Bundespost's standard switch) and a general description of electronic components. The German 16 kc/s meter-pulse technique for private meters, together with the constructional details of the private meter, is given in detail. This clock-type subscriber's private meter has two scales; one (100 pulses per revolution) for per-call reading, and the other (1,000 pulses per revolution) for totalling the meter pulses. The pulse regenerator (of some 70-pulse capacity) is of a novel flip spring type. A small spring, some 70 being fitted, is flipped from the upper face, to the lower face, of a ceramic ring to mark the end of a digit train and thus to store the digit. An output pulse is transmitted for each normal position spring.

Section 4 deals in considerable detail with the various stages of introduction of subscriber trunk dialling in Germany. Commencing with an early design of time-and-zone metering system installed in the Munich area in 1923, it continues with programs and details of 2-wire and 4-wire switching (considerable circuit design detail is given of 2-wire and 4-wire switching) and ends with details of a preferred system. This is a register-controlled system with 4-wire precious-metal-contact motor switches in the speech path. The register is electromechanical with a common electronic translator.

Volume II treats the various systems and problems in a very comprehensive manner.

Both volumes include an excellent bibliography, most of the publications, understandably perhaps, being from German sources. The two volumes form a very excellent treatment of immediate past and current German telephone techniques, Volume I being a general introduction, and a logical approach, to Volume II, which volume then develops the adopted solutions with meticulous reasoning and a wealth of detail. Many of the problems, of course, are not unique to the German Bundespost conditions; they apply to all telephone networks, and these books will undoubtedly create considerable interest outside Germany. In view of this it is a matter of regret that, being published in German, the books will inevitably have limited reading in the United Kingdom.

The production of the text and of the diagrams is of high standard.

S. W.

A Proposed New Cable System Direct to U.S.A.—TAT-3

U.D.C. 621.315.28

ON 20 July 1960 an agreement was signed between the Postmaster-General and the American Telephone and Telegraph Company (A.T. & T. Co.) for the provision of a repeatered submarine cable to run directly between Great Britain and the United States. The system is to be completed as early as possible in 1963 and will provide 128 3 kc/s-spaced telephone circuits, or their equivalent, on a single coaxial cable some 3,400 nautical miles (n.m.) long.

Existing and projected telephone cable systems across the Atlantic include:

(a) TAT-1¹: two unidirectional cables, Scotland–Newfoundland, of 1,950 n.m., provided 36 4 kc/s-spaced circuits initially and subsequently increased by the use of 3 kc/s-spacing and T.A.S.I.² (1956).

(b) TAT-2: as TAT-1, but between Brittany and Newfoundland (1958).

(c) CANTAT³: single cable, Scotland–Newfoundland, of 2,000 n.m., providing 60 4 kc/s-spaced circuits initially and then 80 3 kc/s-spaced circuits (1961).

(d) SCOTICE/ICECAN⁴: single cable, Scotland–Iceland–Greenland–Newfoundland, providing 24 3 kc/s-spaced circuits initially (1962).

The new project, TAT-3, which is estimated to cost about £12 million, will be undertaken by the Post Office and A. T. & T. Co. in equal partnership. The system will employ light-weight (armourless) cable⁵ and two-way rigid repeaters of American design, representing the results of intensive development by the Bell Telephone Laboratories of the type of system being used by Great Britain and the Commonwealth Partners in the CANTAT and Commonwealth Pacific (COMPAC)⁶ cables.

The cable will have a core diameter of 1 in. and will differ from the CANTAT cable in important details, including the use of a single longitudinal copper tape as a return conductor. This gives a more nearly ideal struc-

ture than multiple helical tapes and should tend to be more stable. It is, however, much more liable to damage due to repeated bending and, in consequence, is to be laid by caterpillar gear instead of a rotating cable drum; the caterpillar tracks can distort sufficiently to “swallow” the rigid repeaters.

The system is designed for up to 180 repeaters at a spacing of about 20 n.m. and, to maintain a direct current of 0.43 amp through the system, a terminal voltage of about 6 kV will be required at each end.

The terminal points of the system have not yet been decided. In view of the number of breaks which have occurred in TAT-1 and TAT-2 due to the activities of heavy trawlers, mainly off Newfoundland, very careful consideration will be given to the routing of the shallow-water sections of the cable and to means for their greater protection against damage.

Telephone traffic between Great Britain and the United States is already three-and-a-half times greater than it was before TAT-1 opened in 1956, and is growing at the rate of about 500 calls per month. To begin with, some of the circuits in TAT-3 will be used for telephone calls between the United States and Europe and, so, will provide relief for both TAT-1 and TAT-2.

R. J. H.

References

¹ The Transatlantic Telephone Cable. *P.O.E.E.J.*, Vol. 49, Part 4, Jan. 1957.

² HALSEY, R. J. The Economic Usage of Broadband Transmission Systems. *P.O.E.E.J.*, Vol. 51, p. 212, Oct. 1958.

³ A Proposed New Telephone Cable between the United Kingdom and Canada. *P.O.E.E.J.*, Vol. 50, p. 104, July 1957.

⁴ The SCOTICE/ICECAN Submarine Cable Projects. *P.O.E.E.J.*, Vol. 53, p. 56, Apr. 1960.

⁵ BROCKBANK, R. A., and MEYERS, A. L. A New Deep-Sea Coaxial Cable. *P.O.E.E.J.*, Vol. 50, p. 7, Apr. 1957.

⁶ Proposed Commonwealth Pacific Telephone Cable System. *P.O.E.E.J.*, Vol. 53, p. 42, Apr. 1960.

Book Review

“Fundamentals of Electron Devices and Circuits.” H. R. Weed and W. L. Davis. Sir Isaac Pitman & Sons, Ltd. xii + 591 pp. 379 ill. 60s.

An author who decides to write a comprehensive book on electronics is faced with a dilemma—whether to concentrate on theory with, perhaps, a few practical examples, or deal with practical applications, merely including the minimum theory necessary to make them understood. Messrs. Weed and Davis are no exception: from the very title of the book onwards the conflict over what to include is apparent. In the Preface, for example, it is stated that the book is an “. . . attempt to write a single text covering the essential concepts of a.c. theory and electron devices that is equally useful to the electrical and the non-electrical engineer.” On page 170, however, the statement is made that “The primary purpose of this book is to discuss the applications of electronic tubes to practical problems.”

This conflict is borne out by the subject matter itself: the first few chapters deal adequately with the passive circuit elements, a.c. theory and thermionic valves. Rather too

much space (more than one-third of the whole book) then deals with diodes and the principles of rectification. Transistors, on the other hand, are treated rather sketchily for a book first published in 1959. Chapters are included on magnetic amplifiers, gas tubes (it is a sign of the times that the cold-cathode triode does not even merit a mention!), photo-tubes and some electronic instruments. None of these is dealt with in detail and a major criticism of the book must be the absence of a bibliography—this, despite the fact that on pages 270 and 555 the reader is exhorted to refer to a textbook.

The general appearance and style are good and there are few editorial errors; the same cannot be said of the diagrams and curves. Apart from many of these being too small for the information they are trying to give, there are a number of ambiguities and, indeed, errors.

Most of the practical applications referred to are in the field of industrial electronics and it is felt that, apart from giving an insight into what may be a little-known branch of the industry, the book has little to offer to the telecommunications engineer.

C. A. M.

New Coast Radio Stations

E. BRIGGS and B. PETERS†

U.D.C. 621.396.7:621.396.932.

New coast radio stations have been built for communication with shipping off the United Kingdom coast. A brief outline of the coast radio service and the engineering aspects of modern coast-station provision is given with emphasis on a new style of building designed specially for this service.

INTRODUCTION

THE post-war development of the maritime telegraph and telephone radio services has involved the re-equipping of all the short-range coast radio stations and provision of three new stations. The first new station, at Stonehaven, was opened in January 1958 and replaced a temporary station; the second, near Ilfracombe, took over the local services provided by Burnham and Portishead in January 1959; and the third, located in north-east Anglesey, became operational in May 1960 to take over the services previously operated from Seaforth. A brief outline of the coast radio service is given and the engineering aspects of these new stations are described, with particular reference to the station provided at Ilfracombe.

COAST RADIO SERVICE

There are 11 coast radio stations situated around the United Kingdom coastline to provide communication with shipping within about 250 miles range. The

† Overseas Radio Planning and Provision Branch, E.-in-C.'s Office.

frequencies of operation are in the bands 410–525 kc/s for telegraphy and 1.6–3.8 Mc/s for telephony and also for telegraphy to certain classes of ship, notably trawlers. Direction-finding facilities are also available at certain stations, giving bearings to ships who request this information. Non-commercial services include maintaining a continuous watch on the frequencies 500 kc/s and 2.182 Mc/s to intercept distress calls and other emergency calls and, in the event of a call being received, to control the communication with rescue craft and provide bearings on the vessel involved. Transmission of weather and navigational information, communication with light-houses and light vessels, and the "Medico" service, which enables shipping to obtain advice from a doctor on shore to assist in dealing with casualties on board ship, are also undertaken. The coast radio service is operated throughout the 24 hours and is available to the general public for telegrams and telephone calls to ships.

SITING OF COAST RADIO STATIONS

The provision of a coast radio station involves the selection of three sites separated from one another by at least half a mile. One, the main-station site, is for the building and associated transmitting aerials; another forms the receiving-aerial site at a suitable distance to avoid excessive field from the station transmitters, so as to permit duplex telephony operation and to enable the receiving aerials to be connected to the station building

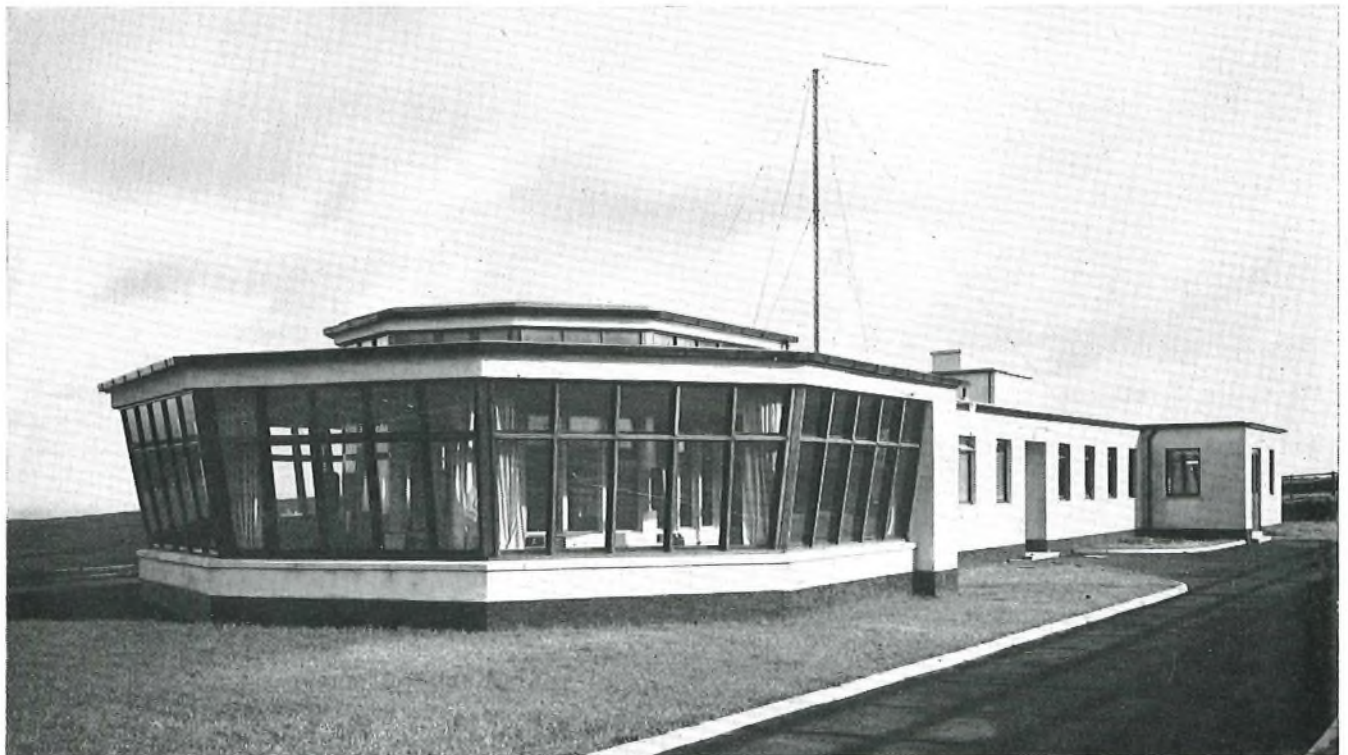

The operations rooms are in the foreground

FIG. 1—MAIN STATION BUILDING

over coaxial cables without excessive losses; the third site is for Adcock direction-finding aerials and should be well spaced from both the other sites, but also at such a distance from the main station as to permit connexion by coaxial cable. To avoid difficulties caused by electrical interference the complete station has to be sited well clear of industrial and built-up areas and clear of overhead power lines. In view of the special requirements pertaining to the selection of a site for direction-finding purposes this provision has first consideration.

As an example, in the final selection of sites for Ilfracombe a group on high land was chosen in order to reduce, as far as possible, the radio-shadow area to be expected on the far side of the high land behind the South Wales coast. The location chosen is approximately two miles from Ilfracombe town and about $\frac{3}{4}$ mile east of Mullacott Cross. The main-station site for the building and the transmitting aerials occupies an area of about 12 acres and is 750 ft above sea level. The remote receiving aerials are situated $\frac{1}{2}$ mile south-west of the main station, occupying one acre of a 6-acre field 700 ft above sea level. The direction-finder site of about 4 acres is south-east of the main station a little over $\frac{1}{2}$ mile away, $\frac{7}{8}$ mile from the receiving-aerial site and 840 ft above sea level.

BUILDING

The Ilfracombe station building is shown in Fig. 1. The layout of the building was based on a study of operational and engineering requirements arising from the reconstruction of existing coast radio stations. Its form and treatment aim to achieve improved operational convenience and pleasant working environment with suitable office, domestic and welfare accommodation, and housing for radio transmitting and receiving equipments. The design also had to allow for expansion of the building to meet future developments in a manner which could be economically achieved by minimum changes to the overall design while retaining the principal features of



FIG. 2—RADIO OPERATOR'S POSITION

the building. This has been catered for by the choice of a building outline with end sections which can be extended and which are joined by a central block. The chief difference from previous coast-station buildings is the treatment given to the operations rooms, which are the hub of the coast radio station. It is from these that messages are transmitted to ship or vice versa and where contact between radio operators and the land-line operator must be as direct as is practicable, particularly at the time of distress working when safety of life may be involved.

Physical separation of the radio and land-line operators is, however, necessary to isolate the radio operator from the noise of teleprinters and of activities of a general office character which are undertaken in the land-line room. These requirements are met in the new building, which is arranged as a large semi-circular room divided by a glass partition into an inner land-line room and an outer radio-operating room. Individual radio operators in the outer room are in visual contact with the land-line room, and posting slots and message containers fitted in the intervening glass partition enable messages to be passed directly between each radio operator and the land-line room. A revolving wall blackboard fitted in the land-line room and visible to each operator is provided to display the names of the ships with whom contact is required, and other information for general transmission.

A radio operator's position is shown in Fig. 2, and three of these are installed at present, located symmetrically at appropriate points around the partition. A maximum of six positions of the present type can be accommodated in this manner and this will meet all foreseeable developments.

The chief external feature of the building is the slope of the outside walls of the radio operating room. This treatment provides all-round good natural lighting and pleasant working conditions. The outside windows are double-glazed for heat insulation except for two windows which may be opened for emergency exit. Double-glazing is also used for the inner partition to reduce the noise of the teleprinter and other activities in the land-line room. Both inner and outer rooms have acoustically-treated walls and ceilings.

Heating of the building is by oil-fired boiler, and in addition the radio-operating and land-line rooms have a low-pressure air ventilation system with optional heating. Artificial lighting is by fluorescent tubes. Electricity supply for the station is normally taken from public mains, with a 20 kVA emergency generator set installed in the power room. Outbuildings accommodate a sewage disposal plant, electricity-supply transformer, and bicycles. Oil storage is provided for the emergency engine by a 500-gallon underground tank, and by an indoor tank for the heating system of the building.

STATION EQUIPMENT

The radio equipment provided at Ilfracombe is typical of the installations at all United Kingdom coast radio stations. There are two main transmitters for operation on radio telegraphy or telephony in the bands 410–525 kc/s and 1.6–3.8 Mc/s, providing an output carrier power of 500 watts, and one transmitter of 140 watts carrier power for radio-telephony only. These transmitters are controlled from the operator's position via low-voltage relay circuits giving push-button selection of transmitter, frequency and type of emission.

For the 410–525 kc/s band either of the two main

transmitters can be connected to an aerial supported between two 120 ft masts with direct lead-in to the transmitters via selective aerial switching. For the band 1.6–3.8 Mc/s each transmitter has a vertical radiator, two of these consisting of the 120 ft masts mentioned above, which are insulated at the base, and a third aerial comprising a 4-wire cage around a 105 ft spliced pole. In the case of the two main transmitters, matching units are fitted at the aeriels for connexion of a coaxial feeder cable, the tuning of the matching unit being remotely adjusted on selection of operating frequency at the transmitter. The aerial for the lower-power transmitter is connected by coaxial feeder cable to a matching network at the transmitter. Each vertical radiator has an extensive earth mat of buried copper wires linking with a similar earth mat beneath the 410–525 kc/s aerial and with the earth system of the building, an arrangement of radial conductors centred on a point below the lead-in of the 410–525 kc/s aerial. All earth wires and feeder cables are buried 2 ft 6 in. below the ground to permit ploughing of the land.

The receiving equipments comprise marine-type communication receivers at each of the operating positions. In an auxiliary apparatus room are housed fixed-tune receivers operating on 2.182 Mc/s and 500 kc/s to provide a loudspeaker distress watch. Associated with the 2.182 Mc/s receiver is a recently developed radio-telephone automatic alarm. This accepts the alarm signal of alternate pulses of 2,200 c/s and 1,300 c/s tones at 2 p.p.s. and operates aural and visual alarms automatically at the coast radio station. This equipment can also generate the alarm signal for modulating a transmitter operating on 2.182 Mc/s if it is required to alert shipping in the area. Ship-owners are being encouraged to fit equipment for generating this alarm signal to precede the present telephony distress call "MAYDAY."

The receiving aeriels erected at the remote site consist of two cage aeriels mounted around 105 ft spliced poles for reception in the band 1.6–3.8 Mc/s, with an aerial suspended between these masts for 410–525 kc/s reception. Each aerial has a mat of buried conductors to ensure a satisfactory earth plane, and is connected to the main building receivers by coaxial feeder cables.

A direction-finding system is not provided at Ilfracombe at present but if required later would comprise an Adcock system, using the standard arrangement adopted at other coast radio stations.

The operating position seen in Fig. 2 is a console type of desk. Connexion of ships to the inland telephone system is controlled from two of the positions, at which land lines and telephone terminal equipment can be selected to convert the 4-wire radio circuit to 2-wire, for connexion to the local trunk exchange. Voice-operated control of the 4-wire path is provided to permit duplex operation. The telephone calls are timed by the coast radio operator. A master-clock system is provided for general time purposes, each operating position having additionally a 1-second impulse clock for log keeping.

FUTURE DEVELOPMENTS

The coast radio service is planned to be capable of expansion to meet an increasing demand for marine radio-telephone service. This will require more equipment at the coast stations for additional services operating in the 1.6–3.8 Mc/s band, a development which may make it necessary, eventually, to treat coast stations on the same general lines as the point-to-point services with transmitting and receiving stations spaced well apart. It is visualized that only one station of a pair would be staffed, the other being remotely controlled. The new type of building would be suitable for such a development, the operations room and administrative offices being omitted from the remotely-controlled station. Other aspects affecting future provision are the possibilities of reducing the area of land required for separate transmitting aeriels by the alternative provision of a wideband type of aerial with combining equipment to permit up to four simultaneous transmissions on suitably spaced frequencies. Such an aerial has been successfully used at the Land's End coast radio station, and further provision is contemplated. On the equipment side emphasis is now given to provision of pre-tuned apparatus suitable either for double-sideband or single-sideband radio-telephone transmissions, rather than manually-tuned equipment suitable only for double-sideband transmissions, as hitherto.

Book Review

"Progress in Semiconductors," Vol. 4. Edited by A. F. Gibson, B.Sc., Ph.D., Dr. F. A. Kröger and Prof. R. E. Burgess. Heywood & Co., Ltd. vii + 291 pp. 120 ill. 63s.

This is the fourth of a now well-respected series of annual volumes, and contains eight review papers by specialists in their respective branches of semiconductor science.

An abstruse theoretical account is given of the way in which a negative effective mass could arise for holes travelling in certain directions in a germanium crystal, and of the possibility (as yet, not very hopeful) of realizing a negative resistance by means of the effect. The subject of germanium surface oxidation, important for the long-term stability of germanium transistors, is well reviewed in a paper often critical of other workers' theories. There are two papers on high-field breakdown effects—on avalanche and tunnel (Zener) effects—the second including a brief

section on the negative-resistance diode first described by Esaki in 1958 and now being considered in several laboratories as a microwave (or lower-frequency) oscillator or as a high-speed switch. The mechanisms of electrical noise in germanium and silicon filaments are examined, and a good description is given of the now well-known but still not satisfactorily explained "1/f" spectral component. The effects of dislocations in the crystal lattice on the mobility and lifetime of carriers are examined for germanium, and the frequency-dependence and temperature-dependence of the dielectric permittivity and loss due to grosser crystalline defects in oxides, halides and other crystals are surveyed. The final paper, by two Russian authors, is concerned with non-crystalline and liquid electronic semiconductors.

This is a book mainly to be referred to selectively by the specialist, but interested users of junction diodes and transistors will find the middle three of four papers to be useful, if in places difficult, background reading.

F. F. R.

Voltage-Margin Testing of Telegraph Electronic Switching Equipment

A. F. HARRISON, Grad.I.E.E., A.M.Brit.I.R.E.†

U.D.C. 621.316.722:621.311.6:621.394.6

The principle of voltage-margin testing is described and it is suggested that this method of testing may be applied to electronic switching equipment in general, not only as an aid in routine testing but also as one of the criteria in acceptance testing.

INTRODUCTION

IN telegraphy, as in most other branches of engineering, an ever-increasing use is being made of electronic techniques. One of the reasons for this is that electronic apparatus normally requires less maintenance than equivalent electromechanical equipment because of the absence of moving parts.

Telegraph transmission is carried out mainly by the use of binary codes and it follows that the circuits involved are largely composed of devices which are allowed to have only two normal states, e.g. a valve may be either conducting or cut-off. Many types of basic circuit-elements well known in other fields of electronics are also used in telegraph equipment. These include triggers, gates, delay devices, storage elements and the many other circuits that are built up to form the usual array of distributors, registers, counters, shift-registers and other units which make up normal binary switching equipment.

Circuits of the above type require voltage-stabilized power feeds that can be maintained within close limits of their nominal voltages irrespective of normal mains variations or load changes. Such stabilized supplies are necessary to prevent interference between various parts of the circuit, e.g. the sudden additional current drawn by several valves switched to the conducting condition must not cause the h.t. voltage to be reduced, otherwise the change may affect another part of the circuit.

Use of Resistors in Switching Circuits

In circuits of the trigger and gate variety mentioned above, fixed-value resistors are used in potentiometer chains to provide desired potentials at certain critical operating points. A simple example of such an arrangement, which might form part of a trigger circuit, is shown in Fig. 1. When V1 is cut off, the voltage presented to the grid of V2 is determined by the relative values of (R1 + R2) and R3, these resistors forming a potentiometer chain between the positive and negative power lines. When V1 is fully conducting the voltage at

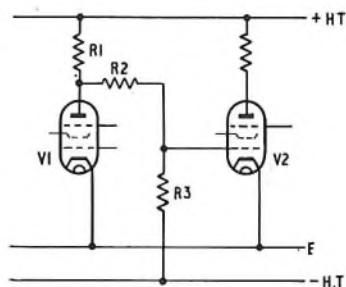
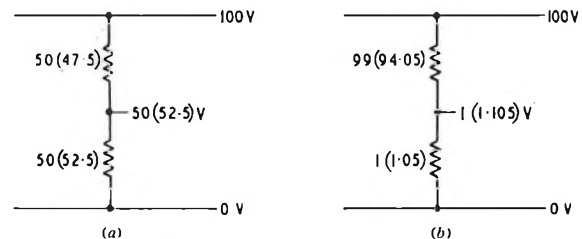

FIG. 1—TYPICAL POTENTIOMETER NETWORK USED IN ELECTRONIC SWITCHING CIRCUITS

the grid of V2 is determined by the relative values of R2 and R3, the resistors forming a potentiometer chain between the anode of V1 and the negative power line. It is obvious that the voltages presented to the grid of V2 by the potentiometer circuit in each instance depend upon the relative values of the resistors, and any inaccuracies in the resistor values will affect these voltages. It is usual to design equipment using resistors with ± 5 per cent tolerance, closer tolerances being used only if essential for the operation of critical circuits. If the values of two resistors forming a potentiometer are changed in opposite senses by 5 per cent, then the voltage at the "pick-off" point will alter by an amount varying from 5 per cent to something over 10 per cent, depending upon the original ratio of the two resistors. Fig. 2 illustrates this.



(a) "Pick-off" voltage varies by 5 per cent
(b) "Pick-off" voltage varies by 10.5 per cent

Note: The figures in brackets denote the values when the resistors are 5 per cent from their nominal values

FIG. 2—VARIATION IN "PICK-OFF" VOLTAGE DUE TO CHANGES IN POTENTIOMETER RESISTOR VALUES

In circuits similar to the example shown in Fig. 1 it is common for V2 to be conducting when V1 is cut off and vice versa. Hence the values of R1, R2 and R3 must be chosen so that the grid of V2 is above cathode potential (earth in this case) for V2 to conduct fully and below the grid cut-off voltage when V2 is to be non-conducting. For these two conditions to be maintained throughout the lives of the resistors, any or all of which may vary by say ± 5 per cent from their nominal values during their lifetime, certain operating margins must be allowed in the designed voltage excursion on the grid of V2. The magnitude of the margin to be allowed may be ascertained by voltage-margin tests.

VOLTAGE-MARGIN TESTS

A convenient way of finding out whether any operating margin exists after an equipment has been made is to see whether it still works satisfactorily when the h.t. voltage is raised and lowered. Both the positive and negative supplies should be varied and their values noted when the circuit fails. It is impossible to determine the precise theoretical h.t. limits which the circuit will withstand unless the potentiometer ratios and relative nominal power-feed voltages are known, but the minimum variation permissible in the circuit of Fig. 1,

† Telegraph Branch, E.-in-C.'s Office.

allowing for ± 5 per cent resistor tolerance, is ± 5 per cent on each of the supply lines, i.e. an h.t. margin at least equal to the resistor tolerance. This assumes that under normal working conditions the h.t. supplies are themselves invariable. If, in comparison with the ± 5 per cent resistor tolerance already mentioned, any appreciable variation in h.t. voltage is expected, this should be added to the 5 per cent figure and the minimum acceptable h.t. margin increased accordingly. For example, if the resistor tolerance is ± 5 per cent and the h.t. tolerance ± 2 per cent, then an h.t. margin of ± 7 per cent should be the minimum figure permissible.

Complex Circuits

Circuits which involve more than a simple potentiometer network have less liability to change their characteristics, as each component variation has less effect upon the whole and, under the worst conditions where all components have adverse tolerances, these complex circuits are no worse than the simple case in which the only two components in a potentiometer have adverse tolerances. Valves in the cut-off condition have no effect upon associated circuits from a point of view of margin testing; neither have conducting valves, which, if working correctly, should be of much lower impedance than the potentiometers across them. Margin testing will show up any valve whose emission has deteriorated to such an extent that the valve no longer presents a voltage source of sufficiently-low impedance to a potentiometer. Cold-cathode tubes should be chosen so that the limits of their operating voltages are at least as wide as the tolerance of the associated circuit elements and, if worked at their nominal voltage, should permit the h.t. margins to be maintained. Tubes whose characteristics are drifting outside limits will be shown up by margin tests due to the fact that the bias and pulses or other triggering potentials supplied to them will be varying in voltage as the h.t. voltage is varied.

Clamp Voltages

If, for example, a pulse height is critical for the

stability of a circuit, it is common practice to provide a desired voltage from a low-impedance source and to "clamp" the pulse wire to this voltage by means of a rectifier. This "clamp" voltage should be varied and the margin determined to ascertain whether the circuits dependent upon it are sufficiently stable.

CONCLUSIONS

Experience has shown that voltage-margin testing is a valuable method of judging the expected performance of electronic telegraph equipment and that, for complete equipments, a margin on each of the h.t. supplies equal to the resistor tolerance (usually ± 5 per cent) should be a minimum acceptance-test figure. Certain critical circuits which are specifically designed with components of closer tolerance may be exempted from this requirement and may be tested individually or, alternatively, compensating adjustments may be made to prevent the failure of these circuits from affecting margin tests of the rest of the equipment. If voltage-margin testing is used as a method of fault location, components whose characteristics may be slowly changing, e.g. resistors, valves and cold-cathode tubes, may be located by regular routine voltage-margin tests and replaced before they cause any misoperation of the equipment while in service. The original voltage margins should be obtained before the equipment is put back in service, and in all circumstances the h.t. voltage should be set to its nominal design figure, not a mid-margin value, as the latter is a value which is optimum only at the time of measurement and is not the theoretical "centre of drift."

Typical h.t. voltage margins which have been obtained on telegraph equipment are:

- (a) Hot-valve circuits: 10 to 20 per cent above and below nominal.
- (b) Cold-cathode tube circuits: 6 to 10 per cent above and below nominal.
- (c) Transistor circuits: 30 to 40 per cent above and below nominal.

Book Review

"Algebraic Theories." Leonard E. Dickson. Dover Publications, Inc., N.Y., and Constable & Co. London. ix + 276 pp. 3 ill. 12s.

"Treatise on Algebraic Plane Curves." Julian L. Coolidge, Ph.D. Dover Publications, Inc., N.Y., and Constable & Co., London. xxiv + 513 pp. 20s.

"Fourier Series and Spherical Harmonics." William E. Byerly, Ph.D. Dover Publications, Inc., N.Y., and Constable & Co., London. ix + 287 pp. 15 ill. 14s.

"The Theory of Numbers" and "Diophantine Analysis" (Bound as one Book). Robert D. Carmichael. Dover Publications, Inc., N.Y., and Constable & Co., London. 94 + vi + 118 pp. 11s.

The above books form a representative sample of the new paper-back Dover re-publication of standard text books on mathematics. They are less than half the price of the same books in hard-covers. Good quality paper of the kind that does not discolour or become brittle with age has been used. The books are well bound and the pages have sewn-in signatures. Consequently, the pages do not drop out and

the binding does not crack or split (as is the case with many paper-back books held together with glue).

The book by Leonard E. Dickson entitled "Algebraic Theories" was first published in 1926. This new Dover edition is an unabridged and unaltered re-publication of the first edition. It is probably the best work available for a student desiring a thorough introduction to the fundamental theory of matrices, invariants, groups and other important concepts in pure mathematics. This volume also provides a clear account of the remarkable algebraic theory introduced by E. Galois who was killed in a duel in 1832 at the age of 21. The author applies the Galois theory to certain problems ignored in elementary geometry. He proves, for example, that it is not possible with ruler and compasses to trisect every angle or to construct a regular polygon of seven or nine sides. For these problems the ancient Greeks sought in vain for constructions with ruler and compasses. Using an argument based on the Galois theory the author shows that a regular polygon of 17 sides can be constructed with only a ruler and compasses. This fact was not suspected during the 20 centuries from Euclid to Galois. All these algebraic theories are studied with rigorous detailed

(Continued on p. 176)

The Use of Modern Materials for Telephone Cords

U.D.C. 621.315.342:621.395.6

INTRODUCTION

THE exploitation of the numerous synthetic materials created in recent years has led to many changes in practice for makers of telephone cords and cables. The most important materials which have become available to them are polyvinyl chloride (p.v.c.), polythene and to a lesser extent nylon and polyethylene terephthalate (Terylene). The part these materials play in the construction of cables has already been described.¹ The way in which they are used in telephone cords is dealt with briefly in this article.

TINSEL CONDUCTORS

In the design of cords subject to severe flexing and pulling (e.g. handset cords) it is usual to employ tinsel conductors if their current rating is adequate. This is because under such conditions they have a long life compared with stranded conductors. High-grade cotton thread has in the past been used as the core material around which the copper tape is wrapped to form tinsel conductors. A number of these tinsel threads sufficient to give the desired current rating are then laid up in the form of a rope, additional cotton threads being added to give the required tensile strength. The standard requirements were as follows:

Breaking strain in excess of 35 lb.

Maximum resistance 0.36 ohms/yard.

Maximum overall diameter 0.060 in.

By using a synthetic yarn of high tensile strength such as Terylene in place of cotton it has been possible to reduce the overall diameter to 0.042 in. By accepting an increase in resistance to 0.52 ohms/yard it has been possible to reduce the diameter still further to 0.032 in. without reduction in breaking strain. This reduction in diameter tends to prolong the life of conductors subject to flexing. A further advantage of synthetic threads is that because they are made by a continuous and closely-controlled process they enable tinsel ropes of much greater length and more uniform diameter to be produced. These features considerably assist the subsequent insulating and sheathing processes.

INSULATION

Until the introduction of the smaller-diameter tinsel conductors described above, a lapping of an insulating textile such as silk, cellulose-acetate rayon, or acetylated cotton was generally used for cords requiring maximum flexibility, such as handset and switchboard cords. This type of insulation is not waterproof and, for cords such as test cords or telephone instrument cords, which are required to be waterproof, a lapping of pure rubber tape was provided. For both types further textile coverings of a lower electrical quality were required to give mechanical protection and conductor identification. A cord produced from these materials, though having good flexibility characteristics, had the disadvantage of size (and hence cost) as well as the complications resulting from having two types of insulation. The old-style standard tinsel conductors insulated in this fashion had overall diameters of 0.085 in. and 0.095 in. for the non-waterproof and waterproof types respectively.

Of the new insulating materials available, the one most suitable for flexible cords is polyvinyl chloride (p.v.c.). It is applied directly over the tinsel conductor by extrusion, it is easily coloured and requires no protecting layer between it and copper as does rubber, nor does it require a subsequent vulcanizing process. It is available in various grades of softness: the one chosen has a B.S. Softness No. 40-50² and combines good flexibility with good resistance to mechanical damage. The minimum radial thickness of p.v.c. insulation at present used is 0.012 in. and, when the new tinsel is insulated in this fashion, the overall diameter is approximately 0.060 in. or about the same as the old-style tinsel prior to the insulation being applied.

OUTER COVERINGS

Braided Cords

The outer coverings of braided cords have without exception used cotton in one of the three following forms, dependent on the use to which the cord was put:

(a) Mercerized cotton for general use with waterproof conductors not subject to severe abrasion, e.g. telephone-instrument cords.

(b) Acetylated mercerized cotton for non-waterproof cords required to have a good resistance to moisture absorption, e.g. handset cords.

(c) Polished cotton for cords subject to rubbing and abrasion, e.g. switchboard cords.

By using the smaller diameter tinsel with p.v.c. insulation it has been possible to produce a waterproof conductor of sufficient flexibility and cheapness to meet the requirements of both the telephone-instrument and handset cord. The need for acetylated mercerized cotton has thus disappeared and only mercerized cotton is now used as the covering for plaited cords.

For the covering of switchboard cords, whose life was formerly determined by the life of the braided covering, a change has been made to nylon or Terylene. The high abrasion resistance and low moisture absorption of these materials results in improved life and appearance. A feature which initially proved to be a disadvantage with the new materials was the small amount of friction between the individual monofilaments from which the threads are formed. Under certain conditions of abrasion, individual monofilaments were pulled out from the threads and caused to form minute loops. Continued abrasion soon produced a cord which had many such loops, resulting in a fluffy appearance. Once a certain stage had been reached, these loops ceased to increase and, due to the strength of the monofilaments, it was rare for a break to occur. This condition did not, therefore, impair the life of the cord. However, by increasing the number of the twists given to the threads formed from the monofilaments, this feature has been eliminated.

Sheathed Cords

Sheathed cords have had relatively little application except for use in call offices, for which at one time such a cord with an overall reinforcing braid was used for the handset connexion, while a rubber-sheathed cord was

and still is used for the connexions between the telephone and bell-set.

There is also a small requirement for cords which can be washed and cleaned, for instance in atomic-energy research stations. Polyvinyl chloride as a sheathing material has many advantages for such applications and, with the advent of the 700-type telephone³ and the desire to provide it with a retractable cord in a wide range of colours, it is the material which meets most of the many and sometimes conflicting requirements. A discussion of all the considerations involved is beyond the scope of the present article, but part of the problem has been dealt with previously.⁴

An important feature of the p.v.c. used for covering telephone cords is that it should be relatively free from interaction between the plasticizer used to make the p.v.c. flexible and any surface with which the cord may come into contact. Tests additional to those specified in the present British Standard⁵ for p.v.c. used for insulating and sheathing purposes have been devised and are applied to ensure a good performance in this respect. Sheathing with p.v.c. permits considerable simplification in the construction of smaller cords (up to 4-way), particularly where the conductors are of the new small-diameter tinsel type. In the past it has been necessary to lay up the insulated conductors with a twist to obtain adequate flexibility and an even distribution of stress within the cord. By laying up the p.v.c. insulated conductors without a twist and taking care to prevent adhesion between the conductor insulation and sheathing material, which should fill the interstices, a cord of

improved appearance and adequate flexibility can be obtained. Cordage produced in this fashion, when made retractable by coiling and heat treatment, produces a cord of superior performance compared with one having twisted conductors.

FURTHER DEVELOPMENTS

The variety of synthetic materials and the forms in which they are available is continually increasing and it is unlikely that any of the materials mentioned here will remain unchallenged for long. One example of such progress is a type of polythene now being made in the form of a fine tape. This, applied as a braid to switch-board cords, could be a strong competitor to nylon and Terylene, and trials are in hand to assess its value. Developments in synthetic rubber have made available a material which approaches p.v.c. in the quality of finish and the brightness of colours obtainable. This material is also being tried out.

K. H. C.

References

- ¹ WINTERBORN, E. L. *Plastics in Cables. P.O.E.E.J.*, Vol. 51, p. 33, Apr. 1958.
- ² B.S. 2571:1955. *Flexible Polyvinyl Chloride (p.v.c.) Extrusion Compounds* (British Standards Institution).
- ³ SPENCER, H. J. C., and WILSON, F. A. *The New 700-Type Table Telephone—Telephone No. 706. P.O.E.E.J.*, Vol. 52, p. 1, Apr. 1959.
- ⁴ DE COSTE, J. B., HOWARD, J. B., WALLDER, V. P., and ZUPKO, H. M. *Plasticized Poly for Retractable Cords. Wire and Wire Products*, Vol. 33, Oct. 1958.
- ⁵ B.S. 2746:1956. *P.V.C. Insulation and Sheath of Electric Cables* (British Standards Institution).

Book Review

“Algebraic Theories, etc.”—*continued from p. 174*

proofs. Also, there is a discussion of Klien’s “icosahedron” and the theory of equations of the fifth degree. These topics are lucidly developed and closely connected with mathematical applications.

The book by Julian L. Coolidge, “*Treatise on Algebraic Plane Curves*,” is one of the best full coverages of this subject in English. It offers to the advanced student a detailed account of the theory of algebraic plane curves and their relations to various fields of geometry and analysis. The text treats such topics as the topological properties of curves, the Riemann-Roch theorem, and all the analytical aspects of a wide variety of linear and non-linear systems of curves. It is almost entirely confined to the properties of the general curve rather than a detailed study of curves of the third or fourth order. Algebraic procedure is generally used but some portions have been written in accordance with the spirit and methods of the Italian geometers. Consequently, occasional use has been made of geometric methods involving the projective geometry of hyperspace. The student will find that this volume will carry him far enough into geometrical theory to appreciate the symbolic notation of Aronhold and Clebsch.

The book on “*Fourier Series and Spherical Harmonics*” by William E. Byerly was first published in 1893. This new Dover edition of 1959 shows that Byerly’s classic is still regarded as one of the best expositions of Fourier analysis available for the student. The text gives a readable exposition of Fourier series and spherical, cylindrical and ellipsoidal harmonics. The author then applies this mathematical theory to practical problems. These problems are fully and lucidly worked out. In addition, the student is

given 190 problems to solve, many with helpful hints as to the method to use. An appendix includes six tables of surface zonal harmonics, hyperbolic functions, and Bessel functions. As a clear exposition of fundamental methods in the field of mathematical physics this book can be recommended to students.

“*The Theory of Numbers*” and “*Diophantine Analysis*” were originally published separately by Robert D. Carmichael in 1914 and 1915, respectively. In this new Dover edition these two complete works are bound together in one volume. Together they form a straightforward introduction to number theory. This theory is probably the one field of mathematics in which a talented amateur to-day may hope to turn up something of interest. “*The Theory of Numbers*” deals with prime numbers, the fundamental theorem of Euclid, the indicator of an integer, congruences, theorems of Fermat and Wilson, modulo m , etc. Included in the text are 76 carefully chosen exercises, which further the collection of useful results. “*Diophantine Analysis*” is organized around the notion of a multiplicative domain. The exposition is supplemented by 222 exercises on three levels of interest: the first is practice material for students; the second deals with special results already obtained and problems found amenable to attack; the third deals with unsolved problems of particular interest.

All these books open flat, and the pages measure 5½ in. by 8 in. This, together with the clear type, makes for easy reading and reference. Considering they are unabridged full-length text books, these Dover re-publications are not only very cheap but remarkably easy to handle. These books can be warmly recommended to those students who cannot afford to buy in hard-covers all the mathematical text books they would like to own.

H. J. J.

A Light-weight Headset for Telephone Operators

H. J. C. SPENCER, A.M.I.E.E., and J. S. P. ROBERTON, B.Sc.(Eng.)†

U.D.C. 621.395.623.64:621.395.722

A new headset for telephone operators has been developed which not only has a superior performance to the head-and-breast set, but is considerably lighter and more comfortable to wear. Unlike the head-and-breast set, the new instrument does not suffer from the disadvantage that the transmitter mouthpiece cannot follow the wearer's mouth as the head turns. This improvement results from the transmitter being mounted next to the receiver in a common housing worn on the ear, a light horn being used to feed speech from the mouth to the transmitter.

INTRODUCTION

FOR very many years the head-and-breast-set type of Operators' telephone has been used in the Post Office. Instruments of this type suffer from the fundamental disadvantage that the mouthpiece of the transmitter does not follow the wearer's mouth as the head turns. As a result, unless the wearer makes a conscious effort always to speak into the mouthpiece, sending efficiency may be seriously degraded. This is illustrated by the curves of Fig. 1, which show how the output decreases as the distance of the mouthpiece from the user's mouth increases. In addition, head-and-

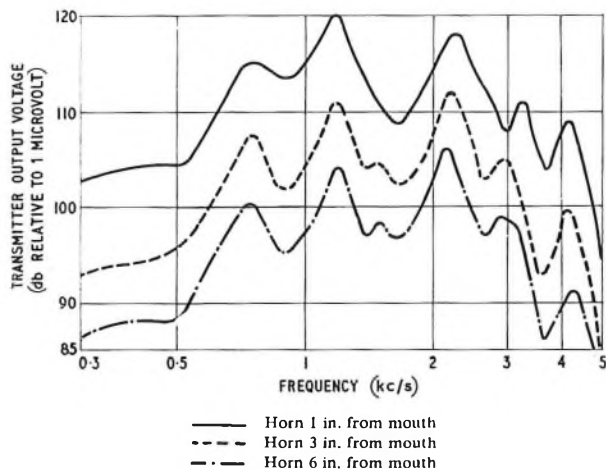

FIG. 1.—BREAST-SET TRANSMITTER—VARIATION OF OUTPUT WITH DISTANCE FROM MOUTH

breast sets are unpopular with operators because they are cumbersome to wear. The particular set used by the Post Office has the further disadvantages of being rather heavy and of having a poor transmission performance compared with that of the new type of table telephone.¹ This poor transmission performance is no disadvantage for public exchange use, because of the operator's favourable position in the line network, but it would present problems if the headset were used at private branch exchanges (P.B.X.s) working on the recently extended transmission limits for local line networks.² Because of these disadvantages the Post Office has now developed, in co-operation with the telephone manufac-

turers, a light-weight one-piece headset to supersede the head-and-breast set, and the process of completely replacing the old instruments by the new has commenced. The new instrument is illustrated in Fig. 2.

THE NEW HEADSET

As a preliminary to work on a new design, user trials were made of a one-piece instrument for which the now conventional practice was followed of putting the transmitter at the end of a boom projecting from the receiver (a practice pioneered in this country in 1933 by Standard Telephones and Cables, Ltd.). The trials showed that the concentration of transmitter weight at the end of the boom resulted in an unstable arrangement, and for the new headset an alternative solution has been adopted; namely, to mount the transmitter next to the receiver in a common moulded housing worn on the ear. Speech is fed to the transmitter from the mouth by a light horn. The advantages of this novel form of construction compared with the use of a transmitter supported on a boom are:

- A better balance is achieved, giving increased stability with lower headband pressure.
- Operators naturally like the obstacle in front of

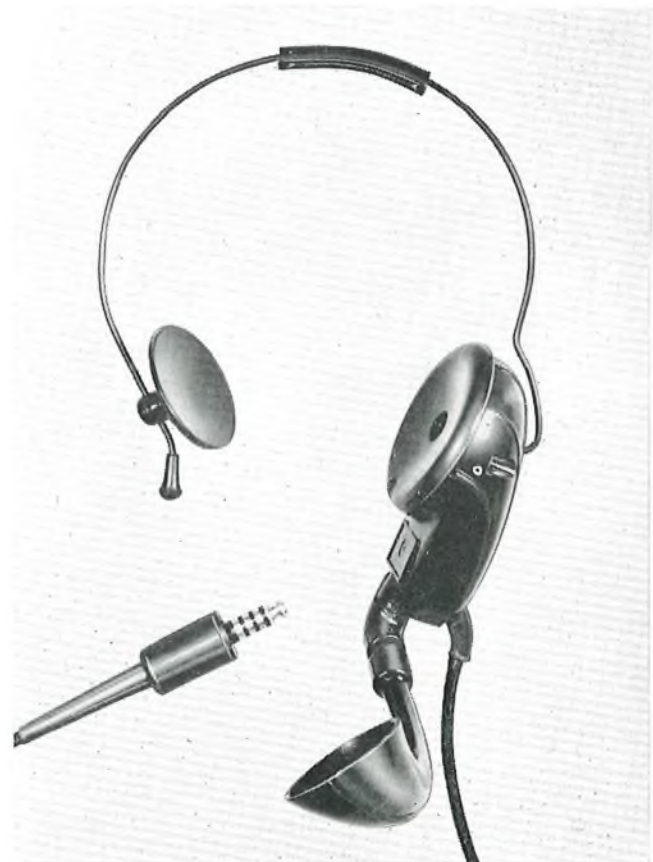

FIG. 2.—THE NEW HEADSET

† Mr. Spencer is in the Subscribers' Apparatus and Miscellaneous Services Branch, E.-in-C.'s Office, and Mr. Robertson is with Standard Telephones & Cables, Ltd.

the lips to be as small as possible. For a given size of obstacle greater sending efficiency is obtained because the whole mouth area of a horn is fully effective, whereas, because its edge is clamped, only part of the area of a transmitter diaphragm is completely effective.

(c) A horn has a slight directional effect which increases with frequency, and this gives some discrimination against undesirable ambient noise.

(d) Cord arrangements are simplified. A 4-way cord enters the set through a single hole and is connected directly to the transmitter and receiver. There is no need for a separate cord to the transmitter; such a cord would involve additional series connexions and could get tangled with other parts of the set.

(e) The transmitter is much less vulnerable to mechanical damage.

(f) The arrangement is more hygienic because the horn can easily be removed and cleaned. It can also be immersed in disinfectant, which would not be possible with a complete transmitter.

(g) The overall design of the set is cleaner, giving fewer awkward traps for hair, and adjustment to suit the head of the wearer can be made naturally while the set is on the head.

The new headset is designed to combine lightness with strength and resilience so that it can withstand mechanical shocks in service. This combination is achieved largely by the use of nylon and other resilient plastics for the mouldings. Nylon has quite a good surface finish, and its toughness and shock resistance give almost unbreakable mouldings. The strength of nylon has allowed thin sections to be used to reduce weight. The total weight of the headset, less plug and cord, is under 5 ounces, which is less than the weight of the receiver alone of the earlier instrument and less than one third of the weight of the complete head-and-breast set. An important feature which contributes to the shock resistance of the headset is the provision of a springy joint at the "elbow" that joins the horn to the body of the set. This joint is often a region of weakness in headsets with transmitters supported on a boom. In addition, the use of flexible plastic gaskets at the joints of the various parts of the acoustic system and the provision of springs for holding the transmitter and receiver capsules in place both contribute to the shock resistance.

Apart from its toughness, nylon is a very suitable material because of the absence of harmful effects to the skin through contact with it; it is, in fact, frequently used in surgery for inclusion within the human body.

A small but useful detail in the body moulding is a frame in which an identifying label may be fixed.

Transmitter and Associated Acoustic System

The transmitter is a miniature carbon-granule sealed capsule designed specifically for use in the headset. It is illustrated in section in Fig. 3. The electrodes of the transmitter are parts of concentric spheres; this shape, combined with a very small carbon charge, makes the transmitter sensitive and reasonably free of amplitude distortion, as may be seen from Fig. 4, which shows sensitivity/frequency curves for three different sound pressures. The electrodes are made from brass plated with gold; the front electrode is fixed to the light alloy diaphragm and the parts are assembled in a die-cast aluminium frame. The charge of carbon granules is

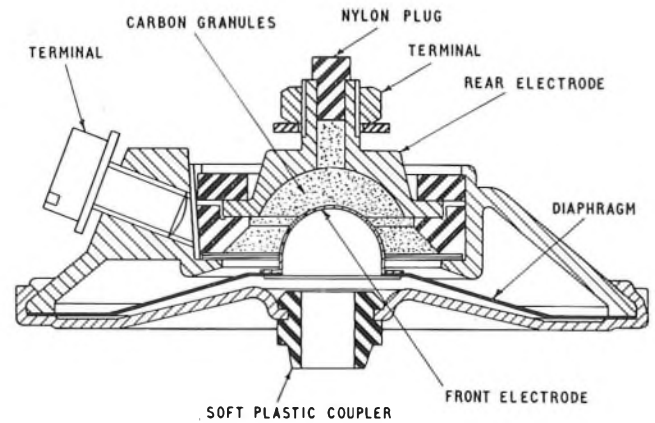

FIG. 3—CROSS-SECTION OF TRANSMITTER

inserted through a hole in the rear electrode terminal, which is then closed with a tight-fitting nylon plug. As the transmitter is designed to be pressure-operated in conjunction with the horn of the headset, the volume of air in front of the diaphragm is reduced by the front cover of the transmitter being designed so that it follows closely the diaphragm contour. The transmitter is sealed to the acoustic tube in the headset by a soft p.v.c. coupler, which is captive in the transmitter front cover.

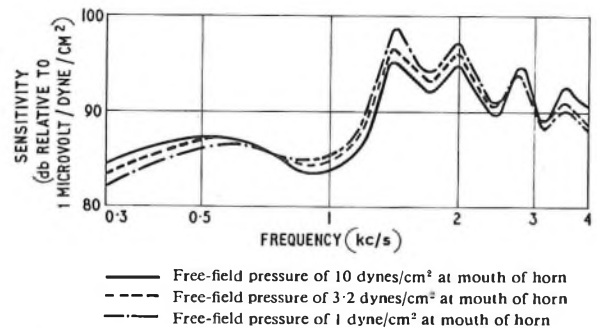

FIG. 4—VARIATION IN SENSITIVITY WITH SOUND LEVEL

The acoustic system consists of the parts shown in Fig. 5. It is designed to allow the horn to take up alternative positions so that the headset may be worn on either ear, and there is a cone of free movement of the horn about each position to cater for variations in head shapes. The parts are assembled with the helical spring passing through them and in tension between a die-cast anchor at the set end and a washer at the horn end. This keeps the joints in the system in compression, so giving good sealing. Sealing at the joints is assisted by resilient polythene washers, the washer between the ball and elbow being conical in shape. The sealing is also improved by care in moulding to obtain close fitting surfaces between the elbow and the headset body. The tension of the spring also ensures a secure connexion between the horn and the headset.

The horn is exponential in shape, i.e. its cross-sectional area at a point distance x cm from the throat is related to the area at the throat by the equation

$$S_x = S_0 \exp mx$$

S_0 and S_x are the areas (cm^2) at the throat and at x respectively, and m (per cm) is known as the flaring constant.

The action of the horn can be likened to that of an

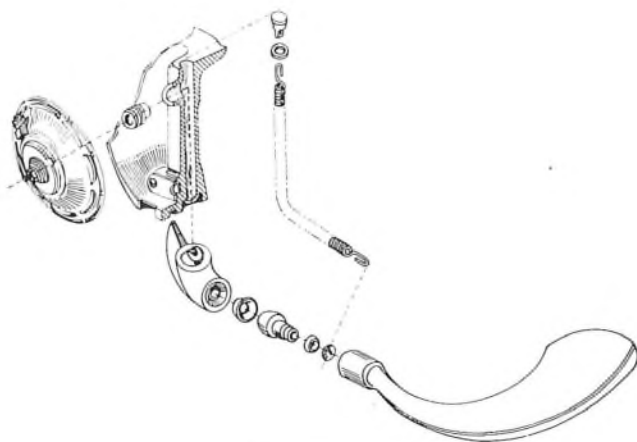

FIG. 5—THE ACOUSTIC SYSTEM

electrical transformer; large air movements with low pressures at the mouth of the horn are converted to small air movements with high pressures at the throat. The small air movements make it unnecessary to have an acoustic channel with a large cross-section, but the high pressures do require the sealing of the channel to be good. Exponential horns have the property of transmitting sound waves efficiently down to a frequency determined by their dimensions. Below this frequency, given by the equation $f_{co} = (mc)/(4\pi)$ where c is the velocity of air in cm/sec and m is the flaring constant already referred to, the horn transmits the sound waves with progressively greater loss, thus acting as a high-pass filter. This property has been used in the headset to equalize to some extent the frequency response of the transmitter. The carbon-granule transmitter has one main resonance, just below 1,200 c/s, controlled largely by the mass and stiffness of the diaphragm and front electrode. If used alone the transmitter would have a peaked response. The horn dimensions have, however, been chosen so that the cut-off frequency is just above the peak of the response of the transmitter alone. This peak is therefore reduced, and the response of the combination is maintained reasonably constant up to a frequency of 4,000 c/s.

A subsidiary function of the helical spring in the acoustic channel is to reduce peaks and troughs in the transmission characteristics of the horn. These occur because the horn is of finite length and is not matched acoustically to free air, so that reflections take place from the open end. These emphasize some frequencies and attenuate others. The presence of the spring more than doubles the surface area within the channel and the consequent acoustic damping reduces the difference between peaks and troughs from 12 db to 5 db, which is tolerable. Below its cut-off frequency the horn behaves as a sound conduit having a rather high acoustic mass. This mass resonates with the acoustic stiffness of the volume of air between the inside of the front of the transmitter and the diaphragm at a frequency of about 500 c/s. This resonant peak is also adequately damped by the presence of the spring in the acoustic channel.

Receiver

The receiver is a miniature version of the rocking-armature receiver,³ and has been developed specially for the headset. The magnetic drive-unit of the new receiver is identical with that in the larger one, but size and weight have been reduced by using a smaller diaphragm and by

omission from the receiver capsule of some of the acoustic equalization structure. Retention of the same magnetic unit has made it necessary to drive the smaller diaphragm off-centre: this has had the beneficial effect of increasing the effective portion of its area so that the loss in efficiency caused by the reduction in size is less than it would otherwise be. The acoustic equalizing-volume and the outlet holes are omitted from the receiver capsule and are formed instead in the moulded earpiece, to which the capsule is sealed by a resilient rubber ring.

A housing for the receiver only of the headset is available. Two receivers may be joined by a common headband to form a double-receiver headgear, and there is also a version of the headset which has a second receiver. By the use of appropriate cords a pair of receivers may be coupled in series or in parallel, or they may be connected to separate circuits. A range of receivers having different impedances is available.

Headband

After trials of a number of different designs, the double-pad headband, shown in Fig. 2, was found to give the greatest comfort and stability, being based on support at three points, the earpiece, the top head-pad and the side head-pad. The pads are made from a soft lead-free grade of p.v.c. Since each is a tight sliding-fit on the headband wire, the pads may be adjusted to the best position for comfort and balance for each wearer. The hard-drawn steel wire is covered with shrunk-on p.v.c. sleeving and may be bent slightly to suit the needs of individual wearers. Soldered to the instrument end of the wire is a phosphor-bronze ball which is gripped in a spring-loaded socket in the headset cover. This ball-joint, while allowing easy adjustment of the angle of the wire to the set, is stiff enough to add stability while the headset is being worn. The free end of the headband wire is guarded with a screw-on nylon ferrule.

Plugs and Cords

To match the light weight of the new headset the Post Office has adopted a new miniature 4-way plug. The plug follows the general form of its predecessor, but improvements in detail and the use of nylon for the moulding material result in its being much more robust and reliable in spite of its reduced size.

The cords used for the new headset have p.v.c. insulation with a nylon outer braiding and are round in cross-section. Particular attention has been paid to relieving the cord terminations of strain. At the plug end of the cord the strains are taken by a long protective sleeve which is too large to pull through the hole in the plug cover. At the headset end, the strains are taken by a grommet moulded on the cord. The grommet is curved to let the cord fall away from the set naturally and is square in cross-section, where it engages the headset, to prevent twisting.

PERFORMANCE

Sending Efficiency

The output/frequency characteristics of the new headset and the old breast-set transmitters are shown in Fig 6. The output of the headset is shown for a feeding current of 40 mA, while the breast-set transmitter output is shown for 120 mA, this being its normal operating condition. It will be seen that, even at the much lower current, the new headset has an output equal to that of the breast set. Where the

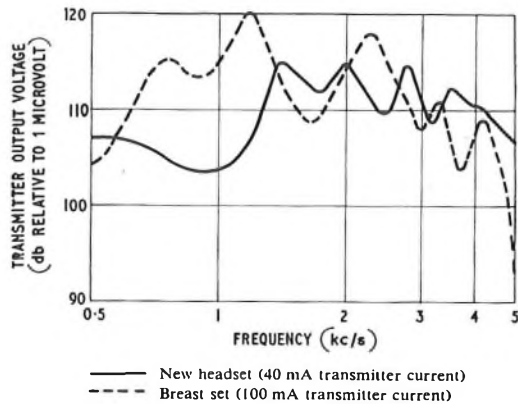

Speaking distance 1 in.: free-field sound pressure 10 dynes/cm² at 1 in. from mouth
 FIG. 6—TRANSMITTER OUTPUT/FREQUENCY CHARACTERISTIC

maximum performance is not required, therefore, it is possible to reduce the feed-current below 120 mA. This has a number of advantages:

- (a) The life of the transmitter is increased (at 120 mA the life of the new transmitter is equal to that of the transmitter in the breast set).
- (b) The heat dissipated in the transmitter is reduced. Because the transmitter is carried on the head any heat from the transmitter might be noticeable, but the effect is negligible at 40 mA.
- (c) Power requirements are reduced. There are some subscribers' installations in which the major power requirement is for the operators' transmitters. Worth-while economies can be realized at such installations.

Receiving Efficiency

The sensitivity/frequency characteristics of the receiver in the new headset and the receiver in the head-and-breast set are given in Fig. 7. They show that the new receiver is approximately 7 db more sensitive than the old and has a superior frequency response. The new receiver shares with the larger rocking-armature receiver the advantage that its acoustic output-impedance is low, so that reduction in sound pressure at the ear by leakage between ear and earpiece is minimized.

INTRODUCTORY PROBLEMS

It has not been possible to use the new headset as a direct replacement for the old, firstly because of the smaller plug used with it, and secondly because in the majority of Post Office applications its superior performance is actually an embarrassment. The following changes, made to the operator's position circuit at sleeve-control exchanges, are typical of those made when the headsets are introduced:

- (a) All jacks are changed to suit the new plugs.
- (b) An additional 820-ohm resistor is inserted in the d.c. feed to the transmitter. This reduces the current to about 40 mA, at which the sending efficiency is the optimum for this application.
- (c) A 150-ohm resistor is fitted within the headset, shunting the receiver and reducing receiving efficiency by about 4 db.

It was necessary to connect the receiver shunt within the headset, rather than in the switchboard, because for an interim period the old-type handsets with 2P receivers will continue to be used on the same switchboard positions and with this type of telephone the shunt would

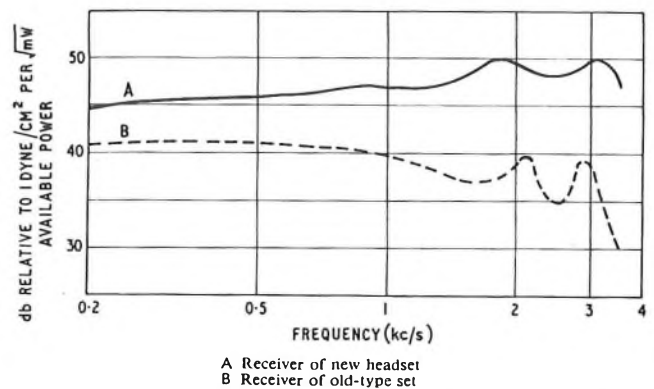

FIG. 7—RECEIVER SENSITIVITY/FREQUENCY CHARACTERISTIC

cause a reduction of receiving efficiency which would not be tolerable. The handset transmitter is sufficiently sensitive, however, to make the reduction of efficiency, caused by the lower feed-current, acceptable.

Even with these changes, the overall sensitivities of the new headset are considerably greater than those of the old and there were fears that this would cause complaints of excessive sidetone. Field trials in telephone exchanges showed that these fears were, however, unfounded. A factor contributing to this was the marked reduction in switch-room noise levels which accompanied a change to the new headset, due to the lower level at which operators found it necessary to speak. If only some instruments had been changed, or if background noise were high for other reasons, the result might not have been so favourable.

For P.B.X. use advantage can be taken of some, and often all, of the additional sensitivities of the headset. For these uses the values of the transmitter feed-current and the receiver shunt are adjusted to give the sending and receiving efficiencies required. In some P.B.X. circuits changes are also made to the balance circuit to reduce sidetone.

CONCLUSIONS

A new headset has been designed which is much lighter and more comfortable to wear than the old head-and-breast set. It has been enthusiastically welcomed by telephone operators. In spite of its small size and low weight, the headset is very robust, and extensive field trials have proved it to be a very reliable instrument.

The transmission performance of the new headset is markedly superior to its predecessor, both in sensitivity and frequency response. Its use enables the transmission performance of P.B.X. switchboard operators' instruments to be maintained with the recently extended transmission limits for local line networks.

ACKNOWLEDGEMENT

The headset has been developed for the Post Office by Standard Telephones and Cables, Ltd., under the British Telephone Technical Development Committee procedure.

References

- ¹ SPENCER, H. J. C., and WILSON, F. A. The New 700-Type Table Telephone—Telephone No. 706. *P.O.E.E.J.*, Vol. 52, p. 1, Apr. 1959.
- ² FUDGE, G. A. E., and MILLER, C. B. Introduction of Increased Transmission and Signalling Limits in the Design of Local Line Networks. *P.O.E.E.J.*, Vol. 50, p. 38, Apr. 1957.
- ³ ROBERTSON, J. S. P. The Rocking Armature Receiver. *P.O.E.E.J.*, Vol. 49, p. 40, Apr. 1956.

Sorting Techniques for Automatic Computers

J. B. STRINGER, M.A.†

U.D.C. 681.142:518.5

The various basic methods of performing the two operations of "sorting" and "re-ordering" in automatic computer systems are described in some detail and the difference between the two processes is explained. Some indication is given of the principal variations of these basic methods which have been proposed or used in practice, and the main advantages and disadvantages of the various methods are outlined. A short list of references is given in which more detailed discussions may be found.

INTRODUCTION

IN automatic data processing systems, the need frequently arises for records to be rearranged into some predetermined order, e.g. in telephone accounting, the sorting of trunk charge dockets, or, in stores stock control, arranging demand notes in inventory order. These operations may entail a considerable amount of work, particularly in the larger and more complex applications. Various methods of performing these tasks have been devised or adapted for use with electronic data processing systems. Interest in these methods is not, however, confined to such systems, and some of the results of studies into the problem have wider application to manual or semi-manual systems.

Sorting and re-ordering may both be defined as changing the order of a set of objects or records in accordance with some criterion derived from the objects. Usually each object bears one or more "keys" such as a serial number or name and it is desired to arrange the objects in a particular order of keys, e.g. ascending numerical or alphabetical.

There are two different kinds of process involved in this general concept and these are best described by example. The first kind, which is usually called sorting, is the kind of process that the Post Office uses in handling mail. A number of pigeon holes are provided into which letters must be placed according to a part of the address. A characteristic of this process is that the final positions which the objects will occupy are fixed. Each position may contain any number of objects, from none to all of the set.

The other process, which is essentially different, is properly called re-ordering. This is like arranging the cards in a hand of bridge into some regular sequence in which it is not the absolute final position of the card that is defined, but only its relative position.

In special cases sorting and re-ordering may amount to the same thing, as in sorting a complete pack of cards into order, since the final position of each card is uniquely determined and only one card belongs in any one position.

In computers the more important process is re-ordering. Sorting as a computer process has little application and is, in general, very wasteful of storage space. Re-ordering may be achieved by many systematic methods. These differ in kind, and the choice will depend on various factors. If the set of objects (in the computer the objects are records of various types) is small enough to be stored entirely in the internal storage of the machine, almost any suitable method may be used. The choice is usually dependent on the time taken

or the amount of extra storage required. If the records must be stored externally, for example on magnetic tape, this implies that the records must be dealt with sequentially and methods must be used which minimize the number of times the tapes need be scanned. Each complete scanning of the information in such a process is termed a "pass."

It may be noticed that re-ordering can be accomplished by a sorting process followed by a collecting process, and that sorting may be accomplished by a re-ordering process followed by a distribution process. The collection or distribution is a relatively trivial operation, and so the choice between sorting and re-ordering need not depend upon the form in which the final result is to be presented, but may be conditioned solely by the properties of the equipment available and the quantity, distribution and nature of the items to be processed.

The various methods of sorting and re-ordering will now be outlined with respect to computers and records.

SORTING

Sorting by "Pigeon Holing"

A number of locations in the store are allocated to each possible value of key. The records are examined one by one, and each placed in the first vacant location of the group appropriate to the key. The placing may be done by reference to a table or an arithmetic relationship between the key and the addresses. Each key must be allocated enough locations to hold the maximum possible number of records bearing that key. For "thin" distributions, for which the total number of records is much less than the possible number of different keys, this may be wasteful of space, since many of the locations will never be used. On the other hand, for "fat" distributions, particularly if nothing is known about the relative numbers of records bearing each key, the method is wasteful, since enough space must be allocated under each key to hold the whole set of records (or nearly so). However, if storage space permits, the method is extremely fast, since each record is operated on only once. The method is, of course, only applicable to "internal" operations, which do not involve the use of external media such as magnetic tape (except for the input of the records).

Radix Sorting

Radix sorting is a method usually employed with punched cards, but it may have other applications. The key is regarded as a number expressed in some suitable radix r . Groups of locations r in number are allocated to each value of a digit. The records are examined one by one and routed to the appropriate location or output channel, according to the value of the least significant digit of the key. When all records have been dealt with, they are gathered together in order of digit values, e.g. the outputs on the r channels are reassembled end-to-end in order. The process is repeated using the next most significant digit of the key and so on until all digits have been dealt with. An example of how this

† Automatic Data Processing Technical Support Unit, E.-in-C.'s Office.

TABLE 1
Radix Sorting

Original Order		First Operation		First Pass Assembled	Second Pass	Third Pass	Fourth Pass	Decimal
Decimal	Binary	0	1					
3	0011	0110	0011	0110	1100	1001	0001	1
9	1001	1110	1001	1110	1001	0001	0010	2
6	0110	1100	0111	1100	0001	0010	0011	3
14	1110	0010	0001	0010	1101	1010	0101	5
12	1100	1010	1101	1010	0101	0011	0110	6
7	0111		0101	0011	0110	1100	0111	7
2	0010			1001	1110	1101	1001	9
10	1010			0111	0010	0101	1010	10
1	0001			0001	1010	0110	1100	12
13	1101			1101	0011	1110	1101	13
5	0101			0101	0111	0111	1110	14

works is given in Table 1. In the first column is shown the initial arrangement of the keys. The radix chosen is binary and the binary equivalent of the keys is shown. In the second column is shown the results of the first operation in two sub-columns corresponding to the two output channels. The remaining columns show the results of successive operations. The intermediate stages are omitted, but the way in which the sorting progresses should be obvious. Since the keys are represented by four binary digits, four passes of the information are necessary. This may be generalized, however. If the range of keys is N , the number of passes required is $\log_2 N$. This is independent of the number of actual items, and so the process is somewhat inefficient if the items form a thin distribution. It is more appropriate to external sorting (or re-ordering).

RE-ORDERING

Re-ordering by Insertion

Re-ordering by insertion is an internal sorting method. The input records are taken one by one and the object is to insert them into the correct place in a sequence of records in the store. The first record is placed in the first location, the next record is then read and, if the key is greater than that of the first, it is placed in the next location. If it is less, the first record is moved down and the new record takes its place. The third record is then read and inserted in its correct relative position, moving down the records as necessary. The process is continued until all the records are in the correct relative positions. The method has the advantage of requiring only storage for the records (in contrast with pigeon-hole sorting) but is obviously rather slow, since much shunting of records is required. There are many variations of the method which are aimed at reducing the amount of shunting, by starting at both ends or in the middle and working in two directions or by calculating the approximate positions of the items from the knowledge of the distribution of keys. For various reasons none of these variations is particularly attractive, usually because of the rather complicated procedures involved.

Re-ordering by Interchange

In the method (or class of methods) of re-ordering by interchange, re-ordering is accomplished by examining the items in pairs and exchanging their positions if they are in reverse order. It is most appropriate to internal sorting and has the same advantage in storage as the

insertion method. One method of this type is as follows. The first two items are compared and the smaller is placed in the first location. The second item is compared with the third, and smaller of these two is placed in the second location. This process is continued until all items are in order. An example is given in Table 2. The input data of Table 1 are used, and successive columns are the results of successive passes. It should be noticed that during the process the higher-numbered keys reach their final positions first, and advantage can be taken of this by no longer

scanning those parts of the data which do not change. A dotted line is drawn across each column to show the point at which the scan could end at each pass. This reduces considerably the number of operations involved, which is otherwise quite large. Variations of this method depend on the order in which the items are scanned or on making comparisons three or more ways at each stage. All such methods aim to reduce the number of passes required.

TABLE 2
Re-ordering by Interchange

Initial Order								Final Order
3	3	3	3	3	3	2	2	1
9	6	6	6	6	2	3	1	2
6	9	9	7	2	6	1	3	3
14	12	7	2	7	1	6	5	5
12	7	2	9	1	7	5	6	6
7	2	10	1	9	5	7	7	7
2	10	1	10	5	9	9	9	9
10	1	12	5	10	10	10	10	10
1	13	5	12	12	12	12	12	12
13	5	13	13	13	13	13	13	13
5	14	14	14	14	14	14	14	14

Merging

Merging is a process which can be used for re-ordering, and it is most attractive for external re-ordering. It consists basically of taking two strings of items (a string consists of sequences of items in correct order) and combining them into one string. By repeated application of the process, strings of increasing length are formed and, eventually, all the items are in one string and the process is complete. The complete process will be described by the use of an example. The initial data are divided (arbitrarily) into two halves and these are presented simultaneously on two input units. The items are selected from the two units and sent to the output channel in the correct order. In the simple merging technique only two items are sent in the first pass, four in the second and so on. After the required number has been sent, the next group is sent to a second output channel and the pass continues, using the two output channels alternately. At the end of the pass the two output sequences are used as input, and the process is repeated, the number of items sent to each output being doubled. This method is shown in Table 3. In general, the rule is: compare the key at the head of each

input channel, send the lower to the output and, during the p th pass, switch to the other output channel after 2^p items. Dotted lines in the table indicate where the switch has taken place.

A drawback of the simple technique just described is that no advantage is taken of the initial "stringiness" of the output data. A slightly modified process can take advantage of this to reduce the number of passes required if the items are already partially ordered. In this method, known as "maximum string merging", each operation consists of a three-way comparison between the items at the head of each input channel and the last item output. If one or both of the input keys is greater than the previous output key, then the lower key becomes the output on the same channel. If neither key is greater than the previous output key, then the output channel is changed. The process is illustrated in Table 4. It will be noticed that this process in the example has allowed a reduction in the number of passes from 4 to 3, a substantial saving.

TABLE 3
Re-ordering by Merging

Input		First Pass		Second Pass		Third Pass		Fourth Pass
(a)	(b)	(a)	(b)	(a)	(b)	(a)	(b)	(a)
3	8	3	5	3	1	1	2	1
9	5	8	9	5	6	3	4	2
6	13	6	1	8	13	5	7	3
14	1	13	14	9	14	6	10	4
12	10	10	2	2	4	8	11	5
7	2	12	7	7	11	9	12	6
11	4	4	15	10	15	13	15	7
16	15	11	16	12	16	14	16	8
								16

TABLE 4
Maximum String Merging

Input		First Pass		Second Pass		Third Pass
(a)	(b)	(a)	(b)	(a)	(b)	(a)
3	8	3	5	3	1	1
9	5	8	6	5	2	2
6	13	9	13	6	4	3
14	1	1	14	8	7	4
12	10	10	2	9	10	5
7	2	12	4	13	12	6
11	4		7	14	15	7
16	15		11			8
			15			9
			16			10
						16

When using the maximum-string-merging method it is often useful to facilitate the initial stages of the process by ensuring that the input has a substantial

proportion of "strings." This may be done by preceding the merging operation by a separate pass of the data, during which blocks are sorted internally by one of the appropriate methods. It is usual for blocks as large as can conveniently be handled internally to be re-ordered in this way, thus ensuring that the strings in the input to the "merge" are as long as possible. This would have the result that the number of merging passes, and hence the time for the operation, would be significantly reduced.

The merging process has been described in terms of two-way merging in which two input strings are merged at each step. It is obvious that more input strings could be handled, and this would accelerate the process, for, instead of the number of strings being halved at each pass, it could be divided by three or more. The limit is usually set by the number of input and output channels available and also by the relative speeds at which the comparisons can be made and the input-output achieved. Thus it would not be particularly useful to increase the time for comparisons beyond the point at which they could be made without interrupting the flow of information to the output medium.

CONCLUSIONS

An essential difference between the sorting and re-ordering processes should have become apparent. Whereas the number of operations or the storage space required in a sorting process is related to the possible range of keys, in re-ordering the number of operations depends on the number of items. Thus, in re-ordering processes, the amount of work does not depend on the thinness of the distribution.

As has been mentioned, there are many refinements of the basic methods described. Such refinements usually aim at reducing the time required for the process by taking advantage of special characteristics of the particular problem under consideration. This is usually achieved at the expense of extra complication in the rules for performing the operation. In electronic systems this amounts to a longer or more involved computer program. Within reasonable limits this is of little consequence. In manual systems it is much more important to keep the operations as simple as possible in order to reduce the chance of error. In any case there is always a point beyond which it is uneconomic to add further complication to the system. Much investigation has been made to determine the optimum method to be used and to estimate the time taken in various practical cases. A selection of papers which discuss these matters in a general way and in more detail than has been possible here are given below.

References

- DAVIES, D. W. Sorting of Data on an Electronic Computer. *Proceedings I.E.E.*, Paper No. 2014M, 1956 (Vol. 103, Part B, Supp. No. 1, p. 87).
- FRIEND, E. H. Sorting on Electronic Computer Systems. *Journal of the Association of Computing Machinery*, Vol. 3, No. 3, p. 134, July 1956.
- BELL, D. A. The Principles of Sorting. *The Computer Journal*, Vol. 1, No. 2, p. 71, July 1958.

Effect of Railway Electrification on Post Office Circuits*

D. W. R. COBBE, A.M.I.E.E., and B. R. HORSFIELD, A.M.I.E.E.†

U.D.C. 621.3.013.71:621.33

Single-phase a.c. electrified railway systems may give rise to inductive interference with telecommunications plant. The interference effects that may be experienced and the difficulties which would arise in making Post Office plant immune from such interference are described. It is concluded that suppression of interference at source is likely to be required on about one-third of such electrified railway routes.

INTRODUCTION

SINGLE-PHASE a.c. electrified railway systems using the rails as a return path, unless equipped with suppression devices, give rise to induction effects over a wide area, and where such railways run parallel to telephone cables, noise troubles and functional interference with d.c. telephone signalling equipment are likely to occur.

The British Post Office telephone system serves over seven and a half million telephones connected to some 6,000 exchanges, and the density of the system, in terms of telephones per square mile, is one of the highest in the world, as may be seen from Table 1.

TABLE 1
Telephone Densities in Telephones/Mile²

Country	Telephones/Mile ²
Switzerland	87
United Kingdom	78
Federal German Republic	49
Japan	27
United States of America	21
France	16
Sweden	14
Portugal	8.8
Norway	4.3

The system has developed gradually over the last 50 years or so, and includes about 20 basically different designs of exchanges using, in many instances, a number of equipments of different vintages.

The exchanges are inter-connected by an extensive network of circuits, largely in unarmoured lead-sheathed cable, of which the shorter-distance circuits, in general, use d.c. rather than a.c. signalling because it is much cheaper. There are a number of fundamentally different types of d.c. signalling systems, the principles of which have been embodied in many different designs of junction terminations to meet different service requirements and to inter-work with the various types of exchanges in the network. It is estimated that there are at present over a quarter of a million junctions using several hundred different designs of d.c. signalling terminations. There are in addition many thousands of longer circuits on a small proportion of which d.c. signalling is also employed.

It will be apparent that, because of the density of the Post Office telephone system, the electrification of British railways at such a late stage in the development of the telephone network would give rise to extremely

* This article is based on a paper presented by the authors to the British Railways Electrification Conference, Oct. 1960.

† Mr. Cobbe is in the External Plant and Protection Branch and Mr. Horsfield is in the Telephone Exchange Systems Development Branch, E.-in-C.'s Office.

serious interference problems, unless the electrified railway system were designed in such a way as to limit the induction to values which would not give rise to noise and functional interference. This may be illustrated by reference to the proposals to electrify a 35-mile section of railway between Manchester and Crewe. A detailed study of this section on a theoretical basis has shown that, without suppression at source, some 1,600 circuits, of which 1,400 are telephone junction circuits, could be adversely affected. The difficulties which would arise would be mainly due to magnetic induction, but electric induction might also cause interference. Examination of other parallelisms has shown that the conditions occurring on the Manchester-Crewe section are not exceptional.

In addition to the telephone trunks and junctions referred to above, other types of circuits would also be affected; these include subscribers' lines, telegraph and television circuits, and circuits leased to private renters (leased circuits constituting about 20 per cent of the total number of circuits in trunk and junction cables).

FUNCTIONAL INTERFERENCE

Telephone Trunk and Junction Circuits

Circuits using a.c. signalling systems are equipped with transformers which provide well-balanced earth-free terminations and are, in general, immune from the effects of 50 c/s induction. D.C. signalling equipment, on the other hand, employs the earth-connected exchange battery for line signalling and is susceptible to the effects of induced voltages. The values of induced 50 c/s voltages above which functional misoperation may be caused are different for various d.c. signalling systems and vary for different designs of terminations using the same signalling principles. Table 2 indicates the induced longitudinal 50 c/s voltages above which functional interference with various designs of junction signalling equipment may result. It should be noted that, in general, circuits using U.A.X. signalling also use loop/disconnect pulsing.

TABLE 2
Failure Points of Trunk and Junction Signalling Systems

Type of Equipment	Longitudinal voltage above which interference may result	Effect
Loop/disconnect pulsing ¹	5	Excessive dial-pulse distortion
Battery pulsing ¹	5	Excessive dial-pulse distortion
Differentiated pulsing ²	5	False switching
Double-current pulsing ³	11	False supervision
Generator signalling, d.c. control	10	False signals
U.A.X. signalling ^{4,5}	20	False signals
Outband carrier, d.c. control ⁶	5	Excessive dial-pulse distortion

It would not be practicable to give a detailed description of all the various effects listed in Table 2, but a brief

reference to the dial-pulse distortion problem will be made. The performance of d.c. pulse-repeating equipment has been perfected over the years to reduce to a minimum the pulse distortion introduced by line-plant characteristics and other variables. Full advantage has been taken of the distortion margin between the output of the dial contacts and the requirements of the selectors to permit the most economical planning of the telephone system both in respect of line plant and exchange equipment, and in many instances the arrangements are such that on some calls the pulses may be repeated over several junctions in tandem without correction or regeneration at tandem switching points.

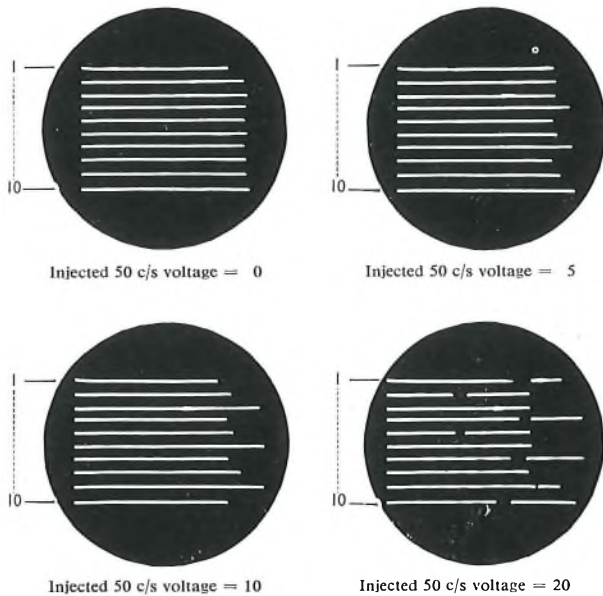

Each oscillogram shows a train of 10 pulses (digit "0")
 FIG. 1—DISTORTION AND SPLITTING OF LOOP/DISCONNECT PULSES
 DUE TO 50 c/s INDUCTION

The oscillograms in Fig. 1 show the effect of induced 50 c/s voltages on loop/disconnect pulsing (the most widely used system). Each oscillogram shows a train of 10 pulses (digit "0") on a typical loop/disconnect junction subject to 50 c/s induction, and it will be seen that, as the interfering voltage increases, the differences between the lengths of the individual pulses become more pronounced. If such junctions were included in multi-link connexions approaching the permitted limits of distortion there would be an increasing risk of failures as the induced voltage increased. It will also be seen that at the higher voltages the pulses are split and this would cause trouble even on call routings which did not approach limiting conditions. Current developments, such as subscriber trunk dialling and direct dialling into the British telephone system from overseas countries, make it increasingly important to maintain a high standard of performance.

Subscribers' Lines

Dangers of functional misoperation due to induced 50 c/s voltages also arise on subscribers' lines, and Table 3 indicates the induced longitudinal 50 c/s voltages above which functional interference with some of the more common types of subscribers' line equipment may occur.

TABLE 3
 Failure Points of Subscribers' Line Equipments

Type of Line	Longitudinal voltage above which interference may result	Effect
Shared service ⁷	25	False bell-ringing
Coin box ⁸	10	False release
Private metering ⁹ (S.T.D.)	10	Failure to operate
P.B.X.	<5	False engaged test

Telegraph Circuits

D.C. telegraph circuits are worked on an earth-return basis and are therefore sensitive to interference from induced longitudinal voltages. Tests have shown that an induced 50 c/s voltage of 10 volts gives rise to an increase in signal distortion which would make it hazardous to include circuits experiencing this or higher values of induced voltages in switched telegraph networks; on point-to-point telegraph circuits the adverse effect would reduce the distortion margins, but such voltages could be tolerated.

Leased Circuits

Leased circuits terminate on a wide variety of signalling equipments, and although these equipments must conform to certain conditions laid down for the protection of Post Office plant, full performance details of the signalling elements are not always known to the Post Office, and the degree of susceptibility of such circuits is therefore not known with certainty.

Television Circuits

Television circuits normally make use of coaxial cable pairs, which are inherently unbalanced with respect to earth. Signals in the video frequency range (0-3 Mc/s) are very sensitive to 50 c/s induction effects and even after means have been adopted to reduce the sensitivity to this type of interference by about 40 db, the maximum induced longitudinal 50 c/s voltage which can be tolerated over a 6-mile section (the maximum distance between amplifiers) is approximately 2.5 volts.

NOISE INTERFERENCE

In general, interference with Post Office circuits from a neighbouring electrified railway system can arise by magnetic induction when current flows in the railway system and by electric induction due to the line voltage of the railway contact wire.

Magnetic Induction

The contact-line current of a single-phase 50 c/s traction system feeding trains equipped with rectifiers and d.c. motors contains a large number of harmonics spread over the speech-frequency range and, in consequence, longitudinal voltages induced in telecommunications circuits also contain these harmonics.

If the telecommunications circuits have a very high degree of balance, a condition which obtains with transformer-terminated a.c. signalling trunk circuits routed in cables, the transverse voltages which appear across the circuits are small and can, in general, be ignored, although fault conditions on such circuits, which would not otherwise be serious, could render the circuits

unworkable, and maintenance standards must therefore be higher than would otherwise be necessary.

If, however, junction circuits with d.c. signalling are considered, even if the circuit terminations are nominally balanced, economic considerations necessitate the acceptance of some unbalance due to manufacturing tolerances on the components used. In practice, the ratio of transverse to longitudinal psophometric voltages varies from about 2 per cent (34 db) to 0.01 per cent (80 db) or less, the former being applicable to a relatively unbalanced junction circuit with earth-connected terminations, and the latter to a transformer-terminated circuit. A typical unbalance distribution for junction calls routed between two director exchanges, measured at the outgoing end, is given in Fig. 2. A reasonable limit for such junction circuits, not erring on the side of caution, would appear to be about 1 per cent (40 db), and to meet a figure of 0.5 millivolts transverse psophometric voltage based on the proposed C.C.I.T.T. limits, the appropriate limit for the longitudinal psophometric voltage would be 50 millivolts.

Electric Induction

Experience on the Colchester-Clacton line has shown

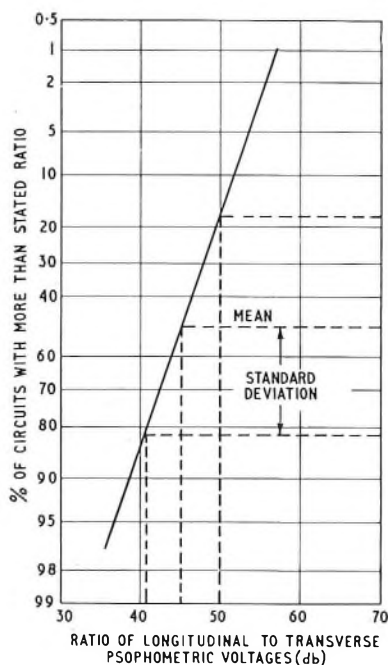

Measurements made at outgoing end. Injected longitudinal harmonic voltage distribution similar to that shown in Table 4. Measured values: maximum 57.1 db, mean 45.5 db, minimum 35.8 db.

FIG. 2.—DISTRIBUTION OF UNBALANCE FOR CALLS BETWEEN DIRECTOR EXCHANGES

that noise can also occur due to the harmonic voltages in the contact-wire system; subscribers' open-wire lines close to the railway have been affected in this way, the mode of coupling being capacitative. It appears that noise, rather than the 50 c/s component, which in severe cases can give rise to danger, is the limiting factor, and telephone lines affected in this way must be placed in a metallic-sheathed cable to be effectively screened.

ESTIMATES OF INTERFERENCE VOLTAGES ON POST OFFICE CIRCUITS IN THE ABSENCE OF SUPPRESSION AT SOURCE

Methods of Assessment

At present, estimates of interference voltages are based on the assumption that the total 50 c/s current in the contact wire of a 25 kV system is 400 amp, and that the harmonic content of this current is as shown in Table 4. This table is based on measurements made on the Lancaster-Heysam line; preliminary measurements made on the Colchester-Clacton line suggest that although the analysis may vary in some minor details, the overall effect on calculations based on these figures would not be substantial.

Using the normal Carson-Pollaczek formulae,¹⁰ transparent masks have been prepared suitable for use with 2½ in. scale maps, from which induced longitudinal voltages may be read off directly—interpolating where necessary. The masks have been prepared in two sets of six, one set for 50 c/s and the other for the psophometric voltage, each set covering a range of earth resistivity. The appropriate masks are chosen following earth-resistivity measurements made on site. A rail screening factor[‡] of 0.5 has been assumed. Cable screening factors are separately assessed as the calculation proceeds, and are based on the sheath resistance. For the psophometric voltages, a sheath resistance of 1 ohm/mile has been assumed in the preparation of the masks, and the voltage obtained from the mask is multiplied by the appropriate value of sheath resistance/mile. An example of a mask used for the calculation of psophometric voltage is shown in Fig. 3.

The assessment of cable screening factors gives rise to difficulties (i) where multi-way cable routes are concerned and (ii) where water and gas pipes are present. In some instances, therefore, the assessment is a matter of judgment.

Average conditions are assumed throughout and, whilst no claim can be made for extreme accuracy, it would be a mistake to assume, as is sometimes done, that measured values will invariably be less than those calculated.

‡ Screening factor—the ratio of the induced voltage when the screening agent is present to the induced voltage when the screening agent is absent.

TABLE 4
Harmonic Content of Traction Current

Frequency (c/s)	Percentage of Fundamental	Frequency (c/s)	Percentage of Fundamental	Frequency (c/s)	Percentage of Fundamental
50	100	950	0.65	1850	0.28
150	14.6	1050	0.55	1950	0.28
250	5.6	1150	0.46	2050	0.28
350	3.1	1250	0.41	2150	0.27
450	2.3	1350	0.37	2250	0.26
550	1.7	1450	0.33	2350	0.26
650	1.32	1550	0.31	2450	0.23
750	1.03	1650	0.3	2550	0.21
850	0.82	1750	0.29	—	—

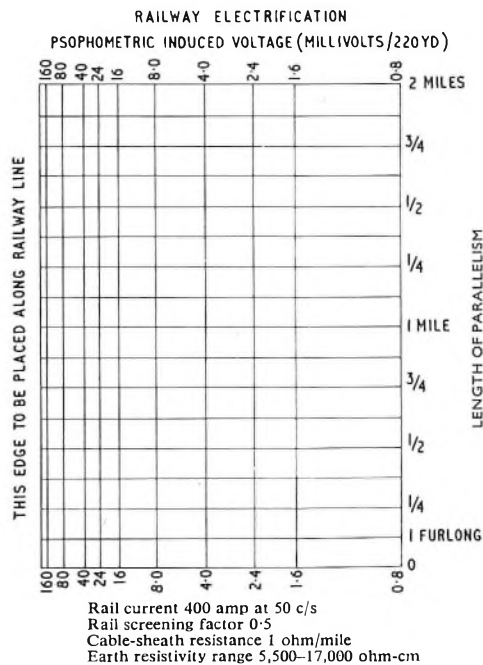

FIG. 3—TYPICAL CALCULATING MASK FOR INDUCED PSOPHOMETRIC VOLTAGE

Estimated Values of Induced Voltage (Manchester-Crewe)

It has been estimated, using the above techniques, that, in the absence of suppression at source, 50 c/s longitudinal voltages up to 60 volts could occur in the Manchester area, the most commonly occurring value being 30 volts. The corresponding longitudinal psophometric voltages would range up to 2 volts, the most common value being about 500 millivolts.

REMEDIAL MEASURES APPLICABLE TO POST OFFICE PLANT
Telephone Equipment

Many remedial measures have been considered with a view to overcoming the effects listed in Tables 2 and 3, but since loop/disconnect pulsing is the most commonly used method of d.c. signalling, the work done on this system will be described briefly. Tests have been made to determine whether chokes so placed as to impede the flow of longitudinal currents could be used to improve the immunity of the system, but inductances of less than 10 henries have not been found to have any significant effect and inductances having higher values have been found to introduce other pulsing difficulties such as pulse-splitting due to damped oscillations in the line conductors. Consideration has also been given to the use of signalling terminations embodying transformers and signal-repeating relays, but this solution would involve extensive modifications to existing plant, and additional pulse-distortion would still be introduced by the measures necessary to overcome noise interference.

Chokes connected as described above are useful in reducing noise interference at harmonic frequencies, but their effectiveness is limited unless accompanied by shunt paths to earth, and unacceptable pulse-distortion is then introduced, together with a transmission impairment. Transformers with signal-repeating relays would probably give a somewhat greater reduction in noise levels, but would introduce additional pulse distortion and transmission losses, owing to the need for such devices at the incoming ends of junctions, where they are not at

present required. Neither longitudinal chokes nor transformers with signal-repeating relays would give the required degree of noise suppression on an appreciable number of circuits, and the only satisfactory solution which can at present be envisaged for such circuits is the use of highly balanced transformers free from earth connexions. Such a solution would however entail the development of a.c. (or similar) signalling equipments which, to meet the wide variety of requirements in the junction network, would be numerous and complex in character and, by virtue of the greater space required, would give rise to accommodation difficulties which would be particularly severe in the smaller exchanges.

Telegraph Circuits

To overcome the effects of interfering voltages on d.c. telegraph circuits, it would be necessary to adopt loop working with signal-repeating relays. This would require twice as many cable pairs as the normal method. The alternative would be to adopt voice-frequency working for such circuits.

Television Circuits

Where the induced 50 c/s voltage exceeded the permissible limit for video-frequency television transmission, frequency translating equipment would need to be provided. The provision of frequency translating equipment would add greatly to the overall costs of such circuits.

SUPPRESSION AT SOURCE

Two methods of suppression at source are known to be practicable. These are the provision of rail-connected booster transformers and the use of booster transformers in conjunction with return conductors, as shown in Fig. 4.

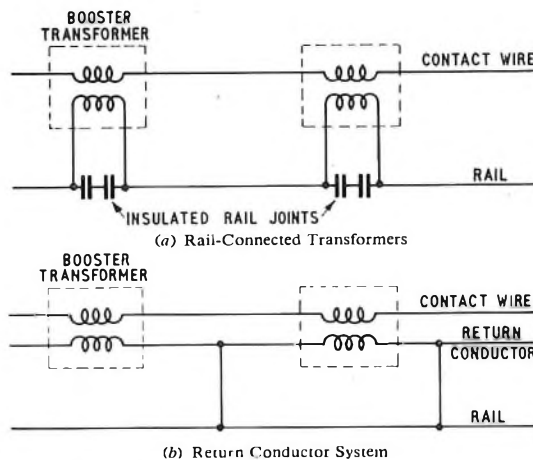
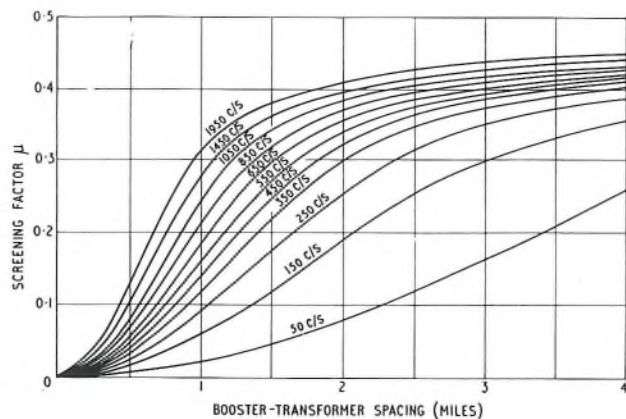

FIG. 4—METHOD OF CONNECTING BOOSTER TRANSFORMERS

Booster Transformers (Rail-Connected)

The screening effect of rail-connected booster transformers^{11,12} depends on the spacing of the transformers and on the propagation coefficient (γ) of the rail-earth return circuit, which in turn depends on frequency and on the insulation of the rails to earth. In Fig. 5 the theoretical variation of rail screening factor with booster transformer spacing and frequency is shown for a value of rail insulation (1.5 ohms/mile) which tests have shown represents average conditions for two rails in parallel; the usual spacing at 1-mile intervals gives a theoretical



$$\mu = \left(1 - \frac{Z_{CR}}{Z_R}\right) \left[1 - \frac{\tanh \gamma l/2}{\gamma l/2}\right]$$

where Z_{CR} = mutual impedance of contact line-rail circuit

Z_R = series impedance of rail-earth circuit

l = booster-transformer spacing, in miles

and γ = the propagation coefficient of the rail-earth circuit, values of which may be obtained from External Plant and Protection Branch Investigation Report No. 70.¹¹

Graphs are applicable to cables 20 ft or more from the railway.

FIG. 5—SCREENING DUE TO RAIL-CONNECTED BOOSTER TRANSFORMERS IN THE ABSENCE OF LINE-SIDE CABLES

screening factor of 0.025 at 50 c/s. As the rail screening factor without booster transformers would be 0.5, the improvement ratio due to the booster transformers is therefore 20 : 1. The reduction at higher frequencies is less, as shown, and hence this method is not very satisfactory for the elimination of noise due to harmonics.

In practice, however, it has been found that the presence of line-side cables can reduce the effectiveness of rail-connected booster transformers because of the induced current which flows in the sheaths of such cables. This effect was observed during tests made on the Lancaster-Heysham line and is supported by a more detailed theoretical analysis¹³ in which the effect of such cables is included. The measured screening factor obtained at a frequency of 50 c/s for a booster-transformer spacing of 1.1 miles was 0.07, the improvement due to booster transformers being therefore only 7 : 1 instead of the theoretical 20 : 1 mentioned above. At harmonic frequencies, where a much greater proportion of the current leaves the rails due to the increase in the series impedance of the rails with increase in frequency, the current induced in the sheaths of line-side cables has very much less effect on the screening factor, and, for the harmonic distribution shown earlier, the screening factor for the induced psophometric voltage is of the order of 0.15 (corresponding to an improvement due to the use of booster transformers of about 3 : 1).

Booster Transformers with Return Conductor

Consideration of the return-conductor system¹⁴ shows that two main effects need separate treatment. The first is induction from through currents, i.e. those currents taken by trains well beyond the parallelism and confined wholly to the contact wire and return conductor. The second is induction due to a train in section, i.e. where the train is within or near to the parallelism, and current is flowing along the rails.

For telecommunications plant well removed from the railway, i.e. for most Post Office cables, the contact wire and return conductor are nearly equidistant from such plant and direct induction due to through currents in the contact wire and return conductor may therefore be

ignored. However, the rails are not, and cannot be, symmetrically disposed with respect to the contact wires and return conductors, and hence an induced current flows in the rails; it is this current which causes induction in the telecommunications plant. Calculations suggest that the system screening factor for such remote cables should then be of the order of 0.025 and should be substantially independent of frequency. This represents an improvement of 20 : 1. When a train is in section, maximum induced voltage occurs when the train is close to a booster transformer, in which event the length between the train and the strap (between rail and return conductor) to which the train current returns may be treated as being equivalent to a normal feeder section without booster transformers, for which a screening factor of 0.5 at all frequencies would be appropriate, provided the parallelism extends for about two miles or more on either side of this equivalent section.

For cables close to the railway, conditions become more complex, and Fig. 6 shows the screening factor appropriate to such cables in various positions where the loop effect and induced rail current have been considered. So far as induction from a train in section is concerned, the appropriate screening factor will be in the range 0.4 to 0.6.

CONCLUSIONS

From considerations such as have been described above, it has been concluded that the development effort which would be necessary to make the multiplicity of Post Office circuits in the affected areas immune from the effects of induced voltages would be so great that it would not be practicable to attempt to carry out the necessary changes. It has therefore been necessary for the Post Office to ask the Transport Commission to incorporate measures for the suppression of interference at source on those sections of the railways which would otherwise give rise to serious interference with Post Office plant. It seems likely that about one-third of the electrified route will fall within this category, and that a booster transformer system with return conductors should provide the necessary degree of protection.

References

- WELCH, S. The Fundamentals of Direct Current Impulsing in Multi-Exchange Areas. *I.P.O.E.E. Printed Paper No. 184*, 1944.
- WELCH, S., and FLEETWOOD, C. H. J. Long Distance D.C. Impulsing. *I.P.O.E.E. Printed Paper No. 178*, 1942.
- WELCH, S., and HORSFIELD, B. R. The Single-Commutation Direct Current Signalling and Impulsing System. *P.O.E.E.J.*, Vol. 44, p. 18, Apr. 1951.
- GRANT, C. G., and COOK, E. M. The Unit Automatic Exchange No. 12. *P.O.E.E.J.*, Vol. 28, p. 105, July 1935.
- GRANT, C. G., and HENK, A. J. C. The Unit Automatic Exchange No. 13. *P.O.E.E.J.*, Vol. 29, p. 141, July 1936.
- HORSFIELD, B. R., and GIBSON, R. W. Signalling over Carrier Channels that provide a Built-in Out-of-Speech-Band Signalling Path. *P.O.E.E.J.*, Vol. 50, p. 76, July 1957.
- CAMERON, C. J., and HUMPHRIES, W. A. Shared Service. *P.O.E.E.J.*, Vol. 41, p. 139, Oct. 1948.
- BASTOW, F. J., COLLINGWOOD, J. D., NEWELL, E., and PRICE, C. K. The Pay-on-Answer Coin-Box System. *P.O.E.E.J.*, Vol. 51, p. 343, Jan. 1959.
- GRESSWELL, F., BELK, J. L., and ALDERSON, G. A. Subscribers' Private Meter Equipment. *P.O.E.E.J.*, Vol. 51, p. 338, Jan. 1959.
- C.C.I.F. Directives Concerning the Protection of Telecommunications Lines Against Adverse Effects of Electric Power Lines. Rome edition, 1937. Revised in Oslo, 1938. Published in Geneva, 1952.

References 11-14 are Investigation Reports of the External Plant and Protection Branch, E-in-C.'s Office, from whom they may be obtained.

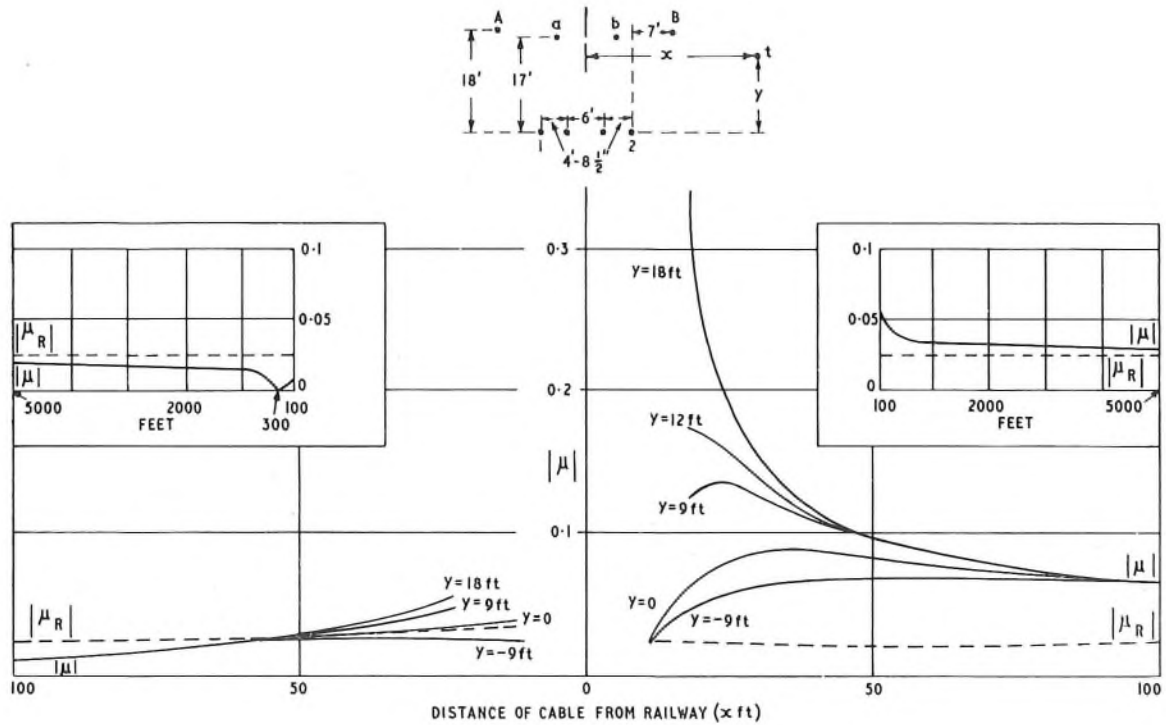

(a) With Current only in Contact Line b and Return Conductor B

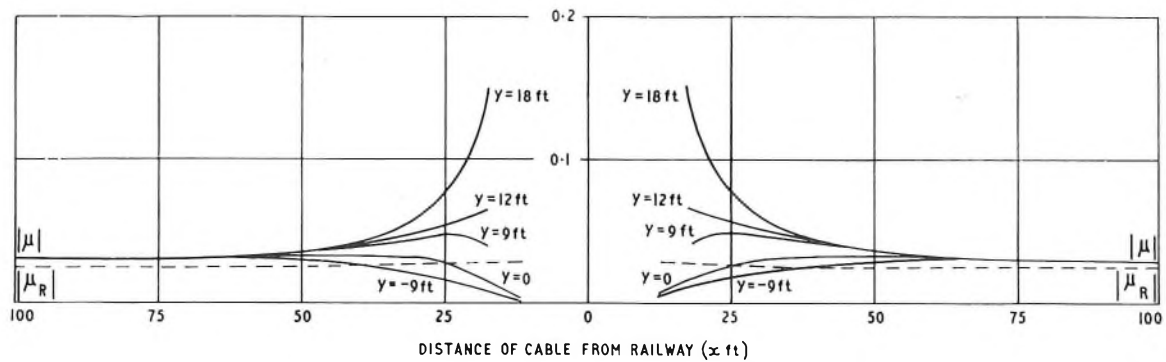

(b) With Equal Currents in Both Contact Lines and Return Conductors

Notes:

a, b = contact wires
A, B = return conductors
t = telephone line
1, 2 = traction return rails

1. The value of $|\mu|$ between $x = 0$ and $x = 300$ ft shown on left-hand side of figure should be regarded as negative with respect to the values at greater separations on the same side and to those for all separations on the right-hand side
2. $|\mu_R|$ is the component of the screening factor due to the "induced rail-current" and is the value to which the curves are asymptotic
3. The inset curves in (a) are extensions of the main curves beyond $x = 100$ ft

FIG. 6—SCREENING FACTOR, $|\mu|$, IN RESPECT OF "THROUGH" CURRENTS WITH BOOSTER TRANSFORMERS AND RETURN CONDUCTORS

¹¹ No. 70—The Characteristics of Rail-Earth Return Circuits and Contact Line-Rail Mutual Impedance.

¹² No. 80—Inductive Screening Due to End Effects in Rail Feeding Sections and the Action of Rail Booster Transformers under Normal Railway Operating Conditions.

¹³ No. 85—Rail Booster Transformer Tests on the Lancaster-

Morecambe-Heysham 6.6 kV Railway.

¹⁴ No. 93—Inductive Screening of Communication Lines Produced Under Normal Railway Operating Conditions by Booster Transformers (Current Ratio 1 : 1) with Return Conductors.

A Table Telephone with Four Push-Button Keys—Telephone No. 710

H. J. C. SPENCER, A.M.I.E.E.†

U.D.C. 621.395.721.4

Table telephones with a single push-button key provide adequate switching facilities for most subscribers' installations. However, for some extension plans and miscellaneous circuits, additional switching facilities are necessary and, to meet such requirements, a new table telephone with four push-button keys has been developed.

INTRODUCTION

THE new table telephone described in an earlier article* can accommodate a single push-button key, and this enables it to satisfy the majority of requirements for telephones. In a number of extension plans, however, and for some miscellaneous circuits such as privacy equipments, a telephone with more than one push-button key is essential, and to meet this need a variant of the basic telephone which will accommodate up to four push-button keys has been developed. An exception to the policy of providing switching within the telephone has been made for Extension Plans No. 5 and No. 7. For these the switches and other special components are being housed within a plinth on which stands a telephone with a single push-button key.



FIG. 1—TELEPHONE NO. 710

The new telephone, which is illustrated in Fig. 1, has been developed from the conventionally-wired single-button instrument. The circuit wiring is identical, and the physical changes have been confined to the gravity-switch structure. This has been re-designed to give space for the extra key mechanisms and spring-sets. Additionally, the length of the gravity-switch plunger arms has been increased to ensure that the light weight of the handset is sufficient to trip the release mechanism of the keys.

KEYS

To give the greatest possible flexibility in use, the telephone has been designed with detachable spring-sets. The basic key mechanism is a permanent part of the telephone, and the spring-sets and push-buttons appropriate to individual installations are added to this basic mechanism.

Mechanism

Four brass plungers (they may in future be formed of moulded nylon) slide vertically in a cross frame within the telephone, and the spring-sets, when fitted, are operated by a step in the rear profile of the plungers. Restoration of the plungers, which are fitted with helical return-springs, is controlled by the latch-plate, which may be seen in Fig. 2. The latch-plate, which is common to all

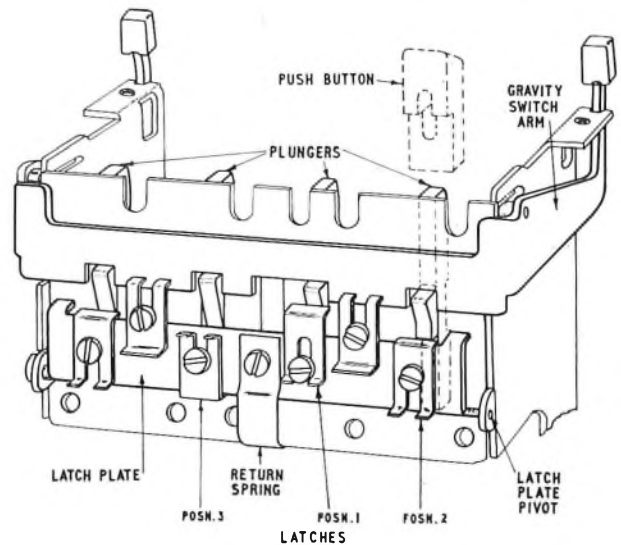

FIG. 2—LATCH-PLATE MECHANISM

four plungers, is pivoted at its lower edge and has a separate latch for engaging each plunger. The latches may be moved into any of three different positions, as shown in Fig. 2, by slackening their fixing screws. When a plunger with its latch in position 1 is pressed, any other locked plunger is released and the pressed plunger is locked in position; when the latch is in position 2, other locked plungers are released as before, but the pressed plunger itself is not locked. When the latch is in position 3 its associated plunger, when pressed, neither releases other plungers nor locks itself. Two further latches on the latch-plate are used to control the gravity-switch release of locked keys. With these latches in the position shown in Fig. 2, replacing the handset trips the latch-plate and releases any locked plunger. When lowered to their alternative positions the latches are clear of the gravity switch, and a locked plunger is not then released by replacing the handset.

Spring-sets

The spring-sets are based on those being developed for a new series of lever keys. The springs are short, less than 1 in. long, and this leads to compact spring-set assemblies. Palladium is used for the twin contacts and the springs are moved by a comb. The maximum number of springs

† Subscribers' Apparatus and Miscellaneous Services Branch, E.-in-C.'s Office.

* SPENCER, H. J. C., and WILSON, F. A. The New 700-Type Telephone—Telephone No. 706. *P.O.E.E.J.*, Vol. 52, p. 1, Apr. 1959.

possible per spring-set is 14, arranged in two banks of seven. Contact combinations provided so far are four change-overs, four make-before-break change-overs, three change-overs and two makes. An additional spring-set is provided having four springs which, by suitable choice of the type of spring used, can be arranged as either type of change-over unit or as a make or a break spring-set. This spring-set is illustrated in Fig. 3,

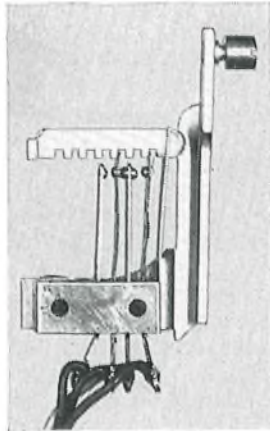

FIG. 3—SPRING-SET CONSTRUCTION

from which the form of construction used for all the spring-sets may be seen. Make-before-break action is obtained by a centre contact bridging the outer ones during the change-over, instead of by the more conventional method of the lever-spring contact lifting the make contact off the break contact.

The spring-sets are assembled on a bracket designed to give quick assembly within the telephone. Connected to the springs are short lengths of flexible wire, terminated with spade tags, by means of which the keys are connected to the telephone circuit.

The gravity-switch spring-sets of the telephone are similar to the key spring-sets and all the spring-sets are protected by transparent dust-covers.

Push-Buttons

The plungers within the telephone are actuated by rectangular push-buttons sliding in holes in the telephone cover, in which the push-buttons are held captive by pins. To avoid the use of separate labels the push-buttons are marked with simple legends.

There is also an alternative locking push-button. When pressed down, this can be latched on to the pin, which holds it in the cover by sliding the push-button top to one side. It is thus locked independently of the latch-plate of the key mechanism. This is a useful feature because this push-button may be used, for example, to switch on and off an extension bell, leaving the locking-latch mechanism free for other switching purposes.

Initially, the holes in the telephone cover are closed by "snap-in" plastic dummies. These are discarded when push-buttons are fitted.

Extra Terminals

It is obvious that, because of the large number of spring-sets which may be fitted, the normal complement of five spare terminals in the telephone circuit will often be inadequate. The number of terminals may, however, be increased by fixing additional 6-way terminal strips to the two uprights of the gravity-switch structure. If 12 extra terminals are insufficient, 18 can be provided by fitting between the uprights a frame holding three of the 6-way strips.

ADDITIONAL COMPONENTS

To extend the use of the telephone a number of simple add-on units have been designed for fitting within it. These units are all terminated with flexible wires fitted with spade tags.

Shared-Service Adaptor

A shared-service adaptor consisting of an assembly of a micro-switch and thermistor can be fitted at any push-button position. The operation of this adaptor was described in the earlier article already mentioned.

Gravity-Switch Contacts

An additional spring-set with up to seven springs may be fitted to the gravity switch. So far only a change-over contact unit has been provided.

Local-Battery Adaptor

An assembly of a choke coil and gravity-switch contact can be fitted to enable the telephone to be used in local-battery-exchange systems, as described in the earlier article. An alternative adaptor includes an additional change-over gravity-switch contact (the adaptors used with Telephone No. 706 are not suitable for use in the new telephone because of the altered gravity switch).

D.C. Bell

A trembler bell that is being designed for use within Telephone No. 706 may also be used in this telephone. When used, however, it takes up the space required for the additional terminals and when both terminals and bell are required it will be necessary to provide an external bell.

Lamp Signals

Provision has been made in the telephone for fitting two signal lamps, if required. The lamps can be mounted in extensions of the gravity-switch spring-set brackets and will be visible through lenses in the telephone cover, the cover having "knock-out" sections at either side above the dial to allow the lenses to be fitted.

ACKNOWLEDGEMENT

The telephone has been developed for the Post Office by Ericsson Telephones, Ltd., under the British Telephone Technical Development Committee procedure.

Calibration

U.D.C. 621.317.7.089.6

AS development proceeds in the field of telecommunications there is an increasing tendency to specify closely toleranced performance requirements. If equipment is to be set up and maintained within such tolerances it follows that the associated test equipment must be maintained at a correspondingly higher order of accuracy. To provide test equipment with absolute accuracy is both impracticable and uneconomical; the important requirements are stability and a knowledge of the value of any errors to be taken into account when using the test equipment. Calibration is the process of checking the stability of equipment and evaluating any errors against basic standards, using precision comparators. The scope of this work can be indicated on the one hand by the calibration of tension gauges using weights and on the other by the calibration of transmission measuring apparatus using a milliwatt calibrator.

In an organization responsible for acceptance testing, a comprehensive calibration scheme is essential. Such a scheme, which covers all items of test equipment used, is necessary if dispute over test results is to be avoided and testing officers are to feel confident that faults lie in the product and not in the test equipment. The operation of a calibration scheme requires that all test equipment be serially numbered. Records must be maintained on a card index so that equipment is recalibrated at appropriate intervals and a history of its performance is compiled.

Some of the basic standards used for electrical calibration work are the Weston cell, standard resistors, inductors and capacitors, and standard time, from which standard frequency is derived. Precision d.c. potentiometers and various precision a.c. bridges are used as comparators in conjunction with the standards. Both the basic physical standards and the precision comparators must be of known, certified accuracy. For mechanical calibration, slip gauges are the basic standards, and precision measuring equipment such as tool-maker's microscopes, depth gauges, verniers and micrometers are used as transfer standards.

One of the authorities competent to certify accuracy is the National Physical Laboratory and most electrical standards are referred to that body for periodical check. In addition, regular inter-comparison of the various standards proves their stability and ensures that any deterioration is detected. Standards must of course be treated with the greatest care and, in order to minimize their use and thus avoid deterioration, it is common practice to calibrate precision instruments from them for use as transfer standards. These are working standards to which the accuracy of the physical standard has been transferred for short-term use on repetitive work.

Possession of standards and comparators is insufficient in itself; the work must be carried out by skilled personnel under favourable conditions. Staff must be trained to recognize and avoid numerous pitfalls which affect the validity of their results. Every stage must be proved, extraneous influences must be eliminated, residuals, i.e. small values existing at zero setting, must be taken into account and all inaccuracies evaluated so that figures are not quoted beyond certainty.

Any necessary preventative maintenance must precede

calibration. Cleaning, lubrication, adjustment and replacement of components whose efficiency has deteriorated must first be carried out so that, as far as possible, the instrument is restored to its original performance before re-calibration. Similarly, after maintenance work has been carried out on a faulty instrument it must be re-calibrated before it is brought back into use.

The nature of calibration work requires that it be carried out under good working conditions. The room used must be clean, well lit and free from draughts. Temperature control is necessary for very precise work but, where it is not provided, a room must be chosen that is not subject to appreciable variation of temperature or humidity. The room must also be free from extraneous electrical interference and mechanical vibration.

Direct-reading electrical measuring instruments are perhaps the most common form of test equipment used by the telecommunication engineer and some aspects of the calibration of these instruments may be of interest. It is useless to attempt to calibrate an instrument to a high degree of accuracy if the scale and pointer are such that it cannot be precisely read; on the other hand, a precise scale is not a guarantee of accuracy. Transfer standards, which have precise scales and very good short-term stability, are first calibrated against basic standards for use as comparators. The transfer standard is then suitably connected to the instrument under test across an appropriate stable supply, which may be adjusted as necessary. Voltage or current is adjusted so that the instrument under test records at marked points on the scale. The errors at these points are then read from the precise scale of the transfer standard and recorded on the calibration chart or graph associated with the instrument. This is a much more accurate calibration method than attempting to estimate the deviation of the pointer from the scale mark of the instrument under test at particular values of voltage or current. A meter which reads higher than the true value is said to have a positive error, and a meter reading lower than the true value has a negative error. The results obtained are compared with the figures for previous calibrations to check that the instrument has remained stable; if it is failing in this respect complete overhaul or replacement of the instrument will have to be considered.

The frequency of re-calibration decided upon for any particular instrument depends upon the conditions under which it is used. An interval of three months may be appropriate for a portable bench-testing instrument in daily use, whereas a check every two or three years may suffice for a rack-mounted instrument which is used infrequently and not subject to mechanical stress or electrical overload. Initially, the periodicity will be determined by that required for other similar apparatus but the work found to be necessary during preventative maintenance, coupled with the stability trend revealed by the calibration records, will determine the optimum period. This period will be that which strikes the right balance between satisfactory performance of the equipment in service, and economy of maintenance and calibration effort.

J. E. O.

Automatic Control of the Rugby Radio (GBR) Time Signals by an Electronic Clock

J. S. McCLEMENTS†

U.D.C. 529.786:389.2

The daily Greenwich time signals have until recently been generated at the Time Department of the Observatory sited at Herstmonceux Castle, Sussex. The signals were transmitted about 140 miles over landline to the Post Office radio station at Rugby where they were radiated from the high-power very-low-frequency transmitter, GBR, on 16 kc/s and from two additional transmitters in the 10–20 Mc/s band. Equipment has now been installed at Rugby to generate the time signals and thereby avoid the need for a long line link.

INTRODUCTION

TIME in the United Kingdom is measured at the Royal Greenwich Observatory and for many years time signals have been sent twice daily from the Time Department of the Observatory, at Herstmonceux Castle, Sussex, to the Post Office radio station at Rugby for world-wide transmission of Greenwich Mean Time (G.M.T.). These signals originated in a timing device at the Observatory controlled by a quartz clock, the rate of which was established from the astronomical data of the Observatory. The most serious cause of time instability in this system arose from line time-delay changes between the Observatory and the transmitter. To reduce such errors the time signal was preceded by a series of test signals sent from the Observatory and received back by radio at the Observatory, and the necessary corrections were made to the official time signal which followed. Short-period delay changes taking place during the actual transmission of the time signal were covered by the issue of a post-transmission time-correction bulletin from the Observatory.

The highly time-stable performance of the Post Office quartz-controlled oscillator used at Rugby in the MSF* standard-frequency service¹ suggested that instability in the time signal could be reduced by generating these signals at Rugby from the MSF master oscillator. Suitable electronic time-signal-generating equipment was therefore designed and put into service at Rugby Radio Station at 10.00 hours on 1 April 1960. The time signals generated by the new equipment are checked daily by the Observatory. Occasionally, adjustments to advance or retard the time signals will be necessary at Rugby and these will be made on the advice of the Royal Greenwich Observatory.

PRINCIPLES OF OPERATION

The Greenwich time signals are radiated daily, commencing at 09.55 and 17.55 G.M.T. precisely, and consist of a 5-minute series of signals which mark each "second" and "minute" during the period.

The basic idea of the time-signal generator is to use an oscillator to drive a chain of frequency dividers to reduce the frequency to some desired value (say 1 c/s) and then produce suitable pulses from this supply. Thus, the

† Post Office Research Station.

* MSF—the call sign of the transmitter used for the standard-frequency service.

¹ Law, H. B. Standard Frequency Transmission Equipment at Rugby Radio Station. *Proceedings I.E.E.*, Paper No. 1762R, Oct. 1954 (Vol. 102, Part B, p. 166, 1955).

² Довгие, А. К. An Electronic Program Clock. *P.O.E.E.J.*, Vol. 48, p. 12, Apr. 1955.

100 kc/s standard oscillator, with frequency known to an accuracy of, say, 10 parts in 10^{10} , driving a divider-pulser generating 1 p.p.s. would produce "second" intervals with an accuracy of 10 parts in 10^{10} . A further unit dividing an input of 1 p.p.s. by 60 would produce pulses marking "minute" intervals, etc. To produce time signals, however, the moment, or epoch, of each pulse must be set to the correct time to within a millisecond or so and this is done by using a manually operated phase shifter which, for convenience, operates in the 1,000 c/s supply circuit to the frequency-divider chains. When this phase shifter is adjusted by hand to generate, say, one cycle, the phase of the signal is advanced (or retarded) by a factor of 1 in 1,000 so that the time-signal phase is advanced or retarded by one millisecond. Thus, the elementary requirements of a time-generator are met by a generator of pulses at a rate of one per second and a phase shifter for sliding them backward or forward in the time scale to get the epoch correct.

It is necessary to distinguish between the "seconds" and "minutes" pulses and this is done by shaping the pulses before they are applied to the transmitter. The shaped pulses are produced by gating the 1,000 c/s supply so that an exact number of cycles is allowed to pass to the transmitter at the required times. The "seconds" pulses occupy 100 cycles of the supply (and hence are 100 milliseconds long) and start where the voltage is zero, positive going. The "minutes" pulses last for 500 cycles (0.5 second) but are otherwise similar. The transmitter includes a thermionic valve relay for on-off keying of the carrier of the GBR transmitter at Rugby.

Besides providing a source of time signals the electronic device can easily be extended to include further dividers to obtain one pulse per hour, per 12 hours, etc. With the aid of an electronic coincidence detector, which operates when a particular combination of pulses is generated, it is possible to select a combination which will occur only once in each 12 hours, say, at 09.55 hours and 17.55 hours precisely, when the transmitter can be arranged to transmit automatically the trains of "seconds" and "minutes" pulses. This function is termed "programming"² and the section of the equipment containing the coincidence detecting circuits is known as the "program unit" as distinct from the actual time-unit generators (T.U.G.).

TIME-SIGNAL CONTROL EQUIPMENT

Fig. 1 shows some of the main units of the time-signal control equipment installed at Rugby Radio Station. A supply is taken from the 100 kc/s MSF master oscillator, A, to a frequency divider, B, from which a 1,000 c/s supply feeds a continuously variable phase shifter, C. One outlet of C feeds the time-unit generators of the MSF electronic clock equipment and a second outlet feeds two separate phase shifters D and E, which precede the time-unit generators of the time-signal control equipment.

Units D and E enable differential time adjustments to be made between the MSF clock and the two time-signal

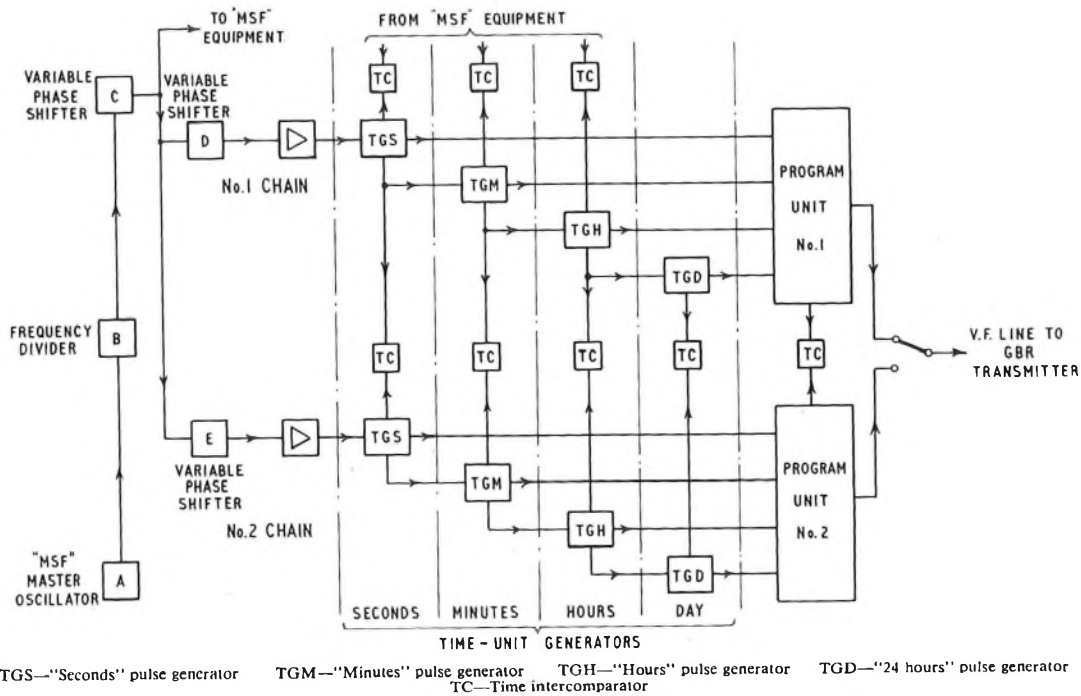

FIG. 1—BLOCK SCHEMATIC DIAGRAM OF TIME-SIGNAL CONTROL EQUIPMENT

control chains and between the time-signal control chains themselves. Suitable connexions are made between the time generators (TGS seconds, TGM minutes, TGH hours, etc.) and the program unit to start the program switching in the sequence required. Cold-cathode gas-filled triode tubes are used in the dividers of the time-unit generators and program units. These tubes contain neon gas and they glow when passing current, so that time can be read at any instant from the pattern of glowing tubes in the seconds, minutes and hours dividers.

Accuracy and reliability are most important and a continuous check is afforded by duplication of equipment, for when correctly synchronized both T.U.G. sections will indicate the same time and both program sections will produce simultaneous and identical signals. This inter-checking is carried out electronically, and automatic time-intercomparators (TC) have been provided, as shown, between the time generators. The inclusion of a comparison with part of the MSF chain allows for recognition of a time slip and for the automatic shutting down of transmission if the controlling chain is faulty. The synchronizing and automatic comparison of the MSF time-interval pulses with those of the GBR time-signal pulses has thus enhanced the value of both services.

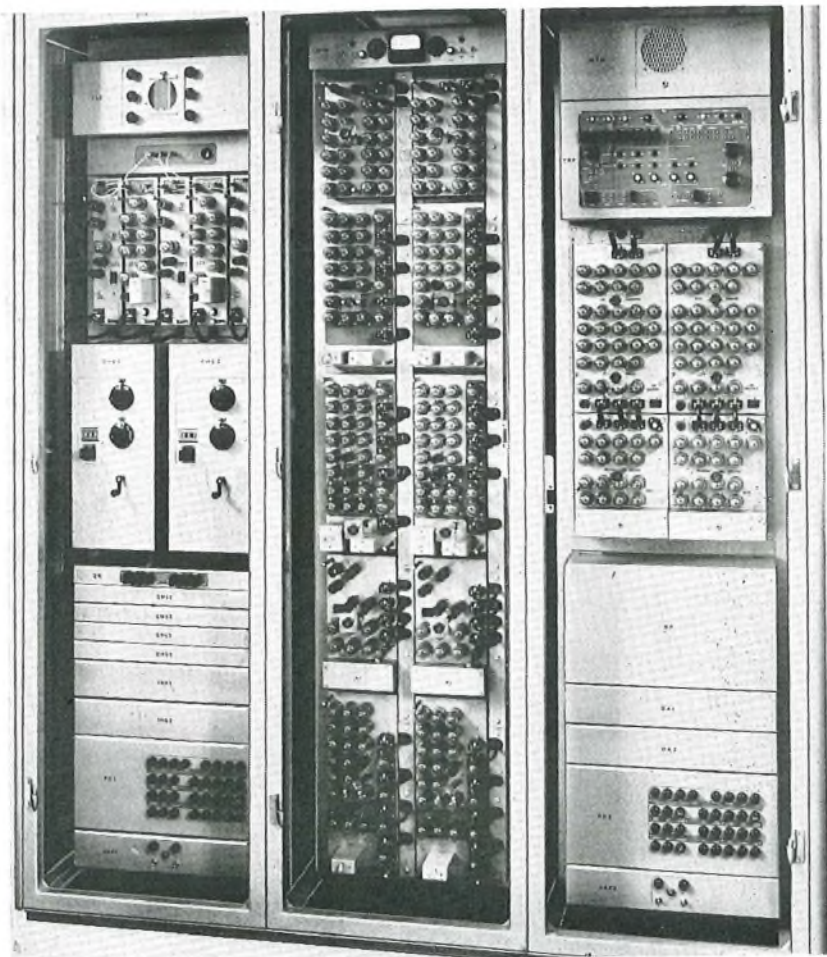

FIG. 2—GBR (RUGBY) TIME-SIGNAL CONTROL EQUIPMENT

Synchronism is observed by displaying the "seconds" pulses from both time-signal generators on a cathode-ray oscilloscope, the sweep of which is triggered once per second from the MSF "seconds" pulses. The adjustments necessary to attain synchronization are made by means of phase shifters D and E, after which the "seconds" comparators take over and give an alarm if a time difference greater than 0.5 ms occurs between the two chains. This is done every second in a novel way. The receipt of a "seconds" pulse at the time comparator from either circuit starts a 4-step ring-counter which produces an alarm condition if the counter steps to the fourth position (which it would do in 80 ms). If, however, the pulses received from both circuits are correctly synchronized their superposition "fires" a gas-filled triode which interrupts the counter ring and resets it before the alarm condition is reached.

A further novel feature of the equipment is the use of a gas-filled triode counter and program unit which, when started by the main time-signal clock-chain, will automatically send the call sign "GBR GBR Time" in morse code four times in the minute preceding the time-signal series.

Fig. 2 shows a general view of the equipment. The two T.U.G. chains are seen side by side on the centre rack, with the "seconds" generator at the bottom, then the generators for minutes, fractions of hours, and finally the hour selector at the top of the rack. The automatic morse-code sender is on the right-hand rack. The phase adjusters, time comparators and cathode-ray oscilloscope for time synchronizing are on the left-hand rack of the cabinet.

The equipment is fully automatic throughout the 24-hour period of each day; in addition to providing a continuous time-monitor between time-division chains,

at the appropriate times, determined by the way the coincidence detectors are connected, it switches land lines, seizes the transmitters, starts and connects the code senders, time-signal gates, etc., to the transmitters, and finally restores the transmitters to the normal traffic channels after the time-signal period. The present time-signal transmission program is shown in the table.

Time (GMT)	Signals
09.45	Transmitter off traffic, tuning starts.
09.53	Tuning finishes.
09.54	Morse code "GBR GBR TIME" (repeated 4 times).
09.54, 30 sec	Tuning "mark" starts.
09.54, 54 sec	Tuning "mark" ends.
09.55	"Minute" marker (0.5 sec long) followed by "seconds" pulses (0.1 sec long), etc.
10.00	Time-signal series ends with 'minute' marker.
10.00, 5 sec	Final "mark" commences.
10.00, 25 sec	Final "mark" ends.
10.01	Transmitter back to traffic.
17.45 to 18.01	Repeat as above.

This program has been transmitted twice daily by the new equipment since 1 April 1960.

ACKNOWLEDGEMENT

It is a pleasure to record the considerable efforts made by colleagues at the Post Office Research Station and in the External Telecommunications Executive (Rugby) in meeting the opening date for the new time service.

Book Review

"Statistical Methods in Radio Wave Propagation." Proceedings of a Symposium held at University of California, Los Angeles, June 1958. Edited by W. C. Hoffman. Pergamon Press, Ltd., London. xiii + 334 pp. 134 ill. 90s.

This book brings together the papers read at a Symposium held by the University of California in 1958. A mere reading of the titles of the papers immediately dispels any notion that here will be found a balanced and progressive development of the statistical method as applied to the study of radio-wave propagation.

The various papers are contributed, in the main, by radio physicists and mathematicians; despite the wealth of data provided, the radio-communications engineer will not find much of immediate profit, at least on a first reading. Nevertheless, there is a considerable amount of information to be gained from this book by those who have the time to look for it, particularly in that vaguely defined field where the interests of the radio engineer and the ionospheric or tropospheric physicist overlap.

It is possible to pick out one or two papers of interest to the radio-communications engineer. One by D. S. Palmer, though unfortunately a theoretical study only, deals with the statistics of breakdowns in multi-section radio-relay links—a subject of considerable practical importance. Another, by E. L. Crow and D. H. Zacharisen, is a com-

prehensive study of the error in prediction of F2-layer maximum usable frequencies (m.u.f.s) by world maps based on sunspot number. The authors conclude that sufficient world-wide data have now been accumulated to warrant the preparation of semi-permanent m.u.f. world charts, with only a 12-month running average sunspot number to be determined. This massive study may well, however, lose something of its value if a more appropriate index, related directly to the state of the ionosphere rather than to sunspot number, is to be internationally accepted.

There is a useful paper on diversity statistics in scatter propagation, and an interesting though brief comment on the applicability of the log-normal distribution law to radio atmospherics. A paper by W. S. Ament makes some attempt to evaluate multiple-scattering (rather than scattering from a single common volume) as the cause of long-distance tropospheric propagation—an approach which in the reviewer's opinion has long been overdue.

This volume, of course, must be considered as a book of reference, mainly for the scientist. The disappointment that must come to the communications engineer who reads it is, in fact, a consequence of the vast amount of detailed research that is being conducted, using radio methods, into the earth's atmosphere. Much of this research is not designed to be of direct application to commercial radio-communications and, for this reason, it is almost inevitable that a symposium of this nature will include much information of no direct or immediate engineering use.

J. K. S. J.

A Tester for Outlets from 2-Motion Selector Banks

U.D.C. 621.395.124:621.395.342.22

MANUAL testing of selector bank outlets is a slow process. Nevertheless, such tests are of definite value because many of the faults found would otherwise remain undetected. A tester (TRT 82) has now been designed to test automatically the bank multiple outlets of 100-outlet or 200-outlet pre-2,000-type, 2,000-type or 4,000-type group and 1st code selectors. The tester comprises a control box connected by a plug-ended cord to a 2-motion selector mechanism. It makes tests on each outlet of a selector bank in turn, for continuity, correct polarity and contact with other outlets or earth.

TESTING CIRCUIT

The basic circuit for testing each outlet is shown in the figure. Before an outlet is seized, the P-wire is tested to ensure that the outlet is not engaged. If the outlet is free it is seized by connecting together the negative and positive wires. At the same time the P-wire is guarded by an earth connected from the tester.

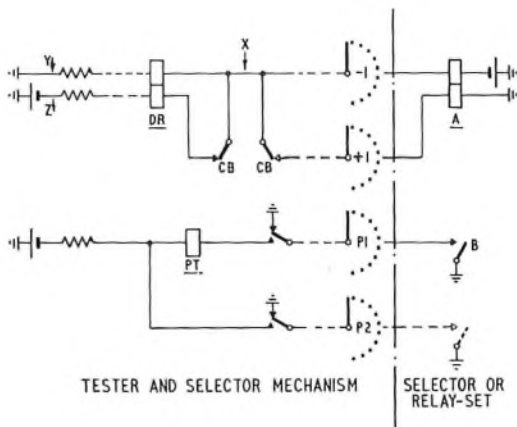

TESTING ELEMENT OF THE BANK-OUTLET TESTER

In preparation for testing an outlet, the battery and earth connexions to the differential relay DR are completed, but, because the windings are connected in opposition, the relay does not operate. Each winding of relay DR and its series resistor have been designed so that the resistance between XY and the potential at point X is approximately 25 volts. A fault-free outlet should also present balanced conditions between the negative and positive

wires so that when seized and extended to point X the currents in the windings of relay DR will not change sufficiently to operate relay DR. The resistors in series with the windings of relay DR reduce its sensitivity to prevent its operation to the current which will flow in the coils of relay DR when the maximum permissible difference in resistance between the windings of relay A in the selector or relay-set is encountered. A fault which results in an out-of-balance condition between the negative and positive wires of the outlet will cause relay DR to operate and light a lamp indicating "positive or negative wire contact or one wire disconnected".

A reversal of the negative and positive wires, or a disconnexion of both wires, will also not disturb the potential at point X. To test for these, therefore, the battery-connected coil of relay DR and the positive wiper of the outlet are disconnected by the operation of relay CB. Relay DR should then operate in series with relay A in the selector or relay-set, and if it fails to do so a lamp is lit indicating "positive and negative wires reversed or both wires disconnected".

The P-wire of a 3-wire outlet is tested by detecting the guarding earth returned from the selector or relay-set. When testing the odd-numbered outlet of a pair, the P-wire earth causes relay PT to operate. Later, when the even-numbered outlet is tested, the P-wire earth releases relay PT. Absence of the busying earth is indicated by lighting a "P-wire disconnected" lamp.

MISCELLANEOUS FACILITIES

In addition to the fault lamps, lamps are provided and are lit to show whether an odd-numbered or even-numbered outlet is being tested, when a busy outlet is encountered and when the test cycle is complete.

Under key control the tester can be arranged to step over busy outlets, thus permitting a quick test to be made of free outlets although, under these conditions, faults which result in permanently engaged outlets, such as contacts between negative and positive wires, will not be discovered. Other keys are provided to enable 2-wire outlets on pre-selected levels to be tested.

The tester is primarily intended for use following major regrading work and for this purpose the selector mechanism is jacked into the last position of the bank multiple. The tester can also be used for verifying the outlet connexions of a selector bank in any position of the multiple.

H. J. T.

Book Received

"Fundamentals of Electronics." E. N. Lurch. John Wiley & Sons, Inc., New York, and Chapman & Hall, Ltd., London. xiv + 631 pp. 504 ill. 66s.

This book, which has been planned to meet the need of the technician, is intended as an introduction to the field of electronics as a whole. It is intended to provide the

background in fundamentals that is necessary for the study of the more specialized aspect of electronics, such as communications, industrial electronics, television, micro-waves, or computer systems. It is not the author's intention, however, to prepare the reader to handle the design calculations and original derivations that are the premise of the electronic engineer. The nomenclature and symbols used throughout do, naturally enough, reflect the American origin of this book.

Time Assignment Speech Interpolation (T.A.S.I.)

C. E. E. CLINCH, B.Sc.(Eng.), A.M.I.E.E., F.S.S.†

U.D.C. 621.395.43

The high cost of very long submarine cable systems makes it necessary to exploit them to the full. The system described enables the number of simultaneous conversations that can be transmitted to be greatly increased by taking advantage of the fact that, during an average telephone conversation, each of the talkers is silent for about 60 per cent of the time. By very rapid switching of the telephone channels this otherwise idle time is used to provide additional speech paths.

INTRODUCTION

DURING a normal telephone conversation each participant usually speaks for only about 40 per cent of the time. The remaining time is spent in listening and waiting. Thus, on average, for about 36 minutes during each hour that a channel is engaged it is not in use for carrying information. By rapidly switching channels between talkers it is possible to use this idle time. Such a process cannot be used with transmission systems having capacity for only a few simultaneous conversations, since the probability of too many talkers wanting channels at the same time would be too high, but, as the number of talkers and channels increases, such interpolation of speech "bursts" becomes possible. This technique is known as Time Assignment Speech Interpolation (T.A.S.I.),^{1,2} because channels are assigned to talkers on a time-sharing basis as they require them

† Main Lines Development and Maintenance Branch, E.-in-C.'s Office.

and the speech bursts of one talker are interpolated with those of another.

The equipment required is complex and costly, but the introduction of very long submarine cables such as the transatlantic ones has made the development of such a technique worthwhile. The Bell Telephone Laboratories have developed suitable equipment and this has been manufactured by the Western Electric Company. The first equipments have been installed in White Plains (New York) and in London.

T.A.S.I. equipment is like an electronic exchange with only one set of junctions, but it needs to work much faster. When a subscriber is connected to a trunk into T.A.S.I. equipment, nothing happens until he starts to talk. When speech is detected by the equipment, it hunts for a disengaged channel, signals over the circuit to the distant end, and then establishes the through connexion. All this has to be achieved in the minimum of time, since speech signals are lost during this setting-up period. The present design of equipment sets up the connexion in about 20 ms if a free channel is available.

THE LONDON INSTALLATION

The main suite of the T.A.S.I. equipment installed in London is shown in Fig. 1. There are 17 racks of equipment, including maintenance and test racks. The main suite consists of 12 racks, each of which is 11 ft 6 in.

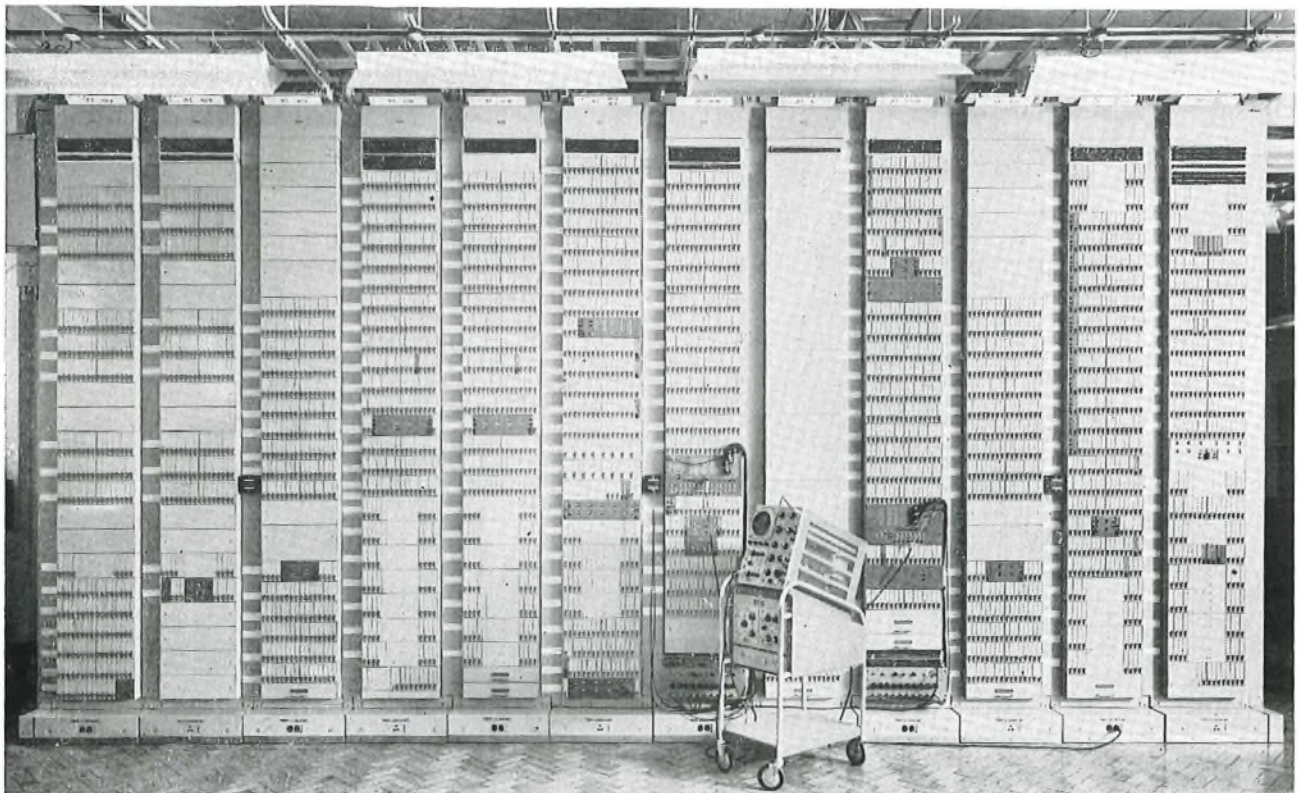
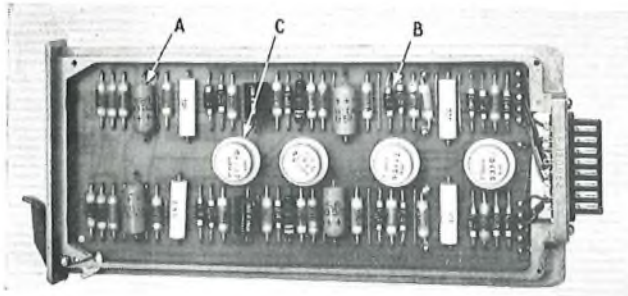

FIG. 1—THE MAIN SUITE OF T.A.S.I. EQUIPMENT IN LONDON



A—Tantalum electrolytic capacitor B—Diodes C—Transistors
The plug contacts are gold plated

FIG. 2—TYPICAL T.A.S.I. PRINTED-CIRCUIT CARD

high. Most of the circuits are on printed-circuit boards, of which there are 116 different types. A typical board is shown in Fig. 2. About 9,000 transistors and 20,000 crystal diodes are used in each terminal.

The present equipment is designed to interpolate 36 telephone channels among 96 input trunks although, with present measured speech activity, it is expected that not many more than 72 talkers could be served by these 36 channels. In addition, one channel is required for control purposes.

The power requirements of the London installation are 125 amp at + 24 volts and 80 amp at - 24 volts. In addition, small currents at + 130 volts and - 48 volts are required for alarm and control purposes. Because of the possibility that T.A.S.I. equipment would be affected by short-duration noise pulses injected from other sources, separate batteries and float charging plant have been provided.

T.A.S.I. was brought into use early in April 1960, to provide more circuits urgently because of a cable fault, and it has been in continuous service since 1 May, although testing was not completed until 1 June. At the present time only 25 channels of the transatlantic telephone cable can be made available for T.A.S.I. and 47 trunks are being derived from these 25 channels.

DESCRIPTION OF EQUIPMENT

Speech Detectors

An important component of the T.A.S.I. equipment is the speech detector. The parameters of the speech de-

tor influence the overall system performance considerably. The objective of the design is that the equipment should detect speech rapidly and not cause breaks between syllables; at the same time it should not operate to noise. The speech detectors being used operate to a signal of -40 dbm* or greater in about 5 ms and remain operated for about 250 ms after the signal ceases if it has lasted more than 50 ms. This feature is called "delayed hangover." If the signal is shorter than 50 ms then the speech detector has a hangover of only 15-30 ms. Echo suppressors are provided on all the trunks associated with T.A.S.I., but these suppressors do not act fast enough to prevent some signals reaching the speech detector on the transmit side due to received signals travelling across the 2-wire/4-wire terminating set. To prevent such signals seizing a channel unnecessarily the speech detector on the transmit side of the trunk is reduced in sensitivity by about 13 db when signals are present on the receive side.

Switching Principles

The main switches in the T.A.S.I. equipment are time-division-multiplex switches, the principles of which are illustrated in Fig. 3. Each incoming wave is sampled at twice its upper frequency (i.e. 8 kc/s) and the resultant amplitude-modulated pulses from each of the trunks are interleaved on a common highway. The channel gates are opened in sequence so that the samples from any one trunk are collected through one channel gate. The original waveform is reconstructed from the samples by passing them through a low-pass filter.

Circuit Operation

A simplified diagram of the equipment is shown in Fig. 4. The heart of T.A.S.I. equipment is a code generator which continuously produces code numbers in a 6-digit binary code for the 36 channels that can be connected to the equipment. Each such channel code recurs every 125 μ s, i.e. 8,000 times/second. The same generator also produces codes for the input trunks up to a maximum of 128 trunks, using a 7-digit binary code. Each input-trunk code recurs every 500 μ s, i.e. 2,000 times/second.

The channel-code-generator output controls the

*dbm—decibels relative to 1 mW.

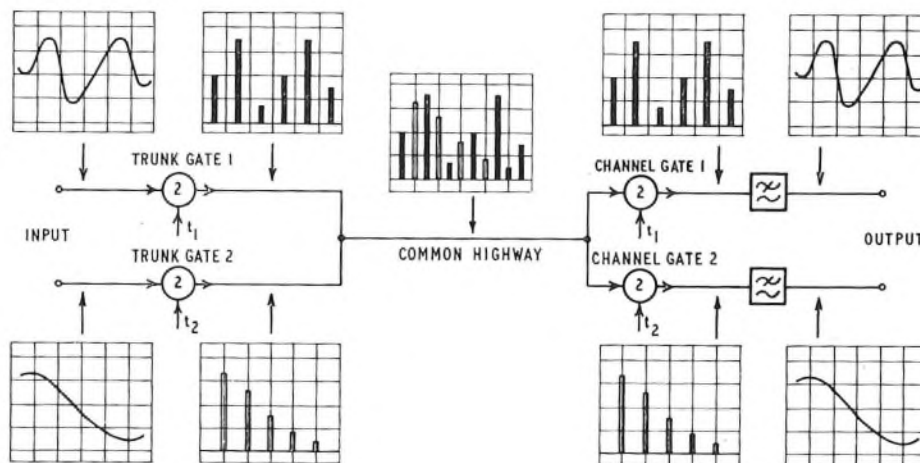

t_1 —a series of pulses occurring at fixed intervals
 t_2 —a series of pulses occurring at the same periodicity as t_1 but commencing later by an amount equal to half the time interval

FIG. 3—PRINCIPLE OF TIME DIVISION MULTIPLEX

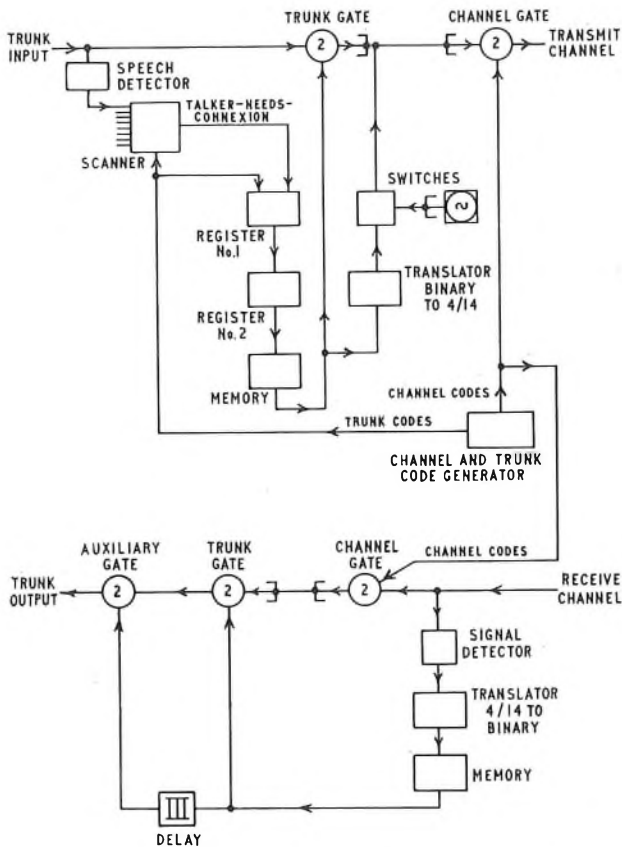

Note: 14 oscillators are required

FIG. 4—SIMPLIFIED BLOCK SCHEMATIC DIAGRAM OF MAIN CONNECTING CIRCUITS

opening of the channel gates so that each channel gate is opened in turn for $2.2 \mu\text{s}$ every $125 \mu\text{s}$.

The input trunk-code generator scans the speech detector associated with each trunk 2,000 times/second and, whenever a trunk is found on which speech has started since the previous scan, the code number of that trunk is written into a temporary store (Register No. 1) for at least $3.47 \mu\text{s}$. If there is no other code waiting to be served, then the code is transferred to the next store (Register No. 2) in the queue. The queue control is informed of the availability of each channel in turn. Some channels will be engaged talking, some signalling and some in the process of being disconnected, while others will be available for new talkers. When there is a trunk code in the queue, as soon as a channel is found to be available the trunk code is written into the memory in such a way that it is asso-

ciated with the available channel. Thus, until disconnection takes place, each time the gate of that particular channel is opened by the channel-code generator the code of the trunk allotted to that channel appears at the output of the memory.

The trunk code at the memory output is translated from binary code into a selection of 4 out of 14 tones in the frequency range 615–2,419 c/s. A 12 ms burst of tone is transmitted on the channel via the channel gate.

At the end of the signalling-tone burst the trunk code at the output of the memory opens and closes the trunk gate in synchronism with the channel gate. This switches the trunk through to the channel to which it has been allocated for $2.2 \mu\text{s}$ every 125 ms. The original waveform is restored by a low-pass filter at the channel-gate output.

At the receive end the signalling tone burst is detected, checked for validity and timed, and then translated back to binary form. The trunk code is then written into the receive memory so that it is associated with the channel on which the code was received. Thus the receive channel gate and trunk gate are both opened in synchronism, as at the transmit end. The initial switching through of the channel causes noticeable clicks, and the lack of line noise when the channel is disconnected would be disconcerting to a listener. An auxiliary gate is therefore provided, the opening of which is delayed so that the clicks are not heard. Also, a noise gate (not shown in Fig. 4) feeds in noise at an average level when the auxiliary gate is shut.

The overall time between the initial detection of speech and the establishment of the through connexion causes about 20 ms to be clipped off the speech burst used to establish the connexion.

The T.A.S.I. equipment does not disconnect any speaker unnecessarily. It requires two channels to be available to ensure meeting demands for channels from new talkers. Every $125 \mu\text{s}$ the number of channels available is counted and, if there are two or more, no further action is taken. If, however, there are less than two a search is made and the first talker who is found not to be talking at that instant, although he is connected to a channel, is disconnected by the following process, the circuits concerned being shown in simplified form in Fig. 5.

The trunk code is erased from the transmit memory (Fig. 4), thus preventing the trunk gate from being opened. Also, the code of the channel required to be disconnected is registered and the code number of the channel is translated from binary form to a 4-out-of-15 code (Fig. 5), and a burst of 4 tones out of 15 (i.e. the same number, 14, as for connect signalling plus an additional tone of 2,501 c/s) is sent to the distant end over a special control channel. The receipt of this 4-tone pulse and its code is checked for validity and the trunk code is erased from the receive memory so that the

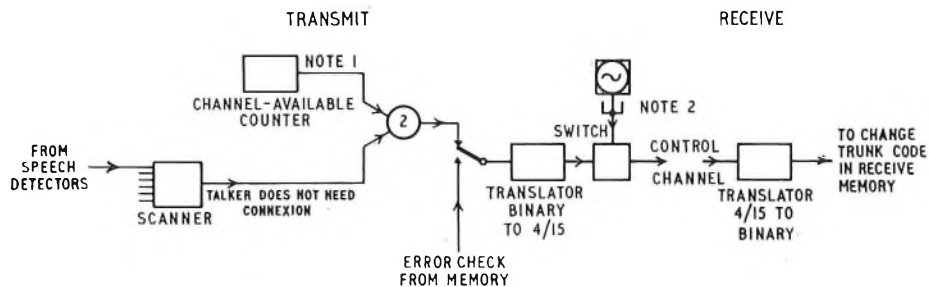

Notes: 1. An output is present when less than two channels are available 2. 15 oscillators are required

FIG. 5—SIMPLIFIED BLOCK SCHEMATIC DIAGRAM OF MAIN DISCONNECTION AND ERROR-CORRECTION CIRCUITS

trunk is no longer associated in the memory with that particular channel. This prevents the trunk gates of the receive end from opening, hence disconnecting the trunk from the channel and connecting noise to the trunk in place of the channel.

Error Correction

Because of the confusion that would obviously arise if incorrect trunk and channel associations were made, the control channel, when not used for sending disconnection information, is used for error correction. The transmit memory entry is checked for each channel in turn, 1-4 seconds being taken to check all channels. The time taken is dependent upon the number of disconnections that interrupt the error-check procedure. First the channel code of the channel being checked, and then the trunk code written in the transmit memory against that channel, are translated from binary into the 4-out-of-15 code, and two bursts of tone are sent on the control channel, one after the other. At the receive end the codes are re-formed into binary code, and the trunk-code entry in the receive memory against the channel is corrected if found to differ from the error-check information.

Alarm System

A complex alarm system is necessary because many of the circuits do not produce regular patterns of operation that would enable simple alarms to be designed. In addition to individual alarms on parts of the equipment whose functions make it possible to provide such alarms, an overall test is performed by sending pulses of 1,000 c/s tone of 0.7 second duration every 5 seconds on looped test trunks and checking that these tone pulses are received back at the sending end.

STATISTICS OF SPEECH

To enable the effects of a T.A.S.I. system to be better understood, some facts about speech as it exists at the output of the T.A.S.I. speech detectors should be known and the characteristics of speech appreciated.

A syllable when pronounced lasts about 200 ms. The average speech burst is about 1 second. In a 5-minute call there will be about 120 speech bursts from each subscriber. During an average busy hour about 60 of these speech bursts will be used to establish new connexions.

EFFECTS OF T.A.S.I. ON SPEECH

The major effect that T.A.S.I. has on speech is the clipping of some of the speech bursts. This clipping can be considered in two parts:

(a) The "initial clip" caused by the need for a signalling burst to precede all speech bursts used to establish a connexion.

(b) "Freeze out," which occurs when more talkers require channels than there are channels in existence. The occurrence and duration of freezing out is a random function.

The initial clip could be eliminated by the provision of delay in the audio path between the speech detectors and the T.A.S.I. switches. At the present time this is considered to be unnecessary; the 20 ms clip is not noticed by the listener. If, however, two or more T.A.S.I. systems were coupled in tandem then the provision of delay networks might have to be considered.

Subjective tests have been made of "freeze out" and it has been found that the effect of the "freeze-out fraction" (i.e. the ratio of the time frozen out to the total active time expressed as a percentage) is barely perceptible at 0.1 per cent, just noticeable at 0.5 per cent and objectionable at 2.0 per cent. The freeze-out fraction can be adjusted by controlling the ratio of trunks to channels. At the present time this ratio is 2 : 1 and, with the present average activity, a mean freeze-out fraction of 0.5 per cent or better is being maintained. This means that in a 10-minute call 5-10 freeze outs would be experienced, one of which would last more than $\frac{1}{8}$ second.

EFFECT ON LINE SYSTEM MAINTENANCE

When channels are switched rapidly between talkers it is important that the overall transmission losses and the noise levels of the different channels used should all be similar. Individual channel faults no longer affect only one circuit but all the circuits connected to the T.A.S.I. equipment. A very high standard of line maintenance is therefore required; short breaks of a few seconds could result in the two terminals getting out of step. In the event of a fault the alarm system associated with T.A.S.I. switches the equipment from service and restores as many trunks as possible straight through. This, however, disconnects the remaining calls, and the restoration of service may take a few minutes.

If channels have to be removed from T.A.S.I., for example, for use temporarily as program circuits, it is essential to maintain the trunk/channel ratio by busying the trunks from the switchboard. If this were not done the talkers would experience excessive freeze out.

EFFECT ON SIGNALLING

It is essential that activity caused by signalling should be kept to a minimum, otherwise the number of talkers must be reduced. In addition, any signalling-system design must recognize the characteristics of the T.A.S.I. system and allow for clipping and freeze out. A separate article in this issue introduces the problems of signalling systems for use with T.A.S.I.³

CONCLUSIONS

T.A.S.I. has been successfully introduced on the transatlantic service and has made an increased number of trunks available at an economic price. There is still development work that can be done but, without doubt, this technique will ultimately be used throughout the world to increase the capacity of long submarine-cable links.

ACKNOWLEDGEMENTS

The author thanks the American Telephone and Telegraph Company for permission to publish this article. In addition, the willing help given by the Bell Telephone Laboratories staff working on T.A.S.I. is greatly appreciated.

References

- ¹O'NEILL, E. F. T.A.S.I. *Bell Laboratories Record*, Vol. 37, p. 83, Mar. 1959.
- ²BULLINGTON, K., and FRASER, J. Engineering Aspects of T.A.S.I. *Bell System Technical Journal*, Vol. 38, p. 353, Mar. 1959.
- ³WELCH, S. Signalling Arrangements for Dialling over the Transatlantic Telephone Cables. (In this issue of the *P.O.E.E.J.*)

Signalling Arrangements for Dialling over the Transatlantic Telephone Cables

S. WELCH, M.Eng., A.M.I.E.E.†

U.D.C. 621.395.63:621.395.51

The use of Time Assignment Speech Interpolation on transatlantic and other transoceanic telephone cables has considerable influence on the signalling techniques used. This article describes in general terms the signalling arrangements agreed for use on the transatlantic telephone cables when semi-automatic operation is introduced in 1963.

INTRODUCTION

IT is planned to introduce semi-automatic operation over the transatlantic telephone cables in the middle of 1963 between the United Kingdom and U.S.A. (TAT-1 and TAT-3), the United Kingdom and Canada (CANTAT), and the U.S.A. and France and the Federal German Republic (TAT-2). Operators in these countries will then be able to dial over the cables and set up calls without the assistance of operators in the distant countries. International switching units are now being designed for this purpose and will be installed in London, New York, Montreal, Paris and Frankfurt.

It is clearly desirable that the facilities and the signalling technique should be the same for all the transatlantic cables, and this introductory article describes the general signalling arrangements agreed between the American Telephone & Telegraph Company, the Canadian Overseas Telecommunication Corporation, and the United Kingdom, French and German telephone administrations. The type of switching equipment in the various international switching units can differ, depending on national preferences, providing the international facilities given are the same.

Later articles will describe in detail the signalling and switching arrangements of the London international unit.

INFLUENCE OF SPEECH INTERPOLATION EQUIPMENT ON THE SIGNALLING TECHNIQUE

The signalling system is required to be compatible with the use of Time Assignment Speech Interpolation (T.A.S.I.)* equipment. Due to the time taken to associate a trunk circuit with a cable channel, T.A.S.I. clips some 17 ms off a signal even when there is a free channel available. Under busy traffic conditions, a free channel may not be immediately available, and the possibility of a partial, or even a complete, "freeze-out" of a signal arises. The initial clip is of no great significance to line signalling as, here, the signals can be of relatively long duration, but the initial clip cannot be tolerated for fast digital signalling. Hence, it is essential that a T.A.S.I. channel should be previously associated for digital signalling. This arrangement naturally eliminates the possibility of freeze-out of the digital signals.

To avoid excessive partial, or total, freeze-out of signals, all line signals are required to be of sufficient duration to assure T.A.S.I. trunk and channel associa-

tion. In the signalling arrangement adopted, this requirement is met by the addition of 500 ms to the duration of pulse signals, and by the adoption of continuous‡ tones for some of the signals.

Some of the signals take advantage of the hang-over time of the T.A.S.I. speech detectors to maintain T.A.S.I. channel association during gaps between successive signals. This is most important in, for example, the digital signalling, as here there are gaps between successive signals and it is essential that the T.A.S.I. channel association should not be broken, otherwise T.A.S.I. channel-association time would require to be added to the digital signals and inadmissibly slow signalling would result.

The purpose of T.A.S.I. is to increase the traffic-carrying capacity of the cables. In other words, to increase the permissible calls during the busy hour. When parts of T.A.S.I. are occupied with signalling, those parts cannot be used for speech. Thus, the less time that is occupied by signalling the greater will be the advantage of T.A.S.I. in terms of permissible calls during the busy hour.

The total efficiency, the number of calls handled per hour, depends on the time required for signalling, and on the signalling activity, which is defined as the proportion of the signalling time there is signalling energy on a T.A.S.I. channel. For example, if, in a signal pulse of 850 ms duration, 500 ms is used for T.A.S.I. channel association, then 350 ms of the signal energy will be transmitted over the channel; the signalling time will be 850 ms and the signalling activity will be $350/850 = 41$ per cent.

The significance of the signalling activity will be readily understood because a channel, in either direction, engaged in transmitting signal energy (or held by speech detector hang-over during gaps between signals) cannot be used for transmitting the speech bursts. The significance of the signalling time is, perhaps, not so obvious. It arises due to parts of the T.A.S.I. common-control equipment being engaged immediately, and during the whole time (the signalling time), the relevant speech detector is energized by the signal applied at the outgoing end of the "Go," or the "Return," path. The parts of the control equipment so engaged during the signalling time cannot be used to control the transmission of speech bursts over the T.A.S.I. channels.

It is thus clearly desirable that signalling be as rapid as possible in the two transmission directions over the T.A.S.I. link, and for this reason the number of signals has been kept to a minimum consistent with the facilities to be given. It is unfortunate that, due to the long T.A.S.I.-channel-association signalling time, the line signalling has to be relatively slow. In an effort to minimize the total signalling time and activity, the digital signalling is being made as rapid as possible. For this reason, multi-frequency coded digital signalling is being adopted and the high speed is facilitated by associating the T.A.S.I. trunk and channel prior to, and maintaining this association during the whole time of, digital signalling.

†Telephone Exchange Systems Development Branch, E.-in-C.'s Office.

*CLINCH, C. E. E. Time Assignment Speech Interpolation (T.A.S.I.). (In this issue of the *P.O.E.E.J.*)

‡The tones are continuous in that they are transmitted until, under normal conditions, acknowledgement signals are received from the distant end to cease them.

GENERAL FEATURES OF THE SIGNALLING TECHNIQUE

No existing international or national semi-automatic signalling system is compatible with T.A.S.I. and, thus, a new system is required for the transatlantic cables. In the design of the new system, reasonable account has been taken of national practices both in Europe and North America in respect of the facilities provided and the signalling techniques existing. Bothway working and 4-wire signalling will be used.

The signalling equipment will be in two parts:

(a) line signalling to control the seizure, supervision and release, and,

(b) inter-register signalling for the transmission of the digital information and other signals convenient to pass between registers.

Considerable study was made of fast digital-signalling methods and it was concluded that the fastest technique with convenient detecting arrangements would be to use one signal pulse to denote a digit. A two-out-of-six frequency signalling code will be used, giving a total of 15 combinations. Ten will be used for the digital signalling to denote the particular of the 10 possible values, 1 to 0, of the digit. The remaining five combinations will be available for other signals passed between the registers.

As such a technique requires 6-frequency transmitting and receiving arrangements, it is undesirable to provide separate equipment for each circuit. The international switching units will be register controlled, and as, like the registers, the digital-signalling equipment is only required for a short time on each call, it is convenient to incorporate it in the registers as common equipment. This technique is known as "inter-register signalling." The use of digital-signalling equipment separate from the line-signalling equipment removes the need to incorporate speech-immunity guards in the digital-signalling receivers since no speech can intrude when these receivers are in use. This simplifies the design of the receivers.

The inter-register signalling will be link-by-link on the transatlantic cables. The information will be transmitted in a continuous sequence between the outgoing and incoming international registers. This link-by-link signalling permits interworking with any existing or desired national or continental signalling system without complication. The alternative of end-to-end signalling to national networks, or to further transoceanic cables of the future, would result in increased signalling time and activity over the T.A.S.I. link, or links, as, assuming pulse signalling, the originating register would be required to hold the information and transmit it to transit and terminal registers under the control of backward proceed-to-send signals from these registers. Also, the design of the receiving equipment becomes more difficult and complex as the number of links in the end-to-end signalling connexion increases.

Line-signalling equipment will be provided for each circuit and will require to be protected against signal imitation by speech. Link-by-link signalling will be used, which will permit interworking with any existing, or desired, line-signalling system. The alternative, end-to-end line signalling, apart from interworking difficulties, would require the duration of the transmitted signals at the originating end to be such as to cater for the maximum foreseeable number of T.A.S.I.-equipped links in a connexion. This would result in extremely slow signalling and, with both pulse and continuous-tone signals, the signalling time and activity would be considerably increased, particularly on the early T.A.S.I. links in the

direction of signal transmission. Link-by-link line signalling allows each link to be treated separately for T.A.S.I. channel-association time and the duration of the transmitted signal is not conditioned by the maximum number of links. While the line signalling is still relatively slow, the time taken to pass signals over the whole connexion is related to the actual number of links in the connexion.

Different frequencies are being adopted for the line and inter-register signalling to avoid interference between the two systems.

LINE SIGNALLING

Table 1 shows the line-signalling code together with the transmitted-signal durations and the received-signal recognition times.

TABLE 1
Line-Signalling Code

Signal	Transmitted Signal		Recognition Time
	Frequency	Duration	
Forward Signals			
Seize	f_1	continuous	40 ± 10 ms
Forward Transfer	f_2	850 ± 200 ms	125 ± 25 ms
Forward Clear	$f_1 + f_2$ compound	continuous	125 ± 25 ms
Backward Signals			
Proceed-to-Send	f_2	continuous	40 ± 10 ms
Answer	f_1	850 ± 200 ms	125 ± 25 ms
Busy Flash (and error detected)	f_2	850 ± 200 ms	125 ± 25 ms
Clear Back	f_2	850 ± 200 ms	125 ± 25 ms
Release Guard	$f_1 + f_2$ compound	continuous	125 ± 25 ms

$$f_1 = 2,400 \text{ c/s} \quad f_2 = 2,600 \text{ c/s}$$

Functions of Signals

The *Seize Signal* initiates the seizure of the incoming equipment and association of an incoming international register.

The *Proceed-to-Send Signal* acknowledges the seize signal and initiates the pulsing out of digital information by the outgoing international register.

The *Answer Signal* indicates that the called party has answered.

The *Busy-Flash Signal* is sent from the incoming end to indicate that either the route, or the called party, is busy. It will be given for congestion conditions encountered at the international terminal or transit centre, but the return of the signal in respect of busy conditions beyond the international terminal will depend on the ability of the distant international switching unit to recognize national busy conditions. The same electrical signal will be transmitted, as a line signal, to indicate an error detected in the reception of the inter-register signals. The busy-flash (and error-detected) signal will automatically release the transatlantic link to minimize the holding time of this link, and will give a re-order signal to the controlling operator. Due to the many different forms of busy tone in the U.S.A. national network, it would be difficult to detect and convert the tones into an electrical signal for transmission over the transatlantic link, and for this reason, North America will transmit only busy tone to Europe.

The Clear-Back Signal is sent from the incoming end to indicate that the called party has cleared.

Forward-Transfer Signal. On an automatically established connexion the forward-transfer signal is sent by the outgoing operator to connect the call to an operator at the incoming international centre. When a call has been completed via an operator at the incoming international centre, the forward-transfer signal will cause this same operator to be recalled.

The Forward-Clear Signal is sent from the outgoing end when the controlling operator clears. It brings about the release of the connexion at, and beyond, the incoming international centre.

The Release-Guard Signal is sent from the incoming end in response to the receipt of the forward clear, and serves to maintain the outgoing end engaged while the incoming equipment is releasing.

Comments on Line Signalling Technique

It will be noted from Table 1 that, except for the forward-clear and release-guard signals, all signals consist of a single frequency. All pulse signals have a duration of nominally 850 ms, of which 500 ms is allowed for T.A.S.I. channel association. Except for the recognition time (40 ms) of the seize/proceed-to-send signal sequence, which can be short as this sequence is not subject to signal imitation by speech and rapid seizure is desired to minimize the probability of dual seizure on bothway working, all recognition times are the same (125 ms). This contributes to simple relay-set design. The recognition time of the compound forward-clear/release-guard sequence could be less than 125 ms, but for uniformity and simple design 125 ms is adopted.

Automatic access to the outgoing international circuits will be incorporated. Compared with manual access, automatic access reduces the probability of dual seizure on bothway working, and facilitates access to the circuits in predetermined order. The outgoing operator will key the numerical information, required to establish the call, into the outgoing international register and seizure of the transatlantic link will be initiated by the outgoing register when the information is completely stored. This arrangement reduces T.A.S.I. signalling activity compared with the seize signal being sent prior to, or during, the storage of information by the outgoing register.

Pulse-type inter-register signalling necessitates a proceed-to-send signal from the incoming end to control the pulsing out from the outgoing register. Thus, signalling systems require a subsequent backward signal after the forward seize signal and before the register commences to pulse out. The forward seize and the backward proceed-to-send signals could be pulse type, but this would slow the signalling when the T.A.S.I. system was lightly loaded, as both forward and backward T.A.S.I. channel-association times of 500 ms each would have to be allowed under all conditions of loading. When T.A.S.I. is lightly loaded, the channel-association time will almost always be less than 500 ms, and while advantage of this cannot be taken with fixed-pulse-type signals, continuous signals will permit advantage to be taken. For this reason, the so-called "compelled" type signalling is adopted for the seize/proceed-to-send sequence. In this technique all signals are continuous and T.A.S.I. channel association is always assured in the actual time required for this function. The continuous seize signal seizes the incoming equipment and, when an incoming international register

has been associated, compels the return of the continuous proceed-to-send signal from the incoming end. Recognition of the proceed-to-send signal at the outgoing end compels the cessation of the continuous seize signal, and the recognition of the cessation of the seize signal at the incoming end compels the cessation of the proceed-to-send signal. It will be seen that the proceed-to-send signal also combines the function of seize acknowledgement.

The outgoing register pulses out its stored information in a continuous sequence. A silent period of 20–100 ms is arranged between the cessation of the seize signal and the beginning of the register pulse-out. T.A.S.I. channel association is maintained by the speech-detector hang-over during this interval, and this, combined with the speech-detector hang-over maintaining the channel association during the gaps between successive digital signals, avoids the inclusion of T.A.S.I. channel-association time in the inter-register signalling.

The use of different frequencies for the seize (2,400 c/s) and the proceed-to-send (2,600 c/s) signals facilitates the recognition of a dual seizure on bothway working. An outgoing end transmitting the 2,400 c/s seize tone and subsequently receiving 2,400 c/s instead of the expected 2,600 c/s proceed-to-send signal will recognize that a dual seizure has occurred. Appropriate action can be taken automatically and lock-ups will not arise.

In the release sequence, signalling systems require a backward release-guard signal after the forward-clear signal to maintain the outgoing end engaged while the incoming equipment is releasing. Here again, pulse signals could be adopted for the two signals, but, for the same reasons that compelled signalling is being adopted for the seize/proceed-to-send sequence, compelled signalling is also being adopted for the forward-clear/release-guard sequence. The recognition of the forward-clear signal at the incoming end compels the return of the release-guard signal to the outgoing end, and also initiates the release of the equipment at the incoming end. Both continuous tones persist while the incoming equipment is releasing, and the outgoing end is maintained engaged. The release-guard signal is disconnected at the incoming end when the incoming equipment is released, and the recognition of this cessation at the outgoing end disconnects the forward-clear signal and the outgoing end is marked free.

The forward-clear/release-guard sequence consists of compound signals (2,400 + 2,600 c/s) to obtain frequency discrimination between this sequence and the other signals. Release must be possible under all conditions of a call. Adoption of single-frequency signals for the forward-clear/release-guard sequence would have necessitated timing discrimination between this sequence and the other single-frequency signals. This would slow the release sequence, which is most undesirable. Typically, the incoming equipment would be required to time discriminate between the forward-clear and the forward-transfer signal. As the forward transfer is a T.A.S.I. pulse signal, almost all of the 850 ± 200 ms transmitted signal will be received at the incoming end when the T.A.S.I. system is lightly loaded. To discriminate against this, the recognition time of the forward clear would require to be of the order 1.5–2 seconds; this would result in extremely slow release, which is inadmissible.

All the remaining line signals are pulse type. Unlike the seize and forward-clear signals, the forward-transfer, answer, busy-flash, and clear-back signals do not

necessitate subsequent return signals. Thus, the use of compelled-signalling technique would only be considered as a means of reducing the likelihood of errors, and should take account of the reactions of the technique on T.A.S.I. signalling time and activity. Under T.A.S.I. conditions there is little to choose between unacknowledged pulse and compelled signalling from the reliability aspect. The compelled-signalling technique, however, has considerable reaction on signalling time and activity. If the T.A.S.I. channel is associated in less than 500 ms of the 850 ms unacknowledged pulse signal, signalling speed advantage cannot be taken of this. Under light T.A.S.I. loading conditions, when a channel is associated almost immediately, compelled signalling would have a speed advantage over the unacknowledged-pulse technique. Under heavy T.A.S.I. loading conditions, the channel-association time will be long rather than short, and could be 500 ms for both the primary forward signal and the acknowledgement backward signal. In this event, the unacknowledged-pulse technique has the speed advantage, all the more so on cable circuits with long propagation times. As the main concern is permissible calls during the busy hour, the compelled technique would result in slow signalling during the very period it is desired that the signalling should be fast. For this reason the unacknowledged-pulse technique is adopted for the signals concerned. Further, if timing discrimination is to be avoided, the compelled technique for all the line signals would require more than two line-signalling frequencies.

It will be noted from Table 1 that there is frequency discrimination between all the line signals except busy-flash and clear-back, which are both 2,600 c/s. As the busy-flash will be received without an answer signal having been received and the clear-back signal will have been preceded by an answer signal, the answer signal is used to bring about a change of circuit condition in the outgoing equipment and timing discrimination between the busy-flash and the clear-back signals is avoided.

All the continuous signals of the two compelled sequences are forcibly disconnected after 15 ± 5 seconds to avoid excessive T.A.S.I. signalling time and activity under fault conditions.

INTER-REGISTER DIGITAL SIGNALLING

Table 2 shows the two-out-of-six frequency inter-register signalling code.

Each digit is represented by one pulse of two frequencies transmitted simultaneously and the whole digital transmission consists of a number of such pulses separated by short fixed gaps.

As stated previously, all the digital information is stored in the outgoing international register before the seize signal is sent over the cable circuit. The controlling operator terminates the digital key-pulsing into the register by an ST pulse. This constitutes a start condition to the outgoing register and, when received, the register initiates the transmission of the seize signal. A forward T.A.S.I. channel, associated on the seize signal, is not released until all the digital information has been sent, the outgoing register sending this in a continuous sequence until completely discharged, the register then releasing. The T.A.S.I. speech-detector hang-over maintains the channel association during the gap (20–100 ms) between cessation of the seize signal and the beginning of digital transmission, and during the 55 ms gaps between successive multi-frequency digital pulses.

TABLE 2
Inter-Register Signalling Code

Digit	Frequencies (c/s) (Compounded)
1	700 + 900
2	700 + 1,100
3	900 + 1,100
4	700 + 1,300
5	900 + 1,300
6	1,100 + 1,300
7	700 + 1,500
8	900 + 1,500
9	1,100 + 1,500
0	1,300 + 1,500
KP ₁ (terminal)	1,100 + 1,700
KP ₂ (transit)	900 + 1,700
Code 11	700 + 1,700
Code 12	1,300 + 1,700
ST	1,500 + 1,700

Duration of signals: KP₁ and KP₂, 100 ± 10 ms.
All other pulses, 55 ± 5 ms.
Interval between all pulses: 55 ± 5 ms.

The numerical digital transmission from the outgoing register is preceded by a KP pulse and is terminated by an ST pulse.

The KP (Key-Pulse) Signal is sent to prepare the incoming international register for the receipt of the numerical information. If desired by an international centre, this signal may also be given a switching function, and for this purpose two different KP signals are provided:

(a) Terminal, KP₁, which can be used to bring about conditions at the incoming end so that equipment exclusively used for switching the call to the national network of the incoming country is brought into circuit, and,

(b) Transit, KP₂, which can be used to bring into circuit at the incoming end the equipment used exclusively for switching the call to another international exchange.

The ST Signal is an indication to the incoming international register that all the digital information has been sent by the outgoing international register. It thus constitutes a stop condition, i.e. digital signalling ceased, to the incoming side of the incoming register, and, if desired, can be used as a start condition to the incoming register to start the further stages of setting up the call.

At the outgoing end the equipment will send the codes in use in the distant country to obtain access to the manual-board services. For calls incoming to Europe, the "Code 11" and "Code 12" operators (so termed because signals performing similar functions are the 11th and 12th, respectively, of the 15 combinations provided by the C.C.I.T.T. digital signalling code) will be obtained by inter-register signals.

The Code 11 operator performs, for calls which cannot be routed automatically at the incoming international exchange, the functions of an operator in the ordinary manual service. The Code 12 operator is in principle a suspended-call operator.

The "speed" of 110 ms per digit (55 ms pulse, 55 ms gap) is necessitated at this stage by the speed limitations of existing multi-frequency equipment in North America. The United Kingdom and Europe will design multi-frequency equipment to work at a faster "speed" of 70 ms per digit (35 ms pulse, 35 ms gap), but in the first stages of transatlantic dialling, this faster equipment will be required to work to the slower "speed" of 110 ms per

digit. The faster speed will be used when the American equipment is redesigned.

As each true inter-register signal consists of two frequencies, this can be used for error detection. The incoming international register incorporates a two-and-two-only check on each pulse received. If one, or more than two, frequencies are received, an error-detected signal is returned to the outgoing end as a line signal, the transatlantic circuit is released and the operator will re-key the call. No signal is returned in the event of no error detected. This is a limited form of error detection as it does not detect an error in the number of pulse signals received.

As the number of pulse signals to be passed between the registers is not a fixed value, a check on the number of pulses received would require a backward acknowledgement signal for each forward primary signal, and thus the adoption of acknowledged-pulse working or, alternatively, compelled-code working with continuous signals. It is considered that such techniques would not achieve a desired efficiency from an error-detecting aspect and adoption is not justified if the technique gives rise to other difficulties. A more serious disadvantage would be the slow digital signalling which would result and the increase in T.A.S.I. signalling time and activity, and the

technique is not being adopted.

In the adopted arrangement it is reasoned that each signal is so short, and the inter-register signalling so rapid, that the probability of coincidence of a pulse with a false line break, preventing a transmitted signal from being received, is remote. This, and the fact that inter-register transit and terminal proceed-to-send backward signals are not required (due to the link-by-link working between international registers), leaves little reason for inter-register backward signalling and in the adopted arrangement none is incorporated.

COMMONWEALTH ROUND-THE-WORLD CABLE SCHEME

One of the transatlantic cables, that between the United Kingdom and Canada (the CANTAT cable), is the first link in the Commonwealth round-the-world cable scheme. It is desirable that all the links in the Commonwealth cable scheme should have the same signalling system as it is likely that, if not initially, speech interpolation equipment will be an ultimate requirement on all the links. The signalling arrangements described for the transatlantic cables will form a first basis for discussion in the formulation of a standard technique for the Commonwealth cables.

Wheatstone Bridge Circuit for Test-Desks

U.D.C. 621.317.733:621.395.73

THE existing method of measuring the resistance of subscribers' lines by means of the voltmeter on the test-desk is inaccurate and cumbersome. A need has long been felt for more reliable measurements, particularly with the advent of shared service, which has necessitated greater attention to earth resistance at subscribers' premises. To meet this need a new testing circuit has been adopted and will be installed on all test-desks.

A low testing-voltage is necessary to prevent possible breakdown of intermittent high-resistance faults and it was therefore decided to adopt the Wheatstone Bridge principle for the new testing circuit. This will enable loop-resistance and line out-of-balance tests to be made with speed and accuracy. The circuit finally decided upon is shown in the figure, which indicates the arrangement for measurement of earth resistance. The meter (a Microammeter No. 7) is also used for a pulse-speed and

ratio-testing circuit which will be described in a later article. Loop-resistance and line out-of-balance measurements are made in the usual way, using keys (not shown) to alter connexions as desired. Range switching is provided, enabling resistances up to 999 ohms to be measured in steps of 0.1 ohm and up to 9,999 ohms in steps of 1 ohm. Sensitivity is such that a resistance change of 3 ohms can be detected in a total of 4,000 ohms. Rectifiers (not shown) are provided to protect the meter from accidental damage.

The conventional type of bridge circuit is unsuitable for measuring earth resistance, because of the effect of earth currents. Several ways of eliminating the effect of earth potential difference were tried, including various forms of a.c. bridge, but circuit complexities, combined with operating complications, made these methods undesirable.

In the circuit shown, earth potential difference is counteracted by injecting a balancing voltage into one arm of the bridge by means of the potentiometer RV 1(A) and (B). A dual potentiometer is necessary to maintain the correct resistance balance between the two arms of the bridge as the balancing voltage is varied. The method of use is, firstly, to balance the earth potential difference using RV 1, and then to obtain a resistance balance on RV 2. Thus, only two adjustments are necessary and, at correct balance, there should be no change of deflexion on the operation and release of the key K.B.

It may be of interest to note that the four-dial rheostat (RV 2) is a new design which will also be used to supersede the portable Rheostat F.

L. W. P.

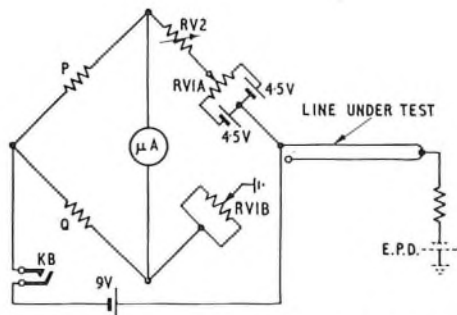

The connexions shown are for measuring earth resistance. E.P.D.—earth potential difference.

THE NEW TESTING CIRCUIT

Notes and Comments

Recent Award

The Board of Editors has learnt with pleasure of the honour recently conferred upon the following engineer:
J. H. H. Merriman .. Engineering Department .. Staff Engineer .. Officer of the Most Excellent Order of the British Empire

H. Stanesby, C.G.I.A., M.I.E.E.

On his appointment as Deputy Director of Research, Mr. H. Stanesby returns to a field with which he has been actively concerned in the past and in which his interest undoubtedly lies.

The early part of Mr. Stanesby's career was spent in the Radio Laboratories at Dollis Hill, which he entered as a Youth-in-Training in 1924; he was successful in the Inspectors' Competition in 1925 and the competition for Assistant Engineers (old style) in 1930, becoming an Executive Engineer (old style) in 1938 and an Assistant Staff Engineer in 1947.

He was intimately concerned with the development of the first long-wave transatlantic radio-telephone system, and with radio receivers for long-distance communications. Later he played an important part in developing coaxial-cable systems for multi-channel telephony. In this connexion he made valuable contributions to the art of quartz-crystal filter design, which were brought to practical fruition in the first London-Birmingham multi-channel telephone coaxial-cable system. He also led a team responsible for the development and equipment of the first London-Birmingham television cable system.

In 1951 Mr. Stanesby was promoted to Staff Engineer and assumed charge of the Radio Laboratories at Dollis Hill. In 1952 he left the research and development field and became responsible for the Radio Planning and Provision Branch of the Engineering Department. His responsibilities covered not only long-wave and short-wave radio transmitting and receiving stations, marine radio and radio aids to navigation, but also microwave radio-relay systems, which were then coming into use for television links. His work as Chairman of Study Group IX (Radio-Relay Systems) of the International Radio Consultative Committee laid the foundation for



international standardization of such systems. He has also been Vice-Chairman of the Joint Phototelegraphy Study Group of the International Radio and Telegraph Consultative Committees and has represented the United Kingdom at a number of international radio conferences. His undoubted success in the international field has been due not only to his detailed knowledge of, and interest in, technical matters, but also to his ability to create a friendly and co-operative atmosphere in international study groups.

Mr. Stanesby has been closely connected with the work of the Institution of Electrical Engineers and was Chairman of the Radio and Telecommunications Section in 1955-56. He has published a number of papers, including several on electric-wave filters, and in 1952 was awarded the Ambrose Fleming Premium of the I.E.E. for a paper which he wrote jointly with Messrs. T. Kilvington and F. J. M. Laver on the London-Birmingham television cable system. In 1953 he was awarded the City and Guilds Insignia Award for Technology in recognition of his work in telecommunications.

His many friends and colleagues not only congratulate him on a well-deserved promotion but look forward with interest to the contributions to research and development which his wide experience, energy and initiative will surely bring.

W. J. B.

J. H. H. Merriman, O.B.E., M.Sc., A.Inst.P., M.I.E.E.

On his appointment as Staff Engineer of the Overseas Radio Planning and Provision Branch, Mr. Merriman returns to the subject that opened his career when he joined the Post Office as a Probationary Assistant Engineer (old style) in 1936. After graduating in physics at King's College, London, he worked under Appleton to prepare a thesis on non-linear oscillations for his M.Sc.; and he went on to do evening work under Blackett on cosmic-ray counting.

The Post Office started him at Dollis Hill on measuring the arrival angles of short-wave pulses from the U.S.A., as a prelude to the development of the steerable aerial system M.U.S.A., still used at Cooling radio station. At the outbreak of war he was involved in schemes to trick enemy radio-navigators, and he was evacuated from London to set up and run radio laboratories at Castleton, near Cardiff. During his stay there he examined the use of frequency modulation and the (then) very high radio-frequencies for relaying multi-channel telephony and television. In fact, part of an experimental 200 Mc/s link from Dollis Hill to Castleton carried the first television programs to Wales (in 1952). Here also, in 1946, he was promoted to Executive Engineer (old style).

In 1948 Merriman was moved from the congenial air of Wales to the City's soot where, promoted to Assistant Staff Engineer in 1951, he planned and provided radio links. These involved him with the International Radio



and Telephone Consultative Committees and other international bodies, civil and military, and led to travel in Europe.

In 1954 he spent a year at the Imperial Defence College. On returning he took charge of the O. & M. Section of the Engineering Organization and Efficiency Branch, and saw work begin on the use of electronic computers. This led, in 1956, to his secondment to the Treasury as the Assistant Secretary responsible for computer work and policy in all government departments. The wide scope of this work appealed to him—as did a wide-ranging high-speed tour of American computer establishments in 1957. His pioneering achievement at the Treasury was recognized in 1960 by the award of the O.B.E. However, the Siren's song of engineering has lured him back to the Post Office, and to a radio branch.

Merriman is characterized by a taste for broad views, by a flair for fresh looks from first principles, and by energetic concentration on whatever problems come his way. He will bring these qualities to his work as the new head of his old branch and will do so with the best wishes of many friends.

F. J. M. L.

Award by the Institution of Electrical Engineers

The members of the Board of Editors have noted with pleasure that their Chairman, Mr. D. A. Barron, M.Sc., M.I.E.E., has been awarded the John Hopkinson Premium by the Institution of Electrical Engineers for his paper "Subscriber Trunk Dialling," which was read during 1959.

Payment for the Journal by Deductions from Pay

Unforeseen accounting difficulties have made it necessary to postpone the introduction of the scheme under which any Post Office employee will be able to arrange to pay for the Journal by deductions from salary or wages. Further information about the matter will be published in the January 1961 issue.

Radio and Electronics Industry Awards for Published Technical Articles

Each year the Radio and Electronics Industry Awards Committee presents up to six premiums of 25 guineas each to writers of published articles which, in the opinion of the panel of judges, are likely to enhance the reputation of the industry and focus the attention of people throughout the world on Britain's leadership in radio, television and electronics.

Any writer will be eligible who is not paid a salary wholly or mainly for writing and is not earning 25 per cent or more of his income from fees for articles or from book royalties.

Writers are invited to submit published articles, together with signed declarations of eligibility, to the Secretary, The Electronic Engineering Association, 11 Green Street, Mayfair, London, W.1, with a request that the article should be considered for an award. Articles will be considered for awards at the end of each year and the results announced early the following year. Writers are, however, urged to send in their entries during the year as soon as possible after publication; all entries must reach the Secretary before the end of the year.

Articles published in this Journal are eligible for the awards.

Book Review

"Principles of Servomechanisms." A. Tyers, A.M.Brit. I.R.E., and R. B. Miles, Grad.Brit.I.R.E. Sir Isaac Pitman & Sons, Ltd. vii + 176 pp. 190 ill. 25s.

The contents of this book are not what the title leads one to expect: a title such as "Electrical components for servomechanisms" would be more helpful in conveying what the book is about.

Of the 13 chapters, the first two deal with principles in that they discuss, in a general qualitative way, the objects and components of closed-loop control systems, dynamic response and hunting, residual errors in position, velocity and acceleration feedback, and error-rate and integral control. There is a chapter comparing the merits of carrier and d.c. systems, and one on analogue computing, emphasizing the contribution of control systems in performing specified operations.

The remaining nine chapters are concerned with the various electrical (or partly electrical) components which are used in control systems. The components dealt with are: amplifiers (valve, magnetic, transistor, rotating); modulators and demodulators (electrical and electromechanical); electromechanical transducers (synchros, motors, rate generators, and various other devices used either at the input or the output of the purely electrical part).

This book is appropriate to junior engineers who are not concerned with the design of control systems but might be concerned with, say, maintenance. It might also be useful to designers in supplementing the idealized versions of component behaviour which tend to be used in books on the theory of control systems.

W. E. T.

Institution of Post Office Electrical Engineers

Essay Competition 1960-61

To further interest in the performance of engineering duties, and to encourage the expression of thought given to day-to-day departmental activities, the Council of the Institution of Post Office Electrical Engineers offers five prizes, a first prize of six guineas and four prizes of three guineas, for the five most meritorious essays submitted by members of the Engineering Department of the Post Office *below the rank of Inspector*. In addition to the five prizes, the Council awards five certificates of merit. Awards of prizes and certificates made by the I.P.O.E.E. are recorded on the staff docketts of the recipients.

An essay submitted for consideration of an award in the essay competition and also submitted in connexion with the Associate Section I.P.O.E.E. prizes will not be eligible to receive both awards.

In judging the merits of an essay, consideration will be given to clearness of expression, correct use of words, neatness and arrangement, and although technical accuracy is essential, a high technical standard is not absolutely necessary to qualify for an award. The council hopes this assurance will encourage a larger number to enter. Marks will be awarded for originality of essays submitted.

Copies of previous prize-winning essays have been bound and placed in the Institution Central Library. Members of the Associate Section can borrow these copies from the Librarian, I.P.O.E.E., G.P.O., 2-12 Gresham Street, London, E.C.2.

Competitors may choose any subject relevant to current telephone or telegraph practice. Foolscap or quarto size paper should be used, and the essay should be between 2,000 and 5,000 words. An inch margin is to be left on each page. A certificate is required to be given by each competitor, at the end of the essay, in the following terms:

"In forwarding the foregoing essay of words, I certify that the work is my own unaided effort both as regards composition and drawing."

Name (in block capitals).....
 Signature
 Rank
 Departmental Address
 Date.....

The essays must reach
 The Secretary,
 The Institution of Post Office Electrical Engineers,
 2-12 Gresham Street,
 London, E.C.2.

by 31 December, 1960.

The Council reserves the right to refrain from awarding the full number of prizes or certificates if in its opinion the essays submitted do not attain a sufficiently high standard.

Associate Section

Subscriptions and Payment for the Post Office Electrical Engineers' Journal

With reference to the announcement published on page 132 of the July 1960 issue of the Journal, owing to unforeseen accounting difficulties it will not now be possible during the month of October to introduce the separate deductions-from-pay scheme for the *P.O.E.E. Journal* nor the revised arrangements for Associate Section sub-

scriptions. A further notice on this subject will be published in the January 1961 issue of the Journal.

S. WELCH,
General Secretary.

Additions to the Library

Library requisition forms are available from Honorary Local Secretaries, from Associate Section Centre Secretaries and representatives, and from the Librarian, I.P.O.E.E., G.P.O., 2-12 Gresham Street, London, E.C.2.

- 2589 *Satellites and Scientific Research*. D. King-Hele (Brit. 1960).
 Describes, as far as possible in non-technical language, the important scientific results so far obtained from satellites.
- 2590 *Colour Films*. C. I. Thompson (Brit. 1959).
 Reviews the field of colour films, with detailed consideration of progressing techniques.
- 2591 *Making and Printing Colour Negatives*. J. Vickers (Brit. 1959).
 A guide to the practice of making and printing colour negatives.
- 2592 *Elements of Radio Engineering*. H. I. F. Peel (Brit. 1960).
 Primarily intended to cover the radio-engineering requirements of the first two years of the City and Guilds' four-year Telecommunication Technicians' Course.
- 2593 *Stereo Handbook*. G. A. Briggs and R. E. Cooke (Brit. 1959).
 Examines the pros and cons of stereo and considers some of the problems involved in choosing, setting up and using the equipment.
- 2594 *Masers*. G. Troup (Brit. 1959).
 An up-to-date survey of the subject of microwave amplification and oscillation by stimulated emission.
- 2595 *Applications of Thermoelectricity*. H. J. Goldsmid (Brit. 1960).
 An elementary account of the applications of thermoelectricity.
- 2596 *Electrical Circuit Analysis*. K. Stephen (Brit. 1960).
 Covers the subject to degree level in electrical engineering.
- 2597 *Punched Cards*. J. Sandford Smith (Brit. 1960).
 A practical handbook.
- 2598 *Simplified Calculus*. F. L. Westwater (Brit. 1960).
 Designed to meet the needs of technical courses, and of students who do not have close contact with a teacher.
- 2599 *Clock and Watch Repairing*. D. De Carle (Brit. 1959).
 Intended primarily for those engaged in clock and watch repairing, but useful for those engaged in the repair of small mechanisms.
- 2600 *The Technical Writer*. J. W. Godfrey and G. Parr (Brit. 1959).
 Designed to give the writer of technical literature the necessary insight into the technique of presentation and production.
- 2601 *Telegraphs in Victorian London*. J. Durham (Brit. 1959).
 An account of the early history of the telegraph system.
- 2602 *Engineering Drawing*. G. Pearson (Brit. 1960).
 Provides a course in engineering (or machine) drawing which introduces the subject and leads to work at and beyond "O" level of the G.C.E. Also covers parts of "O" level syllabuses in metalwork and mechanical science.

W. D. FLORENCE,
Librarian.

Regional Notes

Home Counties Region

NEW REPEATER STATION AND NON-DIRECTOR AUTOMATIC EXCHANGE AT ALDERSHOT (HANTS)

A distinguished body of people assembled on Wednesday, 16 March 1960, to witness the opening of Aldershot automatic exchange. The new building houses both the automatic exchange and the repeater station.

In the basement there are two main and one domestic automatic oil-fired boilers under thermostatic control, the main-cable chambers for the repeater station and the automatic exchange, as well as the main electric-light low-tension switchboard. There are also two water pumps for lifting the water supply to the penthouse tanks; it was found that the height of the building prevented the normal water supply reaching the roof so the main tank was fitted in the basement with secondary tanks in the penthouse.

On the ground floor is the repeater-station power room containing the 240 b.h.p. 6-cylinder standby diesel engine coupled to a 194 kVA alternator. The repeater station is normally supplied with 240 volts a.c. from a continuity set that is driven by an a.c. motor coupled to a d.c. motor, the a.c. motor being driven from the mains supply. Should the mains supply fail, the d.c. motor, driven from the exchange battery, takes up the drive until the engine-alternator replaces the faulty mains supply and the a.c. motor resumes the drive and releases the d.c. motor. The reverse procedure occurs when the mains supply is restored. The output from the continuity set is voltage regulated before being fed to the repeater station. The battery capacity is sufficient to permit the d.c. motor to drive the continuity set for 1½ hours.

On the same floor is the automatic-exchange power room, with two 61.5 b.h.p. motor-generators capable of an output of 1,600 amp on float to a 7,200 Ah 50-volt battery. In the event of a mains failure the motor generators may be switched to the diesel engine-alternator in the repeater-station power room, a purely mechanical operation.

The repeater station was installed by Standard Telephones and Cables, Ltd., and has an R.D.F. of 30 verticals, 252 amplifiers No. 32, with associated terminating units, power panels, amplifiers No. 35, signalling units, etc. There is also a 24-channel carrier system with translating and frequency generating equipment.

The automatic exchange was installed by Siemens Edison Swan, Ltd., now a member of the Associated Electrical Industries, Ltd., who started the main installation in July 1958, completing it in December 1959. The initial equipment is for a 4,500-line subscribers' multiple, with an ultimate capacity for 11,000 subscribers' lines. The equipment comprises over 160 racks, 50 automanual positions, a 12-position directory inquiry bureau, six inquiry positions, three supervisors' desks, two observation desks, and nine testing positions, associated frames and auxiliary equipment.

The transfer was effected in two stages: (a) an interim stage on 17 February 1960, allowing the unit automatic exchanges in the Aldershot group to work via the new equipment, and (b) the main transfer on 16 March 1960, when all the Aldershot subscribers, the remainder of the junctions and the automanual positions were transferred. An exchange area boundary was amended at the same time, involving switching 176 subscribers from Ash Vale to Aldershot exchange.

Preparations have already been put in hand for the introduction of subscriber trunk dialling. As Aldershot is a group switching centre, certain outlying exchanges will use the Aldershot equipment. The planned date for the opening of this service is December 1960.

V. F. L.

Scotland

S.T.D. COMES TO SCOTLAND

Dundee became the first city in Scotland to provide

S.T.D. facilities for its subscribers at 8.0 a.m. on Saturday, 11 June 1960. The transfer of the new Dundee main exchange was the final stage in the replacement and modernization of the communications of Dundee. In the space of two minutes 4,200 subscribers' lines and 1,500 trunks and junctions were transferred from the old exchange in the Head Post Office to the new exchange in Willison Street. Simultaneously with the transfer, S.T.D. and trunk mechanization were introduced.

The old exchange was most unusual in that it used 2-motion switches of North Electric design, in which the rotary action takes place before the vertical. This exchange was opened in 1924 and, in spite of maintenance difficulties due to the shortage of replacement parts, particularly during the war, it has given good service. The trunk service from the old exchange was provided by generator-signalling trunk circuits from a 50-position sleeve-control switchboard.

The site for the new exchange was purchased just prior to the war but it was not until 1954 that building work commenced. The excavation of the basement repeater station and cable chamber was greatly hampered by the presence of rock and natural wells. In addition, sheet-steel piling was necessary on one side to support the foundations of neighbouring buildings, but this was a blessing in disguise since the steel piles now provide an excellent exchange earth. After some four years the new 4-storey building was completed.

The work of installing the new exchange, repeater station, automatic telex exchange and power plant, and the diverting of the external cables, then commenced. The new repeater station is mains operated, with the audio equipment on the first floor and the carrier equipment in the basement. The new carrier equipment is the Carrier System No. 9, having 32 12-channel terminal groups. The audio trunk and junction cables were terminated on test tablets in the new building and extended on temporary tie-cables to the Head Post Office, which housed the old repeater station. The carrier cables were teed to the new repeater station when the carrier equipment was ready to be brought into service, and the channel 2-wire ends were routed via breakjacks and temporary tie-cables to the old exchange. The work of transferring the amplified circuits to the new repeater station was completed in March, 1960.

The basement also houses a 200-line multiple automatic telex exchange, which was opened in November 1959, concurrently with similar exchanges in Glasgow and Edinburgh.

The new telephone exchange equipment was installed by Associated Electrical Industries, Ltd., and consists of a local exchange with a 6,500-line multiple, trunk and junction tandem switching equipment, electromechanical S.T.D. equipment, a 36-position sleeve-control manual board, eight inquiry positions, and a new pattern directory-inquiry suite employing call-queueing facilities. The S.T.D. and trunk automatic equipment comprises 52 register-access relay-sets, 13 registers, two translators, 250 motor uni-selector, and A.C.1 and D.C.2 relay-sets for trunk signalling.

The main installation started in November 1958 and was completed in April 1960, but prior to this the new exchange M.D.F. was installed, allowing the early termination and diversion of the local cables. Once the equipment had been accepted from the contractor there started an 8-week program of pre-transfer testing which was carried out jointly by engineering and traffic staff. The excellent co-operation that was achieved not only cut out unnecessary duplication of tests but also produced more effective testing, which ensured an almost fault-free transfer.

The power plant for the new exchange consists of a divided-battery float system employing three 400-amp generators and two 50-volt batteries of 2,800 ampere-hours capacity. The a.c. supply for the repeater station is derived from a

no-break 407-type power plant, which can operate from a traction-type battery for 2 hours in the event of supply-mains and diesel-engine failures. The standby diesel-engine set consists of a 330 h.p. 8-cylinder engine driving an alternator giving a 190 kVA 3-phase a.c. output.

Due to the complexity of the transfer and its effect on other exchanges, both in the Dundee Area and other large centres in the rest of the country, it was decided to transfer the exchange early on Saturday morning, 11 June, and divorce the transfer from the opening ceremony. The official opening ceremony and inauguration of S.T.D. in Scotland, on Tuesday, 14 June 1960, was carried out by Sir Robert Harvey, K.B.E., C.B., the Deputy Director General, and the Lord Provost of Dundee, with the co-operation of the Assistant Postmaster-General, Miss Mervyn Pike, M.P., who answered an S.T.D. call from the Lord Provost to her home in London. This set the seal on what has been a major achievement on the part of the Dundee Area staff.

J. S. K. and K. F. J.

Midland Region

FLOOR-LOWERING AT STOKE CITY AUTOMATIC TELEPHONE EXCHANGE

Reconstruction of the Stoke-on-Trent City telephone exchange has recently been completed; the work involved increasing the clear height of the second (top) floor of the building by about 3 ft 6 in. so that it could accommodate apparatus. As the floor was strong enough to support apparatus it was decided that the existing slab should be lowered the required amount, and this was accomplished in the following manner.

The slab was temporarily shored up while the centre stanchions were stripped of their concrete casings down to about 3 ft 6 in. below the slab, the beam ends were disconnected from the centre stanchions, the concrete around the edges of the slab was removed, slots were cut in the walls beneath the outer ends of the beams, and the padstones on which the beams rested were re-positioned lower down. The slab, weighing approximately 63 tons, was now free to be lowered. Two props were placed under each end of each transverse beam, i.e. one pair at each wall end and one pair on each side of the centre stanchion. Each prop was provided with a screw adjustment with a range of about 9 in. and coarse adjustment by means of pegs in holes. (This type of prop is frequently used to support shuttering.) Either prop of each pair was capable of taking the full load at the point, to enable the peg on the other prop to be moved when the screw adjustment was at its limit. It was necessary to use 24 pairs of props in rows of four across the building. Shoring was provided in each wall slot and around each centre stanchion to within a few inches of each beam, to minimize any fall of the slab should the props slip or collapse.

The actual lowering was performed by eight men in the charge of a foreman, one man per prop in a row, and at a signal from the foreman each prop was screwed down one turn. The gang then moved to the next row and repeated the process, and so on for the six rows. One turn on each of the 48 props lowered the slab $\frac{1}{8}$ in., and the operation took about 10 minutes. Frequent checks were made to confirm that the lowering was uniform, thus ensuring that there was no undue strain on the slab or props. After 3 days, the slab was finally brought to rest in its new position, and after checking that it was level, the process of re-connecting the beams to the stanchions and filling in the edges and wall slots began.

D. M. C.

WALSALL EXCHANGE TRANSFER

The automanual exchange, installed in 1929 at Walsall, and the relief hypothetical exchange known as Arboretum, having completely exhausted the available accommodation in the Head Post Office building, were replaced on Saturday, 11 June 1960, by a new automanual non-director exchange.

The new building, four storeys in height, provides light and airy conditions for those who work in it, in contrast to the dark and congested apparatus rooms to which they had become accustomed. It is of reinforced-concrete construction with large windows, the front wall of the building being almost entirely of glass. The two entrances and the walls below the ground-floor windows are of grey stonework pointed with a violet-coloured cement, and the doors are of polished teak.

Equipment for the new exchange, which is of the 2,000 type, was installed in about 20 months by Associated Electrical Industries, Ltd. The initial provision is for a multiple of 7,900 lines and the apparatus room consists of three sections. The subscribers' uniselectors and final selectors are at one end; 1st, 2nd and 3rd selectors are in the centre, and all relay-sets are at the far end. The subscribers' and equipment I.D.F.s run conveniently down one side, whilst the M.D.F., 6-position test-desk and the batteries are on the ground floor. The power room is on the first floor along with the apparatus room. S.T.D. is not being introduced until 1962, but the opportunity was taken to introduce code-100 for operator assistance. The new exchange provides direct-dialling facilities to over 90 exchanges.

The power plant, consisting of three generators, two of 400 amp and one of 200 amp output, was manufactured by E.C.C., Ltd., and the batteries, installed under a separate contract by D.P. Battery Company, are two 2,800-ampere-hour capacity batteries normally used as a parallel-battery float system.

Manual-board equipment, which is on the second floor, consists of 36 positions in the main suite, a 6-position inquiry board, and an 8-position cordless board for directory inquiries. After the transfer Walsall became a trunk group centre relieving Birmingham, which previously controlled all trunk calls from the Walsall Area.

Concurrently with the installation of the exchange equipment, an extensive underground-cable development scheme was carried out, and this, together with the building and equipment, brought the total cost up to about £750,000.

The transfer was timed for 7.30 a.m. and 5,500 subscribers and 1,500 junctions were transferred from the old exchange to the new exchange in exactly 2 minutes, the subscribers' numbers being changed from four to five digits in the process. For this purpose some 8,000 break jacks were fitted at the two exchanges, although some circuits were teed externally.

Among the exchanges which could be directly dialled for the first time, as a result of the facilities provided by the new exchange, is Wolverhampton, and the opening of this route was delayed until 10.30 a.m. when the Mayor of Walsall ceremoniously made the first call to the Deputy Mayor of Wolverhampton in the presence of the Deputy Regional Director, Midland Region, the Telephone Manager, West Midland Area, and about 70 other officials and guests. This brought to a successful conclusion the largest transfer of an exchange yet attempted in the West Midland Area.

G. R. P.

London Telecommunications Region

INTRODUCTION OF S.T.D. AT WATFORD

Subscriber trunk dialling made its debut in the London Telecommunications Region on 1 July 1960 at Watford. The Assistant Postmaster-General, Miss Mervyn Pike, M.P., made the inaugural call from a Watford telephone to the Mayor's parlour at Leicester before an invited audience of some 80 guests.

S.T.D. was introduced and changes in local codes were made at 7.0 a.m., the early hour allowing change-over without affecting service, and subscribers began the working day with the new system. Engineering work on code changes, regrouping of incoming junctions, regrading and rearrangement of racks and switches had been in progress for the

previous 12 months and, with one exception, routes were available by dialling new and old codes six weeks prior to change-over. Traffic trials included a test of these new codes, and kiosk dialling-code cards were changed, to show changes to local-dialling codes, over a period of a week prior to the introduction of the new facility.

The S.T.D. installation is of the electromechanical type, comprising 45 registers, 3 translators and 357 register-access relay-sets. A translator normally serves 15 registers, and 30 registers when automatic change-over conditions apply. Manual change-over makes possible the connexion of all 45 registers to any one of the translators. The registers receive instructions from the translator piecemeal, up to six applications being necessary to determine the charge and route for a call. Each application takes approximately 100 milliseconds and the number of applications made will vary with routing requirements. The register-access relay-sets (to meter, monitor and supervise the call) serve 10,000 lines and are of two types, one for metering in the same building and the other with M.O.J. (metering over junction) facilities for part of the multiple sited in another building.

Watford is adjacent to the London director area and has a considerable number of direct routes to exchanges in this area, and to reach these arbitrary numerical dialling codes were available prior to the introduction of S.T.D. There was some doubt, however, whether all subscribers used these codes, and it was felt that many preferred to dial 7 for access to the Toll B director exchange and then dial the 3-letter code, thus overloading the routes to and from Toll B. It is now necessary for subscribers to dial the national code for all director exchanges, and maximum use is made of the local direct routes by translating the codes appropriately and allowing only indirectly-routed traffic to reach Toll B.

Installation of the equipment by the General Electric Co., Ltd., was completed in good time, and traffic-trial telephones were given access to a group of register-access relay-sets for the testing of register-translators and junction routes. A comprehensive test of all register-access relay-sets from the testing telephones was not possible, due to the large grading on level 0 and the need to keep it closed to the public most of the time.

A test-call sender was adapted to make simultaneous calls on seven register-access relay-sets, one on each rack. A special translation routed the call to a local number with subscriber-answer condition, giving metering at the 12-second rate on completion of the call. A 60-second pulse stepped the sender on to the next seven register-access relay-sets, having allowed time for two cycles of operation of the "divide-by-six" periodic-metering circuit. In addition, telephones with meters were used to check manually each register-access relay-set for periodic metering, at approximately weekly intervals and on the day prior to the introduction of the new facility. The first 200 observations after the opening gave a "NIL" fault return for metering on S.T.D. calls.

The register-translator equipment is working satisfactorily although, during testing, intermittent faults were encountered due to the Type 10 relays in the translators. The comb operating the lever springs was occasionally fouling the buffer spring and operating it in advance of the lever spring. A modified armature to overcome this defect was made available by the Engineering Department, and all the relay armatures on one complete translator were changed prior to the opening. Since coming into service some three translator failures might be attributed to the old-type armature but none to the new.

B. H. K.

Book Review

"Simplified Calculus." F. L. Westwater, O.B.E., R.N.(Retd.), M.A.(Edin.), M.A.(Cantab.), A.M.I.E.E. The English University Press, Ltd. xv + 160 pp. 37 ill. 10s. 6d.

This little book is a most welcome addition to the E.U.P.'s Technical Series of textbooks on the City and Guilds syllabuses for craftsmen and technicians. This particular book does not attempt to cover, in part or wholly, any particular syllabus but aims to provide a basic knowledge of the calculus and in particular to assist the student who must rely primarily on private study. It sets out to interest and stimulate the student in the techniques of the calculus and their practical usefulness, and it is likely to achieve this in almost every case.

Its method is to be far more "chatty" than the average formal textbook, and to "talk" to the student in much the same way as a good teacher does. Those who have admired Sylvanus P. Thompson's famous work "Calculus Made Easy," will welcome the present book as a worthy modern successor in a very similar style. Throughout the book the author seeks to overcome the student's apprehension of strange ideas—often made obscure in the formal textbooks—by stressing the simplicity of the idea itself and the way in which the new idea makes particular types of calculation so much easier, surer and more precise.

Although attempts at simplification sometimes result in over-simplification and slipshod popular treatment, there is nothing of this sort to be found in this book. The treatment is quite sound and rigid as well as lucid, and will please the professional mathematician as well as engineers and others who regard mathematics rather as means to

other ends. It is entertaining to read as well as instructive.

The book assumes a mathematical knowledge rather less than G.C.E. O level and builds up the ideas of differentiation from elementary graphs and a study of their algebraic representation. The differential coefficient is initially identified as a shorthand symbol for the slope at a point. In calculating the standard forms for the differential coefficient of different functions, the graphical relationships and other geometrical illustrations (e.g. the use of areas) are continually used. The practical applications of differential coefficients to elementary, practical, scientific problems follow at once. Subsequent chapters deal with trigonometric functions and the techniques of differentiating more complex functions, still amply illustrated graphically. The idea and meaning of differential equations is introduced but without attempting any general treatment of methods of solution.

The integral calculus is similarly treated in the second half of the book, and the object of simplicity in presentation is not used to avoid thorough treatment. The student is introduced to the more advanced methods of integration required to tackle some of the more unusual functions, and ample examples are provided to enable him to get practice in using such methods with skill and confidence. The usual applications of integration to be found in an elementary textbook are well and clearly discussed, including the calculations of moments of inertia, centres of gravity and centres of pressure.

The book has been carefully checked and edited and very few errors have been detected. The type is clear, bold and well spaced and the diagrams are clear and well-proportioned. This book is good value for money to the student and is highly recommended.

I.P.O.E.E. Library No. 2598

F. C. M.

Associate Section Notes

Gloucester Centre

The activities of the 1959-60 session started on 16 July 1959 with a visit to Berkeley nuclear power-station site. A party of 30 members were very impressed by the massive construction work in progress.

A very pleasant day was spent on 20 October when 35 members and wives visited Cadbury's factory at Bourneville. After an efficiently conducted tour of the factory, we were entertained to an excellent tea. The innovation of taking our wives along seemed very successful, and it is hoped to make a similar visit this year if suitable arrangements can be made.

The last visit of 1959 was made by 12 members to the B.B.C. television and radio studios at Bristol during the evening of 26 November.

The following meetings were held during the winter session:

26 October: Mr. Sturton gave a talk on "Overhead High-Voltage Grid Construction," dealing with the civil-engineering aspect of this subject.

25 November: There was something of interest for all in the talk and films on "Cinematography in the Post Office," given by Mr. W. A. J. Paul, Dollis Hill Research Station.

20 January: One of our own members, Mr. D. C. Jones, ably tried to persuade us to accept his "Case for Flying Saucers."

17 February: Mr. P. T. F. Kelly, Main Lines Development and Maintenance Branch, Engineering Department, gave his talk "Transoceanic Submarine Telephone-Cable Systems" to a small but very appreciative audience.

23 March: An outstanding talk was given by Mr. P. Charman, Sales Development Manager of Semiconductors, Ltd., Swindon, who discussed the "Simple Theory and Some Applications of Transistors." Among many interesting exhibits was a fully transistorized television set.

13 April: Mr. G. A. Miles, an installer for Automatic Telephone and Electric Co., Ltd., showed films that he had taken abroad. These were followed by the annual general meeting.

At the annual general meeting the following officers and committee members were elected: *President*: Mr. S. D. Chapman (Area Engineer); *Vice-President*: Mr. R. T. Hoare; *Chairman*: Mr. A. K. Franklin; *Secretary*: Mr. J. A. Wallis; *Treasurer*: Mr. G. Franklin; *Committee*: Messrs. C. Morgan, K. A. Priddey, A. E. Adams, P. D. Smart and J. A. Beard.

The present membership is 91.

J. A. W.

Salisbury Centre

After nine years' suspension, the activities of the Salisbury Centre have been renewed and a moderately successful session was completed during 1959-60. The meetings consisted of a film show, which proved most entertaining, and two papers. The first paper, on "Photography," was by Mr. J. Stamp, of Southampton, who gave an interesting demonstration of the art of picture composition. The second paper was given by Mr. R. Martin, also of Southampton, on "Postal Mechanization." He illustrated his lecture with films from the Postal Training School, Taunton, and discussed the machines in use in this country, including those installed experimentally at Southampton.

Hopes are very high for an enlarged program during 1960-61.

J. H. G.

Chichester Centre

The Chichester Centre now has a membership of 50 and includes staff from all groups in the district. In view of the

distances involved in this rural area, the average attendances at meetings have been most encouraging.

The 1959-60 session opened on 28 October with a film show provided by the Petroleum Film Bureau. On 25 November Mr. J. Gordon opened a discussion on "Modern Line Developments," illustrated by slides, films and samples of modern external plant. On 10 December the members held a technical quiz with the Portsmouth Centre, which was lost by a narrow margin. The 27 January meeting was devoted to the projection of members' colour slides taken during the previous holiday season. The 24 February brought Mr. R. F. Eglon from Bognor Technical College to lecture on "Tape Recorders," and on 23 March travel films of Ireland, the Lake District and Switzerland were shown.

On 27 April we welcomed Mr. A. H. C. Knox, who talked to members on "Appraisements and Promotions." The meeting was attended by Mr. H. W. Harrison, together with other members from Regional Headquarters.

At the annual general meeting on 30 March the following officers were elected: *Chairman*: Mr. R. D. Barrett; *Vice-Chairman*: Mr. A. V. Pont; *Treasurer*: Mr. A. T. Yardley; *Secretary*: Mr. H. S. Pennicott.

H. S. P.

Canterbury Centre

A day's visit to France is not uncommon these days, but a party of 62 Post Office engineers, led by Mr. A. H. C. Knox, President of Associate Section, is unique.

Through the Eurovision Link and the maintenance and testing of the cross-channel cable network, close contact has been made between engineers in the Canterbury Telephone Area and their French colleagues. In order to place this relationship on a more personal basis and to enable the Canterbury engineers to examine the equipment used by the French at their Boulogne repeater station, the Canterbury Centre arranged, with Le Directeur Général Des Télécommunications, a visit to the automatic telephone exchange and the repeater station at Boulogne. It is believed this is the first occasion that British telephone engineers have met their French colleagues informally, and to mark the occasion the Canterbury staff presented the Directeur Télécommunications, Lille, with an illuminated scroll.

The Mayor of Canterbury, Mr. T. McCallum, called at Telephone House and handed to the Telephone Manager a message of goodwill to be conveyed by the visiting party to the Mayor of Boulogne. He also met the officers of the committee organizing the visit, and was photographed by the local press together with the Telephone Manager, senior engineers and committee members.

Thus it was on Wednesday, 8 June, members of the Canterbury Centre wished for a clear sky and a calm sea. This was not to be, for the sky was overcast, the rain, although not heavy, was wet, and the sea was rather rough when our party boarded the *Isle of Thanet* in Folkestone Harbour, bound for Boulogne-sur-Mer. Through the good offices of the Captain and Purser a number of us were able to visit the bridge, study the radar screen and the map compass plans, and generally enjoy 20 interesting minutes. Others visited the engine room, a warmer atmosphere but very interesting. Boulogne Gare Maritime was reached on time and after press photographers and customs formalities, we were greeted by two of our French colleagues.

Arriving at the rendezvous point, we were greeted by the French Regional Director and members of his staff. After a very satisfying lunch we went to the Boulogne telephone exchange, and from there a party of 15 went by car to the repeater station while the remainder were conducted around the automatic exchange.

In the exchange, of comparatively modern design, it was

noticeable that cable racking was at a minimum, while natural lighting and fluorescent lighting were at a maximum. The view of the quay and harbour from the apparatus-room window was to be envied. It was found that the standard of workmanship was extremely high, all switches were enclosed and, as a result, the French engineers were able to smoke in the exchange—a practice which initially caused many raised eyebrows among the British party. The switchroom, although having 65 positions, was staffed by about 25 operators. The A and B positions are separated by the inquiry board.

During the afternoon a visit was made by a party of six to the Mayor's parlour to deliver the goodwill message from the Mayor of Canterbury. This was followed by the presentation of the Canterbury Centre scroll by Mr. Knox to the French Regional Director. Mr. Knox thanked the Regional Director and his staff for looking after us so kindly, and all the party supported toasts in wine to France and England. The hope was expressed that similar meetings might be arranged in the future.

Altogether, an extremely interesting day and one to be recorded with pride in the annals of the Canterbury Centre.
W. J. A.

Bradford Centre

The annual general meeting of the Centre took place on Thursday, 9 June. The following officers were elected: *Chairman*: Mr. A. J. Procter-Blain; *Secretary*: Mr. R. C. Siddle; *Librarian*: Mr. D. Relton; *Committee*: Messrs. E. Dennison, R. A. Gill, M. Farnell, C. M. Rowland, M. Galloway, R. Winterburn and Miss E. P. Hawkins.

The new committee will be meeting shortly to arrange the program for the coming session when we hope to have something of interest to all our members, who now number over 150.

R. C. S.

Sheffield Centre

On 10 May, Mr. H. J. C. Spencer gave his lecture on the 700-type telephone. An outstanding feature of the lecture was the first-class set of colour slides, including diagrams, from which the stages in the development of the electrical circuit were made clear. The speaker also brought samples of the telephone, printed circuit and various component parts.

At the annual general meeting, held on 27 May, the following officers were elected: *Chairman*: Mr. J. McInnes; *Vice-chairman*: Mr. F. S. Brasher; *Secretary*: Mr. L. G. P. Farmer; *Assistant Secretary*: Mr. D. Ashton; *Treasurer*: Mr. C. S. Sheperd; *Scribe*: Mr. J. E. Simons; *Committee*: Messrs. F. Bough, S. Cottage, A. Knowles, R. B. Lines, G. T. Ridsdale, B. A. Sargent, J. Tomlinson and J. Watts. We now have three external members on the committee, and it is hoped that at last we may see some result of our efforts to get the external staff interested in our activities.

A visit of particular interest to Radio Section members was made on 15 June to the Mansfield factory of Whiteley Electrical Radio Company. Although best known for the "Stentorian" range of loudspeakers, the firm also makes other electronic products on a contract basis, including the lineman's test-set and other equipment for the Post Office. Loudspeaker manufacture was followed from raw material to tested product and we were particularly interested in the patented method of making speaker cones.

Another product which aroused considerable interest was the radio-sonde, a weather-information transmitter which is attached to a balloon. The balloon rises until it bursts at approximately seven miles high and the transmitter returns to earth by parachute, continuously transmitting information. The apparatus carries a barometer, hygrometer and thermometer, each arranged to control, in turn, the frequency of an audio oscillator which modulates the radio transmitter. The control selection is effected by a simple brush-and-drum device driven by an external

wind vane, which rotates as the equipment rises or falls.

In the transformer section a wide range of items was being made, and in the amplifier shop we were particularly impressed by the high standard of workmanship, which was indeed evident throughout the factory. To round off the visit refreshments were served in the canteen, followed by a demonstration of monaural and stereophonic reproduction, using the various types of equipment made by the firm.

During May and June the Radio Section heard the first two of a series of talks by Mr. F. S. Brasher on radio and television servicing.

J. E. S.

Sunderland Centre

At Sunderland, the committee has been busy planning the program for the session which commenced in September.

Early in July we had a visit to the works of Bristol Siddeley Engines, Ltd., here in Sunderland, where there was an exhibition of their products.

Saturday, 23 July, found over 30 of us visiting the Atomic Energy Authority's plant at Calder Hall, Cumberland. Two meals were provided during the trip of 240 miles through the Lakes to the west coast and Calder Hall.

W. C.

Edinburgh Centre

At the annual general meeting held on 31 May, the following office-bearers for the 1960-61 session were elected: *Secretary*: Mr. D. M. Plenderleith; *Treasurer*: Mr. T. C. Watters; *Librarian*: Mr. T. J. Peebles; *Committee*: Messrs. A. Robertson, A. G. Gilmour, D. S. Henderson, R. P. Donaldson and W. Hay.

During the year the membership has increased from 82 to 107, 59 of these being subscribers to *The Post Office Electrical Engineers' Journal*.

The first meeting of the 1960-61 session was held on 27 September and consisted of a talk on "Subscriber Trunk Dialling," given by Mr. J. J. Loughlin, Post Office Headquarters, Scotland.

D. M. P.

London Centre

The April talk on "Overseas Telecommunications," given by Mr. A. P. Hawkins, External Telecommunications Executive, was a most illuminating survey of the overseas telephone, telegraph and radio services of Cable and Wireless, and gave many interesting facts about a subject which, to most of us, is somewhat hazy. The Centre was indebted to Messrs. B. B. Gould, S. H. Sheppard and B. F. Yeo, Telephone Exchange Systems Development Branch, Engineering Department, for their talk given at Holborn exchange in May on "S.T.D. as it Affects Director Exchanges." The talk covered the local register, modification to the first-code selector, subscribers' private meter equipment and barred-trunk equipment.

The session was brought to a close at the end of May by Mr. W. S. Proctor's talk "Automatic Aids in Telephone Maintenance" in the library of the Institution of Electrical Engineers. He introduced us to the family of automatic testers, comprising "J.I.M.," "F.R.E.D.," the test-call sender, and the subscribers' apparatus and line tester, which have been introduced throughout the London Telecommunications Region, to ease the problems of exchange maintenance. In the audience of some 200 we were honoured by the presence of Mr. C. E. Calvey, Assistant Engineer-in-Chief, Mr. L. G. Semple, our Regional Director, and the President of the Associate Section, Mr. A. H. C. Knox. During the evening Mr. Semple presented Mr. J. L. Garland with his Institution Certificate and Mr. S. C. N. Balls, Centre Area secretary, with the C. W. Brown Award, and Mr. Knox presented the Inter-Area Technical Quiz Trophy to Mr. Brum, chairman of West Area Associate Section, whose team won the 1959-60 contest.

Following the inaugural lecture, "D-Day for Space," given in September at the London Planetarium, there follows in October, "The Recording of Brain Potentials," a talk on the encephalograph. In November a member of the National Physical Laboratory will talk on "The Problem of Annoying Sound." At the technical film-show in December, the award-winning documentary, "This is the B.B.C.," will be shown together with a striking new industrial safety film, "Hazard."

Early in 1961 there will be a talk, by a representative of the B.B.C., on "Cablefilm," the technique of transmitting film over the transatlantic cable. Following this, in February, there will be talks on the electronic computer, with particular reference to "L.E.A.P.S.," the London area payroll computer, and in March and April there will be talks on the latest developments in the external and electronic-switching fields. The session will be completed by a talk, "Appraisements and Promotions," given by Mr. A. H. C. Knox, President of the Associate Section, at the annual general meeting.

An Associate Section tie has now been produced. Following inquiries from other centres in the country the London Centre committee felt that this backing, together with the interest of certain Areas in the London Telecommunications Region, made the matter worth pursuing. A design of two silver stripes enclosing a red stripe (each stripe being about $\frac{1}{8}$ in. wide) repeated at intervals on a background of engineering green has been chosen. The material is Terylene and the cost about 10s. Inquiries from any other interested Centres should be made to the Secretary, 70 Brook Dale, New Southgate, London, N.11.

The only change in the officers of the London Centre for the new session is the post of radio secretary, which is now filled by Mr. K. K. Smith.

D. W. W.

Cornwall Centre

The annual general meeting was held in April. The secretary reported that membership continued to increase, the attendance at meetings remained good, and the financial position had considerably improved since the last annual general meeting.

The chairman, Mr. D. S. Jenkin, had been promoted to Assistant Engineer and a vote of thanks was proposed to him for his past help with the Centre. The following officers were elected for the 1960-61 session: *Chairman*: Mr. A. E. Furse; *Vice-Chairman*: Mr. J. C. Wyatt; *Secretary*: Mr. A. R. Brown; *Treasurer*: Mr. D. L. Moore; *Committee*: Messrs. G. Tregilgas, H. H. Pearce, R. Sweet, K. Barlow and K. Tonkin.

The Telephone Manager, Mr. H. C. O. Stanbury, gave a talk on "The Proposed New Status for the Post Office," which proved to be most interesting.

In May we visited the new tanker *Derby* which, after making her maiden voyage, had docked at Falmouth. This was a very popular visit to start the summer session, and the hospitality offered by the Dock Co. and shipowners was excellent.

B.O.A.C. are training crews for the Boeing 707 at St. Mawgan R.A.F. Station, and we were fortunate to be able to arrange a most interesting visit to one of these aircraft.

Further visits arranged for the summer session were to Rosewarne horticultural experimental grounds and Holman's Engineering Works at Camborne.

A. R. B.

Glasgow and Scotland West Centre

After a reorganization of both the finance and accommodation of the Centre we started the new session with a new-look organization and a program a little bit different from our previous ones. We hope to prevail upon our speakers to tell us "why" rather than "how"—a more difficult approach, but one which should appeal to a wider audience. Our anticipated program includes lectures on

subscriber trunk dialling, education, and the 700-type telephones, a quiz night and a film-show and, later on, a visit to a shipyard and a nuclear power station.

The following officers have been appointed for the 1960-61 session: *Chairman*: Mr. G. R. Lunn; *Vice-Chairman*: Mr. R. T. Shanks; *Secretary*: Mr. J. Fleming; *Organizing Secretary*: Mr. W. Fotheringham; *Treasurer*: Mr. J. Murray; *Librarian*: Mr. J. Fuller; *Assistant Librarian*: Mr. A. C. Campbell; *Committee*: Messrs. K. Gordon, R. Fraser, J. Bell, E. Carty, H. Macnamara, J. McCallum, J. Deans, C. Faith, A. Kerr, A. Anderson, J. P. Campbell and J. Houston.

J. F.

Leeds Centre

On Wednesday, 13 April, a meeting was held at the Griffin Hotel, Leeds, where an illustrated talk entitled "Subscribers Trunk Dialling" was presented by Mr. T. Barker of the North East Regional Headquarters. The subject was treated from all aspects and Mr. Barker had prepared excellent diagrams and technical notes; many questions were put forward and answered. It was generally agreed that the paper had been very well presented and the chairman thanked Mr. Barker. The meeting was attended by 85 members and guests.

The annual general meeting was held on 4 July in the Regional Conference Room, Park Row, Leeds. General business was discussed and the following officers were elected for the 1960-61 session: *Chairman*: Mr. C. Baker; *Secretary*: Mr. E. B. Bates; *Committee*: Messrs. Bateman, Crowther, Lancaster, Newton, Coyle, Smith, Senior and Rowsby. The meeting concluded with the presentation of three very interesting films, borrowed from Sound Services, Ltd., entitled: "To Have is to Hold," "Pre-cast Concrete" and "Paris-Côte d'Azur via the Alps." These were sound films, in technicolour, and it was generally agreed that they were very instructive and could be recommended.

On 15 September Mr. C. A. May, Telephone Exchange Systems Developments Branch, Engineering Department, gave an illustrated lecture on "Two New Electronic Circuit Devices."

The Centre's program for the remainder of the 1960-61 session is as follows:

- 14 October: A full day's visit of 80 members to Pye Telecommunications, Ltd., and the Cavendish Laboratory, Cambridge.
- 17 November: "Lakeland Days." An illustrated talk by Mr. P. Broadbent (Leeds Centre). This will be an open evening for members and friends, with light refreshments provided.
- 15 December: A dinner-dance at the Ringway Restaurant, Whitehall Road, Leeds.
- 20 January: "Digital Computers and their Application." A lecture by Mr. K. Nicol, Ferranti Ltd., London.
- 31 January: A full day's visit for six members to the Simonstone factory of Mullard, Ltd. (Television Components).
- 15 February: "Closed-Circuit Television." An illustrated lecture by Mr. J. B. Holt, Main Lines Development and Maintenance Branch, Engineering Department.
- 14 March: "We Look Ahead." A talk by Messrs. E. Hopkinson and P. D. Gilbey, Area Engineers of the Leeds Telephone Area.
- 24 March: A full day's visit for 30 members to Chloride Batteries, Ltd., Swinton Works, Manchester.
- 4 April: A full day's visit for six members to the Simonstone factory of Mullard, Ltd. (Television Components).
- 12 May: A visit for 30 members (ladies invited) to Rowntrees, Ltd., Chocolate Works, York.
- 19 June: The annual general meeting, followed by a talk, "Gardening Topics," by Mr. Knight, Superintendent, Leeds City Parks Department.

C. B.

Shrewsbury Centre

On Friday, 20 May, 21 members visited William Asquith's works at Sundorne, Shrewsbury. We were able to see an automatic transfer line which will accomplish 15 operations on an engine cylinder block and complete one every two minutes. We also saw a 12 in. boring machine, standing in a 6 ft well yet still towering up into the roof members of the assembly shed. On this machine, despite its massive size and weight, both horizontal and vertical adjustments can be made within 0.001 in. A very pleasant and interesting tour was rounded off with supper provided by the management.

On Saturday, 25 June, 20 members visited the British Insulated Callender's Cables, Ltd., works at Helsby, Lancashire, where the details of the production of plastic-insulated cables were explained to us. One machine, which looked like a mechanized maypole, held our interest; it very ingeniously carried out the screening of a coaxial conductor. Lunch was provided by the management, and both lunch and visit were thoroughly enjoyed by all members present.

N. C.

Newport (Monmouthshire) Centre

The 1959-60 session ended with the annual general meeting, on 11 April, when the following officers were elected: *Chairman*: Mr. B. Wakeham; *Vice-Chairman*: Mr. D. H. Payne; *Secretary and Treasurer*: Mr. D. A. Evans; *Committee*: Messrs. C. Thomas, G. Evans (Castleton radio station) and N. Ward.

Last year's program included many interesting items. In October we visited Bristol S.T.D. and trunk exchange, which proved a great success. November followed with a visit to the television terminal at Cardiff automatic telephone exchange. We ended 1959 with two visits to the television studios at Pontcanna, Cardiff. So many members were interested in this visit that it was necessary to arrange a draw to fill the places available; we were sorry some members had to be disappointed.

A lecture on photography was given by Mr. N. C. Trott early in 1960. This was followed in February by a talk on radio and television interference by Mr. G. Elliot. At our March meeting a lecture on communications in the Central Electricity Generating Board was given by Mr. Crofts of that organization, and this concluded our winter session.

We are now planning our 1960-61 winter program and look forward to seeing new members at our meetings.

D. A. E.

Dundee Centre

The 1959-60 session was a full and varied one, ranging from "Todd-AO" to a lively comparison between the American system and the British system of telecommunications.

10 October: A party visited the Capitol cinema and saw the projection room and the technicalities of Todd-AO and Cinemascope. This visit was repeated the following Saturday for more of our members.

23 October: An extraordinary general meeting was held and the rules of the Dundee Centre were revised.

4 November: Mr. Pratt, our Telephone Manager, presented a comparison between the American telephone system and the British one, which prompted a very lively discussion.

25 November: Messrs. Hubbard and Mack, Telephone Exchange Standards and Maintenance Branch, Engineering Department, showed, by means of film, slides and photographs, just what can be done with a camera in an automatic telephone exchange.

8 December: Mr. J. M. Tait, Post Office Headquarters, Scotland, showed us, by means of numerous samples, the latest types of underground plant and apparatus with which the underground staff will have to work.

18 January: A visit had been arranged to the National Cash Register factory, but this had to be cancelled because of a heavy snowstorm.

2 February: Mr. K. F. Jalland, our Area Engineer, gave a talk on acceptance testing. At this meeting Mr. R. J. Hines, Chief Regional Engineer, Scotland, presented Mr. J. S. R. Lawson with an award for his paper on "Model Aircraft."

18 February: Another snowstorm in the city prevented a large turnout for a talk by Mr. K. W. Hix and S. J. Little, Telephone Exchange Standards and Maintenance Branch, and External Plant and Protection Branch, Engineering Department, respectively, on "Subscribers' Line Protection and Main Distribution Frame," which was thoroughly enjoyed by those who were able to be present.

8 March: Mr. A. K. Carrie read a paper on radio and television interference, which proved very interesting.

The annual general meeting was held on 29 April, when the following officers were elected for the 1960-61 session: *Chairman*: Mr. R. L. Topping; *Vice-Chairman*: Mr. D. L. Miller; *Secretary*: Mr. J. S. Brown; *Treasurer*: Mr. J. S. R. Lawson; *Committee*: Messrs. E. Taunton, W. Kiddie, G. Deuchars, D. Livingstone, A. W. Brighton and A. K. Carrie; *Auditors*: Messrs. J. A. Lamb and E. MacLaggan.

A committee meeting was held on 17 May to arrange some visits for the period when more reasonable weather could be expected. Resulting from this a visit was made to the North of Scotland Hydro-electricity Board station at Port-na-Craig House, Pitlochry, and the Brown Trout Research Station at Faskally House, Pitlochry, on 10 September 1960.

J. S. B.

Book Review

"Microwave Data Tables." A. E. Booth, M.I.R.E., Grad.I.E.E. Iliffe & Sons, Ltd. 61 pp. 27s. 6d.

The 26 tables in this book cover most of the repetitive calculations entering into the day-to-day design work of the microwave engineer. They include such relationships as decibels to power, v.s.w.r. to reflection coefficient, and frequency to wavelength, for 11 sizes of waveguide. The tables have been computed on an electronic digital computer, using the most recently accepted value for the velocity of light. The compilation has a distinct bias towards the waveguide at the expense of the coaxial line; for instance, there are no tables of the relationship of return loss to v.s.w.r. or to reflection coefficient, or of the effect of

transmission-line loss on mismatches in impedance. The waveguide sizes referred to in the book have been based on the Inter-Service Specification RCL 351. This has now been superseded by Specification DEF 5351. The new specification, among other changes, makes waveguide WG11 (2.372 in. \times 1.122 in.) obsolete and substitutes waveguide WG11A (2.290 in. \times 1.145 in.), so that Table 13 in the book will not be as useful as intended. The only two sizes of circular waveguide, 1 in. and $\frac{3}{4}$ in. diameter, for which guide wavelengths are quoted in Tables 23 and 24, are also non-standard by the new specification.

The book is stoutly made to withstand constant usage and, although the cost is high, it should make a worthwhile design aid for the microwave engineer who spends much time in problems of waveguide realization.

W. A. R.

Staff Changes

Promotions

Name	Region, etc.	Date	Name	Region, etc.	Date
<i>Staff Engineer to Deputy Director of Research</i>			<i>Assistant Engineer (Limited Competition)—continued</i>		
Stanesby, H.	E.-in-C.O.	18.8.60	Harries, D. W.	H.C. Reg. to L.T. Reg.	9.5.60
<i>Assistant Staff Engineer to Staff Engineer</i>			Stewart, C. E.	N.I.	25.5.60
Merriman, J. H. H.*	E.-in-C.O.	18.8.60	Etheridge, J.	S.W. Reg.	9.5.60
<i>Executive Engineer to Senior Executive Engineer</i>			Wood, R. J.	E.-in-C.O.	9.5.60
Mackie, G. W.	H.C. Reg.	12.5.60	Peace, L.	N.E. Reg. to E.-in-C.O.	26.4.60
<i>Executive Engineer (Limited Competition)</i>			Swift, R. F.	S.W. Reg. to H.C. Reg.	23.5.60
Wardman, D.	N.E. Reg.	9.5.60	Bickerdike, C. P.	N.E. Reg. to E.-in-C.O.	23.5.60
Hulse, R. A.	Mid. Reg. to H.C. Reg.	28.3.60	Hirst, B.	N.E. Reg. to E.-in-C.O.	23.5.60
<i>Assistant Engineer to Executive Engineer</i>			Chalk, R. E.	E.-in-C.O. to L.T. Reg.	23.5.60
Radford, W. E.	Mid. Reg.	27.4.60	Smith, J. D.	L.T. Reg.	23.5.60
Cooley, S. J.	E.T.E.	10.5.60	Cartner, J. G.	N.W. Reg.	23.5.60
Beames, A. R.	Mid. Reg.	25.4.60	Chittenden, K. R.	H.C. Reg.	23.5.60
Blackie, K. J.	E.-in-C.O.	6.5.60	Pounder, I.	N.E. Reg. to Scot.	23.5.60
Thomas, H.	W.B.C.	6.5.60	<i>Inspector to Assistant Engineer</i>		
Mitchell, G. A. R.	Mid. Reg.	6.5.60	Benev, E. K.	Scot.	19.5.60
Parsons, E. G. H.	L.T. Reg. to E.-in-C.O.	6.5.60	Edwards, J. A.	N.W. Reg.	25.5.60
Alexander, A. R.	E.-in-C.O.	6.5.60	Davies, R.	S.W. Reg.	31.5.60
Gregory, W.	N.W. Reg.	30.5.60	<i>Technical Officer to Assistant Engineer</i>		
Booth, G. F.	Mid. Reg.	6.5.60	Robb, D. R.	Scot.	2.5.60
Jones, T. J.	E.-in-C.O.	6.5.60	Ovens, W. M.	Scot.	14.4.60
Paul, W. C.	S.W. Reg.	23.5.60	Noble, F. D.	H.C. Reg.	11.5.60
Thomas, E. A.	E.-in-C.O.	26.5.60	Bolton, J.	E.T.E.	19.4.60
Moody, P. H.	Scot.	23.5.60	Johnson, A.	S.W. Reg.	13.5.60
Knell, W. J.	Scot. to N.E. Reg.	23.5.60	Rees, J. A.	W.B.C.	8.5.60
Lawrie, A. P.	Scot.	23.5.60	Eustace, H.	E.-in-C.O.	10.5.60
Haddon, J.	Scot.	23.5.60	Hammett, A. J.	E.-in-C.O.	27.5.60
Walters, E. W.	E.-in-C.O.	22.6.60	Frisby, E.	N.W. Reg.	25.5.60
Bentley, A.	N.W. Reg.	1.6.60	Corlett, J. B.	N.W. Reg.	27.5.60
Page, S.	L.T. Reg.	10.6.60	Oldham, A.	N.W. Reg.	27.5.60
Barnett, F. P.	L.T. Reg.	10.6.60	Tibble, A.	S.W. Reg.	27.6.60
Draper, V.	L.T. Reg.	10.6.60	Ford, H.	S.W. Reg.	20.6.60
Cox, J. S.	H.C. Reg.	20.6.60	McClellan, G. B.	H.C. Reg.	2.6.60
<i>Assistant Engineer (Limited Competition)</i>			Smith, B.	E.-in-C.O.	14.6.60
Geere, R. D.	E.-in-C.O.	20.6.60	Phillips, S. G.	N.W. Reg.	15.6.60
Ramsay, W. R.	N.E. Reg.	28.4.60	<i>Technical Officer to Inspector</i>		
Pritchard, G. T.	N.W. Reg. to E.-in-C.O.	27.4.60	Riddy, E. A.	H.C. Reg.	1.6.60
Hughes, A. D.	E.T.E.	28.4.60	<i>Technician 1 to Inspector</i>		
Petrie, A. S.	E.-in-C.O. to Scot.	27.4.60	Cormack, G.	Scot.	16.5.60
Leggett, J. S.	E.-in-C.O.	10.6.60	Shambrook, R. F.	L.T. Reg.	5.5.60
Berrington, S.	E.-in-C.O. to W.B.C.	25.4.60	Wilkins, M. L.	L.T. Reg.	5.5.60
Lee, B. K.	S.W. Reg.	4.5.60	Kemp, J. A. C.	L.T. Reg.	5.5.60
Larder, D. A.	E.-in-C.O.	4.5.60	Evans, F. R.	L.T. Reg.	16.5.60
Smith, A. P.	E.T.E.	24.5.60	Reah, R.	N.E. Reg.	2.6.60
Jones, J. B.	N.W. Reg.	4.5.60	Price, A. F. H.	H.C. Reg.	15.6.60
Stock, L. A.	L.T. Reg.	16.5.60	Lally, A.	N.E. Reg.	2.6.60
Smith, J. P.	E.-in-C.O. to Mid. Reg.	23.5.60	Ryan, G.	N.E. Reg.	2.6.60
Slater, J.	N.W. Reg.	25.5.60	Hawksey, E.	N.W. Reg.	29.6.60
Critchlow, E.	N.W. Reg.	25.4.60	Mackie, R. C.	N.W. Reg.	29.6.60
Ward, J. D.	L.T. Reg.	25.4.60	O'Neill, A.	N.W. Reg.	29.6.60
Longbottom, R.	N.E. Reg. to E.-in-C.O.	9.5.60	Robinson, J.	N.W. Reg.	29.6.60
Farr, C. F. J.	S.W. Reg.	9.5.60	<i>Experimental Officer to Senior Experimental Officer</i>		
Jones, R. H.	Mid. Reg.	23.5.60	Feasey, R. J.	Birmingham Materials Section	19.5.60
Forrest, J. H.	E.-in-C.O.	9.5.60	<i>Senior Scientific Officer (Open Competition)</i>		
Smith, A.	S.W. Reg. to E.-in-C.O.	25.5.60	Rapsey, A. N.	E.-in-C.O.	2.5.60
Burns, R. P.	E.-in-C.O.	9.5.60	<i>Assistant Experimental Officer (Open Competition)</i>		
French, T. W.	L.T. Reg.	9.5.60	Engvall, P. G.	E.-in-C.O.	5.4.60
Midgley, W. K.	N.E. Reg. to E.-in-C.O.	9.5.60	Pearce, T. E.	London Materials Section	8.6.60
Armstrong, E. S.	H.C. Reg. to E.-in-C.O.	9.5.60	<i>Assistant (Scientific) (Open Competition)</i>		
Day, B.	N.E. Reg. to E.-in-C.O.	9.5.60	Harridence, B. W.	E.-in-C.O.	19.5.60
Canning, W. E.	N.I.	9.5.60	Jacobs, F. G.	E.-in-C.O.	28.6.60
Norton, R. H.	H.C. Reg. to E.-in-C.O.	9.5.60			
Monaghan, D.	N.E. Reg.	9.5.60			
Brownlee, G.	E.-in-C.O.	9.5.60			
Croudace, V. B.	H.C. Reg. to E.-in-C.O.	9.5.60			
Ancliff, B. T.	Mid. Reg.	9.5.60			
Axon, J.	N.W. Reg. to E.-in-C.O.	9.5.60			

* Mr. Merriman was seconded to the Treasury until 3 June 1960.

Promotions—continued

Name	Region, etc.	Date	Name	Region, etc.	Date
<i>Senior Executive Officer to Chief Executive Officer</i>			<i>Clerical Officer to Executive Officer</i>		
Kirby, H. K.	E.-in-C.O.	19.5.60	Hookway, G. T.	E.-in-C.O.	24.3.60
<i>Executive Officer to Higher Executive Officer</i>			Ward, W. H.	E.-in-C.O.	17.6.60
Jones, H. P.	E.-in-C.O.	17.6.60	Cheek, P.	E.-in-C.O. to London Reg. M.T.O.	1.7.60
McCready, R.	E.-in-C.O.	1.7.60			

Retirements and Resignations

Name	Region, etc.	Date	Name	Region, etc.	Date
<i>Executive Engineer</i>			<i>Inspector—continued</i>		
Knott, H. H. R.	S.W. Reg.	16.4.60	Bolitho, W. H.	S.W. Reg.	31.5.60
Preston, I. G.	Mid. Reg.	26.4.60	Cull, V. C. S.	L.T. Reg.	27.6.60
Johnstone, W. S.	E.T.E.	9.5.60	Morton, J. H.	N.W. Reg.	30.6.60
Hull, J. A.	N.E. Reg.	22.5.60	<i>Principal Scientific Officer</i>		
Andrewartha, C. J.	L.T. Reg.	26.5.60	Downes, A. D. W.	E.-in-C.O.	14.5.60
Cooper, H.	Mid. Reg.	28.5.60	<i>Assistant Experimental Officer</i>		
Cross, W. H.	N.W. Reg.	31.5.60	Copper, V. M. (Mrs.)	E.-in-C.O.	17.6.60
Thompson, S.*	E.-in-C.O.	21.6.60	<i>(Resigned)</i>		
<i>Assistant Engineer</i>			<i>Assistant (Scientific)</i>		
Branch, H. T.	E.-in-C.O.	4.5.60	Sargent, J. W.	E.-in-C.O.	19.6.60
Barrass, J. A.	N.W. Reg.	17.5.60	<i>(Resigned)</i>		
Garner, B.	W.B.C.	20.5.60	<i>Assistant Regional Motor Transport Officer</i>		
Helliwell, W. H.	N.W. Reg.	24.5.60	Hidson, C.	N.E. Reg.	20.2.60
Turner, A.	E.-in-C.O.	1.6.60	Payne, F.	N.E. Reg.	30.6.60
Jones, T.	N.W. Reg.	1.6.60	<i>Leading Draughtsman</i>		
Cross, J. J.	N.W. Reg.	1.6.60	Calderwood, S.	Mid. Reg.	7.6.60
King, R. J.	L.T. Reg.	10.6.60	Scott, J. R.	Scot.	20.6.60
Perks, J.	L.T. Reg.	15.6.60	Richardson, E. J.	L.T. Reg.	24.6.60
<i>Inspector</i>			<i>Higher Executive Officer</i>		
Ashton, R.	N.W. Reg.	31.3.60	Hodgkiss, S.	E.-in-C.O.	17.6.60
Jack, A.	Scot.	1.4.60	Bernstein, L.	E.-in-C.O.	30.6.60
Barnett, A. A.	Scot.	11.4.60			
Matson, H.	N.E. Reg.	23.4.60			
Green, F.	N.E. Reg.	25.4.60			
Porter, J. A.	N.I.	25.5.60			

*Mr. S. Thompson is continuing as a disestablished officer with E.-in-C.O.

Transfers

Name	Region, etc.	Date	Name	Region, etc.	Date
<i>Senior Executive Engineer</i>			<i>Assistant Engineer</i>		
Carden, R. W. G.	Secondment to E.-in-C.O.	29.2.60	Barker, A. L.	E.-in-C.O. to F.O. (D.W.S.)	1.11.59
<i>Executive Engineer</i>			Prout, A. G.	Iran to E.-in-C.O.	8.2.60
Belk, J. L.	E.-in-C.O. to L.T. Reg.	15.2.60	Marshall, N. E.	Pakistan to E.-in-C.O.	30.3.60
Blanchard, D. T.	L.T. Reg. to E.-in-C.O.	22.2.60	Lindsey, G. T.	E.-in-C.O. to L.T. Reg.	23.5.60
Collier, E. G.	E.-in-C.O. to Foreign Office	22.2.60	Forrest, J. H.	E.-in-C.O. to Mid. Reg.	23.5.60
Allen, K. H. A.	E.-in-C.O. to Admiralty	1.3.60	Flemons, J. C.	E.-in-C.O. to Mid. Reg.	27.6.60
Bunday, D. C.	E.-in-C.O. to G.C.H.Q.	1.4.60	<i>Technical Assistant II</i>		
Eckersley, G. B.	E.-in-C.O. to G.C.H.Q.	1.4.60	Jarman, A. R.	N.W. Reg. to W.B.C.	14.3.60
Vernon, D. H.	E.-in-C.O. to G.C.H.Q.	1.4.60			
Collings, J. I.	Nigeria to S.W. Reg.	2.5.60			
Childe, P. F.	E.-in-C.O. to N.W. Reg.	7.6.60			

Deaths

Name	Region, etc.	Date	Name	Region, etc.	Date
<i>Executive Engineer</i>			<i>Assistant Engineer—continued</i>		
Balfour, A.	L.T. Reg.	4.4.60	Annall, A.	N.E. Reg.	25.5.60
Dawson, C. F. O.	L.T. Reg.	13.5.60	Cave, S. R.	E.-in-C.O.	25.6.60
Stone, R. A.	N.W. Reg.	7.6.60	<i>Inspector</i>		
<i>Assistant Engineer</i>			Laker, W. J. B.	H.C. Reg.	23.3.60
Smith, H. L.	E.-in-C.O.	10.5.60			

BOARD OF EDITORS

D. A. BARRON, M.Sc., M.I.E.E., Chairman.
 L. F. SCANTLEBURY, Whit.Sch., A.C.G.I., D.I.C., M.I.E.E.
 T. H. FLOWERS, M.B.E., B.Sc.(Eng.), M.I.E.E.
 W. J. E. TOBIN, B.Sc.(Eng.), A.C.G.I., D.I.C., M.I.E.E.
 A. J. LECKENBY, M.B.E.
 G. J. MILLEN, A.M.I.E.E.
 R. F. WALDEGRAVE.
 E. DAVIS, A.M.I.E.E., Managing Editor.
 A. G. LEIGHTON, B.Sc.(Eng.), A.M.I.E.E., Deputy Managing Editor.
 J. MARTIN, B.Sc.(Eng.), A.M.I.E.E. } Assistant Editors.
 R. A. SUDELL }
 B. FARR, A.B.I., Secretary-Treasurer.
 B. CROSS, Advertisement Manager.

Copyright

The entire contents of this Journal are covered by general copyright, and special permission is necessary for reprinting long extracts, but editors are welcome to use not more than one-third of any article, provided credit is given at the beginning or end thus: "From *The Post Office Electrical Engineers' Journal*."

The Board of Editors is not responsible for the statements made or the opinions expressed in any of the articles in this Journal, unless such statement is made specifically by the Board.

Subscriptions and Back Numbers

The Journal is published quarterly, in April, July, October and January, price 2s. 6d. (3s. 6d. post paid) per copy or 14s. per year post paid (2 dollars 25 cents, Canada and U.S.A.). Back numbers will be supplied, if available, price 2s. 6d. (3s. 6d. post paid) per copy. Orders should be sent to *The Post Office Electrical Engineers' Journal*, G.P.O., 2-12 Gresham Street, London, E.C.2.

Employees of the British Post Office can obtain the Journal through local agents.

Binding Cases

Readers can have their copies of volumes bound at a cost of 10s. 6d. by sending the complete set of parts to the local Post Office distribution agent or to *The Post Office Electrical Engineers' Journal*, G.P.O., 2-12 Gresham Street, London, E.C.2. Alternatively, binding cases are available, price 3s., for those readers who wish to make their own arrangements for binding.

Remittances

Remittances should be made payable to "*The P.O.E.E. Journal*" and should be crossed "& Co."

Advertisements

All correspondence relating to advertisement space reservations, copy, proofs, etc., should be addressed to the Advertisement Manager, *The Post Office Electrical Engineers' Journal*, G.P.O., 2-12 Gresham Street, London, E.C.2.

Communications

With the exceptions indicated above, all communications should be addressed to the Managing Editor, *The Post Office Electrical Engineers' Journal*, G.P.O., 2-12 Gresham Street, London, E.C.2. Telephone: HEADquarters 1234.

Model Answer Books

Books of model answers to certain of the City and Guilds of London Institute examinations in telecommunications are published by the Board of Editors. Details of the books available are given at the end of the Supplement to the Journal.

XS2

Dry Reed Relay Insert

A gold-plated relay contact hermetically sealed in inert gas for absolute reliability, high speed and low contact bounce.

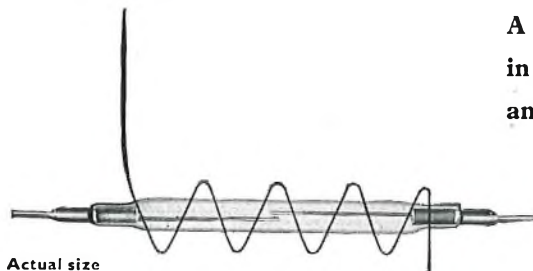

maximum current	250 mA
maximum resistive load ..	15 W
maximum closed resistance	50 mΩ
minimum open resistance	$5 \times 10^{11} \Omega$

nominal operate ampere turns ..	120 AT
nominal release ampere turns ..	60 AT
operate time less than	2 mS
bounce time less than	0.5 mS
release time less than	0.5 mS

Our Technical Service Department is ready to provide further details of characteristics or application.

Hivac Limited

A member of the Automatic Telephone & Electric Group

Stonefield Way · South Ruislip · Middlesex
 Telephone: VIKING 1288

Rectifiers

FOR

ANGLO-SWEDISH SUBMERGED COAXIAL CABLE

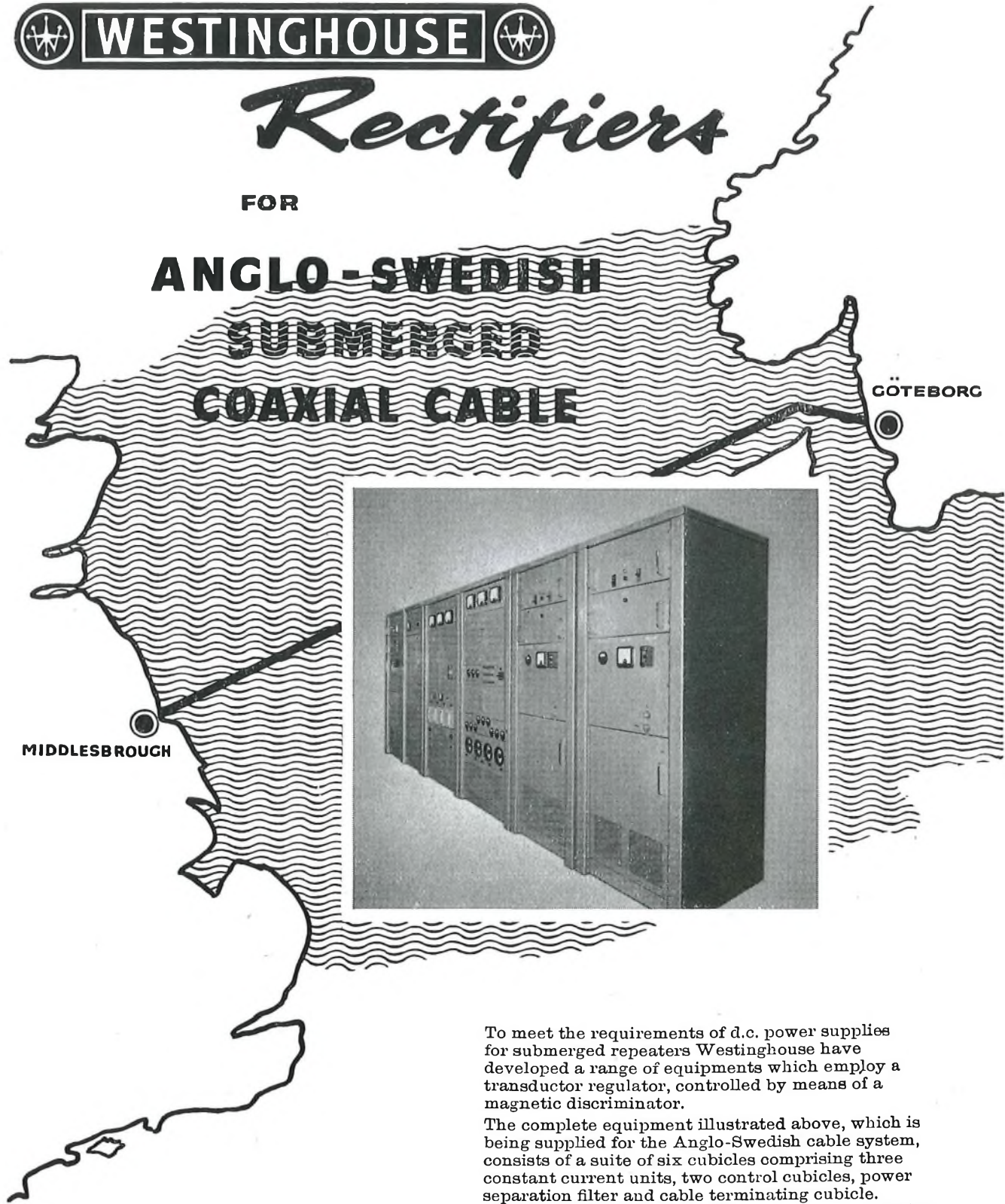

MIDDLESBROUGH

GÖTEBORG

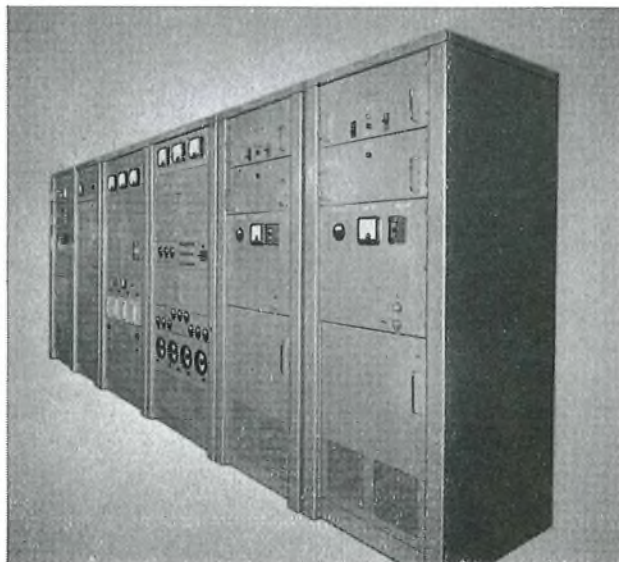

To meet the requirements of d.c. power supplies for submerged repeaters Westinghouse have developed a range of equipments which employ a transductor regulator, controlled by means of a magnetic discriminator.

The complete equipment illustrated above, which is being supplied for the Anglo-Swedish cable system, consists of a suite of six cubicles comprising three constant current units, two control cubicles, power separation filter and cable terminating cubicle. Complete indication, alarm, interlock and test facilities are built into the equipment.

Other equipments are at present in the course of being supplied for the Transatlantic Cable and System, H.M.T.S. Monarch, and the Bermuda Manahawkin Link.

For full details of Westinghouse rectifiers for telecommunications please write to Dept. P.O. 10 Rectifier Division (Special Products)

WESTINGHOUSE BRAKE AND SIGNAL CO. LTD • 82 YORK WAY, KING'S CROSS • LONDON, N1.

Terminus 6432

NEW TRANSISTORIZED CARRIER

For Cable Systems · Radio Systems ·

TECHNICAL FEATURES

- 300-3,400 c/s Channel Bandwidth.
- 4 kc/s spaced.
- Optional Inbuilt Out-band signalling (3825 c/s at -20 dbm0)
- Fully transistorized.
- 96 Circuits without signalling or 48 circuits with signalling per 9 ft. rackside (20½ in. x 8½ in. floor dimensions).
- Compact plug-in units with hinged, card-mounted components give maximum component accessibility.
- Can be supplied on rack-sides or a complete basic group on a sub-frame.
- Available in 60-108 kc/s basic channel groups or as systems for 12-circuit 2-wire cable operation or multi-circuit, for radio links.
- Conforms with CCITT and BPO requirements.

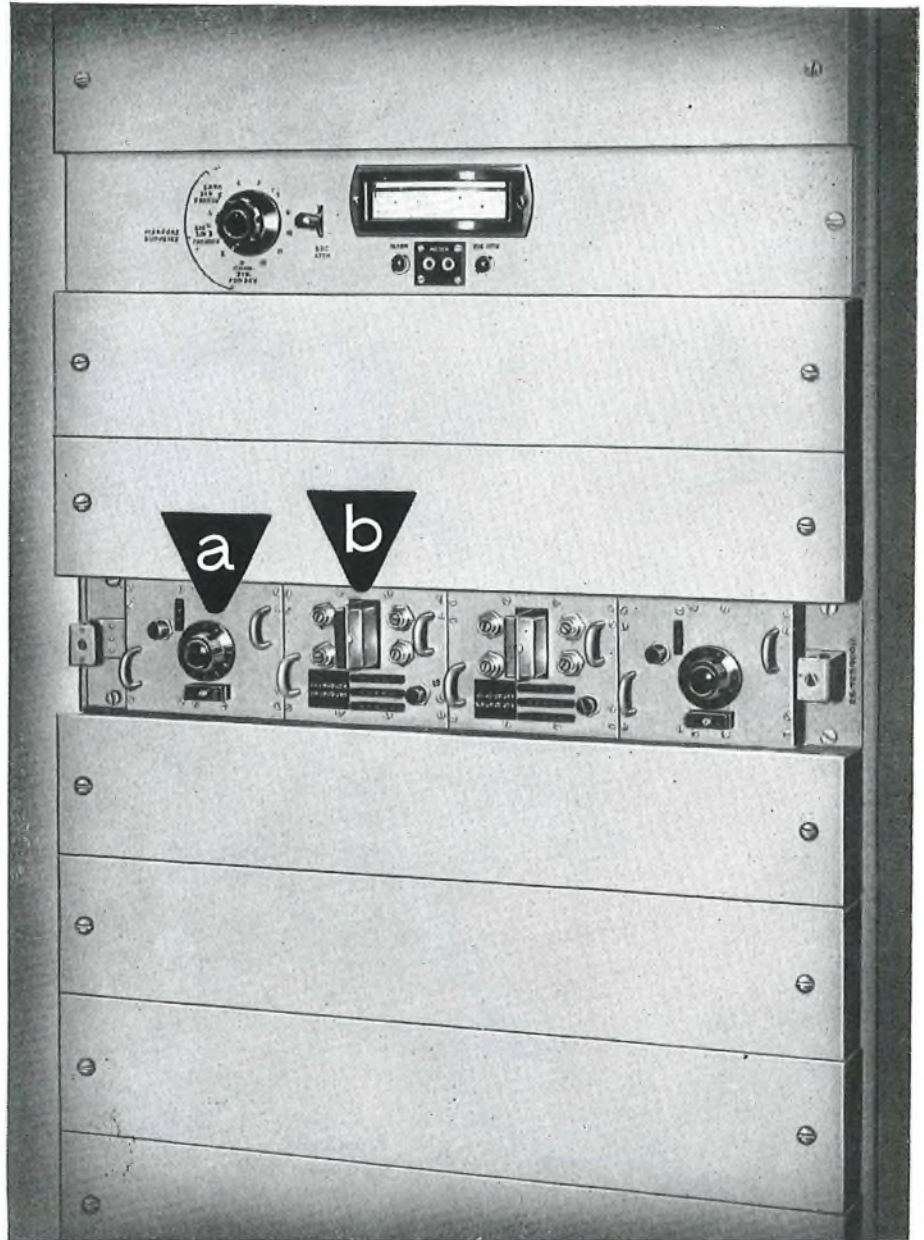

Cover removed to show panel with Channel and Signalling Units in position



Further information from:

TELEPHONE MANUFACTURING COMPANY LIMITED

Transmission Division: Cray Works, Sevenoaks Way, Orpington, Kent

Telephone: Orpington 26611

SELLING AGENTS *Australia and New Zealand:* Telephone Manufacturing Co. (A'sia) Pty Ltd., Sydney, New South Wales.

Canada and U.S.A.: Telephone Manufacturing Co. Ltd., Toronto, Ontario.

All other Countries (for transmission equipment only): Automatic Telephone and Electric Co. Ltd., London.

TELEPHONE EQUIPMENT BY T.M.C.

Channelling Equipment

This is the latest addition to the T.M.C. range which includes: 2, 3, 4 and 6 kc/s spaced carrier telephone equipment for cable, radio and open-wire systems. 120, 170 and 240 c/s spaced FM telegraph equipment. Compandors, negative impedance repeaters, VF amplifiers and privacy equipment.

a

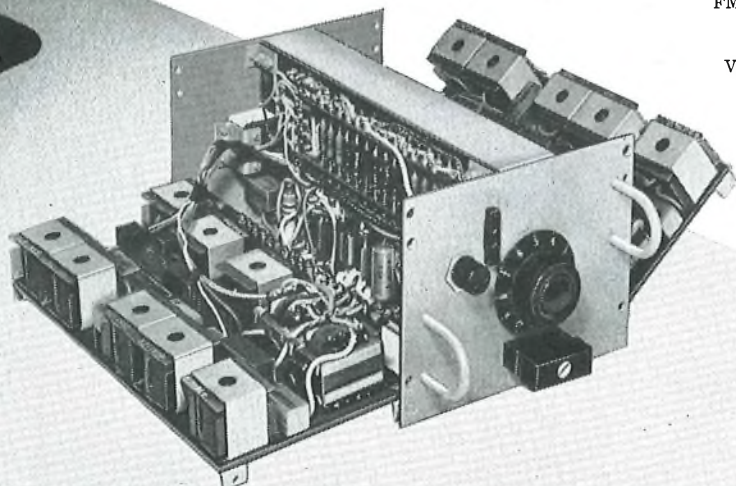

Channel Unit

b

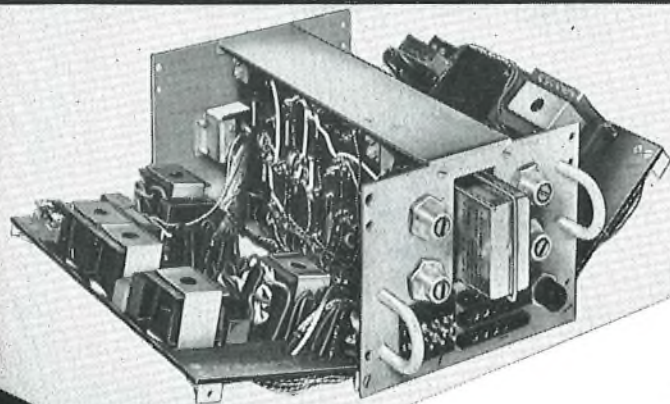

Signalling Unit

GENERAL

- As multi-channel carrier telephone equipment, it is designed to provide high-quality wide-band telephone circuits.
- It can be energized from suitable batteries or a.c. mains.
- Plug-in units and panels make transport, installation and maintenance easier.
- Great care has been taken to simplify the problem of installation. With plug-in panels and units removed, the rackside is easily lifted into position. Rackside may be mounted side-by-side back-to-back or back to a wall. Cable entries are arranged for both overhead and floor-duct distribution.

This new equipment is a further T.M.C. contribution to the recent advances made by the electronics industry in the field of telecommunication. In comparison with similar equipment, it effects considerable economies in the reduction of space used and power consumed. And still more economies are brought about by its simplicity of installation and ease of maintenance.

Vive le new Power Alliance!

Contracts for the manufacture and laying of the cross-Channel submarine power link have now been placed by the Central Electricity Generating Board and Electricité de France

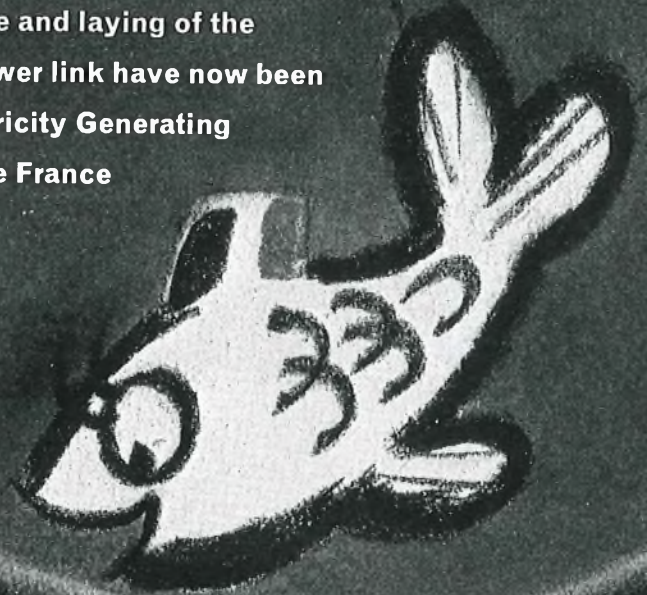

'Ooray for British Cable!

The British contribution to the cross-Channel submarine cable is a joint enterprise—by AEI Cable Division in association with BICC

Two single-core submarine power cables, carrying the heaviest d.c. load ever transmitted by a single circuit under water, will link England and France.

AEI

CABLE DIVISION

Associated Electrical Industries Limited

51-53 Hatton Garden, London EC1. Phone: CHAncery 6822

DENSO MASTIC H.D.

is essential for . . .

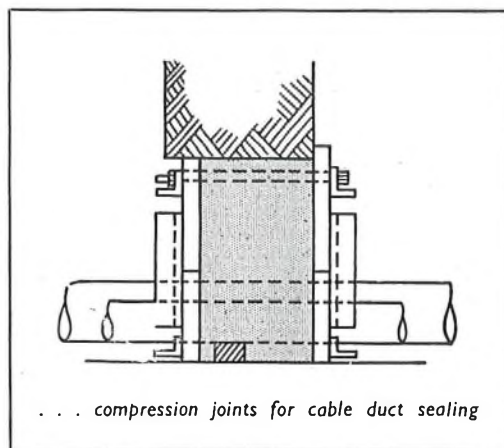
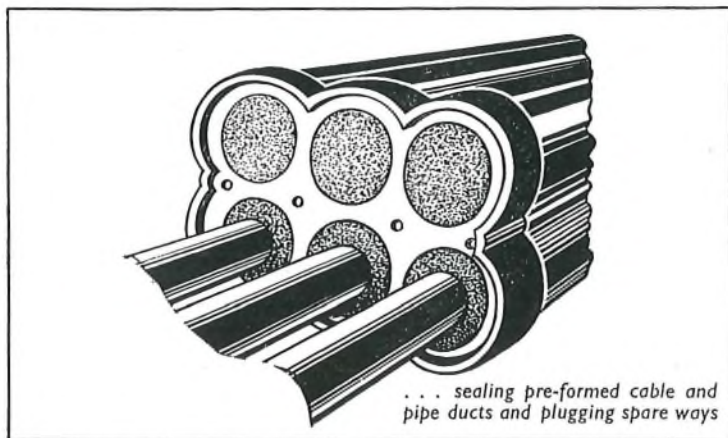

. . . plugging and sealing against air, gas and water. It meets the requirements of the several B.S. Codes of Practice and is adopted generally by Public Authority and Industry . . .

. . . and saves time, labour, money

WINN & COALES LTD

LONDON
Tel.: GIPsy Hill 7511

MANCHESTER
(also Contracting Dept.) Tel.: Sale 8271

BELFAST
Tel.: 56623

DUBLIN
Tel.: 61768

Agents throughout the Commonwealth

Visit our Stand
506
Public Works and
Municipal Services
Exhibition,
Olympia,
Nov. 14-19

Ernest Turner

Electrical Measuring Instruments

Ideally matching contemporary panel design, the Ernest Turner Model 703, illustrated here, is enhanced by the flush-fitting surround. A high degree of accuracy is adequately supported by the easy-to-read scale and clean dial layout. Full details of the range of rectangular electrical measuring instruments and flush mountings are contained in Leaflets 85/G and 85/AF, available on request.

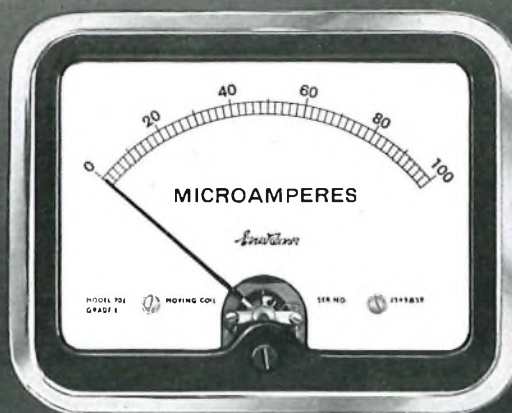

Ernest Turner Electrical Instruments Ltd

HIGH WYCOMBE · BUCKINGHAMSHIRE · ENGLAND

STC Telecommunication Cables

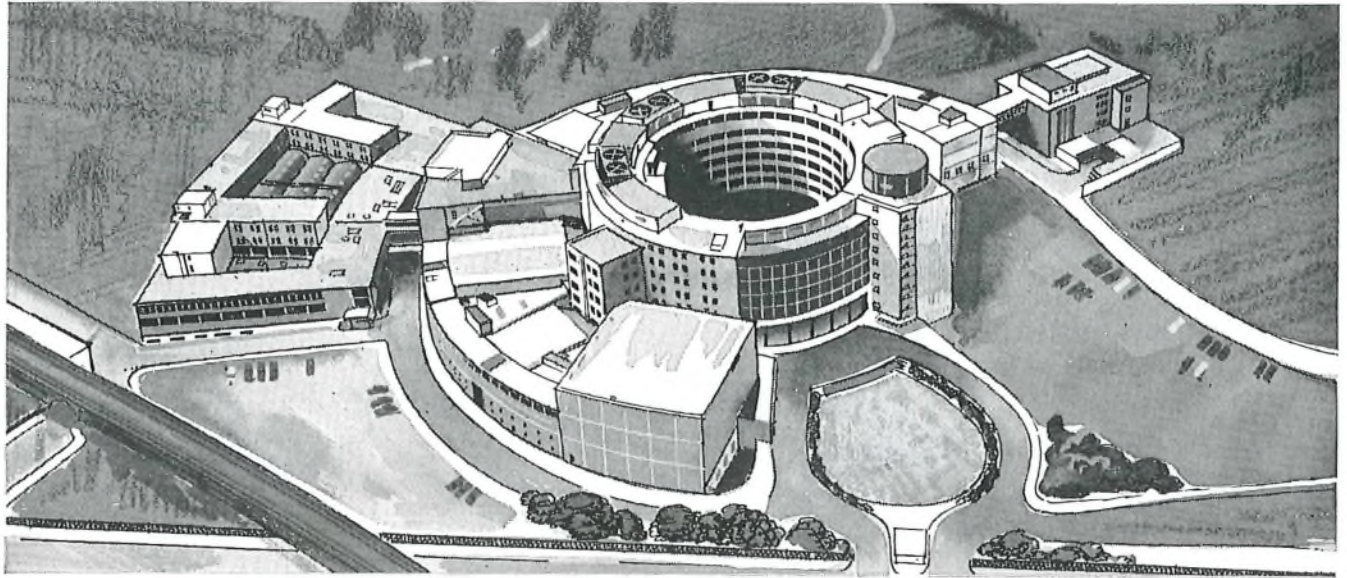

for the B.B.C. Television Centre London

A further major contribution to the British television network consists of telecommunication cables connecting the British Broadcasting Corporation Television Centre, White City, London — the largest centre of its kind in Europe, with various studios, theatres and telephone exchanges. The network of cables manufactured and installed by Standard Telephones and Cables Limited for the British Post Office, will be used by the B.B.C. for sound and television transmission.

STC are fully equipped to undertake the planning, manufacture and installation of complete cable systems . . . whatever the purpose . . . however complex and extensive.

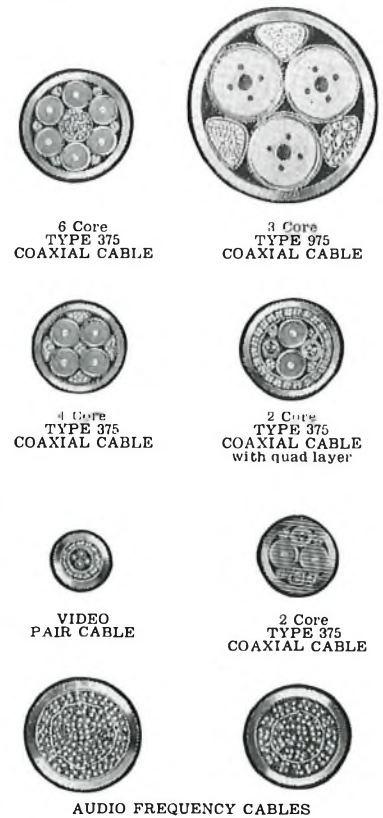
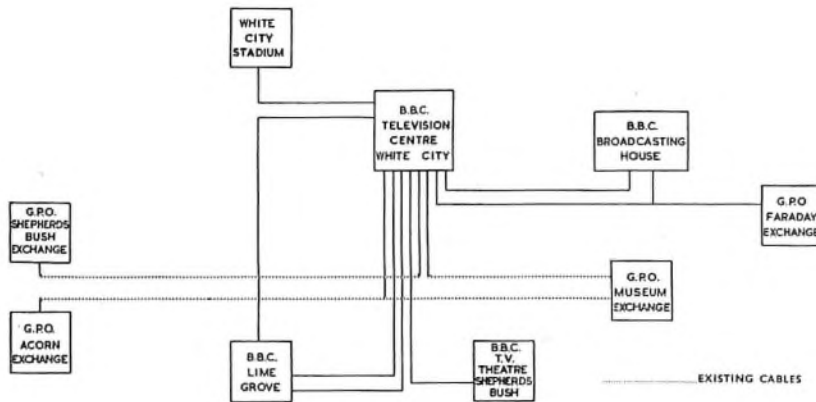

60/5B

Standard Telephones and Cables Limited

Registered Office: Connaught House, Aldwych, London, W.C.2

TELEPHONE CABLE DIVISION: NORTH WOOLWICH · LONDON E.16

ADCOLA

REGISTERED
(Regd. Trade Mark)

FOR
**SOLDERING INSTRUMENTS
and EQUIPMENT**
SUPPLIED FOR ALL VOLTAGES



illustrated

**DETACHABLE
BIT**
MODEL $\frac{3}{15}$ "
List 64

**PROTECTIVE
SHIELD**
List 68

Write for Catalogues
HEAD OFFICE, SERVICE AND SALES

ADCOLA PRODUCTS LTD.
GAUDEN ROAD, CLAPHAM HIGH STREET, LONDON, S.W.4
Phone: MACaulay 3101, 4272

VALUABLE FREE BOOK



**Tells You How to Pass Your C. & G. or
Promotion Exam. at First Attempt!**

All Post Office Engineering personnel who are anxious to obtain early promotion should at once send for a copy of our handbook "ENGINEERING OPPORTUNITIES," which among other intensely interesting matter describes our unique methods of preparation for **TECHNICAL APPOINTMENTS IN THE POST OFFICE** (Assistant Engineer—New Style and Assistant Traffic Superintendent), **CITY AND GUILDS EXAMINATIONS** in Principles of Telecommunications (1-5), Radio (1-4), Telephone Exchange Systems (1-3), Telegraphy (1), Line Transmission (1 and 2), Lines Plant Practice (1 and 2), Mathematics for Telecommunications (1-5), Electrical Engineering Practice (Prelim. Inter. and Final), and outlines a wide range of non-examination courses in all branches of Electrical, Mechanical, Civil, Automobile, Aeronautical and Radio Engineering.

Assistant Engineer and Assistant Traffic Superintendent. Open competitions now resumed. Age extensions for established Civil Servants. Ask us for full details.

**We definitely guarantee
"NO PASS—NO FEE"**

If you intend to make the most of today's opportunities, you cannot afford to miss reading "ENGINEERING OPPORTUNITIES." It tells you everything you want to know to secure advancement, and describes many opportunities you may now be missing through lack of information. Send for your copy to-day—FREE and without obligation.

**BRITISH INSTITUTE
OF ENGINEERING TECHNOLOGY**
369 COLLEGE HOUSE,
29-31 WRIGHT'S LANE, LONDON, W.8

BIET

TELECOMMUNICATIONS

By A. T. Starr, M.A., Ph.D., etc. Second Edition

This book covers the Syllabus for the subject of Telecommunications in the London University Degree, but the choice of material should make the book acceptable to students studying for other similar examinations.

Price 37s. 6d. net.

TELEPHONY

By J. Atkinson, M.I.E.E., Post Office Engineering Department.

A detailed exposition of the telephone exchange systems of the British Post Office. Originally written by T. E. Herbert and W. S. Proctor, the work has been entirely revised and includes the latest advances in telecommunications practice. It covers the syllabuses of the City and Guilds of London Institute examinations in Telephone Exchange Systems, Grades I, II, and III, and the telephone aspects of Elementary Telecommunications Practice.

Vol. I. General Principles and Manual Exchange Systems. 40s. net.

Vol. II. Automatic Exchange Systems. 55s. net.

From all booksellers.

PITMAN

Parker Street,
Kingsway, London, W.C.2

VINKOR

Pot
Core
Assemblies
offer...

adjustment of $\pm 7\%$

with an accuracy of better than $\pm 0.02\%$

Any assembly in the Mullard Vinkor range can be easily adjusted to an accuracy of better than $\pm 0.02\%$ by using a trimming screwdriver, whilst stability is ensured by the self-locking action of the adjuster core. The range of adjustment is approximately $\pm 7\%$ about the nominal mid-position of the adjuster core. Over and above these advantages, for each size of core there is a choice of three permeabilities, which are controlled to close limits so that it is possible to calculate and wind an inductance to $\pm 3\%$ of the value required before adjustment.

These are just some of the reasons why leading equipment designers acclaim Vinkor as the world's most efficient pot core. If you have not received your copy of Vinkor data, write at once to the address below.

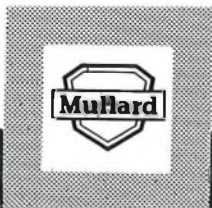

Mullard Ltd. Component Division, Mullard House, Torrington Place, W.C.1.

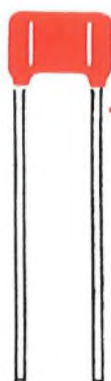

NEW

HIGH TEMPERATURE CAPACITORS

efficient at **250°C**

Type H precision silvered mica capacitors—the latest addition to the JMC range—are suitable for use from -70°C to $+250^{\circ}\text{C}$. Silicone rubber protection safeguards their outstanding performance at very high operating temperatures.

- ★ Fired construction
- ★ Two standard sizes covering all values from $5\mu\text{F}$ to $50,000\mu\text{F}$
- ★ Minimum tolerance $\pm\frac{1}{2}\%$ or $\pm 1\mu\text{F}$ (whichever is greater)
- ★ Small physical size
- ★ Silver or silver-clad connecting leads

Catalogue sheets describing the complete range of JMC precision capacitors are available on request

Johnson  Matthey

JOHNSON, MATTHEY & CO., LIMITED
73-83 HATTON GARDEN, LONDON, E.C.1 Telephone: Holborn 6989
Vittoria Street, Birmingham, 1. Telephone: Central 8004
75-79 Eyre Street, Sheffield, 1. Telephone: 29212



STC

WORLD-WIDE EXPERIENCE

STC are supplying
main line microwave telephone systems
to 18 countries and have
already supplied systems with a capacity
of over 4½ million
telephone circuit miles and over
5,000 television channel miles

ANGLO-FRENCH MICROWAVE TELEPHONE AND TELEVISION SYSTEM

World-wide experience and vast technical resources have enabled STC to design and produce a microwave system of the high circuit capacity necessary for the greatly increased cross-Channel telecommunications requirements.

The 4000 Mc/s, 600 circuit, 2-way microwave telephone channel with standby facilities between Folkestone (England) and Lille (France) is 94 miles long. An STC associate company, Le Materiel Telephonique, has supplied and installed television transmission equipment over this route using the same aerial towers and buildings. Dual diversity reception is employed on the section spanning the English Channel.

This system represents further evidence of STC's unique position in the wide world of telecommunications.

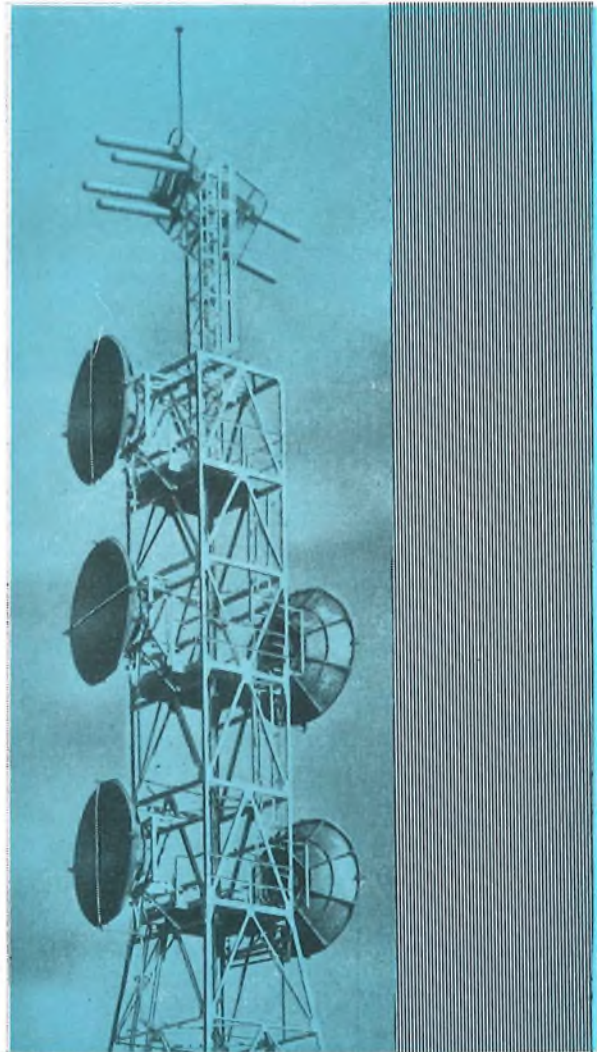

- ———▶ 600 circuit capacity 2-way telephone channel
- - - - -▶ Standby telephone channel
- ———▶ 2-way channel for television signals
- - - - -▶ Standby TV channel
- - - - -▶ Possible third channel extension for each service

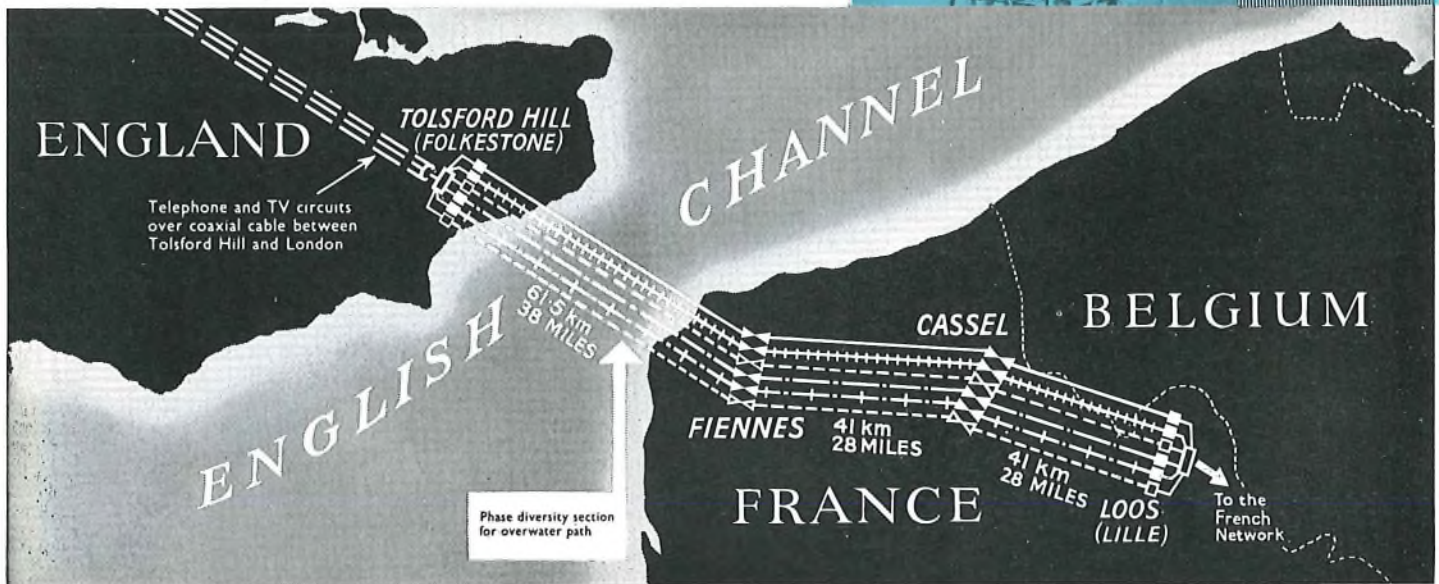

Standard Telephones and Cables Limited

Registered Office: Connaught House, Aldwych, London, W.C.2

TRANSMISSION DIVISION: NORTH WOOLWICH · LONDON · E.16

Telegraph distortion measurement

in the speed range 40-400 bauds

Rapidly increasing international use of high-speed synchronous telegraph systems has led to the urgent need for suitable distortion measuring equipment. M.S. Type TCA1219, manufactured by A.E.I. at their Woolwich factory to a British Post Office design, enables distortion measurements to be made within 1% accuracy. The method of indication is by bright spots on the circular time base of a cathode-ray tube. Screening and the fitting of radio interference suppressors have been given particular attention.

Size	17 in. high x 15 in. wide x 18 in. deep
Weight	110 lb.
Power supply	200/250 v. 50 c.p.s.
Power consumption	170 w.



●
 ●
 1:1
 2:2
 6:1
 7:7
 Q9S
 ●
 ●
 or any
 single
 character

vast experience



in the science of telecommunications



Telecommunications Division

Transmission Department Woolwich London SE18

Associated Electrical Industries Limited



5-unit tape transmitter

model 20

Sequential type for single wire transmission.

For single or double current operation.

7 $\frac{1}{2}$ unit transmission at 45.5, 50, or 75 bauds

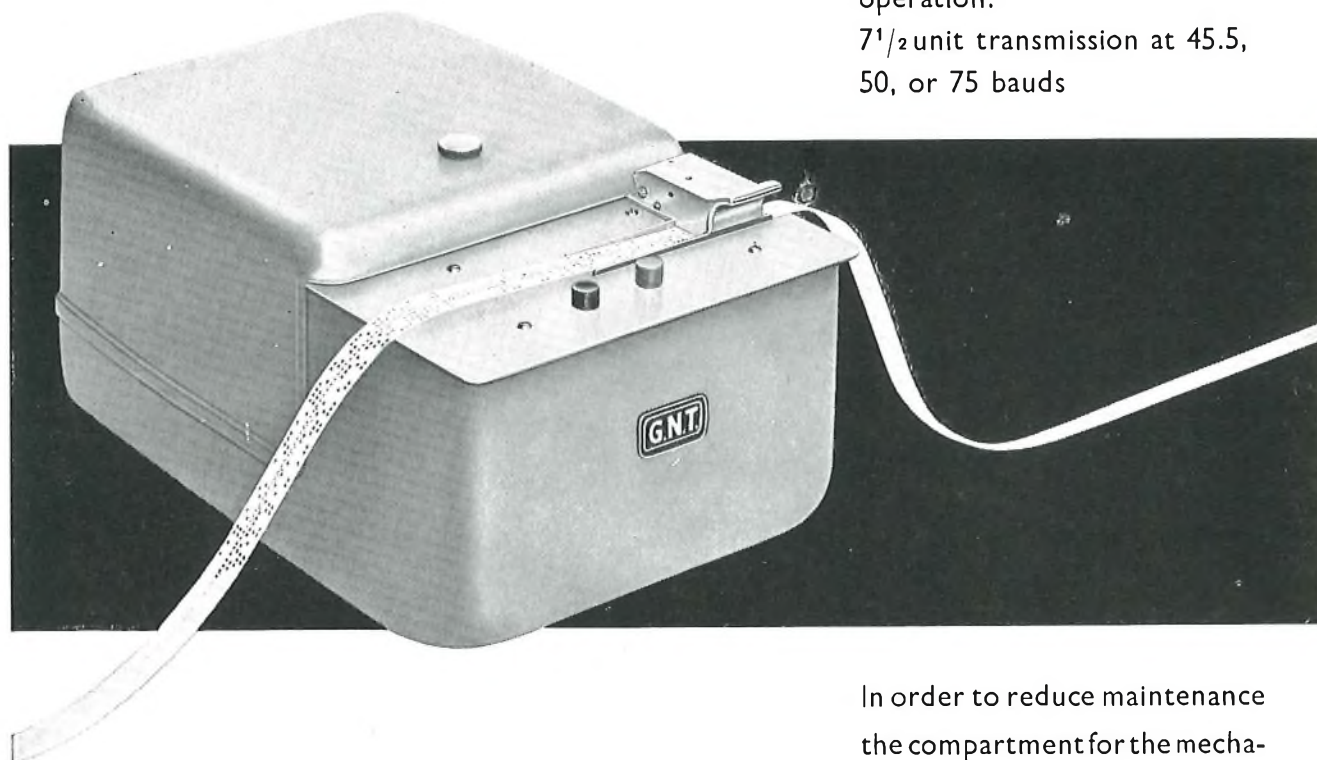

*Meets all the requirements
of a modern 5-unit tape transmitter.*

In order to reduce maintenance the compartment for the mechanism is pressurised so that dust and paper fluff cannot enter the operating parts.

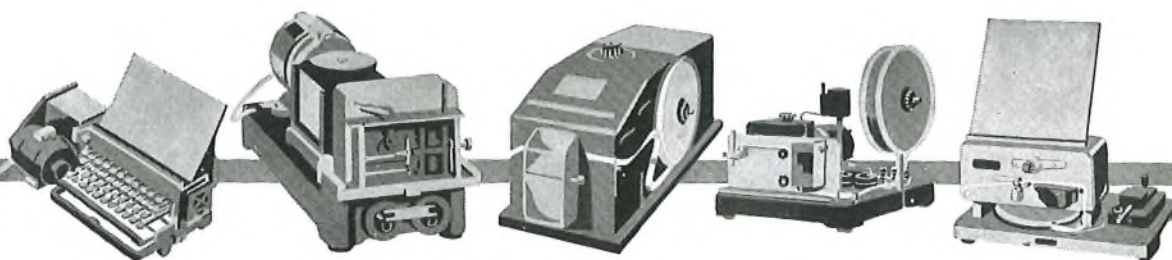

GREAT NORTHERN TELEGRAPH WORKS

DIVISION OF THE GREAT NORTHERN TELEGRAPH CO. LTD.

4, SYDHAVNS PLADS
COPENHAGEN SV, DENMARK

LONDON OFFICE: 5, ST. HELEN'S PLACE
LONDON E. C. 3.



Extension

THE SWITCHING TELEPHONE

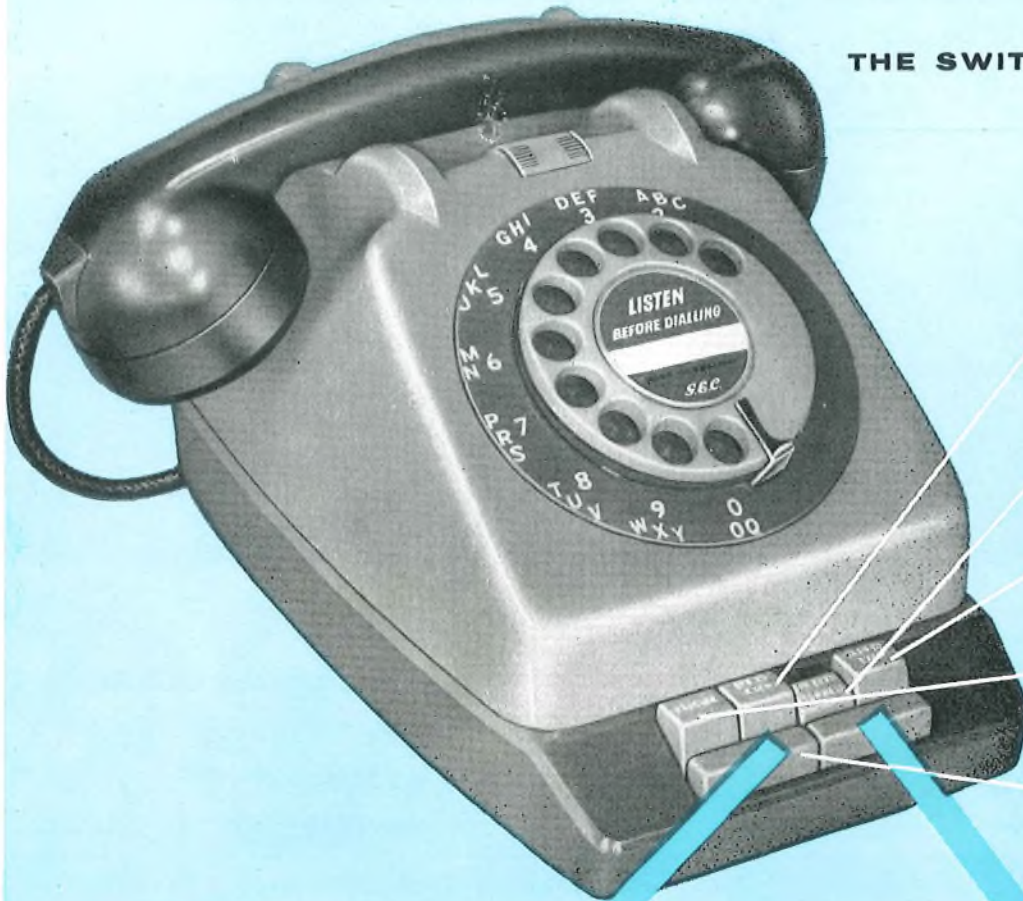

THE EXTENSION TELEPHONES



THE GENERAL ELECTRIC COMPANY LIMITED OF EN

WOR

Telephone System

with 4-button operation

Speak to Exchange

Extension telephones cannot hear the conversation

Speak to Extension (Exchange held)

Exchange line cannot hear conversation between main (switching) telephone and extension telephone.

Extension to Exchange

The conversation can be secret or non-secret from the main telephone.

Release By depressing this button, the other buttons that have been engaged are released to their original positions.

Twin keys By depressing the appropriate key the required extension telephone is called.

This G.E.C. system permits two or three telephones to be associated on one exchange line using one switching telephone and one or two extension telephones. Exchange calls can be made or received by each telephone, as required. Alternatively, any of the telephones can converse independent of the exchange. The maximum line loop resistance between the main and an extension or between an extension and the exchange is 1000 ohms.

The system can easily be connected to any type of exchange, and is especially suitable for commercial organisations where a secretary can filter calls through the switching telephone to an executive and/or his assistant.

These telephones were designed in conjunction with the British Post Office and are the only telephones accepted by the British Post Office giving full plan 5 and plan 7 facilities.

For further details please write to

IND • TELEPHONE WORKS • COVENTRY • ENGLAND
AT COVENTRY • LONDON • MIDDLESBROUGH • PORTSMOUTH

EVERYTHING FOR
TELECOMMUNICATIONS

G.E.C.

GEC

HOW TO PASS YOUR CITY AND GUILDS TELECOMMUNICATIONS EXAMS—BY POST



W. S. Procter, O.B.E., M.I.E.E., F.R.S.E.,
Chief Regional Engineer, London
Telecommunications Region.

The new Bennett College Telecommunications Courses were prepared under the supervision of one of the country's top telecommunications men, W. S. Procter, O.B.E., M.I.E.E., F.R.S.E., Chief Regional Engineer, London Telecommunications Region.

The Bennett College, the oldest and most progressive Correspondence College in the country, are proud to announce that a new, comprehensive course of study for Telecommunications students is now available. You can now study for the first and second year City and Guilds Examinations of the 4-year syllabus—by post—in your spare time at home.

The first and second year subjects are:

FIRST YEAR

1. Practical Mathematics
2. Engineering Science
3. Engineering Drawing
4. Elementary Telecommunications Practice

SECOND YEAR

1. Mathematics for the Telecommunications A
2. Telecommunications Principles A
3. Radio and Line Transmission A
4. Telephony and Telegraphy A
5. Line Plant Practice A

Other subjects will be introduced later.

The certificates awarded by the City and Guilds Institute are accepted in all fields of Telecommunications Engineering as evidence of an efficient training. They are of special value to employees of the Post Office Telecommunications Branches, and the Radio and Telecommunications industry, whether engaged in the manufacture or the maintenance and operation of Telecommunications apparatus.

Just fill in the coupon below, and post it off at once for more information

To: THE BENNETT COLLEGE
(DEPARTMENT 24WSP) SHEFFIELD
*Please send me details of the new
Telecommunications Courses*

NAME.....
ADDRESS.....
.....
AGE.....

Personal postal tuition through the famous Bennett College!

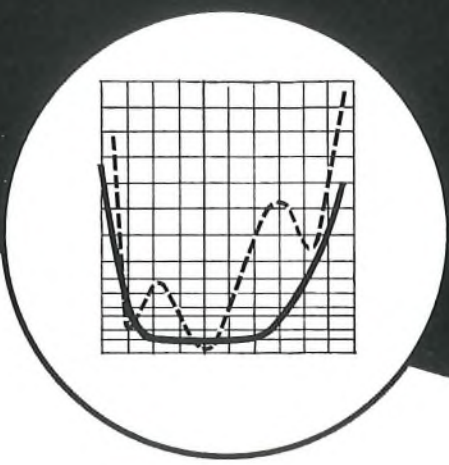

Faster and more accurate measurements

using

Sweep-Frequency Measuring Equipment for Attenuation and Reflection Coefficient 0.45 to 1 · 1.7 to 2.7 · 3.3 to 4.5 · 5.85 to 8.5 kMc/s

Wide application in microwave engineering for development, manufacture, and production

Basic equipment plus plug-in units for different frequency ranges make for economy

Wide measuring ranges

The principle of ratio-measurement results in high accuracy and overcomes the effects of varying oscillator power

Automatic sweep between any two selected points of the frequency scale or manual operation

- Measuring range 55 to 0 dB
- corresponding to Reflection Coefficients of
- 0.002 to 1
- Vertical display 15 dB

Test gear combinations also available for other measurements and frequency ranges

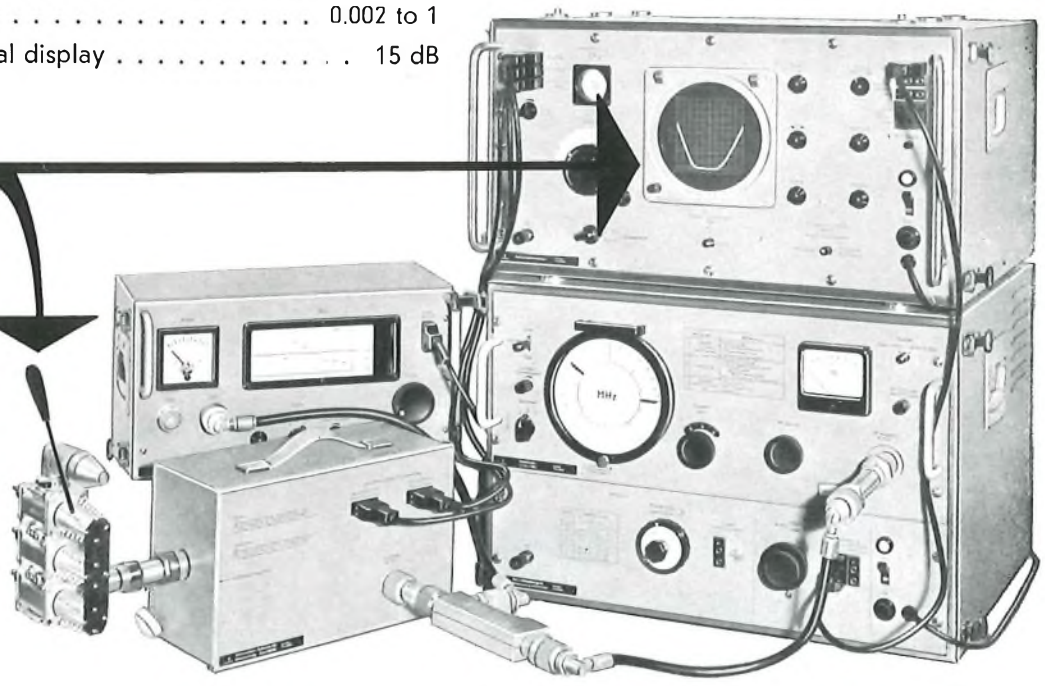

SIEMENS & HALSKE AKTIENGESELLSCHAFT
MÜNCHEN · BERLIN

U.K. Sole Agents

R. H. COLE (OVERSEAS) LTD.

2, Caxton Street, Westminster, London, S.W.1 Telephone: ABBey 3061 · Telex: 23864

WV125 F

As simple as

... plugging in the light!

THE ERICSSON RURAL CARRIER TELEPHONE SYSTEM TYPE R.C.101

has been designed to combine ease of maintenance with small physical size and low power consumption. It is particularly suitable for use in remote areas where personnel trained to service carrier equipment may be limited. A fault may be cleared by substituting a spare for each plug-in unit in turn until the service is restored.

The system will provide up to ten additional speech circuits on an open wire line. The circuits are stackable and thus extra circuits may be added as demand increases. This feature together with a wide range of pole mounted 'drop-off' filter units offers a high degree of system flexibility. Channel re-allocation is easily achieved with this system of plug-in sub-units.

Illustrated on the opposite page are two typical plug-in units, a channel transmit unit and a hybrid unit with V.F. amplifier and limiter. Below is a single channel terminal with mains power unit and compandor units fitted.

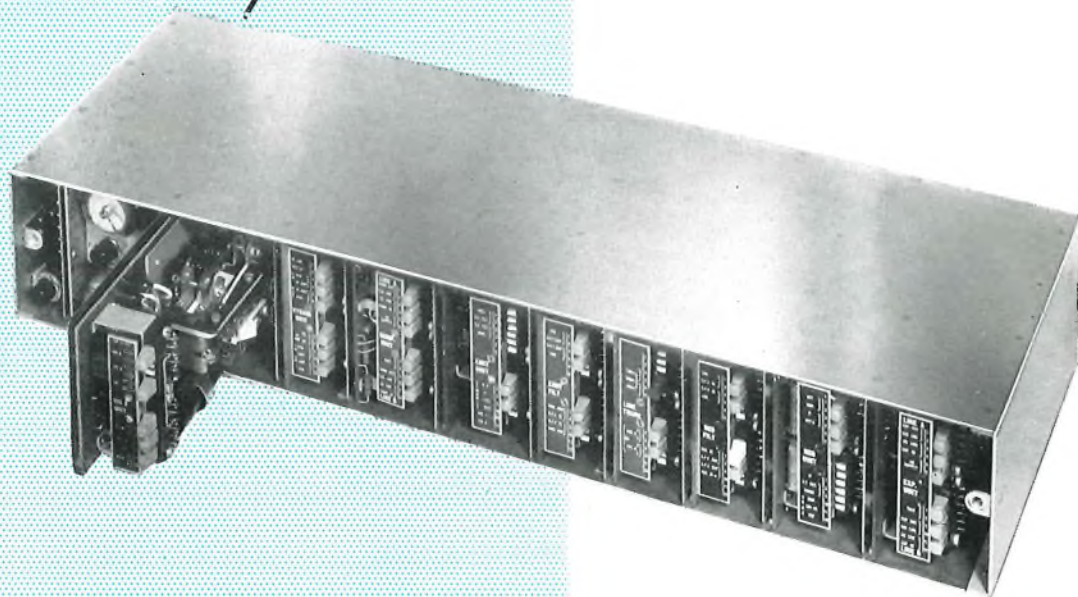
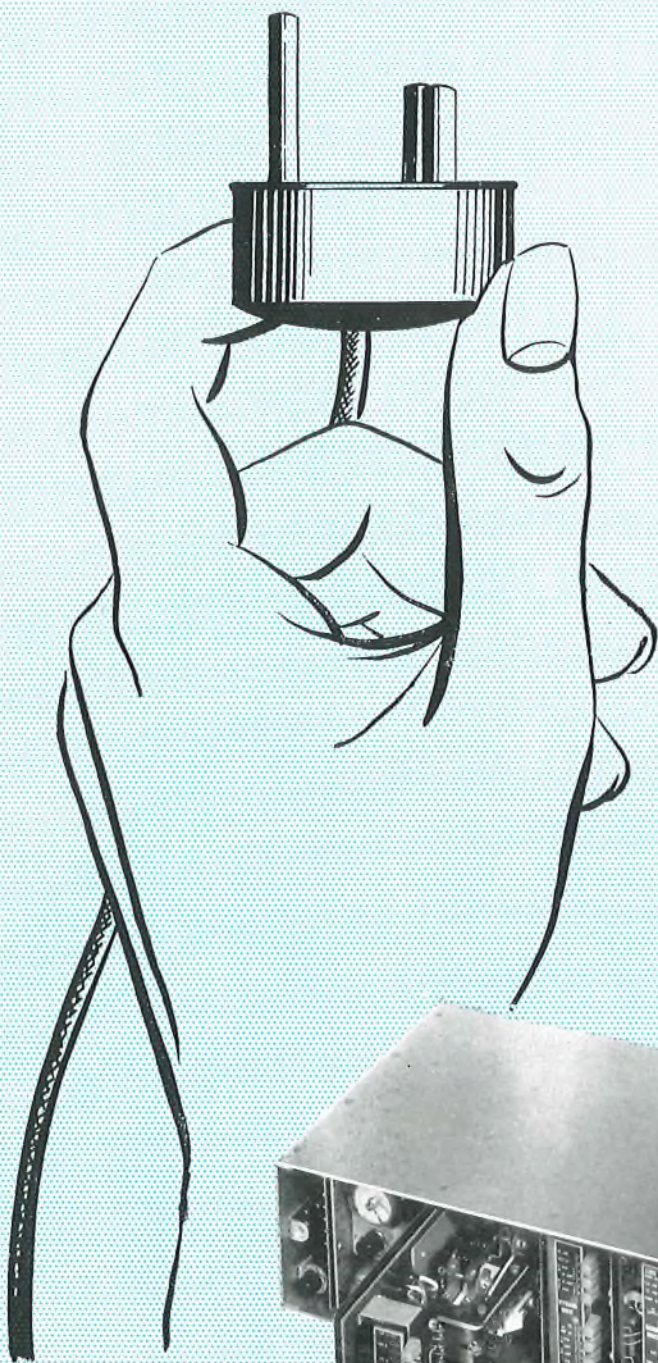

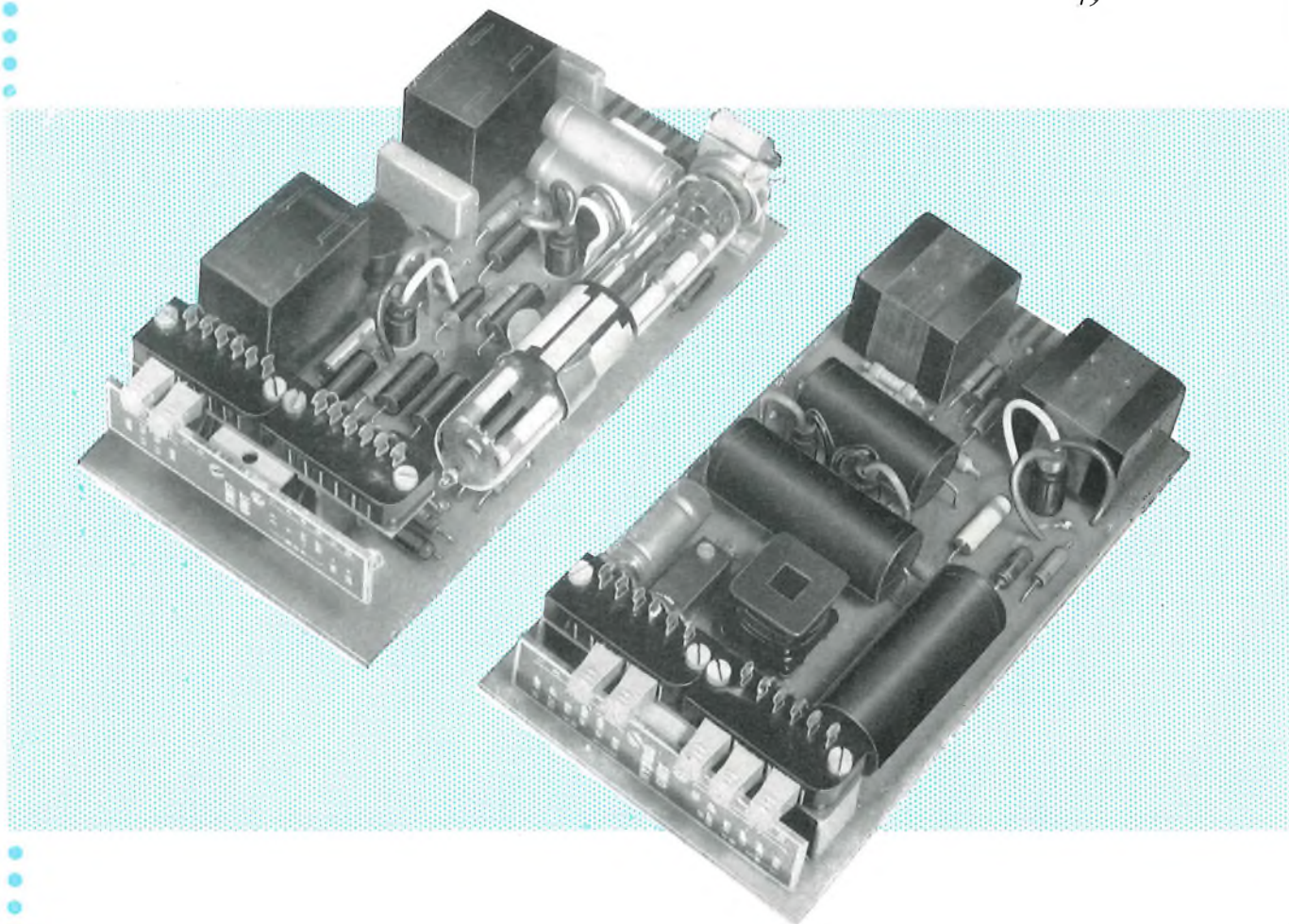

brief specification

Audio bandwidth	300 c/s — 2700 c/s
Overall frequency range (10 channels)	12 kc/s — 172 kc/s
Carrier level to line (per channel)	+ 3 dbm
Minimum acceptable receive level from line	— 40 dbm
2 wire circuit equivalent	— 3 db

POWER CONSUMPTION:—

Standby	10 m.a. at 12 v D.C.
During call	40 m.a. at 12 v D.C.

other features

- ★ LOWER POWER CONSUMPTION.
- ★ BATTERY OR OPTIONAL MAINS OPERATION.
- ★ TRANSMITTED CARRIER FOR AUTOMATIC GAIN CONTROL AND SIGNALLING.
- ★ INTERCHANGEABLE SIGNALLING UNITS.
- ★ TRANSISTOR CIRCUITS.
- ★ COMPANDOR UNITS OPTIONAL.
- ★ AMPLE TEST POINTS.
- ★ ONE 10 CHANNEL TERMINAL ACCOMMODATED ON A WALL MOUNTING RACK 3' 3" HIGH.
- ★ SIMPLE INSTALLATION.
- ★ PORTABLE TEST SET AVAILABLE.

for further information please write to:-

ERICSSON TELEPHONES LIMITED—ETELCO LIMITED

Head Office: 22 Lincolns Inn Fields, London W.C.2. Tel: HOL. 6936 · Works: Beeston, Nottingham and Sunderland



*“Twitterton!
Is this really
FORMICA*?”*



Yes, this is an interesting example of the use of Formica industrial laminates. Here we have a uniselector (one of possibly thousands used in an automatic telephone exchange) made by The General Electric Company Limited. Paper-base laminates were provided for the uniselector by Formica Limited – they possess very high di-electric strength (that is, they are excellent insulators) and conform to the exacting specifications laid down by the G.P.O.

This is just one more of the many unexpected uses of Formica products. Out of the kitchen and into the wide world of telecommunications . . . what *will* Formica Limited be doing next?

FORMICA
make

DECORATIVE LAMINATES
EXTRUDED LAMINATES
INDUSTRIAL LAMINATES
CHAIR SETS



For full information on any FORMICA product please write to:

Formica Limited, De La Rue House, 84-86 Regent Street, London, W.1. Tel: REGent 8020

**FORMICA is a registered trade mark*

PROPAGAS

PROPANE

carries weight
in the
building industry

Propane and Butane are now available to industry from the great British refineries of the Shell, Eagle and BP Groups. They are petroleum gases delivered and stored as liquids under moderate pressure. These versatile products assist the Building industry for temporary or permanent space heating and floodlighting of buildings, the ideal mobile equipment for Builders, Plumbers and Decorators.

See us at Stand No 424
Grand Hall Gallery, Olympia
Public Works Exhibition

For full details of these and other products including Floodlighting and Space Heating Equipment, apply now to:

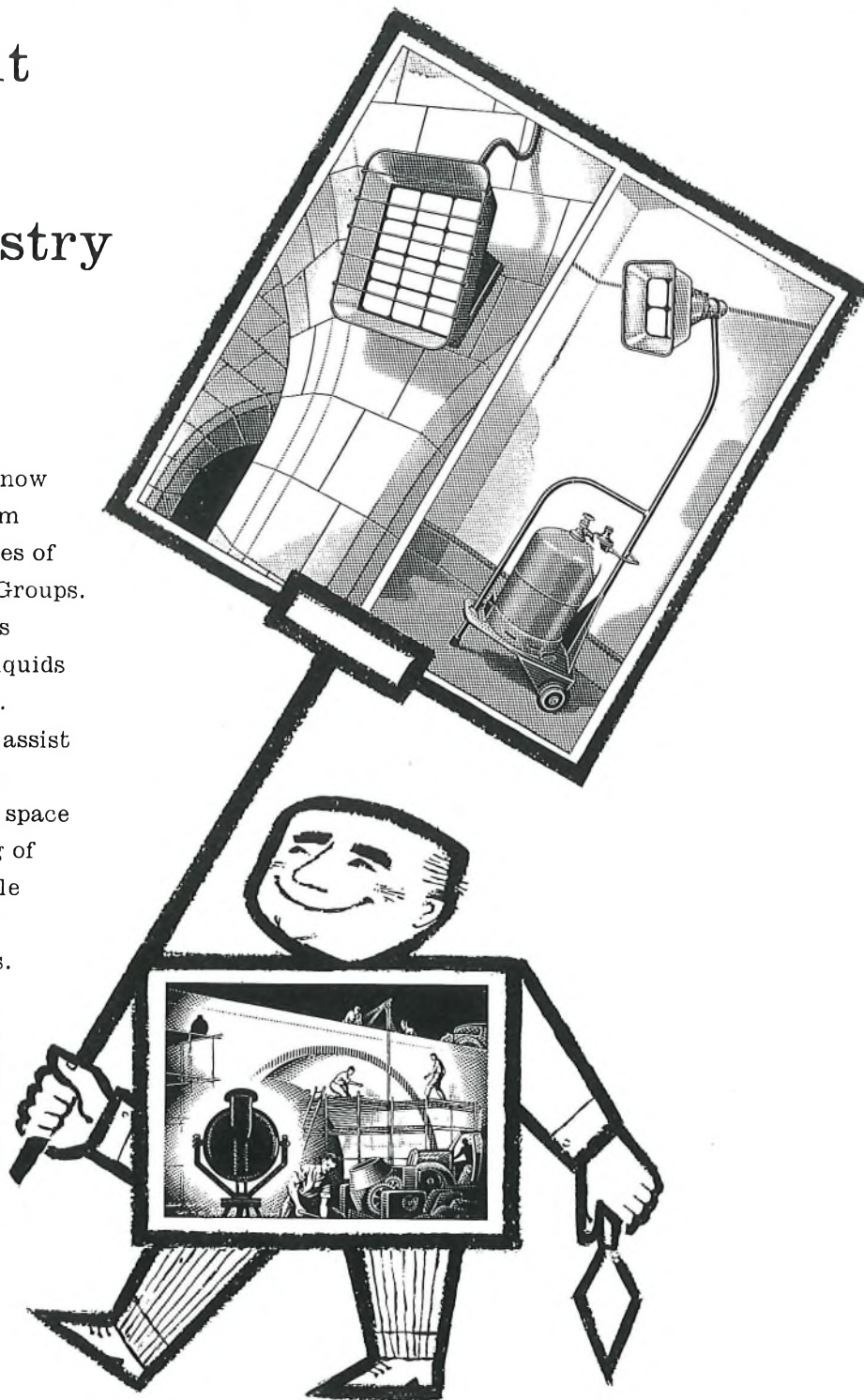

SHELL-MEX AND B.P. GASES LIMITED

(Regd. users of trade marks)

"The biggest distributors of Propane in the U.K."

CECIL CHAMBERS 76-86 STRAND LONDON WC2 Telephone: TEMple Bar 1234



permanent magnets for ELECTRICITY METERS

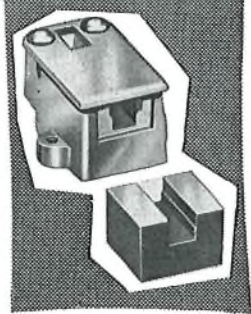
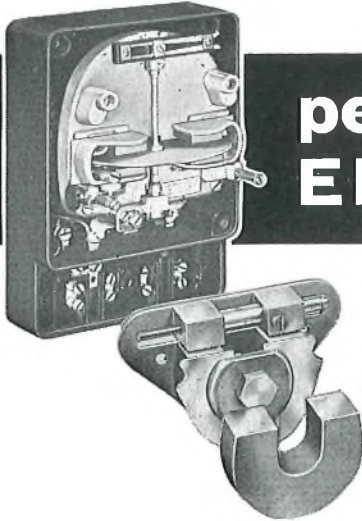

For many years Eclipse magnets have been chosen for eddy-current braking duty, not only in electricity meters but in power relays and many damping devices. They have been chosen particularly for new development work. Eclipse accumulated experience is then invaluable.



PERMANENT MAGNETS for industry

Eclipse publication "Permanent Magnets Summarized" contains a special illustrated section on eddy-current braking magnets.



Made by the designers and manufacturers of Eclipse Permanent Magnet Chucks
JAMES NEILL & CO. (SHEFFIELD) LTD · SHEFFIELD · ENGLAND
M10

More

for less...

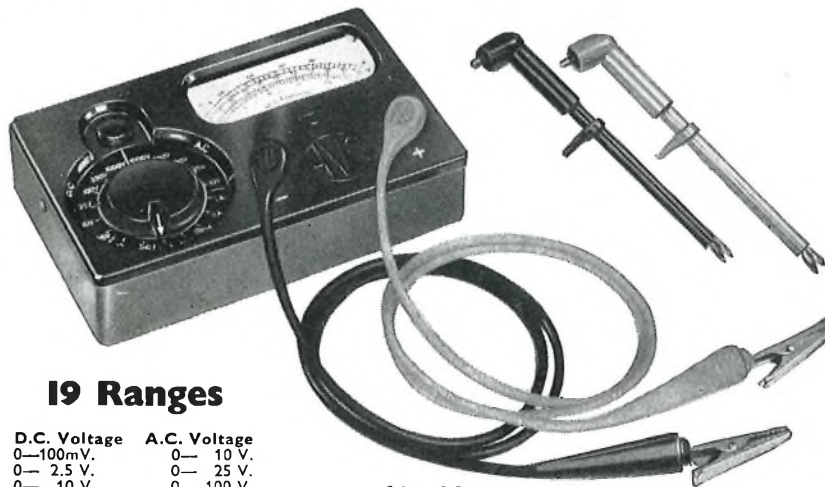

19 Ranges

D.C. Voltage	A.C. Voltage
0—100mV.	0— 10 V.
0— 2.5 V.	0— 25 V.
0— 10 V.	0— 100 V.
0— 25 V.	0— 250 V.
0— 100 V.	0—1000 V.
0— 250 V.	
0—1000 V.	
	D.C. Current
	0—100mA
	0— 1mA
	0— 10mA
	0—100mA
	0— 1 A
Resistance	
0—20,000Ω	
0—2MΩ	

List Price: **£9 : 10s.**

complete with test Leads
and Crocodile Clips.

Leather case if required 39/-

Size 5 $\frac{1}{2}$ × 3 $\frac{1}{2}$ × 1 $\frac{3}{4}$ in.
Weight: 1 lb. approx.

DESIGNED to offer the widest possible range of accurate and reliable measurements at the lowest possible price, the versatility and usefulness of the Multiminor are now further extended by specially designed leads. These new leads, available at no extra cost, will accept crocodile clips or PRODCLIPS.

The Multiminor takes full advantage of the possibilities of printed circuit techniques to achieve outstanding compactness and economy of weight. The scale is clear and open. The fine red coloured pointer and effectively damped movement facilitate easy and rapid reading.

For use in Radio, TV, Electronics, Motor Vehicles, domestic appliances, workshop equipment, you'll find the Multiminor a great little meter!

Use PRODCLIPS with the Multiminor (Pat. No. 748811)

These cleverly designed spring-loaded insulated prods are the complete answer to a long-standing problem. Press the trigger to open-release to grip. Keep your hands free no matter how difficult of access your test points may be! 15/- per pair

...with the

MULTIMINOR

Write now for illustrated literature to:

AVO LTD AVOCET HOUSE · 92-96 VAUXHALL BRIDGE ROAD
LONDON S.W.1
VICtoria 3404 (12 lines)

The steady advance in automatic long-distance telephone communications was emphasized recently when A.E.I. equipment was cut into service for the 'senderization' of the Winnipeg (Manitoba) and Edmonton (Alberta) Automatic Toll Exchanges. The automatic translation and routing equipment which comprise an A.E.I. 'Senderization' installation represents another great step forward in the elimination of operators for handling long-distance calls. In terms of service advantages, it can be compared with the advance that took place with the introduction of automatic exchanges to handle local calls.

Similar equipment is now being manufactured for Halifax, Nova Scotia, and will provide yet another link between the main switching centres in Canada, and in turn with the whole American continent.

▼ Sender

Translator ►

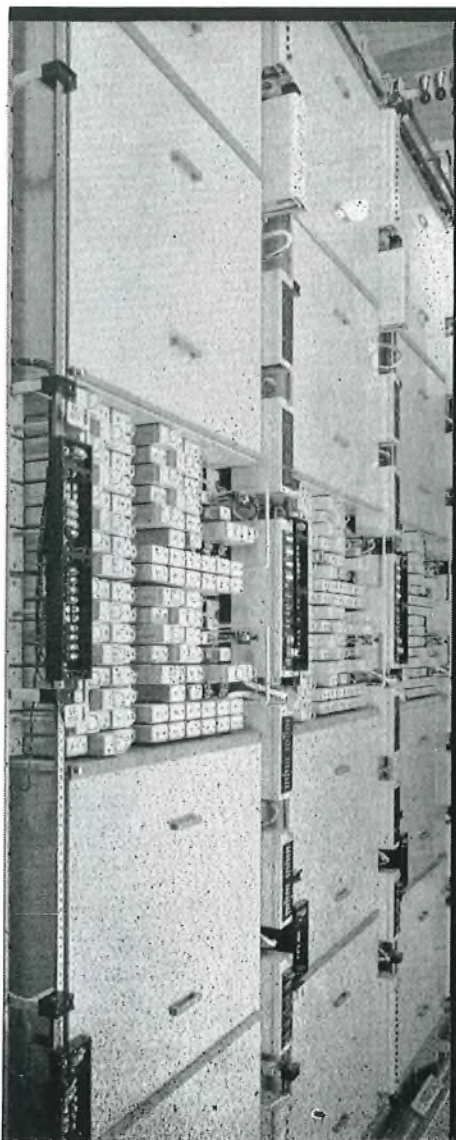

Long
distance
dialling
with

AEI

Senderization

Features include:

- A common translator handling a maximum of 25,000 calls per hour;
- Automatic alternative routing, providing a maximum of six routes;
- High-speed multi-frequency signalling;
- Digit deletion, code conversion and prefixing to cater for all routing requirements;
- Traffic measurement on any route or group of routes.

The continuous process of research and development which produces such equipment keeps the name of A.E.I. in the forefront of Telecommunications.

AEI Telecommunications Division
Woolwich, London, S.E.18

Formerly the Telecommunications Division of Siemens Edison Swan Ltd.

*Channel rack mounting
6 groups without signalling
or 4 groups with in-built
out-of-band signalling.*

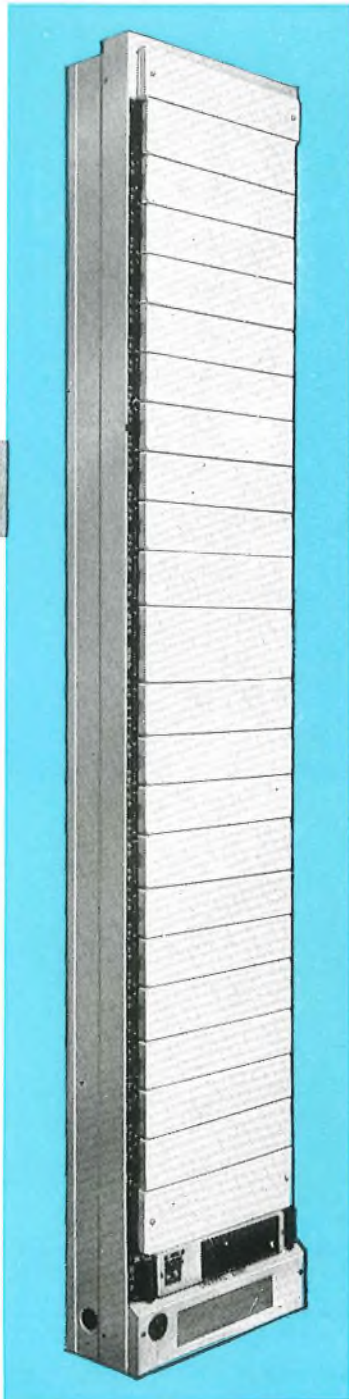

*Group translating rack
mounting 20 groups
(less covers).*

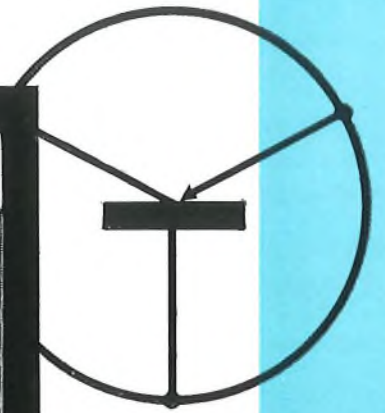
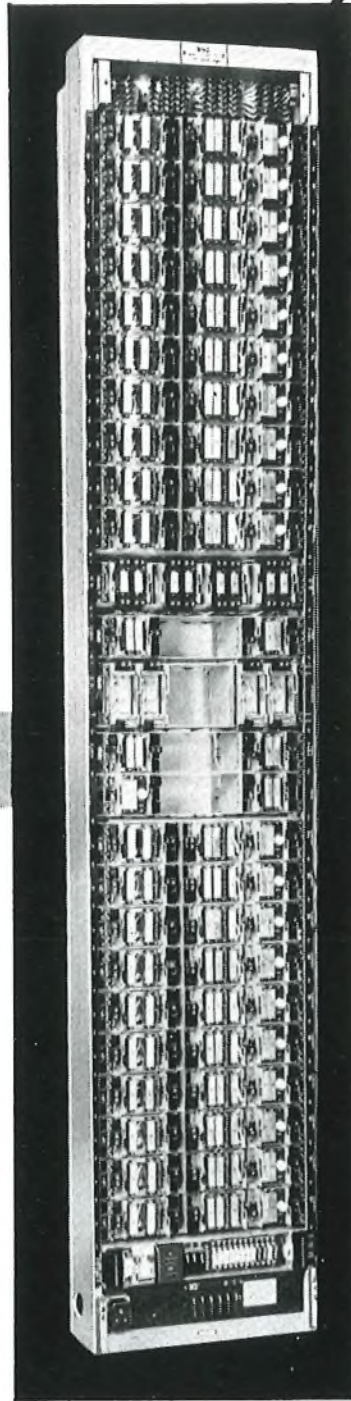

***Transistorised Transmission Equipment
includes***

- | | |
|--------------------------------------|--|
| Channel Equipment | Rural Carrier Equipment |
| Group Translating
Equipment | Voice Frequency Telegraph
Equipment |
| Super Group Translating
Equipment | 3-Circuit open wire line
Equipment |



G.E.C.

FULLY TRANSISTORISED Multiplex Equipment

The General Electric Company Limited, has pleasure in announcing completely transistorised channel, group and super-group equipments.

The first of these transistorised channel equipments is already in service for the British Post Office at Guildford. Orders have been received from the BPO for a total of 234 groups (2808 circuit ends) as well as a substantial quantity of group translating equipment.

The development of these new equipments is the result of six years experience in the design and operation of transistorised transmission equipments.

Since the introduction of their transistorised voice frequency telegraph equipment in 1954, the G.E.C. has supplied high-grade transmission equipment incorporating more than 250,000 transistors.

For further information on the transistorised channel and translating equipment please write for standard specification SPO 1371.

G.E.C.

Everything for Telecommunications

THE GENERAL ELECTRIC COMPANY LIMITED OF ENGLAND

TELEPHONE WORKS • COVENTRY • ENGLAND

WORKS AT COVENTRY • MIDDLESBROUGH • LONDON • PORTSMOUTH

SUBSCRIBER TRUNK DIALLING METERS

Adopted for the new scheme for the United Kingdom and commencing at **BRISTOL**, these counters are part of a British-made range available for telephone and other systems. The designs are based on extensive Continental experience.

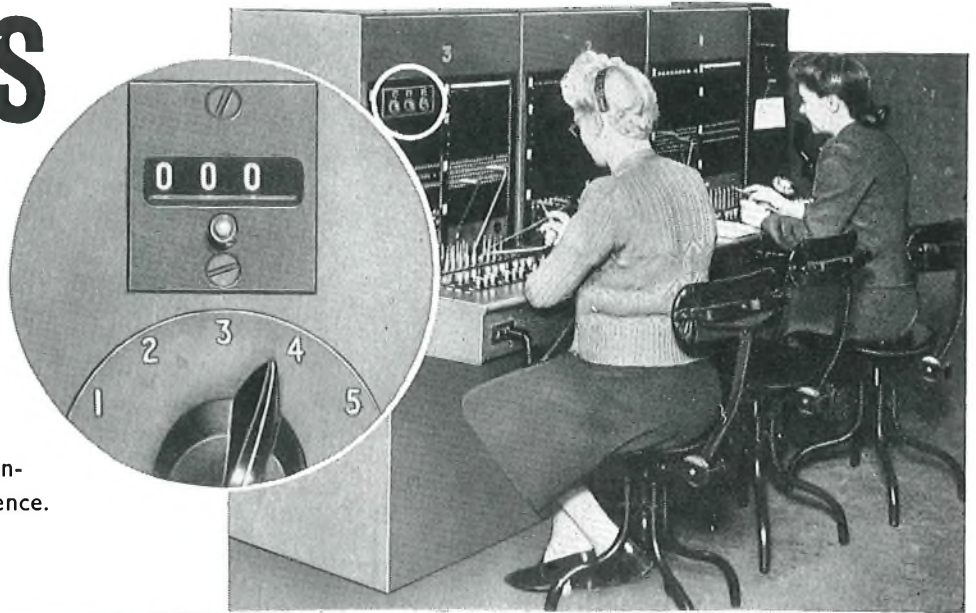

THE STONEBRIDGE ELECTRICAL CO. LTD.

6 QUEEN ANNE'S GATE • LONDON, S.W.1 Telephone : TRAfalgar 1444

CONTROLS & INSTRUMENTS

STONEBRIDGE

Agents and Licensees in U.K. for 'SODECO' Geneva



PIRELLI GENERAL
CABLE WORKS LTD.

PAPER INSULATED TRUNK CABLES
TELEVISION CABLES
RADIO FREQUENCY CABLES
COAXIAL CABLES

PIRELLI-GENERAL CABLE WORKS LIMITED, SOUTHAMPTON



*there's more than
one form of protection . . .*

A troop of Royal Horse Guards passing stacked G.V.C. Conduits ready for the diversion of the London G.P.O. cables, in preparation for the £5,000,000 Hyde Park improvement scheme.

To protect vital electricity cables, telephone mains, television communications and the like from underground risks, **glazed vitrified clay conduits** do much more than provide the highest-known safety factors.

They ensure to the engineer responsible for the reliability of his project a peace of mind not past understanding. Today he has evidence—by tests in laboratory, by time and experience—there is no adequate substitute for

GLAZED VITRIFIED CLAY CONDUITS

*For information write to The Secretary,
NATIONAL SALT GLAZED PIPE MANUFACTURERS' ASSOCIATION
Hanover Court, Hanover Square, LONDON, W.1.
Telephone MAYfair 0364.*



STC

presents **THE NEW FULLY AUTOMATIC 4 CHANNEL
H.F. RADIO LINK CONTROL TERMINAL** *incorporating transistors*

The Radio Link Control Terminal Type TOP 20 is designed for use at terminal stations of international and national high frequency radio telephone links to connect the radio system to the telephone network.

type **TOP 20**

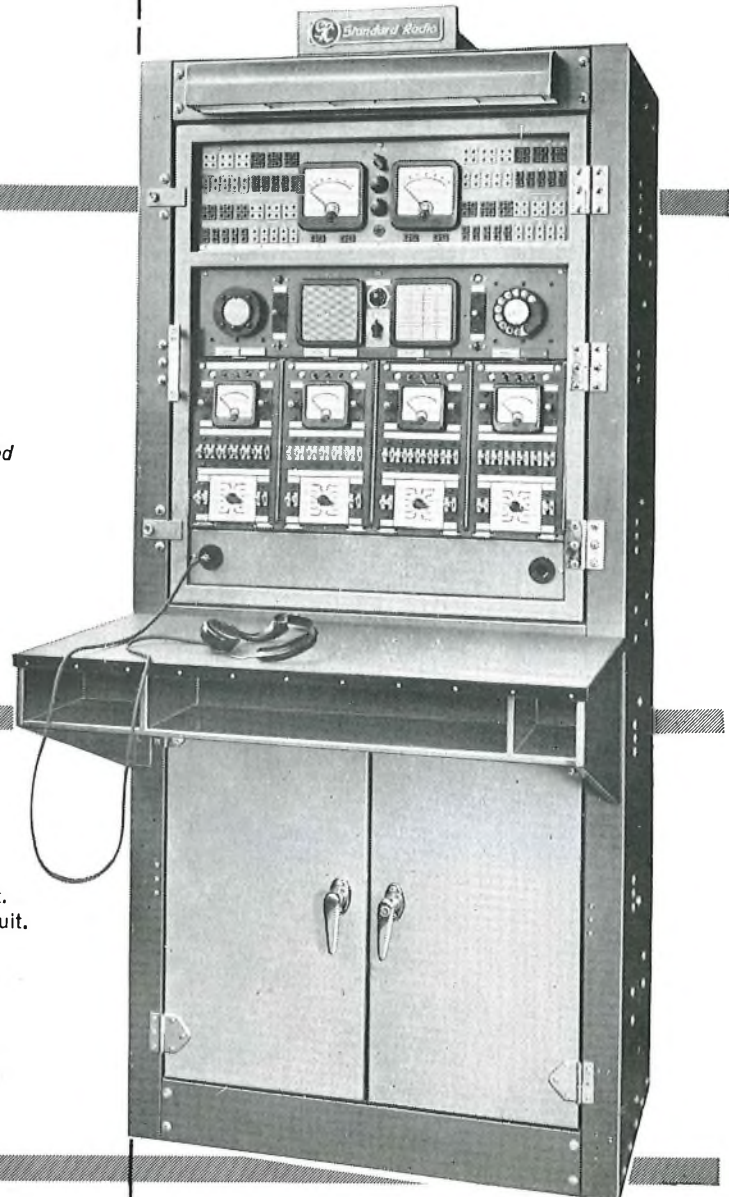
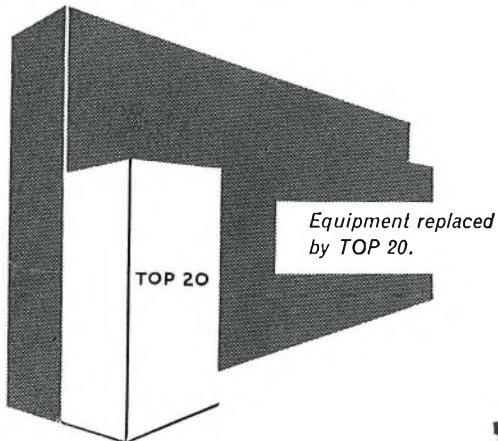

ADDITIONAL FEATURES:—

- 1 Only one type of valve used throughout.
- 2 Relay type VODAS switching.
- 3 Four wire Inverter and Shifter for each circuit.
- 4 Automatic station identification for each circuit.
- 5 Circuit and valve check facilities provided.
- 6 Sealed Relays.
- 7 Extremely compact totally enclosed cabinet.
- 8 Strip Unit construction.
- 9 Full tropical specification.
- 10 Supervision of maximum number of channels by one operator.



60/7E

Standard Telephones and Cables Limited

Registered Office: Connaught House, Aldwych, London, W.C.2

RADIO SYSTEMS DIVISION: OAKLEIGH ROAD · NEW SOUTHGATE · LONDON N.11

The NEW Painton subminiature resistor type 70

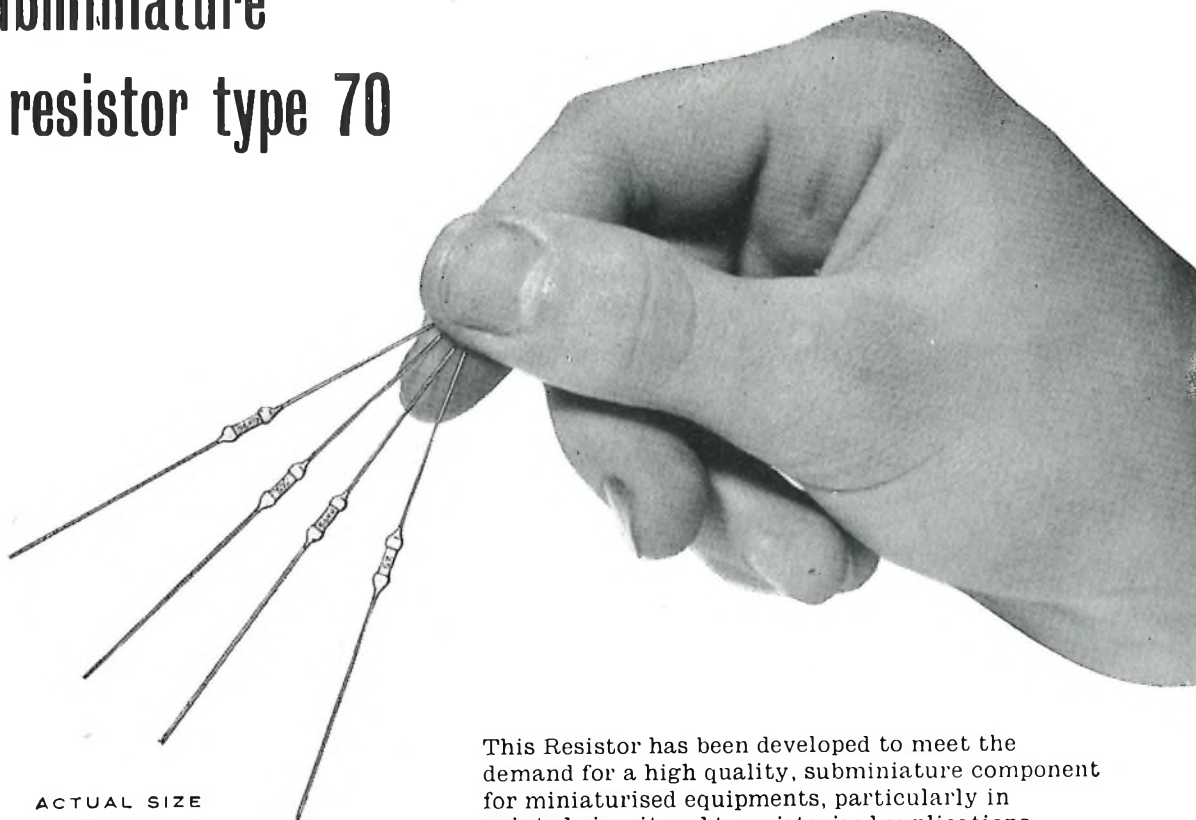

ACTUAL SIZE

This Resistor has been developed to meet the demand for a high quality, subminiature component for miniaturised equipments, particularly in printed circuit and transistorised applications where space is at a premium. The leads are pre-tinned to facilitate dip-soldering.

Resistance Range:	4.7 ohms to 330K ohms. (preferred values).
Tolerance:	5%, 2% and 1% (up to 100K ohms).
Rating:	$\frac{1}{8}$ W at 70° C.
Voltage Limitation:	AC: none within rated wattage. DC: 150 V.

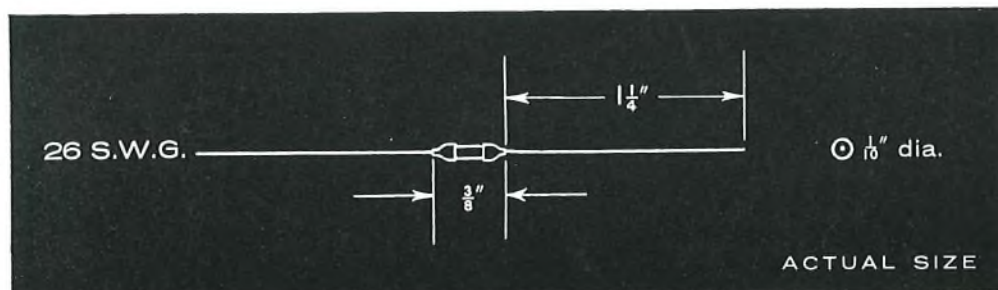

Painton & Co. Ltd.

KINGSTHORPE · NORTHAMPTON

Tel: 34251 (10 lines) · Grams: 'Ceil Northampton'

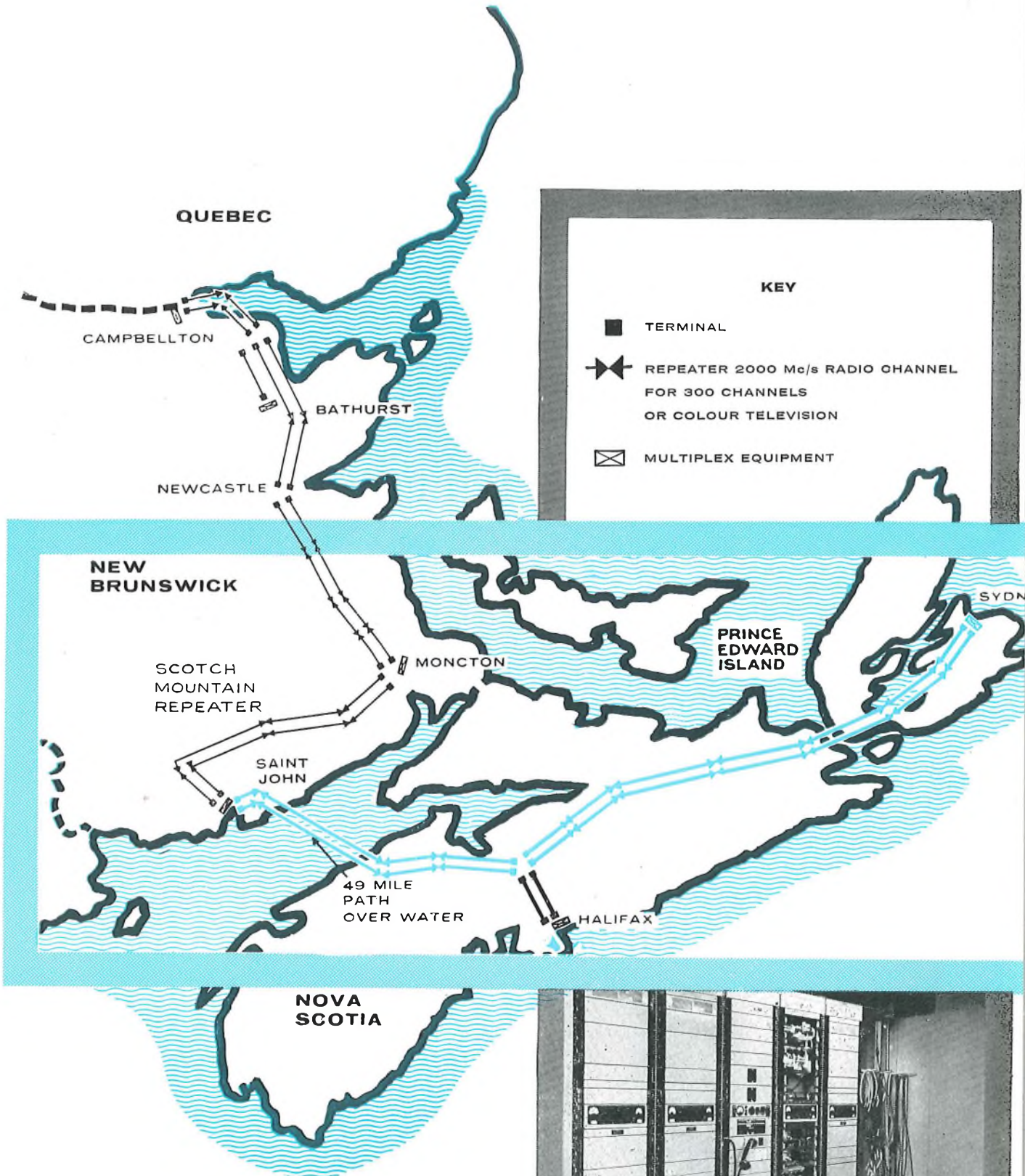

For further information on the radio and multiplexing equipment, please write for Standard Specifications SPO.5502 and SPO.1370.

Radio Equipment at Scotch Mountain Repeater

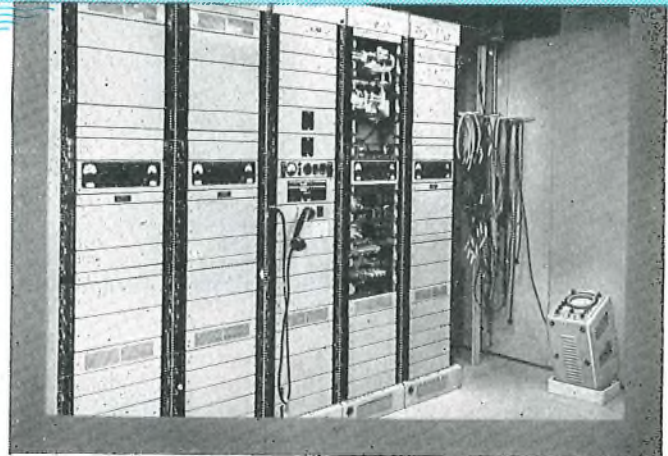

The new microwave radio link in Canada between Saint John, New Brunswick and Sydney, Nova Scotia was completed one month ahead of schedule. The link consists of 8 terminal and 18 bothway repeater stations and includes a path of 49 miles over water. This is the second stage of the East Coast microwave complex undertaken jointly by The New Brunswick Telephone Company and the Maritime Telegraph and Telephone Company. The first stage between Saint John and Moncton was completed last December and work is already well advanced on the third stage between Moncton and Campbellton. The radio system operates in the 2000 Mc/s frequency

band and provides a main and standby (protection) channel on all routes. In the event of a failure or degradation of the working radio channel, changeover to standby is automatic. The capacity of each radio link is 300 speech circuits. When traffic increases and additional links are supplied, one standby will be used for several working channels. The standby channel can be utilised to carry television signals.

The radio and multiplexing equipment used throughout the system were designed and manufactured by The General Electric Company Ltd. of England, and supplied and installed by Canadian General Electric Company.

New Radio Link in Canada completed ONE MONTH AHEAD OF SCHEDULE



EVERYTHING FOR TELECOMMUNICATIONS

THE GENERAL ELECTRIC COMPANY LIMITED OF ENGLAND

TELEPHONE WORKS · COVENTRY · ENGLAND

Works at Coventry · London · Middlesbrough · Portsmouth

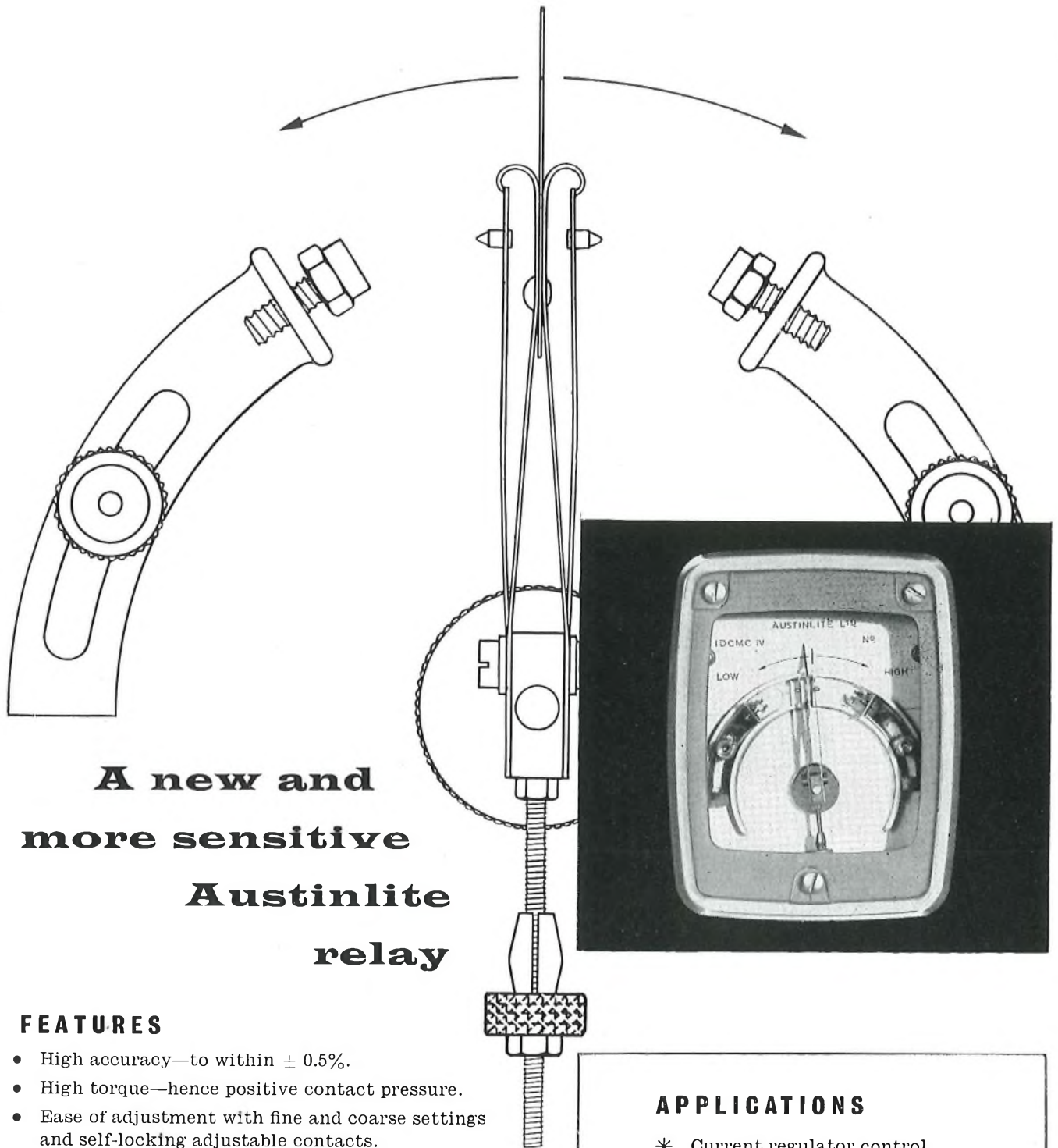

**A new and
more sensitive
Austinlite
relay**

FEATURES

- High accuracy—to within $\pm 0.5\%$.
- High torque—hence positive contact pressure.
- Ease of adjustment with fine and coarse settings and self-locking adjustable contacts.
- Choice of either two or four adjustable contacts.
- Contemporary case design—projection or flush mounting.
- Dustproof and suitable for use in the tropics.
- Conforms to Post Office Specification P.T. 1025B.
- Suitable for current or voltage sensing on either D.C. or A.C.

APPLICATIONS

- * Current regulator control.
- * Voltage regulator control.
- * Monitoring duties.
- * Limiting duties.
- * Equipment protection.

Austinlite **ELECTRICAL EQUIPMENT**
Custom-built by STONE-CHANCE LTD.

(Makers of Sumo Pumps and
Stone-Chance Lighthouses).
CRAWLEY, SUSSEX.

Designed, primarily for use by private and public telephone operators and approved by the G.P.O., STC Lightweight Headsets are now being widely used for other applications. Authorities and operators concerned with audio monitoring and control have quickly recognized the advantages in comfort and sensitivity provided by this new design.

Wider use for **STC Lightweight Headsets**

The "Rocking Armature" principle which gives improved sensitivity and frequency response—an important STC development in telephone receiver design—has been incorporated into these instruments.

The main advantages of this STC product are: extraordinary light weight, a high degree of comfort, stability and manoeuvrability and constant level of transmission regardless of head movement. Available in black or ivory nylon plastic which is virtually unbreakable.

Write for Brochure D/104



STC Lightweight Head Receiver in use at Broadcasting House. These instruments have been adopted by the B.B.C. for use in their London and provincial studios.



At London Airport, B.E.A. Apron Control have recently reorganised their communication facilities to cater for their 400 air movements a day peak load. The controllers use STC Lightweight transmitter/receiver headsets to assist them with strain-free operation.

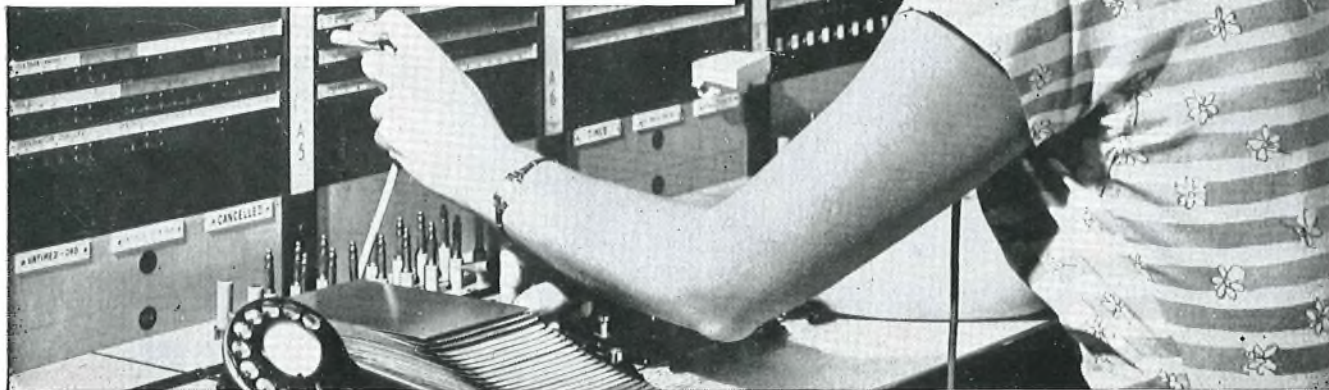

60/1D

Standard Telephones and Cables Limited

Registered Office: Connaught House, Aldwych, London, W.C.2

TELEPHONE DIVISION: OAKLEIGH ROAD · NEW SOUTHGATE · LONDON N.11

TUNGSTONE BATTERIES

are playing their part in the latest development in the Telephone System of this country, viz :-

TRUNK DIALLING SYSTEM

Tungstone Products Ltd. are privileged to have installed their Batteries in the majority of "Satellite" Exchanges in the first area selected by H.M. Postmaster General for this great step forward in the history of the Telephone Service.

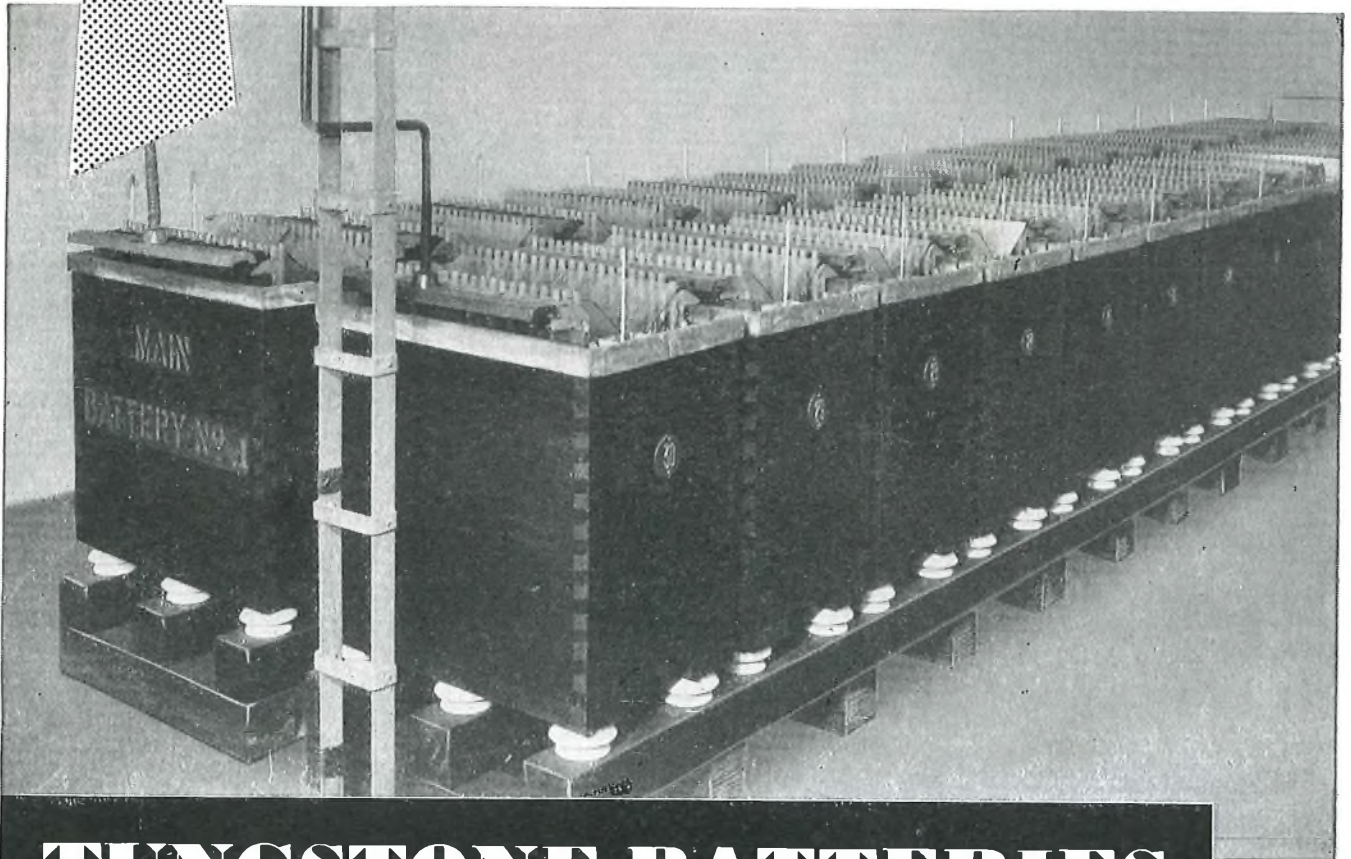

TUNGSTONE BATTERIES

TUNGSTONE PRODUCTS LIMITED, 10 SALISBURY SQUARE, LONDON, E.C.4.

Works: MARKET HARBOROUGH, LEICS.



Pulse and Bar Generator

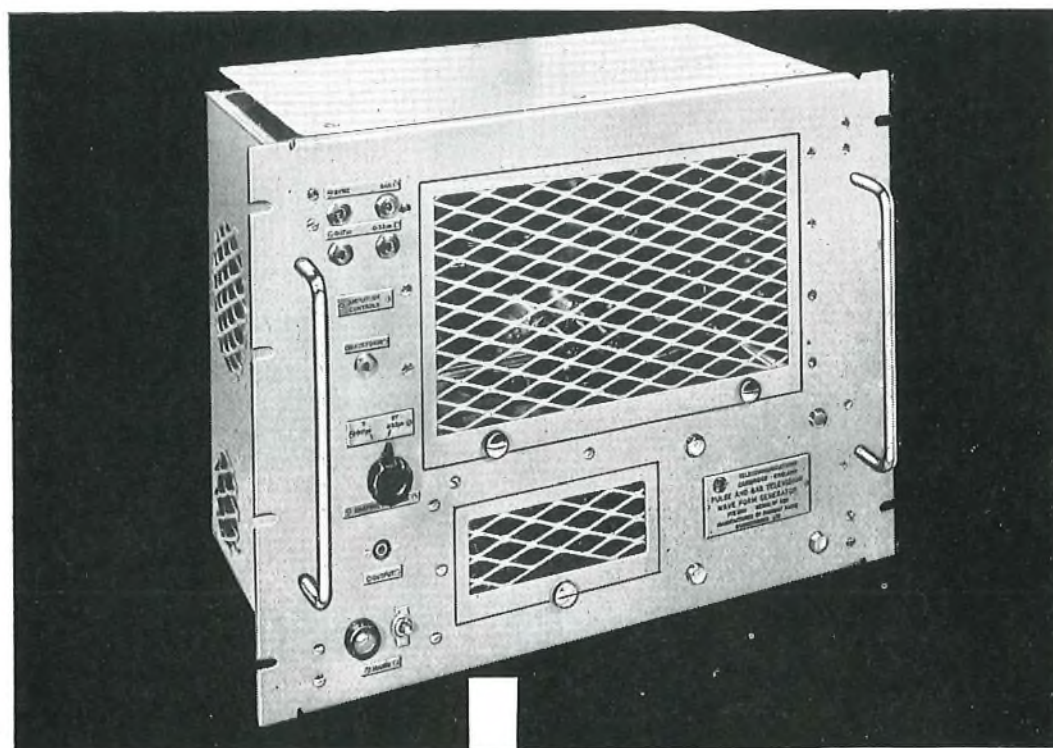

BY APPOINTMENT
TO H.M. DUKE OF EDINBURGH
SUPPLIERS OF
RADIO TELEPHONE EQUIPMENT
PYE TELECOMMUNICATIONS LTD.

Pulse and Bar Generator

Designed by the G.P.O. Research Laboratories, the Pye PTC 1201 Pulse and Bar Television Waveform Generator embodies the C.C.I.F. recommendations for the use of sine squared pulses in testing the video response of a transmission system. In conjunction with a suitable oscilloscope, the Generator renders the testing of microwave links, coaxial links, terminal equipment, receivers etc., a fast and very simple operation, enabling relatively unskilled personnel to decide whether a link is acceptable for use.

PYE TELECOMMUNICATIONS LIMITED

NEWMARKET ROAD • CAMBRIDGE

Telephone: Teversham 3131

Telegrams: Pyetelecom Cambridge

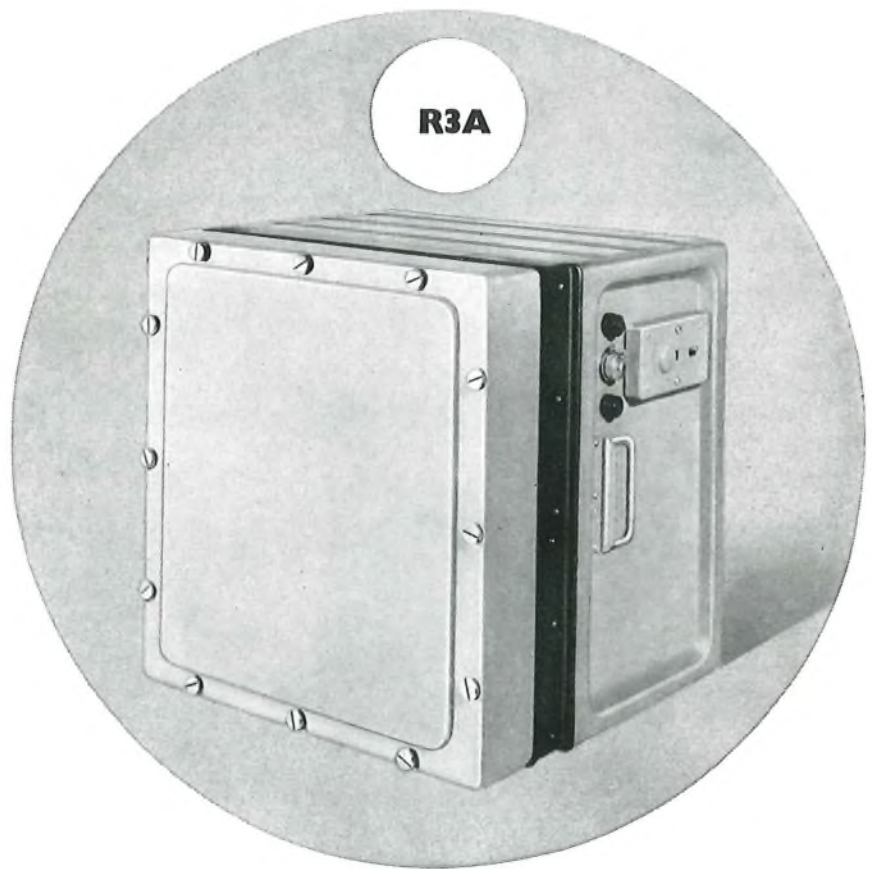

A.T.E. “Packaged” Radio Channelling in Fully-transistorised Basic Units for 3 to 300 Circuits

Economical, reliable, completely self-contained, these terminals are ideal for rapid installation at any microwave or VHF radio terminal. They meet relevant Services and C.C.I.T.T. requirements.

All terminals include inbuilt, outband, signalling facilities suitable for dialling. Simple ringdown relay sets can also be inbuilt when required. Racksides may be mounted back to back or side by side.

AUTOMATIC TELEPHONE & ELECTRIC CO LTD

STROWGER HOUSE · ARUNDEL STREET · LONDON · W.C.2 TEL. TEMPLE BAR 9262

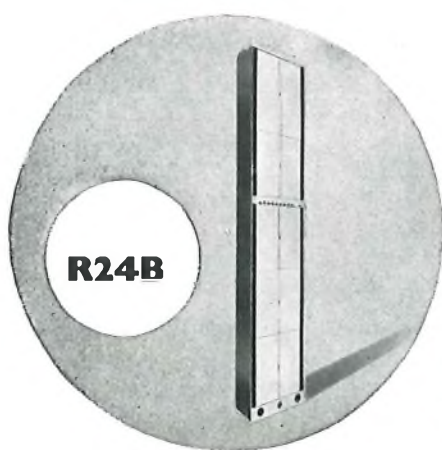
**R24B**

R3A A transportable 3 channel terminal designed for field or Service use. Write for Bulletin TEB. 3303

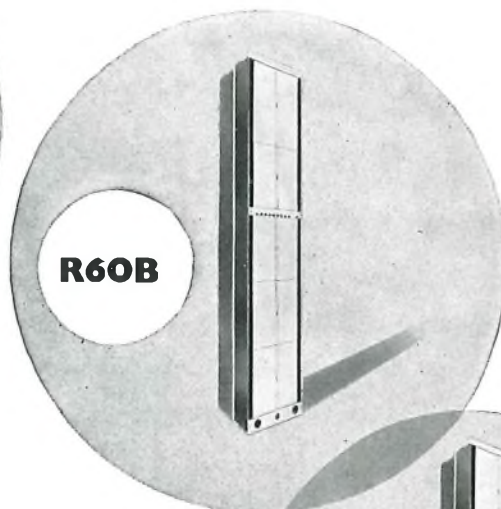
**R60B**

R24B A 12/24 channel terminal in the 6-108 Kc/s spectrum, complete on one rackside. Write for Bulletin TEB. 3301

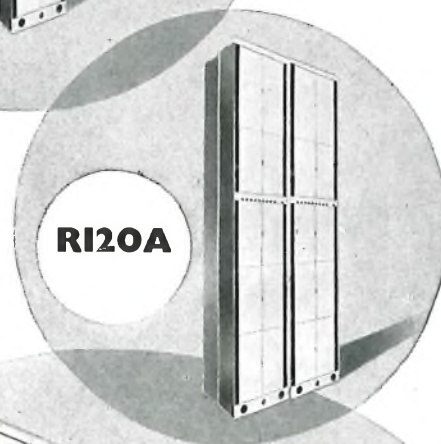
**R120A**

R60B A 60 channel terminal (12-252 or 60-300 Kc/s), complete on two rackside. Write for Bulletin TEB. 3302

R120A A 120 channel terminal (12-552 Kc/s), complete on four rackside. Write for Bulletin TEB. 3304

R300A A 300 channel terminal (60-1300 Kc/s), complete on eight rackside. Write for Bulletin TEB. 3305

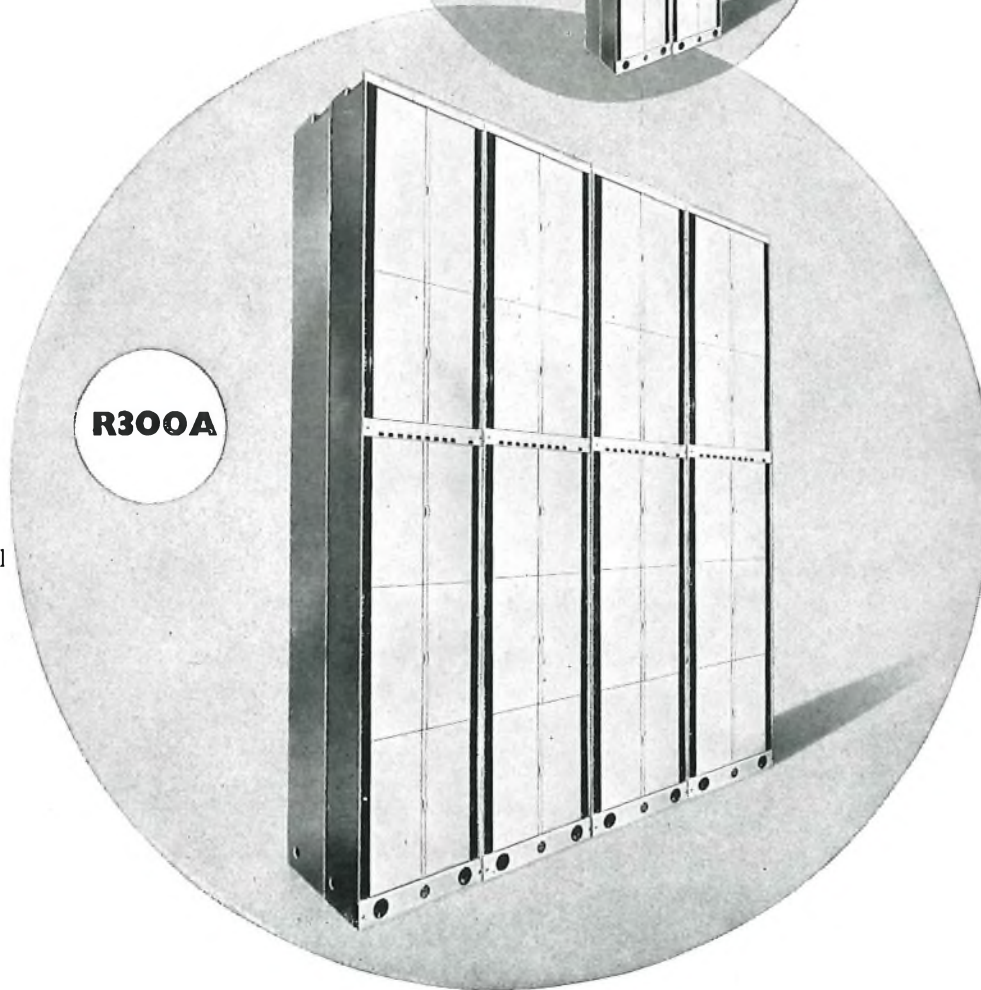
**R300A**

TRANSMISSION EQUIPMENT TYPE CM for line, cable and radio systems

INDEX TO ADVERTISERS

	PAGE		PAGE
Adcola Products, Ltd.	7	Painton & Co., Ltd.	29
Associated Electrical Industries, Ltd.	4, 12, 23	Pirelli-General Cable Works, Ltd.	26
Automatic Telephone & Electric Co., Ltd.	36-37	Pitman, Sir Isaac, & Sons, Ltd.	7
Avo, Ltd.	22	Pye Telecommunications, Ltd.	35
Bennett College, The	16	Shell-Mex & B.P. Gases, Ltd.	21
British Institute of Engineering Technology	7	Siemens & Halske, Ltd.	17
Cole, R. H. (Overseas), Ltd.	17	Smith, Federick, & Co.	39
Enthoven Solders, Ltd.	39	Standard Telephones & Cables, Ltd.	6, 10-11, 28, 33, 40
Ericsson Telephones, Ltd.	18-19	Stone-Chance, Ltd. (Austinlite)	32
Formica, Ltd.	20	Stonebridge Electrical Co., Ltd., The	26
General Electric Co., Ltd., The	14-15, 24-25, 30-31	Taylor Electrical Instruments, Ltd.	38
Great Northern Telegraph Co., Ltd.	13	Telephone Manufacturing Co., Ltd.	2-3
Hivac, Ltd.	218	Tungstone Products, Ltd.	34
Johnson, Matthey & Co., Ltd.	9	Turner, Ernest, Electrical Instruments, Ltd.	5
Mullard, Ltd.	8	Westinghouse Brake & Signal Co., Ltd.	1
National Salt Glazed Pipe Manufacturers' Association	27	Whiteley Electrical Radio Co., Ltd.	39
Neill, James, & Co. (Sheffield), Ltd.	22	Winn & Coales, Ltd.	5

NEW 20,000 o.p.v. ! Model '127A' TAYLORMETER

Pocket Size

Approved by the G.P.O.
and used in bulk quantities

Meters Multirange No. 12 to Drawing No. C.D. 1489/2

PERFORMANCE EQUAL TO A HIGH-PRICED INSTRUMENT

OUTSTANDING FEATURES:

- ★ Sensitivity: 20,000 o.p.v. D.C., 1,000 o.p.v. A.C.
- ★ Very Robust—Shock-proof Moulding.
- ★ Portability.
- ★ 28 Ranges.
- ★ D.C. Current: 50 μ A, 1mA, 10 mA, 100 mA, 1Amp.
- ★ Volts D.C.: 0.2, 2.5, 10, 25, 100, 250, 1,000 V (25 kV by probe).
- ★ Volts A.C.: 10, 25, 100, 250, 1,000.
- ★ 3 Resistance Ranges: from 0-20 megohms (self-contained).
- ★ 40 μ A Meter, 3 $\frac{1}{2}$ " arc.
- ★ Accuracy: D.C. 3%, A.C. 4%
- ★ Dimensions: 5 $\frac{1}{2}$ " x 3 $\frac{1}{2}$ " x 1 $\frac{1}{2}$ ".
- ★ Weight: 14 ozs.



LIST PRICE

£10.0.0

High-quality leather case,
if required, £1.12.0
H.V. Probe for 25 kV,
£4.0.9

We also manufacture a wide range of Electronic Equipment including: Valve Testers; Oscilloscopes; Generators; Valve Volt Meters; Wobulators; Audio Generators; Bridges, etc., as well as a wide selection of Panel Meters incorporating our robust centre pole movement.

Write for full details:

TAYLOR ELECTRICAL INSTRUMENTS LTD

MONTROSE AVENUE, SLOUGH, BUCKS.

Telephone: Slough 21381

Cables: Taylins, Slough

Member of the METAL INDUSTRIES GROUP OF COMPANIES



The *Superspeed*

Soldering Iron

heats up from cold in 6 seconds

Length 10"
Weight 3½ ozs.

For best results
with this iron use
**ENTHOVEN
SUPERSPEED CORED
SOLDER and ALUMINIUM
CORED SOLDER**

- Activated by light thumb pressure on the switch ring. When pressure is released, current is automatically switched off—thus greatly reducing electricity consumption, wear on copper bit and carbon element.
- Can be used on 2.5 to 6.3 volt supply (4 volt transformer normally supplied) or from a car battery.
- More powerful than conventional 150-watt irons; equally suitable for light wiring work or heavy soldering on chassis.
- Simple to operate; ideal for precision work.
- Requires minimum maintenance—at negligible cost; shows lowest operating costs over a period.

LIST PRICES
Iron .. 39/6 Transformer .. 35/6

ENTHOVEN SOLDERS LTD. (Industrial Equipment Division)

Sales Office & Works:
Upper Ordnance Wharf, Rotherhithe Street,
London, S.E.16. Tel.: BERmondsey 2014

Head Office:
Dominion Buildings, South Place, London, E.C.2. MONarch 0391

Designed on an entirely new principle, this lightweight, versatile iron is eminently suitable for soldering operations in the radio, television, electronic and telecommunication industries.

For test bench and maintenance work it is by far the most efficient and economical soldering iron ever designed.

for the right connection

ANACOS

TELEPHONE LINE WIRE

FREDERICK SMITH AND COMPANY
ANACONDA WORKS · SALFORD 3 · LANCs



Radio Sonde and electronic equipment

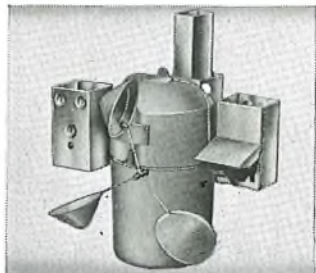

Radio Sonde Transmitter, supplied to British meteorological Office and foreign governments.

The items shown here are representative of the extensive variety of products manufactured by the Whiteley organisation. Our technical resources are available for the development and production of specialised components for the electronic industry.

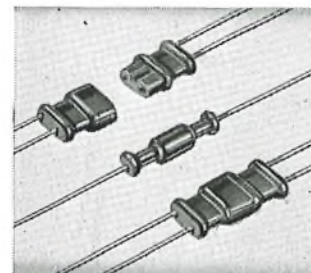

Waterproof plugs and sockets moulded in Polythene for under-water or outdoor installation.



Stentorian Cambric Cone Units, recognised throughout the world as the greatest value in High Fidelity.



The Post Office Tester is a multi-range meter used for making tests on subscribers' apparatus and lines.



Potted components and assemblies in epoxy, Polyester resins and Polythene.



This fixed frequency oscillator is constructed on a standard octal base and encapsulated in epoxy resin.

WHITELEY ELECTRICAL RADIO CO. LTD · Mansfield · Notts

Get to know the range of **STC COMPONENTS**

Write or telephone
for
booklet (M/103)



YOU CAN RELY ON STC COMPONENTS

Brimistors
Capacitors Ferrites
Germanium Diodes
Germanium Photocells
Hermetic Seals
High Stability Resistors
Magnetic Materials
Quartz Crystals
Special Valves
Selenium Rectifiers
Silicon Rectifiers
Silistors · Suppressors
Transistors · Thermistors
Tunnel Diodes
Transformers · Zener Diodes



Standard Telephones and Cables Limited

Registered Office: Connaught House, Aldwych, London W.C.2.

COMPONENTS GROUP · FOOTSCRAY · SIDCUP · KENT
FOOTSCRAY 3333 EXTENSION 322