

R.A. Roe

C. Red

THE POST OFFICE ELECTRICAL ENGINEERS' JOURNAL

Vol. 50

OCTOBER 1957

Part 3

CONTENTS

	PAGE
PROVISION OF DUCT WAYS IN NEATH RIVER BRIDGE AND ITS APPROACHES —A. R. Warren	141
PLASTICS IN TELEPHONE EXCHANGE EQUIPMENT—T. F. Urban, B.Sc.(Eng.), A.M.I.E.E.	145
A 4,000-Mc/s RADIO SYSTEM FOR THE TRANSMISSION OF FOUR TELEPHONY SUPERGROUPS (240 CIRCUITS), Part 2—The Baseband and Supervisory Equipment— R. P. Froom, B.Sc.(Eng.), A.M.I.E.E., J. D. C. Madder, B.Sc.(Eng.), A.M.I.E.E., and C. G. Hilton	150
THE NEW A.C. POWER SYSTEM AT RUGBY RADIO STATION—M. H. James, D.F.H., A.M.I.E.E., and E. A. Ingram, A.M.I.E.E.	159
SIGNALLING OVER CARRIER CHANNELS THAT PROVIDE A BUILT-IN OUT-OF- SPEECH-BAND SIGNALLING PATH, Part 2—Design of Telephone Exchange Signalling Equipment—R. W. Gibson, A.M.I.E.E., and C. B. Miller	165
AN INTRODUCTION TO THE LINE CONNECTOR	171
THE DESIGN AND FIELD TRIAL OF A 12-CIRCUIT CARRIER TELEPHONE SYSTEM FOR USE ON UNLOADED AUDIO CABLES, Part 1—Design, General Description of the System, and the Terminal Equipment—J. Reynolds, B.Sc.(Eng.), A.C.G.I., and E. Jeynes, B.Sc.(Eng.), A.M.I.E.E.	173
AERIALS FOR 4,000-Mc/s RADIO LINKS—R. L. Corke, A.M.I.E.E., and J. Hooper, A.M.I.E.E.	178
AN IMPROVED FREQUENCY MODULATOR FOR BROAD-BAND RADIO-RELAY SYSTEMS—I. A. Ravenscroft, A.M.I.E.E.	186
A SMALL QUARTZ CLOCK WITH TRANSISTOR DRIVE—D. E. Cridlan, A.M.I.E.E., and J. E. Thwaites, M.I.E.E.	189
THE NEW TELEGRAPH DEVELOPMENT LABORATORY	191
NOTES AND COMMENTS	194
INSTITUTION OF POST OFFICE ENGINEERS	195
SILVER JUBILEE OF THE ASSOCIATE SECTION	197
ASSOCIATE SECTION NOTES	197
REGIONAL NOTES	200
STAFF CHANGES	207
BOOK REVIEWS	158, 172, 177, 185, 193, 199

Price 2/6 net

THE INSTITUTION OF POST OFFICE ELECTRICAL ENGINEERS



Radio Communications Division

REDIFON LIMITED, BROOMHILL ROAD, LONDON, S.W.18.

VANdyke 7281

A Manufacturing Company in the Rediffusion Group

PITMAN TECHNICAL BOOKS

CATHODE RAY OSCILLOGRAPHS

By J. H. Reyner, B.Sc. (Hons.), etc. Fifth Edition. A comprehensive account of the practical applications of cathode-ray tubes and the theory underlying them. 20/- net.

GENERATION, TRANSMISSION AND UTILIZATION OF ELECTRICAL POWER

By A. T. Starr, M.A., Ph.D., M.I.E.E. Fourth Edition. This book has been specially written to meet the requirements of the "Electrical Power" syllabus of the Engineering Degree. It covers a very wide field and yet deals with each branch of the subject in considerable detail. In this new edition the author has added an additional Appendix on nuclear energy, and an outline of the Calder Hall Station. 27/6 net.

TELEPHONY, VOLS. I and II

By J. Atkinson, A.M.I.E.E., etc. This massive two-volume treatise is recognised as the standard work on the subject. Volume I is primarily devoted to the signalling and switching of the manual exchange systems. Vol. II deals with the complete range of modern automatic switching and gives a detailed treatment of the various circuits and accessory equipment employed. Vol. I 40/- net. Vol. II 55/- net.

SIR ISAAC PITMAN
& SONS LTD.

Parker Street, Kingsway,
London, W.C.2

PASS YOUR CITY & GUILDS CERTIFICATES AND P.M.G. CERTIFICATE

We offer comprehensive home training in a wide range of subjects, including P.M.G. Certificates, City and Guilds Grouped Certificates in Telecommunications, A.M.Brit.I.R.E. Examination, Radio Amateur's Licence, Radio and Television Servicing Certificates, General Radio and Television Courses, Radar, Sound Recording, etc. Also Courses in all other branches of Engineering.

With the following Courses, Practical Kits are available.

Radio, Television, Mechanics, Electricity, Chemistry, Photography, Carpentry; also Draughtsmanship, Commercial Art, Amateur S.W. Radio, Languages, etc.

Write now

for FREE BROCHURE stating subjects of interest to:—

E.M.I. INSTITUTES

Dept. 97, LONDON, W.4

An Educational Organisation serving the E.M.I. Group of Companies, including "HIS MASTER'S VOICE", MARCONIPHONE, COLUMBIA, etc.

THE POST OFFICE ELECTRICAL ENGINEERS' JOURNAL

Vol. 50

October 1957

Part 3

Provision of Duct Ways in Neath River Bridge and its Approaches

A. R. WARREN†

U.D.C. 621.315.232

This article describes the special methods of construction used in providing ducts in a new high-level bridge across the River Neath and in the viaducts leading to the bridge. The bridge, which has recently been completed, is part of the important roadworks to by-pass Neath in the main route from Cardiff to west Wales.

INTRODUCTION

THE growth of industry in South Wales during and since the 1939-45 War imposed a severe strain upon the highways of the area, and during the period the Ministry of Transport evolved plans for the major development of trunk roads. An important stage in the fulfilment of these plans was completed recently when the Neath by-pass, on the A.48 route from Cardiff to west Wales, was opened to the public. The scheme provided several miles of new roads and included a dual carriageway bridge across the river Neath at Briton Ferry. It shortened the journey from Cardiff to west Wales by some six miles, and eliminated a number of traffic bottlenecks.

Possible effects of this development upon the provision of Post Office underground plant were studied. It was clear that the new road would open fresh territory for possible industrial (and therefore telephone) development, which could be served most economically across the river from Briton Ferry exchange. Even more important was the fact that the shortening of the Cardiff-Swansea route by six miles, and the by-passing of Neath and Swansea in later stages, might well provide substantial economies in future trunk and junction cable provision. Fig. 1 shows the geographical layout of the area affected.

As the new road was to have ample grass verges, it was decided that duct along it would be provided in economic

instalments as the need arose. But, over a 1,000-yd section from the roundabout at Briton Ferry to one at Earlswood, the road was required to span the main railway lines, docks, and steelworks, pass through a cutting in Warren hill, and cross the river Neath on a high-level bridge. Fig. 2 shows this section of the road.

When constructional details of the high-level bridge and its approach viaducts were available (typical sections are shown in Fig. 3), it was apparent that future duct provision over these would be exceptionally difficult, and it was decided that duct ways should be provided in conjunction with the bridge works. Six ways were planned since this was the greatest number that could be accommodated without substantial modification of the bridge design, and they would, in conjunction with the existing route via Neath, meet all foreseeable demands.

GENERAL CONSIDERATIONS

The position of the duct line in the structures had first to be settled. It will be seen from Fig. 3 that the choice of positions accessible from the road was limited to the space between the two carriageways or the spaces between carriageways and cycle tracks. The latter were not large enough in the approaches to carry the ducts in a single formation, so the central position was selected.

Apart from short lengths of earthenware ducts at the ends of the section and in Warren hill cutting, 4-in. steel pipes were used throughout. Alternatives were asbestos

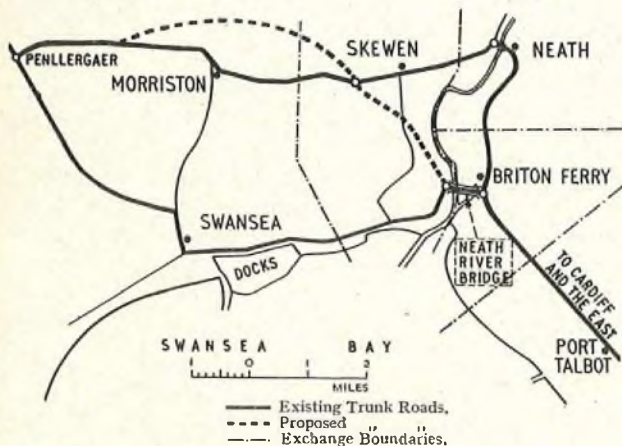

FIG. 1.—MAP SHOWING EXCHANGE AREAS AND MAIN CABLE ROUTES IN THE AREA AFFECTED BY TRUNK ROAD DEVELOPMENT.

† Assistant Engineer, Wales and Border Counties.



FIG. 2.—AN AERIAL PHOTOGRAPH OF THE NEATH RIVER BRIDGE AND ITS APPROACHES. BRITON FERRY IS ON THE RIGHT OF THE PICTURE.

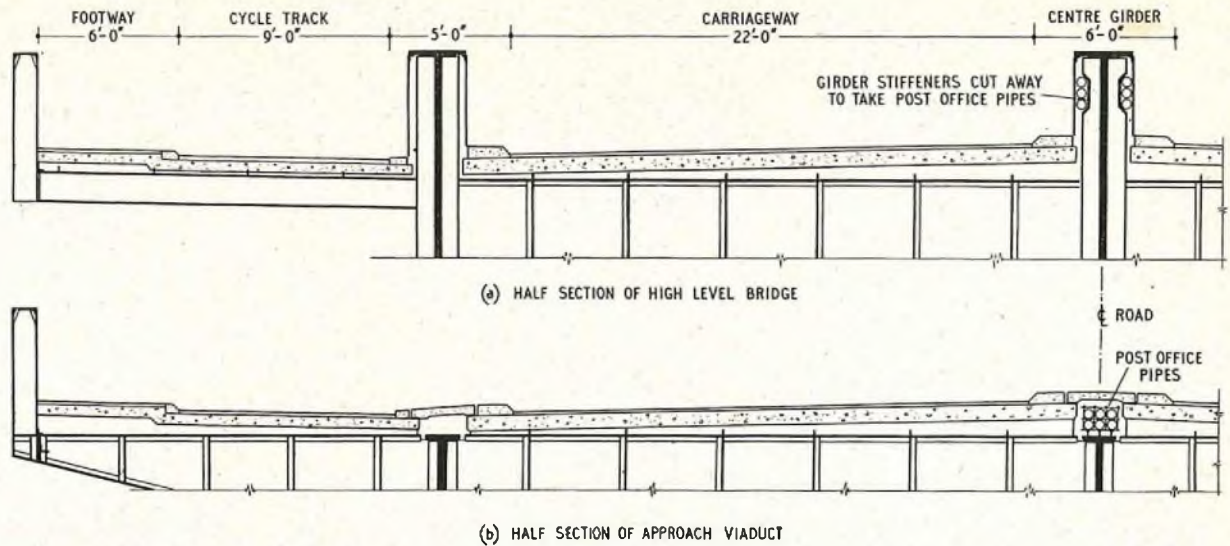

FIG. 3.—TYPICAL SECTIONS THROUGH THE BRIDGE AND APPROACH VIADUCTS.

cement, which was rejected because of its poor mechanical strength, or cables laid without pipes, for which high cabling costs would be incurred and intolerable obstruction caused to traffic when each cable was provided or renewed.

It was foreseen at the outset that it would be difficult with the restricted space available to satisfy the normal Post Office requirement that the steel pipes should be electrically insulated from the steelwork of the structures. No special effort was therefore made to satisfy this condition apart from maintaining the jute wrapping of the pipe throughout. A study of the electrolytic conditions will be made when cables are provided.

Jointing points in the viaducts could not be made sufficiently large to permit the installation of loading coils. Construction for this purpose is impracticable above road level and loaded cables will need to be designed accordingly.

THE APPROACH VIADUCTS

The space available was that between the two carriageways, above the main girder formation. A typical view of the chase thus formed is seen in Fig. 4. This shows a straight section with the main girder flange lying centrally along the chase. Another condition, where the curvature of the road displaces the chase from the central girder, is shown in Fig. 5. Other variations were caused laterally

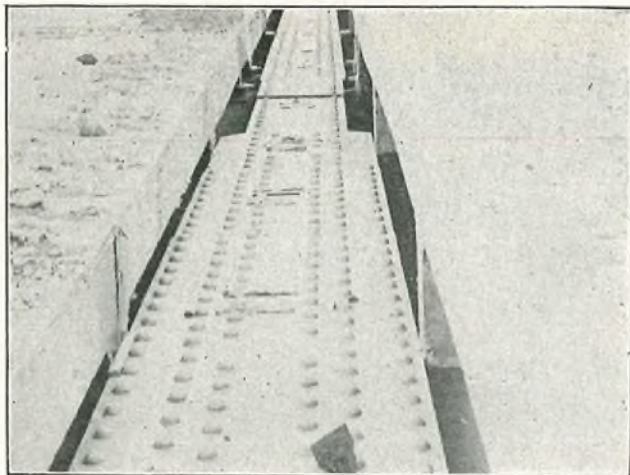

FIG. 4.—CHASE BETWEEN CARRIAGEWAYS ON THE APPROACH VIADUCT.

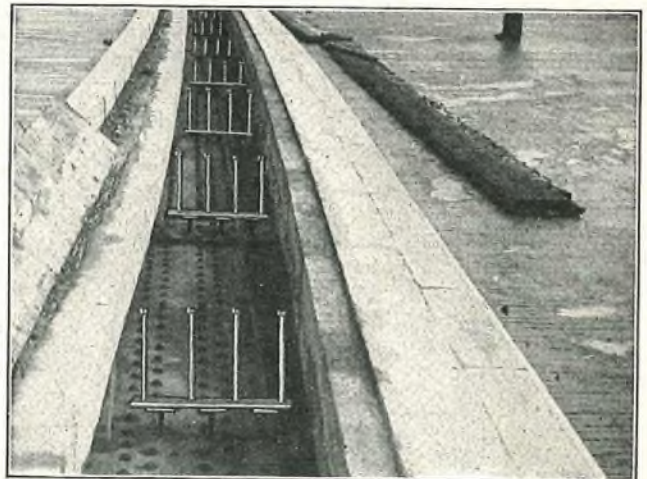

FIG. 5.—ASSEMBLY OF CLAMPS ON WELDED STUDS.

by the changing width of the girder flange (18 in.—24 in.), and vertically by the number of plates used in the make-up of the flange. It was necessary to design a clamp that would be readily adaptable to any of the conditions mentioned, so that it could be mass-produced and used over the whole length of the work. Early proposals for simply clamping the pipes to the girder flange were not acceptable to the Ministry of Transport who specified that:—

- (a) The pipe formation was to be supported not less than 3 in. above the girder flange to permit the free flow of air and prevent the formation of pockets of corrosive moisture.
- (b) The girder and any attachments were to be sanded clean and coated with a Bitumastic compound before the pipes were positioned, to compensate for the fact that the pipes would prevent access for periodic painting.
- (c) No holes were to be drilled in the girder flange and no welding methods permitted that involved the general application of heat to the girders.
- (d) There was to be no drilling of, or attachment to, the reinforced carriageway slabs that formed the sides of the chase.

The design shown in Fig. 6 was adopted. The assembly comprises three $\frac{5}{8}$ -in. diameter studs, each screwed over $2\frac{3}{4}$ in. of its $5\frac{1}{2}$ in. length; three steel plates 4 in. square \times

THE HIGH-LEVEL RIVER BRIDGE

It will be seen from Fig. 3 that over the bridge the central chase gave way to a girder standing some 4 ft above road level. This condition obtained over a 580-ft section, and the problem there was to embody the pipes in the girder without impairing its strength. At the same time it was necessary to provide easy access for cabling, and to consider changes in the cable formation at either end.

The space available was above ground level. It was found that the pipes could best be accommodated by arranging a vertical formation of three on each side of the girder web. Stiffeners, which occur at 5-ft intervals, along the girder were cut to receive the pipes. A shaped piece of $3\frac{1}{2}$ in. \times $\frac{3}{8}$ in. steel plate was welded into position in each stiffener to restore its strength and provide an anchorage for the pipes. This work was done in the factory while the girders were being fabricated. A simple U-bolt device was designed to clamp the pipes at every second stiffener.

For the transition of the cables from the vertical formation described above to the flat formation in adjacent lengths, the vertically formed ducts were stopped approximately 6 ft short of the end of the girder (Fig. 8). Bearers

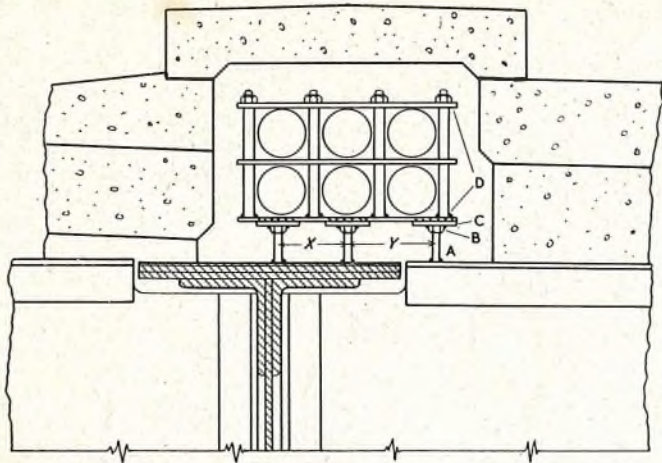

A. Studs welded to main and cross girders.
B. Nuts for level-adjustment welded to square plates.
C. Square plates.
D. Clamping frame welded to square plates.
Dimensions X and Y variable to suit conditions arising from displacement of the girder from the centre line of the chase. This varied with road curvature, from 0 to 11½ in.

FIG. 6.—PIPE CLAMP ASSEMBLY IN TYPICAL POSITION.

$\frac{3}{8}$ in. thick, drilled and welded to $\frac{5}{8}$ in. nuts for receiving the studs; and a clamping frame to carry the pipes. The studs were tipped for use in a stud-welding machine with an instantaneous action so that the heating effect on the girder flange was localized and negligible. Assembly proceeded in the following order:—

1. The three studs were welded in position.
2. The square plates were screwed on to the studs to the required height above the girder flange. Any differences in the levels of attachment of the studs were compensated by adjusting the positions of the plates over the screwed portions of the studs, the projecting ends of which were then dressed-off flush with the tops of the plates.
3. The clamping frame was placed in position across the three plates and welded to them.

The girder and completed assemblies were then treated with Bitumastic compound and the steel pipes jointed and simply clamped in position (Fig. 7).

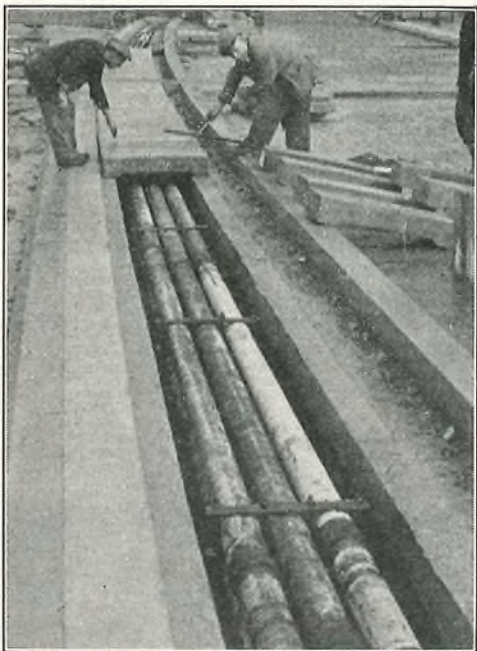

FIG. 7.—STEEL PIPES CLAMPED IN POSITION AND FITTING OF PRE-CAST CONCRETE SLABS

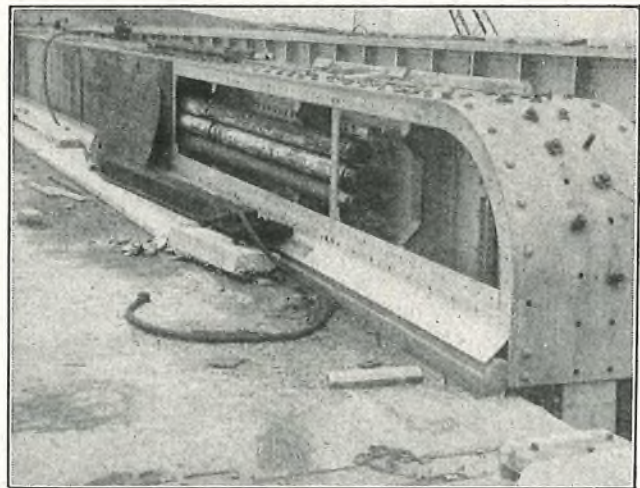

FIG. 8.—END OF THE MAIN GIRDER, SHOWING PIPES IN POSITION.

were fitted in this space to allow cables to be set to pass under the curved end of the girder flange into the adjacent jointing chamber in the chase, as shown in Fig. 9. Bolts were used to secure the curved end of the girder flange and the fascia plates on the sides of the girder to facilitate their removal for cabling operations.

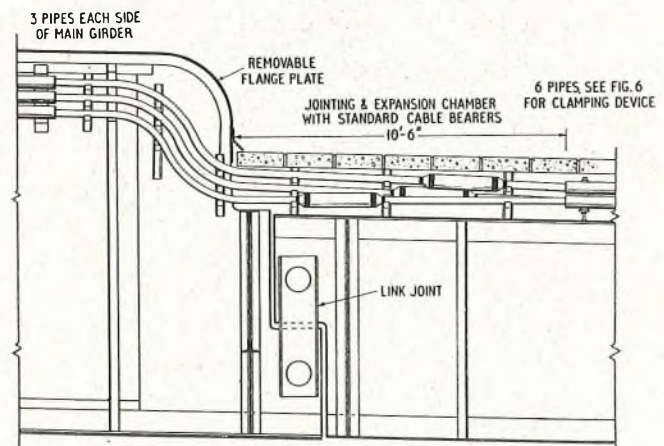

FIG. 9.—CABLES PASSING FROM HIGH-LEVEL BRIDGE TO JOINTING CHAMBER IN CHASE.

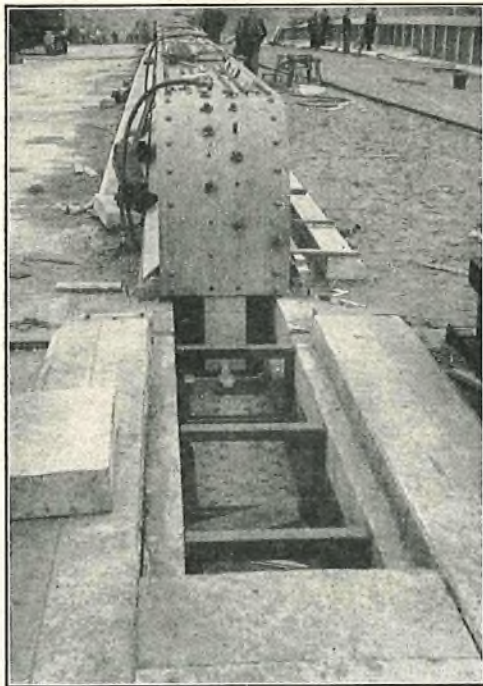

FIG. 10.—JOINTING CHAMBER ADJOINING HIGH-LEVEL BRIDGE, SHOWING CABLE BEARER FRAMES AND APERTURES THROUGH WHICH CABLES WILL ENTER THE GIRDER.

JOINTING CHAMBERS

On the approach viaducts, jointing chambers were limited in width and depth by the size of the chase, but ample length was available. Each chamber was formed by leaving a gap of the required length in the duct formation and fitting cable bearers. Chambers at the ends of the high-level bridge were also of this type (Fig. 10), but those in abutments could be made rather deeper (Fig. 11).

Careful planning of the layout of cables and staggering of joints will be necessary to ensure the best use of available jointing space. Chambers were made up to 11 ft long in viaducts and somewhat longer in abutments. The chase

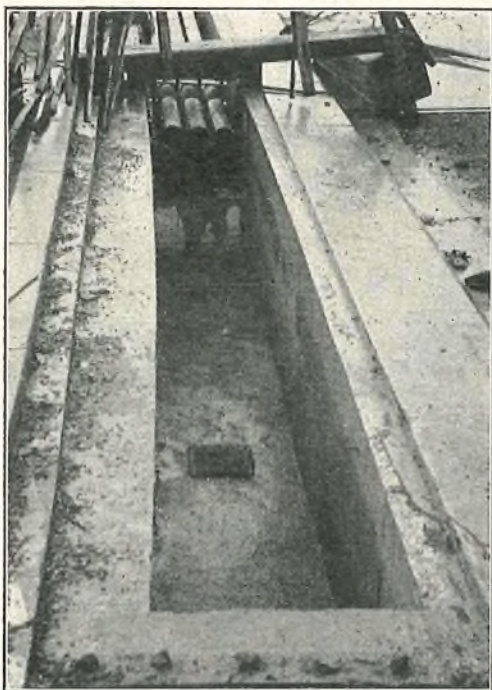

FIG. 11.—JOINTING CHAMBER IN ABUTMENT.

throughout the viaducts was fitted with heavy pre-cast concrete covers; those over the jointing chambers being marked "GPO" to facilitate identification.

The fixing of cable bearers presented a further difficulty in those chambers located on the viaducts, as no fixture could be made to the reinforced carriageway slabs that formed the walls. It was necessary to design a form of bearer that could be attached to the girder flange only, and for fixing, the use of welds $1\frac{1}{2}$ in. long and 6 in. apart was permitted. The top member of the bearer frame (Fig. 10) is designed to clip easily into position after cabling, bracing opposite members against one another to improve rigidity and compensate for the lack of wall fixings.

TEMPERATURE VARIATION AND MOVEMENT OF THE STRUCTURES

The structures of the bridge and viaducts comprise a system of cantilever and suspended sections connected by pivot and link joints to allow movement with variations of loading and temperature. The effects of movement on the pipes and cable were studied, and it was apparent that no excessive strain would be imposed on the pipes or their clamps provided that movement was permitted in the pipe joints associated with pivot joints in the structures. For each of these a length of pipe was selected that fitted easily into the socket of its neighbour, and it was jointed about 1 in. from the fully-home position before being clamped. Jointing chambers in the approach viaducts have been made to coincide with link joints in the structure, but the effect of expansion on cables on the high-level bridge and precautions to be taken against sheath failure through fatigue are matters for further study.

CONCLUSION

Completion of the bridge and road works took several years and it was necessary for duct provision to proceed in stages without obstructing the main work. For this reason the Post Office work was let on a daywork (time and material) basis to the main contractors. That this course was justified was apparent in the smooth running of the work and the fact that the cost compared favourably with the cost of providing six ductways in normal road conditions.

The contractors were The Cleveland Bridge & Engineering Co., Ltd., of Darlington. The Ministry of Transport's consulting engineers were Messrs. Rendel, Palmer & Tritton, of Victoria Street, London, who also co-operated with the Post Office and did much of the work of designing the special fittings required. The Supervising Engineer, Mr. A. F. Allen, M.I.C.E., readily gave assistance in the many details that had to be settled on site.

Within the Post Office organization much help was given by the officers of Headquarters, Wales and Border Counties, who were responsible for preparing and letting the contract, while the Supplies Department satisfied the exceptional demand for four miles of 4-in. steel pipe with time to spare. The enthusiasm of the Area officers who supervised the work ensured the success of the scheme.

ACKNOWLEDGMENTS

Colleagues in the Swansea Telephone Area have assisted by providing photographs, preparing drawings, and offering advice and criticism. The author acknowledges with thanks the help so freely given.

The sketches were derived from original drawings prepared by Messrs. Rendell, Palmer & Tritton, and are reproduced with their kind permission, as also is the aerial photograph at Fig. 2. The photograph was supplied by H. Tempest, Ltd., of Cardiff.

U.D.C. 678:621.395

Plastics are used extensively in telephone exchange equipment and this article discusses the characteristics of some of the items of equipment made from plastics and the improvements in the design of such items that have been made possible by new developments in plastic materials. The reasons are also given why plastics have not been used in some other items of equipment for which, superficially, plastics may appear to have advantages over existing materials.

HISTORY

ONE of the earliest uses of plastic materials was in communication equipment, and if it is allowed that ebonite is a plastic material, based on natural rubber, the use probably goes back to the first public telephone exchange which, in the United Kingdom, was installed in Coleman Street, in London, in 1879. It is interesting to note that one of the earliest applications of injection moulding was in the manufacture of telephone switchboard plugs in this country in 1923. The replacement of machined ebonite internal insulation by moulded cellulose acetate was regarded at that time as an outstanding technical achievement in the use of plastics.

The development and progressive improvement of exchange apparatus were assisted considerably by the introduction of phenolic synthetic resin bonded paper (s.r.b.p.) material; this was used principally for the insulation of bank contacts of automatic exchange switches and for relay coil formers and spring insulators. These s.r.b.p. sheet materials were developed rapidly in the 1920's to give considerable improvements in dimensional stability, hardness and electrical insulation. There is no doubt that the exacting standards required for automatic switching equipment played an important part in accelerating the production of high-grade materials in this category which could be safely used in service in adverse climatic conditions.

The recognition of plastics by the public immediately before the 1939-45 war and the impetus given to their development during the war years have resulted in the production of a wide and complex variety of materials, not only in prefabricated basic forms but also as moulding materials.

APPLICATIONS OF PLASTICS

Plastic materials are not "substitutes" but are new materials possessing unique properties which should compete technically and economically with other new materials. Therefore the engineer proposing to use such materials must design his product to take full advantage not only of the physical properties of the material but also of the manufacturing methods applicable to it.

The attributes of plastics which make them of outstanding interest as a class may be summarized as being: the high-grade insulating properties available; the high resistance of many of these materials to the effects of corrosive atmosphere; and the ease with which such materials may be produced in the variety of shapes and sizes suitable for later pressing work, or may be processed by moulding into shapes of a complexity which would be very costly to produce by fabrication. They may also be self-coloured with a wide range of attractive and brilliant colours.

For the manufacture of mouldings, plastic materials fall into two main divisions. The first is the thermoplastics, which, with the application of heat, melt and become liquid or "plastic" and thus can be injected into a cooling mould where they quickly set. This process is termed injection moulding and can assist in cheapening the production of moulded items owing to the short processing time. The second main group comprises the thermosetting plastics

wherein the application of heat initiates a non-reversible chemical change which sets the plastic into its rigid form. With these materials a measured quantity of moulding powder is placed in the mould, compressed under high pressure and heated. A period is required at a high temperature to cure the moulding. The longer process time may make this slightly more costly as a method of production. However, each system of manufacture has special merit for a given circumstance and the most careful consideration is needed in order to decide which material and process is likely to be the most economical.

In this article various items of telephone equipment are considered, to show how the properties of plastic materials fit them for use in these items. Many examples of the use of plastics are to be found in a rack of switching equipment; it will be useful to consider these examples and the particular properties of plastic materials which make them invaluable in their particular situations.

No mention is made in this article of the very important contribution plastics have made in the development of improved standards of cabling and wiring, as this will be the subject of a future article.

Connexion Strips.

The requirements for connexion strips (Fig. 1) are a high grade of electrical insulation and breakdown strength, good mechanical strength to withstand the considerable stresses that are involved in wiring operations and, on some designs, in the manufacturing operation of firmly staking the tags in position in the insulating material. Since the tags are subject to many and possibly prolonged soldering operations it is essential that the block in which they are mounted shall not be softened by heat, and as these units have to exist in the open atmosphere of the exchange, absence of atmospheric corrosion and a very highly polished surface to minimize the collection of dust are desirable attributes. The front panel must be moulded or formed from a plastic that provides a suitable base for designation letters or numbers. The adhesion and compatibility of the paints or inks used for signwriting or silk-screen printing are also important requirements.

Many plastics have these properties, but as connexion strips are used in very large quantities in exchanges it is essential that the final choice shall be an inexpensive variety; for this reason phenol-formaldehyde (p.f.) was chosen for the main block, although in order to improve the appearance of the blocks and the clarity of the labelling a white urea-formaldehyde (u.f.) material has been used for the front strip.

Because of the large number of these connexion strips that are in use and the large proportion of insulating material incorporated in them, it is essential that only

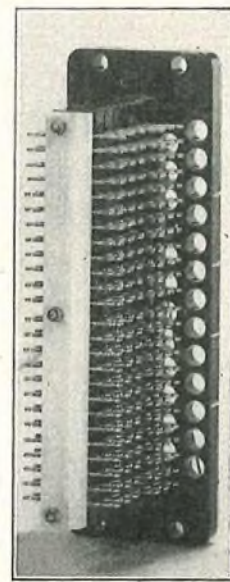

FIG. 1.—MODERN CONNEXION STRIP.

† Chief Factories Engineer, Factories Department, formerly Senior Executive Engineer, Telephone Development and Maintenance Branch, E.-in-C.'s Office.

materials having a low fire risk shall be used. P.F. mouldings meet this requirement.

Resistor Bobbins.

Large quantities of resistors are required in automatic circuits and a cheap material of low fire risk is therefore required for bobbins. Additionally, the material must not soften or deform with the application of heat to the soldering tags or at the normal running temperature of the resistor itself. For low-voltage resistors p.f. resin meets these requirements, although for the higher-wattage resistors the temperature rise is such that normal organic plastics formed from carbon as a base element are liable to destruction. For such resistors, therefore, ceramic materials are required.

Selector Banks.

The insulation required between the contacts of selector banks makes very stringent demands on the properties of the material to be used. The spacing between the contacts is small, being only 0.016 in., while the potential differences appearing across the insulant between the contacts may rise to over 1,000V. It is therefore essential to use an insulant having a high dielectric strength and one, moreover, which is not prone to "tracking" (the formation of a carbonized conducting surface resulting from sparking) between adjacent contacts on the same surface. The high potential difference and small spacing between contacts on opposite sides of the insulant makes the bridging of these contacts by dust a possibility unless the insulant protrudes beyond the tips of the contacts. When this is done the protruding strip of insulant is then very susceptible to mechanical damage; therefore an extremely tough material which will not chip is required. A further mechanical requirement is that the material shall be rigid and shall not flow or become squashed by the high pressures used in clamping the bank assembly into a solid unit, for it is essential that the contacts shall retain their position during the whole of the 30 years or so that they will be subject to the distorting effect of the wipers sliding over them. The material must also be resistant to wear, for the wiper tips rub along the inter-contact surfaces. Chemically it must not be affected by the normal cleaning methods used to remove dirt from the bank contacts and it must withstand the heat of the soldering operations and whatever auxiliary manufacturing operations are necessary to produce a satisfactory bank design. Owing to the very large quantity of the separating insulators required, which amount to some 30 per switch, the material must be inexpensive.

The insulation of selector bank contacts illustrates well the advance of plastics technique and the way in which equipment designers make the best use of improved materials. In the bank as originally designed for the selectors used in the Epsom exchange of 1912, the insulating material was a hard grade of pressed fibre. This was mechanically tough but its electrical properties were poor. With the cheap production of p.f. materials these were used for the insulation between contacts, in the form of s.r.b.p. sheet wherein the mechanical strength was obtained by the paper fibres. Mechanically this was not quite as strong as the fibre sheet originally used, and breakages of the insulating sectors necessitated considerable maintenance effort to replace them without disturbing the wiring or the relative positions of the bank contacts. The electrical properties were, however, of a high standard.

The development of poly-vinyl-chloride (p.v.c.), a thermoplastic material with exceptionally high resistance to chemical corrosion and mechanical abrasion, and also of extreme toughness, held out a prospect of a suitable solution to the problem of finding a material able to meet all the demands outlined above. Some doubt was felt,

however, as to the ability of a thermoplastic to withstand the sustained pressure produced by the clamping screws without creeping and allowing the assembly to become loose.

Although p.v.c. in its unmodified, or rigid, state is an extremely tough material it is usually combined with various other chemicals as plasticizers, lubricants, etc., to make it plastic and workable; as sheets of close tolerance in thickness were required it was initially thought that with the difficulty of working rigid p.v.c. it would be necessary to use the plasticized version; this would have increased the flow under pressure to such an extent that the material would have been unsatisfactory for use as separating insulators for bank contacts. After some considerable effort on the part of the manufacturers, however, it was found possible to press rigid p.v.c. sheets into the required thickness with the necessary accuracy at a cost which made the product acceptable for use in these separators.

The readiness with which p.v.c. may be coloured led to a further advance by the use of a near-white colour for this separator (Fig. 2) in place of the previous brown of the p.f.

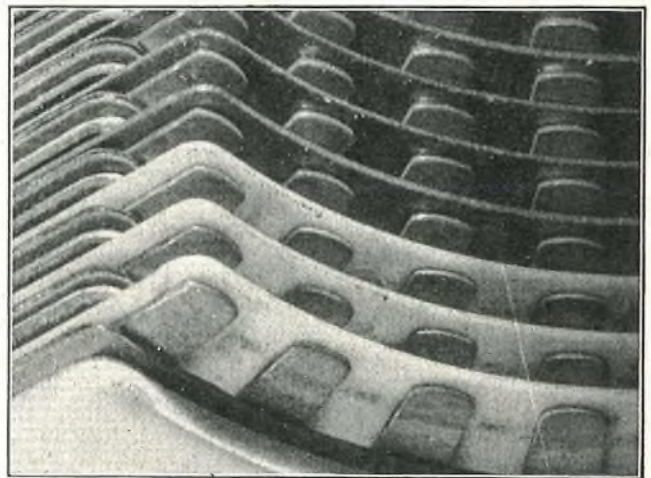

FIG. 2.—SELECTOR BANK HAVING WHITE P.V.C. SEPARATORS IN LOWER THREE LEVELS.

The greater light reflection thus obtained helps the maintenance staff in their adjustment and cleaning operations.

Having found a material which satisfied the requirements of performance in use, it was necessary to review the manufacturing process to determine whether any difficulty would be experienced in this field. There were several methods of constructing the bank in order to meet the requirement that the bank contacts should not be displaced when a separator had to be changed for any reason. In one of these the contacts were fixed to backing segments of insulation by means of a thermosetting cement, and the backing insulators with their contacts stuck to them were then assembled together with the separators to form the complete bank. In another process the backing segments were spread with a thermoplastic cement and then assembled with the contacts and separators to form a complete bank and held under pressure; the whole bank unit was then heated for up to 30 min to permit the thermoplastic cement to flow around and attach fully the associated contacts. This process could not be used with p.v.c. separators as these would flow and distort under the temperature required to melt the thermoplastic cement.

It might be queried why, with the facility of moulding plastics into complex shapes and the ability to incorporate metal inserts in the moulding, it is not possible to use this process to form a complete bank unit at one operation. This alternative has been investigated but one of the major problems of any moulding method where inserts are

required to project above the moulded material at the end of the operation is the cleaning away of the flash or oozing of the moulding material that occurs along the surface of the projecting inserts. It is very difficult to make a clamping arrangement for holding inserts in their correct position so accurately with respect to the material of the insert that there is no space for the moulding material to be extruded along the surface when under the very great pressure involved in moulding thermosetting materials. With such a construction it is necessary to clean off the flash by a second operation after the unit is fully moulded and, having regard to the very small spacing between the contacts in a fully built bank unit, the removal of flash becomes a difficult and expensive operation.

Such extrusion of flash is reduced if thermoplastic materials are used, as the pressure required to mould these is much less. By a suitable design of moulding tool, it is possible to cool to the solid state at such an early stage in the operation that, at the points where flash might be expected, the material becomes solid and is unable to flow into the unwanted cracks. With the exception of p.v.c., most inexpensive and otherwise satisfactory thermoplastic materials are liable to deterioration or the production of surface cracks or crazing when cleaned by some of the materials which are often in use during maintenance operations. Therefore it was considered, in view of the long life expected from banks, this being the full life of the exchange, some 30 years, that such materials could not be accepted. P.V.C. was considered and looked promising but it has such a short temperature range over which it flows easily enough for moulding purposes that an expensive mould would have been required working under close temperature control and high pressure. It was felt that at this late stage in the development of electro-mechanical equipment, the very heavy capital cost involved in the production of the necessary moulds and moulding machines would price out banks formed by such a method.

Relays.

The requirements of the separating insulators between contact springs of relays are not quite so critical as those between bank contacts, being merely rigidity and high electrical resistance and breakdown strength. Mechanical stability is essential, however, since the relay springs are adjusted to very close tolerances to ensure satisfactory operation. Any loosening resulting from shrinkage of insulating materials would destroy this adjustment. The dimensions of the buffer block must also be extremely stable. Until recently the buffer block was formed from a u.f. material but there has been difficulty in maintaining sufficient dimensional stability with this material since it absorbs water to a certain extent and this can cause slight shrinkage under conditions of prolonged exposure to heat as in the v.f. receiver. For this reason the modern tendency is to use a ceramic or alkyd block. Alkyd moulding materials possess the necessary long-term dimensional stability under adverse climatic conditions of dry or moist heat.

In early methods of constructing coils the coil former was fabricated by pressing s.r.b.p. sheet end-cheeks on to the core and wrapping the core within the winding space with strips of cellulose-acetate sheet. The wire itself was enamel insulated. Recently, the facility of moulding the coil former parts has shown possible advantages in providing routing grooves or slots for the coil lead-out wires in the coil cheek and so keeping these leads from contact with other coil wires, while the moulded former (Fig. 3) provides a precise and uniform winding space. Only of late has it been possible to mould the coil former from a material which is sufficiently tough in the thin sections demanded to withstand the normal rough treatment involved in temporary storage in the factory and transfer to the coil-

winding position. The requirement is met by the use of acrylic resin in a transfer-moulding machine, giving a much cheaper moulding operation.

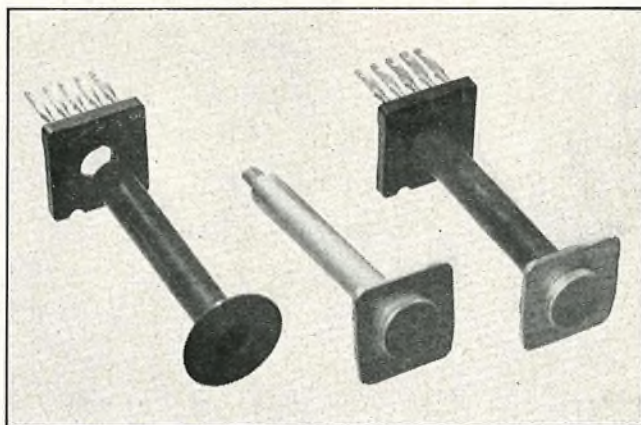

FIG. 3.—RELAY COIL FORMER.

Fuses and Fuse Panels.

For many years the general-purpose insulating material giving constructional strength and good insulating properties has been the basic p.f. synthetic resin paper board, and this was used for the basic strip of the fuse (Fig. 4).

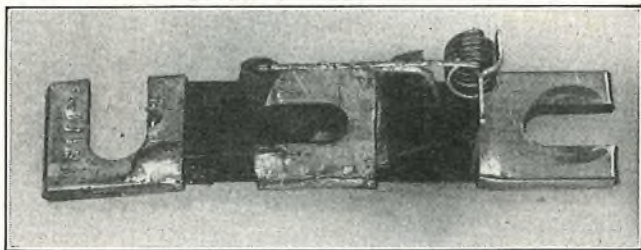

FIG. 4.—FUSE NO. 31, WITH P.F. BASIC STRIP.

This is, however, to some extent inflammable and demands a certain amount of fabrication in fixing contact ends to it by riveting. Attention has therefore been turned to obtaining a construction bearing no greater assembly costs, while providing a greater guard on the fuse wire over its fusing section and so preventing the blowing of one fuse from affecting an adjacent one by arcing over. The problem here has been to find a material which is inherently non-inflammable and cheap to mould. Although polythene proved to be very attractive as a moulding material, it is inflammable and so is undesirable for use around a fusing wire or, indeed, for general use anywhere in telephone exchange apparatus rooms. Attention has therefore been turned, with considerable success, towards the use of rigid p.v.c. and the moulding problems involved with that material. The fuse (Fig. 5) is now an item with a guarded fusing path and of attractive appearance in which the rated current is indicated by the colour of the moulded block.

The mounting block for the fuses (Fig. 6) is mainly required to be of good mechanical strength and to have a labelling surface available on which any fuse titling can be distinctively applied; it must also have good insulating properties as it is mounted on the bus-bar and has fixed to it the distribution connexion studs and the alarm circuit bar. Full advantage is taken of the ability of moulded materials to take on a complex configuration by making this mounting unit a support for the bus-bars for both earth and negative supply and for fixing the bus-bars through it to the rack.

Bus-bar.

In telephone exchanges the battery potential is only 50V

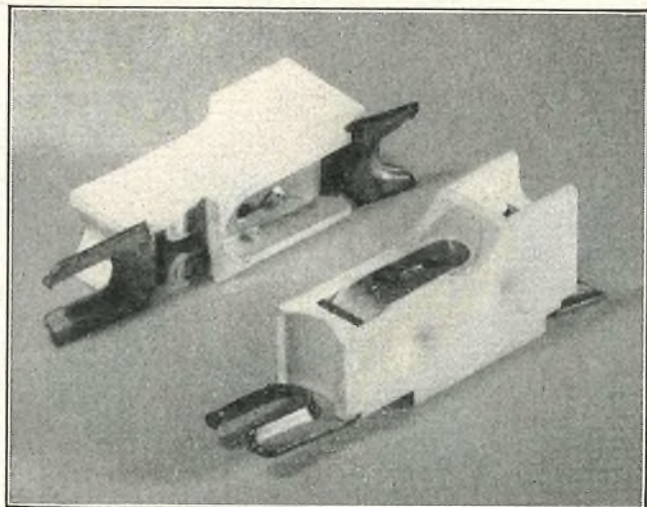
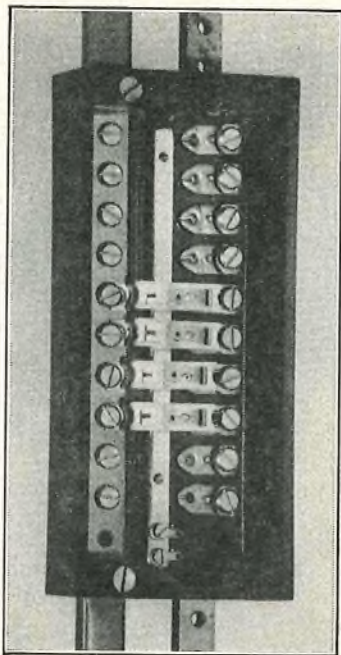

FIG. 5.—FUSE No. 44.



The left-hand (negative) bus-bar is protected by a p.v.c. cover.

FIG. 6.—FUSE MOUNTING BLOCK

and bus-bar insulating problems are not great, but the length of bus-bar and number of support points are such that a low grade of insulation could cause a considerable leakage of the battery power. Bus-bar supports are constructed therefore from a high-quality p.f. material with a wood-flour filling, the moulding processes giving these supports a very high surface finish which acts as a deterrent to collection of dust and dirt which might form a leakage path.

Where the bus-bars are liable to be handled by the staff, i.e. where they run up the side of the racks, a tough insulating surface is necessary to prevent accidental contact by tools between the positive and negative bars. Recently p.v.c. has proved acceptable for this purpose. This material has the advantage of being self-coloured to the standard red, blue or yellow, and also has the property that a p.v.c. tube of a given dimension can be expanded to a diameter about 30 per cent greater than normal by being dipped in certain thinning materials of hydrocarbon or ester base. When these expanding agents dry out, the tube contracts to its normal diameter. This provides an easy method of fitting a closely-shaped insulating tube to the bus-bar.

One problem which arises with plasticized p.v.c. as used for the production of tubes or the extrusion of insulating coverings for wires and cables is that most plasticizers are prone to migrate into certain other materials such as cellulose enamel and polystyrene with consequent softening and damage to the surface of these materials. This drawback to the use of p.v.c. has resulted in a general investigation into the paints and finishes used on equipment wherever it may come in contact with bus-bar covers or cabling and wiring.

Shelf Plugs and Jacks.

Shelf plugs and jacks again indicate the progressive application of plastics; the first designs used ebonite for the main block that positioned the contacts, and fibre insulation; or in some cases ebonite insulation, for the thin sheets fitted between adjacent contacts. Such construction requires the main block to have slots cut in it by a machine operation and holes drilled in it for fixing purposes. The advent of cheap p.f. moulding materials permitted a satisfactory moulded block to be produced at an attractive price while the s.r.b.p. material was incorporated into the design for the contact separating strips. The use, during one period, of silver-plated contact surfaces to improve the reliability of the electrical contact between plug points and the jack points brought to light a serious problem. It was found that under conditions of slight humidity it was possible for the silver surface to undergo a chemical action permitting an extremely thin layer of silver to be deposited or to creep across the surface of the insulating material separating two adjacent contacts. Under the action of a standing potential difference, a leakage current could then flow which, with certain insulating materials prone to tracking, could produce a permanent breakdown path formed by tracking along the surface. Tests to date have shown that no insulating material is completely immune from creepage of silver across the surface although there are some varieties, such as the alkyd resins and, once again, p.v.c. which appear promising under the tests so far carried out. For this reason the design of these plugs and jacks has now been changed so that where silver is essential for contact purposes it is restricted to the contact area by a bimetallic construction and cannot come into contact with the insulating material. To make certain that all possible leakage contingencies are covered when silver contacts are used, the positioning block is now formed from an alkyd resin and the separating pieces from rigid p.v.c.

Two-Motion Selector Interrupters.

The mechanical properties of plastics have been exploited in the latest design of interrupter on 2-motion selectors where, for the rocker arm, it has been possible to combine the toughness and resilience of nylon with the rigidity of phenol formaldehyde by using nylon-loaded bakelite.

Due to the toggle action required of this interrupter, the rocker arm is struck violently by the armature every time the armature operates or releases. Therefore very high resistance to shock is required together with very low inertia to reduce the shock energy necessary to move the armature. The early construction of this interrupter used a fabricated arm of brass with a sleeve of ebonite at the striking point, to provide a cushioning effect against the shock, and with ebonite studs to insulate the contact springs from the arm. To reduce the inertia of the arm to the minimum the construction was made so slender that bearing points were very small and suffered great wear.

With the advent of the nylon-loaded bakelite it was possible to mould the arm in one piece (Fig. 7) to close cross-dimensional tolerances, so ensuring more reliable adjustment, and the size of the bearing surfaces could be greatly increased to reduce wear. At the same time the

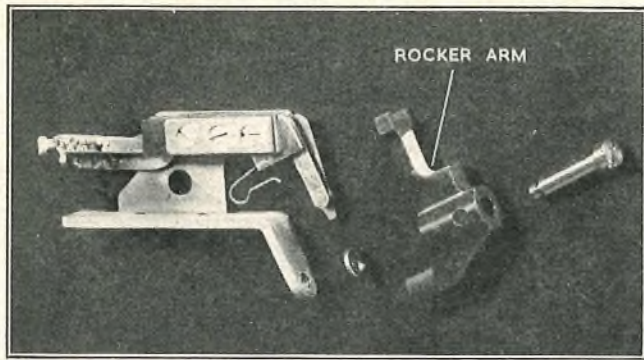

FIG. 7.—EXPLODED VIEW OF INTERRUPTER NO. 4 FOR 2000-TYPE SELECTOR.

reduced density of the plastic as opposed to the brass enabled a much lower inertia to be obtained with a resultant reduction in shock energy. A vastly increased working life has been the result.

Labels.

The provision of labels is an important aspect of the development of telephone exchange equipment, for it is essential for satisfactory maintenance that every item should be labelled clearly and distinctively. Many labels are of the slip-in type wherein a strip of labelling material is inserted into slots in a cover. In these it is essential that there be no warping or the labels will quickly fall out of position.

Plastics of the cellulose acetate type have long been used for labels, but are prone to warping under the action of heat. Further, in order to obtain a distinctive long-lasting marking, it has been the practice to engrave the marking and fill it with black or red as appropriate. This double process makes labelling by no means an inexpensive operation.

A recent advance stemming from plastic development has been the provision of strips of labelling material formed of a sandwich of a coloured material between two outer white surfaces. By using a copolymer of p.v.c. and vinyl acetate a warp-free material has been found, which in the sandwich form permits distinctive marking to be obtained merely by engraving through the top surface into the coloured inside of the sandwich. This advance will result in considerable maintenance savings by reducing the nuisance caused by lost or incorrectly replaced labels.

Covers.

It has often been suggested that the apparent ease with which plastics can be moulded might make them suitable for equipment covers to a far greater extent than they are at present used. It is true that some of the later techniques such as a combination of resin and fibre glass can provide extremely tough covers of light weight, although the material cannot be made in very thin sections. A sheet steel cover, however, if of simple design can be pressed very cheaply and produces a cover which for its thickness has far greater rigidity and resistance to breakage than a comparable thickness of any plastic; in many equipments the spacing between adjacent units is so close that plastic covers cannot be accepted, apart from the fact that the cost of a steel cover often proves to be more favourable than one in plastic.

Ratchet Wheels.

Another application in which the equipment designers

have hoped to use plastics, but so far without success, has been in the ratchet wheels for uniselectors. These suffer a very severe shock during the striking of the pawl on the wheel, and it has been thought that the resilience and the self-lubricating properties of such materials as nylon should be of advantage. To date, however, the very close tolerances demanded of the dimensions of the ratchet wheel with respect to the pawl setting throughout its life and the fact that nylon is subject to (albeit slight) dimensional changes under conditions of varying humidity, has militated against the use of this material.

It has, however, been possible to use an acrylic resin for the very lightly loaded ratchet-cum-number wheel of the subscriber's meter. This has resulted in the number wheel having very distinctive characters and in the combination of plastic wheel and steel spindle being such that less wear and also less friction occurs than was the case with the earlier diecast Mazac wheel. Consequently this new design can meet the increased operating life that will be demanded of meters with the extension of subscriber-dialling facilities.

FUTURE APPLICATIONS

With the probable increased use of electronic techniques for telephone exchange equipment the demands made upon plastics are likely to be heavier than before. One attractive technique is printed wiring, wherein a sheet of plastic has the circuitry deposited on its surface during an etching process in manufacture and carries the components soldered to its etched wiring. As regards its application to telephone exchange equipment, this technique is still in its infancy, and many problems have still to be overcome before the process will prove to be as fully economic over a 30-year life as is the present method of insulated wire connexions. An attractive point about this technique is that the one board provides the support for the components, the necessary insulation of the wiring and the wiring itself.

The large number of very small components used in electronic circuitry necessitate the development of insulated supports and for this work pressed sheet or moulded plastic material in which tags are fixed by crimping or as inserts in the moulding is likely to be satisfactory.

It may be that the equipment of the future will be built up from a framework of plastic elements holding tags to which the circuit elements are fixed rather than, as in the past, a framework of sheet steel to which self-insulated circuit elements carrying their own tags were bolted. Such designs could well be adapted to automatic manufacturing method where the human error element of hand-wired and soldered connexions may be eliminated.

CONCLUSION

An indication has been given of the uses to which plastics are put in telephone exchange equipment, and some of the problems that are met in the application of these new materials have been outlined. It has been shown that although a material may be eminently satisfactory from an electrical point of view the mechanical requirements in use, or the production operations involved in the manufacture of the equipment, may make demands which render an otherwise attractive material unsuitable.

ACKNOWLEDGMENT

The advice and assistance received from Mr. H. D. Ward, of Ericsson Telephones, Ltd., during the preparation of this article is most gratefully acknowledged.

A 4,000-Mc/s Radio System for the Transmission of Four Telephony Supergroups (240 Circuits)

R. P. FROOM, B.Sc.(Eng.), A.M.I.E.E.,
J. D. C. MADDER, B.Sc.(Eng.), A.M.I.E.E.,
C. G. HILTON†

Part 2.—The Baseband and Supervisory Equipment

U.D.C. 621.395.4: 621.396.65

The main radio equipment of the Elgin-Wick multi-channel telephony link was described in Part 1. This part, which concludes the article, describes the baseband and supervisory equipment and gives preliminary overall performance data for the link as a whole.

INTRODUCTION

THE multi-channel baseband signal transmitted over the radio link comprises supergroups 1-4 inclusive and occupies the frequency band 60-1,052 kc/s; the 308 kc/s coaxial line pilot is transmitted with the signals. Fig. 26 shows a simplified block

transmit baseband equipment, where it is split to provide the two outputs at the correct level to feed the two radio transmitters. In the receive direction the outputs from the two space-diversity receivers are fed into the receive baseband equipment. Here the levels of the two signals are stabilized by automatic gain control (a.g.c.) and they are then applied to a high-speed electronic switch where the channel with the lower noise level is selected. The output from the electronic switch feeds the coaxial line equipment. The use of a high-speed switch prevents mutilation of the signal during periods of selective fading on the radio path when the relative levels of the two signals are constantly changing and the switch operates frequently to select the better channel.

Two fundamental problems of design are to decide at any given moment which is the better channel and to detect as soon as possible any degradation of the performance of the channels. A solution to both was found in providing, in the baseband equipment, monitoring devices which measure continuously in a small frequency band above the highest

signal frequency the noise generated in each channel by the entire link. The measurement of these noise levels together with a means of checking the presence of the 308 kc/s coaxial line pilot in each channel provide the basic information on the performance of the channels. The channel switching is arranged to select the channel having the lower noise level at any instant provided that the 308 kc/s pilot is present in the channel to prove its continuity.

Gross fault conditions due to a break or high attenuation in the channel concerned are readily detected by 308 kc/s pilot monitors which give an alarm and initiate channel-change-over (where necessary) whenever the pilot output level drops by 2 db. Any other fault condition, whether it be due, for example, to poor radio propagation conditions or to inter-modulation in the baseband equipment, must give rise to an increase in noise level in the channel. Thus the noise-monitoring technique is an ideal means of monitoring the performance of a channel.

Supervisory.

The original proposals for maintenance control of the radio link followed current coaxial cable practice and treated the cable tail between Aultmore and Braewynner and the radio link as a complete system controlled by Aultmore with Thrumster as the remote unattended terminal. But the provision of a supervisory system on

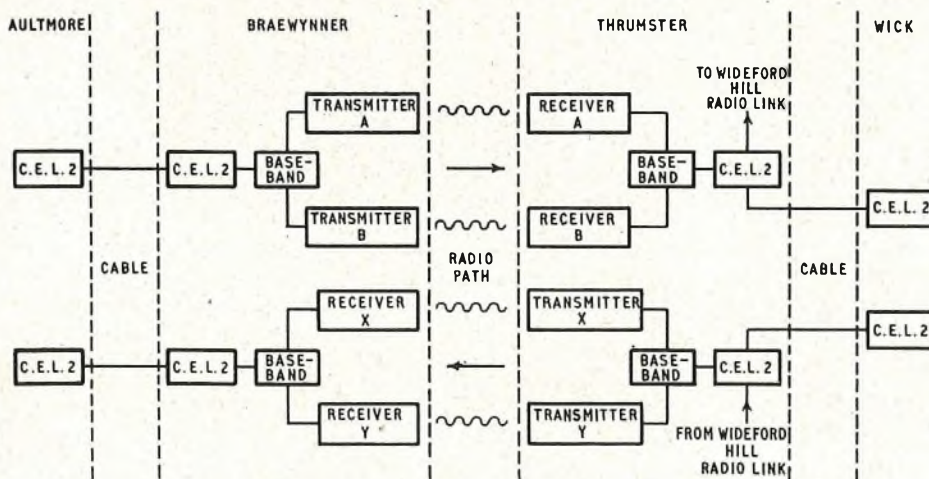

FIG. 26.—SIMPLIFIED DIAGRAM OF THE MAIN TRANSMISSION PATH.

schematic diagram of the whole radio link system. In the "Go" direction the signal is transmitted from Aultmore telephone repeater station (T.R.S.) over a short coaxial cable section using modified Coaxial-Equipment, Line, (C.E.L.) No. 2 to the radio station at Braewynner, where it feeds two radio transmitters designated A and B. These transmitters operate on two different frequencies to give frequency diversity. At Thrumster the A and B channels are received on separate space-diversity receivers and the receiver having the better signal-to-noise ratio at any instant is selected automatically to provide the link output. The signal then passes to the coaxial line equipment where there are facilities for separating the supergroups. Two supergroups feed the Thrumster-Wideford Hill radio link and the other two are transmitted over four miles of coaxial cable to the T.R.S. at Wick.

In the "Return" direction the supergroups from Wideford Hill and Wick are combined in the line equipment at Thrumster to provide the input signal to the radio link, which is similar to that of the "Go" direction except that the two radio channels are designated X and Y. The selected signal from the radio equipment at Braewynner is transmitted over coaxial cable to Aultmore.

GENERAL DESIGN CONSIDERATIONS

Baseband.

The connexions between the coaxial line equipment and the microwave radio transmitters and receivers are made via the baseband equipment. In the transmit direction the signal from the coaxial line equipment is fed into the

† The authors are, respectively, Senior Executive Engineer, Executive Engineer and Assistant Engineer, Radio Experimental and Development Branch, E.-in-C.'s Office.

this basis presented the major problem of how to transmit end-to-end supervisory signals economically over the Thrumster-Braewynner section.

Previous microwave systems in this country have used physical circuits to provide channels for supervisory information and engineering speaker circuits but the geography of the Braewynner-Thrumster link does not lend itself to similar treatment. Whilst the line-of-sight distance between the radio stations is only 55 miles, the road distance round the Moray Firth is of the order of 150 miles and the provision of special audio circuits would have been very costly. An independent radio link for supervisory purposes might have proved feasible, but it would have required an independent source of power in order to continue operating during power supply failures on the main link. The most likely cause of complete failure of the main radio link is a power failure (for in each direction of transmission there are two transmitters and virtually four receivers) so that a separate mains-driven supervisory radio link which would itself be inoperative under these conditions would offer little advantage over a supervisory system carried by the main radio link.

With these considerations in mind the control arrangements for the radio link were reviewed, and it was decided that whilst Aultmore should remain the control station, and should receive all the supervisory information necessary for adequate control of Braewynner and Thrumster, supervisory information relating to Thrumster should be repeated to Wick T.R.S., which would become a sub-control for the radio link. This arrangement made it possible to depend on the radio link itself for all normal supervisory signalling with the safeguard that if the link were completely interrupted the appropriate alarms from Braewynner and Thrumster would be given at the Aultmore and Wick control stations, respectively.

Four audio channels in the frequency band 32-48 kc/s, termed the "sub-baseband," are provided to transmit the supervisory indications over the radio link.

The injection and extraction of the sub-baseband channels is done in the baseband equipment. Interstice pairs in the coaxial cables carry the supervisory and speaker signals from the radio stations to Aultmore and Wick.

A further general design consideration for the supervisory system was that the supervisory system for the radio link should, as far as possible, be integrated with that of the coaxial cable tails feeding the link. The object of this was to simplify maintenance and to gain experience for any combined radio-and-cable links that might be needed in the future. At the same time it was planned to keep to a minimum the number of different alarms and indications from the radio stations in order to keep the supervisory system simple and to facilitate its integration with the cable supervisory system.

Some of the monitoring facilities required to check the operation of the microwave equipment presented the design problem of stable amplification of small direct currents derived, for example, from microwave crystal detectors. Current changes of the order of a fraction of a milliampere or even a few microamperes were required to cause the positive operation of the alarm system and as speed of operation was not vital magnetic amplifiers designed by the Post Office Research Station were used for these applications.

BASEBAND EQUIPMENT

The baseband equipment, part of which is shown in Fig. 27, is mounted in two cabinets separate from the supervisory equipment. A typical panel and unit are illustrated in Fig. 28 and 29. To minimize the risk of

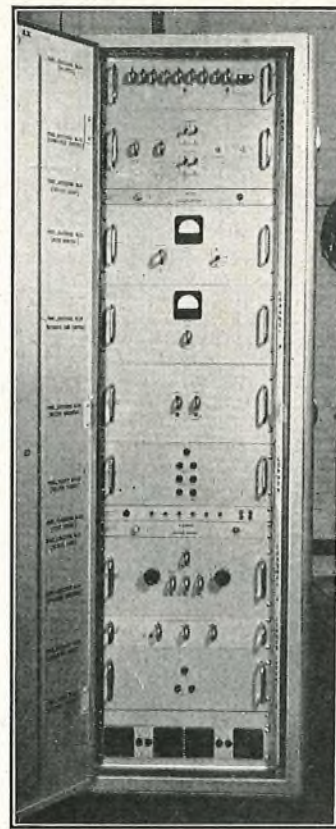

FIG. 27.—BASEBAND CABINET.

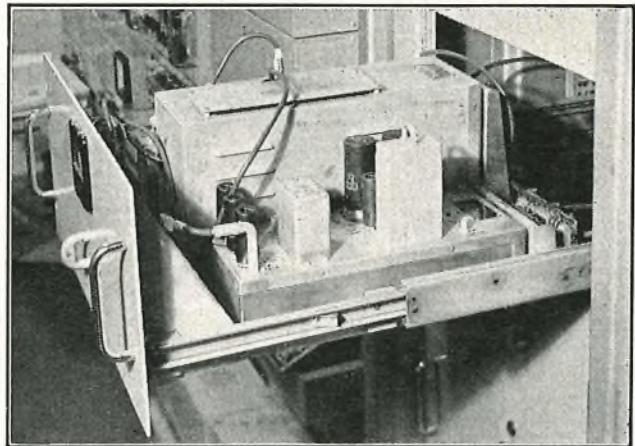

FIG. 28.—A TYPICAL BASEBAND PANEL.

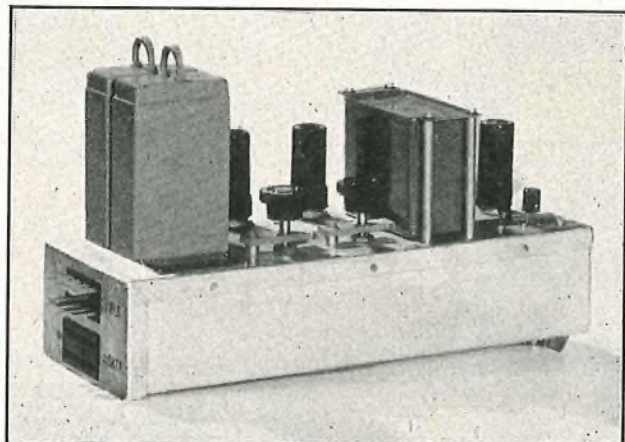

FIG. 29.—A TYPICAL BASEBAND PLUG-IN UNIT.

simultaneous faults on two channels in the same direction, the A transmit and X receive equipment at the southern end of the link is fitted in one baseband cabinet and the B transmit and Y receive equipment is fitted in the other cabinet. A similar arrangement obtains at the northern end with the designations transposed. As a further precaution the A/X and B/Y cabinets are fed from separate voltage regulators on different phases of the no-break a.c. supply. To reduce the risk of both sets of baseband equipment being damaged if a fire should start in one cabinet, the two sets are mounted at opposite ends of the room.

The H.F. Arrangements.

Simplified block schematic diagrams of the baseband transmitting and receiving equipment are given in Fig. 30 and 31, respectively.

The main frequency band received from line for onward transmission is 60-1,052 kc/s, giving a traffic-carrying capacity of four supergroups. A transmitted frequency band of 32-48 kc/s is occupied by speaker and supervisory circuits and the band 1,052-1,260 kc/s is used for monitoring noise.

The main transmission path uses frequency modulation and the demodulated baseband signals, if they are present at all, are of sensibly constant level whereas the background noise varies in level according to the strength of the received signal and the extent of multi-path propagation. Hence the noise level of the baseband signal can be conveniently used as a parameter for selecting the better signal. Because of the appreciable degree of frequency-selective fading and the significant improvement in signal/noise ratio that can be obtained by permitting

frequent operation of the baseband switch a high-speed electronic switch was developed instead of a relatively low-speed electro-mechanical-relay switch, which would suffice to guard against equipment failure.

The transmit path.—In the transmit direction (see Fig. 30) the line frequency band of 60-1,052 kc/s, which includes a low-level pilot frequency of 308 kc/s, is first split into two channels. At Thrumster only, each channel is amplified before passing to the band-stop filter where any spurious tones and intermodulation noise, that may have been accepted from line, are removed from the noise-monitoring band of 1,052-1,260 kc/s. The sub-baseband signal of 32-48 kc/s, which is assembled in the supervisory equipment is then injected before passing to the two microwave transmitters. Two isolation attenuators are provided at the input to each

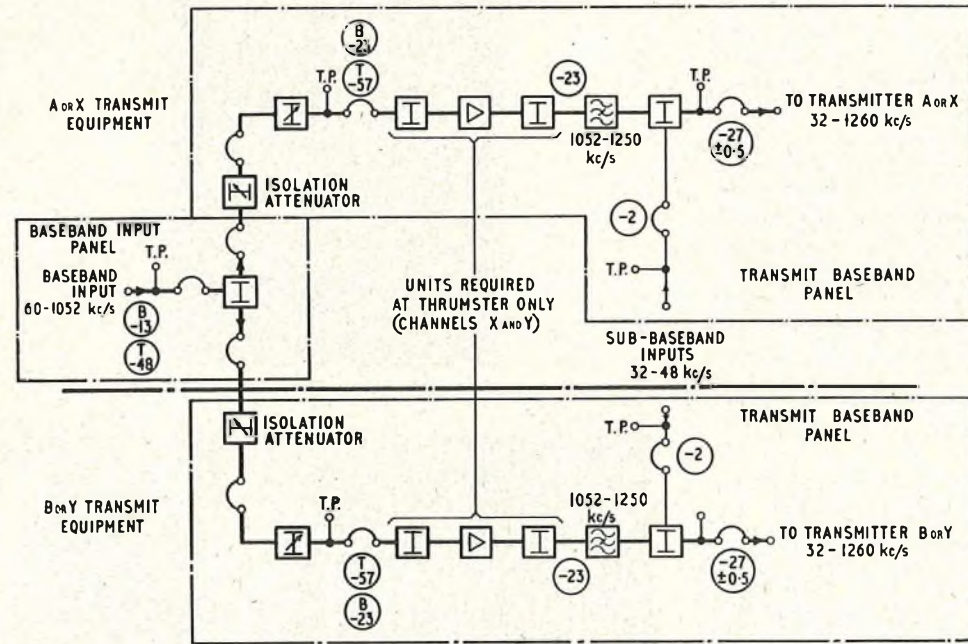

FIG. 30.—BASEBAND EQUIPMENT FOR TRANSMITTERS.

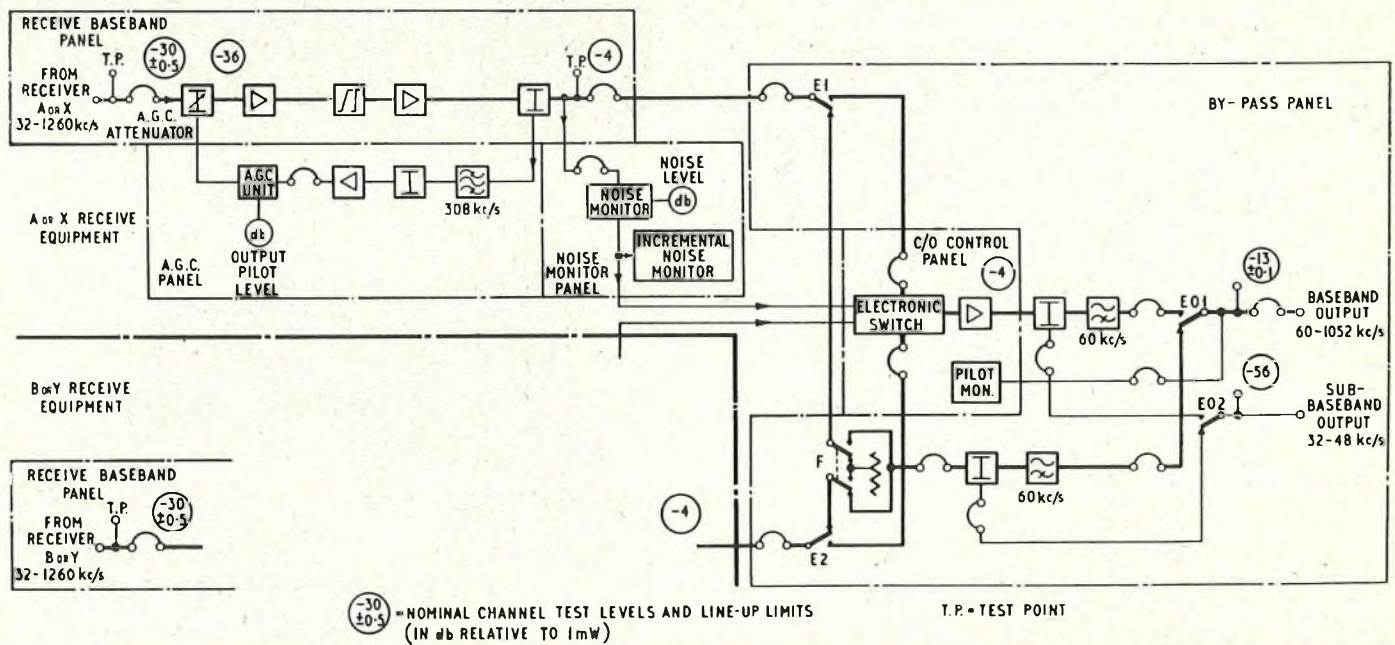

FIG. 31.—BASEBAND EQUIPMENT FOR RECEIVERS.

channel, so that one channel may be isolated for maintenance without disturbing the other channel, which may be carrying traffic.

The receive path.—In the receive direction (see Fig. 31) signals from the two microwave receivers are accepted by an a.g.c. attenuator in each baseband channel where they are subsequently amplified and equalized. At this point a sample of the signal is extracted for the a.g.c. chain, filtered, amplified and fed to the a.g.c. unit. Here the pilot is rectified and compared with a reference voltage, the difference voltage being amplified and applied as a varying current to the a.g.c. attenuator in the main channel from the receiver. This attenuator has a nominal loss of 6 db but can vary between 3 and 9 db in response to the varying current from the a.g.c. unit. As a result, variations of about ± 3 db in the receiver output are compressed in the ratio of 10 : 1, but the larger variations are transmitted uncompressed. An output-pilot-level meter is incorporated in the a.g.c. attenuator circuit and a separate pilot rectifier in the a.g.c. unit is used to operate a "Pilot On" relay, which is arranged to release when the output pilot falls to about 2 db below nominal. Fig. 32 is an

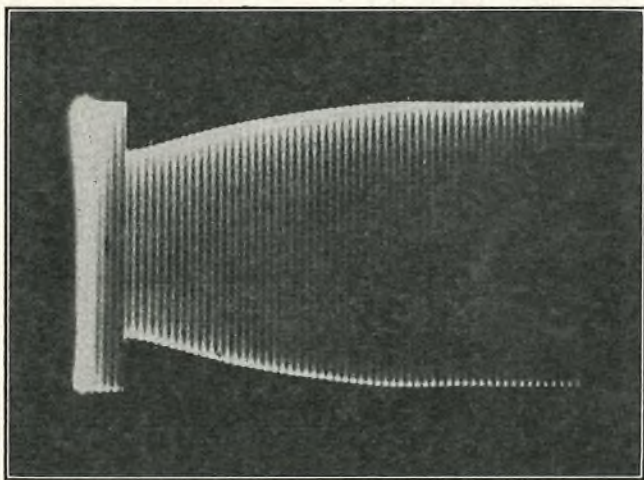

FIG. 32.—A.G.C. UNIT AND ATTENUATOR OVERALL RESPONSE TO 4 DB STEP CHANGE IN INPUT LEVEL.

oscillogram of the output-pilot envelope from the a.g.c. system showing a typical response to a step reduction in input level from +2 db to -2 db relative to nominal. The total time occupied by the trace is 1,300 ms; and the vertical striations are 20 ms time markers provided by spot-brilliance modulation. The response characteristic is an over-damped wave with a time constant of the order of 400 ms. A step increase in level tends to cause overshoot of about 10% of the step but this is not serious.

A noise monitor unit with a high-impedance input is bridged across the output of each channel. Noise in a 40-kc/s band centred on 1,160 kc/s is selected, amplified and then rectified. The rectified output is fed to a meter calibrated over the range -60 to -20 db in terms of the noise in a 4-kc/s band relative to the channel test level. A relay incorporated in the unit is arranged to release at a high noise level, of the order of -30 db. The noise monitor unit provides an output voltage that is substantially proportional to the noise level. The output is applied to the incremental noise monitor unit, and together with the output from the complementary unit on the other channel, to the electronic switch unit.

The incremental noise monitor contains a relay that operates whenever the noise level suddenly increases by about 6 db. This is designed to provide an indication that operation of the i.f. diversity switch incorporated in the receiver has caused a rise in noise level. Since operation

of the switch should normally result in a fall in noise level a rise in noise level implies the existence of a fault and operation of the incremental noise monitor gives rise to an alarm.

The output of each channel is normally fed to the baseband electronic switch which selects the channel with the lower noise level for onward transmission. An amplifier is provided to offset the 20-db loss of the electronic switch and this is followed by a teeing pad for extraction of the sub-baseband signals and a high-pass filter to remove these signals from the main baseband output. The electronic switch change-over time is about 40 μ s and, as the loss variation in the on- and off-going channels is roughly complementary, the degradation caused to traffic by switching every few seconds is negligible.

As a safeguard against faults in the electronic switch or other equipment common to both channels, a standby circuit known as the "by-pass," using telephone-type relays, is provided. Similar relays are used to switch this standby circuit in place of the electronic switch when necessary. In addition to actuating alarms when released, the pilot- and noise-monitor relays control the change-over relays.

Simplification of the supervisory circuits has been achieved by using the by-pass in the event of failure of either radio channel in addition to that of failure of the common equipment: this is permissible because if one channel is faulty frequency diversity is no longer possible. Under normal conditions channels A and B are connected to the electronic switch through the operated relay contacts E1 and E2, as shown in Fig. 31. The electronic switch is connected through the operated relay contacts EO1 and EO2 to the main- and sub-baseband outputs, respectively. Under fault conditions, relays E and EO release so that the electronic switch is replaced by the by-pass change-over relay F. When F is operated channel A is connected to the output and channel B is terminated and when F is released the conditions are reversed.

Change-over Supervisory Circuit.

A positive indication that a channel is working is the presence of pilot at its output whereas an apparent absence of noise could be due to an interruption of the receive baseband path or to failure of the noise monitor. Thus, in the design of the automatic change-over circuit, the general principle has been adopted that a channel should always be selected for service if pilot is present at its output and not at the output of the other channel. If both pilots are present, change-over of the electronic switch occurs if the noise on the channel out of service is less by a few decibels than that on the channel in service.

The electro-mechanical by-pass is automatically brought into service by a pilot failure on one channel only or by a fault developing in the electronic switch. Once this has occurred the electronic switch remains locked out of service until it can be reset manually. In the event of simultaneous pilot failures on both channels, the electronic switch remains in service. The by-pass change-over relay is controlled by pilot failure or high noise level on either channel, and an interlock is provided to minimize interruptions due to unnecessary switching which may otherwise occur after a pilot failure on one channel followed by its re-application. In this event, the by-pass channel first selected by the pilot failure remains in service unless subsequently rejected by pilot failure or a high noise level. A simultaneous pilot failure will switch the by-pass on to the B channel. The automatic control of either the electronic switch or the by-pass can be overridden by remote manual control which, in turn, can be overridden by local manual control.

In the design of the baseband automatic circuitry, the principle of "fail to safety" has been maintained throughout. All relays whose function is to monitor are normally operated and in the case of channel switching, when the relays concerned are operated channel A is selected for service through the electronic switch. As all the common equipment is located in the A/X cabinet, the effect of a power failure in the A/X cabinet is to release all the relays thus switching the traffic to the B channel through the by-pass. In the return direction a power failure in the A/X baseband cabinet will cause the X channel pilot to fail and as a result the X channel will be rejected.

THE SUPERVISORY SYSTEM

Supervisory Signalling and Speaker Circuits.

The supervisory system incorporates standard coaxial cable (C.E.L.2) audio-frequency oscillators and selectors. The intention was to simplify maintenance by the use of a common type of equipment and to adhere to the principle of integrating the cable and radio supervisory where possible.

A separate a.f. tone is used for each supervisory indication and these tones are carried from Aultmore to Thrumster over a four-wire audio circuit. The circuit is carried over the cable portions on the interstice pairs (as already described) and over the radio link in the sub-baseband region below the main signal. Two similar four-wire end-to-end circuits are provided for engineering speakers and a fourth circuit—a spare—is provided over the radio section only. Over the radio link the four circuits are provided in the form of standard 300–3,400 c/s channels translated into the 32–48 kc/s sub-baseband. The translation equipment is non-standard in certain respects and is described later.

Two speakers are provided. An "express" speaker links Aultmore, Thrumster, Wick and Wideford Hill for control purposes, and a "local" speaker links Aultmore, Braewynner, Thrumster and Wick for local maintenance operations.

Remote Controls.

The remote control from Aultmore and Wick of channel change-over in the baseband equipment at Braewynner and Thrumster, respectively, is effected by d.c. circuits on interstice pairs of the coaxial cables. The remote control overrides the automatic control but is itself overridden by the local manual control at the radio stations. The use of d.c. for the control operations was chosen to ensure the maximum of reliability, and guard circuits are provided in the baseband equipment to minimize the possibility of false operation so that failure of the control circuit leaves the change-over equipment undisturbed.

Main Alarms and Indications.

Fig. 33 shows the main alarms and indications and the arrangement of the audio oscillators and selectors. An important requirement of a supervisory system is that it should "fail to safety," in other words, that faults in supervisory circuits should as far as possible give rise to abnormal indications at the control station and that they should not disturb the operation of the main equipment; for example, channel-serviceability indications are sent as positive (i.e., tone-on) signals so that the supervisory channel concerned is normally active and anything that renders it inactive will light the "Channel Output Failure" lamp concerned at the control station. The supervisory circuits are so designed that faults in them are very much more likely to produce a negative, or absence-of-signal condition than the reverse. Negative signals are, however, used for the Bypass-in-

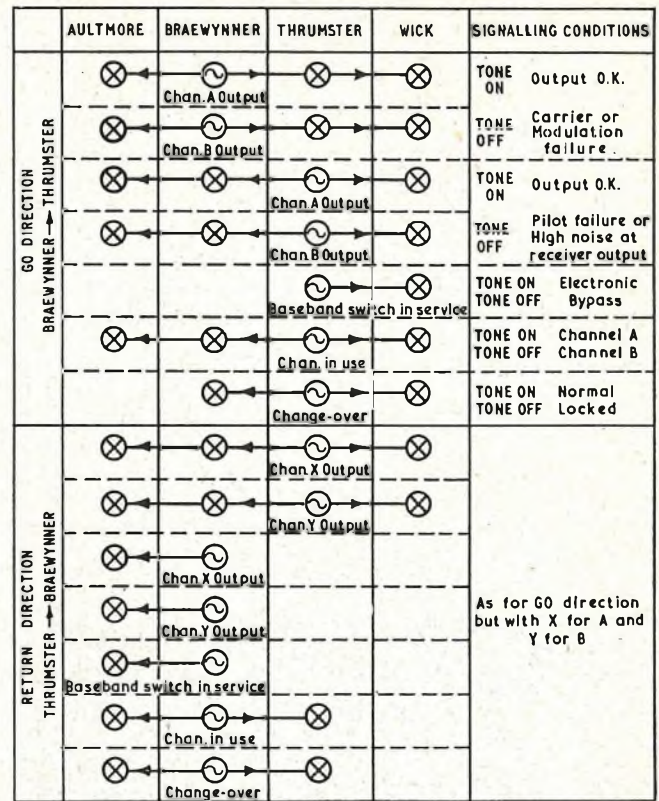

⊗ = AUDIO-FREQUENCY OSCILLATOR ⊗ = AUDIO-FREQUENCY SELECTOR GIVING A LAMP INDICATION

FIG. 33.—MAIN ALARMS AND INDICATIONS.

Service, Channel A (or X)-in-Use and Change-over-Locked indications, which rely on the absence of the appropriate tone signals. Since these indications are used to give an "answer-back" facility on the remote control of channel change-over they can readily be checked from the control station if any doubt exists as to their reliability.

The number of alarms and indications has been kept to a minimum by ensuring that where a number of possible fault conditions demand the same immediate action, e.g. a visit by the maintenance technician, only a single alarm indication is given. Clearly, to localize a fault the control station (Aultmore) must know which channels are in service and the state of each channel output from each station. Since Wick is interested only in Thrumster, Braewynner indications are not repeated at Wick except for the A- and B-Channel-Output indications which are required to differentiate between Braewynner transmitter and Thrumster receiver faults. The Switch-in-Service and Change-over indications at Aultmore and Wick are required as answer-back indications for the remote controls and to indicate local automatic operations at the radio stations.

The channel-output indication for a transmitter is controlled by the presence of carrier at the transmitter output and the presence of the 308-kc/s pilot at the output of a monitoring demodulator. The failure of either carrier or pilot causes the appropriate tone signal to be removed from the supervisory channel in order to give the alarm. The detection of carrier output is effected by diverting a small part of the microwave output from the transmitter into a crystal detector. The d.c. output from this detector is amplified by a magnetic amplifier and operates a normal 3,000-type relay. The circuit is adjusted so that an alarm is given if the carrier level drops by 6 db. Pilot is detected by a pilot monitor of the same type as that used in the baseband equipment.

For a receiver the channel-output indication is controlled by the presence of pilot and the noise level at the input to the baseband switch. Through the action of the baseband pilot and noise monitors the appropriate tone signal is removed from the supervisory channel in the event of pilot failure or high noise level.

The Switch-in-service, Channel-in-use and Change-over indications are derived directly from the baseband relay circuit which controls the application of the appropriate tones to the supervisory channel.

Miscellaneous-Faults Alarms.

Various alarm conditions indicative of potential deterioration of the main transmission path or of actual deterioration not amounting to unserviceability, are grouped in a miscellaneous-faults alarm which is transmitted by d.c. over an interstice pair to the local control station only.

Each fault condition giving rise to a miscellaneous-faults alarm is arranged to operate two relay contacts. When a fault occurs one of the contacts opens a common miscellaneous-faults relay circuit, causing the relay to release and give the remote alarm, the other contact controls a local indication in the radio station. Thus the miscellaneous-faults relay circuit contains a chain of contacts, one for each fault condition; and is referred to as the miscellaneous-faults chain. The monitoring circuits for the various fault conditions are described below and a simplified diagram of the miscellaneous-faults chain at Braewynner is shown in Fig. 34. This diagram does not show the corresponding relay contacts controlling the local lamp indications.

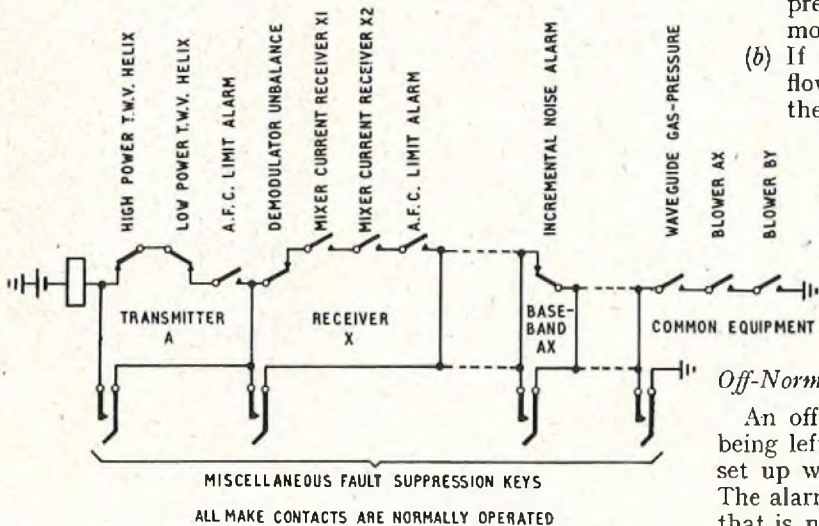

FIG. 34.—BRAEWYNNER MISCELLANEOUS-FAULTS CHAIN (SIMPLIFIED).

Transmitter.—The monitoring facilities on each transmitter are:—

- (a) Should the extent of detuning become such that the a.f.c. system reaches the limit of its range, a contact known as the "a.f.c. limit contact" is opened, and this causes an alarm to be given.
- (b) If the helix current of any of the travelling-wave valve amplifiers should exceed the permissible limit, a relay in the helix circuit operates and an alarm is given.

Receiver.—The monitoring facilities on each receiver are:—

- (a) An a.f.c. limit alarm identical with that in the transmitter.
- (b) To detect faults in the mixer or local oscillator the crystal current in the mixer of each receiver is monitored automatically. The d.c. current in the

mixer-crystal circuit is amplified by a magnetic amplifier and holds a relay operated. If the mixer current falls below 70% of its correct value the relay releases and gives an alarm.

- (c) To guard against frequency drift in a channel which (if allowed to continue) might result in distortion, the d.c. component of the discriminator output is monitored to detect any unbalance appearing at the demodulator. If the discriminator unbalance current exceeds the value corresponding to a frequency error of 1 Mc/s, an alarm is given. To operate the alarm the unbalance current must be amplified and a magnetic amplifier is used for this purpose. This amplifier is particularly sensitive, it has an input impedance of 500 ohms, and the difference between the operate and release currents is only 7 microamperes.

Baseband.—The only miscellaneous-faults alarms originating in the baseband equipment are given by the incremental-noise monitors which are designed to indicate an excessive noise level at the output of each channel. The incremental-noise monitor gives an alarm when the noise in the channel increases suddenly by more than about 6 db. This is to provide an indication when the operation of the space-diversity switch in the receiver i.f. equipment causes a rise in noise level thus implying the existence of a fault.

Common equipment.—Two miscellaneous-faults alarms are derived from the common equipment as follows:—

- (a) Should a fault in the waveguide pressurizing system cause the waveguide gas pressure to fall below a predetermined level, a contact in the pressure monitoring equipment operates the alarm.
- (b) If the blower cooling equipment develops a fault a flow-operated contact in the main air intake operates the alarm.

Miscellaneous-faults-suppression facility.

A locking key is provided for each major item (e.g. transmitter or receiver) of the radio and baseband equipment. When operated, the key short-circuits the loop of the miscellaneous-faults chain that passes through the particular item of equipment, thus suppressing any remote alarms arising from it.

Off-Normal Alarm.

An off-normal alarm is provided to prevent equipment being left, after a maintenance visit, with test conditions set up which are liable to affect its operation in service. The alarm—which is purely local—is controlled by a relay that is normally held operated by an "off-normal" chain of contacts, similar to the miscellaneous-faults chain, so that the opening of any contact releases the relay.

Since a common alarm is used for all off-normal conditions some means of alarm localization is desirable. The arrangement used for this purpose is similar to that for the miscellaneous-faults-suppression facility. A non-locking key, in practice the reverse throw of the fault-suppression key, is provided for each major item of equipment to short-circuit the loop of the off-normal chain that passes through the equipment in question.

Supervisory Displays.

Radio stations.—The local supervisory facilities are concentrated on a display panel, at the front of the supervisory equipment cabinet. The display is visible through a cut-out in the door of the cabinet and the station layout is such that the display is visible from most working points on the main equipment.

The local display includes separate indications for all

the conditions that go to make up the channel-serviceability signals and the miscellaneous-faults signal to the control station. A drop-indicator is associated with each of the alarm lamps to serve as a "memory" to assist in the location of intermittent faults.

A row of keys at the bottom of the panel serves the miscellaneous-faults-suppression facility (locking) and the locate-off-normal-alarm facility (non-locking). The panel carries a jack outlet for the local speaker which is multiplied to each cabinet of the main equipment.

The off-normal alarm is repeated by a lamp in a prominent position over the door of the equipment room, and lamps associated with each item of the main equipment indicate whether the particular item is "In Service" or "Locked out of Service." Work should be carried out on equipment only when it has been locked out of service by permission of the control station.

Control stations.—At each control station the radio link supervisory equipment is grouped with the coaxial equipment but has a separate display panel, which is connected to the station alarm via a spare position on the Coaxial Alarm Relay Panel which includes a self-locking relay circuit and thus provides a common "memory" for intermittent faults on the radio link.

The display panel carries two keys in addition to the lamp indications and the keys providing remote control of channel change-over. The first is a conventional fault key for silencing the station alarm and the second provides two facilities. On the upward throw it is used, when the control station is unstaffed and the station alarm is extended, to disconnect from the station alarm the miscellaneous-faults alarm, alarms due to automatic change-over to the by-pass switch and remote channel-failure alarms. On the downward throw the key provides a Test-Supervisory facility whereby the incoming supervisory signals are removed by short-circuiting the interstice pair carrying the tone signals and disconnecting the miscellaneous-faults pair.

Sub-Baseband Channel Equipment.

The channel and group-modulating equipment used to translate the four 4-wire audio circuits, provided for the speakers and supervisory signals, into the 32-48 kc/s sub-baseband is based on standard Post Office carrier equipment. Since the equipment was to be mains-operated 51-type carrier equipment was adopted.

Channel carrier frequencies of 76, 80, 84 and 88 kc/s were chosen so that after group modulation (carrier frequency 120 kc/s) the four channels occupy the band 32-48 kc/s. The major points in which the carrier equipment is non-standard are:—

Group filtering.—As the four channels in the band 32-48 kc/s are added to the baseband signals in the band 60-1,052 kc/s, the group filtering must be adequate to separate the two systems. On the transmit side it is essential to suppress at the modulator output the image frequency band of 72-88 kc/s, the group carrier at 120 kc/s and the second harmonic of the group carrier at 240 kc/s. On the receive side it is necessary to discriminate against these same frequencies at the input to the demodulator to prevent baseband signals interfering with the sub-baseband channels. A special filter is used on both the transmit and receive circuits. An equalizer is necessary with each filter and for convenience a non-Post Office-standard group modem is used.

Carrier generation.—Because only five carrier frequencies are required per station, they are generated by separate crystal oscillators instead of the standard carrier frequency generating equipment. Limits of ± 5 c/s for the maximum audio-to-audio frequency error are set by the selectivity characteristics of the audio selectors on the supervisory

channel and this performance is achieved without temperature-control of the oscillators.

Standard carrier frequency generating equipment is provided at Thrumster for the sub-baseband equipment of the Thrumster-Wideford Hill link and the carriers from this equipment are available for frequency comparison. The oscillators at Thrumster are adjusted directly against these frequencies and those at Braewynner by transmitting the frequencies over one radio channel released from traffic for this purpose.

Cabinet Layout.

Because the bulk of the equipment in the supervisory cabinet consists of existing standard units it was not possible to adopt a uniform type of panel construction. The standard units in the sub-baseband channel equipment are all of 51-type construction and units, such as the crystal oscillators, which had to be specially designed are made in the same style. This equipment is all mounted in the back of the cabinet.

The front of the cabinet carries all the rest of the supervisory equipment except the magnetic amplifiers which are plugged behind the main equipment, where they are readily accessible from the side of the cabinet. The C.E.L.2 audio oscillators and selectors form a large part of this equipment and are of standard front-of-panel construction with 6-in. covers. The rest of the units on the front are of this pattern, but the display panel is made deeper so that it appears flush with a cut-out in the front door of the cabinet.

A photograph of the supervisory cabinet is shown in Fig. 35.

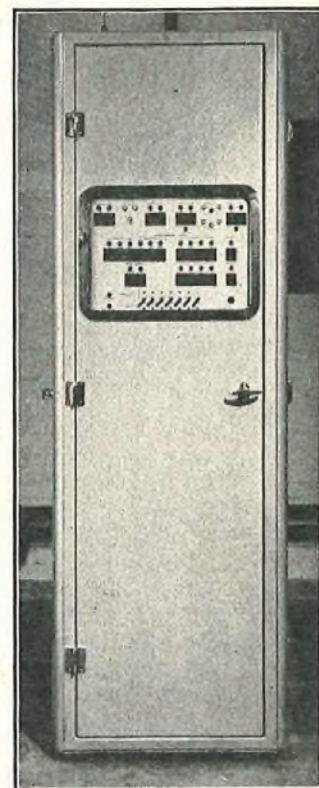

FIG. 35.—SUPERVISORY CABINET SHOWING DISPLAY PANEL.

THE OVERALL PERFORMANCE OF THE RADIO LINK

At the time of writing the complete system has not been operated long enough to determine such factors as the optimum sensitivity required for switching the electronic switch on noise differential and the sensitivity required in the incremental noise monitor for satisfactory detection of incorrect switching in the i.f. diversity selection paths. However, it is a simple matter of adjustment once the appropriate information is available. The Baseband equipment itself has been operating almost continuously since the initial line-up after installation in July, 1956, and has recently been checked with a view to obtaining the final performance figures, the more important of which are given below.

Throughout the installation and final testing the white-noise technique¹ has been used in assessing the performance of the link. The method is direct and simple to apply, and it is proposed to use the technique for subsequent maintenance. In practice, of course, it would be the channel

¹ WHITE, R. W. and WHYTE, J. S. Equipment for Measurement of Inter-Channel Crosstalk and Noise on Broadband Multi-Channel Telephone Systems. *P.O.E.E.J.*, Vol. 48, p. 127, Oct. 1955.

with the smaller noise background that would be selected for service at a given time. Fading causes the performance, particularly the signal/noise ratio, to vary continuously, but the measurements quoted may be regarded as typical. The times at which they were made were entirely arbitrary.

Noise Measurements.

Measurements of the basic noise level were made on each h.f. channel with the electronic switch in service. The results given in Table 3 are noise power ratios in decibels. A definition of noise power ratio is given in Part 1.²

TABLE 3
Basic Noise Power Ratio

Channel	Frequency kc/s		
	70	534	1,002
A	61	56	49
B	61	54	47
X	60	56	51
Y	60	56	51

Measurements of intermodulation noise were made with the h.f. channels loaded with white noise limited to the band 60–1,052 kc/s and having a total power of +12 db relative to channel test level. When all of the 240 a.f. channels capable of being handled by the link are equipped, it is to be expected that this loading will be exceeded for only 1% of the busy hour. The results given in Table 4 are the noise power ratios in decibels (including basic noise).

TABLE 4
Signal Noise Power Ratio

Channel	Frequency kc/s		
	70	534	1,002
A	58	52	46
B	54	47	44
X	57	53	47
Y	56	55	49

Baseband Electronic Switch Clicks.

The effect of change-over of the electronic switch from one channel to another is to produce a click in each 4-kc/s telephone channel. Such a click will be the aggregate of clicks arising from a number of causes which may be summarized as follows:—

- (a) *Switching current clicks.*—Disturbance due to the reversal of current controlling the switch, the effect being greatest at low baseband frequencies.
- (b) *Mutilation clicks.*—Disturbance at frequencies close to each signal component due to momentary fluctuations in level arising from imperfections in the change-over characteristics of the switch.
- (c) *Intermodulation clicks.*—Disturbance due to momentary rise in intermodulation noise as the switch passes through a condition of non-linearity.
- (d) *Level difference between channels.*—Disturbance at frequencies close to each signal component due to step-change of level.

- (e) *Phase difference between channels.*—Disturbance at frequencies close to each signal component due to step-change in phase.

The disturbances (d) and (e) are external to the switch itself, but are included because they affect its overall performance. In telephony, the most serious effect of all these causes of degradation of performance is the momentary burst of interference, or "click," audible in a quiet channel. In telegraphy, the effects must be interpreted in terms of telegraph distortion. The white-noise test equipment includes a frequency selective measuring device convenient for measuring the clicks and by varying the test conditions it is possible to differentiate between the different forms of click. The measurements have no absolute significance in themselves because the receiver was designed for the measurement of white noise, but their interpretation will be discussed. During the tests, the clicks were all measured with the electronic switch operating at 100 change-overs per sec. Only the worst cases are recorded.

- (i) *Switching current clicks.*—40 db at 70 kc/s.
- (ii) *Mutilation clicks.*—These could not be distinguished from those due to step level or phase changes, (d) and (e), when measured over the system as a whole.
- (iii) *Intermodulation clicks.*—42 db at 70 kc/s.
- (iv) *Level difference between channels.*—Clicks from this source may be ignored when measured overall because of the a.g.c. system.
- (v) *Phase difference between channels.*—27 db at 1,002 kc/s.

An investigation into the subjective annoyance value of the clicks indicates that it is roughly equivalent to a noise power ratio 5 db lower than the readings quoted above. A test made with clicks corresponding to a noise power ratio of 40 db showed that whilst the clicks were perceptible no observer described them as seriously annoying, even with the switch operating at 100 change-overs per sec. The worst figure of 27 db under (e) would probably be annoying with this high rate of switching, but this is most unlikely in practice. With switching rates of one a minute or less the clicks would probably go unnoticed. Telegraph distortion from this cause should be less than 3 per cent.

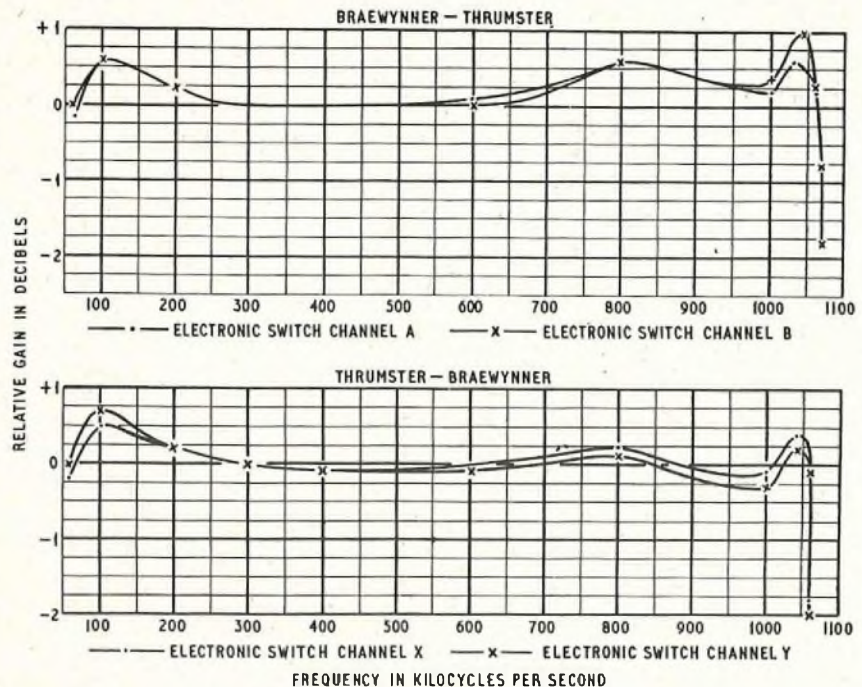

FIG. 36.—GAIN/FREQUENCY CHARACTERISTICS.

² P.O.E.E.J., Vol. 50, p. 106, July, 1957.

Gain/Frequency Characteristics.

The frequency characteristics of both h.f. channels in the two directions of transmission are shown in Fig. 36. The ripple in the characteristics between 1,000 and 1,060 kc/s is due to the low-pass filters at the input of each channel.

Gain Stability.

Because f.m. transmission is employed over the radio section of the link it is expected that the overall gain stability should be good, especially as a.g.c. is provided at the receiving end to maintain the output level. However, a rough check of overall short-term gain stability was made by recording the level of the pilot signals at both ends of the link at intervals over a period of about 18 hours. The variation in level was less than 0.2 db on each channel, but

it should be noted that the accuracy of measurement was of a similar order. The re-adjustment required to the a.g.c. unit after six months unattended operation was less than 0.3 db.

ACKNOWLEDGMENTS

The authors' thanks are due to their many colleagues in the Radio Experimental and Development Branch, E.-in-C.'s Office, who were concerned in the design, construction and installation of the equipment. The co-operation of the Transmission and Main Lines Branch in the design stages, of the Radio Provision and Planning Branch for mast construction, and of the Directorate of the Post Office in Scotland during the installation and testing, is also acknowledged.

Book Reviews

"Electronic Measurements and Measuring Instruments." F. G. Spreadbury. Constable & Co. ix + 459 pp. 248 ill. 50s.

The exhibitions of scientific instruments held annually by the Physical Society have shown, very strikingly, the advance—some might call it infiltration—of electronics into most fields of measuring instruments. Whereas, before 1939, only the telecommunications and radio industries made widespread use of electronic instruments, we see to-day that the aircraft industry, the meteorological services, the medical world and the makers of business machines and atomic piles are all using more and more electronics in their measuring equipment. The physical or chemical quantities they wish to measure may not be electrical, but with the aid of suitable piezo-electric, photo-electric or magnetostrictive transducers, humidity-sensitive resistors, movement-sensitive capacitors and many other converters, electrical quantities are obtained which can be conveniently and accurately measured by an electronic instrument.

Most new instruments receive an adequate description in makers' pamphlets, catalogues or service manuals, or in the technical press. Textbooks on the subject are not plentiful, however, and room exists for a book which sets down clearly the basis for design, the flexibility and the limitations of instruments, and the techniques for using them to their best advantage.

Mr. Spreadbury, an author of some experience, has attempted to rationalize the instruments, rightly pointing out that not only do the many instruments now available have elementary components (valves, resistors, capacitors, etc.) in common, but they have several main parts (e.g. valve voltmeters and oscillograph displays) in common also. Accordingly, he begins by describing the components, stressing their range, accuracy and limitations. Subsequent chapters describe the basic features of valve voltmeters and, more briefly, electronic ammeters and wattmeters. A chapter on the measurement of frequency and time ignores the more sophisticated instruments. Some of the basic circuit configurations of oscillators, e.g. Colpitts, Pierce, Wien Bridge and heterodyne, are adequately described, but no important commercial instruments are studied. Amplifiers are described qualitatively and some attention is paid to multivibrators. Stroboscopes receive attention. The author gives a good account of the electron optics of cathode-ray tubes before describing oscillographs. Modern instruments are not treated, however, no mention being made of distributed amplifiers, the high-speed recurrent waveform monitor and means for accurate calibration. Photocells are briefly described. After a chapter on applications to bridges, an important field of use, there is an unavoidable chapter on miscellaneous instruments, e.g. moisture meters, ohmmeters and vibration testers. The importance of the power supplies in instruments is rightly stressed and typical units described. A final brief chapter describes some of the current practice in constructing instruments.

The book suffers from several faults. The author persists in describing units of his own design rather than those in widespread use; he may have passed on some of the lessons he learnt during his design work, but, by ignoring commercial units designed to meet much more stringent requirements, many difficulties and achievements are missed. The bibliography is unrepresentative. The writing is sometimes careless and the usefulness of the book is also marred by diagrams with no captions and with some symbols that cannot be read (e.g. Figs. 4.25 and 12.31). Some plates convey little information. The faults offset much of the merit of the book.

J. R. T.

"Telecommunications (Principles) I and II in M.K.S. Units."

W. Clark Riddiford. 143 pages, illustrated with line drawings. 10s. 6d. Published by the author and Rotaprinted from direct impression plates prepared by the author.

The author of this small privately published volume is quite honest in his intentions. He has produced a "cramming" book to sell cheaply to students taking City & Guilds Telecommunications (Principles) Grades I and II. The book opens with the syllabus for each of the two examinations. Then follows a praiseworthy page on examination techniques and another which might well be titled "how to avoid careless arithmetical mistakes." Some of this advice, is, perhaps, of doubtful value, and some of it assumes that the use of a formula is the right way to answer a T(P) I or II question. But the book is a cram book, and therefore the advice is in the correct context, whether one considers the technique sound teaching or not. Most people agree it is not.

Much of the book is devoted to the solution of numerical problems, on the basis, says the author, that the best way to pass T(P) I and II is to do the "problematical" questions. His treatment of descriptive theory is terse and incomplete. Theoretical niceties are ignored and hard facts suitable for examination papers are given instead. There is very little descriptive matter, except on such points as stock examination questions, such as the structure of matter, conduction of electricity and magnetic fields around permanent magnets. The chapter on thermionic diodes and triodes is a good one and contains much potted information.

As one dips further into this book, one must admit that the author has a clear purpose in writing it and that he serves it well. Moreover, if every student taking T(P) I or II knew its contents, he should certainly pass the examinations easily. On the other hand, the rise in a man's real worth to himself or his employer would not have increased to the extent that the possession of the pass tickets would suggest if this book were his main source of knowledge.

The author deserves credit for the immense labour he must have expended in preparing all the plates for rotaprinting.

C. F. F.

The New A.C. Power System at Rugby Radio Station

M. H. JAMES, D.F.H., A.M.I.E.E.,
and E. A. INGRAM, A.M.I.E.E.†

U.D.C. 621.311.68:621.396.78

This article describes the rearrangement and expansion of the mains and standby alternating current supplies at Rugby Radio Station to cater for the new high-frequency transmitting station (Rugby "B" on an adjacent site.

INTRODUCTION

WHEN it was decided to extend Rugby Radio Station by erecting a large new short-wave station (Rugby "B")¹ on a new site separated from the existing station by Watling Street, the question of how to provide mains and standby power supplies to the new building had to be considered. As the East Midlands Electricity Board had no distribution system of capacity adequate to supply the station within a reasonable distance of the new site, they agreed to regard the new station, for the purposes of electricity supply, as being an extension to the curtilage of the existing premises and to supply it from their intake point already established at the Short-Wave "A" station. The Post Office already had its own high-voltage (12-kV) distribution system connecting this supply intake to the Long-Wave (Main) station, and it was decided to supply the B station by extending this system across Watling Street to the new site.

As the existing high-voltage network was installed when Rugby Radio Station was first built, in 1926, at a time when the prospective fault currents of public electricity systems were still relatively small and it had not become general practice for switchgear to be type-tested and certified for rupturing capacity, anxiety had been felt for some time about the risk of switchgear failure in the event of a major fault occurring. It was therefore decided to take the opportunity, offered by the need to re-arrange the high-voltage distribution network to provide the supply to the B station, to replace all the existing high-voltage switchgear and certain medium-voltage switchboards whose breaking capacity was in doubt, by modern equipment having adequate certified rupturing capacity.

It is standard practice in Post Office radio stations to guard against failures of the public electricity supply by the provision of engine-driven standby generating plant, and it was therefore necessary to decide what type of standby plant should be provided for the B station and where it should be located. The original intention was to build an engine house on the new site and various types and arrangements of plant were considered, including a proposal to use a gas turbine. Eventually it was decided, for economic reasons, to install the new standby plant, comprising two diesel-alternators, alongside the existing engine in the power house in the Main building. This economy in building was made possible by modern developments in two quite different fields of engineering. It had been decided to replace by rectifiers the high-voltage motor-generators that formerly provided the anode supplies for the long-wave transmitters, and in the space thus made available it was found possible to accommodate

generating plant of the required capacity by adopting high-speed turbo-supercharged engines.

INCOMING MAINS SUPPLY

Two supplies at 12 kV, one of which consists of two feeders in parallel, are taken from two separate points of the East Midlands Electricity Board's network, and each supply is terminated on a separate switchboard. Two annexes were built on to the A building to accommodate these switchboards. The annexes are situated at opposite ends of the building, so as to achieve maximum separation between the two switchboards, thus eliminating the risk of a catastrophic failure in one of them affecting both supplies or both inter-building feeders. These switchboards control the distribution to the whole station, and the Electricity Board co-operated in the layout and design by specially ordering their new equipment to line up with and form an integral part of the new Post Office switchboards. The distribution section of each switchboard is coupled to the Electricity Board's section by a busbar circuit-breaker which can be remotely controlled from the Main building. The two switchboards are interconnected by cable, so that the distribution system can be fed from either incoming supply.

HIGH-VOLTAGE DISTRIBUTION

The high-voltage distribution system is shown schematically in Fig. 1. Each of the switchboards in the annexes to the A building supplies two of the four 450-kVA transformers that provide medium-voltage supplies to the A building, and each is also connected to one of two inter-building feeders that supply the remainder of the station. The two

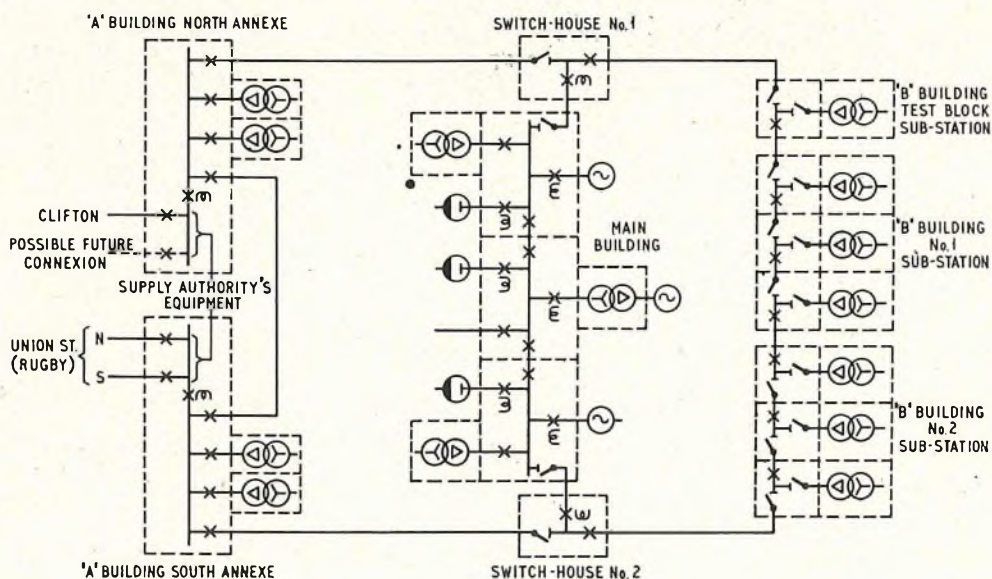

FIG. 1.—SCHEMATIC CIRCUIT ARRANGEMENT OF HIGH-VOLTAGE DISTRIBUTION.

† The authors are, respectively, Assistant Staff Engineer and Executive Engineer, Power Branch, E.-in-C.'s Office.

¹ COOK, A., and HALL, L. L. The Rugby "B" High-Frequency Transmitting Station. *P.O.E.E.J.*, Vol. 50, p. 15, April 1957.

inter-building feeders are led into widely separated detached switch houses located near the Main building, each of which contains a three-panel switchboard from which supplies to the Main building and B building are taken.

The two feeders, one from each switch house, to the Main building terminate on a 21-panel switchboard that is divided into three sections. Owing to lack of space, it was not possible to accommodate each section of this switchboard in a separate masonry cubicle, but the room housing it has been divided into three fireproof cubicles by means of partitions and a ceiling made of "Durasteel."* From this switchboard are supplied the three high-voltage rectifiers that provide the anode supplies for the long-wave transmitters, and the two original 450-kVA transformers, which provide medium-voltage supplies for the Main building. Also connected to this switchboard (one to each section) are the three engine-driven standby alternators.

The supply to the B building is in the form of a ring-main, the ends of which terminate in the two switch houses. Connected in this ring-main are seven ring-main units (Fig. 2), each comprising two isolators and a circuit-breaker

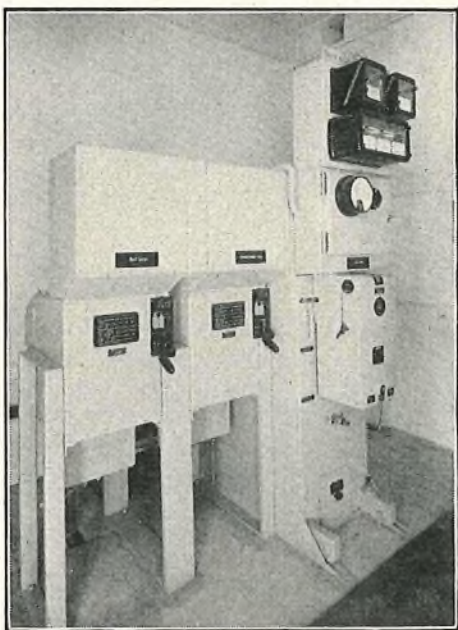

FIG. 2.—RING-MAIN UNIT IN B BUILDING.

and each supplying a 500-kVA transformer. One ring-main unit and its associated transformer are installed in and serve the Test block and part of the Administrative block. The remaining six, together with their transformers, are housed in two sub-stations detached from the B building and supply power for the transmitters and their associated apparatus and also for the accommodation services in the remainder of the building. The ring-main units and transformers are each installed in a separate brick-built fireproof cubicle and the transformers stand on channel-steel runners over pebble-filled pits, which are intended to contain and cool the oil in the event of a burst tank.

High-Voltage Switchgear and Transformers.

The high-voltage switchboards, manufactured by South Wales Switchgear, Ltd., are of the air-insulated metal-clad type, and the oil circuit-breakers are of the vertical-isolation horizontal-draw-out pattern, having a certified rupturing capacity of 150 MVA. The circuit-breakers, other than those arranged for remote operation, are fitted with spring closing mechanisms to ensure rapid closing

* "Durasteel" is a proprietary form of fire-resisting sheeting, consisting basically of asbestos sandwiched between two sheets of steel.

unaffected by any hesitation on the part of the operator. Remotely-controlled breakers are fitted with closing solenoids operated via contactors and metal rectifiers from the secondaries of potential transformers. The isolators are oil-immersed and are capable of breaking full-load current.

The new power transformers, also made by South Wales Switchgear, Ltd., are delta-star connected and have off-load tap-changing gear to compensate for variations in the supply voltage from its nominal value. The transformers are oil-immersed with natural air cooling and are fitted with conservators.

Protection of High-Voltage Network.

Due to limitations imposed by the Electricity Board's own protective scheme and the necessity to achieve discrimination both with their equipment and within the Post Office network, it was decided to adopt the "Translay"‡ system of balanced-current protection for the inter-building feeders and the ring-main. This system is commonly used by supply authorities for the protection of their networks, but this is the first occasion on which it has been applied by the Post Office. The principle of operation is based on the fact that in a healthy feeder the current entering the feeder must equal that leaving it. If a fault occurs on the feeder this balance is disturbed and the protective equipment is designed to detect this condition and disconnect the feeder at each end. Fig. 3

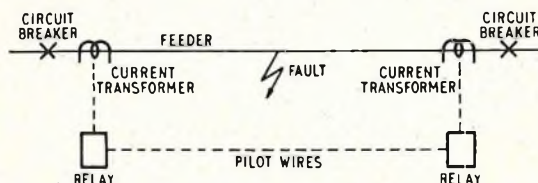

FIG. 3.—PRINCIPLE OF "TRANSLAY" SYSTEM OF PROTECTION AS APPLIED TO A HYPOTHETICAL SINGLE-WIRE FEEDER WITH EARTH RETURN.

shows the principle as applied to a hypothetical single-wire feeder with earth return. The measurement of current at each end of the feeder is by current transformers, the secondaries of which supply the relay equipment. Comparison of the currents is made over a two-core pilot cable; a voltage of magnitude depending on the magnitude of the feeder current being produced by transformer action in each relay and impressed on the pilot wires. If the currents entering and leaving the feeder are equal, these voltages oppose each other and little or no current flows in the pilot wires. If a fault occurs, these voltages do not balance and a resultant current flows in the pilot wires to operate the relays at each end. The relays trip the circuit-breakers at each end of the feeder. Although the action of the Translay is virtually instantaneous, discrimination is achieved since the relays in adjacent healthy sections do not operate, because the balance is maintained even though heavy fault currents are flowing. The relays are of the induction type in which the operating torque is produced by interaction of the pilot-wire current and the current-transformer secondary current.

In the application of this principle at Rugby Radio Station, the high-voltage system is divided into sections having a circuit-breaker at each end and a teed connexion adjacent to one end. On the ring-main serving the B building, each teed connexion feeds a transformer via an isolator as shown in Fig. 4. On the inter-building feeders between the A and Main buildings, this connexion supplies the Main building via a circuit-breaker. To apply the balance principle with this arrangement, it is necessary to

‡ "Translay"—trade name for the system as devised by Metropolitan-Vickers Electrical Co., Ltd.

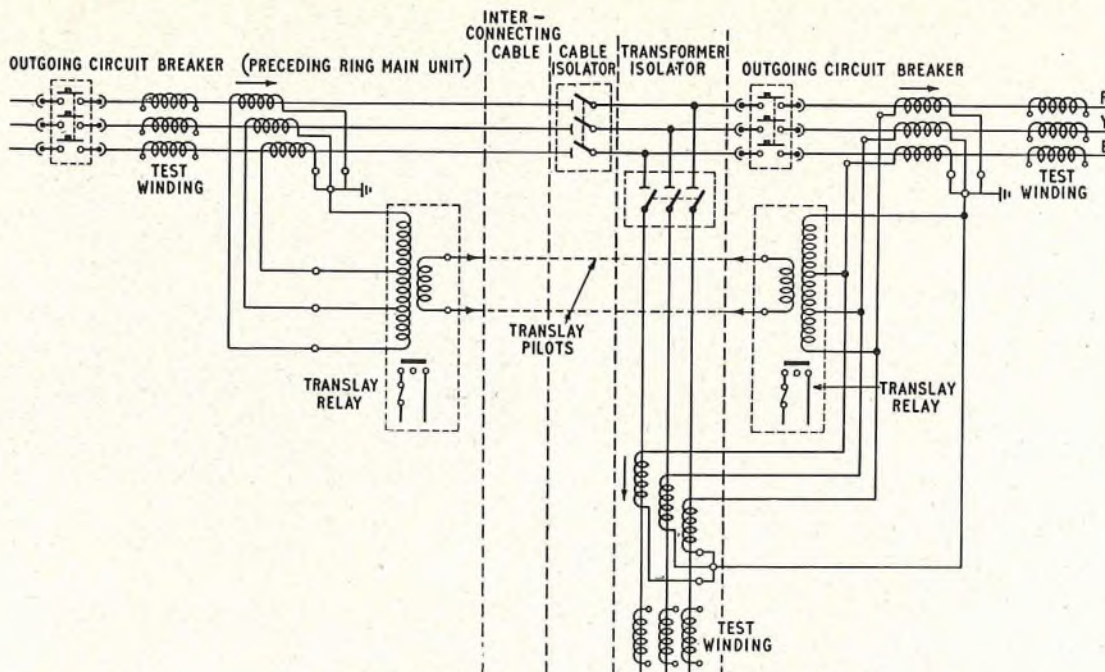

FIG. 4.—"Translay" AS APPLIED TO A TEED CIRCUIT.

summate the currents in the feeder-connected circuit-breaker of the ring-main unit and in the teed connexion and to feed the resultant into the associated Translay relay. This is achieved by connecting the current transformers as shown in Fig. 4. In a healthy section the sum of these currents should equal that entering the section at the far end. As previously described, no current will normally flow in the pilot wires and the relays will not operate; on the occurrence of a fault, pilot current will flow and the relays will operate. The relay at the remote end trips the circuit-breaker at that end, the relay associated with the ring-main unit trips the feeder circuit-breaker and, where the teed connexion supplies a transformer, the circuit-breaker on the medium-voltage side of the transformer. The latter function prevents feed-back into the fault from other transformers, which may be connected in parallel on the medium-voltage side. The faulty section is thus isolated.

The zone covered by the Translay has physical limitations determined by the positions of the current transformers. This means that the power transformer and its high-voltage and medium-voltage cable connexions are outside the protection afforded by the Translay. To cover this equipment, overcurrent and earth-leakage protection, using inverse definite minimum time lag (i.d.m.t.l.) relays, is provided, operated from a separate set of current transformers. This protection is also arranged to trip all three circuit-breakers, the remote circuit-breaker being tripped over inter-tripping pilot wires provided for the purpose. In the teed feeders supplying the Main building, the overcurrent and earth-leakage protection provided is directional and responsive only to current flowing towards the Main building. Inter-tripping of the remote breaker (at the A building) is not carried out in this case, as it is not desired to interrupt the supply to the B building on the occurrence of a fault at the Main building. The inter-building feeder circuit-breakers at the A building are also provided with directional overcurrent and earth-leakage protection, but in this case it is responsive only to current flowing from the feeder into the busbars. This condition arises when the A building is being supplied from the standby alternators in the Main building. By adopting this arrangement, the number of protective devices between which discrimination is required has been reduced to a

minimum. Protection of the transformer feeders at the A building and the outgoing circuits from the high-voltage switchboard at the Main building is by overcurrent and earth-leakage relays, also of the i.d.m.t.l. type.

High-Voltage Switchgear Control Panel.

A central control panel is provided in the Main building to facilitate switching operations and in particular the synchronizing of the diesel-alternator sets with one another and/or with the public supply. The control panel (Fig. 5)

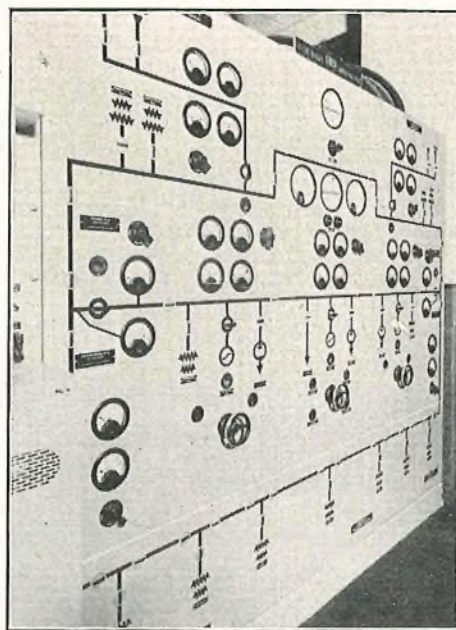

FIG. 5.—HIGH-VOLTAGE SWITCHGEAR CONTROL PANEL IN THE MAIN BUILDING.

also carries instruments to indicate the voltage, current, frequency and power of each alternator and each incoming mains supply to the A building, the voltage, current and power delivered by the ring-main feeders to the B building and the voltage and current into the Main building. The

power factor of the whole station when operating from the mains is also indicated on the control panel. It is possible for the high-voltage system to be split into two isolated sections, each fed from a separate incoming mains supply. Under these conditions, summation of the currents taken from each supply is carried out in the control panel, and fed to the power-factor indicator. Provision is made for the voltage coil to be connected to either incoming supply.

The control panel incorporates a mimic diagram of the high-voltage system. Hand-operated semaphores are provided to represent the hand-operated switches and circuit-breakers, and automatic semaphores for the high-voltage-rectifier circuit-breakers, which are remotely controlled from the transmitter rooms. The alternator circuit-breakers, the busbar circuit-breakers at the A building and the circuit-breakers in the Main building feeders in the switch houses are each controlled by a combined control switch and hand-operated semaphore indicator forming part of the mimic diagram. This device incorporates a lamp, which is illuminated when the semaphore is set in a position differing from that of the circuit-breaker. Closing or tripping of the breaker is effected by depressing the semaphore after first setting it to represent the required condition of the breaker. When the breaker operates, the lamp is extinguished. Synchronizing sockets are located adjacent to each of these control switches. By the use of plugs, one marked "running" and the other marked "incoming," the two circuits to be synchronized are connected to the synchroscope and its associated voltmeters. To guard against the incorrect insertion of the plugs, the circuit is so arranged that if the running plug is inserted in the socket associated with the incoming supply, the synchronizing equipment is not operated and the circuit-breaker cannot be closed. In addition, the circuit-breaker can only be closed if the incoming plug is inserted in the socket adjacent to the corresponding control switch. Also mounted on the control panel are the manual field regulators for the alternators and push-buttons for the control of the engine governor speeder motors.

STANDBY GENERATING PLANT

When design work on the new standby plant installation began, there already existed in the power house at the Main station a direct-coupled 1,150-kW generating set, having a six-cylinder blast-injection diesel engine manufactured by Fraser & Chalmers, Ltd., and designed for running at 300 rev/min. As the output of this set was insufficient to supply the estimated future combined maximum demand of the Long-Wave and Short-Wave A stations, it was decided that the new plant should be large enough to make up this deficiency as well as to supply the maximum demand

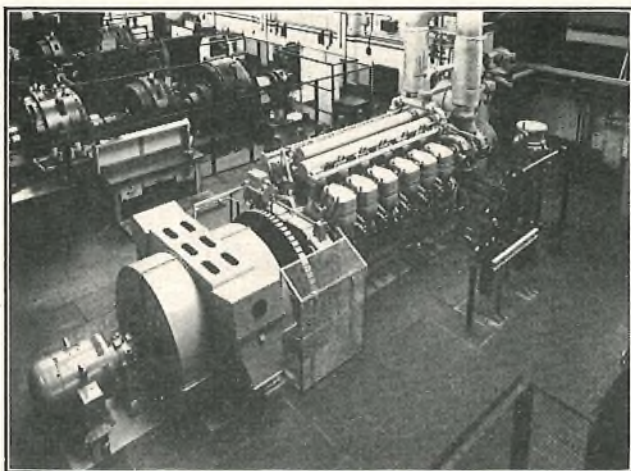

FIG. 6.—ONE OF THE TWO NEW STANDBY GENERATING SETS.

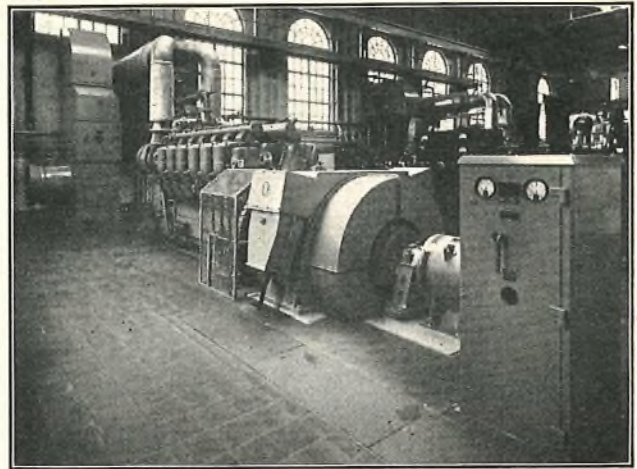

FIG. 7.—ANOTHER VIEW OF ONE OF THE NEW ENGINE-ALTERNATORS SHOWING, ON THE RIGHT, THE FIELD SUPPRESSION CUBICLE AND IN THE LEFT BACKGROUND THE EVAPORATIVE COOLER.

of the B station. This involved the new plant having a total output of 1,646 kW (peak rating 2,260 kW) and in order to accommodate it in the space available, two turbo-supercharged engine-alternator sets (Fig. 6 and 7) were provided. The standby plant therefore has a combined capacity of 2,796 kW and is the largest prime mover installation in use by the Post Office.

The new engines are English Electric type 12 SV, and each has a 12-hour rating of 1,350 b.h.p. and a 30-sec rating of 1,630 b.h.p., both at 750 rev/min. The short-time rating and the special heavy flywheels fitted were required to deal with the peak loads imposed when the GBR transmitter is being keyed. The engines have 12 cylinders of 10-in. bore and 12-in. stroke, arranged in two banks at an included angle of 45°. Each cylinder bank is fitted with a Napier supercharger driven by an exhaust-gas turbine. The engines have direct airless injection, the combustion chambers being of the open type, formed in the piston crowns, and each cylinder head carries two inlet and two exhaust valves. Engine starting is under manual control and, as is usual for engines of this size, is effected by admitting compressed air into the cylinders. Two compressed air receivers are provided, in each of which sufficient air for six normal starts is stored at 300 lb/in². Either air receiver can be used to start either engine and the receivers are normally charged from a motor-driven compressor. A connexion is also provided from the starting air system of the Fraser & Chalmers engine, which includes a compressor driven by a small hand-started oil engine. Thus, the engines can be started even if by some mischance all the air receivers were to be discharged when a mains failure occurred.

The Fraser & Chalmers engine is cooled by means of a spray pond, but as this had no spare capacity, it was decided to provide each of the new sets with a Heenan & Froude mechanical cooler of the evaporative type. Cross-connecting pipework and valves are fitted to enable either cooler to serve either engine. The cooling systems of the new engines are also connected to the spray pond to enable this to be used in emergency if the larger engine is not in use. The two mixing tanks, in which cool water returning from the coolers is mixed with the heated water from the engine jackets, and the primary purpose of which is to ensure that the jackets are kept full of water at all times, are situated on the roof of the power house and are lagged to protect them from frost. Since the coolers are installed in the heated engine room, the whole of the cooling system is safe from freezing when the engines are not in use.

The engines are fitted with governors of the hydraulic servo type, the oil pressure for which is obtained from the engine lubrication system. Thus, inherent protection exists against failure of lubrication, since loss of oil pressure to the governor will automatically shut down the engine. For synchronizing purposes, the governors are fitted with motor-operated speeder gear, the three-phase motors of which are controlled by reversing contactors operated by push-buttons on the high-voltage switchgear control panel. A pair of master push-buttons enables the speed of all three engines to be raised or lowered in unison for synchronizing with the public supply. In addition to the protection against failure of lubrication, provided by the servo governor, the usual visible and audible alarms for low oil pressure and high oil and water temperature are fitted. Flow indicators are fitted in the cooling water systems, and there is a fuel flow meter for each engine. Mechanically operated trips are arranged to shut the engines down in the event of dangerous overspeeding. To minimize the transmission of vibration to the building structure, each engine-alternator set is mounted on an isolated concrete foundation block, each block being 20 ft 6 in. × 9 ft 6 in. × 6 ft deep and weighing some 78 tons.

Alternators.

The original standby alternator is a G.E.C. machine rated at 1,440 kVA and designed to generate at 3,300V. This alternator is solidly connected, without intervening switchgear, to a delta/star connected transformer which steps up the voltage to 12 kV, the busbar voltage. The two new alternators are English Electric salient pole, screen-protected, single-pedestal-bearing machines with overhung exciters and are direct-coupled to the engine flywheels. Each alternator has a continuous rating of 915 kVA at 0.9 power factor and a peak rating of 1,250 kVA for one minute. The alternator output voltage is 12 kV, but the machines are designed to be capable of also giving their rated output at 11 kV so that no alterations to the plant will be needed if at some future time the station supply is converted to the standard voltage.

When the plant is in use, the exciter fields are separately excited from the medium-voltage distribution in the station and are controlled by electronic voltage regulators, designed to maintain the alternator voltage constant within ± 0.5 per cent. To enable the plant to be brought into use after a mains failure, change-over switches are provided to enable the exciters to be connected as self-exciting shunt generators, until the medium-voltage supply is restored from the standby alternators. Under these conditions, voltage control is by manual field regulators on the high-voltage switchgear control panel. The neutral point of each of the new alternators is earthed via a switch and a common earthing resistor, the value of which is sufficient to limit the maximum earth fault current to approximately the full-load current of the machine. The star point of the secondary of the transformer associated with the original alternator is earthed in a similar manner, a separate earthing resistor of appropriate value and current rating being provided for this purpose. In addition, the neutral point of the alternator winding is connected to earth.

Alternator Protection.

Protection against earth or phase to phase faults in the stator windings of the alternators and in the cabling to the circuit-breakers and earthing switches is provided by a circulating current system. In the case of the 1,440-kVA alternator, this system also includes the transformer. Protection against faults outside the zone covered by the circulating current system is provided by overcurrent and earth-leakage relays which also act as "back up" protection

to the circulating current system when the machines are running in parallel. Reverse-power protection is also provided for use when running in parallel. This will disconnect an alternator from the system should its prime mover fail and thus prevent "motoring." The basic principle of the circulating current system is similar to that of Translay. In this system, however, the actual secondary currents of the current transformers, instead of voltages derived from them, are balanced against each other. Under normal conditions a current is continuously circulating through the wires connecting the secondaries of the current transformers. The operating coils of the relay are connected in shunt across the secondaries of the current transformers and normally carry no current except that arising out of slight differences in the current transformer characteristics. On the occurrence of a fault within the protected zone, the secondary currents become unbalanced and the difference current flows in the relay coils to cause operation. Operation of the relay trips the alternator circuit-breaker and automatically disconnects the alternator field from the exciter and connects across it a discharge resistance. Generation thus ceases or is reduced to a negligible value. This suppression of the field prevents the alternator feeding into its own fault and causing further damage.

Alternator Voltage Regulators.

The automatic voltage regulators for the alternators are of the electronic type. This type of regulator is extremely quick acting and was chosen for this installation because of the large and rapid fluctuations of load arising during the operation of the high-power long-wave transmitters. Each regulator is supplied at 415/240V three-phase from the medium-voltage system in the building. This is rectified by grid-controlled rectifiers and fed to the exciter field. Control of the field current is achieved by grid control in the following way. In the voltage regulators for the two new 915-kVA sets, the voltage output from the alternator is compared with a reference voltage obtained from a constant-voltage transformer connected in the medium-voltage supply to the rectifier; the difference voltage is amplified and applied to the grids of the rectifiers in such a way that any increase in alternator voltage is countered by a reduction in the output of the rectifier, and vice-versa. In the case of the 1,440-kVA alternator, the output voltage is fed to a bridge network, two arms of which have linear resistance, and the others non-linear resistance. At normal voltage, the currents circulating in the arms of the bridge maintain balance. A variation in voltage will cause a variation in these currents, which will produce different effects on the linear and non-linear arms of the bridge and cause an unbalance. The output of the bridge is fed through an amplifier to the grids of the rectifiers. The automatic voltage regulator circuits are designed so that in the event of the regulator failing, a change-over to manual regulation is effected automatically.

MEDIUM-VOLTAGE SWITCHGEAR

In addition to the medium-voltage distribution system provided for the new B station, a new main medium-voltage switchboard has been installed in the Main building (Fig. 8) to replace the original one, the rupturing capacity of which was suspect. The new switchboards are all of the air-insulated type and, in accordance with current Post Office practice, fused switches fitted with high-rupturing-capacity fuse links are used wherever practicable, instead of circuit-breakers. Where circuit-breakers are used, they are of the air-break type, and overcurrent protection only is provided. Those switchboards installed in situations where appearance is of importance, for example, in the transmitter halls of the B station, are of the flush-fronted

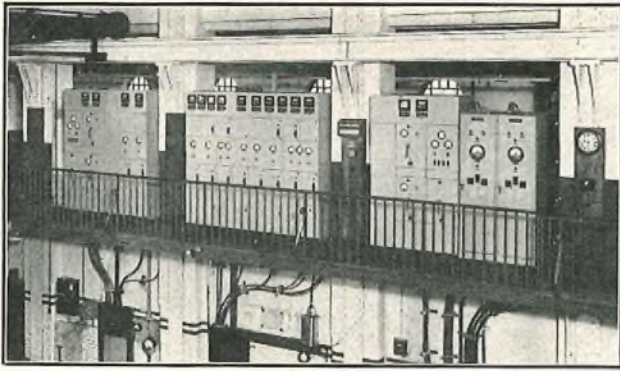

FIG. 8.—THE NEW MEDIUM-VOLTAGE SWITCHBOARD IN THE MAIN BUILDING. ON THE RIGHT ARE THE ELECTRONIC VOLTAGE REGULATORS FOR THE TWO 915 kVA ALTERNATORS.

cubicle type; elsewhere industrial-type switchgear has been used.

Medium-Voltage Supplies to Radio Equipment in the B Building.

The supplies to the transmitters and the rack-mounted transmitter-drive apparatus are taken from two switchboards (Fig. 9) installed at the junction of the three transmitter halls. Each of these switchboards is fed from

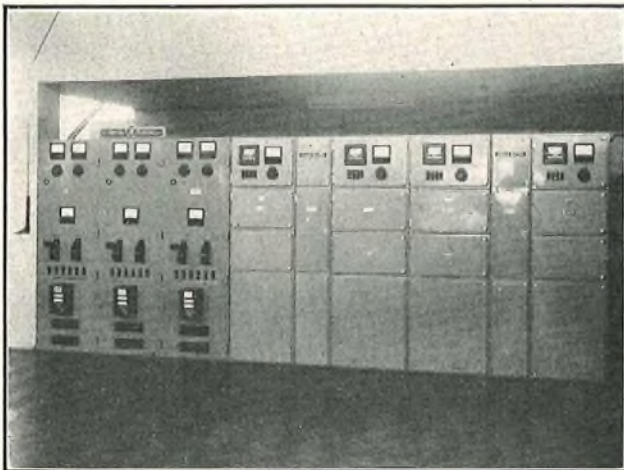

FIG. 9.—ONE OF THE MEDIUM-VOLTAGE SWITCHBOARDS THAT SUPPLY THE TRANSMITTERS IN THE B STATION.

one of the two sub-stations outside the building. The transmitters are arranged in four rows of five and two rows of four. Each row is supplied by one $3\frac{1}{2}$ -core 0.5 in² P.I.L.C. cable and the supply to each transmitter is taken from this feeder via a tee-off unit, consisting of a combined joint and fuse box, and a switch. A subsidiary supply for small miscellaneous loads is taken from the feeder side of the switch. Three of these transmitter feeders are supplied from each switchboard via fused switches.

The voltage regulated supply for the rack-mounted transmitter drive apparatus is obtained from two sets of single-phase regulators, each set being supplied from one of the main switchboards. The outputs of the pairs of regulators connected to the same phases are taken through automatic change-over equipment to the load. Should the output from the working regulator fail, due to failure of the regulator itself or to failure of the supply to it, the load is automatically transferred to the idle regulator. All regulators are normally live and their output voltages are regulated to within ± 0.5 per cent of 240V, irrespective

of whether they are on load or not. Idle regulators are therefore in a position to accept load immediately, and wide changes of voltages on the apparatus are thereby avoided. The outputs of the regulators are continuously monitored, and change-over is prevented if both outputs fail low or high. In the former case, the working regulator continues to take the load, in the latter the load is disconnected. Fig. 10 illustrates this equipment.

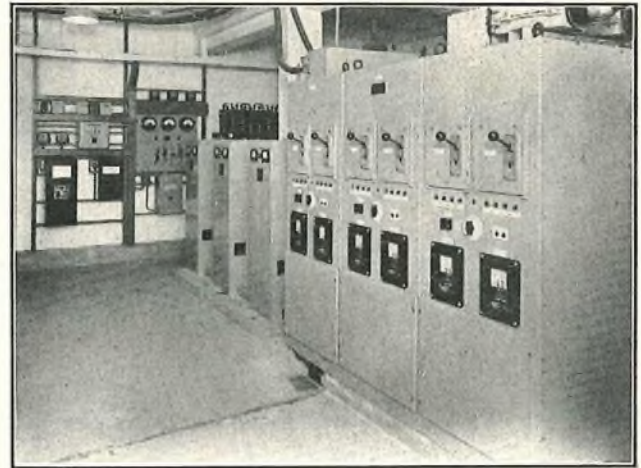

FIG. 10.—AUTOMATIC VOLTAGE REGULATORS AND AUTOMATIC CHANGE-OVER EQUIPMENT FOR SUPPLIES TO THE RACK-MOUNTED APPARATUS.

AUTOMATIC FIRE-PROTECTION EQUIPMENT

In accordance with normal Post Office practice, equipment that automatically releases carbon-dioxide gas into the affected compartment in the event of fire is provided in all rooms which contains oil-filled electrical plant, where such rooms are attached to buildings housing radio apparatus. This equipment is of standard mechanical type the operation of which is initiated by fusible links, and it is provided in the Main building high-voltage switchgear cubicles, the A building annexes and the Test Block sub-station at the B station. The switch houses external to the Main building and the detached sub-stations at the B station are not protected, as they are situated well away from the radio buildings.

CONCLUSION

The plant described in this article has been installed and brought into service in stages extending over a number of years. The stages have been determined mainly by the overriding requirement that any interruptions in the power supply to the radio station must be reduced to an absolute minimum. The first plant to be commissioned, the ring-main supplying the B station, was brought into use in 1954, and the whole installation was finally completed in the summer of 1957.

ACKNOWLEDGMENTS

The authors wish to acknowledge the contribution of their colleagues in the Power Branch, E.-in-C.'s Office, to the design and execution of this installation, which is one of the largest projects of its kind ever undertaken by the Post Office. They also desire to record their appreciation of the co-operation extended by the Radio Planning and Provision Branch and by Mr. G. H. Fogg, Engineer-in-Charge, Rugby Radio Station, and his staff.

Signalling Over Carrier Channels that Provide a Built-in Out-of-Speech-Band Signalling Path

R. W. GIBSON, A.M.I.E.E.,
and C. B. MILLER†

Part 2.—Design of Telephone Exchange Signalling Equipment

U.D.C. 621.395.44:621.395.63

Part 1 of this article discussed the general principles of signalling over multi-channel carrier systems that provide for signalling within the channel frequency band at frequencies outside the transmitted speech band. Part 2 concludes the article by describing the application of these principles to the design of telephone exchange signalling equipment, first for unidirectional trunk and junction circuits and secondly for both-way working; finally a brief account is given of some auxiliary equipment for use with the carrier systems to enable them to work in conjunction with existing telephone exchange signalling equipment as an interim measure where it is desirable for economic reasons to defer the provision of new signalling equipment.

INTRODUCTION

THE main application of carrier systems with built-in out-of-speech-band signalling facilities will be on circuits forming part of the present trunk network and on certain of the longer junction circuits. All of the signals required for these applications can be provided by a continuous signal code, which offers advantages over a pulse code in that it leads to simpler exchange signalling equipment. The signalling principles employed by the new carrier systems permit the use of a continuous code based on simple on/off conditions, as described in Part 1,* and this code has been adopted for the design of the exchange signalling equipment. While it is envisaged that normally a signal code giving tone-off in the circuit-idle condition will be used, the equipment designs are also suitable should tone-on-idle conditions be employed.

GENERAL FEATURES OF EQUIPMENT DESIGN

Location of the 2-wire/4-wire Line Termination.

Modern practice is to extend the 4-wire "transmit" and "receive" speech circuits from the terminal repeater station to the exchange and locate the 2-wire/4-wire line termination

† The authors are, respectively, Executive Engineer and Assistant Engineer, Telephone Development and Maintenance Branch, E.-in-C.'s Office.

* P.O.E.E.J. Vol. 50, p. 76, July, 1957.

in the exchange building. By including the termination in the exchange signalling equipment the 2-wire side may also be used to provide the signalling connexions, thus obviating the need for the separate transmission bridge that would otherwise be required. This principle has been adopted for the new signalling equipment, the arrangements being as shown in Fig. 5.

As the 2-wire side of the termination is extended directly to normal exchange equipment, it is required to carry d.c. For instance, in the case of calls to subscribers served directly by the incoming exchange the 2-wire side of the termination in the incoming equipment will be extended to a final selector in the same building, and under normal speech conditions a current of approximately 80 mA will flow through the 2-wire winding. The transmission performance must not be impaired by the presence of this direct current, and to meet this requirement a new design of 2-wire/4-wire termination has been developed.

While the inclusion of the 2-wire/4-wire termination in the exchange signalling equipment necessitates the provision, in all cases, of 4-wire tie circuits between the carrier terminal and the exchange, it permits a better transmission equivalent (T.E.) to be obtained on the overall circuit between the two exchanges. The loss introduced by both the tie circuit and transmission bridge derived from the termination may be compensated on the overall line-up of the circuit.

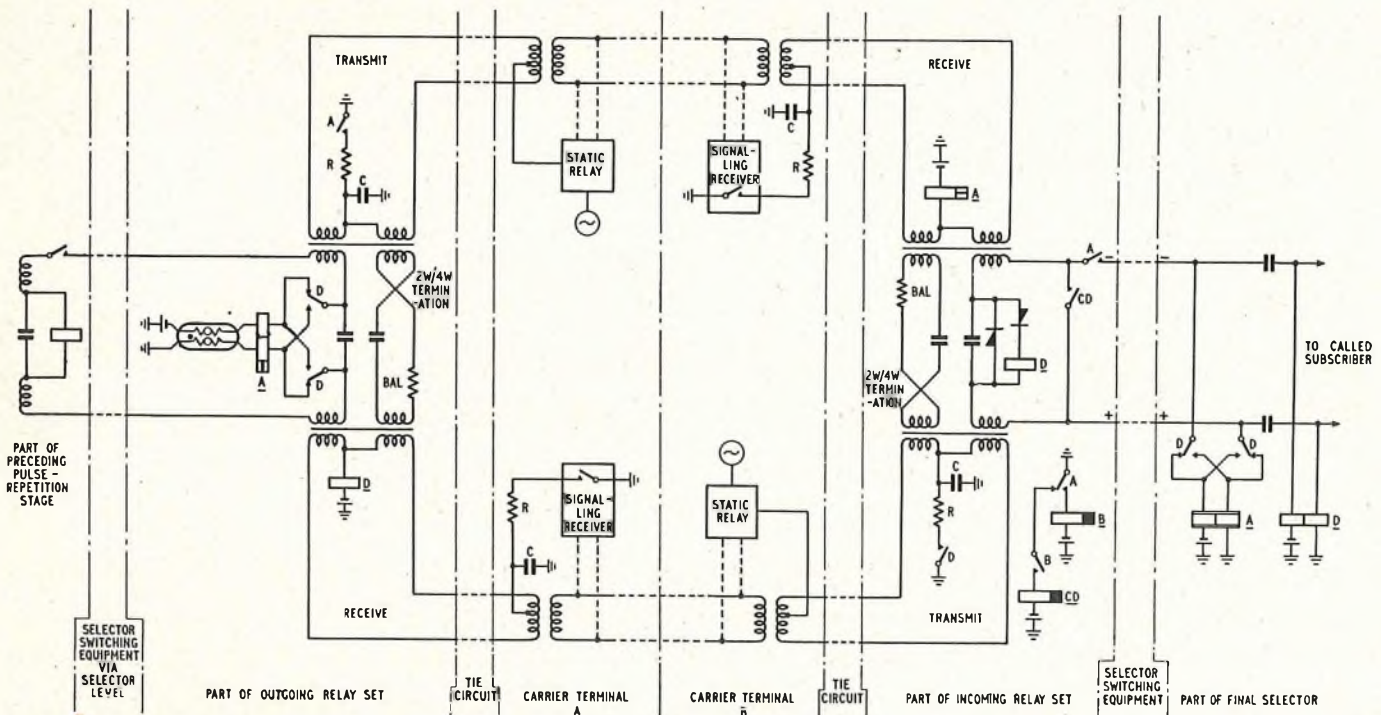

FIG. 5.—SIGNALLING ARRANGEMENTS.

Signalling Arrangements.

With the provision of a 4-wire tie circuit between the exchange and carrier terminal equipment a separate pair is available for each direction of signalling. As discussed in Part 1, earth-return phantom signalling has been adopted for signalling over these circuits.

Where circuits are routed in two or more carrier systems, all of which provide out-band signalling facilities, it may be necessary to repeat signals from one system to another on a d.c. basis. In this case, at an intermediate point, the static relays of one system will be controlled, either directly or over a tie circuit, by the signal receiver contacts of another system. In other applications, where only one carrier system is involved in a connexion, the static relays will be controlled by the exchange signalling equipment. It is desirable that the static relays should be to a common design. Furthermore, in the case of composite routings, with d.c. repetition of signals at intermediate points, each system involved in the connexion should contribute equally to the overall pulse distortion introduced between the outgoing and incoming exchange equipments. It follows that the d.c. signalling conditions presented by a signal receiver should be the same as those presented by exchange signalling equipment. The signal repetition contact of the exchange signalling equipment could be connected to earth or -50V battery, but as the latter is not normally available at carrier terminal stations, earth connexion is preferable.

The use of earth-return signalling principles may give rise to inductive disturbance in other circuits, and to minimize such interference noise-suppression filters comprising a resistor and a capacitor have been connected in the d.c. signalling circuit of the exchange equipment and the signal receivers.

When the outgoing relay set (Fig. 5) is taken into use, relay A operates to a loop extended from the preceding equipment and extends earth via the noise-suppression filter (RC) and tie circuit to the static relay at carrier terminal A. Assuming tone-off-idle conditions, this earth biases the static relay to the conducting condition and signal tone is transmitted over the channel. The signal receiver at carrier terminal B responds to this tone and the receiver contacts extend earth via the RC filter and tie circuit to operate relay A in the incoming relay set. Relay A extends loop conditions to seize the associated selector equipment. When the calling party dials, relay A in the outgoing relay set responds to the loop/disconnect pulses and repeats earth/disconnect pulses to the static relay. The signal tone transmitted from carrier terminal A is interrupted in accordance with the dialled pulses. The signal receiver at carrier terminal B responds and extends earth/disconnect pulses to relay A in the incoming relay set. Relay A repeats loop/disconnect pulses to the exchange equipment.

When the called party answers, the reversal of line polarity from the final selector operates relay D in the incoming relay set. Relay D extends earth via the RC filter and tie circuit to bias the static relay at carrier terminal B to the conducting condition and signal tone is transmitted. The signal receiver at carrier terminal A responds and extends earth via the RC filter and tie circuit to operate relay D in the outgoing relay set. Relay D reverses the line polarity to indicate answer supervisory conditions to the preceding equipment. When the called party clears, relay D in the incoming relay set releases and the signalling conditions in the backward direction revert to those obtaining when the circuit is idle.

When the calling party clears, relay A in the outgoing relay set releases and biases the static relay at carrier terminal A to the non-conducting condition, which disconnects signal tone from the channel. The signal receiver at carrier terminal B restores to the normal condition.

Relay A in the incoming relay set releases and disconnects the d.c. loop to the exchange equipment, which restores to normal.

With tone-on-idle conditions the operating sequence is the same except that the static relays are conducting when the circuit is idle, and are biased to be non-conducting when earth is extended by the operation of relay A or D in the exchange relay sets.

ADDITIONAL FEATURES OF EQUIPMENT FOR UNIDIRECTIONAL CIRCUITS

Sequenced Release of Equipment.

Circuit arrangements which ensure that the incoming and outgoing equipments release in sequence are illustrated in Fig. 6. When the calling party clears, relay A in the outgoing relay set releases and disconnects earth from the transmit circuit to initiate the release of the equipment at the distant end. Relay B in the outgoing relay set releases, but relay GD remains operated via contacts of relay D, which is normal, and maintains an engaged condition on the P wire. In the incoming relay set, relays A, B, CD and MD release in sequence, and on release of MD earth is connected to the transmit circuit, via an operated contact of relay GE, to mark the beginning of the release-guard signal. Relay D in the outgoing relay set operates to the received release-guard signal and releases relay GD. The engaged condition on the P wire is then maintained by a contact of relay D.

When the incoming selector equipment fully restores to normal, earth is removed from the P wire of the incoming relay set and relay GE releases to disconnect earth from the transmit circuit, thereby terminating the release-guard signal. To ensure that the duration of the release-guard signal is sufficient to cover the necessary circuit operations in the outgoing relay set should the selector equipment restore quickly, an alternative circuit for relay GE is provided under the control of relay MD.

On the termination of the release-guard signal, relay D in the outgoing relay set releases to remove the engaged condition from the P wire. All equipment has now restored to normal and is free to accept a further call. Should the calling party clear first, the answer supervisory condition returned from the incoming relay set is maintained and merges with the release-guard signal. In this case, as relay D is operated prior to clear-down, the release of relay B in the outgoing relay set releases relay GD and the engaged condition on the P wire will be maintained until relay D releases on the termination of the release-guard signal. This arrangement avoids a change of the supervisory conditions in the outgoing relay set during the release sequence and eases the design requirements.

Forward-Retest.

As discussed in Part 1, with a continuous signal code there is a choice between tone-off or tone-on in the circuit-idle condition. With tone-off-idle conditions the release-guard signal returned from the incoming equipment is a pulse of signal tone which may be lost, due for instance to a short-term disconnection of the transmission path. In this event the outgoing relay set would be busied out of service after the release of a connexion. To prevent this it is necessary to include in the outgoing relay set a forward-retest feature which on the non-receipt of the release-guard signal causes the transmission of seizure conditions, followed immediately by a forward-clearing signal. These signals are transmitted repeatedly until the incoming equipment, responding to them, returns a release-guard signal which is received by the outgoing equipment.

Referring to Fig. 6, if the release-guard signal is ineffective,

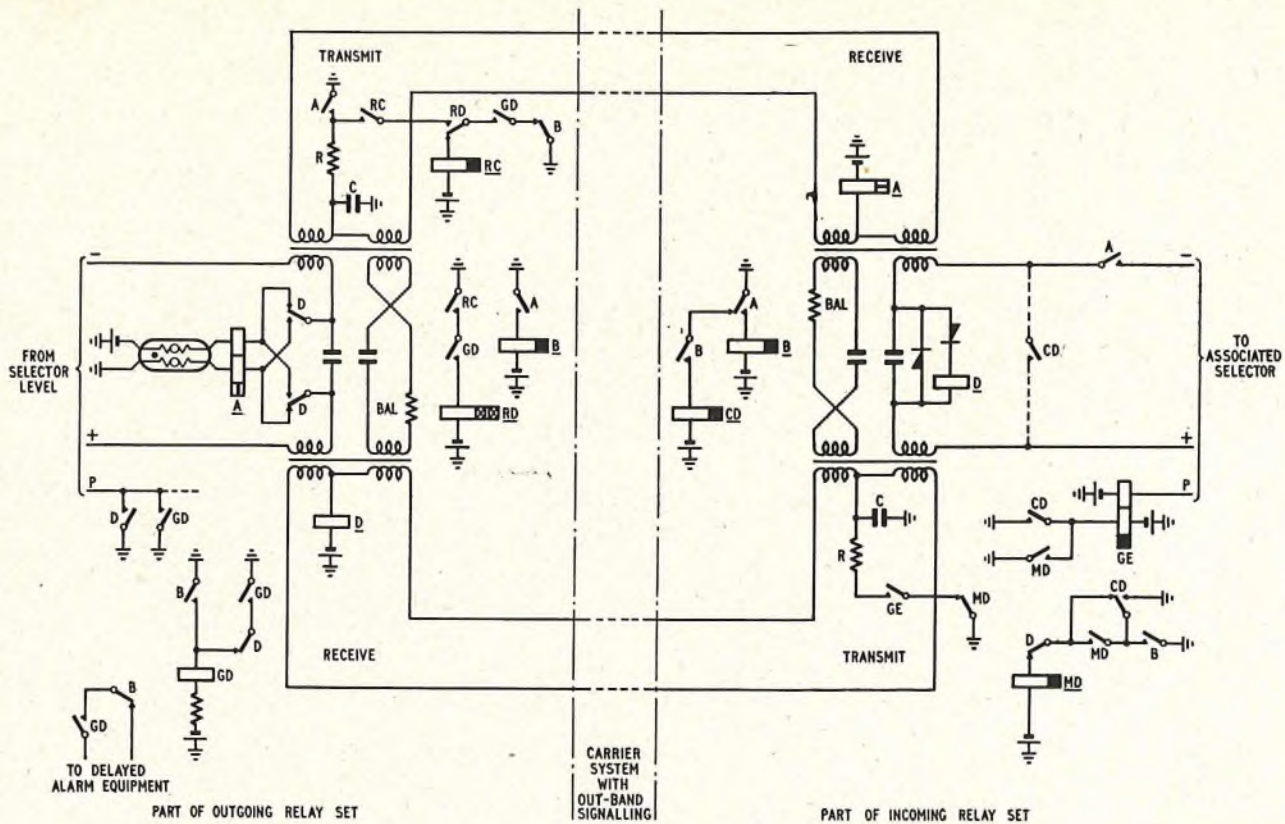

FIG. 6.—RELEASE OF UNIDIRECTIONAL CIRCUIT.

relay GD remains operated. Relay RC operates on the release of relay B and energizes the thermal relay RD, which operates after approximately 30 sec and releases relay RC. Earth is connected to the transmit circuit during the release lag of RC to give a seizure condition and is removed on the release of RC to indicate a clearing condition. Provided that the fault which caused the loss of the release-guard signal no longer exists, this seizure signal followed by a forward clear will cause the incoming relay set to return a release-guard signal and the circuit will clear down as described previously. If, however, the fault condition still persists and the release-guard signal is ineffective, the thermal relay RD will release after approximately a further 30 sec. Relay RC re-operates and the retest sequence is then repeated. This cycle continues until the fault is cleared or maintenance attention is given to the circuit. A delayed alarm is given under continuous retest conditions.

The use of a thermal relay, individual to each outgoing relay set, to control the interval between successive retest cycles ensures that the signals are not applied to a number of circuits simultaneously and is preferred to the use of a common pulse supply. If the latter arrangement were adopted, a common pulse source would control a number of outgoing relay sets and should a line fault occur on the receive path which affected a group or several groups of circuits, the outgoing relay sets would all apply signals to the transmit path at the same instant. The simultaneous seizure and release of the selector equipment at the incoming exchange could cause overloading of the exchange battery distribution fuses.

Blocking.

An earth connected to the P wire of the incoming relay set (Fig. 6) during routine testing or due to the selector equipment being busied or jacked out, will operate relay GE. GE connects earth to the transmit circuit, which results in the operation of relay D in the outgoing relay set and the connexion of an engaged condition to the P wire of the outgoing relay set.

EQUIPMENT FOR BOTHWAY WORKING

In general, bothway working may be provided either by using incoming and outgoing equipment as designed for unidirectional working, in association with some additional switching equipment, or by using a different design of terminal equipment. The use of different equipment has the advantage that the function of the incoming, outgoing, and switching equipment may be combined in one overall design, and also it allows the design to be independent of the requirements of unidirectional circuits. It has the disadvantage, however, that the many combinations of different types of outgoing and incoming equipment required in practice would require the provision of many different designs of terminal equipment for bothway working. To minimize the number of different types of equipment required and to permit standardization as far as possible, it has been decided to provide bothway working by using the incoming and outgoing equipment as designed for unidirectional working, in conjunction with a bothway switching relay set.

In practice the majority of circuits are unidirectional and thus it would be uneconomical to include in the incoming and outgoing equipment features and components additional to those necessary to meet the requirements of unidirectional circuits. Thus any circuit elements required solely to meet the conditions arising on bothway circuits have been incorporated in the bothway switching equipment.

Additional Features Required on Bothway Circuits.

Discrimination between seizure and release-guard signals.—The basic connexions of the signalling equipment on a bothway circuit are shown in Fig. 7. At each terminal the

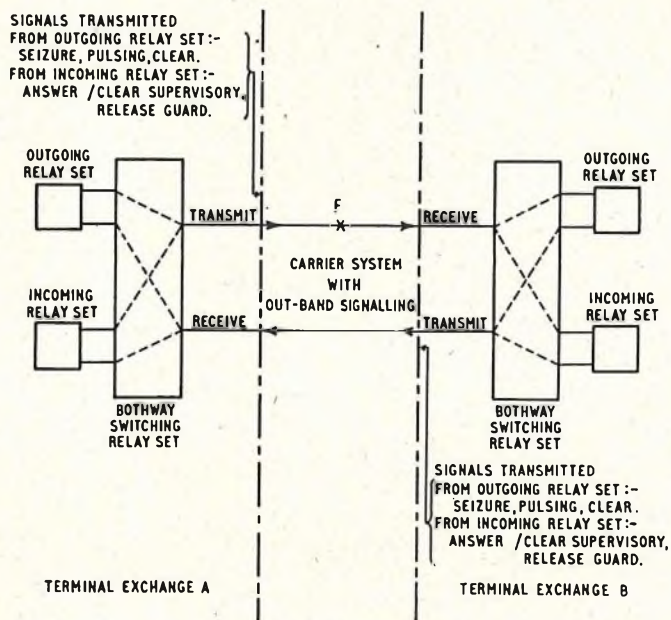

FIG. 7.—BASIC CONNEXIONS OF A BOTHWAY CIRCUIT.

incoming and outgoing relay set are connected in circuit, as required, by the bothway switching relay set. Signals may be transmitted over the transmit signalling channel under the control of either the outgoing or incoming relay set; the outgoing relay set controlling seizure, pulsing and forward-clear signals; the incoming relay set controlling answer/clear supervisory and release-guard signals. With a continuous code of the type previously discussed, seizure and release-guard signals are indicated by similar conditions; for instance, with a tone-off-idle code, both are indicated by the connexion of signal tone.

In the idle state the equipment at both terminals of a bothway circuit must be in a condition to accept a seizure signal. If no distinction is made between seizure and release-guard, the transmission of a release-guard signal from one terminal while the equipment at the other is idle will result in the incoming equipment at the latter terminal being seized for the duration of the signal. When the received release-guard signal ends, this incoming equipment will restore to normal and in doing so will cause a further release-guard signal to be transmitted in the opposite direction. This signal will cause the momentary seizure of the incoming equipment at the other terminal and the subsequent return of a further release-guard signal. This completes the cycle and an interaction will be set up between the terminal equipments.

The basic cause of the interaction is the similarity between seizure and release-guard signals and is initiated by the seizure of the incoming equipment at one terminal when the equipment at the other is not in use. This may occur under fault conditions. For instance, a burst of interference at signal frequency injected at point F (Fig. 7), into a

circuit employing a tone-off-idle code, would result in the incoming equipment at terminal exchange B being seized for the duration of the irregularity, the equipment at terminal exchange A remaining idle. The incoming equipment would subsequently restore to normal when the interference ceased, and a release-guard signal would be transmitted from terminal exchange B and initiate the interaction. Other conditions which may give rise to the interaction are a temporary disconnection of the transmission path of a circuit employing a tone-on-idle code, accidental operation of relays in the terminal equipment, working party faults, etc.

One means of overcoming the interaction difficulty on bothway circuits would be to arrange that a release-guard signal is not returned from the incoming equipment unless a pulse train has been received, and that the release of the outgoing equipment is independent of the receipt of a release-guard signal unless a pulse train has been transmitted. These arrangements, however, would require additional elements in the outgoing and incoming equipment to detect the transmission and receipt of a pulse train and would also result in complication of the forward-retest facility; in addition to seizure and clear signals, the forward-retest would have to include at least one pulse to provoke the return of a release-guard signal. As a result congestion could occur at an incoming centre in the event of a circuit failure causing a number of circuits to retest at the same time.

Alternatively, the difficulty may be overcome by introducing some delay on seizure so that a short-duration signal does not prompt the subsequent return of a release-guard signal. With a continuous code the conditions normally indicating seizure are of an indefinite duration, whereas the release-guard is indicated by a pulse signal. Thus discrimination between the two signals may only be effected by delaying the completion of the seizure sequence in the incoming equipment for a time greater than the maximum possible duration of the release-guard signal. It follows that close control of the duration of the release-guard signal would be an advantage.

When access to outgoing circuits is obtained via selector levels it is required that the search for a free outlet, seizure of the circuit, and the preparation of the incoming equipment for the receipt of a pulse train, should all be carried out during the intertrain-pause period. With present types of selector equipment the greater part of the intertrain-pause period is taken up by the search for a free outlet and this precludes increasing the circuit seizure time. In consequence no protection can be given against seizure of the incoming equipment by short-duration signals. Hence to prevent a false seizure condition causing the subsequent return of a release-guard signal, it is necessary to arrange that no signals can be transmitted from the incoming equipment unless the seizure condition prompting these signals has been maintained for a certain minimum period. If this period is made greater than the maximum possible duration of a release-guard signal, then while receipt of a release-guard signal would cause seizure of the selector, the seizure sequence in the incoming equipment would not be completed and hence the subsequent return of a release-guard signal would be prevented. It is proposed to adopt these arrangements, which are illustrated by Fig. 8.

In the idle condition the receive circuit is connected via the bothway switching relay set to the incoming relay set, and the transmit circuit is connected to the outgoing relay set. When the circuit is seized relay A in the incoming relay set operates and operates relay ID in the bothway relay set. Relay ID switches the transmit circuit to the incoming relay set and also completes the circuit for the timing element made up of slow-acting relays, and after the delay-time introduced by this element has

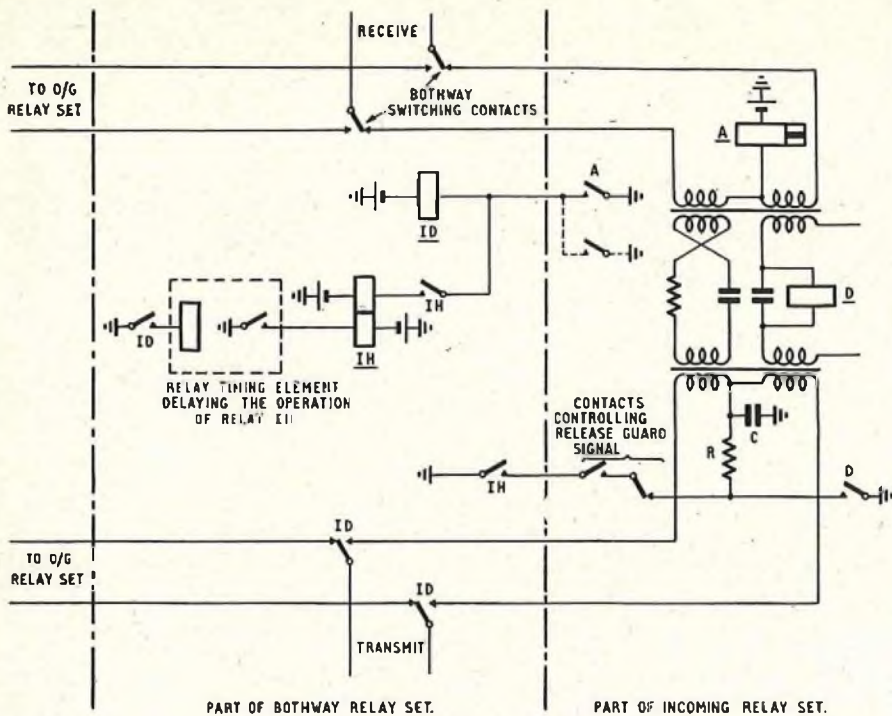

FIG. 8.—BOTHWAY SWITCHING—INCOMING CALL.

elapsed, relay IH operates. The operation of relay IH depends on the seizure condition being maintained while the delay is being timed and it is not until relay IH operates that earth is extended from the bothway relay set to the relay contacts in the incoming relay set that control the release-guard signal. By arranging that the interval between the operation of relay A in the incoming relay set and relay IH in the bothway relay set is greater than the maximum duration of a release-guard signal, it is ensured that although such a signal would seize the incoming relay set the subsequent return of a release-guard signal will be prevented by the non-operation of relay IH.

Forward-retest feature.—On bothway circuits a forward-retest feature is required with both a tone-off-idle and a tone-on-idle code to prevent faults within the transmission path resulting in the outgoing equipment at one terminal being busied out of service. With a tone-off-idle code this may occur due to a transient disconnection resulting in the loss of the release-guard signal. With a tone-on-idle code the release-guard signal is indicated by the absence of signal tone and the effect of a disconnection of the return path occurring during the release sequence would be to prolong the release-guard signal; the outgoing equipment at the terminal originating the call would then be busied out of service while the fault persists. In the meantime, the equipment at the other terminal would have restored to normal, and should this be taken into use, the outgoing equipments at both terminals

would be connected to line. When the transmission path is re-established the outgoing equipment at one terminal would restore, but the other would remain busied.

The provision of a forward-retest feature permits the busied outgoing equipment to be restored to service. Further, by arranging that the retest element maintains seizure conditions between successive clearing signals, the seizure of the outgoing equipment at one end of a bothway circuit, while the other end is retesting, would be prevented. Circuit arrangements which provide the forward-retest feature required for bothway circuits are illustrated by Fig. 9. When the calling party clears, the outgoing relay set functions in the same manner as when associated with a unidirectional circuit; the release of relay A initiating the clearing signal and relay GD remaining operated pending the receipt of the release-guard signal. Relay A also releases relay OG in the bothway relay set; the thermal relay RE is energized and the circuit for relay IH completed via the delay-timing element. The delay introduced by the timing

element is such that under normal conditions a release-guard signal will be received and relay D will be

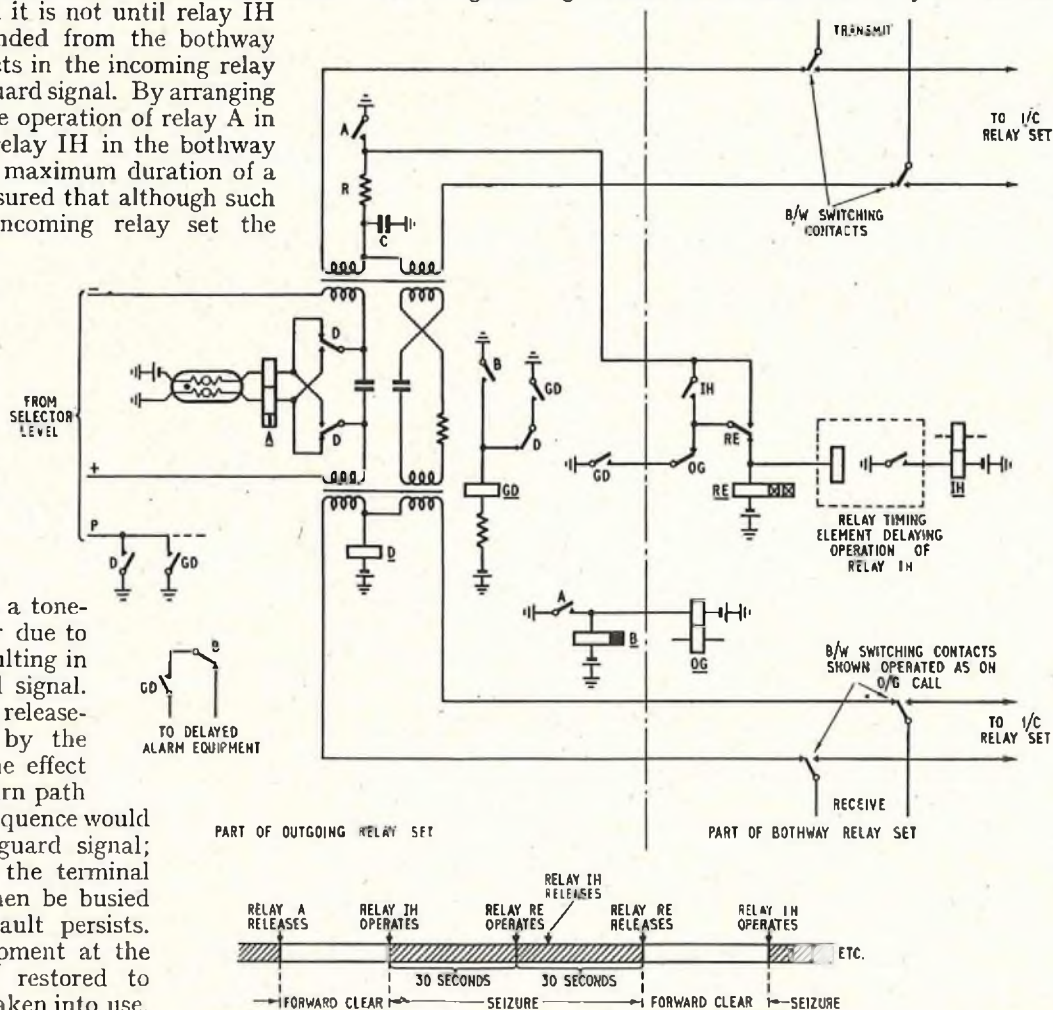

FIG. 9.—FORWARD-RETEST FACILITY—BOTHWAY CIRCUIT.

operated before relay IH operates. In this case relay GD releases, disconnecting the circuit of the retest element, and the outgoing and bothway relay sets restore to normal. Should no release-guard signal be received, relay IH operates after the delay period has elapsed and reconnects earth to the transmit circuit to terminate the clearing signal and re seize the distant incoming equipment. After approximately 30 sec the thermal relay operates, disconnects its own operating circuit and releases relay IH. The earth connected to the transmit circuit (i.e. the seizure condition) is maintained by the thermal relay which remains operated for approximately 30 sec. After this time the thermal relay releases and disconnects earth from the transmit circuit to initiate a forward-clearing signal to the distant equipment. The release of the thermal relay completes the cycle of operations and if no release-guard signal is received, seizure and clear signals will be repeated cyclically and a delayed alarm given.

INTERIM ARRANGEMENTS

It is to be expected that cases will arise where it is required to route circuits over out-band signalling systems, but where it is not practicable to install new signalling equipment in the terminal exchanges. For instance, it may be required to replace an existing audio route that provides d.c. dialling facilities between a C.B. and an automatic exchange by a h.f. route with out-band signalling. If the C.B. exchange is scheduled for early conversion to automatic working, the provision and installation of new exchange signalling equipment would be uneconomical. In this, and similar cases, it would be an advantage if signalling and dialling facilities could be retained on conversion of a route to h.f. working, using existing equipment at the outgoing and incoming exchanges, together with some form of auxiliary equipment at the carrier terminal stations to effect the necessary signal conversion.

Arrangements for Circuits between C.B. and Automatic Exchanges.

At C.B. exchanges the setting up, control and supervision of a call is effected directly by the operator's cord circuit. On seizure of an outgoing circuit, and subsequently for the

holding of the connexion, the cord circuit extends standard C.B. conditions of earth on the A line and battery on the B line. Dialling is effected using battery dialling principles, namely battery to the A line, battery/disconnect pulses to the B line. Answer-supervisory conditions are set up on the receipt of a battery condition on the A line, and thence to the tip of the cord circuit. These d.c. conditions are identical with the conditions given by a continuous signal code of the type illustrated in Part 1, Fig. 3. Thus, at the outgoing carrier terminal it is only required to arrange that the d.c. conditions extended to line from the ring of the cord circuit control, either directly or indirectly, the static relay associated with the transmit channel of the out-band signalling system, and that the signal receiver contacts control the connexion of battery to line, and thence to the tip of the cord circuit, for supervisory conditions.

At the incoming end the automatic exchange equipment is seized and subsequently held for the duration of a connexion, by a loop condition, with pulsing effected by loop/disconnect signals. Answer-supervisory conditions are indicated by a reversal of line polarity. Thus at the incoming carrier terminal it is required that the loop extended to the associated selector equipment be controlled by the signal receiver contacts and also that an element be connected to detect the reversal of line polarity and give the appropriate bias to the static relay associated with the transmit channel.

Fig. 10 illustrates a means of providing dialling facilities over an out-band signalling system between a C.B. and an automatic exchange, using standard equipment at the two exchanges. In this example, as the outgoing circuit is seized directly from the operator's cord circuit, precautions have to be taken to prevent the occurrence of a false signal when the calling plug is first inserted into the jack. This is effected by the false-pulse suppression equipment. In the arrangements shown, the d.c. signals from the cord circuit are repeated to the static relay by relay L. It would be possible for the static relay to be controlled directly by the line signals, but as the carrier terminal and exchange may be located on separate sites and interconnected by an external tie cable, the introduction of relay L results in the static relay operating under constant conditions, thereby easing the sensitivity and pulse-performance requirements.

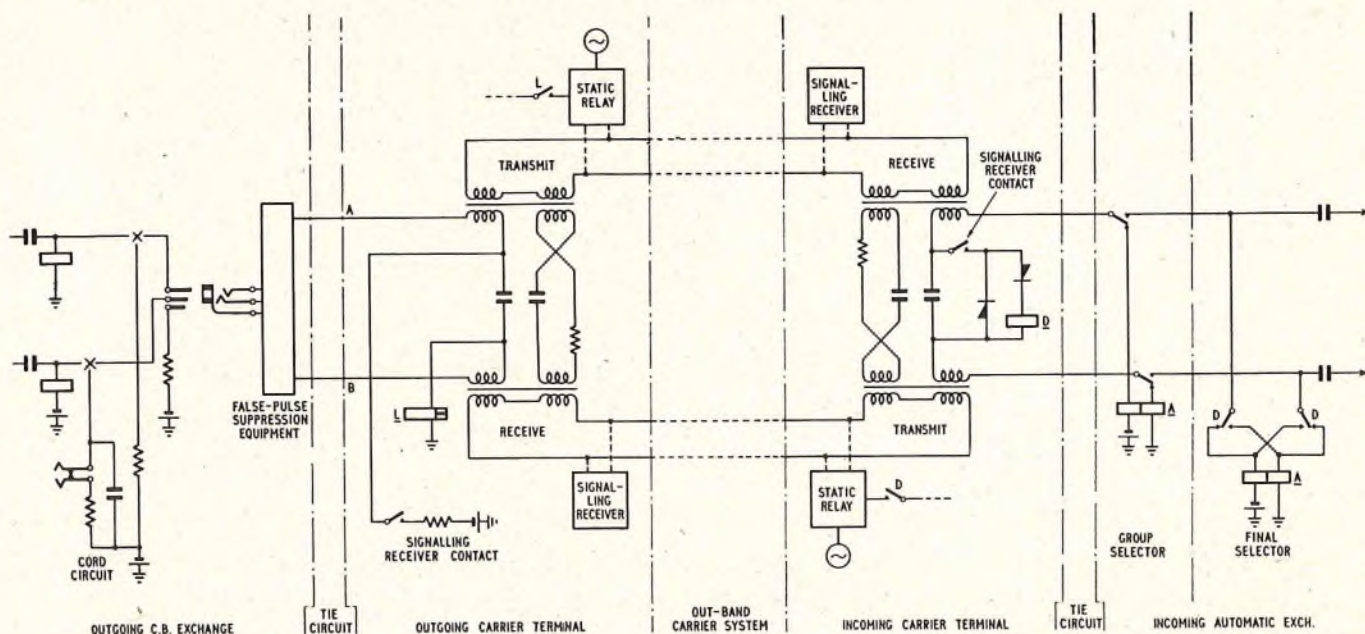

FIG. 10.—ARRANGEMENTS REQUIRED AT OUTGOING AND INCOMING CARRIER TERMINAL STATIONS TO PROVIDE DIALLING FACILITIES FROM A C.B. EXCHANGE TO AN AUTOMATIC EXCHANGE.

In practice the 2-wire/4-wire line terminating unit may be situated at the exchange, carrier terminal station, or at any intermediate point. When situated other than at the carrier terminal, the signalling path between the exchange and carrier terminal would be derived wholly or partly from the phantom of the 4-wire circuit. The auxiliary equipment designed permits any location of the 2-wire/4-wire termination, provided that the overall resistance of the signalling path between the incoming or outgoing exchange and the associated carrier terminal equipment does not exceed 600 ohms, and if derived wholly or partly from a 4-wire circuit, the overall route mileage of the d.c. signalling path does not exceed 10 miles.

Arrangements for Other Applications.

Auxiliary equipment may be designed to interwork with standard equipment at other types of exchanges, and, as an example, Fig. 11 illustrates the arrangements required at the outgoing end to permit dialling facilities over circuits between automatic exchanges with selector-level access via standard auto-auto relay sets at the outgoing exchange.

Limitations of These Arrangements.

While the interim arrangements outlined permit the provision of signalling and dialling facilities at minimum cost on circuits routed over out-band signalling systems, they have certain limitations. These limitations result mainly from the use of auxiliary signal conversion equipment at the carrier terminal stations. In particular, as the signal conversion equipment at the outgoing and incoming carrier terminals is dissimilar, the arrangements do not readily permit bothway working. To provide this facility, relatively complicated switching equipment would be required at the carrier terminal stations to connect in circuit the signal conversion elements appropriate to the direction of a particular call. Further, the arrangements do not necessarily give the optimum pulse distortion performance, and thus, unless some form of pulsing aid is introduced at the incoming exchanges, some restriction of the permissible dialling range may be necessary. Also, resulting from the use at the outgoing and incoming exchanges of standard equipment designed primarily for d.c. signalling over local junction circuits, the arrangements

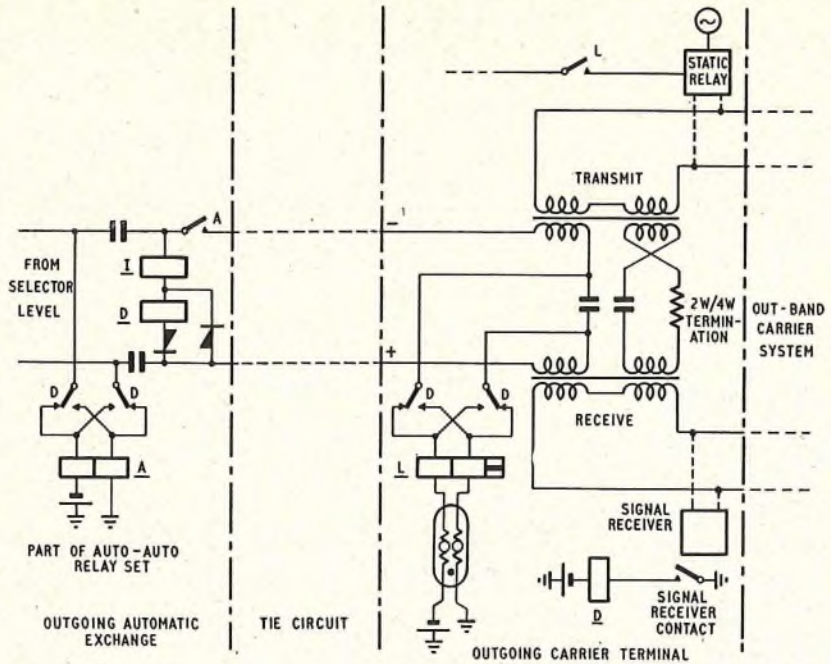

FIG. 11.—ARRANGEMENTS REQUIRED AT OUTGOING CARRIER TERMINAL TO PROVIDE DIALLING FACILITIES WITH LEVEL ACCESS FROM AN AUTOMATIC EXCHANGE.

provide only the basic signals. Additional signalling features which are most desirable on the longer junction circuits and trunk circuits, for example, release-guard and blocking signals, cannot be provided. In view of the limitations inherent with these arrangements, they are regarded as interim measures to be used pending the provision at the terminal exchanges of standard signalling equipment designed specifically for use with systems providing out-band signalling facilities.

CONCLUSION

The first applications planned for carrier systems that provide built-in out-of-speech-band signalling facilities are certain routes in the South West Region and part of the Manchester-Preston route. Exchange signalling equipment employing the principles outlined in this article is being developed for these applications and the new signalling system has been designated S.S. A.C. No. 8.

An Introduction to the Line Connector

U.D.C. 621.395.348

THE linefinder is a fairly well-known feature of exchange design, and given the right traffic conditions there are equipment economies to be achieved by its use. Each subscriber's line connected to a linefinder must, however, be brought into the exchange merely because the linefinder is located there, but there is no reason, theoretically at least, why the linefinder should not be located much nearer the subscribers served; it should then be possible to achieve economies in line plant. The requirement would be for remote linefinder units which could be located at suitable points in the local line network at some distance from the exchange. On the subscribers' side of such units there would be individual connexions to each of the subscribers served, and on the exchange side there would be individual connexions only

for each of the linefinders contained in the units. Any potential savings in line plant would, of course, need to be set off against the cost of any additional equipment required. For example, a linefinder located in the exchange would, in general, be arranged to handle originating traffic only. Remote linefinders would, however, need to carry both originating and terminating traffic and the number of remote linefinders required would be greater than the number that would normally be provided in the exchange for the same grade of service. The control of the remote linefinders might also call for control equipment of a rather more elaborate kind than is normally associated with exchange linefinders.

The possibility of out-housing linefinders is not a new idea. It has occurred to equipment designers in various

countries and several successful designs are now available. Usually there is a subscribers' unit and an exchange unit for each out-housed linefinder group. The subscribers' unit is arranged for installation in a weatherproof case which can be pole-mounted, or which can be placed in a cabinet intended for use on the footway. Alternatively, the subscribers' unit may be wall-mounted in a subscriber's premises. The exchange unit co-operates with the subscribers' unit over interconnecting line links and the combined equipment is known in this country as a Line Connector.

A typical subscribers' unit, based on uniselectors for ease of explanation, would contain line and cut-off relays for each subscriber's line and one unselector linefinder per line link. The line links would terminate on link circuits at the exchange where each link would be connected to a standard subscriber's calling equipment, giving access to first selectors in the normal way. Each line link would also be associated with a second unselector which would be arranged to operate in step with its associated remote unselector to establish connexion to the appropriate subscriber's meter on originating calls, and to direct terminating calls from the multiple number, via a link circuit, to the wanted subscriber's line. Originating and terminating calls would use only one line link whereas calls between subscribers connected to the same subscribers' unit would employ two line links, one in each direction. The arrangement would in no sense be a party-line system, each line being the exact equivalent of an exclusive connexion.

Any of the standard types of unselector or cross-bar switch can be, and have been, used in the subscribers' unit, but they have the disadvantage that a local power supply is necessary. The local supply, in the form of a small secondary cell battery of a special type, simplifies design but offers maintenance problems which are preferably avoided. New types of switch of both rotary and cross-bar types, specially adapted for low power consumption and the elimination of the local battery, have been designed by various manufacturers, and several of the currently available models of the line connector incorporate such equipment, but the elimination of the local power supply usually means that a power lead has to be provided in addition to the line link pairs. A connexion, once established via the subscribers' unit, is "straight through" to the exchange unit and in some models of the line connector a connexion, once established, is also "straight through" to the first selector. This has advantages, particularly in this country, but carries with it a certain degree of complication in the control arrangements and may in certain circumstances call for a control pair in addition to the line link pairs and the power lead.

The ratio of lines to line links is determined from the character of the traffic originated by the subscribers concerned, it being necessary to take into account the total traffic originating and terminating and the proportion of traffic which originates and terminates within the same group of lines. Since the line connector is basically a remote linefinder, it follows that traffic loadings should be suitable for linefinder working rather than, say, unselector working, and it is desirable, therefore, that the subscribers served

via a line connector should have medium to low calling rates. This requirement is generally satisfied by residential lines in this country, particularly, since in small groups of such lines the amount of traffic originating and terminating within the same group is small, say, less than 10 per cent. With these factors in mind, typical sizes of line connector are 10 lines with 2 line links, 20 lines with 4 line links, 50 lines with 9 line links and 100 lines with 16 line links.

The emphasis so far has been placed on the economic aspects of the use of line connectors as devices for improving the flexibility of planning schemes. This is without doubt an important application, but there are other applications which, on a short-term basis, may well be the more important. The line connector can, for example, prove to be a powerful method of relieving closed distribution points in the face of restrictions on capital expenditure on local line plant. In such applications a suitable site in the local line network would be found for, say, a street cabinet in which a line connector would be fitted, providing for perhaps 20 lines working over four line links. Four of the existing lines from the selected point back to the exchange would then be taken over as line links, and immediately terminations for 20 lines would become available, a gain of 16 terminations if the lines taken over were originally exclusive lines, or 12 terminations if they were shared-service lines. The choice of a site for the line connector would involve a study of the local conditions in order to obtain the best compromise. It would, for example, be desirable for some of the local distribution to the new subscribers already to be available. Generally speaking, when used in this manner as an expedient, the cost of the line connector is substantially less than that of a new distribution scheme, and experience abroad suggests that installation for as little as two years is profitable.

Other applications of the line connector are to replace small dependent manual exchanges and country satellite exchanges when the associated parent exchanges are converted to automatic working, and to serve small groups of subscribers in rural and urban fringe areas without incurring the cost of a U.A.X., which would be uneconomic. Blocks of flats may also offer a useful field for the economic use of line connectors.

In this country, line connectors have not so far been used except on an experimental basis in Scotland,¹ where a unit has been used to replace a small manual (magneto) exchange. The results of this experiment are encouraging, and economic studies of alternative designs are in progress. These studies suggest that there is a useful field for the exploitation of at least two sizes of line connector in this country, namely, a 20 + 4 unit and a 50 + 9 unit. As a first step, a 20-line model has been constructed and, if laboratory trials are successful, a number of these will be installed shortly on a trial basis in locations yet to be determined. These units will include a facility permitting them to be partially equipped in circumstances not justifying full equipment.

J. A. L.

¹Field Trial of 10-line Subsidiary Automatic System. Regional Notes, P.O.E.E.J., Vol. 50, p. 136, July 1957.

BOOKS RECEIVED

"Analysis of Bistable Multivibrator Operation: The Eccles-Jordan Flip-Flop Circuit." P. A. Neeteson. Philips Technical Library. 82 pp. 34 ill. 15s.

This is a book for the expert designer of valve trigger circuits. Expressions are derived for the operation of such circuits under certain idealized conditions and used to explain the practical behaviour.

Das Fernmelderelais (in German). M. Hebel, R. Oldenbourg, München. 184 pp., 55 ill. DM28.

This book contains information on the general construction and characteristics of a wide variety of relays used in telephone and telegraph equipment by foreign administrations. It also discusses magnetic and electrical considerations in terms of relay performance. It is well illustrated and would serve as a useful reference book for relay designers and students having a knowledge of the German language.

The Design and Field Trial of a 12-Circuit Carrier Telephone System for Use On Unloaded Audio Cables

J. REYNOLDS, B.Sc. (Eng.), A.C.G.I.
and E. JEYNES, B.Sc. (Eng.), A.M.I.E.E.†

Part 1.—Design, General Description of the System, and the Terminal Equipment

U.D.C. 621.395.44:621.315.2.029.3

This article, which will be published in two parts, discusses the technical problems involved in the application of carrier telephony to audio cables, and describes how these problems have been dealt with in a 12-circuit carrier telephone system designed at the Post Office Research Station. Part 1 deals first with the problems involved and then gives a general description of the system, followed by a more detailed account of the terminal equipment. Part 2, to be published later, will describe the line equipment and a field trial of the system on an audio cable between Elstow and Hendon repeater stations.

INTRODUCTION

CARRIER telephone systems were developed to reduce the very high line costs of long-distance trunk circuits using audio plant. With progressive improvement in carrier systems, and in particular of coaxial cable systems, the relative cost of a carrier telephone circuit has been reduced, and on heavy traffic routes the use of carrier systems may now be contemplated for distances as short as 30 miles.

While carrier telephony was growing in importance, the provision of audio cable to meet the growth of the shorter trunk circuits continued until there is now a main underground trunk and junction network of over 30,000 miles of cable, serving all exchanges except a few small remote ones by underground cable. Thus, in order to meet normal circuit growth and possible large increases arising from the increasing automatization of the trunk network, it was very natural that thought should be given to the possibilities of increasing the circuit capacity of existing audio cables, as has been done successfully by other Administrations.

One important possibility is the application of carrier telephony to audio cables. This involves technical problems additional to those involved when using cables specially designed for carrier working, and this article describes one of the possible designs of a system in which these problems are overcome. The design has an economic field of use as compared with current established methods of providing circuits, but its position, in the economic sense, relative to a number of competing developments now in progress has still to be established. A brief description of this system has appeared in a previous article.¹

DESIGN OBJECTIVE

It was visualized that this carrier system would be used principally on existing audio cable with carrier terminals often sited in exchanges, and it was, therefore, highly desirable that the system should work on a single cable, and that each carrier terminal should be completely self-contained, i.e. with its own power and frequency generating equipment. The design of a single-cable scheme on existing cables must cater for routing over small cables in which no advantage is obtained by the use of separate groups of pairs for the two directions of transmission, and the necessity arises to use separate frequency bands for the two directions. It was decided to use one quad for a system instead of a cable pair, which might theoretically be more economical, to avoid the complications of directional filters. With the self-contained principle applied to line equipment as well as terminals, a design was contemplated by which a single system or a large number of systems could be installed with equal facility and equal cost per system. This principle

† The authors are, respectively, Senior Executive Engineer and Executive Engineer, Post Office Research Station.

¹ CHILVER, L. W. J., and WATKINS, A. H. New Line Transmission Equipment. *P.O.E.E.J.* Vol. 49, p. 12, April 1956.

* Decibels with reference to 1 mW.

promised an advantage over conventional h.f. systems for which a complete h.f. line link, of perhaps 600 circuits capacity, must be installed before the first circuit can be set up. In some preliminary studies, systems with 8 and 16 circuits were considered but were abandoned in favour of a 12-circuit system; this was not required to be compatible with the standard 60–108-kc/s group.

Thus, the design objective became:—

A 12-circuit system to work 4-wire over the pairs of a deloaded quad in an audio cable with different frequency bands for the two directions of transmission, the design permitting a system on each quad of such a cable and allowing each system to be provided independently of the others. The possible range of use was over distances of 25–100 miles.

MAIN CONSIDERATIONS IN THE DESIGN

Considerations Arising from Cable Characteristics.

The audio trunk cable network consists predominantly of 20-lb quad cable and hence the design of the system has been based on the use of this cable. Little, if any, modification would be required for the system to work over other conductor gauges but the permissible repeater station spacings would need investigation. The system is less likely to be economical on 10-lb cable but it might be particularly profitable, as an alternative to re-loading or recovery, on some of the older cables with large-gauge conductors and heavy loading. The attenuation/frequency and impedance/frequency characteristics of 20-lb cable are given in Fig. 1 and 2. The design of the system was based on

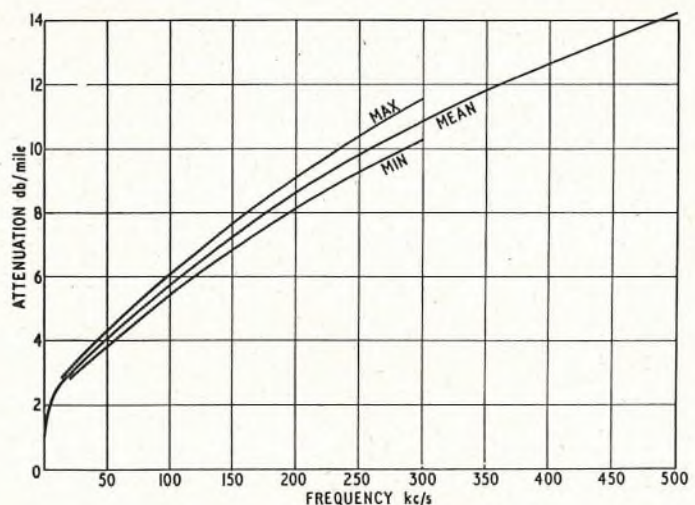

FIG. 1.—ATTENUATION/FREQUENCY CHARACTERISTIC OF P.C.Q. 20-LB CABLE.

the "maximum" attenuation curve and an impedance of 125 ohms. D.C. signalling on audio circuits gives rise to noise extending to above 200 kc/s with little falling off in level on pairs used for carrier working in the same cable. A maximum noise level of -95 dbm* (flat) in a 300–3,400-c/s

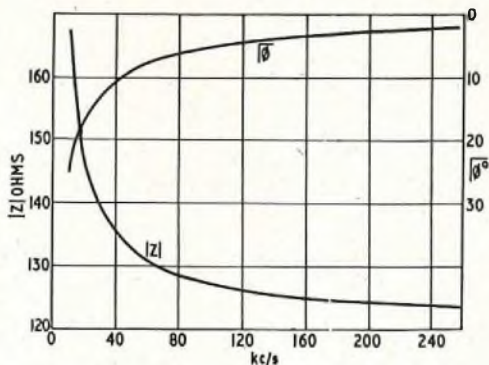

FIG. 2.—MEAN IMPEDANCE/FREQUENCY CHARACTERISTIC OF P.C.Q. 20-LB CABLE.

band at the input of the receive terminal was assumed, making allowance for the addition of noise in successive repeater sections.

Distant-end crosstalk (d.e.x.t.) causes intelligible interference between cable pairs transmitting the same frequency band in the same direction. Hence, d.e.x.t. becomes of major importance as soon as it is desired to set up two or more systems of the same type in the same cable. In a cable designed for audio working, it is not surprising that the crosstalk at carrier frequencies is poor. Some representative figures are given in Table 1.

TABLE 1

D.E.X.T. on P.C.Q. 20-lb cable. Measured on pairs in the outer layer.

Frequency (kc/s)	20	80	150	300	150
Signal/Noise Ratio (db)	6-miles Cable Section				Estimated for 100 miles
90 per cent of combinations better than	63	51	46	40	36

In a large cable crosstalk between pairs in inner layers may be 10–15 db better than Table 1 but advantage cannot be taken of this fact since freedom to route a system on any quad in a cable is required.

An adequate performance in respect of d.e.x.t. might be obtained by,

- measuring the crosstalk on all pairs and selecting only those combinations which are good enough,
- re-balancing the cable, or part of it as required, probably necessitating both balancing in the field and the use of balancing frames in each repeater section, or
- using compandors.

The last method was adopted for the present system because it imposes no restrictions on the choice of pairs for carrier working and because it gives a specific crosstalk advantage which is independent of cable rearrangement and replacements. The principle of the compandor has been known and used for many years but the present application is the first that contemplates its large-scale use on inland trunk circuits in this country. The compandor designed for the system will be described in a future issue of the Journal.

Representative figures of near-end crosstalk (n.e.x.t.) are given in Table 2.

In a carrier system where the two directions of transmission are closely associated, n.e.x.t. imposes a requirement for different frequency bands for the two directions. Appropriate filters at repeater inputs can then reduce the crosstalk from one direction to the other to acceptable

² HORSFIELD, B. R., and GIBSON, R. W. Signalling Over Carrier Channels that Provide a Built-In Out-of-Speech-Band Signalling Path. Part 1. P.O.E.E.J. Vol. 50, p. 76, July 1957.

TABLE 2
N.E.X.T. on P.C.Q. 20-lb cable.

Frequency (kc/s)	20	80	150	300
Signal/Noise Ratio (db) 90 per cent of combinations better than	71	59	54	48

levels. But in the present application the audio pairs that are not intercepted provide crosstalk paths from repeater outputs to repeater inputs for the same direction of transmission and if the frequency band remains the same an impossibly high crosstalk level results. One solution to this difficulty is to fit crosstalk-suppression filters in all the audio pairs at each repeater station; this could involve fitting hundreds of filters so that two or three carrier systems could work and it is therefore not attractive. Another solution, which was adopted, is to incorporate frequency changers in the repeaters so that the input to a repeater is in one of the two frequency bands while the output is in the other, an arrangement known as "frequency frogging," and adequate crosstalk attenuation can then be ensured by filters at the input of the carrier repeaters.

The repeaters are then of two types alternately along the line, high-frequency group to low-frequency group (H-L) and low to high (L-H), but at any one station the repeaters are all of the same type.

The change of frequency band at a repeater is accompanied by frequency inversion, i.e. the lowest frequency of the low group becomes the highest frequency of the high group and so on. This inversion leads to two very substantial advantages:—

- Over two repeater sections of equal length, the cable loss, half the mileage at one frequency and half at the "inverse" frequency, is very nearly constant over the frequency band, i.e. the system is largely self-equalizing. Similarly, the change of cable attenuation due to temperature is made very nearly constant over the frequency band.
- Over two repeater sections the two repeaters have to make good the nearly constant cable loss referred to in (a), which means that the repeater gain need correspond only to the cable loss at the mean frequency of the system instead of at the maximum frequency as in more conventional carrier systems.

Frequency Synchronization.

Following the adoption of frequency-frogging repeaters, and a further decision to use single-sideband suppressed-carrier working, various methods of synchronizing the terminals were considered. It was decided to use a free-running crystal oscillator for each repeater to supply carrier to the frequency-frogging modulators. These oscillators would be subject to slight frequency drift giving frequency errors on transmitted signals, which would need correction at the receiving end.

Signalling.

Much emphasis was placed on devising the simplest and cheapest signalling arrangements. On the carrier system these requirements led to the use of out-of-band signalling² by which, on each channel, d.c. input signals are repeated over the system by means of a tone at a frequency above the speech range. The desire for simplicity in this system also led to the use of a "continuous signalling code," of "tone-on" in the circuit-idle condition and of direct operation of the receive relay at the exchange by rectified tone from the carrier terminal to save a repeating

relay at the carrier terminal. Earth-phantom signalling over the audio tails was adopted to enable a tail of up to 30 miles to be used.

Automatic Gain Control.

Automatic gain control was adopted to reduce the need for manual adjustments of the gain of the system. Its desirability is emphasized by the fact that any level change at the expander input, due for example to change of cable temperature, is doubled at its output. For a circuit 100 miles long, a temperature change of $\pm 20^\circ\text{F}$ was estimated to cause a level change of ± 12 db at the centre frequency of the line frequency band adopted. Level changes of this order cannot reasonably be catered for at repeater outputs and hence it was necessary to arrange for level control at points along the line and at receive terminals.

Power Feeding.

A method of supplying power via the cable to dependent repeater stations was adopted to reduce the amount of line equipment as far as possible, and d.c. was used for the same reason. A maximum voltage of 130V to earth was specified and hence power was fed at +130V and -130V d.c. A system of safety precautions based on interlocking keys at power-feeding stations ensures that cabling operations can be undertaken without interruption to the carrier system and do not commence until the power is disconnected from the cable section concerned.

TERMINAL EQUIPMENT

Fig. 3 shows the frequency allocation of the system. Fig. 4 gives a block schematic of a carrier terminal, and also includes the extension of one circuit into the exchange to show the hybrid termination in the exchange relay set. The carrier terminal and the exchange are shown as being in different buildings with audio underground cables connecting them but they could be in the same building. Fig. 4 shows the terminal repeater since this is mounted on the terminal rackside although in the technical sense it is part of the line. The complete carrier terminal occupies one

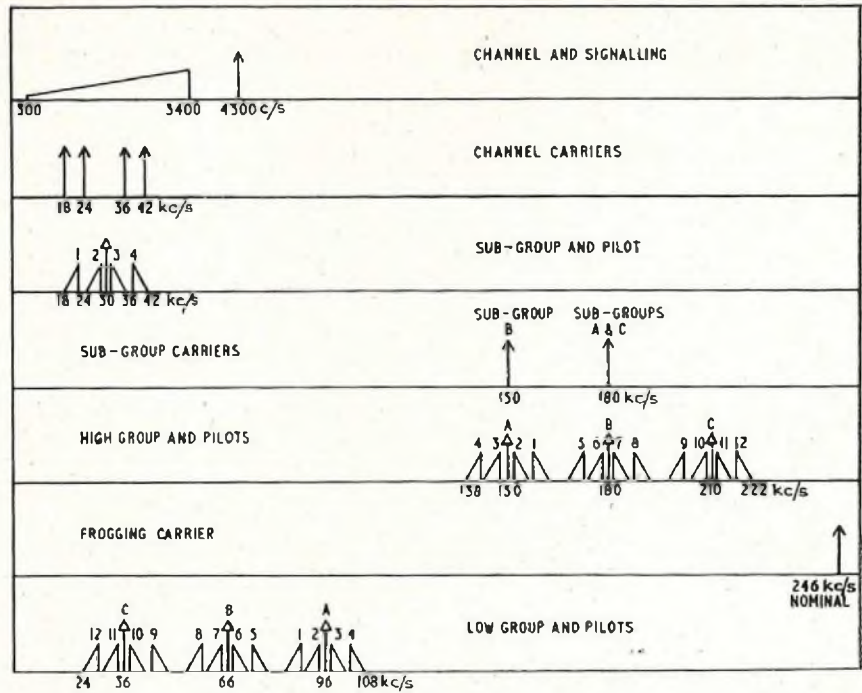

FIG. 3.—FREQUENCY ALLOCATION.

rack-side and on installation it requires only the connexion of a mains feed to the power distribution panel and of one h.f. and 12 audio quads plus signalling wires to the connexion strips. The terminal equipment and transmission panels on the line equipment are of 51-type construction. Ferrite pot cores are used for all filter inductors and for most of the carrier-frequency transformers.

Channel Equipment.

Channels are assembled initially into sub-groups of four at low carrier frequencies, and this, in conjunction with a channel spacing of 6 kc/s, permits the use of coil and capacitor channel filters of simple, economical and compact design.

The channel modulators (and demodulators), basically of the Cowan type, are modified as in Fig. 5 to permit the carrier supply to be multiplied to a number of modulators used in unbalanced circuits. Four-rectifier shunt modu-

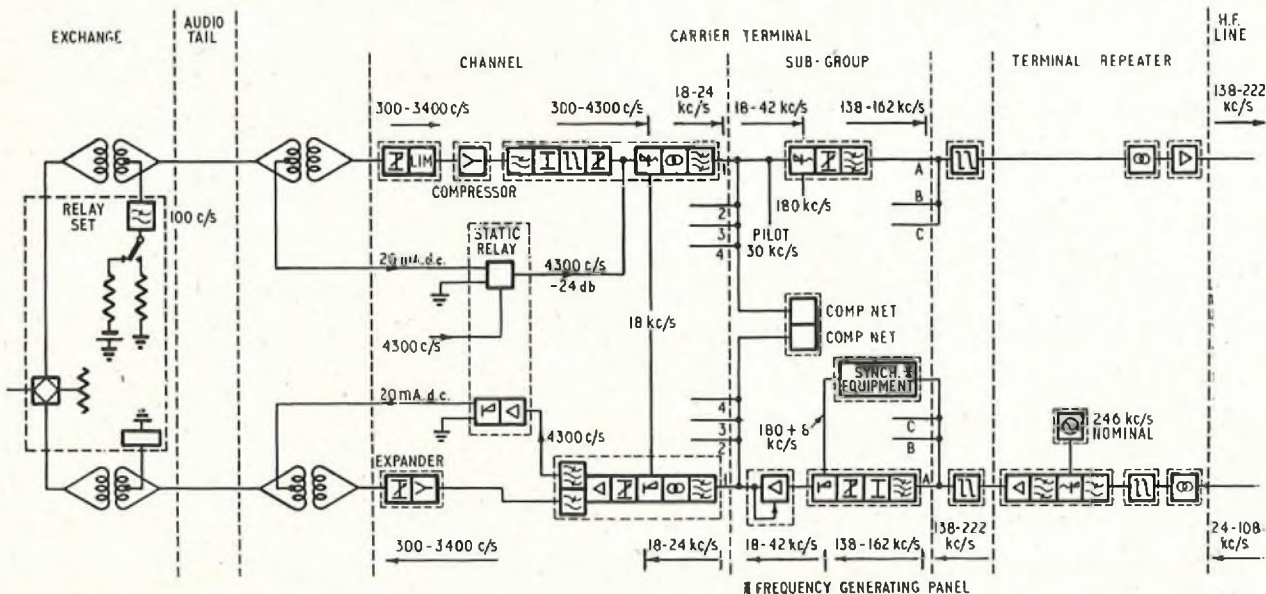

FIG. 4.—BLOCK SCHEMATIC DIAGRAM OF CARRIER TERMINAL.

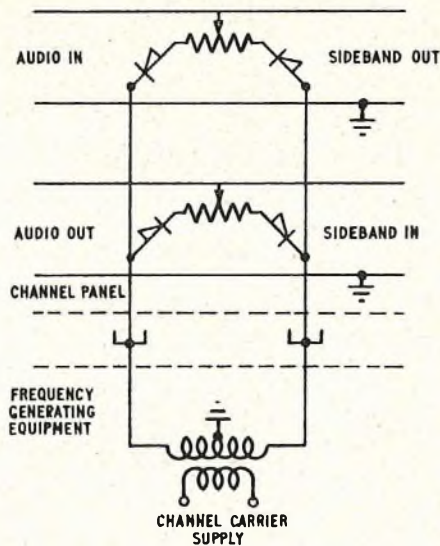

FIG. 5.—SHUNT MODULATOR FOR UNBALANCED CIRCUITS.

lators in unbalanced circuits would form direct couplings between all circuits connected to the same carrier supply. The centre-tapped carrier supply winding in Fig. 5 is balanced and tightly coupled so that negligible signal voltage (audio and sideband) from one circuit can appear across it and be injected into any other circuit connected across the same winding.

Separation of speech and signalling paths is effected by the low-pass filter following the compressor and the low-pass and band-pass filters in the channel amplifier output. This separation must not be destroyed by allowing distortion of the speech signal to occur after the paths are physically combined and so let speech energy into the signalling channel. Hence the channel modulator must be linear and may not be used for speech limiting as in the No. 7 carrier system, for example. A simple limiter, consisting only of a pair of unbiased rectifiers across the circuit, is placed at the beginning of the circuit followed by the compressor, which also has a limiting action on levels above test level, and then by the low-pass filter which has an attenuation peak at 4,300 c/s to remove distortion products near the signalling frequency. At the receive end, the low-pass filter eliminates the signalling tone from the speech path. Send and receive low-pass filters are of the same simple design, consisting of one coil and three capacitors.

The action of the expander doubles the level variations of the system; it doubles all contributions to the channel attenuation/frequency characteristic arising between the compressor and expander, as measured by single-tone signals. These contributions include those of the low-pass, channel and sub-group filters and the line frequency response.

Two channels of a sub-group use erect sidebands and two use inverted sidebands (see Fig. 3). Thus the sub-group pilot occupies a gap in the frequency spectrum and can be selected for a.g.c. or frequency synchronizing purposes by means of comparatively simple filters.

Three sub-groups are assembled by means of two carriers to form the high-frequency group (h.g.). Sub-group A is formed as the lower sideband of 180 kc/s, B as the upper sideband of 150 kc/s and C as the upper sideband of 180 kc/s. Thus the h.g. extends from 138 to 222 kc/s with pilots at 150, 180 and 210 kc/s. Two of the h.g. pilots have the same frequencies as the sub-group carriers; this has been arranged

as the basis of the method of frequency synchronization. Ring modulators are used in the sub-group stage and the filters are simple and compact.

The h.g. may be transmitted direct to line or, depending on the arrangements of a particular system, it may first need to be modulated to the low-frequency group (l.g.) in a frequency-frogging modulator using a carrier of 246 kc/s. Similarly, either h.g. or l.g. may be received from line but the h.g. is required at the sub-group stage. These requirements are met by using a standard line repeater at the terminal and strapping-out the modulating stage in the direction where it is not required.

Signalling.

Referring to Fig. 4, d.c. signals from the exchange relay set pass through a low-pass filter, to prevent interference with other audio circuits in the tail cable, and over an earth-phantom circuit to control a static relay in the carrier terminal. Direct current flowing in the static relay causes a tone at 4,300 c/s to be injected into the channel modulator at 10db below test level. At the receiving end, this tone is selected, amplified, rectified and the resulting d.c. transmitted over the earth-phantom to the exchange relay set. Means are provided for building out the resistance of the audio phantom circuits to standard values and for setting the levels of the injected tone and of the d.c. output. The simplicity of the signalling receiver is due to the use of a separate signalling path and to the constancy of the signalling tone level due to the use of a.g.c.

Automatic Gain Control.

Level control is achieved in two stages, (a) on line amplifiers at power feeding stations and (b) at the receiving terminal sub-group stage. It is, however, convenient to deal with both at this stage.

Line level control operates on the centre pilot (66 kc/s or 180 kc/s). A coil-and-capacitor filter selects the pilot at the output of a controlled line amplifier and derived d.c. is fed to the heater of a thermistor, the bead of which is in the feedback path of the amplifier. A modest level-compression ratio is used (3 db to 1 db), this being sufficient to keep the line level variation within the capacity of the terminal a.g.c. because the control is applied successively along the line.

Terminal level control operates at the receiving end on

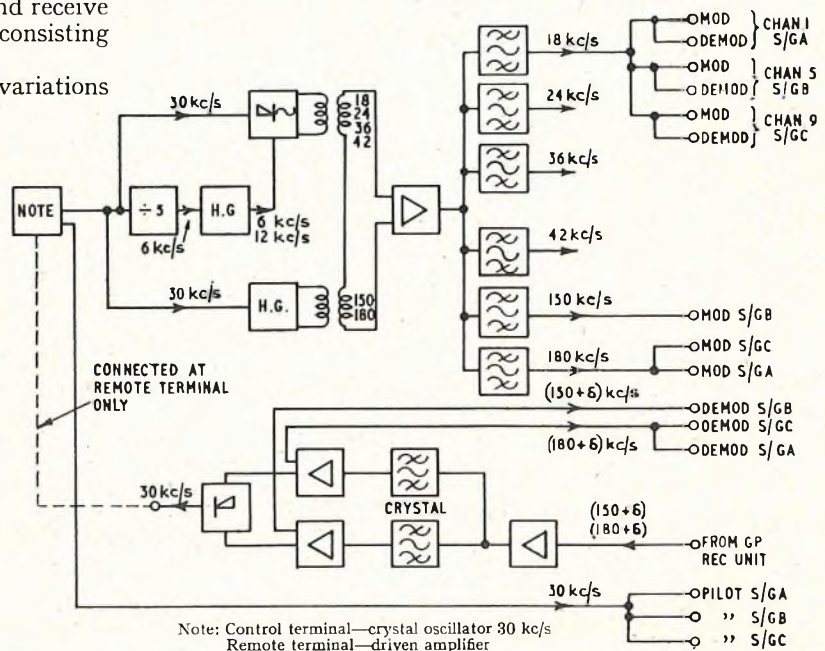

FIG. 6.—BLOCK SCHEMATIC DIAGRAM OF FREQUENCY-GENERATING EQUIPMENT.

each sub-group independently, using the sub-group pilot to control the gain of the sub-group amplifier. The pilot is selected at the amplifier output and d.c. derived from it is used to control the gain of the first stage of the amplifier in vari-mu-fashion. The level compression ratio is about 10 : 1 (in db). Anode relays give alarm indications when the input level deviates by more than ± 5 db from nominal, corresponding to ± 0.5 db variation at the output.

Frequency-Generating Equipment.

A block schematic diagram of the frequency-generating equipment is given in Fig. 6; it occupies a 3-unit panel and consists of a generating and a synchronizing unit.

At the Control terminal, the generating equipment contains, and is driven by, the 30-kc/s master oscillator of the system to produce the channel carrier, sub-group modulator carrier and pilot supplies. The method of generation shown in Fig. 6 was chosen in order to use the minimum number of valves. At the Remote terminal, the oscillator is replaced by a 30-kc/s constant-volume amplifier which is supplied with a 30-kc/s drive from the synchronizing equipment.

The frequency band received from line has a frequency error of a few c/s due to the net frequency error of the repeater oscillators, and although this error is not expected to exceed about 20 c/s a possible error of 80 c/s has been allowed for. The synchronizing equipment selects the nominal 150 kc/s and 180 kc/s pilots, amplifies them and feeds

them to the appropriate sub-group demodulators. Since the carrier and signal frequencies are in error by the same amount, in the required lower sideband output the error is cancelled. The synchronizing equipment also takes the difference between the two selected pilots, which is always 30 kc/s—identical with the master oscillator—and is used to drive the generating equipment at the Remote terminal.

A.G.C. is used extensively in this equipment in order to stabilize carrier supply levels.

Power Supplies.

Since the terminal was obviously going to contain a comparatively large number of valves, the CV850 (6AK5) was adopted as the standard valve wherever possible because of its 1W heater power. Larger valves had to be used for the signalling receivers, which are required to deliver 1W of output power, and in the sub-group amplifiers and frequency-generating equipment. The terminal rack dissipates about 400W and appreciable temperature rises occur.

The use of the CV850 valve sets the h.t. voltage of the rack at 180V, which was the specification figure at the time. The need to fit components to 51-type panels made it necessary to use two similar power units each giving 600 mA at 180V and 10A at 6.3V.

The rack was designed to operate from a stabilized mains supply.

(To be continued.)

Book Reviews

"Variable Resistors." G. W. A. Dummer. Sir Isaac Pitman & Sons, Ltd. 176 pp. 101 ill. 30s.

This is the second volume of a series of books being written by G. W. A. Dummer on the subject of Radio and Electronic Components. Like its predecessor, Vol. I, on Fixed Resistors, it sets forth a wealth of information on the subject which has not previously been collected together in a book published in this country. The layout is similar to that of Vol. I and certain of the more general information is common to both books.

All aspects of variable resistors are covered in considerable detail; specifications, materials used, and their characteristics, measurements of resistance and various other coefficients, the various types of variable resistors existing—general purpose, special purpose and precision—and features of their design, experimental types and some remarks on future developments. The book is written in a clear concise fashion with liberal illustrations and tables and includes a useful bibliography and a chart which compares the main characteristics, mechanical, electrical and climatic, of the various types of resistors.

The book has been written from the viewpoint of the user to enable him to choose the best component for his particular requirement and to understand its fundamental characteristics, and it achieves this object well.

I.P.O.E.E. Library No. 2405.

D. J. G.

"Engineering Mathematics." K. S. Miller. Constable & Co., Ltd. 417 pp. 89 ill. 47s. 6d.

The book opens with an account of determinants and matrices. The treatment is very brief; for example, only five lines are used to describe matrix multiplication. Yet this inadequate outline of matrix algebra is made to form the basis on which network theory is treated in a later chapter. The first chapter also contains a somewhat full discussion of the ideas of linear dependence; it is surprising, therefore, to find that the author does not show how easy it is to apply these ideas to the formation of the inner products of single-row and single-column vectors, and thereby demonstrate the non-commutative multiplication law which is the foundation of the theory of matrices.

The next chapter covers the special integrals defining Gamma Beta and error functions; there is also an elementary treatment of the sine-integral function and elliptic integrals. All these functions appear later in the book: for the Gamma and Beta functions are used in developing Bessel's equation, the error function appears in certain problems involving the Fourier integral, the sine-integral function arises in examining the transient response of the low-pass filter, while elliptic integrals appear in certain probability problems. After dealing with these special functions the author goes on to discuss some topics in linear differential equations not usually covered in a first course on differential equations. The methods of Frobenius are applied to the solution of the equations of Bessel, Hermite and Legendre; and the functions that arise are well described and illustrated.

Then follow chapters on Fourier Series and Integrals and the Laplace Transform. The functional analysis contains much to be admired: but it is a pity that the author has omitted to multiply the fundamental equation (8) on page 198 by the parameter S ; for then his function $F(S)$ would not have differed from $f(t)$ in dimensions, and those important cases where the easiest method of solution is direct integration become apparent immediately. These chapters contain many interesting applications to engineering problems; and answers to the exercises set for the reader are given at the end of the book.

The cream of this volume has been saved to the end and is offered in the form of a concluding chapter on random functions. It is the largest chapter in the book and contains nearly a hundred pages. The foundations of probability theory are discussed from the Kolmogoroff axiomatic point of view; probability is treated as a branch of measure theory, with its own special emphasis and field of application, and no attempt has been made to sugar-coat this fact. Thus the reader may find himself thinking about the unions and intersections of measurable point sets in some n -dimensional Borel sampling space. Nevertheless, this last chapter is by far the most valuable in the book and contains interesting treatments of stochastic problems that arise in the field of telecommunications.

This book can be recommended to those engineers who have a good mathematical background for there is much in it that will well repay careful study.

H. J. J.

Aerials for 4,000-Mc/s Radio Links

R. L. CORKE, A.M.I.E.E.,
and J. HOOPER, A.M.I.E.E.†

U.D.C. 621.396.677.833.2:621.396.65

After a brief discussion of normal radio propagation losses a simple explanation is given of the way microwave aerials function. A particular form of the paraboloidal reflector aerial is then described in some detail.

INTRODUCTION

MICROWAVE radio links are becoming increasingly used within the British communication network.¹ Systems with carrier frequencies at about 2,000 Mc/s, wavelength 15 cm, and at 4,000 Mc/s (7.5 cm) are in service for television relays and will be in use soon for multi-channel telephony. Descriptions have already been given in the Journal of microwave components,^{2,3} and waveguide principles,^{3,4} and this article describes the aerial system for a microwave link.

The forms that a microwave aerial may take are many, and depend upon the purpose of the aerial, the type of feeder used to connect it to the radio equipment, and the wavelength at which it operates. This article describes one type which has been developed in the Radio Experimental and Development Branch at Dollis Hill, but in so doing it outlines the principles that are involved and which are applicable to other forms of microwave aerial. The aerial to be described is one with a solid-metal reflecting surface having a profile in the form of a paraboloid and with a feed made of rectangular waveguide. The feed "illuminates" the reflector, which directs the energy to the distant receiver. The aerials for receiving and transmitting are identical. They have been designed for use in the communication band that extends from 3,800 Mc/s to 4,200 Mc/s.

FUNCTIONS OF AN AERIAL

The functions of an aerial are two-fold. The first is to radiate energy into space with a suitable distribution of energy in various directions of space for the particular duty for which the aerial is required. Thus, a broadcasting aerial would normally be required to radiate equally in all horizontal directions whereas an aerial for a fixed point-to-point service would be arranged to direct as much of its energy as possible towards the distant receiver. Similar considerations apply to receiving aerials as regards directional properties. The second function of an aerial is to match the transmitter to space, and it is obviously necessary to match the impedance of transmitter to feeder, feeder to aerial and aerial to space to obtain a maximum possible power radiation. In addition, the inherent losses of the feeder and of the aerial should be kept small.

Considering the two properties of directivity and impedance in more detail, it is first necessary to say what is meant by directional property. It is possible to take as a reference an aerial system that radiates energy equally in all directions. This is called an isotropic aerial. It cannot be constructed in practice, but it is nevertheless a convenient theoretical reference. If two such aerials were separated by a considerable distance (d) and free from any interfering effects of the earth's surface, the atmosphere and other objects, it would be found that the power received, P_r , would be inversely proportional to the square of the distance d separating the aerials and would be given by:

$$P_r = P_s / (4\pi d / \lambda)^2 \dots \dots \dots (1)$$

where P_s is the sent power and λ is the wavelength measured in the same units as d , and $d \gg \lambda$. Thus, the power ratio is inversely proportional to the square of the number of wavelengths separating the two aerials. Substituting a few figures into equation (1), the power ratio

for a typical microwave path length can be found. If $\lambda = 7.5$ cm (4,000 Mc/s) and $d = 48$ km (30 miles), then, for a sent power P_s of 1W, P_r would be only about $0.015 \mu\mu\text{W}$, i.e. a power level of -138 dBW.* That this is so small in the example is not because unrealistic figures have been taken, but because there are many wavelengths in the typical path length of 48 km. The received power can be increased in two ways, by increasing the sent power and by using aerials that can concentrate the available energy in the radio path. The first question to answer, however, is: what is the likely minimum tolerable received signal power? To answer this, it is necessary to know why $0.015 \mu\mu\text{W}$ is too small in the above example.

This is an important point. The limitation is set by noise self-generated in the receiver. This noise arises in two ways, the first due to thermal agitation noise in the input circuit of the receiver and the second due to noise generated in the valves of the receiver. Thermal agitation noise is caused by the random movement of electrons, which increases with temperature, and is therefore unavoidable in working equipment. Any resistor or conductor can be regarded as a generator of noise. The energy is proportional to absolute temperature, T , and since the noise is due to the random movement of many electrons, it is random in character and spread evenly over the spectrum so that the power is proportional to the bandwidth, B , in which the noise is being observed. The expression for the thermal agitation noise power is

$$W_N = KTB \text{ watts}$$

where the factor K is known as Boltzmann's Constant and is equal to 1.37×10^{-23} joules/degree, and the bandwidth B is in cycles/second.

In a superheterodyne receiver the thermal noise in both the signal and the image bands can penetrate to the i.f. amplifier so that in a bandwidth B , the noise will be $2 KTB$ watts. The noise inherent in the valves, mainly in the early stages of the receiver, can be reckoned by multiplying the noise $2 KTB$ by a numerical factor, called the noise factor, N_F , to give the total equivalent noise that appears to be present at the input to the receiver. The total noise is thus:

$$W_{NT} = 2 N_F KTB \text{ watts} \dots \dots \dots (2)$$

Numerical values will be, in practice, $N_F = 25$ (14 db); $B = 3$ Mc/s (for 405-line television); $T = 290^\circ\text{K}$ (17°C); which makes the equivalent input noise power,

$$W_{NT} = 0.6 \times 10^{-12} \text{ watts or } -122 \text{ dBW.}$$

This noise power is greater than the carrier power that would be expected when assuming 1W transmitted over 48 km with isotropic aerials. Clearly a large increase of carrier over noise is required to ensure that the signal/noise ratio is adequate. A useful margin would be 60 db which would require the received power to be 76 db greater than that obtainable with isotropic aerials and which would allow for the possibility of fading increasing the path loss by up to about 20 db.

The received power can be increased by increasing the transmitter power and by using aerials that can concentrate the available power. It is not possible to increase the sent

† The authors are Senior Executive Engineer and Executive Engineer, respectively, in the Radio Experimental and Development Branch, E.-in-C.'s Office.

* Decibels with reference to 1 watt.

power by 76 db above the assumed 1W; a few watts is the most that could be expected from existing valves. The necessary improvement in the received carrier level must therefore come from the aeriels.

The Relative Gain of an Aerial and Its Radiation Pattern.

It is fortunate that the same factor that makes path loss high (the small value of λ) also makes feasible the construction of an aerial with a reasonable size to have a large power gain with respect to an isotropic radiator. If two such aeriels were to be set up correctly, one for the transmitter and the other for the receiver, the path loss between isotropic aeriels would be reduced by the sum of the aerial gains. This is done in the aerial by constructing it in such a way that, unlike the isotropic aerial, the energy is radiated and received mainly along one direction.

Suppose it is possible to make an aerial which will radiate only along those radii of the sphere, Fig. 1, contained in the cone. If the whole of the energy previously radiated in an isotropic manner is confined to the cone and distributed equally over its circular base, the density will be increased in the ratio of the areas of the surface of the sphere and the base of the cone. Taking as an example a ratio of 10,000, and referring to Fig. 1 in which the circle is very small, $\pi r^2 \approx 4\pi R^2/10,000$, or $r \approx 0.02 R$. The plane apical angle of this cone is about 2.3° .

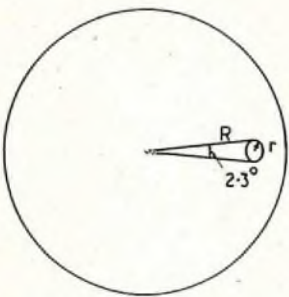

FIG. 1.—ENERGY FLOW CONFINED TO 1/10,000TH OF SPHERE.

The density of flow being 10,000 times that of the isotropic aerial, if the beam is directed towards the distant receiver the signal would be increased by 10,000 times, or 40 db as compared with the isotropic aerial, for the same total transmitted power. If the receiver is equipped with an identical aerial carefully lined up with the transmitting aerial, the total received power will be 80 db greater than when two isotropic aeriels are used.

It is not possible to make an aerial having the exact form of radiation pattern assumed, that is with no radiation except along the radii within the 2.3° cone. The radiation pattern corresponding to this ideal arrangement would be as shown in the dotted curve of Fig. 2. The shape of the

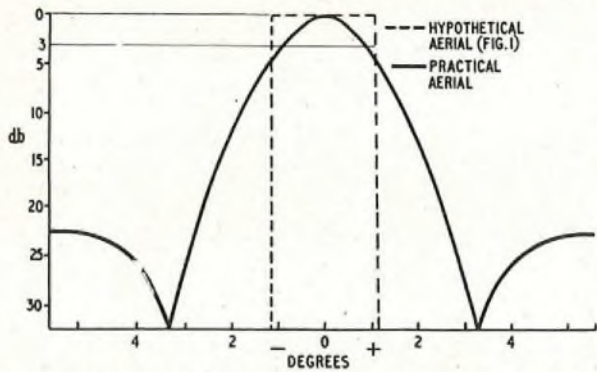

FIG. 2.—RADIATION DIAGRAMS OF HYPOTHETICAL AND PRACTICAL AERIELS.

radiation pattern that can be obtained in practice is like that of the full-line curve of Fig. 2. It could have the same relative gain on its axis as had the "cone" form, but it would radiate a small amount of energy in other directions as well, and the beam width would be somewhat less than the ideal aerial. The beam width of such an aerial is usually

understood to be the angular width between the points on the radiation diagram 3 db below the maximum response.

The explanations given above are somewhat simplified in order to present some general ideas connected with radio-path loss and with aerial gain with respect to the isotropic aerial. The numerical values of path loss and aerial "gain" used above are, however, quite typical. It is clear that what is loosely called "gain of an aerial" must be associated with the phrase "with respect to the isotropic aerial" because a passive device cannot produce a power gain. Nor must it be overlooked that in introducing equation (1) it was stated that the equation holds only for aeriels "separated by a considerable distance." For if the equation were used for distances d smaller than the wavelength λ , then P_R would exceed P_s , which is impossible. The reason for the breakdown of equation (1) for small distances is that it depends upon approximations that only hold when d is very much greater than λ .

Impedance Matching.

Impedance matching between equipment and feeder and between feeder and aerial is important. If the power reflected at each of these junctions is, say, 10 per cent of that incident, and if the feeder is loss-less, there will be a transmission loss of less than 1 db, but more serious, there will be a series of "echoes" radiated after 2, 4, etc., transits of the feeder. Thus, the first echo, for the assumed reflection coefficients of 10 per cent., has a power about 1/100th of the originating wave and is thus at a level only 20 db below the main signal. It is delayed by twice the transit time of a wave along the feeder, which may be many feet long*, and is therefore radiated many wavelengths behind the main wave. This sort of echo could cause serious distortion to a link carrying television signals and would introduce severe intermodulation distortion into multi-channel telephony signals. Fortunately, it is not too difficult to match much better than 10 per cent. Normal waveguide transmission loss, which is about 1 db per 100 ft at 4,000 Mc/s for copper waveguide, helps to reduce the relative level of the echo signals because the main signal traverses the feeder once only and the echoes more than once. In a 600-channel system operating at 4,000 Mc/s with one copper feeder 125 ft long, having a voltage-standing-wave ratio (v.s.w.r.) of 0.95 at each end, the intermodulation noise in the highest channel, due to this cause alone, would be -80 db relative to the signal level. The level of the noise would be -75 db for v.s.w.r. values of 0.93†.

Calculation of Relative Gain and Effective Path Loss.

It is necessary to be able to express the power gain of an aerial with respect to that of the isotropic aerial. If the effective area of the reflector is A_{eff} , the relative power gain is numerically:

$$G = 4\pi A_{eff}/\lambda^2$$

where λ is the wavelength measured in the same units as are the linear dimensions of area.

If two aeriels with numerical gains G_1 and G_2 are set up at a large distance d from each other and directed towards each other without any intervening obstacles, then the received power per watt transmitted would be:

$$P_{R1} = G_1 G_2 / (4\pi d / \lambda)^2$$

and with isotropic aeriels the received power would be

$$P_R = 1 / (4\pi d / \lambda)^2$$

* Feeders some 370 ft long are in use on the 4,000-Mc/s Isle of Wight television link at the relay station near Alton. The number of wavelengths in this feeder is 1,160. It is interesting to note that at the lowest frequency commercially used for radio (16 kc/s) this same number of wavelengths spans 13,500 miles.

† V.S.W.R. values of 0.95 and 0.93 correspond closely to voltage reflection coefficients of 2.5 per cent and 3.5 per cent respectively.

An aerial, diameter 10 ft, operating at 4,000 Mc/s with an effective area 60 per cent of its aperture would have a relative power gain of:

$$G \text{ db} = 10 \log_{10} (4\pi A_{\text{eff}}/\lambda^2)$$

where $A_{\text{eff}} = 0.6 \pi (152)^2 \text{ cm}^2$; $\lambda^2 = 7.5^2 \text{ cm}^2$. From which $G = 40 \text{ db}$ (nearly). Two such aerials properly aligned and separated by a distance of 48 km would have between them a total transmission loss

$$L = 10 \log_{10} (4\pi d/\lambda)^2 - 2G = 58 \text{ db.}$$

Thus, for 1W transmitted, the received power for normal propagation conditions, that is when equation (1) holds, would be -58 dBW or $1.6 \mu\text{W}$.

The above discussion has been made in terms of an aerial whose form and method of operation are as yet unspecified. In the next section a particular form of aerial is described that is used in several Post Office microwave installations.

PARABOLOIDAL REFLECTOR AERIALS*

The type of mirror most frequently used in microwave systems is the paraboloidal reflector. In Fig. 3 (a) a

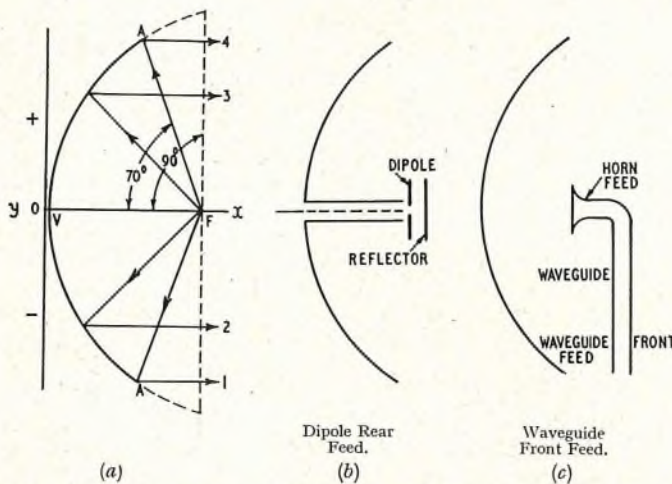

FIG. 3.—PROPERTIES OF PARABOLA AND METHODS OF FEEDING AERIAL.

parabola is shown against x and y axes with the vertex V at the origin of the co-ordinate axes. The equation of the curve as shown is given by $y^2 = 4fx$ where f is called the focal length and is the distance between the focus, F , of the parabola and the vertex, V . The shape of the paraboloidal mirror, or dish as it is sometimes called, is generated by rotating the parabola about the x axis. Any rays originating from a point source located at the focus, F , are reflected parallel to the x axis, as shown in Fig. 3 (a) with rays numbered 1, 2, 3 and 4. Furthermore, the lengths of these rays between the focus and the aperture AA are all equal, so that the phase of the radiation is uniform over the aperture. Thus, in the case of a transmitting aerial the radiation is projected along the x axis, whilst in the case of a receiver the plane-wave radiation arriving at the aerial is gathered over the area of the aperture and concentrated at the focus with all components in phase.

For a given focal length the dish may be designed to embrace a wide or narrow cone of radiation from the focus. In Fig. 3 (a), for example, the edge of the parabola is shown as subtending an angle of 70° at the focus, whilst shown dotted is an extension of the curve subtending an angle of 90° . Reflectors corresponding to these shapes are described as "70 degree" and "90 degree," respectively. The choice of angle generally ranges between 60° and 90° and depends upon factors discussed later.

Devices for illuminating the reflectors are described as

"feeds," and are generally one of two types, either a dipole or a form of waveguide horn. Such feeds may be mounted coaxially with the dish or in front of it and are known as "rear" and "front" feeds respectively. Fig. 3 (b) illustrates a dipole rear feed and Fig. 3 (c) a waveguide-horn front feed. With a rear feed, a small auxiliary reflector is necessary, as shown in Fig. 3 (b), to make use of the forward radiation, which would otherwise be undirected, hence improving the efficiency. A dipole front feed would also require an auxiliary reflector. From the point of view of bandwidth, the waveguide front feed is the best combination because it does not require the use of an auxiliary reflector, which would tend to cause the impedance of the feed to vary rapidly with frequency.† The penalty paid with the front feed is the greater difficulty of providing a stable mechanical support across the aperture of the dish, without blocking the aperture excessively.

The feed should, ideally, radiate a perfect spherical wave for maximum gain, that is, the feed should act as a true point source located at the focus of the dish. A practical feed has the dimensions of about half a wavelength, however, so that the wave radiated from the feed is not spherical, hence the radiation is not brought to the aperture uniformly. The non-uniformity is least and the gain a maximum when the feed is located with its "phase centre" at the focus of the paraboloid; the phase centre can therefore be thought of as a mean starting point for the rays. For a dipole and reflector the phase centre is about midway between the dipole and reflector, and for the waveguide horn between the horn aperture and the throat of the horn.

The choice of angle for the dish depends primarily upon the feed and vice versa. Supposing, for example, that the feed itself radiates non-directionally. Then the dish would be substantially uniformly illuminated and its whole area would be effectively used as a reflector, Fig. 4 (a). In contrast, a highly directional feed, Fig. 4 (b), would illuminate only a part of the area of the dish and its effective area and hence its gain would be lowered. On the other hand, a uniformly illuminated dish must necessarily be accompanied by loss of power due to "spill-over" at the edges of the dish. The gain of the aerial measured at the feeder would therefore be somewhat below the theoretical maximum. A working compromise between efficiency of illumination and spill-over, to give highest overall efficiency and gain, is a feed whose illuminating power drops by about 10 db at the edge of the dish relative to the power at the dish vertex (see Fig. 4 (c)). This form of tapered illumination has an advantage, in that the amplitude of the unwanted side lobes in the polar diagram is decreased relative to the major lobe. The gain of such an aerial is slightly below the theoretical maximum, and it is usually 60 per cent efficient, i.e. its relative power gain is about 2 db less than the theoretical maximum.

By suitable design it is possible to produce a waveguide-type feed with the 10 db points of its polar diagram anywhere between, say, $\pm 20^\circ$ to $\pm 90^\circ$. In practice, the 90° type of feed and dish are preferred, first because for a given size of aperture the focal length increases with decreasing angle, thus making the problem of maintaining mechanical rigidity between feed and dish more difficult, and secondly, because a less directional feed intercepts less energy reflected from the dish, and there is a consequent improvement of the match. The mismatch due to the

* Generally throughout the remainder of this article the aerial will be described as if it were a transmitting aerial. The receiving aerial is always the converse.

† Briefly, this variation of impedance with frequency can be regarded as being caused by multiple reflections. When the source and point of reflection are electrically close the variation of impedance with frequency is slow, i.e. the bandwidth is great; when separated by some distance the variation of impedance with frequency is rapid and the bandwidth is small.

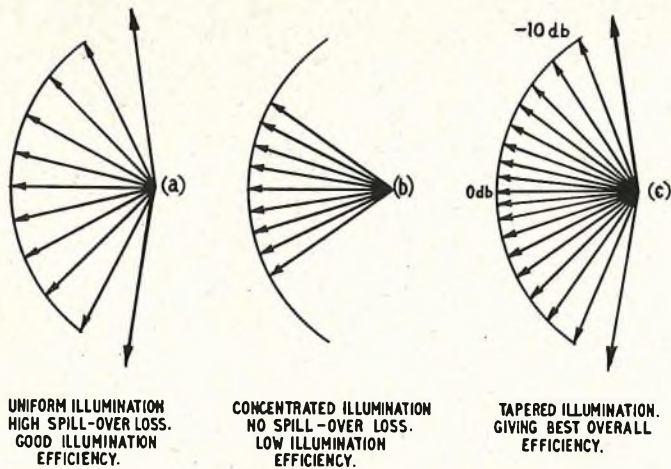

FIG. 4.—THE ILLUMINATION OF A DISH BY THE FEED.

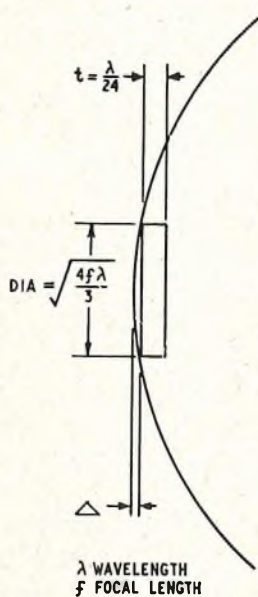

FIG. 5.—THE VERTEX MATCHING PLATE.

pick-up by the feed may be alleviated by using a "vertex matching plate." The use of this plate is illustrated in Fig. 5, where a circular flat plate is shown, in cross-section, placed over the vertex of a dish. The thickness of the plate (about $\lambda/24$) and the space Δ are chosen so that the radiation reflected from it, back into the feed, is opposite in phase to that collected by the feed from the remainder of the dish. By adjusting the size of the plate to a diameter of about $\sqrt{4f\lambda/3}$ the amplitude is such that almost complete neutralization may be obtained, which holds over a fairly wide frequency band. This expression for the diameter of the plate shows that for a dish with a small angle, and hence a long focal length, f , the size of the vertex matching plate has to be larger, in order effectively to decouple the dish and feed.

It was stated previously that the area efficiency obtainable was normally about 60 per cent. The factors which cause the 40 per cent loss are:—

- The illumination/spill-over compromise, which accounts for about 25 per cent of the loss.
- The phase errors, due to the presence of the vertex matching plate, the finite size of the feed, and errors in the contour of the dish. These phase errors probably account for 5–10 per cent loss, making, in conjunction with (a), a potential efficiency of 65–70 per cent.
- The blocking of the aperture by the feed mounting, which casts a shadow. Its effect may be approximately assessed by considering the obstacle to represent an aerial whose gain corresponds to its shadow area, but which radiates in phase opposition to the dish. The total power radiated by this representative aerial is equal to the power which is blocked off by the obstacle. For example, suppose the feed mounting across the aperture of a 115-in. diameter dish consists of a piece of metal $1\frac{1}{2}$ in. wide by 115 in. long. Then the ratio of power gain of the

obstacle to the power gain of the dish is the ratio of their areas, that is $(1.5 \times 115)/(115^2 \times \pi/4) = 0.0165$. Similarly, assuming the original field at the aperture to be uniform, the ratio of power blocked off to the original power transmitted is 0.0165. The ratio of power delivered at a distant point by the obstacle and the unblocked aerial is therefore 0.0165^2 and the ratio of their field-strength is 0.0165. Since these two fields are in phase opposition the relative combined strength will be $1 - 0.0165 = 0.9835$. The relative power will therefore be $0.9835^2 = 0.965$, corresponding to a further loss of 3.5 per cent. In a practical case the loss would be slightly greater than this because the aperture field is more intense in the centre and hence the obstacle is more effective in blocking the aperture. The actual loss experienced due to blocking would, in this case, be about 5 per cent, and the overall aerial efficiency between 60 and 65 per cent. The obstacle will also radiate backwards into the dish and into the feed, where it appears as a mismatch. This mismatch effect may be mitigated by inclining part of the feed mounting, such as any bracing members that may be necessary, at an angle to the dish aperture. The radiation which would otherwise be reflected back as a uniform "bundle" into the feed is now mainly scattered sideways (see Fig. 6).

The testing of paraboloidal aeriels is, in some respects, more easily carried out than the testing of aeriels used at lower frequencies, provided a suitable testing site is available. In principle, the aerial under test is mounted on a turntable and the level of signal received from a distant transmitting aerial is measured relative to the maximum level when the test aerial is "looking" at the transmitter. The power gain of the aerial is measured by comparing the level of the received signal with that from a standard aerial of known gain mounted nearby. This aerial is usually a rectangular waveguide flared out to form a pyramidal horn, often called a "standard horn," since the gain is readily calculable. Difficulties can arise when the aerial under test is large, because there is a minimum test distance allowable between receiver and transmitter which depends upon frequency and the size of the aerial. This minimum distance is given by $2D^2/\lambda$, where D is the size of the aperture of the aerial. At a distance less than $2D^2/\lambda$ the aerial no longer appears as a point and the gain of the aerial varies cyclically with distance and frequency. As an example, at 4,000 Mc/s a 10-ft aerial would require a test site 800 ft long, whilst a 15-ft aerial at the same frequency would require 1,800 ft. Sites with clear ground over distances such as these are not difficult to find, but to obtain results that are not sensitive to frequency, it is necessary to avoid reflections from the ground and neighbouring objects like trees and houses. Both aeriels should be mounted so that their beams are well clear of the ground, which might require expensive tall towers for the longer distances. Alternatively, the ground reflections can be absorbed at the point of reflection, or measurements can be made at various heights to enable ground reflections to be measured and allowed for.

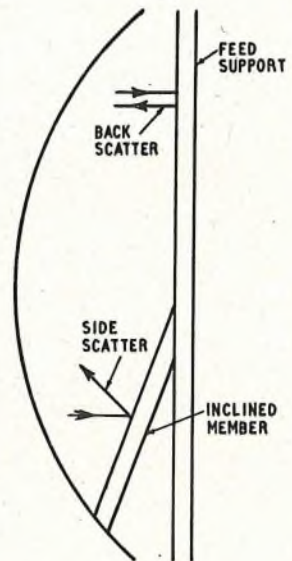

FIG. 6.—OBSTRUCTION BY FEED SUPPORT MEMBERS.

AERIAL, DISH, No. 1

A practical form of a microwave aerial will now be described. This aerial, shown in Fig. 7, comprises a 115-in. diameter, 90° paraboloidal reflector and supporting framework, with a front waveguide feed and feed mounting. The waveguide feed was designed in 1949 to suit a 7-ft diameter 90° reflector, which was then readily and cheaply available, the feed being suitable for any size of 90° reflector for use in the band 3,800 to 4,200 Mc/s.

The Waveguide Feed.

The waveguide feed is illustrated in Fig. 8. It consists basically of a piece of 2½-in. by 1½-in. rectangular brass waveguide fitted with a connecting flange. Since the radiation pattern of an open-ended piece of waveguide is too directive to illuminate a 90° dish effectively, particu-

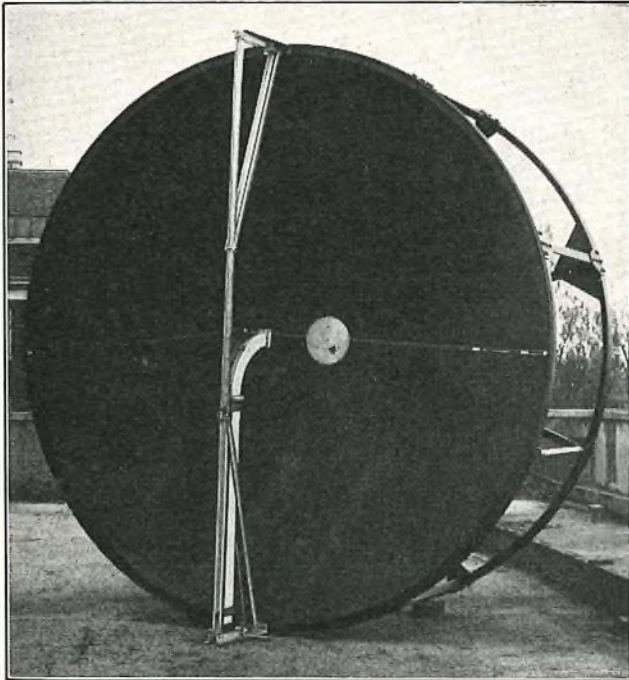

FIG. 7.—PARABOLOIDAL AERIAL 10 FT IN DIAMETER WITH FEED AND VERTEX MATCHING PLATE.

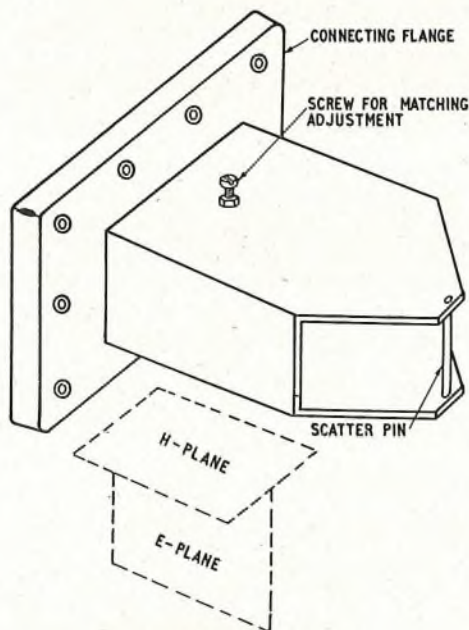

FIG. 8.—WAVEGUIDE FEED.

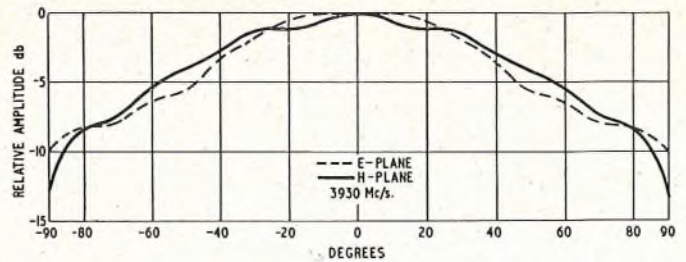

FIG. 9.—AMPLITUDE OF RADIATION FROM WAVEGUIDE FEED.

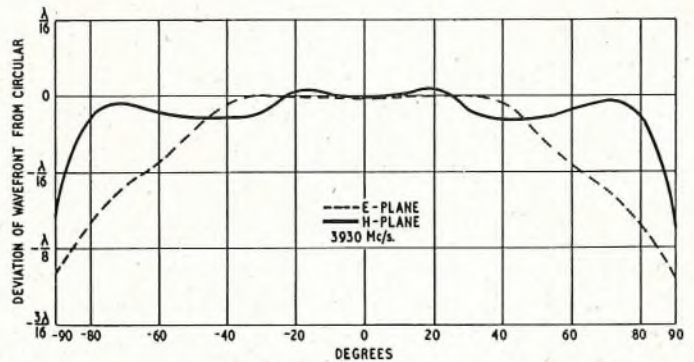

FIG. 10.—PHASE CHARACTERISTICS OF WAVEGUIDE FEED.

larly in the H-plane³ (parallel to the magnetic field), the corners of the waveguide end have been cut off and a $\frac{1}{16}$ -in. brass pin secured into position as shown in Fig. 8. These two modifications to the open-ended waveguide have the effect of broadening the beam from the feed so that the illumination of the dish is close to optimum (see Fig. 9). The pin also has the effect of improving the matching of the waveguide to free space over a wide frequency band. To complete the matching an 8-B.A. screw and locknut are provided in the middle of one of the broad faces. Such a screw correctly located acts as a capacitance across the guide. Adjusting its penetration enables the v.s.w.r. of the feed to be adjusted to better than 0.99 at a given frequency. For matching, the distance of the matching screw from the pin varies slightly with frequency, and it is the practice to place the pin in such a position that the best match occurs at the mid-band frequency of the system in which the aerial is to be used. When the feed is matched at 4,000 Mc/s the v.s.w.r. drops to about 0.95 at 3,800 Mc/s and at 4,200 Mc/s.

In addition to the amplitude characteristics of the radiation from the feed in various directions, the phase characteristic is important. As mentioned earlier, a point-source feed is the ideal because it would radiate a perfectly spherical wave. To find the phase characteristic of a feed the phase of the wave emerging from the feed is compared with that of a spherical wave. In practice this is done by rotating the feed about its nominal phase centre and measuring the change in phase at a fixed receiver. The phase characteristic determined in this way for one plane in the sphere is shown in Fig. 10, where the deviation of the wavefront from circular is given in terms of fractions of a wavelength at a frequency of 3,930 Mc/s in the E and H planes. It will be seen that the phase error just exceeds $\lambda/8$ in the E plane at the edge of the dish. A phase error of this kind would result in a loss of gain of 6 per cent if the error occurred in both planes. Since, however, the phase is substantially uniform in the H plane, except at the extreme edges of the dish, the loss of gain due to these phase errors may be assumed to be more nearly 3 per cent.

The parts of a waveguide feed assembly, as shown in Fig. 7, consist of a straight length of waveguide secured to the feed mounting by adjustable clamps, a large-radius

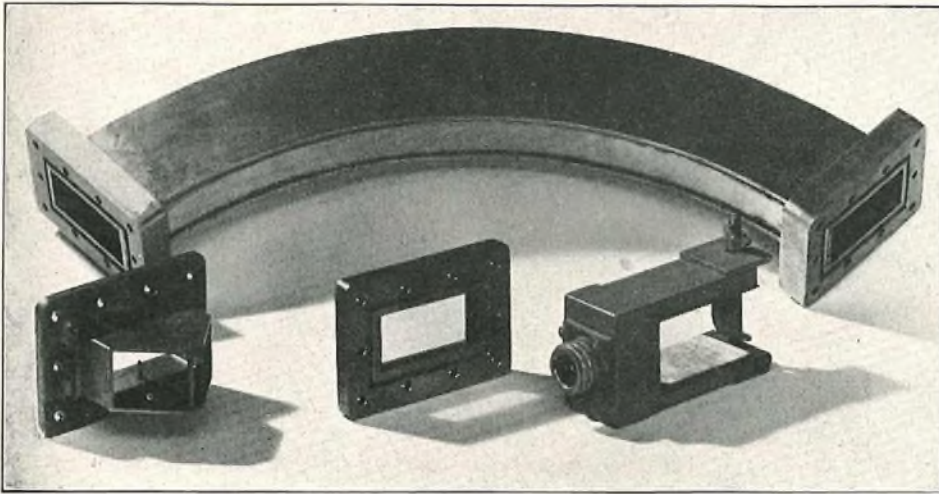

FIG. 11.—PARTS OF WAVEGUIDE FEED. (LEFT TO RIGHT) FEED, WINDOW, HEATER, (AT BACK) WAVEGUIDE BEND.

waveguide bend, which is held by locking clamps to a rectangular support plate, a waveguide window and the feed itself. The bend, window and feed are shown in Fig. 11. The adjustable clamps allow the position of the feed to be moved so that the phase centre of the feed may be set at the focus of the dish. This adjustment is normally carried out mechanically by removing the feed and replacing it by a jig extending to the vertex of the dish. The rectangular support plate is stabilized by a stainless steel wire extending across the aperture, to ensure that there is negligible sideways movement of the feed during high winds. A relatively large-radius waveguide bend is used following the feed. This has a good match to the feed and to the straight waveguide. The waveguide window makes a weather- and pressure-tight⁴ seal at the end of the waveguide system, whilst allowing free passage of radio-frequency energy. It consists of two thin sheets of mica and a sealing ring held in a brass frame designed to be sandwiched between two waveguide connecting flanges. The thin copper strips along the shorter edges of the mica sheets have the effect of a shunt inductance in the waveguide to compensate the shunt capacity caused by the mica sheets, thus producing a v.s.w.r. for the window better than 0.98 over the band 3,800–4,200 Mc/s. In order to prevent snow and ice remaining in the waveguide feed, and thereby causing loss and mismatch, a small electric heater is mounted at the end of the waveguide bend. This heater is shown in Fig. 11. The electricity supply to the heater is 50W at 4V and is obtained from a mains transformer mounted on the aerial mast. The heater is intended to be operated by an automatic temperature-controlled switch.

The feed support consists of a piece of steel channel supported on each side of the dish rim by a pair of brackets. The channel is braced on each side of the dish by two L-section members, the lower pair of which are cut back to allow fitting of the straight waveguide feeder. As well as stiffening the structure these members also help to reduce the effects of aperture blocking. The lower brackets of the feed support carry a pair of steps to facilitate examination of the feed in service. For protection against corrosion the whole of the feed support is hot-dip galvanized. To reduce the risk of damage when handling, the straight length of waveguide feeder and its connecting flange do not project outside of the rim of the dish.

The Reflector and Supporting Framework.

The overall diameter of the reflector is 9 ft 11½ in., including the rim flange, and the diameter of the paraboloidal aperture is 115 in. The reflector is made of 10-gauge

aluminium built up from two semi-circular flat aluminium sheets welded across a diameter. The resulting flat disk is shaped by a spinning process, which consists of mounting a paraboloidal-shaped metal former on a spinning lathe together with the disk and pressing the disk against the male former with the end of a hand-controlled lever whilst the lathe is turning. When spinning one of these reflectors, the peripheral velocity of the disk approaches 60 miles/hour. Fig. 12 shows the spinning operation being carried out. This method of manufacture enables a reflector to be produced to close tolerances. The allowable deviations from a true paraboloidal shape specified for this reflector are $\frac{1}{32}$ in. for the



FIG. 12.—SPINNING A 12-FT DISH.

inner area up to 2 ft diameter, $\frac{1}{16}$ in. for an annular area between 2 and 7 ft diameter and $\frac{1}{8}$ in. for the remainder of the reflector.

To maintain the specified reflector tolerances, during handling and in service, the reflector must be held in a rigid framework. The framework consists essentially of three L-section hoops, two of which are bolted together with the rim of the reflector sandwiched between to form a T-section hoop, around the periphery of the reflector. The remaining hoop is connected by nine radial triangulated assemblies of L-section members to the T-section hoop, to form a rigid drum-shaped framework. In addition to the rim support the reflector is attached, on a 3-ft radius, to each of nine radial members, with special flush-mounted bolts to preserve the reflector contour. The hoops and radial members are of aluminium bolted together with galvanized nuts and bolts, and the whole assembly is painted for protection. The drum shape of the assembly, while not the most elegant shape, has proved very useful in the early stages of development, where frequent handling is necessary, because the aerial can be rolled by hand into position by two men and conveniently stood on edge or on its back. Later models have the shape of a truncated cone and are not so convenient to handle, though they are stronger. The type of mast-mounting for these aerials varies with requirements but the usual form is a three-point suspension, using three steel lugs welded to steel plates bolted into the back of the framework. This enables the

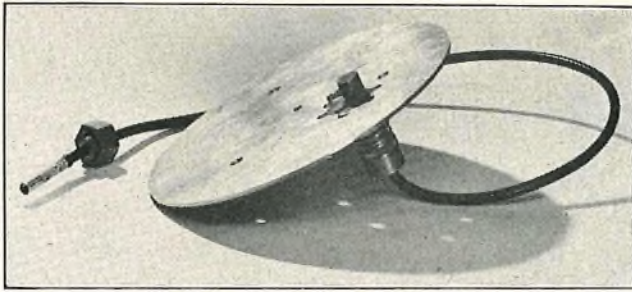

FIG. 13.—VERTEX MATCHING PLATE AND AERIAL MONITORING PROBE.

aerial to be pivoted in both the horizontal and vertical plane for accurate alignment. The total weight of reflector, framework and supporting lugs is 600 lb.

Referring to Fig. 7, it will be noticed that there is a hole in the vertex matching plate, somewhat offset from the centre. This is a locating hole for a weatherproof probe unit containing a crystal detector, shown together with a vertex matching plate in Fig. 13. When the aerial is used as a transmitter the energy sampled by the probe is rectified by the detector. The resulting d.c. is connected by a screened cable to a micro-ammeter on the control board, thus giving an indication of the level of radiated power. In a receiving aerial the hole is filled with a blanking plate.

Performance of Aerial, Dish, No. 1.

The measured gain of these dishes lies between 40 and 38.5 db at 3,930 Mc/s, that is, they have an area efficiency between 70 and 50 per cent. The spread in the measured values is mainly due to the limitations in measuring accuracy inherent in practical field-strength determinations and partly due to slight variations in the manufacture and assembly of the aerals. The beam-width of the aerals between half-power points is 1.75° in both E and H planes. Radiation patterns measured on a typical 10-ft dish at 3,930 Mc/s in the E and H planes are shown, respectively,

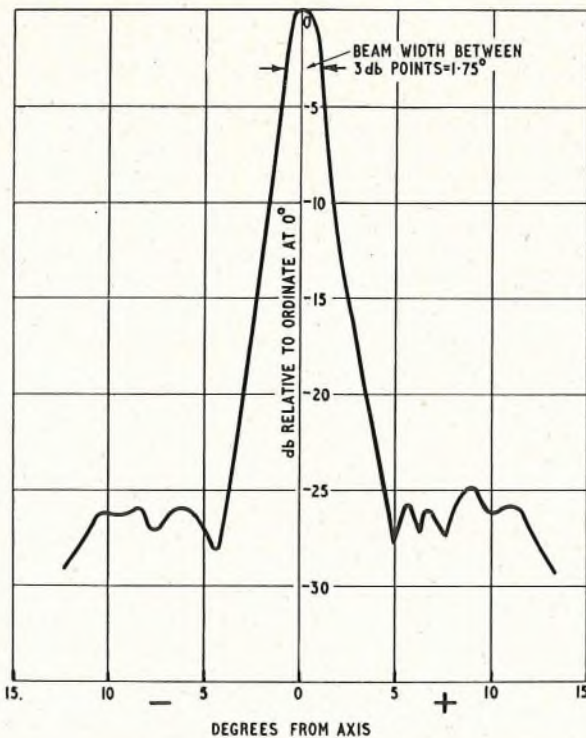

FIG. 14.—E-PLANE RADIATION PATTERN.

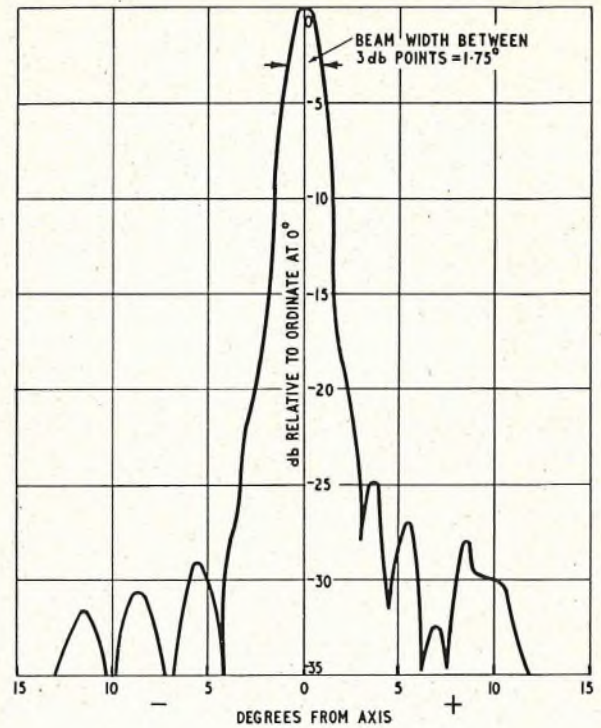

FIG. 15.—H-PLANE RADIATION PATTERN.

in Fig. 14 and 15. The asymmetry shown in the side lobes of the H-plane pattern is due to a low-level reflection from an obstacle near the test site, and off the line of shoot between transmitter and receiver, which has the effect of somewhat upsetting the side-lobe pattern on the right of the diagram. This asymmetry is less marked on the E-plane diagram because of the higher side-lobe level. The cause of the higher side-lobe level in the E-plane pattern is re-radiation from the feed mounting, as already explained. In both patterns the minimum between the main lobe and the first side lobes, which should occur in the region of $\pm 2.5^\circ$, is filled in. This is an indication of the presence of phase errors in the aerial.

When this aerial was first tested the feed was moved back and forth along the axis of the aerial whilst the gain was measured, in order to decide the optimum focusing position. It was found that near the position of maximum gain it was possible to move the feed over a range of more than a quarter of an inch without substantially affecting the gain. Closer examination showed that the H-plane pattern and beam-width improved with the feed moved toward the dish whilst the E-plane pattern and beam-width deteriorated. The opposite effect took place when the feed was moved away from the dish. This indicates that the position of the effective phase centre is different in the E and H planes. It is now the practice to adjust the position of the feed to obtain the best compromise between the E and H plane patterns. This means that there are necessarily small additional phase errors due to the slight defocusing in each plane.

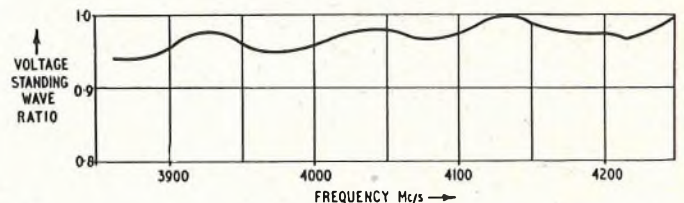

FIG. 16.—TYPICAL VOLTAGE-STANDING-WAVE RATIO OF AERIAL, DISH, No. 1.

Fig. 16 shows the v.s.w.r. of a dish measured over a range of 400 Mc/s. The v.s.w.r. falls just below 0.95 in parts of the band. Such a performance requires that careful attention must be paid to the design and alignment of each component part of the feed and dish. The sources of mismatch are:—

- The waveguide junctions between the components of the waveguide feed, four in number.
- The waveguide bend.
- The waveguide window.
- The feed.
- Interaction of feed and dish.
- Interaction of feed, dish and feed mounting.

The average value of reflection coefficient allowable to each of the above sources is less than 0.5 per cent (corresponding to a v.s.w.r. of better than 0.99), to meet the performance

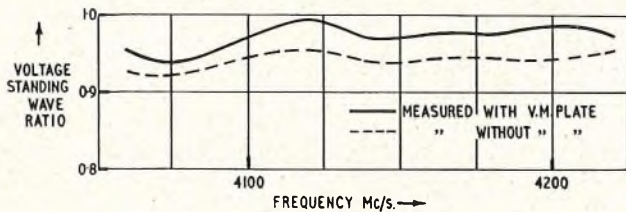

FIG. 17.—EFFECT OF VERTEX MATCHING PLATE.

shown. Fig. 17 shows how the effect of interaction between feed and dish has been reduced by use of the vertex-matching plate, by comparing the measured v.s.w.r. of a dish with and without the vertex-matching plate, hence showing that the measured v.s.w.r. has been improved from a mean value of 0.94 to 0.97.

ACKNOWLEDGMENTS

The mechanical development of the 10-ft diameter aerial described in this article was carried out in conjunction with Precision Metal Spinings (Stratford-on-Avon), Ltd., and the authors are indebted to Mr. C. L. S. Fraser for permission to reproduce, in Fig. 12, a photograph of a reflector on the spinning lathe.

References.

- CORKE, R. L., EPHGRAVE, E. V., WRAY, D., and HOOPER, J. A 4,000-Mc/s Radio System for the Transmission of Four Telephony Supergroups (240 Circuits) Part I. *P.O.E.E.J.*, Vol. 50, p. 106, July 1957.
- BRAY, W. J. A Survey of Modern Radio Valves, Part 6—Valves for Use at Frequencies above 3,000 Mc/s. *P.O.E.E.J.*, Vol. 43, pp. 148 and 187, July and Oct. 1950.
- FLOYD, C. F., and RAWLINSON, W. A. An Introduction to the Principles of Waveguide Transmission. *P.O.E.E.J.*, Vol. 47, pp. 63 and 153, July and Oct. 1954.
- HOBBS, J. G. A Pressurized Waveguide System. *P.O.E.E.J.*, Vol. 49, p. 52, April 1956.

Book Reviews

“Applied Electrical Measurements.” Isaac F. Kinnard and others. Chapman & Hall. 600 pp., 368 ill. 120s.

This is a reference book prepared by members of the instrument division of the General Electric Co., of America. It sets out to cover, in a broad way, the basic principles commonly employed in electrical measurement and their application to the measurement of electrical and non-electrical quantities. Attention is directed throughout to the practical aspects of the subject but sufficient theory is given for the principles involved to be understood and applied.

The first part of the book deals with the measurement of the usual electrical quantities ranging from current and potential difference to frequency and waveform. Chapters are also included on magnetic quantities, instrument transformers and telemetering. The treatment is directed more to the requirements of power engineers than communication engineers for whom some of the subjects, as for example bridge methods of measurement of electrical quantities, could with advantage be dealt with in much greater detail.

In the second part of the book, which deals with the measurement of non-electrical quantities by electrical methods, the field covered is extremely wide—light, heat, sound, statics, kinetics, liquids, gases and time—and the authors have, of necessity, to content themselves in many cases with an indication of the method involved.

The book is very well produced and the numerous excellent illustrations make it much easier to understand the text. It is a pity that some minor printing errors escaped detection and that some slight inaccuracies have been allowed to remain.

There is an unevenness in the treatment of the different subjects which may be due to the number of contributors or to the fact that an attempt has been made to cover an extremely wide field but this is a useful book to go to in the first instance and the very many references should prove helpful in following up points of interest.

E. F. H. G.

“Mathematics.” A. T. Starr, M.A., Ph.D., M.I.E.E. Pitman & Sons, Ltd. 547 pp. 239 ill. 45s.

This book, which appears in Pitman’s well-known Engineering Degree Series, has been specially written for students. It covers the syllabus of Mathematics Part I and II of the University of London B.Sc.(Eng.) Examination. It also covers the syllabuses of the Ordinary and Higher National Certificates

and is suitable for students preparing for the Graduateship Examination of the I.E.E. Consequently the book will be welcomed by students who seek an up-to-date and authoritative text.

The first three chapters of the book are devoted to a recapitulation of the algebraic theorems needed by the student: such topics as the solution of equations, partial fractions, Argand diagrams, trigonometric series, exponential and logarithmic functions with real and complex arguments, etc., are briefly discussed and illustrated by worked-out examples taken from recent examination papers. Then follow three chapters dealing with the calculus and differential equations; here it is apparent that the purely mathematical discussion has been cut to a minimum in order to give as much room as possible to the illustrative examples. This feature will appeal strongly to those students who like to prepare for an examination by working the greatest possible number of examples taken from past examination papers.

This book also contains chapters on probability and statistics, determinants and matrices, harmonic analysis, complex integration, as well as applied mathematics. In these chapters the fundamental theory is passed over very quickly and the discussion is largely based on the examples. The result of neglecting the basic theory is well illustrated in Chapter 14, which is concerned with the Heaviside Operational Calculus. Here the author, following Heaviside, introduces the operators p^{-1} (definite integration), p (differentiation), and e^{-px} (Taylor’s theorem), which he manipulates freely according to the rules of ordinary algebra; but he says nothing about the non-commutative properties of these operators and ignores the question of convergence. To interpret these operators the author inverts the Heaviside impulse integral and obtains the Bromwich contour integral; but, later in this chapter, when dealing with more complicated operators, he drops the p from the Heaviside-Bromwich formulation as if it were a matter of no mathematical interest; the result is that his function $F(p)$ now differs from $f(t)$ in dimensions and direct integration processes are no longer apparent. At this stage the student may begin to have doubts about the validity of the operational method; and these doubts will not be dispelled until he knows enough about the basic principles to prove for himself that a rigorous theory can be based on the definition of p^{-1} alone.

But these are minor criticisms. The main point is that this book can be recommended to the engineering student, who will find in it much that will repay careful study.

H. J. J.

An Improved Frequency Modulator for Broad-Band Radio-Relay Systems

I. A. RAVENSCROFT, A.M.I.E.E.†

U.D.C. 62.376.32:621.396.65.029.62

The linearity of a frequency-modulated oscillator is sufficiently improved by the use of a small amount of negative feedback for it to be considered as a modulator in radio-relay systems for at least 600 telephone channels. A method of minimizing distortion at high modulation frequencies is also described.

INTRODUCTION

THE use of frequency modulation in microwave systems for relaying multi-channel telephony or television signals has created the need for a frequency modulator having a very linear characteristic of frequency against applied voltage. The basic design of an intermediate-frequency modulator suitable for such systems has been described previously,¹ and a simplified diagram of that circuit is shown in Fig. 1. The circuit

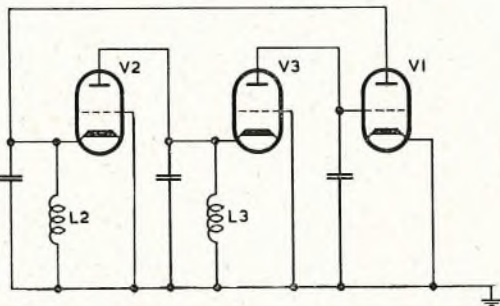

FIG. 1.—SIMPLIFIED CIRCUIT OF INTERMEDIATE-FREQUENCY MODULATOR.

functions as a resistance-capacitance phase-shift type of oscillator, the phase shift in the loop being determined by the phase inverter valve, V1, and its input impedance, plus the phase shift through the grounded-grid valves. The frequency of oscillation is given by the approximate formula

$$f = \frac{g_m}{2\pi C} \text{ c/s,}$$

where g_m is the mutual conductance of each of the two grounded-grid valves (assuming them to be similar) and C is the total circuit capacitance across the input of each grounded-grid valve.

The performance of this simple circuit has not been made sufficiently good to consider its use in 600-channel telephony systems designed to meet C.C.I.R. standards. The main limitations encountered are:

- the characteristic of mutual conductance of the valves used against grid voltage is not sufficiently linear, despite the high sensitivity of the circuit (at least 20 Mc/s per volt at 70 Mc/s in the circuit previously described), and
- as the modulation band increases, unless the carrier frequency is raised in proportion, the problem of separating the modulation frequencies from the radio frequency signal path in the oscillator loop becomes difficult.

The grounded-grid valves require some form of d.c. return from cathode to ground, and small inductances are used to provide low impedances in the modulation frequency band. Despite the precautions taken to minimize the values of these inductances and the mutual conductance of the valves, the linearity of the circuit deteriorates as the

modulation frequency is raised. Two modifications to the circuit have been introduced, which enable the performance of the modulator to be improved sufficiently for it to be used for 600-channel telephony.²

IMPROVEMENT OF LINEARITY

Examination of a typical valve mutual-conductance/input-voltage characteristic shows that it is not always possible or desirable to operate at the mutual conductance corresponding to the most linear part of the characteristic. Considering the typical triode mutual-conductance/input-voltage characteristic in Fig. 2 ($R_k = 0$), the optimum working point, as far as linearity is concerned, is at the point of inflexion, corresponding to a mutual conductance of 5.5 mA/V. The capacitance across the circuit can be

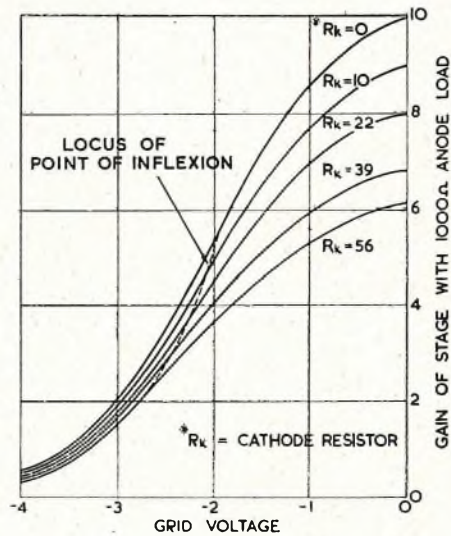

FIG. 2.—GAIN/GRID-VOLTAGE CHARACTERISTICS OF A TRIODE VALVE.

adjusted to suit this requirement, but, in the interests of reducing the working mutual conductance whilst maintaining sensitivity (the latter being inversely proportional to the capacitance), it is desirable to keep the circuit capacitance to a minimum. The application of a small amount of feedback over the valve circuit can have the desired effect of decreasing the value of the mutual conductance for optimum linearity. This feedback can be introduced either as voltage feedback, from anode to grid, or as current feedback by the insertion of a small resistor in the cathode circuit of the valve. The effects of various values of cathode resistors upon the apparent mutual conductance of a valve circuit are shown in Fig. 2; it can be seen that increasing the cathode resistor reduces the optimum working mutual conductance of the valve for this application. A value of cathode resistor can thus be chosen to give the most linear characteristic for a given value of mutual conductance.

REDUCTION OF DISTORTION AT HIGH MODULATION FREQUENCIES

The operation of the modulator circuit can be extended to accommodate modulation frequencies up to 2.5 Mc/s, or above, if the offending voltages developed across the

† Executive Engineer, Radio Experimental and Development Branch, E.-in-C.'s Office.

¹ RAVENSCROFT, I. A., and WHITE, R. W. A Frequency Modulator for Broad-Band Radio Relay Systems. *P.O.E.E.J.*, Vol. 48, p. 108, July 1955.

² Patent Application No. 38142/56.

cathode chokes are removed. Since, however, the reactances across the cathode circuits are required to be capacitive at the carrier frequency, a high-pass form of network is not practicable, and the impedance must inevitably rise to a peak at some frequency between the modulation and carrier frequency bands. The voltages can be reduced considerably in amplitude by applying additional voltages approximately equal in amplitude but opposite in phase. The voltages appearing across L3 through V3 in the basic circuit shown in Fig. 1 are automatically cancelled by the antiphase voltages developed in the anode of V2, since the load is common to both valves (assuming that to the load the valves appear as similar generators). Thus a differential adjustment of grid bias to the two valves would enable the necessary condition of equality of mutual conductance to be obtained.

To provide a similar form of cancellation in the cathode circuit of V2, the anode circuit of another triode of similar dimensions can be connected across the cathode choke L2. If the grid of the additional triode is connected to the grids of the working valves, the function of the additional valve in so far as modulation signals are concerned is similar to that of V2. The effect of the additional valve on the operation of the oscillator is mainly to increase the capacity across the cathode circuit of V2.

BASIC CIRCUITS OF THE IMPROVED MODULATOR

Basic circuits showing two possible ways of embodying the improvements in the modulator circuit are shown in Fig. 3 and 4. The first (Fig. 3) has a resistor, R, placed in

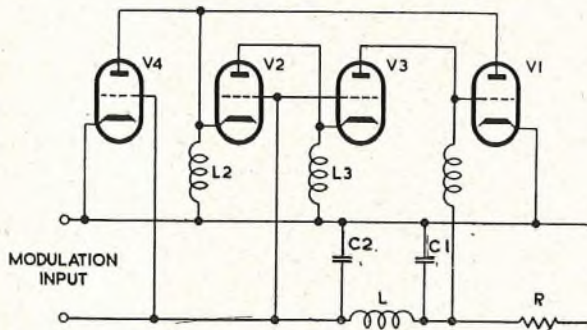

FIG. 3.—BASIC CIRCUIT WITH VOLTAGE FEEDBACK AND CANCELLATION.

the anode circuit of V3. Modulation voltages developed across this resistor are fed back through the low-pass filter, C1, L and C2, to the grids of the valves V2 and V3, providing the required amount of feedback (dependent upon the value of R). The capacitors C1 and C2 serve as decoupling reactances at the carrier frequency in the anode and grid circuits respectively. The valve V4 provides the required cancelling effect across the choke L2. This circuit suffers the disadvantage that the feedback is limited in frequency range by the low-pass filter and is consequently

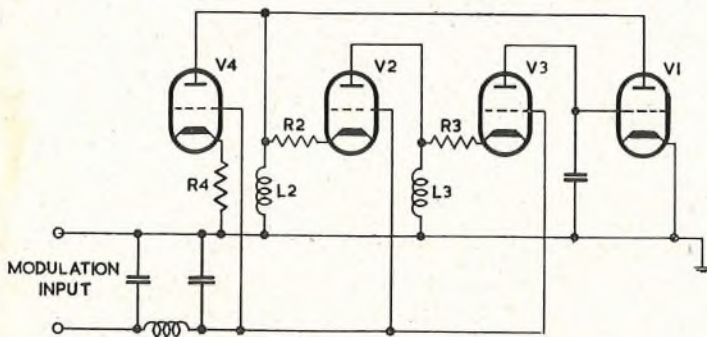

FIG. 4.—BASIC CIRCUIT WITH CATHODE FEEDBACK AND CANCELLATION.

dependent on the modulation frequency.

The second circuit, in Fig. 4, shows feedback introduced with cathode resistors, R2, R3 and R4, that are not bypassed. With this method the cancelling effects of V2 and V4 would nullify the feedback if their anodes were connected directly to the respective cathodes. This interdependent effect is avoided by connecting the anode to the junction of the cathode resistor and choke in each case. In this manner, modulation frequencies are developed across each cathode resistor giving the desired effect of the negative feedback, and at the same time the signals are cancelled out across each choke. The oscillating voltage is fed through the cathode resistor to the following valve, so that the simple basic formula is modified to the approximate form

$$g_m = (C_a + C_k)\omega + R C_a C_k \omega^2$$

where C_a is the anode plus stray capacitance of the previous valve, C_k is the cathode capacitance of the grounded-grid valve, ω is 2π times the frequency of oscillation and R is the feedback resistor. It can be shown, however, that the modified characteristic is such as to assist the effect of negative feedback in lowering the optimum working mutual conductance of the valve. The cancelling valve, V4, has a feedback resistor in its cathode circuit to make its operational characteristic similar to that of the other valves.

TYPICAL CIRCUIT

A circuit diagram of a typical frequency-modulated oscillator is shown in Fig. 5. Valves V2 and V3 function as the grounded-grid valves in the oscillator loop, with V1 as the phase inverter valve. Compared with the original circuit, modifications involve

- the use of the cancelling valve V4, with its anode circuit connected across the cathode choke of V2, and
- the inclusion of feedback resistors in the cathode circuits of the triodes V2, V3 and V4.

It will be noted that a triode is used as a phase inverter instead of the pentode that has been used in previous circuits. A triode operates under stable conditions in this circuit, as the reactive component of its anode load is capacitive. The CV408 triode that is used possesses the advantage of having less transit time than the normal pentode valve, enabling the circuit to operate more efficiently (in terms of deviation sensitivity).

For convenience in alignment, the differential bias to V4 is fixed and the d.c. grid voltages of V2 and V3 are adjustable to a limited extent, sufficient to allow the necessary equality of circuit conductances to be obtained. A fine adjustment for optimum linearity is provided by means of a small variable capacitor; variation of this capacitance alters the mutual conductance required for a given carrier frequency, which in normal practice is fixed by the automatic frequency control. The modulation signal is applied to the triode grids through a 75-ohm low-pass filter, one capacitive shunt arm providing the required decoupling of the triode grids at radio frequencies. The oscillator operates at a mean frequency of 35 Mc/s and is followed by a frequency doubling circuit (not shown in the diagram) to give 70 Mc/s, the standard intermediate frequency for broad-band microwave systems.

Operation at 35 Mc/s has the advantage that the oscillator functions in an isolated frequency band, the doubler stage providing good buffering action against possible interaction from other sections of the complete unit. The frequency multiplication involved increases the sensitivity of the oscillator as the deviation for the same applied voltage is increased proportionately. The linearity is thus improved because a smaller portion of the mutual-conductance/grid-voltage characteristic of the valve is required for a given deviation.

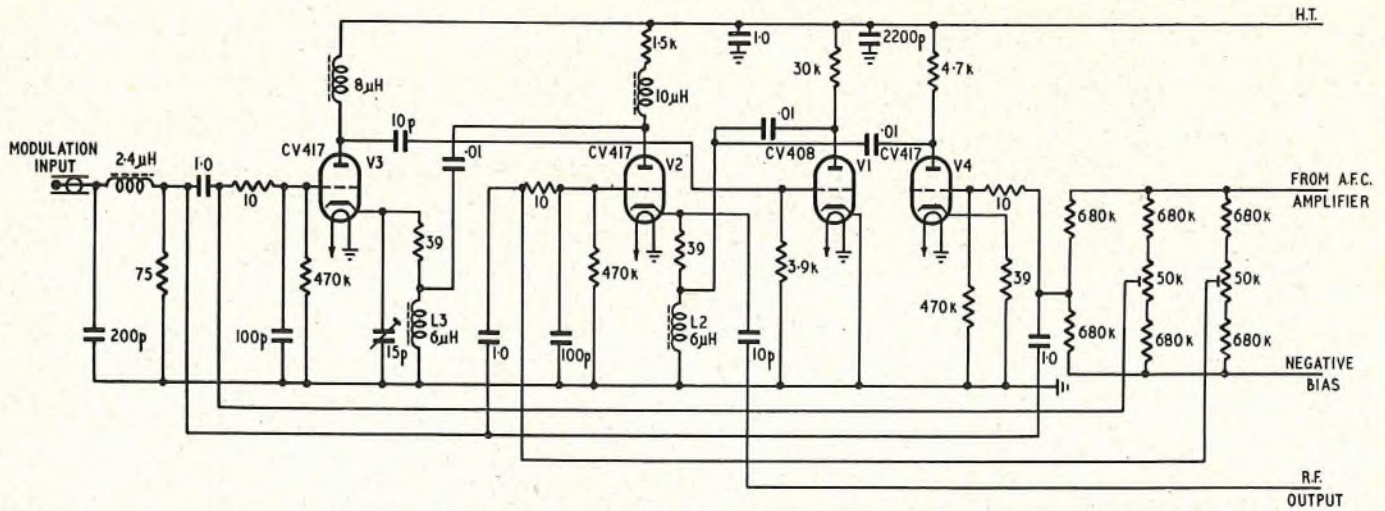

FIG. 5.—TYPICAL CIRCUIT OF FREQUENCY-MODULATED OSCILLATOR.

Operation directly at 70 Mc/s has some advantages, however, primarily that of increasing the ratio of the fundamental carrier frequency to the highest modulation frequency, and reducing the inductances of the cathode chokes. Such a method cannot therefore be overlooked in future designs.

The upper frequency limit of the oscillator is determined by the ratio of the phase inverter mutual conductance to the capacitance at its input, neglecting transit time effects, and is given by the formula

$$f_1 = \frac{g_{m1}}{4\pi C_3}$$

where f_1 is the upper frequency limit of the oscillator, g_{m1} is the mutual conductance of V1 (amp/volt) and C_3 is the total circuit capacitance across the grid of V1 (farads). Thus, the operating frequency can be extended by increasing this ratio by the use of a valve with a higher figure of merit and preferably also with a lower transit time.

PERFORMANCE

The modulation frequency response of the circuit of Fig. 5, measured in terms of deviation against modulation frequency at a fixed input level, is shown in Fig. 6. Up

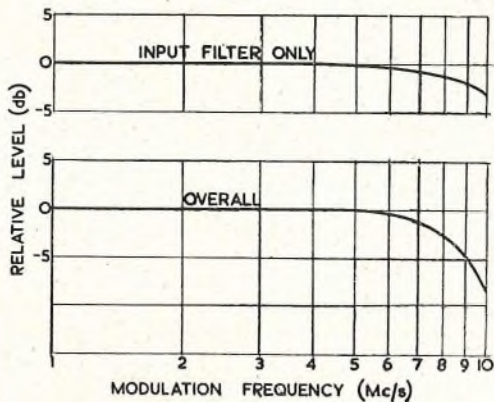

FIG. 6.—MODULATION FREQUENCY RESPONSE.

to 5 Mc/s the overall response is substantially constant and falls to -3 db at about 8 Mc/s. This fall in response is partially due to the input filter characteristic (shown separately), which could be extended if additional sections were included. However, the response is sufficiently broad to accommodate 960-channel telephone or 625-line television signals.

The sensitivity of the circuit, measured at 70 Mc/s, is approximately 25 Mc/s per volt; for use in a multi-channel telephony system, a level of -27 dbm* in 75 ohms (2 microwatts) is adequate to produce a r.m.s. deviation of 200 kc/s, which is the recommended deviation at test level.³ For television applications, an input level of 0.3 volt peak-to-peak is required to produce the recommended deviation of 8 Mc/s peak-to-peak.

The basic frequency modulation noise produced by the circuit has been measured to give less than -80 db relative to test level in any one channel, test level corresponding to a tone giving a r.m.s. deviation of 200 kc/s.

Measurements of intermodulation noise using random noise test equipment⁴ indicate that the circuit is suitable for use in 600-channel and possibly 960-channel systems designed to meet C.C.I.R. standards of performance.³ Waveform tests using sine-squared pulse and bar generating equipment⁵ show that the performance is adequate for the transmission of television signals.

CONCLUSIONS

Improvements to a frequency-modulated oscillator, described previously,¹ have enabled the performance to be extended sufficiently for the circuit to be considered as part of 600-channel telephony systems required to meet C.C.I.R. transmission standards. The circuit as a whole is straightforward and should prove reliable in service.

* Decibels with reference to 1 mW.

³ C.C.I.R., VIIIth Plenary Assembly, Warsaw, 1956.

⁴ WHITE, R. W., and WHITE, J. S. Equipment for Measurement of Inter-channel Crosstalk and Noise on Broad-Band Multi-channel Telephone Systems. *P.O.E.E.J.*, Vol. 48, p. 127, Oct. 1955.

⁵ LEWIS, N. W. Waveform Responses of Television Links. *Proc.I.E.E.*, Vol. 101, Pt. III, No. 72, p. 258, July, 1954.

A Small Quartz Clock with Transistor Drive

D. E. CRIDLAN, A.M.I.E.E.,
and J. E. THWAITES, M.I.E.E.†

U.D.C. 529.786:621.373.52:621.375.4

A small, "mantel-piece" quartz clock has been designed and assembled, using transistors instead of thermionic valves in the oscillator-drive circuit, frequency dividers and amplifier. This article describes the clock and gives details of its performance.

INTRODUCTION

THE quartz clocks used by observatories and frequency-standard laboratories are generally elaborate installations involving a fair amount of electronic apparatus. They consist essentially of:

- (a) a quartz vibrator of high precision, of frequency usually 100 kc/s,
- (b) elaborate arrangements for keeping the vibrator at constant temperature,
- (c) thermionic amplifiers and frequency dividers, and
- (d) means for comparing the frequency of the vibrator with other standards and for determining its frequency directly in terms of standard time.

A complete installation comprises three independent vibrators and means for intercomparing the frequencies of these vibrators by counting the beats between them. The installation may or may not incorporate a clock mechanism and time-indicating dial. Such an installation may readily be adapted to provide standard frequencies as well as accurate time intervals.

The quartz clock described in this article is not of this kind, but may fairly be described as a "mantel-piece" clock. Apart from the power source, it occupies a volume not greater than 120 in³, and it may be run from a small mains unit or from a battery. The power consumption is 45 mA at 10V and a mains unit to provide this power could readily be built into the clock case. For battery operation the size of the battery required will depend on how long a period of uninterrupted operation is required. Despite its small size, however, its time-keeping properties are comparable or superior to those of a chronometer.

DESCRIPTION OF CLOCK

Compactness of construction and economy of power are accomplished by the use of transistors, in place of thermionic valves, for maintaining the crystal in vibration and for frequency division and amplification. At the outset the object of the designer was to drive an ordinary 50c/s-mains clock movement from a crystal, and for reliability of operation it was decided that the process of frequency division, commencing with the crystal frequency and arriving at the final output frequency of 50c/s, should be accomplished in successive stages of division by 2. It followed that the frequency of the crystal would have to be (50×2^n) c/s, where n is an integer. To minimize the number of division stages, n would have to be as small as possible.

Since the rate of the clock will vary in sympathy with the crystal frequency, the crystal should have as low a temperature coefficient of frequency as possible. In the audio-frequency region, in which quartz flexural vibrators can be used, there are several types to choose from, namely,

- (a) straight bars vibrating in free-free mode, which might be NT-cut, duplex, or XY'-flexure bars,
- (b) gapped rings vibrating in free-free mode in the XY plane, and
- (c) tuning-forks vibrating in fixed-free mode, either Karolus type¹ or +5° XY'-flexure type.

† The authors are, respectively, Executive Engineer and Senior Executive Engineer, Radio Experimental Branch, E.-in-C.'s Office.

¹ KAROLUS, A. "A New Quartz Oscillator in the Frequency Range 1-20 kc/s." *E.T.Z.* Vol. 74, No. 5, pp. 136-140. March, 1953.

² DEUTCH, D. E. "Junction Transistor Switching Characteristics." *Transistors*, 1, p. 609. R.C.A. Laboratories, Princeton, N.J. March, 1956.

All these vibrators have parabolic frequency/temperature characteristics, the frequency reaching a maximum at a temperature, $T_0^\circ\text{C}$, known as the turnover temperature, and the curve of the relation between temperature and frequency being expressed by the equation

$$\frac{\Delta f}{f} = A (T^\circ - T_0^\circ)^2 \times 10^{-6} \dots \dots \dots (1)$$

where A is a constant of the order of 0.02 and of negative sign.

For minimum variation of frequency in such a vibrator the turnover temperature T_0° should correspond with the temperature of operation. It was considered that the lowest frequency of vibrator combined with the most suitable temperature characteristic could be achieved with a tuning-fork of +5° orientation vibrating in the XY' plane. The tuning-fork used has a frequency of 800 c/s; it is 70 mm long and is mounted in a glass envelope 113 mm long and 18 mm in diameter.

The circuit arrangement is shown in Fig. 1. The crystal oscillator is essentially a two-stage directly-coupled grounded-emitter amplifier with the crystal connected as a direct feedback path between the collector of VT2 and the base of VT1. The crystal has a high impedance and to assist in starting oscillation a resistance-capacitance network is connected in parallel with it as an additional feedback path. Oscillation builds up until the transistors are fully loaded and the output has a square waveform. A.V.C. is not used. Fine frequency adjustment is made by changing the setting of the preset capacitor C4 in series with the crystal.

The frequency of 800 c/s derived from the oscillator is divided in four successive identical binary stages, using junction transistors in a bi-stable circuit arrangement, to give the final frequency of 50 c/s. The component values are chosen so that satisfactory operation is obtained over a wide range of audio frequencies. The operation of this type of circuit is described by Deutch.²

The two outputs derived from the collectors in the fourth binary stage are in phase opposition, thus simplifying connexion to the push-pull amplifier. The mismatch offered by the low impedance of the amplifier is sufficient to upset the sure operation of the last binary stage and it is necessary to increase the input impedance of the amplifier with series resistors to ensure the certain operation of the combination. Large coupling capacitors are necessary in the amplifier stages to preserve the waveform and prevent loss of power.

The final stage employs two type-OC72 small-power transistors in a quiescent push-pull stage, and this circuit provides approximately 150 mW at 9V to the clock motor winding. The use of a centre-tapped motor winding avoids the necessity of including an output transformer.

The mechanical part of the clock consists of a standard commercial movement modified for low-voltage operation from a push-pull supply. The winding of the synchronous motor is on a single bobbin which is easily removed from the motor housing. For this clock it was rewound with 2,000 turns of No. 40 S.W.G. enamelled copper wire and centre-tapped. In its present form the clock indicates "12-hour clock time" and carries a seconds hand which completes one revolution per minute.

The construction is illustrated in Fig. 2. The crystal, transistors and other components are mounted on a

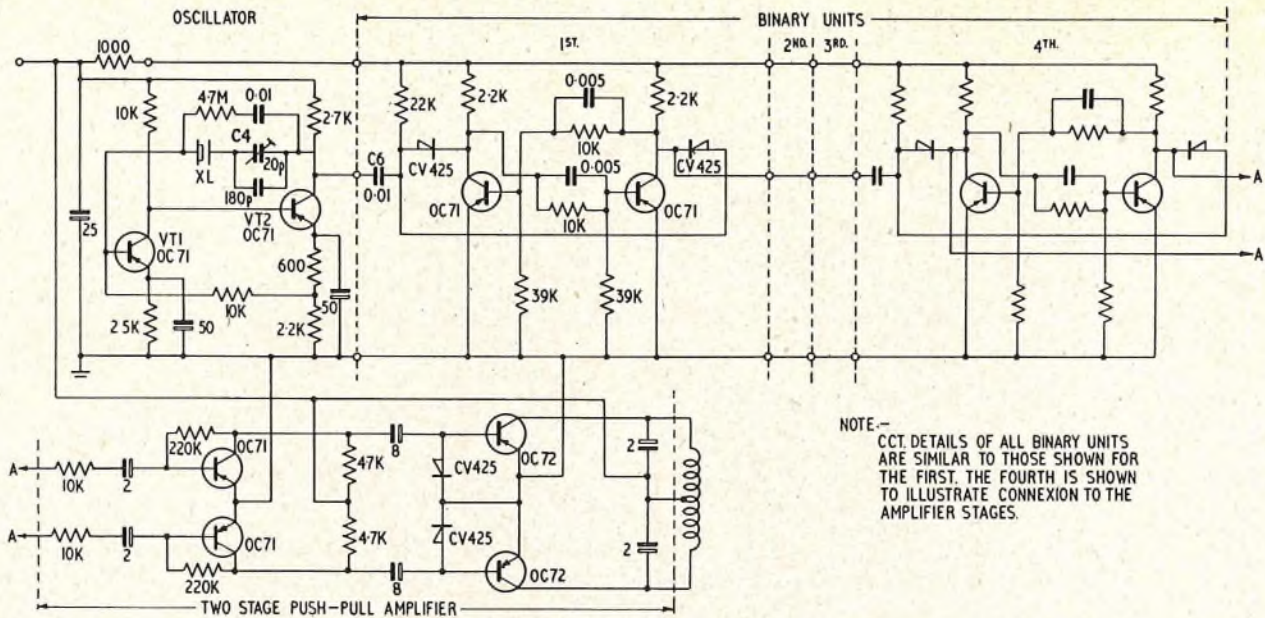

FIG. 1.—CIRCUIT OF QUARTZ CLOCK WITH TRANSISTOR DRIVE.

framework behind the clock movement, and the whole unit, with clock bezel but without any case, measures 5 in. × 5 in. × 4½ in. overall. The knob for adjusting the hands is situated on the under side of the movement. The preset trimmer for adjusting the crystal frequency is set by means of a screw-driver.

PERFORMANCE

The accuracy of the clock is dependent on the accuracy of the crystal frequency, and this in turn is governed by,

- (a) the precision with which the frequency can be set to its nominal value of 800 c/s,
- (b) temperature, and
- (c) drive level.

The crystal tuning-fork is adjusted during manufacture so that when operating in the drive circuit its frequency can be brought precisely to its nominal value by varying the capacitance connected in series with it. The maximum amount of adjustment possible in this way is of the order of 50 parts in 10⁶. In the present case the series capacitance

is variable between 180 and 200 pF, and the resulting frequency adjustment is some 8 parts in 10⁶.

If the crystal is subjected to temperature change, its frequency will change according to equation (1). For example, supposing that at the temperature T_0° , the frequency is adjusted exactly to its designed value, and the temperature falls or rises to a value 3°C below or above T_0 , then the frequency will fall by 0.18 parts in 10⁶ and in these conditions the clock will have a corresponding losing rate of 15.5 ms a day. This loss could be avoided by setting the crystal 0.18 parts in 10⁶ above its nominal frequency at T_0° .

The turnover temperature, T_0° , of the crystal used in the experimental model is 22°C, so that if the clock were operated at an average temperature of, say, 0°C the crystal frequency would be some 10 parts in 10⁶ low and the clock would lose about one second a day, unless an adjustment of about 10 parts in 10⁶ were made to the crystal to compensate. Greater accuracy could, of course, be achieved by mounting the crystal in a temperature-controlled oven, but this would complicate the installation and would impose a fairly heavy load on the power unit.

After constancy of temperature, the next most desirable feature of operating conditions is constancy of amplitude of vibration of the crystal. It has been observed that low-frequency crystals, vibrating in a flexural mode, are subject to change of frequency if the amplitude changes. In this apparatus the amplitude is a function of the battery voltage, and will decrease if the voltage falls. The effect will be to increase the crystal frequency gradually and to cause the clock to gain. A decrease of 10 per cent in battery voltage will bring about an increase of 2.5 parts in 10⁶ in oscillator frequency, with a corresponding clock gaining rate of about 1.5 sec a week. It is therefore important to use a battery of such a capacity as to sustain the normal continuous load of 45 mA for a sufficiently long period without a serious drop in voltage.

Superimposed on these factors is the effect of the "aging" of the crystal. This is generally characterized by an upward drift in frequency, which is most rapid immediately after manufacture and gradually diminishes. The total amount of frequency change to be expected during the first few months of operation is of the order of 5 parts in 10⁶.

In the laboratory a general accuracy of better than one second a week has been maintained, there being usually a

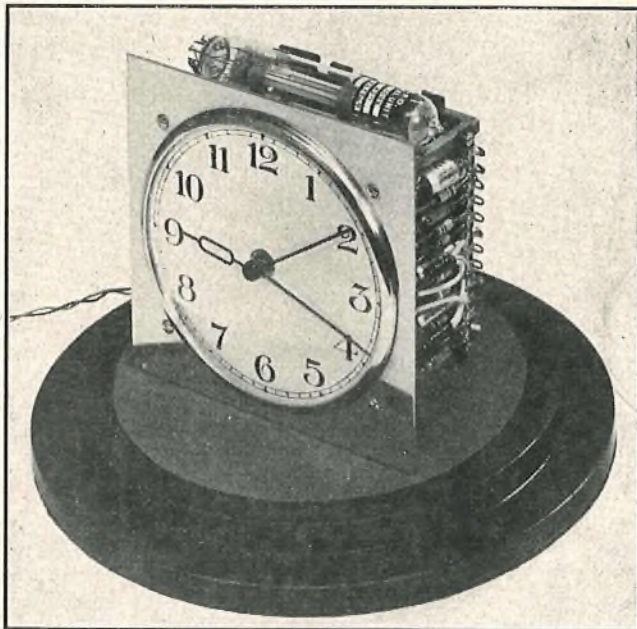

FIG. 2.—A QUARTZ CLOCK WITH TRANSISTOR DRIVE.

steady gain throughout the observed period. This gain is ascribed to the crystal's being still in its initial aging period, during which the frequency is drifting upward. Better results are expected when the crystal is fully aged.

FURTHER DEVELOPMENT

This small quartz clock has been assembled in order to determine the measure of simplicity and compactness that can be effected with transistor circuitry. The ordinary clock movement, intended for use on 50 c/s mains, is not necessarily the best component to employ as the time-indicating mechanism. In an electric mains clock plenty of power is available for its operation, and there is

no real incentive to improve the mechanical efficiency of the unit. For the present application a light motor, capable of responding to 400 or even 800 c/s, followed by a clock movement of the quality normally associated with a moderately priced pocket watch, might well result in the saving of at least two of the binary stages and the final push-pull amplifier. The final drive might then be derived from a push-pull amplifier of similar design to the present pre-amplifier. The saving of six and perhaps eight transistors and a similar number of crystal diodes would more than compensate for the additional cost of such a motor and movement, and the total d.c. current drain might well fall from 45 to 15 mA.

The New Telegraph Development Laboratory

U.D.C. 727.5:621.394

INTRODUCTION

SINCE the war the experimental work necessary to the expanded development program being undertaken by the Telegraph Branch of the Post Office Engineering Department has been carried on in premises at 100 Aldersgate Street. Recently this accommodation has been given up and the laboratory transferred to more suitable accommodation at 18-20 Crucifix Lane, S.E.1. Opportunity has been taken to improve the facilities available for the wide range of development work now required in connexion with such projects as the automatization of the telex service and the extension of telex subscriber dialling to other countries, the provision of new facilities for private renters, developments in connexion with overseas telegraph services and the introduction of new telegraph machines. The move to the new premises has been carried out in stages so as to minimize the disturbance to the work of the laboratory, but when the equipping of the new accommodation had been completed it was judged of advantage to open the laboratory to those most nearly interested and to demonstrate the type of development work on which the Telegraph Branch was now engaged. The visits were arranged to take place on the 8th and 9th August, preceded by a visit by the Engineer-in-Chief and other senior officers.

GENERAL DESCRIPTION

A description of the facilities and work undertaken in the telegraph development laboratory has appeared in an earlier article¹ and some reference to the long history of experimental and development work on telegraphy in the Post Office was also included in a recent article.² A short description of the present organization of the laboratory and of the more important work in progress is given in the following paragraphs.

The *Main Development Laboratory* (Fig. 1), of some 2,300 sq. ft., is equipped to deal with developments concerning switching equipment (e.g. automatic, manual and tape relay systems) and telegraph transmission equipment of all types. Opening off this laboratory is a store for accommodating specialized testing equipment and other plant which is not in daily use. Machine developments are carried on in another laboratory (Fig. 2) of some 600 sq. ft. which, in addition to the requisite bench space and testing equipment, provides the necessary machine tools (lathes, grinding machine, milling machine, drills, etc.) for the production of prototype precision parts for telegraph machines. Nearby is a soundproofed *Machines Life Test Room* (Fig. 3), for endurance testing all types of telegraph

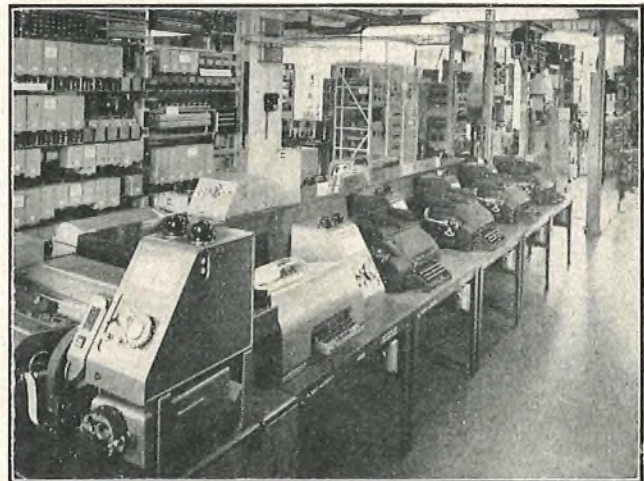

FIG. 1.—SECTION OF MAIN DEVELOPMENT LABORATORY.

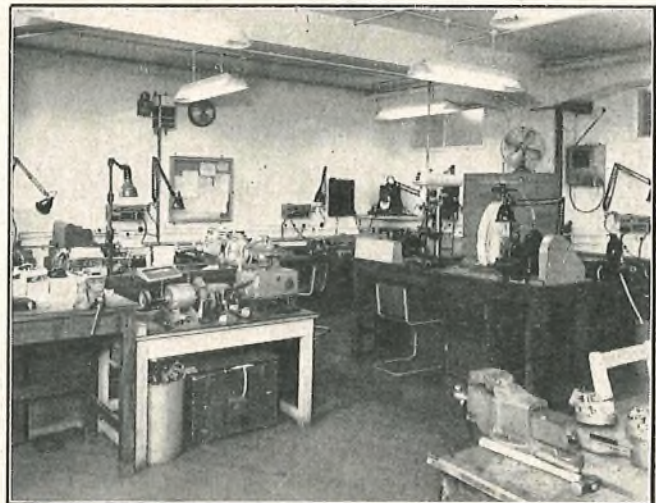

FIG. 2.—PART OF TELEGRAPH MACHINES DEVELOPMENT LABORATORY.

machines. A small *Demonstration Room* has been provided adjacent to the main laboratory; it may also be used for lectures when training staff on new developments, or as a small conference room.

Facilities additional to those provided by the main laboratories include a *Metalwork Shop* equipped with bending machine, drill, etc., and a *Woodwork Shop* supplied with suitable power-driven hand tools. There is also a *Wiring Shop* fitted with wiring benches and equipped for

¹ P.O.E.E.J., Vol. 47, p. 10.

² P.O.E.E.J., Vol. 49, p. 236.

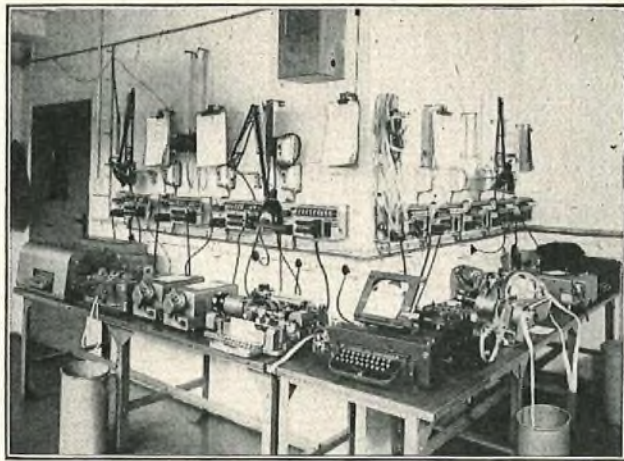

FIG. 3.—PART OF MACHINES LIFE-TEST ROOM.

relay assembly and coil winding, and a *Dark Room* utilized mainly for oscillographic and phototelegraphic processing. Power requirements for the laboratories are provided by means of a special power installation furnishing all the standard supplies, as well as stabilized and limiting voltages, used for telegraph machines, switching equipment and transmission equipment. Most of the benches throughout the development laboratories have cupboards underneath for accommodating day-to-day testing equipment, but a separate storeroom is also provided mainly to cover the issue of consummable items.

A *General Office* provides accommodation for the senior resident staff of one Executive Engineer, four Assistant Engineers and two clerical staff. The total resident staff numbers somewhat more than 30. While the laboratory is attached to one Development Group of the Telegraph Branch for the purpose of administration, all the Development Groups have working facilities in the laboratory and supervise their own case work. Space is therefore provided in the general office to meet the needs of visiting officers from other Groups.

DEVELOPMENT WORK IN PROGRESS

Switching Systems.

In the section of the main laboratory allocated to the testing of switching systems are located the rack- and table-mounted equipments of the various systems in being and under development. In the former category comes the model equipment of the Teleprinter Automatic Switching System (T.A.S.) in use in the public telegraph service, together with the necessary additional switching equipment and special position equipment that is used in conjunction with T.A.S. switching equipment for the provision of specialized private switching networks. Also in this category is a two-position suite of teleprinter switchboards (partially equipped) now in general use in the rapidly expanding Manual Telex system, as well as a rack of automatic sub-centre equipment which is used in conjunction with the manual switching network as a "line-connector" for groups of subscribers remote from an established manual switching centre. This equipment provides per rack for up to 20 subscribers to be connected by up to 10 junctions to the remote manual switchboards.

In the current development category comes the laboratory model of the Telex Automatic Switching System, of which the pilot (inland) equipment should be installed in London by mid-1958. This model—as with all those previously described—has been developed by the Telegraph Branch, and the relay set and selector equipment have been constructed and wired in the laboratory, as also have the dialling units

associated with the teleprinter positions, which may also have automatic transmission from perforated tapes, and/or reperforation facilities as required—see foreground, Fig. 1.

In association with all switching systems must be developed the necessary ancillary and testing equipment, e.g. routine testers, test desks, observation desks, all of which are first constructed as prototypes in the laboratory. Thus, as well as holding models of all such equipment relating to existing systems, the laboratory is at present engaged in producing equivalent items for the Telex Automatic Switching System as a matter of urgency. The improved construction facilities now available are invaluable for urgent projects of this type.

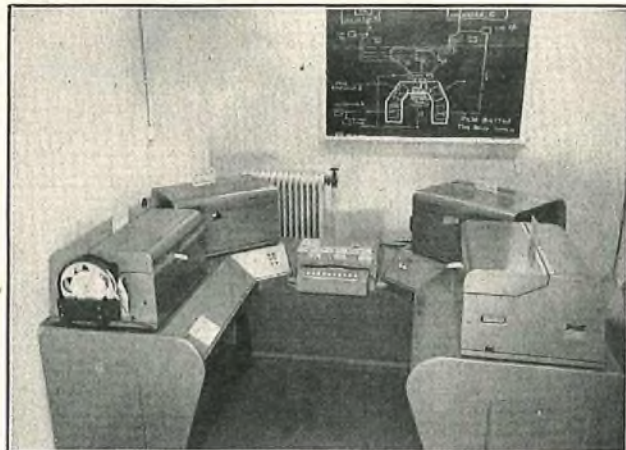

FIG. 4.—MODEL OF OPERATOR'S POSITION, PUSH-BUTTON TAPE RELAY SYSTEM.

Illustrated in Fig. 4 is an example of the prototype construction work undertaken by the Laboratory (in particular the Woodwork Shop) for a table-mounted console for use on a specific project for a push-button torn-tape reperforator switching system. This system, developed in the Telegraph Branch, permits an operator sitting within the "U" of the console to tear a message tape from any incoming printing reperforator, read the destination address, place it in one of the auto-heads sited near the push-button panel and depress the required circuit push-button, after which the transmission to the required destination is automatic when the line is free. The associated switching rack (not illustrated), comprising uniselectors and relays, was also constructed and wired in the laboratory. The system can be readily applied to networks with up to 49 outgoing circuits, and automatic serial numbering using electronic equipment may be incorporated if required.

A further activity of the switching development group, namely phonogram working, is represented by a model of the phonogram automatic distribution and queueing equipment which was brought into service at Newcastle in 1949 and later at Liverpool, Bournemouth and Electra House.

The appearance, in the Telegraph Laboratories, of purely telephone switching equipment developed by the Telegraph Branch in co-operation with the Telephone Branch is a constant reminder of the close—if sometimes happily informal—association between the switching groups of these two Branches of the Engineering Department.

Telegraph Machines.

Development work on telegraph machines has expanded considerably over the last decade due to the demand for new facilities and a considerable growth in the use of automatic transmitting and receiving instruments for private wire and telex services. A number of specialized signal generators have also had to be designed for generating a

variety of service signals and teleprinter test signals for use in automatic teleprinter switching systems. The main work on teleprinters and ancillary machines is devoted to critical examination and testing of contractors' designs to assess their performance and maintenance characteristics and, where necessary, to suggest or evolve improvements in design. Various investigations are undertaken as the result of reports of maintenance difficulties in the field and continuous development effort is directed towards improvements in design and maintenance techniques to increase reliability and reduce maintenance costs. The life-test room enables machines to be tested continuously on a 24-hour basis and all durability tests and lubrication trials are conducted in this room. Of major interest at the present time are the endurance tests that are being conducted on a model of the new Creed Page Teleprinter (Model 75). The associated test control equipment enables a repeated cycle of tests to be made of the transmitting, receiving and answer-back mechanisms, thus exercising the whole of the mechanism comprehensively. The keyboard is actuated by a mechanical manipulator controlled by a uniselector so as to reproduce as nearly as possible the sending of test messages from the keyboard. Other current work includes tests of a.c. motors and start relays to be used on automatic telex installations, and a 75-baud automatic transmitter and printing reperforator to be used in a tape relay system. An interesting example of work in the machines shop is a prototype 5-wire tape reader which has been developed for use in conjunction with error-correcting radio teleprinter circuits.

Transmission.

The transmission laboratory includes typical multi-channel voice-frequency telegraph terminal equipment with frequency spacings of 120 c/s, 240 c/s and 480 c/s. Comprehensive testing equipment such as noise generators, level measuring sets, synchronous and start-stop distortion measuring sets and a telegraph distortion analyzer are available for various transmission studies. The telegraph distortion analyzer, which enables the distribution of distortion to be accurately recorded for various periods of observation, is an invaluable tool which is currently being employed in an investigation of the transmission limits to be used for subscribers' lines when the automatic telex system is introduced. Performance tests of transistorized prototype frequency-modulated telegraph equipment are currently in progress and will include tests of performance

over a looped coaxial circuit. Other work on 240 c/s and 480 c/s voice-frequency equipment used in conjunction with radio circuits is concerned with changes in design to reduce the distortion at high signalling speeds.

Among the testing equipment used is a commercially available distortion set modified in the laboratory for higher speed working on wider-band telegraph systems.

An electro-mechanical two-channel error-detecting equipment with automatic correction facilities of a type now in service is installed in the laboratory and connected to typical input arrangements as used for public, private-wire and telex services. Various studies have been made to investigate maintenance requirements and evolve improvements in design and to check compatibility with an electronic system designed by the Post Office Research Branch. To facilitate tests on equipment of this type and to eliminate confusion due to errors which may be caused by normal tape readers a special 5-wire simultaneous test message generator has been designed.

A range of message facsimile and phototelegraph equipment is included in the laboratory plant for experimental purposes. Recent work included experiments with the object of producing a facsimile receiver employing a percussion recording method so as to avoid the use of relatively expensive recording paper.

CONCLUSION

As already mentioned each of the Development Groups concerned with the different aspects of telegraphy takes a close part in the experimental work. Thus while some of the work, in particular the construction of models, etc., is undertaken directly by the laboratory staff, other members of the Branch are free to conduct experiments, with the assistance of the resident staff, in connexion with problems in which they are concerned. While this results in a certain indeterminateness as regards the area of responsibility, the practice has become so well established, and the mutual co-operation so good, that it works very successfully and the opportunity it gives for direct contact with and handling of the equipment on the part of the staff is undoubtedly of considerable value. Nevertheless the Telegraph Branch as a whole is indebted for the enthusiasm and success with which the laboratory staff, and those directly responsible, have organized and brought into operation the new arrangements, and the goodwill and co-operation with which they meet the demands of their many visiting experimentalists.

Book Review

"The General Theory of Electrical Machines." Bernard Atkins, M.A., M.I.E.E. Chapman & Hall. 237 pp. 68 ill. 45s.

In the Preface the author says "This book is intended for students and others who already have some knowledge of electrical machines, as it does not include any descriptions of their construction. The mathematics required include differentiation and integration, and complex algebra. The Heaviside operational calculus is used for several problems and a brief explanation of the method is given." It is also obviously a book for the specialist in electrical rotating machine design and for those teaching electrical machine theory.

The general theory of electrical machines presented here is applicable to all normal types of machine and to transient as well as steady-state conditions. It is not applicable to machines of the inductor type having salient poles on fixed and moving elements.

The method adopted is to reduce any type of electrical machine to an idealized 2-pole machine with a sufficient number of coils on each of two axes at right-angles to one another on the fixed and moving element to represent the type of machine. Various transformations are necessary to do this, enabling, for example, the 3-phase coils of typical a.c. machines to be replaced by two equivalent axis coils. The coils on the moving element must be endowed with special properties to be representable by the theory, and are then called "pseudo-stationary" coils. They are given the properties of commutated windings, namely, (a) a current in the coil produces a field which is stationary in space, and (b) a voltage can be induced in the coil by rotation of the moving element.

The theory is then developed by deriving a set of voltage equations relating the voltages and currents of the generalized machine and in addition a torque equation relating the torque to the currents. The speed appears as a variable in the equations.

(Continued on p. 199)

Notes and Comments

Special Commendation

The Board notes with pleasure that the Postmaster-General has personally commended Mr. G. A. Evans, Technician, Class IIA, Brighton Telephone Area, to whom the Royal Humane Society has awarded its Testimonial on Vellum for his gallant attempt to rescue a man from drowning in rough seas at Brighton on 20th March, 1957.

P. L. Barker, B.Sc., M.I.E.E.

Mr. Barker, who has been appointed Chief Regional Engineer, Wales and Border Counties, entered the Post Office Engineering Department in 1925 through the Open Competition for Probationary Assistant Engineers, after graduating in engineering at Birmingham University.

He was appointed to the Wireless Experimental Section of the Radio Branch of the Engineer-in-Chief's Office, at Dollis Hill, in September of that year and remained there until 1935 engaged on development work in connexion with



transatlantic short-wave radio telephony and propagation measurements.

After a short period in the Cambridge Sectional Engineer's Office, Mr. Barker returned to the Engineer-in-Chief's Office in 1936, on promotion, in the newly formed Wire Broadcasting Branch, where he spent three years in charge of the experimental section concerned with the development of equipment for audio and carrier transmission over local line networks.

During the war years Mr. Barker served with the Royal Electrical and Mechanical Engineers, at home in South-Eastern and Scottish Commands, and overseas with the British Army Staff, Washington.

On returning to the Post Office in 1945 he went to Chester as Area Engineer, and a year later was promoted Chief Engineer in Northern Ireland; from 1950 onwards he held the dual post of Regional Engineer and Telecommunications Controller in the Northern Ireland Directorate.

In that capacity he was responsible for the large building and exchange equipment program and the considerable

expansion of the local line and junction network that were undertaken after the war.

Mr. Barker was keenly interested in all the problems associated with personnel and in his dual capacity had the unusual experience of dealing with both engineering and non-engineering staffing problems. He was also a member of both Clerical and Engineering Regional Whitley Committees.

Mr. Barker has always been a keen supporter of the activities of The Institution of Electrical Engineers and served on the Northern Ireland Local Centre Committee from 1949 to 1957. He became Chairman of the Centre in the 1954-55 Session.

He was Chairman of the local Centre of the I.P.O.E.E. during the whole period of his stay in Northern Ireland and the success and informality of the meetings was due to his pleasant personality. His success as a chairman is perhaps reflected in the fact that he was interested in the art of public speaking, in which he gained a silver cup.

In his spare time he has a flair for gardening and his success with strawberries is well known throughout the office.

His colleagues everywhere wish him well in his new post.

F. E. W.

Awards by The Institution of Electrical Engineers

The Board notes with pleasure that the following members of the Post Office Engineering Department have been awarded premiums by The Institution of Electrical Engineers for papers published during the 1956-57 Session:—

H. B. Law, B.Sc.Tech., The Kelvin Premium, for his papers, "The Detectability of Fading Radiotelegraph Signals in Noise" and "The Signal/Noise Performance Rating of Receivers for Long-Distance Synchronous Radiotelegraph Systems using Frequency Modulation."

J. W. Allnatt, B.Sc.(Eng.), E. D. J. Jones and H. B. Law, B.Sc.Tech., The Fahie Premium, for their paper, "Frequency Diversity in the Reception of Selectively Fading Binary Frequency-Modulated Signals, with special reference to Long-Distance Radiotelegraphy."

Increase of Postal Charges for the Journal and Model Answer Books

When postal charges were increased on 1st January, 1956, the Board of Editors decided that the increased cost of distributing the Journal to subscribers who receive their copies by post would be borne by the Journal for as long as was practicable. Since then there has been an appreciable increase in the cost of producing the Journal, while maintaining its present size, and a further increase in postal charges on 1st October, 1957. The Board regrets that the Journal can no longer bear the increased cost of postage and that it is necessary to increase the charges made for posting copies of the Journal and of Model Answer Books for City and Guilds of London Institute Examinations. From the 1st October, 1957, the following charges will be made:—

Journal, Annual Subscription (post free)	13s. 0d.
Single copies of the Journal (post free)	3s. 3d.
Model Answer Books (post free)	.. 5s. 6d. per copy

Institution of Post Office Electrical Engineers

Essay Competition 1957-58

To further interest in the performance of engineering duties, and to encourage the expression of thought given to day-to-day departmental activities, the Council of the Institution of Post Office Electrical Engineers offers five prizes, a first prize of five guineas and four prizes of three guineas, for the five most meritorious essays submitted by members of the Engineering Department of the Post Office *below the rank of Inspector*. In addition to the five prizes the Council awards five certificates of merit. Awards of prizes and certificates made by the I.P.O.E.E. are recorded on the staff docketts of the recipients.

An essay submitted for consideration of an award in the essay competition and also submitted in connexion with the Associate Section I.P.O.E.E. prizes will not be eligible to receive both awards.

In judging the merits of an essay, consideration will be given to clearness of expression, correct use of words, neatness and arrangement, and although technical accuracy is essential, a high technical standard is not absolutely necessary to qualify for an award. The Council hopes this assurance will encourage a larger number to enter. Marks will be awarded for originality of essays submitted.

Copies of previous prize-winning essays have been bound and placed in the Institution Central Library. Members of the Associate Section can borrow these copies from the Librarian, I.P.O.E.E., G.P.O., Alder House, Aldersgate St., London, E.C.1.

Competitors may choose any subject relevant to current telegraph or telephone practice; foolscap or quarto size paper should be used, and the essay should be between 2,000 and 5,000 words. An inch margin is to be left on each page. A certificate is required to be given by each competitor, at the end of the essay, in the following terms:—

*"In forwarding the foregoing essay of words,
I certify that the work is my own unaided effort both
as regards composition and drawing."*

Name (in Block Capitals)

Signature

Rank

Departmental Address

Date

The essays must reach

The Secretary,

The Institution of Post Office Electrical Engineers,
G.P.O., Alder House, Aldersgate St., London, E.C.1,

by the 31st December, 1957.

The Council reserves the right to refrain from awarding the full number of prizes or certificates if in its opinion the essays submitted do not attain a sufficiently high standard.

Review of Prize-winning Essays— 1956-57 Competition*

The Council of the Institution is indebted to Mr. W. S. Proctor, M.I.E.E., F.R.S.E., Chairman of the Judging Panel, for the following review of the five prize-winning essays:—

"During the summer of 1954, Mr. J. R. Haggart, Technical Officer, Edinburgh, found himself on holiday in Norway and, in a manner not revealed in his prize-winning essay, 'An Electronic Crossbar System,' he heard about the first system of this kind to be brought into public service anywhere in the world, at the small town of Ski, some 12 miles distant from Oslo. Obtaining permission to be shown through the new telephone exchange building, he spent a worthwhile three hours studying the facilities, performance and capabilities of this 2,000-line

system under working conditions. The results of this experience form the material of this very readable essay. The judges were impressed by the author's enterprise in obtaining such interesting information while on leave, and thus demonstrating his interest in, and enthusiasm for, his job and they had no hesitation in awarding him the first prize.

Mr. E. G. Clayton, Technical Officer, Norwich, takes the second prize for his essay entitled 'Hearing Speech Sounds.' Dealing first with the production of human speech and the properties of speech sounds, the writer then gives a detailed description of the mechanism of the human ear and the properties that it possesses in hearing sounds of various frequencies and degrees of loudness. He then deals with various hearing phenomena and rounds off his essay with a brief discussion of some of the defects of hearing.

The third prize was awarded to Mr. A. L. Watson, Technical Officer, Lincoln, for his essay on the subject of 'The Planning of Buildings for Unit Automatic Exchanges.' Dealing first with the various causes that give rise to the need for a new telephone exchange building, the author then discusses the forecasts for subscribers' lines and junction circuits and describes how these are turned into switch quantities, in the form of standard units, for the new exchange, together with the power plant required to operate it. He then deals with the secondary accommodation requirements that may arise and affect the design of the building. The size of the site and the considerations determining the area of search next claim attention; a discussion of the main points to watch in placing the building contract and the erection of the building complete the essay.

Next, Mr. R. J. Lukehurst, Technical Officer, Canterbury, takes the fourth prize for his essay entitled 'Some Aspects of Line Plant Planning and Its Allied Works.' The development forecast is the foundation of local line plant planning, and the author deals at length with the sales development study that produces the forecast figures for the anticipated growth of the telephone system in a given territory. Then follows a description of the operation of 'spotting' and a discussion of the various considerations that govern the number and siting of new D.P.s. Dealing next with the straight line diagram, the author concludes with a description of the preparation of a development scheme.

Finally, the fifth prize was awarded to Mr. J. S. Kendall, Technical Officer, Birmingham, for his essay on 'The Development of the Direct-Coupled Amplifier for High Quality Sound Reproduction.' This covers the work in this field from 1927 to the present day and includes an account of some of the writer's original research into the subject."

Annual Awards for Associate Section Papers— Session 1956-57

The Judging Committee has selected the following from the papers submitted by the Local Centre Committees, and prizes of £4 4s. and Institution Certificates have been awarded to the following in respect of the papers named:—

F. S. Brasher, Technical Officer, Sheffield Centre. "Some Aspects of Modern Tape Recorders."

K. O. Verity, Technical Officer, London Centre. "Electrical Power from Nuclear Fission."

G. R. Parr, Technical Officer, London Centre. "Outside Broadcast Television Equipments."

P. Sayers, Technical Officer, London Centre. "The Mechanization of the Telephone Trunk Network."

C. Biddlecombe, Technical Officer, London Centre. "What's in a Cord?"

In addition, the following papers, which were considered worthy of submission to the Judging Committee for the main awards, have been awarded a prize of one guinea each:—

P. McAnulty, Technical Officer, Aberdeen Centre. "Atomics."

S. A. Watcham, Technical Officer, Colchester Centre. "Some Aspects of Long Distance Signalling."

R. F. Hoff, Technical Officer, Tunbridge Wells Centre. "Brief Outline of the History of Telegraphy."

* The full list of Awards was published in the *P.O.E.E.J.*, July, 1957, p. 127.

H. Thompson, Technical Officer, Darlington Centre. "The Manchester-Leeds-Newcastle Coaxial Cable."

R. J. Morgan, Technical Officer, Tunbridge Wells Centre. "Methods of Repairing Cables by Uni-diameter Jointing."

J. Lodge, Technical Officer, Newcastle Centre. "Electrical Installations in Buildings."

J. G. Phillip, Technical Officer, Aberdeen Centre. "Miscellany."

The Council is indebted to Messrs. G. S. Berkeley, W. B. Jago and A. M. Stonebanks for kindly undertaking the adjudication of the papers submitted for consideration.

Review of Prize-Winning Papers—1956-57 Session

The Council of the Institution is indebted to Mr. G. S. Berkeley, M.I.E.E., Chairman of the Judging Panel, for the following review of the five prize-winning papers:—

"Twelve papers were entered for the 1956-57 awards. Although they varied widely in subject matter, from Telephone Cords to Nuclear Fission, and the style differed from cheerful conversational to serious technical, they all reached a high standard and showed that a great deal of work had been put into them by their authors. Judging them was not easy, because although two or three were outstanding in some respects, the assessment of the majority was so close that the margin between prize-winners and non-prize-winners was quite small. A brief note on each of the papers selected is given below.

The paper presented by Mr. F. S. Brasher, Technical Officer in the Sheffield Area, entitled 'Some Aspects of Modern Tape Recorders' was placed first in order of merit. After a brief outline of the development of tape recording, an interesting explanation is given of the magnetic principles involved in obtaining good-quality recording and reproduction. The limitations imposed by mechanical considerations in respect of frequency response are also covered adequately.

Second in order of merit is the paper 'Electrical Power from Nuclear Fission,' by Mr. K. O. Verity, Technical Officer in the Long Distance Area, London Telecommunications Region. This subject, which is much in the news, is dealt with simply and very effectively. A short survey is given of the early work leading up to fission and chain reaction. Various types of nuclear reactors are mentioned and certain features of their design are brought out, together with a general description of the Calder Hall station.

Mr. G. R. Parr, Technical Officer of the London Test Section, Engineering Department, offered a paper entitled 'Outside Broadcast Television Equipments.' In this paper, Mr. Parr describes methods of testing employed to ensure that the outside broadcast equipment supplied to the field conforms in every respect with specification requirements. Pulse-testing techniques are explained, together with tests on the line network, and testing of picture monitors, pulse-and-bar waveform generators, etc.

A paper entitled 'The Mechanization of the Telephone Trunk Network' was given by Mr. P. Sayers, of Long Distance Area, London Telecommunications Region. After a short survey of the development of the trunk service from the early days, Mr. Sayers follows with an explanation of the methods adopted in London to meet the switching of trunk and toll calls automatically. Various forms of a.c. and d.c. signalling are mentioned, as also are the facilities provided by the congestion and delay announcement equipment, and a brief mention is made of the possible future conditions.

A somewhat unusual paper was that presented by Mr. C. Biddlecombe, Technical Officer, London Test Section, Engineering Department, with the title 'What's in a Cord.' In this paper Mr. Biddlecombe deals entertainingly, and at the same time, instructively, with a subject which is usually taken for granted. Attention is drawn to the different types of hard usage to which cords are subject and the methods adopted in manufacture to minimize the results of such usage. This paper was exceptionally well illustrated."

Silver Jubilee of the Associate Section

The Associate Section is celebrating its Silver Jubilee during the current session, and the Council of the Institution is pleased to take this opportunity of wishing the Section continuing

success in its activities, and in particular of those occurring during its Silver Jubilee session.

An important object now included in the Rules of the Institution is to "Encourage the formation of Associate Section Centres," and the Council is gratified at both the encouraging growth of the membership figures, and of the activities of the Associate Section generally. Some information of these matters, and details of the Jubilee Celebrations planned by the London Centre of the Associate Section, are contained in the contribution, on p. 197, prepared by Mr. R. W. Palmer, M.I.E.E., who was appointed by Council as President of the Associate Section, in 1955, to act in an advisory capacity in matters relating to its welfare.

H. E. WILCOCKSON,
Secretary.

Additions to the Library

Books are available on loan to all members and Associates. Local Secretaries will be pleased to supply requisition forms, and a copy of the Library Catalogue if required, or application can be made direct to the Librarian, I.P.O.E.E., Alder House, Aldersgate St., London, E.C.1.

- 2438 *The Nature of Management*. H. R. Light (Brit. 1957).
A preliminary survey of the field of management. Covers the syllabus for "The Nature of Management" paper in the Common Intermediate Examination in Management.
- 2439 *Planned Artificial Lighting*. J. W. T. Walsh (Brit. 1956).
Shows how to plan a lighting installation to satisfy a set of specified requirements.
- 2440 *Power System Communications*. Ed. E. O. Taylor (Brit. 1957).
Based on a series of lectures on the communication aspect of power systems.
- 2441 *Television Explained*. W. E. Miller, rev. E. A. W. Spreadbury (Brit. 1957).
Assumes some knowledge of a sound-radio receiver.
- 2442 *The Bases of Atomic Physics*. H. W. Heckstall-Smith (Brit. 1956).
Covers the elementary ground of atomic physics.
- 2443 *Atomic Structure and the Strength of Metals*. N. F. Mott (Brit. 1956).
Explains the most familiar properties of metals and relates them to the atom. Written for the non-specialist.
- 2444 *The j Operator for Electrical Engineers*. P. Kemp (Brit. 1956).
A straightforward account of the j operator and its uses, including all the basic illustrations of the applications of the method to the problems met in electrical circuits.
- 2445 *Television Engineering: Principles and Practice, Vol. 3—Waveform Generation*. S. W. Amos and D. C. Birkinshaw (Brit. 1957).
The third volume of B.B.C. training manuals. Mainly devoted to the fundamental principles of the circuits commonly used to generate the various waves used in television.
- 2446 *V.H.F. Radio Manual*. P. R. Keller (Brit. 1957).
Covers the theory, practice and operation of commercial and amateur v.h.f. two-way radio systems, f.m. broadcasting transmitters and receivers, and television tuners. Assumes a knowledge of the basic fundamentals of radio.
- 2447 *Protective Painting of Structural Steel*. F. Fancutt and J. C. Hudson (Brit. 1957).
States the results of the investigations of the Protective Coatings (Corrosion) Sub-Committee of the British Iron and Steel Research Association.
- 2448 *Realities of Space Travel*. Ed. L. J. Carter (Brit. 1957).
Selected papers of the British Interplanetary Society, giving the known facts, outlining the problems still confronting man, and describing how they are slowly being solved.
- 2449 *Stereo-Photography*. K. C. M. Symons (Brit. 1957).
A guide to those knowing basic photographic technique who wish to take up stereo-photography.
- W. D. FLORENCE,
Librarian.

Silver Jubilee of the Associate Section

Following the Golden Jubilee of the Institution of Post Office Electrical Engineers in 1956, the Associate Section is now celebrating its own Silver Jubilee on a more modest scale, but with equal enthusiasm. The history of the Section was described a year ago in this Journal (*P.O.E.E.J.*, Vol. 49, p. 158, October 1956), and it is pleasing to note that the number of active centres has since risen from 44 to 47, and the total membership from 7,000 to 8,800—a spectacular rise and a new record.

Twenty-five years ago, when the so-called "Junior Section" held its first meeting, it had been stated that the object was not only to provide facilities for discussion and interchange of ideas among the technical grades concerned, but also to promote a "higher technical standing among such a large body of men." That quotation is from the report in which Mr. E. Gomersall, then chairman of the London Centre, made the proposals for setting up the new venture. The development and activities of what is now named the Associate Section have most certainly achieved this objective.

A major difference from the rest of the Institution is that the Associate Section is comprised of a number of self-contained local centres, each self-governing within a general directive from the Council. For example, the members of each centre decide their own detailed constitution, fix their own subscription (at a few pence per week) and decide their own programs of meetings, visits and other activities. It follows that each centre is financially self-supporting. The elected chairman of a centre may be drawn from among the local members or may be a Senior Section member whom they have invited. Help and encouragement from the senior staff is always available, and the Council of the Institution appoints a President for the whole Associate Section and arranges for Liaison Officers in every Post Office Region and in every centre.

The meetings and visits cover an exceptionally wide range. The main objective is the reading and discussion of papers on telecommunications, sometimes by Associate Section local members and sometimes by senior staff of the Post Office, or from outside organizations, but the basic constitution also includes the phrase—"and the allied arts and sciences." This wide outlook, which seemed novel a quarter of a century ago, is now seen to accord well with the modern demand for broad engineering knowledge and a cultural background as a supplement to specialist knowledge. The centre programs are initiated and organized entirely by the Associate Section members, and the following selection of subjects (from outside the main program of telecommunications) studied during the last year reveals that a satisfactory liberal element is included—

Lectures—Atomic energy	Visits—Power stations
Radiology	Copper works
Refrigeration	Glass works
Motoring	Paper mills
Radio-astronomy	Oil refineries
Photography	Airports
Rocket propulsion	Motor works
Heredity	Coal mines
Visits abroad	Ocean liners
Polar exploration	Shipbuilding yards.

Another live feature of the Associate Section is the facility for distribution of technical literature of all kinds, mainly in the form of circulation of the many technical journals that are now produced. Members are also able to borrow books from the library of the main Institution.

As the separate centres have considerable freedom, it is not surprising that many variations in activity are to be found throughout the country. In the provinces the membership tends to be small in comparison with the potential figure in terms of Post Office staff. This is not unconnected with the problem of travelling for scattered communities, and is also directly dependent on the availability and ability of a few natural leaders. Some of the most successful provincial centres are those whose meetings are held in an informal atmosphere. The Institution is not constituted as a social organization, but a human view of one's vocation is not to be deplored in this mechanized age.

The London Centre of the Associate Section requires special mention because of its size which, for example, enables it to play such a prominent part in celebrating the silver jubilee of the Section as a whole. It embraces twelve sub-centres, one each in the Telephone Managers' Areas plus one in the Circuit Laboratory, one in London Test Section, and one in Cable & Wireless, Ltd. There is also a separate Radio Section for enthusiasts in that field. The sub-centres and sections hold a large number of informal meetings, but the large total membership (which is nearly one half of the total in the U.K.), enables the London Centre to organize events on a far larger scale than any other. It produces its own quarterly journal and has on one occasion staged a meeting in the lecture theatre of The Institution of Electrical Engineers, attracting an audience far beyond its own class of membership, and including some very senior members of the Post Office. It is no surprise, therefore, that London takes the lead in the Jubilee celebrations, and is staging a public exhibition of "Telecommunications, Past, Present and Future," on 2nd, 3rd and 4th October, at the Hotel Metropole. This exhibition will be opened by Mr. R. J. Halsey, C.M.G., B.Sc.(Eng.), D.I.C., A.C.G.I., M.I.E.E., Assistant-Engineer-in-Chief, on Wednesday, 2nd October, and will be reported in a future issue of the Journal, but it is important to note that it is a spontaneous venture organized by members of the Associate Section themselves, although supported by the Post Office and the telecommunications industry. It will tell Post Office people and the public something of the fascination of a technical career in the Post Office. Naturally, the exhibition will be largely a reflection of Post Office practice and standards, but the section depicting "the future" will necessarily include new technical and scientific developments which may not even be economical or commercially practical—even straying into the realms of phantasy. In this and in other respects the Associate Section of the Institution is celebrating its silver jubilee in a spirit of adventure, looking forward to the important part that the Post Office technical staff have to play in an increasingly technical age.

R. W. PALMER,
President,
Associate Section,
I.P.O.E.E.

Associate Section Notes

Southend-on-Sea Centre

The first Annual General Meeting of the Southend-on-Sea Centre was held on 25th April, when the Centre had been in existence 11 months, and the following officers were elected for the 1957-58 session:—

President: Mr. C. J. Vann, Area Engineer; *Chairman*: Mr. S. I. Restorick; *Vice-Chairman*: Mr. A. J. Humby; *Treasurer*: Mr. J. Dickson; *Secretary*: Mr. D. W. Everett; *Committee*: Messrs. B. C. Carter, A. P. Padbury, S. T. Ralph, A. N. Topsfield and F. E. Wright; *Auditors*: Messrs. A. Cullen and A. Salisbury.

Since the inauguration of the Centre membership has steadily increased from 21 to 109 and we can reflect upon the

activities of the past year with considerable satisfaction. The program for 1956-57 has been as follows:—

22nd September—Talk on "Promotion," by Mr. Knox.

23rd October—Talk on "Principles of Carrier," by Mr. R. Hayward, assisted by F. E. Wright.

11th November—Talk on "D. Q. Bureau and Speaking Clock," by Mr. R. Wyndham.

31st January—Talk on "A General Guide to Car Maintenance," by Mr. F. Kimmings.

14th February—Talk on "The Work of the C.I.D.," by Detective Chief Inspector Poole.

19th March—Talk on "P.A.B.X.s," by Mr. A. P. Padbury.

25th April—Annual General Meeting, followed by film show.

During the past three months we have had visits to Shell Refinery, Ford Motor Works, E. K. Cole, Ltd., Southend

Gasworks, and Stratford Locomotive Works & Signal Box. The summer program will be concluded with more visits, to the Southend Marine Radar Station of Messrs. Kelvin Hughes.

Arrangements are now being made for the forthcoming winter program and this promises to maintain the high standard previously attained.

In conclusion we wish to express our sincere appreciation to the numerous helpers who have consolidated the growth of the Centre.
D. W. E.

Bradford Centre

The Annual General Meeting of the Bradford Centre was held on 1st July, 1957, at Bradford Central Auto Exchange. The Secretary spoke briefly of the successful session just completed and also the satisfactory state of the Centre's finances. The following officers were elected for the 1957-58 session:—*Chairman*: Mr. A. J. Proctor-Blain; *Secretary*: Mr. W. J. Hardie; *Treasurer*: Miss E. P. Hawkins; *Committee*: Messrs. E. Dennison, M. Farnell, A. Fawbert, J. Naylor, D. Relton, C. M. Rowland, J. Rowley and R. C. Siddle.

After discussion in committee it is hoped to include, in the 1957-58 program, visits to the British Nuclear Power Station at Calder Hall, Cumberland; the Radio Telescope, Jodrell Bank, Cheshire; the Bradford City Police and Bradford Corporation's Waterworks undertaking at Scarr House in Nidderdale. Also planned is a paper on "Subscriber Trunk Dialling" or "Electronic Exchanges," and a paper on "Post-war Developments in Telecommunications." In addition we have been invited to attend a meeting of the Leeds Centre in January, when a paper entitled "The Manufacture of Radio and Special Quality Valves" will be presented by Mr. C. H. Gardner of Mullards. It is also hoped to take advantage of a further invitation to visit Emley Moor I.T.A. Television Transmitter in order to accommodate members who were unable to go there last session.

In closing we would like to thank the Senior Section for its support in the past and we look forward to a very full and successful session in 1957-58.
W. J. H.

Huddersfield Centre

At the Annual General Meeting of the Centre, at the H.P.O. on 28th May, 1957, the following officers were elected:—*Chairman*: Mr. P. Wade; *Secretary*: Mr. B. Stephens; *Treasurer*: Mr. B. B. Howell; *Committee*: Messrs. H. A. Burden, P. Holroyd, T. Johnson, D. M. Lee, M. S. Smith and L. Thwaite.

The change in secretary was due to Mr. B. Haigh's promotion. Mr. Wade thanked Mr. Haigh for his hard work for the Centre in the previous year, and Mr. Haigh in his reply, after a presentation, wished the Centre well for the future.

For the membership, which is now over 60 in number, the committee have arranged the following program for the 1957-58 session:—

September—"Radio Interference," by Mr. G. Sutcliffe.

October—Afternoon visit to the British Iron & Steel Research Association at Sheffield.

November—"The Man in the Middle," by Mr. J. Sunderland, T.T.S. (Work in Traffic Division of an Area Office.)

December—Afternoon visit to "Huddersfield Examiner."

January—Lecture on Valves, at Leeds, by Mullards.

February—Some aspects of day-to-day jobs.

March—Day visit to Ericsson Telephones, Ltd., Nottingham.

May—Annual General Meeting.
B. S.

Leeds Centre

The 1956-57 session ended with a visit to Crompton Parkinson, Ltd., at Guiseley, and since the publication of the last notes we have had a return visit to Ledston Luck Colliery and a visit to the Departments of Physics and Electrical Engineering at Leeds University.

At the time of writing these notes the membership numbers 168. The committee would like to remind non-members of the interesting visits and talks that they are missing and hope that they will soon join the Associate Section.

The Centre has started to build up a library and at the moment copies of Post Office correspondence courses, I.P.O.E.E. printed papers, the "New Scientist" and technical literature on transistors and magnetic recording are available. It is hoped, in the near future, to purchase technical periodicals such as "Wireless World" and "British Communications and

Electronics." These will be circulated to members who let the Chairman or Secretary know that they wish to read them.

A. A. G.

Sheffield Centre

The 1957-58 session opened in May with the Annual General Meeting and a social held at the West Street Hotel, when due to a vastly increased membership it was decided to enlarge our Committee.

The officers elected were:—*Chairman*: Mr. J. McInnes; *Vice-Chairman*: Mr. F. S. Brasher; *Treasurer*: Mr. S. Shepherd; *Secretary*: Mr. G. T. Ridsdale; *Asst. Secretary*: Mr. K. T. Gray; *Librarian*: Mr. G. Woodhouse; *Committee*: Messrs. F. Bower, J. Brown, S. Cottage, F. Gosling, C. Gray and J. Watts; *Auditors*: Messrs. W. B. Green and S. Cole.

Following the business meeting we had a splendid evening's entertainment when our Liaison Officer, Mr. T. C. R. Harrison, completely mystified us with a "Show of Magic." Refreshments were served by the very capable hands of Mr. McInnes.

Our first meeting of the session, in July, took the form of a visit to the works of the Derwent Valley Water Board and the Ladybower Reservoir. This proved to be a very enlightening and entertaining visit. The evening was concluded by a short stop at one of the ancient coaching inns overlooking the dams.

In September a visit was arranged for 25 of our members to the works of the Laycock Engineering Co., Ltd., Sheffield. Laycocks are the makers of a very famous automobile "overdrive" and, as many of us are motor car enthusiasts, it proved to be very interesting.

In conclusion the Committee will be very happy to receive suggestions or criticisms from other centres. Communications should be addressed to the Secretary, c/o E.M.5, Telephone Buildings, Sheffield.
G. T. R.

Sunderland Centre

During the period 11th July to 17th July, H.M.S. *Jamaica*, a Colony-class cruiser of 8,880 tons, and H.M.S. *Reward*, an ocean-going tug of the Bustler class and displacing 1,700 tons, paid a courtesy visit to the port of Sunderland.

Negotiations were immediately opened with the cruiser's commander which resulted in 17 of our members paying a successful and very informative visit to the cruiser on 13th July.

The Centre was pleased to return the compliment when a party of chief petty officers toured the Sunderland automatic telephone exchange at a later date.

Since our Annual General Meeting efforts have been made to contact speakers from other industries and, as those approached have been most responsive, the following program has been arranged for the 1957-58 session. It is hoped that this will meet with the approval and support of members.

27th September—Film, "The Principles of Gas Making,"

Mr. W. Q. Kirkwood (Northern Gas Board).

3rd October—Visit to Hendon Gas Works.

25th October—"Getting the Best from Your Camera,"

Mr. W. V. Hornsby (Sunderland Photographic Association).

29th November—"Behind the Screen," Mr. F. M. Inglis (The Edison Swan Electric Co., Ltd.).

10th December—Visit to television tube factory.

30th December—Films "Mirror in the Sky" and "Echo Whalerfinder."

31st January—"Organization within the Post Office Engineering Department." A member of the Senior Section.

28th February—"British Railways Electrical Signalling Principles," Mr. R. Ord (District Signals Assistant, North Eastern Region).

8th March—Visit to Signal Box, Newcastle upon Tyne.

28th March—"Power in the Mines," G. W. Milner, B.Sc., A.M.I.Mech.E., and R. Davis, Assistant Group Electrical Engineer.

25th April—"The Magnetic Drum, A Revolutionary Technique," Mr. F. L. N. Samuels. [Although other Centres have not yet been approached it is hoped that this will be a joint meeting.]

D. A. C.

Manchester Centre

By the time these notes appear the new Manchester Centre will have held its Inaugural Meeting. There is no doubt that enthusiasm is widespread, as indicated by an initial membership of over one hundred, and we look to a greater success than that achieved by the "Junior Section" before the war. We also intend to establish contact with other Centres and exchange ideas for future developments.

E. C. B.

Edinburgh Centre

The last meeting of the 1956-57 Session was held on the 5th April, when, after the usual Annual General Meeting activities the members present adjourned to partake of an excellent dinner. The following members were elected as office-bearers and committee for the coming session:—*Chairman*: T. J. Potter; *Secretary/Treasurer*: J. R. Haggart; *Committee*: C. O. Anderson, D. M. Plenderleith, W. Mackie, J. H. Phillips, S. V. Dodd and A. Simpson.

The membership over the past year was quite a disappointment to the committee, but such a good start has been made to this session that it is hoped the drop in numbers was only a temporary setback.

We are pleased to record that for the third year in succession an Essay Award has come to our Centre.

J. R. H.

Aberdeen Centre

On 25th May the Aberdeen Centre had a well-attended and interesting outing to the Conon Valley in the Scottish Highlands for the purpose of visiting the Conon Valley Hydro-electric Scheme. The round trip was over 300 miles, and a modern coach provided the means of transport for 38 of our members and guests. We picked up some of our out-station members on the way.

The Glen Afric and Conon Valley Schemes have an output of 155 megawatts, and this is sufficient to supply the requirements of the North of Scotland and leave a surplus which is fed in to the National Grid.

We saw the turbines at Torr Achilty and Luichart, the generators at these stations give an output of 39 megawatts. Torr Achilty is also a group control centre, and has switching apparatus and v.f. equipment similar to that used by the Post Office.

Extensive arrangements are made for salmon to go up the river to spawn, and in May the first salmon of the season were on their way up what is known as the Borland Fish Pass. The Borland Fish Pass is the first of its type in Scotland, and works on a similar principle to that of a canal lock. To date, over

2,000 salmon have passed Torr Achilty Power Station this season. In agreement with the Fishery Board, the Hydro-electric Authority must allow a minimum amount of water to pass when the turbines are not in use.

Our program for the 1957-58 session will be issued shortly.
J. G. P.

London Centre

The 1956-57 Session of the London Centre ended with a lecture by a member of E.M.I., Ltd., on "Compatible Colour Television," which was illustrated with slides and an excellent demonstration. We were again honoured by the presence of the Associate Section President, Mr. R. W. Palmer, who kindly introduced the various speakers, including Mr. C. W. Brown, the first President of the then Junior Section. In the Annual General Meeting which followed, the officers elected for the 1957-58 session were: *Chairman*: A. G. Welling; *Vice-Chairman*: H. A. Horwood; *Treasurer*: W. C. Peck; *Secretary*: P. Sayers; *Assistant Secretary*: W. H. Upton; *Visit Secretary*: B. C. Hatch; *Librarian*: S. Challoner; *Radio Secretary*: G. Robotham; *Editor*: P. Sayers.

During the summer months the committee have been very busy preparing the program for the session and arranging for the London Centre's celebrations of the Silver Jubilee of the formation of the Associate Section.

The lecture program is as follows:

1st October, 1957—"Progress of Underwater Exploration,"

J. C. G. Gilbert, Associate I.E.E., M.Brit.I.R.E.

6th November, 1957—Technical Film Show, including "Mirror in the Sky" and "Foothold on Antarctica."

4th December, 1957—"Electricity in your Garden," A. W. Gray, Associate I.E.E.

21st January, 1958—"Pulse Techniques in Telephone Exchanges," T. H. Flowers, M.B.E., B.Sc., M.I.E.E.

19th February, 1958—"The Work of the Royal Observatory," Dr. A. Hunter, F.R.A.S.

25th March, 1958—"Radio-activity and Some Peaceful Applications," K. O. Verity.

23rd April, 1958—"Closed Circuit Television," Pye, Ltd.

29th May, 1958—"Sound Reproduction," R. E. Cooke, B.Sc.(Eng.), A.M.I.E.E., followed by the Annual General Meeting.

The Silver Jubilee celebrations consist of an exhibition, "Telecommunications, Past, Present and Future," at the Hotel Metropole, Whitehall Place, W.C.2, Wednesday, 2nd October, to Friday, 4th October, 11.30 a.m. to 8.0 p.m. each day, and a special edition of the London Centre's Quarterly Journal. It is hoped that a full report of the exhibition will be in the January edition of this Journal.

P. S.

Book Review

"The General Theory of Electrical Machines"—*continued*
from p. 193.

These equations can be used to determine the performance of any type of machine under any condition of operation. For steady-state conditions they reduce to normal algebraic equations with real variables in the d.c. case, and complex ones for a.c. machines. For transient conditions, however, differential equations result and in some cases are difficult to solve. Some explanation is given of the Heaviside operational method of solving linear differential equations with constant coefficients, and a brief description is given of types of analysers and computers which may be used to solve the more complex problems. These descriptions are only introductory in style, whereas a considerable knowledge of these subjects is necessary for the designer wishing to make full use of the book.

Once the equations for the idealized machine corresponding to the actual machine under consideration are set up they provide—for the mathematically minded—a complete picture of the behaviour of the machine in terms of the resistances, inductances, leakage inductances, and mutual inductances of the various windings. The methods of achieving these resistances and inductances in a practical machine are not dealt with in this book.

Eight chapters are devoted to demonstrating the application of the theory, two on d.c. machines and six on a.c. machines.

The book is extremely well arranged and well written, and contains over 50 references to other work in the same field.

R. W. H.

Regional Notes

South-Western Region

RECOVERING HESSIAN-PROTECTED CABLES

In an earlier note* it was explained that faulty hessian-protected carrier cables had been substituted by similar cables in an adjacent way of a nest of six 3¼-in. steel pipes and the original cables freed by applying steam through the pipes. Although this was successful it proved to be very costly in labour, and had the disadvantage of leaving a residue of bitumen and hessian in the pipe, which also had to be cleared. When, therefore, it was found that the hessian-protected interruption cables, which had only been in the pipe for a few months, could not be withdrawn by normal methods, consideration was given to an alternative means of softening the bituminous compound and so freeing the cables from the pipe. The alternative involved filling the pipe line with the following solution, recommended by the Post Office chemists:—

Caustic Soda	—1 lb
Oleic Acid	—2 pints
Paraffin	—4 gallons
Water	—4 gallons.

It was calculated that approximately 140 gallons of the mixture would be required to fill the pipe and ensure the cables being covered throughout the 184-yd section. The problem was to get the mixture into the pipe line and hold it there for a period to allow it to do its work. This was achieved by using a large tank at the "sending" end, mounted close to the manhole at a higher level than the highest point of the pipe line. Rubber hose was used to connect the tank to the steel pipe.

At the distant end, fortunately, the steel pipe projected about an inch inside the manhole wall and a lead sleeve was fitted over this projection, the other end of the sleeve being capped. Two small water taps were inserted in the sleeve, one at the top of the cap end to check the level of the solution and the other in the bottom of the sleeve to allow the solution to be released. After 16 hours the solution was released and attempts made to withdraw the cable. This was unsuccessful but appeared promising. A 1-in. hole was then drilled and tapped on the steel pipe midway in the section and the cable cut. The two halves were then comparatively easily withdrawn, and the steel pipe finally made good by means of a screwed plug.

There is no doubt that of the two alternatives the one using the solution is far more economical, particularly as regards the number of men required, and the time taken.

The cause of the adhesion between cables and pipe appears to be that the bitumen softens in the early stages sufficiently to get through the coating of graphite and then hardens. It is possible that an alternative to graphite or whitewash as a coating over the graphite might overcome the difficulty.

W. C. M. and G. A. W.

Home Counties Region

GATWICK AIRPORT

The expansion of Gatwick Airport has necessitated a road diversion work of abnormal size. The new runways will cross the London-Brighton, A23, road, which carries some of the heaviest holiday traffic, and a new section of road has been built to skirt the airport to the east. The new road is 2.6 miles long and includes a complicated fly-over system in the vicinity of Gatwick railway station and the new terminal building for the airport. The Post Office has large commitments on the airport itself, but the road diversion alone provided work of some magnitude, as four of the London-Brighton trunk cables are routed on the A23 road. The new duct route was provided by contract but all cabling work was done by direct labour.

It was planned to open the new road in the summer of 1957 and the final planned date was 1st August. The road is, for the most part, above the level of the countryside, and ducts had to be laid in newly built verges. For various reasons the verges were not available until October, 1956, and from that time onwards the duct contractor was working close behind the

* "Steaming Out Hessian-Protected Cables." *P.O.E.E.J.*, Vol. 48, p. 251, Jan. 1956.

road builders. Post Office staff began cabling on 1st January, and because of various delays with the road they were often working on the heels of the duct layers. However, the whole job, was completed on 29th July, including the recovery of the cables immediately underlying the site of the new runways. The old A23 road was closed on 1st August, giving unimpeded access to the runway contractor.

Apart from the size and urgency of the job, the difficulties inherent in any scheme where a number of undertakings are working to close schedules, and changes in the planning of the road, special arrangements were also necessary on account of the distance of Gatwick from the main staff headquarters. Staff were transported daily from Tunbridge Wells—a distance of 25 miles—by motor coach, a contract being negotiated by the Post Office Contracts Department for the purpose. Public transport in the East-West direction is very poor and lodgings in the vicinity of the airport virtually unobtainable. All vehicles, averaging 9 lorries, a tractor and cable drum trailers, were kept on the airport and looked after by the R.M.T.O.'s staff at Crawley. Large numbers of pumps and lighting sets were also kept there and it was found useful to employ a man full time on maintaining mechanical aids and acting as store-keeper. A little shift work was necessary when cable pairs were being changed over, but apart from this a 5-day week was worked throughout and the completion of the job on time reflects great credit on all members of the staff.

North-Western Region

"ERNIE"; COMMUNICATION FACILITIES FOR THE OPENING CEREMONY AND FIRST DRAW

ERNIE† arrived at the Premium Savings Bond Office at Lytham St. Annes in February, 1957, and was installed and tested by the Engineering staff of the Post Office Research Station, assisted by the local staff of the Preston Telephone Manager's Office.

At the end of April the Preston Area was informed that some 50 press reporters, 35 photographers, 25 radio and cinema operators, etc.—in fact, some 125 press and similar representatives—were expected to be present for the opening ceremony and the first draw, and that communication facilities would be required.

Telephone facilities for the Premium Bond Office are normally provided by a C.B.9 P.B.X., which also serves a number of other government departments on the same site. The P.B.X. is connected to St. Annes manual exchange which, in turn, is connected to Blackpool auto-manual exchange, its group centre, about 5 miles away. Neither the P.B.X. nor the local manual exchange could have dealt with any great overload of traffic and, therefore, it was decided, after a review of the line plant position, to divert as much traffic as possible direct to the Blackpool auto-manual switchboard and operate the telephone circuits on a trunk subscriber basis. As the result of some small rearrangements in the local line network, 36 spare pairs were extended from St. Annes exchange to the Premium Bond site. In addition, 10 of the P.B.X. exchange lines were intercepted, via keys, at the P.B.X. and the local exchange so that the circuits could be quickly switched from their normal use to augment the spare pairs if it became necessary. As the draw was taking place mainly during a week-end it was possible to use some of the P.B.X. exchange lines to make up trunk subscriber circuits, should the need arise.

A room some 35 ft × 47 ft, near to the room accommodating ERNIE, was made free for the press communication facilities three days before the draw. The pairs were extended to this room and the following facilities were provided:—

- Trunk subscriber positions.*—22 telephones, each provided with an acoustic screen, were connected as trunk subscriber circuits on Blackpool auto-manual exchange. Each telephone position had a tablespace of 4 ft × 2 ft 3 in., which allowed room for the reporters' press copy.
- Picture transmission positions.*—Four requests for picture transmission facilities were received. Each position consisted of a 4 ft 6 in. × 2 ft 6 in. table provided with a power supply and a 4-wire local end. Separate dark

† HAYWARD, R. K., and BOBB, E. L. "ERNIE"—The Electronic Random Number Indicating Equipment for the Premium Savings Bonds Prize Draws. *P.O.E.E.J.*, Vol. 50, p. 1, April, 1957

room facilities were also made available.

- (c) *Telex*.—Two telex demonstration installations, each provided with an auto-transmitter, were connected direct to the Manchester telex switchboard. One perforator was also provided. In addition, a teleprinter No. 7 B.R.P. and an auto-transmitter were provided in separate accommodation. This equipment was used by Post Office staff to prepare a punched tape of the £1,000 and £500 prize winning bond numbers and the tape was then made available to the press representatives for automatic transmission on the telex equipment.
- (d) Two exclusive exchange lines were asked for by press agencies. These were provided on the same basis as described in (a).
- (e) *B.B.C. and I.T.A.*—Circuits were made available for a live B.B.C. television transmission on Friday, 31st May and further B.B.C. television and sound transmissions were made on Saturday, 1st June. In addition, circuits were made available for A.B.C. transmission on Saturday, 1st June. These facilities were provided as required, either from the press room or the room accommodating "Ernie."
- (f) *Enquiry positions*.—Two enquiry positions, staffed by members of the Telephone Manager's and Head Postmaster's staffs, were set up to deal with telephone and telegram enquiries.

The circuits mentioned in (a) above were connected to the exchange via control panels installed on the enquiry position in the press room. By this means calls could be controlled at the source in the event of pressure. The panels were also useful for handling the fixed time and incoming calls.

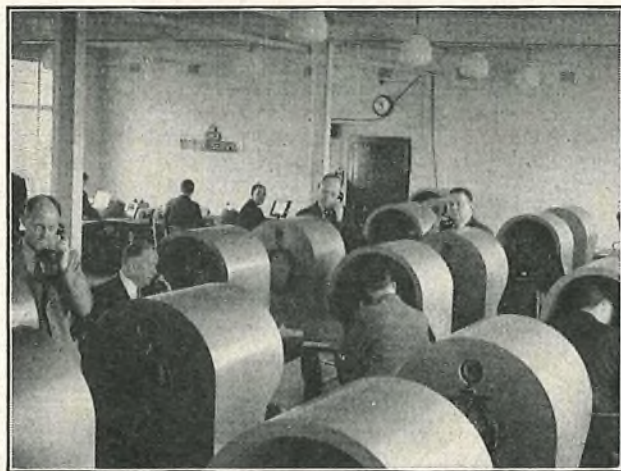

PRESS COMMUNICATIONS ROOM FOR "ERNIE" OPENING CEREMONY.

The photograph shows a portion of the press communications room and some of the facilities provided. On Friday, 31st May, the press were conducted round the Premium Bond Office and given a description of ERNIE. In the afternoon they attended a press conference which was addressed by the Postmaster-General.

On Saturday, 1st June, the Postmaster-General, after making an introductory speech, pressed a switch at approximately 9.15 a.m. and ERNIE started producing and printing the prize-winning bond numbers for the first draw of the Premium Savings Bond Scheme. The film and television cameras went into action accompanied by the operation of some 50 or more press cameras and their associated flash bulbs. The B.B.C. also made a sound broadcast of the opening ceremony.

There was quite a rush of reporters to the press room after Lord Mackintosh had displayed the first £1,000 winning bond number, and further peaks of traffic occurred when the lists of £1,000 and £500 prize winners were distributed for publication.

Good use of the facilities provided was made by the press throughout the two days, especially as free calls were allowed, on press business dealing with the Premium Bond scheme, to anywhere in the United Kingdom. During the two days the traffic handled was:—341 telephone calls, 9 picture transmission calls and 9 telex messages totalling some 2,200 words.

In addition, 13 press agencies and offices made use of the prepared punched tapes for the transmission of the first £1,000 winner and the lists of the 96 £1,000 and 192 £500 winners.

By about 3.30 p.m. on the Saturday all the press representatives had left the site and the press room was closed down. During the remainder of the week-end all the equipment provided for the press was recovered and the room was handed back for its normal office use on Monday morning. ERNIE, however, had continued to operate day and night, except for staff meal breaks, from 9.15 a.m. on Saturday, 1st June, until 3.4 p.m. on Monday, 3rd June. During this period ERNIE and the associated teleprinters had produced satisfactorily 58,000 bond numbers from which were compiled the prize-winning lists.

H. G. C.

"ELECTRONICS AT WORK" EXHIBITION

An exhibition under the title "Electronics at Work" was held at the Manchester College of Science and Technology on the 26th and 27th March, 1957. It was organized by the Radio and Telecommunication Group of The Institution of Electrical Engineers (N.W. Centre) primarily for the purpose of interesting school-leavers and graduates in the electrical engineering profession.

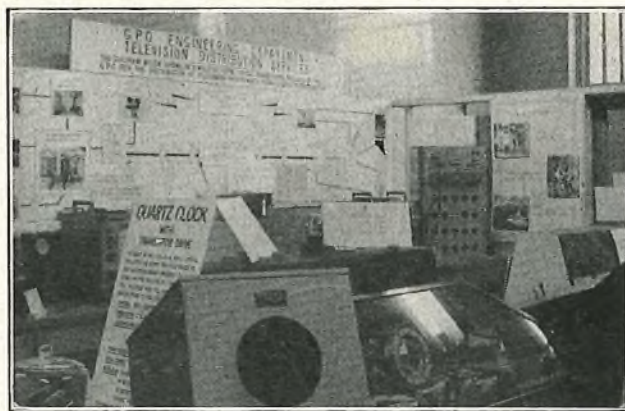

PART OF THE "ELECTRONICS AT WORK" EXHIBITION AT MANCHESTER.

The Post Office contribution comprised six exhibits, namely:—

- Quartz Crystal Display
- Electronic Exchange
- Submerged Repeater
- Telex Display
- Transistor Amplifier
- Post Office Television Network, including Television Outside Broadcast Equipment.

The design, construction and staffing of the exhibits was effected jointly by Engineering Department, Regional and Area staff. In addition, Area staff were in attendance to deal with enquiries and issue literature on engineering and scientific careers in the Post Office.

The total attendance on the two days of the exhibition was approximately 2,000, including over 1,000 older school children in organized parties from 70 local schools.

S. D. M.

London Telecommunications Region

RE-SITING A CROSS-CONNEXION CABINET BY MEANS OF A CRANE

When the West Ham Borough Council decided to widen Woodgrange Road, E.6, a Cabinet No. 2 at the junction with Romford Road was found to be in the proposed carriageway. It was decided that a number of advantages could be secured if the cabinet were removed bodily to its new position on the line of the new footpath. The normal procedure would have occupied a considerable number of manhours.

A detailed survey was made and it was found to be practicable to move the cabinet, cabinet base and cables to a point approximately 6 ft along the road and inside the new kerb line.

The cable tails consisted of two 400-pair and two 100-pair cables of 7 ft 6 in. effective length and no obstruction was

encountered to preclude the moving of the cables from their existing position in the side wall of the joint box to the required position in the end wall.

A program of operations was prepared by the Planning Group, and the actual re-siting was arranged for a Thursday, this being early closing day. During the morning, the brickwork of the joint box was broken down to duct level and excavations were made around the cabinet base and in the area of the new cabinet position. The cables were exposed by removing the ducts, and ropes were passed under the base of the cabinet and secured above the cabinet. Mild-steel angle brackets with wood battens were secured to the front foundation bolts to locate the cables during movement, as shown in the drawing.

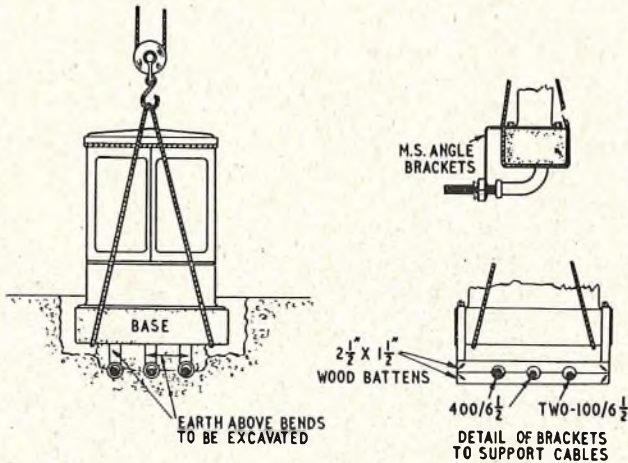

RE-SITING OF A CABINET NO. 2.
METHOD OF LIFTING CABINET AND CABLES.

A "Hydra-Crane" lifted the cabinet and base clear of the pavement level and then to a position over the new cabinet site, the cables being straightened by the jointing staff as this operation proceeded. In this position the cabinet was rotated until parallel with the new kerb line, the cables were bent as required at the cabinet end, and the cabinet was then lowered into its final position, the cables being placed into the trench previously excavated. The plan shows this in progress and the photograph shows these operations completed. Finally, the space beneath and around the base was filled with "dry" concrete and the cabinet levelled. These operations took under two hours to complete.

A new joint box was built in front of the cabinet to accommodate the cable bends, split ducts were fitted, and the

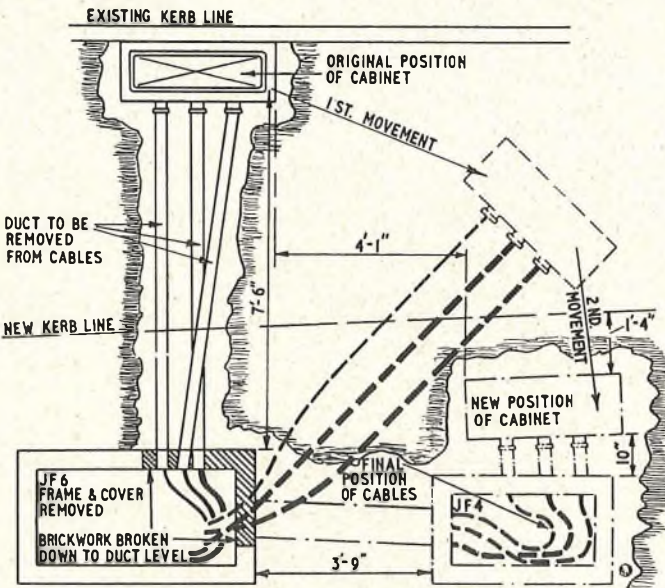

RE-SITING OF A CABINET NO. 2.
PLAN SHOWING MOVEMENT TO NEW POSITION.

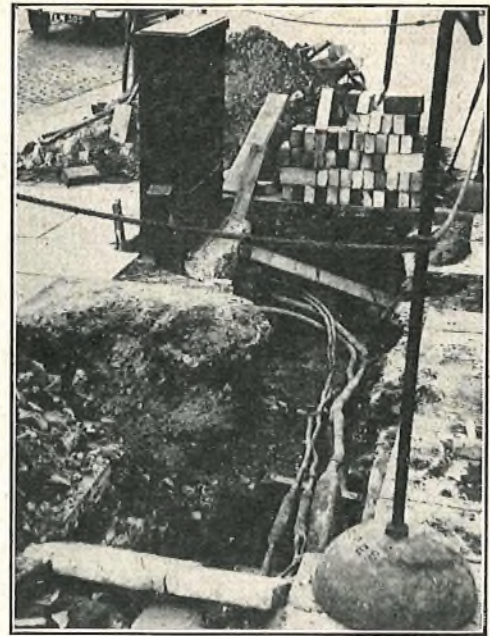

CABINET NO. 2 IN NEW POSITION.

brickwork of the existing box made good. The mutual benefits that were derived were:—

A direct saving of £320 to the Highway Authority in the cost of Post Office diversions and a speeding up of the road works at this busy road intersection.

A "profit" of some 550 manhours to the Post Office. Considerable planning and survey time would also have been needed to produce diversion schedules, etc., for a substitution of the cabinet and its associated jumpering.

No new stores were used, and the financial loss on the assemblies which would have been recovered unfit for re-use because of the shortened cable tails and obsolete type was avoided.

From an engineering point of view, this method has the advantage that the multiple joints on the cables are maintained intact, obviating deterioration of the paper insulation when diversions are made to new cables.

E. C. B.

THE REPLACEMENT OF EDGWARE SATELLITE EXCHANGE

Edgware is a discriminating satellite exchange using directors at the main exchange (Colindale). In 1950, on the completion of Extension 7, it had a multiple of 10,000. Telephone growth in the area was still rapid, so a comprehensive plan was formed to build a relief exchange called Stonegrove to take about half the subscribers, and to use the space thus thrown spare to replace Edgware by a modern director exchange. The two exchanges together will have an ultimate capacity of about 16,000 and should give better service at lower maintenance cost than the old exchange.

In 1952 the first step was taken when Stonegrove hypothetical exchange was opened using the upper half of the Edgware numbering range (5300-9999). Since the two exchanges, Edgware and Stonegrove, would eventually serve geographically separate areas, it was necessary to change the subscribers' numbers so that they were in the appropriate exchange number range. This was the first major engineering operation and involved in all about 5,000 number and/or name changes. In the case of the number changes (about 3,000) each number thrown spare had to be connected to changed number interception (C.N.I.) until calls to it dropped to a negligible level. To keep this C.N.I. traffic to a reasonable level the changes were spread over a period of nearly two years.

Meanwhile Stonegrove physical exchange was built in a new building with a multiple of 4,700 and was opened on the 17th February, 1955, by the transfer of 3,800 subscribers from Edgware. Again C.N.I. was necessary, as although the subscribers were all called Stonegrove already, they could be

obtained up to that time by dialling Edgware instead. In fact, some callers maintained that they got through better this way!

The opening of Stonegrove threw spare enough space to permit the replacement of Edgware to start, but unfortunately the equipment thrown spare was not in the positions required for the first section of the new exchange so a further major rearrangement of lines was necessary. This involved re-numbering nearly all the line and final units and rejumping some 5,000 subscribers' lines. To avoid delaying the start of the new installation this work was pushed ahead as quickly as possible. A slung scaffold erected against the M.D.F. by a firm of scaffolding specialists enabled several jumpering teams to operate at once, and proved a very profitable investment.

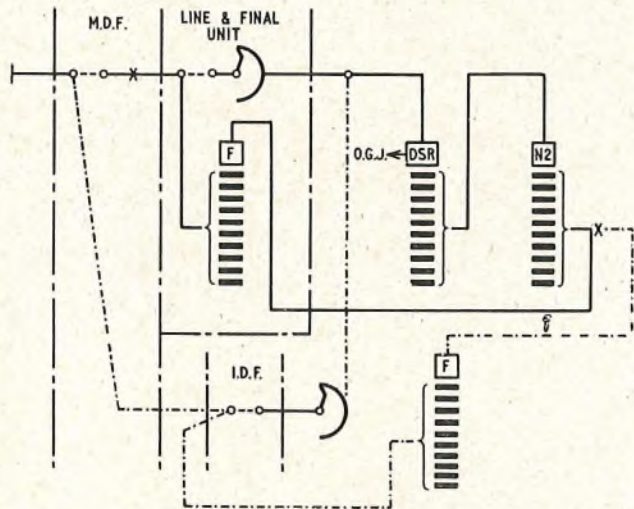

CHANGE-OVER OF UNISELECTORS AND FINAL SELECTORS AT EDGWARE EXCHANGE.

Eventually the correct equipment was thrown spare and recovered, the floor was relaid where worn, minor building alterations were completed and in September, 1955, the equipment contractor started work. The contract called for building the new exchange and recovering the old, and the work was divided into four stages:—

- Stage 1. Uniselectors and final selectors for 3,200 multiple.
- Stage 2. Uniselectors and final selectors for 2,100 multiple.
- Stage 3. Numerical selectors.
- Stage 4. Directors, etc.

After each stage the Post Office had to bring into use the equipment provided and dispossess of the old equipment thrown spare.

The method of changing from old to new uniselectors and final selectors is shown in the diagram. The new unselector banks were graded to the D.S.R.s in parallel with the old unselector banks, and the new M.D.F. and I.D.F. jumpers run. Before these jumpers were terminated all the new K relays were operated by placing wooden wedges inside the relay covers. These wedges were designed locally and made by the L.T.R. Power Section and have since won the suggestor an award. When all was prepared, the subscribers were changed over in batches of 200 multiple by changing the second numerical outlet from old to new final selectors, cutting the old multiple cable near the M.D.F. and removing the wooden wedges. These changes were made daily at 7.30 a.m. and in every case the change was completed within a few minutes and all lines tested before 9.0 a.m. This is the stage reached at the time of writing.

The next stage—introduction of new numerical selectors—should be straightforward since the new N 2nd outlets can be connected in parallel with the old and the D.S.R. outlets then transferred piecemeal from old to new N 2nds.

A similar piecemeal procedure will be followed for the introduction of the directors, code selectors, etc., the only complication here being that outgoing junctions must be transferred from the old D.S.R. route to the new routes from C 1sts as work proceeds and traffic moves over from the old to new equipment.

The replacement of this 10,000-line director satellite exchange is now well under way and it is hoped that the most difficult stages are over. Final completion is due in December, 1958. From the contractor's point of view, the most difficult part of the operation has been getting the new cable runs into positions obstructed by existing working cables and this and similar difficulties have led to the work being spread over a much longer period than usual. For the Post Office the most difficult part has been disposing quickly of apparatus racks recovered and, to quote the specification, "handed to the Department's representative on site." Thanks to close co-operation between contractor and Post Office staff at Edgware the actual changes and preliminary jumpering have gone very smoothly and without any delays. Engineering work started effectively in 1952, so the work will have taken six years by the time it is finished. If the work could have been planned even earlier, some of the preliminary rearrangement and number changes might have been avoided, but it is perhaps too much to expect that the old exchange could have been designed with one eye on its eventual recovery and that it could have been foreseen how the area would develop and what plan would be adopted to cater for that development.

J. O. C.

CIVIL AVIATION COMMUNICATIONS CENTRE CROYDON

The Ministry of Transport and Civil Aviation Communications Centre (C.A.C.C.), Croydon, is the central point from which teleprinter circuits radiate to airports and other signals centres in Europe and to many beyond. Being a focal point for such a large network the C.A.C.C. is often involved in the re-transmission of operational messages between air traffic

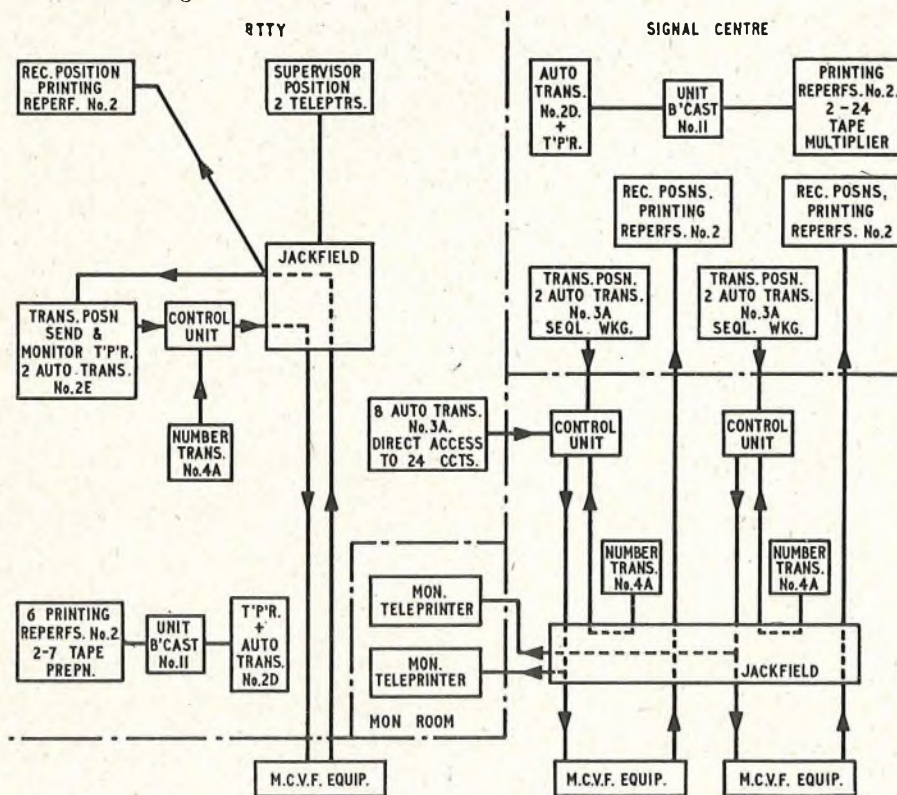

BLOCK SCHEMATIC DIAGRAM OF THE LAYOUT AT CROYDON C.A.C.C.

control centres and operating companies. Until recently traffic routed to and from many of the overseas control centres was received over radio equipment at Birdlip and re-transmitted from the Sub-Signals Centre there.

Work has recently been completed to integrate the work of this Sub-Signals Centre with the C.A.C.C. In addition to considerable rewiring and recabling in the Croydon centre it has been necessary to arrange for the remote control of the radio terminal equipment over multi-channel voice-frequency telegraph (m.c.v.f.t.) equipment to Croydon. The object of this change has been to speed up the time previously incurred for re-transmission of telegraph traffic routed over the radio circuits parented at Birdlip.

In addition to the use of m.c.v.f.t. channels for extending the Birdlip radio circuits, a complete redistribution of equipment and the addition of new facilities in the Signals Centre were involved.

The block schematic diagram of the layout in the C.A.C.C. shows the interconnexions between the radio tele-type (R.T.T.Y.) monitoring room, Signal Centre and Post Office equipment room.

Dealing first with traffic incoming to Croydon over the radio circuits extended by m.c.v.f.t. channels, the receive line is terminated on a console-mounted printing reperforator No. 2, shown on the right in the first photograph. Whilst incoming traffic is being received it is desirable for the operator on the send position, which is installed some distance from the receiving reperforator, to be made aware that the circuit is being used for transmission in that direction and to observe the traffic then passing. A receive monitoring teleprinter is

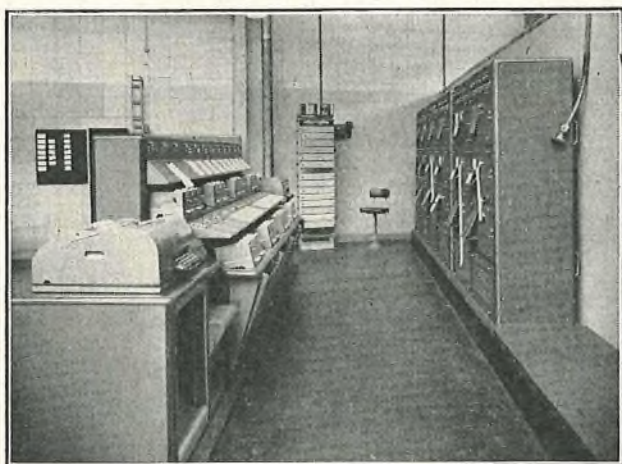

THE RADIO TELE-TYPE MONITORING ROOM.

thus provided on her send position. The message is received on the printing reperforator in the form of perforated tape and this might be due for re-transmission over any one or a number of telegraph circuits. Normally the perforated tape is sent by pneumatic tube to the Signals Centre, where re-transmissions can be made. Automatic transmitters No. 3A* are used which employ three automatic transmitters operating from one motor, each of which can operate independently. The machines are sometimes known as triple-headed automatic transmitters. Each circuit of the transmitting positions in the Signals Centre is fitted with two automatic transmitter heads wired for sequential working over the m.c.v.f.t. "send" lines. The sequential working is a facility that enables the idle transmitter head to be loaded with a message tape in readiness for transmission, which will occur automatically when the circuit becomes free. In every case the message is preceded by a number from the associated automatic numbering transmitter No. 4A.

When the delay occasioned by traffic passing from R.T.T.Y. to the Signals Centre by pneumatic tube is undesirable, particularly when the amount of traffic for a certain route would justify joint access from the R.T.T.Y. room, circuits share access via the control unit to triple-headed automatic

transmitters 3A in the R.T.T.Y. room, also wired for sequential working (seen on the left in the first photograph).

For traffic originated over R.T.T.Y. circuits from Croydon, positions are used that accommodate two automatic transmitters No. 2E, a send teleprinter and a receive monitoring teleprinter. These positions are shown in the second photograph. The function of the receive monitoring teleprinter on the transmit position has already been stated. The automatic

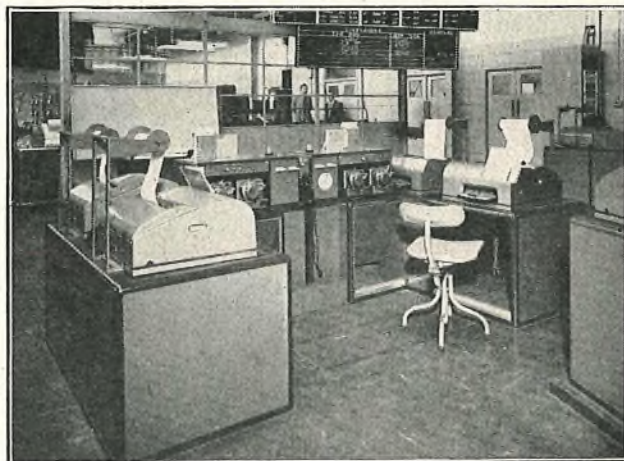

ANOTHER VIEW OF THE RADIO TELE-TYPE MONITORING ROOM SHOWING AUTOMATIC TRANSMITTERS.

transmitters 2E are wired for sequential working and an automatic transmitter No. 4A again provides for message numbering. Whilst an automatic transmitter is in operation the send teleprinter serves to monitor transmission but this machine can also be used if manual transmission, as distinct from tape re-transmission, is required. A local jack-field in R.T.T.Y. facilitates re-distribution or re-allocation of equipment terminating the circuits and also the association of the supervisor's two teleprinters with any circuit.

In both R.T.T.Y. and Signals Centre tape duplication is provided for by transmitting into broadcast units No. 11, giving 2 to 7 copies in R.T.T.Y. and 2 to 24 copies in the Signals Centre.

The main jack-field in the equipment room facilitates access to circuits for testing or patching and the association of monitoring teleprinters with circuits for prolonged periods.

The equipment was opened for service on 25th June, 1957, and has been used for the transmission of a daily average of approximately 25,000 messages.

Midland Region

REPLACEMENT OF 21-YEAR-OLD BATTERIES AT TELEPHONE HOUSE, BIRMINGHAM

The 50V batteries serving Central and the trunk and toll exchanges have been replaced recently after giving 21 years service. The batteries consisted of No. 15/9,900 cells and were originally installed in 1936. From 1936 to 1940 they were worked on a charge-discharge basis, the load during this period being comparatively small. Concurrently with the installation of 2-V.F. equipment in the trunk exchange in 1940 the power plant was replaced by a divided battery float plant to cater for the increased power consumption. The increase in load involved the provision of additional main distribution circuits from the power board to the 2-V.F. apparatus rooms which were situated 3 floors away from the power plant. These new circuits consisted of copper bars having a total cross-sectional area of 32-in²/pole, and the battery power-board connexions, including the inter-row connectors, were increased in the course of the work to a cross-sectional area of approximately 40-in² of copper. In view of the weight of these inter-row connectors, well over 1 ton each, it was deemed necessary to support them directly from structural beams in the battery room and to allow this the batteries were rearranged. As it was necessary to dismantle the batteries to carry out this rearrangement, the opportunity was taken to overhaul them

* EASTERLING, C. E. Automatic Teleprinter Working. *P.O.E.E.J.*, Vol. 47, p. 80. July, 1954.

and certain minor repairs were made and a number of faulty plates replaced. No serious maintenance difficulties were encountered from that time until early in 1956 when the incidence of short-circuit faults began to increase rapidly, which on examination was found to be due to buckling of the positive plates. As these plates had been converted almost completely to active material it was not possible to straighten them and a complete replatal was envisaged. For the future development of the services in the building it was found that these batteries would be inadequate and it was decided that new batteries, consisting of No. 16/14,190 cells, should be installed. It is of interest that, had the old batteries been replated, the negative plates were in such condition, both electrically and mechanically, that they could have been re-used.

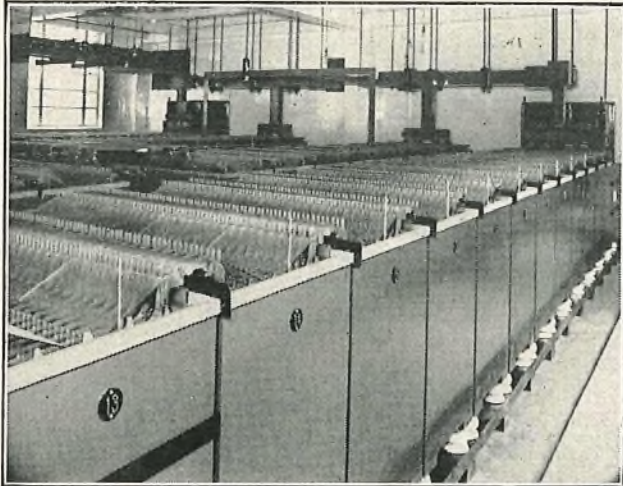

Photo by courtesy of The D. P. Battery Co. Ltd.

PART OF THE TWO NEW 50V, 14,190-AH BATTERIES AT TELEPHONE HOUSE, BIRMINGHAM.

To provide space for the new batteries it was necessary to rearrange all the other batteries in the battery room. Two 63-cell "B" batteries, each consisting of two banks of 500-Ah pasted-plate secondary cells, and a 90A P.B.X. counter-e.m.f. battery, consisting of 7 cells in stoneware boxes, were transferred to an old battery room some distance from the present power area. To reconnect the "B" batteries to the repeater power switchboard a half-mile of 4-in. \times $\frac{1}{4}$ -in. copper bar had to be erected to give the required cross-section of 3 in². Two 24V "A" batteries, each of two banks of 5,000-Ah submarine-type cells, were repositioned close to the battery room walls and their power board connexions, consisting of 16 laminations of 6-in. \times $\frac{1}{4}$ -in. copper bar, were altered to suit their new positions. This bus-bar work involved the stripping down, cleaning, re-setting and re-erecting of 10 tons of copper, which together with a further 4 tons of bar made spare brought the total length of bar handled up to three-quarters of a mile. The paralleling bars between the two banks forming each battery are run on insulated supports underneath the rows of cells.

Standby batteries for the 50V and "A" batteries were made up from 5,000 Ah submarine-type cells, the cells being grouped to form 10,000 Ah batteries for either service as required. A standby battery for the "B" batteries was assembled from 500 Ah electric vehicle cells.

At the time of writing the new batteries are the largest 50V exchange batteries in the country. Some idea of their size is given by the photograph and the following figures:—

Dimensions of one cell—5 ft 4 in. long, 2 ft 3 in. wide, 4 ft 0 in. high.

Weight of one complete cell—3½ tons.

Weight of two batteries, complete with stillage, etc.—200 tons.

8,000 gallons of acid required for filling.

G.F.B.

TRANSFER OF A COAXIAL SYSTEM FROM ONE SET OF TRANSLATING EQUIPMENT TO ANOTHER AT BIRMINGHAM

To make space available for the development of television equipment in Telephone House, Birmingham, it was necessary

to recover the complete coaxial terminal, including the Remote line equipment, that served the London-Birmingham "C" system on tubes 1 and 2 of the London-Birmingham No. 4 coaxial cable.

A spare set of line equipment had become available by the earlier diversion of tubes 3 and 4 of the London-Birmingham No. 4 cable into Lyndon repeater station. This equipment, together with a complete set of group and supergroup translating equipment that had not been taken into use due to the cancellation of a former program, was already installed in another repeater room in Telephone House, Birmingham, and it was decided that this equipment, after first being thoroughly overhauled and rechecked, could replace that existing on the London-Birmingham "C" system.

To avoid having the system out of service during peak traffic periods it was decided to parallel the old and the new equipment, and two low-loss coaxial leads were run between the two rooms, the ends being equipped with Sockets, Coaxial, No. 1. It was arranged that these leads could be connected when required to the CX1 test points in the cable termination boxes on the existing equipment and the 75-ohm side of high-impedance teeing networks on the new line equipment rack, as indicated in the diagram.

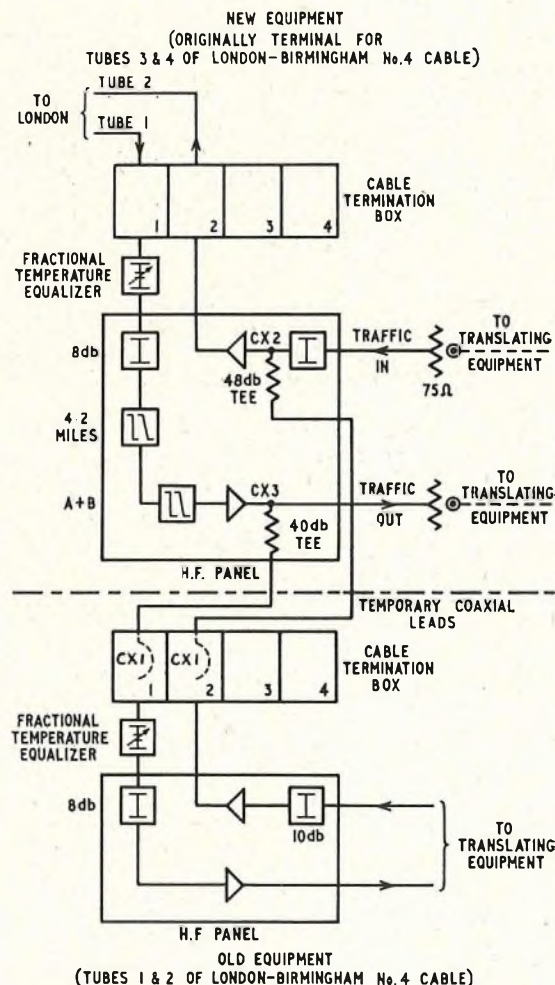

LONDON-BIRMINGHAM No. 4 CABLE. SCHEMATIC DIAGRAM OF CONNEXIONS AFTER EXTERNAL CABLE DIVERSIONS.

On the new equipment, the "traffic in" and "traffic out" points on the transmit and receive control panels, respectively, were terminated with 75-ohm resistors and both pilots were disconnected from the transmit control panel.

The system was then taken out of service for a night, and tubes 1 and 2 were interchanged with tubes 3 and 4 in the first cable joint outside Telephone House so that tubes 1 and 2 then terminated on the new equipment and tubes 3 and 4 would be available in the old room, after the diversion, for television purposes at a later date. Whilst the jointing operations were in progress, the main line equalizer and attenuator (Coaxial

Unit, No. 5A) and the sub-equalizers were transferred to the new line equipment rack, an 8-db attenuator replacing these items on the receive h.f. panel on the old line equipment rack. The fractional temperature equalizer on the new equipment was set to zero. The two temporary coaxial leads were then connected to the CX1 test points in compartments 1 and 2 on the old equipment, as shown, the other ends of these leads having been connected to the new line equipment rack. On completion of the cable-jointing work, the old line equipment racks were, therefore, connected via the new racks to tubes 1 and 2 of the cable. The overall gain of the system was then temporarily equalized, by using the fractional temperature equalizers on the old equipment, and restored to service.

The following week-end the system was taken out of service and the supervisory and control pairs were transferred to the new line equipment by rearrangement of the internal cabling in Telephone House. The 75-ohm resistors were removed from the "traffic in" and "traffic out" points of the new line equipment racks and the new group and supergroup translating equipment was connected thereto. Overall h.f. measurements were then taken between the new line equipment rack and the Control terminal at London and minor adjustments made as required. By adjusting the fractional temperature equalizer on the old line equipment to give approximately the same levels as those received on the new equipment, it was possible to route a group over the old or the new translating equipment as required. The outgoing pilots from Birmingham were then transferred to the new line rack.

The supergroup transmit amplifiers on the new equipment had previously been disconnected to minimize interference due to carrier leak between the two parallel sets of translating equipment and a line-up of the transmit direction on the new group and supergroup translating equipment had also been carried out. It was therefore only necessary for the receive direction to be lined-up with the aid of a test signal from London, after which the system was restored to service with the groups still working via the old equipment.

As the two sets of translating equipment were then connected in parallel it was possible for the transfer of groups to the new translating equipment to be carried out without causing interruptions.

The old translating equipment, together with most of its associated through-group filters and channel equipment, was terminated on one Group Distribution Frame (G.D.F.) (No. 1) whilst the new translating equipment was terminated on G.D.F. No.2, and it was necessary to use transfer circuits between these two G.D.F.s for many of the groups. New jumpers were, therefore, connected between these transfer circuits and the new translating equipment on G.D.F. No. 2 in advance of the transfer of any of the groups. When the jumpering of a supergroup had been completed, the appropriate supergroup transmit amplifier on the new equipment was reconnected so that the equipments for that supergroup were in parallel, a channel of the first group to be moved being continuously monitored by loudspeaker amplifier No. 6B. Patching cords were inserted on G.D.F. No. 1 in parallel with the old jumpers, which could then be moved carefully without interrupting the group. The new jumpers on G.D.F. No. 1, which had previously been connected on the new equipment side, were connected to the appropriate through-group filter or channel equipment, leaving the group working over both sets of translating equipment. By removal of the patching cord on G.D.F. No. 1, the group was left working on its new routing.

On completion of the transfer of all groups in a supergroup, the supergroup transmit amplifier on the old equipment was disconnected to avoid interference due to carrier leak. When all the supergroups had been transferred, the high impedance teeing networks were removed from the new line equipment racks and the whole of the old equipment was thrown spare to await recovery. The actual transfer was completed in two weeks, and due to the method employed and the effective team work of the staff concerned, the work proceeded smoothly and without serious interruption to service.

D. C., L. T. and J. W. T.

FAREWELL TO BYPATH

With the transfer of Burton-on-Trent exchange to standard non-director working, on 23rd July, the last bypath exchange in the Midland Region has been closed.

Burton-on-Trent multi-exchange area was opened in 1932 and contained a bypath main exchange and two satellite exchanges, Swadlincote and Tutbury, and associated with the multi-exchange area were three bypath U.A.X.s, Hoar Cross, Alrewas and Sudbury.

The process of natural growth has resulted in the conversion of the unit exchanges to U.A.X. No. 13 and U.A.X. No. 13X, and Tutbury satellite exchange was converted to U.A.X. No. 14 in January, 1956. Swadlincote became a non-director exchange in February, 1957, and the conversion of the Burton main exchange completed the life of a system which had endeared itself to the maintenance staff who dealt with it, although it was rather bewildering to visiting officers more familiar with the step-by-step system.

The new Burton exchange has been provided in an additional wing on the old building and has been completely cabled in cream-coloured plastic-covered cable with cream cable racking. The result has been a very attractive looking exchange and has provided working conditions very superior to those enjoyed in the old exchange.

At the opening ceremony the Mayor of Burton-on-Trent inaugurated the new system by making a call to the Lord Mayor of Derby, thus symbolizing the very enhanced range of exchanges which can now be obtained by direct dialling.

W. L. S.

TEMPORARY (LOW-VOLTAGE) ELECTRIC LIGHTING IN MANHOLES

The provision of a new trunk exchange and repeater station at Nottingham presented problems in adequately lighting the various manholes in the vicinity of the building where several months of shift working were envisaged in connexion with jointing, balancing and "cutting-in" the new cables to the existing trunk and junction network. Conventional petrol-engine-driven lighting sets were used initially but it soon became evident that these were by no means ideal, due to the heavy maintenance liability of almost continuous use, excessive noise at night near residential property and the need to conserve petrol during the rationing period.

As the program was likely to extend through a lengthy period it was decided to install in each of the twelve manholes concerned a temporary low-voltage lighting supply feed from a common battery in the cable chamber of the new building.

The power installation consisted of a battery of 13 second-hand traction-type cells, floated from a rectifier No. 47E. Both these items were available locally. The rectifier output was set to float the battery at a nominal 2.1V per cell at no load, thus giving an open-circuit battery voltage of approximately 27V to compensate for the voltage drop in the feed cables and enable a supply of approximately 24V to be obtained at the furthest manholes.

The manholes were grouped into four "runs" and Cable, Polythene, 10/10, was drawn into a spare bore on each "run." All conductors were bunched on each "run" to minimize voltage drop and were teed to a 5-amp, 3-pin socket outlet mounted as near to the top of the shaft in each manhole as possible, well above anticipated water level. A soldered bond was made to the sheaths of the cable network in the cable chamber and in each manhole to serve as an earth return. Provision was made for up to three or four lamps to be plugged in as required in each manhole, including one for the jointers' tent or vehicle.

At no time has the supply been used concurrently in all manholes, but lighting has been available in each of the manholes as required. Also, the staff, as well as the public, have appreciated the absence of noise common to all forms of continuously running petrol engines.

The whole installation was carried out at little expense as the rectifier, battery, power board, switches and polythene cable will all be recoverable as "fit for re-issue".

G. F. A. and J. W. W. S.

Staff Changes

Promotions

Name	Region	Date	Name	Region	Date
<i>Area Engr. to Asst. Staff Engr.</i>			<i>Asst. Engr. (Open Competition) (continued).</i>		
Swain, E. C.	L.T. Reg. to E.-in-C.O.	8.4.57	Warren, H.	N.W. Reg.	20.5.57
<i>Snr. Exec. Engr. to Asst. Staff Engr.</i>			Plumstead, J. L.	L.T. Reg.	20.5.57
Cooper, W. D.	E.T.F.	22.5.57	Dykes, J. L.	L.T. Reg.	23.4.57
<i>Area Engr. to Reg. Engr.</i>			<i>Asst. Engr. (Limited Competition).</i>		
Cawsey, A. J.	S.W. Reg.	8.4.57	Cross, B.	E.-in-C.O.	23.4.57
O'Roark, A. F.	H.C. Reg. to Mid. Reg.	29.4.57	Ewens, D. S.	S.W. Reg.	23.4.57
Duff, J.	N.W. Reg.	13.5.57	Mason, D. J.	H.C. Reg.	23.4.57
Haliburton, F. C.	H.C. Reg. to N.E. Reg.	13.5.57	Haigh, B.	E.-in-C.O.	23.4.57
Nicholls, C. A. L.	N.W. Reg. to S.W. Reg.	1.7.57	Best, G. R.	S.W. Reg.	23.4.57
Robins, A. G.	H.C. Reg. to Scot.	19.6.57	Montague, S. J.	E.-in-C.O.	23.4.57
<i>Efficiency Engr. to Reg. Engr.</i>			Parry, C.	W.B.C.	23.4.57
Thomsett, H. S.	H.C. Reg.	15.2.56	Lord, J. A.	Mid. Reg.	23.4.57
<i>Area Engr. to Dep. T.M.</i>			Lisney, D. L.	E.-in-C.O.	23.4.57
Alston, G. J.	W.B.C. to L.T. Reg.	20.5.57	Lomas, R.	S.W. Reg.	23.4.57
<i>Exec. Engr. to Area Engr.</i>			Knight, J. O.	L.T. Reg.	23.4.57
Francis, R. S.	H.C. Reg.	6.5.57	Gibson, M. E.	E.-in-C.O.	23.4.57
Barnsdall, L. G. W.	S.W. Reg. to W.B.C.	15.7.57	Wickens, R. F.	E.-in-C.O.	23.4.57
<i>Exec. Engr. to Snr. Exec. Engr.</i>			Adam, A. R.	Scot.	23.4.57
Mansfield, P. M.	Scot.	8.4.57	Cook, F. W.	L.T. Reg.	23.4.57
McMillan, F. N.	E.-in-C.O. to Scot.	13.5.57	Luetchford, J. C.	E.-in-C.O.	23.4.57
Kimber, G. H.	E.-in-C.O.	17.5.57	Fawkes, P.	N.W. Reg.	23.4.57
Parker, P. N.	E.-in-C.O.	17.5.57	Barnfather, F. R.	E.-in-C.O.	23.4.57
Walters, J. R.	E.-in-C.O.	17.5.57	Viney, W.	N.W. Reg.	23.4.57
Marshman, R. C.	E.-in-C.O.	17.5.57	King, D. F.	L.T. Reg.	6.5.57
Catt, L. H.	E.-in-C.O.	17.5.57	Price, G. W. G.	E.-in-C.O.	6.5.57
Hutton-Penman, P. R.	E.-in-C.O.	17.5.57	Young, J. W. A. F.	W.B.C.	6.5.57
Davis, E.	E.-in-C.O.	17.5.57	Johnston, G. A.	Mid. Reg.	6.5.57
Hughes, A. V.	E.-in-C.O.	29.5.57	Yeeles, J. H.	W.B.C.	6.5.57
Seymour, E. H.	E.-in-C.O.	3.6.57	Clow, D. G.	E.-in-C.O.	20.5.57
Rutterford, L. F.	E.-in-C.O.	3.6.57	Crocker, J. T.	H.C. Reg.	6.5.57
Whyte, J. S.	E.-in-C.O.	17.6.57	Faller, R. D.	H.C. Reg.	6.5.57
Thomas, L.	E.-in-C.O.	17.6.57	Sach, F. W.	H.C. Reg.	6.5.57
Hill, B. C.	E.T.E.	24.5.57	Coules, S. P.	Mid. Reg.	6.5.57
New, S. E.	W.B.C.	22.5.57	Clifton, J. J.	E.-in-C.O.	6.5.57
Tomlinson, H.	N.E. Reg.	31.5.57	Windle, R. W.	L.T. Reg.	6.5.57
Crooks, R. H.	L.T. Reg.	8.5.57	Croft, F. W.	N.W. Reg.	6.5.57
French, J. A. T.	E.-in-C.O.	26.6.57	Bateson, W. R.	Mid. Reg.	6.5.57
<i>Exec. Engr. (Open Competition).</i>			Messent, W. A. P.	L.T. Reg.	6.5.57
McCarthy, C. R. S.	E.-in-C.O.	7.3.57	Lee, P. J.	E.-in-C.O.	6.5.57
Beardmore, A. F.	E.-in-C.O.	3.6.57	Townson, J.	N.E. Reg.	6.5.57
Kirtland, J. P.	E.-in-C.O.	11.6.57	Jackson, D. W.	L.T. Reg.	6.5.57
<i>Asst. Engr. to Exec. Engr.</i>			Skues, R. T.	H.C. Reg.	6.5.57
White, J. S.	Scot.	7.1.57	Stayton-Davis, A.	E.-in-C.O.	6.5.57
Whitby, R. A.	E.-in-C.O.	5.3.57	Ward, K. E.	L.T. Reg.	6.5.57
Blanchard, J. A.	N.E. Reg.	26.3.57	Simmen, W. D.	N.W. Reg.	20.5.57
Kent, E. R.	H.C. Reg.	28.5.56	Pacey, G. R.	Mid. Reg.	20.5.57
Brown, L.	H.C. Reg.	7.6.56	Cheong, R. K. H.	E.-in-C.O.	20.5.57
Rae, W. I. L.	Scot. to E.-in-C.O.	15.4.57	Gardner, B. W.	L.T. Reg.	20.5.57
Sheppard, S. H.	E.-in-C.O.	12.4.57	Whitlock, R. T.	L.T. Reg.	20.5.57
Bathie, J.	Scot.	12.4.57	Stacey, P. J.	E.-in-C.O.	6.5.57
Seach, E. G.	H.C. Reg. to N.E. Reg.	15.4.57	Pease, S.	N.E. Reg.	6.5.57
Barnard, F.	L.T. Reg. to E.-in-C.O.	17.6.57	<i>Inspector to Asst. Engr.</i>		
Secker, C. E.	E.-in-C.O.	24.6.57	Wiseman, J. E.	N.E. Reg.	18.9.56
<i>Asst. Engr. (Open Competition).</i>			Smith, C. H. J.	L.T. Reg.	14.2.57
Myers, E. A.	E.-in-C.O.	23.4.57	Craig, W. H.	H.C. Reg.	21.12.56
Hambleton, C. T.	L.T. Reg.	20.5.57	Plasom, G. A.	H.C. Reg.	21.12.56
Bailey, A. J.	E.-in-C.O.	23.4.57	Godfrey, L. A. R.	S.W. Reg.	12.11.56
Thorpe, C. A.	L.T. Reg.	20.5.57	Southway, P. K.	S.W. Reg.	13.2.56
Street, M. J.	H.C. Reg.	20.5.57	Carder, S. G. S.	S.W. Reg.	16.2.57
Gardner, D.	Mid. Reg.	20.5.57	Watts, W. H.	N.W. Reg.	6.3.57
Humphries, M. A.	L.T. Reg.	6.5.57	Richards, E.	N.W. Reg.	15.3.57
Alderson, H. B.	N.E. Reg.	6.5.57	Parnham, C. A.	L.T. Reg.	30.3.57
Court, W.	Mid. Reg.	6.5.57	Sandiford, W. N.	N.W. Reg.	9.4.57
Gilham, M. P.	L.T. Reg.	23.4.57	Shepherd, H. F.	Mid. Reg.	31.10.56
Massingham, R. P.	E.-in-C.O.	20.5.57	McBrien, G. H.	N.I.	2.5.57
Hammond, E.	E.-in-C.O.	20.5.57	Robertson, T.	Scot.	13.6.57
Rodcliffe, G. T.	L.T. Reg.	20.5.57	<i>Tech. Offr. to Asst. Engr.</i>		
Thomas, P. G.	E.-in-C.O.	20.5.57	Tompsett, D. C.	H.C. Reg.	21.12.56
Leach, S. C.	L.T. Reg.	20.5.57	Brown, H. W.	H.C. Reg.	21.12.56
			Brown, S. W.	H.C. Reg.	21.12.56
			Ketteringham, A.	L.P. Reg.	19.12.56
			Maxwell, T.	Scot.	20.2.57
			Davis, H. R.	S.W. Reg.	22.3.55
			Murrin, A. B.	S.W. Reg.	21.1.57
			Tait, J. Y.	Scot.	7.3.57
			Newborough, H.	N.W. Reg.	6.3.57

Promotions—continued.

Name	Region	Date	Name	Region	Date
<i>Tech. Offr. to Asst. Engr. (continued).</i>			<i>Tech. I to Inspector (continued).</i>		
Davis, S. J.	H.C. Reg.	13.2.57	Hart, F. W.	Mid. Reg.	31.12.56
Beasley, D. J.	H.C. Reg.	13.2.57	Clarke, P. B.	Mid. Reg.	24.9.56
Jackson, G. E. T. ..	H.C. Reg.	26.2.57	Allman, G. D.	Mid. Reg.	1.4.57
Edgar, A.	Scot.	4.3.57	Allen, J.	Mid. Reg.	22.5.56
Wyndham, R.	H.C. Reg.	11.3.57	Winder, W.	Mid. Reg.	3.4.57
Hayworth, H. W. ..	H.C. Reg.	11.3.57	Dewey, F. R.	L.T. Reg.	29.3.57
Musselwhite, C. E. ..	L.T. Reg.	2.6.57	Mathers, S. R.	L.T. Reg.	18.12.56
Lucas, G. S.	L.T. Reg.	1.1.57	Nash, J. T. R.	L.T. Reg.	1.3.57
Tingey, H. J.	L.T. Reg.	17.1.57	Ellis, F.	N.W. Reg.	3.4.57
Johnson, R. W. K. ..	L.T. Reg.	28.1.57	Gilbert, T.	N.W. Reg.	15.4.57
Hicks, R. T.	L.T. Reg.	1.4.57	Clark, A. F.	N.W. Reg.	16.4.57
Carr, M. T. M.	L.T. Reg.	1.4.57	Dow, G. H.	N.W. Reg.	17.4.57
Pike, S. A. R.	L.T. Reg.	15.4.57	Kewley, C. L. R. ..	N.W. Reg.	17.4.57
Hopkins, J.	L.T. Reg.	25.3.57	Cooper, W. G.	L.T. Reg.	30.3.57
Hearn, J. R.	L.T. Reg.	15.4.57	Clarke, J.	N.I.	15.1.57
Pethurst, I. A.	L.T. Reg.	1.1.57	Shaw, H.	N.W. Reg.	6.5.57
Willoughby, S. J. ..	E.-in-C.O.	27.4.57	Harris, H.	N.W. Reg.	20.5.57
Brading, E. T. A. ..	S.W. Reg. to E.-in-C.O. ..	27.4.57	Boyle, G. P.	N.W. Reg.	20.5.57
Bamford, W. H.	N.W. Reg.	9.4.57	Knight, R. L.	W.B.C.	18.2.57
Daniels, T. W.	E.-in-C.O.	3.6.57	Batchelor, J. H. ..	W.B.C.	4.3.57
Gaunt, T. J.	H.C. Reg.	1.4.57	Parker, T. L.	L.T. Reg.	8.6.57
Gant, W. L. B.	H.C. Reg.	1.4.57	Barrows, P. R. A. ..	Mid. Reg.	6.11.56
Huckle, D. A.	H.C. Reg.	1.4.57	Cowell, G. A.	N.W. Reg.	24.6.57
Collins, R. A.	H.C. Reg.	15.4.57			
Hoff, R. F.	H.C. Reg.	1.4.57	<i>Sur. Sc. Offr. (Open Competition).</i>		
Tucker, H. R.	N.I.	6.11.56	Austin, E. R.	E.-in-C.O.	3.6.57
Bennett, R. J.	E.-in-C.O.	31.5.57	<i>Sc. Offr. (Open Competition).</i>		
McEvoy, J. E.	W.B.C.	15.5.57	Stelzer, I.	E.-in-C.O.	3.6.57
Forbes, W.	N.W. Reg.	6.5.57	<i>Asst. Explt. Offr. (Open Competition).</i>		
Berry, G.	N.W. Reg.	6.5.57	Stringfellow, K. (Miss)	E.-in-C.O.	9.4.57
Lockett, A. E.	N.W. Reg.	7.5.57	Hodges, L. R.	E.-in-C.O.	8.4.57
Burrows, N. S.	H.C. Reg.	5.4.57	<i>Asst. (Sc.) (Open Competition).</i>		
Evans, T. G.	L.T. Reg.	1.5.57	James, T. D.	E.-in-C.O.	10.5.57
Kellerd, J.	Scot.	19.6.57	Whitehouse, D. L. ..	E.-in-C.O.	5.6.57
Robertson, J.	E.T.E.	24.6.57	Okoro, M.	E.-in-C.O.	1.7.57
Sowerby, K. T.	E.T.E.	24.6.57	Yule, S. K. (Miss) ..	E.-in-C.O.	8.4.57
Southall, R.	E.T.E.	15.7.57	Waller, W. J.	E.-in-C.O.	26.4.57
Gent, W. G.	E.T.E.	24.6.57	Clarke, B. E. (Miss) ..	E.-in-C.O.	29.4.57
<i>Tech. Offr. to Inspector.</i>			<i>Ldg. Dsman. to Snr. Dsman.</i>		
Johnson, L. V.	L.T. Reg.	6.5.57	Mitchell, A. P.	Scot.	29.4.57
Brunwin, J. R.	L.T. Reg.	13.5.57	Holding, H. J.	H.C. Reg. to L.T. Reg. ..	1.4.57
Cooper, F. G.	L.T. Reg.	20.5.57	Firth, D. I.	H.C. Reg. to N.E. Reg. ..	14.3.57
Davis, G. H.	L.T. Reg.	6.5.57	Rawlings, L. J. J. ..	S.W. Reg. to L.T. Reg. ..	24.4.57
<i>Tech. I to Inspector.</i>			Briant, G. A.	L.T. Reg.	14.3.57
Murray, R. W.	H.C. Reg.	21.12.56	Taylor, L.	Scot.	8.4.57
Lamper, J. A. M. ..	H.C. Reg.	21.12.56	<i>Dsman. to Ldg. Dsman.</i>		
Besant, D. A.	H.C. Reg.	25.1.57	Gallop, E. A. T.	H.C. Reg.	1.4.57
Bishop, T. E.	H.C. Reg.	25.1.57			
Leake, E. R.	H.C. Reg.	25.1.57			
Gray, G. J.	H.C. Reg.	25.1.57			
Kenyon, J. D.	H.C. Reg.	25.1.57			
Weller, F. W. G. ..	H.C. Reg.	25.1.57			
Green, J. D.	N.E. Reg.	1.10.56			

Retirements and Resignations

Name	Region	Date	Name	Region	Date
<i>Area Engr.</i>			<i>Asst. Engr. (continued).</i>		
Davies, R. C.	N.W. Reg.	14.3.57	Barker, J. (Resigned) ..	S.W. Reg.	13.3.57
<i>Snr. Exec. Engr.</i>			Perkins, M. R. (Resigned)	L. T. Reg.	31.3.57
Welsby, V. G. (Resigned)	E.-in-C.O.	31.5.57	Hodkinson, G. L. (Resigned)	N.W. Reg.	31.3.57
<i>Exec. Engr.</i>			Savage, A. (Resigned) ..	N.W. Reg.	31.3.57
King, R. R.	H.C. Reg.	24.5.57	Johnson, E. J.	E.-in-C.O.	12.4.57
Lloyd, H. H.	Mid. Reg.	2.1.57	Coombes, R. G.	E.-in-C.O.	19.4.57
Lester, T.	N.W. Reg.	31.1.57	Outhwaite, O.	N.E. Reg.	30.4.57
Nixon, G.	Mid. Reg.	16.3.57	Draper, T. J.	Mid. Reg.	13.4.57
Greene, A. H.	N.E. Reg.	31.3.57	Spilsbury, J. C.	Mid. Reg.	5.5.57
<i>Asst. Engr.</i>			Lillywhite, A. G. ..	H.C. Reg.	10.5.57
Nisbet, T. H.	Scot.	14.3.57	Carne, J. A.	L.T. Reg.	16.5.57
Henley, F.	L.T. Reg.	29.3.57	Barnes, J. L.	Mid. Reg.	16.5.57
Wall, W. H.	L.T. Reg.	31.3.57	Oliver, G. C.	L.T. Reg.	20.5.57
Hurrell, W. R. (Resigned)	N.W. Reg.	6.3.57	Grimes, L.	Mid. Reg.	23.5.57
			Butcher, E. E.	H.C. Reg.	30.5.57
			Coppock, F. C.	L.T. Reg.	31.5.57
			Waldie, L. R. (Resigned)	E.-in-C.O.	3.5.57
			Bremner, W.	Scot.	1.6.57
			Topple, A. W.	L.T. Reg.	2.6.57

Retirements and Resignations—continued.

Name	Region	Date	Name	Region	Date
<i>Asst. Engr. (continued).</i>			<i>Inspector (continued).</i>		
Fairs, T. F.	L.T. Reg.	2.6.57	Hacking, W.	N.W. Reg.	30.4.57
Norton, W. A.	E.T.E.	12.6.57	Biddolph, H.	N.W. Reg.	2.5.57
Halliday, A. A.	L.T. Reg.	12.6.57	Sears, H. F.	L.T. Reg.	9.6.57
Best, R. G.	S.W. Reg.	13.6.57	Tanner, C. E.	L.T. Reg.	9.6.57
McCorquodale, J.	Scot.	13.6.57	Adams, A. W.	H.C. Reg.	22.6.57
MacDonald, A.	H.C. Reg.	15.6.57			
Jenkins, A. V.	E.T.E.	15.6.57	<i>Exptl. Offr.</i>		
Findlay, W.	E.T.E.	23.6.57	Smith, J. S. (<i>Resigned</i>)	E.-in-C.O.	31.5.57
Wenman, G. A.	L.T. Reg.	25.6.57	<i>Asst. Exptl. Offr.</i>		
Lidstone, F. J. W.	E.-in-C.O.	9.7.57	Eisenegger, K. M. (Miss)	E.-in-C.O.	30.6.57
Rolfe, R. A. (<i>Resigned</i>)	L.T. Reg.	21.6.57	<i>(Resigned)</i>		
Rogers, S. V. (<i>Resigned</i>)	E.-in-C.O.	5.7.57	<i>Ldg. Dsman.</i>		
White, D. C. (<i>Resigned</i>)	E.-in-C.O.	17.7.57	Allen, H.	Mid. Reg.	30.6.57
<i>Inspector.</i>			Polling, T. W.	E.-in-C.O.	18.6.57
Almond, C. H. R.	H.C. Reg.	2.3.57	Freeman, J. S.	E.-in-C.O.	31.3.57
Davenport, H.	N.W. Reg.	6.3.57			
Prewett, P. J.	H.C. Reg.	10.3.57			
Howell, F. W.	N.W. Reg.	31.3.57			
Batchelor, A. E.	L.T. Reg.	12.5.57			

Transfers

Name	Region	Date	Name	Region	Date
<i>Area Engr.</i>			<i>Asst. Engr. (continued).</i>		
Arnold, G. F.	Mid. Reg. to H.C. Reg. ..	11.6.57	Hearn, J. R.	L.T. Reg. to E.-in-C.O. ..	1.5.57
Neate, A. D.	L.T. Reg. to H.C. Reg. ..	1.7.57	Bennett, J. G.	E.-in-C.O. to Sarawak ..	5.4.57
<i>Exec. Engr.</i>			Shaw, M. L.	E.-in-C.O. to Nigerian P. & T. Dept.	10.9.53
Dolman, W.	E.-in-C.O. to Board of Trade	13.5.57	Horden, A. V.	L.T. Reg. to M.T.C.A. ..	11.6.57
<i>Asst. Engr.</i>			<i>Inspector.</i>		
Holliday, A.	L.T. Reg. to Nigeria ..	20.10.53	Lane, R. J. F.	H.C. Reg. to Persian Gulf (Seconded)	14.1.57
Robinson, T. O.	E.-in-C.O. to H.C. Reg. ..	17.3.57	Sutton, T.	H.C. Reg. to Pakistan (Seconded)	1.6.57
Still, L. A. H.	L.T. Reg. to E.-in-C.O. ..	1.4.57			

Deaths

Name	Region	Date	Name	Region	Date
<i>Snr. Exec. Engr.</i>			<i>Inspector.</i>		
Birch, S.	E.-in-C.O.	11.4.57	Connell, T. H.	L.T. Reg.	22.4.57
Joyce, R. M.	E.-in-C.O.	25.6.57	Forster, J.	L.T. Reg.	24.4.57
<i>Exec. Engr.</i>			Archer, G. P.	H.C. Reg.	15.6.57
Wicks, W. L.	Scot.	12.4.57	<i>Ldg. Dsman.</i>		
<i>Asst. Engr.</i>			Turner, H. S.	N.W. Reg.	18.3.57
Pike, G. C.	E.-in-C.O.	15.4.57	<i>T.A. II.</i>		
Ellis, D. D.	N.E. Reg.	2.6.57	Sledge, J. O.	H.C. Reg.	14.5.57

BOARD OF EDITORS

D. A. BARRON, M.Sc., M.I.E.E., Chairman.
 L. F. SCANTLEBURY, Whit.Sch., A.C.G.I., D.I.C., M.I.E.E.
 H. G. BEER, Whit.Sch., A.C.G.I.
 T. H. FLOWERS, M.B.E., B.Sc.(Eng.), M.I.E.E.
 W. J. E. TOBIN, B.Sc.(Eng.), A.C.G.I., D.I.C., A.M.I.E.E.
 R. H. DE WARDT, B.Sc.(Eng.), A.C.G.I., A.M.I.E.E.
 R. F. WALDEGRAVE.
 W. A. HUMPHRIES, T.D., A.M.I.E.E., Managing Editor.
 J. H. BROADHURST, A.M.I.E.E.
 E. DAVIS, A.M.I.E.E. } Assistant Editors.
 B. FARR, Secretary-Treasurer.

Copyright

The entire contents of this JOURNAL are covered by general copyright, and special permission is necessary for reprinting long extracts, but Editors are welcome to use not more than one-third of any article, provided credit is given at the beginning or end thus: "From the *Post Office Electrical Engineers' Journal*."

The Board of Editors is not responsible for the statements made or the opinions expressed in any of the articles in this JOURNAL, unless such statement is made specifically by the Board.

Communications

All communications should be addressed to the Managing Editor, *P.O.E.E. Journal*, Engineer-in-Chief's Office, Alder House, Aldersgate Street, London, E.C.1. Telephone: HEAdquarters 1234. Remittances should be made payable to "The *P.O.E.E. Journal*" and should be crossed "& Co."

Binding Cases

Cases for binding are available, and may be obtained from the Local Agents for 3s. Subscribers can have their copies of volumes bound, at a cost of 10s. 6d., by sending the complete set of parts to the Local Agents or to the *P.O.E.E. Journal*, Engineer-in-Chief's Office, Alder House, Aldersgate Street, London, E.C.1. Orders for binding for Vols. 1-19 should indicate whether the original binding case with black lettering, or the later pattern with gold, is required. Cases with gold lettering are the only type stocked from Vol. 20 onwards.

Back Numbers

The price of the JOURNAL, which is published quarterly, is 2s. 6d. (3s. 3d. post free) per copy, or 13s. per annum, post free. Back numbers can be supplied, subject to availability of stocks, at 2s. 6d. (3s. 3d. each post free) except for Vol. 49, Part 4 (January 1957), the Transatlantic Telephone Cable issue, the price of which is 12s. 6d. (post free). Orders for back numbers may be sent to the *P.O.E.E. Journal*, Engineer-in-Chief's Office, Alder House, Aldersgate Street, London, E.C.1, or to the Publishers.

Employees of the British Post Office can obtain the *Journal* through Local Agents at the reduced price of 2s. per copy.

Advertisements

All communications relating to space reservations should be addressed to the Advertisement Editor, *P.O.E.E. Journal*, Alder House, Aldersgate Street, London, E.C.1. Communications regarding advertisement copy, proofs, etc., should be addressed to the Publishers, Messrs. Birch & Whittington (Prop. Dorling & Co. [Epsom] Ltd.), Depot Road, Epsom, Surrey.

S.T.C.

transistor transmiss equipmen

FOR TELEGRAPHY AND TELE

CONSUMES LESS POWER

MINIMISES FLOOR SPACE

LONG LIFE OPERATION

**UP-TO-DATE CONSTRUCTION
SIMPLIFIES MAINTENANCE**

Leaders in the design and manufacture of telegraph equipment, S.T.C. research and development has met the increasing demands for high quality communication equipment. The use of transistors is one of the latest techniques in the various applications are illustrated in the accompanying equipment shown.

A longer working life, greater economy in power occupation of a minimum of floor space, and improved accessibility to the equipment.

S.T.C. hermetically-sealed junction-type transistors. Operation is from mains voltages of 100V/50/60 c/s, or from station batteries of 24V.



Standard Telephones and Cables

Registered Office: Connaught House, Aldwych, London, W.C.2

TRANSMISSION DIVISION • NORTH WOOLWICH •

ised ion t

PHONY

re of Transmission
ent continues to meet
unication equipment.
chniques and some of
in the systems and

y of power and the
pace are advantages
struction gives greater

transistors are used.
-130V or 200-260V,
4-50V.

Limited

LONDON · E.16



TRANSISTORISED 3-CHANNEL TELEPHONE AND TELEGRAPH SYSTEM TYPE STOC & D3/6
*Provides three CCITT quality telephone channels or two CCITT quality, plus one narrow band, telephone channels with six frequency-modulated telegraph channels on one open-wire pair.
Two complete terminals mounted on one 9 ft. high × 1 ft. 8½ in. wide equipment rackside.*

240-CHANNEL SMALL DIAMETER COAXIAL CABLE SYSTEM

Ideal for the economic provision of telephone circuits over trunk routes of comparatively low traffic density, this system employs a small compact transistorised dependant repeater which may be buried in the ground. The light-weight cable is suitable for aerial installation.

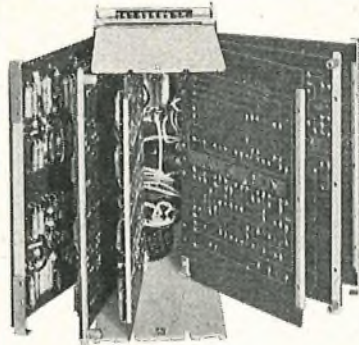

TRANSISTORISED REGENERATIVE REPEATER EQUIPMENT

Reforms signals having up to 49% distortion, at signalling speeds up to 100 Bauds with 7, 7½ or 8 unit codes. 36 repeaters can be accommodated on one 9 ft. rackside.

12-CHANNEL 2-WIRE CARRIER-ON-CABLE SYSTEM

Provides 12 two-way CCITT telephone channels on one cable pair and is suitable for application to many types of cables. Two terminal equipments complete with ring-down signalling panels and 2/4 wire terminating sets are mounted on one 9 ft rackside.

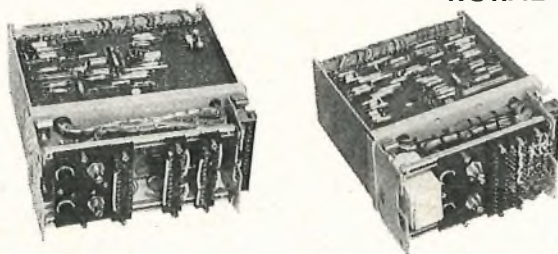
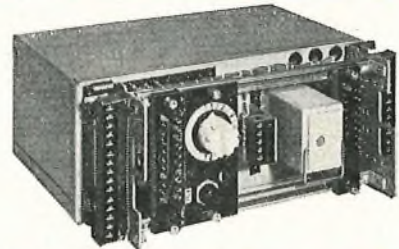

RURAL CARRIER TELEPHONE SYSTEM

Provides 21 "stackable" channel frequencies to enable up to 10 two-way circuits to be transmitted over one pair of wires with facilities for terminating one or more circuits at intermediate points on the route.

TRANSISTORISED AUDIO REPEATER

A complete VF junction-type repeater with through dialling and ringing facilities for installation at each terminal of a loaded junction-type circuit. The power drain of the repeater is less than ½ W.

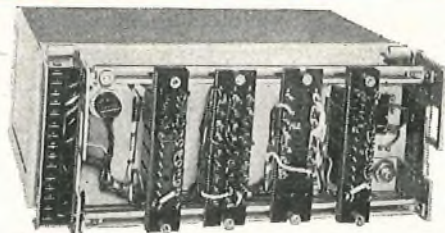

a new design



IN

TELECOMMUNICATIONS

**MODERN BUSINESS
DEMANDS MODERN
COMMUNICATIONS**



At every stage, in the design and production of these compact and elegant Cordless Switchboards, careful consideration has been given to the requirements of simple and positive operation.

The smooth lines and pleasing contours typify their efficiency, and make them a worthy addition to the wide range of modern Telephone Equipment manufactured by this Company.

Attractive colours and handsome styling will blend so well with the decor of modern offices and reception rooms, yet harmonize pleasantly with less contemporary surroundings.

The combination of dependability and low maintenance requirements, inherent in all Ericsson products, is clearly evident in these new switchboards, ensuring a service you will find hard to ignore.



The use of new components and materials has very considerably reduced the size of these modern Cordless Switchboards, making them particularly suitable for easy operation on table or desk. Their beauty will complement the most handsome office.

The styling and construction follows contemporary practice, having a 'drop on' cover with moulded ends and aluminium centres finished in an attractive mottle enamel. Components are mounted on a two-way hinged metal chassis and cast baseplate, providing trouble free operation and easy maintenance.

All inter-connections are made by keys with indicators providing positive supervision. Exchange line indicators are manually restored by depressing the transparent covers. In addition to the latest moulded hand-micro an auto dial is provided, mounted at the front of the key panel for automatic working. A hand generator at the right-hand side is used for calling extension telephones and a buzzer gives audible alarm when any indicator is actuated.

Two models are available at present :
2 Exch. Lines 3 Exch. Lines
4 Extn. Lines or 9 Extn. Lines
3 Connecting ccts. 5 Connecting ccts.

The size of both switchboards is :—
13" × 13" × 8½".

With an alternative colour scheme :—
Grey-green, Brunswick green and Black.
Grey-green, Brunswick green and Biscuit.

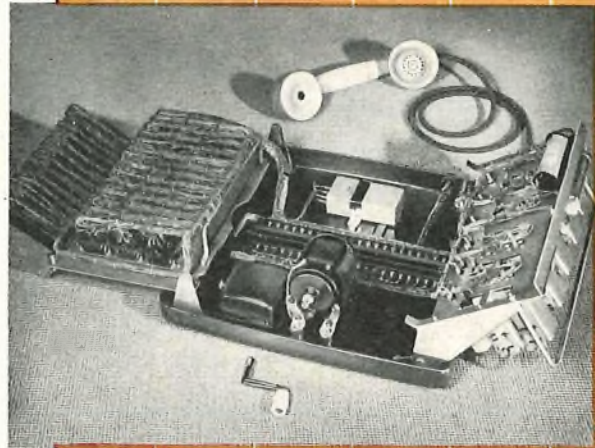
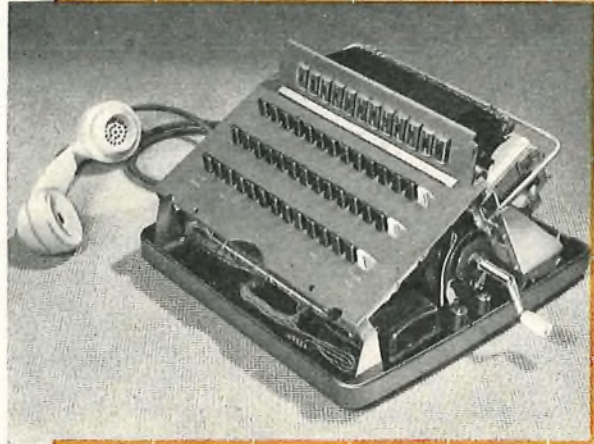

FULL PARTICULARS ARE AVAILABLE ON REQUEST

ERICSSON TELEPHONES LIMITED

HEAD OFFICE: 22 LINCOLNS INN FIELDS, LONDON, W.C.2. TEL: HOLBORN 6936
WORKS: BEESTON, NOTTINGHAM & SUNDERLAND

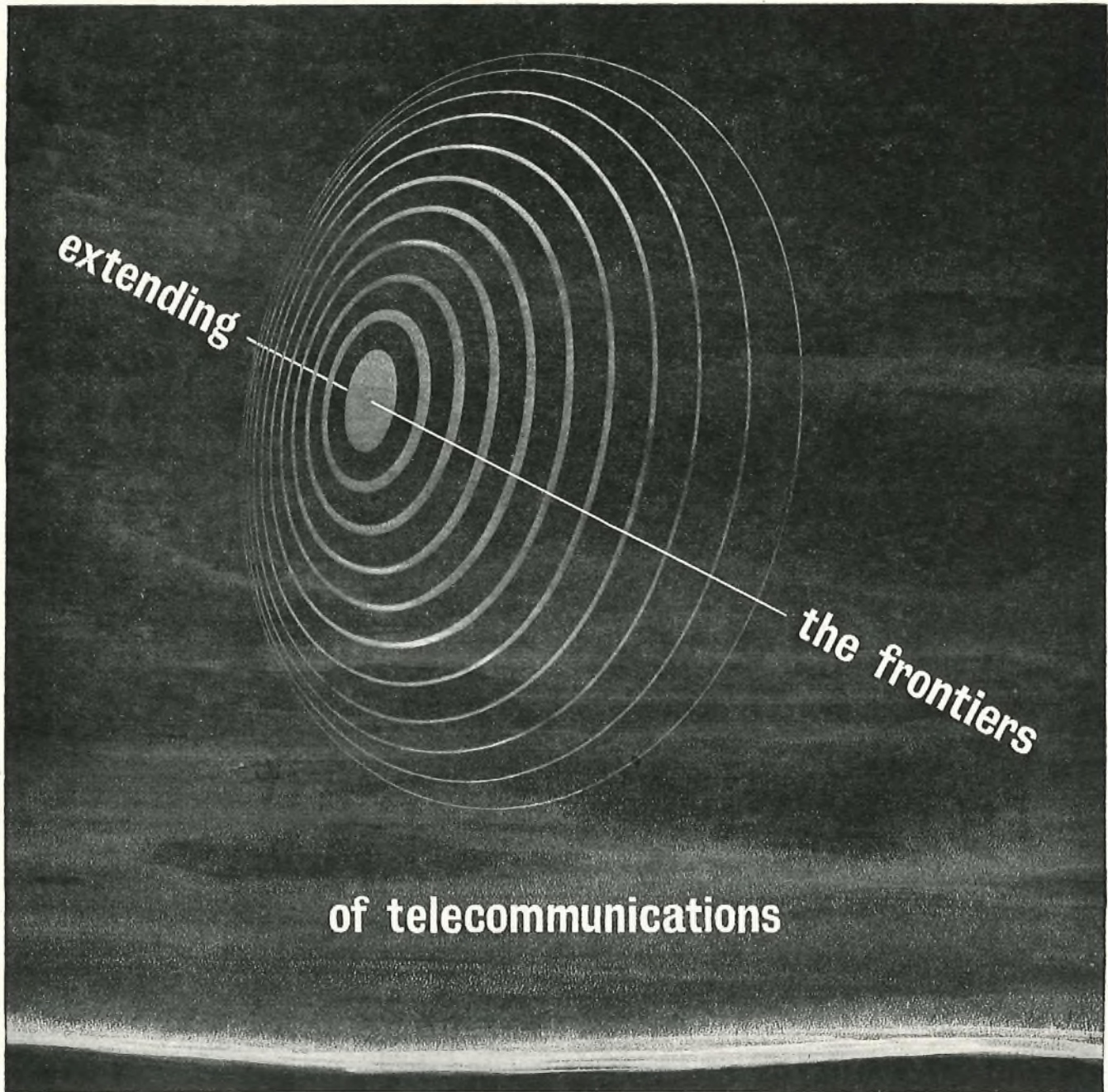

SIEMENS EDISWAN is rapidly becoming an important name in the world of telecommunications. Faithful adherence to the high standards of manufacture and testing established for so many years by Siemens Brothers and Ediswan, coupled with an extensive programme of continuous research and design, are the keystones of this progress. They are the reasons why Siemens Ediswan are gaining a fine reputation as makers of telecommunications equipment second to none in dependability and efficiency.

Details of our current range of equipment are available on application.

BROAD BAND CARRIER TELEPHONE EQUIPMENT
PROGRAMME CHANNEL EQUIPMENT
VOICE FREQUENCY TELEGRAPH EQUIPMENT
VOICE FREQUENCY REPEATER EQUIPMENT
RADIO TELEPHONE TERMINAL EQUIPMENT
FIVE BAND PRIVACY EQUIPMENT
TRANSMISSION TEST GEAR
COMPONENTS AND OTHER EQUIPMENT



SIEMENS EDISON SWAN LTD *An A.E.I. Company*
Telecommunications Transmission Division, Woolwich, London SE18
Telephone: Woolwich 2020 Telegrams: Sieswan Souphone London



SUBSCRIBERS' LINE CONCENTRATOR

An all-relay communication system which provides Telephone Service for TEN subscribers over TWO connecting links to an EXCHANGE

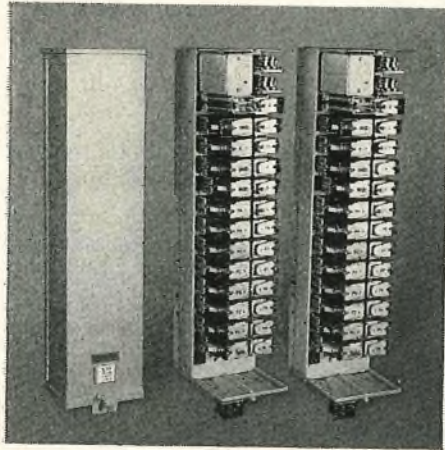

Parent Unit (cover removed)

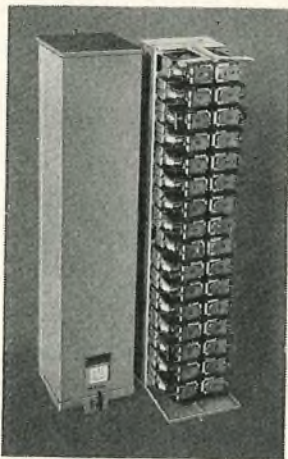

Subsidiary Unit

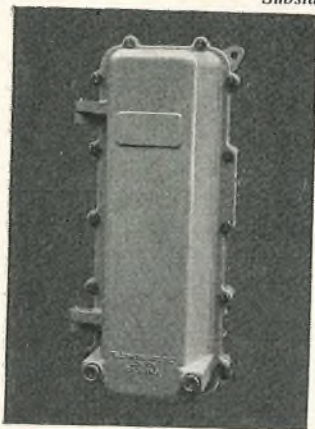

Weatherproof case for subsidiary unit

The TMC Subscribers' Line Concentrator is *not* a Party Line — subscribers are operationally indistinguishable, in all respects, from directly connected lines. It is fully secret and standard subscribers' telephone sets are used.

Plant costs are drastically reduced by its use, without any sacrifice of facilities. A complete system can be installed in a few hours, with a minimum of internal construction work, whether for permanent or temporary installation.

Batteries or power leads are not necessary at the remotely located Subsidiary Unit, nor are premises required for housing it.

Maximum reliability, with negligible maintenance requirements, is ensured by the use of 3000-type relays throughout. Visual and audible alarms are provided in the Parent Exchange to indicate line faults, and a faulty junction is automatically taken out of service.

The system is supplied to the British Post Office and the Corporation of Kingston-upon-Hull, in England. Overseas it is in use in Australia, British Guiana, Jamaica, Nyasaland, Singapore and Hong Kong.

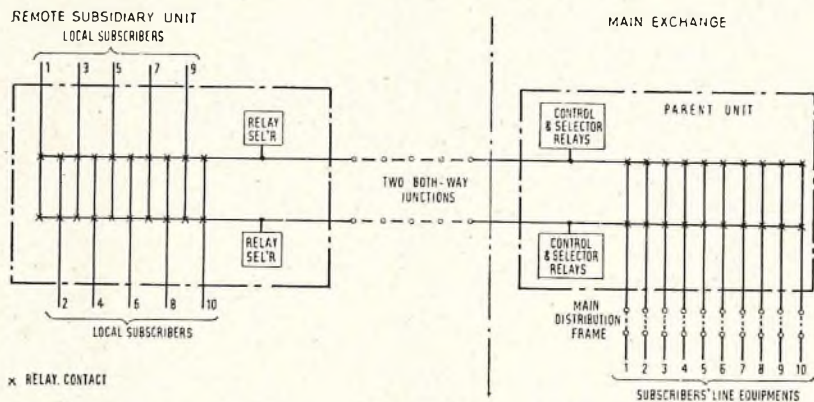

A call at either end of the system causes the selecting relays to hunt. The corresponding outlets at each end of the junction are selected simultaneously and tested for *calling* and *busy* conditions. When the calling condition is located the hunt action is arrested, and interconnection between the subscriber and the subscribers' line equipment is provided by the junction. The call then proceeds in the normal manner according to the type of Parent Exchange.

The scheme can also be used to provide a variety of services, e.g.—

- Night service for selected subscribers connected to an Exchange with restricted hours of attendance . . .
- Release of cable pairs to fully loaded D.P.'s . . .
- Release of pairs on cable routes pending provision of new plant . . .
- Service to blocks of residential Flats, as an alternative to a P.B.X. . . .
- Service for short duration events such as Exhibitions and Race Meetings by making pairs available without additional plant.

Write for full technical data to:

TELEPHONE MANUFACTURING CO LTD

HOLLINGSWORTH WORKS · DULWICH · LONDON S.E21

TELEPHONE: GIPSY HILL 2211

TRANSISTORISED

rural carrier
telephone
system

TRC-7

now being
used by
Overseas
Administrations

Increased traffic facilities over short haul routes are provided quickly and easily by the TRC-7. Full exploitation of transistors has resulted in a design with exceptional advantages. The TRC-7 is tropicalised and may be operated in ambient temperatures up to 50°C.

SEVEN EXTRA CHANNELS

A maximum of seven extra speech channels can be provided on an existing open wire pair. Channel units may be stacked and added as required. Channels may also be dropped at different points along the line.

LOW POWER CONSUMPTION

Junction transistors are used throughout, giving such an economy of power consumption that batteries may be used for subscribers' terminals where there is no mains supply. Each channel unit consumes only 0.4 watt.

PHYSICAL CIRCUIT UNAFFECTED

Operation of the TRC-7 does not interfere with the existing physical circuit. The system is suitable for lines with an attenuation of up to 30dB.

SIGNALLING FACILITIES

Signalling facilities are provided by a range of standard relay sets and include ring down, C.B. and simple auto.

SIMPLE INSTALLATION

The equipment is compact and easily transportable, and is especially suitable for the provision of temporary extra lines. It can be supplied for operation from A.C. mains or 24 or 48V station batteries.

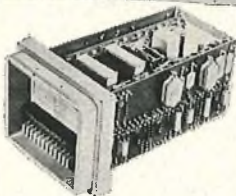

Each channel unit is self-contained

Three-channel terminal complete with relay sets



Mullard Limited,
Equipment Division,
Mullard House,
Torrington Place,
London, W.C.1



Post Office
Switzerland

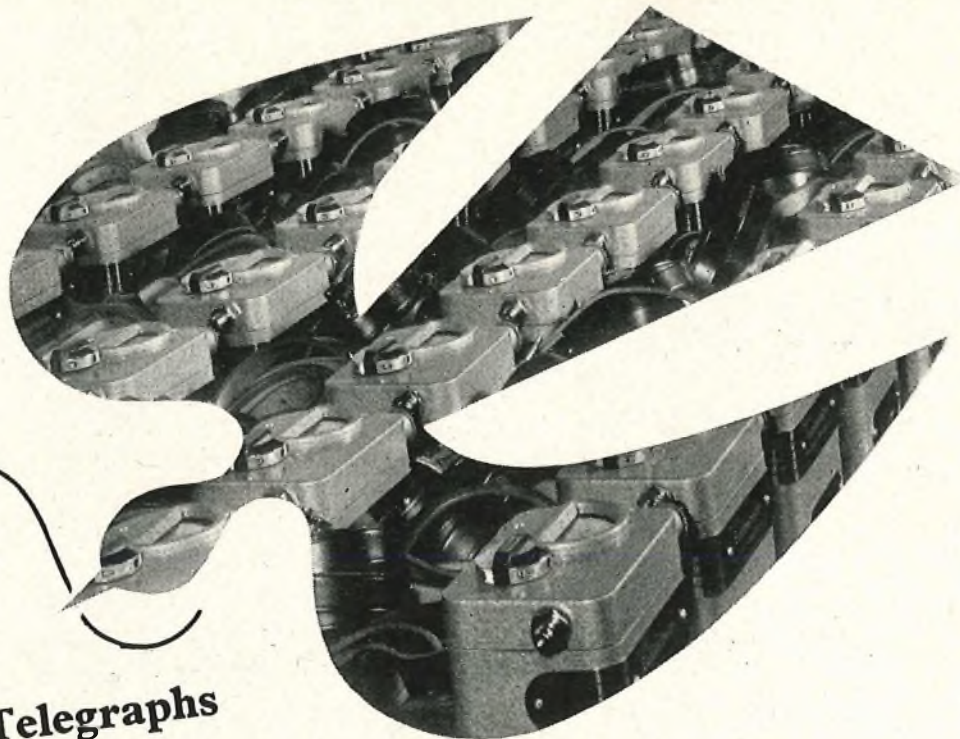

Swiss Posts & Telegraphs
Administration chose

the M.S.A. EXPLOSIMETER

Seeking safety for employees working in confined spaces underground, the Swiss post office authorities have equipped their engineers with the Model 2 Explosimeter. This sensitive, sturdy and inexpensive instrument gives an accurate indication of the presence of combustible

gases and indicates whether or not the concentration is within the explosive range.

Joining engineers with the Swiss post office will now be able to check for safety before lighting their blowlamps—and spot gas leaks or petroleum vapour before trouble starts.

There are many more uses for this simple instrument in industry, with gas and electricity services and, indeed, wherever men work in poorly ventilated spaces where an explosive hazard may exist.

If you would like to know more about the M.S.A. Explosimeter, please write for details to:—

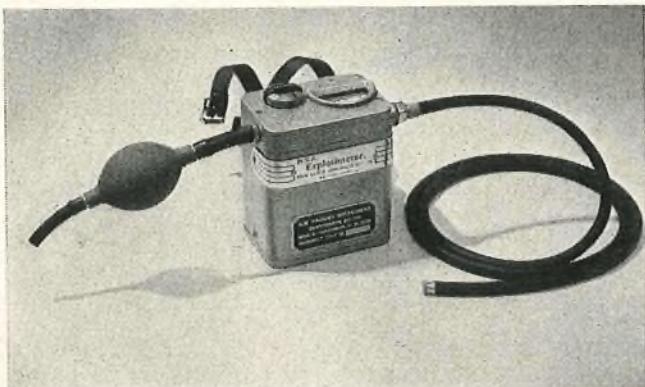

MINE SAFETY APPLIANCES CO. LIMITED

QUEENSLIE INDUSTRIAL ESTATE, GLASGOW, E.3. Telephone: SHETTLESTON 3421/4



world-wide approval

Pye Telecommunications Limited are now marketing the widest and most modern range of V.H.F. fixed and mobile radio-telephone equipment available in the world. This range of equipment has been designed to expand the application of Pye Radio-Telephones already in constant use all over the world.

Pye Ranger V.H.F. equipment has now received approval from the British G.P.O. for Land, Marine and International Marine applications employing A.M. or F.M. systems, type approval from the Canadian D.O.T., and type acceptance of the F.C.C. of the United States of America.

No other Company holds so many approvals for this range of equipment, which now covers every conceivable requirement.



**Leading the world in
V.H.F. RADIO-COMMUNICATION**

PYE TELECOMMUNICATIONS
distributors in 91 countries ensure
trouble-free service

We can offer

FREQUENCY RANGE

All frequencies from 25 to 174 Mc/s

POWER RANGE

All powers up to 1 Kilowatt.

CHANNEL SPACING

All channel spacings including 20 and 25 kc/s in full production.

MODULATION

A.M. or F.M.

No matter what your V.H.F. requirements are, Pye Telecommunications Ltd., can fulfil them. Your enquiries are invited.



It does you good to look around you here. You'll never see farms in better heart or villages in better shape or cottage gardens more skilfully tended, than you will from the roads and lanes round Alton. And in Alton itself you'll find plenty of evidence of the local belief that what's worth doing is worth doing well. The reason? Possibly this belief—less widely held than it was, some people think—flourishes best where families take root, and cottager, no less than squire, grows up with a sense of belonging—by right of birth. In the Battery Works son still follows father at the bench—as proud of his skill as his father was, as touchy concerning his personal standard of work. And as proud, and with equal right to be, of the workmanship Alton men put into Alton batteries.

ALTON *Batteries of Merit*

Alton stationary batteries: 10 to 15,000 ah. Also in regular production renewal plates for all makes of battery, British and Continental.

THE ALTON BATTERY COMPANY LIMITED, ALTON, HANTS • Telephone: ALTON 2267 and 2268 • Telegrams: BATTERY, ALTON

A.28

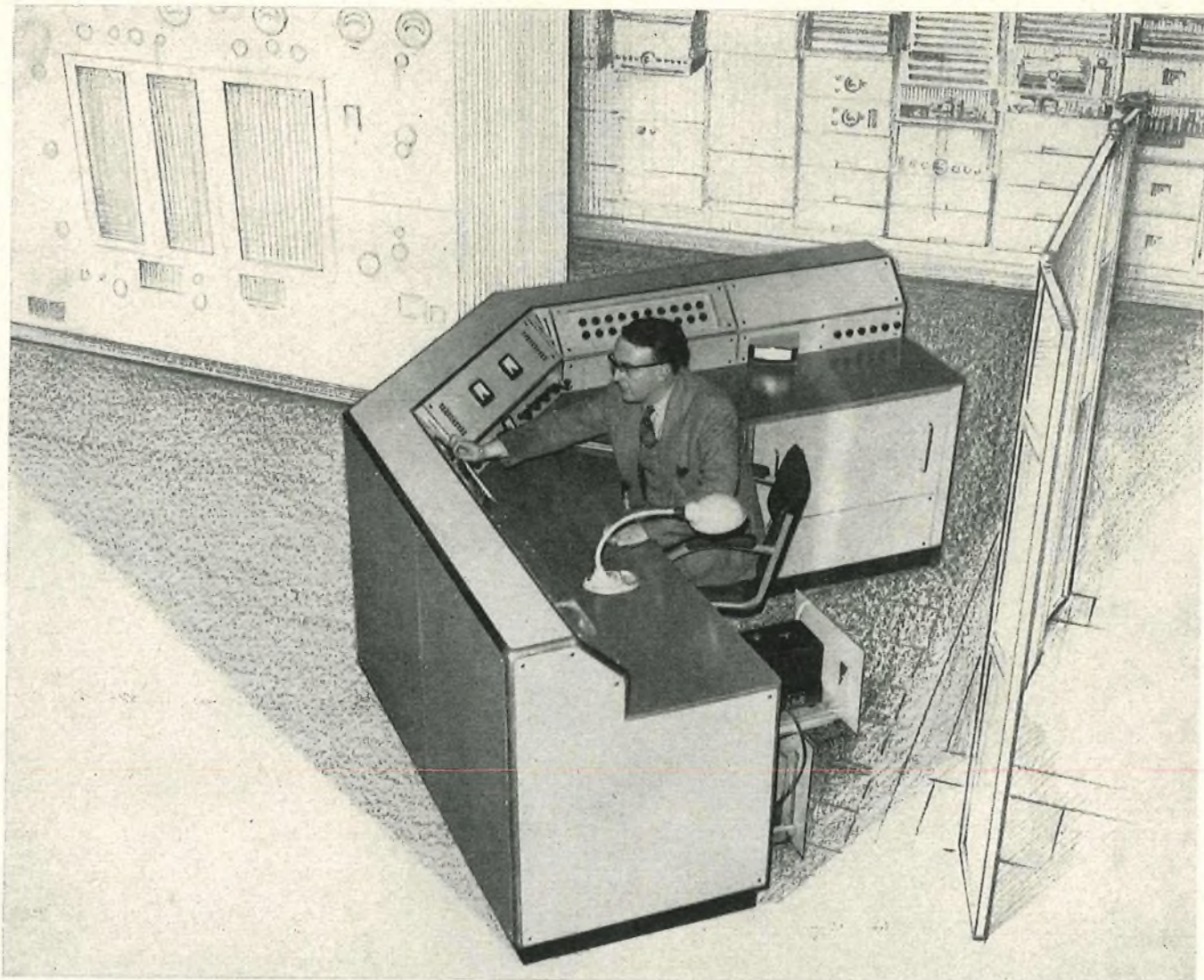

Photograph by courtesy of the Oxford Mail and Times Ltd.

The Central Monitoring Desk of the Post Office Radio Station at Leafield, Nr. Oxford, was constructed entirely from the Widney Dorlec Cabinet System. This consists of a range of prefabricated corners, extruded sections and various components which enable modern, fully radiused cabinets and racks to be built economically, and is produced in five different sizes of framework which can vary in size from small instrument cases to the most complicated consoles. Catalogues giving a general specification of our cabinets will be forwarded on request.



Widney Dorlec

ELECTRONIC ENCLOSURES • MOUNTINGS

HALLAM, SLEIGH & CHESTON LTD., WIDNEY WORKS • BIRMINGHAM 4 • ENGLAND
PHONE: ASTON CROSS 0914. GRAMS: SUPERFINE, BIRMINGHAM
SALES OFFICE: OLDFIELD ROAD • MAIDENHEAD • BERKS. PHONE: MAIDENHEAD 4311

WD 19



news for coil makers

a **TOUGH** self-fluxing winding wire

For continuous operation at "hottest-spot" temperatures of up to 120°C.

Adherent and resistant to solvents.

Can generally be used without changes in coil design, winding or impregnation.

Developed in BICC's own laboratories, Bicelflux is an enamel covering for winding wires with toughness approaching that of vinyl acetal or epoxy resin coverings but — *much easier to solder*.

Bicelflux is self-fluxing, with an action comparable to that of organic activated rosin fluxes.

As a result, Bicelflux windings are ideal for applications where large numbers of soldered joints are required, for example in radio and telecommunication equipment.

Further details are given in BICC Publication No. 376 — yours for the asking.

BICC

Bicelflux WINDING WIRES

SKILLMAN

1 + 6 CHANNEL SYSTEM TYPE S36

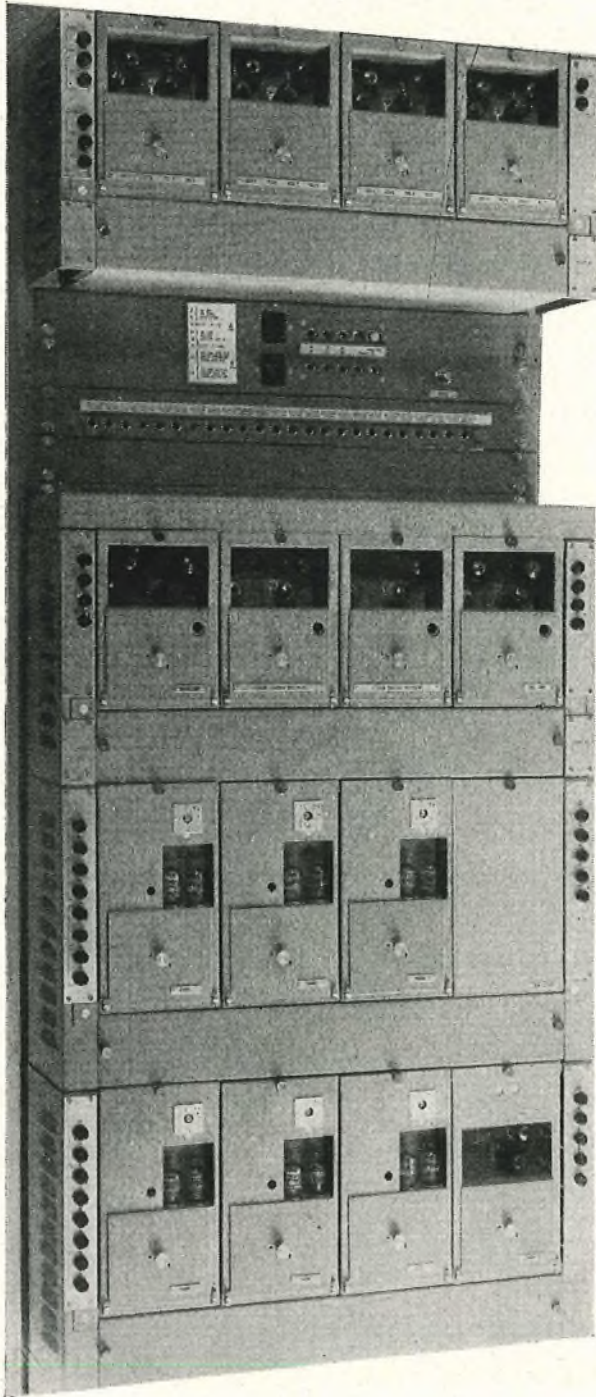

TERMINAL UNIT TYPE S36

- ★ Provides SIX additional speech channels of 300-3,400 c/s on a single pair, in the range 4-56 kc/s.
- ★ Low line frequencies mean it can be used on VF and other cables not normally suitable for carrier.
- ★ The physical line can be retained for normal use.
- ★ The complete terminal occupies only 26 units of a standard rack.

**A SUPPRESSED CARRIER SYSTEM
FOR SPEECH AND SIGNALLING
ON CABLES AND OPEN WIRE LINES**

FREQUENCY ALLOCATION

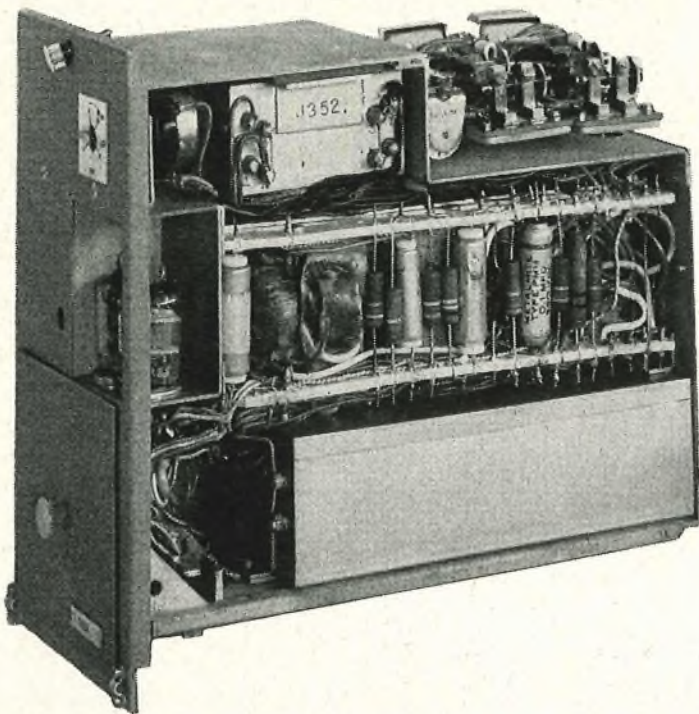
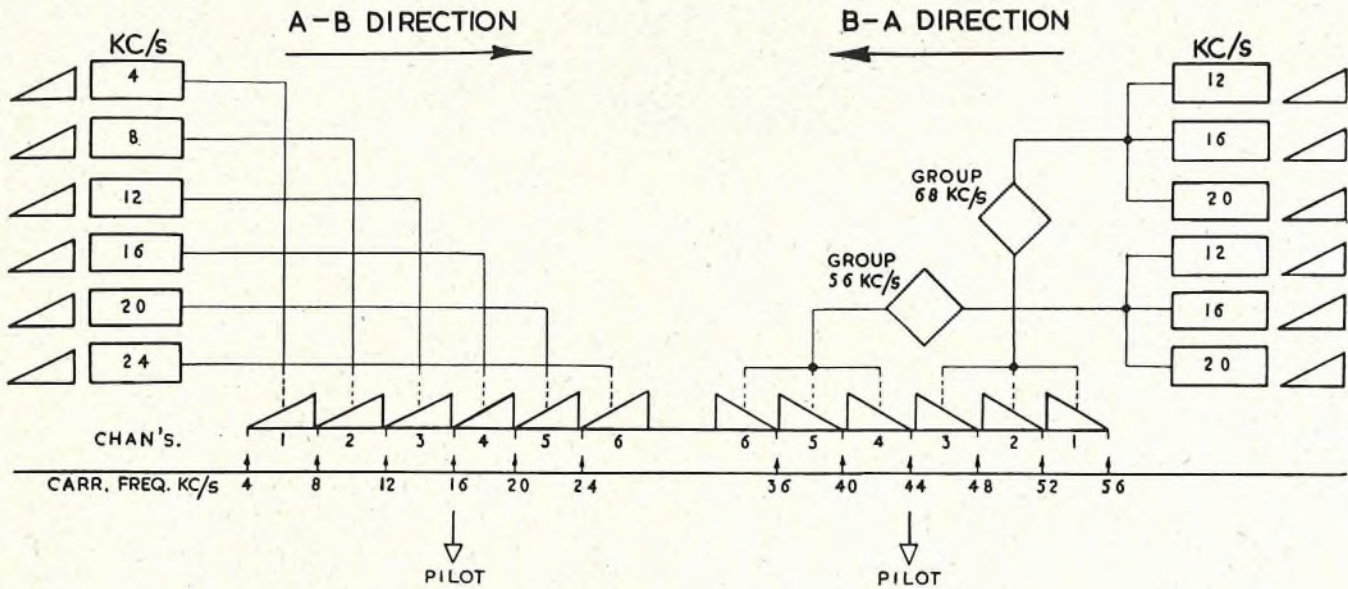

CHANNEL UNIT BOX
(Covers removed)

The equipment illustrated is
SKILLMAN NEW STYLE EQUIPMENT
with these special features:—

- **interchangeable plug-in units**
(channel units, oscillators, etc.)
- **ease of installation and maintenance**
- **economy of operation.**

SIGNALLING

The Channel Unit shown here incorporates built-in **Channel Edge Signalling**, providing E & M conditions straight out of the box.

Simple exchange relay sets permit fully automatic dialling, ringing, etc., over any channel.



T. S. SKILLMAN & CO. LTD. Harrow-on-the-Hill, England.
T. S. SKILLMAN & CO. PTY. LTD. Cammeray, N.S.W. Australia.

The

G.E.C.

1000

NEW CIRCUIT

RED, GREEN,

NEW COMPONENTS

In the "G.E.C. 1000" Telephone new components
in a new circuit give a standard of performance that is unsurpassed
by other telephones available to-day

THE GENERAL ELECTRIC CO. LTD. OF ENGLAND • TELEPHONE, RADIO AND TEL

Telephone



IVORY OR BLACK CASES



The appearance has been redesigned to blend with modern styles of decoration, whilst retaining the dignity essential to office furnishings.

PERFORMANCE

The rocking-armature receiver has an excellent frequency response and an output 10 dB higher than its predecessors. Part of this improvement is transferred by the induction coil to the sending side, giving a resultant improvement in performance of 6 dB on sending and 4 dB on receiving.

This improved performance means that the new G.E.C. telephones will operate over a local-line loop of 1,120 ohms of 6½-lb cable (·5 mm conductor) with a performance equal to that of previous telephones operating over a local-line loop of 660 ohms, i.e. a local line may be extended by 70%. Alternatively, the new telephones will operate over a length of 4-lb cable (·4 mm) with a performance equal to that of a previous telephone operating over the same length of 10-lb cable.

Despite the increased level of performance, the maximum amount of sidetone suppression has been retained.

COLOUR

In addition to the normal black instrument, a range of two-tone telephones can be supplied in which the case is coloured and all other parts, including the dial, are black. The range of colours is red, green and ivory. The two-tone telephones have the following advantages over the all-colour telephones:

More delicate shades can be used since shade matching is eliminated.

The number of spare parts required to be held by an Administration using more than one colour of instrument is greatly reduced.

APPEARANCE

The pleasing appearance is achieved by blending a number of curved lines and surfaces to form outlines for the case and handset that are in complete harmony with one another. The camber of the sloping front houses the dial in the automatic telephone and the dial dummy in the C.B. set. The incline of the telephone front is such that the telephone is easy to use, and the dial numbers easy to see, whether the user is in a standing or sitting position.

A curved insert is fitted in each side of the case in front of the cradle to provide finger-tip grips for lifting and carrying the instrument. When resting in the cradle, the curved handset gives the telephone a domed silhouette in accord with the remainder of the instrument. The increased curvature of the handset over previous types gives greater comfort to the user, and tilts the transmitter to a more sensitive position.

TROPICALISATION

The three G.E.C. features—special insulation, ventilation, and protection against moisture and insects—are incorporated in all telephones supplied to tropical areas.

Power without fail — AUTOMATICALLY

This mains standby plant is one of seventeen manufactured for Standard Telephones and Cables Ltd., and is for installation overseas.

It comprises two fully automatic units controlled by a single switchgear cubicle. One unit is a Regenerative Flywheel 'No break' set, the other a 'Normally Stationary' set. Dual standby is provided because of site conditions and the vital need for continuity of supply.

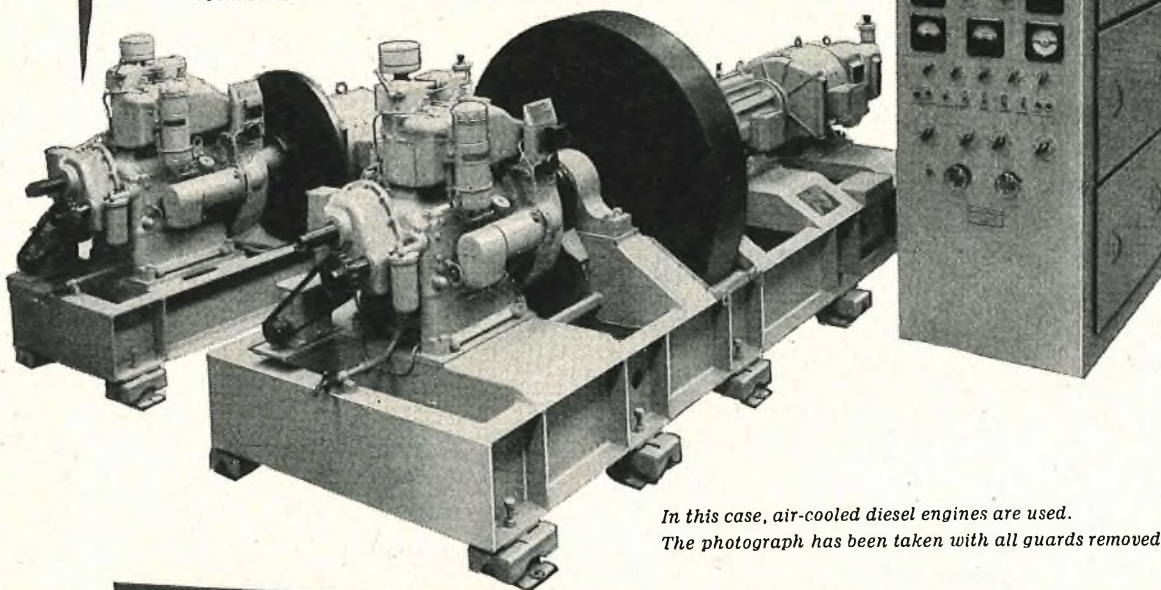

*In this case, air-cooled diesel engines are used.
The photograph has been taken with all guards removed.*

This is what happens

1. *Mains within limits.* The three-phase electric motor drives both flywheel and alternator of the 'No-Break' set (foreground), the alternator supplying regulated single phase current to the telecommunications equipment.
 2. *Mains outside limits.* The electric motor is disconnected, the diesel engine starts automatically and when up to speed is connected to the alternator by the magnetic clutch. During this cycle, stored energy in the flywheel drives the alternator, thus maintaining a continuous power supply within the closest limits of frequency and voltage.
 3. *Mains restored within limits.* The electric motor is automatically reconnected and resumes the drive, the magnetic clutch opens and the diesel engine shuts down.
 4. Should the 'No-Break' set develop a fault, the 'Normally Stationary' set (background, left) starts and takes over supply to the equipment. The sets are designed to restrict the supply interruption to the minimum possible under the circumstances of the fault. Manual paralleling of the two sets is provided for maintenance periods.
- CONTROL. Automatic controls and indicators are provided to ensure reliable operation in accordance with designed limits.

Austinlite

AUTOMATIC POWER PLANT

**Tailor-made by
STONE-CHANCE LTD.**

(makers of Sumo Pumps and
Stone-Chance Lighthouses)
CRAWLEY, SUSSEX.



By Appointment to the Professional Engineer

TOGGLE SWITCHES

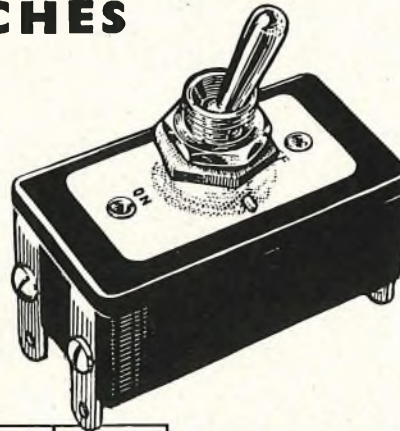
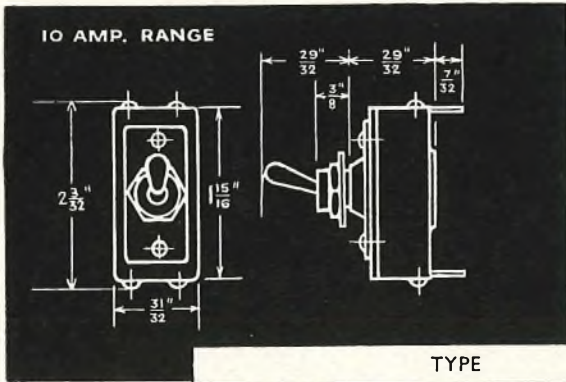

TYPE	CAT. No.
SINGLE POLE CHANGE OVER OPERATION.	501056
DOUBLE POLE ON/OFF OPERATION.	500705
As 500705, but fitted for two-hole mounting by 4 B.A. bushes on $1\frac{3}{16}$ " fixing centres.	501089
DOUBLE POLE ON/OFF. Dimensions and finish of bush and lever to conform to current RCL 151.	501402

10 AMP

SWITCH RATINGS:
10 amps. at 250 volts AC/DC
AVERAGE INTERNAL RESISTANCE:
Less than .002 ohm.
CONTACTS AND TERMINALS:
Silver clad phosphor bronze.

6 AMP

The Painton 6 Amp. Toggle Switches are designed to conform to the performance requirements of appropriate R.C.S.C. Specification.

SWITCH RATINGS:
6 amps. at 250 volts AC/DC
AVERAGE INTERNAL RESISTANCE:
Less than .002 ohm.
CONTACTS AND TERMINALS:
Silver clad phosphor bronze.

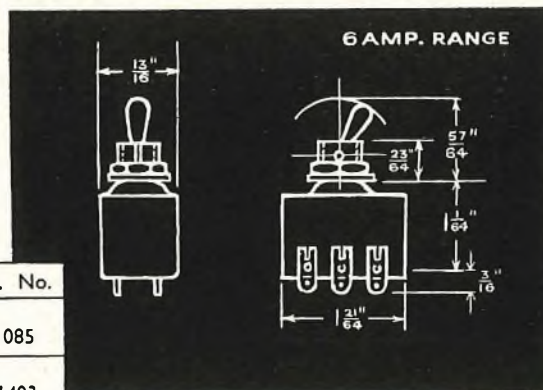
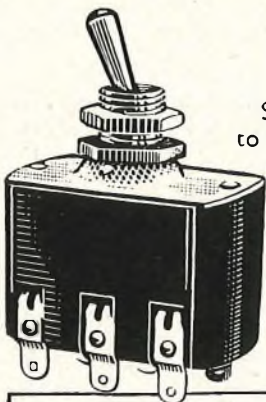

TYPE	CAT. No.
DOUBLE POLE CHANGE OVER. Dimensions shown in line drawing. Heavy duty chrome finish.	501085
DOUBLE POLE CHANGE OVER. Dimensions and finish of Bush and Lever to conform to current RCL 151.	501403
DOUBLE POLE CHANGE OVER. Bush and Lever Dimensions to conform to current RCL 151 but with chrome finish.	501521

PAINTON
Northampton England

**A multi-channel telephone link
extensible to 720 speech circuits**



240-circuit UHF RADIO EQUIPMENT

Designed for long life & easy maintenance

This compact radio equipment allows economical provision of a high-quality link for 240-speech circuits. The equipment is particularly attractive to Administrations establishing new networks where the future circuit requirements are indeterminate, since the initial requirements can be met with a minimum capital outlay by installing a 240-circuit link: additional equipment can be installed in multiplex to provide a total capacity of 480 or 720 speech circuits.

The experience gained by G.E.C. engineers in providing microwave links in many parts of the world has been incorporated into the design of this new system. The components have been conservatively rated to ensure long life, and

the arrangement of equipment is such that maintenance is easy to effect.

The system employs frequency modulation, operates in the 1700 to 2300 Mc/s band, and is suitable for point-to-point transmission over distances of up to 30 miles providing line of sight conditions exist between the stations. Longer single hops can be obtained under special conditions. The range of communication can be increased by the use of repeaters; non-demodulating repeaters ensure that there is a minimum of modulation distortion on the system.

The equipment is constructed in accordance with the modern practice adopted by the G.E.C. for transmission equipment.

The apparatus is mounted on panels which slide into position on guides fitted into the rack. The panels are connected to the rack wiring by plugs, and panels can be removed, or changed, without disconnecting any wiring.

Each rack includes a meter panel, which assists maintenance and makes the equipment self-testing to a large extent. Throughout the equipment no voltage higher than 220V is used.

A complete transmitter and receiver is mounted on one single-sided rack 7 ft. 6 in. high. All the apparatus is accessible from the front of the rack, therefore the racks can be mounted either side-by-side or back-to-back.

The G.E.C. can manufacture and supply a fully integrated multi-channel radio communications system including the towers, aerials, supervisory, and multiplex equipment.

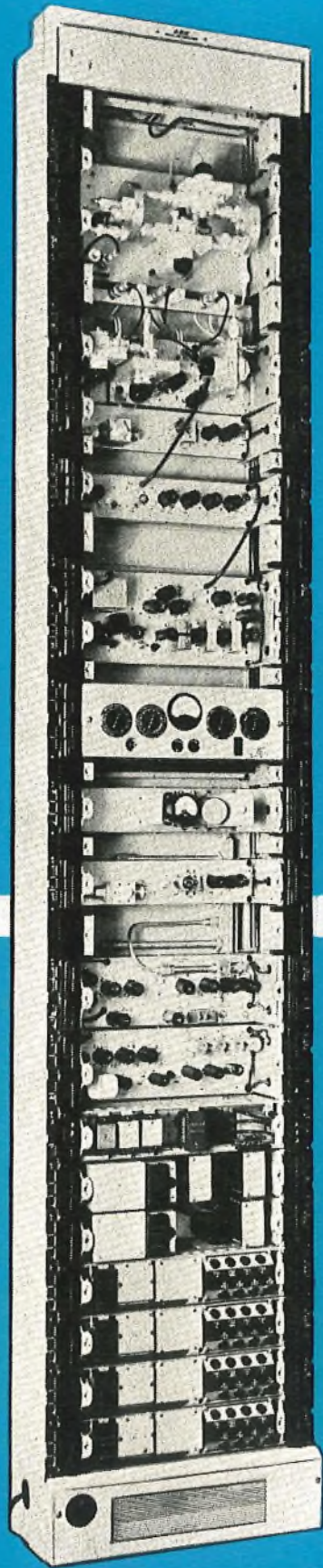

UHF AMPLIFIER

AMPLIFIER & MIXER

LOCAL OSCILLATOR

LIMITER

MODULATOR

METER PANEL

POWER MONITOR

LOCAL OSCILLATOR

RECEIVE MIXER & IF AMPLIFIER

DEMODULATOR

BASEBAND AMPLIFIER

POWER SUPPLY UNIT + 216V

POWER SUPPLY UNIT - 150V

POWER SUPPLY UNIT 1

POWER SUPPLY UNIT 2

POWER SUPPLY UNIT 3

POWER SUPPLY UNIT 4

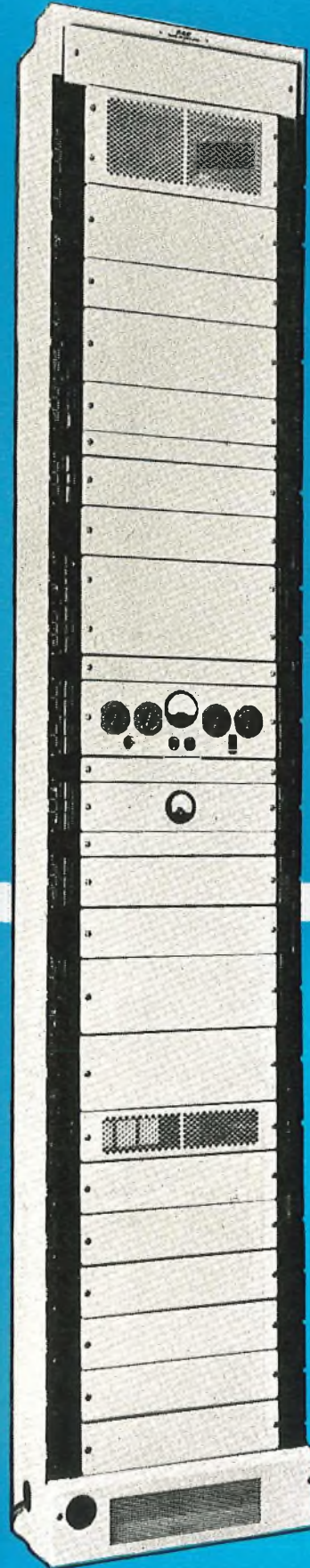

SIEMENS EDISWAN introduce

the first printed



SIEMENS EDISON SWAN LTD

An AEI Company Woolwich, London, S.E. 18, England



THE CENTENARY NEOPHONE

A quality instrument at an economical price, especially suitable for use overseas.

circuit telephone



This entirely new instrument, a product of the designers of the world-famous "Neophone" which established new standards in telephone performance and appearance in the nineteen-thirties, incorporates the following attractive features —

Improved performance, using latest design of components.

Lower first cost, achieved by the most modern manufacturing methods.

Lower maintenance cost.

Suitably finished for tropical use. Sealed case keeps out dust and insects.

Reduced size and weight — handset weight halved — only 7 ounces.



21 COLOUR COMBINATIONS

7 different handset shades and a choice of 3 case colours. The case can be changed WITHOUT DISTURBING THE DIAL SWITCH.

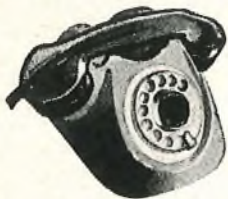

The centenary NEOPHONE



THE NEW INSTRUMENT WITH NEW FEATURES

Complete technical details are available on request.

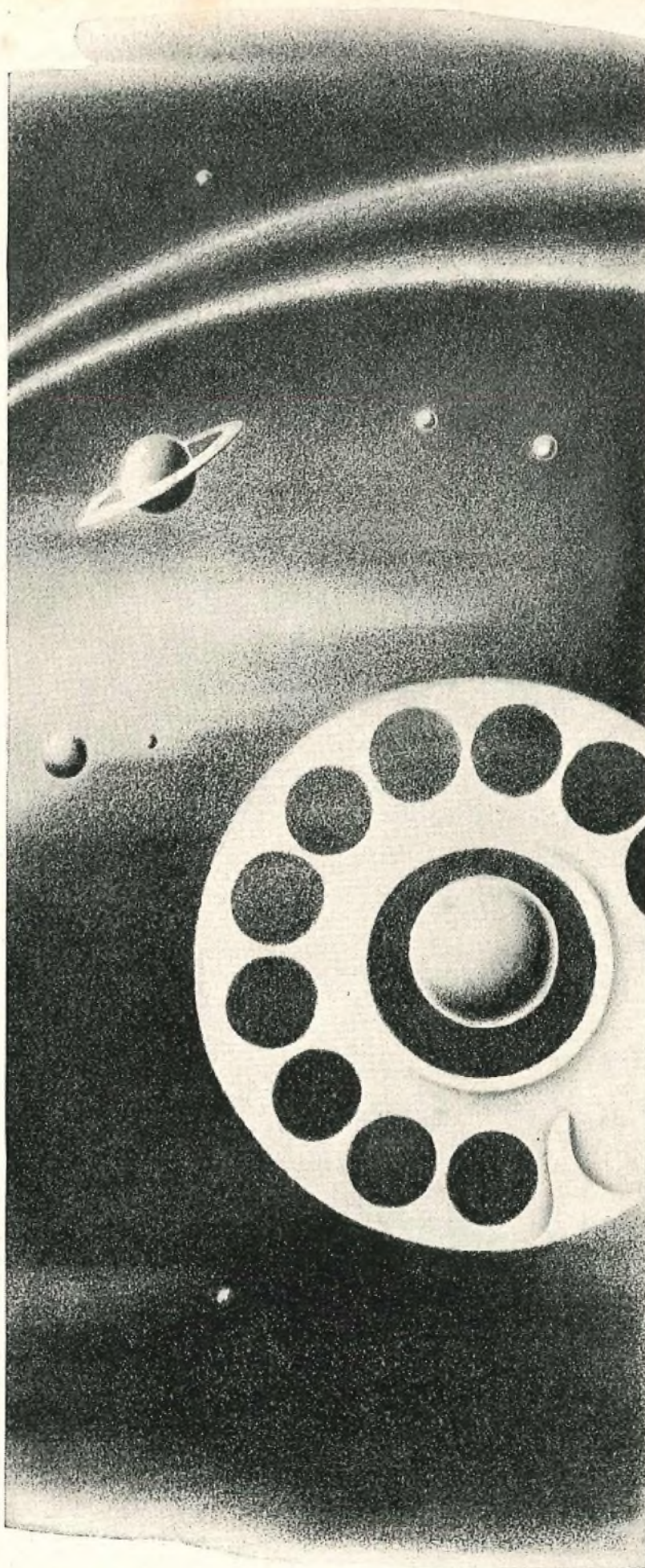

STROWGER

*and the pattern
of world
telecommunications*

To-day, Strowger is the basic system for 70% of the world's automatic telephones. Its qualities of flexibility, simplicity and reliability will continue to serve future telephone requirements—whatever form they may take.

*Strowger—designed and
built for continuous service*



AUTOMATIC TELEPHONE AND
ELECTRIC CO. LTD.,
LONDON AND LIVERPOOL

AT 7041

MULLARD HIGH EFFICIENCY POT CORES

have these outstanding features

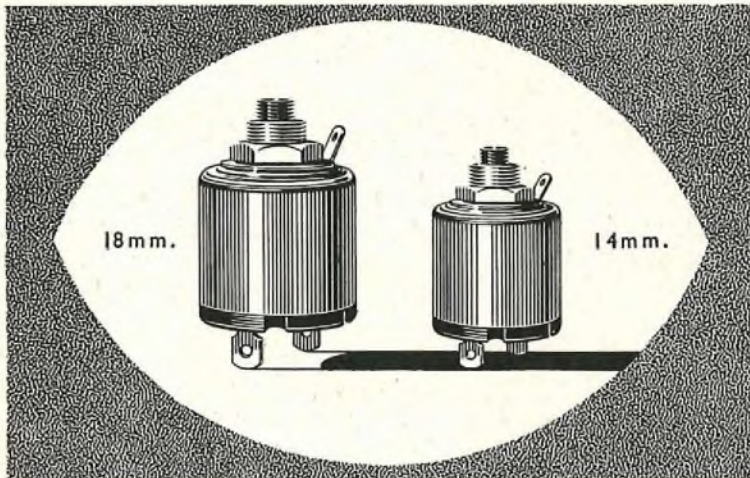

- * Pot core design facilitating rapid assembly
- * Small size
- * High value inductance
- * Low losses resulting in high Q values
- * Very fine setting accuracies
- * Operative over a wide frequency range
- * Controlled temperature coefficient

Wherever high quality pot cores are required, there will be a Mullard type available to meet the specification, furthermore, they can be supplied wound to customers individual requirements.

Write now for full details of the comprehensive range currently available.

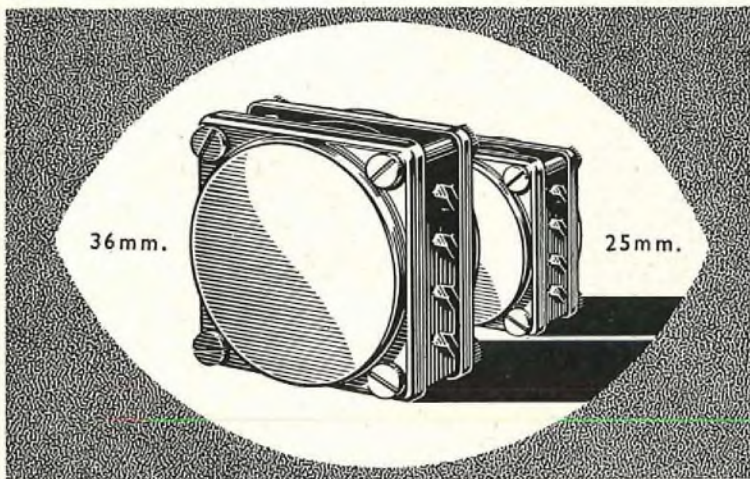

Mullard



'Ticonal' permanent magnets
Magnadur ceramic magnets
Ferroxcube magnetic cores

MULLARD LTD., COMPONENT DIVISION, MULLARD HOUSE, TORRINGTON PLACE, W.C.1

MC 255A

FREE!

to YOU!
-if you seek
SUCCESS!



If you lack qualifications which would get you a better job, more pay and faster progress; if you really want to succeed in your studies for the City & Guilds Certificates . . . send *now* for this stimulating, important book—**"Train your mind to SUCCESS."** **HERE** is the amazing story of The Famous Bennett College, its awards, scholarships, medals. Read what eminent educationists have to say about Personal Postal Tuition—The Bennett College way! **READ** actual cases taken from its half a million success stories—from Bricklayer to Assistant Manager, from Draughtsman to Director—and many others! **SEE** how you will learn when you enrol—how your own personal tutor watches over every step of your progress—how your success is *guaranteed*. **POST THIS COUPON NOW!**

"I GUARANTEE TUITION UNTIL YOU HAVE PASSED"

**Preliminary Course
Telecommunications
Principles I - V
Radio I - IV
Telegraphy I & II
Line Transmission I & II
Mathematics for Telecommunications
Radio Servicing Certificate**

BENNETT COLLEGE
(DEPT. J.24.F.), SHEFFIELD

Please send me, without obligation, a free copy of "Train your mind to SUCCESS" and the College Prospectus on:

SUBJECT _____
NAME _____
ADDRESS _____

AGE (if under 21) _____

Please write in Block Letters

THIS DAY
COULD BE THE TURNING-
POINT IN YOUR LIFE.
THIS COUPON
COULD BE YOUR PERSONAL
PASSPORT TO SUCCESS.
Send it NOW!



GENERATING EQUIPMENT

from 500w to 60 kW

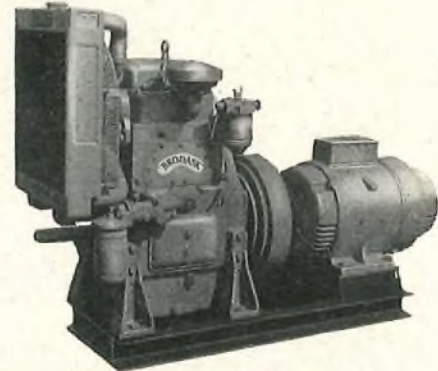

A Typical 12 kVA Set

FULLY AUTO — NON AUTO

BRODIE & ASKHAM LTD.,

57/61 ST. ALBANS ROAD,
WATFORD, HERTS.

PHONE:
WATFORD 5175

GRAMS:
BRODASK, LONDON

2" 2½" 3¼" 3½"
ROUND OR SQUARE FLUSH RECTANGULAR

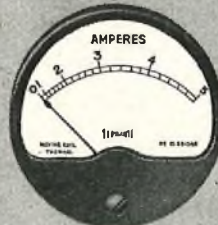

Ferranti Panel Instruments

Ferranti Panel Instruments are supplied in a wide variety of types and sizes. Moving coil, rectifier, moving iron, thermal and electrostatic. 2", 2½", 3¼" and 3½" dial. Round, square and rectangular. Catalogues supplied on request.

There are large stocks of standard models of 2½" round or square flush instruments. Please write for a stock list.



FERRANTI LTD. • MOSTON • MANCHESTER 10

London Office:
KERN HOUSE • 36 KINGSWAY • W.C.2.

ceilings

RAWLBOLTS

For heavy fixing to Ceilings, Walls & Floors

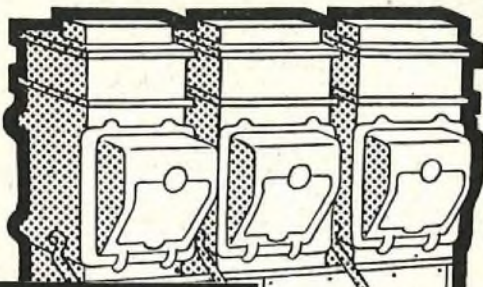

walls

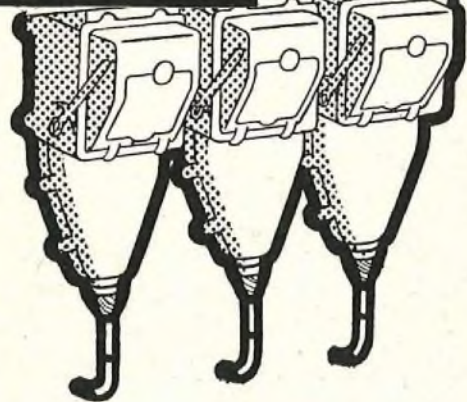

For more information, please write for Dimensional Chart of the Rawlbolt Range and full descriptive literature.

Rawlbolt fixings in concrete, whether in ceilings, walls or floors, are fast and efficient and make real savings in time and money.

Older methods of fixing involve laborious chiselling of holes, grouting in and waiting several days for cement to harden. With Rawlbolts, the job is far simpler and quicker. Drill a hole, insert a Rawlbolt and tighten up. Your equipment is fixed and ready for use immediately.

Civil Engineers, Consulting Engineers, Building Contractors, Structural Engineers are large and regular users of Rawlbolts.

TWO TYPES OF RAWLBOLT

**LOOSE
BOLT
TYPE**
for fixing
to floors



**BOLT
PROJECTING**
for fixing
to walls
and ceilings

floors



THE RAWLPLUG COMPANY LTD.,
GROMWELL ROAD, LONDON, S.W.7.

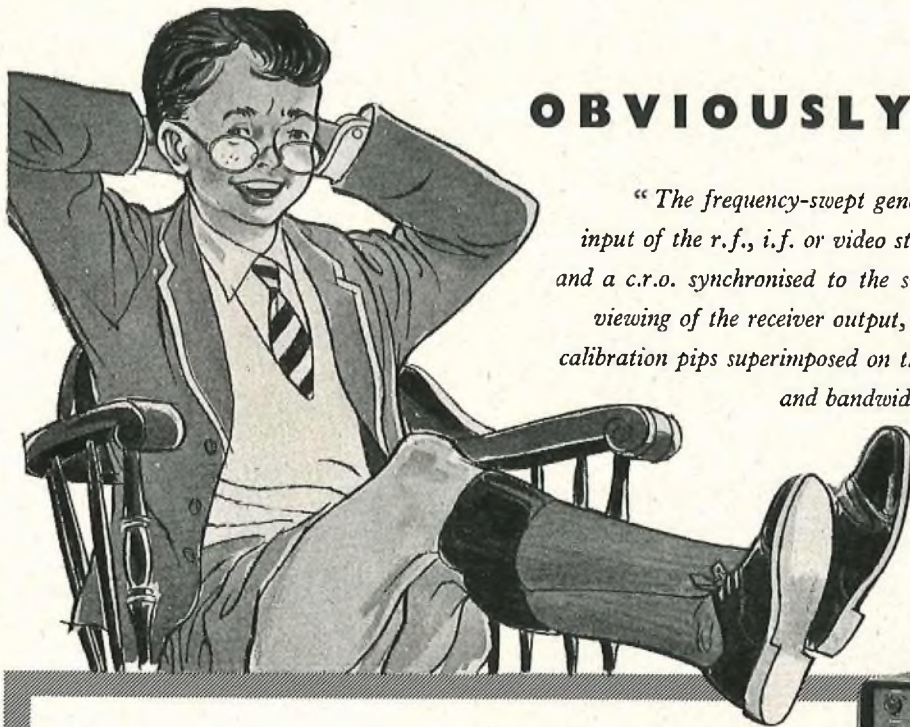

OBVIOUSLY . . .

"The frequency-swept generator connected to the input of the r.f., i.f. or video stages of the receiver, and a c.r.o. synchronised to the sweep frequency, permits viewing of the receiver output, while internally generated calibration pips superimposed on the display enable tuning and bandwidth adjustments to be made with precision."

THAT'S the Marconi V.H.F. Alignment Oscilloscope in a nutshell. If he'd had any breath left our young student might have added that other important applications include the adjustment of discriminators in f.m. receivers and the matching of aerials to transmission lines.

However, the lad's penetrating observation will have revealed to those who are no less observant that here is another important Marconi instrument.

If you don't know as much about it as he does it's time you did. Write and ask for leaflet L 104 for the full facts and this we'll send you post-haste.



**MARCONI V.H.F.
ALIGNMENT OSCILLOSCOPE
Type TF 1104**

For use with television and f.m. receivers. Frequency-swept output and visual display on built-in c.r.t. facilitates rapid evaluation and alignment without ancillary equipment. R.F. ranges: v.h.f. bands I, II and III. I.F. range: 10 to 40 Mc/s. V.F. range: 5 kc/s to 10 Mc/s. Frequency sweep: 10 Mc/s max., with marker pulses at 0.5, 1.0, or 5 Mc/s intervals.

**MARCONI
INSTRUMENTS**

AM & FM SIGNAL GENERATORS · AUDIO & VIDEO
OSCILLATORS · FREQUENCY METERS · VOLTMETERS
POWER METERS · DISTORTION METERS · FIELD
STRENGTH METERS · TRANSMISSION MONITORS
DEVIATION METERS · OSCILLOSCOPES, SPECTRUM &
RESPONSE ANALYSERS · Q METERS & BRIDGES

MARCONI INSTRUMENTS LTD · ST. ALBANS · HERTFORDSHIRE · TELEPHONE: ST. ALBANS 56161

London and the South: Marconi House, Strand, London, W.C.2. Tel: COVent Garden 1234

Midlands: Marconi House, 24 The Parade, Leamington Spa. Tel: 1408

North: 30 Albion Street, Kingston-upon-Hull. Tel: Hull Central 16347

WORLD-WIDE REPRESENTATION

TC 104

cable to CANADA...

The latest development in modern telecommunications: the new Transatlantic Telephone Cable. The part played by DENSO in this gigantic enterprise, while not visually spectacular, was vitally important: the protection of cable joints on the British side and of steel channelling on the cable route in Newfoundland.

We are proud and happy to have been members of a highly successful team.

DENSO

Anti-Corrosion Products

WINN & COALES LTD

Denso House, Chapel Road,
London, S.E.27

Telephone: GIPsy Hill 4247 (PBX)

Telegrams: Denselte, Westnor, London



ZEVA

Electric

SOLDERING TOOLS

INFLATION ARRESTED...

PRICES REDUCED

It is with considerable satisfaction that we are enabled to announce impressive reductions in prices of these world-famous Soldering Irons and Crucibles. This downward price trend is accompanied by strict maintenance of the high standard of ZEVA efficiency, and is made possible by improved up-to-date manufacturing methods to cope with vastly increased demand.

ZEVA Tools are made under a patented process of manufacture which invests them with advantages that cannot be claimed for any other tools. The electric heating elements are virtually hermetically sealed into the aluminium housings and are fully guaranteed.

ZEVA Tools are acid-proof, air-proof, water-proof and fool-proof. There is no odour, no over-heating or under-heating. They are unexcelled for dependability and unequalled for long service.

Write for complete Illustrated
Catalogue and revised Price List

AVO LTD.

(Formerly The Automatic Coil Winder & Electrical Equipment Co. Ltd.)

AVOCET HOUSE, 92-96 VAUXHALL BRIDGE ROAD, LONDON, S.W.1. VICTORIA 3404 (9 lines)

ZEVA heating elements never need renewal. They last the life of the tool.

ZEVA Irons can be left switched on all day without detriment to the tool.

ZEVA current consumption for rated temperature is less than that of any other make of tool.

ZEVA initial cost is the only cost.

ZEVA Irons are guaranteed.

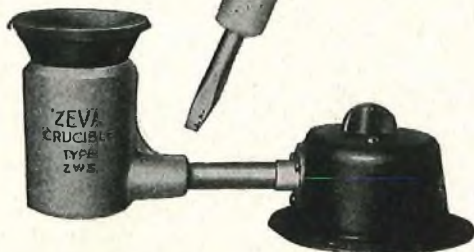

New!



The

CATHODEON e CUB

CRYSTAL UNIT

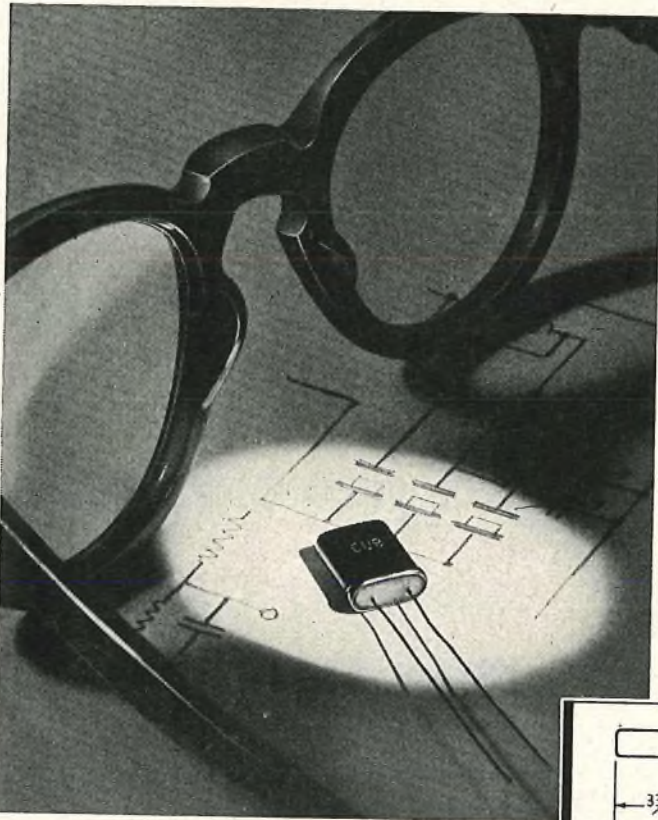

Might in miniature

- Precision frequency control from 5.0 Mc/s to 60.0 Mc/s.
- Above average frequency stability without oven control.
- Wide operating temperature range.
- Direct soldering to printed circuits or selector switches.
- Ideal size for packaged and transistorised circuits.
- Specially suitable for frequency synthesising as used in the latest transmitter-receivers.
- Fundamental 5 to 20 Mc/s
3rd Overtone 20 to 60 Mc/s.
- Frequency tolerance $\pm 0.005\%$ -55°C. to $+105^{\circ}\text{C.}$
- 2MM holder equivalent to R.C.S.C. Style J and American type HC-18/U.

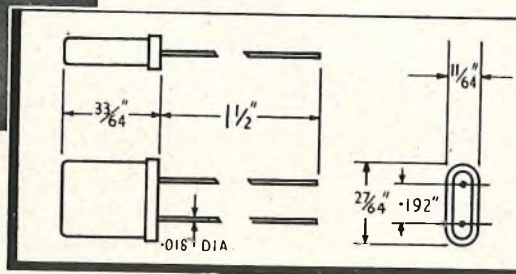

ACTUAL SIZE

CATHODEON CRYSTALS LIMITED

LINTON CAMBRIDGESHIRE

TELEPHONE LINTON 223





CONVERTERS

MODEL 2201

FOR CONVERSION OF MORSE CODE OR CABLE CODE PERFORATED TAPE TO 5-UNIT SIGNALS OR 5-UNIT PERFORATED TAPE AT TELEPRINTER SPEED

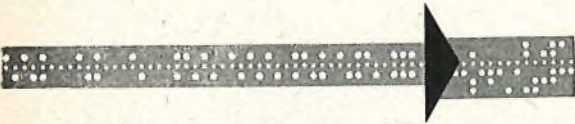
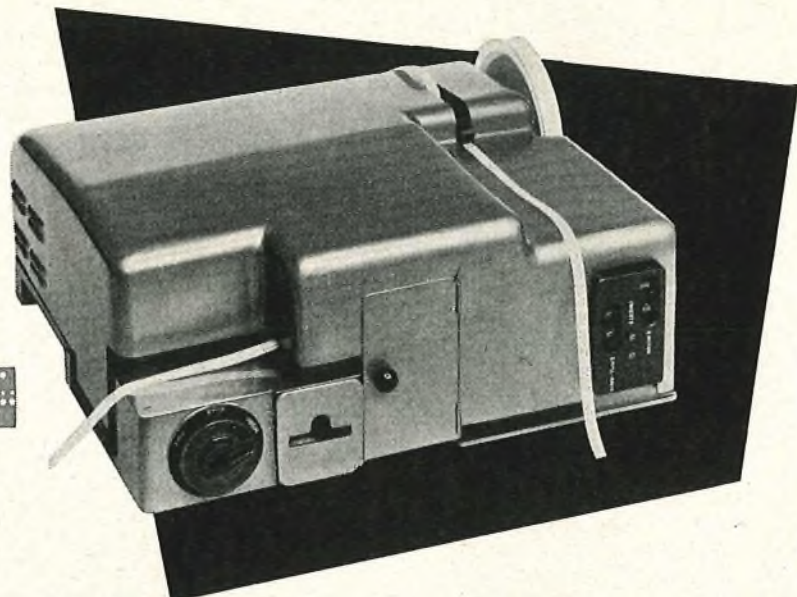

DIMENSIONS: 23" x 21" x 10"

MODEL 2206

FOR CONVERSION OF 5-UNIT PERFORATED TAPE TO MORSE CODE OR CABLE CODE PERFORATED TAPE, AT THE RATE OF 650 CHARACTERS PER MINUTE

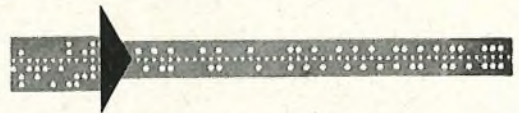
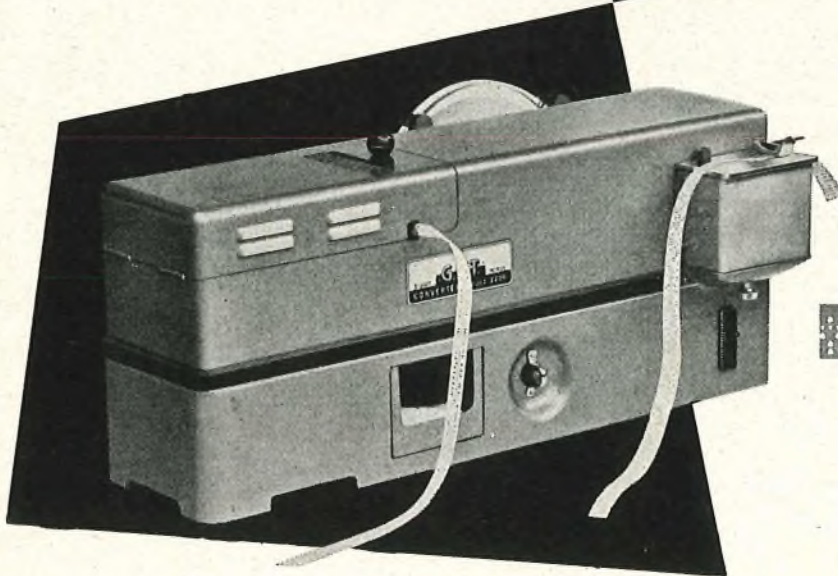

DIMENSIONS: 26" x 12" x 12"

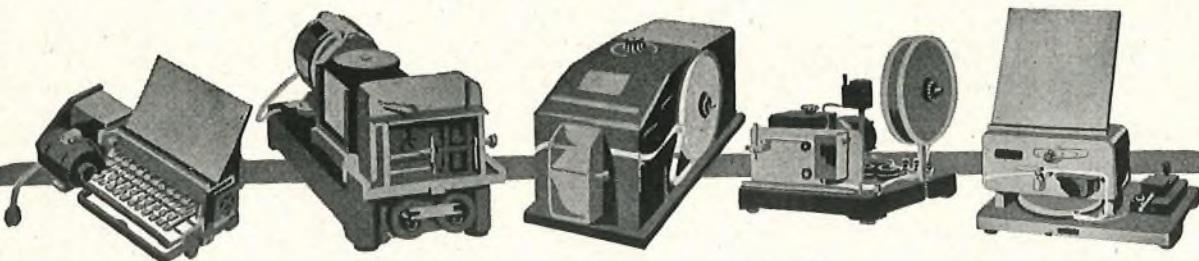

GREAT NORTHERN TELEGRAPH WORKS

DIVISION OF THE GREAT NORTHERN TELEGRAPH CO. LTD.

4, SYDHAVNS PLADS
COPENHAGEN SV, DENMARK

LONDON OFFICE: 5, ST. HELEN'S PLACE
LONDON E. C. 3.



MARCONI



MULTI-CHANNEL SYSTEMS

VHF radio telephony was welcomed in its early days as an economic means of providing communication over inhospitable or undeveloped terrain. Today, such is the flexibility and reliability of multichannel radio equipment, that radio links carrying up to 600 telephone channels or a colour television programme are recognised as being preferable to the use of line or cable systems in many instances on grounds of performance as well as installation cost.

COMPLETE COMMUNICATION SYSTEMS – *all the world over*



INSTALLED

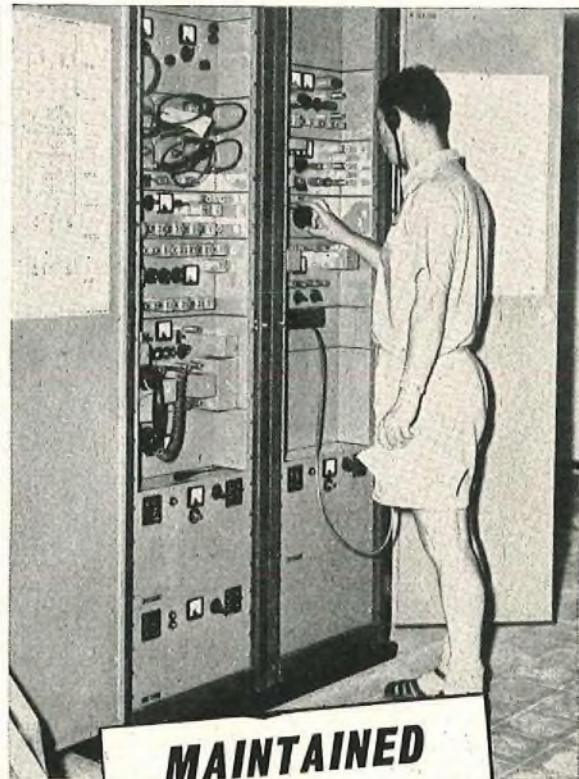

MAINTAINED

MARCONI'S & A.T.E. Co-operation between Marconi's and Automatic Telephone and Electric Co. Ltd., now brings together an unrivalled wealth of knowledge and experience for the benefit of all whose work lies in the field of telecommunications.



The Lifeline of Communication is in experienced hands

MARCONI

Complete Communication Systems

MARCONI'S WIRELESS TELEGRAPH COMPANY LIMITED, CHELMSFORD, ESSEX

LC 17



Momental! Monumentous!

'This is an old Roman way, built about 150 A.D., I believe, by Roman rabbits,' said Baron Rabbit. 'Perhaps those pipes on which you stand are Roman remains.'

'No, no, sir,' replied the Constable. 'These are not pipes, they are called conduits and are quite modern. Been here only 50 years or so. They are made of vitrified clay.'

'That,' said the Baron, 'is precisely the stuff the Romans used, too. Long-lasting, money-saving, acid-resisting stuff. And smooth. Cables slide easily through that kind of conduit.'

'Salt glazed vitrified clay conduits are momental,' said the Constable.

'Salt glazed vitrified clay conduits are monumentous!' agreed the Baron.

Put down Salt Glazed Vitrified Clay Pipes and Conduits — they stay down for centuries!

NATIONAL SALT GLAZED PIPE MANUFACTURERS' ASSOCIATION



ADCOLA

(Regd. Trade Mark)

FOR

SOLDERING INSTRUMENTS and EQUIPMENT

SUPPLIED FOR ALL VOLTAGES

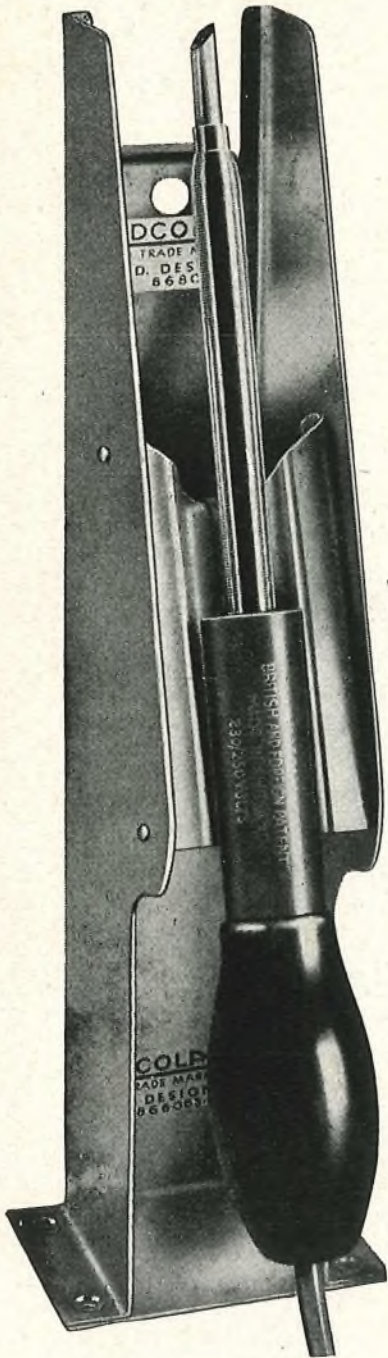

illustrated

**DETACHABLE
BIT
MODEL $\frac{3}{16}$ "**

List 64

**PROTECTIVE
SHIELD**

List 68

16 features prove Bercostat ★ strongest, most compact rheostat for precise current control

Bercostats are at work down coalmines . . . in the Viscount and Britannia . . . wherever designers want a sturdy, compact unit for accurate control of volts and amps. We will gladly advise on your own uses and give quick delivery. Study the features below, and you'll agree the Bercostat proves BERCO know how!

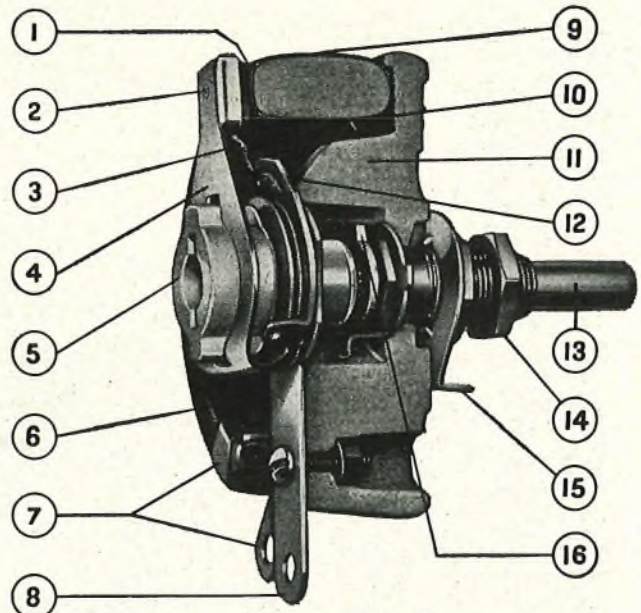

★ *Bercostat toroidal-wound power rheostats, now in 8 sizes. Ask for Lists 613A and 613C.*

- | | |
|--|---|
| 1 Silver graphite brush contact. | 9 Winding embedded in vitreous enamel. |
| 2 Balance point for self-aligning brush. | 10 Vitreous enamel bond between former and base. |
| 3 Pigtail shunting brush arm. | 11 All ceramic construction withstands 5000v. flash test. |
| 4 Nickel silver brush arm. | 12 Non-grooving return contact plate. |
| 5 Glazed porcelain brush arm insulator. | 13 Stainless steel spindle. |
| 6 Winding welded to terminal band. | 14 Electro-tinned mounting assembly. |
| 7 End contact band and terminal. | 15 Panel locating washer. |
| 8 Brush terminal. | 16 Special stop feature. |

Berco pioneered toroidal-wound power rheostats . . .

BERCO KNOW HOW

THE BRITISH ELECTRIC RESISTANCE CO., LTD.,

in association with

THE BRITISH POWER TRANSFORMER CO., LTD.,
QUEENSWAY · ENFIELD MIDDLESEX

Telephone: HOWard 2411 · Telegrams: Vitrohm, Enfield

.....Write for Catalogues.....
HEAD OFFICE, SERVICE AND SALES
ADCOLA PRODUCTS LTD.
GAUDEN ROAD, CLAPHAM HIGH STREET, LONDON, S.W.4
Phone: MACaulay 3101, 4272

BR 1381

DESIGNED to meet G.P.O. specification

TUNGSTONE PLANTÉ CELLS are being regularly supplied to the British Post Office and Post and Telegraph Departments in many countries overseas. They conform fully to G.P.O. Standard specifications.

OPEN TYPE CELLS

Similar to the illustration here, these are available in glass and/or lead lined wooden boxes in capacities from 100 a.h. to 5000 a.h.

REPLATALS

We are in a position to supply plates for the replating of existing Planté Batteries.

ENCLOSED TYPE CELLS

As illustrated below, these are in moulded glass boxes with sealed-in lid. Capacity range from 10 a.h. to 200 a.h.

PORTABLE TYPE BATTERIES

A range of portable type Batteries is in regular production, made to G.P.O. specifications, for ancillary duties.

Overseas customers are invited to cable or write their enquiries for batteries or parts. Visitors to London are welcome at our offices. (Just off Fleet Street.)

50 Cells. BSSDW. 25.
1200 a.h. at the 9-hour rate.
Installed for the
General Post Office

TUNGSTONE

REGD TRADE MARK

BATTERIES



TUNGSTONE PRODUCTS LTD., 10 SALISBURY SQUARE, LONDON, E.C.4, ENGLAND. CABLES: "DILUTUM" LONDON

Tc14

IMPROVEMENT IN THE ACCURACY OF DECADE RESISTANCES

We have pleasure to announce that the well-known and novel

SULLIVAN and GRIFFITHS

DUAL DIAL DECADE RESISTANCE BOXES

FOR ALL FREQUENCIES

Moreover, the windings are now of Manganin in order to reduce the temperature coefficient; more important still, to improve the long period of stability and make them as suitable for all direct-current purposes as they are for alternating currents of all frequencies.

Screened Resistances of guaranteed accuracy exactly similar to our well-known Decade Resistances but specially arranged so that one box of a given number of dials gives many different values of maximum resistance. Thus a three-dial box (as illustrated) may be used for instance for

three decades of Thousands, Hundreds and Tens	a total of 10,000 ohms.
or three decades of Hundreds, Tens and Units	a total of 1,000 ohms.
or three decades of Tens, Units and Tenths	a total of 100 ohms.
or three decades of Units, Tenths and Hundredths,	a total of 10 ohms.

have now been improved in accuracy to

0.05 PER CENT

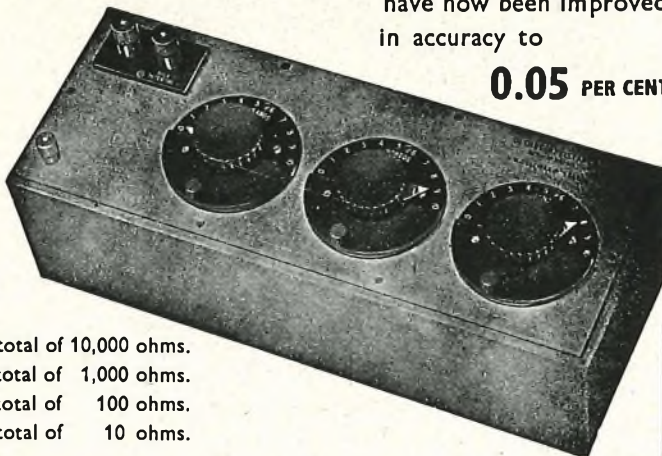

H. W. SULLIVAN
LIMITED

LONDON, S.E.15

Telephone: New Cross 3225 (P.B.X.)

The advantages of such a system will be obvious, for in addition to the economy involved much space is saved and the residual resistance and inductance is much reduced.

The resistances are available in 3-dial, 4-dial and 5-dial types with subdivision of 0.001% down to 0.001 ohm if necessary, depending of course on the number of dials incorporated.

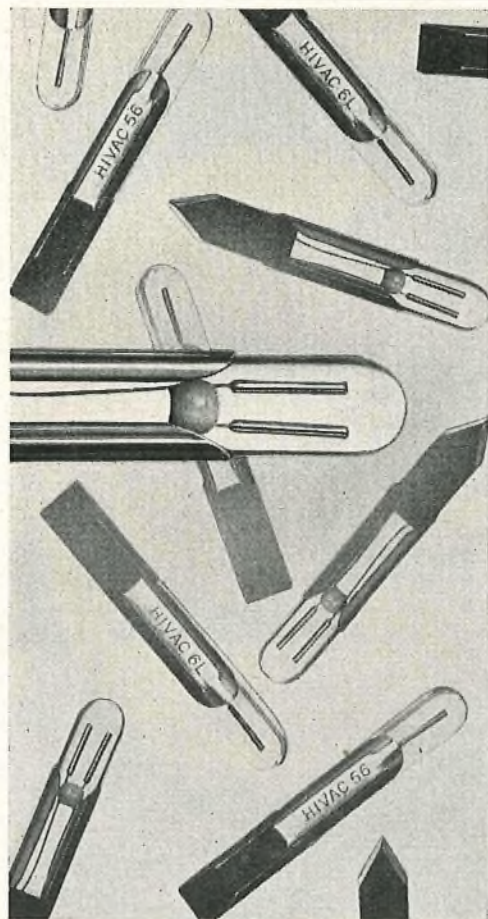

Neon Indicator Lamp type 6L

(P.O. Lamp type 36A)

Neon Indicator Lamps have the advantage of extremely long life and resistance to vibration.

The Neon Indicator Lamp type 6L conforms mechanically in all respects with the specifications for the No. 2 type telephone switchboard lamp.

Nominal striking voltage	80V
Nominal maintaining voltage	60V
Maximum current	0.65mA

"IT JUST GLOWS TO SHOW"

Hivac Limited

Stonefield Way
Telephone: Ruislip 3366

South Ruislip

Middlesex

N6



The

DETECTOR No. 4 Mk. 10

—a TURNER instrument produced for Post Office engineers and combining a high level of sensitivity with accuracy and robust design for work in the field.

ERNEST TURNER ELECTRICAL INSTRUMENTS LTD.

HIGH WYCOMBE BUCKS ENGLAND

Telephone: HIGH WYCOMBE 1301-2-3

Telegrams: GORGEIOUS, HIGH WYCOMBE

WESTINGHOUSE

Dependable
in design and performance

DC CONSTANT VOLTAGE
power supplies

WESTINGHOUSE BRAKE & SIGNAL CO., LTD.
82 York Way, King's Cross, London, N.1
Tel: TERminus 6432

Hackbridge Cables



for
every
purpose

Contractors to the G.P.O., National Coal Board, British Railways, C.E.A. and British and Dominion Government Departments.

HACKBRIDGE
Cable Company Limited

KELVIN WORKS · HACKBRIDGE · SURREY

In Association with Bryce Electric Construction Company Ltd.

for the
right
connection

ANACOS
REGD.

telephone
line
wire

FREDERICK SMITH & COMPANY
ANACONDA WORKS, SALFORD, 3, LANCs.
*Incorporated in The London Electric Wire Company and Smiths Limited.
Associated with The Liverpool Electric Cable Co. Ltd. and Yacrite Wire Co. Ltd.*

VALUABLE FREE BOOK

Tells You How to Pass Your C. & G. or Promotion Exam. at First Attempt!

All Post Office Engineering personnel who are anxious to obtain early promotion should at once send for a copy of our handbook "ENGINEERING OPPORTUNITIES," which among other intensely interesting matter describes our unique methods of preparation for **TECHNICAL APPOINTMENTS IN THE POST OFFICE** (Assistant Engineer—New Style and Assistant Traffic Superintendent), **CITY AND GUILDS EXAMINATIONS** in Principles of Telecommunications (1-5), Radio (1-4), Telephone Exchange Systems (1-3), Telegraphy (1), Line Transmission (1 and 2), Lines Plant Practice (1 and 2), Mathematics for Telecommunications (1-5), Electrical Engineering Practice (Prelim. Inter. and Final), and outlines a wide range of non-examination courses in all branches of Electrical, Mechanical, Civil, Automobile, Aeronautical and Radio Engineering.

Assistant Engineer and Assistant Traffic Superintendent. Open competitions now resumed. Age extensions for established Civil Servants. Ask us for full details.

We definitely guarantee
"NO PASS—NO FEE"

If you intend to make the most of today's opportunities, you cannot afford to miss reading "ENGINEERING OPPORTUNITIES." It tells you everything you want to know to secure advancement, and describes many opportunities you may now be missing through lack of information. Send for your copy to-day—FREE and without obligation.

**BRITISH INSTITUTE
OF ENGINEERING TECHNOLOGY**
369 COLLEGE HOUSE,
29-31 WRIGHT'S LANE, LONDON, W.8

BIET

INDEX TO ADVERTISERS

	PAGE		PAGE
Adcola Products, Ltd.	xxxvi	Marconi Instruments	xxix
Airmec, Ltd.	xlii	Mine Safety Appliances Co., Ltd.	x
Alton Battery Co., Ltd., The	xii	Mullard, Ltd.	ix, xxvi
Austinlite, Ltd.	xix	National Salt Glazed Pipe Manufacturers' Association	xxxv
Automatic Coil Winder & Electrical Equipment Co., Ltd.	xxx	Painton of Northampton	xx
Automatic Telephone & Electric Co., Ltd.	xxv	Pirelli-General Cable Works, Ltd.	xlii
Bennett College, The	xxvii	Pitman, Sir Isaac, & Sons, Ltd.	ii
British Electric Resistance Co., Ltd., The	xxxvi	Pye, Ltd.	xi
British Institute of Engineering Technology	xl	Rawplug Co., Ltd.	xxviii
British Insulated Callender's Cables, Ltd.	xiv	Redifon, Ltd.	ii
Brodie & Askham, Ltd.	xxvii	Riddiford, W. Clarke	xli
Cathodeon Crystals, Ltd.	xxxix	Siemens Edison Swan, Ltd.	vii, xxiii-xxiv
Dale Electric (Yorkshire), Ltd.	xli	Skillman, T. S., & Co., Ltd.	xv-xvi
E.M.I. Institute	ii	Smith, Frederick, & Co.	xl
Ericsson Telephones, Ltd.	v-vi	Standard Telephones & Cables, Ltd.	iii-iv, xliii
Ferranti, Ltd.	xxvii	Sullivan, H. W., Ltd.	xxxviii
General Electric Co., Ltd., The	xvii-xviii, xxi-xxii	Telephone Manufacturing Co., Ltd.	viii
Great Northern Telegraph Co., Ltd.	xxxii	Tungstone Products, Ltd.	xxxvii
Hackbridge Cable Co., Ltd.	xl	Turner, Ernest, Electrical Instruments, Ltd.	xxxix
Hallam, Sleigh & Cheston, Ltd.	xiii	Westinghouse Brake & Signal Co., Ltd.	xxxix
Hivac, Ltd.	xxxviii	Winn & Coales, Ltd.	xxx
Marconi's Wireless Telegraph Co., Ltd.	xxxiii-xxxiv		

Get your

CITY & GUILDS INTERMEDIATE CERTIFICATE

with the aid of the second edition of my

TELECOMMUNICATIONS (PRINCIPLES) I and II

which covers both these C. and G. syllabuses (Tels. I and Tels. II in separate sections). Worked and unworked problems of every type included. Worked problems from 1957, 1956 and 1955 exam papers.

Fully indexed. Uses m.k.s. units throughout. Price 10/6,* (4 Malay dollars, 8 Hong Kong dollars, 6 Pak/India rupees)—post free anywhere in the world.

*Discount to Post Office staff via Area Training Officers or Regional Training Schools

RADIO ENTHUSIASTS RADIO REFERENCE

is the most comprehensive work on this subject in the world—it covers everything from elementary principles to v.h.f., aerial arrays, f.m., transmitters, etc.—suitable for C. and G. Radio I, II and III. Price 25/- with usual Post Office discount.

W. CLARKE RIDDIFORD

384 Tilehurst Road, Reading, Berkshire

TRY THE NEW WAY **ROLL-A-DRUM** SUPPORTS CABLE DRUMS WITHOUT JACKS

Are you still using the clumsy, dangerous old method of hoisting cable drums on jacks! To-day scores of up-to-date firms are using the Roll-a-Drum. They all report excellent results! The Roll-a-Drum operates swiftly on smooth-running rollers from ground level. Compared with the price of similar-capacity jacks it is a very economical proposition indeed, £11.10s. or £23, according to size. Obtain leaflet and discount details by return.

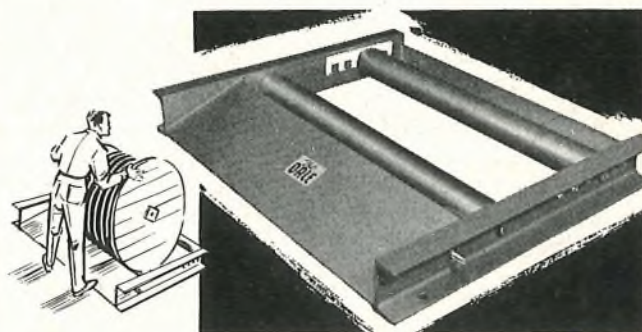

DALE ELECTRIC (Yorkshire) LIMITED

ELECTRICITY BUILDINGS, FILEY, YORKSHIRE. Tel: 2301 (3 lines). Grams: 'Daletric' Filey.

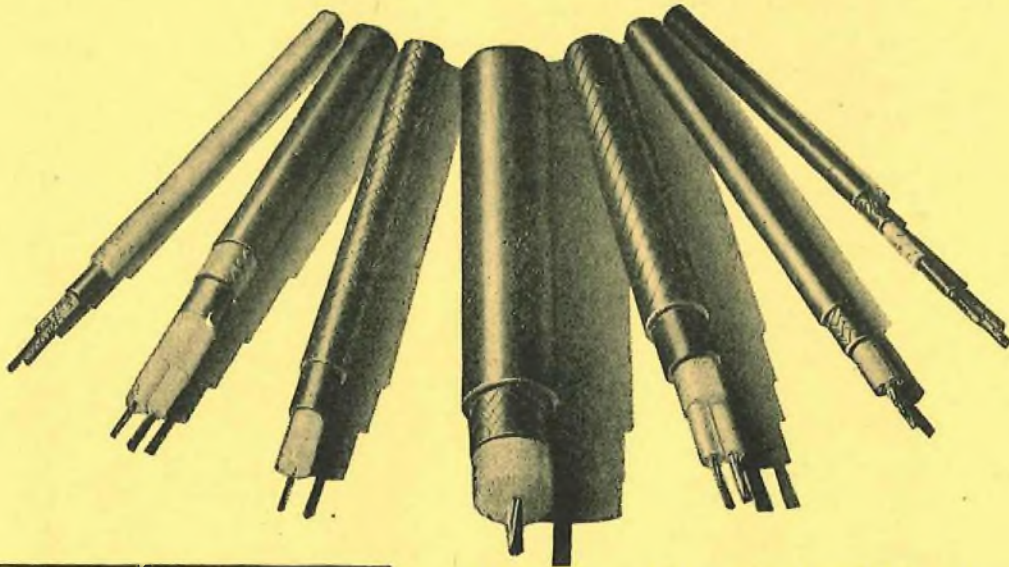

PIRELLI-GENERAL
CABLE WORKS LTD.

PAPER INSULATED TRUNK CABLES
TELEVISION CABLES
RADIO FREQUENCY CABLES
COAXIAL CABLES

PIRELLI-GENERAL CABLE WORKS LIMITED, SOUTHAMPTON



H.F. SIGNAL GENERATOR

Type 701

THIS instrument is a standard signal generator of moderate cost but high performance, operating over the frequency range 30 kc/s-30 Mc/s. The use of a tuned buffer circuit which operates on all ranges helps to reduce harmonic distortion and ensures that the oscillator frequency is independent of the setting of the output and attenuator controls. Special features include a completely stabilised output level over the entire frequency range and the provision of a high voltage output.

SPECIFICATION

- Frequency Range:** 30 kc/s-30 Mc/s
- Output Level:** 1.1 volts open circuit
- Output Level:** Constant to within 1 db over entire frequency range
- Stabilisation**
- Attenuators:** A 75-ohm slide-wire and step attenuator calibrated in db and volts open circuit enables the output to be reduced to 1 microvolt.
- External Field:** Less than 1 microvolt per metre at a distance of 1 foot
- High Output:** A signal voltage of from 5-20 volts is available from a separate 300-ohms output socket



Full details of this or any other Airmec instrument will be forwarded gladly on request

AIRMEC HIGH WYCOMBE BUCKINGHAMSHIRE ENGLAND

L I M I T E D Telephone: High Wycombe 2060

Cables: Airmec High Wycombe



S.T.C. have always led in pioneering telecommunications developments.

S.T.C. developed the first microwave system for 600 telephone channels.

S.T.C. developed in 1946 the New Equipment Practice for the unit construction of slide-in panels.

S.T.C. developed in 1951 a more compact form of unit construction which has been accepted as the model for up-to-date equipment.

S.T.C. developed the first major submerged repeater system in Europe.

S.T.C. developed in 1955 the new channel panel which has been adopted by leading organisations as the model for their present equipment.

The latest S.T.C. systems include:

Transistorised 12-channel, 2-wire, carrier-on-cable telephone system.

A 12 Mc/s coaxial system handling up to 2700 high quality telephone circuits or 960 telephone circuits and a television channel.

A transistorised 3-channel, open-wire, carrier telephone system.

A transistorised 10-channel, rural carrier system.

A 7000 Mc/s portable television outside-broadcast system.

A small-diameter, coaxial cable telephone system for 240 channels using buried transistorised repeaters.

A transistorised 24-channel, frequency modulated, voice-frequency telegraph system.



**To be up-to-date follow S.T.C.
Leaders in Telecommunications Systems design**



Standard Telephones and Cables Limited

Registered Office: Connaught House, Aldwych, London, W.C.2

TRANSMISSION DIVISION: NORTH WOOLWICH · LONDON · E.16