

*RA Roe Petersfeld*

# THE POST OFFICE ELECTRICAL ENGINEERS' JOURNAL

Vol. 46

October 1953

Part 3

## CONTENTS

	PAGE
THE PRODUCTION OF VERY THIN QUARTZ OSCILLATOR PLATES—J. E. Thwaites, A.M.I.E.E., and C. F. Sayers .. .. .	105
THE MOTOR UNISELECTOR-TYPE GROUP SELECTOR FOR TRUNK SWITCHING—A. J. Barnard, A.M.I.E.E. .. .. .	108
A MAINS-OPERATED PSOPHOMETER—F. H. Goldsmith, B.Sc., A.M.I.E.E., and J. A. Widdicks .. .. .	112
THE NEW MIDLAND REGION ENGINEERING TRAINING SCHOOL .. .. .	115
THE BIRMINGHAM-MANCHESTER-HOLME MOSS TELEVISION-CABLE SYSTEM, Part 1—Transmission Requirements, General Design Considerations and Cable Characteristics—R. J. Halsey, B.Sc., M.I.E.E., and H. Williams, A.C.G.I., M.I.E.E. .. .. .	118
SEVENTH PLENARY MEETING OF THE C.C.I.T., ARNHEM, 1953 .. .. .	121
AN OUTLINE OF THE BRITISH TELEVISION SYSTEM, Part 2—Transmitting the Picture Waveform—D. Wray, B.Sc.(Eng.), A.M.I.E.E. .. .. .	123
SOFT MAGNETIC MATERIALS FOR TELECOMMUNICATIONS .. .. .	128
TELEVISION SERVICE TO BELFAST—T. Kilvington, B.Sc.(Eng.), M.I.E.E. .. .. .	130
POOR SOLDERABILITY OF TAGS, AND DRY JOINTS—H. F. Hourigan, B.Sc., F.R.I.C., J. W. Robinson, B.Sc., Ph.D., A.R.I.C., and W. T. Edwards, F.R.I.C., A.I.M. .. .. .	134
SINGLE-SIDEBAND MULTI-CHANNEL OPERATION OF SHORT-WAVE POINT-TO-POINT RADIO LINKS, Part 4(a)—An Independent-Sideband High-Power Short-Wave Transmitter—The Radio and Power Units—H.E. Sturgess, A.M.I.E.E. and F. W. Newson, A.M.I.E.E. .. .. .	140
THE LOCATION AND VERIFICATION OF PAIRS IN CABLES—H. E. Barnett, T.D., M.Sc.(Eng.), A.C.G.I., D.I.C., M.I.E.E. .. .. .	144
NOTES AND COMMENTS .. .. .	149
INSTITUTION OF POST OFFICE ELECTRICAL ENGINEERS .. .. .	149
REGIONAL NOTES .. .. .	151
ASSOCIATE SECTION NOTES .. .. .	154
STAFF CHANGES .. .. .	156
BOOK REVIEWS .. .. .	111, 133, 139

Price 2/6 net

THE INSTITUTION OF POST OFFICE ELECTRICAL ENGINEERS

# AIRMEC TELEGRAPH DISTORTION MONITOR *Type 787*

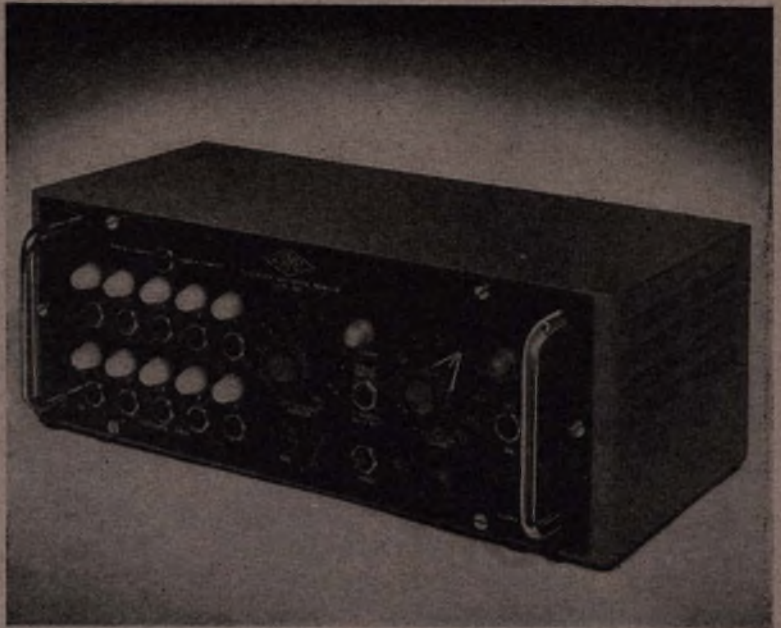

- Monitors up to ten lines
- Double or single current circuits
- May be supplied to operate at either 50 or 45.5 bauds
- Permissible distortion variable between 0 and 50%
- Monitor will remain connected to faulty line until cleared
- Indicates either single errors or five errors in twelve seconds as required
- Immediate delivery

THE TELEGRAPH DISTORTION MONITOR TYPE 787 enables teleprinter signals on up to ten telegraph lines to be monitored for distortion, the amount permissible being set by a control on the front panel. One line may be monitored continuously or each line in turn for a period of one minute. When excessive errors occur, the alarm lamp lights, and, if desired, an external bell or buzzer may be operated.

*Full details of this or any other Airmec Instrument will be forwarded upon request.*

**AIRMEC**  
L I M I T E D

HIGH WYCOMBE  
Telephone: High Wycombe 2060

BUCKINGHAMSHIRE

ENGLAND

Cables: Airmec High Wycombe



**DENSO**  
Industry's protection  
against corrosion

*Photograph by courtesy of  
Imperial Chemical Industries Ltd.*

The tanks, the supporting steelwork, the stair stringers, hand-rails and standards in this illustration have all been protected with DENSO TAPE, and over-wrapped with DENSO products ensure permanent protection for pipes, mains, cables and all structural steelwork, below and above ground, against atmospheric, industrial and electrolytical corrosion. They are acid-resistant and completely impervious to water.



Full information from:  
**WINN & COALES LTD.** DENSO HOUSE, CHAPEL ROAD, LONDON, S.E.27  
Telephone: GIPsy Hill 4247/8      Telegrams: Denselte, Westnor, London.

## How to make certain of your City & Guilds Certificates



**"I guarantee  
tuition until you  
have passed"**

If you consider taking one or the whole series of C. and G. examinations then I can help you. BY POST, in your own time, one of my Telecommunications specialists will coach you until you pass. He will give you individual attention, he will study you and your problems. And you will be surprised how fast you progress. For The Bennett College has specialised in technical subjects since it was founded 50 years ago. My system of personal postal tuition has helped thousands of students through their exams. It can do the same for you.

Send me the coupon to-day. I will send you—without obligation—full information on your subject.

### WHICH IS YOUR NEXT STEP?

- Preliminary Course
- Telecommunications Principles I—V
- Telecommunications Practice
- Telephone Exchange Systems I—III
- Radio I—IV
- Telegraphy I & II
- Line Transmission I & II
- Mathematics for Telecommunications I—V
- Radio Servicing Certificate
- Television Servicing Certificate
- A.M.I. Mech.E.
- and many other subjects

### The BENNETT COLLEGE

To the Governor, Dept. J24, The Bennett College, Sheffield, England. I would like to have (at no cost) your prospectus and

particulars of .....

NAME .....

ADDRESS .....

..... AGE (if under 21).....

PLEASE WRITE IN BLOCK LETTERS



**TEAR OUT**

with monthly instalments of 15/-

# THE POST OFFICE ELECTRICAL ENGINEERS' JOURNAL

Vol. 46

October 1953

Part 3

## The Production of Very Thin Quartz Oscillator Plates

J. E. THWAITES, A.M.I.E.E.,  
and C. F. SAYERS†

U.D.C. 621.924:553.621

To produce a quartz crystal plate of thickness less than about 0.25 mm., grinding or lapping by hand has been the normal practice as conventional crystal-lapping machines are unsatisfactory for such thin plates. Hand lapping, however, requires a high degree of skill and is a lengthy process. The authors describe the construction and operation of a machine in which plates have been successfully lapped to a thickness of approximately 0.055 mm. and which shows promise of solving the difficulties hitherto experienced in producing very thin plates.

FOR the control of the frequency of a short-wave radio transmitter it is usual to employ a quartz vibrator in the form of a thin plate vibrating in its thickness-shear mode, the frequency of vibration being inversely proportional to the thickness of the plate. In fixed transmitters it is practicable to use frequency multipliers which also function as amplifiers and thus the frequency of the crystal element often need be no higher than a fraction of that of the radiated wave. For example, a transmitter radiating at a frequency of 20 Mc/s and employing two frequency-doublers would need a controlling crystal element of frequency 5 Mc/s, which would probably be a square or circular quartz AT-cut plate 0.335 mm. thick.

Radio communication channels employing very high frequencies can be used satisfactorily over short distances, and such channels are eminently suitable for portable equipment, since the radiating aerials required are small and the power need not be high. Accuracy and stability of frequency, such as are conferred by the use of crystal control, are still required, and because, in the interests of smallness and lightness of equipment, it is desirable to keep the number of multiplying stages to the minimum, it is essential that the vibration frequency of the crystal unit—the starting point as it were—should be high. As a result the crystal engineer is faced with the problem of producing crystal units vibrating at frequencies up to 100 Mc/s or even higher.

There are two types of quartz plate that can be considered for the purpose, the AT-cut and the BT-cut. The AT-cut has the better frequency/temperature characteristics and is therefore to be preferred when the apparatus is to be subjected to a wide range of temperature. In fact, when the permissible frequency variation or tolerance is small and the temperature range is great, the BT-cut may be incapable of meeting requirements. Now the thickness of an AT-cut plate to have a fundamental frequency of, say, 90 Mc/s would be only 0.0186 mm. (0.00073 in.), that is, thinner than a cigarette paper. Fortunately, it is possible to use a thicker plate and to make it oscillate in an overtone mode to give the desired frequency. Thus, to generate a frequency

of 90 Mc/s, an AT-cut plate 0.0558 mm. thick, having a fundamental frequency of 30 Mc/s and oscillating on its third overtone‡, or a plate 0.093 mm. thick with a fundamental frequency of 18 Mc/s oscillating on its fifth overtone could be used. Even with the advantage of overtone operation, however, the plates are very thin and difficult to make.

In producing plates of finished thicknesses down to about 0.25 mm., slices of quartz are first cut at the appropriate orientation, but considerably thicker, say, 0.8 mm. thick, and they are ground or "lapped" down to the required thickness in order to remove the outer layers, which are invariably somewhat damaged in the sawing process, and to make the surfaces quite flat and parallel. The grinding or lapping process can be carried out by hand, or in a machine such as that shown in Fig. 1, commonly called a "drill-press lap." Lapping by hand is a skilled operation, hence the drill-press lap has become widely used because, when properly maintained, it gives good results without the necessity for great manual skill.



FIG. 1.—DRILL-PRESS LAP.

† The authors are respectively Senior Executive Engineer and Executive Engineer, Radio Experimental and Development Branch, E.-in-C.'s Office.

‡ The 3rd, 5th . . .  $n$ th overtones as dealt with in this article have frequencies approximately 3, 5 . . .  $n$  times the fundamental frequency. The term "harmonics" is not used because the overtone frequencies are not exact multiples of the fundamental.

When plates thinner than about 0.25 mm. have to be ground or lapped, it has been the practice to employ the optical flat technique. In this method the quartz plates are stuck to a flat glass plate in batches of perhaps 10 or 20 of similar thickness, and their exposed surfaces are lapped by hand manipulation on a flat lap until these surfaces are flat and in the same plane. The plates are then turned over and "wrung down" on to the flat glass plate, and the exposed surfaces are again lapped by hand on a flat lap until the plates are of the required thickness. By this method a skilled operator can produce very thin quartz plates with flat surfaces and of uniform thickness and, indeed, many thousands of very thin plates have been produced thus. The process, however, calls for considerable skill, both in the treatment of the quartz plates and in the preparation of the optically flat glass plates on which they are mounted, and efforts have been made both in this country and elsewhere to develop an alternative process. The machine now to be described promises to go some way towards a solution of the problem. Certain features of this machine are covered by British Patent Applications.\*

#### Description of Machine.

In the conventional drill-press lap, Fig. 1, the quartz plates are located in holes in a thin metal diaphragm, or work-holder, and both diaphragm and plates rest on the lower lap, while the upper lap rests on the quartz plates, the diaphragm being somewhat thinner than the plates. The driving shaft is fitted with a crank which engages in a bearing at the centre of the diaphragm and the latter is driven round between the two laps. The plates travel in a quasi-cycloidal path over the entire surfaces of the laps and at the same time rotate on their axes. In some machines both laps are stationary and in others one lap rotates and the diaphragm is driven in a definite path by two crank pins.

In attempting to use this method for very thin plates two difficulties are encountered. First, the diaphragms, which must be thinner than the plates, become so thin that they will not, without buckling, transmit the force required to move the plates between the laps, when that force is applied at the centre. Secondly, thin metal foils are difficult to obtain and in use develop a wavy surface which allows the plates to slip out of their locating holes and become wedged between diaphragm and lap. In the new method the first difficulty is overcome by clamping the diaphragm round its outer edge and by communicating the drive to the clamp. By shaping the clamp in a particular manner, the diaphragm is tensioned and becomes flatter and more rigid. Even with these modifications, however, metal diaphragms have not proved very suitable, and better results have been achieved with diaphragms of thin paper coated with lacquer or with thin cellulose acetate sheet.

Besides the application of the drive at the periphery of the diaphragm and the tensioning of the diaphragm, the machine that has been developed has other features, chief of which are the method of supporting the diaphragm in relation to the laps and the means of achieving relative motion between the plates and the laps. These features will be better understood with the aid of the illustrations. Fig. 2 is a photograph of the machine assembled for running, Fig. 3 shows the component parts, and Fig. 4 shows the construction in more detail. The driving mechanism, which is located below the machine, is not shown.

The lower lap is a ring of cast iron or meehanite,  $\frac{1}{2}$  in. thick, of outer diameter  $4\frac{1}{4}$  in. and of annular width  $\frac{7}{8}$  in., resting on three levelling and elevating screws in the base plate of the machine (not shown in Fig. 4) and fitting snugly over a central boss which holds it in position. The upper lap is a similar ring, restrained horizontally by an



FIG. 2.—THE NEW LAPPING MACHINE.



FIG. 3.—COMPONENTS OF THE NEW MACHINE.

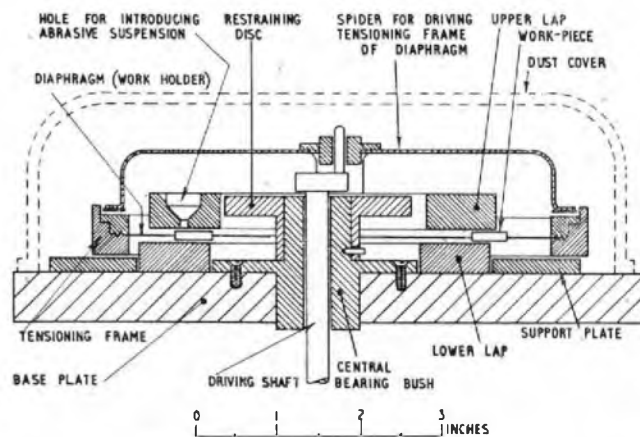

FIG. 4.—SECTION OF LAPPING MACHINE.

inner disc  $2\frac{1}{4}$  in. diameter which is fixed to the central boss. The upper lap is thus free to move vertically, and also horizontally within the limits set by the difference between the diameter of the restraining disc and the bore of the lap. The diaphragm holder, or tensioning frame, consists of two metal rings, one fitting inside the other, and clamped together by screws. To tension the diaphragm the mating

\* Patent Applications 15396-7/1951.

surfaces of the rings may be provided with annular corrugations which grip the edge of the diaphragm and tension it in a radial direction. Another method of applying the tension is to grip the edge of the diaphragm between a metal ring and an oil-resistant rubber tube and draw it down into a recess, as shown in Fig. 5. The diaphragm holder or

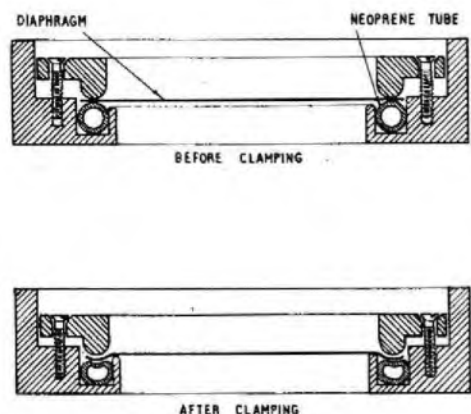

FIG. 5.—A TENSIONING FRAME FOR DIAPHRAGM OF LAPPING MACHINE.

tensioning frame rests on an annular support plate at such a height that the diaphragm is just clear of the lower lap, and is driven by a four-armed "spider" which engages with the crank pin of the driving shaft. As the driving shaft rotates an eccentric motion is communicated to the diaphragm which carries the workpieces between the surfaces of the laps. The frictional forces between diaphragm holder and support plate and between workpieces and laps are so related that the diaphragm gradually rotates on its axis and the upper lap also rotates at a higher speed in the same direction. The upper lap rolls round the restraining disc and as a result the motion of the upper lap as well as that of the diaphragm is compounded of a rotary motion about its own axis and a rotation of this axis about the axis of the machine. The upper lap is provided with holes through which a suspension of fine abrasive powder in kerosene can be introduced while the machine is running.

For making the diaphragm, metal foils, tracing linen and various kinds of paper, in the thickness range 0.025 mm. to 0.1 mm., have been used. Diaphragms of paper or linen are prepared by fixing a sheet of the material to a wooden frame and spraying it with cellulose lacquer. When dry, the sheet is removed from the frame and cut to the required shape, and the holes for the quartz plates are punched out. The lacquer greatly strengthens the paper and renders it proof against the lapping liquid. Good results have been produced with diaphragms of commercial cellulose acetate sheets, which are obtainable in thicknesses 0.05, 0.1, 0.15, 0.2 and 0.25 mm.

This type of machine is capable of dealing with thick as well as thin quartz plates, but would seem to be best employed to extend the range which can be dealt with by the ordinary drill-press lap, that is, to work on plates thinner than 0.25 mm. The grade of abrasive and the weight of the upper lap can be chosen to suit the thickness of the plates and the amount of quartz which is to be removed.

The abrasive used in lapping very thin plates is 303½ or 304 emery powder. The rate of lapping, using the former powder and an upper lap weighing 500 grams, may be expressed as a reduction in thickness of the order of 0.05 mm. an hour, when eight plates 12 mm. in diameter are

being lapped. The plates have a fine finish, with little edge damage, and when removed from the machine they oscillate readily in a suitable test circuit, without further treatment other than cleaning.

Circular AT-cut quartz plates have been lapped in this machine to oscillate at a fundamental frequency of 30 Mc/s. The thickness of these plates was approximately 0.055 mm., or roughly two-thirds the thickness of the paper on which this article is printed.

The upper limit to the frequency that can be reached, so far as can be seen, is determined by the lower limit of thickness of diaphragms which can be used.

#### Performance Test of Machine.

The performance of the machine is illustrated by a test carried out with a batch of eight circular quartz discs, 12 mm. in diameter, and ranging in thickness between 0.595 and 0.645 mm. Besides being of different thicknesses the plates were not parallel, that is, any given plate was not of uniform thickness. They were lapped for four ten-minute periods in a cellulose acetate diaphragm 0.1 mm. thick. During the first two periods the plates were arranged indiscriminately in the diaphragm apertures, and during the third and fourth periods were arranged in a balanced distribution of thickness. The results are given in Table 1. The test serves to show that the machine produces plates to a high order of uniformity of thickness and parallelism. To achieve similar results by hand lapping, in a similar period of time, would require extremely skilled manipulation.

TABLE 1  
Performance Test of Lapping Machine  
(Batch of plates lapped for four periods of ten minutes)

Thicknesses of quartz discs arranged in order of magnitude				
Initial dimensions mm.	After 1st Period	After 2nd Period	After 3rd Period	After 4th Period
0.645 to 0.620	0.6075	0.591	0.580	0.570+
0.630 to 0.625	0.610 to 0.600	0.590	0.580-	0.570+
0.640 to 0.600	0.605 to 0.600	0.5875	0.5795	0.570+
0.620 to 0.605	0.600	0.585	0.578	0.570+
0.620 to 0.600	0.5975	0.585	0.5775	0.570
0.610 to 0.600	0.600 to 0.595	0.585	0.577	0.570
0.610 to 0.600	0.5925	0.583	0.577	0.570
0.610 to 0.595	0.590 to 0.585	0.583	0.577-	0.670-
Average thickness 0.614	0.599	0.586	0.5782	0.570
Total variation of thickness 0.050	0.025	0.008	0.003	0.0005

Diameter of discs, 12 mm.

Abrasive, emery No. 303½ suspended in kerosene.

Approximate thickness of quartz removed, 0.044 mm.

Total lapping time, 40 minutes.

Note.—Measurements appearing on the same horizontal line do not necessarily refer to the same plate.

#### Conclusion.

The machine described is a small one whose best sphere of usefulness is in the later or final processes of lapping, where good finish and high accuracy are required. A larger machine, based on the same principle, has been constructed, having 2½ times the capacity and five times the lapping speed of the smaller machine. This should be useful as an intermediate stage between the conventional drill-press lap and the small finishing machine.

# The Motor Unselector-type Group Selector for Trunk Switching

A. J. BARNARD, A.M.I.E.E.†

U.D.C. 621.395.343: 621.395.5

The construction and operation of the Post Office standard motor unselector has been described in a previous issue of the Journal.\* The present article explains how the motor unselector is associated with a controlling relay set (incorporating a digit switch) to function as a group selector for trunk switching. Within the bank capacity of 200 outlets, various combinations of 20- and 40-availability groups can be provided to suit individual trunk routes. The impulsive performance of the group selector is comparable with that of a standard 2-motion switch.

## Introduction.

FOR the Trunk Mechanisation scheme, which is now in progress, it is proposed to convert all trunk switching centres to automatic working. With the existing manual switching system the operators can be given access to all outgoing trunk circuits, but with automatic working it is not practicable to provide full availability on all routes due to limitations in the physical design of the selector. It is necessary therefore to use limited availability and grade the outlets to trunk routes. A graded group requires more trunks to carry a given amount of traffic at a given grade of service than does a full availability group. The increase is, however, not great providing the availability is not less than 40, and when the circuits involved are trunk circuits their cost is sufficiently high to make possible a considerable saving by using 40- instead of 20-availability at the ultimate switching stage of the trunk exchange. When 40-availability is used a selector with a high hunting speed is desirable so that all outlets may be tested in the dialling inter-train pause without using complicated testing arrangements.

These special requirements have led to the selection of the motor unselector as the most suitable switch for use in Zone, Sub-Zone and the larger Group Centres. To employ the motor unselector in this function the Group Selector (Motor Unselector type) has been developed.

## General Description.

The group selector consists of two main parts, a sixteen-level motor unselector and a jacked-in controlling relay set incorporating a P.O. type 2 unselector functioning as a

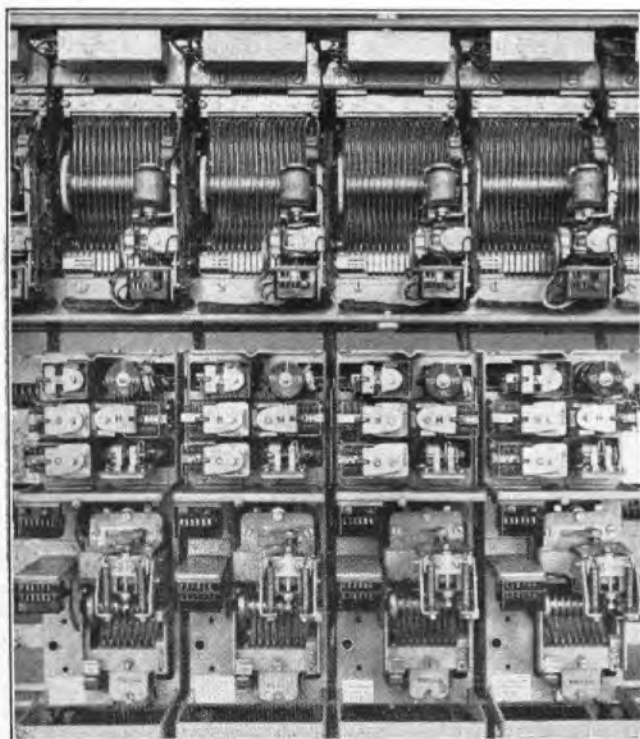

FIG. 1.—LAYOUT AND MOUNTING OF THE GROUP SELECTOR.

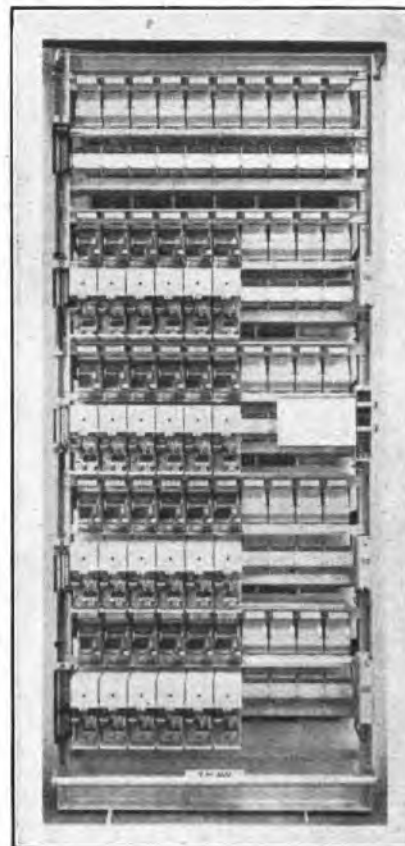

FIG. 2.—FRONT VIEW OF GROUP SELECTOR RACK.

digit switch. Fig. 1 shows the layout and mounting arrangements of these components. The motor unselector is mounted directly above its associated controlling relay set. Fig. 2 shows a front view of the group selector rack. A standard 10' 6½" × 4' 6" rack is used and has a capacity of fifty selectors. Grading, in conformity with standard practice, is carried out on connection strips at the rear of the selector rack.

## Use of 20- or 40-Availability.

As mentioned in the introduction it is desirable to use 40-availability on certain routes at the ultimate switching stage of the trunk exchange. In the present application the use of 40-availability on all levels of the selector reduces the number of groups of outlets to five since the selector is used as a 200-outlet switch. Thus, only five of the ten available routing digits can be used, the remainder becoming spare and unusable. Use of 40-availability at all switching stages in the trunk exchange would therefore require more stages of selection to provide a given number of routings than would be necessary with 20-availability and would be wasteful where small groups of circuits are to be switched.

† Executive Engineer, Telephone Development and Maintenance Branch, E.-in-C.'s Office.

\* P.O.E.E.J., Vol. 46, p. 79.

The selector has therefore been designed to give either 20- or 40-availability outlet groups as desired, by means of strapping on a tag strip associated with the motor unselector bank. Thus, within the bank capacity of 200 outlets, five 40-availability groups, ten 20-availability groups or 6 to 9 groups of 20- and 40-availability can be provided.

#### Association of Digits with Outlet Groups.

The motor unselector is essentially a hunting switch and is not designed for direct impulse controlled selection. A P.O. type 2 unselector, termed the digit switch, is used therefore to respond to the impulse train and select the motor unselector wipers over which the call is to be routed and the group of outlets, in the arcs swept by these wipers, in which testing is required. This function is analagous in some respects to the vertical stepping of the two-motion group selector. Since only half of the outlets of the digit switch are required for this purpose the wiring is duplicated on the second part of the bank so that the switch makes only a quarter revolution per call.

The sixteen arcs of the motor unselector are used in five sets of three arcs (-, + and P wire), the sixteenth arc being used as a group marking arc in the outlet testing circuit.

Fig. 3 shows the use of the 51 outlets from the motor unselector bank. Outlets 1-40 are used for routing calls through the exchange, the remainder for overflow, spare digit and delay announcing purposes. The method of selection of the required motor unselector arcs and outlet group by the digit switch is shown in Fig. 4. It will be seen that reception of either of two digits selects a set of motor unselector wipers at digit switch arcs DS4, 5 and 6 in preparation for switching through the -, + and P wires.

For example receipt of digit 1 or 2 selects motor unselector wipers G1, 2 and 3. The group of outlets in the selected arcs over which testing takes place is controlled by strapping between the D and M tags. The testing relay circuit passes via arc DS7, the outlets of which are wired to tags D1-D0 so that after receipt of the impulse train the testing circuit is extended to the D tag appropriate to the digit received. To identify a digit with outlets 1-20 in the selected motor unselector arcs the appropriate D tag is strapped to M1 so that the testing circuit is completed via the marking arc G16 when the motor unselector wipers pass over outlets 1-20. In a similar way testing takes place over outlets 21-40 if the D tag is strapped to M2. To provide a 40-availability group the D tag of the digit of the pair available which it is desired to associate with this group is strapped to M3 and testing takes place over outlets 1-40. The additional outlets marked are termed overflow outlets and their function is explained later. The D tags of digits left spare by 40-availability groups are strapped to the SP tag. When these digits are received testing takes place over outlets 48 and 49 and the selector switches to a spare digit relay set on one of these outlets from which N.U. tone is returned. Digits can also be spare because the outlet groups with which they can be associated are not used. The D tags of these digits are similarly strapped to the SP tag.

The typical strapping between the D and M and SP terminals shown in Fig. 4 gives the following use of digits.

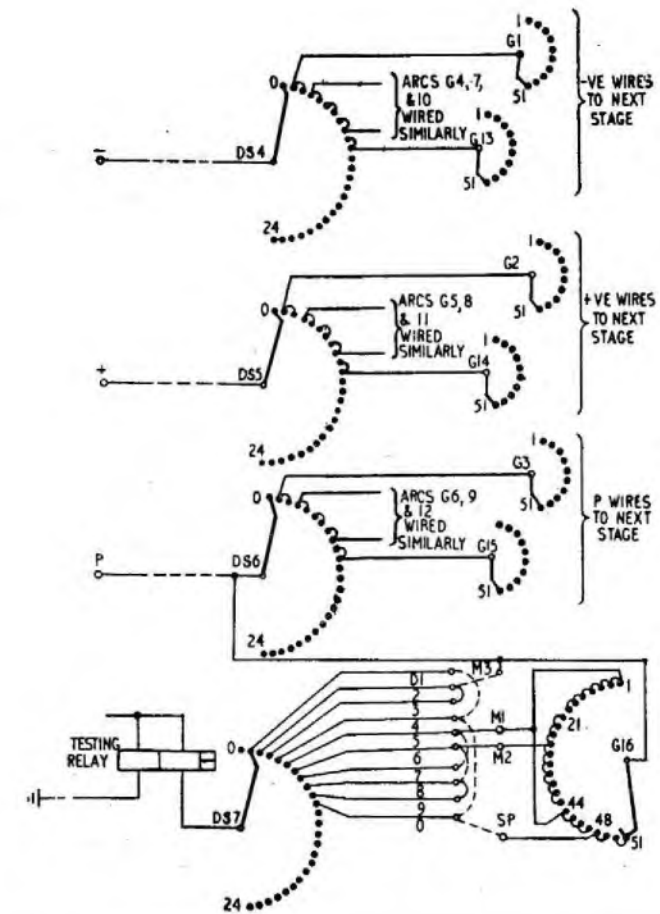

FIG. 4.—SELECTION OF MOTOR UNSELECTOR ARCS AND OUTLET GROUPS BY DIGIT SWITCH.

Digit Received	Outlet group tested	Remarks
1	Spare digit outlets	Partner digit 40-availability
2	Outlets 1-40, Arcs G1, 2 and 3.	40-availability group
3	Outlets 1-40, Arcs G4, 5 and 6.	" " "
4	Spare digit outlets	Partner digit 40-availability
5	Outlets 1-20, Arcs G7, 8 and 9.	20-availability group
6	Outlets 21-40, Arcs G7, 8 and 9.	" " "
7	Outlets 1-20, Arcs G10, 11 and 12	" " "
8	Outlets 21-40, Arcs G10, 11 and 12	" " "
9	Outlets 21-40, Arcs G13, 14 and 15.	" " "
0	Spare digit outlets.	Outlets 1-20, Arcs G13, 14 and 15 not used.

#### Impulsing and Wiper Selection.

The circuit elements used in these operations are shown in Fig. 5 and function as follows. Operation of relay A on seizure of the selector operates relay B from the DS magnet battery to earth at DS2 wiper. The DS magnet does not operate to this current. Contact B4 operates relay C via DS8 arc. Contacts B3 and C1 complete a circuit for energising C during the break pulses of the impulse train and C2 prepares a circuit for stepping DS. The selector is now ready to receive the impulse train. Release and reoperation of A1 to the impulse train steps DS to earth from B1, the DS magnet releasing in series with relay B. Relay B holds

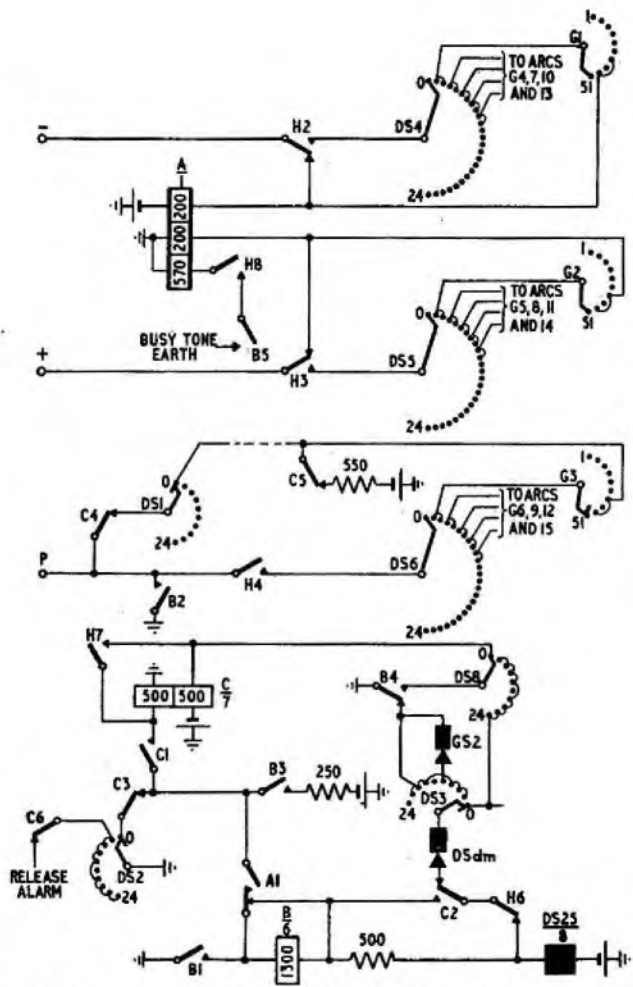

FIG. 5.—IMPULSING, WIPER SELECTION AND RELEASE CIRCUIT ELEMENTS.

during the break pulses by virtue of the short-circuit on its coil. During the first make pulse DS steps from the home contact disconnecting the operate circuit of relay C at DS8 wiper and leaving C holding to the short-circuit on its other coil by earth from B1. During subsequent break pulses C is re-energised by battery via B3. At the end of the impulse train the short-circuit on C is maintained and C releases to start the motor uniselector hunting.

#### Hunting, Testing and Switching to Outlets.

Fig. 6 shows the circuit elements used for these functions. Battery testing with a two-coil high-speed relay working on

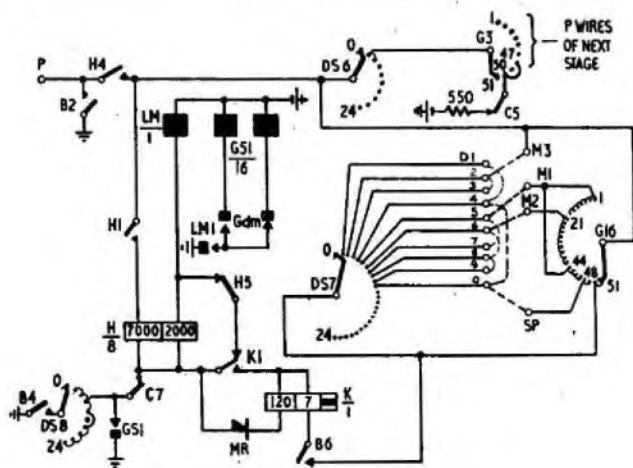

FIG. 6.—HUNTING, TESTING AND SWITCHING CIRCUIT.

the "high-low" testing principle is used. The free condition of an outlet is the 50-volt exchange battery via a 550-ohm resistor. Relay C releasing during the inter-train pause connects earth from contact B4 via arc DS8 and contact C7 to operate the latch magnet and start the motor uniselector running. The same earth is connected via MR, the two coils of relay K in series, DS7 arc, G16 arc (when the motor uniselector reaches the part of the arc to which the selected D tag is strapped), DS6 arc to G3 wiper (assuming digit 1 or 2 dialled). When the P wire of a free outlet is reached relay K operates to the 550-ohm battery. K1 at its break contact inserts the 2000-ohm coil of relay H in series with the latch magnet. Due to the high inductance of the H relay coil the latch magnet releases to this condition in 2-3 mS, stopping the motor uniselector on the outlet. At its make contact K1 short-circuits MR and the 120-ohm coil of relay K which holds on its 7-ohm coil. The outlet is guarded against intrusion during the operate time of relay H by this 7-ohm earth. The rectifier MR increases the efficacy of this guard condition due to its non-linear voltage/resistance characteristic. When a selector tests in to a free outlet the rectifier is in series with the full 50 volts and presents a resistance of about 80 ohms which does not greatly limit the relay operate current. When testing in to an outlet guarded by a 7-ohm earth the rectifier presents a resistance of about 1000 ohms to the small voltage on the outlet and so makes the non-operate condition for the testing relay less onerous. Relay H operates in series with the latch magnet and guards the outlet with earth from B2 contact. H2 and 3 (Fig. 5) switch the negative and positive wires through and release relay A. H7 re-operates relay C which at C7 disconnects the H relay operate earth leaving H holding on its two coils in series to the P-wire earth. Relay H is made high resistance so that on clear-down of a call the paralleled H relays of the selectors involved do not simulate the free condition of an outlet to selectors testing in during the interval between the removal of earth from the P wire and the self-disconnection of the H relays from the P wire.

Release of relay A releases relay B and the selector holds with relays H and C operated.

#### Release of Selector (Figs. 5 and 6).

Disconnection of earth from the P wire at the end of a call releases relay H which in turn releases relay C. The release time of relays H and C provides an open period on the P wire to release any preceding selectors before connection of guarding earth, (not shown in Fig. 5), from DS1 arc via C4 normal.

If the motor uniselector is on any contact other than contact 51 the cam-springs GS1 are made and GS2 broken. Earth from GS1 via C7 and H5 normal homes the motor uniselector while earth from B4 via DS3 arc and C2 drives DS, but homing is not completed until GS2 makes, i.e. when the motor uniselector has homed. This arrangement ensures that DS always homes last thus permitting release guard and alarm for both switches to be done from arcs DS1 and 2.

#### Overflow Outlets.

Associated with each group of call-routing outlets is a group of overflow outlets over which testing takes place if all outlets in the main group are engaged. In the case of outlets 1-20 the overflow outlets are numbers 44-46, for outlets 21-40 outlets 41-43 are used and when outlets 1-40 are used as a single group, outlets 41-46 are also used as a single overflow group. On outlet groups other than those outgoing to trunk circuits the first outlet of the overflow group is connected to a relay set which, on seizure, returns



busy tone and operates an overflow meter. The remaining outlets of the overflow group are not used. The overflow outlets of groups outgoing to trunk circuits are connected to relay sets from which congestion or delay announcements are returned. Fig. 7 shows a verbal announcement relay

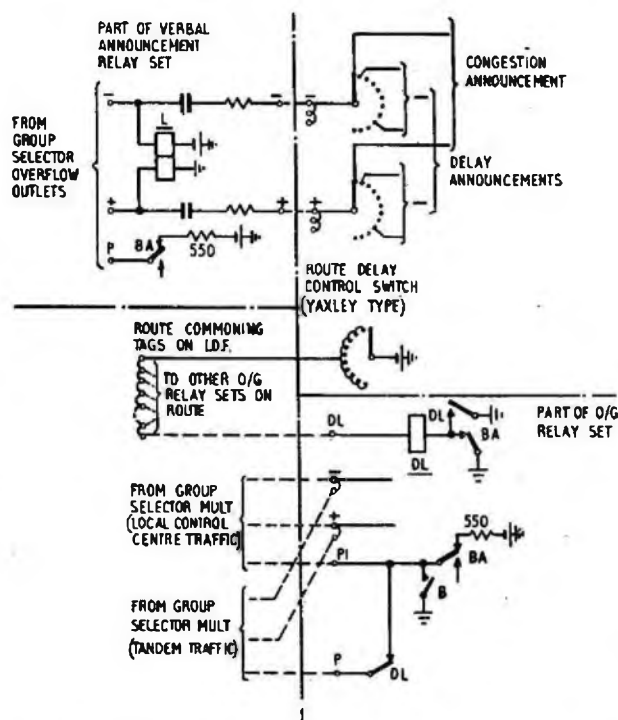

FIG. 7.—VERBAL ANNOUNCEMENT AND DELAY SWITCHING CONTROL CIRCUIT.

set and the arrangements for switching a route to delay working.

It is necessary under delay working conditions to permit only the local Trunk Control Centre (T.C.C.) operator access to routes in delay. This is done by providing separate sections of the exchange for tandem traffic and local T.C.C. traffic. These two sections combine at the ultimate switching stage and test into the same outgoing

circuits but via two separate P wires. Normally these P wires are connected in the outgoing relay set and congestion announcement is connected to the overflow relay set. When all outlets are engaged traffic from both sources overflows and receives the congestion announcement which states that all lines are engaged and gives the exchange name to assist the calling operator on tandem routings. To switch a route to delay working the control switch for that route is operated, disconnecting the congestion announcement from the announcement relay sets for that route and connecting the required delay announcement in its place. At the same time battery is connected to the DL leads of all outgoing relay sets on the route. The DL relays of all free relay sets operate so that the whole route is busied to tandem traffic by the disconnection of the free-condition potentials from the tandem P wires. The P wire into which the T.C.C. traffic tests is unaffected. The DL relays of relay sets engaged on calls operate when the calls clear. With all outlets busied to tandem traffic all calls from this source overflow and receive the delay announcement.

Should all the overflow outlets be engaged the selector tests into outlet 47 in the case of digits strapped to tags M1 and M3, and into outlet 50 in the case of digits strapped to M2, and switches to an individual 550-ohm battery in its own circuit. The selector holds to its own A relay via contacts 47 or 50 and returns busy tone from the A relay tone coil.

#### Selector Performance.

The impulsing performance of the selector is comparable with that of the 2000-type two-motion group selector. The time taken from the end of the impulse train to switch to the 40th outlet varies between 330-430 mS depending on the adjustment of the components concerned. The maximum release time of the selector from the switched condition is 350 mS.

#### Acknowledgments.

Acknowledgment is due to the members of Telephone Branch and Messrs. Siemens Bros. who co-operated in this development.

## Book Review

"Radio Designer's Handbook." 4th Edition. Edited by F. Langford-Smith, B.Sc., B.E., M.I.R.E., A.M.I.E.(Aust.) Iliffe & Sons Ltd. 1482 pp. 42s.

Langford-Smith's handbook was first distributed in Great Britain during 1940 in its third edition. This new edition, with its 1482 pages, is about four times longer and five times costlier than its predecessor. Like the earlier edition, the scope of this handbook is less comprehensive than its title suggests, for it is restricted to radio-receiving and audio-frequency reproducing systems. It does not deal with radio transmitters, television, radar or radio aids to navigation, radio measurements, or what is conveniently called "electronics." Aerials and receivers are considered almost entirely from the point of view of broadcast reception, which limits the upper frequency range to about 150 Mc/s and means that such topics as microwave and single-sideband techniques, diversity reception and the more elaborate types of receiving aerial are not treated, or are dismissed summarily.

Apart from the general increase in space available for each topic, the principal changes compared with the third edition are the addition of chapters on loudspeakers, oscillators, vibrators, and the design and testing of complete AM and FM receivers. And a more than proportionate expansion has been made in the sections on mathematics, negative feedback,

audio-frequency power amplifiers, sound recording and intermediate-frequency amplifiers. On its chosen topics the book is a mine of information, both in its text and in the lists of references provided. Rather surprisingly, magnetic recording receives a bare mention, but even so more than 400 pages are devoted to audio-frequency recording, amplification and reproduction. The approach generally resembles that of the third edition and as well as basic design data and formulae, worked examples of design and practical circuits with component values are included.

The author's stated aim has been to make the book comprehensive and self-contained, which has led in some sections to a treatment that sweeps rapidly from the very elementary to the advanced. Thus, the mathematics section beginning with "A figure (e.g. 5) indicates a certain number of a particular object—e.g. five resistors or five radio receivers; . . ." passes in a mere 14 pages to a list of hyperbolic functions. The chapters on valves and networks are similar in range. This attempt at completeness the reviewer considers to be mistaken, for the purchaser of an advanced handbook is unlikely to need the elementary material, and those who do could not absorb it at the rate at which it is provided. In all, it is a very useful book, but one that might be more useful if it did not attempt to combine the functions of the textbook and the handbook.

F. J. M. L.

# A Mains-Operated Psophometer

F. H. GOLDSMITH, B.Sc., A.M.I.E.E.,  
and J. A. WIDDICKS†

U.D.C. 621.317.7 : 621.395.822

This article describes an experimental psophometer with improved characteristics designed as a self-contained unit for mains operation. The overall accuracy of voltage measurement is within 3 per cent. as compared with the C.C.I.F. tolerance of 5 per cent.

## Introduction.

THE psophometer, or circuit noise meter, was designed originally with the primary object of measuring the subjective effect of noise interference induced on telephone lines from power system conductors. Following a meeting of the *Commission Mixte Internationale* at Dollis Hill in 1930, it was agreed that the valve-voltmeter method of measurement should be adopted internationally and that a precise specification for a suitable instrument would be drawn up by the C.C.I.F. This was prepared, and with subsequent amendments, comprises the recommendations now in force; these were agreed by the XVIth Plenary Assembly of the C.C.I.F. held in Florence in 1951.

The psophometer is essentially a valve-voltmeter measuring the R.M.S. voltage of a complex audio frequency signal, and incorporating a frequency weighting network. A complex voltage is measured in terms of an equivalent single frequency signal which would produce the same subjective loudness when applied to a normal telephone line and receiver.

The use of the psophometer has extended in recent years from the function of power circuit noise interference measurement to the measurement of overall noise on transmission lines and equipment; applications are found in the acceptance testing of audio and carrier transmission equipment as well as in maintenance investigations. The instrument was intended originally to measure periodic voltages of constant amplitude such as would be induced from a power conductor, but a specification for the meter time-constant has allowed a limited application in the measurement of noises of varying intensity.

Two types of psophometer are in current use in the Post Office; both of these are battery operated, and the weighting networks and amplifiers are contained in separate boxes. It was considered desirable to develop a mains-operated psophometer which would be completely self-contained. Since it was found that psophometers were seldom used in locations at which there was no A.C. mains supply, and in view of the availability of the older designs, provision in the new design for battery operation as an alternative to mains operation was not warranted.

This article describes an experimental model, the principal features of which are:—

- a new method of input transformer screening which allows the C.C.I.F. specification in respect of input terminal symmetry to be met with an adequate margin,
- weighting networks designed by the insertion-loss synthesis technique, instead of, as formerly, by constant impedance section methods. The "flat" loss introduced by the networks is reduced, and a closer approximation to the specified weighting values is obtained,
- a low-pass filter with a nominal cut-off at 12 kc/s to reduce possible interference from carrier telephone frequencies,
- a push-pull amplifier circuit which minimises the effect of mains hum in the low-level part of the circuit,
- a new type of square-law meter circuit, depending on the multiplicative effect of two signals applied to

separate grids in a hexode valve of the frequency changer type. This circuit has the advantage over previous metal rectifier square-law circuits of being insensitive to ambient temperature changes and of not requiring the special selection of components. A zero setting adjustment is necessary.

## Outline of Circuit.

Fig. 1 shows the various units of the psophometer circuit. A pre-amplifier (Fig. 2) placed before the weighting net-

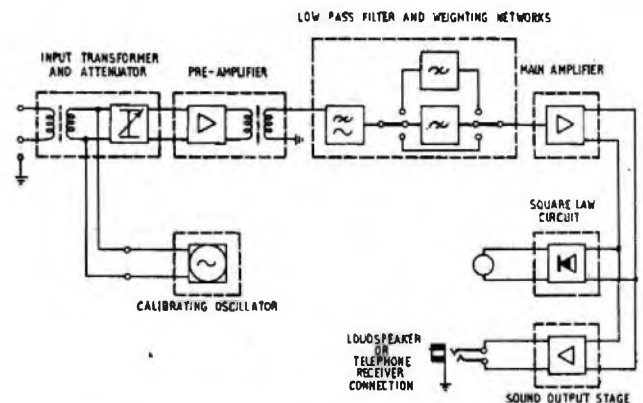

FIG. 1.—BLOCK SCHEMATIC DIAGRAM OF PSOPHOMETER.

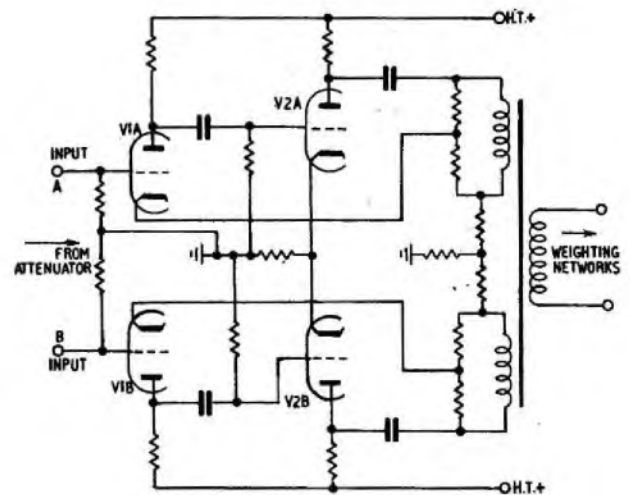

FIG. 2.—SIMPLIFIED CIRCUIT OF PRE-AMPLIFIER.

works provides a high input impedance and enables a constant generator impedance to be presented to the weighting networks. The use of a push-pull circuit overcomes mains hum trouble due to A.C. filament heating and eases the problem of eliminating regenerative coupling at sub-audio frequencies between the amplifier stages. A combination of voltage and current feedback maintains the correct output impedance by stabilising the effective A.C. resistance of the output valve. The pre-amplifier is followed by the low-pass filter and the weighting networks, a three-position switch selecting the required network, giving a "flat," "broadcast" or "telephone" characteristic.

†The authors are respectively Senior Executive Engineer and Assistant Engineer, P.O. Research Station.

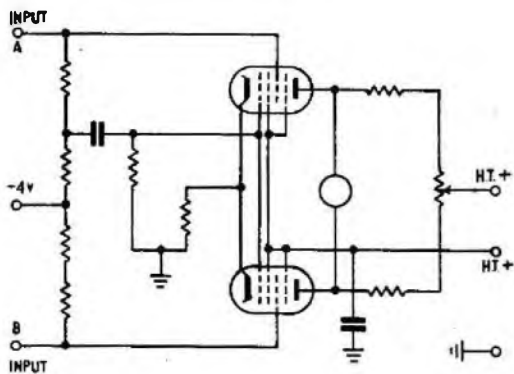

FIG. 3.—THE SQUARE-LAW METER CIRCUIT.

The three-stage main amplifier which follows employs three double-triode valves in a push-pull circuit and provides sufficient voltage gain to operate the square-law meter circuit (Fig. 3). The indicating instrument is a microammeter connected between the anodes of the square-law circuit hexode valves. A separate audio amplifier stage allows for loudspeaker or headphone monitoring without disturbance of the meter reading.

A double triode oscillator provides a calibration reference voltage. Good amplitude stability is obtained by deriving the grid bias from a gas-filled voltage reference tube. This voltage in conjunction with the large common cathode resistance accurately determines the limiting amplitude in the oscillator feedback loop.

A conventional mains-operated stabilised power supply is included. Special circuit features are dealt with in the following sections.

#### Input Transformer and Attenuator.

In order that accurate measurements may be made of the transverse voltage on well balanced lines in which there is a large induced longitudinal voltage, a very high degree

of input balance is required of the psophometer input transformer. The specified test is that an earth-connected generator of 10V at 800 c/s applied to the input terminals through separate 300 ohm resistors should not produce an effective transverse voltage of more than  $10^{-5}$  times its own value. Some difficulty had been experienced in previous psophometers in achieving this degree of balance and a different method of input transformer screening has been adopted in the new instrument. Fig. 4 contrasts the two methods of construction. The principal feature of the new design is that current cannot flow in the primary due to asymmetry in the distributed capacitance of the winding to a screen. Each half of the primary winding is contained in a separate screen with the screens connected to the respective ends of the windings. Provided that the screens are capacitively balanced to earth, the two halves of the primary winding and the screens will be at the same potential under the conditions of the symmetry test, and balance is therefore unaffected by inequality of inductance or of distributed capacitance in the two halves of the winding. A trimming capacitor is provided to allow an accurate adjustment of balance to be made.

The transformer screening is provided by concentric brass bobbins, on which an outer layer of copper foil is soldered. A saw-cut through each bobbin and a suitably positioned overlap of the outer foil prevents the screen forming a closed electric circuit. An input balance of  $4.5 \times 10^{-6}$  (ratio of effective transverse to longitudinal voltage) is obtained in practice at 800 c/s. Variation of the residual unbalance with frequency shows it to be almost entirely capacitive.

Owing to the steep upward slope of the lower portion of the attenuation-frequency response of the telephone weighting network, the effect of harmonic distortion of low audio frequencies in the psophometer is greatly accentuated, and care must be taken to ensure that such distortion is insufficient to produce any appreciable error. Ideally the input range attenuator should precede the input transformer to avoid transformer overload at low frequencies but it proved difficult to provide a practical design which would maintain the specified input balance on the lower voltage ranges. The attenuator has therefore been placed between the transformer and the pre-amplifier. No appreciable transformer overload occurs with transverse input voltages up to 1V.

Voltage ranges in decimal multiples of 1 and 3 have been found suitable, and the attenuator provides for full-scale deflections of from 100 mV to 1V in 9 steps. A separate attenuator preceding the input transformer is provided to allow the measurement of unbalanced inputs of up to 100V.

#### Weighting Networks.

The weighting network circuits are shown in Fig. 5, and the telephone weighting design function curve derived from the C.C.I.F. specification in Fig. 6. The networks are designed for an input circuit resistance of 1,500 ohms and

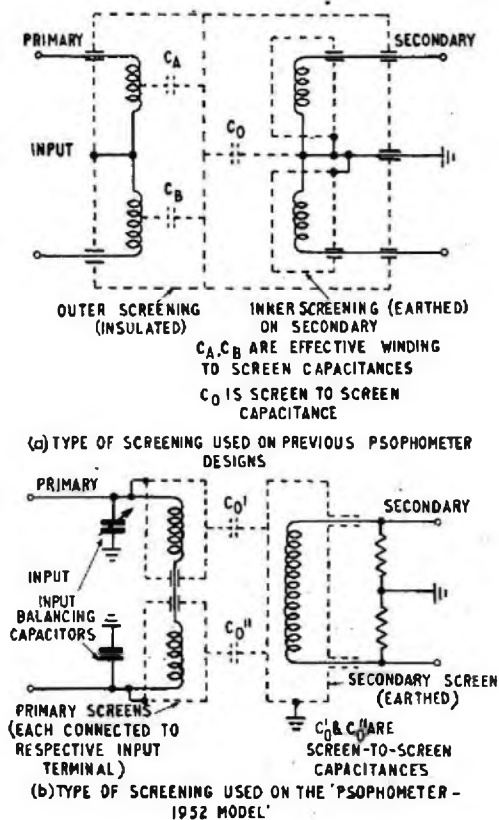

FIG. 4.—METHODS OF SCREENING INPUT TRANSFORMERS.

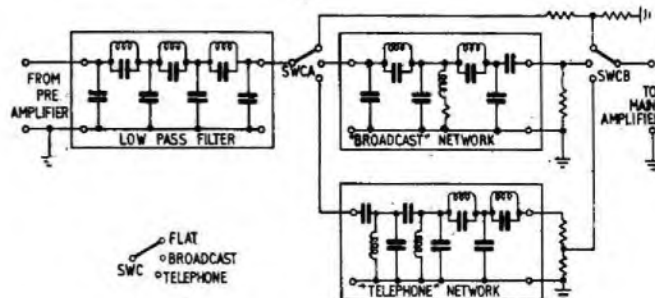

FIG. 5.—THE WEIGHTING NETWORKS AND LOW-PASS FILTER INTERCONNECTIONS.

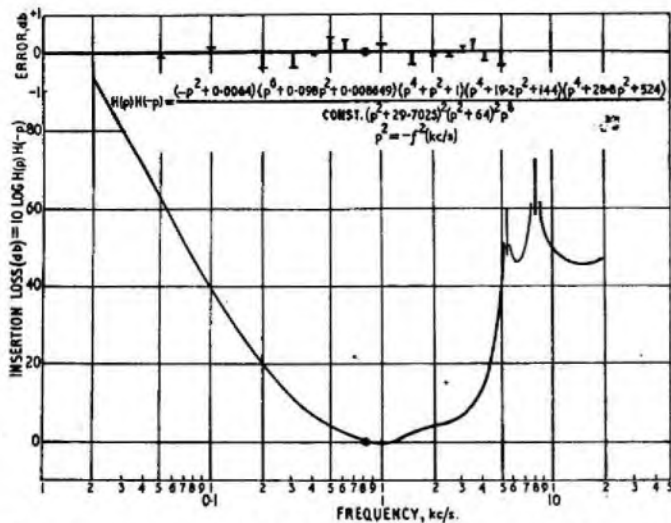

FIG. 6.—DESIGN CURVE FOR TELEPHONE WEIGHTING NETWORK.

an output resistance of 5,000 ohms. The method of determining an insertion loss function to fit a set of specified values and the synthesis of a network from this function has been described by Linke.<sup>1</sup>

#### Square-Law Circuit.

The square-law circuit uses two hexode valves in a manner suggested by Pierce.<sup>2</sup> In the valve used (CV 132) the mutual conductance between the control grid potential and anode current is closely a linear function of the oscillator grid potential over a suitable range of values.

In the circuit used, equal and opposite signal voltages are applied to the oscillator grids of a pair of CV 132 valves, and about half of one of these voltages is applied to the control grids in parallel. The following analysis shows the method of operation. Symbols for voltages and currents represent incremental changes from the "no-signal" values.

If  $i_{a1}$  and  $i_{a2}$  are the respective anode currents,  $g_{m1}$  and  $g_{m2}$  are the respective control grid/anode mutual conductances,  $e$  is the input signal voltage and  $k_1, k_2, \dots$  are constants, then:

$$\begin{aligned} i_{a1} &= k_1 g_{m1} e \\ i_{a2} &= k_1 g_{m2} e \end{aligned}$$

But  $g_{m1}$  and  $g_{m2}$  are linear functions of the voltages on the oscillator grids.

$$\begin{aligned} g_{m1} &= k_2 + k_3 e \\ g_{m2} &= k_2 - k_3 e \end{aligned}$$

Thus combining the two results,

$$\begin{aligned} i_{a1} &= k_1(k_2 + k_3 e) e \\ i_{a2} &= k_1(k_2 - k_3 e) e \\ \therefore i_{a1} - i_{a2} &= k_4 e^2 \end{aligned}$$

Thus the instantaneous difference between the two anode currents is proportional to the square of the signal voltage. A moving coil microammeter (150  $\mu$ A F.S.D.) is connected between the two anodes, so that the current flowing through it is proportional and nearly equal to  $i_{a1} - i_{a2}$ . Since the meter records the time average of the current passing through it (for audio frequency signals) the meter deflection is proportional to the mean square value of the signal voltage. The response of the square-law circuit is shown in Fig. 7. An input of about 5V (R.M.S.) is required for full-scale meter deflection. As the circuit is required to give a true R.M.S. reading on waveforms of large peak factor the provision of meter overload protection would be difficult, and an instrument has been obtained which is

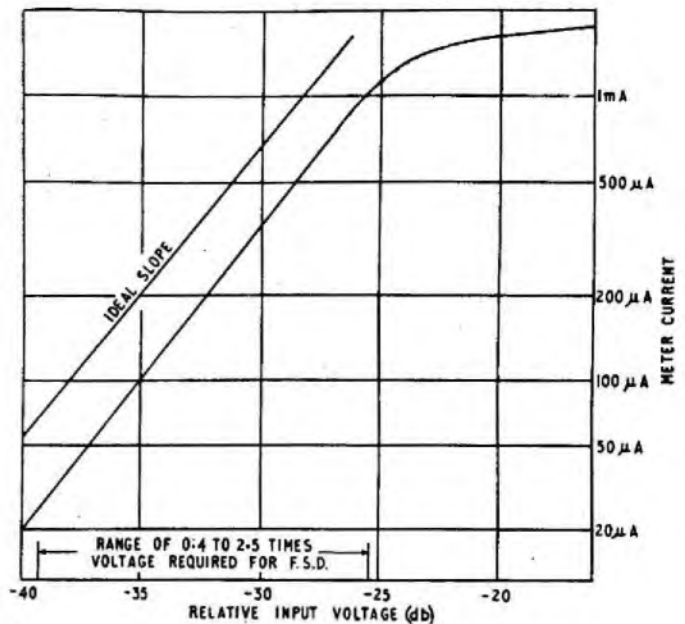

FIG. 7.—INPUT VOLTAGE/METER CURRENT CHARACTERISTIC OF SQUARE-LAW CIRCUIT FOR SINGLE FREQUENCY (1 KC/S) INPUT.

capable of withstanding an overload current of at least 30 times its F.S.D. current.

The meter time-constant and damping are within the C.C.I.F. specification; on a step input,\* 90 per cent. of the steady reading is reached in 170 milliseconds and the overshoot is 7 per cent.

#### Mechanical Construction.

The assembly consists of a front panel and two chassis mountings. One chassis holds the pre-amplifier, main amplifier and weighting networks, the other the square-law circuit, oscillator, audio stage and power unit. The front panel measures 19 in.  $\times$  10½ in. and the assembly is 10 in. deep.

#### Performance.

The instrument meets the C.C.I.F. specification in all respects. Space considerations preclude the reproduction of the specification; the main points covered are: accuracy of frequency weighting, a minimum value of input impedance, accuracy of square-law characteristic on peaky waveforms, input terminal symmetry and indifference to external fields.

The overall accuracy of voltage measurement is within 3 per cent. against the C.C.I.F. tolerance of 5 per cent.

#### Acknowledgment.

Acknowledgment is due to Dr. J. M. Linke and Mr. H. J. Orchard who undertook the synthesis of the frequency weighting networks.

#### References.

- <sup>1</sup> Linke, J. M. "Graphical Approach to the Synthesis of General Insertion Attenuation Functions," *Proc.I.E.E.*, 97, Pt. III, 1950, pp. 179-187.
- <sup>2</sup> Pierce, J. R. "A Proposed Wattmeter Using Multi-electrode Tubes," *Proc.I.R.E.*, 24, 1936, pp. 577-583.
- <sup>3</sup> Harbottle, H. R. "The Circuit Noise-Meter (Psophometer) and its Applications," *Journal I.E.E.*, 83, 1938, pp. 261-273.
- <sup>4</sup> Frost, P. B. and Gould, E. F. H. "Telephone Interference from Power Systems," *Journal I.E.E.*, 93, Pt. I, 1946, pp. 255-267.

\*An input signal consisting of a sinusoidal audio-frequency wave of constant amplitude, instantaneously applied.

# The New Midland Region Engineering Training School

U.D.C. 727:621.39

This article, which describes the new Midland Region Engineering Training School and the scope of the courses held there, is based on extracts from a description kindly supplied by Mr. O. D. Robinson, M.I.E.E.,† who played a leading part in the setting-up of the school. While the courses held are typical of similar schools throughout the country, this school is unique in being the first to be housed in accommodation designed and built specifically for a Post Office Engineering Training School.

## Introduction.

THE Central Training School of the Engineering Department has been described in a previous issue of the Journal\* and, since the school was opened in 1947, the range of its operations has become well known. Possibly less familiar, however, are the arrangements made at the Engineering Training Schools located in various parts of the country to cater, on a Regional basis, for a wide range of courses normally outside the scope of the Central Training School; for example, overhead and underground construction, subscribers' fitting and the training of Youths.

All other engineering training schools have had to be set up in accommodation which could be adapted for the purpose, but the new establishment at Shirley, Birmingham, which replaces various school premises scattered around Birmingham, was designed and built specifically as a training school. For this reason a description of some of its main features may be of interest. At the same time this article may serve as a reminder that the Regional Schools are an essential part of the Department's scheme of training, which must cater for advanced techniques such as television link maintenance as well as for the less technical but equally important tasks such as joint box construction.

The instruction given at the new school follows the same pattern as for other Regional schools and covers the subjects listed in the Appendix.

## The New School.

As will be seen from the general view of the school in Fig. 1, the building is of single-storied brick construction,



FIG. 1.—GENERAL VIEW OF SCHOOL PREMISES.

and presents an attractive appearance in its open situation. Internally, the brick walls are unplastered and treated with permanent colour-wash in pastel shades, with the object of giving cheerful surroundings which are considered to be conducive to better work. Fluorescent lighting of a warm shade is generally employed throughout the school, and has given entire satisfaction. Heating is by low-pressure, forced-circulation, hot water.

† Mr. Robinson was Regional Engineer, Midland Region, until his retirement early in 1953.

\* P.O.E.E.J., Vol. 40, p. 19.

Fig. 2 shows a simplified plan of the school buildings which comprise six lecture rooms, 13 rooms for practical work, a cinema, library, general offices, dining room, kitchen, and welfare and miscellaneous accommodation.

As the school is primarily intended to be used for instruction in certain aspects of telephone engineering, the cabling layout has been carefully arranged so that, by means of the M.D.F.s, distribution cases, cabinets, pillars, etc., provided, it is possible to reproduce at any point in the school the actual conditions which would occur in practice. In the fitting school, for example, completed work can be connected to an exchange test-desk and all the necessary tests for continuity, insulation, loop-resistance, etc., carried out. Similarly, working circuits can be supplied to jointers for "changing-over" purposes, and lines can be connected in advance for overhead parties so that on completion of their work they may ring through and obtain their "Slip Nos." as on "live" work.

The lecture rooms are well lighted and ventilated; they are equipped with the usual necessities and also with power points for operation of epidiascopes, and slide, film or film strip projectors as required. The rooms, together with the cinema, are used for all the courses described in the following paragraphs and, in addition, for courses which do not include practical work, such as those on organisation and supervision.

## Underground Courses.

The room for instruction in underground jointing is shown in Fig. 3. There are 12 surface-boxes built up from the ground instead of in it. The arrangement provides a compromise between doing the work under actual conditions and doing it in somewhat easier conditions to facilitate the acquisition of skill in jointing. Joints are first made on the superstructure above the chambers and then, when the method has been learned, on cables in the chambers themselves. In the illustration, joints are being made on the type of cable used for the transmission of television between London and Birmingham. M.D.F.s, a cabinet, D.P.s and pillars will be seen, and instruction in terminating cables on all these items is given. Along one side of the room are gas-heaters for use in pot-and-ladle plumbing instruction. These obviate the necessity for starting and using blow-lamps in the room—instruction on the handling and use of blowlamps is given in the open. Also outside are more joint-boxes, cabinets and pillars so that cabling and jointing under external conditions can be carried out. Particular attention is paid to methods of testing for explosive and asphyxiating gases. The Gas-leak Indicators Nos. 1 and 2 are meticulously explained and demonstrated and the necessity for their constant and invariable use is stressed. In fact, on all courses precaution against accidents is made a very prominent feature of the instruction.

## Overhead Courses.

The section of the school devoted to overhead work is also divided into two parts, one internal and the other external to the building. The main part is in the overhead construction park at the rear of the buildings. Work is normally carried out here, but there are occasions when bad weather

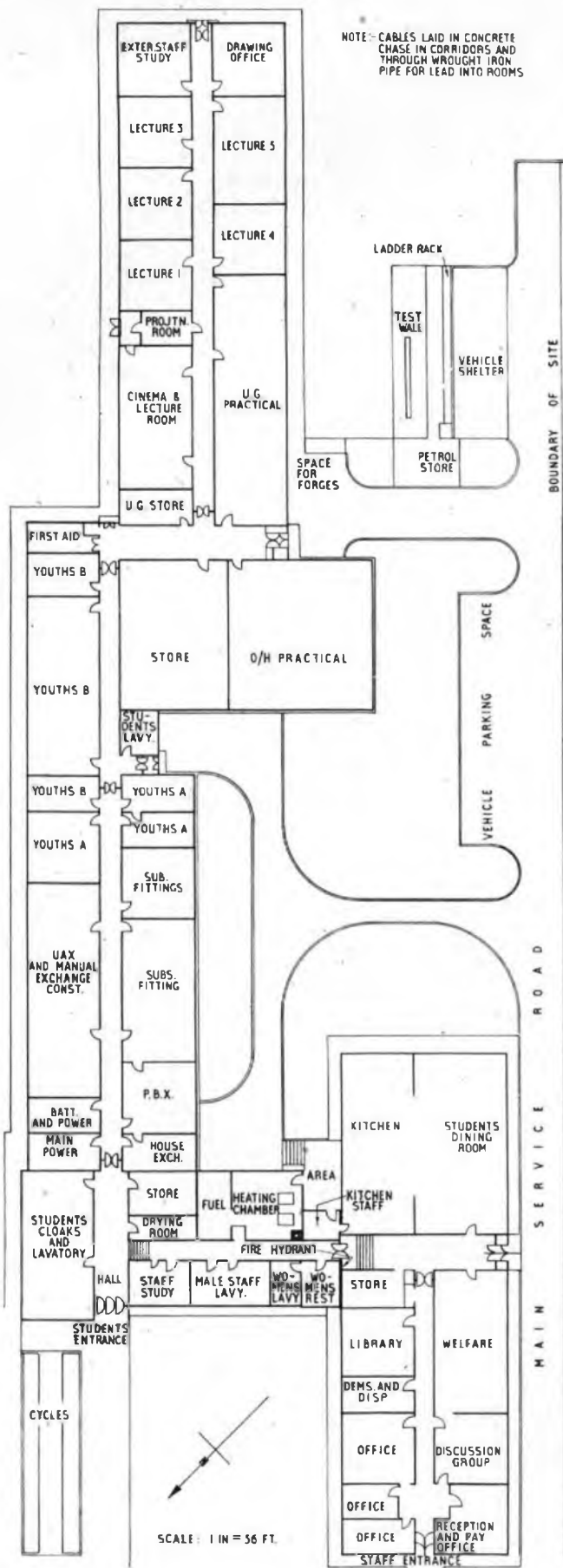

FIG. 2.—PLAN OF THE SCHOOL.



FIG. 3.—UNDERGROUND JOINTING ROOM.

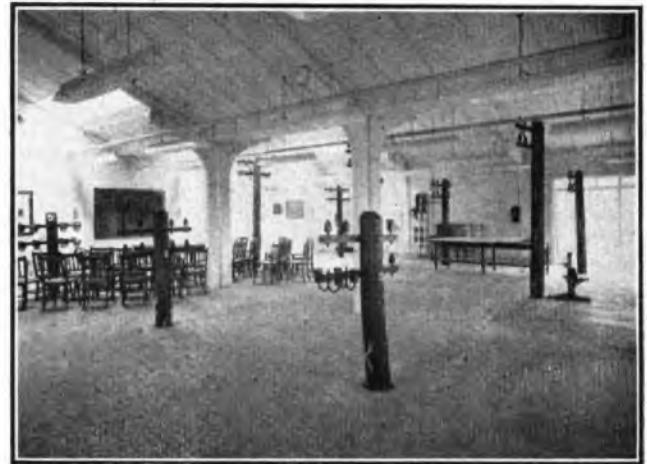

FIG. 4.—INDOOR ACCOMMODATION FOR O/H CONSTRUCTION.

makes this impossible, and an internal room has been provided so that instruction and practice in overhead construction can proceed as necessary. Fig. 4 shows this room. In the overhead school everything needed for the construction of overhead lines is taught. This includes the erection of poles by the bar and spoon, earth-auger, stepped-hole and derricking methods; arming with 8-way and 4-way arms, fitting arm braces and combiners; fitting ringhead D.P.s; running wires, binding-in and terminating; fitting stays and struts; drop-wire distribution, leading-in from open wires, fitting spindles and insulators.

In addition, specialist courses are carried out in this park. These include the practical side of survey officers' and routing officers' work; pole-testing for decay of poles *in situ*; the use of explosives for excavating pole holes and in underground construction; the various methods of erection of aerial cable, including that of lashing by cable-spinner. Here also are carried out experimental changes of practice on behalf of the Engineering Branch of the Regional Director's Office.

#### Internal Courses.

Courses are provided on subscribers' fitting; exchange construction, both U.A.X. and manual; relay adjustments; and instrument and call-office maintenance. Illustrations of the rooms devoted to all these courses would take up too much space so only two are included, namely, Fig. 5, showing one end of the exchange construction room, and Fig. 6, which is a plan of the lay-out of a typical room for subscribers' fitting.

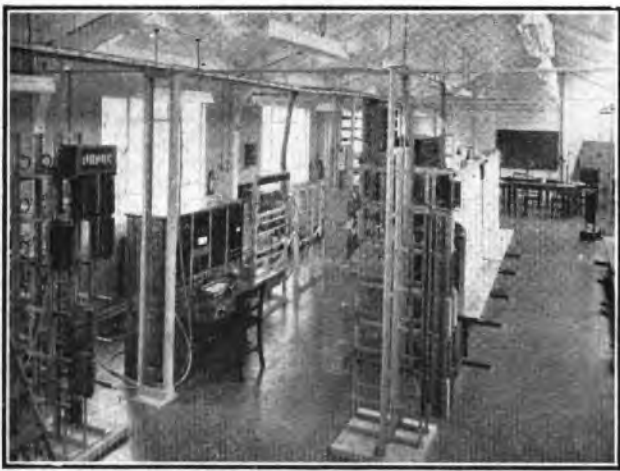

FIG. 5.—PART OF THE MANUAL EXCHANGE CONSTRUCTION ROOM.

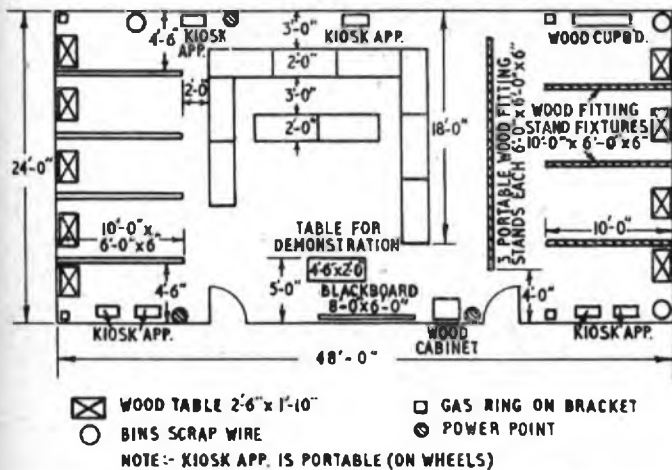

FIG. 6.—LAYOUT OF PRACTICAL ROOM (SUBSCRIBERS' APPARATUS FITTING).

The exchange construction room is designed for practice in cabling, forming and tagging on all kinds of exchange apparatus—M.D.F., I.D.F., jacks, tag-blocks, etc., and the complete job is taught here from lacing the cables in position, forming the strippers and skimmers, lacing the form, and bees-waxing, to soldering the individual wires to the apparatus. Facilities for complete continuity and insulation testing of finished work are provided. There is a modern test-desk from which tests as from an exchange are made to students on other courses in other parts of the building. For U.A.X. cabling, skeleton U.A.X.s have been provided and the whole installation of a U.A.X. is taught, including the power plant. For maintenance instruction, a complete U.A.X. is installed in one room exactly as it is in a standard building. It might be mentioned in this connection that a complete example of the wooden U.A.X. buildings has been erected in the school grounds for the instruction of Clerks of Works watching the erection by contract of this type of building.

The subscribers' fitting rooms (as typified by Fig. 6) are made so that men may work singly or in pairs as desired. Each man or pair can occupy a separate cubicle to reduce disturbance from other members of the class.

Instruction is given in all types of fitting, from the single exchange connection with one instrument, shared-service and plan numbers to the more complicated House-Exchange System. The walls of the cubicles are of wood to facilitate the rapid completion of the installation so that its operation

can be studied. Practice in fitting apparatus on various types of surface is provided by means of a special wall in the grounds which is surfaced variously in plaster, brick, cement, concrete, glazed-brick and tiles, etc., so that experience can be gained in any kind of surface likely to be met with in a subscriber's premises.

#### Youths Courses.

As is fairly well known, all youths are given an initial training course of a general introductory nature in which they are taught the rudiments of the arts they are to acquire more thoroughly at a later stage. For these preliminary, or "A", courses three rooms have been provided. They are equipped with simple apparatus and samples of cables and wires in everyday use.

The Youths "B" courses are for those who show potentialities for the more skilled and intricate work such as auto-exchange and repeater station maintenance. Here again the equipment is not specialised, but of a general nature, and use is made of equipment in other rooms when required.

#### Welfare and Catering Accommodation.

The welfare accommodation, which has been carefully planned to provide the amenities expected in a modern training establishment, includes adequate cloakrooms, first-aid and rest rooms, clothes-drying room, car park, cycle sheds and a students' lounge.

The dining room seats 100 at a time, and is supplied from kitchens equipped with the most modern labour-saving devices for the preparation of food.

#### Conclusion.

The Midland Region Engineering Training School was first occupied in April, 1952, and is now in full operation. It is confidently anticipated that the accommodation provided will prove to be quite adequate to cover the Regional training requirements for many years to come without the necessity for any major alterations to the premises.

#### APPENDIX

##### Courses normally available at Regional Schools.

- Youths-in-Training : General instruction (preliminary).
- Youths-in-Training : General instruction (advanced).
- Exchange Construction (Manual).
- Exchange Construction (Auto) (U.A.X. 12 and 13).
- Subscribers' Installation (Gang fitting work).
- Subscribers' Installation (Initial).
- Subscribers' Installation (Intermediate).
- Subscribers' Installation (Advanced).
- Subscribers' Installation (House exchange system).
- Relay adjustments 3,000-, 600- and 500-types.
- Single instrument and Plan No. extension working (Maintenance).
- Overhead Construction (Initial).
- Overhead Construction (Advanced)
- Routine Testing of poles.
- Survey officers' work.
- Routing officers' work.
- Local Line Planning (Preliminary).
- Underground Construction (Initial).
- Underground Construction (Advanced).
- Coaxial Cable Jointing.
- Coaxial Cable Jointing (Refresher).
- Fault locating in U.G. cables (Local).
- Joint-box building.
- Basic Transmission (Preliminary).
- Stamp-selling machines and scales.
- Call office maintenance.
- Organisation and supervision.

# The Birmingham-Manchester-Holme-Moss Television-Cable System †

R. J. HALSEY, B.Sc., M.I.E.E.,  
and H. WILLIAMS, A.C.G.I., M.I.E.E.

## Part 1.—Transmission Requirements, General Design Considerations and Cable Characteristics

U.D.C. 621.397.242:621.396.65

The television transmitter at Holme Moss is connected to Birmingham by a two-way transmission system on standard  $\frac{3}{8}$ -in. diameter coaxial cable and thence to London via the earlier system on 1-in. coaxial cable. The new link is the first to be based on the recommendations of the C.C.I.F. for the transmission of television signals within the frequency band 60–4,000 kc/s, approximately, as an alternative to 960 telephone channels.

Part 1 of the article describing this system deals mainly with the transmission requirements based on provisional C.C.I.F. recommendations and target specifications agreed between the Post Office and the B.B.C., the general design considerations which arose, and the characteristics required of the cable. The H.F. line system and frequency-translating equipment will be described in Part 2 which includes details of the overall performance obtained.

### INTRODUCTION

IT is the responsibility of the Post Office to provide the network of point-to-point television links required in the B.B.C. plan for connecting the television transmitters to the programme control centres. No standard method of provision has yet been adopted; Birmingham and London were initially connected by a radio-relay system operating at about 900 Mc/s<sup>1</sup> and subsequently by a system on 0.975-in. coaxial-cable pairs operating in the frequency range 3–7 Mc/s;<sup>2</sup> another radio-relay system using frequencies of about 4,000 Mc/s has recently been installed between Manchester and the Scottish transmitter at Kirk o' Shotts. For the Birmingham-Manchester-Holme-Moss link the television signals are transmitted over  $\frac{3}{8}$ -in. coaxial pairs of the type standardised for multi-channel telephony; the London-Wenvoe link has been provided in a similar manner and with equipment which is technically identical.

From the inception of wide-band transmission on coaxial-pair cables the Post Office has borne in mind the use of such plant for the transmission of television signals.<sup>3</sup> The use of a common type of plant for both telephony and television results in much greater flexibility, common specifications and certain economic advantages. Internationally, study of the problem commenced in 1938 when questions were initiated by the 3rd Study Group of the *Comité Consultatif International Téléphonique* (C.C.I.F.).<sup>4</sup> These studies were dropped during the 1939–45 War but were subsequently restarted with the result that, in 1946 at Montreux, a specification for the performance of a high-frequency system for  $\frac{3}{8}$ -in. coaxial-pair cables was agreed.<sup>5</sup> The recommendations recognised that, provided certain precautions unnecessary for telephony were taken in the manufacture of the plant, the future European coaxial-cable network would be suitable for the transmission of television signals of 3,000-kc/s video bandwidth; this is appropriate to the standards adopted in the United Kingdom. Considerable attention has been given to the problem since this date, although very little change is to be seen in the current C.C.I.F. recommendations.<sup>6,7</sup>

The standard foreseen for international telephony<sup>8</sup> is a 16-supergroup (960-circuit) system transmitted over  $\frac{3}{8}$ -in. coaxial pairs in the frequency band 60–4,028 kc/s, with line pilots at 60 (or 308) and 4,092 kc/s; the repeater-station spacing will not exceed 10 km (6.2 miles). This is suitable for transmission of the 3,000-kc/s video signals, the requirements for which do not affect in any major sense the spacing of repeater stations, although correction of delay distortion

and more accurate correction of attenuation distortion (involving greater attenuation of echoes) are essential. In order to provide for the transmission of a 3,000-kc/s video signal it has proved desirable, however, to increase the frequency of the upper line pilot to 4,340 kc/s. It may well be that, in a few years' time, it will prove practicable and economic to use the same line amplifiers for the two purposes. For the routes now being considered, however, this is not economic.

The prototype system of telephony at present used in the United Kingdom<sup>9</sup> provides 10 supergroups on  $\frac{3}{8}$ -in. coaxial pairs, with a maximum repeater spacing of 6 miles. The transmission band on the cable is 60–2,852 kc/s, and the line amplifiers have a uniform gain of 48 db. over this range, being preceded by appropriate line-attenuation equalisers. In this system the line amplifiers are conveniently arranged with three valve stages and overall negative feedback. Increasing the highest transmitted frequency from 2,852 to 4,340 kc/s has necessitated increasing the number of valve stages, but more recent developments point the way to the design of a more economical line amplifier which will be suitable for either telephony or television.

In order to accommodate the 3,000-kc/s video band within the transmission band available, it is essential to use an asymmetric-sideband system of modulation; there is insufficient bandwidth for both sidebands and a single-sideband system is technically impracticable. The C.C.I.F. makes no detailed recommendations in this respect in its earlier specifications but has lately recommended<sup>10</sup> a carrier frequency of 1,056 kc/s, which is the same as that already adopted by the British Post Office and here described. In the United States, a system for the transmission of television signals, having a video bandwidth of 2,800 kc/s, over  $\frac{3}{8}$ -in. coaxial-cable pairs has been standardised.<sup>11</sup> In this, the signals are transmitted as the upper sideband and vestigial lower-sideband of a 311-kc/s carrier, the frequency range involved being 200–3,111 kc/s. The Birmingham-Manchester system was the first commercial link in the world to be based on the C.C.I.F. specification.

### OVERALL TRANSMISSION REQUIREMENTS

#### *Provisional C.C.I.F. Recommendations.*

The C.C.I.F. has made some provisional recommendations in respect of the overall transmission requirements for television signals; although it is not specifically stated, these may be presumed to apply to a single link of 1,000 km.

*Band of frequencies effectively transmitted.*—A frequency is said to be effectively transmitted if the following limits are observed:

- (a) Between 30 c/s and 200 kc/s, the phase/frequency characteristic does not depart by more than  $\pm 6^\circ$  from a straight line having a zero-frequency intercept of zero or an integral multiple of  $180^\circ$  ‡

† This article is a shortened version of the paper of the same title presented at the I.E.E. Television Convention in 1952. Permission to reprint in this form is gratefully acknowledged to the Institution of Electrical Engineers.

\* The line equipment described in Reference 9 was designed for 11 supergroups, but only 10 are equipped.

‡ If the integer is odd the signal will be inverted so that this condition is not really acceptable.

<sup>1</sup> For references see end of article.



- (b) Above 200 kc/s the group delay is uniform within  $\pm 0.1$  microsec.  
 (c) The gain/frequency characteristic is uniform within about  $\pm 2$  db.

The recommendations state that, on  $\frac{3}{8}$ -in. coaxial-cable pairs, it is probable that the band of frequencies so transmitted will be from about 30 c/s to about 3,000 kc/s.

*Difference between propagation times of vision and sound.*—The difference between the minimum group-delays on the two channels should not exceed 0.1 sec., but this is considered to be so large that it will not impose a limitation in practice.

*Signal/noise ratio.*—The minimum acceptable ratios between the peak-to-peak voltage of the picture signal (excluding synchronising pulses) and the peak-to-peak voltage of the noise are:

- (a) For sporadic impulse noise, 30 db.  
 (b) For continuous random noise, 35 db.  
 (c) For pattern noise, 50 db.

*Crosstalk.*—Expressed in the same manner as for noise interference, the crosstalk interference from another system (television or telephony) should not be worse than 50 db.

*Non-linear distortion.*—This should be negligible for variations in the signal amplitude of at least 45 db.

#### *Transmission Performance agreed between the B.B.C. and the Post Office.*

In the present state of the art it seems unlikely that the C.C.I.F. recommendations, particularly in respect of group-delay distortion, can be met for a chain of separately equalised links. A review of known information has led to the specification of a required transmission performance based on the assumption that up to four long-distance links, totalling about 500 miles, may be used in tandem connections. It is not yet practicable to specify rigidly all of the transmission characteristics of a single link, but Table 1 gives the overall video-to-video target values and tolerances for a four-link network which have been jointly laid down by the B.B.C. and the Post Office.

TABLE 1  
*Attenuation/Frequency Characteristic*

Frequency	Attenuation limits relative to 0 db. at 100 kc/s
kc/s	db.
Up to 500	$\pm 1$
500–1,000	Increasing linearly from $\pm 1$ to $\pm 1.5$
1,000–2,800	Increasing linearly from $\pm 1.5$ to $\pm 2.5$

The network should also provide significant transmission at 3,000 kc/s.

*Phase/frequency characteristic.*—From 50 c/s to 200 kc/s, the phase/frequency characteristic should not deviate by more than  $\pm 6^\circ$  from a straight line having a zero-frequency intercept of zero or an integral multiple of  $360^\circ$ .

From 200 kc/s upwards, the group delay measured with a modulating frequency of 100 kc/s should not exceed the limits given in Table 2.

TABLE 2

Frequency	Group delay limits relative to 0 $\mu$ S at 200 kc/s
kc/s	$\mu$ S
200–2,000	$\pm 0.15$
2,000–2,500	$\pm 0.25$
2,500–2,800	$\pm 0.5$

The characteristic should not show sudden excursions between these limits.

*Transient response.*—The response to a step waveform having a 10-90 per cent. rise-time not greater than 0.05

microsec. should have a rise-time not exceeding 0.16 microsec. Limits for other features (e.g. overshoot and ringing) of the response have not been specified in view of the probable adoption of the "sine-squared" pulse as a test-signal for indicating the waveform distortion which corresponds to attenuation and phase distortion in the upper part of the frequency range.

*Linearity.*—The amplitudes of synchronising pulses should remain between +10 per cent. and -30 per cent. of their nominal value with any variations of picture content of the video signal. These are provisional limits which take into account the possibility of reshaping synchronising pulses at the broadcasting transmitters.

For the picture signals, the value of gamma should not vary beyond the limits 0.9 to 1.1.

*Signal/noise ratio.*—Expressing the signal/noise ratio in decibels corresponding to the ratio of the peak-to-peak voltage of the picture signal (excluding synchronising pulses) to the peak-to-peak voltage of the noise, the minimum values should be 35 db. for uniform-spectrum random noise, 27 db. for random noise having a non-uniform spectrum of the type occurring in a frequency-modulation system (a limit of this order also applies to noise of the type occurring in the cable link described) and 50 db. for periodic noise.

It is appreciated by all concerned that these requirements are very severe and that the best available techniques may be inadequate to ensure that they are met fully. Moreover, it is recognised that the specification is incomplete in that it does not, as it stands, ensure the satisfactory transmission of the signals. The ultimate criterion must be a subjective appraisal of picture quality, and the finer points in the transmission requirements are undefined—and probably undefinable—at present.

#### GENERAL CONSIDERATIONS IN DESIGN

##### *Facilities Required.*

The specific requirement covered in this article was for a link giving simultaneous two-way transmission between B.B.C. premises at Birmingham (Broad Street) and Manchester (Piccadilly) and thence to the transmitting station at Holme Moss, some 18 miles east of Manchester. The Manchester office functions as a switching centre controlling distribution to Holme Moss and links going north; in addition it controls outside broadcasts from the Manchester area.

##### *Method of Provision.*

At the inception of the scheme, a cable with four  $\frac{3}{8}$ -in. coaxial pairs was about to be laid between Birmingham and Manchester for telephony, and it was possible to increase the number of pairs to six to cover the television requirement at a relatively small increase in cost. Similarly it was possible to include extra coaxial pairs in a new Manchester-Sheffield cable along the greater portion of the Manchester-Holme Moss route, only the last few miles being required as a separate project. The integration of telephony and television requirements led to the adoption of the cable scheme as being cheaper than radio relay for providing the television link.

##### *Design Problems.*

In the asymmetric-sideband system, which is necessary to preserve the low-frequency video response, frequencies near the carrier are transmitted as both upper and lower sidebands, suitably proportioned and tapering to normal single-sideband transmission for video frequencies above about 500 kc/s. In order to avoid direct break-through of the video frequencies it is necessary to employ double modulation in the frequency-translating equipment.

Owing to the stringent requirements in respect of delay

distortion it is necessary for the carrier frequency to be transmitted over the system, although a measure of selective amplification of the carrier at the receiving terminal would be permissible. The choice of an erect or inverted sideband (i.e. with the carrier near the lower or upper end respectively) depends on the following arguments:

- The effect of random noise on the picture is greater at low frequencies than at high frequencies. Less low-frequency noise is therefore contributed by the line if the sideband is erect and if rising-gain amplifiers are used instead of conventional attenuation equalisers and flat-gain amplifiers.
- If an erect sideband is transmitted, harmonics of the carrier, generated by non-linearity in the frequency-translating equipment or line equipment, will fall within the sideband and, if of sufficient amplitude, will lead to periodic interference in the picture.
- From a wider point of view than the present project, an erect-sideband system would be usable, without modification, on an H.F.-line system of more restricted bandwidth.

On balance the argument is in favour of erect-sideband transmission with a high degree of linearity to minimise the generation of carrier harmonics.\* After discussions with the Post Office a contractor produced frequency-translating equipment of this type, using a carrier frequency of 1,056 kc/s† and a transmission band 500-4,056 kc/s; this equipment has been provisionally adopted as standard.

The television links provided and projected for the B.B.C. are diverse in character, and there is no prospect at present of making tandem connections except at video frequencies. Since the frequency-translating equipments introduce significant amounts of distortion, the permissible distortion in the H.F.-line systems or radio-relay systems is correspondingly reduced.

The above considerations, together with the agreed specification for overall performance and some supplementary subjective tests carried out by the Post Office, determined the performance requirements for the line amplifiers; these requirements represent a very high technical standard.

It has been noted that rising-gain amplifiers are an important feature of an erect-sideband system of transmission, and in order to standardise the design they are arranged to compensate for exactly six miles of cable. Any mileage deficiency between repeater stations is corrected by the addition of cable-simulating networks.

A requirement for the transmission of television signals, which is non-existent for telephony, is that short echoes, such as might arise from reflections within a repeater section, shall be highly attenuated. This necessitates both a high degree of uniformity of the cable, including joints, and high return-losses between the cable and the amplifiers. Previous amplifiers designed for telephony only have a very low return-loss at the output, although that at the input is relatively high by virtue of the constant-impedance line equaliser which precedes the amplifier proper.

It was found that the new line amplifiers could not be constructed within the physical dimensions of the standard amplifiers used for telephony and so some rearrangement of coaxial-line and control bays was necessary although most of the standard auxiliary equipment was retained. Line pilots of 308 and 4,340 kc/s were adopted, the former controlling the overall gain and the change-over to reserve line amplifiers when the normal amplifiers fail; the difference between the levels of the two pilots at the receiving terminal determines the insertion of temperature equalisers.

\* The later developments previously referred to may make an inverted-sideband transmission the more desirable.

† This frequency lies midway between the 812-1,052 kc/s and 1,060-1,300-kc/s supergroups used for telephony.

### Type.

The signals are transmitted on coaxial pairs which are identical with those already standardised for wide-band carrier telephony. For the majority of the way between Birmingham and Holme Moss the cable consists of six 0.375-in. coaxial pairs around which are laid four layers of normal audio-frequency quads. In addition there are 32 audio-frequency pairs in the interstices of the coaxial pairs; some of these interstice pairs are used for control purposes.

For the transmission of the television signals two coaxial pairs are used, one in each direction; the remaining four coaxial pairs have been equipped to carry standard 600-circuit carrier systems. The enclosure of the six coaxial pairs and the 376 audio-frequency pairs under the one lead sheath enables maximum use to be made of a single duct.

### Electrical Characteristics.

The coaxial pairs have characteristic impedances well within the specification limit of  $75 \pm 1$  ohms at 2,500 kc/s. The measured attenuation/frequency characteristics are very uniform and are shown typically in Fig. 1 for a temperature of 10°C. The dielectric losses are negligible, and,

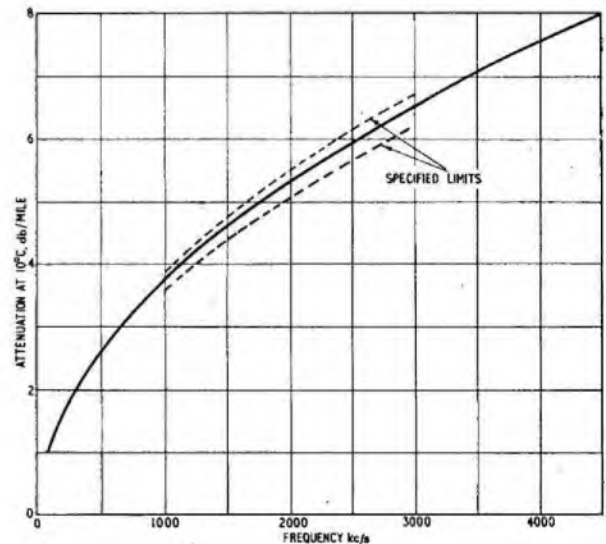

FIG. 1.—BIRMINGHAM-MANCHESTER COAXIAL CABLE; TYPICAL ATTENUATION/FREQUENCY CHARACTERISTIC.

for the purpose of line-amplifier design, the attenuation was assumed to have a maximum value of  $4.01\sqrt{f}$  db./mile at the highest cable temperature (22°C) where  $f$  is in megacycles per second. The group delay is shown in Fig. 2.

The insulation resistance exceeds 5,000 megohm-miles at 20°C and the pairs are capable of withstanding an R.M.S. alternating voltage of 2,000V applied for two minutes.

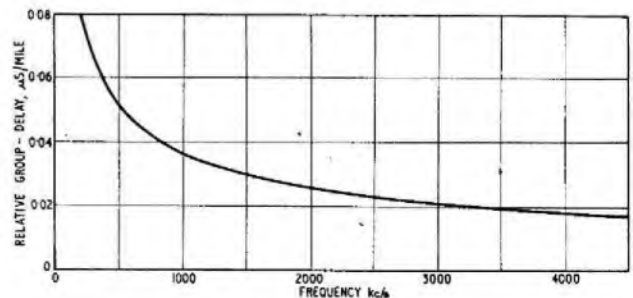

FIG. 2.—BIRMINGHAM-MANCHESTER COAXIAL CABLE; GROUP DELAY RELATIVE TO ASYMPTOTIC VALUE. (5.58 microseconds/mile = 179,500 miles/sec.)

## Joints.

The cable was drawn into the ducts in standard 176-yd. lengths. During manufacture it was carefully graded to minimise impedance changes between adjacent lengths, and the joints are so proportioned as to have the same impedance as the coaxial pairs. Tests taken on each repeater section indicate that a very close limit on the impedance irregularities has been maintained. Fig. 3 shows a typical

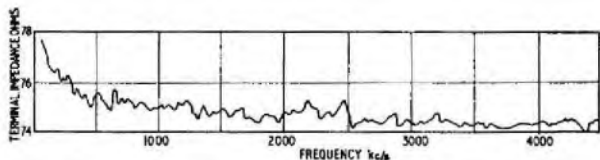

FIG. 3.—BIRMINGHAM-MANCHESTER COAXIAL CABLE; TYPICAL IMPEDANCE/FREQUENCY CHARACTERISTIC. (Pair 1. Maximum Deviation from Smooth Mean Curve Equals 0.8%.)

impedance/frequency characteristic for a repeater section, the specified maximum impedance deviation from a mean smooth curve being 3 per cent. Measured by a pulse-reflection method in which D.C. pulses of 0.1-microsec. duration are applied to the end of the repeater section, the return loss at the joints is of the order of 70 db.; this results from small errors in joint dimensions and impedance mismatch between adjacent lengths.

## Seventh Plenary Meeting of the C.C.I.T., Arnhem, 1953

U.D.C. 061.3:621.394

### Introduction.

IN May of this year representatives of some 31 countries assembled at Arnhem, Holland, for the Seventh Plenary Meeting of the International Telegraph Consultative Committee (C.C.I.T.). The C.C.I.T., as an international body, is relatively small—the total number of delegates, representatives and officials attending the meeting was not more than about 250—and it was thus possible for the Netherlands Administration to arrange adequate accommodation for the conference in this pleasant provincial town. Although Arnhem, scene of the airborne invasion in 1944, suffered extensive damage during the ensuing battle, considerable progress has been made with the work of reconstruction. The town, which is somewhat in the nature of a tourist centre for the surrounding country, is, for its size, very well supplied with amenities and it proved to be an excellent choice of venue for the conference.

The Sixth Plenary Meeting of the C.C.I.T. was held at Brussels in 1948.<sup>1</sup> The Seventh Plenary Meeting was due to be held in 1951, but it was decided to postpone this meeting, its place being taken by meetings of most of the constituent Study Groups at Geneva in 1951.<sup>2</sup> By a special arrangement, approved by the Administrative Council, the Study Groups were empowered to issue "provisional recommendations" or alternatively "draft recommendations," which would achieve the status of provisional recommendations if not objected to by any of the Administrations concerned in the C.C.I.T. This procedure was adopted so as to give point to the work of the Study Groups and minimise the effect of the two years delay due to the postponement of the plenary meeting. In the event the innovation proved to be of great use in crystallising the position on a number of questions and it considerably facilitated the work of the Study Groups at Arnhem where time was somewhat limited.

The Arnhem meeting was the first plenary meeting of the C.C.I.T. to be held under its revised rules of procedure, adopted at Brussels, following on the Atlantic City Convention. In the past the conference has opened with a

### References.

1. Clayton, R. J., Espley, D. C., Griffiths, G. W. S., and Pinkham, J. M. C. "The London-Birmingham Television Radio-Relay Link," *Proceedings I.E.E.*, 1951, 98, Part I, p. 204.
2. Kilvington, T., Laver, F. J. M., and Stanesby, H. "The London-Birmingham Television-Cable System," *ibid.*, 1952, 99, Part I, p. 44.
3. Mumford, A. H. "The London-Birmingham Coaxial Cable System," *P.O.E.E.J.*, 1937-8, 30, pp. 206 and 270; 1938-9, 31, pp. 51 and 132.
4. Comité Consultatif International Téléphonique (C.C.I.F.). Réunions d'Oslo, 1938, 1, p. 165.
5. C.C.I.F. Programme général d'interconnexion téléphonique en Europe, Montreux, 1946, p. 129.
6. C.C.I.F. Programme général d'interconnexion en Europe et dans le Bassin Méditerranéen, Florence, 1951, p. 145.
7. C.C.I.F. XVI<sup>e</sup> Assemblée Plénière, Florence, 1951, *Tome 3bis*, p. 167.
8. *Ibid.*, p. 114.
9. Brockbank, R. A., and Floyd, C. F. "The Unit Bay 1B Coaxial Cable Transmission System," *P.O.E.E.J.*, 1945-6, 38, pp. 43 and 82; 1946-7, 39, pp. 14 and 64.
10. C.C.I.F. XVI<sup>e</sup> Assemblée Plénière, Florence, 1951, *Tome 3bis*, p. 174.
11. Morrison, L. W. "Television Terminals for Coaxial Systems," *Transactions of the American I.E.E.*, 1949, 68, p. 1193.

(To be continued.)

plenary assembly which then broke up into separate committees for specialised subjects and was only re-united for ratification of the various recommendations and resolutions towards the end of the conference. This permitted meetings of the technical commissions to continue almost throughout the whole period of the meeting, administrative and general questions being dealt with simultaneously in other special commissions or in meetings of the Heads of Delegations. Under the revised rules the Study Groups set up at the previous Plenary Meeting, hold preparatory meetings immediately prior to the next Plenary Meeting, and prepare reports and recommendations for presentation to the Plenary Assembly. The Plenary Assembly has also to deal with any other matters of general or administrative interest. Amongst the questions of this character to be dealt with at Arnhem was the very important one of the possible fusion of the C.C.I.T. and the C.C.I.F. It was inevitable that with such a vital question on its agenda the period allocated to sessions of the plenary assembly had to be more extended than would otherwise have been necessary and seven out of the sixteen working days available had to be reserved accordingly. Nevertheless by dint of great pressure good progress was made on technical matters during the remaining available days and much of the work on which the Study Groups had been engaged since the Brussels meeting was brought to a satisfactory conclusion.

### Technical Discussion.

Among the technical matters on which agreement was reached was an extension and revision of the definitions relating to telegraph transmission and signal distortion to take into account new ideas mainly arising from the wider use of teleprinter switching systems. A large number of new recommendations and improvements to current recommendations relating to the standardisation, operation and maintenance of voice-frequency telegraph channels and of start-stop regenerative repeaters were agreed. Recommendations were also issued on points regarding the operation of teleprinters, on the code used (Telegraph Alphabet No. 2), and on the use of teleprinters in inter-continental

<sup>1</sup> *P.O.E.E.J.*, Vol. 41, p. 68.

<sup>2</sup> *P.O.E.E.J.*, Vol. 44, p. 86.

relations. Agreement was reached on several important points of principle affecting the interworking between national teleprinter switching networks in the international telex service. In respect of phototelegraphy opportunity was taken to hold a meeting of the joint C.C.I.T./C.C.I.R. Study Group for phototelegraphy and agreement was reached regarding standards applicable to the extra-European field. Discussions took place and agreement was reached on problems associated with the facsimile transmission of large weather charts, the advice of the C.C.I.T. on this subject having been sought by the World Meteorological Organisation. The use of direct recording facsimile equipment for the transmission of telegrams and business documents in general was also reviewed. Other matters dealt with by the Study Groups were the revision and improvement of the regulations covering the international telex service, revision of operating methods in the public service, means of speeding the transmission of international telegrams, utilisation of emergency routings, questions related to the specialised leased telegraph networks employed in the international aeronautical services, and rationalisation and definition of telegraph terms and graphical symbols.

#### *General Discussion.*

General questions dealt with by the Plenary Assembly included one related to the methods whereby the C.C.I.T. could contribute to the general programme of technical assistance to underdeveloped countries. It was agreed that future publications and recommendations should be drawn up with a view to making them as educative as possible. Of interest in this connection was a decision to revise the numbering and classification of current recommendations to facilitate reference. Coupled with this the Plenary Assembly set the Study Groups the somewhat formidable task of revising and unifying the texts of all recommendations issued before the Seventh Plenary Assembly.

#### *Discussion on Fusion of C.C.I.T. and C.C.I.F.*

Overshadowing all else in the deliberations of the Plenary Assembly was the question of the possible fusion of the C.C.I.T. and C.C.I.F. This question had been raised at the Plenipotentiary Conference at Buenos Aires in 1952 and the Plenary Assemblies of the C.C.I.T. and C.C.I.F. (International Telephone Consultative Committee) were asked to give the matter detailed consideration and formulate appropriate recommendations for submission to the next Administrative Telegraph and Telephone Conference. At the same time the Administrative Telegraph and Telephone Conference was authorised to approve the amalgamation of the C.C.I.T. and the C.C.I.F. into one permanent organ of the Union, should it judge this course to be in the best interests of the Union as a whole.

In coming to this decision the Conference was to be guided by the recommendations made by the C.C.I.T. and the C.C.I.F. The proposal before the Plenipotentiary Conference was made with a view to simplifying so far as possible the organisation and working methods of the C.C.I.s with a view to securing increased efficiency and realising financial savings. Supporters of the proposition also claimed that many technical problems are now common to the telegraph and telephone services and are frequently dealt with by the same experts, and therefore amalgamation of the two Committees would make it possible to reduce the number of meetings, and economies would be effected by reducing the number of journeys made by experts actively concerned in the work of both Committees. Discussions at Arnhem ranged over a wide field and views expressed showed a fairly evenly divided body of opinion for and against amalgamation. Two committees were set up, one to consider in detail the question as to how far the work of the

Study Groups of the C.C.I.T. overlapped that of the Study Groups of the C.C.I.F., and the other to consider the financial aspects of amalgamation. The committee dealing with the Study Groups reported that almost without exception the activities of the C.C.I.T. Study Groups were so specialised that whatever re-organisation was brought into effect, they would need to retain their individual character. The second committee dealing with the question of the structure and cost of a unified Directorate and specialised Secretariat reported that amalgamation was likely to have very little effect on the total expenses concerned. With these reports before them, together with a note by the Interim Director of the C.C.I.T. indicating that even if amalgamation were carried into effect it appeared that entirely separate meetings could be held to deal with purely telegraph and purely telephone matters, the Plenary Assembly proceeded to discuss the formulation of a recommendation for submission to the Administrative Conference. From the views expressed it was clear that little change had occurred in the attitude of the various Administrations and as a first step a vote was taken on the principle of amalgamation, 13 countries voting in favour, 15 against. The proposal in favour of the principle of amalgamation having been defeated, the plenary assembly then proceeded to vote on separate points as to the procedure if amalgamation were in fact carried into effect. A resolution was finally passed by 17 votes in favour with 10 votes against, stating that it would not be in the best interests of the Union that the C.C.I.T. and C.C.I.F. should be amalgamated; that, subject to approval at the appropriate stage by the Administrative Council, the amalgamation, if effected, should be carried out in accordance with the proposals in the reports of the special committees and of the Interim Director of the C.C.I.T.; and that the Plenary Assembly of the unified C.C.I. should normally meet separately for the consideration of telegraph and telephone questions.

It is not perhaps irrelevant to remark at this point that, in the international field, telegraphy is still responsible for by far the greatest proportion of telecommunications business. The expanding telex service is also a factor of growing importance in international communications. It may also be added that while no spectacular results to compare say, with the original recommendations standardising start-stop working, were produced at Arnhem, taken as a whole, the meeting probably covered a wider range, and brought to a conclusion a greater volume of work, than any previous meeting of the C.C.I.T.

#### *Conclusion.*

The conference was, of course, in progress at the time of the Coronation and readers will probably already know that Holland was one of the countries which relayed the television programmes. The Netherlands P.T.T., who were in fact responsible for the relaying arrangements in Holland, arranged for a number of television sets to be set up in the lounges in the conference building and the sessions of the various committees were arranged so that delegates were free at the material times. The reception was of very high quality. Bearing in mind that Arnhem was at some distance from the radio transmitting station, and that the signals had to be converted from 405 lines to 625 lines before re-radiation, the extremely good results were a high tribute to the care and skill which had been exercised by all concerned. While the members of the U.K. and other Commonwealth delegations were particularly grateful for this opportunity to join in the Coronation functions all the delegates showed great interest in the programme. The arrangements made in this respect by the Netherlands Administration can be taken as typical of the many kindnesses and courtesies which the delegates enjoyed at the hands of their Netherlands hosts.

E. H. J.

# An Outline of the British Television System

D. WRAY, B.Sc. (Eng.), A.M.I.E.E.†

## Part 2.—Transmitting the Picture Waveform

U.D.C. 621.397.5

The British five-channel vestigial sideband television broadcasting system is outlined, and some features of the transmitters are described. The transmitters are connected to the main London studios by cable and radio point-to-point links. Outside broadcast material may be transmitted from places outside the studio for short distances over either coaxial or balanced-pair cable, portable radio links, or ordinary telephone pairs.

### INTRODUCTION

IN the first part<sup>1</sup> of this series of articles the processes were described by which the variations of light and shade in a scene are translated into an equivalent electrical waveform. This electrical waveform must then be transmitted so that the original picture can be reproduced on the screens of the domestic receivers scattered over the entire country. The links in the chain that connect scene to screen may be of several different types. There may be a link between the site of an outside broadcast back to the parent studio; there are the cable and radio point-to-point links between the studios and the transmitters; and, finally, there is the broadcast radiation from these transmitters that is picked up by the television receivers.

Now the video waveform as derived from the camera and its associated studio equipment is often unsuitable for transmission over some of these links, just as the audio waveform straight out of a microphone would be useless for broadcast radiation. For short cable links the video signal may be used in its original form, but for transmission over long distances, either by cable or radio link, and for broadcasting, some form of modulated carrier system is normally necessary.

### BROADCAST TRANSMISSION

Basically, the methods used in television radiation are the same as those employed in sound broadcasting; a carrier frequency is generated, modulated by the video waveform, and then radiated as an electromagnetic field by a transmitting antenna. Because of the very great bandwidth necessary for the modulating video signal, television broadcasting requires a very high carrier frequency. It is well known that if  $f_c$  is the carrier frequency and  $f_m$  the modulating frequency, then the sideband components in the modulated output are  $f_c + f_m$  and  $f_c - f_m$ . Now we have seen that in television working,  $f_m$  may extend up to 3 Mc/s, so obviously the carrier frequency should be much higher than this; in fact, since the narrower the range of sideband components in proportion to the carrier frequency—i.e.,  $2f_m/f_c$ —the easier it is to maintain satisfactory amplitude and phase responses in the equipment, the carrier frequencies employed need to be about 40 Mc/s or higher.

#### Frequency Allocation.

The first British high-powered television broadcasting station to go on the air was at Alexandra Palace, in North London. That was fifteen years ago, and today it is still working, using a vision carrier frequency of 45 Mc/s and transmitting both sidebands. Transmitting stations built since the war, however, have employed a system in which the lower sideband is fully transmitted but only part of the upper sideband. The frequency allocation of both sound and vision carriers is shown in Fig. 1 and the power ratings of the British transmitters are given in Table 1.

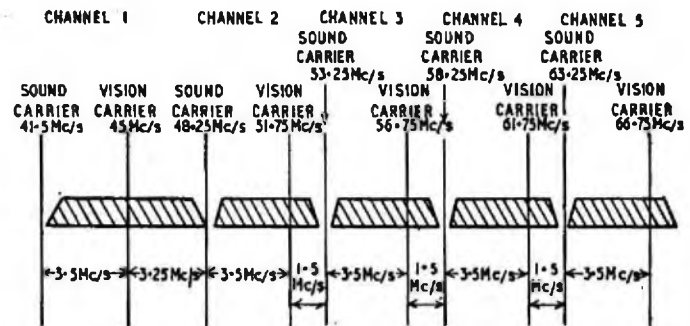

FIG. 1.—FREQUENCIES ALLOCATED TO BRITISH TELEVISION CHANNELS.

TABLE 1  
B.B.C. Television Transmitting Stations

	Channel Number	Carrier Frequency (Mc/s)		Transmitter Power (kW)	
		Vision	Sound	Vision	Sound
Alexandra Palace	1	45	41.5	17	3
Holme Moss	2	51.75	45.25	50	12
Kirk o' Shotts	3	56.75	53.25	70	16
Sutton Coldfield	4	61.75	58.25	45	12
Wenvoe	5	66.75	63.25	70	15
Belfast	1	45	41.5	5*	2*
Newcastle	5	66.75	63.25	6*	2*
Isle of Wight	3	56.75	53.25	5	2
Aberdeen	4	61.75	58.25	5	2
Plymouth	2	51.75	48.25	5	2

\* The temporary transmitters being installed initially are of lower power than this.

It can be seen from the diagram that, except for Channel 1, there is a simple relationship between the carrier frequencies. The vision carrier frequencies are 5 Mc/s apart from 51.75 Mc/s for Channel 2 upwards, and the sound carrier is always 3.5 Mc/s below its associated vision carrier frequency.

The five high-powered transmitters listed above provide an adequate service to about 77% of the population of the United Kingdom. Five low-powered transmitters are also planned, working at the same frequencies as the high-powered stations, but radiating about 5 kW each; it is expected that these will raise the proportion of the population served to about 85%, the highest television service coverage in the world. Areas served by the low-powered transmitters will be protected against interference from the high-powered station working at the same frequency by arranging that the two stations on the same frequency are geographically remote (e.g., Belfast has the same frequency as London, 45 Mc/s), and that the high-powered transmission is vertically polarised whilst the low-powered, except for the Isle of Wight transmitter, uses horizontal polarisation.

The map in Fig. 2 shows the location of the television transmitters in the United Kingdom, both existing and projected, with the service areas that these stations provide.

† Executive Engineer, Radio Experimental and Development Branch, E.-in-C.'s Office.

<sup>1</sup> For references see end of Article.



FIG. 2.—THE BRITISH TELEVISION NETWORK.

### Vestigial-Sideband Transmission.

It has been mentioned that the post-war transmitters do not radiate both sidebands of their modulated carrier, but only the lower sideband and part of the upper sideband. By this means, four television channels, together with their respective sound transmissions, can be accommodated in a spectrum only 20 Mc/s wide whilst still containing all the information present in the modulating waveform. This method of spectrum economy cannot be taken to the lengths employed in speech and telegraphy transmitters, in which just one sideband is transmitted with the other sideband and the carrier completely suppressed, for the video bandwidth extends down to D.C., and no filter yet devised could suppress one sideband and the carrier frequency whilst passing the other sideband in full.

The 'receiver attenuation' system is employed in this country. In this, the receiver is designed to have a response characteristic which gives a constant video-frequency output although the full two sidebands are not present at the input. This is illustrated in Fig. 3, which shows idealised characteristics of both transmitter and receiver. From this it is seen that the transmitter radiates the whole of the lower sideband at full voltage, but frequencies in the upper sideband higher than 0.75 Mc/s above the carrier frequency ( $f_c$ ) are increasingly attenuated, being completely suppressed at  $f_c + 1.5$  Mc/s. The receiver, however, begins to attenuate the receiver signal at frequencies 0.75 Mc/s below  $f_c$ ,  $f_c$  is itself reduced to half its incoming value, and the upper sideband is completely suppressed at  $f_c + 0.75$  Mc/s. Thus the whole of the effective receiver characteristic falls inside the full voltage part of the transmitter characteristic.

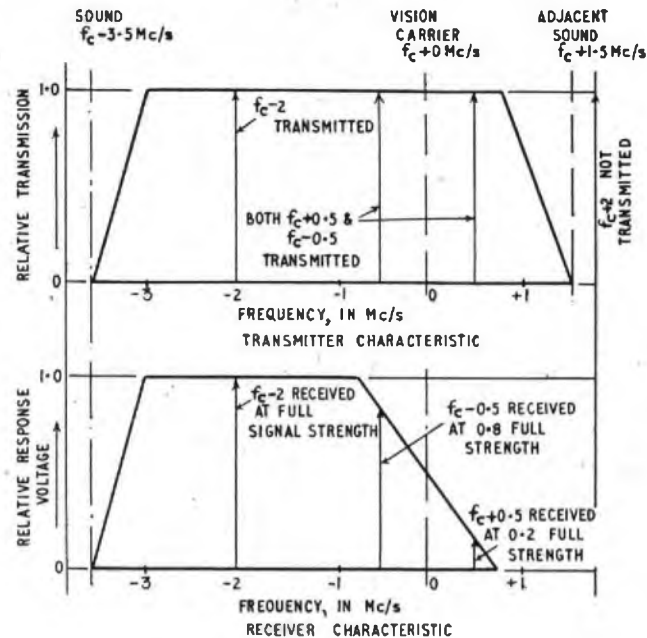

FIG. 3.—VESTIGIAL SIDEBAND WORKING.

Now if, for example, the video modulation contains a frequency component of, say, 2 Mc/s, the lower sideband component  $f_c - 2$  will be transmitted, but  $f_c + 2$  will not;  $f_c - 2$  will be received by the receiver and detected to give the original 2 Mc/s again at a voltage of, say,  $E$ . If the modulating frequency is reduced to 0.5 Mc/s, then both  $f_c - 0.5$  and  $f_c + 0.5$  are transmitted; from the receiver characteristics we can see that 0.8 of the incoming lower sideband signal is accepted, and only 0.2 of the upper sideband; the net result after detection of these two sidebands is that a video voltage output of  $E$  is again obtained. In this way all modulating frequencies from 0 to 3 Mc/s give a constant output from the vestigial-sideband receiver although part of the upper sideband is not transmitted.

### Depth of Modulation.

In most carrier systems for speech and music, the average amplitude of the modulated carrier output corresponds to the average value—usually the datum voltage—of the modulating waveform. In television waveforms, however, there is no fixed average voltage, for the waveform is not symmetrical, so the normal definition of modulation depth cannot apply. The modulation factor is therefore defined as the difference between the maximum and minimum carrier amplitudes divided by the sum; this will give the same values as the normal definition when applied to sine-wave modulation.

As shown in Fig. 4, two methods of amplitude modulation are possible, positive and negative. In positive modulation (Fig. 4a), which is the system adopted for broadcast transmission in this country, the synchronising pulses correspond to minimum carrier level, and the peak white in the picture drives the carrier up to its maximum voltage. Negative modulation, as in Fig. 4b, has the synchronising pulses at maximum carrier amplitude, and is used in broadcasting in America and in most cable systems. The standard modulation depth for broadcast radiation in this country is 100%; that is, during the synchronising pulses there is no carrier transmitted at all.

### The Transmitter.

There has been rapid development in the design of high-powered transmitters since the war, particularly in the art of obtaining a high power from a relatively small installation; in this respect the post-war transmitters are much

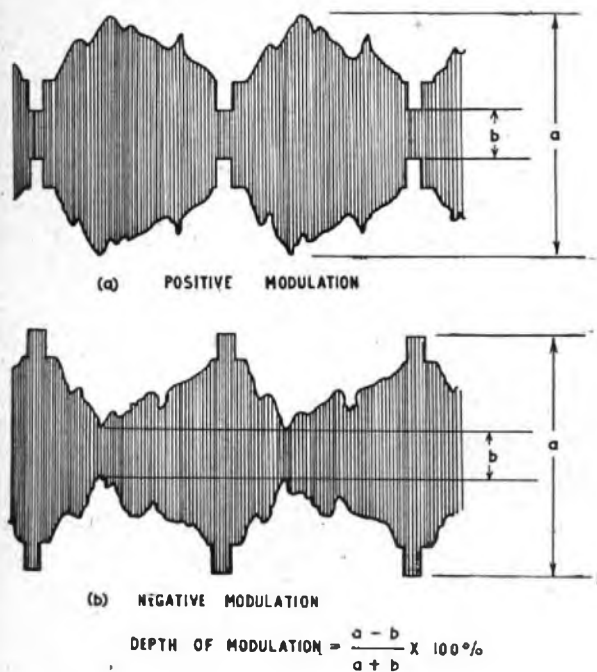

FIG. 4.—TELEVISION WAVEFORM MODULATION.

more efficient than the original Alexandra Palace equipment, principally because of the superior performance of modern high-powered valves compared with those available in 1937. Since the five high-powered stations in this country employ different techniques it is not practicable to describe them all, but two—the Holme Moss and the Wenvoe transmitters—can be taken as representing two different aspects of modern practice.

A block schematic diagram of the Holme Moss transmitter is given in Fig. 5(a). This is a high-level-modulated

tion of their characteristics, and the transmitted carrier envelope would not bear the correct relationships of 7 : 3 for picture content to synchronising pulse voltages were it not for circuits introduced into the video-modulation amplifier chain; these stretch the synchronising pulse amplitude of the modulating signal to compensate for the subsequent crushing in the r.f. stage. It is also necessary to employ circuitry which prevents the voltage corresponding to black level from wandering as the picture content changes, for this would cause variation in the modulation depth of the modulated carrier waveform.

When this transmitter is radiating synchronising pulses only, i.e., an all-black picture, its total measured power supply input is 110 kW; this increases to 160 kW when the picture changes to an all-white one.

The Wenvoe and Kirk o' Shotts 70-kW transmitters use a different principle from earlier installations, namely, that of low-level modulation; the method of operation is illustrated in the block schematic diagram of Fig. 5(b). In this case the modulation takes place quite early in the r.f. chain, the modulating video voltage being applied to the grids of two air-cooled triodes working in push-pull, which give an output of 600 watts during a peak-white picture.

The r.f. input to the modulating stage is derived from a crystal-controlled oscillator and a pre-modulation amplifier. The modulated carrier output from the modulated amplifier stage is amplified by three push-pull earthed-grid Class B power amplifiers, the final stage using a pair of water-cooled triodes giving a 70 kW maximum carrier output. The inter-stage coupling circuits from the modulation amplifier stage onwards are tuned so that the upper sideband is attenuated to some extent, but not enough to give the required sideband shaping for vestigial-sideband transmission.

In fact, in both the transmitter types described above, and, indeed, in all post-war vision transmitters, there is a filter between the final output stage and the antenna which shapes the upper sideband characteristic to the prescribed vestigial form. This filter must be able to dissipate a considerable amount of power as well as possess the correct attenuation performance, and in practice these filters are constructed from 5-inch diameter copper tube coaxial transmission lines, with liquid-cooled absorber loads. Lengths of tube are bent and interconnected together with stubs of tube fixed to give the electrical performance of a low-pass filter. The filter, which covers a large part of one wall in the transmitter room, is further complicated by the necessity for a combining circuit in which both sound and vision carrier signals are fed to be radiated from the same antenna.

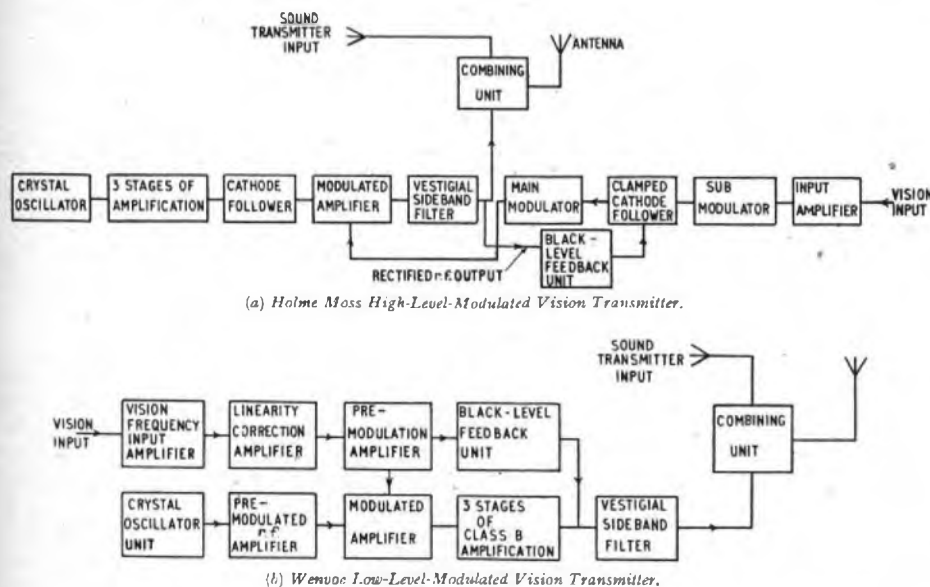

FIG. 5.—BLOCK SCHEMATIC DIAGRAMS OF TWO MODERN VISION TRANSMITTERS.

system in which a crystal-controlled oscillator unit is followed by three r.f. amplifier stages, a cathode-follower and the final r.f. output stage, which uses two water-cooled triodes. It is at the grids of these triodes that the modulation by the amplified video signal takes place. The final stage of the video amplifier chain culminates in an output cathode-follower across which, for peak white signals, a swing of 1,100 volts at a peak current of 3 amps. is obtained. The valves in the r.f. amplifier are operated beyond the linear por-

#### Transmitting Antennae.

There are four principal requirements for a television transmitting antenna: it must possess a bandwidth that encompasses the sound carrier frequency and its sidebands, the lower vision sideband and the vestigial remnant of the upper sideband—in all, 5 Mc/s—and have a constant impedance over this band; it should give a useful power gain relative to a single half-wave dipole; it must give a circular horizontal polar diagram; and it must be of simple

sturdy construction capable of withstanding the rigours of the British climate.

It has been found that the most satisfactory solution—or, rather, compromise—for these problems, is to use two tiers of four vertical half-wave folded dipoles, with a vertical displacement between the two tiers of one wavelength. The four dipoles of each tier are fixed on horizontal steel supports at  $90^\circ$  intervals round the mast (Fig. 6), and are excited by currents of equal amplitude but shifted in phase round each tier in  $90^\circ$  steps. Besides fulfilling the requirements listed above, this arrangement also has the advantage that there is a very low field at the centre point of the four elements, so the central steel support mast has virtually no effect on the performance. The folded dipoles themselves are made of galvanised steel strips, and are in contact with 7.5-kW heating elements which are needed to prevent the ice formation which, uncombated, would change the impedance presented by the dipoles.



FIG. 6.—FOLDED-DIPOLE TYPE TRANSMITTING ANTENNA.

The lowest field-strength necessary for satisfactory television reception in residential areas is usually taken to be 0.5 mV/meter; a somewhat lower field is usable in rural areas where man-made interference (e.g., internal combustion engine ignition interference, radiation from medical diathermy equipment, etc.) is not so great. Since propagation in the 40-60 Mc/s band is almost entirely of a 'line-of-sight' nature, it is essential for the transmitting antenna to be well elevated to give an adequate coverage (the service usually aimed at is a field strength of not less than 0.5 mV/meter for a 50 mile radius round the high-powered transmitters). Consequently the transmitting antennae are mounted on tall masts which are themselves situated on high ground. The modern masts used for supporting the antennae are of lattice steel construction, with a triangular cross-section of 9 ft. face. This rises to 600 ft. above the base pedestal, and is surmounted by a cylindrical slot aerial, a further 110 ft. in height, which may be used in future for experimental 90 Mc/s sound broadcasting. On top of all is the square cross-section top mast that supports the television folded dipole antennae and which brings the total height up to 750 ft. The whole mast, weighing about 140 tons, is supported on a two-inch diameter steel ball at the centre of the base pedestal, and is stayed at heights of 200, 400, 600, and 710 ft. by steel ropes spaced at  $120^\circ$ ; this arrangement permits some angular movement, and the mast head may move as much as 7 ft. under severe wind-loading conditions.

Intensive preliminary tests are made before a transmitter site is finally chosen. A 1-kW mobile transmitter is used for site testing, the antenna being a half-wave dipole supported at a height of about 600 ft. by a captive balloon. A van fitted with a test receiver and aerial is then driven round the district to be served by the transmitter; inside the van the signal output from the receiver is recorded continuously on a chart which is controlled in drive by the

road wheels of the vehicle. In this way a complete record of the field-strength variation with receiving location is obtained, which gives an indication of any 'blind spots' in reception that may exist. The final selection of the site will depend, not only on the number of viewers that can be served (a factor that depends on the altitude of the site, and the population distribution), but also on accessibility, water and power supply, whether there is sufficient flat and firm ground for the building and mast, and many other practical factors.

#### LONG DISTANCE POINT-TO-POINT TRANSMISSION

The great complexity and expense of the television studios necessary for the production of ambitious national programmes effectively prohibits the building of a studio attached to each regional transmitter under present economic conditions. Instead, all studio facilities are concentrated in the London area at Lime Grove and Alexandra Palace and the programmes emanating from them are relayed by point-to-point links to the broadcast transmitters. Since, in general, the Post Office is responsible for all point-to-point transmission in this country, it is these interconnecting links that are the Departments' principal interest and responsibility in the television service. In some links the equipment has been designed and constructed by the Post Office itself; in others the manufacture has been by outside firms under contract, to Post Office specifications; in all cases, the links are finally manned and maintained by Post Office staff. The principal links are shown in the map of Fig. 2. Before describing them briefly in turn, it is well to consider what the requirements are for permanent relay links of this sort.

First, the gain/frequency characteristic from input to output should be substantially flat over the range 0 to 3 Mc/s; also, since the picture-reproducing equipment depends on the *shape* of the video waveform, the frequency components must arrive with the same relative timing as well as in the relative amplitudes; this means that the link must have the same delay for all frequencies between 0 and 3 Mc/s. Other requirements are that there should be no interference due to electrical noise (whether it be due to the random voltages produced in valves or resistors giving the 'snow-storm' effect, or the striped patterns due to interfering fixed signals); there should be good linearity, so that the picture has the same tone gradation at the output as it did at the input; and there should be stability of gain and complete reliability.

#### The London-Birmingham Radio Relay System.

The first long-distance television relay system to go into regular service was the radio link between London and Birmingham,<sup>2</sup> which was provided for the opening of the Sutton Coldfield transmitter in December, 1949. The terminal stations are on the roofs of Museum Exchange, London, and Telephone House, Birmingham, and are connected to the B.B.C. studios and transmitters by short tail-cables. There are four intermediate repeater stations between these terminals, and two different frequencies are used for each direction of transmission to avoid interaction between the transmitter and the receiver at the same repeater site. The frequencies used are 917 Mc/s and 937 Mc/s for the 'Go' direction and 951 Mc/s and 971 Mc/s for the 'Return', but at each repeater the incoming signal is translated to an intermediate frequency of 34 Mc/s and it is at this frequency that the signal is amplified. Frequency modulation is used, with a maximum deviation of 3 Mc/s. To avoid losses in the antenna feeders at these high transmission frequencies the radio equipment is housed in small cabins at the top of the antenna supporting towers.



### The London-Birmingham Cable System.

After ten months of continuous service, the radio relay system between London and Birmingham was succeeded by a cable link.<sup>3</sup> The composite cable laid for this service is a complex one, comprising two one-inch diameter tubes and four  $\frac{3}{8}$ -inch tubes as well as a number of music and control circuits. The two large coaxial tubes have a lower attenuation per mile at a given frequency than any other long-distance cable installed to date, and would be capable of carrying carrier systems of 12 Mc/s bandwidth or even greater if suitably equipped. (The present transmission equipment is designed for a vision bandwidth of 3 Mc/s.) It is not possible to transmit the video waveform directly over coaxial cables, for their screening against low frequency noise and interference is poor, and the waveform would be seriously distorted. Instead, a carrier system is used, with a carrier frequency of 6.12 Mc/s which employs the same sort of vestigial sideband system as was discussed in an earlier section. The successive steps in the transmission process are illustrated in Fig. 7 (a). The incoming video

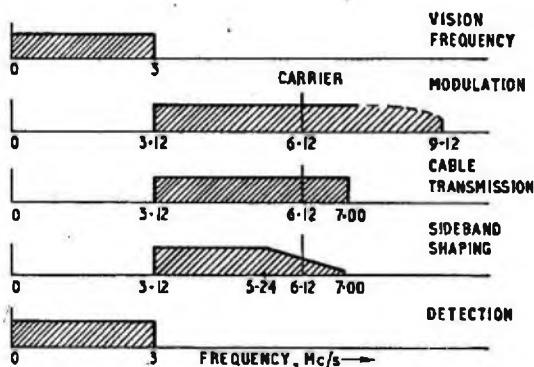

(a) London-Birmingham Coaxial-Cable System.

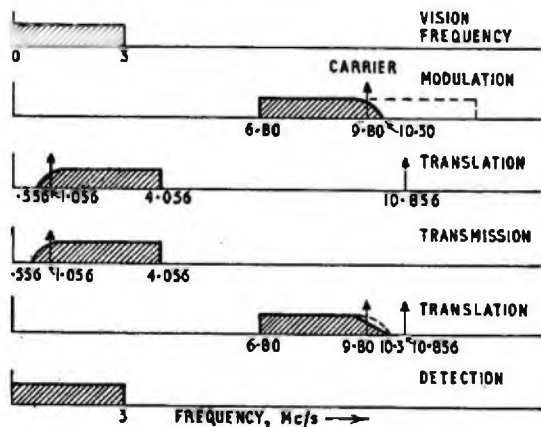

(b) Birmingham-Manchester and London-Wenvoe Coaxial-Cable Systems.

FIG. 7.—STAGES IN THE TRANSMISSION OF TV SIGNALS OVER THE BRITISH COAXIAL-CABLE TV SYSTEMS.

signal from the studio, extending in its frequency components from D.C. up to 3 Mc/s, modulates a 6.12 Mc/s carrier and produces both sidebands varying from 3.12 to 9.12 Mc/s. Successive amplifiers in both the terminal equipment and the intermediate repeaters are designed to pass the band from 3 to 7 Mc/s only, i.e., the complete lower sideband with a 1 Mc/s vestige of the upper sideband. At the receiving terminal equipment a filter shapes the response to the characteristic vestigial sideband system shape of Fig. 3, and the carrier is then demodulated to give the video frequency output. Both modulator and demodulator use silicon crystal diodes for the frequency translation processes.

For cable transmission of television, negative modulation is normal (See Fig 4), for the constantly recurring pulses of maximum carrier, corresponding to the synchronising pulses, permit the use of simple level indicators and automatic gain control systems. Positive modulation, with its constantly changing maximum carrier excursion, would complicate such matters. Any intermediate repeater between London and Birmingham is automatically replaced by a standby repeater should the signal disappear from the output of the amplifier normally in use.

### The Birmingham-Manchester and the London-Wenvoe Cable Systems.<sup>4</sup>

The cable links between Birmingham and Manchester and between London and Wenvoe provide two-way systems over standard  $\frac{3}{8}$ -inch diameter coaxial pairs. Since the attenuation of this type of cable is considerably higher than that of the one-inch cable, it is not current practice to work at such a high carrier frequency as is used between London and Birmingham. Instead, a double modulation process, illustrated in Fig 7 (b), enables a lower frequency band, extending from 0.5 to 4 Mc/s to be transmitted over the cable. Between Telephone House, Birmingham, and Telephone House, Manchester, there are 16 intermediate repeater stations, and in the spur from Manchester to the transmitter at Holme Moss there are a further three repeaters.

The Welsh relay system is routed via Museum Exchange, London-Bristol-Wenvoe. There are 23 repeater stations between London and Bristol, and eight more between Bristol and Wenvoe. In nearly all these cables there are extra  $\frac{3}{8}$ -inch coaxial pairs supplied for the telephone service.

### The Manchester-Edinburgh Radio Relay System.

A microwave radio link, working on frequencies in the region of 4000 Mc/s extends the television service from Telephone House, Manchester, to the Scottish transmitter at Kirk o' Shotts. The route was chosen to pass close to Newcastle to facilitate the provision of a spur to the local transmitter there, and also runs near Leeds and Edinburgh, both of which are likely sources of outside broadcast material. This route distance is 250 miles, but only seven intermediate repeater stations are necessary.

The terminal transmitter employs a klystron oscillating at the radiated frequency which is frequency-modulated by the incoming video signals; an automatic frequency control system operates by comparing the mean frequency of the klystron with a stable crystal-controlled oscillator. The oscillator output is amplified by a travelling-wave amplifier which delivers one watt into the transmitting paraboloid aerial. At the repeater stations the incoming signals are translated down to an intermediate frequency of 60 Mc/s, and amplified. The frequency is then changed again to a value that is 37 Mc/s different from the incoming signal frequency, for the same two frequencies are used for the 'go' and 'return' links, but alternating at each step. Pressurised waveguides connect the equipment to the paraboloid aerials.

This is the first large-scale use of the waveguide and travelling-wave valve in Post Office practice, and the performance of the link will be studied with interest over the next few years to see how it compares, both economically and in the quality of its service, with the older established cable systems.

### The Temporary Northern Ireland Link.<sup>5</sup>

A temporary service is to be provided to the Belfast area for the next few years by a 1-kW transmitter at Glencairn. The broadcast radiation from Kirk o' Shotts is picked up

by a high-gain aerial array and a receiver with automatic gain control situated on the top of Black Mountain, a prominence to the West of Belfast. The video-frequency output from the receiver is transmitted over a short length of coaxial cable to the Glencairn transmitter, using the same carrier system that is employed in the London-Birmingham transmission. In spite of the very long signal path, a high-quality service is provided.

#### OUTSIDE BROADCAST LINKS

For outside broadcast programmes it is necessary to provide an additional link in the chain connecting the site of the broadcast to the nearest control point in the national network, from where the signal can be conveyed to all transmitters. Ideally, the transmission standards of outside broadcast links should be as high as those for the permanent links, but since they are essentially of a temporary nature, long-term reliability and stability of performance requirements are not so stringent.

When the site of the broadcast is in a heavily built-up area, a land line is usually the best way of connecting the originating point to the control centre; such links are provided by the Post Office at the request of the B.B.C. In some cases, where the site contributes frequently to the programmes—such as Wembley Stadium and Pool, or Lords Cricket Ground—coaxial cables have been laid especially to take outside broadcast material; in these instances a carrier system is used of precisely the same type as that employed in the local permanent link, e.g., a 3.7 Mc/s system in the London area, or a 0.5-4 Mc/s system in Manchester. Small, sturdy, portable versions of standard modulators are used to translate the video waveform output from the mobile control rooms into the appropriate carrier form.

In the vast majority of broadcast sites, however, no coaxial cable is available, but it has been found practicable to use ordinary telephone pairs for transmitting the video waveform directly over the short distances involved. Such pairs, of course, were intended for audio frequencies, say from 0 to 5 kc/s, whilst the video spectrum extends up to 3 Mc/s. Special equipment<sup>6</sup> has been developed that can equalise the telephone pair over the necessary frequency band, and which is sufficiently flexible in its electrical characteristics to compensate for the many differing types and lengths of cable that may be encountered. Apparatus of this type can be used to equalise up to  $\frac{3}{4}$  mile of 6 $\frac{1}{2}$  lb. pair, or 1 $\frac{1}{4}$  miles of 10 lb. pair, or 2 miles of 20 lb. pair. In 1937 a balanced-pair cable of special design was laid to cover the route of the Coronation procession; this was capable of carrying the video frequencies with little loss, and passed through several telephone exchanges *en route*. It is still in use, for, by using the equalised telephone-pair technique,

its coverage can be extended by up to about 4 miles in the London area. Video frequency transmission over telephone lines is also being developed in provincial towns.

For outside broadcasts over long distances, particularly in rural areas, mobile radio links are having an increasingly wide application. Equipment working at about 65 Mc/s was developed before the war and is still useful for links where a critical siting of the mobile transmitter is not possible; a more modern transmitter working at 200 Mc/s is also used. This apparatus is mounted in a large van with the transmitting antenna raised to about 100 ft. by a fire escape type elevator; a power of 1 kW is radiated during peak white. The range of transmission is normally about 30 miles. In the London area a permanent receiver is located at Swain's Lane, on Highgate Hill, whence the signal is passed to Alexandra Palace over balanced-pair cable. A more recent development is to use centimetric-wave links with light-weight easily-managed equipment working at 4600 and 6925 Mc/s. This apparatus must be fixed on some local prominence, such as a water-tower, from which it transmits the signals over about 30 miles to the next relay point and so on to the final control centre.

On many occasions two or more of the systems described above have been used in tandem to form a composite link. For instance, in a broadcast from the Glyndebourne Opera House, use was made of a short land line with equalised video transmission to a nearby hill, and then a three-hop radio link to London. Some of the Boat Race broadcasts have used radio, coaxial cable and telephone pair links to complete the transmission path.<sup>7</sup>

The methods of television transmission, whether broadcast radiation or point-to-point relaying, are undergoing continuous and rapid development, but it is salutary to reflect that Baird, as long ago as 1928, had already transmitted pictures across the Atlantic, and had relayed a video signal from London to Glasgow over Post Office lines. In those pioneer days, however, to transmit a recognisable image was an achievement in itself whereas today, a reliable high-quality television service is available in most parts of the country.

#### References.

- 1 Wray, D. "An Outline of the British Television System. Part I—Generating the Picture Waveform". *P.O.E.E.J.*, Vol. 48, p. 59.
- 2 Mumford, A. H. and C. F. Booth, "Television Radio-Relay Links" *P.O.E.E.J.*, Vol. 43, p. 23.
- 3 Stanesby, H. and W. K. Weston, "The London-Birmingham Television Cable". *P.O.E.E.J.*, Vol. 41, p. 183 and Vol. 42, p. 33.
- 4 See p. 118.
- 5 See p. 130.
- 6 Kilvington, T. "A New Television Repeater for Telephone Cable Circuits". *P.O.E.E.J.*, Vol. 42, p. 76.
- 7 Moore, B. H. "Boat Race Television Broadcast". *P.O.E.E.J.*, Vol. 42, p. 99.

## Soft Magnetic Materials for Telecommunications

U.D.C. 538.2: 621.318

A brief review of an International Symposium held at the Post Office Research Station, Dollis Hill, in April 1952.

THE art of telecommunication as now practised depends very largely on the use of magnetic materials in one way or another; permanent magnets for telephone receivers, silicon-iron for transformer cores, and nickel-iron powder for loading coils are but a few examples. It is undoubted that some of the future progress in the art will depend on the provision of new or improved magnetic substances. In the past thirty years the rate of development in magnetic materials has been phenomenal and has not generally been attributable to the urge of total war.

Compare only the properties of Alnico, Supermalloy and grain-oriented silicon-iron with those of the best materials available in 1920; the change is surprising. Alnico V and Alcomax II have an energy product  $[(BH)_{max} \times 10^{-5}]$  of over 40 compared with 3 for tungsten steel, used in candlestick-type telephone receivers, and 6 for 35% cobalt steel. Silicon-iron had an initial permeability of 400 whereas modern nickel-iron alloys have one of 30,000, and in their highest stage of development—Supermalloy and similar substances—100,000. Even silicon-iron in its new guise as

grain-oriented strip may have an initial permeability of 4,000. Then we have the entirely new commercial development of the ferrites which has given us a series of magnetic materials which are nevertheless insulators.

All the substances mentioned are of immediate interest to telecommunications engineers; conventionally they are divided into "hard" and "soft" magnetic materials, and though these terms were at one time closely related to the mechanical properties of the metals concerned, there are now so many anomalies that there is a case for inventing new generic terms.

Soft magnetic materials for telecommunications are in a class all of their own. They are used in relatively small quantities so that their cost may often be secondary in importance to their performance. There are many cases in which the use of a high-performance material at a high price may enable completed equipment to be cheaper and to occupy less space than before. These materials must often work in magnetic fields approaching zero, and their properties in such fields are most important. Their behaviour in high fields is becoming more important with the interest now being taken in magnetic amplifiers (these are circuits which are for some purposes replacing valve amplifiers in spite of the disadvantage that they must be energised from a high-frequency power supply).

It was thought that to hold a discussion limited to the properties of materials interesting to telecommunication workers—and therefore excluding all reference to problems associated with power engineering—would be a worthwhile experiment and invitations were sent to academic workers, manufacturers and users to come to Dollis Hill and discuss "Soft Magnetic Materials whose Properties are of Use or Significance in Telecommunications." Originally a discussion group of about 20 people was intended, and inevitably many who would have liked to come were overlooked. Even so the number attending grew to seventy. The meetings were held in the Lecture Theatre on 3rd-4th April, 1952, and overflowed into Saturday, 5th April. Besides people from our own country we had visitors from France, Germany and the Netherlands.

The guests were welcomed by Brigadier L. H. Harris, Controller of Research, Post Office, and then settled down to discuss the thirty-four papers which had been presented. As these papers had been distributed before the meeting they were not read, but each one was briefly introduced by the author, and was then thrown open for discussion. Our foreign guests very kindly and competently spoke in English.

Four sessions were held; Brigadier Harris presided over the first, and the others were in charge of Professors W. Sucksmith, L. F. Bates and E. B. Moullin.

"Soft Magnetic Materials" may sound a very restricted field for work, and it would not have been surprising had there been considerable overlapping in the papers. Authors had, however, found so many distinct facets to write about that it was not always possible to group papers for common discussion. In fact, as Brigadier Harris remarked at the close of the first session, the subject was refreshingly varied; one paper discussing powders having a particle diameter of about one micron, and in the next, in spite of its dealing with telecommunications, there was some reference to water wheels. So far as the papers could be grouped they fell into the following main categories:—

the mechanism of magnetic loss; extremely high permeability materials; powder cores; ferrites; materials having nearly rectangular hysteresis loops; methods of measurement.

Looking back at the meeting after a lapse of time, and in the light of reading all the papers several times whilst preparing them for the press (they are to be published shortly in book form by Pergamon Press Ltd.), one can

discern that the principal underlying theme was magnetic loss, its causes, measurement and effects. More than half the papers were directly concerned with it. We understand a little about the origin of some of the kinds of loss, but much more work is needed, for neither hysteresis nor eddy-current losses are as simple as they appear to be, while there seem to be at least two other types of loss as well. There are several motives for further work: the academic scientist wants to be able to place these losses accurately in his magnetic theory, the manufacturer wants to know how to reduce them, and the user must know about the effects they will produce in his equipment.

A second focus of interest was in materials having the so-called rectangular hysteresis loops. These substances are not new—they were produced in the laboratory nearly 20 years ago—but they are only now being put to work. They are being used in magnetic amplifiers (although there is some doubt about whether they are the most suitable alloys for the purpose) and in magnetic "delay lines" for storage of information; they can also form the basis of switching circuits. In all these devices they absorb little power, are very stable elements, and once incorporated they are unlikely to change or give rise to faults. They are likely to find wide application in future telephone exchanges. Metals useful for these purposes can be made by heavily cold-rolling certain alloys and so producing grain orientation, or by cooling other alloys in a magnetic field from above the Curie point and obtaining domain orientation. In practice there is little to choose between the performance of the two types, but it must be remembered that the use of grain-oriented material imposes certain restrictions on the design of cores.

The work on extremely high permeability materials has been important in that it has shown that the recognised alloy Supermalloy is a particular instance in a more extensive series of alloys all having similar properties. This gives hope that the composition may not be extremely critical even if the heat treatment is.

Powder cores have been known for a long time, but there has never been a satisfactory reason why certain types of carbonyl-iron give lower loss cores than any other material. This was one of the matters discussed in papers mainly related to the structure of this substance.

Ferrites are another example of materials which have been known for a long time but have only just been commercially developed. They owe this development to the work of Snoek and his associates during the war, and are now becoming steadily more interesting to engineers. They differ from other magnetic substances in being insulators, and whilst this feature may often be an advantage, the dielectric losses in them may impose limitations on their use.

Finally we come to methods of measurement. These have had to be improved again and again to get some insight into the losses associated with the different materials; the newer ones, particularly ferrites and rectangular loop materials, present new problems in measurement and may lead to new conceptions of the magnetic process. On conventional materials the use of very high frequencies to study the losses in magnetic strip is interesting.

The discussion was always lively and, owing to the small numbers present, all of whom were actively concerned with the subject under discussion, never became formal. On many occasions it had to be curbed so that the session's quota of papers could be dealt with. To the organisers the occasion was a very happy one at which many old friends could meet again and new friendships be formed; and on the more businesslike side many useful contacts were made. We hope that our foreign guests enjoyed their visit as much as we did.

C. E. R., A. C. L.

# Television Service to Belfast

T. KILVINGTON, B.Sc.(Eng.), M.I.E.E. †

U.D.C. 621.397.2 (416)

Vision signals for the B.B.C. temporary television transmitter at Belfast are picked up direct from Kirk o' Shotts on 56.75 Mc/s at a receiving site on Black Mountain and passed on a carrier of 6.12 Mc/s over about a mile of coaxial cable to the temporary transmitter site in Glencairn, whence they are re-broadcast on a carrier of 45 Mc/s.

## INTRODUCTION

WHEN the B.B.C. decided in the autumn of 1952 to set up, in time for the Coronation, a temporary television station to serve the Belfast area of Northern Ireland, the Post Office Engineering Department was faced with the problem of providing a link between some point on the existing television network and the new station. Time was short, about seven months—or rather less if transmissions were to start in time to allow a reasonable period for viewers and dealers to install and test receivers before the big event. The nearest point on the existing network was Kirk o' Shotts, but to provide a fully equipped cable or radio link between here and Belfast in the time available was out of the question. Consideration was therefore given to the possibility of picking up the signals, as radiated by the B.B.C. from Kirk o' Shotts, at some point on the Ayrshire coast, and relaying them across the Irish Sea by means of a 200 Mc/s link, equipment for which could be made available. However, from a consideration of the long sea path to be crossed and as a result of measurements of the Kirk o' Shotts field strength made both in Ayrshire and near Belfast, it appeared that this solution did not offer the prospect of any better service than if the signals were picked up in Northern Ireland direct from Kirk o' Shotts. The obvious simplicity of the latter scheme led to its adoption.

The site chosen by the B.B.C. for their permanent Northern Ireland television transmitter is between the summits of Black Mountain and Divis, some three miles west of the centre of Belfast. Access to this site is very difficult however, and the B.B.C. did not feel able to set up a station there until a road had been built, a process too lengthy to be carried out in the time available. It was therefore decided to set up the temporary transmitting station at a more accessible site alongside an existing road in Glencairn, about a mile north-east of the final site and about 600 feet lower in level.

Tests made by the Post Office in November 1952 at a point near the summit of Black Mountain, just above the 1200-ft. contour, indicated that, at that time of the year, there was an adequate field strength available from Kirk o' Shotts to provide a good noise-free signal. In fact it was estimated that with an aerial array having a gain of some 15 or 16 db. relative to a half-wave dipole, there should be a margin of about 25 db. against fading before the signal became unusable. Approach to this site was, of course, just as bad as in the case of the B.B.C. permanent site, but in view of the lighter equipment to be transported, it was felt that, although it might be very difficult, it was not wholly impracticable to set up a receiving station on Black Mountain.

For the connection between the receiving site and Glencairn it was decided to use coaxial cable. There were two main grounds for this choice. First it would be possible to transmit power over the coaxial tubes, thereby feeding the Black Mountain station without the need for a separate expensive power cable; and secondly, suitable translation equipment of proved reliability, as used on the London-Birmingham television cable system, was immediately available.

## BUILDING SITES AND CABLE ROUTE

### *Black Mountain.*

As already mentioned, the Black Mountain site is near to the summit at about 1200 ft. There is an infinite variety of approaches to the site—all bad! The only practicable route for wheeled vehicles, however, is from Good's Farm by a circuitous route of about three miles across a trackless waste with many boggy patches. When the project was mooted in November, local opinion was that the hilltop would be inaccessible for a considerable proportion of the winter and steps were taken to get as much material as possible on site before the weather became too bad. However, thanks to a winter of unprecedented mildness a tractor was able to make the journey on most days, though not without getting bogged down on a number of occasions. Later, a Land Rover was also used with considerable success to transport goods and personnel over the route.

The task of setting up the aerial array and the timber buildings was no mean one. The bulky building sections, the cement and ballast for the foundations, the poles for the aeriels and a variety of other materials all had to be conveyed to the site by tractor-drawn trailer. Even the water for mixing the concrete had to be carted, for the plentiful bog water at hand was not considered suitable for the purpose.

Timber buildings of types that are now standardised in the Post Office were erected: a B1 building with an internal partition added to make two rooms, one for equipment and the other for staff welfare facilities; and an A-type building to house the supplementary diesel-driven power supply generator. The larger building is shown in Fig. 1. Stout



FIG. 1.—THE B1 TIMBER BUILDING ON BLACK MOUNTAIN.

wire stays over the roof are fitted to prevent the buildings from being carried away in the high winds that may be expected.

### *Glencairn.*

The Post Office building at Glencairn, also of timber, was a considerably easier problem as there was good access from a road. The building is situated on the B.B.C. site, close to the building housing the transmitter.

† Senior Executive Engineer, Radio Experimental and Development Branch, E.-in-C.'s Office.

### Cable.

The inter-site cable is a standard two-tube  $\frac{3}{8}$ -in. coaxial cable with 16 interstice pairs, some of which are used for supervisory and control purposes, and with armouring added. It is laid directly in the ground along a route of about one mile which is almost a straight line joining the two sites. Although this route is short, it is very steep, with gradients of more than 1 in 2 in parts, and the laying of the cable appeared to be a very formidable task. However, thanks to the enterprise and ingenuity of the Northern Ireland staff, it went surprisingly smoothly. Most of the drums of cable were hauled to the mountain top by means of the tractor towing a specially constructed drum trolley.\* The cable was then taken off the drums and man-handled into position down the hillside.

### EQUIPMENT

Fig. 2 is a schematic diagram of the equipment. The two stations are intended for unattended operation and in order to avoid the need for automatic changeover equipment two continuously running, completely independent signal channels are provided, the B.B.C. engineers effecting a manual changeover at the output when necessary. Figs. 3 and 4 are photographs of the equipment at Black Mountain and Glencairn respectively.



FIG. 3.—EQUIPMENT AT BLACK MOUNTAIN.



FIG. 4.—EQUIPMENT AT GLENCAIRN.

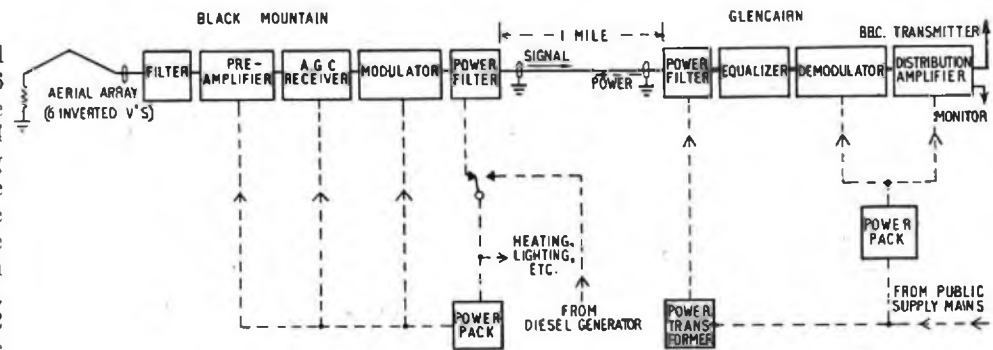

FIG. 2.—BLOCK SCHEMATIC DIAGRAM OF EQUIPMENT.

equipment. Fig. 5 shows the construction of the aerials. This type of aerial, besides having a high gain, also has a very broad bandwidth and will pick up signals even down to the medium frequency band. Precautions had to be taken, therefore, to avoid intermodulation troubles that might be caused in the receiver by the presence of strong unwanted signals. There are two possible sources of such signals—local medium-wave broadcasting stations and the local B.B.C. television station itself, the latter being the more important. The normal field strength of the Kirk o' Shotts transmitter at Black Mountain is about 100 microvolts per metre on 56.75 Mc/s whereas it was estimated that the field from the local vision and sound transmitters might be as much as 2 volts per metre at 45 and 41.5 Mc/s respectively. To avoid blocking of the first stage of the pre-amplifier, a high-pass filter is included in circuit

### Aerial Arrays.

Twelve inverted-V aerial elements supported at the apexes by a triatic suspended from three 45-ft. poles and at the ends by individual short poles, are combined in two groups of six in such a way as to provide two independent arrays each with a theoretical gain of 16.5 db. relative to a half-wave dipole and a beam width of 10 degrees to the half-power points. In practice the gain of each array was found to be 15 db. The outputs from the two arrays are matched to 75-ohm coaxial cable for leading in to the

having a loss of 28 db. at 45 Mc/s and 40 db. at 41.5 Mc/s but passing the wanted signal without appreciable attenuation. This filter, together with rejection circuits in the pre-amplifier following it, gives a substantial measure of protection against interference from the local transmitters, but there are three other factors that also help in this respect. One is the fact that the direction of the local transmitter is depressed substantially below the horizontal and the aerial picks up signals from this direction less efficiently; secondly, the path between the local transmitting and the receiving array is non-optical, a shoulder of land intervening; and finally the local transmission is

\*See p. 152.

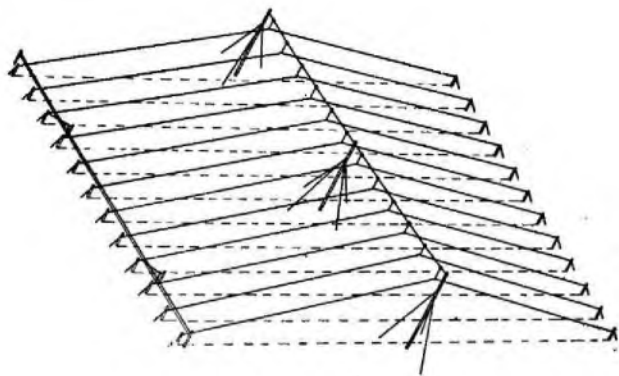

FIG. 5.—AERIAL ARRAY AT BLACK MOUNTAIN.

horizontally polarised whereas the receiving array is designed for the reception of vertically polarised signals. In the latter respect it is perhaps fortunate that the line of sight from the receiving array to Kirk o' Shotts passes almost directly over the local transmitter, for in other directions the array of V's would offer less discrimination against horizontally polarised signals.

#### Radio Equipment.

Each radio receiving channel comprises a low-noise pre-amplifier followed by a receiver fitted with automatic gain control. The average, R.M.S. and peak levels of a television modulated carrier are not constant but change according to the brightness of the picture transmitted. They cannot, therefore, be used for automatic gain control and a more complicated arrangement has to be resorted to. In the television signal, following each synchronising pulse, a short period of black level is transmitted. This is known as the post-synch. suppression or "back porch" and since it always represents black level, the carrier amplitude during this period does give a measure of the signal strength. In the receiver, therefore, arrangements are made to pick out this particular portion of the signal, measure its level, and use a D.C. voltage derived therefrom for gain control in such a way as to maintain the black at a substantially constant level. The receiver delivers a video signal in the band 0.3 Mc/s of amplitude one volt, peak to peak, which is then passed to the cable transmission equipment.

#### Cable Transmission Equipment.

For transmission over the coaxial cable to Glencairn the video signal is put on to a carrier of 6.12 Mc/s as used on the London-Birmingham television cable.\* In this case, however, owing to the short length of the cable, no line amplifiers are required, the output from a modulating unit being fed directly to the cable at Black Mountain and the signal from the cable being fed, after equalisation by passive networks, directly to a demodulating unit at Glencairn. The separate video signals from the two channels are fed to the B.B.C. transmitter building via short coaxial cable leads.

The power filters that enable power to be fed into the coaxial tubes at Glencairn at the same time that the signal is being taken from them (and vice versa at Black Mountain) are similar to those used with C.E.L. 3 equipment except that they are modified to take  $\frac{3}{8}$ -in. coaxial cable sealing ends and to handle a little more power current than normal. Transformers are used at Glencairn to feed power from the public supply mains into the coaxial tubes, but at Black Mountain power from the tubes is fed directly without

transformers from the power filters to the equipment. As with the rest of the equipment, two completely independent power feeds are provided, each tube carrying power for the equipment associated with it on the mountain. Up to 10 amps. can be passed over each tube, enough to supply not only the equipment but also a certain amount of power for lighting, heating and test apparatus. Additional power at Black Mountain for heating, cooking or extra test gear is provided by a 5-kW diesel set which can also be used for running the equipment in the event of cable faults requiring the cable to be isolated from the mains supply.

Picture monitoring facilities are provided both on Black Mountain and at Glencairn, and at the latter place a trolley monitor is provided of the type specially designed for use with London-Birmingham translation equipment. The link will not normally give an output unless Kirk o' Shotts is transmitting, so in order to test the serviceability of the equipment at other times, a rudimentary form of transmitter is provided at Glencairn. This transmitter can be switched on if Kirk o' Shotts is not radiating and a signal from it received at Black Mountain and arriving back at Glencairn by way of the cable indicates that all is well with the equipment.

To assist the maintenance staff, the Kirk o' Shotts sound transmission is also received on Black Mountain and passed at audio frequencies down an interstice pair to Glencairn, to enable them to hear any announcements that may be made. The sound feed for the B.B.C. transmitter, however, is by cable over a normal music circuit.

#### THE LINK IN OPERATION

The preliminary period of observation of signal strength using equipment hurriedly assembled in a small battery hut on Black Mountain occupied about a week in November 1952. During this time a steady signal was received, the deepest fade being of the order of 10 db. Observations with the final aerial array and with the station approaching a state of completion were begun early in March 1953. As might be expected, there was rather more fading at this time of the year and on two occasions the signal strength fell to an unusable level for periods of 5 and 3 minutes. At other times the signal was usable and was held at a substantially constant output level by the receiver automatic gain control, although occasionally during the deeper fades the background noise was higher than would normally be acceptable from a point-to-point television link.

The installation of the link was completed by the target date, 1st April, 1953, and the B.B.C. first started to radiate the signals for test purposes on 11th April. A week later regular test transmissions were commenced and the full programme service began on 1st May. For the first month of service and until after the Coronation, Post Office staff were in daily attendance at Glencairn, but since this date the stations have been operating on an unattended basis. A pen recorder has been used to keep a continuous record of the receiver A.G.C. voltage and hence of signal strength. An analysis of the record shows that over a period of four weeks in June the signal strength fell below the usable level for about 0.44 per cent. of the total time during which Kirk o' Shotts was transmitting. This is believed to be the worst part of the year for fading and it is expected that the record over a whole year will show a substantial improvement. There is some evidence to show that the worst fading conditions are associated with periods of warm, stable weather and that the deepest fades occur an hour or two after sunset, although this is not at all conclusive. As with all radio engineering projects, the design is a compromise between cost and speed of provision on the one hand, and reliability on the other. In this particular case the emphasis

\* The system is fully described by Kilvington, Laver and Stanesby, *Proc. I.E.E.*, 1952, Vol. 99, Part I, p. 44.

was entirely on speed of provision with some inevitable sacrifice of reliability on account of propagation uncertainties. Nevertheless, the periods of loss of signal so far recorded represent only a very small percentage of the total time and, if this performance is maintained, the grade of service must be considered very satisfactory in the circumstances.

ALL SAINTS CHURCH		
KINGSTON SEYMOUR		
BILL	DIAMETER	WEIGHT
TENOR	3 1/8 in.	17 cwt
FIFTH	3 1/4 in.	10 1/2 cwt
FOURTH	3 in. 0 in.	8 cwt
THIRD	2 ft 10 in.	6 1/2 cwt
SECOND	2 ft 7 in.	6 cwt
TREBLE	2 ft 6 in.	5 1/4 cwt
		<b>2 TONS 13 CWT</b>

FIG. 6.—PICTURE RECORDED AT BROADCASTING HOUSE, BELFAST.

Fig. 6 shows a television picture recorded by kind permission of the B.B.C. at Broadcasting House, Belfast. The illustration is of particular interest because of the number of links in tandem over which it had passed. Originating at an outside broadcast from Kingston Seymour in Somerset, it was passed to Wenvoe by B.B.C. microwave link, thence by Post Office  $\frac{3}{8}$ -in. cable to London, 1-in. cable from London to Birmingham,  $\frac{3}{8}$ -in. cable from Birmingham to Manchester, and microwave relay from Manchester to Kirk o' Shotts. From Kirk o' Shotts it was radiated by the B.B.C. transmitter, and picked up by the Post Office receiver on Black Mountain; thence by cable to Glencairn whence it was re-radiated by the B.B.C. transmitter, finally being picked up on a receiver at Broadcasting House, Belfast. Eight different video-to-video links were therefore involved in the transmission over a distance of about 770 miles.

#### CONCLUSION

The author would like to pay tribute to all those who helped in setting up the stations and in particular to the staff of the Northern Ireland Region who carried out their work on Black Mountain under very arduous conditions, and to the staff of Construction Branch who assisted with the cable jointing. To them must go the main credit for the fact that the "ready for service" target date of 1st April was met.

## Book Reviews

"Electro-Magnetic Machines." R. Langlois-Berthelot, M.I.E.E., M.A.I.E.E. Macdonald & Co. (Publishers), Ltd., London. 535 pp. 309 ill. 65s.

This is a translation from the French. The subject is presented in a very refreshing manner but the student at the beginning of his studies of electrical machines might have difficulty in finding his way in a book which the author describes as "A sort of grammar or abstract study of the machines." The claim is made in a foreword that "This book is unique in respect of objectivity in excluding as far as is practical everything that is transitory and in retaining what appears to be permanent. It is thus a happy mean between the classical French treatise, which tends to exclude everything which savours of practice, and the materialistic English type which concentrates on what is, for the time being, practical and utilitarian." This claim is largely borne out by the contents. Since the general theory of electrical machines (both A.C. and D.C.) and transformers is dealt with and the treatment is mathematical, individual machines of special types such as variable-speed A.C. motors and converters are not covered in any detail. After dealing with his main subject the author proceeds to give some very interesting views on standardisation, the relation between scientific and technical viewpoints, method of reasoning in electro-techniques, and on the field of industrial research. The titles of the first two of the six parts into which the book is divided give an idea of the author's somewhat novel approach. Part 1 is headed "The Families of Electrical Machines" and Part 2 "The General Anatomy and Physiology of Electrical Machines." There are 29 chapters in some 530 pages dealing with the electro-magnetic theory of machines, general constitution of rotating machines, the form of the magnetic field, the applications of Ampère's, Faraday's and La Place's Laws to rotating machines, self and mutual inductance of machines, equations of rotating machines, properties of materials used in electrical construction, the action of temperature on insulating materials, losses and efficiency, commutation, design office calculation of a machine, the specification of electrical machines, acceptance tests, characteristics of machines, harmonics and transient conditions for the fluxes and currents. The book is well illustrated with very neat diagrams.

A. E. P.

"Radio Interference Suppression." G. L. Stephens, A.M.I.E.E. Iliffe & Sons Ltd. 130 pp. 65 ill. 10s. 6d.

This book, which is a revised version of an earlier work by G. W. Ingram published in 1939, presents a useful and comprehensive survey of the problem of radio interference and its suppression. It deals with the subject from the essentially practical aspect and as such should be invaluable both to manufacturers and users of electrical appliances and to all concerned with the control of radio interference.

Although this book has brief appendices covering such matters as the measurement of interference and the Wireless Telegraphy Act, 1949, the emphasis throughout is on the practical problems of how radio interference is caused, how the source can be located and how best it can be suppressed. The accompanying illustrations have obviously been carefully selected and their form and presentation calls for particularly favourable comment. The text itself is written in a pleasing and easy style, so rendering what might otherwise be a mere catalogue of technical facts and circuits a book worthy of study by all concerned with the problems of radio interference and its suppression.

D. A. T.

"The Use of A.F. Transformers." N. H. Crowhurst, A.M.I.E.E. Norman Price (Publishers), Ltd., 64 pp. 44 ill. 3s. 6d.

In this booklet the author has shown how the suitability for a particular purpose of any given transformer may be determined from a knowledge of certain of the transformer parameters. Sufficient information is presented in various parts of the book to enable the reader to determine the parameters of any A.F. transformer with sufficient accuracy for most purposes. Some useful charts are provided for the prediction of the performance of the transformer when associated with varying values of source and load impedances. In an appendix the parameters of a number of stock lines of commercial transformers are listed.

The main emphasis of this work is the relevance of the associated circuit values to the performance of the transformer and for those who have not had much experience of transformers the book should be very useful.

J. W. McP.

# Poor Solderability of Tags, and Dry Joints

H. F. HOURIGAN, B.Sc., F.R.I.C.  
J. W. ROBINSON, B.Sc., Ph.D., A.R.I.C.  
W. T. EDWARDS, F.R.I.C., A.I.M.†

U.D.C. 621.791.3

Many of the brass connection tags used in Post Office equipment are finished by mass dipping in a hot solder bath and tags processed in this manner have been found to exhibit widely varying degrees of solderability. The authors show that in mass soldering, copper and zinc—the constituent metals in brass—dissolve into the hot solder and contaminate the bath with the result that the solder surface of many tags has a high zinc content giving bad solderability. Experiment indicates that a nickel flash on the brass tag followed by mass soldering at a controlled temperature effectively prevents contamination.

## INTRODUCTION.

IN the past 10 years there have been revolutionary changes in the processing of tags for assembly in electrical apparatus on to which wires have ultimately to be soldered. It had, for many years, been the practice to dip the tags individually and this method is still followed when it is necessary to restrict the solder to a part of the surface only. Where this restriction did not apply the production of tags was speeded up by mass solder coating all over thereby using the solder coat as a protective finish as well as a preparation for soldering.

It should perhaps be mentioned in passing that electro-tinning and hot-dip tinning with tin, as distinct from solder, were both tried but neither was completely satisfactory. Although solder coating has hitherto been considered the best mass treatment of tags it will be seen later that it is, in fact, much inferior to the individual treatment which it superseded. Soon after mass solder coating was introduced, works chemists were faced with a problem as the factory operatives began to complain of poor solderability. This difficulty was traced to the fact that copper and zinc are dissolved from the brass tags when immersed in hot solder and these metals contaminate the solder. The first effect of this is to increase the viscosity of the solder and reduce its wetting power. In general, the more contaminated the solder, the more pores leading down to the surface of the brass will be found.

As the amount of copper and zinc increases, copper-rich and zinc-rich "phases" begin to separate out, and as they have a higher melting point than the solder, these phases will be solid; for this reason and because of increase of viscosity, the solder ultimately becomes impossible to use.

The obvious remedy is to increase the temperatures of the solder, liquifying the "ice-flows" and again enabling the solder to spread out on the work. Unfortunately, raising the temperature rapidly increases the rate of solution of the brass, and it is soon necessary to adopt other measures.

When the problem was realised much ingenuity was used by works chemists in overcoming the trouble. "Freezing," i.e., cooling to a suitable temperature and skimming the solid phases from the surface, was introduced and this enabled the period between the discarding of the bath and replacing with new solder to be extended, while producing a tag surface that was just tolerable to the operator. It is probable too that the soldering iron heats were raised to help overcome the difficulty. Along with this, the need for careful temperature control of the bath was recognised; and the size of the bath was reduced to an optimum.

This was the picture of present day production at the time the authors' attention was drawn to the hopelessly bad solderability of certain tags (STA/36 and /37) which had been in stock for a long time.

## PRELIMINARY INVESTIGATIONS

Preliminary investigations to discover whether there was a case for formal investigation revealed two salient points:

† The authors are respectively, Principal Scientific Officer, Senior Scientific Officer, and Senior Experimental Officer, Birmingham Chemical Section, Test and Inspection Branch, E.-in-C.'s Office.

(a) the product of one firm, on inspection obviously individually dipped, had never been known to give trouble and (b) some mass-produced tags which were quite old were reasonably good.

It was evident, therefore, that some differences existed between the individually dipped article and the mass produced one, which reduced the solderability of the latter. As marked differences existed between the solderability of different samples of aged tags there appeared to be a variable, which if identified and eliminated would secure the production of coated tags with a better average level of solderability. It also seemed likely that there was some association between age and a change in appearance from light metallic to dark grey non-metallic. Clearly a case existed for further investigation.

The first step was to devise some reliable means of grading the varying solderability of samples as a guide to further experiment. For this purpose a test set was made up based on the idea that at high temperatures there would be little differentiation between good and bad solderability, but that by reducing the temperature a point could be found where the very bad cases would be on the verge of refusing to take, while good tags would still solder as well as ever. By inserting a variac in the A.C. mains circuit of an electric iron and cutting down the heat this postulate was shown to be true and at a temperature of 220°C a good differentiation was obtained as explained in the following section.

## Solderability Tests on Tags.

Fig. 1 shows the layout for the test, with the soldering iron notched to provide a flat on which the tags rest. The variac in the mains circuit affords a simple temperature control. As the temperature of the circumambient air has an appreciable effect on the temperature of the iron for a given variac setting, it was necessary to make regular checks on the temperature, which in this test were carried out by means of a thermo-couple placed in a small hole drilled in the side of the bit.

The small mechanical device on the left consists of a guillotine, pivoted at one end and fitted with a spacing piece, which was used for cutting off standard beads of resin-cored 16 S.W.G. solder. By this means the beads could be reproduced to a weight of 0.03 gm.  $\pm$  0.003 gm.

Studies were made with tags STA/36 and /37 of various ages and from several sources. It was clear that by reducing the soldering temperature the deficiencies of some of these tags were thrown into relief. At 220°C the differentiation was striking and samples were selected to illustrate five gradings of solderability. The gradings are shown in Fig. 2 for three different temperatures and, reading from top to bottom, these may be described as Very Good, Good, Fair, Bad, and Very Bad, respectively.

The method of test was to lay the tag in the notch of the iron for 30 seconds, timed with a stop clock, and then to place three standard beads of solder on it, one in the centre and one at each end. While the visual control of the test by comparison, as in Fig. 2, is adequate it is also possible to fix the grading by determining the height of the pool of



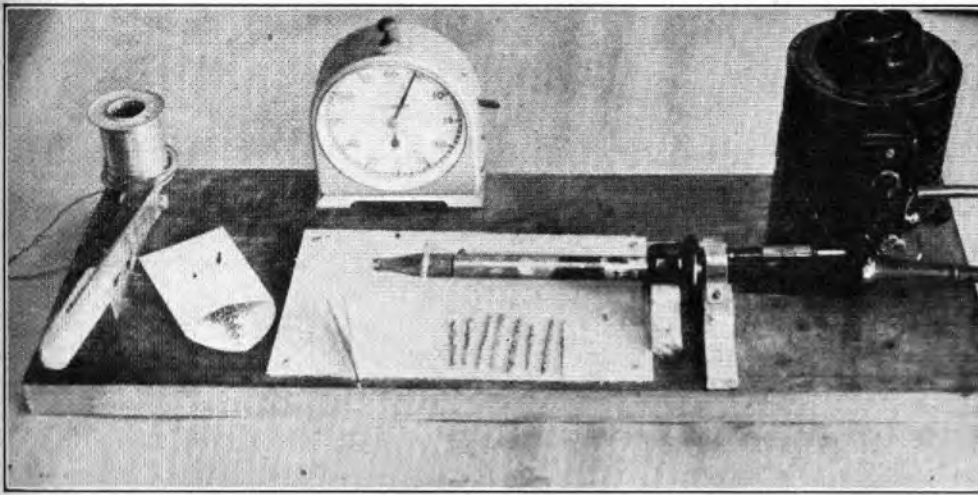

FIG. 1.—LAYOUT OF EQUIPMENT FOR SOLDERABILITY TESTS ON TAGS.



FIG. 2.—TAGS AFTER TEST, SHOWING FIVE GRADES OF SOLDERABILITY.

solder, from the bead, with a micrometer screw gauge since the quality of solderability is decided by the extent to which the bead will spread (in other words, wet). Table 1 illustrates this and shows the degree of spread produced by the standard bead at various temperatures on the five grades of tags.

The three temperatures have been shown in both table and photograph as evidence of the validity of the principle of decreasing the temperature of the iron to improve the differentiation of the test.

Fig. 2 also shows clearly the refractory effect of the highly oxidised surface on "Bad" and "Very Bad" tags with the bead standing up as a sphere on the surface. Close observation when the bead is first dropped on reveals that a longer time elapses before the piece of resin-cored solder melts and takes up the form of a sphere, and also that the oxide film is massive enough to absorb the flux and thus prevent wetting.

TABLE 1  
Solder Spread at Various Temperatures

Tag	..	..	220° C	285° C	390° C
Very Good	..	..	0.007 in.	0.006 in.	0.0055 in.
Good	..	..	0.019 in.	0.009 in.	0.007 in.
Fair	..	..	0.045 in.	0.02 in.	0.008 in.
Bad	..	..	0.058 in.	0.043 in.	0.018 in.
Very Bad	..	..	Not melted	0.056 in.	0.04 in.

The following descriptions of the gradings for solderability of tags may help to fix the levels in conjunction with Fig. 2 and Table 1:—

*Very Good.* The solder immediately wets the surface and spreads over the whole surface of the tag.

*Good.* The solder wets the surface immediately but

does not spread over the whole surface of the tag.

*Fair.* The wetting is slightly delayed and spread is not so great as in the previous grading.

*Bad.* Wetting is delayed 5 to 10 sec. and there is little spread.

*Very Bad.* There is no wetting, and melting of the solder bead to a sphere takes 10 to 20 sec.

#### CHEMICAL EXAMINATION

Having thus established a means of classifying the solderability of tags the chemical investigation could be commenced. Three tags from a block which fell in the solderability category of "Very Bad" were selected for chemical study of their surfaces. The procedure was dictated by the following considerations:—

(1) Samples had to be obtained in such a way that it would be improbable that any impurity found came from the brass of the tag *at the time of*

*sampling.*

- (2) Cleaning of the surface was not permissible as this might have disposed of something which it was important to know about.
- (3) Lead and tin needed to be removed from surface samples to facilitate the estimation of traces of other elements.
- (4) To avoid trouble regarding availability of samples and provide ease of manipulation it was desirable to work with a sample of 1 to 5 milligrams.

The thickness of coating on tags is in the order of one thousandth of an inch and calculation showed that removal of a top layer weighing 5 milligrams from three tags (surface area 2 sq. in.) would reduce the thickness by 0.00002 in or 2 per cent. at most. The chance of penetrating a normal and continuous coat when stripping with acid was therefore remote. The possibility of minute discontinuities existing had, however, to be taken into account. In such case it was reasonable to expect that the resulting copper and zinc content would increase with each successive sample from the same tags, and this would be the signal to discontinue the series of tests; in practice this eventuality did not arise.

On 5 secs. immersion in hot hydrochloric acid three tags with a surface area of 2 sq. in. gave a sample of between 1 and 5 milligrams. The solution was "taken down" on the hot plate to less than 1 millilitre and given three successive treatments with hydrochloric acid saturated with bromine to eliminate tin, followed by precipitation of the lead by adding dilute sulphuric acid and taking to fumes, diluting and filtering. These operations could be carried out with great speed due to the small quantities involved. From the weight of sample taken and the surface area of the sample it was possible to calculate the thickness of solder removed. Hence the zinc concentration at various distances from the surface could be computed.

The surface layer weighing 0.0018 gms. from the three tags having a surface area of 2 sq. in. was found polaro-

graphically\* to contain 23 per cent. zinc. Successive acid stripping and polarographic examination showed that the second layer contained 3.8 per cent. zinc and the third 3.0 per cent. On the other hand three tags from a block showing good solderability (Category "Good") and some years old had only 1.4 per cent. zinc in the surface layer and 0.25 per cent. zinc in the second. This state of affairs was found to be quite general and it was noticed too that old tags with high zinc surfaces were more reactive to the acid used for stripping. In other words a bigger weight of surface material went into solution in the first acid treatment with an old "high zinc" sample than with a new "high zinc" sample, and the solution weight declined even further when the zinc figure was low. It was also noticed that the amount of sample obtained decreased with each successive acid strip of the same sample.

#### RATE OF ATTACK OF MOLTEN SOLDER ON BRASS AND NICKEL-PLATED BRASS

Returning to the question of solution of metal from the tags it was decided to make studies of the rate of attack of molten 60:40 solder on bright-dipped brass and on nickel-plated brass, as in preliminary experiments at contractor's works nickel plating seemed to offer a solution to the soldering problem.

The detailed objects of this part of the investigation were to ascertain:—

- If any preferential solution of either zinc or copper took place in the solder when mass treating brass tags.
- The actual rate at which these metals were attacked.
- The effect of a nickel flash on brass tags treated the same way.

#### Experimental Procedure.

A bath of 60 : 40 solder was made-up in a glass beaker and maintained at a steady temperature.

It was decided to use brass wire rather than tags since the surface area could be accurately measured, and because the surface area was greater per unit weight of material than with a tag. Hence 60 : 40 brass wire 0.04 in. dia. and 36 in. long was used as a standard sample.

A sample was taken, bright-dipped, washed and dried. This was then submerged in the solder bath for 30 minutes. At the end of this time, the wire was replaced by a new length of wire, similar in all respects to the first. This procedure was repeated, with constant stirring until the solder had been in contact with brass wire for 7 to 8 hours.

At various intervals of time, samples of the solder were taken for analysis, zinc and copper being estimated.

This experiment was repeated at various temperatures. Simultaneously, brass wire from the same reel as that already used was given a nickel coating 0.0001 in. thick and a duplicate set of experiments performed, in all ways similar to those using ordinary brass.

#### Results.

The experimental results are summarised in the graphs, Figs. 3, 4 & 5.

It is significant that in all cases the ratio of copper to zinc was 60 : 40, showing that the brass was simply dissolved in the solder. Another important feature of the results was the rapidity of the uptake of brass by the solder

\*Polarography is a rapid and accurate technique of chemical analysis in which the electrolysis of solutions between mercury electrodes is studied. During the electrolysis, a voltage which increases at a uniform rate is applied to the cell and the current/voltage curves thus obtained are recorded.

From these curves (polarograms) the identity and concentration of substances in solution can be determined. The identity is inferred from the voltage at which a sudden increase in current takes place and the concentration from the extent of the increase in current.

and the levelling off after a period showing that the rate of solution of the brass was equal to the rate of loss from the molten solder to the dross. The graphs show how rapidly a solder bath becomes contaminated with zinc and copper when brought in contact with brass.

Fig. 3 gives the nickel content of the bath at various times. It does not give the rate of solution of nickel in

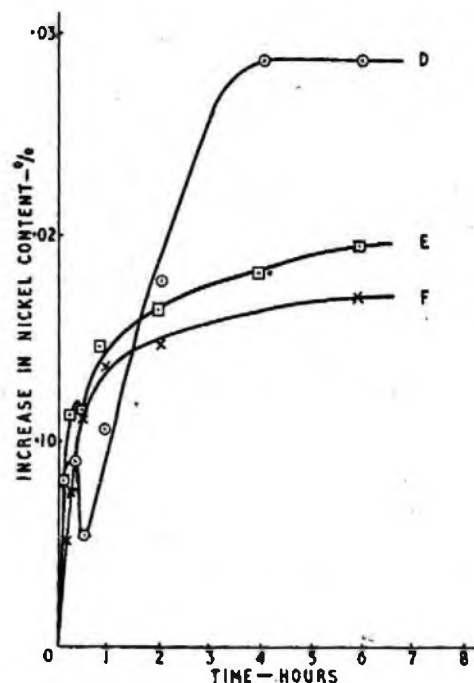

FIG. 3.—NICKEL CONTENT OF 60/40 SOLDER AFTER PROLONGED CONTACT WITH NI-PLATED BRASS WIRE WHEN SOLDER TEMPERATURE WAS: D—350°C; E—250°C; F—210°C.

solder at the temperatures given since it is very likely that the nickel content increased rapidly when a fresh wire was immersed in the bath, but decreased when rate of drossing exceeded the rate of solution, e.g., after it had all been dissolved. This is particularly so with the curve obtained for 350°C.

At 250°C there was a short period after 25 minutes when all the nickel was dissolved off the wire, exposing the brass to the solder. Five minutes later a fresh wire was inserted in the bath. It can be seen from Figs. 4 and 5 that the bath was contaminated in this period. The nickel does not appear to have been penetrated again in this series. This fact suggests that the presence of a small amount of nickel in the solder reduces the rate of solution of the nickel coating. This question is being examined.

At 210°C the nickel appears to have stayed intact throughout and to have completely protected the brass.

Fig. 4 gives the change in copper content of the bath plotted against time. With plain brass, the copper is dissolved more quickly as the temperature of the solder bath is increased.

Nickel plating produced a notable effect. At 350°C the coated and uncoated brass dissolved at similar rates showing that the nickel provides no protection at this temperature. At 250°C the nickel plating of the first sample was penetrated and copper contamination of the bath took place. The amount of copper present in the bath remained constant, showing that no drossing or solution of the copper took place. At 210°C no copper was dissolved, showing that the nickel provided complete protection.

Fig. 5 showing the increase in zinc content with time indicates results very similar to those obtained for copper. With the uncoated wire, increase in temperature increased

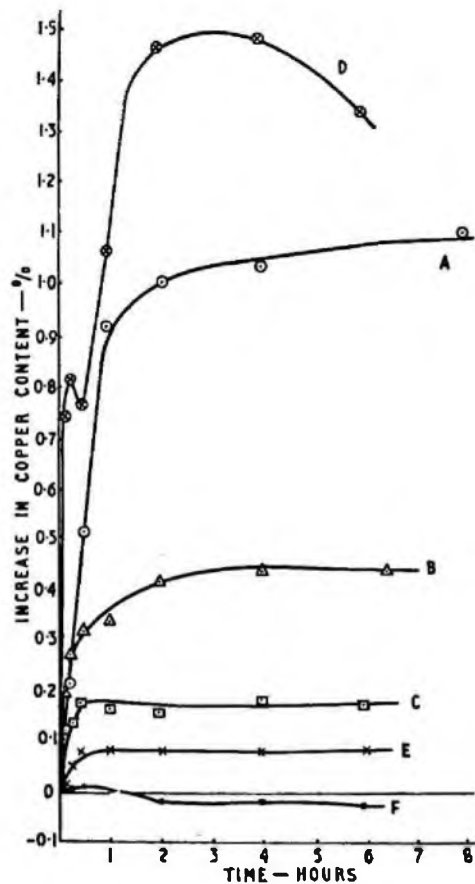

FIG. 4.—COPPER CONTENT OF 60/40 SOLDER AFTER PROLONGED CONTACT WITH:—  
 "BRIGHT-DIPPED" BRASS WIRE WHEN SOLDER TEMPERATURE WAS: A—350°C; B—250°C; C—210°C.  
 NI-PLATED BRASS WIRE WHEN SOLDER TEMPERATURE WAS: D—350°C; E—250°C; C—210°C.

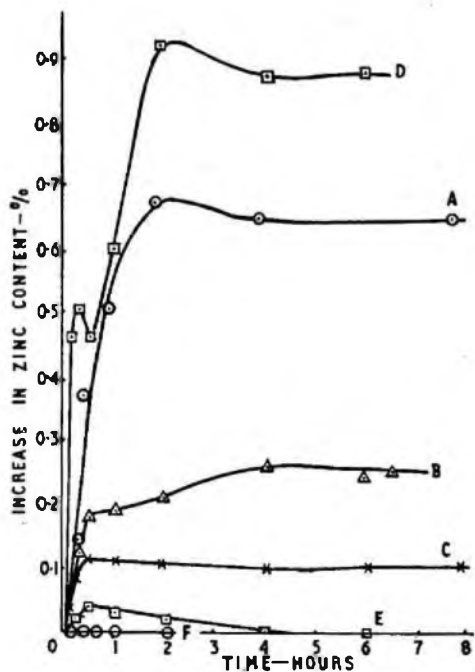

FIG. 5.—ZINC CONTENT OF 60/40 SOLDER AFTER PROLONGED CONTACT WITH:—  
 "BRIGHT-DIPPED" BRASS WIRE WHEN SOLDER TEMPERATURE WAS: A—350°C; B—250°C; C—210°C.  
 NI-PLATED BRASS WIRE WHEN SOLDER TEMPERATURE WAS: D—350°C; E—250°C; F—210°C.

the rate of solution of zinc. With the nickel-coated wire at 350°C the protection was ineffective; at 250°C, after early contamination the nickel gave complete protection and the zinc slowly crossed out; at 210°C the nickel gave complete protection.

The results show that nickel coating provides protection to the brass from the solder. This protection is very good below 250°C and complete below about 200°C with a thickness of nickel coating of 0.0001 in.

It is also apparent that zinc will slowly cross out of the solder bath, but that although copper crosses out when the concentration is high, it does not cross out at low concentrations, indicating an appreciable solubility of copper. Both metals reach a high concentration if contact between the brass and liquid solder is allowed to continue.

#### SURFACE OXIDES AND CORROSION TESTS

It was considered worth while in view of the detection of a zinc-rich surface to attempt to establish the identity of the compounds on the surface of old tags. Electro-chemical theory provided interesting corrosion possibilities once the presence of zinc on the surface had been established. It was decided therefore to examine the surface by means of an electron microscope. Appendix I gives a short discussion on the results and their implications.

It was felt that one point might well be followed up to add even more weight to the experimental evidence. It had been observed that high zinc surfaces were more reactive in acid than surfaces with negligible zinc. While this seemed to show that the zinc made the surface more corrodible it was thought that there was too great a difference between acid and the normal atmospheric attack to admit this observation to the consideration. An experimental series was devised, however, in which solders containing varying amounts of zinc were steam-aged and the gain in weight observed. The curves obtained and photographs of the test series together with explanatory notes will be found in Appendix II.

#### CONCLUSIONS

The methods employed in the mass solder coating of tags result in a product in which the solderability is reduced by as much as 40 per cent. The small zinc content of these coatings is much more detrimental than would appear to be the case due to the surface effect. Nickel plating of the tags before coating effectively prevents the contamination of the solder coating providing the nickel is 0.0001 in. thick and the temperature kept between 200° and 250°C.

For hand-dipped tags it has always been the practice to nickel plate the brass. Moreover, the very short time of dipping reduces still further any likelihood of contamination of the bath, since not only is the time of contact between solder and brass, short, but also the temperature of the brass will not have increased to equilibrium with the bath.

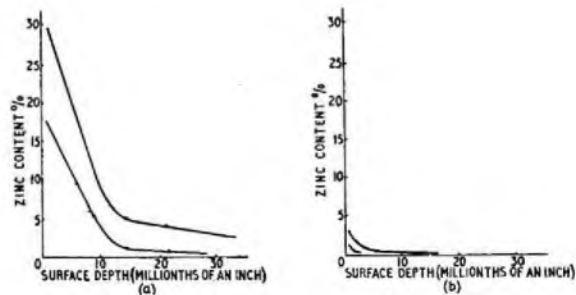

FIG. 6.—COMPARISON OF ZINC CONTENT IN SURFACE SOLDER APPLIED TO TAGS BY (a) MASS SOLDERING ON BRASS TAGS; (b) USING NI-PLATED BRASS TAGS AND A TEMPERATURE-CONTROLLED SOLDER BATH.

It can be seen, therefore, that the conditions recommended for mass production have been unwittingly observed for hand dipping.

Many of the telephone contractors have now changed over to the nickel plating and control of temperature to about 200°C recommended as a result of this work. Fig. 6 shows how the new product compares with the old.

This work may provide the beginning of a theory to account for sound joints becoming dry after a period of time.

## APPENDIX I

### EXAMINATION OF SURFACE OXIDES

The experimental procedure followed is described below:—  
Pure specimens of all the possible surface compounds were examined and the diffraction pattern of each taken.

A series of tags were then dipped in "Formvar" solution (0.5 per cent. in 50/50 chloroform and acetone mixture) for 5 minutes. They were then removed and dried at 110°C for 1 hour. This left a Formvar coating of 50 Angstroms on the material.

The tag was then immersed in 10 per cent. bromine in alcohol solution which attacked the metallic solder and allowed the Formvar skin and adhering oxides to be removed.

The oxides were examined on the electron microscope and diffraction patterns taken from individual crystals. Zinc oxide and cuprous oxide were identified in addition to the lead and tin oxides present. Zinc or copper were not found present in any other forms, e.g., basic carbonate.

It was not possible to deduce any quantitative estimation of these compounds from this investigation.

#### Theoretical Consideration.

The function of the zinc at the surface is uncertain. It is known that the net result is the formation of a porous oxide layer at the surface of the solder.

Two possible mechanisms are as follows:—

- (1) Galvanic corrosion between the zinc and the tin and/or lead. It is known that copper forms  $\text{Cu}_3\text{Sn}$  and  $\text{Cu}_6\text{Sn}_5$  which is noble to the solder and does cause galvanic corrosion.
- (2) The brass is known to be dissolved by the solder when molten. On solidification diffusion of these metals still proceeds, but at a much reduced rate. Any zinc which reaches the surface will be oxidised (galvanically) and by atmospheric oxidation to  $\text{ZnO}$ , and will be unable to rediffuse into the solder.

This would lead to an accumulation of zinc oxides at the surface of the solder, which may give rise to a non-coherent oxide film leading to slow but continuous atmospheric oxidation and corrosion.

Solder normally forms a coherent oxide film and thus the oxidation is not progressive. The presence of zinc oxide in this case would lead to the formation of a non-coherent oxide film leading to slow but continuous atmospheric and galvanic oxidation.

Only time, oxygen and water vapour would be required to produce a massive oxide film capable at once of heat insulating the solder bead and "mopping up" any flux that might be with it.

These considerations lead to the experimental series described in Appendix II.

## APPENDIX II

### CORROSION TESTS

#### Effect of Zinc as an Impurity.

The object of this work was to determine directly the effect of zinc on the rate of corrosion of solder.

#### Experimental Method.

A quantity of 60 : 40 solder was fused and the appropriate amount of zinc metal added. After mixing, the alloy was chill cast. Portions of this alloy were then re-melted and fresh 60 : 40 solder added to each, giving a range of alloys containing 0.60 per cent., 0.12 per cent., 0.06 per cent. and 0.00 per cent. zinc. The pure solder had zinc impurity of 0.0045 per cent. Polarographic analysis of this alloy gave results of 0.71 per cent.,

0.119 per cent., 0.062 per cent. and 0.0045 per cent. zinc respectively.

The samples were then rolled to a thin section in order to give a large surface area. Samples of about 1 sq. cm. were cut, weighed and steam-aged at 100-105°C and re-weighed at various intervals.

The gain in weight was considered to be representative of the degree of oxidation of the material, and hence the corrodibility.

#### Results and Conclusions.

The results are summarised in Figs. 7 and 8. From these results it can be seen that the rate of corrosion of solder containing zinc is greatly increased, with the formation of a

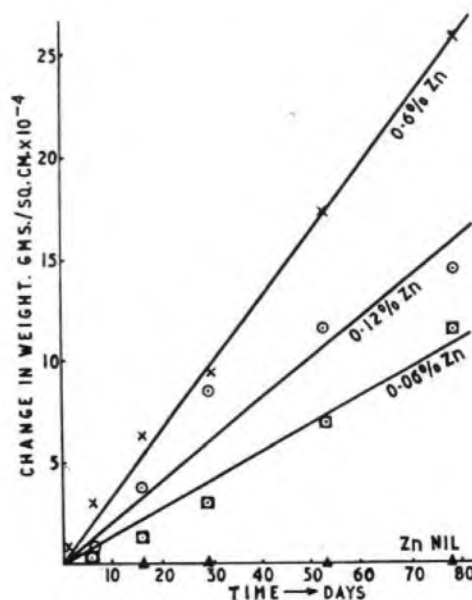

FIG. 7.—INCREASE IN WEIGHT OF 60/40 SOLDER CONTAINING VARIOUS AMOUNTS OF ZINC WHEN EXPOSED TO STEAM ATMOSPHERE AT 100°C.

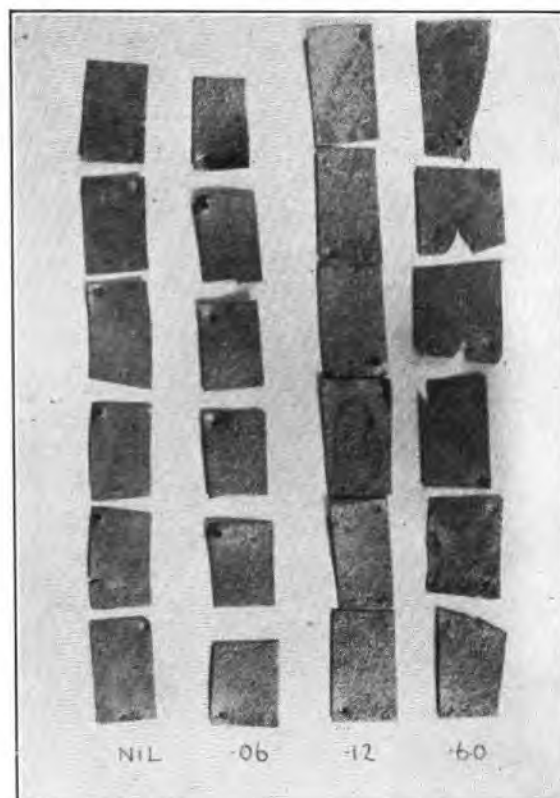

FIG. 8.—TEST PIECES CONTAINING ZINC AFTER STEAM-AGEING FOR 80 HOURS AT 100-105°C.

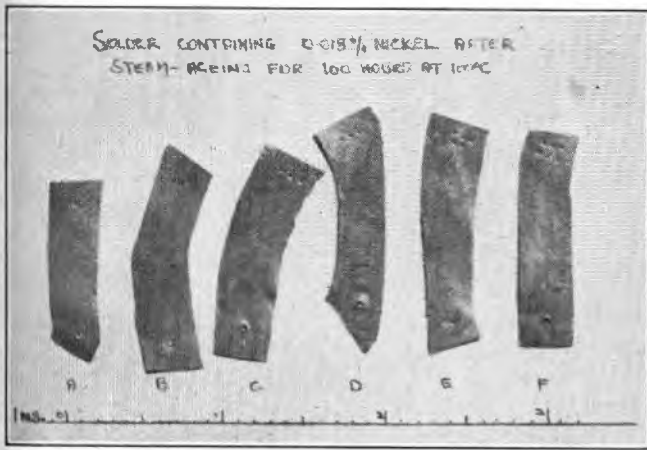

FIG. 9.—TEST PIECES CONTAINING NICKEL AFTER STEAM-AGING.

loose oxide coating. This supports the view that a non-coherent oxide film is formed on solder with zinc impurity even as low as 0.06 per cent. Fig. 8 shows the test series after 80 hours

steam-aging at 100-105°C. The roughening of the surface, due to massive oxide formation, is clearly visible.

#### Effect of Nickel as Impurity.

Since any nickel coat will be dissolved to some extent by molten solder, it was felt desirable to obtain information on the effect of nickel on the corrosion of solder.

The sample used contained 0.018 per cent. nickel, which was the content of the solder bath after being in contact with nickel for 8 hours.

The results after steam-aging for 500 hours are tabulated below. Fig. 9 shows the samples after this period of aging.

Sample	Wt. of Sample	Wt. of Sample after 500 hours	Area
A	0.21752 gm.	0.21753 gm.	3.84 sq. cm.
B	0.22725 gm.	0.22733 gm.	5.02 sq. cm.
C	0.19333 gm.	0.19337 gm.	5.70 sq. cm.
D	0.26071 gm.	0.26072 gm.	4.62 sq. cm.
E	0.31633 gm.	0.31634 gm.	4.66 sq. cm.
F	0.23909 gm.	0.23913 gm.	4.68 sq. cm.

It can be seen that nickel has no injurious effect on the solder, and that the rate of corrosion up to 500 hours was very similar to that of pure solder.

## Book Reviews

"Practical Clock Repairing." Donald de Carle, F.B.H.I. N.A.G. Press, Ltd., London. 239 pp. 412 figs. 30s.

Craftsmen have, in this volume, their first modern textbook on mechanical clocks of wall, bracket, carriage and grandfather classes.

Workshop facilities and typical methods of examination, repair and renovation are fully described, with numerous line drawings, the greatest attention being paid to the practical manner in which the work is performed, together with the use of tools and materials. Traditional as well as modern types of tools are included.

Principles of function and special design features are explained and illustrated. These include escapements of anchor (solid and strip forms), cylinder, pin pallet, deadbeat and verge types, and mechanisms of striking, alarm, ting-tang, chiming, repeating and grande sonnerie clocks.

Gearing problems are explained in ample detail for repair purposes as required to check the correct meshing of teeth, calculate the size of a missing wheel or (with a table of constants supplied) find the length of a required pendulum.

The subject of pendulums—their operation, construction, circular error, temperature and barometric variation and service faults—receives due attention.

For those who wish to make a clock for practice or pleasure, working instructions are given for making a complete time-piece of fusee and pendulum type from stock materials.

Due to previous publication in serial form, the book has the quality of a second edition. The art of hot lacquering might, however, have been better described, and, surely, lacquered movements should be relacquered when they are disfigured by repair or age, but these are trivial matters in a book which has been welcomed by the trade, and which not only horologists will find a useful and reliable work of reference. E. W. W. *I.P.O.E.E. Library No. 2059.*

"Electrical Fundamentals of Communication." Arthur L. Albert, M.S., E.E. McGraw-Hill Publishing Co., Ltd. 531 pp. 363 ill. 59s. 6d.

The term "Telecommunication Principles" will be fairly well known to readers of the *Journal*, and it may be helpful to explain that this, in essence, is the subject of Professor Albert's book, now in its second edition. As one would expect from a teacher of communication engineering with long experience, the book includes a thorough treatment of basic electrical principles with theories and discussion withstanding rigid examination. The application of these principles in the fields of telegraphy, telephony and radio is explained in sufficient detail to prepare a student for the more advanced study of telecommunications engineering, and the book thus forms a most valuable introductory work.

A feature of particular interest is the emphasis on radio fundamentals, nearly 100 pages being devoted to two of the later chapters entitled "Fundamental Principles of Electron Tubes" and "Electron Tubes as Circuit Elements." Broadly speaking the earlier chapters cover the principles of direct and alternating currents, conductors and insulators, magnetic and electric fields, measuring instruments, networks, bridge circuits, electromagnetic waves and, finally, electro-acoustics, with the explanations and illustrations for each chapter drawn almost exclusively from the telecommunications field.

Special points that will appeal to students are: the inclusion of many worked examples; chapter summaries of all the principal points covered; review questions for self-examination; and a selection of numerical problems (without answers).

The book is printed and bound to the high standard one associates with the publisher named and represents good value for money under present conditions. It is a matter for regret that current publication costs so often, as in this case, render a book too expensive for many of those who could make the best use of it. G. E. S.

"Industrial Brazing." H. R. Brooker and E. V. Beatson. Iliffe & Sons, Ltd. 344 pp. 235 ill. 35s.

The authors, who have produced a reference book of wide scope, begin with definitions, terms and a brief history of brazing. The various methods of heating described, which range from the simple bunsen burner to complex induction heaters, clearly show the flexibility of the process. The methods include torch and furnace brazing, brazing by induction and by electrical resistance heating. Salt bath brazing and dip brazing are also described.

The significance of oxidising and reducing conditions of heating is dealt with, and the various methods of producing and applying protective atmospheres are explained. A chapter devoted to brazing materials lists the alloys used and the forms in which they are available. Metallurgical considerations and the uses of various fluxes are discussed.

Methods of brazing are dealt with separately and exhaustively and recommended combinations of parent and brazing metals are given for each process.

The book contains much useful information on the design and strength of brazed joints and of methods for testing and inspecting the joints.

Several special applications, such as the brazing of cemented carbides and stainless steel, are given and the final chapter is concerned with selection of process.

Success in brazing largely depends on the selection of suitable materials and method and while each job calls for individual planning, much improvisation with comparatively simple equipment can be successfully employed. This volume deals thoroughly with the subject and should provide a useful guide for those interested in brazing. N. F. S.

# Single-Sideband Multi-Channel Operation of Short-Wave Point-to-Point Radio Links

H. E. STURGESS, A.M.I.E.E. and  
F. W. NEWSON, A.M.I.E.E.†

## Part 4(a).—An Independent-Sideband High-Power Short-Wave Transmitter—The Radio and Power Units.

U.D.C. 621.396.41:621.396.61.029.58

This article describes the radio and power units of an independent-sideband transmitter capable of providing a peak power output of up to 70 kW in the frequency range 4-22 Mc/s. Although primarily intended for i.s.b. operation, using the two-channel drive unit described in Part 2 of the series, the transmitter can also be used for double-sideband telephony and C.W. and M.C.W. telegraphy. The concluding part of the series will cover the design features of the transmitter and give details of its performance.

### INTRODUCTION

THE transmitter described in this article has been installed at the Post Office Radio Station, Leafield, near Oxford. It was designed, constructed and tested by staff of the E.-in-C.'s Office (WP Branch), much of the construction work being carried out at the radio station with some assistance from the station staff. The complete equipment has been operating on traffic since late 1951.

A primary requirement in the design of the transmitter was that it should be capable not only of independent-sideband (i.s.b.) operation but also of double-sideband (d.s.b.) working and be suitable for C.W. and M.C.W. telegraphy, with the largest practicable power output.

The main performance features are as follows:—

- (a) Output frequency range—  
3.85 to 22 Mc/s.
- (b) R.F. power output.  
Peak envelope power—  
70 kW at 3.85 Mc/s,  
50 kW at 22 Mc/s.  
Mean power—  
35 kW at 3.85 Mc/s,  
25 kW at 22 Mc/s.
- (c) Types of emission<sup>1</sup> when used with a 3.1 Mc/s Independent-sideband Transmitter Drive Unit (described in Part 2 of this series).<sup>2</sup>
  - (i) Single-sideband (s.s.b.) multi-channel telephony or telegraphy.
  - (ii) Independent-sideband (i.s.b.) multi-channel telephony or telegraphy.
- (d) Types of emission without 3.1 Mc/s Drive Unit.
  - (i) Double-sideband (d.s.b.) telephony.
  - (ii) Continuous-wave (C.W.) or Modulated continuous-wave (M.C.W.) telegraphy.

A more detailed specification will be given in Part 4(b) of this series of articles.

### DESCRIPTION OF TRANSMITTER

#### Layout of equipment.

The equipment is divided into three main sections as follows:—

- (a) Oil-filled and other equipment involving some fire risk.
- (b) Equipment not requiring frequent attention from operating staff.
- (c) Equipment in regular use by operating staff.

A floor layout showing the disposition of the major equipment is given in Fig. 1. A fireproof cubicle houses the apparatus referred to in (a) and contains such items as the transformer and induction regulator for the 144-kW main high-tension rectifier and the associated smoothing inductors and capacitors. The cubicle is a single-storey structure about 10 ft. × 12 ft. × 8 ft. high located outside but adjacent to the radio station building.

† Until his recent retirement Mr. Sturges was Senior Executive Engineer, Radio Planning and Provision Branch, Engineer-in-Chief's Office; Mr. Newson is Executive Engineer in that Branch.

<sup>1</sup> References are given at the end of the article.

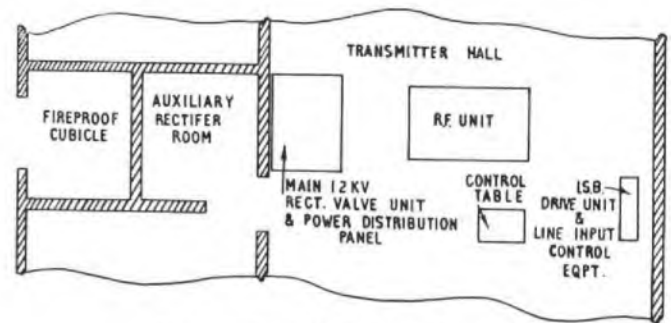

FIG. 1.—APPARATUS ROOM LAYOUT.

The filament, grid-bias and auxiliary high-tension metal rectifiers (item (b)) are installed in an auxiliary room which is adjacent to, and of similar dimensions to the fireproof cubicle.

The equipment referred to in item (c) is installed in the main transmitter hall of the radio station and includes the main radio frequency (r.f.) unit, control table, main 12-kV rectifier valve unit and power distribution panel, and the i.s.b. drive unit and line input control equipment.

#### Radio-frequency unit.

A photograph of the radio-frequency unit is shown in Fig. 2. The overall size of the unit is 10 ft. 6 in. long, 5 ft. 6 in. wide and 7 ft. 2 in. high (8 ft. 2 in. including the projection above the centre of the unit). The framework is constructed of brass and fitted with aluminium panels to give good r.f. screening and to minimise r.f. losses. The exterior surface is finished in light grey cellulose with chromium-plated fittings.

Power supplies are fed to the r.f. unit via a fuse and distribution board inside and at the rear of the unit. For safety reasons, high-voltage supplies are also taken via an isolator and earthing switch.

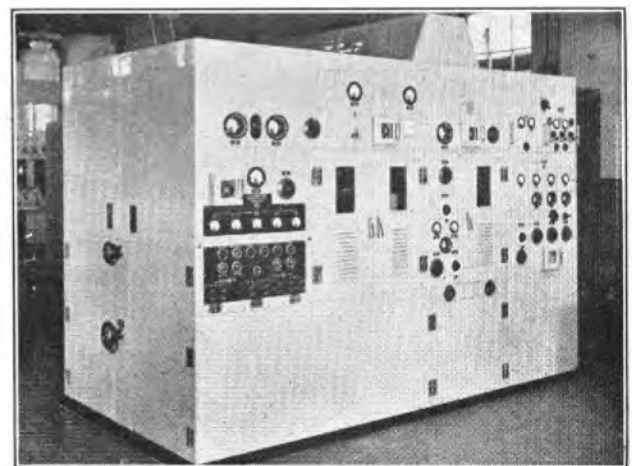

FIG. 2.—THE RADIO-FREQUENCY UNIT.

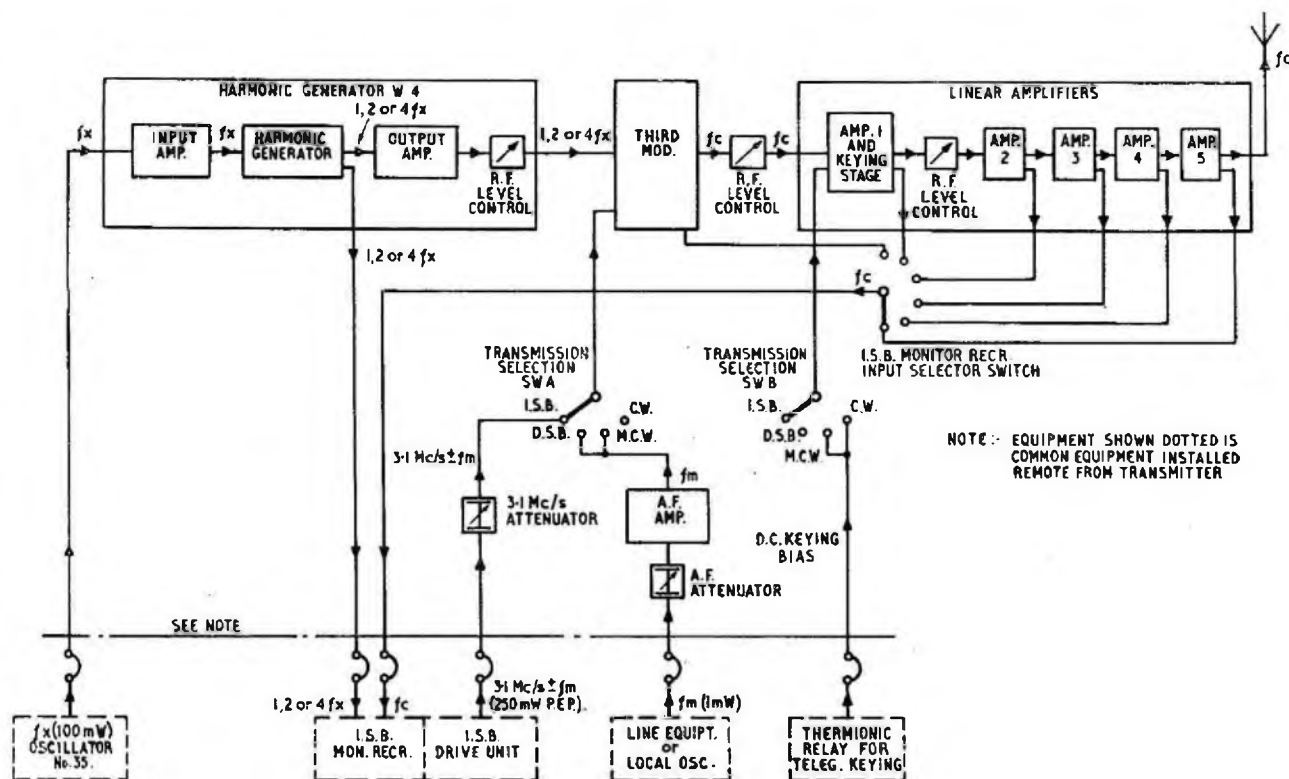

FIG. 3.—BLOCK SCHEMATIC DIAGRAM OF RADIO FREQUENCY UNIT.

A schematic diagram of the r.f. unit is given in Fig. 3. When the transmitter is operating with the 3.1 Mc/s i.s.b. drive unit, the r.f. output ( $f_x$ ) from a crystal oscillator is fed via a harmonic generator unit to provide a carrier source which when mixed with the 3.1 Mc/s signal in the frequency-changer or third-modulator (M3) stage will produce the final frequency  $f_c$ . The output from the M3 stage is then amplified by a series of five linear amplifiers, A1 to A5.

When the 3.1 Mc/s i.s.b. drive unit is not in use, the M3 stage is operated either as an amplifier for C.W. emissions or as an a.f. modulator-amplifier for d.s.b. or M.C.W. emissions.

**Crystal Oscillators.**—The crystal oscillator output frequency  $f_x$  is in the frequency range of 3.5 to 7.0 Mc/s at a level of 100 mW into 75 ohms. The oscillators are located at a central point remote from the transmitter and the selected r.f. output is fed via coaxial cable to the transmitter.

**Harmonic Generator Unit.**—The crystal-controlled frequency  $f_x$  is fed to the input of the harmonic generator (h.g.) unit (Harmonic Generator W4) and this produces an r.f. output frequency of  $f_x$ ,  $2f_x$  or  $4f_x$  in the range of 3.5 to 28 Mc/s (only 3.85 to 22 Mc/s is utilised in this particular transmitter) at a level of not less than 50V across 10,000 ohms. This output is fed to the input of the third modulator stage.

The h.g. unit is self-contained and is easily removable from the r.f. unit for maintenance purposes. It comprises three single-valve stages each using a 25-W beam tetrode. The first or input stage is an amplifier designed to operate with an input voltage which may be between about 2.5 and 8.5V across 75 ohms. The second stage is biased to operate as a harmonic generator and the third, or output, stage is adjusted as a class-B amplifier. Control of the r.f. output level is provided by variation of the screen potential of the class-B amplifier. In addition to the main r.f. output, a low-level output at the same frequency is provided for operation of the i.s.b. drive unit monitor receiver.

**Third-Modulator (M3) Stage.**—This stage derives its name from the fact that three frequency-changer or modulator stages are required in this system to produce i.s.b. emissions. Two of these, M1 and M2, are incorporated in the drive unit described in Part 2 of the series.<sup>2</sup>

The M3 stage is used under three different conditions, depending upon the type of emission required. They are:—

- (a) With i.s.b. drive unit in use, the 3.1 Mc/s signal is fed to the M3 stage input in series with the output of the h.g. unit at frequency  $(1, 2 \text{ or } 4)f_x$ . The M3 output frequency  $f_c$  is then given by:—

$$f_c (\text{when below } 10 \text{ Mc/s}) = (1, 2 \text{ or } 4)f_x - 3.1 \text{ Mc/s}$$

$$f_c (\text{when above } 10 \text{ Mc/s}) = (1, 2 \text{ or } 4)f_x + 3.1 \text{ Mc/s}$$

- (b) For d.s.b. or M.C.W. emissions the M3 stage is used as a grid-modulator-amplifier with the a.f. signal modulating the output of the h.g. unit. In this case  $f_c$  is given by:—

$$f_c = (1, 2 \text{ or } 4)f_x$$

- (c) On C.W. emissions the M3 stage is used as in (b) but with no a.f. modulation applied and  $f_c$  is given by:—

$$f_c = (1, 2 \text{ or } 4)f_x$$

The M3 is a single-ended stage employing a 125-W beam tetrode which, when connected for condition (a), operates as a grid-modulated class-C amplifier without grid current. The two r.f. signals are fed in series between the grid and cathode, and the anode circuit is tuned to the sum or difference frequency  $f_c$ . Under condition (b), the stage is operated as a modulated class-A amplifier without grid current. The r.f. output from the h.g. unit is applied to the grid of the valve and the a.f. modulation in series with the grid-bias supply, the anode circuit being tuned to the grid input r.f. Under condition (c) the stage is operated as a straight-forward class-A amplifier without grid current.

The levels of the inputs and output of M3 stage are adjustable to ensure the correct operation of the stage and to permit control of the final power output of the transmitter to the aerial. The various operating conditions (a), (b) and (c) are obtained by adjustment of grid-bias and

loading conditions effected by operation of the transmission selection switch A (see Fig. 3). The level of the a.f. modulating voltage is also adjustable to control the depth of modulation on d.s.b. emissions.

The frequency range of the output is 3.85 to 28 Mc/s but, as already stated, the maximum frequency required is restricted to 22 Mc/s.

**Audio-frequency Amplifier.**—The audio-frequency amplifier (Amplifier W88) is a self-contained unit which is easily removable from the r.f. unit for maintenance. A 12-W beam power amplifier is used as a single-stage fixed-gain amplifier capable of amplifying the signal received from the land-line or local oscillator (about 1 mW in 600 ohms) up to the level required for grid modulation of the M3 stage (about 50V across 5,000 ohms). The output voltage level is controlled by means of an attenuator connected across the a.f. input to the amplifier.

**Linear r.f. amplifiers (A1—A5).**—Except for "on-off" telegraph signals which are keyed in the A1 stage, the r.f. output from the M3 stage is a complete signal at a power level of about 0.25 W and is therefore suitable for amplification up to the output power level required at the aerial. For satisfactory i.s.b. operation this amplification must be achieved with as little distortion as possible and in the transmitter described, five linear push-pull amplifiers (A1—A5) are used to step up the peak envelope power output to between 50 kW and 70 kW.

The first amplifier (A1) stage employs two 125-W beam tetrodes operated as a class-A push-pull amplifier with no grid current. Gain control is effected by screen-grid voltage variation and is used for final power output adjustments on all except i.s.b. emissions where the power output is controlled by variation of the 3.1 Mc/s level. The A1 stage is grid-keyed for on-off telegraphy emissions and this facility is switched in by means of the transmission selection switch B (Fig. 3).

The A2 amplifier is a neutralised class-B push-pull stage employing two 135-W triodes. The input is capacitively-coupled from the A1 stage and the output is fed in a similar manner to the A3 stage.

The A3 amplifier is a similar stage to A2 except that it employs two 350-W triodes. The upper half of the stage is just visible in Fig. 4 which is a view taken from the rear of the r.f. unit.

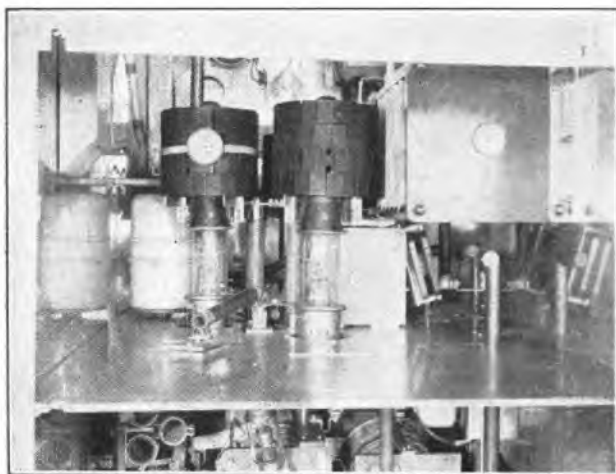

FIG. 4.—A3 AND A4 STAGES VIEWED FROM REAR OF R.F. UNIT.

The anode circuits of M3, A1, A2 and A3 stages are each parallel-tuned with a variable capacitor and switched inductors. The inductors are divided into seven inductance ranges and assembled on motor-driven ganged switches. The frequency ranges are:—3.85-5, 5-6.4, 6.4-8.2, 8.2-10.5, 10.5-13.5, 13.5-17 and 17-22 Mc/s.

The A4 amplifier is a neutralised parallel-push-pull stage employing four 800-W triodes with a parallel-tuned anode circuit comprising a variable capacitor and preset variable inductors. For frequencies above 13 Mc/s additional inductors are connected in circuit. The lower half of the stage can be seen in Fig. 4.

The final amplifier (A5) stage is also a neutralised parallel-push-pull stage employing four 15-kW water-cooled triodes. The anode circuit is a "balanced- $\pi$ " matching network with capacitive shunt arms and inductive series arms; it provides for matching the feeder impedance to the valves to obtain a good transfer of power with a minimum of distortion. The input shunt capacitance includes the valve internal capacitances and the neutralising capacitors; the output shunt capacitance is a variable capacitor which controls the impedance matching ratio. The series inductors are arranged in four pairs on a turret rotatable about a horizontal axis. Part of the turret and a pair of inductors can be seen in the lower left-hand corner of the front view of the A5 stage given in Fig. 5. The inductors are tapped

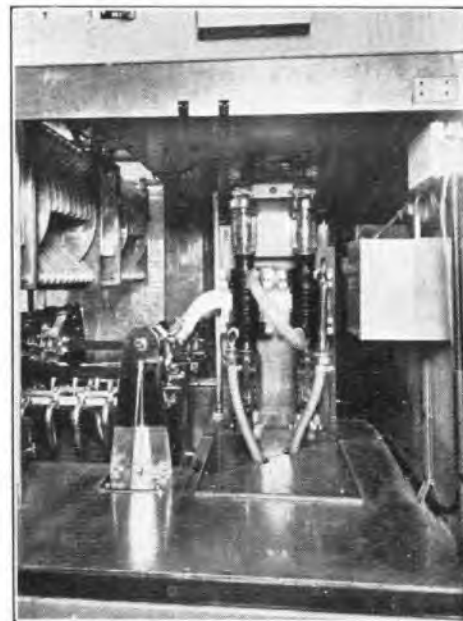

FIG. 5.—A5 STAGE OF THE R.F. UNIT.

but are not continuously variable and tuning is effected by means of variable capacitors (seen in the upper left-hand corner of Fig. 5) connected in series with the inductors. The frequency ranges covered by the four sets of inductors are 3.85-5.5, 5.5-9.5, 9.5-13.5 and 13.5-22 Mc/s.

**Water and air-cooling arrangements.**—Cooling water for the A5 stage valves is supplied to the anode water-jackets via  $\frac{3}{4}$  in. internal diameter polythene tubing (visible in Fig. 5) at the rate of at least 5 gallons per minute. To minimise leakage current from the anodes to earth, distilled water is used and is supplied from a centralised distribution system at a pressure of about 40 lb. per sq. in.

The normal ventilation in the r.f. unit is supplemented by cool air blown from a small motor-driven fan to the A5 tuning inductors, the A4 stage valves and inductors and the A3 stage valves.

**Power supplies.**

The distribution of power supplies from the 3-phase 400-V, 50 c/s supply to the various stages of the r.f. unit is shown in Fig. 6.

The valve filament-heating supplies (with the exception of those in the harmonic generator and a.f. amplifier which



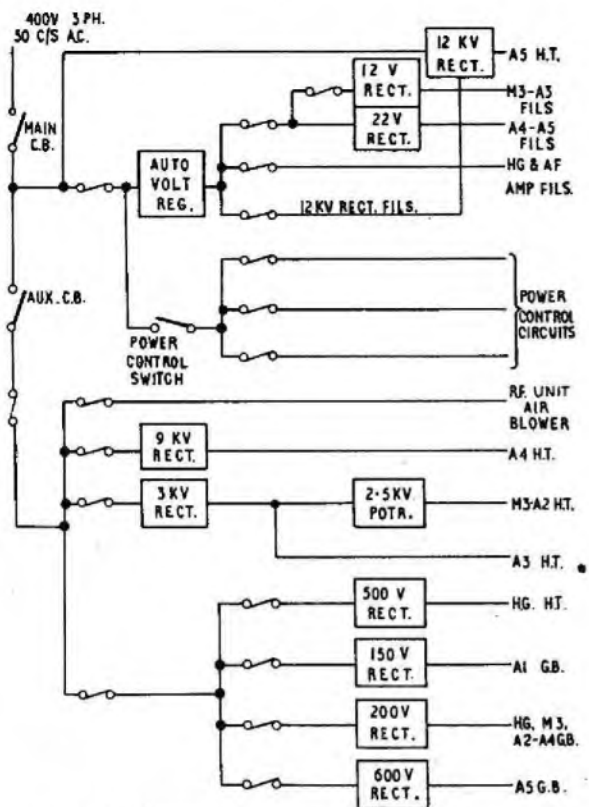

FIG. 6.—POWER DISTRIBUTION TO TRANSMITTER.

are heated from 6.3V A.C.) are all D.C. supplied from two selenium rectifiers installed in the auxiliary rectifier room. All filament supply voltages are stabilised by an automatic voltage regulator operating on the A.C. supply to the rectifiers. The D.C. outputs of the two rectifiers are 22V, 360A and 12V, 50A; these supplies are applied to the valves in three stages of increasing current, controlled by time-delay relays, to avoid damage to the filaments which might otherwise occur.

The three grid-bias rectifiers are situated in the auxiliary rectifier room. The two larger rectifiers supply 200V, 4A for M3, A2, A3 and A4 stages and 600V, 4A for the A5 stage and a smaller rectifier (150V, 100 mA) with its output free from earth, is used for the A1 stage which is keyed for telegraph signals. High current rectifiers are used in order that low-resistance potentiometers may be used for controlling the grid voltage applied to each stage. This ensures that the passage of grid-current through the potentiometers has no appreciable effect on the grid-bias voltage.

Four rectifiers are provided for high-tension anode supplies of which three are accommodated in the auxiliary rectifier room. Part of the fourth, the main 12,000V rectifier, is in the fire-proof cubicle and part in the transmitter hall. A 500-V, 0.5-A selenium rectifier provides high tension for the harmonic generator unit and is a single-phase full-wave rectifier with a two-stage inductance-input smoothing filter. The 3,000-V, 1.8-A and 9,000-V, 1.5-A rectifiers provide high-tension anode voltages for stages M3 and A1 to A4 and are both three-phase full-wave selenium rectifiers employing single-stage inductance-input smoothing filters. The main high-tension rectifier is for the A5 stage and is a three-phase full-wave rectifier employing six hot-cathode mercury-vapour valves giving a maximum output of 12,000V, 12A. A continuous control of output voltage from 4,000V to 12,000V is obtained by means of a motor-driven

induction-regulator. Adequate smoothing is obtained by use of a single-stage inductor-capacitor filter.

#### Safety provisions and power control circuit.

Since high voltages are used in the transmitter, special precautions are necessary to reduce to a minimum the risk of operating staff receiving an electric shock. In addition, the equipment must be protected from damage due to the application of excessive voltage or current.

All wiring and equipment operating at potentials up to 50V A.C. or D.C. with respect to earth is given reasonable protection to avoid the possibility of maintenance staff having accidental contact with it or causing a short-circuit. Where the potential is above 50V and not exceeding 250V A.C. or D.C., protection is generally given by using completely insulated wiring and shrouded terminals and tags. Where the potential is in excess of 250V A.C. or D.C., all wiring and equipment is completely insulated and enclosed and arranged so that access is only possible when the supply concerned is disconnected.

All doors of the r.f. unit are mechanically interlocked with an isolating and earthing switch by means of sliding bars and rods. The interlocking mechanism is arranged so that all doors must be closed before the switch can be placed in the "on" position; the doors are then locked by the operation of the switch. In the "off" position, the switch disconnects all the high-voltage supplies and earths the high-voltage wiring to the various stages of the r.f. unit. In addition, the switch includes auxiliary contacts, which are electrically interlocked with the contactors controlling the connection of the A.C. primary supplies to the high-voltage rectifiers so that the supplies can only be connected when the switch is in the "on" position.

The doors of the 12,000-V rectifier valve unit are mechanically interlocked, by means of locks and keys, with the switch controlling the primary A.C. supply to the rectifier and as an additional precaution, an auxiliary contact on the door mechanism is interlocked electrically with the primary A.C. supply contactor. The grid-bias and other high-tension rectifiers have all panels screwed in position and no special interlocks have been provided.

Earthing rods have been provided so that equipment which has been operating at a high potential can be earthed before handling to make quite certain that no static charges remain.

The equipment, especially the valves, is protected from electrical damage by means of voltage and current relays; these ensure that the supplies can only be switched on or off in a particular sequence and that the valve anode cooling water is flowing while power supplies are connected.

The power control circuit co-ordinates all the various electrical protective devices and interlocks for gates and switches and provides a means whereby the power supplies to the various stages of the r.f. unit can be controlled from a set of non-locking push-buttons. The use of push-buttons ensures that positive action on the part of the operator is required to connect a supply and if that supply subsequently becomes disconnected for some reason, it cannot be reconnected without again operating the appropriate push-button.

(To be continued)

#### REFERENCES

- "Single-Sideband Multi-Channel Operation of Short-Wave Radio Links, Part 1.—General Survey." W. J. Bray and D. W. Morris, *P.O.E.E.J.*, Vol. 45, p. 97.
- "Single-Sideband Multi-Channel Operation of Short-Wave Radio Links, Part 2.—An Independent-Sideband Transmitter Drive Unit and Monitor Receiver." *P.O.E.E.J.*, Vol. 45, p. 154. F. C. Owen and A. B. Ewen.

# The Location and Verification of Pairs in Cables

H. E. BARNETT, T.D., M.Sc.(Eng.), A.C.G.I., D.I.C., M.I.E.E. †

U.D.C. 621.315.21:621.395.74

At various times during the period 1946-1951 the author conducted experiments in the London Telecommunications Region with a view to simplifying the problem of verifying the location and route of pairs in the cable network. This article explains how the experiments were made and, in particular, refers to a method which normally renders unnecessary the opening of cable joints. In this method pulses of 1000 c/s tone are transmitted over the pair under test and a signal is picked up external to the cable sheath by means of a search coil, amplifier and headphones. As no measurements are necessary the method is well suited to rapid testing in the field. Recommendations are made regarding a number of improvements to the testing equipment which the author considers desirable for future work.

## INTRODUCTION

THE experiments which resulted in the technique to which this article relates started in 1946 in the West Area of the London Region where high expenditure on "wires changed over" (partly on diversions for advice notes) and the rapidly increasing expenditure on maintenance of underground plant were causing concern.

The author came to the conclusion that the then usual method of opening a cable joint (or joints) every time it was necessary to trace a pair or locate a fault was unscientific, probably unjustifiable and certainly having a bad effect on the cable plant. It was learnt by chance that some equipment originally designed for tracing lost cables on airfields had been considered by the Research Branch for tracing cables pairs but had not been tried out. Arrangements were therefore made to try this equipment on subscribers' cables.

Little progress had been made regarding the possibility of receiving a signal from a single pair through the lead sheath of a cable, and it was surprising that satisfactory results were obtained at the first trials of the new method. Four cases were taken, in a particular exchange area, of reports from installation staff alleging that pairs allotted for completion of advice notes could not be found at the addresses specified.

The equipment used for these initial tests consisted of a pulsed oscillator christened the "ticker," a search coil, amplifier and headphones, the amplifier being powered by dry cells. Some description of these items is given later in this article.

The ticker was applied to each pair in turn at the exchange main frame and the signal was followed outward from the exchange from manhole to manhole using the search coil, portable amplifier and headphones. All four pairs were duly traced and were found available for the intended services though in two cases the locations were slightly different from those recorded. The interest of these experiments was twofold—firstly they proved the method and secondly they showed a way of avoiding the extensive testing or costly rearrangement which would have been required under normal procedure to complete the four services.

Further experiments showed that cables pairs could be traced in almost every case to the appropriate D.P. Two difficulties were encountered. The first was that when the pair was sound and open-circuited at the D.P., the signal became inaudible at a distance of the order of 50 to 100 yards from the D.P. When the pair could be looped (as with overhead D.P.s or D.P.s on wall blocks) an increase in strength was found to occur which made the signal audible and also served to identify the appearance of the pair at the D.P. For the underground D.P. this could not be done unless the required pair appeared on a block in accessible premises, but on the other hand it was found that unless a pair in an underground D.P. had been stumped

very near the beginning of the D.P. there was sufficient signal strength at the beginning of the D.P. length to show the required pair entering the D.P. length (if it did), which was sufficient justification for opening the D.P. cable outside the premises to be served. The second difficulty occurred when near the outer end of one of the longer cables in one of the more scattered exchange areas; the faint signal was blotted out by noise picked up from what appeared to be a supply transformer buried nearby. Similar troubles were met at a later date with interference from supply mains, but it should be possible to overcome this, and suggestions to this end are made later in this article.

The experiments also showed that when a cable pair had been correctly reported as disconnected between the exchange and the D.P. it was usually possible to locate the point of disconnection fairly accurately. With the apparatus used for those experiments it was found, as stated above, that the signal on a disconnected pair in a relatively small cable became inaudible about 50 to 100 yards from the point of disconnection. Using this fact and identifying carefully the last joint box or manhole in which a signal could be heard it was possible in most cases to deduce correctly the joint in which the disconnection lay. This was proved many times, the exceptions being those cases where only one wire was disconnected or where crosses occurred between wires of two pairs.

It was also found that a short-circuited pair could be traced right up to the point of short-circuit and, of course, that when a joint was finally opened to put a pair through or remove a short-circuit, the pair to be dealt with could be identified with ease, without making any contact with it.

Two difficulties were found in using the equipment then available. The first was that the dry cells supplied with the equipment were liable to fail without warning, in which circumstance the listener would receive no signal when perhaps he should have done. The second was that for any operation other than the tracing of a single pair it was necessary to provide two-way communication between the men listening outdoors and the men in the exchange. It was found unsatisfactory to rely on the availability of kiosks and as speaker pairs could not be provided (the cables not having been opened) it was clear that only a two-way radio link would give the required facilities. (Ex-Army "walkie-talkie" sets were tried but found insufficiently powerful, especially among buildings.)

These results were reported, but for various reasons three years elapsed before the experiments could be resumed.

## APPLICATION TO MASS CHECKING OF CABLE PAIR RECORDS

In 1950 some equipment (described later) was made available for maintenance testing and at about the same time it was decided to make a check of the records of pairs in subscribers' cables in representative exchange areas throughout London. This appeared to be work ideally suited to the method tried in the earlier experiments, and further experiments were started in East Area.

Tests were carried out in seven exchange areas in East Area

† Inspectorate of Electrical and Mechanical Equipment, Ministry of Supply (formerly Area Engineer, London Telecommunications Region).

—five automatic and two manual. All these exchanges serve urban areas, all are relatively large, and in each case the exchange area is fairly compact, the maximum distance from any exchange to the edge of its area being under three miles. In each case the cables are mainly of 10 lb. or 6½ lb. copper, cable sizes ranging from 1,400 pairs down to 15 pairs. Almost all the distribution is via overhead D.P.s except in a few main roads and one or two residential areas, as underground services have never been greatly used in the East Area—the tendency in the past has been to serve main-road property from overhead D.P.s in side roads. The few residential areas with underground D.P.s are in the main those where special agreements with local authorities have operated in the past to reduce the cost of reinstatement.

The existence of so high a proportion of overhead D.P.s would, of course, have made it easier to verify D.P. pairs by traditional means had it not been for the fact that so many D.P.s in the areas chosen had no spares which could conveniently be used as speakers and in any case such methods can only be used to verify pairs which actually reach the recorded D.P.—they do not help to find the pair which should go to a given D.P. but apparently does not.

The experiences in the seven areas included the following which may be of interest to others using similar equipment.

In checking underground D.P.s without using a radio link to the exchange it was found that the necessary opening and closing of one joint per D.P. to provide a speaker took about one hour with incidental work and therefore cost nearly three man-hours per D.P. (two men at the D.P. and one at the exchange mainly standing by).

When checking underground D.P.s using the ticker and a radio link there is no need to open any joint, but the check then only shows whether the cable pair reaches the D.P. length; it does not show to which D.P. pair it is connected. This, however, does not appear to be a disadvantage in practice.

In two cases difficulty was experienced in identifying the route followed by the pair carrying the tone from the ticker. In one instance this was because the listening equipment picked up considerable extraneous noise which appeared to be associated with supply mains. This was not verified but the effect showed the desirability of providing the listening equipment with filters tuned to the frequency of the ticker oscillator. In the other case the difficulty was due to the fact that many spares had been bunched in a joint so that the test tone spread widely over the network until the bunch was broken up. This showed the need for insulating the ends of all stumped pairs.

In one area some difficulty was found in using radio equipment because D.P.s serving an arcade of shops could not be reached with a vehicle. This emphasised the desirability of making all the equipment for the field party completely portable and as compact and light as possible.

On one occasion when it was intended to demonstrate picking-up of ticker tone on a cable pair the wanted tone was swamped by a continuous noise apparently carried on the cable sheath. Subsequent investigation showed that the exchange howler was connected to a pair in that cable, which had shown a P.G. in the exchange. The pair carried two shared service subscribers and the fault was a contact between two wires serving one subscriber, so presumably the howler tone got on to the cable sheath via the subscribers' condensed bells. To verify this, the howler was connected to an exclusive circuit in the same cable; in those conditions there was no interference with the ticker tone. This test:—

(a) confirmed previous tests which showed that the application of ticker tone at a useful level to one pair in a subscribers' cable was not liable to cause

overhearing in another working pair, and

(b) suggested that some freedom from interference with the tests might be secured if the ticker were to be operated at a frequency rather above the audio band, in conjunction with a superheterodyne receiver in lieu of a plain amplifier.

In one case a pair was found to be split at a joint, the two legs following different routes from the joint. Some tone was encountered on each of the cables carrying the single legs; the split was suspected and subsequently verified.

No satisfactory technique has yet been found for locating, with this equipment, the position of the fault on a pair which is partially earthed.

#### TONE EQUIPMENT USED FOR THE TESTS

##### *Tester SA9077 ("Ticker").*

This part of the equipment consists of a three-valve oscillator providing an output of 1,000-c/s tone which is split up into pulses at repetition frequencies varying between about two per second and continuous tone. Experience shows the most satisfactory repetition rate (because most distinctive) to be about four pulses per second. The oscillator can be served from either A.C. or a 12-volt battery so that it can be used in any exchange, subject to the availability of a vehicle battery in the absence of A.C. supply, or by the roadside should it be desirable to trace a cable pair inwards from its outer end. It was not developed for the second purpose but has been found very satisfactory for it.

This oscillator has been superseded by the Oscillator No. 23A.<sup>1</sup> The new oscillator is a smaller version using a similar circuit but apparently cannot be operated from a 12-volt battery. This is a disadvantage when it is necessary to work in an area where the public supply is D.C. or not available at the exchange (as in some U.A.X.s), or when it is desirable to work at a point remote from the exchange, though admittedly this latter contingency does not often arise.

##### *Search Coil.*

This consists of a coil wound on laminations, the whole being fitted in a can as used for P.O.-type transformers and filled with compound. It is provided with a handle and a flexible lead consisting of screened single conductor, the screen being used for one lead. This coil picks up signals fairly satisfactorily but is an awkward shape and extremely difficult to place in the best position in a congested joint-box.

##### *Amplifier No. 37A.*

This is a three-valve R-C amplifier equipped with hearing-aid valves (1.5-volt heaters) and supplied from dry cells. It has been superseded by Amplifier No. 55A<sup>1</sup> which is generally similar but includes a filter for eliminating unwanted signals or noise.

One of the earlier-type amplifiers was experimentally modified to operate from a power unit (ex-Army radio equipment) supplying 12 volts for filaments and suitable H.T., the unit being supplied from a 12-volt battery. This arrangement was much more satisfactory as it eliminated the uncertainty which frequently arose due to failure of the dry batteries which were inadequate for continuous use. It is not known whether this problem will arise with the new model.

#### METHODS OF TESTING

##### *Selection of pair, identification and communication.*

For the earlier checks of D.P.s, radio facilities were not available for most of the time, and ticker facilities

<sup>1</sup>P.O.E.E.J., Vol. 44, p. 127.

were only available intermittently. Consequently identification was by picking up a 3-volt battery and communication was over a prearranged speaker from D.P. to exchange.

Access to each pair to be identified was via a test distributor. One test distributor circuit was borrowed from the test desk and teed via miscellaneous blocks on the frames to a convenient point at one end of the M.D.F., at which the testing control point was established. To this circuit was connected a Tester AT 2607 modified locally.

The "through" key was modified to connect, when operated, each wire of a pair through a Detector No. 4 (additional to the voltmeter in the tester) to a 3-volt battery earthed on the positive side. This detector was used on its 5-volt range. The mobile party then searched for the marked pair using a Detector No. 4 on its 50-volt range and earthed on its positive side. The particular pair was identified by a forward deflection of nearly 3 volts; the detector at the D.P. was then switched to the 5-volt range and the increased current in the 3-volt circuit signalled to the man at the exchange that the pair had been identified. The arrangement is shown in Fig. 1.

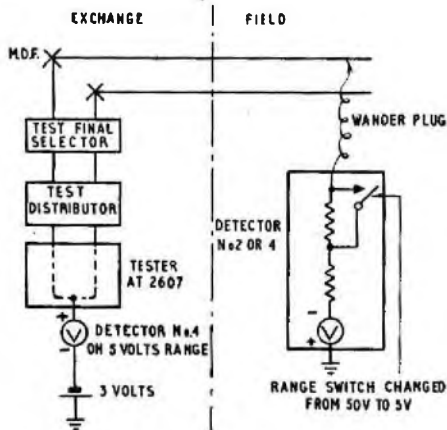

FIG. 1.—IDENTIFICATION OF CABLE PAIRS AT D.P.S USING 3-VOLT BATTERY.

This arrangement was possible because access to the pair was obtained through the test distributor and so the exchange battery was cut off from the pair under test. It has the advantage that should the man at the D.P. pick up a working circuit he will not damage his detector and moreover there is no difficulty with backward deflections. This method of testing has the disadvantage that while the test is in progress the subscriber loses the use of his line.

The next method of identification tried was using the

output of the ticker oscillator. It had been stated that this should not be directly connected to a working line so the output was fed to line through a step-down transformer and the Tester AT 2607. At the reduced level, speech could over-ride the tone. The tester was then again modified as follows. The dial speed relay (DS), which was not required for its normal purpose, had its break contact transferred to the circuit over which the test distributor is switched by dialling. Then as soon as the distributor is stepped to an engaged line, or when a subscriber lifts his receiver to make a call while his pair is under test the test distributor control circuit is broken, the line reverts to normal and a pilot lamp shows what has happened (see Fig. 2).

This facility is not available when identification is by battery (as described above) because in that case the operation of the "through" key disconnects relay DS. It is not possible to use a low-voltage battery for identification and at the same time retain the "subscriber's forced release" feature.

This forced release arrangement was developed as a means of protecting subscribers against hearing the ticker output without imposing on the testing staff any difficult conditions about the level at which the ticker could be run or the circuits to which it could be connected.

It was found in practice that the forced-release arrangement was completely reliable, so when the provision of radio-link facilities eliminated the need to speak over a tone-carrying pair it was found unnecessary to keep the output of the ticker below its normal level. A pair is then identified by hearing the tone in a headgear receiver. If the D.P. has open terminals (e.g. overhead) the receiver is used with prods and condensed so as not to operate the subscriber's release. If the D.P. is underground the receiver is used in conjunction with the search coil and its amplifier.

For the manual exchanges it was considered desirable to reproduce as far as possible the conditions which had been established when working at the auto exchanges. Test distributors not being available, the connections were set up from the manual board, one man being stationed there and linked to the control position near the M.D.F. by a local speaker circuit and a connecting circuit via a spare outgoing junction jack.

Two break contacts of P relay (see Fig. 3) were put into the feed from the oscillator to the Tester AT 2607 and this ensured that should the subscriber make a call the tone would be disconnected from his line and the engaged condition would be cancelled. Likewise, should the test circuit plug be inadvertently plugged into an engaged line, tone would be immediately disconnected and there would be no interference with the subscriber.

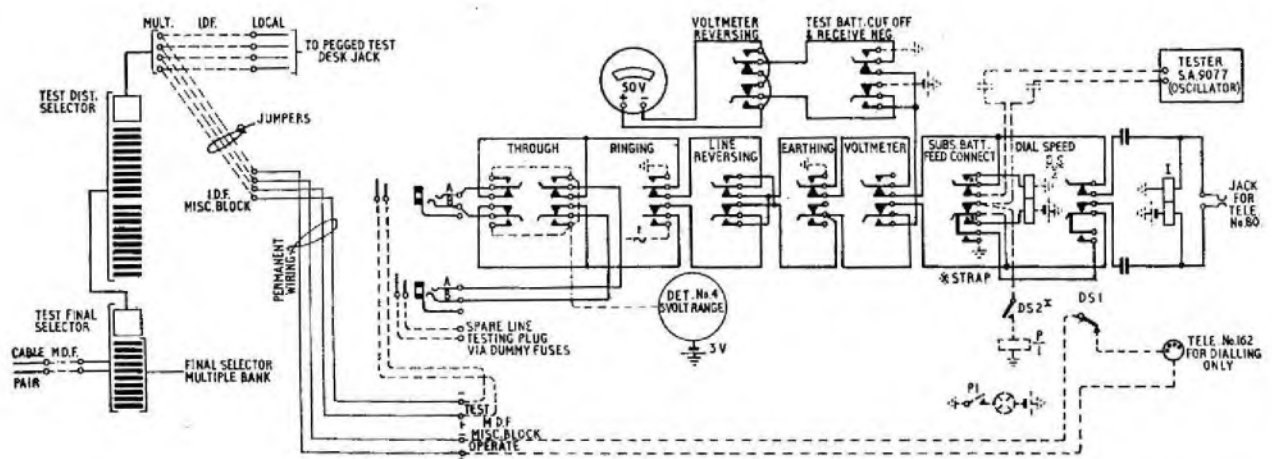

FIG. 2.—TESTER AT 2607 MODIFIED (AS SHOWN BY DOTTED CONNECTIONS) FOR USE AT AUTOMATIC EXCHANGES ONLY.

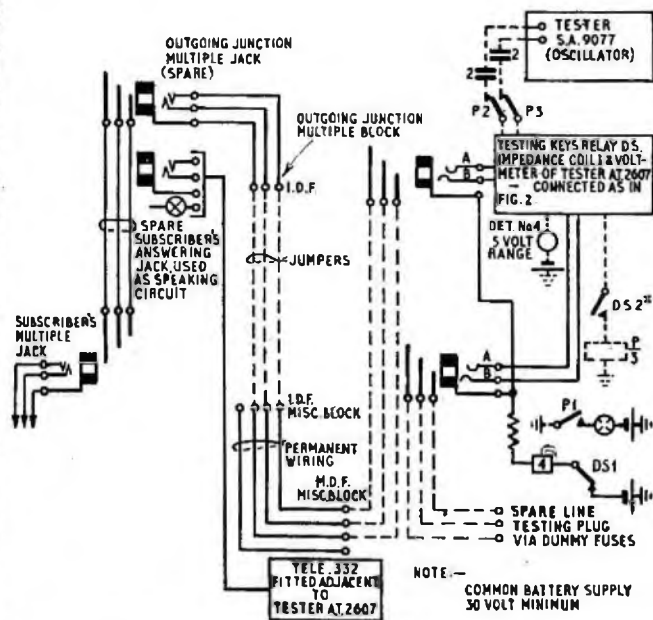

FIG. 3.—TESTER AT 2607 MODIFIED (AS SHOWN BY DOTTED CONNECTIONS) FOR USE AT AUTOMATIC OR MANUAL EXCHANGES.

The mobile party was provided with head-and-breast sets. One headgear receiver in the set used by the man identifying the pairs was used as described above; the other receivers and the transmitters were associated with the radio link.

Various arrangements of the radio equipment were tried. The most satisfactory with the equipment available was that shown in Fig. 4 using two frequency-modulated V.H.F. transmitter-receivers operating from 12-volt batteries on two frequencies—77 Mc/s and 87 Mc/s—to provide two-way communication.

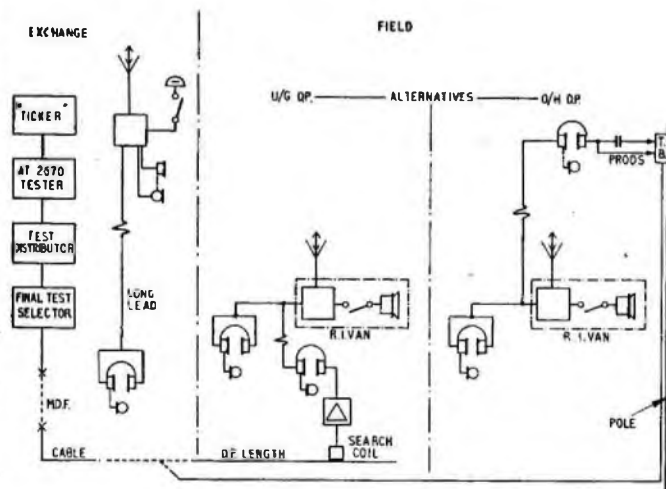

FIG. 4.—EQUIPMENT FOR FIELD TESTING PARTY USING TICKER FOR IDENTIFICATION AND RADIO FOR COMMUNICATION.

The men in the exchange were provided with head-and-breast sets on long cords so that they could remain in contact with the field party over the radio link while moving about the M.D.F. and keeping their hands free for testing. They also had hand microtelephones for use while recording.

#### Procedure.

Before any field tests were made, schedules were prepared showing main cable pairs and circuit numbers and useful details. The correctness of allocation of circuit

number to cable pair was checked by the exchange party before field verification started, by dialling each subscriber's number over the test distributor (or connecting via the multiple, in manual exchanges), operating the "voltmeter" and "earthing" keys on Tester AT 2607 and then looping the main cable pair on the line side of the M.D.F. and verifying receipt of the "loop" at the tester.

The exchange party and the field party were each supplied with a copy of the schedule mentioned above and a cable distribution plan of the territory to be covered. This was covered in cabinet areas, the D.P.s within each cabinet area being taken in order of geographic convenience.

All pairs in respect of which there were discrepancies or queries were noted on both schedules (field and exchange). These cases were saved until all D.P.s in the cable had been checked. The discrepancies were then followed up, this being found the best method, as often several pairs could be dealt with at one joint. The disposal of each case was limited to:—

- (a) tracing a pair to its actual destination (if other than that recorded), or
- (b) tracing a faulty pair to the approximate location of a short-circuit or disconnection.

### TEST RESULTS

#### Existing networks.

The results of the tests in parts of seven exchange areas are summarised in Table 1. Bearing in mind the facts that

TABLE I

Summary of faults and discrepancies found in existing network.

Item No.	Item	Quantity	Per cent. of total
1	Cable areas checked	14	
2	Cable pairs checked	10,822	
3	D.P.s checked (73% O/H, 27% U/G)	1,811	
4	Pairs found at recorded D.P. but on terminal block pair other than that recorded	2,344	14
5	Exchange or circuit number wrong on D.P. card	260	1.5
6	Spare pairs recorded as working	150	0.9
7	Working pairs recorded as spare	97	0.6
8	Working pairs found at D.P.s other than recorded	98	0.6
9	Spare pairs found at D.P.s other than recorded	68	0.4
10	Spare pairs identified at D.P.s but faulty	83	0.5
11	Spare pairs not identified at D.P.s and testing faulty from M.D.F.	584	3.5
12	Pairs found at M.D.F., but not in records, traced to D.P. or disconnection	50	0.3
13	Pairs shown on A 9828 as "no record held" traced to disconnection	518	3.1
14	Miscellaneous discrepancies (local extensions etc.)	150	0.9
15	Net additional spares found at D.P.s (item 6—item 7)	62	0.4
16	Total additional spares found at D.P.s recorded as having no spares	17	0.1
17	Faulty pairs which could probably be cleared without opening any joint larger than 200 pr.	315	1.9
18	Pairs in item 17 which are for D.P.s with no spares	150	0.9
19	Manhours spent in checking pairs	7,424	
20	Manhours spent in tracing S/C and dis. pairs (items 10, 11, 12 and 13) (avge. 2.2 mh/pair)	2,759	
21	Average expenditure for checking only (mh/pair) (item 19 divided by item 2)	0.44	
22	Average expenditure for checking and tracing (mh/pair) (items 19 plus 20, divided by item 2)	0.60	

the cable areas in which the work was done were selected because of known difficulties with the records and that the costs include the costs of learning how best to do the job and of various experiments, it appears that given suitable equipment the records of cable pairs in an urban network can be completely checked for an average expenditure of less than half a man-hour per pair.

It also appeared during the tests that of the pairs which should have reached D.P.s but were faulty (as distinct from those deliberately stumped on route) the majority were faulty in small cables. While correction of errors in records of spare and working pairs would clearly provide very little in the way of additional spares, quite a useful number could be provided by clearing faults in joints of 150 pr. and smaller sizes.

#### *New work.*

Following the work already described, the application of these methods to the check-testing of new works and rearrangements was authorised. Most of the schemes checked during the period covered by this article involved cabinets and included unequal numbers of pairs on the exchange and distribution sides. Consequently it was difficult to assess the costs of checking these schemes on a basis of the number of exchange pairs involved. As a rough check the numbers of E-side pairs and D-side pairs were added together and divided into the cost of the checks; on this basis the average cost per E-side pair or per D-side pair worked out at about three-tenths of a man-hour including, where necessary, the cost of tracing faults and discrepancies. This figure was based on a total of about 5,000 pairs.

Where cabinets were involved the procedure was to test the E-side pairs from exchange to cabinet, then extend the tone from exchange to cabinet over one of the new spares and verify from cabinet to D.P.s by jumpering through the cabinet.

#### ORGANISATION AND STAFFING OF THE WORK

The work was started (using the slower methods of verification) with two two-men parties in the field and one two-men party in the exchange.

As a result of the provision of the radio link equipment the field party covered the D.P.s so much faster (on one occasion one field party of two men checked 28 underground D.P.s (221 pairs) in one day—without, of course, verifying D.P. loop numbers) that it was found that one pair of men in the field could keep one pair of men in the exchange fully loaded. The limiting factor appeared to be the rate of working at which the field party became fatigued (through climbing poles or opening boxes).

For tests of existing networks in manual exchange areas it was found necessary to station a man in the switchroom to change the connecting circuit from line to line under the direction of the man controlling the operations from the M.D.F.

For tests on new work involving cabinets the arrangement adopted has been to post an additional man at the cabinet to make cross-connections to the distribution pairs but it may be found advantageous, given a battery-operated ticker, to deal with such cases by putting the ticker and the men previously referred to as the exchange party out at the cabinet site and then checking the whole of the D-side of the cabinet at once.

It is a matter for decision whether the faults located by this technique should be cleared by special jointer pairs working to the exchange party acting as a control or whether the faults should be handed to the maintenance division for clearance. In the latter event it would be desirable for the maintenance division to provide "clears"

to the exchange control set up for this work, in order to complete the records of this work.

#### CONCLUSIONS

The types of fault which are not at present readily amenable to location with this equipment can be dealt with by other known methods: one-leg disconnections by use of Tester SA 9004 and earth faults by Varley test (though this is sometimes difficult when a pair changes gauge on route).

Consideration might with advantage be given to the provision of a ticker unit as part of the permanent equipment of each major exchange. Listening equipment should be available for use by maintenance staff in clearing faults, by construction or works control staff for checking new work and by installation staff in proving pairs required for their work. Radio equipment would be worthwhile for all works involving considerable checking in one locality.

In installation work it is always desirable to prove the existence at the right place of the allotted pair before an installation party is sent out. For areas with overhead D.P.s this is already done. Where the D.P.s are underground this is either not done or done by a jointer in advance of the installation party. This latter arrangement involves two openings and two closings of one joint for one advice note and is clearly undesirable. Use of the ticker would make it possible to follow correct survey procedure in all cases.

Based on the experience gained in the London Telecommunications Region a number of improvements in testing equipment seem worth consideration. For example, a supersonic ticker giving the present range of tick frequencies and associated with a heterodyne receiver would give greater immunity against interference from external sources, and alternative input from a 12-volt battery for all portable units would also be an advantage. As already mentioned, the present design of the search coil is not satisfactory. What is wanted is a coil which will lie close to a cable and partially wrap it, with the lead coming out at one end and the coil case fitting snugly in the palm of the hand. The coil case should be waterproof and the lead should be of screened twin cable earthed to the amplifier case. A further improvement in operation would be obtained if some means were provided to ensure that an amplifier is still operating (e.g. a push-button to provide feed-back and cause A.F. oscillation). Without this facility, absence of a signal can be most misleading.

The radio link equipment, which should be continuously rated, should work duplex preferably as neither man in a mobile party has a hand to spare to operate a transmitter change-over switch. Auto-call facilities or an alarm at the exchange end would avoid the need for the exchange party to monitor while the field party is moving from point to point. A further advantage would result if the field equipment provided facilities for both the members of the field team to talk to the exchange party and also to each other, since the man making the tests may be up a pole or down a manhole while his mate will be on ground level recording results.

#### ACKNOWLEDGMENTS

The thanks of the author are due to Mr. C. E. P. Jones who had a large part in developing the idea and arranging the early tests; to Mr. J. J. Edwards who encouraged the development and the use of radio equipment; to Mr. C. Harvey of East Area who produced the "subscribers' forced release" arrangement and organised the systematic checking of pairs; and to those of the staff of West and East Areas who worked so enthusiastically in the trials of the scheme.

# Notes and Comments

## Special Commendation

The Board notes with pleasure that the Postmaster-General has personally commended Mr. I. Munro, Technician IIA, Fraserburgh, to whom the Royal Humane Society has awarded its Testimonial on Parchment, for his gallantry in attempting to save the life of a member of the crew of the Fraserburgh lifeboat, which capsized in heavy seas on 9th February, 1953.

## Revision to I.E.E. Examination Regulations

The Institution of Electrical Engineers has announced that the Institution Examination is to be revised. The revised Examination will be in three parts which, briefly, are as follows:—

*Part I* will be much on the lines of the existing Section A Examination and will be held jointly with the Institution of Civil Engineers.

*Part II* will consist of three subjects: Electrical Engineering, Mathematics and either Engineering Physics or Thermodynamics.

*Part III* will include Advanced Electrical Engineering as a compulsory subject, and a choice of two others from a list of eight.

The revised Examination will come into force by progressive stages between April, 1954, and October, 1956. The Examination Regulations have now been published and, in due course, model examination papers will be available.

Further information can be obtained on application to The Secretary, The Institution of Electrical Engineers, Savoy Place, London, W.C.2.

## Award by Institution of Electrical Engineers

The Board notes with pleasure that Mr. A. H. Mumford, O.B.E., B.Sc.(Eng.), jointly with Mr. G. R. M. Garratt, M.A. (Science Museum), has been awarded a Radio Section Premium for a paper on "The History of Television," during the 1952-53 Session.

## Thermistor Production

It is regretted that an error occurs on p. 34 of the April 1953 issue in the resistance/temperature relationship quoted for a semi-conductor. The equation should read,  $R_T = R_0 e^{b/T}$ .

# Institution of Post Office Electrical Engineers

## Essay Competition 1953-54

To further interest in the performance of engineering duties, and to encourage the expression of thought given to day-to-day departmental activities, the Council of the Institution of Post Office Electrical Engineers offers five prizes, a first prize of Five Guineas and four prizes of Three Guineas, for the five most meritorious essays submitted by members of the Engineering Department of the Post Office below the rank of Inspector. Draughtsmen Class II, with less than five years' service in that grade, are also eligible to compete. In addition to the five prizes the Council awards a limited number of Certificates of Merit. Awards of prizes and certificates made by the I.P.O.E.E. are recorded on the Staff Dockets of the recipients. An essay submitted for consideration of an award in the Essay Competition and also submitted in connection with the Associate Section I.P.O.E.E. prizes will not be eligible to receive both awards.

In judging the merits of an essay, consideration will be given to clearness of expression, correct use of words, neatness and arrangement, and although technical accuracy is essential, a high technical standard is not absolutely necessary to qualify for an award. The Council hopes this assurance will encourage a larger number to enter. Marks will be awarded for originality of essays submitted.

Hints on the construction of an essay can be obtained, if desired, upon application to the Secretary at the address given below. Copies of previous prize-winning essays have been bound and placed in the Institution Central Library. Members of the Associate Section can borrow these copies from the Librarian, I.P.O.E.E. (G.P.O.), Alder House, London, E.C.1. Competitors may choose any subject relevant to current telegraph or telephone practice.

Foolscap or quarto size paper should be used, and the essay should be between 2,000 and 5,000 words. An inch margin is to be left on each page. A certificate is required to be given by each competitor, at the end of the essay, in the following terms:—

*"In forwarding the foregoing essay of.....words, I certify that the work is my own unaided effort both as regards composition and drawing."*

Name (in Block Capitals).....

Departmental Address.....

Signature.....

\*Rank.....Date.....

(\*If a Draughtsman Class II, state date of appointment to that grade.)

The essays must reach The Secretary, The Institution of Post Office Electrical Engineers, G.P.O. (Alder House), London, E.C.1, by the 31st December, 1953.

The Council reserves the right to refrain from awarding the full number of prizes or certificates if in its opinion the essays submitted do not attain a sufficiently high standard.

## Review of Prize-winning Essays—1952-53 Competition\*

The Council of the Institution is indebted to Mr. W. S. Procter, M.I.E.E., F.R.S.E., Chairman of the Judging Panel, for the following review of the five prize-winning essays:—

"The essay judged to merit first place, 'The Problem of Interference to Television Reception from Amateur Transmitting Stations', by G. H. Bedford, is a succinct, well-written, well-produced account of some of the difficulties overcome by amateurs in suppressing harmonic radiation, so enabling them to avoid interference to television receivers. After a brief account of the growth of amateur radio, and the extent of the frequency bands allocated to amateurs in the United Kingdom, the author shows that the harmonic relationship between the amateur bands and the television channels is such that each band has harmonic relationship with at least two television channels. He then investigates the cause and nature of harmonic interference and proceeds to a consideration of methods of locating and reducing it. He also suggests that the intermediate or image frequency band of television receivers should not be centred upon an amateur band and that, where this is done, it is illogical to hold an amateur transmitter responsible for either intermediate frequency or image breakthrough. Finally, he suggests the need for an additional amateur licensing clause and changes in the licensing regulations with the purpose of enabling television and amateur transmission to enjoy a peaceful and active co-existence.

"Next in order of merit is 'The Problem of Fading in the Long-Distance Communication Circuit,' by S. C. Boas. The author first investigates the causes of fading and gives an account of fading patterns observed by using the 16 aerials of the multiple unit steerable antenna system (M.U.S.A.). He then describes various methods of reducing fading effects and discusses the advantages and disadvantages of each.

"The third essay is 'Lift Installations: Aspects of Maintenance and Salient Features of Design Advancement' by G. Chalk. In the first part of the paper the author deals with the types of equipment available and discusses their merits for specific purposes. He pays particular attention to the various safety devices available. In the second part of the paper the

\* The full list of Awards was published in the July, 1953, issue, p. 94.

author discusses the maintenance routines and gives a detailed account of the points that must receive attention. The inspection of lift ropes and rope renewal are particularly well described.

"The next paper is 'Post-War Developments in the Testing of Dials Automatic,' by G. W. Bates, in which the author, writing mainly about the acceptance testing of bulk supplies of dials, deals with the latest dial test set and electronic methods for the rapid testing of large numbers of dials.

"The last paper to be awarded a prize is that on 'Shared Service in Rural Areas' by J. L. Bowley. This is a well-written account of the various schemes applicable to U.A.X. and small manual exchange areas followed by an account of the more stringent maintenance conditions incurred and the author suggests reasons why shared service is not so satisfactory in rural areas as it is in urban and city areas."

H. E. WILCOCKSON,  
Secretary.

### London Centre

The programme arranged for the first half of the 1953-54 session is as follows:—

#### Ordinary Meetings†

6th October, 1953.—Chairman's Address. "Recent Developments in Subscribers' Apparatus and Services." F. C. Carter, O.B.E., B.Sc.(Eng.), M.I.E.E.

10th November, 1953.—"The Influence of Signal Imitation on the Design of V.F. Signalling Systems." S. Welch, M.Sc.(Eng.), A.M.I.E.E.

11th December, 1953.—"Maintenance of TV Links." C. E. E. Clinch, B.Sc.(Eng.), A.M.I.E.E., F.S.S., and L. Thomas, A.M.I.E.E.

#### Informal Meetings‡

21st October, 1953.—Vice-Chairman's Address. "Some Aspects of the Growth and Maintenance of the Telephone Service." G. S. Berkeley, M.I.E.E.

25th November, 1953.—"Regional Engineering Training—Is it worth while?" C. E. Palmer Jones and G. W. P. Hills.

† Held at the Institution of Electrical Engineers, Savoy Place, Victoria Embankment, W.C.2, commencing at 5 p.m.

‡ Held in the Conference Room, Waterloo Bridge House, S.E.1, commencing at 5 p.m.

### Recent Additions to the Library

2108 *Electrical Measurements and the Calculation of the Errors Involved*, Pt. II—A.C. (Brit. 1953.)

Covers the syllabus of the B.Sc.(Eng.) degree in Electrical Measurements and Measuring Instruments; shows how errors can be calculated, what methods to use for a particular measurement and the conditions for which a method will give the best results; and provides a Laboratory Manual giving proved methods of measurement.

2109 *From Atoms to Stars*. M. Davidson (Brit. 1946).

Provides a general outline of the most up-to-date knowledge of the heavenly bodies and shows the methods employed by the astronomer to derive their distances, sizes, masses, temperatures, etc.

2110 *The Cold Working of Non-ferrous Metals and Alloys*. Inst. of Metals (Brit. 1952).

A symposium on metallurgical aspects of the subject on the occasion of the Annual General Meeting of the Institute in 1951.

2111 *Modulators and Frequency Changers*. D. G. Tucker (Brit. 1953).

Intended for engineers who have to design and maintain modulators and frequency-changers and other systems associated with them, and for the communications student.

2112 *Heat and Thermodynamics*. J. K. Roberts, rev. A. R. Miller (Brit. 1951).

Primarily for the use of students taking a university honours course in Physics; the book in general has been written from the experimental point of view.

2113 *The High-Speed Compression Ignition Engine*. C. B. Dicksee (Brit. 1940).

Deals in detail with the principle governing the operation of these engines.

2114 *Applied Electronics*. D. H. Thomas (Brit. 1948).

Emphasises the fundamental principles and illustrates them with applications to give an insight into the possibilities and limitations of electronic equipment.

2115 *Polyphase Commutator Motors*. B. Adkins and W. J. Gibbs (Brit. 1951).

Describes the most important methods of control and the characteristics obtained, the theory being given in separate sections which can be omitted by those primarily interested in what a machine will do.

2116 *Automation*. J. Diebold (Amer. 1952).

Concerns the future of electronic aids in commerce.

2117 *Remote Control in Radio*. A. H. Bruinsma (Dutch 1952).

A treatment of two systems—amplitude modulation and impulse technique.

2118 *The Principles of Line Illustration*. L. N. Staniland (Brit. 1952).

Designed to help students and research workers who have difficulty in making drawings for their own information or for reproduction.

2119 *The High-Speed Internal Combustion Engine*. H. R. Ricardo (Brit. 1953).

Represents the author's experience of and conclusions drawn from the research, design and development work of his firm, and stresses particularly sleeve-valve engines.

2120 *Internal Combustion Engineering*. A. T. J. Kersey (Brit. 1949).

A general survey of the construction, applications and operation of all classes of internal combustion engines.

2121 *Radio and Television Servicing, Vol. 1, Radio*. E. Molloy and W. F. Poole (Brit. 1953).

2122 *Radio and Television Servicing, Vol. II, Television*. E. Molloy and W. F. Poole (Brit. 1953).

2123 *Radio and Television Servicing Charts*. E. Molloy and W. F. Poole (Brit. 1953).

The above three books form a comprehensive and detailed manual dealing with the installation, maintenance and repair of all the leading makes of television, and post-war broadcast-, automobile- and communications-type radio receivers.

2124 *Examples in Electrical Calculations*. Admiralty (Brit. 1952).

Covers the requirements of Preliminary and Intermediate C. and G. examinations.

2125 *Atoms and Energy*. H. S. W. Massey (Brit. 1953).

A non-technical account of the developments in atomic physics which led to the large-scale release of atomic energy, emphasising the scientific rather than the technical aspects of the development.

2126 *Print Control*. M. P. Wooller (Brit. 1953).

Covers enlarging techniques and afterwork on prints.

2127 *Electrical Transmission of Power and Signals*. E. W. Kimbark (Amer. 1949).

Intended as a textbook for junior and senior students in electrical engineering who have had the usual courses on D.C. and A.C. circuits with lumped parameters, but none on electrical machinery or on electron tubes.

2128 *Management*. E. F. L. Brech (Brit. 1953).

An exploratory treatise on the theory of management.

2129 *Vacuum-Tube Oscillators*. W. A. Edson (Amer. 1953).

A systematic and reasonably complete treatment of the many factors which affect the behaviour of vacuum-tube oscillators.

2130 *Television Receiver Design: I.F. Stages*. A. G. W. Uitjens (Dutch 1953).

One of the Philips series, this volume deals particularly with pentode amplifiers operating in a frequency range between 10 and 100 Mc/s, and includes high-frequency amplifiers of T.R.F. receivers (40–70 Mc/s).

W. D. FLORENCE,  
Librarian.



# Regional Notes

## South Western Region

### BOURNEMOUTH TELEGRAPH/PHONOGRAM TRANSFER

At 2 p.m. on Sunday, 28th June, Bournemouth became the third town in the country to change to the Automatic-Call-Distribution Phonogram System. Also brought into service at the same time were six new teleprinter suites. Thus the whole of Bournemouth's Central Telegraph/Phonogram services now operate from a new Switchroom/Instrument Room located in the H.P.O. building in Albert Road.

Apart from the automatic switching apparatus and the message conveyors, the entire installation has been carried out by direct labour and comprises:—

- (a) 6 Teleprinter Suites (26 equipped positions).
- (b) Circulation Table (Pneumatic tube, etc.).
- (c) 4 Phonogram Suites (32 equipped positions).
- (d) Enquiry Desk (2 positions).
- (e) Supervisor's Control Desk.

The new phonogram equipment is standard except that the Queue Limit has been tailored to suit local traffic requirements, i.e., the maximum "length" of the waiting call queue is limited to 15.

With regard to the teleprinter positions, the transfer merely required providing positions for such circuits as already existed, i.e., 5 point-to-point circuits, 15 T.M.S. circuits and 6 T.A.S. circuits. Opportunity was taken however of so arranging the teleprinter table layouts, etc., that when Telegraph Automatic Switching apparatus is installed, the conversion of the operators' positions will be a relatively simple matter.

Also planned for the near future is the transfer of the V.F. terminal from its present location to the new apparatus room, so that ultimately all this associated plant will be housed in one common apparatus room.

D. P. M.

### A STARLING'S NEST IN A TELEPHONE POLE

When a decayed pole was cut down at Chewton Mendip, Somerset, three starling eggs rolled out of a hole near the top of the pole. A careful examination was made, and a section cut through below the hole revealed that a "house hungry" starling attempted to solve the shortage by taking over a woodpecker's excavation. The bird built the nest at the bottom of a hole (at the centre of the pole) some 16 inches deep and had laid three eggs before being disturbed by Post Office operations. It must be recorded that one of the eggs was a casualty but the two others were returned for photographing.

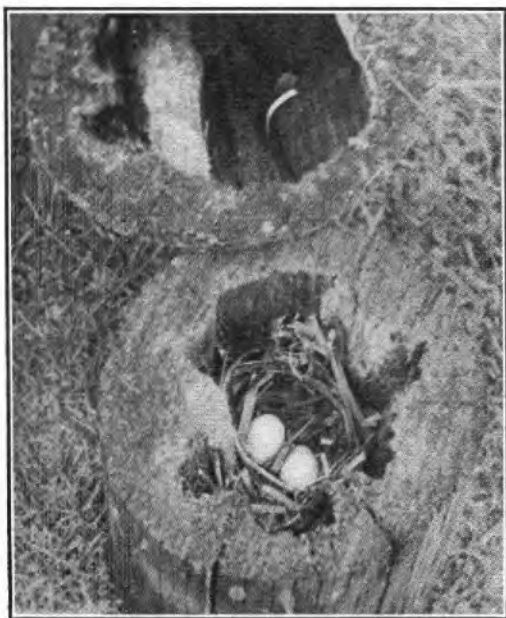

STARLING'S NEST IN POLE TOP.

It is amusing to speculate on the chances the fledglings would have had to get out of the hole; perhaps ornithologists would advise!

F. B. W.

## North Western Region

### THE ROYAL SHOW, BLACKPOOL, 1953

The Royal Agricultural Society of England held their 107th Show at Blackpool from 7th to 10th July and during that period 118,000 people paid for admission. This factual statement does not in any way reveal what the coming of the Show to Blackpool had meant to the Area staff. To answer this we must go back a few months to July, 1952, when it became known to the Preston Area that the "Royal Show" for 1953 would be held on the site of the old Stanley Park Airport at Blackpool, and that the exhibits would cover a site of 136 acres.

From this information the usual questions soon started to arise, but the answers were not so readily forthcoming, e.g. how many exhibitors will require telephones? Will they be served from a show site exchange? What will be the engineering costs in order that the rentals can be assessed, and so on. There are, of course, the experiences of past Royal Shows to study to enable some ideas of requirements to be formed; but each Show sets its own problems, governed mainly by the amount of spare exchange equipment and external plant and its availability for the show.

As mentioned above, the show occupies a large site and invariably one which is not developed and normally has no need for development from a telephone viewpoint. Therefore the provision and recovery of a fair amount of external plant is usually involved.

The Blackpool site was situated just over two miles from Blackpool Central exchange, a main non-director 2000-type. Fortunately, a 2400 multiple extension to the exchange was being installed and was to be available before the show commenced. Also, with the exception of 75 yards, spare underground duct existed from the exchange past the site. These two factors determined the method of providing service for the event.

It was decided to reserve a portion of the exchange extension and by suitable re-grading and some temporary cabling, provide a "Show Exchange" hypothetical on the main exchange for an estimated maximum of 200 subscribers, including kiosks and service requirements. Provision for 50 '0' level circuits, for the show subscribers, was made and these were trunked out to separate '0' level appearances on the auto-manual positions. To cater for the 37 kiosk and coin-box circuits provision was made to terminate these circuits on a spare uniselector rack, the outlets from which were graded out to 32 '0' level relay sets calling on "Show" coin-box appearances on the manual board. With this arrangement post-payment coin boxes were used in the kiosks and in effect they worked as trunk subscribers calling direct on the auto-manual board. Access to the Show exchange subscribers, ordinary and coin box, was provided from the final selector multiple of Central exchange.

The traffic requirements called for 79 additional temporary trunk circuits to various zone and group centres, six temporary directory enquiry positions and six portable trunk units. This meant the provision of additional outgoing junction multiple and conversion of a portion of the answering multiple from a 6-panel to a 12-panel appearance to allow for the additional circuits.

So far as the external plant was concerned, it was finally decided to draw in a 150-pair cable from Central exchange to the site. In addition to this cable a further 50 pairs were available, if required, from spares in the local underground network, some  $\frac{3}{4}$  mile from the site.

The provision of the external plant to the site and on the site was delayed as long as practicable because it had, in effect, to be a "made to measure" job. This delay gave more time in which to obtain reliable estimates of the number of subscribers requiring service and thus helped to keep engineering costs to a minimum. In fact, the external work to, and on site, was not commenced until April.

The on-site cabling work was made much easier by the use of a mole-drainer. Also, the 35 kiosks, No. 6, were assembled at the Blackpool stores and taken out to the site on the kiosk trailer; this aid proved very useful.

Eventually, everything was in readiness, including a Show telephone directory for the 158 subscribers and kiosks connected to the Show exchange. Even the weather was ready because on the night before the opening day a 40 mile-an-hour gale swept the site! Canvas was torn for 100 yards from the roof of the grandstand and the carpeted Royal Box stood open to the sky. However, carpenters and others repaired most of the damage in time for the opening. Fortunately, the Department's plant was not affected by the gale.

Some idea of the size of the Show can be gathered from the fact that 4,000 tons of buildings and fittings were erected by the Royal Agricultural Society, providing four miles of shedding and buildings. In addition, nine miles of water mains, eight miles of electricity supply cables and 30,000 railway sleepers for roadways were provided on site. H. G. C.

### Northern Ireland Region

#### LAYING ARMOURED CABLE FOR BELFAST TELEVISION SERVICE

The article on p. 130 of this issue, covering the provision of temporary television service to the Belfast area, mentions the formidable task of laying armoured coaxial cable in mountainous country. The cable, over a mile long, connects the P.O. receiving site on Black Mountain with the temporary B.B.C. transmitter in Glencairn. Some details of the method of laying this cable in ground having an average gradient of 1 in 3 will no doubt be of interest.

The cable was supplied on eight drums, each containing 250 yards. Five drums were necessary to cover the distance involved where the gradient was maximum. It was apparent that these particular lengths could better be handled in the downward direction, and as it was not practicable to convey the drums and mount them on jacks at 250-yard intervals, the five drums were taken to the mountain site. Each length was then uncoiled and manhandled to its appropriate position along a previously prepared trench. Of the remaining drums of cable, one was uncoiled at the terminal site, Glencairn, and two at an intermediate point.

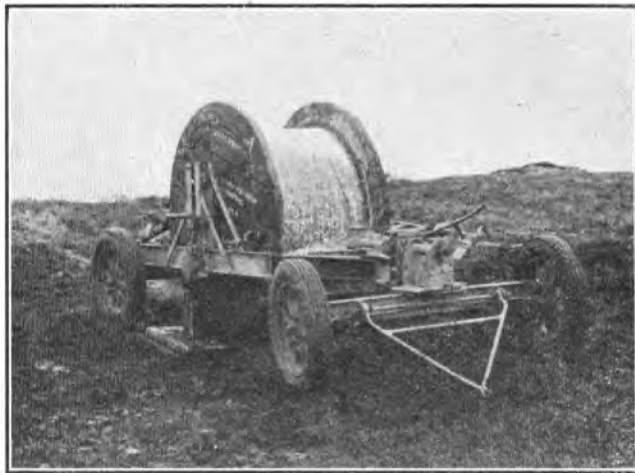

SPECIALLY CONSTRUCTED CABLE DRUM TRAILER.

The tractor and trailer used for the transportation of other stores across the mountain was unsuitable for carrying the drums of cable because of their bulk and weight. A standard cable-drum trailer would not meet the exceptional requirements and a special drum trailer was, therefore, designed and constructed locally and proved to be entirely successful.

In the construction of the special trailer the wheels of two jointers' trailer tool carts were used with a considerably extended wheelbase. The chassis was made of R.S.J.s and was in two parts coupled together over the front wheels. The front axle was swivelled vertically and horizontally to provide the maximum stability when traversing the uneven ground. The rear portion of the chassis contained the complete sides just sufficiently spaced to permit them being lifted over the cable drum before being coupled to the front portion. The cable drum was then jacked up in the normal manner until a

position was reached where the trailer fittings replaced the jacks. The cable drum was then still free to revolve and this feature of the design was fully appreciated on the occasions when the narrow wheels of the trailer "bogged down" in the marshy ground, the cable drum momentarily taking over their function.

The combined weight of the trailer and drum of cable was over two tons and it was therefore necessary to use two tractors for the haulage, and to by-pass an exceptionally "boggy" portion of the route by building a bridge of poles across a stream. Finally it should be mentioned that for a short section of the route a river crossing was necessary; this was arranged by carrying the cable on double supporting steels between poles on each bank. W. J. B., H. F.

### Wales and Border Counties

#### A CABLING SCHEME REQUIRING SPECIAL LOADING COILS

The Chester Area, like many other areas, has a considerable main cable programme to deal with, and one work in particular is of special interest.

This cable, the Colwyn Bay-Bangor 490/20 + 4 S.P., was difficult to plan from the commencement. The existing cable route consists of a single 4-in. duct, an old cast iron pipe and one armoured cable, all laid in a rather narrow main road where no footpaths exist, the carriageway extending to the foot of the hedge bank at either side.

There were severe objections from the road authorities to laying a further duct in the existing carriageway, and because of this and the fact that a new carriageway was projected for the future, it was decided to erect aerial cable in the adjacent fields over the disputed section of about three miles. After difficult and protracted wayleave negotiations, permission was secured from the owners to erect poles and aerial cable as required. Unfortunately, however, one tenant would not agree to the Department entering upon the site to do the work and this had to be abandoned. On further negotiations, it was found that no objections would be raised to cables laid in the ground. The whole scheme, therefore, was replanned to provide a two-way duct through woods, fields, over streams, etc., on a line calculated to be suitable when the new carriageway is constructed.

No serious difficulties were met with in laying the duct, but boulders in many hundreds, some of considerable size, delayed the work.

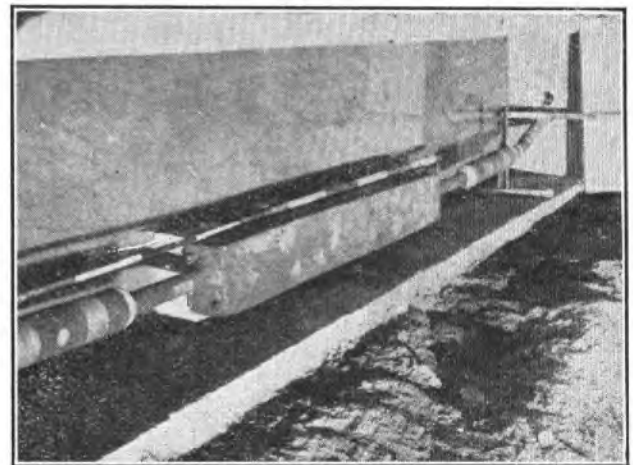

LOADING COIL CASE IN NON-STANDARD BURIED CHAMBER.

Joint Boxes J.R.C.7 were kept near hedge-rows in order to reduce possible damage to crops later, but the loading coils presented a little difficulty.

It was desirable to avoid building large and deep manholes in the fields and therefore buried jointing chambers 19 ft. x 2 ft. 6 in. x 2 ft. with removable slabs, similar to J.R.C.7 type, were constructed, and special loading coils were used.

Cabling was an easy operation, mainly because of the good weather. Had it been wet, the handling of cable drums

weighing over 3 tons across grass fields would have been a serious difficulty.

The loading coil cases used are rectangular in shape, some 7 ft. long and several inches in cross section. This type, although not new, is not generally known, and has proved extremely useful in overcoming a difficulty on the work.

#### AN UNUSUAL CASE OF TELEVISION INTERFERENCE

A Cardiff televiewer living in a self-contained flat recently complained of a slight distortion of the picture and an intermittent rasping noise on the sound. Although various receivers and aerials had been tried, the interference had persisted since the set had been installed several months previously.

The interference was present in the receiver only during transmitting periods, and it could not be heard on any of the portable locators. The complainant's T.V. installation, house-wiring and electrical equipment were checked without result. As the interference was characteristic of a faulty mains supply meter, every meter in the vicinity was checked, but again with no success.

A temporary indoor aerial was then erected near the T.V. set, and on moving it a variation in the strength of the interference was obtained, indicating a close proximity of the interfering source. Therefore, all electrical equipment in the adjoining flat, which was normally empty all day, was checked.

By chance an ancient grandfather clock (non-electric) was noticed. On opening the inspection door, it was seen that the pendulum was about 42 in. or a quarter wavelength long, and on stopping it the interference ceased. Several stop-start tests proved conclusively that the clock was causing the interference.

The obvious method of suppression (i.e. stopping the clock) was not adopted, and the effective earthing of all the internal metal parts eliminated the trouble.

L. W. A.

#### Scotland

##### AN UNUSUAL SUBSCRIBER'S INSTALLATION

An interesting and novel installation was carried out recently in the Edinburgh Telephone Area. A request was received from the Infantile Paralysis Fellowship to provide telephone service to two patients in an Edinburgh hospital who were under treatment in iron lungs. The two patients were given shared service, but when standard apparatus was fitted it was found that the equipment was very inconvenient. Assistance was necessary, by nurses or attendants, to enable the patients to make and receive calls. The hand set had to be held to the patient's head during conversation, and all dialling operations had to be carried out on the patient's behalf. This involved considerable wastage of time by hospital staff as well as placing the two patients under obvious restriction in freedom of conversation. The two patients were very keen to carry out all telephone operations themselves, although their capability of movement was very limited.

To overcome these difficulties, modifications were made to the equipment which finally resulted in the patients being able to make and receive calls without other assistance. The ordinary telephone was replaced by the following equipment. A bell set No. 59 was modified by fitting a capacitor No. 97, induction coil No. 27, rectifier element 1/12A and a thermistor, in conjunction with a twelve-terminal strip and jack No. 300B6. A twelve-way cord was connected to the terminal strip, passed through an airtight gland in the side of the iron lung cabinet, carried along the inside and terminated on a test jack No. 21 bolted to the upper framework of the lung cabinet. The dial was fitted in a key mounting NAA, together with a key 68, and a key 302B was mounted above the dial on the NAA mounting. The whole dial equipment was attached to the framework of the bed stretcher. Connection between dial, keys and the jack test No. 21 was made by means of a twelve-way cord and plug No. 1205. A detachable bracket was fixed on the outside bulkhead of the lung cabinet and carried a transmitter No. 22 and watch receiver IOP on an adjustable extension piece. By this arrangement the patient has only to turn the head slightly to have these items in the correct position for conversation.

The transmitter and receiver were connected to the jack 300 B6 in the bell set by a three-way cord and plug 316. This

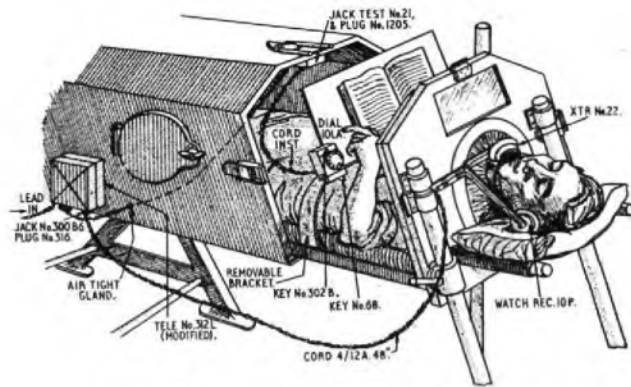

TELEPHONE INSTALLATION FOR PATIENT IN IRON LUNG.

allows for removal and disconnection as required. The key 68 was fitted in place of the cradle switch and can be operated by the patient with the minimum movement of the fingers. The key 302 B had to be fitted owing to the type of exchange on which service was given, but the arrangement, with minor modifications, could be made suitable for any auto system.

The various items of equipment had to be carefully mounted in such positions as to enable the patients, who have very little power of movement in their hands, to operate them easily. The equipment also had to be arranged so that it could be readily removed, if necessary, while the patient received medical attention. The telephone equipment can be used either with the lung cabinet closed or open and the arrangement enables this to be done without severing or damaging the cords in the movement of the airtight bulkhead.

The patients are thus able to make and receive calls wholly without assistance and with the minimum of movement.

The illustration shows the approximate position of the various components of telephone equipment on the lung cabinet.

G. E.

#### GREAT BRITAIN'S SIX MILLIONTH TELEPHONE

Since 1935 the island of Stroma, situated in the storm-lashed Pentland Firth about two miles from the Scottish mainland, and with an area less than two square miles, has been linked to the mainland by radio phonogram telegraph.

To commemorate the provision of the six millionth telephone in Great Britain, it was decided to provide full telephone facilities to the island at a kiosk in the centre of the island community.

While the two-mile sea channel separating the island from the mainland may not appear to present any untoward difficulties, the tide race between the Atlantic Ocean and the North Sea at this point attains a speed of some twelve knots. A submarine cable was not considered suitable for such a project, and the obvious solution was a radio telephone link. There is no power supply in Stroma, but the problem was

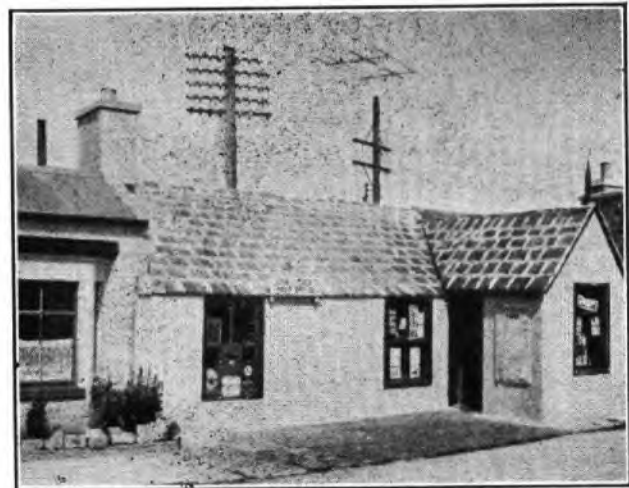

AERIAL ERECTED BEHIND JOHN O'GROATS POST OFFICE.

solved by the newly available low-power battery-operated V.H.F. equipment.

The installation of the aerial and equipment was done by Aberdeen Area staff, with technical assistance from Headquarters.

The official opening ceremony, at which Colonel Gardiner, the Director of the Post Office in Scotland, presided, took place at 3 p.m. on Saturday, 15th August. The Right Honourable James Stuart, Secretary of State for Scotland, made the inaugural call from the Town Hall at Wick via the C.B.S.3

## Associate Section Notes

### Aberdeen Centre

The Annual General Meeting was held on 18th March when the balance sheet for 1952-53 was presented and approved. The total membership was 110. The following office-bearers were elected for 1953-54:—

*President*, Mr. R. C. Birnie (Area Engineer); *Chairman*, Mr. R. T. Ross; *Vice-Chairman*, Mr. D. S. C. Buchan; *Secretary and Treasurer*, Mr. J. H. Lawrence; *Librarian*, Mr. W. F. Leith; *Auditors*, Mr. D. D. Milne and Mr. R. W. Lord; *Committee*, Mr. M. G. Ronalson, Mr. G. C. McKee, Mr. F. L. Crabbe, Mr. E. D. Petrie, Mr. J. Yule, and Mr. J. Hutchison.

The programme for session 1953-54 has been arranged as follows:—

October, 1953.—“The New Standard P.A.B.X.s,” Mr. J. H. Lawrence (T/O, Aberdeen).

November, 1953.—“Introduction to Mechanical Engineering,” Mr. R. T. Ross (T/O, Aberdeen).

January, 1954.—“Radar,” Mr. G. T. J. Donaldson (T/O in Training, Aberdeen).

February, 1954.—“Modern Housing,” Mr. E. A. Meldrum, A.R.I.B.A. (Aberdeen).

March, 1954.—Annual General Meeting followed by paper on “TV Links,” Mr. T. Moxon (Regional Headquarters).

The attendance throughout the last session was very disappointing, so please come along and support us by your presence.

J. H. L.

### Birmingham Centre

During the past three months no meetings or visits have been held, but this does not mean that the Centre has been dormant; on the contrary quite an amount of “behind the scenes” activity has been going on.

A letter has been sent to all members of the staff in the immediate area around Birmingham to publicise the activities of the Institution in an attempt to increase further the numbers who are members of this Centre. This has resulted in 36 new members up to now (August) which brings the total membership to 280. The Librarian has revised the lists for the circulation of periodicals for the 1953-54 session and as a result of the demand by members for this popular service, additional periodicals are being purchased.

The programme for the coming session has now been arranged and it is hoped that it will satisfy all tastes. The President of the Associate Section, Col. C. E. Calveley, kindly consented to open the session on 17th September by addressing a joint meeting of this Centre and the recently formed Birmingham Test Section Centre on “The Present System of Appraisal and Promotion.”

The remainder of the programme is as follows:—

12th October, 1953.—“Jet Propulsion.” R. H. Spikes, of Joseph Lucas (Gas Turbine Equipment), Ltd.

17th October, 1953.—Visit to Hamstead Colliery.

10th November, 1953.—“3-D Films”—a talk and demonstration.

18th November, 1953.—Visit to Fort Dunkop.

December, 1953.—“My Impressions of the American Telephone Service.” C. Morgan.

15th December, 1954.—Visit to the Museum of Science and Industry.

14th January, 1954.—“The Work of the Cable Ships.” G. Cottam of the Submarine Branch.

23rd January, 1954.—Visit to Birmingham University Physics Department.

8th February, 1954.—“Rockets”—a film show by A. C.

exchange at John o'Groats and the call was accepted by Councillor Allen at the kiosk on behalf of the 95 islanders.

After the ceremony the islanders proceeded to deplete the stock of coins which they had been accumulating for the occasion. The link was kept in almost constant use until 10 o'clock on Sunday evening.

There are many similar islands around the coast of Scotland and the Post Office has a fairly extensive programme for providing similar links when equipment and manpower become available.

Rotherham.

25th February, 1954.—Visit to B.S.A. Motor Cycle Plant.

9th March, 1954.—“Accommodation.” C. L. Topham, A.M.I.E.E.

22nd March, 1954.—Visit to Fisher & Ludlow, Ltd. (metal pressings).

7th April, 1954.—“The City of Birmingham Water Supply.” C. A. Risbridger (Chief Engineer).

27th April, 1954.—Annual General Meeting.

May or June, 1954.—Visit to Elan Valley.

K. G. S. A.

### Darlington Centre

The Annual General Meeting was held on 20th May, 1953, and the officers elected for the 1953-54 session are as follows:—

*Chairman*, N. V. Allinson; *Vice-Chairman*, W. Gosling; *Secretary*, C. N. Hutchinson; *Treasurer and Librarian*, B. Midcalf. *Local Committee*: R. W. Cowan, D. E. Dodds, G. A. Garry, T. L. M. Hebron, T. James, K. Johnson, S. Little, R. Moore, E. Pinkney, J. Ronaldson, A. Snowden, W. L. Young. *Auditors*: A. S. Hyatt and P. Dodd.

The fact that this committee is representative of both external and internal staffs means that the out-stations will be more fully informed and this should result in even better attendances at the meetings.

It was the unanimous decision of the meeting that the membership fee be increased to 2s. which is still apparently very low in comparison with other centres.

18th June, 1953.—A visit to the Darlington and Simpson Rolling Mills proved most enjoyable. Mr. W. French, the general works manager, had made excellent arrangements to receive us and departmental heads accompanied the party and explained the various processes in the manufacture of the firm's products.

The visit was the sequel to an excellent talk on “Steel” given by Mr. French to the Centre some time ago.

Sunday, 19th July, 1953.—Twenty members joined forces with the Middlesbrough Centre in a visit to the Thornaby R.A.F. Station. Here, again, excellent arrangements had been made by a departmental colleague, Major R. R. Johnson, R.A. (T.A.), who has seen long service at the station.

The visit was of six hours' duration without a dull moment, and Major Johnson was thanked for his services and requested to convey to the Station Commander our appreciation of the facilities afforded.

Arrangements are well in hand for the 1953-54 session, with the usual endeavour to provide a programme better than the previous one.

C. N. H.

### Dundee Centre

A new session is again with us and it is the object of the Dundee Centre Committee to bring before the membership a very full and varied programme from which much enjoyment should be had.

It is intended that visits be made to a local news-printing office, Briggs' tar distillation refinery, sugar-beet factory, modern jute works, Burndeft battery makers, and a locomotive shed.

It is also intended that papers be read on the following subjects: Power—E.L. and P.; U.G.—Planning and Maintenance; Repeater Stations; Radio Interference; A.C. Signalling Systems; Sales Development; Training; Trunk Mechanisation; C.P.C.; Music Recording.

With such a programme it is to be hoped that the membership will take full advantage and find something of interest.

R. L. T.

## Edinburgh Centre

A talk by the Telephone Manager, Mr. R. F. Bucknall, at the September meeting will be the beginning of what is hoped will be an interesting session. A varied programme has been arranged and the outside visits, so popular throughout the year, will again be a prominent feature. The popular and technical magazine list which began a few months ago as an experiment will be continued and it is hoped to increase the number of periodicals. New members are continually being enrolled and a welcome at any of our meetings awaits all interested.

J. R. H.

## Glasgow and Scotland West Centre

The programme arrangements for the 1953/54 session are as follows:—

2nd October.—“Electronic Switching,” by Dr. Coombs, London.

30th October.—Member's Paper by Mr. R. Goldie.

27th November.—“Localisation of Cable Faults,” by Mr. A. J. Allen, Glasgow.

22nd January.—Member's Paper by Mr. J. J. Brown.

26th February.—“Training,” by Mr. S. Munro, Edinburgh.

26th March.—“Trunk Mechanisation,” by Mr. G. Campbell, Edinburgh.

Proposed visits are as follows: Cyclotron, Glasgow University; Dobbie's Tobacco Works, Paisley; Weather Ship.

Two summer visits are also proposed: (1) Hydro-electric station at Loch Sloy; (2) B.B.C. station at Westerglen.

The Centre has been singularly fortunate in obtaining the services of Mr. J. L. Angus, B.Sc., A.M.I.E.E., Area Engineer, as Chairman.

A cordial invitation is given to everyone, especially in the Scotland West Area, to join this session's activities.

## Gloucester Centre

Although with a smaller membership for the 1952/53 session this centre's activities have been well maintained. The programme was as follows:—

October.—“Britain's Largest Non-Director Exchange,” by Mr. G. J. Hoare, illustrated with films in colour as well as black and white.

November.—“Television,” an excellent paper given by Mr. F. N. Bedwell, A.Brit.I.R.E.

December.—“The Internal Combustion Engine,” by Mr. H. R. Hudson, resulted in a large number of questions from the audience.

January.—“'65 M.P.G.,” by Mr. J. M. Readings, Grad.I.M.E., who achieved this exceptional consumption rate in the *News Chronicle* road fuel economy test run.

A visit to the British Electricity Authority's Castle Meads Generating Station at Gloucester gave us a chance of being in the warm on a bitterly cold day.

February—A return Quiz with the Bath Centre resulted in a well-deserved victory for them, making the score one all.

At the Annual General Meeting held on 20th May, 1953, renewed interest was shown and the Committee increased in size. Elected were: *President*, E. H. Jeynes, A.M.I.E.E., Area Engineer; *Chairman*, K. A. Priddey; *Secretary*, J. W. Cox; *Assistant Secretary*, H. D. Cook; *Treasurer*, A. K. Franklin; *Committee*, A. E. Adams, J. W. Brookes, D. A. Cooper, D. Collins, C. R. Johns, C. W. Morgan, H. R. Moule, J. A. Page and K. Savery.

Immediately prior to this meeting, our Telephone Manager, Mr. W. Moseley, M.B.E., presented Mr. R. T. Hoare with the Institution Award and three-guinea cheque gained for his paper, “An Outline of Carrier Telephony,” which he had previously read to the Centre during the 1951/52 Session, earning the President's prize. Mr. G. J. Hoare received the current year's local award given by Mr. F. D. W. Embling, Area Liaison Officer.

A more ambitious programme is being aimed at for the coming winter and further details will be given later.

J. W. C.

## Guildford Centre

The Annual General Meeting was held on 23rd April, 1953, and the following officers were elected for the ensuing year: *President*, H. M. Wells (Area Engineer); *Chairman*, A. B. Biggs; *Secretary*, L. G. Wallis; *Treasurer*, R. J. Nichols; *Committee*, J. W. Moon, F. Lancaster, G. M. Newman and E. Knott; *Auditors*, A. J. Daborn and F. B. Amey.

The annual outing was to Oxford, where the party was entertained to lunch by the Nuffield Organisation and afterwards shown round the plant. The evening was spent in visiting the Colleges and their surroundings.

Programmes of all the proposed activities during the 1953/54 session have not been completed but it is hoped to include: Eight film shows and seven factory visits and the following lectures: “The Television Receiver,” L. G. Wallis (October, 1953); “The Medical Aspects of Aircraft Design,” Group-Capt. Stewart, Principal of Aero Medical College, Farnborough (November, 1953); “Interplanetary Travel (February, 1954); “Wood Turning” (March, 1954).

L. G. W.

## London Centre

The London Centre 1953/54 session commenced on 26th August with the final round of the Inter-Area Quiz between City and S.W. Areas. The adjudicator was Mr. Deveraux, A.M.I.E.E., and the quiz master Mr. A. W. Lee. The result of the final round was a win for City Area by half a point. In the previous round Long Distance Area held the lead against S.W. Area until the last question.

A News Letter is now being published at quarterly intervals in order to keep members in touch with past, present and future activities of the London Centre.

A further new venture this session is the setting up of a Technical Advice Panel under the guidance of the previous librarian, Mr. Skinner. Its purpose is to give users of the service the information that they require, and put them in touch with a source that can settle their problems. The panel when complete will cover all branches of Telecommunications and allied subjects.

The London Centre programme for 1954 will include the following lectures:—

“Telegraph Automatic Switching,” Mr. L. A. T. Martindale.

“Outside Broadcasts,” Mr. Sanderson.

“Cable and Wireless, Communications of the World,” Col. H. J. Wellingham.

“Electric Timekeeping,” Mr. H. T. Stott.

The London Centre Committee would like to take this opportunity of reminding members of the library facilities. Books are obtainable from the I.P.O.E.E. Library at Alder House, or if necessary from Messrs. H. K. Lewis. It is felt that members should make more use of this facility.

E. W. B.

## Middlesbrough Centre

The Annual General Meeting was held on the 14th May, 1953. The following officers were elected: *Chairman*, W. J. Costello; *Vice Chairman*, D. B. Oliver; *Secretary*, G. Finch; *Assistant Secretary*, P. Garrick; *Treasurer*, R. R. Johnson.

A fully representative committee was elected covering officers concerned in all phases of our work. A pleasing feature was the number of young members elected to office, which augers well for the future of the Centre. The meeting offered congratulations to the Chairman, W. J. Costello, on his National Award, and to Ted Grimshaw for his Regional Award.

The new committee are busy with next session's programme but in the meantime visits have already been made to the Television Station at Arncliffe Wood and the R.A.F. Station at Thornaby.

Other visits planned are to the new power station at Billingham and to Kemsley Newspapers at Middlesbrough.

The committee ask all members of the staff to rally round the new officers and give them full support. It is only by having a large and active membership that we can hope to maintain a live centre.

G. F.

# Staff Changes

## Promotions

Name	Region	Date	Name	Region	Date
<i>Exec. Engr. to Snr. Exec. Engr.</i>			<i>Tech. Offr. to Asst. Engr.—continued.</i>		
Carden, R. W. G.	E.-in-C.O.	8.5.53	Laurie, D.	Scot. to L.T. Reg.	30.6.53
Leek, T. W.	S.W. Reg. to Scot.	11.5.53	Dobson, E. D.	S.W. Reg. to E.-in-C.O.	1.7.53
Little, S. J.	L.T. Reg. to E.-in-C.O.	15.6.53	Bennett, J. G.	E.-in-C.O.	6.7.53
Smith, D. C.	E.-in-C.O. to Fact. Dept.	15.7.53	Anderson, D. S.	Scot. to L.T. Reg.	6.7.53
Wase, A. E. N.	E.-in-C.O.	23.7.53	Murfitt, R.	H.C. Reg. to E.-in-C.O.	6.7.53
Duff, J. B.	Scot.	3.8.53	Wells, C. R.	E.T.E. to E.-in-C.O.	13.7.53
<i>Asst. Engr. to Exec. Engr.</i>			<i>Williamson, J. B.</i>		
Postance, J. C. E.	Mid. Reg. to N.W. Reg.	8.6.53	Povey, J. A.	Mid. Reg.	13.7.53
Crisp, A. J. E.	E.-in-C.O.	1.4.53	Taylor, F. J. W.	H.C. Reg. to E.-in-C.O.	20.7.53
Kitching, J. K.	E.-in-C.O.	15.5.53	Woods, A. S.	H.C. Reg. to E.-in-C.O.	20.7.53
White, G.	E.-in-C.O.	20.5.53	Bartlett, L. W.	N.W. Reg.	28.7.53
Forbes, E. D.	E.-in-C.O.	13.7.53	James, E. C.	S.W. Reg. to E.-in-C.O.	4.8.53
<i>Inspr. to Asst. Engr.</i>			<i>Chandler, K.</i>		
Craigie, F. R.	H.C. Reg.	31.3.53	Chandler, K.	H.C. Reg. to E.-in-C.O.	17.8.53
Pither, R. T.	S.W. Reg.	15.6.53	Bunday, D. C.	Mid. Reg. to E.-in-C.O.	17.8.53
Horton, B. L.	S.W. Reg.	15.6.53	<i>Asst. (Sc.) to Asst. Engr.</i>		
<i>Tech. Offr. to Asst. Engr.</i>			<i>Beardmore, A. F.</i>		
Duncan, C. L.	N. Ire. Reg.	31.1.53	Beardmore, A. F.	E.-in-C.O.	26.5.53
Atherton, H.	N.W. Reg.	2.2.53	<i>Asst. Exptl. Offr. to Asst. Engr.</i>		
Gooch, S.	H.C. Reg.	25.2.53	Keen, D. S.	E.-in-C.O.	26.5.53
Clark, R. A. S.	W.B.C.	26.4.53	<i>Tech. IIA to Asst. Engr.</i>		
Roberts, F.	N.W. Reg.	4.5.53	Wootten, P. L. G.	L.T. Reg.	26.5.53
Hornsby, H. C.	Mid. Reg.	11.6.53	Pritchard, D. A.	E.-in-C.O.	26.5.53
Baldwin, I. H.	E.T.E.	11.5.53	<i>Asst. Exptl. Offr. to Exptl. Offr.</i>		
Brown, G.	E.T.E.	11.5.53	Shirley, D. G. M.	E.-in-C.O.	4.8.53
Robertson, S. N.	E.-in-C.O.	26.5.53	<i>Inspr. to Traffic Offr.</i>		
Taylor, F. C.	E.-in-C.O.	26.5.53	Purdon, J.	Scot. to L.T. Reg.	17.2.53
Woollett, B. J.	S.W. Reg.	1.6.53	<i>Tech. Offr. to Inspr.</i>		
Step, E. C.	L.T. Reg.	3.6.53	Powell, F. E.	H.C. Reg.	17.2.53
Bond, B. L.	L.T. Reg.	3.6.53	Chapman, A. E.	H.C. Reg.	17.2.53
Price, N. W.	E.-in-C.O.	8.6.53	Chaney, W. J. E.	H.C. Reg.	26.5.53
Davies, H. B.	N.E. Reg.	15.6.53	Steele, J.	H.C. Reg.	26.5.53
Gaukrodger, D.	N.E. Reg.	15.6.53	<i>Tech. I. to Inspr.</i>		
Palmer, D.	E.-in-C.O.	15.6.53	Davies, S. W.	W.B.C.	19.3.53
Mellors, H. R.	L.T. Reg.	15.6.53	Rafferty, W.	N. Ire. Reg.	1.4.53
Drinkwater, R. W.	E.-in-C.O.	22.6.53	Bihet, F. L. W.	H.C. Reg.	11.5.53
Billcliff, D.	N.E. Reg. to E.-in-C.O.	22.6.53	Hall, T. E.	H.C. Reg.	31.5.53
Bowdidge, W. L.	L.T. Reg. to E.-in-C.O.	22.6.53	King, H. J. A.	Mid. Reg.	23.6.53
Barnes, P. R.	H.C. Reg. to E.-in-C.O.	29.6.53	<i>Retirements</i>		
Courage, D. R.	S.W. Reg. to L.T. Reg.	29.6.53	<i>Name</i>		
Tolboys, P.	N.E. Reg.	29.6.53	<i>Region</i>		
			<i>Date</i>		

Name	Region	Date	Name	Region	Date
<i>Snr. Exec. Engr.</i>			<i>Asst. Engr.—continued.</i>		
Gambier, J. E.	S.W. Reg.	18.6.53	Freshwater, R. A. A.	L.T. Reg.	15.8.53
Pirie, H. A.	E.-in-C.O.	25.6.53	Pratt, E.	E.-in-C.O.	16.8.53
Sturgess, H. E.	E.-in-C.O. (Voluntary)	30.6.53	Rogers, T.	L.T. Reg.	16.8.53
<i>Exec. Engr.</i>			<i>Norman, S. J.</i>		
Moore, H. J.	N.W. Reg.	30.6.53	Norman, S. J.	L.T. Reg.	18.8.53
Benson, W. K.	N.W. Reg.	2.7.53	Warburton, E.	N.W. Reg.	20.8.53
Jones, C. J.	N.E. Reg.	31.8.53	Jack, A.	L.T. Reg.	31.8.53
Hutchings, W. S.	L.T. Reg.	31.8.53	<i>Inspector</i>		
Ware, W.	E.-in-C.O.	24.7.53	Mayes, J. W.	L.T. Reg.	15.2.53
<i>Asst. Engr.</i>			<i>Laney, W. H.</i>		
Wallis, H. W.	H.C. Reg.	31.1.53	Laney, W. H.	Mid. Reg.	11.5.53
Power, W.	E.T.E.	31.3.53	Moss, J.	S.W. Reg.	16.5.53
Milne, G. W.	E.T.E.	30.4.53	Newey, L. G. B.	Mid. Reg.	21.5.53
Clayton, C. E.	Scot.	31.5.53	Bantin, A. L.	L.P. Reg. (Voluntary)	31.5.53
Thorn, G.	L.T. Reg.	4.6.53	Paton, R.	Scot.	30.6.53
Tovey, F. P.	Mid. Reg.	11.6.53	Richards, G. H. P.	L.T. Reg.	30.6.53
Rae, G.	Mid. Reg. (Health grounds)	11.6.53	Wills, H. H.	L.T. Reg.	30.6.53
Poole, H.	N.E. Reg.	13.6.53	Godfrey, G. M.	L.T. Reg.	30.6.53
Gibbons, T.	N.E. Reg.	30.6.53	Vause, J. C.	N.E. Reg.	1.7.53
Braddick, H. A.	E.-in-C.O.	6.7.53	Collins, E. R.	L.T. Reg.	2.7.53
Richardson, W. A.	N.E. Reg.	7.7.53	Cohu, M.	S.W. Reg.	12.8.53
Buchanan, D. G.	Scot.	16.7.53	Norton, L.	N.E. Reg.	10.8.53
Nevin, D. C.	N.W. Reg.	27.7.53	Stockwell, W. A.	L.T. Reg.	31.8.53
Jalland, F. R.	E.-in-C.O.	3.8.53	<i>Tech. Asst. I.</i>		
			<i>Finlayson, J. W.</i>		
			Scot.		
			31.8.53		

### Transfers

Name	Region	Date	Name	Region	Date
<i>Snr. Exec. Engr.</i>			<i>Exec. Engr.—continued.</i>		
Smith, R. C.	W.B.C. to S.W. Reg.	22.6.53	Iliffe, D. E. L.	E.-in-C.O. to Telecomms. Dept., Malaya	4.8.53
			Williams, J. B. F.	E.-in-C.O. to N.W. Reg.	17.8.53
<i>Exec. Engr.</i>			<i>Asst. Engr.</i>		
Heath, F. J.	E.-in-C.O. to E.A. High Commission	3.2.50	Moore, J. C.	E.-in-C.O. to Min. of Supply	4.8.53
Kyme, R. C.	E.-in-C.O. to H.C. Reg.	1.6.53	Gough, G. J.	E.-in-C.O. to Mid. Reg.	1.6.53
Tinto, J. M.	Mid. Reg. to S.W. Reg.	29.6.53	Hodgkinson, A. A. A.	E.-in-C.O. to N.E. Reg.	14.6.53
Freere, S. E.	E.-in-C.O. to Mid. Reg.	4.8.53	Thompson, C. H.	E.-in-C.O. to Mid. Reg.	6.7.53
			Brookes, G. A.	L.T. Reg. to E.-in-C.O.	13.7.53

### Deaths

Name	Region	Date	Name	Region	Date
<i>Area Engr.</i>			<i>Asst. Engr.—continued.</i>		
Leek, T. W.	Scot.	26.6.53	Prince, C. J.	L.T. Reg.	5.8.53
<i>Asst. Engr.</i>			Fitzgerald, J. C.	N.W. Reg.	9.8.53
Casemore, F. H.	H.C. Reg.	5.8.53	Rutherford, W.	Scot.	11.8.53
			Bennett, J. S.	N.W. Reg.	28.8.53

### DRAUGHTSMEN

#### Promotions

Name	Region	Date
<i>D'man Cl. I to Ldg. D'man.</i>		
Hampton, T. E.	E.-in-C.O.	4.3.53
Bradford, H. J.	E.-in-C.O.	5.1.53
Key, H. J. L.	E.-in-C.O.	14.3.53

#### Transfer

Name	Region	Date
<i>D'man.</i>		
Harrison, A. F.	L.T. Reg. to E.-in-C.O.	4.5.53

### BOARD OF EDITORS

H. FAULKNER, C.M.G., B.Sc., M.I.E.E., F.I.R.E., Chairman.  
 W. WEST, O.B.E., B.A., M.I.E.E.  
 L. F. SCANTLEBURY, Whit.Sch., A.C.G.I., D.I.C., M.I.E.E.  
 D. A. BARRON, M.Sc., A.M.I.E.E.  
 H. G. BEER, Whit.Sch., A.C.G.I.  
 E. DAVIS, A.M.I.E.E.  
 L. CHANT.  
 G. E. STYLES, A.M.I.E.E., Managing Editor.  
 W. A. HUMPHRIES, A.M.I.E.E.  
 J. P. HARDING, B.Sc.(ENG.),  
 A.M.INST.C.E., A.M.I.E.E. } Assistant Editors.  
 A. J. HUTCHISON, Secretary-Treasurer.

#### Copyright

The entire contents of this JOURNAL are covered by general copyright, and special permission is necessary for reprinting long extracts, but Editors are welcome to use not more than one-third of any article, provided credit is given at the beginning or end thus: "From the *Post Office Electrical Engineers' Journal*."

The Board of Editors is not responsible for the statements made or the opinions expressed in any of the articles in this JOURNAL, unless such statement is made specifically by the Board.

#### Communications

All communications should be addressed to the Managing Editor, *P.O.E.E. Journal*, Engineer-in-Chief's Office, Alder House, Aldersgate Street, London, E.C.1. Telephone: HEADquarters 1234. Remittances should be made payable to "The *P.O.E.E. Journal*" and should be crossed "& Co."

#### Binding Cases

Cases for binding are available, and may be obtained from the Local Agents for 3s. Subscribers can have their copies of volumes bound, at a cost of 10s. 6d., by sending the complete set of parts to the Local Agents or to the *P.O.E.E. Journal*, Engineer-in-Chief's Office, Alder House, Aldersgate Street, London, E.C.1. Orders for binding for Vols. 1-19 should indicate whether the original binding case with black lettering, or the later pattern with gold, is required. Cases with gold lettering are the only type stocked from Vol. 20 onwards.

#### Back Numbers

The price of the JOURNAL, which is published quarterly, is 2s. 6d. (2s. 9d. post free) per copy, or 11s. per annum, post free. Back numbers can be supplied, subject to availability of stocks, at 2s. 6d. each (2s. 9d. post free). Orders for back numbers may be sent to the *P.O.E.E. Journal*, Engineer-in-Chief's Office, Alder House, Aldersgate Street, London, E.C.1, or to the Publishers.

Employees of the British Post Office can obtain the *Journal* through Local Agents at the reduced price of 2s. per copy.

#### Advertisements

All communications relating to space reservations should be addressed to the Advertisement Editor, *P.O.E.E. Journal*, Alder House, Aldersgate Street, London, E.C.1. Communications regarding advertisement copy, proofs, etc., should be addressed to the Publishers, Messrs. Birch & Whittington (Prop. Dorling & Co. [Epsom], Ltd.), 49 Upper High Street, Epsom, Surrey.

## INDEX TO ADVERTISERS

	PAGE
Airmec Laboratories, Ltd. . . . .	ii
Alton Battery Co., Ltd., The . . . . .	ix
Automatic Coil Winder & Electrical Equipment Co., Ltd. . . . .	xxiii
Automatic Telephone & Electric Co., Ltd. . . . .	xv-xvi
Bennett College, The . . . . .	ii
British Electric Resistance Co., Ltd., The . . . . .	xxix
British Institute of Engineering Technology . . . . .	viii
Edison Swan Electric Co., Ltd., The . . . . .	xxxii
E.M.I. Institute . . . . .	xxx
Ericsson Telephones, Ltd. . . . .	xx
Evershed & Vignoles, Ltd. . . . .	vii
Ferranti, Ltd. . . . .	iii
General Electric Co., Ltd., The . . . . .	xvii-xviii, xxi-xxii
Great Northern Telegraph Co., Ltd. . . . .	xxiv
Hackbridge Cable Co., Ltd. . . . .	xxiv
Hivac, Ltd. . . . .	viii
International Correspondence Schools, Ltd. . . . .	iii
Jones, Walter, & Co. (Engineers), Ltd. . . . .	xxix
Marconi's Wireless Telegraph Co., Ltd. . . . .	x
Marconi Instruments . . . . .	xiii
Muirhead & Co., Ltd. . . . .	xi
Mullard, Ltd. . . . .	iv-xii
Neill, James, & Co., Ltd. . . . .	xi
Painton of Northampton . . . . .	xiv
Pirelli-General Cable Works, Ltd. . . . .	xxxi
Pitman, Sir Isaac, & Sons, Ltd . . . . .	viii
Pye, Ltd. . . . .	v-vi
Siemens Brothers & Co., Ltd. . . . .	xix
Smith, Frederick, & Co. . . . .	xxx
Standard Telephones & Cables, Ltd. . . . .	xxvii-xxviii
Sullivan, H. W., Ltd. . . . .	xxv
Telephone Manufacturing Co., Ltd. . . . .	xxiii
Tungstone Products, Ltd. . . . .	xxvi
Turner Electrical Instruments . . . . .	xxx
Westinghouse Brake & Signal Co., Ltd. . . . .	xxv
Winn & Coales, Ltd. . . . .	ii

# Be ready to step up to that BETTER JOB!

THE more progressive posts in electrical engineering need special technical qualifications. The right training is essential. Learn at home, in your own time. I.C.S. offer you specialised instruction in preparation for the following examinations—

**C. & G. ILLUMINATION ENGINEERING (INTER.)**  
**C. & G. ELECTRICAL ENGINEERING PRACTICE, INSTALLATION AND TELECOMMUNICATIONS**  
**GRADUATESHIP OF THE B.I.R.E.**  
**C. & G. RADIO SERVICING CERTIFICATE (R.T.E.B.)**  
**P.M.G. CERTIFICATES FOR WIRELESS OPERATORS**

C.S. Examination students are coached till successful.

**I.C.S. Home Study courses are also available to those wishing to qualify for responsible, well-paid positions in—**

Electric Power	Radio Servicing
Illumination	Advanced Short Wave Radio
Heating	Basic Radar
Traction	Basic Electronics
Radio Engineering	Television Technology

**DON'T DELAY—WRITE TODAY!** Send for FREE descriptive booklet, stating course or examination which interests you! Reduced Terms to H.M. Forces.

Dept. 165B, I.C.S., 71 Kingsway, W.C.2

**INTERNATIONAL CORRESPONDENCE SCHOOLS**  
 Dept. 165B, International Buildings, Kingsway,  
 London, W.C.2

Please send me FREE Booklet on \_\_\_\_\_

Name \_\_\_\_\_ Age \_\_\_\_\_  
 (BLOCK LETTERS PLEASE)

Address \_\_\_\_\_

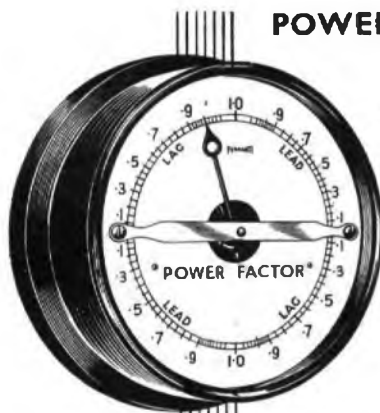

## POWER FACTOR METERS

- *New design*
- *Compactness*
- *Good delivery*

*Round Pattern*

This is one of the new Ferranti Power Factor Meters. Shallow pressed steel case. Balanced or unbalanced load. Small V.A. burden. 4", 6" or 8" round or square dial, semi-projecting or flush mounting. Other recently designed Ferranti switchboard instruments with features similar to the above include ammeters, voltmeters, watt-meters and frequency meters.



**FERRANTI** Switchboard Instruments

FERRANTI LTD · MOSTON · MANCHESTER 10

London Office: KERN HOUSE, 36 KINGSWAY W.C.2.

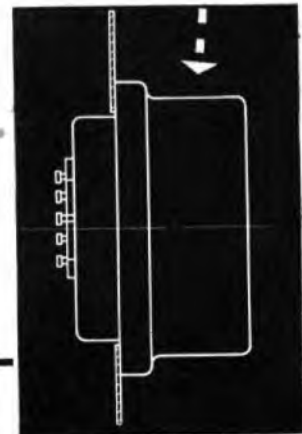

F1123A





*Mullard Ferroxcube  
being extruded into  
rods for H.F. cores.*

**MAGNETIC MATERIALS** Extensive

research and manufacturing facilities have established Mullard as the leading producers of magnetic materials. They were the first, for example, to introduce Ferroxcube, the world's most efficient magnetic ferrite; 'Ticonal' anisotropic permanent magnets, renowned for their high stability and high energy output; and Magnadur, an entirely new type of permanent magnet with the insulating properties of a ceramic.

The wealth of experience gained from these developments is available to all users of magnetic materials through the Mullard advisory service. An enquiry to the address below will put a team of specialised engineers at your disposal.



**Mullard**

• TICONAL' PERMANENT MAGNETS • MAGNADUR (Formerly Ferroxdure)  
PERMANENT MAGNETS • FERROXCUBE MAGNETIC CORE MATERIAL

MULLARD LTD., COMPONENT DIVISION, CENTURY HOUSE, SHAFTSBURY AVENUE, LONDON, W.C.2.



# TELEVISION

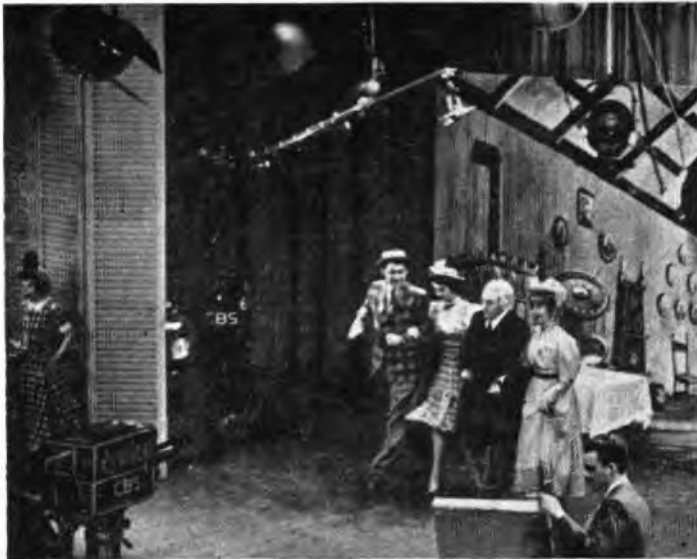

*Pye TV equipment being used in two American studios*

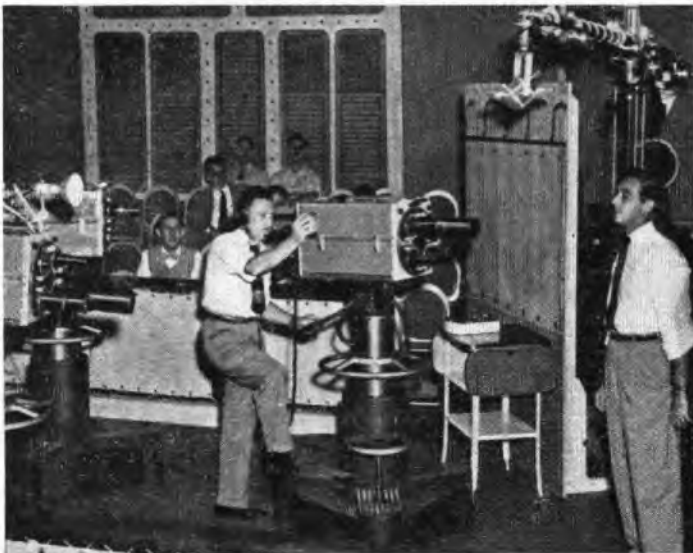

*Section of Pye control apparatus*

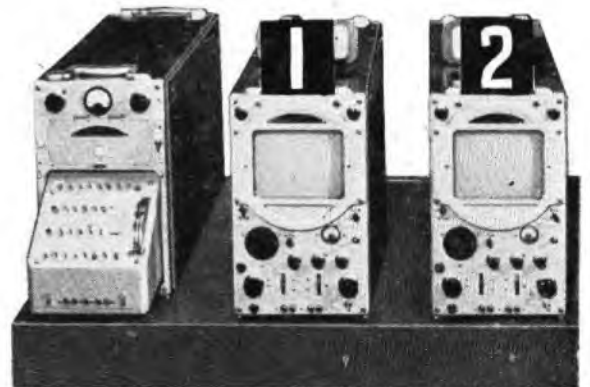

THE PYE GROUP OF COMPANIES

# CAMERAS IN AMERICA

American technicians agree that the efficiency and adaptability of Pye TV transmission equipment make it ideal for the high speed production necessary for their numerous programmes.

Illustrated here is the Pye television camera and associated apparatus as used in the Columbia Broadcasting System studios in New York.

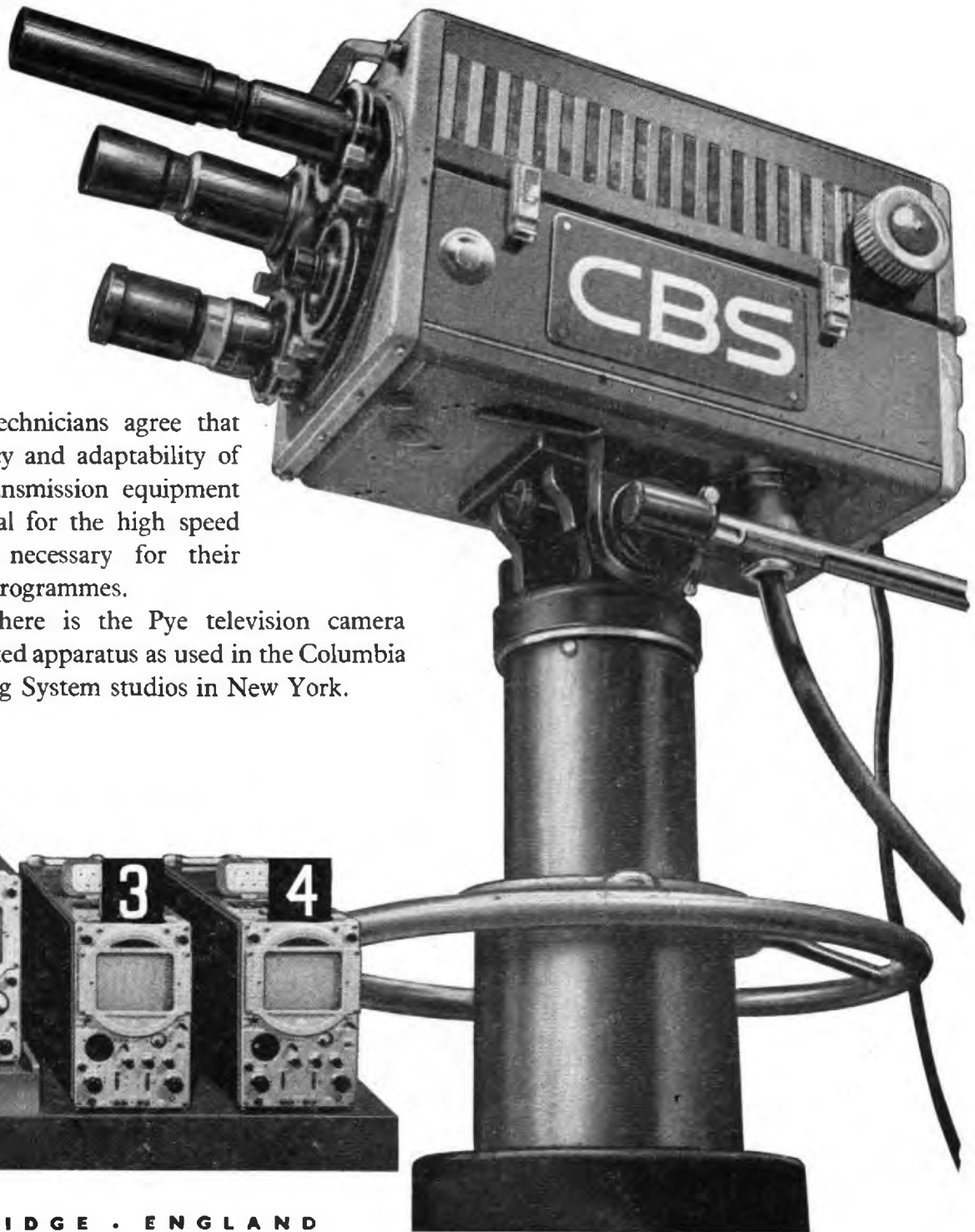
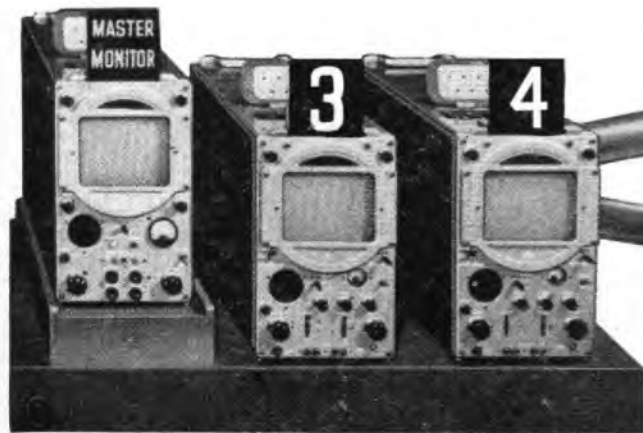

CAMBRIDGE . ENGLAND

# “MEGGER” TESTERS AT WORK

Widely used by the British Electricity Authority and the Area Boards the “Megger” Insulation Tester performs many tasks, among which is that of testing new public lighting installations before connection to the mains. It is seen here in use by the Southgate and Wood Green District staff of the Eastern Electricity Board.

In the top illustration a Series 2 “Megger” Insulation and Continuity Tester is checking the insulation of a lamp installation. In the bottom illustration a similar instrument is making a continuity test on wiring of one of the local authority’s public lighting columns.

Publication No. X236 illustrates and describes Series 2 Insulation and Continuity Testers. Free on request.

**DID YOU KNOW?** That 64% of all faults on the 34,000 miles of main underground Post Office cables in the United Kingdom are located by “Megger” Testers.



**MEGGER**  
TRADE MARK

Telephone: Chiswick 3670

**EVERSHED & VIGNOLES LIMITED**

ACTON LANE WORKS · CHISWICK · LONDON · W. 4

Telegrams: Megger, Chisk, London

Cables: Megger, London  
6/57

# VALUABLE FREE BOOK



Tells You How to Pass Your C. & G. or Promotion Exam. at *First Attempt!*

All Post Office Engineering personnel who are anxious to obtain early promotion should at once send for a copy of our handbook "**ENGINEERING OPPORTUNITIES**," which among other intensely interesting matter, describes our unique methods of preparation for **TECHNICAL APPOINTMENTS IN THE POST OFFICE** (Assistant Engineer—New Style and Assistant Traffic Superintendent), **CITY AND GUILDS EXAMINATIONS** in Principles of Telecommunications (1-5), Radio (1-4), Telephone Exchange Systems (1-3), Telegraphy (1), Line Transmission (1 and 2), Lines Plant Practice (1 and 2), Mathematics for Telecommunications (1-5), Electrical Engineering Practice (Prelim. Inter. and Final), and outlines a wide range of non-examination courses in all branches of Electrical, Mechanical, Civil, Automobile, Aeronautical and Radio Engineering.

Assistant Engineer and Assistant Traffic Superintendent. Open competitions now resumed. Age extensions for established Civil Servants. Ask us for full details

We definitely guarantee  
"NO PASS—NO FEE"

If you intend to make the most of to-day's opportunities, you cannot afford to miss reading "**ENGINEERING OPPORTUNITIES**." It tells you everything you want to know to secure advancement, and describes many opportunities you may now be missing through lack of information. Send for your copy to-day—**FREE** and without obligation.

BRITISH INSTITUTE  
OF ENGINEERING TECHNOLOGY  
368 SHAKESPEARE HOUSE,  
17-19 STRATFORD PLACE, LONDON, W.1

# BIET

## PITMAN

### THE M.K.S. SYSTEM OF UNITS

A Guide for Electrical Engineers

By T. McGreevy, M.Sc.Tech., M.I.E.E., Head of the Electrical Engineering Department, Portsmouth Municipal College. Provides separate approaches to the M.K.S. system for experienced electricians and for students without previous knowledge of electrical units. With numerous reference tables. 21s. net.

### INFORMATION THEORY

And Its Engineering Applications

By D. A. Bell. 20/- net.

"... a comprehensive summary of all the papers that have been written on information theory, and is, in fact, probably the first real book on the subject."—*Wireless World*.

### D.C. GENERATORS AND MOTORS

By J. E. MacFurlane, B.Sc.(Eng.), M.I.E.E., A.M.I.Mech.E. This book provides a simple introduction to these important machines for engineering students and for all engaged in electrical installation work. Illustrated. 8/6 net.

### DEFINITIONS AND FORMULAE FOR STUDENTS: TELEGRAPHY AND TELEPHONY

By E. Mallett, revised by W. T. Palmer. An up-to-date Second Edition of this useful reference work. 1/6.

### FASTER THAN THOUGHT

By B. V. Bowden. A general account of digital computing machines, which surveys their history and background, their theory and design, and their uses both in specialised work and in general office work. Illustrated. 35/- net.

Sir Isaac Pitman & Sons Ltd.

PARKER STREET · KINGSWAY · LONDON · W.C.2.

# SUB-MINIATURISATION

# HIVAC

THE FIRST TO  
GET DOWN  
TO IT!

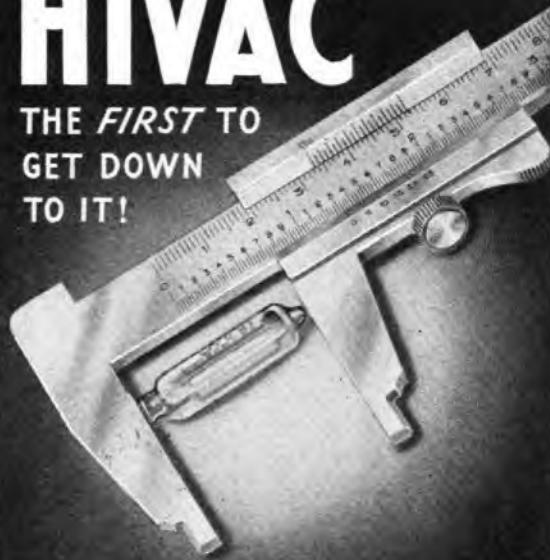

## XFY 41

Beam Tetrode

Sub-Miniature Output Valve  
with still lower filament current

### TYPICAL OPERATION

Filament Voltage .....	1.25	1.25 V.
Filament Current .....	10	10 mA.
H.T. Voltage .....	22.5	30 V.
Control Grid Voltage.....	0	-1.2 V.
Power Output.....	1.8	3.3 mW.

The maximum cross-section is only 8 mm. x 6 mm. with a maximum glass length of 35 mm.

A small flat sub-miniature output tetrode with still lower filament current and improved performance at reduced battery voltages.

# HIVAC

THE SCIENTIFIC  
VALVE

## Hivac Ltd.

Telephone: HARrow 2855  
GREENHILL CRESCENT, HARROW-ON-THE-HILL, MIDDLESEX

**Know this village?** If you worked at the Alton Battery works you'd know it well—and a dozen others like it. You'd know the lanes that lead to each. You'd know the streams—and the fish in them: the pubs and the beer they cool in their cellars, the teas they serve on their lawns . . . Alton's a country town—and the men it breeds are countrymen at heart. Men with roots in their birthplace. Men with a quiet pride in themselves and the patient skill of their hands. A clipped yew hedge in his garden . . . a battery plate at 'the Works' . . . *making something better than merely well comes very naturally to an Alton man.*

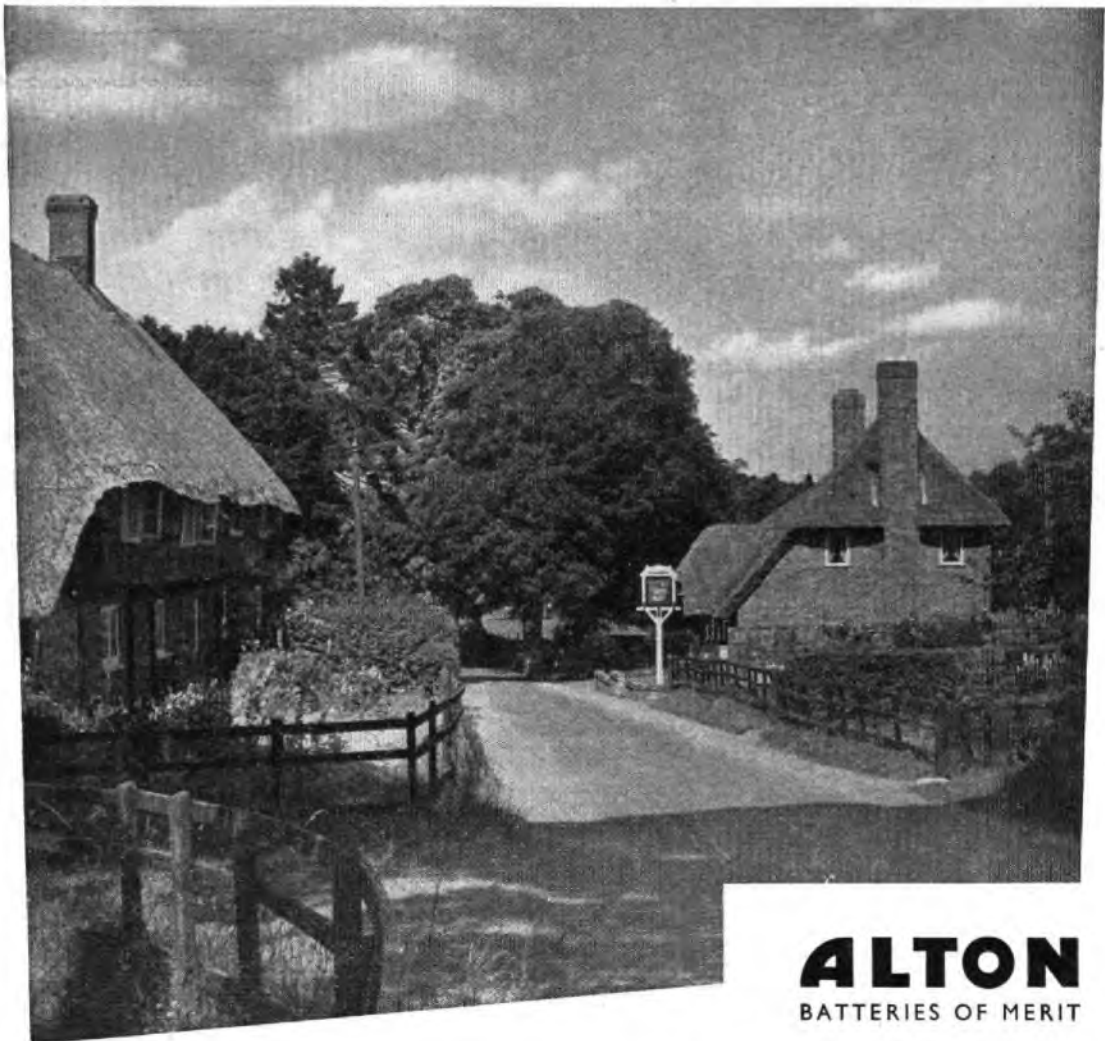

**ALTON**  
BATTERIES OF MERIT

Alton stationary batteries: 10 to 15,000 Ah. Also in regular production, renewal plates for all makes of battery, British and Continental

A26A

The Alton Battery Company Limited · Alton · Hampshire · Telephone: Alton 2267 and 2268 Telegrams: Battery, Alton

# MARCONI communication systems

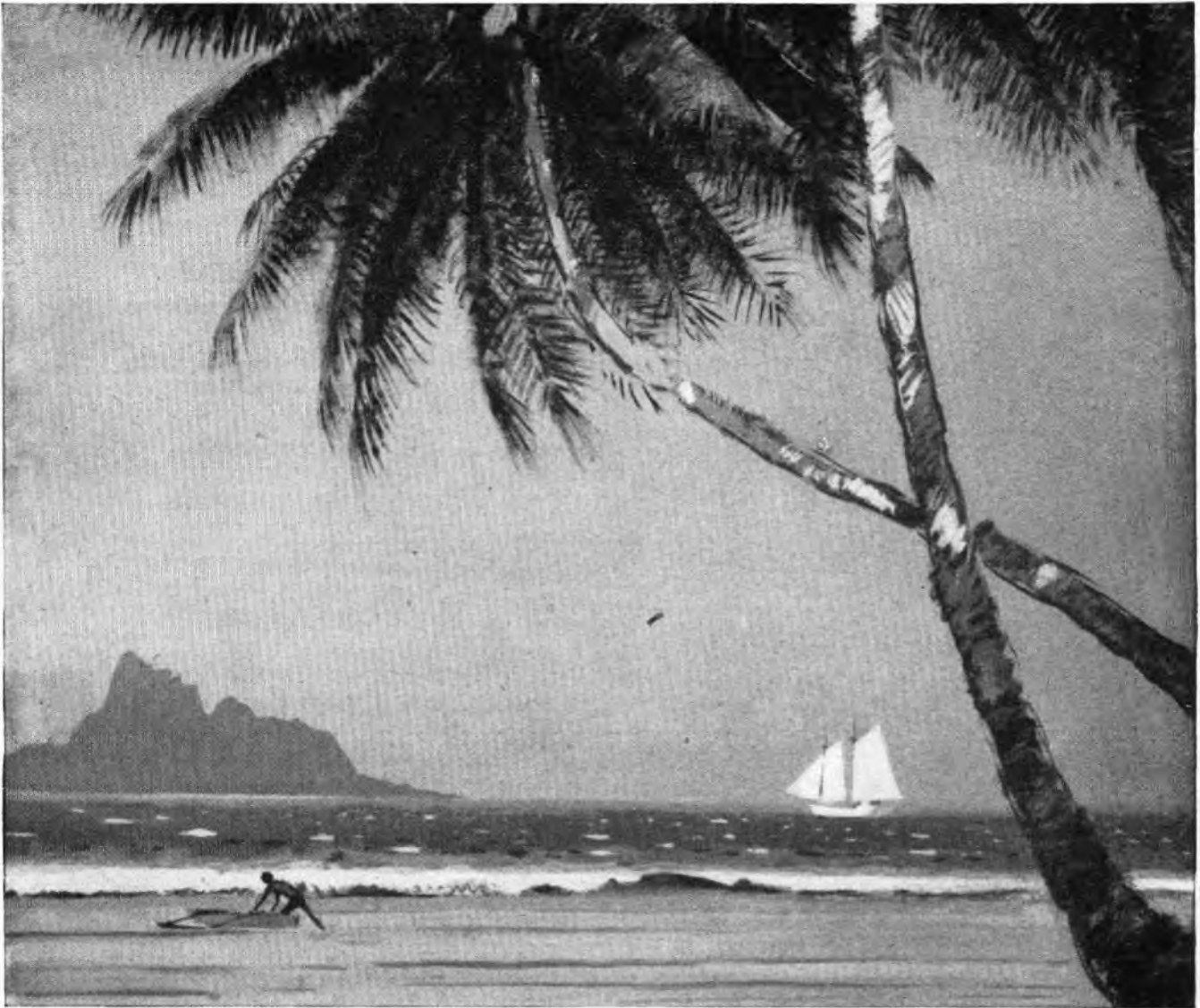

## serve mankind

Wherever men live together (in industrial areas or in tropical archipelagoes) prosperity is largely a matter of communications.

Island communities seem blessedly self-contained. But, for effective government,

hygiene, safety, husbandry, commerce — welfare, in short, and prosperity — archipelagoes are increasingly interdependent. Marconi's invention is bringing to island peoples a fuller and richer way of life.



**SURVEYED**



**PLANNED**



**INSTALLED**

MARCONI'S WIRELESS TELEGRAPH COMPANY LTD • CHELMSFORD • ESSEX





*a new*  
**INDEPENDENT SIDEBAND  
RECEIVER**

... developed to British Post Office  
**Specification**

**T**HIS new Independent Sideband Receiver type GFR 552 is designed for operation on long-distance, point-to-point, short-wave radio links forming part of the international trunk network. On independent sideband working, the GFR 552 provides facilities for the reception of two single sideband signals, each 6 kc/s wide, one above and one below the frequency of a reduced-level pilot carrier. Each sideband will accommodate either two 3 kc/s wide telephony channels, or several voice frequency telegraph channels. The GFR 552 may also be used for reception of single sideband or double sideband transmission. In the case of the second application this receiver offers two advantages: firstly, the absence of non-linear distortion which occurs in normal D.S.B. receivers when signals are subjected to selective fading conditions; and, secondly, the ability to select upper or lower sideband for demodulation, dependent upon which is freer from adjacent channel interference. The circuit and chassis layout of the GFR 552 closely follows that of the Mullard Receiver GFR 551, which was based on a British Post Office design (Receiver, Radio No. 22).

Special features of the GFR 552 include a high order of oscillator stability and freedom from cross-modulation through which cross-talk between channels or inter-modulation between wanted and unwanted signals might occur. A brief technical summary is given below. More detailed information supplied on request.

**FREQUENCY RANGE**—4-30 mc/s.

**NOISE FACTOR**—better than 7 db over the band.

**SIGNAL TO NOISE RATIO**—25 db for 4 microvolts peak sideband input over the band.

**SELECTIVITY**—The response is flat within 2 db for sideband frequencies between 100 c/s and 6000 c/s. At 10 kc/s from the carrier frequency the response is -60 db relative to the pass band.

**A.F.C.**—The A.F.C. system operates effectively with a pilot carrier level of -26 db relative to 1 microvolt (which corresponds to a peak sideband level of 1 microvolt and a signal to noise ratio of 15 db).

**NON-LINEAR DISTORTION**—Third order intermodulation products which might result in cross talk between sidebands do not exceed -50 db relative to the sideband levels.

**OUTPUT**—Variable up to +14 db relative to 1 mW into 600 ohms.

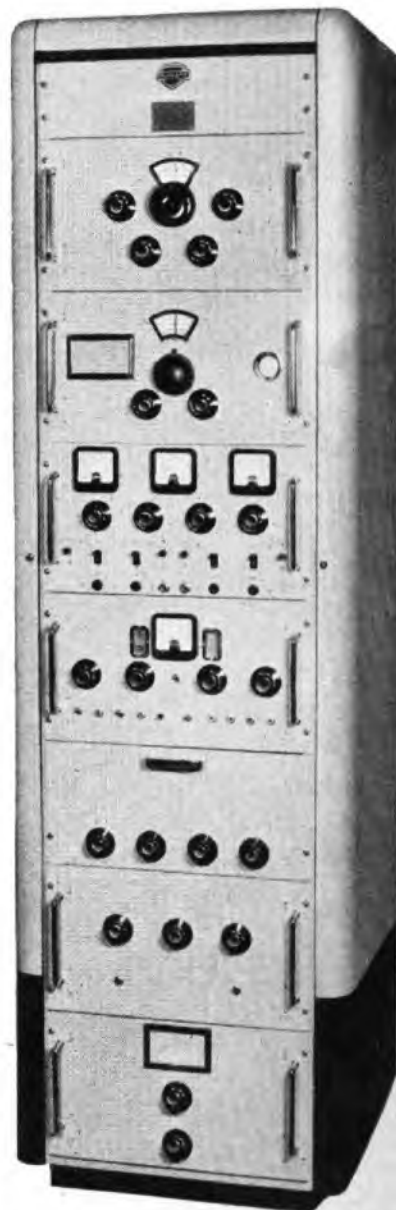

**Mullard** 

**SPECIALISED ELECTRONIC EQUIPMENT**

MULLARD LIMITED, EQUIPMENT DIVISION, CENTURY HOUSE, SHAFTESBURY AVENUE, LONDON, W.C.2  
(M14177)



25 cycles to  
5 megacycles.

**VIDEO OSCILLATOR**  
Type TF 885A

LF — MF

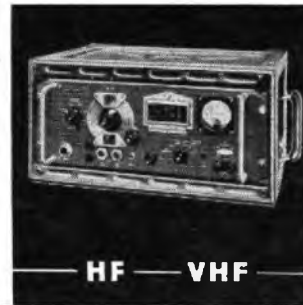

2.5 to 10 megacycles  
and 20 to 100 megacycles.

**CARRIER DEVIATION METER**  
Type TF 934

HF — VHF

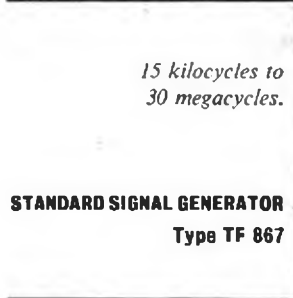

15 kilocycles to  
30 megacycles.

**STANDARD SIGNAL GENERATOR**  
Type TF 867

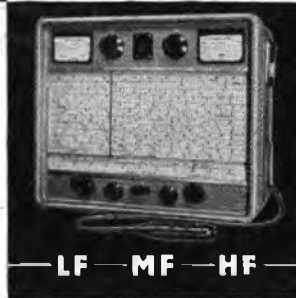

300 to 600 megacycles  
or 200 to 400 megacycles  
or 450 to 900 megacycles.

**SIGNAL GENERATOR**  
Type TF 762C (series)

LF — MF — HF

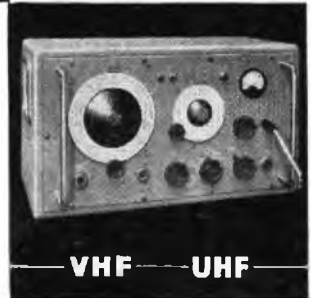

VHF — UHF



1,000 cycles, Inductance  
and Capacitance;  
Resistance at D.C.

**UNIVERSAL BRIDGE**  
Type TF 868

LF



13.5 to  
216 megacycles.

**FM/AM SIGNAL GENERATOR**  
Type TF 995

HF — VHF

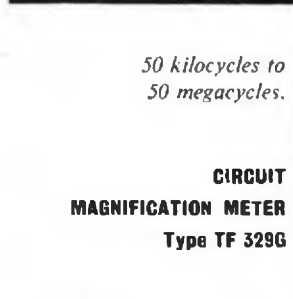

50 kilocycles to  
50 megacycles.

**CIRCUIT  
MAGNIFICATION METER**  
Type TF 329G

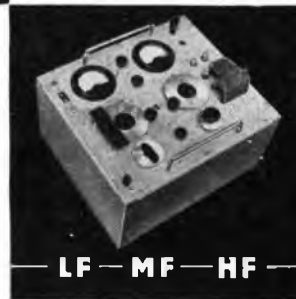

9,000 to  
9,680 megacycles.

**R.F. TEST SET**  
Type TF 890A

LF — MF — HF



SHF

## ◀ Covering the whole radio spectrum ▶

A few examples of telecommunications test equipment, representative of the quality, reliability and precision workmanship of the wide range manufactured by

# MARCONI INSTRUMENTS

SIGNAL GENERATORS · BRIDGES · VALVE VOLTMETERS · WAVE METERS · Q METERS  
FREQUENCY STANDARDS · WAVE ANALYSERS · BEAT FREQUENCY OSCILLATORS

**MARCONI INSTRUMENTS LTD., ST. ALBANS, HERTS. TELEPHONE: ST. ALBANS 6161/7**

Midland Office: 19 The Parade, Leamington Spa.

Northern Office: 30 Albion Street, Kingston-upon-Hull

Export Office: Marconi House, Strand, London, W.C.2



*By Appointment to the Professional Engineer*

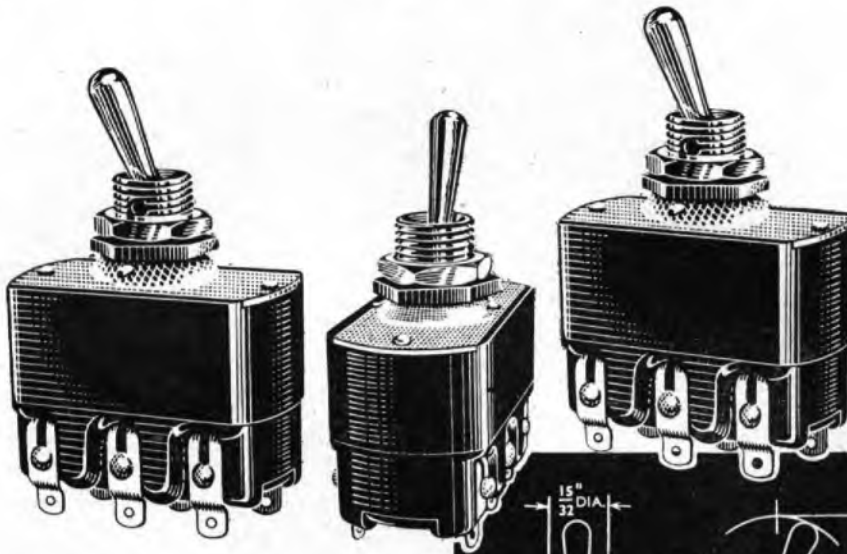

**TOGGLE SWITCH**

**6 AMP.  
DOUBLE POLE  
CHANGE OVER**

**FEATURES**

Catalogue No. 501085 (illustrated).  
6 Amps. 250 Volts A.C./D.C. rating.  
Double Pole Changeover Operation.  
Internal Resistance: less than .002 ohm.  
Silver Plated Phosphor Bronze Contacts.  
Heavy Duty Chrome finish.

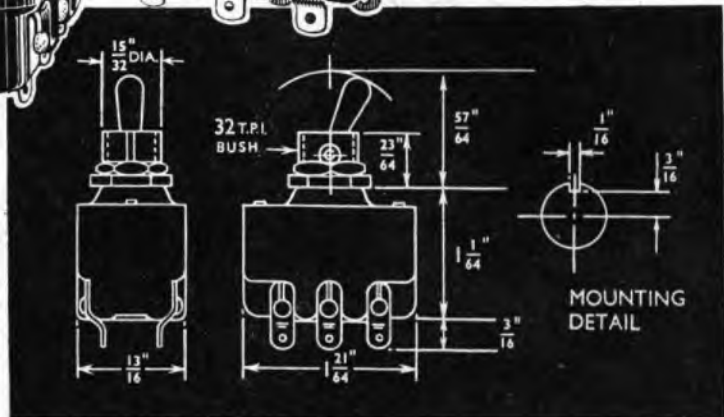

This new Painton 6-Amp. Toggle Switch Series has been designed to conform to the stringent performance requirements of the appropriate R.C.S.C. Specification. The 6 Amps. 250 Volts A.C./D.C. rating is conservative, and the Double Pole Changeover operation meets the requirements of most single or double pole switching applications. Essentially a quality component to be incorporated in the production lines in all kinds of electrical and electronic engineering, its multi-switching facilities make it also the ideal unit for prototype and laboratory equipment. Different bush and lever lengths from those illustrated can be supplied, to conform to RCL 151, or to meet individual requirements where the standard size is unsuitable.

**PAINTON**  
*Northampton England*

**ATTENUATORS AND FADERS • STUD SWITCHES • FIXED AND ADJUSTABLE WIREWOUND RESISTORS  
WIREWOUND POTENTIOMETERS • MIDGET R.F. CHOKES • HIGH STABILITY CARBON RESISTORS • TERMINALS  
PLUGS AND SOCKETS • KNOBS, DIALS AND POINTERS • TOGGLE SWITCHES • PUSH BUTTON SWITCHES**

Designed

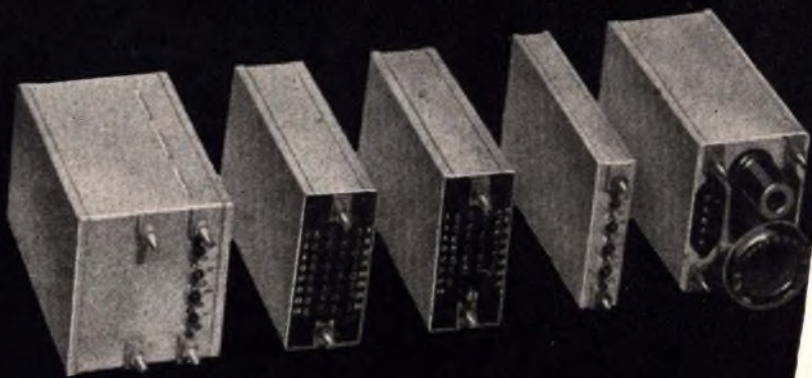
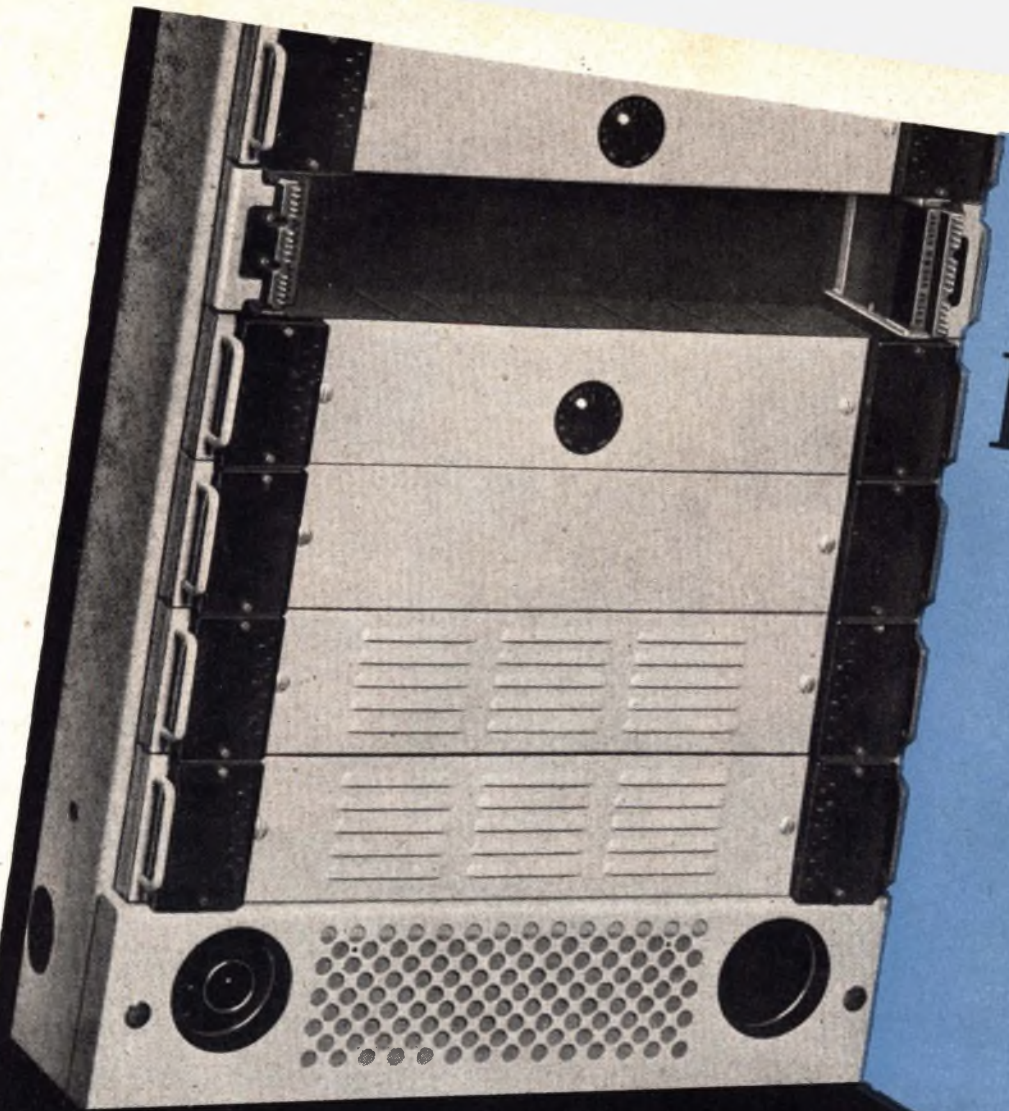

# for Continuous Service

ATE/TMC Transmission equipment is designed to offer an operating administration the maximum facility in the performance of maintenance routines. Jack-in panel frames fitted with quickly detachable functional units ensure the most rapid form of servicing yet devised. You are invited to apply for a copy of "Unit Construction Practice" which describes the technique employed.

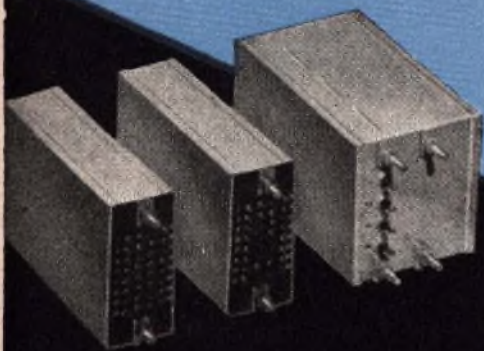

## **AUTOMATIC TELEPHONE & ELECTRIC CO. LTD.**

*Radio and Transmission Division,*

STROWGER HOUSE, ARUNDEL STREET, LONDON, W.C.2. Telephone, TEMple Bar 9262. Cablegrams: Strowgerex, London.

Manufacturers:—AUTOMATIC TELEPHONE & ELECTRIC CO. LTD., Liverpool and London.

TELEPHONE MANUFACTURING CO. LTD., St. Mary Cray, Kent.



# SE 50

**COMPLETING THE RANGE  
OF *G.E.C.* SWITCHES DESIGNED  
TO CUT THE COST OF  
EXCHANGE MAINTENANCE**

# *G.E.C.*

---

THE GENERAL ELECTRIC COMPANY LIMITED OF ENGLAND

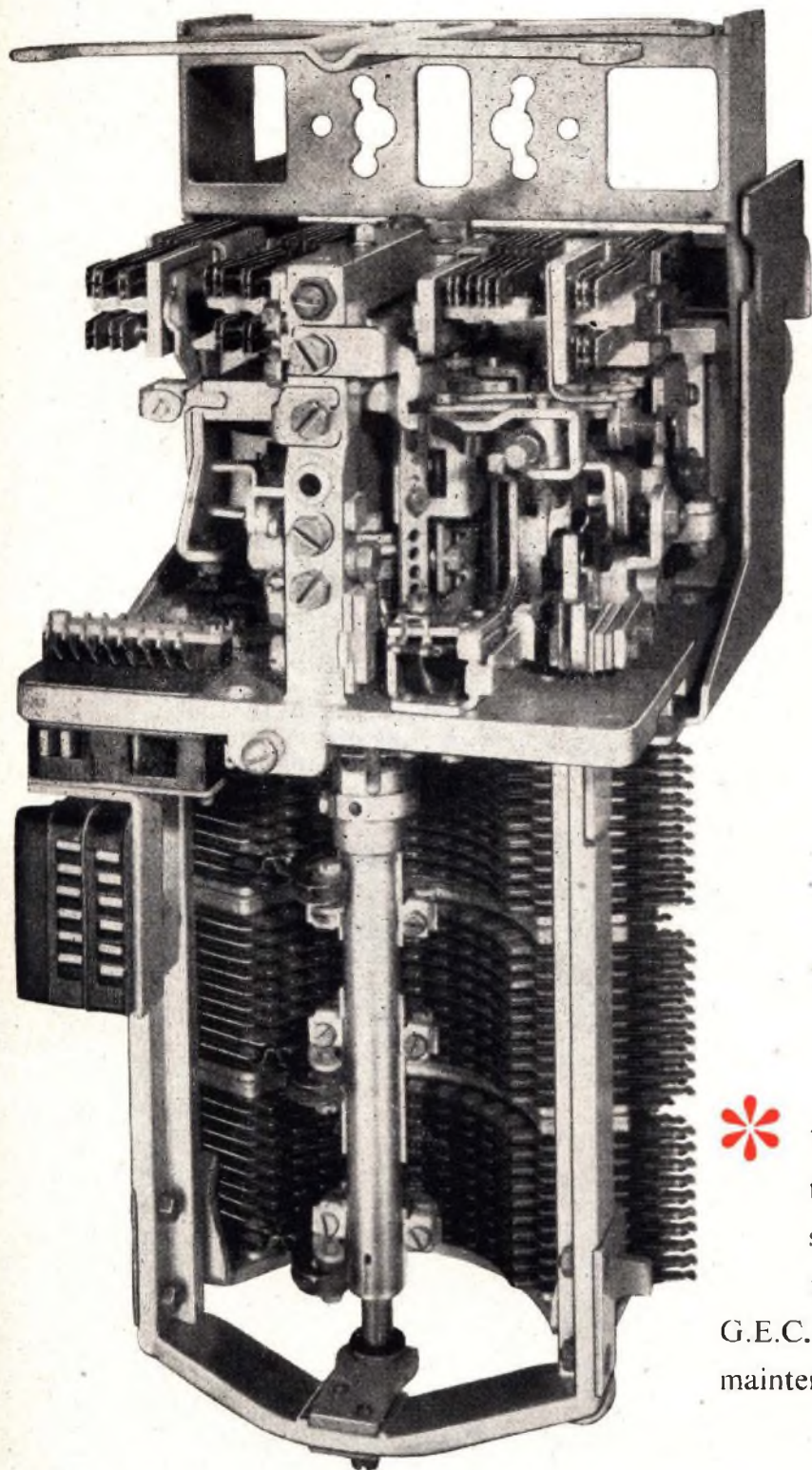

The S.E.50 Selector completes the G.E.C. range of major switches for Strowger Automatic Exchanges. Used together, G.E.C. switches combine to reduce maintenance costs to the minimum.

---

TELEPHONE, RADIO AND TELEVISION WORKS, COVENTRY.

**VERNON  
BRITISH  
COLUMBIA**

*another*

**SIEMENS**

**N° 17 M.A.X.**

*for the*

*Okanagan Telephone Company*

With the cut-over of Vernon No. 17 M.A.X. equipped with 2,200 lines initially, the Okanagan Telephone Company completed their large scheme to convert the Okanagan Valley local telephone exchanges to automatic working. Previous No. 17 M.A.X.'s supplied are Kelowna and Penticton of the same size which, with Vernon, are the main exchanges in the scheme; they will shortly be linked by a 2 V.F. operator dialling system designed, supplied and installed by Siemens Brothers.

The Siemens No. 17 M.A.X. System has been adopted by Administrations in many parts of the world to provide a telephone service of proven reliability, efficiency and low maintenance costs.

*The illustration shows the Siemens High-Speed Motor Uniselector, which is the basic switching medium of the No. 17 M.A.X. and Motor Uniselector Trunk Systems. This remarkable switch has found many other applications in a variety of fields.*

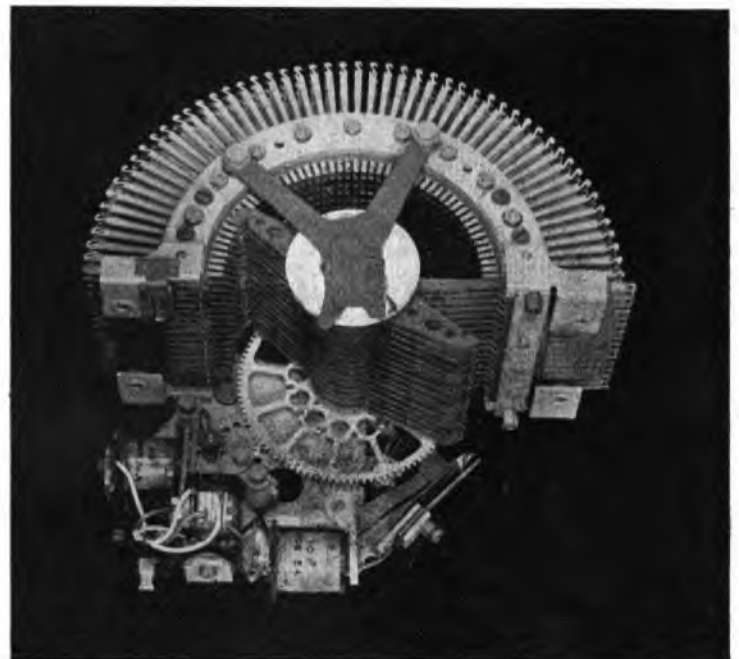

**SIEMENS BROTHERS & CO., LIMITED**  
WOOLWICH • LONDON • S. E. 18.

REPRESENTED IN CANADA BY

SIEMENS BROTHERS (CANADA) LIMITED AT WINNIPEG & EDMONTON



# Cold Cathode Tubes



**DEKATRONS**

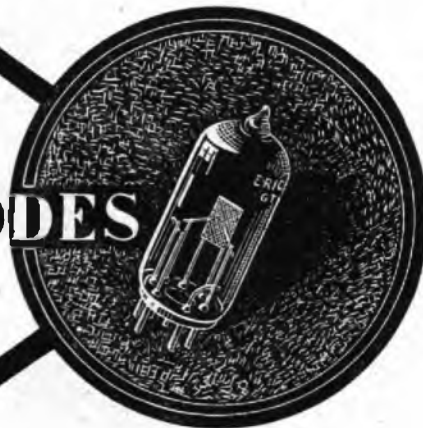

**TRIGGER TETRODES**



**STABILISERS**

*Descriptive Catalogue available on  
application to:-*

WORKS:  
BEESTON,  
NOTTINGHAM  
Beeston 54225



HEAD OFFICE:  
22, LINCOLN'S INN FIELDS,  
LONDON, W.C.2  
HOLborn 6936

# WHEN LINE OR CABLE

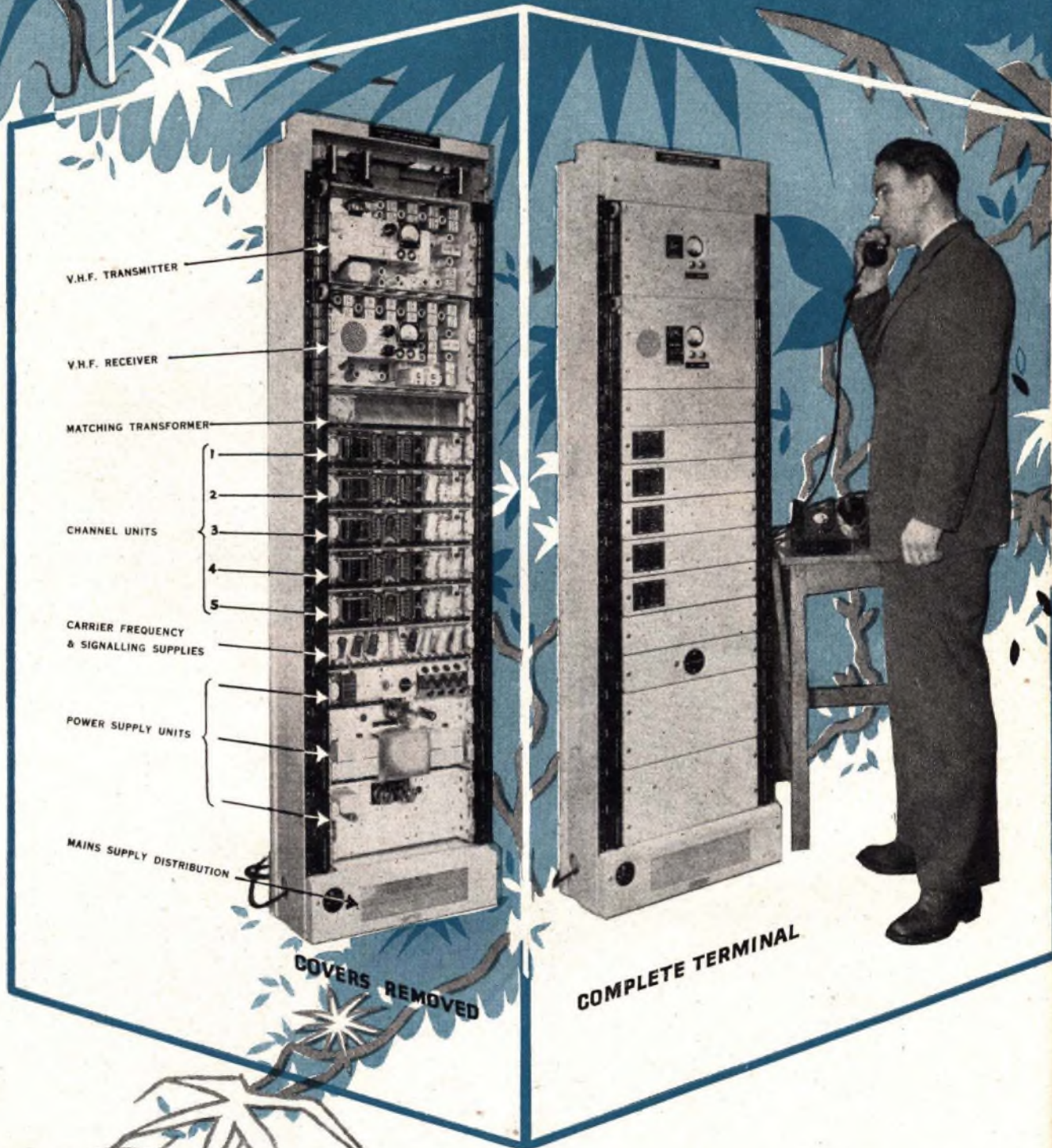

THE GENERAL ELECTRIC COMPANY LIMITED OF ENGLAND.



**SYSTEMS ARE  
IMPRACTICAL OR UNECONOMICAL**

USE

**G.E.C.**

**MULTI - CIRCUIT  
JUNCTION RADIO EQUIPMENT**

**Small—inexpensive—available for quick delivery—**this V.H.F. Radio Telephone equipment is especially valuable for the provision of small numbers of circuits. Up to five circuits are provided by frequency-division-multiplex operation over the frequency-modulated V.H.F. radio link.

*Operating over a distance of 50 miles the total cost of a system consisting of two complete terminal equipments, aerials and feeder cables is less than the cost of the copper required to derive a single open-wire pair for the provision of equivalent facilities.*

All panels of the equipment are of the slide-in type and can be removed in a few seconds for ease of maintenance.

**ALSO AVAILABLE:**—Single-circuit, 3-circuit and 12-circuit equipment for operation over open wire lines.  
12-60 circuit equipment for operation over non-loaded carrier cables.  
Coaxial cable terminal equipment for up to 16 super groups (960 circuits).  
Coaxial cable systems for television and radar display relays.  
Power line carrier equipment.  
Wide-band V.H.F. and U.H.F. Trunk Radio systems for up to 720 speech circuits.

**TELEPHONE, RADIO AND TELEVISION WORKS, COVENTRY**

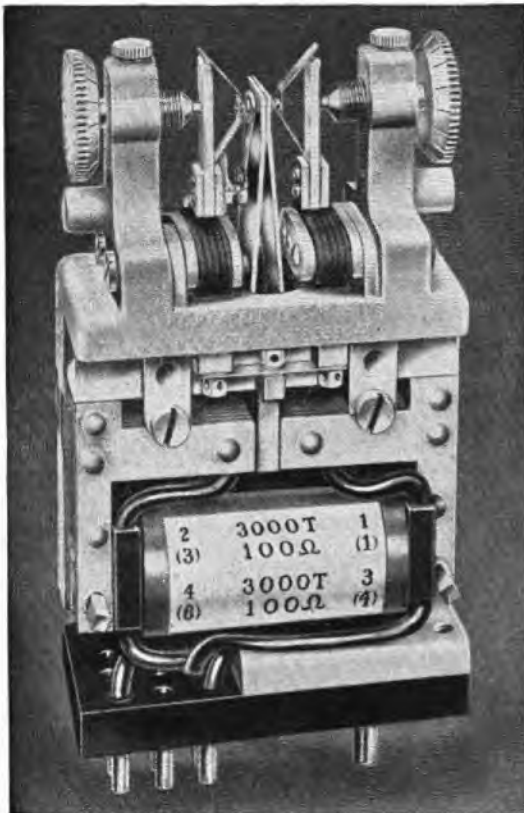

## CARPENTER POLARIZED RELAY TYPE 4

The chief characteristics of this relay are low transit time—high contact pressure—freedom from contact chatter and positional error—high sensitivity—stability—symmetrical action—and ease of adjustment.

On V.F. dialling systems its use facilitates the design of sensitive receiving equipment, and on trunk telephone circuits the relay's high sensitivity enables it to respond to D.C. dialled impulses received over unrepeated trunk lines of up to 100 miles long.

It is particularly suitable as an impulse accepting relay when a minimum of signal distortion is imperative, and because of the excellent change-over action and absence of contact chatter the relay is unequalled for impulsing the selector magnets in teleprinter automatic switching systems.

The relay responds satisfactorily to frequencies up to 100 c/s, when the contact gap is adjusted to 0.004 in. nominal, without serious bias disturbance. It can be left connected to line whilst awaiting a clearing signal, there being little distortion of through signals since the total leak can be of the order of 10,000 ohms.

Dimensionally the relay is interchangeable with the "3000" type relay. Terminations can either be made by means of a 12-pin plug base as illustrated, or with soldering tags in place of the pins. Protection is given by a magnetic screen and a transparent cap which is removable for contact adjustments.

*Complete details supplied on request.*

*Manufactured by the Sole Licensees:—*

**TELEPHONE MANUFACTURING COMPANY LIMITED**

*Contractors to Governments of the British Commonwealth and other Nations*

**HOLLINGSWORTH WORKS · DULWICH · LONDON S.E.21 TEL: GIPSY HILL 2211 (10 LINES)**

# ZEVA

*Electric*

## SOLDERING TOOLS

for **SPEED, ECONOMY**  
and **BETTER WORK**



The news that this famous range of Soldering Irons and Crucibles is again available has been welcomed in numerous branches of industry everywhere. Zeva Tools are unquestionably without equal for efficiency, economy and trouble-free long life.

- ZEVA heating elements never need renewal. They last the life of the tool.
- ZEVA Irons can be left switched on all day without detriment to the tool.
- ZEVA current consumption for rated temperature is less than any other make of tool.
- ZEVA initial cost is the only cost.
- ZEVA Irons are guaranteed.

Write for complete  
Illustrated Catalogue:—

**THE AUTOMATIC COIL WINDER & ELECTRICAL EQUIPMENT CO., LTD.**  
Winder House, Douglas Street, London, S.W.1 Phone: VICTORIA 3404-9

Z/P2/ZWS

# G.N.T.

## UNDULATORS MODEL 309 ☆ 310

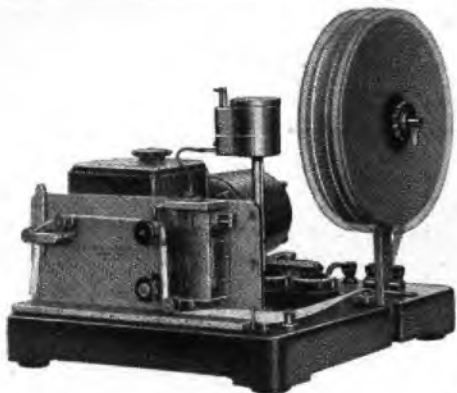

Model 309 is fitted with a single recording part while model 310 has two recording parts and is useful in connection with diversity reception.

Both models can record signals up to 300 w. p. m. Supplied with A. C. or D. C. motors as required.



☆ Write for comprehensive catalogue.

### THE GREAT NORTHERN TELEGRAPH COMPANY'S FACTORY

4, SYDHAVNS PLADS  
COPENHAGEN SV . DENMARK



LONDON OFFICE: 5, ST. HELENS PLACE  
LONDON E.C.3.

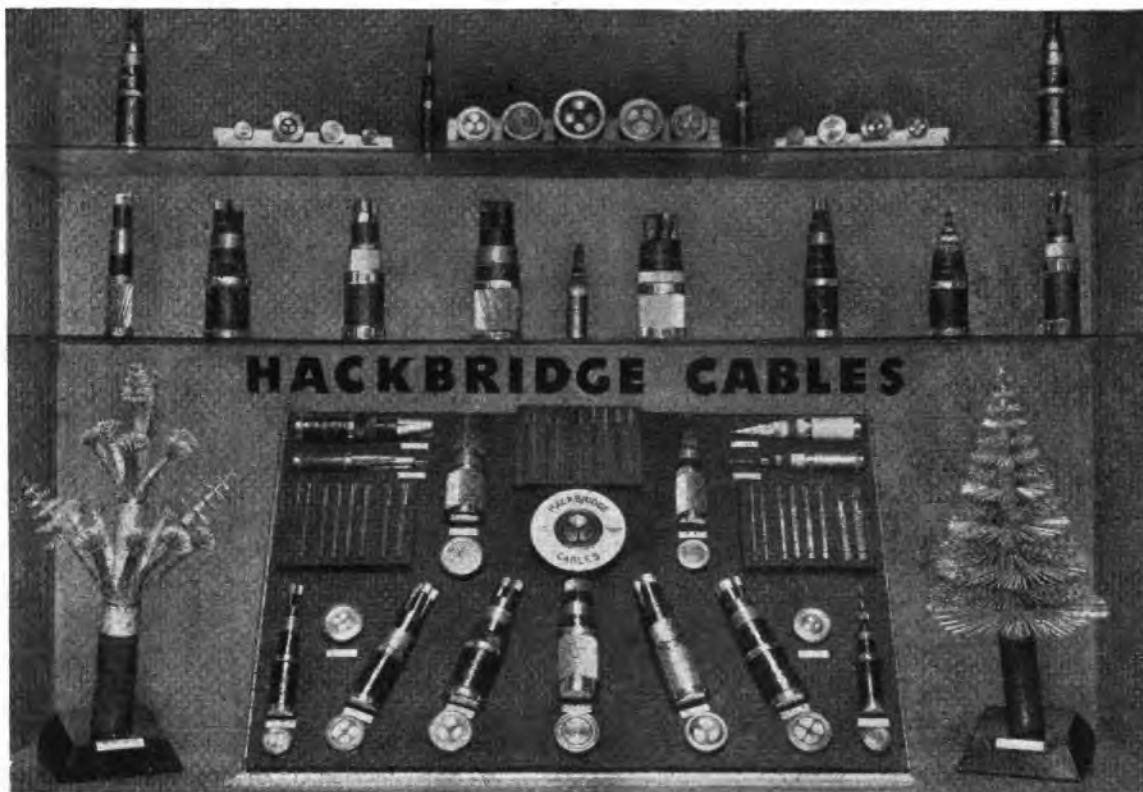

**HACKBRIDGE**  
*Cable Company Limited*

KELVIN WORKS, HACKBRIDGE, SURREY  
In Association with BRYCE ELECTRIC CONSTRUCTION Co. Ltd  
Branches at BIRMINGHAM, BRISTOL, CARDIFF, MANCHESTER, NEWCASTLE, SHEFFIELD



# THE TRANSBOOSTER

The Transbooster is an improved method of voltage control, the equipments being produced in either static or mobile housings to suit varying requirements. A range of outputs is available and the illustration here shows a 3 kW model giving an output of 60 amperes at 50 volts nominal, smoothed for telephone exchange use. It is designed to hold D.C. output voltage within limits of  $\pm 1\%$  from 1/20th up to full load and is independent of mains voltage variations of  $-10\%$  to  $+6\%$  and frequency variations from 41 to 52 c/s. The applications of this equipment are extensive, and full details of



**CONSTANT POTENTIAL RECTIFIERS**

*can be obtained on request to . . .*

Dept. P.O.E.E.J. 10

**WESTINGHOUSE BRAKE & SIGNAL CO. LTD, 82 YORK WAY, KING'S CROSS, LONDON, N.1**

SULLIVAN & GRIFFITHS  
 DIRECT READING  
 VARIABLE CONDENSERS  
 WITH NOVEL AIR CAPACITANCE  
 DECADE RANGE EXTENSION

This air dielectric condenser comprises a decade of air capacitance and a continuously variable air condenser thus giving a scale accuracy ten times that of an ordinary variable condenser of the same range.

Thus a decade of capacitance is provided—permanent in value and entirely free from loss, the only loss present in the complete combination of decade and variable condenser being that due to the solid insulating material which is ordinarily employed in the construction of the latter.

The variable condenser has a range of  $100\mu\mu\text{F}$  which is extended to  $1100\mu\mu\text{F}$  by ten increments of  $100\mu\mu\text{F}$ , all adjusted with accuracy so that the decade is absolutely direct reading in  $\mu\mu\text{F}$ , no corrections or calibration being necessary.

## Electrical Standards for Research and Industry

Testing and Measuring Apparatus for Communication Engineering



LIST No. C 880

**H. W. SULLIVAN, LTD., LONDON, S.E. 15.**

# POWER *behind the lines*

TUNGSTONE PLANTÉ CELLS are being regularly supplied to the British Post Office and Post and Telegraph Departments in many countries overseas. They conform fully to G.P.O. Standard specifications.

#### OPEN TYPE CELLS

Similar to the illustration here, these are available in glass and/or lead lined wooden boxes in capacities from 100 a.h. to 5000 a.h.

#### REPLATALS

We are in a position to supply plates for the replating of existing Planté Batteries.

#### ENCLOSED TYPE CELLS

As illustrated below, these are in moulded glass boxes with sealed-in lid. Capacity range from 10 a.h. to 200 a.h.

#### PORTABLE TYPE BATTERIES

A range of portable type Batteries is in regular production, made to G.P.O. specifications, for ancillary duties.

*Overseas customers are invited to cable or write their enquiries for batteries or parts. Visitors to London are welcome at our offices. (Just off Fleet Street.)*

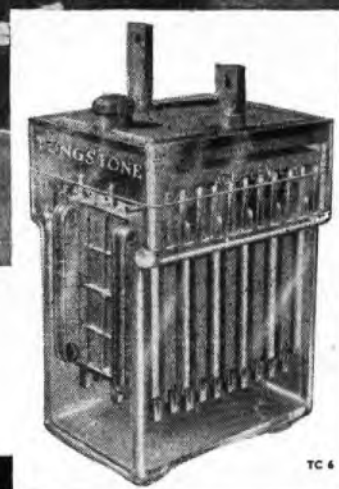
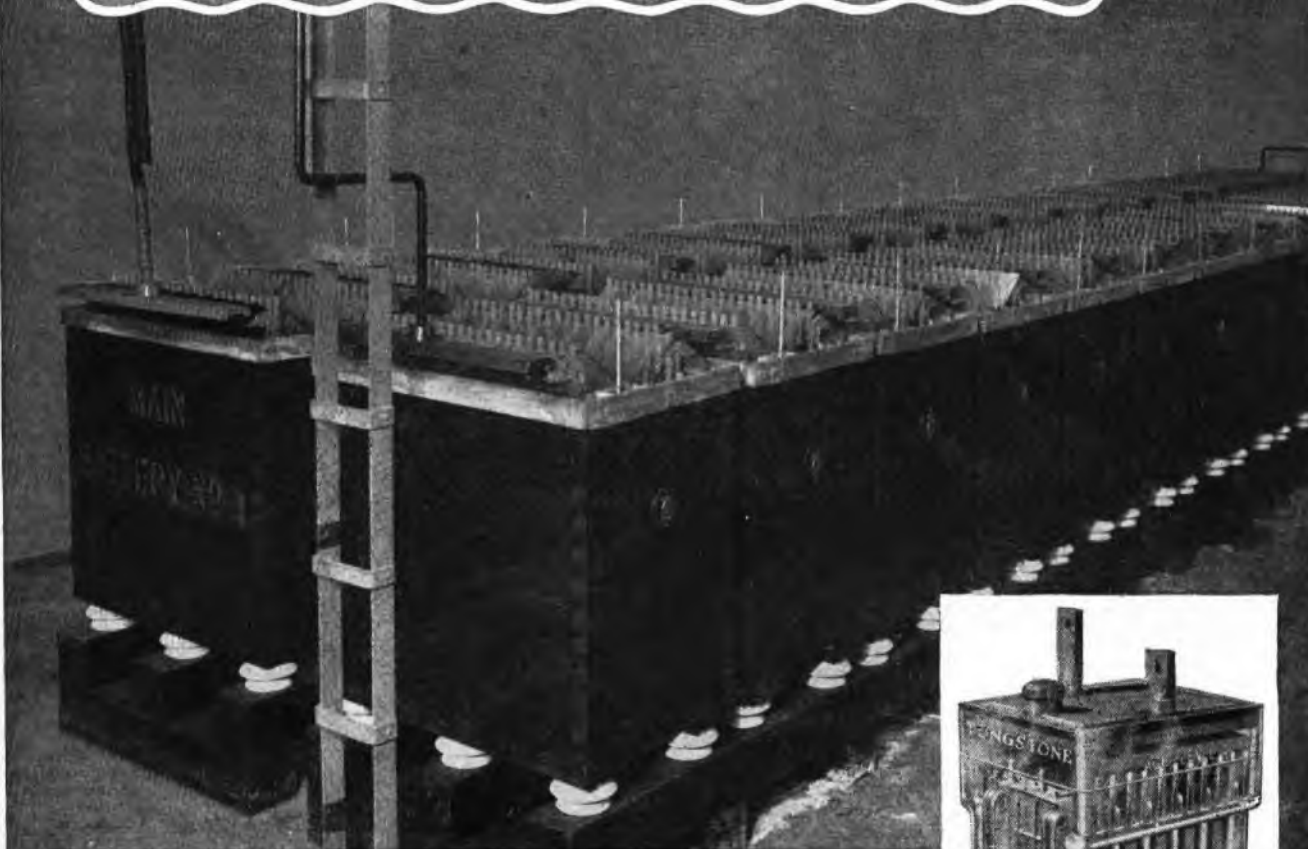

## TUNGSTONE *Batteries*

For further particulars write : TUNGSTONE PRODUCTS LIMITED,  
10 SALISBURY SQUARE, LONDON, E.C.4, ENGLAND. Cables: "Dilutum" London.

TC 4

# Communication

*Standard Systems in Service*

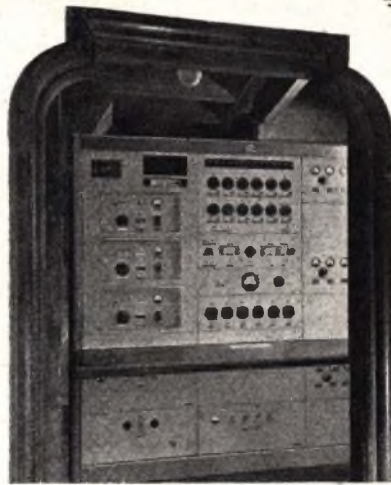

*The Sound Reinforcement Equipment in Westminster Abbey Control Room.*

Under contract to the Ministry of Works, Standard Telephones and Cables Limited installed and operated a sound reinforcement system in Westminster Abbey for the Coronation of H.M. Queen Elizabeth II. "Standard" sound reproduction and dissemination systems with public address facilities were also provided over the major portion of the processional route controlled by the Ministry of Works and the London County Council.



*Standard Telephones*

(TELECOMMUNICATION)

**Connaught House, Aldwych,**

Cairo

Dublin

Johannesburg



# and Control

## *Standard systems include:—*

Standard's wide resources, their long experience in the design and manufacture of systems and equipment for telecommunications and control have enabled them to produce an extensive range of apparatus for use in all parts of the world.

These resources and experience are at your service, either for the systems listed or for their development to meet specific needs, as well as for the supply of equipment, materials and components including:—

Power Factor Correction

Capacitors

Magnetic alloys

SenTerCel Selenium Rectifiers

Thermionic Valves

Quartz crystals

Telephone

Telegraph

Teleprinter

Radio Broadcasting

Radio Communication

Radio Navigation

Sound Reproduction

Remote Control

Remote Indication

Telemetry

Railway Signalling

Railway Control

Power Cable

Communication Cable

Airfield Lighting Control

Street Lighting Control

Fire Alarm

Totalisator

Public Indicator

Signalling (Office and Factory)

## *and Cables Limited*

ENGINEERS)

London, W.C.2, England

Karachi

New Delhi

Salisbury

The problem of

**maintaining** constant Voltage!

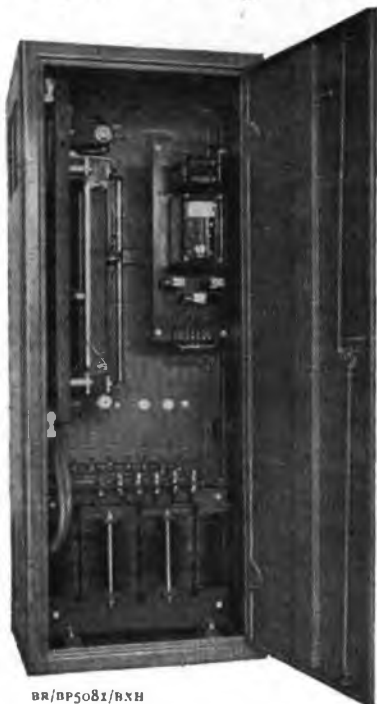

BR/DP5081/BXH

25KVA, 3 phase,  
floor mounting cubicle  
type fully automatic  
Voltage regulator.

Users of industrial and scientific electrical equipment that is normally sensitive to voltage fluctuations are constantly faced with the problem of maintaining a constant supply voltage.

Experienced engineers in well-planned organisations throughout the world solve this problem by installing BERCO/B.P.T. "On-Load" Voltage Regulating Equipment.

May we send you further information and performance details? Please write for booklet 5081.

Applications include induction heating equipment, electric furnace control, radio and scientific equipment, X-ray and electro-medical apparatus, meter testing equipment and all electric or electronic equipment for which a constant supply voltage is essential.



Single phase  
"Regavolt" hand operated  
voltage regulator.

**THE BRITISH ELECTRIC RESISTANCE CO. LTD.**  
**BRITISH POWER TRANSFORMER CO. LTD.**

Queensway • Ponders End • Middlesex

Telephone: HOWard 1492

Telegrams: "Vitrohm, Enfield"

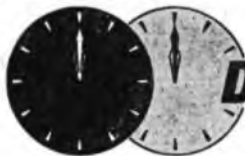

**DESIGNED FOR 24 HOURS PER DAY OPERATION**

**BATTERY DRIVEN CARRIER CURRENT  
GENERATORS FOR VOICE FREQUENCY  
TELEGRAPH TRANSMISSION . . . .**

These generators are the result of many years experience in this field. They are made in three forms for 18, 24 or 27 channel transmission systems. Frequency ranges 420 to 2460 c.p.s., 420 to 3180 or 300 to 3420 c.p.s. in 120 c.p.s. steps. Speed and frequency accuracy  $\pm 12\%$  for long periods without maintenance. Input 20 to 28 volt d.c. or 150 to 184 volts d.c.

Comprehensive details from the Manufacturers . . .

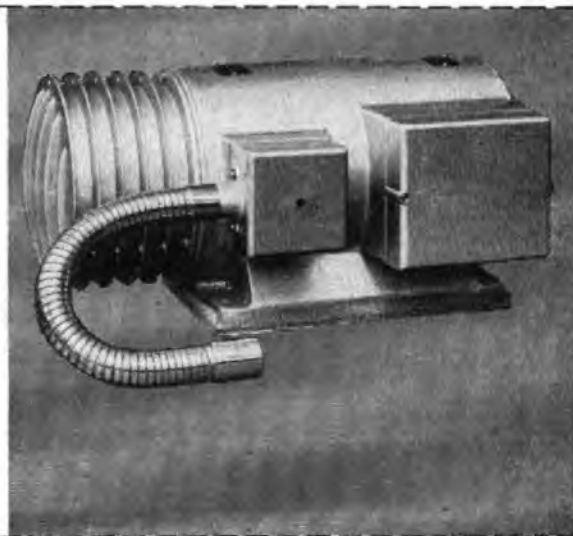

**WALTER JONES**  
& Company (Engineers) Limited

NEWLANDS PARK • SYDENHAM  
LONDON • S.E.26 • SYDenham 6264

**ELECTRICAL MEASURING  
INSTRUMENTS  
OF THE HIGHER GRADES**

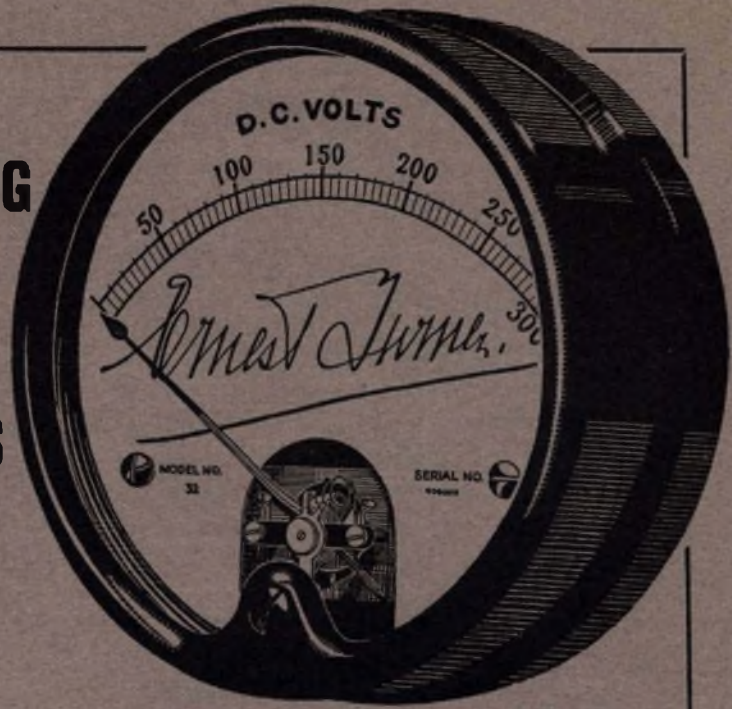

**ERNEST TURNER ELECTRICAL INSTRUMENTS LTD.**  
CHILTERN WORKS, TOTTERIDGE AVENUE, HIGH WYCOMBE, BUCKS.

Telephone : High Wycombe 1301/2

Telegrams : Gorgeous, High Wycombe



**FOR THE RIGHT CONNECTION**

**FREDERICK SMITH & COMPANY**  
ANACONDA WORKS, SALFORD, 3, LANCS.

Incorporated in The London Electric Wire Company and Smith's Limited.  
Associated with The Liverpool Electric Cable Co. Ltd. and Electric Wire Co. Ltd.

**FREE** THIS VALUABLE BOOK



which details the wide range of Engineering and Commercial courses of modern training offered by E.M.I. Institutes.

Courses include training for:

P.M.G. Certificates, City and Guilds Grouped Certificates in Telecommunications; A.M.Brit.I.R.E. Examination, Radio Amateur's Licence, Radio & Television Servicing Certificates, General Radio and Television Courses, Radar, Sound Recording, etc. Also Courses in all other branches of Engineering.

★  
COURSES FROM  
**£1**  
PER MONTH

★  
**E.M.I.**  
INSTITUTES

The only Postal College which is part of a world-wide industrial organisation.

**POST NOW**

Please send, without obligation, the above FREE book. E.M.I. Institutes, Dept. 22, 43 Grove Park Road, London, W.4.

Subject(s) which interest me .....

Name .....

Address .....

IC 108

# TELEPHONE DISTRIBUTION

## EQUIPMENT

ENGINEERS WHO ARE INTERESTED  
IN TELEPHONE DISTRIBUTION EQUIP-  
MENT ARE INVITED TO REQUEST  
SECTION T.C.13 OF OUR TELECOM-  
MUNICATION CABLES CATALOGUE.

TELEPHONE:  
SOUTHAMPTON  
2141 (5 lines).

**IRELLI GENERAL**  
CABLE WORKS, Ltd., SOUTHAMPTON

TELEGRAMS  
"PIGEKAYBEL  
SOUTHAMPTON"

# EDISWAN

## *Telephone Line Protectors*

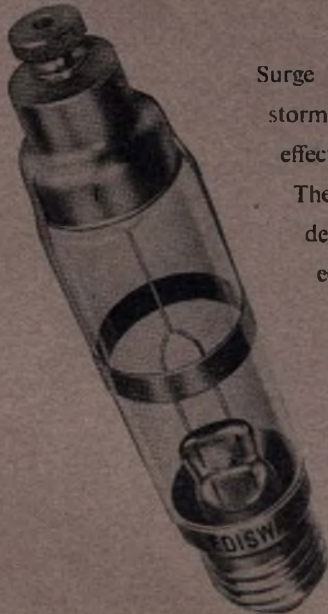

Surge currents induced on telephone lines by electric storms or breakdowns on neighbouring power lines may be effectively controlled by Ediswan telephone line protectors.

These special electrode gas discharge tubes have been developed in collaboration with G.P.O. Engineers to provide economical and effective protection for telephone systems without impairing the service.

Full details of these protectors and their application is given in the Ediswan publication C.1581 which is available on application.

**THE EDISON SWAN ELECTRIC CO., LTD.**  
155 CHARING CROSS ROAD, LONDON, W.C.2

*Member of the A.E.I. Group of Companies*

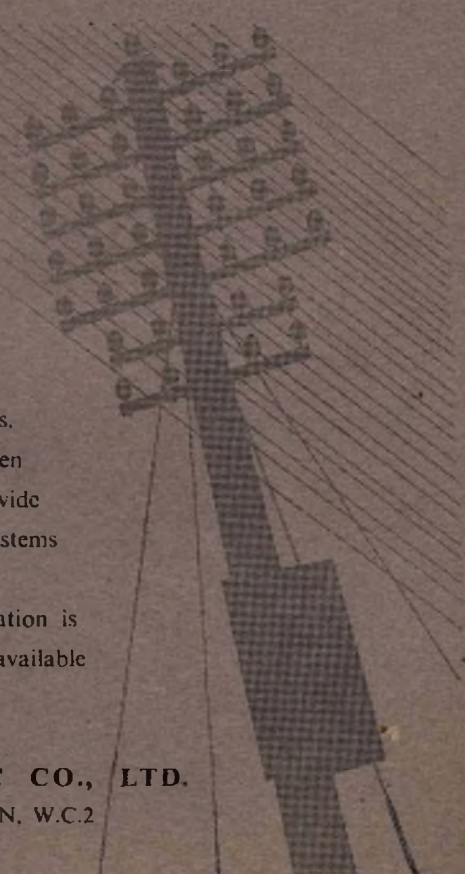

TE107