

# THE POST OFFICE ELECTRICAL ENGINEERS' JOURNAL

Vol. 45

JULY 1952

Part 2

## CONTENTS

	PAGE
THE DETECTION OF TELEVISION RECEIVERS—W. J. Bray, M.Sc.(Eng.), A.M.I.E.E.	49
THE USE OF EXPLOSIVES IN EXTERNAL OPERATIONS—L. W. Barratt, A.M.I.E.E.	52
CARDIFF NON-DIRECTOR AUTOMATIC AND ZONE CENTRE TRUNK EXCHANGE— S. E. New .. .. .	58
NEW-TYPE ROUTINERS FOR AUTOMATIC TELEPHONE EXCHANGE EQUIPMENT Part 3.—Circuit Principles of Test Relay Sets and Common Test Relay Sets—L. Green ..	61
INTERFERENCE FROM CATHODIC PROTECTION RECTIFIERS—D. W. R. Cobbe, A.M.I.E.E. .. .. .	68
REFLECTIONLESS JOINTS FOR COAXIAL PAIRS—R. J. Turner, B.Sc.(Eng.), A.M.I.E.E.	72
NEW METHODS OF LOCATING FAULTS IN TELEPHONE CABLES—E. R. Oakford ..	77
AN APPROACH TO THE STANDARD EQUATIONS FOR A UNIFORM TRANS- MISSION LINE—Part 2.—Propagation of Current and Voltage in a Chain of Impedance Sections, Simulating the Uniform Transmission Line.—H. R. Harbottle, O.B.E., B.Sc., D.F.H., M.I.E.E. .. .. .	80
THE COLOUR PRINTING OF LINE PLANT NETWORK DIAGRAMS—C. D. Lipscombe .. .. .	83
THE EXTRAORDINARY ADMINISTRATIVE RADIO CONFERENCE, GENEVA, 1951	85
NOTES AND COMMENTS .. .. .	87
INSTITUTION OF POST OFFICE ELECTRICAL ENGINEERS .. .. .	87
JUNIOR SECTION NOTES .. .. .	88
REGIONAL NOTES .. .. .	90
STAFF CHANGES .. .. .	95
BOOK REVIEWS .. .. .	57, 67, 76, 84, 86, 96

Price 2/6 net

THE INSTITUTION OF POST OFFICE ELECTRICAL ENGINEERS

# How to make certain of your City & Guilds Certificates



**"I guarantee tuition until you have passed"**

If you consider taking one or the whole series of C. and G. examinations then I can help you. BY POST, in your own time, one of my Telecommunications specialists will coach you until you pass. He will give you individual attention, he will study you and your problems. And you will be surprised how fast you progress. For The Bennett College has specialised in technical subjects since it was founded 50 years ago. My system of personal postal tuition has helped thousands of students through their exams. It can do the same for you.

Send me the coupon to-day. I will send you—without obligation—full information on your subject.

*Rep. Bennett*  
GOVERNOR

**YOU CAN START ON A BENNETT COURSE FOR ONLY 30/-**  
with monthly instalments of 15/-

**TEAR OUT**

## WHICH IS YOUR NEXT STEP?

- Preliminary Course
- Telecommunications Principles I—V
- Telecommunications Practice
- Telephone Exchange Systems I—UI
- Radio I—IV
- Telegraphy I & II
- Line Transmission I & II
- Mathematics for Telecommunications I—V
- Radio Servicing Certificate
- Television Servicing Certificate
- A.M.I. Mech.E.
- and many other subjects

## The BENNETT COLLEGE

To the Governor, Dept. G24, The Bennett College, Sheffield, England. I would like to have (at no cost) your prospectus and

particulars of \_\_\_\_\_

NAME \_\_\_\_\_

ADDRESS \_\_\_\_\_

AGE (if under 21) \_\_\_\_\_

PLEASE WRITE IN BLOCK LETTERS



## FOR THE RIGHT CONNECTION

### FREDERICK SMITH & COMPANY

ANACONDA WORKS, SALFORD, 3, LANC.

*Incorporated in The London Electric Wire Company and Smiths Limited  
Associated with The Liverpool Electric Cable Co. Ltd. and Yastie Wire Co. Ltd.*

## VALUABLE FREE BOOK



**Tells You How to Pass Your C. & G. or Promotion Exam. at First Attempt!**

All Post Office Engineering personnel who are anxious to obtain early promotion should at once send for a copy of our handbook "ENGINEERING OPPORTUNITIES," which among other intensely interesting matter, describes our unique methods of preparation for **TECHNICAL APPOINTMENTS IN THE POST OFFICE** (Assistant Engineer—New Style and Assistant Traffic Superintendent), **CITY AND GUILDS EXAMINATIONS** in Principles of Telecommunications (1-5), Radio (1-4), Telephone Exchange Systems (1-3), Telegraphy (1 and 2), Line Transmission (1 and 2), Lines Plant Practice (1 and 2), Mathematics for Telecommunications (1-5), Electrical Engineering Practice (Prelim. Inter. and Final), and outlines a wide range of non-examination courses in all branches of Electrical, Mechanical, Civil, Automobile, Aeronautical and Radio Engineering.

**Assistant Engineer and Assistant Traffic Superintendents. Open competitions now resumed. Age extensions for established Civil Servants. Ask us for full details**

**We definitely guarantee "NO PASS—NO FEE"**

If you intend to make the most of to-day's opportunities, you cannot afford to miss reading "ENGINEERING OPPORTUNITIES." It tells you everything you want to know to secure advancement, and describes many opportunities you may now be missing through lack of information. Send for your copy to-day—FREE and without obligation.

**BRITISH INSTITUTE OF ENGINEERING TECHNOLOGY**  
369 SHAKESPEARE HOUSE,  
17-19 STRATFORD PLACE, LONDON, W.1

# BIET



Our South African friends write "Your last lot of transformers were sold before they arrived".

Everyone likes Savage quality and service and all appreciate the fact that SAVAGE TRANSFORMERS ARE DESIGNED BY EXPERTS AND MADE BY PEOPLE WITH A CONSCIENCE.

Phone your transformer problem to Devizes 536.

**SAVAGE TRANSFORMERS OF DEVIZES LIMITED**

SAVAGE TRANSFORMERS LTD., Nursted Road, Devizes, Wilts.  
Telephone: Devizes 536

# THE POST OFFICE ELECTRICAL ENGINEERS' JOURNAL

Vol. 45

July 1952

Part 2

## The Detection of Television Receivers

W. J. BRAY, M.Sc.(Eng.), A.M.I.E.E.†

U.D.C. 343.3: 621.397.62: 621.396.677.1

The induction magnetic field radiated by a working television receiver can be detected at a distance by sensitive radio receiving equipment. This fact is made use of in the technique employed in tracing unlicensed television receivers, and in this article the author explains the principles involved and describes the equipment used in detection. The Appendix shows how the magnetic induction field strength may be calculated.

### Introduction.

ON 1st February, 1952, a newly developed technique for the detection of television receivers was demonstrated to the Press in the courtyard of King Edward Building, near St. Paul's, London, in the presence of Earl De La Warr, the Postmaster General, and Mr. David Gammans, the Assistant Postmaster General. The Postmaster General said, in a speech to the Press, that it was estimated that between 100,000 and 150,000 unlicensed television receivers were in use and that the users of such receivers were receiving free entertainment subsidised by those who had paid. He went on to outline the steps that were being taken by the Post Office to track down users of unlicensed receivers, not only in London but also in the Provinces. A film, showing the first detector van in operation was shown in Television Newsreel on 1st and 2nd February, 1952, and the principles of the detection technique employed were given by Mr. Gammans in a Written Answer to a Parliamentary Question in the House of Commons on 30th January, 1952. The purpose of the present article is to give a more detailed description of the equipment used and its principle of operation.

The equipment, which is suitable for fitting in a standard Post Office Radio Interference van, enables the majority of working television receivers on both sides of a road to be detected, and the houses containing the receivers to be located, as the van moves along the road. The television receivers are detected by means of the induction magnetic field emanating from the line-scanning coils of the receiver; it is important to note that almost all working television receivers\* produce this field, that it is independent of whether an outdoor or an indoor aerial is used and that it is not readily possible to screen receivers to reduce the strength of the field to a degree such as to make detection impossible.

### Principle of Operation.

The principle of operation is illustrated in Fig. 1, which shows the approximate distribution of the lines of force of the magnetic induction field from the line scanning coils of a television receiver. This field is predominantly vertical and horizontal loops are therefore used to couple to it. Since the field arises from the saw-tooth current wave in the scanning coils it contains high levels of 2nd, 3rd, etc., harmonics, as well as the fundamental at 10·125 kc/s; for

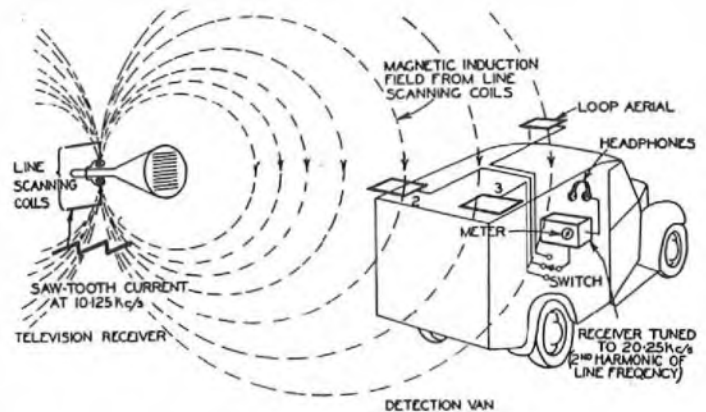

FIG. 1.—THE PRINCIPLE OF OPERATION.

reasons that will be discussed later the second harmonic of 20·25 kc/s has been used in the present equipment. The intensity of the vertical component of the magnetic induction field decreases inversely as the cube of the distance from the television receiver (see Appendix); this fact enables satisfactory discrimination to be obtained between receivers in adjacent houses. The intensity of the vertical component is approximately the same for different horizontal directions from a given receiver, at a specified



FIG. 2.—THE DETECTION VAN, SHOWING LOOP AERIALS ON ROOF.

† Assistant Staff Engineer, Radio Experimental and Development Branch, E.-in-C.'s Office.

\* The exceptions being the very few receivers employing electrostatic deflection systems.

distance, i.e. it does not vary markedly with the orientation of the receiver. This fact is made use of for locating the position of receivers by an intensity-comparison technique.

Three horizontal loop aerials, each tuned to 20·25 kc/s, and arranged in an "L" formation are mounted on the roof of the detection van, as shown in Fig. 2. The outputs of these loops are connected via a three-position switch, to the input of a sensitive radio receiver tuned to 20·25 kc/s. A beating oscillator, operating at 19·25 kc/s, is included in the receiver and enables an audio beat note of 1 kc/s to be obtained. The receiver is also connected to an audio output level indicator and headphones or a loudspeaker.

As the detector van proceeds along a road and approaches a house containing a working television receiver an audio beat note is heard which rises in level to a maximum when the van is opposite the receiver and then decreases in level. By switching from the forward loop (1) to the near side loop (2), the operator can decide whether the television receiver is ahead of, or behind, the van; if the television receiver is ahead of the van the stronger signal is of course obtained from the forward loop. He then proceeds until equal strength signals are obtained from loops (1) and (2); the van should then be directly opposite the house containing the television receiver. By comparing the signal strength from the near-side loop (2) with that from the off-side loop (3) it is then possible to decide on which side of the road the television receiver is situated.

The variation of signal strength observed in practice is indicated approximately in Fig. 3; it should be noted that not all the receivers marked by circles or dots in Fig. 3 were necessarily switched on at the time the test was made. It can be seen that the sharpness of response is sufficient to distinguish between two working television receivers in adjacent houses on the same side of the road; furthermore the variation of signal strength across the road is sufficient to determine on which side of the road the receiver is located. Should there be any difficulty in distinguishing between receivers in adjacent semi-detached houses, or in close proximity in blocks of flats, a portable receiver with a single loop aerial can be used for closer investigation.

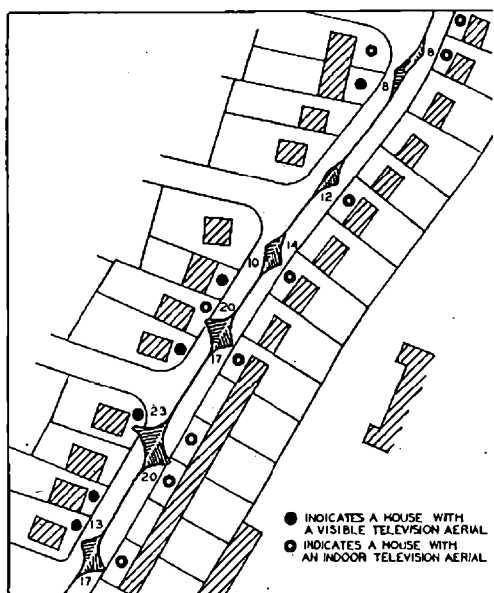

FIG. 3.—VARIATION OF SIGNAL STRENGTH IN TRAVELLING ALONG TYPICAL SUBURBAN ROAD.

The strength of signal is indicated by hatched curves, the figures denoting maximum amplitudes. Two curves are shown in each instance, corresponding to travelling first in one direction and then in the other.

Interference from the ignition system sets a limit of about 100 ft. to the range of the van-installed equipment when "normal", i.e. resistor, suppression of the interference is used. With more complete suppression, such as can be obtained by the use of screened leads and screened plugs, it is possible to extend the range; on the other hand, that obtained with normal suppression is adequate for the detection of the majority of television receivers under normal suburban conditions in which the houses are set back from the road by not more than about 50 ft.

#### Choice of Operating Frequency.

As has already been mentioned the line scanning oscillator of a television receiver produces a saw-tooth current wave with a repetition frequency of 10·125 kc/s; such a wave contains the 1st, 2nd, 3rd, etc., harmonics, the levels varying inversely as the order of the harmonic. In order to obtain the maximum field strength it is therefore desirable to use a low order harmonic, perhaps even the fundamental itself; however, the field strength of the ignition interference increases as the frequency is decreased, partly due to the fact that the suppression is less effective at low frequencies. The fundamental frequency is thus less satisfactory than the second or third harmonic as regards signal-to-interference ratio. At higher frequencies, there is the risk of confusion of the wanted signal with the carriers of long-wave radio transmissions. Another reason for the choice of a relatively low frequency is that the distortion of the field due to steel frames of buildings, iron drain pipes, etc., is less at low frequencies, and this enables the receivers to be located more accurately.

The second harmonic (20·25 kc/s) is used in the equipment described; it is the lowest order harmonic that can be received on commercially-available communication receivers.

The line frequency is itself a high order harmonic of the mains supply frequency (nominally 50 c/s) at the transmitter; variations of mains supply frequency as large as 2 c/s occur occasionally in practice, and there is thus an equal percentage variation of the line frequency. A receiver bandwidth of some 4% of 20·25 kc/s, i.e. 800 c/s, would therefore be needed to accommodate the maximum variations of mains frequency. In practice a somewhat smaller bandwidth is satisfactory and is desirable to minimise ignition interference. In the equipment described the bandwidth, about 200 c/s, is substantially that of the audio note-filter in the receiver. Some re-tuning of the receiver may therefore be necessary to correct for variations in mains frequency.

#### Magnetic Induction Field Strength from Typical Television Receivers.

Tests indicate that the strength of the vertical component of the magnetic induction field due to the second harmonic of the current in the line scanning coils is equivalent to an electric field strength of about + 55 db. relative to 1 microvolt/metre, at a distance of 75 ft. from a typical television receiver, and that it varies approximately inversely with the cube of the distance from the receiver. This value is in satisfactory agreement with that calculated from the theory given in the Appendix. The fields set up by most receivers are within about  $\pm 10$  db. of the value quoted above; a few may be up to 20 db. below the stated value, when efficient iron circuits are used in the scanning coil assembly.

The effective height of each loop aerial is about 0·01 metre and its Q is about 50 at 20·25 kc/s; the voltage available across the tuned loop is thus about  $+ 55 - 40 + 34 = + 49$  db. relative to 1 microvolt at 75 ft. from a typical receiver. This value is well above the receiver noise but is

only slightly above the ignition noise with normal suppression; thus it is clear that an increase in range is obtainable by more complete suppression.

The strength of the magnetic induction field is substantially unaffected by the brick walls of ordinary houses, due to the relatively low frequency employed; it is, however, modified in value, and the field distribution is distorted, by the steel frames of buildings, as already mentioned. The electrostatic screening employed in certain television receivers to minimise interference to broadcast receivers due to pick-up of harmonics of the electric field created by line fly-back E.H.T. supplies, is ineffective in screening the low frequency magnetic induction field from the line scanning coils.

**Conclusion.**

The technique described has proved a simple and effective means for detecting the majority of working television receivers, irrespective of whether outdoor or indoor aerials are employed. By its use "combs" for unlicensed receivers can be readily and quickly carried out, although not quite in the manner described in a very amusing account of the van's activities recently published.<sup>1</sup>

An interesting sidelight on the detection technique is that it provides a means for assessing the popularity of a television programme by counting the number of receivers switched on in a given area.

**Acknowledgments.**

The author's thanks are due to his colleagues Messrs. D. W. Morris, G. Mitchell and W. N. Genna of the Radio Experimental and Development Branch Laboratories, Dollis Hill, who carried out the development of the detection equipment; he also wishes to acknowledge the assistance of officers of the Radio Services and Maintenance Branch, the London Telecommunications Region and the London Postal Region in carrying out field trials.

**APPENDIX**

**CALCULATION OF MAGNETIC INDUCTION FIELD STRENGTH AT A DISTANCE FROM THE LINE SCANNING COILS OF A TELEVISION RECEIVER**

It will be assumed that the line scanning coils can be represented, with sufficient accuracy for present purposes, by a single turn circular coil with the same number of ampere-turns as the actual coils. Let  $\hat{I}$  be the peak-to-peak value of the saw-tooth current in the coil; the r.m.s. value of the  $n$ -th harmonic of the current is given by

$$I_n = \frac{\hat{I}}{\sqrt{2} \pi n} \dots\dots\dots(1)$$

In order to find  $I_n$  it is first necessary to consider the deflectional sensitivity of a magnetically deflected cathode ray tube, i.e. the magnetic field strength required for a given deflection. A theoretical formula for the deflectional sensitivity is

$$\hat{H} = \frac{3.37d \sqrt{E}}{al} \dots\dots\dots(2)*$$

- where  $\hat{H}$  is magnetic field strength in lines/sq. cm.,
- $d$ , deflection in cm.,
- $E$ , beam voltage,
- $a$ , effective axial length in cm. of region of uniform magnetic field,
- and  $l$ , beam length between coil centre and screen.

In a typical case

- $d = 25$  cm.
- $l = 25$  cm.
- $a = 9$  cm.
- $E = 10,000$  V.

Hence, from equation (2),

$$\hat{H} = 37 \text{ lines/sq. cm.}$$

The magnetic strength  $\hat{H}$  at the centre of a circular coil of radius  $r$  carrying a current  $\hat{I}$  is given by

$$\hat{H} = \frac{\hat{I}}{2r} \dots\dots\dots(3) \ddagger$$

Hence, from equations (1) and (3),

$$I_n = \frac{\sqrt{2} r \hat{H}}{\pi n} \dots\dots\dots(4)$$

The r.m.s. magnetic field strength  $H_d$  at a distance  $d$  from a circular coil of radius  $r$  carrying a sinusoidal current of r.m.s. value  $I_n$ , measured normal to, and at a point in the plane of, the coil is given by

$$H_d = \frac{r^2 I_n}{4 d^3} \dots\dots\dots(5) \ddagger$$

where  $d$  is assumed large compared with  $r$ .

Equation (5) is applicable for distances up to about one-sixth of a wavelength; in this region the magnetic induction field predominates over the radiation field. In the present case the wavelength corresponding to the second harmonic of the line frequency is some 15,000 metres and it is only the induction field that is significant in practice.

Hence, from equations (4) and (5),

$$H_d = \frac{r^3 \hat{H}}{2\sqrt{2} \pi n d^3} \dots\dots\dots(6)$$

It will be observed that the field strength varies inversely as  $n$ , the order of the harmonic, and inversely as the cube of the distance from the line scanning coils.

It is convenient to specify  $H_d$  in terms of the equivalent electric field strength  $E_d$ , i.e. in terms of the e.m.f. that would be induced in a loop of unit effective height.

If  $H_d$  is in amperes/metre,

$$E_d = 120 \pi H_d \text{ volts/metre} \dots\dots\dots(7a)$$

or, if  $H_d$  is in lines/sq. cm.

$$E_d = 30 \times 10^3 H_d \text{ volts/metre} \dots\dots\dots(7b)$$

The field strength of the second harmonic at a distance of 10 metres from the typical television receiver referred to above will now be estimated.

Let  $\hat{H} = 37$  lines/sq. cm.

$r = 4$  cm.

$d = 10$  metres,

and  $n = 2$  (second harmonic).

Then, from equation (6),

$$H_d = 1.3 \times 10^{-2} \text{ lines/sq. cm.}$$

Hence, from equation (7b),

$$E_d = 4.0 \times 10^{-3} \text{ volts/metre.}$$

Since  $E_d$  varies inversely as the cube of the distance, it follows that for

$d = 10$  metres,  $E_d = +72$  db. relative to  $1 \mu\text{V/metre}$ .

$d = 20$  metres,  $E_d = +54$  db. relative to  $1 \mu\text{V/metre}$ .

$d = 40$  metres,  $E_d = +36$  db. relative to  $1 \mu\text{V/metre}$ .

It is emphasised that the field strength found in practice varies appreciably with the form of magnetic circuit used in the scanning coils; receivers with highly efficient magnetic circuits have less external field than is predicted by equation (6). Nevertheless, for the majority of receivers at present in use, the measured field strengths are within  $\pm 10$  db. of those predicted.

<sup>1</sup> "The Two Pound Look or Someone at the Door." J. B. Boothroyd. *Punch*, 30th April, 1952.

\* See p. 343, Terman, *Radio Engineers' Handbook*. McGraw-Hill Book Co., Ltd.

† See, for example, p. 82, "Electromagnetic Waves and Radiating Systems." E. C. Jordan. Constable & Co.

‡ Loc. cit. p. 89.

U D.C. 662.2:624.133

The author describes the general nature of explosive materials, the types used by the Post Office on external operations and the technique of blasting for different types of excavation and soil.

## INTRODUCTION TO EXPLOSIVE MATERIALS

THE purpose of this article is to present explosive material as an addition to the list of mechanical aids. It has long been used for blasting rock in various parts of the country, but it is also an invaluable agent in softer soils. This applies particularly to those small isolated jobs where it is not always economical or convenient to provide machine digging tools. Explosives and their accessories are sufficiently cheap to allow them to be supplied on an individual basis to every gang, so that they are ready for heavy work whenever required, however small or unexpected the job.

The conception of explosive material as a mechanical aid is an apt one, because an explosion may be thought of as a terrific hammer blow which the shot-firer can direct to any chosen spot underground.

### *The Nature of Explosives.*

An explosion may be described as a chemical change which produces gas and heat at a very high rate. It is well known that if hydrogen and oxygen are mixed together in a container in the ratio of 2 : 1 by volume and ignited by an electric spark, the resultant gas (steam) and heat are produced at so high a rate as to constitute an explosion and the pressure of the superheated steam may shatter the container.

Explosions arising from the ignition of a mixture of gases are comparatively mild and readily controlled, as in the internal combustion engine. Gunpowder, which is a mixture of charcoal, sulphur and saltpetre, also produces a comparatively mild explosion; in fact it will not explode at all unless it is strongly confined. The process is much more rapid if the oxygen and the substance to be burned are contained within the same molecule instead of in separate molecules. Most explosive substances are of this type and their power is produced by molecular disruption. Not every explosive contains oxygen, however. For example, lead azide, a well-known detonant, contains atoms of lead and nitrogen only and produces free nitrogen on exploding.

The power latent in an explosive may be gauged from the fact that when gunpowder explodes it produces 500 times its own volume of gas, which is increased to 4,000 volumes by the heat liberated at the same time. Nitro-glycerine, the base of many industrial explosives, produces 1,200 times its own volume of gas, increased by the liberated heat to 10,000 times.

### *Types of Explosives.*

There are various methods of classifying explosives, none of them wholly satisfactory, because not only do various types differ from each other in a number of ways, but the same explosive may behave differently according to circumstances. Perhaps the most convenient method is to use the classification derived from their military use, which refers more to the violence than the power of the explosion. The types are as follows:—

(a) *Propellants.* When a propellant burns, gas is liberated at a comparatively slow rate and there is none of the shattering effect which is a characteristic of high explosives. Gunpowder is a prominent example in the industrial world.

If it is fired in the open it burns fiercely and quickly, but the gas readily disperses and there is no resultant explosion. If it is confined behind a wall of rock and well tamped in, the pressure from the gas increases until the rock gives way at its weakest point. Enormous power is developed, but as it is applied gradually there is no shattering; the gunpowder may be said to do its work by "heaving".

The terms "slow" and "fast" as applied to explosives are of course purely relative, but as a guide it may be noted that under the best possible conditions the rate of burning of gunpowder does not exceed 400 metres a second. Gunpowder is used in industry for safety fuses and the quarrying of building and monumental stone. It is fired by a flame.

(b) *High Explosives.* The essential feature of high explosives is the suddenness with which their power is liberated. They always have a shattering effect, and although their effectiveness is enhanced if they are confined, it will be found that if a suitable quantity is exploded on the surface in the open air, the rate at which gas is liberated is such that it cannot be dispersed quickly enough to prevent the surface being shattered.

In practice high explosives are invariably fired by means of a detonator, and the qualities of most industrial explosives are such that they cannot be readily exploded by any other means, except in large quantities. Small quantities of dynamite, for instance, will merely burn away quietly if ignited by a flame.

(c) *Detonants or Initiators.* A detonant invariably explodes with great violence, although it is not necessarily very powerful or especially sensitive. It has a highly unstable molecular structure and once the process of disintegration has started it is rapidly accelerated until a violent explosion occurs, accompanied by intense shock waves. It is these waves which initiate the explosion in nearby masses of high explosive. They travel at speeds of between 3,000 and 9,000 metres a second and the temperature at the wave front may reach as high as 10,000°C. It is, therefore, quite understandable how a high explosive which would otherwise burn away quietly suffers violent molecular disruption when detonated. A small amount of detonant readily causes what is effectively an instantaneous explosion in a charge of high explosive of any size and the shock waves may operate even over gaps between adjacent charges. As each particle of explosive disintegrates it sets up its own detonation waves, which are thus propagated throughout the mass.

Detonants used in industry are very sensitive to heat and are fired either by safety fuse or an electric filament. Their sensitivity to other forms of stimulus, such as shock, friction and pressure, is reduced as far as possible by modern methods of manufacture, so that although they must always be treated with great care as a matter of routine, the risks of normal handling are reduced to infinitesimal proportions.

## EXPLOSIVES FOR POST OFFICE USE

### *High Explosives.*

Most of the industrial explosives available to retail purchasers are variations of nitro-glycerine, which, although a powerful explosive, is not used in its raw state because of a number of inherent disadvantages. Dynamite was the invention of Alfred Nobel, the Swedish scientist, in 1867.

\* Based on a paper read before the I.P.O.E.E. (South-Western Centre) on 4th October, 1950, and subsequently at other Centres.

† Area Engineer, Tunbridge Wells.

It consists of nitro-glycerine (which is a liquid) in a solid inert substance known as "kieselguhr," a soft white earth with an exceptionally high power of absorption. Many absorbent bases have since been used, however, and the term "dynamite" is nowadays often employed in the nature of a family name to cover a number of individual explosives.

The next stage in the evolution of modern industrial explosives, also due to Alfred Nobel, was the replacement of the inert kieselguhr by collodion cotton (cellulose dinitrate), which is itself an explosive. This gave rise to blasting gelatine, which was, and still remains, the most powerful of all industrial explosives and is the standard to which all other explosives are referred for purposes of comparison.

Milder explosives are obtained by varying the proportion of collodion cotton and adding other absorbents. There are a great many different types and in quarrying or mining the characteristics are carefully chosen according to the work to be done. For day-to-day Post Office work, however, there is little to choose between any of them, and one type can be used for all jobs. Gelignite, which has about 75 per cent. the power of blasting gelatine, is very popular and generally easy to obtain.

Explosives of the gelatine type are very easy to handle. They have a jelly-like formation which is fairly water-resistant, enabling them to be used in wet situations and obviating many storage difficulties. The explosive is put up in waxed paper cartridges of about 2 oz. and upwards, and the waxed paper increases the natural water resistance.

Kieselguhr dynamite freezes at about 4°C, in which state it is somewhat dangerous to handle, as it is liable to explode on ignition and is also difficult to detonate. The old-time quarryman kept his dynamite in a warming pan, an inner container with an outer jacket of warm water. Such precautions are no longer necessary. Most of the modern explosives are low-freezing, and I.C.I., for example, do not market in this country any explosives which are affected by the lowest temperature likely to be experienced.

#### Safety Fuse.

Safety fuse, the invention of William Bickford in 1831, consists of a train of black powder (gunpowder) embedded in a flexible tube of braided coverings to which may be added a covering of tape or gutta-percha. It is manufactured under carefully controlled conditions and guaranteed to burn at a speed of 90 seconds a yard, with a maximum variation either way of 10 seconds. Both waterproof and non-waterproof types are available; the latter may be waterproofed for wet situations by a thorough coating of grease, but it is better in such conditions to use detonating fuse.

#### Detonating Fuse.

Detonating fuse consists of a core of high explosive in a flexible tube of suitable material. As made by I.C.I. under the trade name "Cordtex," the explosive is a white powder of the T.N.T. family, having a speed of detonation of about 7,000 metres a second. It is enclosed in layers of jute and cotton yarn with a strong plastic outer sheath, the weight of explosive being 3½ lb. per 500 ft. of fuse. When exploded by a detonator it transmits the detonation waves to all charges of high explosive with which it is in contact. By its use, any number of charges may be fired simultaneously by one detonator, which considerably reduces the element of danger. Being waterproof it is invaluable for use in wet holes.

Safety fuse and Cordtex are readily distinguishable from each other, but even if they were confused no harm would result since safety fuse cannot be detonated and Cordtex cannot be ignited by a flame.

#### Detonators.

A detonator is a small tube of aluminium or copper containing a small quantity of initiating explosive in compressed form. A typical detonator is illustrated in Fig. 1(a)

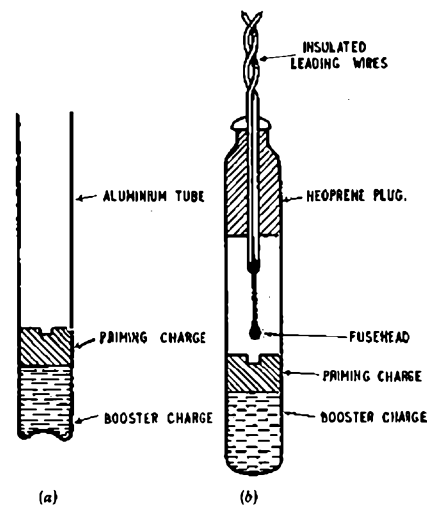

FIG. 1.—DETONATORS; (a) PLAIN AND (b) ELECTRIC.

It contains two explosive charges. The first, or priming charge, is very sensitive to heat but not very powerful. It is a mixture of lead azide, lead styphnate (both very sensitive detonants) and flake aluminium powder. The last-named material acts as a lubricant to prevent the crystals of lead azide and lead styphnate exploding by friction when the mixture is being compressed during the manufacture of the detonator. The second, or base charge, is of tetryl, which is less sensitive but more powerful than the priming charge. When the detonator is fired, the priming charge explodes, the base charge follows, and the detonation waves from the latter operate the high-explosive charge to which the detonator has been fixed.

The detonating mixture is very stiff, and providing it is not tampered with or allowed to get wet it will not fall out of the tube. The size of the charge varies with the type of explosive it is desired to detonate. Detonators are, by general consent, classified according to their strength by the series of numbers 1 to 10, irrespective of their actual make-up. No. 6 is a good all-round detonator and is readily available.

A plain detonator intended for use with safety fuse has an open end into which the fuse is pushed and crimped (see Fig. 1(a)). Electric detonators have, in addition to the detonating mixture, a small fuse head something like the head of a safety match, which is fired by the heat from a small electric filament embedded in it. The fuse head, together with the leads, is sealed and crimped in the tube, as in Fig. 1(b).

#### THE TECHNIQUE OF BLASTING

Blasting is used to soften up the soil which is to be excavated from a pole hole, stay hole, or trench, so that the spoil can be removed with a minimum of effort using, ideally, nothing but a shovel. To do this, a small bore hole is driven into the ground and a charge of high explosive placed therein. The bore hole is then stemmed, that is, filled up with soil, and the charge is fired. The following paragraphs deal with the technique necessary for this operation.

#### Drilling the Bore Hole.

The best methods of drilling bore holes can only be learnt by experiment in local soils, because soils vary so much between different localities. It is therefore only possible to discuss the problem in general terms.

The tools readily available are:—

(a) *Bar and Sledge.* Much useful work is possible with the simple diamond-pointed bar, providing the soil is reasonably compressible. Some soils may be found to pinch badly and care has to be taken not to drive the bar beyond the point at which it becomes difficult to withdraw.

(b) *Power-driven Bar, i.e. Road Breaker.* This tool is sometimes valuable where a large number of bore holes have to be driven in very hard soil. Extra care is necessary where the soil is liable to pinch badly, as it is not desirable to use a sledge to loosen the steel.

(c) *Rock Drill and Hammer.* The rock drill is a rod of suitable length with a steel bit at one end. At each blow of the hammer the bit crushes a small portion of the rock into powder and the drill is rotated after each blow to bring the bit against a fresh face of the rock. Constant rotation is of more importance than heavy blows and a 2-lb. or 4-lb. hammer is often as effective as a sledge. The rock dust has to be disposed of from time to time to prevent it acting as a cushion between the bit and the rock face. One way of clearing the hole is to blow it out with an air pump. Another is to fill the hole with water which turns the dust into sludge. Some of the sludge will creep up the face of the drill but it may be necessary to remove the drill occasionally and mop the hole clean. A useful mop may be improvised by "jumping-up" the end of a malacca cane until the fibres loosen and spread out.

The bit is somewhat wider than the diameter of the drill rod to prevent the rod binding in the hole. If very deep holes are to be drilled it may be convenient to use drills of different lengths. A very important point is that drills used in the same hole must be progressively narrower. The reason is that the bit first used becomes worn during its passage through the rock and if another bit of the same nominal size is inserted it will in fact be a trifle larger. Although this may not be noticeable in the downward movement because it is hammered downwards, it may be quite impossible to withdraw it through the first part of the hole.

(d) *Hand Jumper.* The hand jumper is a long double-ended drill jumped up and down (and rotated) by hand instead of being hammered. The tool is extremely valuable in suitable soils and can easily be operated by one man. Water is generally used to keep the working face clean and it is advisable to place an old sack round the hole to save the operator being badly splashed with mud.

(e) *Power-driven Rock Drill.* Both petrol driven and pneumatic rock drills operated from a compressor are available. The drills function in the same way as the hand drill, but the rods are hollow and air is forced down through the duct to an outlet just behind the bit to keep the bore hole free of dust. The air for this purpose is supplied from the power unit.

#### *Selection of Bit.*

The best shape of bit for local soils can only be found by experiment. Hand-operated drills usually carry single chisel bits, as illustrated in Fig. 2(a), but in power drills there are a number of shapes to choose from and the bits are often detachable. The single chisel is perhaps the most common, and if it is supplied in a hard alloy such as tungsten carbide it is not detachable because the bit is many times more expensive than the rest of the rod and, if detachable, is easily lost. The double chisel (Fig 2(b)) may be found valuable in rocks containing cracks where a single chisel may tend to lodge, but there is a tendency for dust to collect between the two cutting edges and render them inoperative. The 4-point cross (Fig. 2(c)) is widely used for hard rocks. The reverse Z (Fig. 2(d)) is designed for soft rocks, including

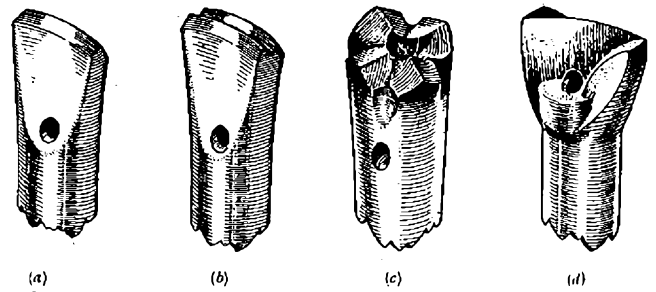

FIG. 2.—FOUR TYPES OF BIT USED FOR DRILLING BORE HOLES.

those containing pockets of clay. Its action is similar to that of the carpenter's auger and the likeness is strengthened when it is used with a spiral drill rod to assist in the clearance of clayey soil.

#### *Depth and Weight of Charge.*

Both the weight of the charge and the depth at which it is buried are matters to be decided after experiment in the local soils. Broadly speaking, the size of the charge should be such as to open up the pole hole or trench to the required width, and the depth such as to shatter the soil up to, or nearly up to, ground level. If this does not give a sufficiently deep hole, blasting will have to be done in stages. Because of the wide variations in soils, the following details can only be regarded as suitable starting points for experiment.

*Pole Holes.* If the hole is not required to be more than 3 ft. 6 in. deep, a 2-oz. charge at a depth of 2 ft. 6 in. to 3 ft. should be suitable. In the ideal case the explosion will result in a core of shattered spoil covered by a thin crust of slightly disturbed top soil as in Fig. 3(a), which can easily be broken through with a spade. When the subsoil is

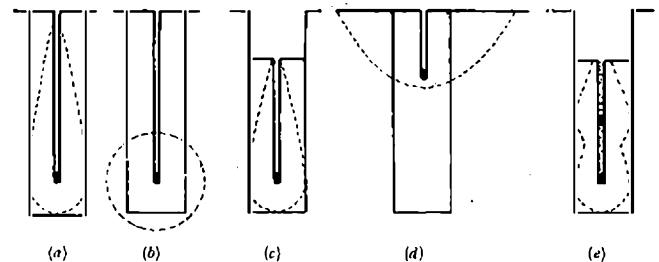

FIG. 3.—(a) IDEAL HOLE, (b) CHARGE TOO DEEP IN COMPRESSIBLE SOIL, (c) REDUCING BURDEN IN COMPRESSIBLE SOIL, (d) EFFECT OF SHALLOW CHARGE IN SOFT SOIL, (e) "DECK LOADING."

easily compressible, however, a charge at this depth may cause a wide hole underneath a thick top crust as in Fig. 3(b). When these conditions are likely to be met, it is desirable to remove the top spit of soil and to place the cartridge a little higher, thus reducing the burden above the charge and causing an upwards rather than a sideways thrust when it is exploded (see Fig. 3(c)).

When the top soil is soft it is undesirable to place the charge too near the surface or a wide shallow depression may result, leaving no solid wall at the top of the hole, as in Fig. 3(d). The top soil should always be removed initially if it is soft and covers a hard subsoil which calls for a charge at shallow depth.

It is seldom necessary to use charges in excess of 2 oz., but it may sometimes be advantageous to "deck load" the bore hole, that is, to place charges in it at different levels as in Fig. 3(e) and fire them simultaneously. When conditions are suitable this may obviate the necessity for blasting in stages.

*Stay Holes.* A stay hole may be regarded as two adjacent pole holes, and two charges are fired simultaneously, one in



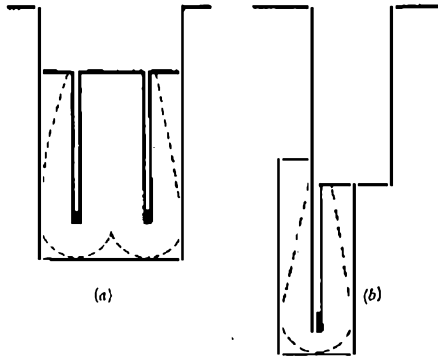

FIG. 4.—TWO METHODS OF BLASTING A STAY HOLE.

each of the equivalent pole holes; see Fig. 4(a). If a stay hole is to be blasted in stages the second set of charges may be placed to give a degree of undercutting, as in Fig. 4(b).

**Trenches.** Trenches may be excavated by one of two methods, depending mainly on the type of soil. In the first method a number of charges are spaced along the line of trench and fired simultaneously. The spacing should be such that the effects of adjacent charges overlap so as to avoid unbroken patches. There is no technical limitation to the number of shots that can be fired simultaneously, but unless an unbroken crust of top soil can be guaranteed, the number is limited by the availability of blasting mats or other appliances for smothering the explosion. It is usually convenient to fire 6 to 12 charges at once.

It is important not to invite public criticism by unduly loud explosions, and this fact alone will limit the number of simultaneous shots except in lonely places. Twelve charges is not a heavy explosion, but the amount of detonating fuse used will make it a loud one.

The second method of opening trenches is useful when loud explosions are undesirable or when trenching in hard rock. It consists of firing one charge at a time, and although

it takes longer it has the advantage that each charge operates against a free face (see Fig. 5) and is therefore more effective. The possibility of keeping the width of the trench to the minimum by using half cartridges should not be overlooked.



FIG. 5.—BLASTING A TRENCH BY FIRING ONE CHARGE AT A TIME.

#### Preparation and Firing of Charge.

Before the charge is placed in position it has to have connected to it the means to detonate it. This may be a plain detonator connected to a length of safety fuse, an electric detonator, or a length of detonating fuse. After placing, the bore hole is stemmed and the detonator may then be operated. As the procedure for handling the charge varies slightly with the method of detonation employed, the process is described separately for each of the three methods.

**Plain Detonator and Safety Fuse.** Great care is necessary in connecting the detonator to the safety fuse, because although the operation is perfectly simple and safe, the neglect of even a minor precaution may result in a "misfire," or the failure of the detonator to operate the charge. It is an essential feature of the scheme that the heat from the burning gunpowder is transmitted right up to the detonating mixture. The precautions are directed to ensuring that the train of gunpowder is absolutely unbroken and that the detonator remains in contact with the charge.

Detonators are packed in sawdust, every grain of which must be shaken out from the open end. As a precaution an inch or so is cut from the end of the coil of safety fuse in

case some of the powder may have become dislodged. The safety fuse should be cut square and clean, preferably with a proper pair of cutting pliers. The freshly cut end is then inserted in the detonator as far as it will go and firmly crimped in position, using a proper crimping tool. Ordinary pliers are not suitable because there is a danger that the gunpowder train may be squeezed and broken.

The paper-covered cartridge is then opened at one end and a hole made in the explosive material with a small rod of non-ferrous material called a pricker. The detonator is pushed home into the cartridge and the latter squeezed slightly to make a good mechanical contact. For added safety, to prevent the possibility of the detonator being pulled out of the cartridge by subsequent operations, the loose paper at the end may be whipped to the safety fuse with string.

The cartridge is now lowered to the bottom of the bore hole and lightly pressed into position with the blasting stick, which is a wooden rod of suitable diameter. If the charge consists of more than one cartridge the free cartridge is dropped in the hole first and pressed down in position before the priming charge is inserted. The hole is then stemmed, or filled up with soil consolidated as far as possible to equal the original soil. If the stemming is not well done the effectiveness of the charge is reduced and in extreme cases there is a possibility of the charge being flung into the air and entirely wasted. The initial stages must be carefully carried out to prevent any chance of the detonator being operated by pressure from a sharp stone. As long as the first couple of handfuls are of soft earth or sand there is no danger. The stemming should be inserted in small quantities and well tamped. The safety fuse may now be cut off to a suitable length and lit. A total length of 2 ft. is generally ample—this gives the shot-firer one minute to place the blasting mat and move to a place of safety. The safety fuse can be cut open at the end to expose the gunpowder and it is easiest to light it by means of the old-fashioned fusee matches, especially if the weather is windy. It is, as a matter of fact, difficult to light the fuse with an ordinary match once the initial flare has ceased.

**Electric Detonator.** Electric detonators are supplied with standard lengths of insulated wire crimped into the detonator and the joint made waterproof with a neoprene plug. The wires themselves are also reasonably waterproof, and will stand up to damp conditions for a short period. The detonator is inserted into the cartridge in the same way as the plain detonator, and fastened securely by taking a half hitch around the cartridge with the firing leads. The firing leads are then led out to a suitable point for attachment to the firing cable. The method of inserting the cartridge and the stemming are exactly the same as when plain detonators and safety fuse are used, care being taken to ensure that the firing leads are not broken during the process of stemming.

The firing cable should of course be sufficiently long to enable the shot to be fired from a safe distance. The current for firing is obtained from a battery, the lorry battery, for instance, or from a mechanically operated generator called an "exploder," which is connected to the firing cable by the shot-firer when all other work is finished. Needless to say, he should have the battery or exploder under his sole control. Suitable means of ensuring this are to arrange for the completion of the battery circuit to be dependent on a safety link which the shot-firer can carry in his pocket, and, using the exploder, for the shot-firer to carry in his pocket the detachable handle without which the instrument cannot be operated. The exploder is shown in use in Fig. 6.

The standard low-tension detonators require for their operation a minimum current of 0.6 amp. for 50 milliseconds. An ample factor of safety should be used.



FIG. 6.—THE EXPLDER.

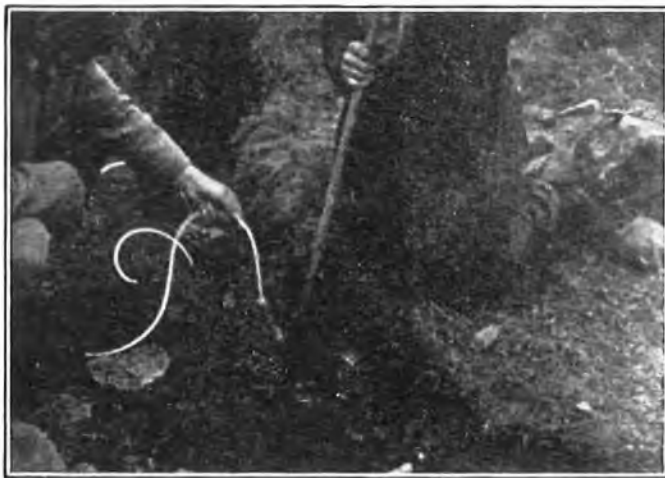

FIG. 7.—CARTRIDGE THREADED ON DETONATING FUSE BEING LOWERED INTO BORE HOLE.

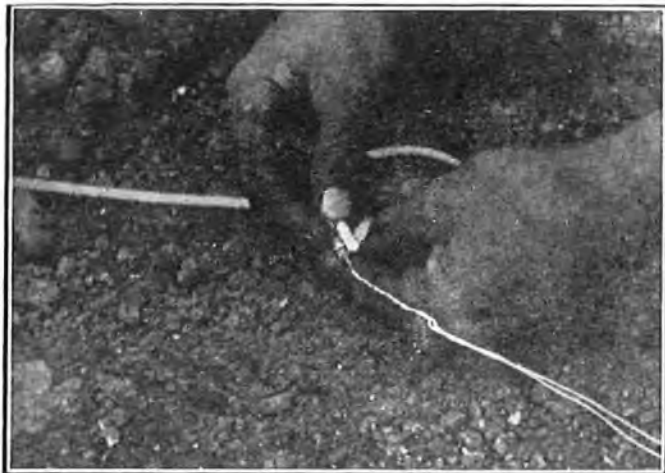

FIG. 8.—ATTACHING DETONATOR TO DETONATING FUSE.

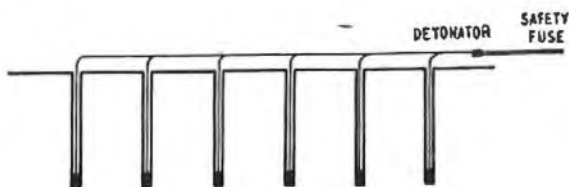

FIG. 9.—SIMULTANEOUS FIRING WITH DETONATING FUSE

Although they are more expensive than the plain type, they possess the great advantage that the charge can be fired at a given instant, which is useful when blasting alongside busy roads or on farm land. In the first place a suitable break in the traffic can be awaited and in the second there is no fear of young animals rushing up unexpectedly after the fuse has been lit.

*Detonating Fuse.* Detonating fuse can be regarded as an extension of the high-explosive charge, and as the fuse can be of any length this allows the detonator to be fixed to it above ground level instead of being buried with the charge. It follows that the detonator need not be fixed until all other preliminary work, including the stemming, has been completed, and since the charge is innocuous without the detonator, beginners and others with little experience can undertake blasting without any fear that a vital safety precaution may have been overlooked. For this reason alone the use of detonating fuse is strongly recommended, but there is the further advantage that simultaneous blasting and blasting in wet holes are considerably simplified and made safer.

The detonating fuse has to be held in reasonably close contact with the charge to be detonated, the only precaution necessary being to ensure that it is not pulled away from the charge during stemming. A hole is made right through the cartridge with the pricker, and the fuse is threaded through it and knotted at the far end to prevent it pulling through. The cartridge is then lowered into the bore hole, as shown in Fig. 7 and pressed well home with the blasting stick. If more than one charge is necessary the free cartridges are dropped in the bore hole afterwards, and they will be in contact with the fuse even though they may be separated from the first charge by a layer of stemming. The stemming should be carefully carried out as a matter of precautionary habit, although there is no danger of the charge being prematurely exploded by stones. When the stemming has been completed and, if desired, the blasting mat placed in position, the detonator can be fastened to the fuse with a lapping of insulating tape. Fig. 8 shows an electric detonator being attached to the detonating fuse, but either type of detonator can be used.

#### *Simultaneous Firing.*

There are various ways of firing a number of charges simultaneously, but the use of detonating fuse is, in the author's opinion, by far the best and safest in the hands of non-experts, and is the only method described here. The arrangements are shown in Figs. 9 and 10. One length of fuse is taken from the furthestmost charge to the detonator and the spur lengths are taped on at convenient points. The only precaution necessary is to ensure that each spur faces the detonator, otherwise the detonation wave may pass it by. The closed end of the detonator should point in the direction of the line of detonating fuse. In the unlikely chance of one of the charges failing to operate no harm will be done, as there will not be a live detonator to cause trouble.

#### *Blasting Mats.*

It is generally advantageous to place a blasting mat over the hole or trench to prevent debris flying into the air, and sometimes it is essential, as when trenching in stony soil immediately under power wires. The qualities called for in a good mat are :—

- (a) It must be heavy enough to prevent it rising more than a few feet under the force of the explosion.
- (b) It must be light enough to handle easily and to be carried by one man.
- (c) It must not take up too much room in the lorry.

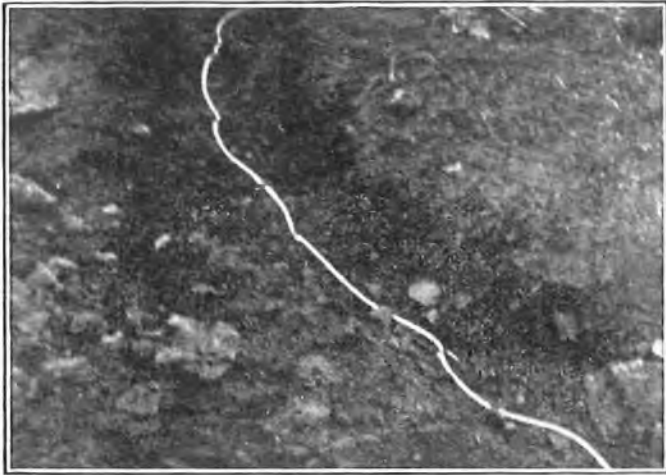

FIG. 10.—CHARGES LINKED BY DETONATING FUSE.

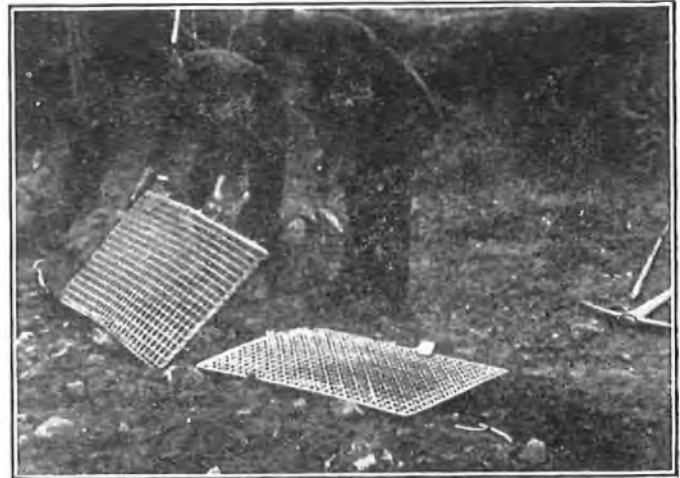

FIG. 11.—PLACING BLASTING MATS IN POSITION.

- (d) It must allow the gases liberated by the explosion to pass through it easily.
- (e) It must stop the passage of small stones.
- (f) It must stand up to hard usage.

It is not easy to reconcile all the above requirements, but the author recommends light steel grids, weighted down with sandbags along the edges. Two such mats are shown being placed in position in Fig. 11.

#### Wet Holes.

It is possible to obtain safety fuse and electric detonators for use under water, but it is unlikely that either would be necessary to an extent which would justify complicating the purchase and storage of blasting materials. Safety fuse and the firing leads of electric detonators can be water-proofed if necessary by giving them a thorough coating of

grease, but if detonating fuse is used no departure from standard practice is called for. If the bore hole is completely flooded it may be difficult to stem it, but fortunately this is not very important as water, being of an incompressible nature, makes an efficient stemming agent.

#### ACKNOWLEDGMENTS

The author has received help and encouragement from many people. Among his former colleagues in the Plymouth Area he is particularly grateful to Mr. S. T. Stevens for his admirable film made to illustrate the original I.P.O.E.E. paper (shots from which are reproduced in this article), and to Mr. J. Shaw for his enthusiastic co-operation in the field. He is also grateful for information and technical literature supplied by Imperial Chemical Industries, Bickford Smith Powder Factory, Camborne.

## Book Reviews

"Microphones." The staff of the B.B.C. Engineering Training Department. Iliffe & Sons, Ltd. 114 pp. 76 ill. 15s.

This slim volume has been written to serve as a text book for students and operational engineers employed at studio centres. Apart from five short appendices the treatment is essentially non-mathematical, though formulæ are quoted where required. The reader is assumed to have little academic knowledge of acoustics but to be well grounded in electrical alternating-current theory; many such readers might find the description of sound waves (chapter 2) no less difficult, but less useful, than one which freely uses mathematical explanation.

The distinction between pressure and pressure-gradient operation of microphones is well drawn, and effects of diffraction and other influences affecting polar response of microphones are described and illustrated. The last and longest chapter gives constructional details and a few notes on design and performance of some half-dozen types of microphones used for broadcast programmes. The mechanical and acoustical analogies to electrical quantities are introduced in a chapter which mostly deals with mechanical systems and is curiously entitled "Electro-acoustics." The terminology here favours American rather than British practice, though the British Standard Glossary of Acoustical Terms and Definitions is cited in the small list of references. No reference is made to the concept of the Equivalent Piston, with the result that the important term for area in the relation between mechanical and acoustical impedances is taken to be the area of the diaphragm. Anomalous statements as to the rigidity of diaphragms result and the useful lesson is missed that at audio frequencies diaphragms (and other surfaces) may not be so rigid as they appear.

The special requirements of microphones used very close to the source of sound receive attention, but not so the effects of the room or studio on sounds at microphones placed at more usual distances from the source. Too much cannot, however, be expected from so small a book on so large a subject. If the book stimulates the interest of studio engineers in this important item of their equipment, it will do useful service.

W. W.

"Thermostats and Temperature Regulating Instruments." R. Griffiths, M.Sc. Chas. Griffin & Co. Ltd. 20s.

This book deals with a very large range of temperature-controlling devices, the instruments used in industry, and schemes which are more relevant to laboratory work.

Industrial regulators are fully described and references to suitable applications are made where this is desirable; the book ends with a short chapter on heat exchangers and a valuable appendix on theoretical considerations of temperature controls. The author has a lively appreciation of the practical laboratory application of temperature control. He goes out of his way to give precise practical details which will save laboratory staff much time and heartbreak.

The need for brevity has led to one or two passages being a little obscure, for example the one on page 31 about the use of phosphoric acid mixtures. On the same page there is a reference to the use of lead oxide base cements for jointing glass plates. The reviewer prefers where possible to use some of the newer synthetic resins such as Araldite for this purpose.

The book is to be recommended to engineers and perhaps more particularly to all laboratory workers who need to use thermostatic devices. It is well produced, adequately illustrated and there is a full list of references at the end of each chapter.

E. C. R.

# Cardiff Non-Director Automatic and Zone Centre Trunk Exchange

S. E. NEW†

U.D.C. 621.395.722: 621.395.34

This recently completed installation is the largest single-unit non-director exchange in Britain. The size of the undertaking produced some unusual planning and installation problems which, together with several new equipment features, are described in this article.

## Introduction.

SINCE 1910 the Cardiff main exchange subscribers have been served by a 24-V C.B.1 manual exchange of Hilsby manufacture. In 1934 this was supplemented by a 50-V sleeve control trunk exchange and in 1949 a 40-V, C.B.10 exchange was opened as a local service relief. The new automatic exchange, which was brought into service on 16th February, 1952, replaces all these, allows for development of the central area which has been closed to new subscribers for a considerable time, and brings to South Wales an improved trunk and toll service. Equipment for 16,000 subscribers' multiple has been provided with 167 switchboard positions.

No attempt is made in this article to give a detailed description of the new Cardiff exchange, but some special problems involved in the installation and transfer of an unusually large non-director unit are outlined.

## The Building.

The new building, having basement, ground and four floors has a superficial area of approximately 80,000 sq. ft. The ground floor accommodates a repeater station, a double M.D.F., test desk and trunk test racks. The automatic switching equipment is on the 1st and 2nd floors and the manual switchroom on the 3rd floor with welfare accommodation above. The basement is used for cable chamber, diesel driven stand-by generator, H.T. and L.T. switchgear, stores, etc.

Foundations were laid and the basement constructed in 1939 but work ceased on the outbreak of war. After some necessary alterations to the plans, work recommenced in 1947. One post-war alteration was to plan for all floors to be of apparatus height and strength. Others were to include the repeater station and to provide a prime mover generating set capable of maintaining complete service in the case of mains failure.

Two passenger and one goods lift have been installed.

## General Facilities.

The subscriber's numbering scheme is of five digits and allows for the opening later of satellite exchanges. Level multi-metering up to 4-unit fees is provided allowing the local subscribers to dial to automatic exchanges up to 15 miles radius. A full scheme of through-dialling is available to manual exchange operators and to U.A.X. subscribers within the control of the route-restricting equipment at the individual U.A.X.s. The auto-auto relay sets have been connected between switching ranks and impulse regenerators have been installed where necessary to facilitate tandem dialling. Trunk dialling has been provided by the 2 V.F. system. Special arrangements were necessary however for the Cardiff-Swansea route, Swansea being a Siemens No. 16 type exchange (due shortly for replacement) to which the 2 V.F. system was not designed to work. To meet this case use has been made of V.F. telegraph equipment for the provision of signalling channels separate from the speech paths. The V.F. telegraph equipment has been installed remote from the terminal ex-

changes in accommodation where it will ultimately be used for its proper purpose.

Fig. 1 shows a small section of the automatic equipment installed on the first floor.

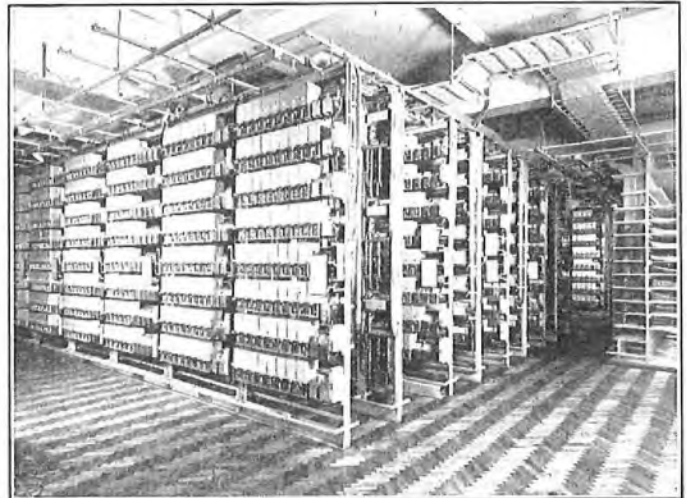

FIG. 1.—A CORNER OF THE 1ST FLOOR APPARATUS ROOM.

Speaking clock service has been given from a newly developed rack which includes permanently run main and standby amplifiers. These, together with the control test panel, were constructed by the Research Branch.

## I.D.F. Arrangements.

The ultimate I.D.F. requirement for subscribers is 100 verticals and these, in accordance with the standard practice, were provided on a separate Subscribers' I.D.F. The group selectors are on graded type racks, which makes it necessary that all inter-rack connections should be made via an I.D.F., with consequent increase in requirements; 20,400 tie circuits, occupying 54 verticals, were necessary for this purpose. A further 45 verticals were necessary for the manual board multiple terminations, each suite being terminated on a separate group of tag blocks provided with a strapping system which allows the suites to be coupled or uncoupled as desired, without recabling. In addition there are connections for a large number of relay sets and miscellaneous circuits.

During the planning of the exchange, it became clear that there would be advantages in having a separate manual board I.D.F. (Equipment I.D.F. No. 2) on the second floor on which to terminate the switchboard multiples. There would be an economy in the use of cable and as the equipment associated with the manual board was to be accommodated on that floor, an advantage to the maintenance staff. To avoid the use of tie circuits between I.D.F.s it was necessary to terminate the manual board side of the relay sets on Equipment I.D.F. No. 2 and the selector side on Equipment I.D.F. No. 1. A typical diagram of the arrangement is shown in Fig. 2 and the scheme has proved most satisfactory in practice.

† Executive Engineer, Engineering Branch, Welsh and Border Counties Region.

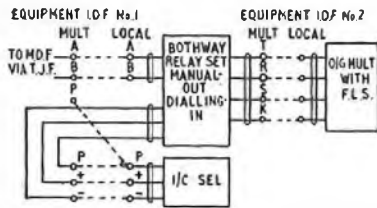

FIG. 2.—TYPICAL TERMINATIONS ON THE EQUIPMENT I.D.F.S.

The number of verticals provided on the three I.D.F.s totals 295. A view taken half-way along the Subscribers' I.D.F. and including Equipment I.D.F. No. 1 is reproduced in Fig. 3.

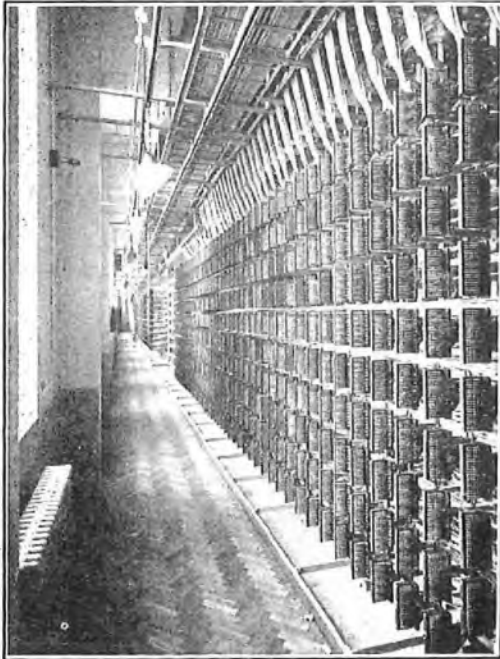

FIG. 3.—SUBSCRIBERS' I.D.F. AND EQUIPMENT I.D.F. No. 1.

When the M.D.F. and Subscribers' I.D.F. are on different floors the usual method of cabling between the protectors on the M.D.F. and the multiple side of the I.D.F. is by means of a large runway which is taken via a cable hole at the non-growing end of the frames. On the Cardiff installation, however, a novel arrangement was considered, with the object of economy in use of switchboard cable, i.e., the provision of a slot in the ceiling above the M.D.F. through which cables could rise vertically to the I.D.F. on the next floor. Because this scheme gave rise to certain practical difficulties in supporting the cables, a modified arrangement was adopted in which the proposed slot was reduced to a series of holes midway between each 6 verticals.

#### The Switchboards.

A general view of the switchroom is shown in Fig. 4. The controlling positions are in three suites, two of which are for joint trunk working with a total of 115 positions and the third an incoming suite of 24 positions. The jack field of the joint trunk suites is fully taken up and there is little space for increase on the incoming suite. It is planned that the answering multiples, at present in parallel, will later be split.

The enquiry suite, composed of twenty 4 ft 8½ in. sleeve control switchboards is to be seen along the centre of the room. This suite stands above the structural ventilating duct serving the floor below and the cable hole had therefore



FIG. 4.—THE SWITCHROOM.

to be offset, making necessary a special cable-turning section with a projection between floor and keyshelf level. Opportunity was taken to accommodate the fault docket pneumatic tube terminal in this section, the carrier receiving cage being out of sight, with a sliding door for access. The sending tube is let into the woodwork.

The switchboards are of a new construction which leave the face appearance unaltered but have the following advantages:—

- (i) Light steel angle iron frames.
- (ii) Universal base assembly for 6 ft. 4 in. and 4 ft. 8½ in. positions with improved cabling facilities.
- (iii) Butt-to-butt kicking panels and rear doors on 4 ft. 8½ in. sections.
- (iv) One continuous plug seat of phenol fibre for which a reduced cord fraying effect is claimed.
- (v) New type cord terminal and pulley arrangements for quick change of cords.

Directory Enquiry traffic is taken on a six-position cordless suite with cyclic distribution and call queueing facilities. The physical construction of this suite is of an experimental pattern which provides the operator with the necessary space for filed information and a desk top free from plugs and keys. A two-position Directory Enquiry monitor suite is also provided.

#### Supervisors' Desks.

The three supervisors' desks are of a new type being essentially knee-hole desks with a low instrument turret which accommodates keys and lamps for incoming and outgoing circuits and Yaxley switches for the selection of listening lines. One desk may be seen in the foreground of Fig. 4. The circuit arrangement for the listening lines is shown in Fig. 5. A limit of 80 listening lines per desk has been fixed and the ten arcs available on the "tens" switch limits to three the suites over which these can be spread. The dotted lines show the strappings for Desk No. 1 which serves Positions 1-17, 501-520 and 601-606. On the "units" switch only 3 of the 10 arcs have been shown. For the first suite the position numbers have to be made up to 3 digits by prefixing noughts. On Desk No. 2 which serves positions 28-37 only, the "hundreds" switch has been omitted and it is unnecessary to prefix noughts. The arrangements would be unified if all positions were given three digit numbers. The contacts of the tens switch are connected to commons each serving ten positions. Each position has an LI relay which is connected to the contacts of the units switch. Only one LI relay can be operated at a time.

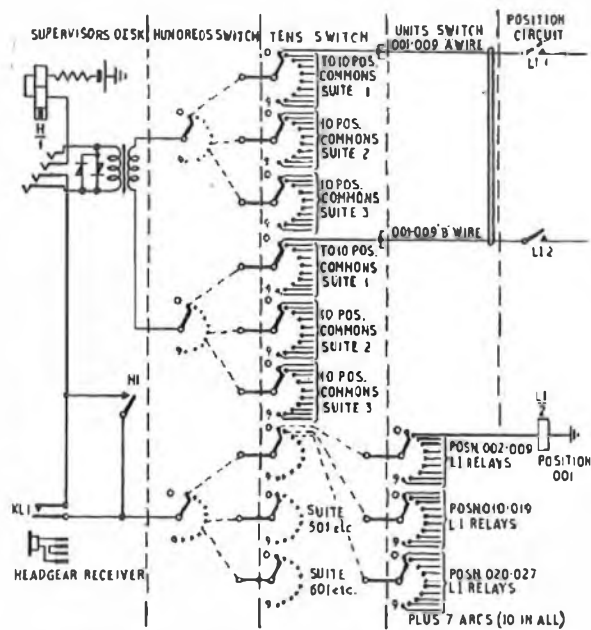

FIG. 5. CIRCUIT ARRANGEMENTS FOR SUPERVISOR'S DESK LISTENING LINES.

When the desired position has been selected by setting the Yaxley switches, key KLI is operated to cause the appropriate LI relay to operate and switch the listening tap to the "10's common." The high speed relay H ensures that relay LI is released immediately a switch is moved and that no LI relay is operated while the switches are being positioned. The switchboard operator receives no click when the connection is made, surges being taken up by the rectifiers in the receiver circuit.

#### Switchboard Finishes.

As part of the policy to brighten the appearance of switchrooms, alternatives to the traditional mahogany finish have been considered and various lighter tone woods tried. At Cardiff it was decided to use polished beech together with green fibre keyshelves and green lino kicking panels. Spacing strips in the multiple panels are also green. On the 4 ft. 8½ in. enquiry suite green "Warerite" (a laminated plastic) has been used, as a trial, in the kicking panels. To match with the main colour scheme it was necessary to arrange for switchboard accessories to be suitably coloured. As examples, the plug covers, visible index files and ticket trays are green, the operator's headset jack escutcheon plate ivory, and the key plates on the cable turning section "old gold."

#### The Transfer Arrangements.

The M.D.F. at the old exchange was in very congested accommodation in the basement and the jumper fields were in a considerable state of confusion as a result of protracted expedients. A certain amount of low insulation existed on the frame so that any scheme which did not involve work on it offered a considerable advantage. The external cables entered the basement of the old exchange from a congested manhole which would have made teeing of the 14,000 pairs very difficult. The old and new exchanges occupied adjacent sites and in view of the conditions first mentioned and the short lengths of temporary cables which would be required, it was decided that the distribution cables should be permanently diverted to the new M.D.F.s and that from there the working circuits should be looped back by tie

cables jointed to the ends of the cable originally connected to the old M.D.F.

The arrangements at the new exchange are illustrated in Fig. 6. The tie cables were terminated on temporary frames

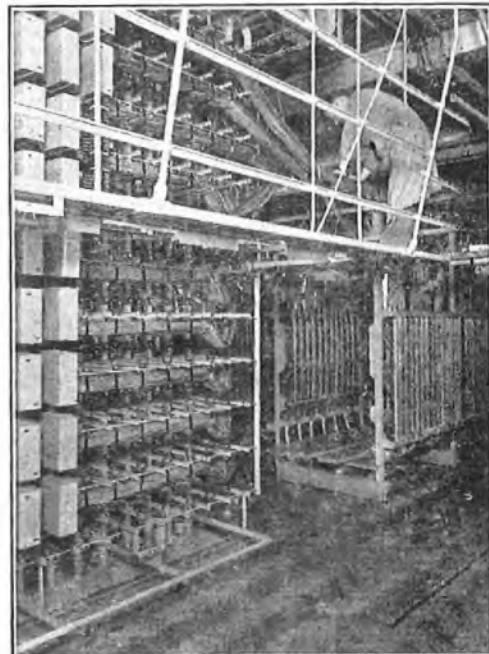

FIG. 6.—TEMPORARY FRAMES IN LINE WITH THE M.D.F.s.

placed in line with the two M.D.F.s. The slots in the floor for ultimate pipes from the cable chamber were left open for this purpose and the terminations made direct on to changeover strips. From the other side of the changeover strips temporary jumpers were taken to the permanent line terminations. It was necessary that these temporary jumpers should cross the mezzanine platform and this was done by grouping them into eleven runs, each serving an M.D.F. horizontal, which crossed the platform from the top of the temporary frame. Having entered the M.D.F. they were taken along temporary jumper rings, fitted below the horizontal members. Switchboard wire was used to reduce space and the connection to the line made on the permanent wiring side of the fuse mountings by means of a twisted and soldered joint, an end of wire on the silk and wool termination having been left for this purpose.

Before deciding upon the use of temporary jumpers, consideration was given to the practicability of using switchboard cable between the changeover jacks and the fuse mountings, but the use of cable would have either added to the jointing difficulties in the congested H.P.O. manhole or necessitated temporary cable forms passing vertically behind the fuse mountings with consequent hindrance to the running of permanent jumpers.

The transfer scheme had the advantage of allowing all pre-transfer testing to be controlled entirely at the new exchange and also permitted the transfer operation to be made at that point. The "Relief" exchange, being some distance away, was not involved in this scheme, the usual teeing arrangements being made in that case.

#### Acknowledgment.

Acknowledgment is made to Ericsson Telephones, Ltd., who supplied and installed the exchange equipment, for the illustration used in Fig. 1.

# New-type Routiners for Automatic Telephone Exchange Equipment

L. GREEN†

## Part 3.—Circuit Principles of Test Relay Sets and Common Test Relay Sets.

U.D.C. 621.395.365

In this final part of the article the author explains how test relay sets provide for the application of individual test conditions, and common test relay sets provide for the application of particular types of test, being common to all test relay sets. The circuit principles are described and it is shown how these tests may be applied over a wide range of testing conditions.

### TEST RELAY SETS

FROM the description given in Part 2 of this article, it has been shown that the seizure of test relay sets in cyclic order provides the means of applying test conditions direct to the equipment under test. The circuit for the control of the test relay sets is standardised and each test relay set position is wired for the full complement of testing leads, but individual relay sets provide for connection only to those leads required for the test. These arrangements permit flexibility such that the position of a relay set is not limited by shelf-wiring considerations.

In general the relay sets are arranged in the order of first applying "static tests," e.g., continuity and timing; then "functional tests," e.g., impulsing and hunting; and finally over-all performance tests. For this reason, relay sets are arranged in a definite order which is shown in tabular form in the block schematic diagram of the particular routiner. The block schematic diagram includes complete information for all circuit diagrams comprising a routiner and its title identifies the routiner, e.g., "Routiner for Group Selectors to AT ----."

#### Typical Test Relay Set Circuit.

The circuit of Fig. 1 is a typical test relay set and tests

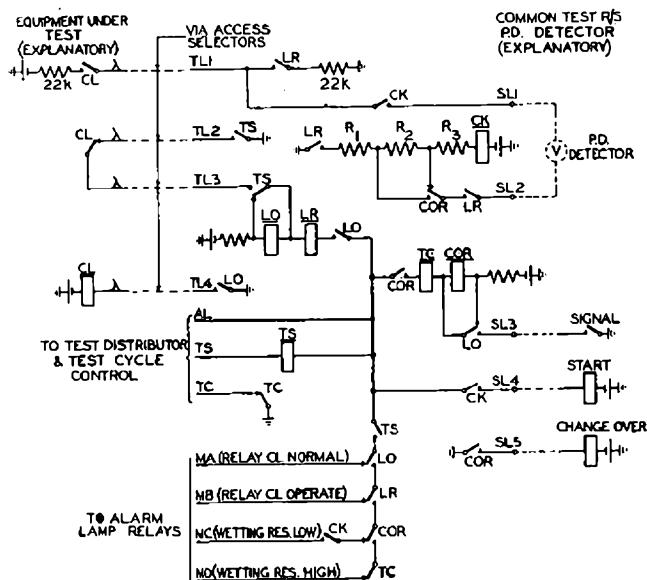

FIG. 1.—TYPICAL TEST RELAY SET.

that correct wetting battery potential exists in the speaking path of the equipment under test. (In this instance, incoming relay set for Signalling System A.C. No. 1.)

The test relay set provides for the operation of a relay in the main equipment to establish wetting battery conditions and, after checking the operation of this relay, extends the wetting battery potential, via secondary leads, to the

Potential Difference Detector common test circuit, which in effect, is a voltmeter.

With selection of the test relay set by the test distributor, full earth is applied to the common earth lead, AL, and battery is connected to relay TS. The operation of relay TS completes a path for the operation of relay LO via the normal contact of CL and relay CL is then operated, allowing the operation of relay LR in series with LO; this completes the preparation of the 22k resistor "arm" by closing the circuit with an arm of equal value and the junction of the two resistors is available for extension to the P.D. Detector. The operation of LR completes the circuit for relay CK in series with three resistors, these forming a "reference arm" and completing a Wheatstone bridge formation. The series relay CK proves the continuity of this circuit and its operation starts the P.D. Detector, which then tests the voltage sense, checking that the resistance of the item is greater than the lower tolerance limit as determined by the reference voltage. With this voltage sense correct, the detector operates and locks, returning an earth signal to operate relay COR which then applies the upper tolerance reference voltage by change of the tapping point on the reference resistors. A contact of COR also signals the detector to re-check to the changed-over conditions, namely, that the resistance of the item is less than the upper tolerance limit of reference voltage. With this correct, the detector "unlocks" and the removal of the earth signal allows relay TC to operate, removing earth from lead TC and giving the "test complete" signal for stepping the test distributor.

It will be observed that each stage of operation controls the connection of the four lamp relay leads MA to MD, against which the fault description is given in brackets.

#### Features of Test Relay Set Design.

The following features are common to the circuit design of all test relay sets and are worthy of special mention because they are not immediately apparent from inspection of the diagrams.

**Fault indications.**—The lamp indications are given during the application of test conditions and, in general, describe the test being made, so that an alarm indicates failure to complete that test, i.e., a negative indication. A positive indication can be given when a test is made to two limits, e.g., timing tests and resistance tests. The latter case applies in Fig. 1 where the indications MC and MD describe in which way the resistance value fails.

**Differentiation between routine and routiner faults.**—During the application of test conditions a circuit is completed for one of four fault lamp relays, switching between successive lamps being dependent upon successful completion of a test and successful completion of local relay set switching. A failure occurring within the relay set prevents switching to the next lamp lead and the absence of a lamp relay signal provides "routiner fault" indication. This is illustrated in Fig. 1 where the operation of relay LR prepares lamp circuit MC which is then dependent upon the operation of relay CK.

† Executive Engineer, Telephone Development & Maintenance Branch, E.-in-C.'s Office.

*Positive tests.*—A test is made "positive" by checking that the correct condition is received and proving this is from the correct source by changing the condition. The circuit for doing this uses two series relays, the correct condition operating one relay and short-circuiting the other, but the change of condition allowing both relays to be operated. This is done to guard against a fault in the testing circuit giving false "O.K." indications. The addition of the sequence relays requires guard against faults in this portion of the circuit. For example, permanent energisation of a relay might give rise to O.K. indication irrespective of test lead conditions. The arrangement adopted guards the sequence relays by ensuring that the operating and releasing sequence must be completed.

Failure of an operating sequence stops the testing progress and a fault is indicated as already described. Failure of any relay to release is detected at the end of the test over the common earth lead, AL, by the control circuit introducing a pilot relay which prevents the test distributor stepping until the AL lead is cleared of battery connections. (See also Fig. 9 in Part 2.)

*Faulty testing components.*—When components, used for providing testing conditions, develop faults which would vitiate the test, the circuit is arranged to detect the fault and stop the testing sequence. One method is illustrated in Fig. 1, namely, the use of relay CK to detect a disconnection fault in resistor  $R_2$ . Without this relay the fault would extend battery and earth reference potentials to the detector such that the item under test would be accepted if its resistance were infinite or zero. In another method use is made of the detector to verify that the voltages governed by resistor components are correct. This method is applied when checking the current regulating resistors for relay non-operate, operate and hold tests.

#### COMMON TEST RELAY SETS

These circuits have been designed so that the method of executing tests of a particular type, e.g., Timing, Transmission and Impulse Distortion, is uniform. This enables a standard circuit to be used on any routine requiring these types of test. The differing testing limits are catered for by the individual test relay sets, connection between test relay set and common test relay set being via secondary leads (SL). The permanent shelf wiring for these leads from the common test relay sets is terminated on connection strips with a multiple appearance on each test relay set shelf, thus enabling the jumpering of any test relay set to any common test relay set.

Because common test relay sets form part of the testing circuit, the self-checking feature is included in the form of check test conditions applied at the commencement of each routine cycle, check being made that the circuits function correctly and are within prescribed calibration limits. The check test is controlled from the routine control circuit, although the limiting test conditions applied are incorporated in the common test relay set circuit.

#### Potential Difference Detector.

This is used to fulfil the prime testing need for a voltage sensitive device and its use may be regarded in the same way as that of a voltmeter; but, because in an automatic test a "reading" requires interpretation, the device responds to voltage sense and measurement is done by verifying the correct polarity between lower and upper limits. In application, the P.D. Detector takes the place of the galvanometer in a Wheatstone bridge network and responds to the changes of voltage sense at points either side of balance; the points selected correspond with the lower and upper tolerance limits of the item. Thus an item outside tolerance will not provide the correct change of potential sense.

To avoid influencing the bridge voltages it is desirable that no current be drawn by the "galvanometer" path and the circuit uses a small capacitor to collect the voltage difference. The capacitor voltage is then transferred to a three-valve direct-coupled amplifier, operating a relay in the output stage if the input is 100 mV or more, positive. The relay biases the amplifier to remain locked in the operated condition, and is restored by a further input signal, but this time requiring 100 mV or more, negative.

The essentials of the circuit are given in Fig. 2, the test

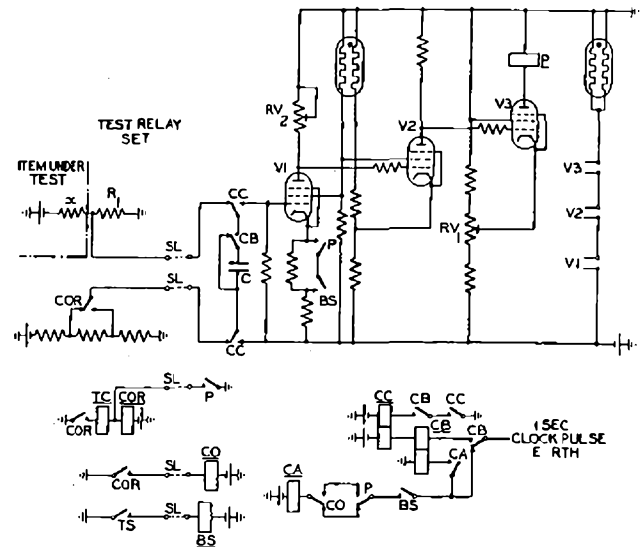

FIG. 2.—COMMON TEST RELAY SET—P.D. DETECTOR.

commencing with the operation of relay BS from a test relay set. It will be seen that the "collecting" capacitor, C, is controlled by time pulses in three stages in which the capacitor is:—

1. maintained in a discharged state for one second. (CB normal)
2. applied to the bridge network for one second (CB operated, CC normal)
3. transferred to the input of V1 (CC and CB operated).

The capacitor is allowed to discharge via the grid leak resistor but the instantaneous grid signal on V1, which will be positive under correct tolerance conditions, is amplified and appears at V3 where the resulting rise in anode current operates the anode relay P. A contact of relay P reduces the bias on V1 cathode, the resulting change of its anode volts maintaining V3 "on" by virtue of the direct coupling between the stages.

The successful operation of relay P is signalled to the test relay set which establishes the other reference voltage by the operation of COR; on the other hand, failure of relay P to operate would prevent the test relay set sequence proceeding. The operation of relay CO reconnects the pulse counting relays and a repetition of the three capacitor switching stages is made, a negative input voltage being required to overcome the locking bias and release the anode relay; this removes the earth signal from the test relay set. A second positive signal would only serve to maintain the relay operated and prevent the sequence proceeding.

The time pulse method of controlling the connection of the capacitor in three switching stages, ensures a minimum discharge time of one second. This overcomes residual voltage due to any dielectric absorption tendency. The further one second provides ample charging time should the charging time-constant be relatively long. The amplifier requires the normal safeguards from drift which is inherent in this type of circuit and the use of barretters provides



stable screen voltages and heater current against battery voltage variations. Separate battery supply leads are provided to prevent surges from relays affecting the amplifier.

The checking arrangements (not included in Fig. 2) operate the circuit in normal sequence, a checking potential of + and - 100 mV being applied to the input capacitor. In this way correct operation to the required sensitivity is checked. The checking potential is also used as the reference for the initial calibration of the circuit, which is effected by the adjustment of  $RV_1$  and  $RV_2$ .

### Timing.

Tests for timing measurement cover a wide range of times, from the relatively short times of relay lags to the relatively long times used, for example, for 2 V.F. signals. It is desirable, therefore, that the timing device caters for this wide range so that the basic calibration and check are covered by one operation, this need being emphasised by the limited availability of an accurate timing reference source. From the nature of the times to be measured, an accuracy of  $\pm 5$  per cent. is adequate for the device used and this has been obtained using normal components. The one-second clock pulse is used as the reference source for the purpose of calibration.

The timing principle uses the well-known "capacitor charge time-constant," in which the voltage attained by a known capacitance being charged in series with a known resistance is a measure of the charging time. The measurement of the capacitor voltage, without causing its discharge, makes use of a "cathode-follower" valve, and the P.D. Detector is used to verify that this cathode voltage lies between acceptable limits.

Fig. 3 shows the circuit essentials. Resistor R in the test

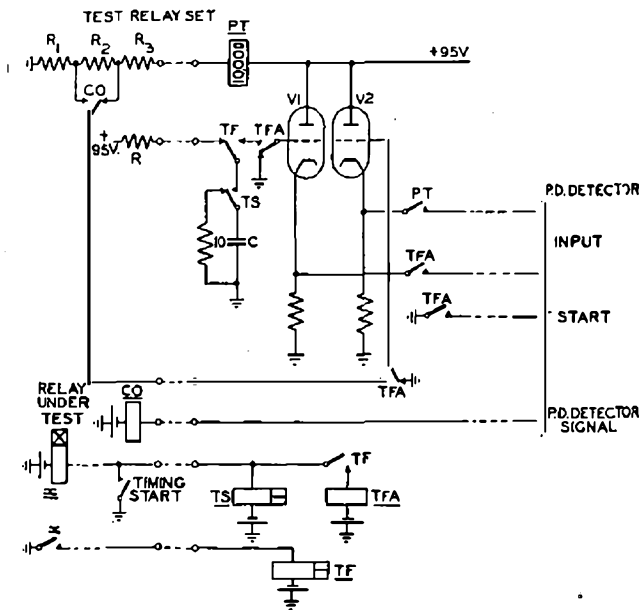

FIG. 3.—COMMON TEST RELAY SET—TIMING.

relay set forms the charging resistor for capacitor C. The value of R chosen is such that the longest time to be measured equals CR (the time-constant); this choice determines the rate of charge and hence the timing scale being used. Relay TS operates simultaneously with commencement of the event to be timed—in the example shown the operate lag of a relay—and connects capacitor C to the positive H.T. supply via R. The end of the event operates relay TF, disconnecting the charging circuit and preparing for application of the capacitor potential to the grid of V1.

Relay TFA establishes connections to the P.D. Detector and applies a reference voltage to the grid of V2. The cathodes of V1 and V2 "follow" the voltages applied to their grids and it is the cathode voltages which are applied to the P.D. Detector, the latter checking that the potential of V1 cathode lies between the values determined by resistors  $R_1$ ,  $R_2$  and  $R_3$  as measured at V2 cathode. This check is made in two stages, the detector operation resulting in the operation of relay CO which changes the potential applied to the grid of V2. Relay PT checks the continuity of resistor  $R_2$  in the test relay set to guard against a faulty relay set component.

The circuit arrangements for calibration have not been shown in the diagram in order that the normal use be made clear. Provision is made for the two valves to be balanced with a fixed potential applied to both grids. Calibration for time is then made on a two-second scale, that is the R value is made 200 k ohms and two clock pulses are used to derive the timing start and finish signals. A two-second interval is necessary to avoid error which arises from differences in the mechanical settings of the two sets of one-second springs relative to the pendulum of the master clock. Using a close tolerance resistor for the R value, the capacitance of C is adjusted by trimming in steps of 0.05 microfarad until the measured voltage across the capacitor is as close as possible to the calculated value, based on 10 microfarad which is used for the reference voltage.

The P.D. Detector is used for calibration and the potential difference required by the detector (approx. 100 mV), together with any differences in the times of the switching relays TS and TF, are included in the calibration, this contributing to the accuracy obtained. With the components comprising the circuit calibrated in this way, the timing range can then be varied by selecting a suitable R value, the overall accuracy being maintained on all ranges from 50 mS to 10 seconds. The check test applies the two-second clock signals to prove that the circuit remains within calibration limits.

It has previously been mentioned that the very high input resistance of the cathode-follower valve does not discharge the capacitor. The valve, however, introduces a slight loss in the stage and it is for this reason that the reference voltages are applied via a second cathode follower, V2, so that both outputs are modified proportionately.

### Tone Detector.

For measurement of the received level of signalling tones, or the insertion loss of transmission bridges, use is made of a tone-detecting device having a known sensitivity, to prove that a tone is received at levels either side of the operating point of the device. The levels are predetermined by suitable attenuator pads, the values of which depend upon the tolerance limits of the test being made.

Consideration of the testing requirements led to the conclusion that a detector sensitive to -40 db. would permit its use for such additional requirements as the testing of band-pass filter networks. A sharp discrimination is required at the critical level to provide reliable relay operation. The frequency response is not important because insertion loss tests will be made at a fixed frequency at which the detector circuit is calibrated. The measurement of levels of exchange tones using normal transmission testing methods is, strictly speaking, inadmissible, because the tone wave forms are not sinusoidal. In practice, however, the falling amplifier response with lower frequencies tends to compensate for the higher peak voltage of the tone generator outputs and a reasonable approximation of level with respect to 1 mW in 600 ohms is obtained.

The application of the tone detector for the test of a speaking bridge is shown in Fig. 4. The test is made in two

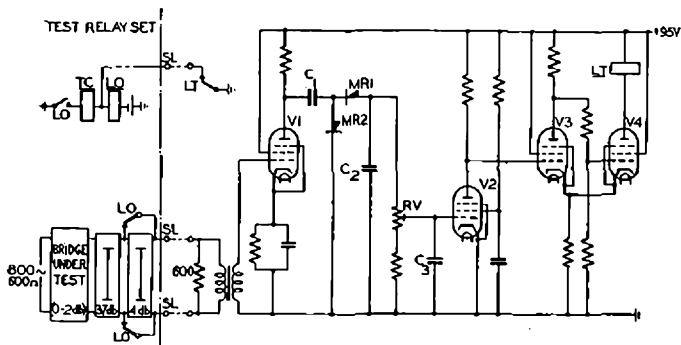

FIG. 4.—COMMON TEST RELAY SET—TONE DETECTOR.

sequences of operation, the first testing the maximum tolerance limit and the second the minimum tolerance limit. With the heater and H.T. supplies connected, relay LT is operated and this is the normal circuit condition. Tone at zero level is applied via the bridge under test and in series with a suitable attenuator pad such that the total maximum loss is made  $-39$  db. to the input of V1 via the transformer. The first valve is a normal amplifier stage and its output is rectified and applied to the grid of V2 as a negative polarity. Valve V2 applies an amplified positive signal to V3 which is one of a "flip-flop" pair, normally stable with V3 non-conducting. The positive signal to V3 causes V3 and V4 to change over, a triggering effect being gained by the common coupling in the cathode load resistor of these valves. This results in the release of relay LT which applies an earth signal to the test relay set, where the operation of relay LO introduces a further pad, say 4 db., thereby increasing the loss to  $-41$  db., minimum. At this input level the amplified and rectified tone is insufficient to maintain the positive bias to V3 and the fall of this voltage allows a reverse triggering action to occur between V3 and V4, re-operating relay LT which provides the "test complete" signal in the test relay set by the operation of relay TC.

With the tone detector calibrated to respond between  $-39$  db. and  $-41$  db., i.e., nominally  $-40$  db., the transmission loss of the bridge under test must lie between 0 and 2 db.

The check test conditions arrange for the application of tone direct from the oscillator via pads of 39 db. and  $39 + 2$  db., to check that the correct response is maintained.

#### Oscillator.

For transmission tests as described above, a tone source at reference level is required on the routiner. Various oscillators have been designed for transmission test purposes, but the nature of their power supplies or their physical arrangements render them unsuitable for application to the routiner, for which low voltage supplies and a single output of 1 mW are required. By developing an oscillator for these conditions a more suitable unit has been provided and can be accommodated on a jack-in relay set.

The circuit uses a single-valve phase-shift oscillator with a cathode-follower output stage. The oscillator frequency is 800 c/s instead of the standard 1,600 c/s because this permits tests of the insertion loss of low pass filters in addition to the normal speaking bridge tests. The accuracy of this frequency is not critical and special selection of components is unnecessary.

In the circuit of Fig. 5 the oscillator valve V1 is maintained in oscillation by feed-back from anode to grid, the feed-back path including the phase-shift network  $R_1C_1$ ,  $R_2C_2$  and  $R_3C_3$ , the values being such that at 800 c/s the returned grid signals are in phase, i.e.,  $360^\circ$  from grid back to the grid. The output from V1 is also applied to valve V2 which provides a buffer stage on the oscillator and prevents

the application of load affecting the oscillator valve. The output impedance of V2 is made 600 ohms. Individual check conditions are not provided in this circuit because it is used in conjunction with the check test of the tone detector and failure of this latter test will draw attention to the need for re-calibration.

Test jacks provide for the connection of a db. meter, or preferably, a "milliwatt calibration unit," and resistor RV enables the output to be adjusted to 1 mW in 600 ohms.

#### Impulse Distortion.

The measurement of impulse distortion provides a reliable guide to the adjustment of an impulsing relay and when associated with current and mechanical adjustment checks, becomes a useful aid in detecting obscure faults, for example, due to short-circuited coil turns. This reason alone would justify the inclusion of distortion testing. With the extension of trunk dialling facilities and the development of new impulsing systems, the need for maintaining a high standard of impulsing performance is emphasised; moreover, the so-called "distortionless impulsing" systems can only be within distortion limits to which they can be maintained. For this reason some maintenance aid for distortion measurement becomes essential.

The application of distortion testing by routiners introduces the problem of interpreting whether the actual distortion occurring is within acceptable limits. The inherent limits of the device should be of the smallest magnitude if the "distortionless" condition is to be approached. Several methods of making distortion tests were considered and it was decided that the comparison of capacitor charges representing the sent and received impulses, offered the necessary flexibility for routiner application. In this method the impulse sent to the impulse repeating element is also applied to charge a capacitor having a known time-constant, and the voltage attained becomes the "sent reference." The impulse received from the repeating element is applied to charge two capacitors, one in which the time-constant is related to the lower "time" limit and the other in which the time-constant is related to the upper "time" limit. Check is then made that the voltage across the two capacitors representing the tolerance limits, are positive and negative with respect to the voltage across the reference capacitor.

Referring to the circuit of Fig. 6 the impulsing relay under test is extended to the impulse distortion circuit via a test relay set and relay AA is operated. Start of the test is under control of the test relay set, the operation of relay DS connecting machine generated impulses to relay SI.

Considering the response of relay SI to impulses, the first operation of SI sends a break pulse to the relay under test and prepares the circuit for relay MK. The resulting release of relay AA is ineffective because the capacitors are not connected. The release of relay SI operates relay AA and also operates relay MK, this preparing the capacitor charging circuits. (This first break pulse allows stabilisation of the "back-bridge" of the relay set under test, i.e., by operation of its C relay.) The next operation of relay SI

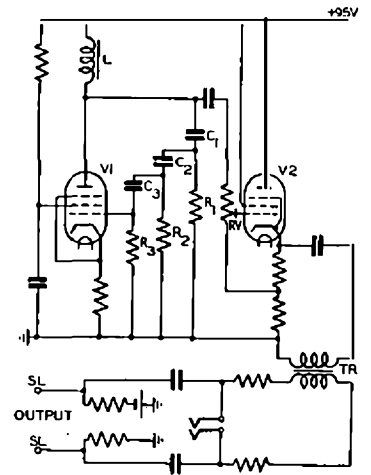

FIG. 5.—COMMON TEST RELAY SET—800 c/s OSCILLATOR.

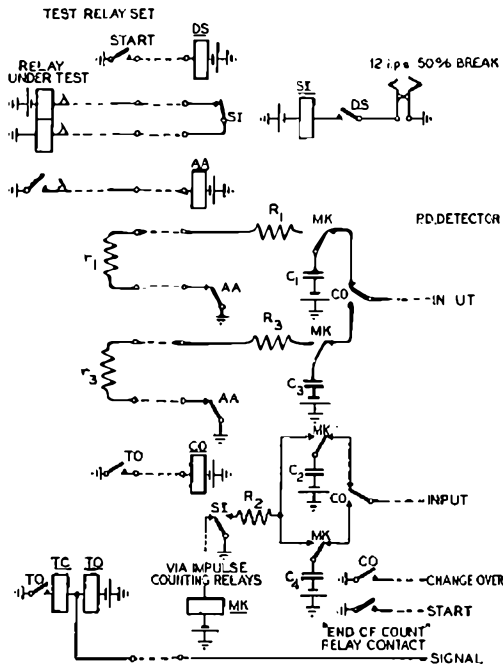

FIG. 6.—COMMON TEST RELAY SET—IMPULSE DISTORTION.

results in the release of relay AA which completes the charging circuits for the capacitors;  $C_2$  and  $C_4$  are charged for the period of the sent pulse and  $C_1$  and  $C_3$  for the period of the repeated pulse. Release of relay SI disconnects the charging circuits and allows relay MK to release, the capacitors then being switched to the P.D. Detector for voltage check.

If the charging time of the two sets of capacitors is the same (the distortionless condition) then the voltages attained by the capacitors will be the same. This is a null condition and does not provide the positive indication necessary for an automatic test. It is for this reason that two capacitors ( $C_1$  and  $C_3$ ) have been used, these being arranged so that the time-constant  $(R_1 + r_1)C_1$  is made equal to the shortest break time admissible, by the choice of a suitable value for resistor  $r_1$ ; similarly, the time-constant  $(R_3 + r_3)C_3$  is made equal to the longest break time. If now the received break pulse time is within permissible limits, then the voltage attained by  $C_1$  will be positive with respect to  $C_2$ , and the voltage attained by  $C_3$  negative with respect to  $C_4$ . This condition is verified by the P.D. Detector in two stages, the control of relay CO being dependent upon a successful test signal from the P.D. Detector.

A slight loss of voltage occurs on  $C_2$  in the transfer of the potential difference between  $C_1$  and  $C_2$  to the detector capacitor and because of this the reference voltage of  $C_2$  is duplicated at  $C_4$  (by being charged in parallel); the check for the negative potential difference is made between  $C_3$  and  $C_4$ .

The circuit is calibrated by arranging for the machine source of impulses to be applied direct to the impulse receiving relay AA, thus simulating the distortionless condition. The values of  $R_1$  and  $R_3$  are then pre-set to provide the minimum voltage differences between  $C_1$  and  $C_2$ , and  $C_3$  and  $C_4$  to operate and release the P.D. Detector. The impulse repeating relays (SI and AA) are included in the calibration so that any timing differences between these relays is neutralised; the relays are of the polarised type to obtain fast and bounce-free response. It will be evident that the care with which this calibration is made determines the accuracy of subsequent testing.

The check test is made by applying machine impulses under the "distortionless" calibration conditions.

### Impulse Ratio.

Routiners used for testing equipment with regenerators check the impulsing output of the regenerator for both speed and ratio, the impulsing speed being measured by timing the sending of a known number of impulses and using the timing common test relay set.

Check of the impulse ratio requires the comparison of the break/make pulse times or, if the total make-and-break time is known, the ratio can be deduced from the separate measurement of break time; this latter method has been adopted for the routiner tests. Three complete impulses are taken for measurement, this covering the three impulsing wings of the regenerator impulsing cam. The principle used for the test is the same as that used for distortion tests, but for ratio tests, capacitor charge related to the break time of three impulses is compared with capacitor charge related to the total time (break plus make) of three impulses.

Using the circuit element of Fig. 7 as the basis for description, the time-constants of the circuits for capacitors  $C_1$  and  $C_3$  are related to the lower and upper break time limits of the impulses under test and the time-constant of the circuit of  $C_2$  is related to the total time. Received impulses are counted by a group of relays, and relay H is operated to connect the capacitors.  $C_1$  and  $C_3$  are charged during the break periods only, and  $C_2$  for the total period of three impulses; relay H is then released to prevent further charging. If the break period charging time is within 63-70 per cent.

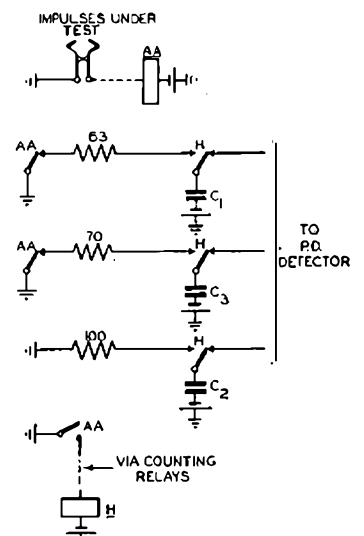

FIG. 7.—COMMON TEST RELAY SET—IMPULSE RATIO.

of the total charging time, then the voltages of capacitors  $C_1$  and  $C_3$  will be respectively positive and negative relative to  $C_2$  and this is checked by the P.D. Detector in a similar manner to that described for distortion tests.

Provision is made for the circuit to be calibrated and checked by using the machine source of 50 per cent. break impulses as a "reference" supply.

### Time Interval Generator.

Tests by the routiner avoid using slow relays for timing when this forms part of the test condition, because such timings are dependent upon relay adjustment and may vary over wide limits. The use of clock pulses is not wholly satisfactory for the longer times because of the expense of relays for pulse counting; for short times the use of clock pulses is impracticable. It was, therefore, necessary to develop a circuit capable of delivering accurately-timed signals and able to operate over a range of times of the order of 50 mS to 10 seconds. Suitable timing ranges may be provided by utilising the principle of the "capacitor time-constant" arranged so that the R value, included in the test relay set, determines the scale in use. Thus the simple variation of the time-constant resistor enables any time delay to be introduced from the same basic generating circuit.

The circuit of Fig. 8 is taken into use from a test relay set which prepares the circuit for charging capacitor C via a resistor R, the values chosen being such that CR (the time-constant) equals the time delay required. Operation of

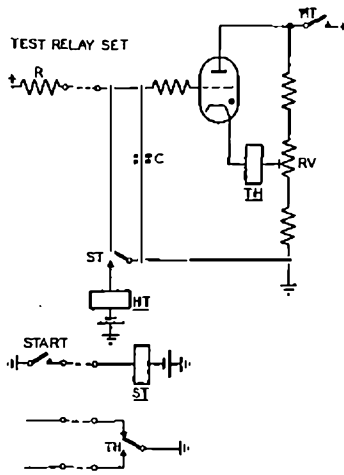

FIG. 8.—COMMON TEST RELAY SET—TIME INTERVAL GENERATOR.

relay set, of the expiry of the delay period. The circuit is restored by the release of relay ST which discharges the capacitor and the release of relay HT de-ionises the thyatron.

Provision is made for calibration and check by using the timing circuit for measuring the "operate lag" on a two-second scale; calibration to effect the correct timing being made by adjusting the cathode bias at RV so that relay TH operates after an interval of 2 seconds. The overall accuracy obtained is within  $\pm 5$  per cent.

#### H.T. Supply.

The common test circuits outlined use electronic devices to give improved testing standards, and stable power supplies for these circuits are essential. Normally the use of valves, and particularly the range of preferred types of valve, involves an H.T. supply at dangerous voltages. Protection conforming with standard requirements is not readily achieved on jack-in equipment, and the use of strip-mounted equipment seriously detracts from the required flexibility of a standard routiner rack. Means were sought, therefore, to confine the need for protection to the connection of mains supply, and by keeping the H.T. voltage below 100 V normal rack wiring methods can be used and jack-in circuits retained. The use of exchange positive battery supply is unsatisfactory because of the wide voltage variations which can occur and the fact that the sensitivity of valves to supply changes is more pronounced at this lower working voltage.

By keeping the load on the H.T. supply relatively light it was possible to provide a "power pack" for converting A.C. mains to a stabilised D.C. of 95 V over a range of output from 0-30 mA. The power pack is mounted in relay set form, this then being the only point requiring protective measures which are effected by interlock between the relay set cover and the supply socket.

The circuit for the stabilised H.T. supply is shown in Fig. 9 and follows well-known practice for electronic circuits. So far as is known, the application has not hitherto been applied to telephone exchange equipment and its advantageous features will be apparent from the following outline of its operation.

The mains supply is full-wave rectified and applied to the load via the series valve V1, and also to the voltage stabiliser V3. The voltage across V3 remains constant and the cathode of V2 is, therefore, held at a constant potential. A proportion of the output voltage via V1 is applied to the grid of V2 and this valve responds to any change of potential relative to its stable cathode voltage, grid voltage changes causing

relay ST removes short-circuiting conditions from the capacitor and charging commences, the operation of relay HT preparing the anode circuit of the thyatron. The voltage rise of the capacitor causes the grid of the thyatron to become positive with respect to earth and at a critical potential, determined by the cathode bias setting on RV, the grid voltage initiates ionisation of the thyatron and anode current flows, operating relay TH. The contacts of relay TH provide the indication via the test

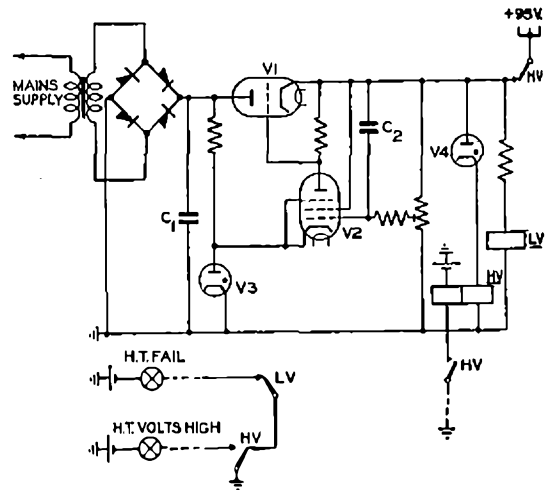

FIG. 9.—COMMON TEST RELAY SET—VOLTAGE-STABILISED H.T. 95 V.

antiphase voltage to be applied to the grid of V1. Thus, with changes of load current, a rise of output voltage is offset by increased resistance of V1 and, conversely, a falling output voltage is offset by a lowered resistance of V1. Capacitor C<sub>2</sub> allows full "ripple" voltage to be applied to V2 grid and provides effective smoothing of the supply without using filters. Changes of mains supply input voltage are similarly controlled by this action of resisting change to the working potentials. Stabilisation of output voltage is maintained within  $\pm 1$  per cent. with loads between 0 and 30 mA and with supply voltage changes of  $\pm 15$  per cent.

Protection against fault conditions causing dangerous voltages to be extended on the output supply wiring, is given by valve V4. This valve is normally non-conducting at voltages below its "striking" point of 140 V, and a rise above this figure allows V4 to conduct, operating relay HV to isolate the rack wiring and to give an alarm indication. Mains failure or loss of output voltage for any other reason, is indicated by the release of relay LV.

#### Common Test Relay Sets for Special Requirements.

The common test circuits described are those with the most general application and are provided as required according to the nature of the tests to be made by the routiner. Other common test relay set shelf positions may be used for tests of exceptional type; for example, Signalling System A.C. No. 1 equipment requires the use of a "common test receiver" for checking the received tone signals, also, a "tone control" relay set for controlling the sending levels and mixing interfering tones when testing the response of A.C. No. 1 receivers. Such common test relay sets have limited application but the flexibility of the standard rack admits these exceptional testing requirements. Common test relay set positions in excess of individual routiner requirements remain unequipped.

The common test relay sets which provide the "impulse sending" requirements are given individual treatment. Consideration was given to the design of a standard impulse sending circuit, but the big variation in testing conditions, particularly for such equipment as directors and discriminators, proved such a scheme was impracticable. A standard circuit introduced considerable complexity with some loss of flexibility as compared with circuit design to individual routiner requirements. Two common test relay set positions have been specially wired so that equipment for impulse sending and also impulse counting (i.e., impulses received after translation or from regenerators) may be designed to the testing requirements of the main equipment. Uniselectors used in the sending and counting equipment are

strip-mounted, and they are wired to a connection strip which forms a connecting point for the remainder of the circuit.

A general view of a shelf of common test relay sets is shown in Fig. 10.

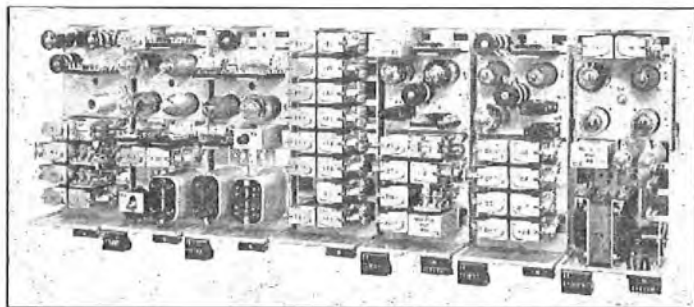

FIG. 10.—SHELF OF COMMON TEST RELAY SETS.

## CONCLUSION

The routiner described in this article is the outcome of prolonged study and has involved complete revision of routine testing methods. The value of the routiner in detecting incipient faults before these can give rise to equipment failures in service, should, in due course, be reflected in the fault returns. A field trial of the new routiner is being made on group selectors at two public exchanges and should yield useful information on many aspects of testing. Arising from the field trial, changes may be found desirable, but it is anticipated that the basic design principles of the routiner circuits will be unchanged.

Finally, the author wishes to say that this development has been made possible by the team work of colleagues in the Telephone Branch and thanks are extended for their help in this work and for assistance in the preparation of these articles.

Acknowledgment is due to Standard Telephones and Cables, Ltd., for their co-operation and for supplying the photograph used in Fig. 10.

## Book Reviews

"Principles of Alternating Currents." W. Sluckin, B.Sc.(Eng.), B.Sc.(Lond.). Volume No. 3 of the Cleaver-Hume Electrical Series. 320 pp. 165 ill. 10s. 6d.

A student's first year on the theory of alternating currents is one of the most important in his training as an electrical engineer. Pressure of work often forces him to remain satisfied with lecture notes as his only source of information and, moreover text-books are now so expensive that he is reluctant to buy, elementary books, knowing that the more advanced works are likely to be of more permanent value to him. There is, therefore, a need for an elementary text-book covering the introduction to A.C. theory which is within the price range of a young student and is, at the same time, sound in its construction and method of presentation of this difficult subject.

Mr. Sluckin has realised this and in his book on the "Principles of Alternating Currents" has gone a long way towards providing the answer to the student's requirements. He is concerned chiefly with the young power engineer commencing A.C. theory, who is equipped with a mathematical background restricted to that of, say, the Ordinary Level of the General Certificate of Education and whose frequency horizon is limited to low-order harmonics of the 50-c/s power supply mains.

The first four chapters are devoted to an introduction to various aspects of sinusoidal waveform notation, to their representation by vectors, to the solution of simple types of A.C. circuits, and to series and parallel resonance. A useful chapter on polyphase working contains an excellent introduction to the principles of alternators and star and delta connection in 3-phase circuits; but the best section of the book is undoubtedly that on transformers, which is a section of the subject that often causes much difficulty both to the teacher and the student. The author has devoted over 50 pages to a comprehensive survey of practical and theoretical aspects of power transformers, starting with elementary concepts and gradually building up the more complicated vector diagrams and equivalent circuits. The remaining chapters are devoted to the basic features of power transmission and distribution, treated in a non-mathematical and readable manner, power factor correction, measuring instruments, elementary electronics, and some modern applications of A.C. such as discharge lamps.

The book is well illustrated and many worked examples are distributed throughout the text. A set of test questions on each chapter in turn is included at the back of the book and answers to numerical questions are given. Students engaged on a course for the National Certificate in Electrical Engineering will find this volume valuable. It also covers many features in the Grades 1, 2 and 3 syllabuses of Telecommunications (Principles) of the City and Guilds of London Institute. C. F. F.

"Elementary Mathematics." Lewis W. Philips, M.I.E.E., F.Inst.P. Macdonald & Co. (Publishers), Ltd. 339 pp. 147 figs. 12s. 6d.

As the term "elementary mathematics" may be variously interpreted according to one's mathematical ability it is as well to indicate immediately what this book actually covers. The first half is devoted primarily to the fundamental processes of arithmetic, fractions, decimals, ratios, percentages, powers and roots and the mensuration of plane and solid figures; the second half covers the elements of algebra, geometry and trigonometry and includes a chapter on logarithms. The standard is such as to suit particularly those whose school mathematics may have been largely forgotten and who now wish to refresh their memories prior to embarking on a course of study for technological and other certificates needing a good grounding in mathematics.

The book is extremely easy to read and the material is laid out in a manner most suitable for students, i.e. each sub-section of a chapter is self-contained, giving first an explanation of the process, then examples worked out in detail, and finally a group of exercises for which solutions are given at the end of the book.

Although intended as a text-book covering the syllabus of the Royal Society of Arts Examination (Grouped Course) in Elementary Mathematics, the book will also be extremely useful to anyone studying Mathematics for Telecommunications (Preliminary) in the City and Guilds of London Institute syllabus. It may also be recommended (perhaps not too seriously) to a wider circle as a suitable gift to a young person of school age, with the object of avoiding unwelcome requests for assistance with homework, and the possibility of being "caught out" on L.C.M.s, H.C.F.s, the manipulation of logarithms and like questions.

At the modest price of 12s. 6d. the book is excellent value and deserves to achieve a wide circulation among the particular class of student for whom it is intended. G. E. S.

# Interference from Cathodic Protection Rectifiers

U.D.C. 621.395.82 : 620.197.5

D. W. R. COBBE, A.M.I.E.E.†

In this article is outlined an investigation carried out in the Middle East to determine what interference to telecommunication circuits would result from applying rectifier-operated cathodic protection to oil pipe lines. The nature of the interference is considered and a brief description given of the test procedure and test observations. The article concludes with an indication of the precautions which may be taken to limit such interference to a satisfactory level.

## Introduction.

WHEN a pipe is buried in the ground, a cell action is set up, due to differences in the composition of the metal and soil (i.e. the electrolyte), causing currents of both a local and a "long-line" character to flow. These currents cause loss of metal (i.e. corrosion) at points where the current leaves the pipe, i.e. at the anodic areas. The principle of cathodic protection is to apply a voltage between pipe and earth to force current on to the pipe at all points, thus making the pipe the cathode of the system.

The Post Office has had a few experimental rectifier-operated cathodic protection installations in service for some years.<sup>1</sup>

The Iraq Petroleum Company is now installing equipment for cathodic protection<sup>2</sup> involving the use of rectifiers spaced at frequent intervals along the length of their pipelines. The effect of such an electrical installation in close proximity to the company's telephone plant was not known with certainty when the scheme was originally proposed; it was feared that interference with audio communications and possibly with D.C. teleprinter circuits would result. As a result of preliminary discussions, it was decided that a satisfactory solution of the interference problem could be obtained only by investigations conducted on site, and it is the purpose of this article to review briefly the problems involved and to describe the tests carried out in the Middle East during March and April, 1950.

## General.

The geographical layout of the pipeline system is shown in Fig. 1. Four lines have been constructed, two of 12-in. dia. and two of 16-in. dia. These follow a common path between K1 (Kirkuk) and K3 (Haditha) where the route bifurcates, one 12-in. and one 16-in. pipe forming the "T" line to the North, and the remaining two pipes forming the "H" line to the South. Spaced approximately 60 miles apart are the oil pumping stations K1-3, H1-5 and T1-4. The company's right of way, except at the station and terminal sites, is approximately 30 yds. wide and all services are, therefore, necessarily in close proximity. The relative positions of the 12-in. and 16-in. pipes in the section K1-K3 are shown in Fig. 2. From K3 to the coast, over the two sections K3-Haifa and K3-Tripoli, the oil pipes are approximately 10 and 20 ft. from the telephone route. Construc-

tion of a further pipe of 30 in. dia. between K1 and Banias is now completed. Its route is shown in Fig. 1, and its relative position between K1 and K2 is shown in Fig. 2. The large size of the new pipe and the attendant difficulties of lifting and repair, taken with the high cost of reconditioning, led to the company's decision to protect the pipe by a scheme of cathodic protection; at the same time, similar

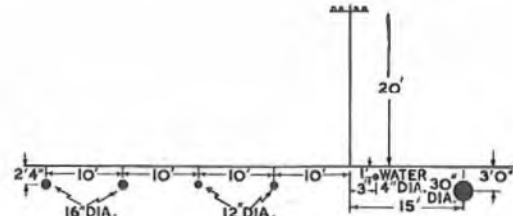

FIG. 2.—RELATIVE POSITIONS OF PIPES.

protection will be given to the original pipe system. A general view of a section of the line is shown in Fig. 3.



FIG. 3.—VIEW OF A SECTION OF THE LINE.

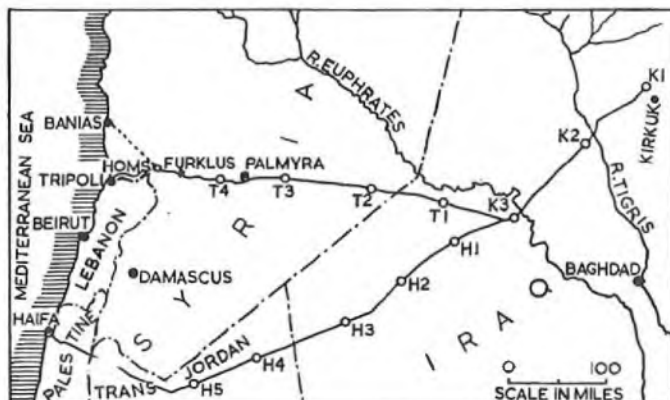

FIG. 1.—GEOGRAPHICAL LAYOUT OF PIPELINES.

The small electric currents, which are the chief cause of corrosion, are reduced by the application, by machine, of an insulating coating to the pipes during installation. The coating in use at present consists of a primer, a  $\frac{1}{16}$ -in. enamel coat into which is wrapped fibre glass, whilst the enamel is still hot, and finally a rubberoid shield. It is, however, impossible to obtain perfect insulation, and

† Executive Engineer, External Plant and Protection Branch, E.-in-C.'s Office.

<sup>1</sup> "Cathodic Protection of Underground Cables." J. Gerrard. *P.O.E.E.J.*, Vol. 44, p.71.

<sup>2</sup> "Cathodic Protection and its application to the Iraq Pipelines." W. C. R. Whalley. *J.I. Petroleum*, Vol. 35, No. 310.

corrosion still occurs on wrapped pipes. For instance, between 6 and 13 years after installation more than 7,000 leaks had been reported in the two 12-in. lines.<sup>2</sup>

The amount of current required to afford cathodic protection to pipes is considerably less for wrapped than for bare pipes.

#### The Cathodic Protection Scheme.

Rectifiers are being installed at approximately 6-mile intervals along the line, with the positive and negative terminals connected respectively to a sacrificial earth electrode system, consisting of large quantities of scrap iron buried in the ground, and to the pipes. The rectifier units are of the transductor type (Fig. 4) giving a constant

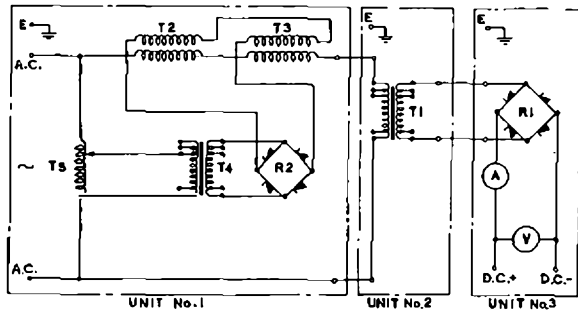

FIG. 4.—TRANSDUCTOR CIRCUIT (EXPERIMENTAL MODEL).

current, thereby avoiding large current variations during variations in soil conditions, e.g., after rain. Power for the rectifiers will be derived from the station 400V A.C. supplies, stepped up to 11 kV (single phase) and transmitted by aerial cable (aluminium cores and sheath), which will be suspended from the telephone poles. There will be a break in the power line between stations, i.e. between rectifiers fed from opposite directions. Incorporated in each rectifier unit is a step-down transformer which will deliver 230V A.C. to the rectifier. The maximum D.C. output is 40 amps. at 50V.

The criterion adopted to measure the efficacy of the scheme from the point of view of protection is a voltage measurement between the pipe and an adjacent copper sulphate half-cell\* placed on the ground. The copper sulphate provides a reliable non-polarising standard against which to measure the pipe potential. The potential so measured is loosely referred to as the "pipe-to-soil" potential, and a minimum value of 0.85V is considered adequate for protection. The maximum value at the point of application which it is considered desirable to use is 3V, although normally the voltage is not greatly in excess of 2V.

Additional rectifiers (about 4 per station) are to be installed for the protection of all station piping, tank bases and other buried structures.

#### The Telephone System.

The landline network for the North line, as it exists at present, consists essentially of two main physical circuits, Trunk No. 1 and Trunk No. 2. Trunk 1 is used for long-distance carrier circuits and inter-station audio circuits. Trunk 2 is used for inter-station audio circuits. The phantom of Trunk 1 carries an omnibus teleprinter circuit Tripoli-K3-K1, and the phantom of Trunk 2 carries omnibus morse circuits. An H.F. teleprinter system, occupying the frequency range between 4 kc/s and 7 kc/s, is also in operation over Trunk 2 between Tripoli and all Line stations. The 3-channel carrier telephone circuits are to be replaced by a 12-channel carrier telephone system,

\* A copper electrode immersed in a saturated solution of copper sulphate, the container having a porous base.

and the phantom telegraph circuit on Trunk 2 is to be converted to teleprinter operation.

#### Nature of Interference.

It is not anticipated that the currents in the power line will cause any serious interference in view of the small values involved, and the fact that the cable pair is to be twisted.

The oscillograms (Fig. 5) show the wave shape of direct

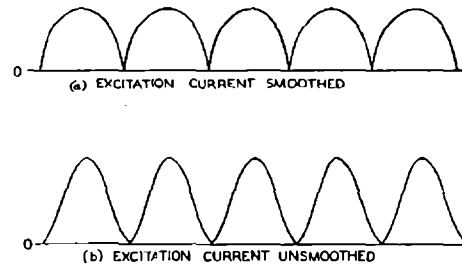

FIG. 5.—WAVE SHAPE OF D.C. AT FULL LOAD. (MEAN CURRENT 40 AMPS.)

current at full load for the two cases, where the excitation current is smoothed and unsmoothed. For the unsmoothed excitation current, the waveform departs somewhat from the sinusoidal form with alternate half-cycles inverted. This departure is due to the reaction of current from the subsidiary rectifier in the excitation circuit and results in an increased 100 c/s component in the output wave, together with a reduction in the amplitude of higher frequencies.

Thus, at full output using the unsmoothed excitation circuit as adopted, the pipes may carry an alternating component of 26 amps. at 100 c/s, plus higher harmonics.

The rectifiers protecting the pipeline may be divided into two main categories:—

- (1) those situated between the pumping stations, and
- (2) those sited at the stations.

The first give rise to a nearly-balanced system relative to the telephone wires (Fig. 6), since current is fed approximately equally in each direction from the point of application. Since the separation of the telephone route from the pipes is constant, two nearly equal and opposite induced voltages result. Thus, the overall effect from each rectifier is small.

The second group feed current to the pipes on one side of the station, and, for a telephone line terminating at a station, there is no balancing effect. As may be seen from the diagram, these induced voltages are of a longitudinal nature, and are, therefore, in series with the telegraph signalling batteries. Each telegraph circuit has, therefore, two main induced voltages—one from each of the station rectifiers which are fed from independent power systems—and several smaller induced voltages from intermediate rectifiers. If the amplitude of the overall induced voltage at the fundamental ripple frequency (i.e. 100 c/s) is sufficiently great, distortion of telegraph signals will occur.

Carrier frequency telephone circuits will not suffer interference since the harmonic content at frequencies above 1,000 c/s is negligible.

The audio telephone circuits may be affected by the transverse voltage which is mainly caused by small equipment or line unbalances.

#### Test Equipment.

A brief description of the test equipment used for noise measurement may be of interest at this stage.

The psophometer used is primarily a high-gain valve-voltmeter designed to record the square root of the sum of

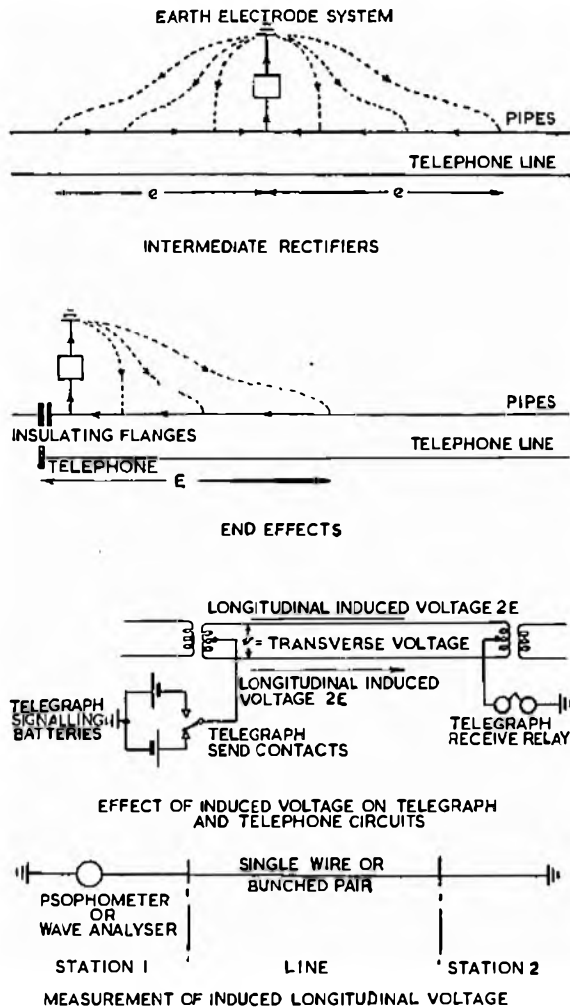

FIG. 6.—Distribution of Rectifier Current Along Pipe ; Induced Voltages in Telephone Lines and Circuit Arrangement for Measuring the Induced Voltage.

the squares of the applied voltages. It may be preceded by a weighting network which attenuates or increases the effect of each frequency in accordance with its interfering effect on telephone speech. The weighting network used was that specified in the *C.C.I.F. Directives* (Rome edition 1937, revised at Oslo 1938).

The ratio of the interfering effect of a particular frequency to that of 800 c/s is known as the weighting factor and designated  $p$ .

If a complex wave containing frequencies  $f_1, f_2$ , etc., of magnitudes  $e_1, e_2$ , respectively, is applied to the psophometer and the corresponding weighting factors are  $p_1, p_2$ , etc., the instrument reads as follows:—

- (a) Flat (i.e. without weighting network),  
 $[e_1^2 + e_2^2 + \dots \dots \dots]^{\frac{1}{2}}$
- (b) Weighted (i.e. including weighting network),  
 $[(p_1 e_1)^2 + (p_2 e_2)^2 + \dots \dots \dots]^{\frac{1}{2}}$

The psophometer in the "flat" condition, therefore, reads mainly the value of the fundamental frequency since this is usually large compared with the harmonics, and in the "weighted" condition shows the voltage at a frequency of 800 c/s, which would cause the same disturbance to speech as the mixture of frequencies under consideration.

When measuring longitudinal voltages, the "flat" reading is of importance since it is a measure of the voltage liable to disturb telegraph working, and, when measuring

transverse voltage, the "weighted" reading is of importance since it is a measure of the noise liable to affect speech.

A wave analyser was used to determine the amplitude of the constituent frequencies of a complex voltage.

A search coil of known dimensions and turns was used in conjunction with the above instruments to measure the alternating component of the current flowing in the pipes at a particular point. If the coil is placed a known distance from the pipe with the plane of the coil containing the axis of the pipe, the induced voltage in the coil per unit of current in the pipe may be calculated, and hence, the pipe current may be measured. An allowance may be made for the interfering effect of current in adjacent pipes.

#### Nature of Tests.

With the small amount of information available it was not considered possible to predict the current distribution in the pipes. The initial experiments were, therefore, conducted with the aim of measuring the current attenuation and thus obtaining a picture of the "spread of current" over the appropriate range of frequencies. Simultaneously, measurements were made of pipe-to-soil potential and of induced longitudinal voltage in the telephone wires.

T4 was selected as the site for these initial tests, mainly because a third telephone pair, which could be used for tests, existed between T4 and Furklus.

Further, the effect of earthing the power cable sheath was not known with certainty. It seemed possible that it might either act as a screen if well earthed or carry some of the D.C. (and ripple) close to the telephone wires and possibly augment the interference. A 0.1 sq. in. copper wire was, therefore, erected over a distance of 2 miles in a position similar to that to be taken by the cable. Apart from tests on the screening effect of this wire, it was used to induce a large longitudinal voltage into the telephone wires and thereby determine the value of induced voltage liable to cause interference to the teleprinter circuit.

Various further sites along the line were selected for tests of longitudinal and transverse voltage.

Consideration was also given to the effect of the rectifiers to be installed in the stations for the protection of station plant, but no extensive tests on this problem were made.

Earth resistivity measurements were also made at selected sites.

#### Test Observations.

Measurements of direct current flowing in the pipes were made by means of a voltmeter recording the potential drop across a 100-ft. length of pipe. Alternating current measurements were made using a search coil in conjunction with a wave analyser. The results are shown graphically in Fig. 7, and a graph showing potential drop across the pipe coating due to the current flow is also included. This forms part of the voltage measured by the "pipe-to-soil" meter. The remainder of the voltage recorded by the meter is that existing prior to the application of the current, and is due to the iron-copper cell formed by the steel pipes and the copper sulphate half-cell. The attenuation of current in the pipes increased with frequency from 1.43 db. per ml. for D.C. to 5.6 db. ml. at 100 c/s and 14.4 db. per ml. at 1,000 c/s.

It was noticed in the above tests that the majority of the applied current tended to flow back into the station rather than out to line, and the same effect was recorded at all other sites, despite the fact that, at some stations, insulating flanges had been fitted in the pipes to reduce the flow of "long-line" currents. The final arrangement, however, will provide for rectifiers inside the stations to maintain a similar pipe potential relative to earth as will exist on the pipes, and it must, therefore, be assumed that the total



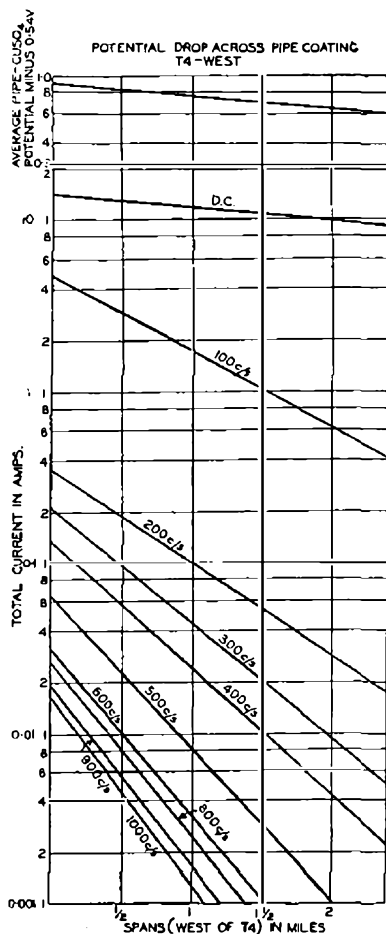

FIG. 7.—CURRENTS MEASURED DURING TESTS AND (at the top) P.D. ACROSS THE PIPE COATING.

rectifier output will flow to line. The designed rectifier spacing is based on this assumption.

It was necessary, therefore, to measure the total pipe current flowing to line and the induced voltage in the telephone line and then to apply a correction based on the above assumption. Thus, it is estimated that an average induced voltage at 100 c/s of approximately 8V will be induced from each "end effect" and, consequently, any telegraph line is liable to a total induced voltage of 16V for appreciable periods, i.e. when the two "end effect" voltages are in phase.

By applying the rectifier output to the screen wire described above, in order to induce a large voltage into the telegraph line, it was ascertained that the maximum voltage at 100 c/s that could be tolerated without distortion of characters was 6V.

The screening action of the wire used to simulate the cable sheath was, however, found to be negligible unless very low resistance earth connections could be made to it, and has, therefore, been ignored in estimating the values of induced voltage.

The next problem considered was the induced voltage from the intermediate rectifiers which induce only a small voltage by virtue of the balancing effect of the current flowing in two directions. For this purpose, mobile generating sets with rectifiers were available. The longitudinal induced voltage was found to be extremely small, being of the order of 40 mV at 100 c/s for each rectifier. It was therefore necessary, during tests of induced voltage from intermediate rectifiers, to reduce the speed of the motor generator set, and thereby change the frequency, in order to differentiate between the existing power supply second harmonic of 100 c/s found in the lines, and the induced 100 c/s voltage from the rectifiers. The rectifier fundamental ripple frequency was, therefore, reduced to between 80 and 90 c/s and the wave analyser used to identify it.

In the simple case of a pipe having a certain leakance to earth in one direction, and a different leakance in the opposite direction from the point of application of current, then a larger current will be taken in the direction having the larger leakance. It may be shown theoretically that the attenuation of current in this direction is, however, increased and so far as the two induced voltages are concerned, the two effects exactly counterbalance so that equal and opposite voltages are induced. The practical

system is, of course, more complex than this, since the leakance, which is dependent on the state of the pipe coating, will vary along the whole length of the pipe. It is, however, an indication of the reasons for the very low value of induced voltage recorded under these conditions.

The fact, previously referred to, that most of the current from the rectifiers when applied to the pipes at the stations flowed back into the stations rather than out to line resulted in a low value of transverse noise voltage in the telephone circuits, and consequent measurement difficulties, since the noise was in most instances of a comparable level to that existing on the lines. However, in certain locations, reliable readings were obtained by taking numerous precautions to reduce the existing level. It was found that the noise level due to the rectifiers should not normally interfere with speech seriously, but minor fault conditions, such as low insulation resistance, which can at present be tolerated in the absence of an interfering magnetic field, would cause serious interference.

It was not possible to make an exhaustive study of the possible effects of rectifiers sited within the stations for the protection of station plant, but it would appear to be undesirable to leave such large fluctuating currents in close proximity to telephone plant. For example, it may be necessary to connect the sheaths of telephone cables to the protection scheme. The effects of such proximities could, however, probably be nullified by careful installation.

#### Conclusions.

As a result of the above tests which have shown that serious interference to telegraph and telephone circuits may be caused by the rectifiers installed at the pumping stations for the protection of the line pipes, the Iraq Petroleum Company have agreed to use smoothing equipment on all station rectifiers feeding the line pipes. Should it be found necessary, it will be possible to add suitable smoothing units to rectifiers installed within stations for protection of station plant. No modifications have been recommended for the intermediate rectifiers, since the total induced longitudinal voltage from all the intermediate rectifiers on the longest circuit, if added arithmetically, would not cause trouble and, in fact, phase variations, cancellations, etc., reduce the effect considerably.

It has been found that reasonable agreement can be obtained between the measured attenuation values at different frequencies and calculated values which are based on a measured value of leakance. The latter may be simply obtained by measurements of direct current from which the leakance may be deduced. The problem then becomes fundamentally one of transmission in which the series components are the earth return resistance and inductance together with the pipe resistance and inductance, and the leakance term is mainly due to the pipe coating leakance, but includes a term involving earth resistivity which becomes significant in areas of high resistivity. It has been shown theoretically that the addition of the 30-in. pipe to the route will not materially affect the values of induced voltage recorded during the tests. Thus, it appears that if any similar case were to occur consideration of the problem from a theoretical aspect may prove feasible, although rectifiers having a smoothed output would not give rise to any problem.

#### Acknowledgments.

It is desired to thank the Iraq Petroleum Company for permission to publish this article. Thanks are specially due to members of the Corrosion and Telecommunications Departments, in particular Messrs. Sparrow and Odell, for their willing and able assistance in the conduct of these tests.

# Reflectionless Joints for Coaxial Pairs

R. J. TURNER, B.Sc. (Eng.), A.M.I.E.E.†

U.D.C. 621.315.212: 621.315.68: 621.392.43

Reflectionless joints are required to ensure that no echo is produced when a television signal is transmitted over a long line. In this article a simple design theory for such joints is outlined and its application to a joint for 0.375-in. coaxial pairs is given.

## INTRODUCTION

WHEN television signals are relayed over long distances by coaxial cable, as for example, from Alexandra Palace to Sutton Coldfield, visible echoes may reduce the quality of the picture received unless great care is taken to avoid electrical reflections in the transmission system. Fig. 1 shows the effect that could occur,

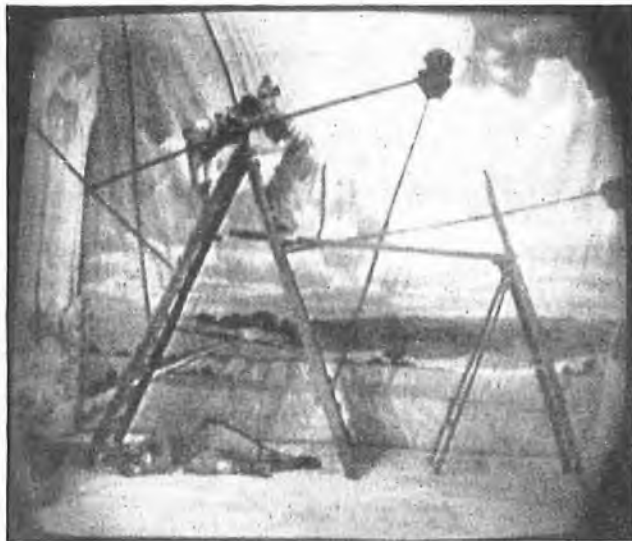

FIG. 1.—EFFECT ON TELEVISION PICTURE OF ECHO DUE TO TRANSMISSION OVER LONG ROUTE WITH MISMATCHED JOINTS.

for example, as a result of reflections at joints between successive drum lengths of coaxial cable if special precautions were not taken in the design of the cable joints.

If coaxial cable, or indeed, any type of transmission line, is to deliver into its terminating load all the energy which arrives at the receiving end, the terminating load impedance must equal the characteristic impedance of the line. If the terminating impedance differs from this value, the line is said to be mismatched with the result that a fraction of the energy arriving at the mismatch is reflected back along the line towards the generator. A similar effect is produced by a sudden change of characteristic impedance within the line itself. This is illustrated in Fig. 2a where the sudden change of impedance at A from  $Z_0$  to  $Z_1$  causes some energy to be reflected back to the sending end as shown by the dotted line. A joint is equivalent to a short length of transmission line of impedance  $Z_j$  inserted in a line of impedance  $Z_0$ , as shown in Fig. 2b. If  $Z_j$  is not equal to  $Z_0$  the joint is said to be mismatched; the input impedance of the joint then differs from the characteristic impedance of the line and thus reflection occurs.

Now take the case where the line contains two mismatched joints but is otherwise uniform as shown in Fig. 2c; the energy reflected backwards at B is attenuated by the part BA of the line and is partially reflected again at A to form a signal travelling in the same direction as the main signal. This reflected signal, after being attenuated again in the part AB, continues to the receiving end of the line. Such a

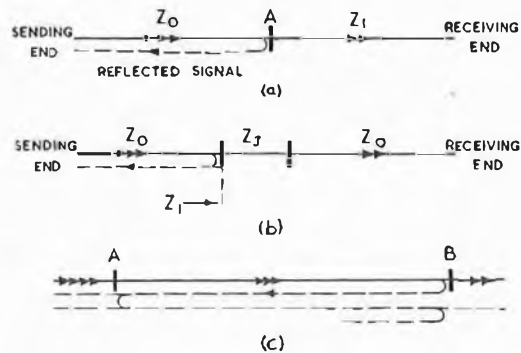

FIG. 2.—(a) REFLECTION AT CHANGE OF CHARACTERISTIC IMPEDANCE OF LINE, AND (b) AT A MISMATCHED JOINT. (c) DOUBLE REFLECTION BETWEEN TWO MISMATCHED JOINTS.

double reflection component arrives later than the parent wave by the time taken for the reflected wave to travel twice the distance AB. If a series of joints A, B, C, . . . are mismatched, a double reflection is formed over each drum-length of cable AB, BC, CD, etc. Since joints are normally spaced at equal intervals, each double reflection is delayed behind the main signal by the same time and thus at the end of a long route an appreciable echo signal may be built up.

From the above it will be seen that it is necessary to make all cable joints match the cable as closely as possible. A joint which is perfect from an electrical point of view could be made by keeping the dimensions of the inner and outer conductors the same as those of the cable to be joined, and by making the dielectric in the joint the same as in the cable. From mechanical considerations, however, it is more convenient to make the diameters of the conductors in the joint larger than those of the corresponding members of the coaxial pairs. Another requirement in air-spaced coaxial pairs is that a water-tight barrier, such as a solid disk of insulating material, should be inserted at joints so that in the event of a puncture occurring in a cable, any water penetrating is confined to a single drum-length. This barrier increases the mechanical complexity somewhat; nevertheless, the dimensions of the various parts of the joint could be so proportioned that each part of the joint has a characteristic impedance equal to that of the coaxial cable itself. A simpler, semi-empirical approach to the design of a suitable joint has been found more convenient however. The general form of the mechanical design is first decided upon from experience and a joint is then made to this design; it is tested in the laboratory and modifications are introduced until negligible reflections occur when it is inserted in a length of coaxial pair.

## TELEVISION TRANSMISSION OVER A LONG ROUTE

### Definitions.

In order to discuss the values of reflections at impedance irregularities it is necessary to give some definitions. The vector ratio of the voltage wave reflected from an irregularity to the incident voltage wave is known as the reflection coefficient,  $\rho$ , of the irregularity. Referring to Fig. 2a the

† Executive Engineer, Radio Experimental & Development Branch, E.-in-C.'s Office.

reflection coefficient  $\rho$  is given by

$$\rho = \frac{Z_0 - Z_1}{Z_0 + Z_1} \dots\dots\dots(1)$$

If  $r$  is the modulus of the reflection coefficient, then  $r^2$  is the ratio of the energy reflected to the incident energy. The logarithm of the reciprocal of this ratio is defined as the return loss,  $A$ , of the irregularity, so that

$$A = 20 \log_{10} 1/r \text{ db.} \dots\dots\dots(2)$$

It is convenient to use the return loss as a measure of the "goodness" of a joint. The bigger the value of return loss the better the joint.

The input impedance  $Z_1$  of a joint (see Fig. 2b) is given by the ordinary transmission line equation

$$Z_1 = Z_0 \frac{Z_0 + Z_l \tanh Pl}{Z_l + Z_0 \tanh Pl} \dots\dots\dots(3)$$

where  $P$  = the propagation coefficient of the joint.  
 $l$  = length of the joint.

The return loss of the joint is obtained by substituting this value of impedance in equation (1) and then calculating  $A$  from equation (2).

*Causes of mismatch at a joint.*

The cable for a long route is manufactured in short lengths, usually about one tenth of a mile long. Reflection can occur at joints between these drum lengths of cable from one or both of the following causes:—

- (a) *Impedance mismatch between the adjacent lengths of coaxial pair.* If the characteristic impedance is not the same in the two lengths of pair at the ends that are jointed, there will be reflection at the joint; this reflection would still occur even if it were possible to join the two lengths of pair together without interposing any special jointing parts.
- (b) *Mismatch between the joint and the coaxial pairs.* The joint is usually of appreciable length and includes various jointing parts, and reflection will occur if it is not electrically equivalent to a length of the coaxial pair. In this event, reflection would still occur even if the joint were inserted in a uniform coaxial pair.

Mismatch of the kind (a) does not vary with frequency and is limited in the first instance by the specification limits on the cable characteristic impedance. This type of mismatch is made as small as possible in practice by laying lengths of cable along a route in the order in which they are manufactured. The effect of any gradual change of cable characteristic impedance due to wear in the cable-making machinery is thus minimised.

The present article is concerned with the general principles involved in the design of joints to give minimum mismatch of the kind (b), and with the magnitude of the mismatches of this kind that can occur at individual joints. It will be seen below that the mismatch due to this cause increases with increase of frequency; it thus follows that the higher the maximum frequency to be transmitted the better the joint is required to be. In general, a joint should be designed to give minimum reflection, i.e. maximum return loss, with cable of mean specification impedance; if the actual cable impedance at parts of the route differs from the mean specification impedance (still being within the specification limits however) mismatch of kind (b) will occur even with perfect joints. Provided, however, the cable impedance varies in a random manner about the mean specification impedance, any double reflections resulting from these mismatches will arrive at the far end with random magnitude and polarity.

As a result of these considerations it is clear that a minimum permissible value of return loss must be laid down for joints in coaxial pairs in main trunk cables if satisfactory transmission of television signals is to be obtained. This

minimum value of return loss has been taken as 70 db., and, in the following sections of this article, the design of a new type of joint is described which has this high value of return loss up to frequencies of the order of 10 Mc/s.

ELECTRICAL ANALYSIS OF JOINT

*Approximate Analysis for use at Low Frequencies.*

*Design Criteria.*—A joint may be regarded as a number of very short sections of coaxial transmission line in tandem, each section being uniform but having characteristics differing from those of the other sections. Let any one of these sections, say the  $n^{\text{th}}$ , have a length  $d_n$ , an inductance  $L_n$  per unit length and a capacitance  $C_n$  per unit length. Provided that this section has negligible dissipation and is sufficiently short electrically compared to a quarter wavelength, it is equivalent to a network having a total lumped series inductance equal to  $L_n d_n$  and a total lumped shunt capacitance equal to  $C_n d_n$ . Provided also that the shunt capacitive reactance of a section is much greater than the series inductive reactance, the whole joint is equivalent to a network having a total series inductance  $\Sigma L_n d_n$  and a total shunt capacitance  $\Sigma C_n d_n$ . Further, if the whole joint is sufficiently short compared to a quarter wavelength this network is in turn equivalent to a uniform line having the same total inductance and capacitance. The joint will introduce no mismatch if the characteristic impedance of this equivalent uniform line is equal to the characteristic impedance,  $R_0$ , of the coaxial pair in which the joint is inserted, i.e. if

$$\frac{\Sigma L_n d_n}{\Sigma C_n d_n} = R_0^2 \dots\dots\dots(4)$$

This formula indicates a convenient basis for the design of a joint. Assuming that the inductances per unit length of the coaxial pair and of the sections of the joint do not vary with frequency, the joint will give a substantially perfect match at low frequencies, but the mismatch will increase with increasing frequency as the assumption that the electrical length of the joint is small ceases to be valid.

The assumption that the inductance per unit length is independent of frequency is, of course, an approximation; the inductance per unit length of the coaxial pair, and consequently the characteristic impedance, will in fact decrease somewhat with frequency, each tending towards limiting values as the frequency is increased. The effect of the assumption is, however, unlikely to be appreciable, since the variation is a small proportion of the total inductance and the proportional variations for the cable, and for each section of the joint, are likely to be of the same order. Hence if the limiting values of  $L_n$  and  $R_0$  are used in calculations, the joint may be expected to give satisfactory results at all frequencies sufficiently low for the assumption of short electrical length to be valid.

*Effect of Abrupt Changes in Dimensions.*—A convenient mechanical design of joint necessarily includes abrupt changes in diameter of the inner and outer conductors and these give rise to electrical discontinuities at the junctions between the different sections of the joint. Discontinuities associated with such changes in diameter have been shown<sup>1</sup> to be equivalent to shunt capacitances. The magnitudes of these capacitances can be calculated for any particular joint and can be taken into account in designing the joint to comply with equation (4).

*Calculation of Return Loss.*—To complete the analysis of a joint it is necessary to calculate the return loss when it is not matched to the cable. In the Appendix it is shown that a short section of joint having a higher characteristic impedance than that of the coaxial pair in which it is inserted will behave as though it were equivalent to an inductance

<sup>1</sup> Coaxial Line Discontinuities. Whinnery, J. R., Jamieson, H. W., Robbins, T. E., *Proc. I.R.E.*, Vol. 32, pp. 695-709.

in series with a short line having the same impedance as the coaxial pair. The inductance may be called the excess inductance of the joint. In a similar way if the section has a lower characteristic impedance then it will exhibit excess capacitance. From the expressions for the excess capacitance it is then shown that the return loss,  $A$ , of a joint is given by

$$A = -20 \log_{10} \frac{\omega R_0}{2} \left( C_r - \frac{L_r}{R_0^2} \right) \text{ db.}$$

where  $L_r$  = total series inductance of the joint.  
 $C_r$  = total shunt capacitance of the joint.

*More Accurate Analysis for use at Higher Frequencies.*

At higher frequencies the various sections of the joint are again regarded as transmission lines; the assumption that the individual sections are short compared to a quarter wavelength is now no longer tenable, however. The rigorous transmission line formula must be applied to each section in turn, starting with the section which is terminated in the cable impedance and taking account of shunt capacitance due to discontinuities as before. The attenuation of each section may be neglected compared to the phase shift; the error in assuming that the characteristic impedance does not vary with frequency is negligible, being less at high frequencies than at low frequencies.

PRINCIPLES APPLIED TO A JOINT FOR 0.375 IN. COAXIAL PAIR WITH POLYTHENE INSULATING DISKS

*Requirements.*

The coaxial cable most used in the Post Office trunk network has a solid inner conductor 0.104 in. diameter and an outer conductor whose inner diameter is 0.375 in. Steel tapes are wrapped spirally round the outer conductor to provide adequate crosstalk attenuation and to give mechanical strength. A number of variations of this type of cable are in existence, differing in their dielectric materials and thicknesses of their outer conductors. A joint is required which can be used with any type of 0.375 in. coaxial pair. The polythene spacers used in some types of cable tend to distort with the heat used in soldering and the design of joint has to allow for this fact. The joint must be mechanically strong and easy to make, bearing in mind the fact that jointing work must often be carried out under difficult conditions. The component parts of the joint must be simple and a water barrier is required to prevent water in a faulty length from passing to the adjacent length.

The characteristic impedance of 0.375 in. pairs is required by specification to be 75 ohms  $\pm$  1 ohm at 2.5 Mc/s. As mentioned above, the characteristic impedance of a coaxial pair decreases very slightly with frequency and in this case the mean limiting impedance as the frequency is increased indefinitely is 74.5 ohms. The return loss of the joint must be at least 70 db. at 10 Mc/s\* when inserted in coaxial pair of mean specification

impedance; this condition means that the characteristic impedance of the joint shall be within  $\pm$  1.5 ohms of the cable impedance at 10 Mc/s. The joint cannot be allowed to reduce the crosstalk attenuation between pairs.

*Mechanical Design.*

The final form of the joint is shown in Figs. 3 and 4.

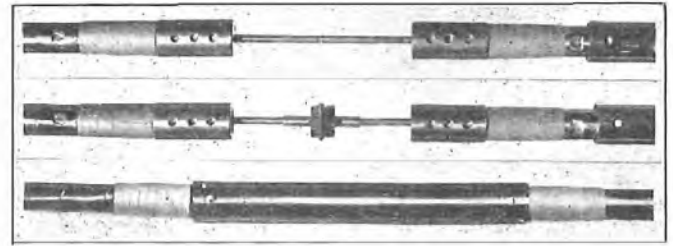

FIG. 4.—THREE STAGES IN PREPARATION OF JOINT IN 0.375 IN. COAXIAL CABLE.

External jointing ferrules are used for both the inner and outer conductors. Collars are required at the ends of the coaxial pairs to trap the steel screening tapes and to provide suitable seatings for the outer conductor ferrule. An insulating disk is required in the middle of the joint to position the inner conductor, and the water barrier forms a part of this insulator. The mechanical design is such that without this insulator the joint has a higher limiting characteristic impedance than 74.5 ohms so that an insulator can then be inserted having a length which gives the joint the correct characteristic impedance. The constituent parts of the joint will now be examined in more detail.

The external diameter of the inner conductor jointing ferrule has been made 0.150 in.; the cross-sectional area of the ferrule is then slightly greater than that of the inner conductor and thus the ferrule is at least as strong as the inner conductor. A length of 1 in. has been found to give sufficient area of soldered surface to make the joint equally strong. Slots are provided at the ends of the ferrule to facilitate soldering.

The maximum external diameter of the outer conductor of any type of 0.375 in. pair is about 0.445 in. Hence the

\* Various frequency ranges are required for the systems of transmission in use or proposed; for the purpose of specification, the highest transmitted frequency has been taken as 10 Mc/s.

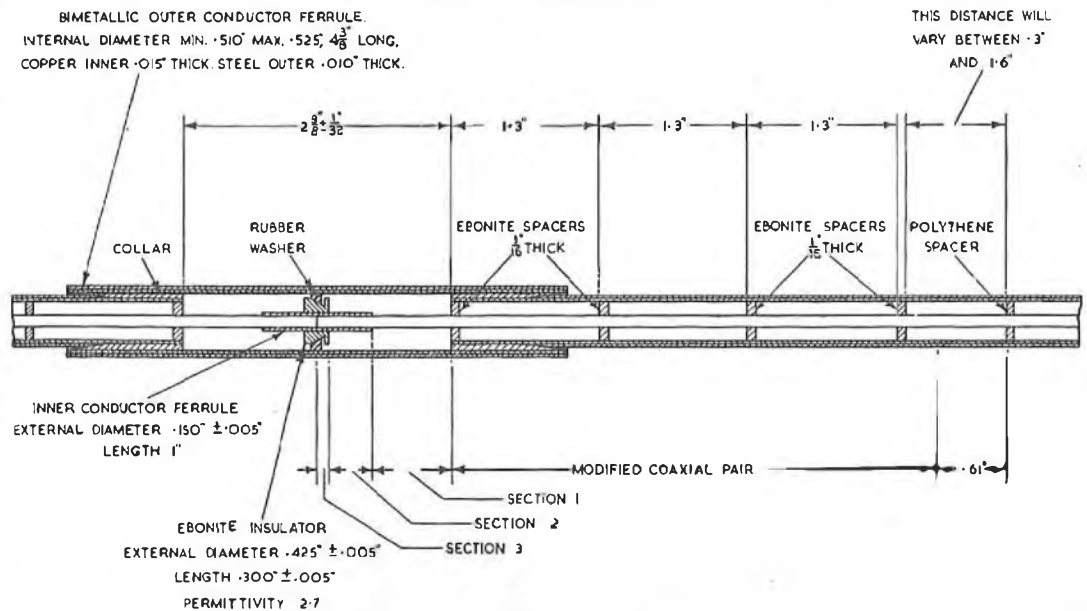

FIG. 3.—JOINT WITH WATER BARRIER FOR 0.375 IN. COAXIAL CABLE WITH POLYTHENE SPACERS.

collars which fit over the outer conductor should have an outer diameter of not less than about 0.52 in. so that they have a reasonable thickness. Since the inner diameter of the collars must suit the external diameter of the outer conductor, this item will vary for the different types of cable. The outer ferrule is made from bimetallic tube with copper on the inside 0.015 in. thick and steel on the outside 0.010 in. thick; the steel provides crosstalk screening.

The material of the insulator is required to have a low permittivity and high resistivity and to be sufficiently immune from the effects of heat to allow the inner conductor ferrule on which it is mounted to be soldered to the inner conductor without damaging the insulator. High quality ebonite meets these conditions. The water seal is provided by a rubber ring seated in a V-shaped slot made round the periphery of the insulator. The outer ferrule when pushed over the rubber ring compresses it and so gives a good water seal.

To avoid distorting the polythene spacers of the coaxial pair during the soldering process some polythene spacers are removed and four ebonite spacers are substituted before the joint is made. The ebonite spacers are  $\frac{1}{16}$  in. thick and are spaced at intervals of 1.3 in., the last disk being placed flush with the end of each cable.

#### Electrical Design.

The above mechanical considerations have fixed all the dimensions of the joint with the exception of the axial thickness of the centre insulator. By calculation of the electrical properties of the joint at various stages of the mechanical design it has been verified that the joint without the insulator has excess inductance when connected in 75-ohm coaxial pair. The thickness of the insulator necessary to give the equivalent amount of excess shunt capacitance to correct for this, and so to give maximum return loss, can then be calculated and this final stage will be described in some detail.

When a coaxial pair is prepared for jointing, the spacing between the innermost ebonite spacer and the first polythene spacer may be anything from 0.3 in. to 1.6 in.; the joint has, therefore, been designed so that it should be reflectionless when this spacing has its mean value of 0.95 in. In a long transmission line, reflections at joints which are perfect except that the spacing between the ebonite and polythene disks differs from this mean distance will then tend to be random in magnitude and sign. The mean length of the end of the coaxial pair affected by the replacement of polythene disks with ebonite is 4.300 in. This includes four ebonite disks each 0.0625 in. thick and hence there is 0.250 in. of coaxial pair with ebonite dielectric and 4.050 in. of coaxial pair with air dielectric at each cable end. The capacitance and inductance of these sections of the coaxial pair have been calculated and are given in Table 1. The joint itself is

2d. The inductances and capacitances of the three sections are also given in Table 1. The capacitances due to discontinuities are then calculated from graphs given in Reference (1). The presence of the rubber ring in the water barrier increases the capacitance, making a correction necessary which has been found by experiment to have a value 0.0264 pF. From Table 1 it follows that the joint has a total capacitance of  $2(6.4280 + 1.2814 d)10^{-12}$  farads and a total inductance of  $2 \times 36.772 \times 10^{-9}$  henrys; it is required to have a mean limiting characteristic impedance of 74.5 ohms. Hence, substituting in equation (4), the following equation in  $d$  is obtained.

$$\frac{36.772 \times 10^{-9}}{(6.4280 + 1.2814d)10^{-12}} = (74.5)^2$$

From this it follows that the length  $2d$  of the joint insulator should be 0.308 in.

#### Tolerances on Dimensions.

A joint made exactly in accordance with these calculations should have an infinite return loss. But the joint need only have a return loss of 70 db. to be satisfactory and tolerances on the dimensions can be fixed bearing this in mind.

Calculations have shown that, with the joint dimensions and tolerances quoted in Fig. 3 when all tolerances are adverse in such a manner as to give, say, an inductive joint, then the return loss will be more than 68 db. at 10 Mc/s. As the construction of the joint with these tolerances has proved straightforward and this value of return loss is normally exceeded, the dimensions shown in Fig. 3 have been accepted as standard.

#### Experimental Check of Joint Design.

It was desired to confirm by experiment that the theoretical basis of design already described does in fact give the optimum dimensions for a joint. It might at first appear sufficient to make a joint between two lengths of coaxial pair and to measure the mismatch at the joint by a pulse method. If, however, two lengths of coaxial pair selected at random are jointed, then any difference in impedance between the two lengths will give rise to a mismatch that is not due to any deficiency in the joint. To test a joint, it is thus necessary to cut a continuous length of pair and insert the joint at the point of cutting. The apparent mismatch at a joint is influenced by impedance irregularities in the pair near the joint and hence it is desirable that the length of coaxial pair used should be as free from impedance irregularities as possible. To avoid the correction necessitated by the water barrier, the check was carried out on a joint with plain insulator and it was considered desirable to take a series of measurements of return loss for various lengths of insulator.

The tests were made as follows. The limiting value of the resistive component of the characteristic impedance of a 360-yd. length of a lead-sheathed cable containing a single 0.375 in. coaxial pair, having polythene spacers, was measured and found to be 74.36 ohms. The pair was examined for impedance irregularity with a 20 Mc/s Pulse Test Set<sup>2</sup> and was cut at a point where such irregularities appeared to be a minimum. The ends were cut back so that the distance between the last polythene spacer and the first ebonite spacer was 0.95 in. The dimensions of the piece parts and the permittivity of the ebonite were checked; the distance between the ends of the coaxial pairs was made  $2\frac{3}{8} \pm \frac{1}{32}$  in. The length of the insulator was varied and measurements were made of the return loss of the joint using the Pulse Test Set. The results are compared in Fig. 5 with the theoretical figures calculated from the actual

TABLE 1

Joint for 0.375 in. Coaxial Pair

Constants for half the joint, where  $2d$  is the axial length of the joint insulator

	Length in.	Capacitance $10^{-12}$ F	Inductance $10^{-9}$ H
Modified Coaxial Pair .. ..			
Air .. ..	4.050	4.4023	} 28.016
Ebonite ( $k = 2.7$ ) .. ..	0.250	0.7437	
Joint (Fig. 3)			
Section 1 .. ..	0.0875	0.6051	} 5.608
Section 2 .. ..	0.5 - $d$	0.5701 - 1.1402 $d$	
Section 3 .. ..	$d$	2.4216 $d$	
Capacitance due to discontinuities ..	—	0.0204	} 3.148
Capacitance due to water barrier ..	—	0.0264	
Total .. ..		6.4280 + 1.2814 $d$	36.772

divided into three sections of differing impedance as shown in Fig. 3, the length of the insulator being assigned a value

<sup>2</sup> A Pulse Test Set for the Measurement of Small Impedance Irregularities in High Frequency Cables, Roberts, F. F., *Proc. I.E.E.*, Vol. 96, Pt. 111, No. 39, pp. 17-23.

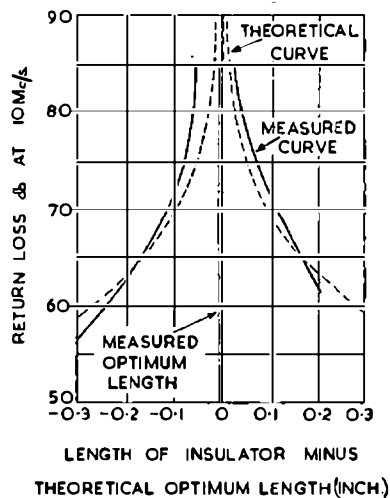

FIG. 5.—RETURN LOSS OF JOINT AS FUNCTION OF INSULATOR LENGTH.

measured dimensions of the piece parts and the impedance of the cable used. The experimentally determined insulator length was only 0.01 in. less than the theoretical figure. The correction for the water barrier was obtained experimentally by comparing the lengths of insulators necessary to give maximum return loss, (a) when a plain insulator was used and (b) when a water barrier was added. The length of insulator in a given joint equivalent to the water barrier was thus obtained. From this, the capacitance equivalent to the water barrier was then calculated and used in the computations in Table 1. The measurements were repeated on the joint complete with water barrier for various insulator lengths. Again the experimentally determined optimum insulator length was 0.01 in. less than the theoretical figure and, in view of this slight discrepancy, the calculated length of 0.308 in. has been made 0.300 in. on the production drawings. The return loss of a joint made in accordance with the nominal dimensions given in Fig. 3 and tested in cable of nominal characteristic impedance is better than 84 db. at 10 Mc/s and this is well within the specification figure.

#### Theoretical Prediction of Performance at Higher Frequencies.

Calculations have been made in the manner given above to obtain the return loss of the joint shown in Fig. 3 at higher frequencies and under ideal conditions. The results given below show that the approximate method of design results in a joint which, theoretically, is satisfactory at frequencies well above those normally used for television

Frequency Mc/s	Return Loss db.
100	80
200	43
600	27

## Book Review

"Advanced Theory of Waveguides." L. Lewin. Published for *Wireless Engineer* by Iliffe & Sons, Ltd., London. 192 pp. 54 ill. 30s.

Numerous textbooks have been written which deal with principles of waveguide transmission, but very few give the fundamental principles necessary for the theoretical design of components. The present book is devoted almost exclusively to the analytic treatment of obstacles and discontinuities in waveguides. The analysis is restricted to rectangular waveguides; no difficulty should, however, be experienced in applying the methods used to circular waveguides.

The book opens with a résumé of Maxwell's equations and gives their solutions in rectangular, cylindrical and spherical co-ordinate systems; the results are then applied to rectangular waveguides. Inductive and capacitive posts are considered in the second chapter. Chapter 3 is devoted to diaphragms and strips, a variety of methods of analysis being used which are summarised at the end of the chapter; no attempt is made, however, to consider the effect of the thickness of the dia-

phragms and strips. In the following chapter, the analysis is extended to include tuned posts and tuned windows. Waveguide steps, T-junctions and tapers are dealt with in Chapter 5 and radiation from the open end of a waveguide is considered in Chapter 6. Propagation in loaded and corrugated guides is covered in Chapter 7 and will be of particular value to those engaged in the design of strip attenuators, phase-changers and travelling wave valves. References are given at the end of each chapter and a comprehensive bibliography is provided. The inclusion of a chapter dealing with hole and slot coupling between waveguides would have made the book more complete. On page 113 and in Chapter 6 some of the more important results are presented graphically; had this been done throughout the book its usefulness would have been considerably extended. The C.G.S. practical system of units is used and, although rules are given for transforming formulæ to the rationalised M.K.S. system, it would probably have been more convenient for the majority of readers if the latter system of units had been used.

The author is to be congratulated on writing a book which will prove a very useful addition to the literature on waveguides.

C. F. D.

## ACKNOWLEDGMENTS

Acknowledgments are due to officers of the External Plant and Protection Branch for the details concerning the mechanical design of the joint for the 0.375 in. coaxial cable and for their co-operation in meeting the requirements of the electrical design. The author also wishes to express his thanks to Mr. E. C. H. Seaman for clarification of the theoretical work and to Messrs. J. T. Hales and K. A. Brown for painstaking measurements.

## APPENDIX

### Calculation of Return Loss.

The return loss of a joint may be calculated as follows. Suppose that the total series inductance and shunt capacitance of the joint have values  $L_T$  and  $C_T$  respectively. Now the inductance,  $L_T'$ , required to give a section of transmission line equal in impedance to the cable is given by

$$L_T' = R_0^2 C_T$$

Hence the joint is electrically equivalent to an inductance  $(L_T - L_T')$  in series with a short line having the same impedance as the cable; the inductance  $(L_T - L_T')$ , which can be positive or negative, may be called the excess inductance,  $\delta L$ , of the joint; it is given by

$$\delta L = L_T - R_0^2 C_T$$

It can be shown in a similar way that the mismatch can be regarded alternatively as equivalent to that arising from the presence of an excess capacitance  $\delta C$  in shunt with the coaxial pair, where  $\delta C$  is given by

$$\delta C = C_T - L_T/R_0^2$$

If a section of joint has a higher characteristic impedance than that of the coaxial pair in which it is inserted then it will exhibit positive excess inductance or what is the same thing, negative excess capacitance; if the section has a lower characteristic impedance then it will exhibit positive excess capacitance or negative excess inductance.

By substituting in equation (1) it can then readily be shown that the modulus of the reflection coefficient,  $r$ , for the mismatch arising from the presence of  $\delta L$  or  $\delta C$  is given by

$$r = \frac{\omega \delta L}{2R_0} = \frac{\omega R_0 \delta C}{2}$$

approximately, provided that  $\omega \delta L/2R_0$  or  $\omega R_0 \delta C/2$  is small compared with unity. The corresponding return loss,  $A$ , is then

$$A = 20 \log_{10} 1/r \text{ decibels}$$

$$\text{or } A = -20 \log_{10} \frac{\omega R_0}{2} \left( C_T - \frac{L_T}{R_0^2} \right)$$

# New Methods of Locating Faults in Telephone Cables

E. R. OAKFORD†

U.D.C. 621.317.333.4

The author describes new tests, based on mutual capacitance comparisons, which simplify the location of split pair faults in telephone cables. An improved test for the location of particular types of earth fault is also given.

## Introduction.

A TYPE of cable fault which occasionally arises in practice is one which is due to a jointing error. The insertion of an incorrect cross which splits the pairs when jointing the wires of a quad, produces an impedance irregularity or unbalanced condition that causes degradation in the crosstalk between the pairs. The location of the joint in which the error has occurred is possible using any of the following tests:—

- (1) Impedance-frequency test.
- (2) Crosstalk-frequency test.
- (3) Mutual capacitance tests.

The first two tests are lengthy and require equipment which is not always available, and for these reasons are rarely used.

The third method is the most usual and gives an indication of the length of cable over which the split has occurred. Sometimes, however, the pairs may be split at two points in the cable, the second split neutralising or rectifying the first split so that the wires tap out straight from termination to termination. Here it is necessary to open the cable within the split portion so that the two faults can be isolated and treated separately. The mutual capacitance tests give very little help in determining a point within the split portion, but two tests which the author has devised provide a quick, accurate and simple method of obtaining precise locations with these types of faults.

A further problem is that of locating earth faults in telephone cables when using a testing loop which is subjected to irregular induced currents from adjacent circuits, and as far as is known there are only two tests at present in use which have been designed to overcome these difficulties. The original test, known as the Simon test, requires the use of a differential galvanometer and a duplicate Wheatstone bridge. Its use is somewhat limited as the only available galvanometer of this type meeting the necessary requirements is of low sensitivity. In the second test, J. M. Allan overcame this disadvantage and used a normal type of reflecting galvanometer.<sup>1</sup> The author has developed a third method which is based upon the principle of the Allan test but has the added advantage that only a minimum of equipment is required.

## TEST FOR THE LOCATION OF A SPLIT PAIR FAULT

The test to be described is a development of the "method of mixtures" test and consists of making capacitance comparisons on the faulty quad, the balance of which has been upset by the split inserted in the pairs of the quad.

The crossed wires are first identified from the ends of the cable by normal methods of tapping out, and the testing arrangement is then set up as shown in Fig. 1. For illustration purposes the quad is connected as for a BC cross: different connections, which may be readily worked out, are required for splits involving other conductors in the quad. The quad is kept disconnected at the distant end.

The test is conducted in two parts. During the first part

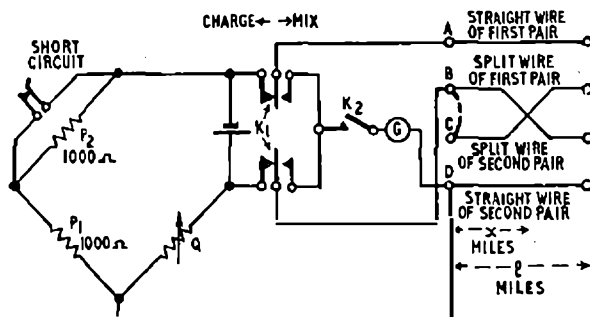

FIG. 1.—CIRCUIT ARRANGEMENT FOR LOCATION OF SPLIT PAIR.

a short-circuit is maintained across the ratio arm  $P_2$ :  $K_1$  is first moved to the CHARGE position and then to the MIX position after a pause of about one second.  $K_2$  is then closed and the galvanometer deflection observed. The movements of the keys are repeated and between each sequence, resistance  $Q$  is adjusted until finally there is no deflection on the galvanometer.

Let  $Q_1$  be the resistance when balance has been obtained.

For the second part of the test a short-circuit (shown dotted in Fig. 1) is placed across the split, or, in this case, the BC wires, and the short-circuit across resistance  $P_2$  removed. The keys are again manipulated as already described and a new balance,  $Q_2$ , obtained.

The distance between the point where the split has been inserted and the distant end is then equal to

$$(l-x) = \left( \frac{Q_1 - 1000}{Q_2 - 1000} \right) l \dots \dots \dots (1)^*$$

where  $l$  is the length of the circuit under test.

## Proof of the Formula.

For this proof the following facts are assumed:—

- (a) The cable is perfectly uniform.
- (b) Leakage and dielectric hysteresis do not exist.
- (c) Charging and mixing are sufficiently long for transmission time effects to be absent.

Let the cable quad parameters be:—

- $a$  = Direct wire-earth capacitance per unit length.
- $w$  = Direct wire-wire (adjacent) capacitance per unit length.
- $m$  = Direct wire-wire (diagonally opposite) capacitance per unit length.

Fig. 2 shows the capacitances of the faulty quad, viewed from the testing (left-hand) end. Since no earth connection is applied during the tests the earth point can be eliminated by a star-mesh transformation, giving the configuration of Fig. 3, where

$$\begin{aligned} L &= wl + a/4 \\ M &= wx + m(l-x) + a/4 \\ N &= mx + w(l-x) + a/4 \end{aligned}$$

Consider now the conditions in the first part of the test. The point C is left disconnected and may therefore be eliminated by a further star-mesh transformation, with the result shown in Fig. 4. In the first part of the test a comparison is made of the two direct capacitances  $C_{AD}$  and  $C_{BD}$ : the capacitance  $C_{AB}$  has no effect because its charge is lost when the MIX key is operated.

† Assistant Engineer, London Telecommunications Region.

<sup>1</sup> P.O.E.E.J., Vol. 39, p. 70.

\* When this test is applied to pairs having a split followed by a rectified split, the formula gives the distance between the two splits.

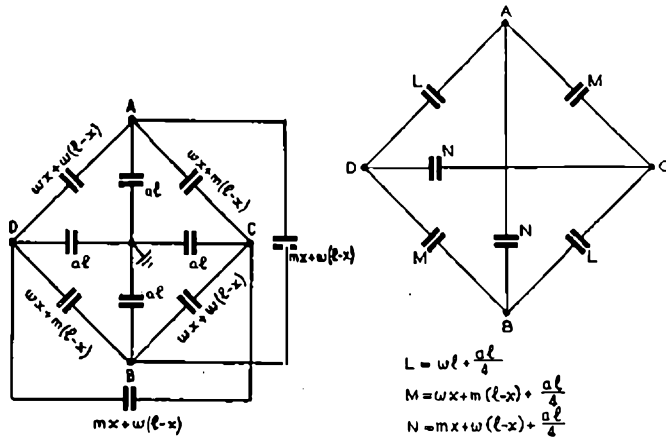

FIG. 2.—CAPACITANCES OF FAULTY QUAD, VIEWED FROM TESTING END.

FIG. 3.—EQUIVALENT CAPACITANCES OF QUAD WITH EARTH POINT ELIMINATED BY STAR-MESH TRANSFORMATION.

$$L = wl + \frac{al}{4}$$

$$M = wx + m(l-x) + \frac{al}{4}$$

$$N = mx + w(l-x) + \frac{al}{4}$$

Hence

$$\frac{P_1}{Q_1} = \frac{M + \frac{LN}{L+M+N}}{L + \frac{MN}{L+M+N}} \dots \dots \dots (2)$$

Considering now the second part of the test; referring to Fig. 5, the balance condition is:—

$$\frac{P_1 + P_2}{Q_2} = \frac{2P_1}{Q_2} = \frac{M + N}{L} \dots \dots \dots (3)$$

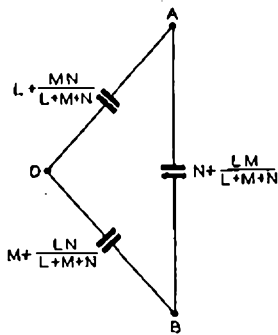

FIG. 4.—EQUIVALENT CAPACITANCES WHEN POINT C OF FIG. 3 IS ELIMINATED BY STAR-MESH TRANSFORMATION.

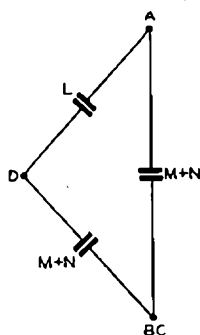

FIG. 5.—SECOND PART OF SPLIT-PAIR TEST; EQUIVALENT CAPACITANCES WITH B AND C JOINED AND EARTH POINT ELIMINATED BY STAR-MESH TRANSFORMATION.

Hence from equation (2)

$$\frac{Q_1 - P_1}{P_1} = \frac{L - M}{M + N} = \left(\frac{l-x}{l}\right) \left(\frac{w-m}{w+m+a/2}\right) \dots \dagger (4)$$

and from equation (3)

$$\frac{Q_2 - P_2}{P_2} = \frac{Q_2 - P_1}{P_1} = \frac{2L - (M + N)}{M + N} = \frac{w-m}{w+m+a/2} \dots \dots \dots (5)$$

Dividing equation (4) by equation (5),

$$\frac{l-x}{l} = \frac{Q_1 - P_1}{Q_2 - P_1}$$

and substituting the values used, equation (1) is obtained, i.e.,

$$(l-x) = \left(\frac{Q_1 - 1000}{Q_2 - 1000}\right)l$$

† The expression  $\frac{w-m}{w+m+a/2}$  is a dimensionless constant

whose value depends on the geometry of the cable quad. Examination of the nominal capacitances of various types of quad show that in practice the value of this constant is 0.3 for all types of cable quad.

TEST FOR THE LOCATION OF A RECTIFIED SPLIT PAIR FAULT

In this test, advantage is taken of the fact that the unbalanced condition over the split portion provides a residual capacitive coupling between the two pairs of the quad so that a direct current impulse on one of the pairs will produce a corresponding impulse in the other pair. As this test is a ballistic method, employing direct-current impulses, this residual capacitance may be regarded as a lumped capacitance at the mid-point of the split portion.

The method of testing is shown diagrammatically in Fig. 6

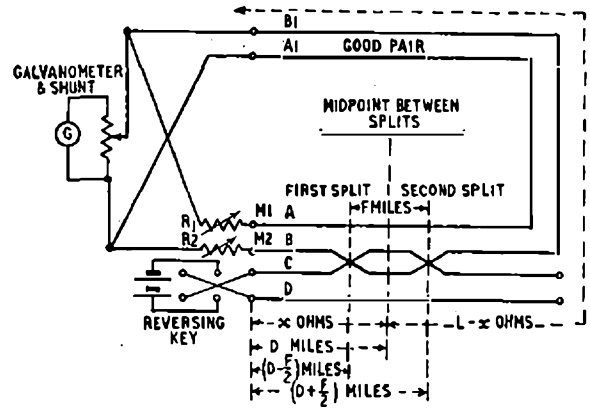

FIG. 6.—CIRCUIT ARRANGEMENT FOR LOCATING RECTIFIED SPLIT PAIR.

where a rectified split has been indicated in the BC wires. The faulty quad containing the splits is used in conjunction with a good pair in the cable, which should not be adjacent to the faulty quad. It is not necessary to determine which of the wires contain the two crosses as the circuit arrangement caters for any of the possible combinations of incorrect crosses between the wires of the quad.

It will be seen from Fig. 6 that direct current reversals in the CD wires of the quad will produce momentary currents in the AB wires. These current impulses in the AB wires of the looped circuits will be opposite in direction through the galvanometer. In the unbalanced condition, the impulses are unequal in value and deflect the galvanometer to an extent dependent upon their difference. When balance has been obtained, the currents are equal so that there will be no deflection of the galvanometer.

To obtain a balance, the reversing key is manipulated to give approximately two reversals per second while resistances  $R_1$  and  $R_2$ , which must be maintained equal to one another, are adjusted in step until there is no deflection of the galvanometer. Let  $R$  be the value of  $R_1$  (or  $R_2$ ) when the circuit is balanced.

The loop resistance,  $L$ , can be measured by connecting a three-volt battery across the A and B wires at points M1 and M2 in Fig. 6, and then adjusting  $R_1$  and  $R_2$  equally for balance. For simplicity, Figs. 7(a) and 7(b) show the bridge formations for the impulse current test and the loop resistance test, respectively.

If  $x$  is the resistance in ohms from the testing end to the mid-point of the split portion when the circuit is balanced, then,

$$R + x = L - x$$

$$\text{or } x = \frac{L - R}{2} \text{ ohms.}$$

The distance  $D$  in miles from the testing end to the mid-point of the faulty section is  $\frac{x}{\text{resistance per mile}}$ .

To determine the exact location of each of the two splits it is necessary to apply the first test described (location of



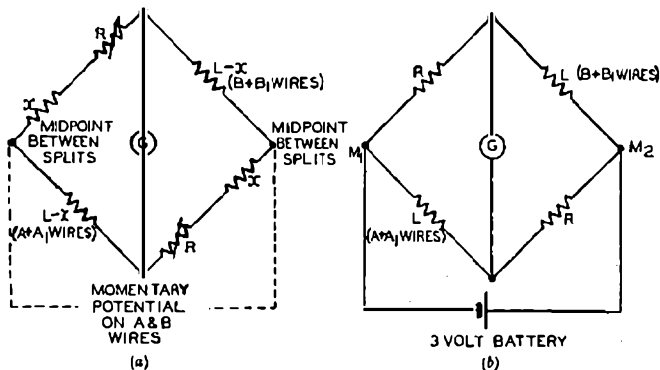

FIG. 7.—BRIDGE FORMATIONS FOR, (a) IMPULSE CURRENT TEST, (b) LOOP RESISTANCE TEST.

split pair fault) in which the  $x$  value will give the distance ( $F$ ) between the two splits. The distance to the first split is thus  $(D-F/2)$ , and to the second split,  $(D+F/2)$  miles, both measured from the testing end.

A battery of 500 volts is required for the test to locate the mid-point between the two splits (Fig. 6). The galvanometer should be one suitable for ballistic measurements and have a sensitivity of the order of 2,000-3,000 millimetres per micro-ampere. This is particularly necessary when the distance between the two splits is short.

#### LOCATION OF EARTH FAULTS

The circuit for this test is shown in Fig. 8, which is similar to the arrangement in the test described by J. M.

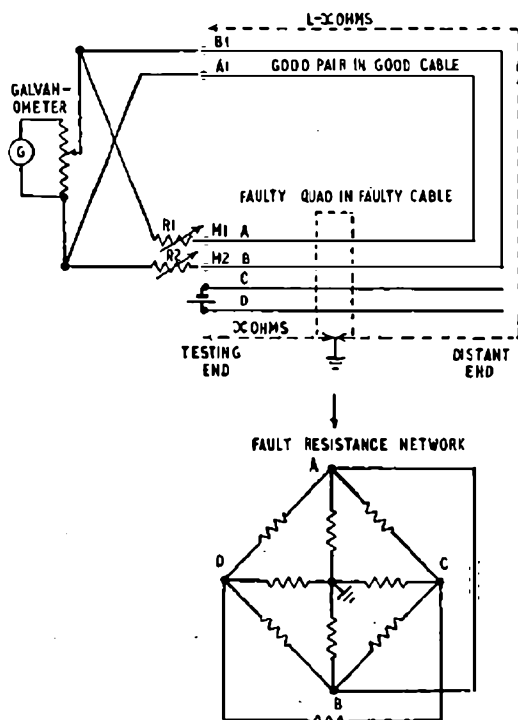

FIG. 8.—CIRCUIT ARRANGEMENT FOR LOCATION OF EARTH FAULTS.

Allan except that ratio arms are not required. The loops formed by the good and faulty wires and the variable resistances then become the two branches of a bridge network. The method relies upon the fact that in a normal quad the insulation resistances between the wires form a balanced bridge. When a fault occurs, this bridge will become unbalanced if the insulation resistances between the wires are affected to different degrees. Thus a potential difference applied to one pair produces a potential difference

across the other pair. In the test, a battery is connected to two wires of the faulty quad and the testing circuit can now be shown as in Fig. 9, which may also be drawn as

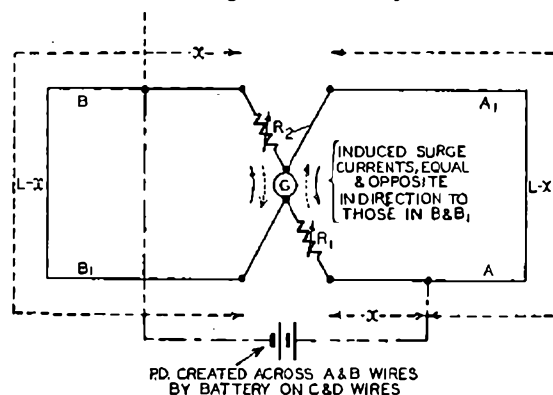

FIG. 9.—EQUIVALENT CIRCUIT OF TEST FOR LOCATION OF EARTH FAULTS.

Fig. 10. The bridge is balanced by maintaining  $R_1$  equal to  $R_2$  and adjusting both in step with one another until there is no deflection of the galvanometer. The resistance to the fault can then be determined from the formula

$$x = \frac{L - R}{2}$$

where  $x$  = resistance to the fault in ohms.

$L$  = loop resistance of faulty and good wires in ohms,

$R$  = value of  $R_1$  (or  $R_2$ ) at balance.

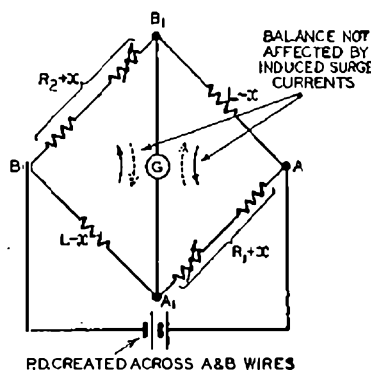

FIG. 10.—BRIDGE CIRCUIT EQUIVALENT OF FIG. 9.

Earth faults of up to 50 megohms or even higher can be located with this test using a testing battery up to 500 volts and a highly sensitive galvanometer. The testing current is, of course, dependent upon the extent of the insulation resistance unbalance of the faulty quad and it is necessary to select a faulty quad having the greatest unbalance.

For an incipient fault or a low insulation fault having a high ratio of insulation to conductor resistance all that is necessary to determine the loop resistance,  $L$ , of  $A+A_1$  or  $B+B_1$ , is to disconnect the testing battery from across the  $C$  and  $D$  wires and to join a three-volt battery across points  $M_1$  and  $M_2$  shown in Fig. 8.

When a balance is reached by adjusting  $R_1$  and  $R_2$  equally, the loop resistance  $L$  is equal to the value of  $R_1$  (or  $R_2$ ).

#### Acknowledgments.

The author is indebted to the Transmission and Main Lines branch of the Engineering Department for assistance in the preparation of this article.

Credit is also due to Messrs. J. Osborne and G. E. Cochrane, of the London cable and precision testing staffs, for their help in the formulation of the tests.

# An Approach to the Standard Equations for a Uniform Transmission Line

H. R. Harbottle, O.B.E., B.Sc., D.F.H., M.I.E.E.†

## Part 2.—Propagation of Current and Voltage in a Chain of Impedance Sections, Simulating the Uniform Transmission Line.

U.D.C. 621.3.09

In this article the author derives the standard equations for a uniform transmission line in a manner which avoids the use of differential calculus. The propagation of current and voltage in a chain of similar symmetrical resistance sections were considered in Part 1. Part 2 shows how the results obtained are applied to the general case of propagation through a chain of impedance sections, simulating the uniform transmission line.

### The General Case.

In the general case of a chain of  $n$  similar sections terminated in a resistance,  $R$ , Fig. 14(a), the terminating resistance can be replaced by a source which has an e.m.f.,  $e'$ , and internal resistance,  $R_0$ , provided that

$$\frac{e_R + e'}{2R_0} = \frac{e_R}{R_0 + R}, \quad (\text{Figs. 14(b) and (c)}).$$

$$\text{But } e_R = e_s r^{-n}$$

$$\therefore e' = e_s \left( \frac{2R_0}{R_0 + R} - 1 \right) = \frac{R_0 - R}{R_0 + R} e_s r^{-n}$$

Thus, the original circuit can be represented by Fig. 14(d). The current at the sending end (and at any other point) of this circuit can be determined from consideration of the separate effects of the sending end e.m.f.,  $e_s$ , and the equivalent e.m.f. at the receiving end.

$$e' = \frac{R_0 - R}{R_0 + R} e_s r^{-n}$$

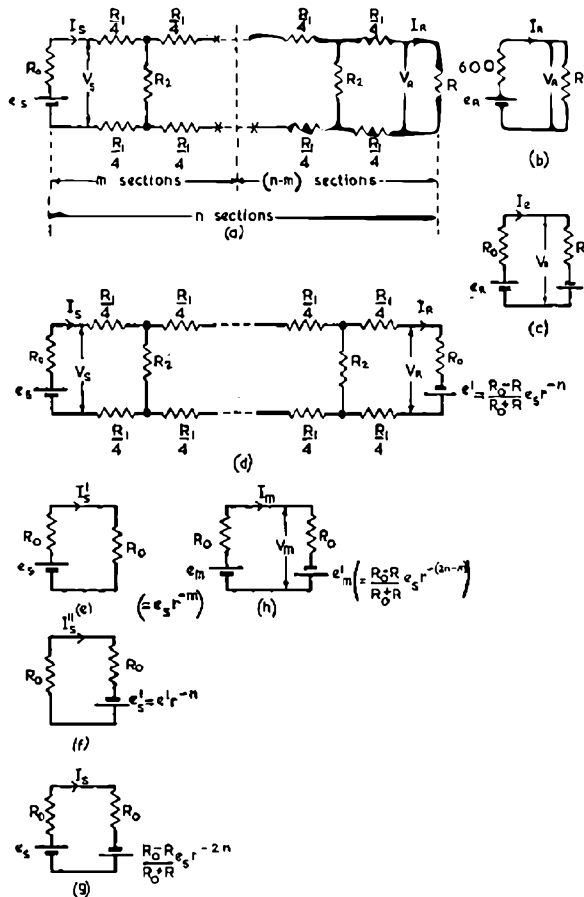

FIG. 14.

Thus, if  $I_s$  is the total current at the sending end

$$I_s = I' + I''$$

where:—

$$I' = e_s / 2R_0$$

is the component of the total sending current due to  $e_s$  acting alone and  $I''$  is that component due to the equivalent e.m.f.,  $e'$ , at the receiving end acting alone.

$I'$  is the value of the current which would have occurred at the sending end, if the receiving end terminals had been closed in the characteristic resistance,  $R_0$ , of the network.

$I''$  is the current which appears at the sending end due to the change in termination at the receiving end from  $R_0$  to  $R$ . To determine  $I''$ , we must calculate the value of the effective e.m.f.,  $e'_s$ , which is produced at the sending end of the chain of networks by the e.m.f.,  $e'$ , at the receiving end.

Since the chain of networks is symmetrical and since a source at the sending end, which has an e.m.f.,  $e_s$ , and an internal resistance,  $R_0$ , equal to the characteristic resistance of the network, will cause an e.m.f.,  $e_R = e_s r^{-n}$  at the receiving end, then, a source at the receiving end having an e.m.f.,  $e'$ , and internal resistance,  $R_0$ , will cause an e.m.f.,  $e'_s$ , at the sending end, where,

$$e'_s = e' r^{-n} = \frac{R_0 - R}{R_0 + R} e_s r^{-2n}$$

$$\text{Hence, } I'' = \frac{e'_s}{2R_0} = \frac{e_s}{2R_0} \cdot \frac{R_0 - R}{R_0 + R} r^{-2n} \quad (\text{Fig. 14(f)})$$

Therefore,

$$I_s = I' + I'' = \frac{e_s}{2R_0} \left\{ 1 + \frac{R_0 - R}{R_0 + R} r^{-2n} \right\} \quad (\text{Fig. 14(g)})$$

$$\text{and } V_s = e_s - R_0 I_s = \frac{e_s}{2} \left\{ 1 - \frac{R_0 - R}{R_0 + R} r^{-2n} \right\}$$

$$\therefore R_s = \frac{V_s}{I_s} = R_0 \frac{1 - \frac{R_0 - R}{R_0 + R} r^{-2n}}{1 + \frac{R_0 - R}{R_0 + R} r^{-2n}}$$

N.B.—For the original network,  $r = 3/2$ . With one section short-circuited at the receiving terminals  $n = 1$  and  $R = 0$ .

$$\therefore R_{s1} = 600 \frac{1 - \left(\frac{3}{2}\right)^{-2}}{1 + \left(\frac{3}{2}\right)^{-2}} = 600 \frac{\frac{5}{9}}{\frac{13}{9}} = 230.8 \text{ ohms}$$

as before.

Referring again to Fig. 14(d), let us find an expression for the current leaving the  $m$ th section and entering the  $(m+1)$ th section. By considering the e.m.f.,  $e_s$ , at the sending end and the equivalent e.m.f.,  $e'$ , at the receiving end separately as before, it will be realised that the circuits on either side of this junction can be represented as in Fig. 14 (h), provided that:—

$$e_m = e_s r^{-m}$$

† Staff Engineer, Training Branch, E.-in-C.'s Office.

$$\text{and } e'_m = e' r^{-(n-m)} = \frac{R_0 - R}{R_0 + R} e_s r^{-(2n-m)}$$

Then,

$$I_m = \frac{e_m + e'_m}{2R_0} = \frac{e_s}{2R_0} \left\{ r^{-m} + \frac{R_0 - R}{R_0 + R} r^{-(2n-m)} \right\}$$

To find  $I_m$  and  $V_m$  in terms of  $I_s$  and  $V_s$ .

Considering the expression inside the brackets above:—

$$r^{-m} + \frac{R_0 - R}{R_0 + R} r^{-(2n-m)} = \frac{r^{-m}}{2} + \frac{\frac{R_0 - R}{R_0 + R} r^{-2n} r^m}{2} = \left\{ \frac{r^{-m}}{2} - \frac{\frac{R_0 - R}{R_0 + R} r^{-2n} \cdot r^m}{2} \right\}$$

$$\text{Add and subtract } \frac{r^m}{2} \text{ and } \frac{\frac{R_0 - R}{R_0 + R} r^{-2n} \cdot r^m}{2}$$

Then, we obtain:—

$$\begin{aligned} r^{-m} + \frac{R_0 - R}{R_0 + R} r^{-(2n-m)} &= \frac{r^m + r^{-m}}{2} + \frac{R_0 - R}{R_0 + R} r^{-2n} \left( \frac{r^m + r^{-m}}{2} \right) - \\ &\quad \left\{ \frac{r^m - r^{-m}}{2} - \frac{R_0 - R}{R_0 + R} r^{-2n} \left( \frac{r^m - r^{-m}}{2} \right) \right\} \\ &= \left\{ 1 + \frac{R_0 - R}{R_0 + R} r^{-2n} \right\} \frac{r^m + r^{-m}}{2} - \\ &\quad \left\{ 1 - \frac{R_0 - R}{R_0 + R} r^{-2n} \right\} \frac{r^m - r^{-m}}{2} \end{aligned}$$

Thus,

$$I_m = \frac{e_s}{2R_0} \left\{ 1 + \frac{R_0 - R}{R_0 + R} r^{-2n} \right\} \frac{r^m + r^{-m}}{2} - \frac{e_s}{2R_0} \left\{ 1 - \frac{R_0 - R}{R_0 + R} r^{-2n} \right\} \frac{r^m - r^{-m}}{2}$$

But it was shown earlier that:—

$$I_s = \frac{e_s}{2R_0} \left\{ 1 + \frac{R_0 - R}{R_0 + R} r^{-2n} \right\}$$

$$\text{and } V_s = \frac{e_s}{2} \left\{ 1 - \frac{R_0 - R}{R_0 + R} r^{-2n} \right\}$$

$$\therefore I_m = I_s \frac{r^m + r^{-m}}{2} - \frac{V_s}{R_0} \frac{r^m - r^{-m}}{2}$$

Similarly it can be shown that:—

$$V_m = V_s \frac{r^m + r^{-m}}{2} - I_s R_0 \frac{r^m - r^{-m}}{2}$$

N.B.—To check these expressions,

$$\frac{V_m}{I_m} = \frac{V_s \frac{r^m + r^{-m}}{2} - I_s R_0 \frac{r^m - r^{-m}}{2}}{I_s \frac{r^m + r^{-m}}{2} - \frac{V_s}{R_0} \frac{r^m - r^{-m}}{2}}$$

If the chain of sections were disconnected after the  $m$ th section,

$$\frac{V_m}{I_m} = \infty$$

$$\therefore I_s \frac{r^m + r^{-m}}{2} = \frac{V_s}{R_0} \frac{r^m - r^{-m}}{2}$$

$$\text{or } \frac{V_s}{I_s} = R_0 \frac{r^m + r^{-m}}{r^m - r^{-m}} = R_{oc}$$

For the original network,  $r = 3/2$  and  $R_0 = 600$ .

When  $m = 1$  (one section),

$$R_{oc} = 600 \cdot \frac{\frac{3}{2} + \frac{2}{2}}{\frac{3}{2} - \frac{2}{2}} = 600 \cdot \frac{13}{5} = 1,560.$$

When  $m = 2$  (two sections),

$$R_{oc} = 600 \frac{\frac{9}{4} + \frac{4}{9}}{\frac{9}{4} - \frac{4}{9}} = \frac{97}{65} \cdot 600 = 895 \quad \text{etc.}$$

Again, if the chain were short-circuited at the output of the  $m$ th section

$$\frac{V_m}{I_m} = 0$$

$$\therefore V_s \frac{r^m + r^{-m}}{2} = I_s R_0 \frac{r^m - r^{-m}}{2}$$

$$\frac{V_s}{I_s} = R_0 \frac{r^m - r^{-m}}{r^m + r^{-m}} = R_{sc}$$

For the original network, when  $m = 1$

$$R_{sc} = 600 \cdot \frac{5}{13} = 230.8$$

when  $m = 2$ ,

$$R_{sc} = 600 \cdot \frac{65}{97} = 402.2 \quad \text{etc.}$$

#### PROPAGATION OF CURRENT AND VOLTAGE IN A CHAIN OF SIMILAR SYMMETRICAL IMPEDANCE SECTIONS

The above expressions can be applied to symmetrical impedance sections of the form shown in Fig. 15.

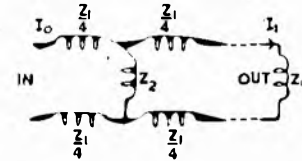

FIG. 15.

For this, the characteristic impedance

$$Z_0 = \sqrt{Z_{oc} Z_{sc}} = \sqrt{\frac{Z_1^2}{4} + Z_1 Z_2}$$

$$r = \frac{I_0}{I_1} = \frac{\frac{Z_1}{2} + Z_2 + Z_0}{Z_2}$$

$$= 1 + \frac{Z_1}{2Z_2} + \frac{Z_0}{Z_2} = |r| / \theta$$

It will be noted that in this case  $I_1$  and  $I_0$  are not only different in magnitude, namely:—

$$\frac{I_0}{I_1} = |r|$$

but they are also different in phase, namely,

$I_1$  lags by an angle  $\theta$  behind  $I_0$ .

Also,

$$I_m = I_s \frac{r^m + r^{-m}}{2} - \frac{V_s}{Z_0} \frac{r^m - r^{-m}}{2}$$

$$\text{and } V_m = V_s \frac{r^m + r^{-m}}{2} - I_s Z_0 \frac{r^m - r^{-m}}{2}$$

In this form, the evaluation of the expressions would present undue difficulty, but before simplifying them let us consider the case of a transmission line having uniformly distributed primary coefficients.

Conductor resistance  $R$  ohms/loop mile  
 Conductor inductance  $L$  henrys/mile  
 Conductor capacitance  $C$  farads/mile  
 Conductor leakage  $G$  mhos /mile.

### THE UNIFORM TRANSMISSION LINE

A very short section of this line  $1/y$  mile in length can be represented as in Fig. 16, and this will become a more accurate representation of a line having the larger  $y$  is, that is, the shorter the section is in length.

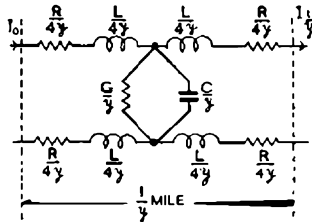

FIG. 16.

At an angular frequency of  $\omega$  radn./sec.

$$Z_1 = (R + j\omega L) \frac{1}{y}$$

$$\text{and } Z_2 = \frac{y}{G + j\omega C}$$

$$\therefore Z_0 = \sqrt{\frac{\{(R + j\omega L) \cdot 1/y\}^2}{4} + \frac{R + j\omega L}{G + j\omega C}}$$

As  $y$  is increased indefinitely, the section of Fig. 16 will eventually be an accurate representation of a line having uniformly distributed primary coefficients. Thus, finally,

$$Z_0 = \sqrt{\frac{R + j\omega L}{G + j\omega C}}$$

Again, with reference to Fig. 16,

$$\frac{I_0}{I_{1/y}} = r_{1/y} = 1 + \frac{1}{2y} (R + j\omega L) \frac{1}{y} (G + j\omega C) + \frac{1}{y} (G + j\omega C) \sqrt{\frac{\{(R + j\omega L) \cdot 1/y\}^2}{4} + \frac{R + j\omega L}{G + j\omega C}}$$

Here, also, when  $y$  is increased indefinitely,

$$\frac{I_0}{I_{1/y}} = r_{1/y} = 1 + \frac{1}{y} \sqrt{(R + j\omega L) (G + j\omega C)}$$

Let  $p = \sqrt{(R + j\omega L) (G + j\omega C)} = \alpha + j\beta$   
 then,

$$\frac{I_0}{I_{1/y}} = r_{1/y} = 1 + \frac{p}{y}$$

Therefore, if  $I_0$  is the current entering and  $I_1$  the current leaving a one-mile section of such a line infinitely long,

$$\begin{aligned} r &= \frac{I_0}{I_1} = \left(\frac{I_0}{I_{1/y}}\right)^y = (r_{1/y})^y = \left(1 + \frac{p}{y}\right)^y \\ &= 1 + y \frac{p}{y} + \frac{y(y-1)}{1 \cdot 2} \left(\frac{p}{y}\right)^2 + \frac{y(y-1)(y-2)}{1 \cdot 2 \cdot 3} \left(\frac{p}{y}\right)^3 + \text{etc.} \\ &= 1 + p + \frac{y(y-1)}{1 \cdot 2} \frac{p^2}{y^2} + \frac{y(y-1)(y-2)}{1 \cdot 2 \cdot 3} \frac{p^3}{y^3} + \text{etc.} \end{aligned}$$

When  $y$  is increased indefinitely,

$$\frac{I_0}{I_1} = 1 + p + \frac{p^2}{1 \cdot 2} + \frac{p^3}{1 \cdot 2 \cdot 3} + \text{etc.} = \text{Limit}_{y \rightarrow \infty} \left(1 + \frac{p}{y}\right)^y$$

Put  $p = 1$  in this expression, then

$$\begin{aligned} \text{Limit}_{y \rightarrow \infty} \left(1 + \frac{1}{y}\right)^y &= 1 + 1 + \frac{1}{1 \cdot 2} + \frac{1}{1 \cdot 2 \cdot 3} + \text{etc.} \\ &= 2.7183 \dots \end{aligned}$$

The sum of this series is denoted by  $e$  and is the base of natural or Napierian logarithms.

$$\text{i.e. Limit}_{y \rightarrow \infty} \left(1 + \frac{1}{y}\right)^y$$

Now,

$$\begin{aligned} e^p &= \text{Limit}_{y \rightarrow \infty} \left\{ \left(1 + \frac{1}{y}\right)^y \right\}^p = \text{Limit}_{y \rightarrow \infty} \left(1 + \frac{1}{y}\right)^{py} \\ &= 1 + py \frac{1}{y} + \frac{py(py-1)}{1 \cdot 2} \left(\frac{1}{y}\right)^2 + \text{etc.} \\ &= 1 + p + \frac{py(py-1)}{1 \cdot 2} + \text{etc.} \\ &= 1 + p + \frac{p^2}{1 \cdot 2} + \text{etc.} = \left(1 + \frac{p}{y}\right)^y \end{aligned}$$

$$\text{Hence, } \frac{I_0}{I_1} = r = e^p = e^{(\alpha + j\beta)} = e^\alpha \cdot e^{j\beta}$$

$$= e^\alpha / \beta$$

$$\text{or } \frac{I_1}{I_0} = e^{-\alpha} \sqrt{\beta}$$

In other words, the ratio of the magnitudes of  $I_0$  and  $I_1$  is  $e^\alpha$

$$\text{i.e. } \left| \frac{I_0}{I_1} \right| = e^\alpha$$

and  $I_1$  lags by an angle of  $\beta$  radians behind  $I_0$ .

It follows then that:—

$$|I_l| = |I_0| e^{-\alpha l}$$

and  $I_l$  lags behind  $I_0$  by  $\beta l$  radians,  $I_l$  being the current at a point  $l$  miles further from the sending end than the point at which the current is  $I_0$  in an infinitely long transmission line having uniformly distributed primary coefficients.

### PROPAGATION OF CURRENT AND VOLTAGE IN A TRANSMISSION LINE OF FINITE LENGTH, HAVING UNIFORMLY DISTRIBUTED PRIMARY COEFFICIENTS, IN TERMS OF SENDING END VOLTAGE AND CURRENT

A uniform transmission line can be regarded as a chain of simple symmetrical impedance sections. If each section is equivalent to a mile length of line, then the current,  $I_x$ , at a point  $x$  miles from the sending end can be determined from the expression obtained earlier, thus:—

$$I_x = I_s \frac{r^x + r^{-x}}{2} - \frac{V_s}{Z_0} \frac{r^x - r^{-x}}{2}$$

$$\text{But } r = e^p$$

$$\therefore I_x = I_s \frac{e^{px} + e^{-px}}{2} - \frac{V_s}{Z_0} \frac{e^{px} - e^{-px}}{2}$$

$$\text{Let } \frac{e^{px} + e^{-px}}{2} = \cosh px \text{ and } \frac{e^{px} - e^{-px}}{2} = \sinh px$$

$$\text{Then, } I_x = I_s \cosh px - \frac{V_s}{Z_0} \sinh px$$

$$\text{Also, } V_x = V_s \cosh px - I_s Z_0 \sinh px$$

These are the standard equations for the current and voltage in a uniform transmission line and include any effects of terminal mismatch.

### ACKNOWLEDGMENT

The author is most appreciative of the helpful suggestions given by certain members of the Training Branch.

# The Colour Printing of Line Plant Network Diagrams

C. D. LIPSCOMBE †

U.D.C. 655.3.024:912

The amount of information to be included on line plant network diagrams is, in some instances, so large that colour printing has become necessary to ensure legibility. The article gives a brief outline of the production of such diagrams with particular reference to the accurate registration between the various colour originals used.

## Introduction.

THE colour printing of maps and network diagrams depicting line plant and similar information relating to Post Office facilities has become not only desirable but in some instances a necessity. The increase in line plant has made it impossible, in certain cases, to include all the desired information on one linen tracing without the town names, etc., being partially obscured or alternatively being too small to be readable when the diagram is reduced to the required size. This situation was aggravated by the general adoption of stencil-guide lettering which not only needs more space than hand printing but also cannot be compressed to suit restricted positions.

Printing in colour offers the only satisfactory solution to these difficulties. It also permits the permanent features of the network, such as the coastline and town names, to be drawn on one linen, and the network details on another; this enables periodic review to be carried out with the minimum amount of work, as amendment and even re-drawing can usually be restricted to the network sheet.

Colour printing has also become desirable where various types of plant or other features have to be differentiated one from another.

## Methods of Printing.

The potentialities of the rotaprint machine<sup>1</sup> for multi-colour printing have been known since its introduction into the Post Office, and a trial job within the size limitation of the brief-size machine was therefore made. This proved that colour printing by this means, including photographic reduction from the original tracings, was a practical possibility. As most diagrams are larger than brief size an attempt was made to print a two-colour map on the true-to-scale table<sup>2</sup>, but because of the difficulty of attaining even a reasonable register, the time involved and the wastage due to a certain amount of unusable copies, it became apparent that printing by the offset lithographic printing process would be necessary; this type of printing has to be executed by commercial printers and contract arrangements were concluded through H.M. Stationery Office.

## CONDITIONS AFFECTING METHOD OF PREPARATION

The experience gained in earlier work made it increasingly evident that greater attention would have to be given to the accurate matching of detail on, and good registration between, the various originals during preparation. This was necessary to ensure, in the course of reproduction, a register sufficiently close for the final prints to be acceptable. The accuracy of the copies after the etched plates have been produced is affected by a number of factors during printing. Among these are the quality and condition of the paper used; the direction in which the paper in relation to its stretch is fed in the machine; the accuracy of the size of sheet, or its distortion after each colour impression has been printed; and the type of machine used. The dimensional stability of the material to be used for the originals, there-

fore, is important, not only during the initial period when the work is being prepared, but also during the ageing over a number of months, after which the next re-issue would have to be made.

As the method of preparation is determined by the necessity for a separate original for each colour, the choice of material is restricted to one that is transparent, thereby permitting each overlay to be positioned over the basic original during preparation. As is usual with this type of diagram, proof copies must be obtained in some form for the purpose of checking, outside the drawing office, before final printing. This is achieved by the use of a non-continuous photo-printing machine, in which the tracings and sensitised photo-copying paper remain stationary, while the arc-lamp traverses the surface to be printed. In this way any possibility of slip between the tracings, which would occur in a continuous copier, is avoided. Each colour original can be paired with the basic outline and printed, and if desired all the originals can be printed together, each colour being just distinguishable from others by a variation in density in its printed impression. Although by no means ideal this method serves the purpose sufficiently well.

## Tests of Various Materials.

Tests were made with a number of transparent plastic materials of the cellulose acetate and polyvinyl groups. The former has little if any better stability than tracing linen, but can be seriously affected by heat at as low a temperature as 100°F. This means that strong sun or the close proximity of a drawing-bench spotlight, or even the use of an electric erasing machine, can cause permanent local distortion. The polyvinyl group of materials, while having excellent stability, are so impervious to moisture that it is difficult to get any form of black drawing ink thin enough to flow in drawing instruments and stencil pens, and yet have enough body to remain sufficiently dense and adhere satisfactorily to the material. Various coloured inks have been tried, but they tend to thin out while drying and cannot be relied on to give consistent results. Until there is available a suitable ink which does not require a special technique in application for use with a polyvinyl material, all colour originals are being prepared on "double dull" pencil linen. This is the best quality tracing cloth obtainable, and is hung up and weathered for about two weeks before being used. With it is used artist's quality black drawing ink.

## Registration and Design.

Every effort is made to maintain accuracy and good register between the various colour originals comprising one job. To ensure this—particularly with the larger diagrams comprising the British Isles, which can be as large as 66 in. × 40 in. for a scale of 10 miles to one inch—a graticule of about 6-in. squares is ruled in a non-photographic blue drawing ink on all originals. This allows the local registration of selected parts of the diagram without the necessity of lining up the complete sheet by means of the registration crosses provided for the printer. Tracing cloth is extremely susceptible to moisture, expanding and contracting as much as  $\frac{1}{32}$  in. per foot according to the

† Senior Draughtsman, Transmission and Main Lines Branch, E.-in.-C.'s Office.

<sup>1</sup> P.O.E.E.J., Vol. 30, p. 227.

<sup>2</sup> P.O.E.E.J., Vol. 30, pp. 225 and 226.

prevailing humidity. This has to be taken into account in the design of diagrams, and the general layout and the separation of the total information into various colours has to be carefully considered in order to minimise the effect of this instability. The symbols used to depict towns, stations, line plant, etc., must also be chosen with care to avoid the necessity for extreme accuracy of registration.

The general layout must ensure that the basis of the diagram, which is usually the coastline and town names, will permit a certain amount of misregistration without the information to be shown in colour getting sufficiently out of place as to be incorrect. In deciding the separation of the information into various colours, care is taken not to separate closely related details as they would have to be disassociated on to the different colour originals with the same chance of misregistration. Towns, exchanges or repeater stations, according to the type of network being dealt with, usually connect up the various colours, or at least are terminal points of the coloured lines. As such, therefore, they have to "pull" the colours together by obscuring any misregistration that might occur. It will be seen from Fig. 1 that a solid black circle would permit a far greater degree of acceptable misregistration than an open circle consisting of even a moderately thick line.

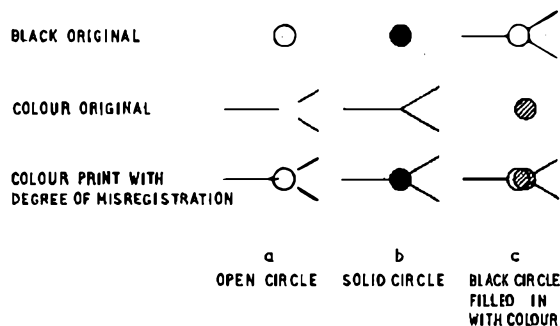

FIG. 1.—EFFECT ON REGISTRATION OF USING ALTERNATIVE SYMBOLS FOR A TOWN OR STATION.

Similarly, closely spaced parallel lines of differing colours, or one line made up of different colours to indicate various types of line plant, have to be avoided as the slightest misregistration will be apparent.

## Book Reviews

"The Watchmakers' Lathe and how to use it." Donald de Carle, F.B.H.I. N.A.G. Press Ltd., London, W.6. 154 pp. 210 ill. 30s.

Mr. de Carle is a well-known authority on horological matters and is the author of several works on the repair of watches and clocks.

Several chapters of this book are devoted to consideration of the basic design of watchmakers' lathes, with very full descriptions of the various types and their numerous accessories. One chapter describes in detail the method used in making certain watch parts utilising the special attachments for such operations as the cutting of wheel teeth, and pivoting.

The final chapter consists of a catalogue of practically every watchmakers' lathe on the market to-day with a brief specification and list of equipment for each. The book is richly illustrated with beautifully executed drawings.

To the engineer many of the terms used appear strange, but watch and clock making is an ancient craft with a jargon of its own.

The book will be of great interest alike to the amateur and to the professional watchmaker, although perhaps to the amateur there might appear to be not enough description of the uses of the various accessories, while the professional will probably regard it more as a very useful catalogue of lathes. For both it should prove a welcome addition to the bookshelf.

O. W. G.

The thickness of lines and the actual colour shades to be used have to be decided so that the significant information is given the correct prominence in contrast to the less important detail. For this reason it is not always advisable to print the coastline and towns in black, as black will obliterate any other colour over which it is printed. For map indexes or key plans it may be an advantage to print the sheet lines and numbers in black with the geographical details in dark red. In other cases the use of a colour instead of black can be used to subdue the effect of a thick coastline.

## Colours.

The question of the actual colours to be used presents some difficulty because there is no recognised standard range of lithographic printing inks except for the three- or four-colour process. The quoting of names, although giving a rough guide, can give no clear indication of the tint and density required. However, a system of specimens is being built up from off-cuts from printed sheets; these are being supplied as samples to provide a more accurate method of colour definition. The mixing of colours by the printer is more or less arbitrary, and it is found in practice that a proof must be run off to prove the colours.

## Recent Developments.

Experiments are now being made to print on a transparent polyvinyl plastic material so that basic maps such as county boundaries, map indexes, etc., can be used in conjunction with paper copies of detailed diagrams to associate information that has not been included in the diagrams. For this purpose the originals must be drawn to a standard map projection, and the copies must be printed accurately to scale. This is accomplished by drawing on the originals a datum line which must be reduced to a specified dimension during the photographic reduction.

## CONCLUSION

Owing to the cost of reproducing an illustration in colour it is not possible to include a specimen diagram with the article. Copies of a typical map, D43/20, printed in colour, are available to any interested reader on application to the Drawing Office, LM Branch, Engineering Department.

"Three-Phase Motors. Theory and Operation." T. F. Wall, D.Sc., D.Eng., M.I.E.E. George Newnes Ltd. 232 pp. 150 ill. 30s.

This book follows the lines of Dr. Wall's other publications and maintains the same high standard. The treatment is entirely mathematical and there is little or no descriptive matter. To this extent the sub-title, "Theory and Operation," is therefore misleading as the book is devoted to theory. All types of three-phase motors, including Schrage and Selsyn, are covered together with the Ward-Leonard and Kramer systems of speed control. The publishers claim that the book "will be found invaluable to designers, advanced students and professional engineers concerned in the efficient use of electric power." The author assumes that the reader is familiar with the basic theory of circle diagrams and with the design and calculations of magnetic circuits. The book should be of considerable value to students in the final year of a degree course specialising in A.C. machinery. The presence of a few of the diagrams, such as Fig. 5 on Page 11, is difficult to understand as their value is very questionable. Some confusion is likely to arise, particularly as chapters are short, because the diagram numbering starts afresh in each chapter. Expressing the output of motors in kW may be convenient mathematically but is not likely to find favour with professional engineers.

A. E. P.

# The Extraordinary Administrative Radio Conference, Geneva, 1951

U.D.C. 061.3:621.396

These notes give a brief outline of the main provisions of the agreement reached at the Extraordinary Administrative Radio Conference held in Geneva, 15th August to 3rd December, 1951.

## Introduction.

AT Atlantic City, 1947,<sup>1</sup> the Radio Conference revised the Radio Regulations which had been approved at Cairo in 1938.<sup>2</sup> These Regulations govern the working of radio services and include the planning of the frequency spectrum. The latter is, of course, a very difficult problem, since, although the frequency bands suitable for world-wide coverage are limited, the number of stations operating is increasing continuously. At Atlantic City a new Table of Frequency Allocations for that part of the spectrum 10 kc/s to 10,500 Mc/s (wavelength range some 30,000 metres to 3 cms.) was prepared, to take into account the developments in the several different Services and in techniques which had been achieved during the nine years since the Cairo Conference. The Services include Aeronautical, Maritime, Fixed, Broadcasting, Land Mobile, Standard Frequency and Amateur requirements. The new table differs appreciably from the Cairo table in several respects; in particular, more bands have been allocated exclusively to some Services as compared with the greater use of shared bands at Cairo, and the spectrum space allocated to particular Services has been changed considerably. Thus considerably greater spectrum space has been allocated to the Aeronautical Service at the expense of the Fixed Service. It will be appreciated, therefore, that the changeover from the Cairo to the Atlantic City Frequency Allocation Table presents a major problem because a very large number of operating stations will be called upon to change their frequencies and, for some Services, the total bandwidth in the new table is appreciably less than that in the old table.

It was agreed at Atlantic City that certain of the new Radio Regulations should come into force on 1st January, 1949, and that some of the more important Regulations, including the new Table of Frequency Allocations dealing with Services operating in the range 14 to 27,500 kc/s (wavelength range some 21,500 to 11 metres), should come into force upon the effective date of a new International Frequency List (I.F.L.) as determined by a Special Administrative Radio Conference. The new I.F.L. would provide assignments for all the stations operating in the band in question, and the Special Conference would be convened when such a list had been prepared. It was also agreed that the new I.F.L. would be prepared by a Conference dealing with High Frequency Broadcasting, by Regional Conferences dealing with allocations between 150 and some 4,000 kc/s in the three regions\* of the world, and by a Board designated the Provisional Frequency Board (P.F.B.), dealing with Services other than High Frequency Broadcasting in the ranges 14 to 150 kc/s and 4,000 to 27,500 kc/s. Unfortunately, for technical and practical reasons, attempts to prepare acceptable plans for High Frequency Broadcasting (Mexico City and Rapallo Conferences) and for the Fixed Service (range 4,000 to 27,500 kc/s) proved unsuccessful. However, generally acceptable plans were prepared by Regional Conferences for the band 150 to 4,000 kc/s and by the P.F.B. for the band 14 to

150 kc/s and for the Aeronautical and Maritime Mobile Services. The position in 1950 in respect of the Fixed and High Frequency Broadcasting Services was unfortunate because it made it impossible to prepare plans for all the Services from which a comprehensive new I.F.L. could be made for consideration and adoption by a Special Administrative Radio Conference, as had been visualised at Atlantic City some three years before.

Many Administrations, including the U.K., gave serious consideration to the general question of the most appropriate action to be taken in respect of the two difficult Services, and it was proposed to hold a Special Administrative Radio Conference at The Hague in the autumn of 1951. However, as the Conference opening date approached it was felt by some Administrations that the time was not opportune for a settlement of the problem and the Conference was postponed. Subsequently, constructive proposals for the Fixed and High Frequency Broadcasting Services were made and it was decided, early in 1951, to hold a Conference, to be known as the Extraordinary Administrative Radio Conference (E.A.R.C.) in Geneva from August to November, 1951.

The E.A.R.C. opened as planned on 15th August and sixty-three of the seventy-six countries represented signed an agreement on 3rd December, 1951, for the preparation and adoption of a new I.F.L., with a view to bringing into force the Atlantic City Table of Frequency Allocations between 14 and 27,500 kc/s. The agreement was not signed by the U.S.S.R. and associated countries. It is a relatively complicated document and only the general outline will be given here.

## NEW INTERNATIONAL FREQUENCY LIST

### Band 14 to 4,000 kc/s.

Plans for stations operating in this band were adopted and assignments will be transferred into their appropriate Atlantic City bands in accordance with the plans except for the exclusive aeronautical mobile bands, for which the frequency usage will be determined by allotment plans based on those prepared by the International Aeronautical Administrative Conference. The change-over for the lower part of the band in question will be made in the different Regions on various dates up to 1953, and subsequently for the higher part of the band.

### Band 4,000 to 27,500 kc/s.

*All Services.* It was not found possible to agree plans for the Fixed, Land Mobile and Broadcasting Services in this very important band, and it was decided, as from the date of signature of the Final Acts of the Conference, that, during an interim period, assignments of all Services in the band would be moved gradually into the appropriate Atlantic City bands by a process of voluntary adjustment. During this process the movement of Aeronautical and Maritime Mobile Service assignments, for which lists or plans were approved, would be to assignments in accordance with the approved plans or lists, as far as possible. It was agreed that each Administration would first reduce its out-of-band assignments as far as possible by interchanges between its own Services and would then collaborate with other Administrations in arranging suitable interchanges. When searching for new in-band frequencies for out-of-

<sup>1</sup> *P.O.E.E.J.*, Vol. 40, p. 175.

<sup>2</sup> *P.O.E.E.J.*, Vol. 31, p. 204.

\* The world is divided into three regions for purposes of frequency allocations of some of the bands; Region 1 comprising Europe, Africa, Outer Mongolia and the extra-European territory of the U.S.S.R.; Region 2 comprising the Americas; and Region 3 comprising Australasia and Asia except Outer Mongolia and the U.S.S.R.

band Services, Administrations would follow the customary procedure of requesting other Administrations to monitor a suitable frequency band in the area of reception. The International Frequency Registration Board (I.F.R.B.) would assist Administrations by making proposals for the transfer of out-of-band assignments and by the compilation, for publication by the Secretary General, of summaries of monitoring information to be supplied by Administrations. Administrations would facilitate the adjustment process by the supply of monitoring information, by slight adjustments of existing services, by the supply of information concerning their services, by the use of improved techniques, by limiting operational schedules and by increased sharing of assignments. Assignments transferred into band must not interfere with existing assignments. A similar procedure would be followed for new assignments.

No date was set for the completion of the voluntary adjustment process, but the Administrative Council is invited to review, at its session in 1955, the progress made during the interim period of adjustment and, if possible, to recommend a date on which final adjustments are to begin. It was agreed that the final adjustment would be carried out over a period of a few months, the whole band being divided into sub-bands, and that, starting with the highest sub-band, each sub-band would be cleared of out-of-band assignments and finally adjusted each month. During this final adjustment period the process of bringing Services into full conformity with such plans as have been agreed would be completed.

*Fixed, Land Mobile and Broadcasting Services.* Notwithstanding the result of the voluntary adjustment process, the final arrangement of frequency usage for the fixed, land mobile and high frequency broadcasting services will be determined by a future I.F.L., and the I.F.R.B. is asked to begin the preparation of a draft I.F.L. as soon as practicable. This draft will take into account the actual usage of the spectrum realised after the final adjustment process, modified where necessary to improve the exploitation of the spectrum, and will be submitted to an Administrative Radio Conference for adoption as the new I.F.L.

High Frequency Broadcasting assignments will be determined by plans, and the I.F.R.B. is asked to start the preparation of draft plans immediately. The adopted plans will be incorporated in the new I.F.L.

*Maritime Mobile Services.* The final arrangement of frequency usage for the exclusive maritime mobile bands will be determined by the agreed plans. For the interim period, before the start of the final adjustment period, a programme was agreed for clearing the ship bands of all out-of-band assignments by voluntary transfers. The programme comprises five stages, each applying to part of the Maritime Mobile Service, and the aim is to complete the first stage before 3rd June, 1953, to complete the second stage within six months of completing the first, and so on.

## Book Review

"Fluorescent Lighting." Edited by C. Zwikker. Philips Technical Library. 248 pp. 203 ill. 35s.

This is an English translation from the Dutch. It has been written by a team at the Philips Lighting Laboratory, Eindhoven. It deals with tubular fluorescent lamps of the mains voltage type and their applications. Luminescence, fluorescence, phosphorescence, suitable fluorescent materials, colour of the light, gaseous discharge, lamp construction, efficiency, standard switches and other ancillaries, suitable fittings, some fundamentals of lighting technology and applications of fluorescent lamps are covered very adequately.

The book has all the advantages of being prepared by a team and of production by a manufacturer and a few of the disadvantages. Every aspect of tubular fluorescent lamp

*Aeronautical Mobile Services.* The final arrangement of frequency usage in the exclusive aeronautical mobile bands will be determined by the adopted plans.

## FREQUENCY LISTS

It was agreed that the I.T.U. List of Frequencies (Berne List) will be brought up to date by publishing a final supplement which will include all notifications received up to 29th February, 1952. After that it will be replaced by a list detailing actual frequency usage (known as the Radio Frequency Record (R.F.R.)) until the complete new I.F.L. enters into force. The R.F.R. will include the assignments in the lists for the band 14-4,000 kc/s, the allotments and assignments in the plans for the Maritime and Aeronautical Mobile Services, frequencies for special purposes as laid down in the Radio Regulations, and the frequency assignments in the band 4,000 to 27,500 kc/s, actually used by Administrations to maintain their existing services over a complete solar cycle. The first edition will be published by 1st October, 1952, and it will be kept up to date by the publication of quarterly supplements.

## ENTRY INTO FORCE OF CERTAIN PROVISIONS OF THE ATLANTIC CITY RADIO REGULATIONS

Agreement was reached on the dates on which certain provisions of the Radio Regulations would enter into force, provisions very largely relating to procedure, use of frequencies and general conditions for the mobile services, service documents published by the I.T.U. and regulation of the quality of emissions.

## CONCLUSIONS

It will be appreciated that the impossibility of preparing assignment plans for the Fixed and High Frequency Broadcasting Services which occupy several sub-bands in the range 4,000 to 27,500 kc/s has complicated considerably the achievement of the containment of the various Services within their respective Atlantic City bands. Thus, for example, it is necessary to move some 30 per cent. of the existing Fixed Service assignments to make room for other services which have been allocated part of the Cairo Fixed Service Bands, but such moves can be made only slowly, in fact, as and when each out-of-band Fixed Service finds a suitable in-band frequency. The problem is also complicated by the need to ensure that radio communications are not appreciably degraded during the transition phase.

The ultimate success of the Geneva Agreement will be decided by the effective co-operation of the great majority of users of the spectrum. Given that co-operation, success can be achieved; without it, the way will be made more difficult and the goal may be impracticable.

C. F. B.

theory and design is very fully covered in a detailed and expert manner. The editing is much better than in many books written by a team; the changes in style are hardly apparent and there is very little repetition. The translation is excellent. The format, paper and production are almost luxurious to those accustomed to the austere text-books here. The book of course deals almost exclusively with Messrs. Philips' products and techniques and with their Continental practice. The bulk of the illustrations show their lamps and fittings. It is perhaps unfair to criticise the amount of space devoted to photographs of shop windows, show rooms, model kitchens, etc., showing applications of fluorescent lighting. The technical value of these illustrations is doubtful but they do not appear to have been included at the expense of more useful and relevant material. Some will doubtless find them refreshing and others distracting.

A. E. P.



# Notes and Comments

## Recent Honour

The Board of Editors note with pleasure that His Late Majesty the King approved the appointment as Aide-de-Camp (Supplementary Reserve) of Lt.-Col. C. E. Calveley, O.B.E., Assistant Staff Engineer, Central Training School, Stone.

### R. O. Carter, M.Sc.(Eng.), A.C.G.I., D.I.C., A.M.I.E.E.

Mr. R. O. Carter is to be congratulated on promotion to Staff Engineer in the Research Branch at Dollis Hill. He was an Imperial College scholar at the City and Guilds (Engineering) College, South Kensington, from 1923 to 1926, where he gained the following distinctions: Siemens Memorial Medal, A.C.G.I., B.Sc.(Eng.), with 1st Class Honours, and D.I.C. In 1928 he gained the M.Sc.(Eng.) degree.

On leaving college he entered the International Telephone and Telegraph Laboratories, Hendon, where he was engaged on a variety of problems arising in connection with the projected trans-Atlantic telephone cable.

In 1930 he went to the Research Laboratories of the General Electric Co., Wembley, and carried out some of the pioneer work on the development of the radio-frequency pentode. In 1931 he was appointed Assistant Lecturer in Telecommunications Engineering at the City and Guilds College. As the result of success in the Special Competition held in 1932, he entered the Post Office as an Assistant Engineer (Old Style) in March, 1933, and was appointed to the Research Branch at Dollis Hill. Here he was primarily concerned with sub-audio telegraph circuits in submarine cables and also with V.F. telegraph systems. In 1938, on his promotion to Executive Engineer, he took charge of the Electrical Group of the Research Branch and his work included studies of power induction and smoothing equipment for telecommunications power plant. During the war he carried out a number of special investigations for the Fighting Services, including various problems of speech transmission over submarine cables, arising in connection with the projected Allied invasion of France.

On his promotion to Assistant Staff Engineer in 1946, he was in control of the Telegraph and Postal Engineering Groups of the Research Branch, and during this time he was a member of the E.-in-C.'s Library Committee, and President of the Research Station Horticultural Society. In 1950 he was awarded the Mather premium by the I.E.E.

Carter combines modesty, a strong sense of humour, quiet efficiency and an infectious enthusiasm for any activity on which he or his staff is engaged. These qualities should ensure his continued success.

F. C. M.

### J. R. Tillman, Ph.D., A.R.C.S.

Dr. J. R. Tillman, who became Senior Principal Scientific Officer in charge of the Electronics Division of the Research Branch on the 12th February, 1952, received his University education as a Royal Scholar at Imperial College, London, becoming in 1932 a B.Sc. with 1st class honours and Prizeman in Physics, and also an Associate of the Royal College of Science. Two years' post-graduate research at the University in electron diffraction earned him a Ph.D. degree and a further two years as Beit Fellow on nuclear physics were distinguished by his discovery, with P. B. Moon, of thermal neutrons.

Entering the Post Office as a Probationary Assistant Engineer in 1936, he was engaged in the Research Branch first on cables and transmission measuring apparatus and later on mobile recorders, metal detectors for war purposes, valves and magnetic dusts. Returning in 1945 after a year on loan to the Telecommunications Research Establishment, he was first concerned with the design of a F.M. telegraph system, but, on promotion to Executive Engineer, he turned his attention to signalling problems. During this period he designed the 2-V.F. compound signalling receiver now being used for the C.C.I.F. trials of international signalling and similar equipment for the British national system. Appointed Principal Scientific Officer in 1946, he has since been concerned with such subjects as the transient response of networks, the physics of valves and crystal diodes and basic electronic switching techniques directed towards the production of an electronic exchange. He is the author of numerous papers dealing with his work.

A genial personality with an incisive mind and a wide knowledge and interest not limited to his official work, all who know him look to his future with confidence and wish him well in his new capacity.

T. H. F.

### Teleprinter Test Equipment

With reference to the Teleprinter Speed Tester, described on page 110 of the October, 1951, issue of the Journal, we are asked by Creed & Co., Ltd., to state that they consider that the arrangement falls within the scope of British Patent No. 505575.

## Institution of Post Office Electrical Engineers

### Essay Competition 1951/52—Results

A Prize of £5 5s. 0d. and an Institution Certificate have been awarded to the following competitor in respect of the essay named:—

J. C. Belcher, Technical Officer, Bradford (N.E. Reg.).  
"Radio Interference due to Non-linear Circuit Elements."

Prizes of £3 3s. 0d. each and Institution Certificates have been awarded to the following four competitors:—

T. A. Ferris, Technical Officer, Plymouth (S.W. Reg.).  
"Design and Manufacture of Quartz Crystal Oscillators."

J. Tippler, Technician Cl. IIA, Spalding (Mid. Reg.). "The Promotion of Telephone Mindedness."

T. S. Stephenson, Technician Cl. I, Newcastle (N.E. Reg.).  
"Use of Explosives for Post Office Engineering Works."

G. R. Patrick, Technician Cl. I, L.P. Reg. "Vacuum Steam Heating."

Institution Certificates of Merit have been awarded to:—

J. C. Glennie, Technical Officer, Wick (Scotland). "Operation 'Cross-talk.'"

R. S. G. Wooding, Technical Officer, E.-in-C.O. (L/M. Bch.).  
"The Transmission and Main Lines Branch Laboratory."

R. Grant, Technical Officer, Glasgow (Scotland). "The New Psychology and the Telephone Service."

W. K. Taylor, Technical Officer, Stranraer (Scotland).  
"Sixty Circuit Carrier System for use over Submarine Cables."

C. J. T. Ivatts, Technician Cl. IIA, E.-in-C.O. (L/M. Bch.).  
"Industrial Psychology."

The Council of the Institution records its appreciation to Colonel C. E. Calveley, O.B.E., Messrs. G. N. Davison and H. Leigh, who kindly undertook to adjudicate upon the essays entered for the competition.

H. E. WILCOCKSON, Secretary.

N.B.—Particulars of the next competition, entry for which closes on the 31st December, 1952, will be published later.

## Additions to the Library

2025 *The Mechanical Handling of Mails in Large Sorting Offices—British, Swiss and Netherlands Administrations (1952).*

This brochure has its origin in the action taken by the Executive and Liaison Commission of the Universal Postal Union to provide Postal Administrations with information about technical developments of all kinds in the postal field.

2026 *Earthing Principles and Practice.* R. W. Ryder (Brit. 1952).

Gives authoritative information on the theoretical and practical sides of the various problems of earthing large electricity supplies.

2027 *A.C. Machines.* H. Cotton (Brit. 1952).

Describes the principles and construction of all the main classes of alternators, A.C. motors and rotary convertors; only a slight knowledge of mathematics is assumed.

2028 *A.C./D.C. Test Meters.* W. H. Cazaly and T. Roddam (Brit. 1951).

Principles, design and construction of instruments of workshop grade for testing low-power apparatus.

2029 *Microphones.* B.B.C. (Brit. 1951).

Being the B.B.C. textbook for students and operational engineers employed at studio centres; assumes a basic knowledge of electrical engineering and A.C. theory.

2030 *Foundations of Wireless.* M. G. Scroggie (Brit. 1951).

Covers the whole basic theory of radio; no previous technical knowledge is assumed.

2031 *Application of the Electronic Valve in Receivers and Amplifiers. Vol. II.* R. G. Dammers, etc. (Dutch 1951).

Being the second part of the trilogy on valve application; deals with A.F. amplification, power amplification and power supply.

W. D. FLORENCE, *Librarian.*

## Junior Section Notes

### Birmingham Centre

The session just concluded has been notable for its varied programme of talks ranging from one entitled "Servicing Television Receivers," by a representative of E.M.I. Sales & Service, Ltd. (this was extremely popular and is likely to be repeated during the coming session), to that by the Curator of the Botanical Gardens, Birmingham, on "Flowering Trees and Shrubs." The visits during the session included an inspection of the equipment at the Gaumont Cinema and an outing to the South Bank Exhibition for members, their families and friends.

Mr. J. Taylor, Liaison Officer, came along to a recent Committee meeting to explain his duties and to find out any difficulties being experienced by the Centre. The Officers and Committee were very appreciative of Mr. Taylor's keen interest, not only in the programme but on our behalf at the Liaison Officers' Conference held annually.

At the Annual General Meeting the following members were elected to office for the 1952-53 session:—

*Chairman*, E. W. Newnham; *Secretary*, K. G. S. Adams; *Assistant Secretary and Librarian*, W. G. Johnson; *Treasurer*, A. C. Rotherham; *Committee*, A. E. Carpenter, B. W. Headley, F. G. Windsor, L. H. Oliver, F. Edmonds, J. H. Cockbill, and J. S. Kendall; *Auditors*, J. R. Ford and H. E. Dinnes.

A large number of suggestions are already being explored in connection with planning an ambitious programme of talks and visits. This is already increasing the membership and it is hoped that it will have the same effect on attendance at meetings, which is, on occasions, disappointing to those who put in quite a lot of work in making the necessary arrangements.

K. G. S. A.

### Tunbridge Wells Centre

The 1951-52 session has been a very successful one, the membership showing a steady increase in numbers, due, no doubt, to the many activities we have engaged in. Our Radio and TV Section is flourishing with a membership of approximately one-third of the total membership.

It is hoped to arrange a first-class programme for the 1952-53 session.

E. L. E.

### Portsmouth Centre (Isle of Wight Branch)

The 1951-52 session has been an interesting one, finishing with the April meeting at which the Regional Liaison Officer gave a talk on "Promotions and Appraisements."

The following visits are included in the proposed programme for the coming session:—

National Physical Laboratories, Teddington.  
Royal Aeronautical Display at Farnborough.  
Morris Motors, Cowley.  
London Airport.

A. J. E.

### London Centre

In presenting the following Annual Report, it is a matter of pride to record that the year 1952 will be a milestone in the history of the London Centre. Twenty years ago the Junior Section was founded and the following extract is from the *Post Office Electrical Engineers' Journal*, Vol. 25, Part 2, July 1932:—

"The Inaugural Meeting of the Centre was held at Denman Street on the 23rd May, 1932. The chair was taken by Mr. W. C. Burbridge, who welcomed Mr. Gomersall to the Meeting and invited him to address the gathering of 200 Members. Mr. Gomersall stated how in 1931 it was thought that it would be beneficial both to the Staff and to the Department to form a Junior Section, and he was very happy to see that the idea had materialised. The Junior Section would be a self-governed and self-supporting body, but it would be closely linked with the Parent Institution through its President.

After a brief account of the Inauguration, the Chairman stated that the enrolments for the London Centre now totalled 500. The President, Mr. C. W. Brown, gave the Inaugural Address, outlining the objects and aims of the Junior Section in promoting the advance of communication engineering among the Staff, the free inter-exchange and expression of ideas, and the advancement of their knowledge of the intricate work carried out by the Department.

In conclusion, the President made reference to Mr. Gomersall and his Staff in forming the London Centre which he felt sure would maintain the standard set by the Parent Institution."

In reading the reports of those past years, one is impressed by the enthusiasm and progressive spirit which has pervaded throughout the years, and there is no doubt that the talent and organising ability among the Members, Committees and Officers has led to the realisation of all those ideals laid down in the early days of the London Centre.

The programme for this session has been varied and extremely instructive, and it is pleasing to record the increased attendance at the Centre's Meetings. The Area Representatives, Secretaries and Committees have shown initiative in their lectures, the "quiz" and visits, and members owe them a debt of gratitude.

The Senior Section Library has been beneficial to our members. A study of the Centre's Librarian's Report will show how popular the periodical circulation is; our thanks to Mr. W. P. Skinner for carrying out his task so efficiently.

The Radio Groups have maintained steady progress and they excelled themselves during 1951 by presenting a London Centre Radio Exhibition at Waterloo Bridge House. This exhibition showed that a high standard of craftsmanship exists amongst the members. Thanks are due to the Radio Sub-Committee and in particular their energetic Secretary, Mr. L. W. Evans, for this superb display.

During 1951 a meeting was arranged by Mr. Greening, our Senior Section Representative, and Mr. Knox, of the Home Counties, between Junior Section Representatives from the Home Counties and the Officers of the London Centre Committee, the object of the meeting being the proposed Junior Section National Council. It is a matter of regret to report that our proposals were rejected; however, the Sub-Committee is still pursuing our ideas for this long-neglected project.

On behalf of the London Centre, deep appreciation is recorded to our Senior Section Liaison Officer for his advice and practical assistance during this session.

Congratulations and best wishes are offered to our retiring General Secretary, Mr. A. W. Lee, on his promotion to the rank of Assistant Engineer. Since 1948 Mr. Lee has managed the affairs of the London Centre. His consistent efficiency and eloquent speeches round the Committee table will be sadly missed.

Finally, it is a pleasure to record a membership of well over 3,200 and a sound financial position. This is a very good augury for the future. A. G. W.

### Kingston-upon-Hull Centre

This new Centre was inaugurated at a meeting held on Thursday, 30th April, in the Sports and Social Club of the Kingston-upon-Hull Telephone Department. This was a joint meeting of the Hull Corporation and Hull Post Office engineering staffs under the chairmanship of Mr. J. M. Markey (Area Engineer, York). The Chairman and other members of the I.P.O.E.E. Senior Section, including Messrs. H. A. Clibbon (Telephone Manager, York), T. Jordan (Executive Engineer, York), S. Saner (Training Officer, York), spoke about the aims and aspirations of the I.P.O.E.E. Junior Section. Representing the Hull Telephone Manager, Messrs. C. A. Price (Assistant Telephone Manager, Hull) and S. C. Gower (Equipment Engineer, Hull), addressed the meeting, Mr. Price expressing the hope that the I.P.O.E.E. would some day allow him and his colleagues similar facilities in the Senior Section as had just been accorded to his staff in the formation of a joint Junior Section. The meeting then decided by a unanimous hand vote that the new joint Junior Centre should be set up and the undermentioned officers were elected to serve the Centre for the year 1952-3:—

*Chairman*, Mr. E. Rackley (Hull Corporation); *Vice-Chairman*, Mr. J. Battarbee (Post Office); *Secretary*, Mr. L. Johnson (Post Office); *Treasurer*, Mr. R. Baker (Hull Corporation); *Committee* (four from Hull Corporation, three from Post Office), Messrs. Burn, Coates, Crossland, Hall, Owen, Rowland and Soper.

After the election of officers, two 16-mm. sound films were shown: "Aircraft Review" and "The Wealth of the World: Oil." Both proved entertaining and instructive.

As a new Centre, and the only joint one, there is, of course, much work yet to be done, but we feel confident to take our place with other Centres in the Junior Section. Within the Areas of the North Eastern Region, there has been many a Quiz in the past—any offers from outside our Region? L. J.

### Darlington Centre

On 25th February Mr. C. R. Harrison (Sales Superintendent) was the guest speaker and the subject, "Saints and Salesmen." The talk was most refreshing in that Mr. Harrison was in his element and had the happy knack of blending his discourse with a little humour. A most enjoyable discussion followed and the members dispersed with the feeling that a little more respect was due to the Sales Division.

A Red Letter Day for the Centre was 25th March. The occasion was the presentation of the National Award to Mr. B. V. Northall, and the Telephone Manager's prize to Mr. E. O. M. Grimshaw, with the guest speaker in the person of Mr. H. R. Harbottle, O.B.E. (the former President of the Junior Section), deputising for the President, who was unavoidably absent.

The Chief Regional Engineer, Mr. W. F. Smith, in handing over the National Award, described Mr. Northall's success as "a great achievement."

The Telephone Manager, Colonel J. R. Sutcliffe, presented his prize to Mr. E. O. M. Grimshaw and, in congratulating him, commented that he was present when the paper "Domestic Radio" was given and that it was outstanding.

Mr. H. R. Harbottle had for his subject "Training Economy"; his talk commanded close attention and a very lively discussion had to be curtailed by the Centre Chairman, Mr. Gosling, due to the late hour.

A very pleasing feature to record was the attendance of so many of our Centre members plus a sprinkling of Middlesbrough members. Mr. A. C. Pitcairn (Area Engineer), Mr. F. W. Allan



Photo by courtesy of "Northern Despatch," Darlington.

PRESENTATION OF NATIONAL AWARD TO MR. B. V. NORTHALL.

(Executive Engineer) and Mr. N. Burley (Executive Engineer) were present; a Senior Section meeting at Newcastle prevented others attending.

This meeting drew to a close another successful session for the Centre, and the Two-Way Quiz, Darlington v. Middlesbrough, has had to be carried over until the 1952-3 session.

One paper has been submitted for the National Competition. C. N. H.

### Middlesbrough Centre

The 1951-52 session programme should have ended with a "Quiz," but actually ended with a special meeting at Darlington on the 25th March, 1952, when an enjoyable talk on "Training Economy" was given by Mr. H. R. Harbottle, O.B.E. (Dollis Hill), preceded by presentations to Messrs. B. V. Northall (National Prize) and E. O. M. Grimshaw (Telephone Manager's Prize). Congratulations to our Darlington colleagues for carrying off the honours this time.

As an addition to the arranged programme of the Centre, we were invited to a Senior Section meeting on the 8th May, 1952, at the Cleveland Scientific and Technical Institute where, with Mr. A. C. Pitcairn (Area Engineer) in the chair, a lecture on "Call Queueing" was given by Mr. B. Winch (E.-in-C.'s Office) and Mr. F. Cox (I.T.D.). The lecture—aided by slides—was most informative and entertaining. Everyone showed particular interest in this new subject and it is felt that the field trial "Call Queueing" equipment will certainly get a useful test by the operating, traffic and engineering staffs of the Middlesbrough Area.

This meeting was a practical example of showing how co-operative and helpful our Senior Section is to us. Is it too much to hope that the Senior Section can put on a similar show at Middlesbrough each year? All Divisions of a Telephone Manager's Area have something in common with one another and the Engineer may be better understood and appreciated if he is able to tell others what he is doing or going to do, but in a less formal manner than appropriate in the conference room.

Our Annual General Meeting was held on the 15th May, 1952.

The following officers were elected for the 1952-53 session:—*Chairman*, D. Paterson; *Vice-Chairman*, W. J. Costello; *Secretary*, J. Brown; *Assistant Secretary*, G. Finch; *Treasurer*, R. R. Johnson; *Committee*, A. Bumis, H. Carr, P. Garrick, J. S. Gates, E. O. M. Grimshaw, J. Mansfield, E. E. Sparkes, D. L. Taman, W. E. Torbet, D. B. Oliver; *Auditors*, C. Kirkland, H. Walker.

It is hoped that another interesting programme will be arranged. We are pleased to report that attendance at meetings has generally been good during the session, but, nevertheless, we hope for some improvement. Meetings are more successful when there are "packed houses."

There are many members of the staff, particularly those on external duties, who are still not members of the Centre, and an appeal is made to them to enrol as soon as possible. Ask any of the Centre officials for particulars. J. B.

# Regional Notes

## South Western Region

### PECULIAR DUCT OBSTRUCTION—GLOUCESTER

An unusual form of duct obstruction was encountered during cabling operations in Southgate Street, Gloucester. The cane rods met a solid obstruction between a footway joint box J.R.F. 6 and a J.R.C. 3 on the main thoroughfare. The resultant excavation revealed that the duct was choked with a fungus formation resembling wood pith, grey in colour, and reproducing the inside of duct as in a mould.



FUNGUS FORMATION REMOVED FROM DUCT.

The obstruction was removed by tunnelling on both ends of the excavation, and lifting out three lengths of the empty duct. The growth was then pushed out of each duct. The fact that the fungus had grown into the spigot and collar joint prevented movement before the duct line was dismantled.

It is assumed that the presence of a reputedly old wooden Roman water pipe some 3 in. from the Department's duct provided humus to feed the spores. The presence of some moisture in the duct line no doubt provided favourable conditions for germination of spores, but it is a mystery why the germination should have taken place inside the duct at all. J. S. H.

### UNUSUAL DUCT OBSTRUCTION—DORSET/SOMERSET BORDER

Not very far from the Dorset-Somerset border in the Taunton Arca lies the hamlet with the intriguing name of Ryme Intrinseca, skirted by the main Dorchester-Yeovil Road, a Roman road through which runs the Dorchester-Yeovil main underground duct track. Here an unusual blockage was found in the two-way multiple duct.

The cabling contractors having rodded and roped the section attempted to pull through the cylindrical brush, but it jammed as though there might have been a dropped duct with a broken collar. Digging down to examine the cause it was found that the spare way was half blocked with a limestone deposit so hard and solid that it could not be removed. In appearance the deposit resembled the well-known granular limestone Portland stone.

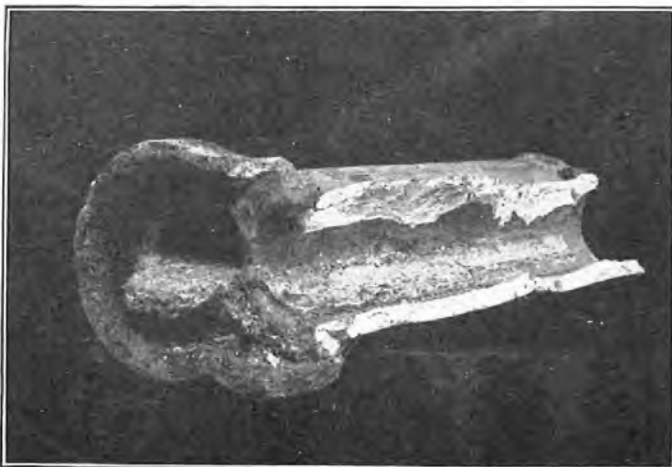

DUCT SHOWING LIMESTONE OBSTRUCTION.

It is believed that spring water charged with limestone particles entered the track some little distance from the deposits in the duct.

The clearing of the blockage was left to departmental staff as is usual in these cases. Several expedients were tried, but it was impossible to loosen the deposit. Cables in the occupied way were found to be encrusted in this limestone, it being possible that the charged water had been precipitating its particles since the laying of the duct twenty-one years ago.

It was finally decided to lay 350 yards of new track, seal the duct entries, and drain the jointing chambers to prevent water entering the track.

### SUBMARINE CABLE OPERATIONS AT COMPASS COVE, DARTMOUTH

On Wednesday, 23rd April, St. George's Day, the cable ship *Alert*, after a spell of duty in the Channel Islands in dull and boisterous weather, dropped anchor off Compass Cove. Weather experts were forecasting a change and, happily, this was borne out, for the next three days were summer-like with the sea as calm as a mill-pond.

The operation was in preparation for the laying of submerged repeaters in the two Channel Islands coaxial submarine cables later this year, and involved replacing the shore ends of the two cables with lead-covered paraggutta cable from a point below low water up to the cable hut, and jointing these cables on to the recently laid polythene land cables between the cable hut and Dartmouth R.S. As a separate part of the operation, an earth cable terminating at sea in a large steel earth plate, was to be laid and jointed at the cable hut to a power-type cable laid up to Dartmouth R.S.



TESTING ONE OF THE SHORE ENDS.

The two coils of coaxial cable, each of about 170 yards in length, and later the earth cable, were landed from boats lashed to form a raft. Headquarters and Regional Officers had some anxious moments when landing pick-a-back through the surf, but, thanks to the stout shoulders of the *Alert's* seamen, were safely put ashore dry-shod.

The cliffs at the landing point rise steeply to the cable hut, and then rise at a stiff climb for another 300 feet to the cable track leading to Dartmouth, but by setting up two cable winches at strategic positions it was possible to haul the three cables up the cliff to the cable hut and lay them in a newly cut track by 5.30 p.m. on Thursday, 24th. Three Man Works gangs supplied the physical effort, but without the winches this operation usually requires anything up to 50 strong men. On the same afternoon the *Alert* steamed out to lay some 1,600 yards of earth cable and to drop the earth plate overboard. By the evening of the same day the cable jointers from the *Alert* had completed one of the joints of the land cable.

The next day saw the completion of the joint between the second shore end and the land cable to the repeater station, and the three cables trenched and finally buried from the cable hut to the low-water mark. On the Saturday, with the weather still warm and the sea calm, the joints on the sea end of the shore cables were completed and the circuits transferred.

J. E. M.

## Welsh and Border Counties Region

### WALL PLUGGING BY "GUN FIRE"

An interesting mechanical aid, consisting of a patent gun on the lines of a humane killer and firing a 0.22 cartridge has been employed at the new Hereford telephone exchange. The building contractor was faced with the problem of fixing considerable lengths of wood batten to the walls and ceiling of the exchange battery room, to carry the lead-covered lighting and power cables. The wooden battens were merely held in position and the gun, loaded with a special steel spike with a counter-sunk head, was fired with its muzzle pressed against the batten. The spike was thus driven through the wood and plaster to penetrate the brickwork or concrete to a depth of approx.  $1\frac{1}{2}$  inches, leaving the head of the spike flush with the surface of the batten. With spikes inserted at normal intervals a test piece withstood the concerted efforts of several men levering with crowbars, the woodwork giving way before the steel spikes. Spikes can be supplied with the outer end threaded, for use where it is necessary to fix clamps, etc. The gun can be used to drive spikes into mild steel joists.

Considerable time saving over normal plugging methods is achieved and it is understood that this method is being used by some of the larger electrical contractors on all varieties of plugging work. R. E. R.

### MODEL C.B. EXCHANGE FOR ENGINEERING TRAINING

Hearing and seeing account together for most of what we learn, and successful teaching methods involve the use of diagrams, pictures, etc., in addition to the spoken word. To impart the detail of more complex subjects demands the use of visual aids, so that seeing plus hearing may produce the required believing. It was with this in mind that the model of C.B. exchange working was constructed by members of the staff of the Regional Training School, Penarth.

The model is 18 feet by 4 feet and is a working diagrammatic layout of the various 40V, C.B. circuits. In order that the circuits dealt with in lecture should be shown functioning, it was decided to demonstrate the progress of a call originated by a subscriber, passed on via an "A" position over a B/W junction to a universal "B" position and finally via an O/W keyless

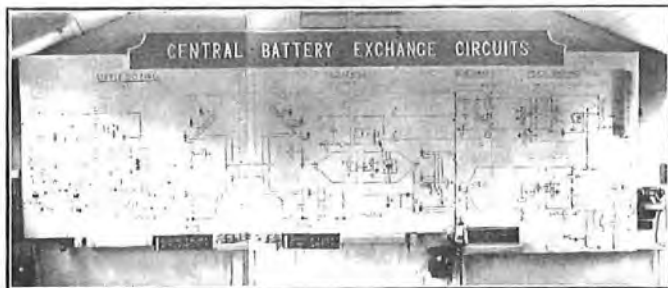

THE MODEL C.B. EXCHANGE.

ringing plug-ended junction to the required subscriber. This resulted in the layout shown, the various circuits being grouped under fictitious exchange titles.

The model has been constructed with sheets of hardboard and plywood which were painted and signwritten by the staff. At all the connection points normally shown on the relevant departmental diagrams, metallic terminal sockets are fitted. This facilitated the wiring of the circuits which are painted on the surface of the model. Some of the equipment (e.g. relays, capacitors, transformers) is fitted on mountings at the bottom of the board, whilst the remainder (e.g. meters, clock 44, speak and ring keys, O/W keys) is inset close to the associated symbol. The wiring is concealed so that the circuit diagram and equipment are not obscured. The model demonstrates clearly the operating procedure and the through circuit operation, in an interesting and convincing manner.

To further increase the practical value of the model, artificial faults may be introduced via test tablets fitted at the bottom of the board. By the insertion or removal of U-links, faults

may be simulated on any part of a circuit. The overall dimensions are such as to permit four students to work simultaneously, each on a section of the board. A Detector No. 4 or test lamp is used to prove the actual point at which a fault exists. The painted circuit diagram on the surface of the board obviates the need for reference to other diagrams.

The model is an example of initiative and resourcefulness of the demonstrators who built it and reflects much credit upon them. R. A. K.

### SWANSEA NEW BRANCH POST OFFICE

The new Kingsway office was opened for service to the public on the 22nd April and some comment on its electric lighting and heating installations may be of interest.

The building is of prefabricated construction, and to offset the disadvantages of the "broken" sloping ceilings the lighting scheme has been carried out in twin- and single-tube fluorescent fittings. With the colourful decoration scheme adopted for the public office a very pleasing lighting effect has been produced.

The heating system has features which are unusual in Post Office practice in that the boiler is gas fired. In consequence, its performance is to be studied for experimental purposes. The choice of a gas-fired boiler was largely influenced by the limited chimney-stack height and the proximity of taller office buildings, conditions which would have led to complaints from neighbours if a solid-fuel boiler had been used. The boiler room is sealed off from the main office and only reached by an outside door so that any danger from fumes or explosion is limited. Safety devices include a down-draught diverter in the stack pipe and an automatic cut-off in the supply to the burner, which operates when the pilot jet becomes extinguished. The working controls consist of thermostats in the office block and on the boiler flow main. They operate mechanically and so are independent of electricity supplies. An 8-day mechanical clock controls the operation of the boiler for a normal 6-day week to ensure that the heating is switched on or off shortly before the office opens or closes for business. Adjustments can be made to cover special conditions such as closures for Christmas Day, etc. Whilst the fuel costs are likely to be higher than for an ordinary solid-fuel boiler, it is hoped to achieve considerable savings on attendance costs and to provide a more even level of heating with this system. R. E. R.

## Midland Region

### TELEVISION CABLE FAULT

The first major fault on the London-Birmingham No. 4 cable occurred at 3.50 a.m. on Monday, 4th February, 1952, when alarms at Birmingham showed that all tubes were faulty and all control pairs earthing. On that date tubes Nos. 1 and 2 were in use for coaxial systems, tubes Nos. 3 and 4 were under test, and the 1-inch tubes Nos. 5 and 6 carried the television programme to and from Birmingham.

The fault was proved between Daventry and the next 3-mile repeater station at Dodford. Fortunately, whilst jointers were travelling to that section, a policeman reported three broken joint box covers and the maintenance officer was able to stop the jointers at the actual position of the fault.

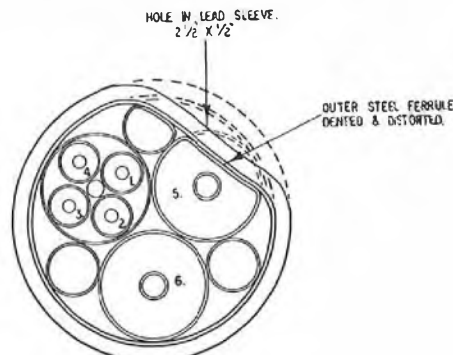

CROSS-SECTION OF CABLE AT FAULT.

A No. 6 footway cover was found smashed and the jagged edge of the broken centre bearer had pierced the lead sleeve, making a hole  $2\frac{1}{2}$  in.  $\times$   $\frac{1}{2}$  in. The box was full of water. The two adjacent footway covers were broken, but they had not damaged the cable.

At the fault, the outer steel ferrule of the television tube No. 5 was badly dented and distorted, so allowing water to enter the tube and to bypass the water barriers at either end of the joint.

Tube No. 6 was not affected, but water had entered the telephone tubes Nos. 1 to 4 apparently between the steel tapes and through the crimped seam in the outer conductors.

Power is normally fed over this section from Daventry to Church Stowe and Towcester and the fuses on tubes Nos. 1 to 4 had blown. Towcester was changed over to local power supply, and the wet and damaged tube No. 5 carried the morning television programme, but it was patched out with tube No. 6 between Daventry and Towcester for the rest of the day's programme.

By the evening three double lengths of coaxial interruption cable had been used to restore two telephone tubes and the No. 5 television tube. As Church Stowe has no local power supply a 2-kW mobile generator was sent there to restore service on the telephone tubes. A second 2-kW set was sent later to ensure a continuous supply.

During the night the cable was cut and found dry at 40 yds. uphill on the Birmingham side of the fault and at 100 yds. downhill on the London side. At the fault the joint was full of water, and water ran out of the tubes when the water barriers were taken off. It was later found that water had penetrated only 6 yds. on the uphill side.

A 140-yard length of the cable was then renewed and the damaged joint box replaced with a length of  $3\frac{1}{4}$ -in. steel pipe secured to the C.I. pipe with Clips, Jointing No. 1. Buried joint boxes were provided at the ends of the new length.

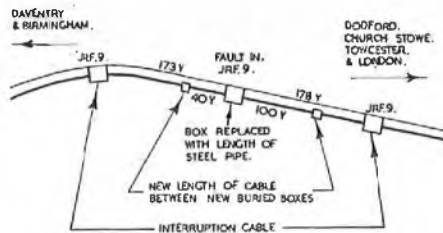

LAYOUT OF TRACK AT SITE OF FAULT.

The jointers concentrated on restoring television tube No. 6 in readiness for an outside broadcast in the Birmingham-London direction. This was ready when news of the death of H.M. the King was received by the jointers over a speaker circuit, and the consequent rearrangement of programmes upset the arrangements for releasing the cables. The interruption cables were cut out on the Thursday when testing commenced and full service was restored.

When the fault occurred the road was very icy and wheel tracks showed that large vehicles were running with their near-side wheels on the footpaths and grass margins. Exceptionally heavy and bulky loads are frequently seen on this road, and they have difficulty in passing in the narrower sections. This was demonstrated during the work by a 20-ton loaded tractor and trailer which travelled along the footpath between the jointers' tents to pass a large excavator travelling the other way.

As the result of the fault it was decided to replace all footway covers along the narrow section of road by reinforced concrete slabs buried just below the tarred gravel footpath. H. H.

#### LIGHTNING DAMAGE

On Easter Bank Holiday a lightning storm of only short duration but exceptional intensity passed over the Stoke-on-Trent Area. Over a score of small underground cables were damaged and a very unusual, if not unique, incident was the splitting of four consecutive poles in a line to a farm. As may

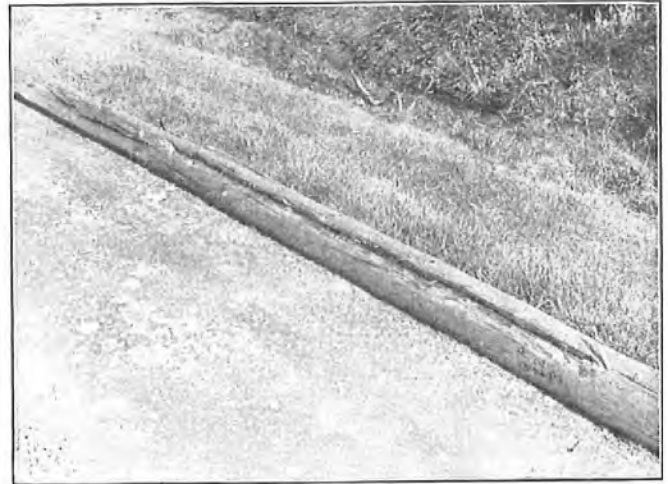

POLE SPLIT BY LIGHTNING.

be seen from the accompanying photograph one of these poles was badly splintered, but for some not very obvious reason the discharge, after it had reached the G.P.O. marking, did far less damage to the timber and left only a slight crack down to the ground line. G. R. S.

#### London Telecommunications Region

##### USE OF A MINE DETECTOR FOR TRACING BURIED PLANT

The tracing of buried footway boxes and manholes for an underground plant survey has been facilitated by the use of a mine detector borrowed from the military authorities.

In one estate where plant was provided while the footways were unmade, boxes were evidently covered with ashes in an intermediate stage, prior to the final finish of flags and asphalt margins. Three boxes were readily traced near their recorded positions under the asphalt. In other places, where boxes had been placed in grass, or unmade ground, and had become covered (in some cases assisted by garden throwouts, etc.), they were easily found, even where buried several inches deep.

A manhole cover was traced on a roadside margin under 9 in. of rough soil on a site covered with brambles, nettles and rubbish.

A carriageway oval known to exist at a gap in a roadside hedgebank between carriageway and field side footpath was traced at roadway level at a depth of 18 in. below the tarmac path and 2 ft. below the toe of the bank. The bank consisted mainly of dry builders' rubbish from the houses opposite, but the blocks in the cover were so rotten that a crowbar used in exploring the excavation went right through the cover in at least two places. If further encouragement had not been forthcoming from the indications of the detector, the site might have been abandoned. The footpath alongside appeared to have a clinker foundation as no silent spot could be found. The time taken at this site, including excavating a hole to the depth of 2 ft., sufficient to identify and fix position of the cover, and temporary filling in, was under an hour.

Success in locating plant depends on the absence of other undertakers' plant or metal from the immediate vicinity, and on the desired plant having a sufficient bulk of metal. Clinker is troublesome, but it can be overcome if the plant is at shallow depth. Objects, such as old tins and rusty nails, are easily found by the detector, but the difference between the response obtained from such small objects and a buried cover is quite distinct.

When dealing with finished surfaces, no other item is required at the time except perhaps a piece of chalk. Under grass or unmade surfaces a spade is essential; it enables suspected position to be investigated right away and confirmed, or search made elsewhere.

Besides outdoor uses, the mine detector may be useful sometimes inside buildings, e.g. for tracing cables, etc., buried under plaster, and for indicating the absence or presence of services where it may be necessary to cut through walls. Tests

made inside a house indicated that, in the absence of other metal, the detector could be used to locate the positions of beams through the floor coverings—even the positions of wall ties in a cavity wall.

If the search coil unit of a mine detector could be associated with the new Amplifier No. 55A\* the usefulness of this very compact item could be extended as the tracing of cables and of boxes *en route* could be done with accessories to the same piece of equipment.

A. F. T.

### Scotland

#### FITTING OF THE 100,000th TELEPHONE IN THE SCOTLAND WEST AREA

On 12th May, 1952, a small party, including Press representatives, assembled at Drumardoch Sheep Farm, near Callender, Perthshire, on the occasion of the bringing into service of the 100,000th telephone in the Scotland West Area.

Mr. Bucknall, Telephone Manager, in a short speech, referred to the growth of the Area's telephones from 50,000 in 1938 to the present 100,000, with another 10,000 applicants on the waiting list. He said that farmers featured prominently in the Area and, despite their high priority, had to wait lengthy periods for their telephones. Col. Forman, the owner of Drumardoch Farm, had made his application just over two years ago.

The Provost of Callender also made a short speech. Col. Gardiner, Regional Director, then formally presented Col. Forman with his telephone and invited him to make his first call at the Department's expense. Col. Forman replied suitably and, after he had made his call, invited the party to tea at a local hotel.

The farm is situated about 800 ft. above sea level in the hills north of Callender, some two miles from the nearest public road. Service is shared with a neighbouring farm, 16 new poles being required to connect with the existing line.

J. H. R.

#### AUTOMATIC TELEPHONE EXCHANGE DEMONSTRATION SETS

Many members of the press and public were shown around the new Fountainbridge building (containing a 7,000-line Director, D.A. Tandem, ENG suite, and new Joint Trunk exchange) during its opening phases in March and April of this year. On short visits such as these, it is difficult to avoid giving a confused picture of the operation of the automatic system and the two demonstration sets, described briefly below, were built locally to assist in describing the operations a little more clearly.

One set consisted of self-contained working models of a non-director and a director exchange mounted side by side.

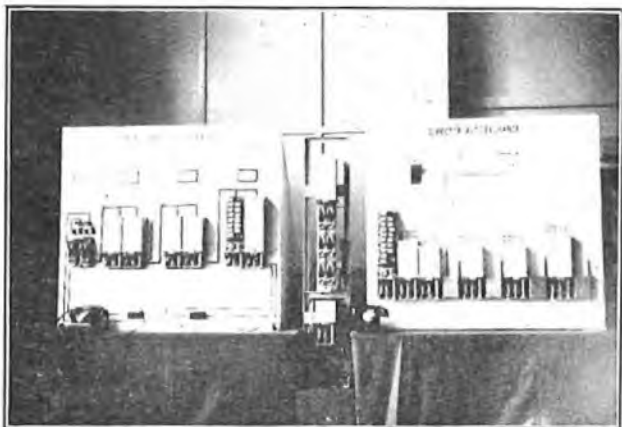

WORKING MODELS OF DIRECTOR AND NON-DIRECTOR EXCHANGES.

All facilities associated with these systems, from the setting up of a call to the application of forced release conditions, could be conveniently demonstrated. Two additional facilities were found to be useful; the commencement of the pulsing out by the director could be put under the control of a key to allow

the demonstrator to show the pulsing in and out more clearly; and an alternative translation for the same dialled code could be switched in by another key to show how translation could be varied at will.

The whole set was mains driven, power, tones, 10 I.P.S. and time delay pulses, etc., being provided by a small power unit mounted on trolley wheels.

The other set consisted of a ground glass panel on which a call through a director exchange was automatically built up in slow motion in the form of pictorial trunking diagram by means of small lights. The set was designed primarily to be unattended and each phase of the call, from the lifting of the

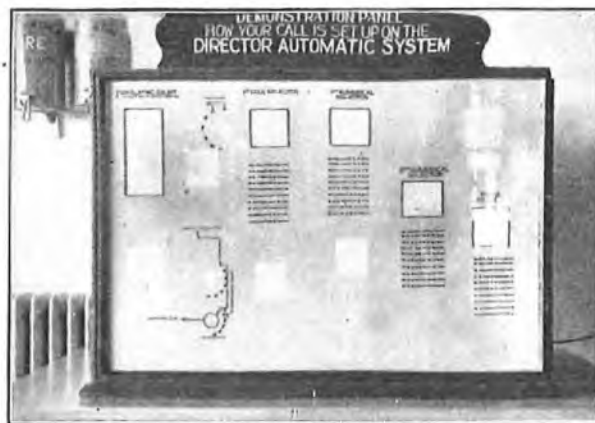

DISPLAY PANEL ILLUSTRATING SETTING-UP OF A DIRECTOR CALL.

calling handset to that of the called subscriber answering, was accompanied by a "running commentary" in the form of illuminated legends which appeared from behind at the appropriate time and in the appropriate position on the diagram. As each legend appeared, the process was delayed sufficiently to allow the notice to be read. The stepping of wipers and the general principle of "hunting" was depicted by a travelling illuminated arrow. The pulsing in and out of the director was simulated by means of fast-moving shadows progressing along the lighted trunking at the appropriate times.

The mechanism operating this panel was self-contained in the cabinet housing the panel. It consisted essentially of a Siemens 17-type, 16-bank switch stepping with 1-second pulses obtained from an "XYZ" chain of relays, the banks being wired to bring in the appropriate lamps and legends. The delay periods were provided by cutting the drive, and the timing of the delay was obtained from a small two-valve univibrator circuit. The setting of the univibrator for the required length of delay (2, 5, 10 or 15 seconds) for the particular notice was selected on one of the banks of the Siemens switch. The imitation of dialling impulses passing along the trunking was obtained by wiring the lamps, constituting the trunking chain, to the banks of a standard uniselector which self-drove at the required times and shunted each lamp in turn.

J. J. L.

### Home Counties Region

#### NORWICH—INTRODUCTION OF MULTI-METERING

On 3rd April, 1952, multi-metering was introduced at Norwich non-director auto-exchange, when subscribers were given direct dialling access to 37 U.A.X.s and six manual exchanges in the multi-fee area. This was part of a major scheme involving the connection of a further 17 exchanges to selector levels for trunk and toll tandem dialling access, and a normal multiple extension of 1,200 lines. At the same time Thorpe satellite exchange was extended by 200 lines and converted to satellite discriminator working. Some 273 circuits over 43 routes up to 15 miles and 166 circuits on 17 routes over 15 miles were connected to selector levels.

Previously, eight single-fee exchanges were available to Norwich subscribers on level 4 and a further 15 exchanges were spread over levels 5, 6, 7 and 8 for U.A.X. tandem dialling access. Since level 8 was allocated for the new 3-digit multi-metering codes, the existing level 8 had to be cut out of service at an early stage in the installation.

\* P.O.E.E.J., Vol. 44, p. 127.

All existing routes were teed and the new routes were connected to selector levels one week before the changeover, and U.A.X. tandem dialling was suspended. At the same time, cord circuit modifications to provide guarded metering were completed at the six manual exchanges.

It was not possible to strap both the old and new dialling codes on the multi-metering sets at the U.A.X.s without considerable overlapping of codes. The work of re-strapping at U.A.X.s, therefore, was arranged to take place after the main changeover during a period of approximately six weeks.

Although the introduction of multi-metering coincided with a new issue of the directory, it was decided, experimentally, to issue Norwich subscribers with a new type of dialling code card which can be folded and inserted in the tray of the telephone instrument. U.A.X. subscribers are being issued with the standard dialling code list.

R. M. M.

#### DYMCHURCH EXCHANGE

In September, 1951, conditions arose which made it necessary to replace Dymchurch exchange (3 position C.B.S. No. 2 with 260 subscribers) by the end of February, 1952. The provision of a U.A.X. 14 was already in the planning stage and building had commenced, but it was impossible to complete by the required date. Consideration was given to the following methods of meeting the situation:—

- (1) Provision of another C.B.S. exchange in a hut or similar accommodation. Difficulties in staffing and welfare made this impracticable.
- (2) Splitting the exchange area into two, one-half to be served by a mobile U.13, and the other by a mobile U.12 located at St. Mary's Bay. This scheme involved numbering complexities and would be expensive.
- (3) Provision of a U.13X.

Scheme No. 3 was decided upon, the planned operation being as follows:—

Provision was to be made of 200 multiple by a mobile U.13 and of a further 100 multiple by using equipment to be installed in an adjacent hut. To provide for conversion of coin box lines and P.B.X.s, 21 Units Aux.Appts., and a power plant consisting of two 12-V car batteries and a rectifier were to be located in the hut. All U/G cables were to be diverted to the A trailer and working lines returned to the old exchange via break jacks located in the A trailer, and a 300-pair tie cable. Links between trailers and hut were to be provided by E.S. and W.C.Q. cables.

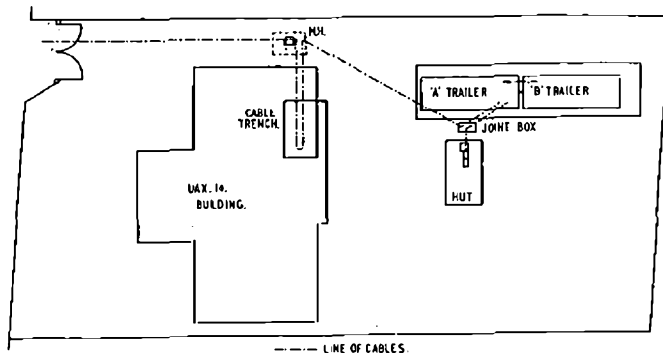

LOCATION OF TRAILERS AND CABLING ARRANGEMENTS.

The hut was completed by the builders on 7th December, 1951, and 2A and 1C units were moved in under difficult conditions.

The E.S. and W.C.Q. cable was not available, so the links between trailers and hut were provided by plastic switchboard cable, which had been obtained from various parts of the country as the result of an S.O.S. Considerable saving in pairs was made, by wiring the junctions as unidirectional only. Plastic cable was also used for the ringing and tone leads, pairs being double-banked where necessary.

Difficulty in obtaining paper-core cable necessitated a revision of the U/G arrangements to dispense with the tie

cable; however, the bulk of the working lines were cut in and out of the mobile unit by the wise use of spares and back ends, and only a small number had to be teed. The jointing group worked under very bad conditions, due to the fact that Dymchurch is largely below high water level and has an antiquated sewage system. This resulted in sea water flowing back through the sewers at high tide, and finding its way into the manholes. A motor-driven floodgate pump was necessary to keep the water down to workable limits.

The area serves a large rural district and contains many long overhead routes, and some 120 of the 260 subscribers' lines were below reasonable insulation standards. Gangs worked in all weathers to clear them by transfer date. On 30th January, 1952, overall tests of the auto equipment were commenced; also the modification of 80 equipments for shared service, separate metering and the provision of multiple jumpers. The cutting-in of working lines was completed by the jointing group on 8th February, 1952, and dial speed testing and conversion of coin box and P.B.X. equipment was then commenced. Subscribers conversion work, dial speed testing, and low insulation faults were completed on 27th February, and the transfer was effected on 28th. There were two transfer faults, both on overhead lines.

J. R. M.

#### THE USES OF A MINE DETECTOR

Experiments with a mine detector equipment have recently been carried out in the Colchester Area and the set has been found useful for the following purposes:—

- (a) Locating nails and other metal objects in poles before cutting up.
- (b) Checking for joists and girders in concrete floors of buildings prior to cutting holes.
- (c) Locating the position of conduits in floors and walls.
- (d) Checking the track of underground cables and conduits.
- (e) Checking the depths of cables and conduits.
- (f) Locating the position of empty conduits by using a continuous steel rod.
- (g) Locating earth and disconnection faults on P.V.C. 1-pair cables.

Experiments are also being made in locating faults on aerial cables and no doubt other uses will arise.

The detector is an instrument designed to give audible warning of the presence of metal objects, such as buried mines. In use, a whistle is heard in a pair of headphones when the search coil of the detector is passed over the mine. The detector consists of two parts—the search coil and the oscillator/amplifier. The search coil is assembled in a flat case at the end of a handle and the oscillator/amplifier in a metal case carried in a satchel.

The principle of operation is as follows. The electro-magnetic coupling (mutual inductance) between two coils will change if a conducting body is brought near them. This effect is even more pronounced if the body is of ferromagnetic material. The amplifier is coupled to the oscillator by mutual inductance and by a capacitance which is adjustable so that the total coupling can be made zero. When the coils are brought near a conducting or magnetic object, the change in mutual inductance upsets the balance between the two couplings and a note is heard in the headphones connected in the output of the amplifier.

The coil system consists of two overlapping circular coils mounted horizontally at the end of the handle. One coil forms part of the oscillator circuit; the other forms part of the input circuit to the amplifier. In the top of the handle are mounted two trimming capacitors which are used to produce a silent point in the headphones. In practice, it is not possible to get absolute silence owing to the harmonics produced by the oscillator, and the detector cannot be made more sensitive by increasing the amplifier gain beyond the point where harmonics are of appreciable loudness.

A switch has been fitted to cut out the oscillating circuit when required and by using a tone on the cable, etc., the set becomes a highly amplified search coil with extremely fine direction-finding capabilities.

H. C.



# Staff Changes

## Promotions

Name	Region	Date	Name	Region	Date
<i>Exec. Engr. to Senr. Exec. Engr.</i>			<i>Asst. Engr. to Exec. Engr.</i>		
Evans, H. E. .. ..	L.T. Reg. .. ..	29.11.51	Murray, F. .. ..	N.E. Reg. to E-in-C.O. ..	1.3.52
Marshall, W. J. ..	E-in-C.O. .. ..	2.3.52	<i>Tech. Offr. to Asst. Engr.</i>		
Smith, W. J. .. ..	E-in-C.O. .. ..	13.2.52	Wood, P. R. C. ..	E-in-C.O. .. ..	16.2.52
Stewart, A. D. ..	E-in-C.O. .. ..	4.4.52	Prince, J. A. C. ..	E-in-C.O. .. ..	26.1.52
Jemmeson, A. E. ..	N.E. Reg. to E-in-C.O. ..	4.5.52	Tucker, E. P. ..	L.T. Reg. to E-in-C.O. ..	15.3.52
Palmer, R. N. .. ..	W.B.C. Reg. .. ..	12.5.52	Hunter, R. S. ..	L.T. Reg. to E-in-C.O. ..	3.5.52
Guy, L. .. ..	Scot. .. ..	18.5.52	Lock, D. C. A. ..	L.P. Reg. to E-in-C.O. ..	3.5.52
<i>Senr. Draftsman to Senr. Exec. Engr.</i>			<i>Draftsman Cl. 1. to Asst. Tfc. Supt.</i>		
Mulvey, G. P. .. ..	E-in-C.O. .. ..	1.4.52	Edwards, P. W. ..	E-in-C.O. to H. C. Reg. ..	17.3.52

## Transfers

Name	Region	Date	Name	Region	Date
<i>Senr. Exec. Engr.</i>			<i>Exec. Engr.—continued.</i>		
Harris, R. J. .. ..	E-in-C.O. to Admiralty ..	1.3.52	Tod, D. S. .. ..	E-in-C.O. to P. & T. Dept., Malaya .. ..	22.8.52
Mahe, W. S. .. ..	E-in-C.O. to L.T. Reg. ..	3.3.52	Haward, J. W. G. ..	E-in-C.O. to L.T. Reg. ..	28.4.52
Lovegrove, L. W. ..	E-in-C.O. to H.C. Reg. ..	1.3.52	Burton, R. N. .. ..	E-in-C.O. to P. & T. Dept., Sudan .. ..	27.12.51
Crow, D. A. .. ..	E-in-C.O. to Admiralty ..	1.4.52	<i>Asst. Engr.</i>		
Ellis, H. O. .. ..	E-in-C.O. to P. & T. Dept., Nyasaland .. ..	25.8.49	Partridge, J. E. ..	E-in-C.O. to Min. of Civil Aviation .. ..	28.4.52
Taylor, T. A. .. ..	H.C. Reg. to E-in-C.O. ..	1.1.52	Needham, F. .. ..	Scot. to E-in-C.O. ..	1.4.52
Adams, W. E. .. ..	Scot. to E-in-C.O. ..	6.5.52	Iles, A. R. .. ..	L.T. Reg. to E-in-C.O. ..	7.4.52
<i>Exec. Engr.</i>			Clarke, G. E. .. ..	E-in-C.O. to H.C. Reg. ..	1.5.52
Gordon, J. C. .. ..	E-in-C.O. to Scot. ..	21.1.52	<i>Senr. Draftsman</i>		
Faulkner, A. H. ..	E-in-C.O. to P.M.G.'s Dept., Australia ..	20.3.52	Martin, T. .. ..	E-in-C.O. to L.T. Reg. ..	4.5.52
Gerry, P. R. C. ..	E-in-C.O. to H.C. Reg. ..	1.4.52			

## Retirements

Name	Region	Date	Name	Region	Date
<i>Regl. Engr.</i>			<i>Asst. Engr.—continued.</i>		
Hannaford, F. S. ..	N.W. Reg. .. ..	30.4.52	Bourne, E. J. .. ..	L.T. Reg. .. ..	21.3.52
<i>Senr. Exec. Engr.</i>			Blower, W. M. .. ..	Mid. Reg. .. ..	20.3.52
Linck, H. C. A. ..	W.B.C. Reg. .. ..	11.5.52	Laidler, W. .. ..	N.E. Reg. .. ..	29.3.52
<i>Exec. Engr.</i>			Marsden, B. .. ..	N.E. Reg. (Ill health)	15.2.52
Glenn, B. .. ..	Mid. Reg. .. ..	31.3.52	Gates, G. F. W. ..	L.T. Reg. .. ..	30.4.52
Hepplestone, H. ..	N.W. Reg. .. ..	31.3.52	Horner, W. .. ..	N.E. Reg. .. ..	26.5.52
Brogden, A. E. ..	E-in-C.O. .. ..	9.3.52	Walker, W. .. ..	E-in-C.O. .. ..	30.5.52
Powell, S. J. .. ..	H.C. Reg. .. ..	31.3.52	Robertson, A. ..	Scot. .. ..	31.1.52
<i>Asst. Depy. Engr.</i>			Lush, A. .. ..	H.C. Reg. .. ..	1.2.52
Wilson-Jones, D. ..	E-in-C.O. .. ..	30.1.52	Lamper, F. .. ..	H.C. Reg. .. ..	2.3.52
<i>Asst. Engr.</i>			Goodwin, W. O. L. ..	H.C. Reg. .. ..	26.3.52
Kriegal, A. A. .. ..	E-in-C.O. .. ..	29.2.52	McEwen, M. .. ..	L.T. Reg. .. ..	29.5.52
Hazlewood, H. A. S. ..	E-in-C.O. .. ..	29.2.52	Jardine, C. T. .. ..	Scot. .. ..	1.4.52
			<i>Inspector</i>		
			Hall, W. .. ..	N.W. Reg. .. ..	3.6.52
			Day, W. S. C. .. ..	H.C. Reg. .. ..	1.2.52
			Nichols, F. J. E. ..	H.C. Reg. .. ..	6.3.52

## Resignations

Name	Region	Date	Name	Region	Date
<i>Senr. Exec. Engr.</i>			<i>Exec. Engr.</i>		
Lawton, J. .. ..	E-in-C.O. .. ..	29.2.52	Green, R. .. ..	E-in-C.O. .. ..	26.4.52

## Deaths

Name	Region	Date	Name	Region	Date
<i>Asst. Engr.</i>			<i>Inspector</i>		
Fowler, W. W. .. ..	L.T. Reg. .. ..	18.3.52	Scammell, E. A. ..	L.T. Reg. .. ..	14.3.52
Newton, A. W. .. ..	E-in-C.O. .. ..	4.4.52	Prentice, W. A. ..	L.T. Reg. .. ..	17.3.52
Ellis, G. P. .. ..	L.T. Reg. .. ..	4.4.52	Lloyd, R. J. .. ..	W.B.C. Reg. .. ..	19.2.52
Holmes, C. W. .. ..	L.T. Reg. .. ..	19.4.52	Maxwell, H. .. ..	Scot. .. ..	21.4.52
Blower, L. I. .. ..	L.T. Reg. .. ..	19.4.52			
Rayment, A. O. ..	S.W. Reg. .. ..	21.5.52			

## Book Reviews

"Transformation Calculus and Electrical Transients." S. Goldman, Ph.D. Constable & Co., Ltd. 439 pp. 30s. net.

This book discusses the mathematical analysis of problems involving the transient response of linear electrical systems. It is well known that the calculation of the steady-state characteristics of such systems is formally straightforward; but the calculation of the transient characteristics is more involved, and may demand the application of difficult mathematical theory. The analysis in this book has been based upon the Laplace integral; and the associated transform theorems and their corollaries have been called the "Transformation Calculus."

The earlier chapters outline the methods of establishing and solving networks equations and the problems discussed involve bridge, amplifier and transmission circuits, etc. If the reader has an elementary knowledge of complex numbers, determinants, calculus and differential equations, he will not find these chapters difficult to understand. The later chapters, however, discuss impulse problems which arise in the development of television and radar systems; and certain theorems are used which may make great demands upon the reader's mathematical understanding. These difficult theorems, when interpreted operationally, form the basis of Heaviside's symbolic calculus.

The author of this book, following Heaviside, does not believe in wasting time over questions of rigorous mathematical proof. Consequently, his discussion of subtle mathematical theory is often bright and entertaining. For example, after pointing out in Chapter 5 that the study of the theory of functions of a complex variable amounts essentially to a study of a pair of real functions which satisfy the Cauchy-Riemann equations, he warns the reader that . . . "he should not get the impression that the quantity  $\sqrt{-1}$  is introduced purely as a convenient and shorthand method of notation." He adds a footnote with the equation  $e^{j\pi} = -1$ , and points out that no matter how you boil down and explain this equation, which relates four of the most remarkable numbers of mathematics, it still has a certain mystery about it that cannot be explained away. The reader, after finding that this equation leads him to write  $\pi = \log(-1)/j$ , will probably agree with the author without further argument.

In Chapter 7 the relationship between Laplace and Fourier transforms is discussed and methods of using Campbell and Foster's table of Fourier pairs (Bell System Monograph B584) are explained and illustrated by practical examples. The

Chapter on Bessel Functions is clearly set out and will be appreciated by engineers; and so will the concise account of asymptotic series solutions of transmission line problems in Chapter II. To anyone who is ambitious to master the modern approach to electric circuit theory, this book can be warmly recommended.

H. J. J.

"Radio Installations and their Design and Maintenance." W. R. Pannett, A.M.I.E.E. Chapman & Hall. 454 pp. 244 ill. 45s.

This book, so far as is known, is unique in the very large quantity of literature which is already available dealing with various aspects of radio engineering, as its whole theme is to instruct the reader how to install radio apparatus, make it work, and keep it functioning satisfactorily.

It is not intended for the seeker after information about the more abstruse points of any particular facet of the subject, but is written to appeal mainly to the engineer in the field who has to contend with such diverse factors as floor loadings, local bye-laws or the broad outlines of single side-band working.

In very general terms the book deals with such aspects of the subject as sites and buildings, including station layout, radio equipment, power supplies, including prime-movers, line equipment, radio control centres, etc.

The various systems of radio telegraphy transmission are described briefly, and terminal and privacy equipment for radio telephony are mentioned. One would have liked to have seen a fairly large section dealing with aerials, although it may be argued that external construction work is not appropriate to a volume dealing primarily with "Installations." The introduction of power balance sheets in the treatment of radio senders is to be particularly commended, but the reader may well be surprised that single side-band systems have not been treated more fully when the amount of such equipment already installed is considered.

The final chapter dealing with station maintenance and component testing contains much useful information of a type rarely found in text-books, for example, care of valves and rotary machines and how to test transformer oil. An appendix contains many useful conversion tables. No bibliography is included, which is scarcely surprising considering the scope of the book.

Altogether this volume should be a valuable acquisition to those concerned with the broader aspects of radio communication and will form a useful addition to the specialist literature already existing.

R. J. H.

## BOARD OF EDITORS

H. FAULKNER, C.M.G., B.Sc., M.I.E.E., Chairman.  
W. WEST, B.A., M.I.E.E.  
Capt. C. F. BOOTH, O.B.E., M.I.E.E.  
L. F. SCANTLEBURY, Whit.Sch., A.C.G.I., D.I.C., A.M.I.E.E.  
D. A. BARRON, M.Sc., A.M.I.E.E.  
E. DAVIS, A.M.I.E.E.  
L. CHANT.  
G. E. STYLES, A.M.I.E.E., Managing Editor.  
W. A. HUMPHRIES, A.M.I.E.E.  
J. P. HARDING, B.Sc.(ENG.).  
A.M.INST.C.E., A.M.I.E.E. } Assistant Editors.  
A. J. HUTCHISON, Secretary-Treasurer.

## Copyright

The entire contents of this JOURNAL are covered by general copyright, and special permission is necessary for reprinting long extracts, but Editors are welcome to use not more than one-third of any article, provided credit is given at the beginning or end thus: "From the *Post Office Electrical Engineers' Journal*."

The Board of Editors is not responsible for the statements made or the opinions expressed in any of the articles in this JOURNAL, unless such statement is made specifically by the Board.

## Communications

All communications should be addressed to the Managing Editor, *P.O.E.E. Journal*, Engineer-in-Chief's Office, Alder House, Aldersgate Street, London, E.C.1. Telephone: HEADquarters 1234. Remittances should be made payable to "*The P.O.E.E. Journal*" and should be crossed "& Co."

## Binding Cases

Cases for binding are available, and may be obtained from the Local Agents for 3s. Subscribers can have their copies of volumes bound, at a cost of 10s. 6d., by sending the complete set of parts to the Local Agents or to the *P.O.E.E. Journal*, Engineer-in-Chief's Office, Alder House, Aldersgate Street, London, E.C.1. Orders for binding for Vols. 1-19 should indicate whether the original binding case with black lettering, or the later pattern with gold, is required. Cases with gold lettering are the only type stocked from Vol. 20 onwards.

## Back Numbers

The price of the JOURNAL, which is published quarterly, is 2s. 6d. (2s. 9d. post free) per copy, or 1 ls. per annum, post free. Back numbers can be supplied, subject to availability of stocks, at 2s. 6d. each (2s. 9d. post free). Orders for back numbers may be sent to the *P.O.E.E. Journal*, Engineer-in-Chief's Office, Alder House, Aldersgate Street, London, E.C.1, or to the Publishers.

Employees of the British Post Office can obtain the *Journal* through Local Agents at the reduced price of 2s. per copy.

## Advertisements

All communications relating to space reservations should be addressed to the Advertisement Editor, *P.O.E.E. Journal*, Alder House, Aldersgate Street, London, E.C.1. Communications regarding advertisement copy, proofs, etc., should be addressed to the Publishers, Messrs. Birch & Whittington (Prop. Dorling & Co. [Epsom], Ltd.), 49 Upper High Street, Epsom, Surrey.

## INDEX TO ADVERTISERS

	PAGE		PAGE
Airmec Laboratories, Ltd. . . . .	xxvii	Jones, Walter, & Co. (Engineers). Ltd. . . . .	xxvi
Alton Battery Co., Ltd., The . . . . .	ix	Marconi Instruments, Ltd. . . . .	vii
Automatic Coil Winder & Electrical Equipment Co., Ltd. . . . .	xxii	Marconi's Wireless Telegraph Co., Ltd. . . . .	x
Automatic Telephone & Electric Co., Ltd. . . . .	xii-xiii, xvi-xvii	Muirhead & Co., Ltd. . . . .	iii
Bennett College, The . . . . .	ii	Mullard, Ltd. . . . .	vii
British Electric Resistance Co., Ltd., The . . . . .	viii	Painton of Northampton . . . . .	iv
British Institute of Engineering Technology . . . . .	ii	Pirelli-General Cable Works, Ltd. . . . .	xxviii
Creed & Co., Ltd. . . . .	xix	Pitman, Sir Isaac, & Sons, Ltd. . . . .	vi
Dexion, Ltd. . . . .	xxvii	Savage Transformers . . . . .	ii
Dubilier Condenser Co. [1925], Ltd. . . . .	xi	Savage, W. Bryan, Ltd. . . . .	xxvi
Edison Swan Electric Co., Ltd., The . . . . .	xxviii	Siemens Brothers & Co., Ltd. . . . .	xxviii
Ericsson Telephones, Ltd. . . . .	v	Smith, Frederick, & Co. . . . .	ii
General Electric Co., Ltd., The . . . . .	xiv-xv	Standard Telephones & Cables, Ltd. . . . .	xx-xxi
Great Northern Telegraph Co., Ltd. . . . .	xxiii	Sullivan, H. W., Ltd. . . . .	xxiv
Hackbridge Cable Co., Ltd. . . . .	xxiii	Telephone Manufacturing Co., Ltd. . . . .	xxii
Hivac . . . . .	vi	Tungstone Products, Ltd. . . . .	xxv
International Correspondence Schools, Ltd. . . . .	xxvii	Westinghouse Brake & Signal Co., Ltd. . . . .	xxiv
Winn & Coales, Ltd. . . . .	vi		



# A STANDARD SIGNAL SOURCE

for  
**THE AUDIO FREQUENCY BAND**

**T**HE R.C. Oscillator Type D-330 gives a wide range of known levels into a 600-ohm load at any frequency from 20 c/s to 20 kc/s.

### BRIEF SPECIFICATION

- FREQUENCY:** 20 c/s—20 kc/s.
- ACCURACY:**  $\pm 1\%$  or better.
- OUTPUT LEVEL:** 1W or 10mW into 600 ohms, selected by means of a switch.
- ATTENUATORS:** 7 steps of 10 db plus 12 db continuously variable.
- HARMONICS:** 1.75% total at 1W above 40 c/s. 1.0% total at 10 mW above 40 c/s.
- HUM LEVEL:** 50 db below output level.
- DIMENSIONS:** 20½-in x 12½-in x 11-in bench mounting — can be supplied for 19-in rack mounting if required.

*Post this coupon*

BY PASTING ON A POSTCARD

MUIRHEAD & CO. LTD · BECKENHAM · KENT · ENGLAND

*Please send me Bulletin B-614 fully describing the R.C. Oscillator advertised in 'The Post Office Electrical Engineers' Journal'.*

NAME .....

ADDRESS .....

**MUIRHEAD & Co., LTD.**  
PRECISION ELECTRICAL INSTRUMENT MAKERS  
**BECKENHAM · KENT · ENGLAND**  
Phone: BECKenham 0041      Telegrams & Cables: MUIRHEADS ELMERS-END

PRECISION  
**MUIRHEAD**  
ELECTRICAL INSTRUMENTS

MU. 24.



*By Appointment to the Professional Engineer...*

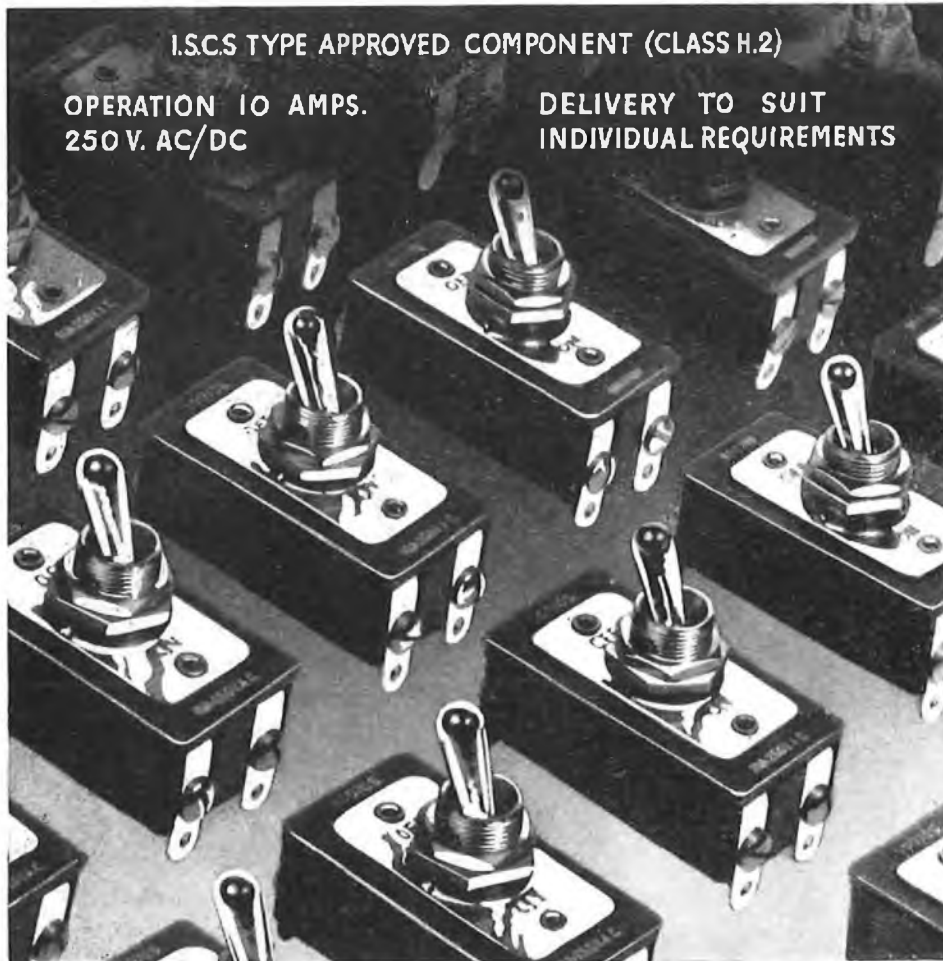

I.S.C.S TYPE APPROVED COMPONENT (CLASS H.2)

OPERATION 10 AMPS.  
250 V. AC/DC

DELIVERY TO SUIT  
INDIVIDUAL REQUIREMENTS

ATTENUATORS · FADERS · SWITCHES · WIREWOUND POTENTIOMETERS · PLUGS  
AND SOCKETS · WIREWOUND RESISTORS · HIGH STABILITY CARBON RESISTORS  
KNOBS DIALS AND POINTERS · TERMINALS

**PAINTON**

*Northampton England*

# The 'DEKATRON'

A MULTI-ELECTRODE  
COLD-CATHODE  
COUNTING TUBE

for  
counting..  
computing..selecting..

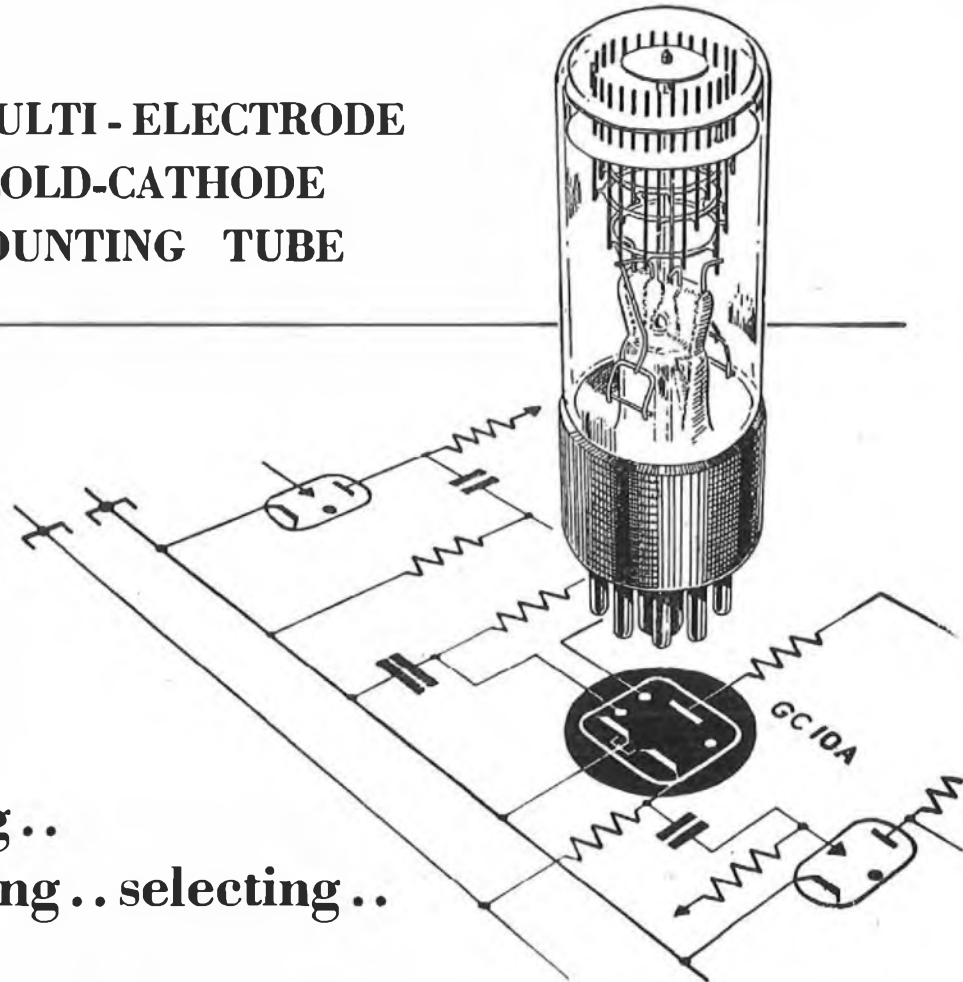

**Ericsson**

TELEPHONES LTD.

22 LINCOLN'S INN FIELDS, LONDON, W.C.2 · Tel. HOLborn 6936 · Works: BEESTON, NOTTS.

ES

# Denso

PERMANENTLY PLASTIC PROTECTION



gives **3-FOLD** Protection for all Metalwork above or below ground.

Denso Permanently Plastic Tape seals pipes, mains, cables and all metal structures—exposed or buried—from the menace of chemical and electrolytical corrosion.

Indispensable for sealing cable ends—the temporary repair of fractured gas-mains—and a real aid to frostproofing.

Full technical details of Denso Anti-corrosive and Sealing Products gladly supplied.

## WINN & COALES LTD.

DENSO HOUSE, CHAPEL ROAD, LONDON, S.E.27.

telephone : GIPsy Hill 4247/8.

Telegrams : Denselte, Westnor, London.

# PITMAN

## Earthing Principles and Practice

By R. W. Ryder, B.E., B.Sc., A.M.I.E.E. This is a useful book for all concerned with protective measures. It is a complete guide to the theory and practice of earthing, and includes the I.E.E. regulations for earthing in buildings. With 45 illustrations. 15/- net.

## The Calculation of Unsymmetrical Short-Circuits

By H. Rissik, B.Sc.(Eng.), M.Amer.I.E.E. Second Edition, revised by W. F. Lovring. 12/6 net.

"We commend this book for its simplification of the problems."  
—ELECTRICAL SUPERVISOR.

## Telephony (2 vols.)

By J. Atkinson, A.M.I.E.E. Area Engineer, Post Office Engineering Dept. A standard textbook for Post Office engineers and students. With over 1500 illustrations. Vol. I (General Principles and Manual Exchange Systems) 35/- net. Vol. II (Automatic Exchange Systems) 55/- net.

## Telecommunications Principles

By R. N. Renton, M.A.I.E.E. Covers the syllabus for the City and Guilds examinations in Telecommunications Principles, Grades I, II & III. Illustrated. 37/6 net.

"Can be recommended confidently to all students of Telecommunications."—Post Office Telecommunications Journal.

PITMAN, Parker Street, Kingsway, London, W.C.2

# H.F. Power Triode

6C4

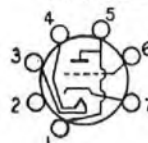
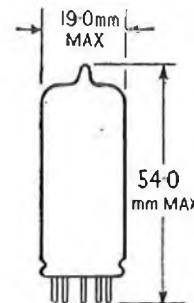

The 6C4 is an indirectly heated miniature triode for use as an R.F. power amplifier or oscillator at frequencies up to approximately 150 Mc/s.

It may also be used as an A.F. amplifier under class A. conditions.

## RATINGS

Heater voltage .. .. .	6.3V.
Heater current .. .. .	0.15A.
Max. anode voltage .. .. .	300V.
Power output (R.F.) .. .. .	5.5W.



GREENHILL CRESCENT,  
HARROW-ON-THE-HILL, MIDDLESEX

Telephone: HARrow 2655

**T**HE REPUTATION enjoyed by Marconi instruments for precision engineering and skilful design is jealously guarded. At all stages of manufacture, and especially in the final testing, the greatest attention is paid to detail. In the future, as in the past, the Company will maintain its policy of producing an unrivalled range of equipment "that is just that little bit better," serving communications and industry, medicine and research, in the precise Marconi manner.

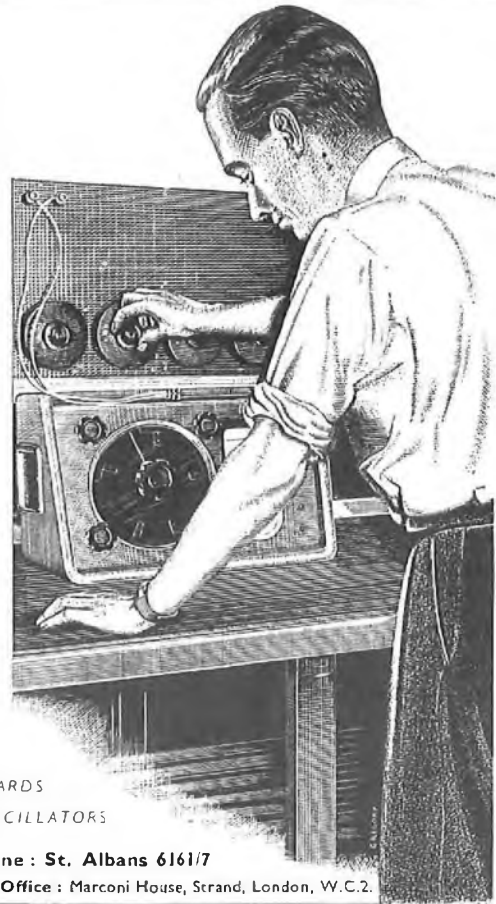

## MARCONI instruments

SIGNAL GENERATORS - BRIDGES - VALVE VOLTMETERS - FREQUENCY STANDARDS  
OUTPUT METERS - WAVE METERS - WAVE ANALYSERS - BEAT FREQUENCY OSCILLATORS

MARCONI INSTRUMENTS LTD · ST. ALBANS · HERTS · Phone: St. Albans 6161/7  
Midland Office: 19 The Parade, Leamington Spa. Northern Office: 30 Albion Street, Hull. Export Office: Marconi House, Strand, London, W.C.2.

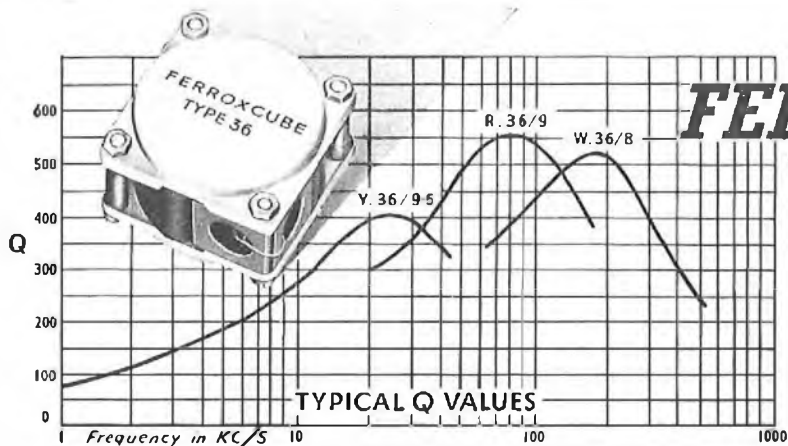

## FERROXCUBE

FERROMAGNETIC FERRITE

### For Line Communications :

IN THE design of Mullard pot core assemblies types 36 and 25 full advantage is taken of the characteristics of Ferroxcube to produce inductances of remarkably high "Q" factors. This, combined with ease of winding, makes these cores very suitable for use in filter networks and wherever high quality inductances are required.

Fine adjustment of inductance is obtained by control of the air gap rather than by variation of the turns.

The good screening properties of the Ferroxcube and the convenient shape of the assemblies, which allows stacking or individual mounting, are other features which distinguish these Mullard cores.

#### OUTSTANDING FEATURES

- ★ Low hysteresis coefficient
- ★ High values of inductance
- ★ Low self capacitance
- ★ Controllable air gap facilitating inductance adjustment
- ★ Self screening
- ★ Controlled temperature coefficient
- ★ Operation over a wide frequency range
- ★ Ease of winding and tapping
- ★ Easily mounted

PLEASE WRITE FOR FULL DETAILS



# Mullard

FERROXCUBE  
FERROMAGNETIC FERRITE

MULLARD LIMITED · CENTURY HOUSE · SHAFTESBURY AVENUE · LONDON · W.C.2

(MF175)

# Quality Components for INDUSTRIAL ELECTRONICS

## VOLTAGE STABILISERS

The B.P.T. single phase and three phase voltage stabilisers maintain a *constant* voltage from a *fluctuating* supply regardless of fluctuation in load, load power factor, and normal frequency variations. Standard models—air and oil cooled—available from 3 to 75 kVA.

## HERMETICALLY SEALED POTENTIOMETERS, MODEL R5

Wire wound—ohmic value range covers from 5 to 5,000 ohms. Rating 5 watts. Dimensions  $1\frac{3}{8}$ " diameter  $\times$   $1\frac{1}{4}$ ". Weight 3 oz. (without knob). Withstands tropical damp and humidity and arctic cold—salt, dust and chemical laden atmospheres. Complies with inter-service standard specification RCL/131.

## VITREOUS ENAMELLED RESISTORS

A wide range of vitreous enamelled resistors from 6 watt to 180 watt on 16 standard tube sizes with more than 20 alternative mountings, terminations and fittings. Fully tropical. Exclusive Bercohm craze free, non-porous, vitreous enamel gives stress-free winding and eliminates hot spots. Fully approved by R.C.S.C.

*Other BERCO products include fixed and variable wire wound resistances and potentiometers, "Regavolt" infinitely variable auto-transformers, rotary rheostat potentiometers, stud switches, control knobs, etc., for all laboratory and industrial purposes.*



THE BRITISH ELECTRIC RESISTANCE CO. LTD.  
Queensway, Ponders End, Middlesex  
Telephone: HOlWard 1492      Telegrams: "VitrOhm" Enfield

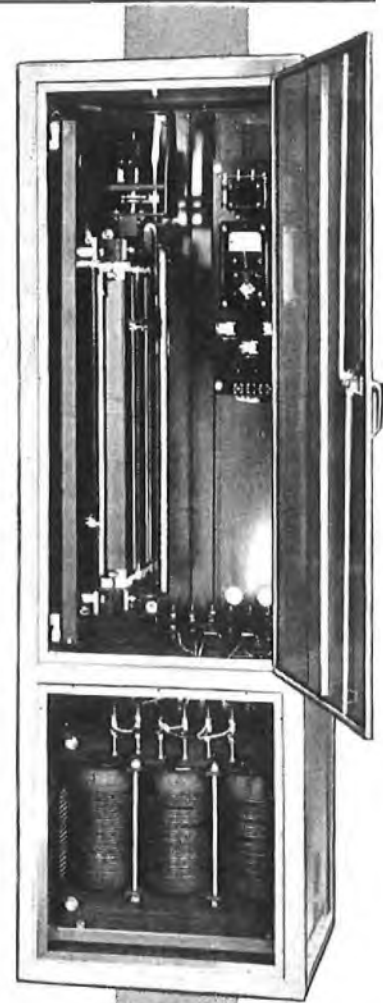



**Right round the world**, men know what Alton means. A storage battery—with a distinctive merit entirely its own. Where can distinction lie, in an era of rigid battery standardisation? One answer is that, in Hampshire, Alton means something else—a little countrytown. A town with a busy, neighbourly life within its boundaries, and the peace of lovely and unspoilt countryside beyond. A place where the sky is clean and growing things do well: flowers and fruit and children; a woman's pride in the home she makes—a man's in the skills of his trade. Making something better than 'well enough' is a habit that grows strongly in Alton soil. And Alton batteries are made by Alton men.

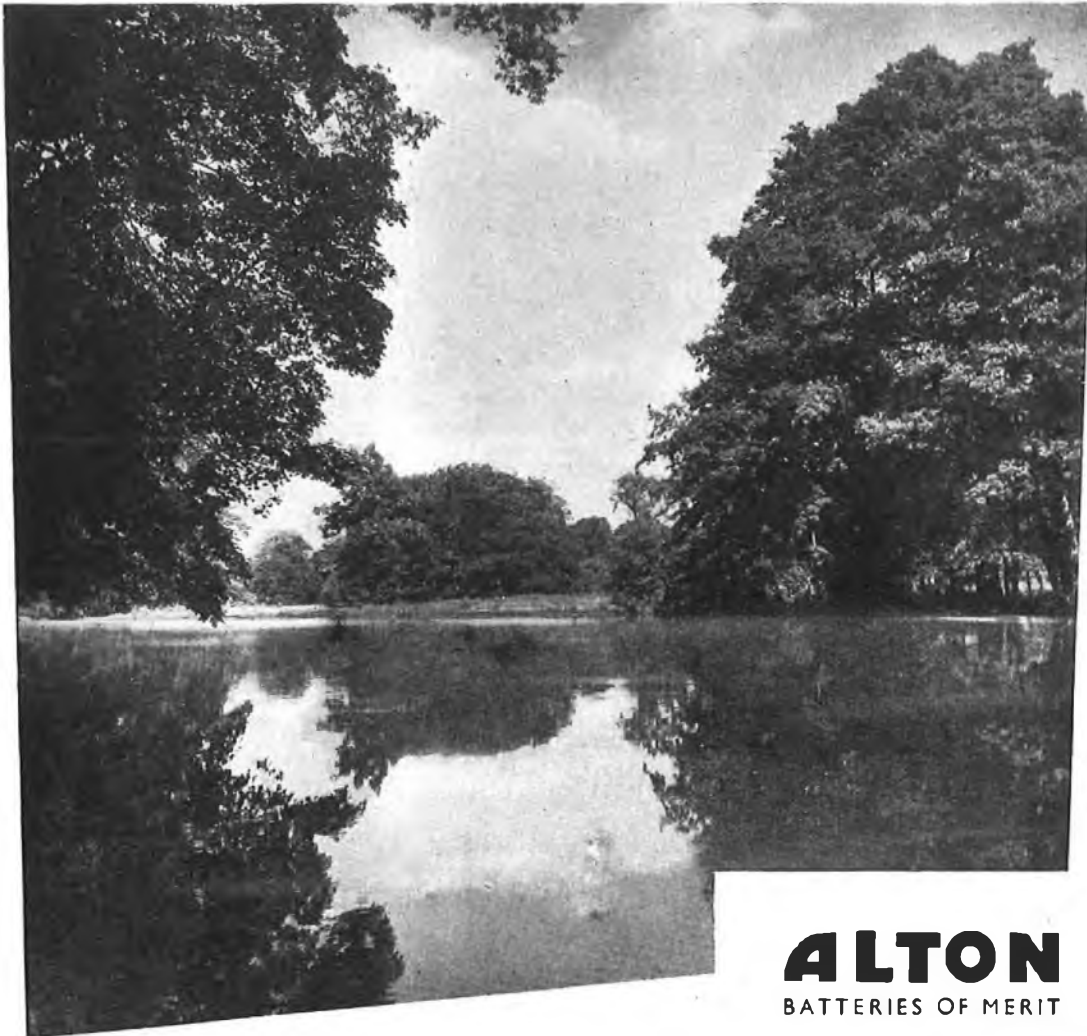

**ALTON**  
BATTERIES OF MERIT

Alton stationary batteries: 10 to 15,000 Ah. Also in regular production, renewal plates for all makes of battery, British and Continental

A25A

The Alton Battery Company Limited · Alton · Hampshire · Telephone: Alton 2267 and 2268 Telegrams: Battery, Alton

# MARCONI communication systems



## serve mankind

The need to keep in touch is as essential for the scattered look-outs of a forest empire as it is for the offices and homes of a crowded metropolis. What is the best way to go about it? How much will it

cost to install? . . . to maintain? It is to such questions that Marconi's will be glad to give the relevant answers, drawn from unrivalled experience in communications all over the world.



**SURVEYED**



**PLANNED**



**INSTALLED**

# DUBILIER

## MICA DIELECTRIC CAPACITORS

*Eminently suitable for H.F. Transmitting and R.F. Heating Circuits.*

Makers of the first and of the largest Mica Capacitors in the World, Dubilier have maintained the lead in this important branch of Capacitor Engineering.

The example shown is a high grade, oil immersed, naturally cooled mica capacitor, designed to ensure the maximum surface cooling area for the bulk, thereby occupying the minimum of floor space.

Made especially for use in the oscillatory and radio-frequency circuits of Radio-Transmitters and Radio-Frequency Heating equipment, these capacitors are available in two sizes suitable for a frequency band covering 100 to 1,600 kilo-cycles per second and with the following ratings:—

Peak Working kV	24.0	24.0
Maximum Current	70 Amps	70 Amps
Maximum kVA	350	500
Overall Height	21½"	31½"
Base Space	11¼" x 9½"	11¼" x 9½"

*Full details of these and other outstanding Capacitors are available upon application.*

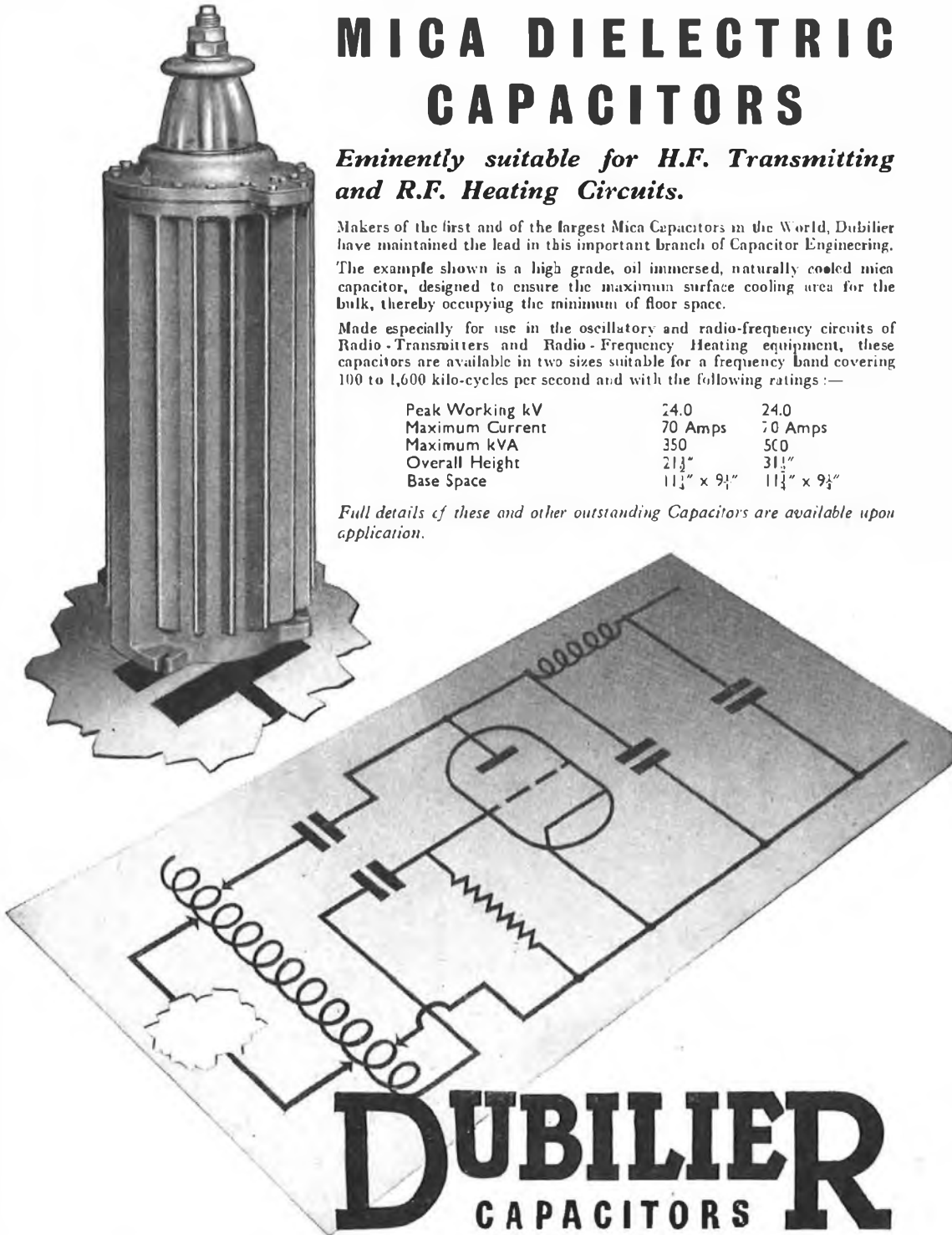

# DUBILIER

## CAPACITORS

DUBILIER CONDENSER CO. (1925) LTD., DLCON WORKS, VICTORIA RD., N. ACTON, LONDON, W.3.  
Phone: Acorn 2241 (5lines). Grams: Hivoltcon, Wesphone. London. Cables: Hivoltcon, London, Marconi International Code

D68

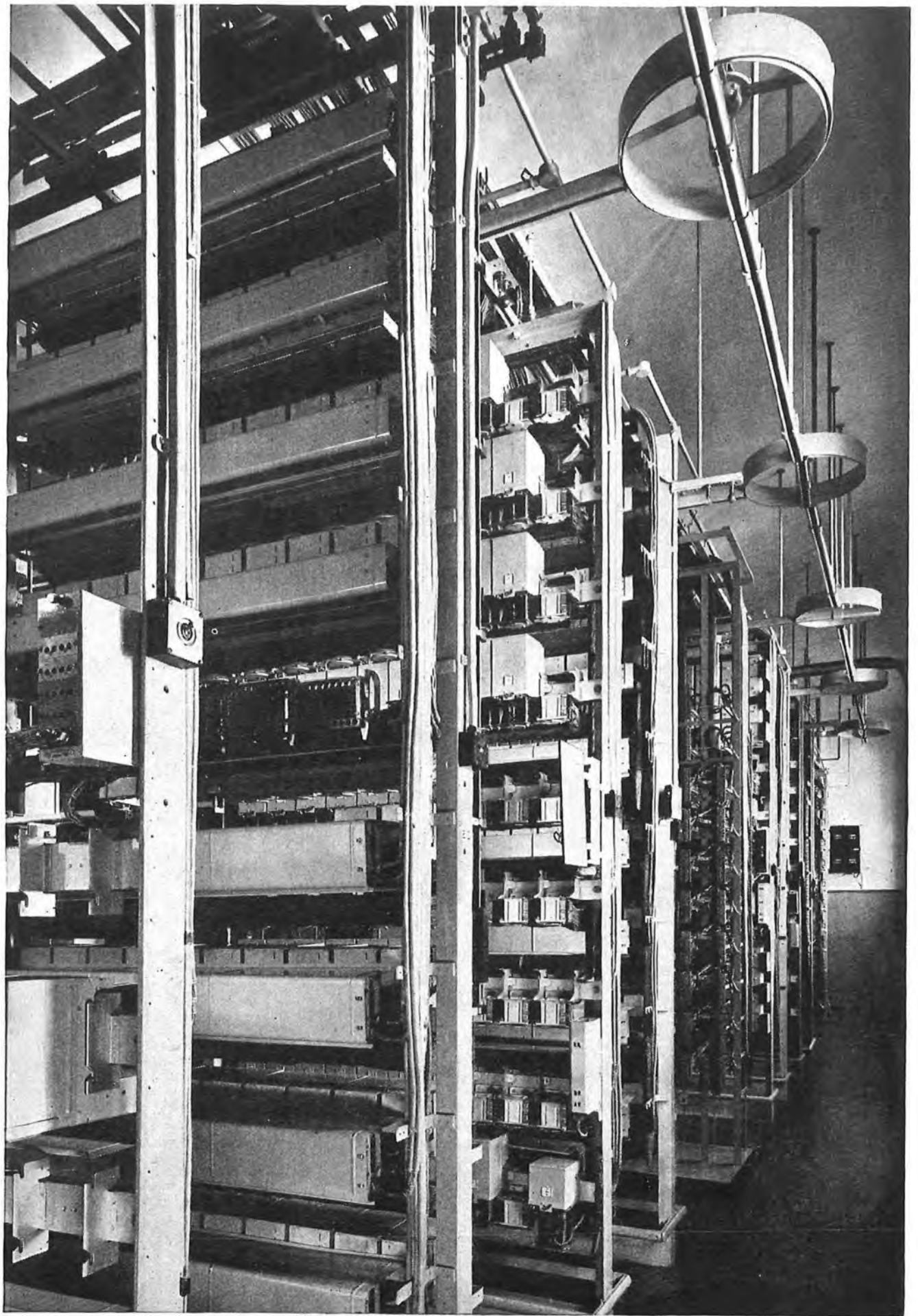

## ANOTHER STROWGER EXCHANGE

---



IN 1939 THE ADMINISTRAÇÃO GERAL dos Correios, Telégrafos e Telefones decided to automatise the telephone communication system of Portugal. In 1943 Coimbra was commissioned and many exchanges have since been put into service including those at Braga, Guimarães, Vizeu, Torres Novas, Setubal, Leiria and Caldas da Rainha. Evora, Figueira da Foz and Viana do Castelo are now being installed. When the plan is completed the whole

country will be on a fully automatic basis.

The Strowger selector, thousands of which form part of the equipment of the above exchanges, is used at all selecting stages and incorporates in its design all the facilities which many years' operational experience have shown to be necessary, yet retains the simple, straightforward step-by-step principle of operation characteristic of the Strowger system.

These qualities are apparent to a most marked extent in the type 32A Mark II selector which is the most recent design. Today this selector offers the most suitable basis for automatic telephone systems of any size. Its simplicity, economy, reliability and ease of maintenance are the factors of principal appeal to telephone administrations of more than seventy countries.



## Automatic Telephone & Electric Co. Ltd.

Export Department : Strowger House, Arundel Street, London, W.C.2

Telephone: TEMple Bar 9262.    Telegrams: Strowgerex, London.    Strowger Works, Liverpool, England

AT-7751-AA-104

# How automatic is a telephone exchange ?

*In operation it is fully automatic, but there is nothing automatic about its maintenance.* Only man-hours expended by skilled personnel will guarantee efficient maintenance. Since the virtues and failings of a telephone system must depend ultimately on the ease or difficulty of maintenance, the G.E.C., after years of research, has re-designed apparatus used in the Strowger system, to obtain greater reliability, maximum ease of adjustment and instant accessibility. The results are now apparent in the new G.E.C. two-motion selectors, the heavy- and light-duty uniselectors and the trigger dial. All of them can now be maintained with much less skill and in much less time than ever before. Combined with the electrical simplicity exclusive to the Strowger system, these components mean that automatic exchanges manufactured by the G.E.C. are the most valuable investment an Administration can make.

## **On Maintenance**

### **ONE HUNDRED MILLION STEPS GUARANTEED**

Adjustable wiper assembly for precise setting of wiper tips in centre of bank contact. Adjustable knife-edge armature pivot permits simple and adequate adjustment of pawl and armature stroke.

Unit construction and rocking type mounting simplifies setting of self-drive contact gap.

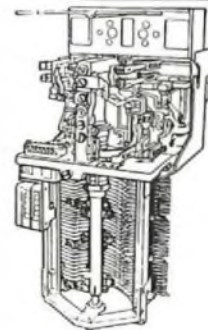

**... CUTTING COSTS OF MAINTENANCE**



**EFFICIENT**

Bank, wipers, collector rings, and wiper brushes of high grade nickel silver.

Design of magnetic circuit ensures ample driving power at requisite speed.

**RELIABLE**

Bifurcated collector brushes and grooved collector rings ensure reliable contact.

Radially operating stainless steel detent provides ideal action.

**ROBUST**

Frame and coil unit provide rigid mechanism housing.

All parts designed to give long trouble-free service under heavy-duty conditions.

*Full Particulars  
are given in  
Leaflet UNLI*

**G.E.C.**

**OF ENGLAND**

THE GENERAL ELECTRIC CO. LTD., OF ENGLAND

Telephone, Radio & Television Works, Coventry

# ATE/TMC

**OPEN-WIRE AND CABLE TRANSMISSION EQUIPMENT**

**in service the world over!**

# ACCESSIBILITY

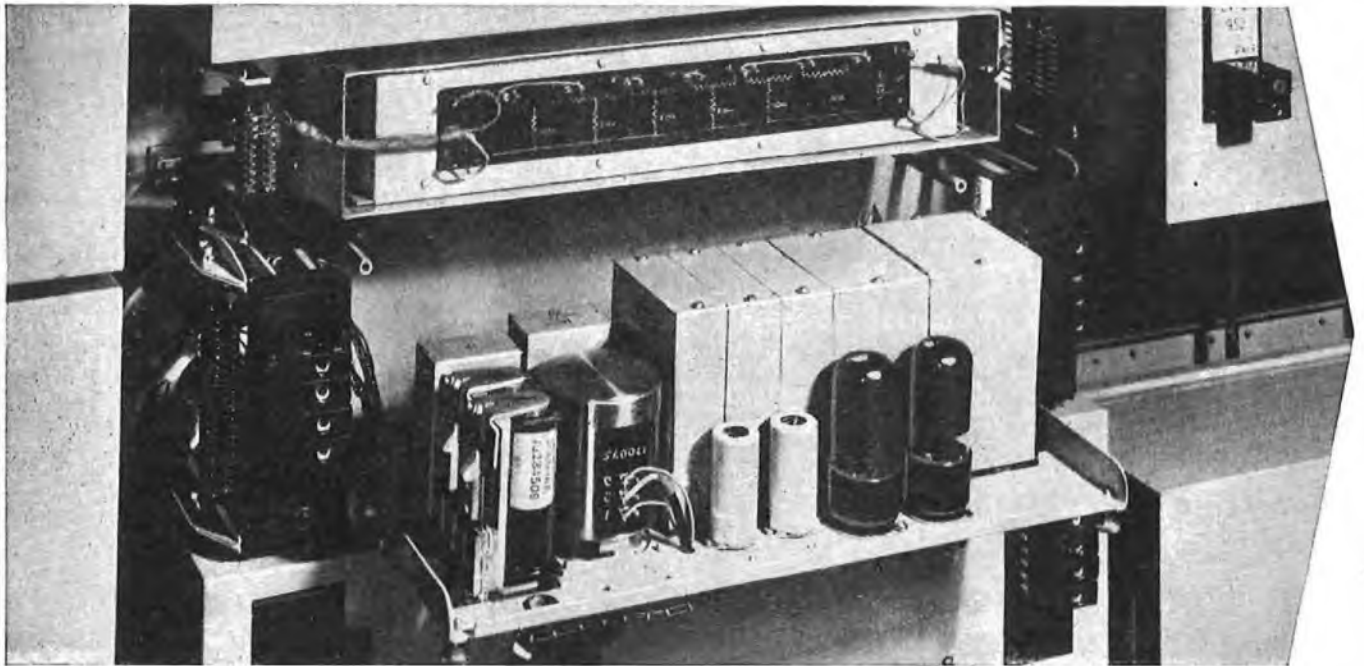

In the selection of a transmission system, ease of maintenance is a factor of the greatest importance when considering long term operation at the most economic figure. For this reason, ATE/TMC equipment is designed to give the full accessibility that makes servicing and routine inspection a simple matter. With this equipment the highest standard of performance is achieved and can be maintained at modest cost. A typical example where accessibility for maintenance routines has been given special

consideration, is the 12 circuit cable type carrier telephone equipment of which six systems have been supplied to the British Post Office. Valves have been selected for long life and easy availability and the double modulation principle is employed for flexibility and reliability. In cases where accessibility would normally be difficult, panels are hinged and can be dropped forward to expose all the components. Wiring is on one plane on the front and readily accessible for inspection.



**AUTOMATIC TELEPHONE & ELECTRIC CO. LTD.**

RADIO AND TRANSMISSION DIVISION

Strowger House, Arundel Street, London, W.C.2. Telephone: TEMple Bar 9262. Cablegrams: Strowgerex, London

Manufacturers: AUTOMATIC TELEPHONE & ELECTRIC CO. LTD. Liverpool and London  
TELEPHONE MANUFACTURING CO. LTD. St. Mary Cray, Kent



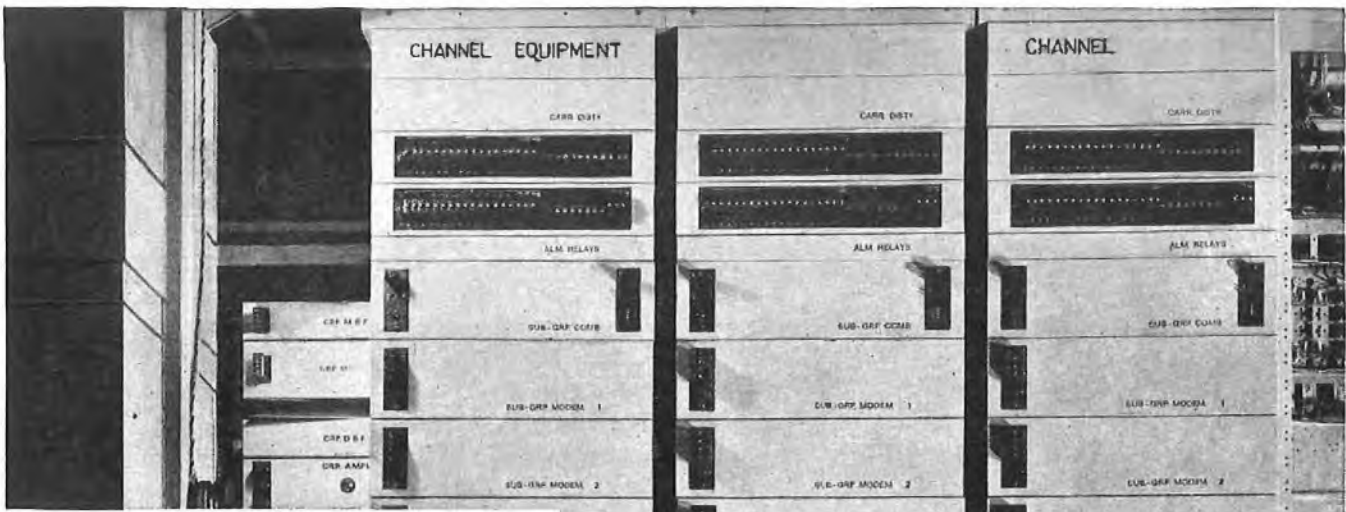

# ...the key to ease in maintenance

12-channel equipment at the trunk  
and toll exchange, Lancaster House,  
Liverpool.

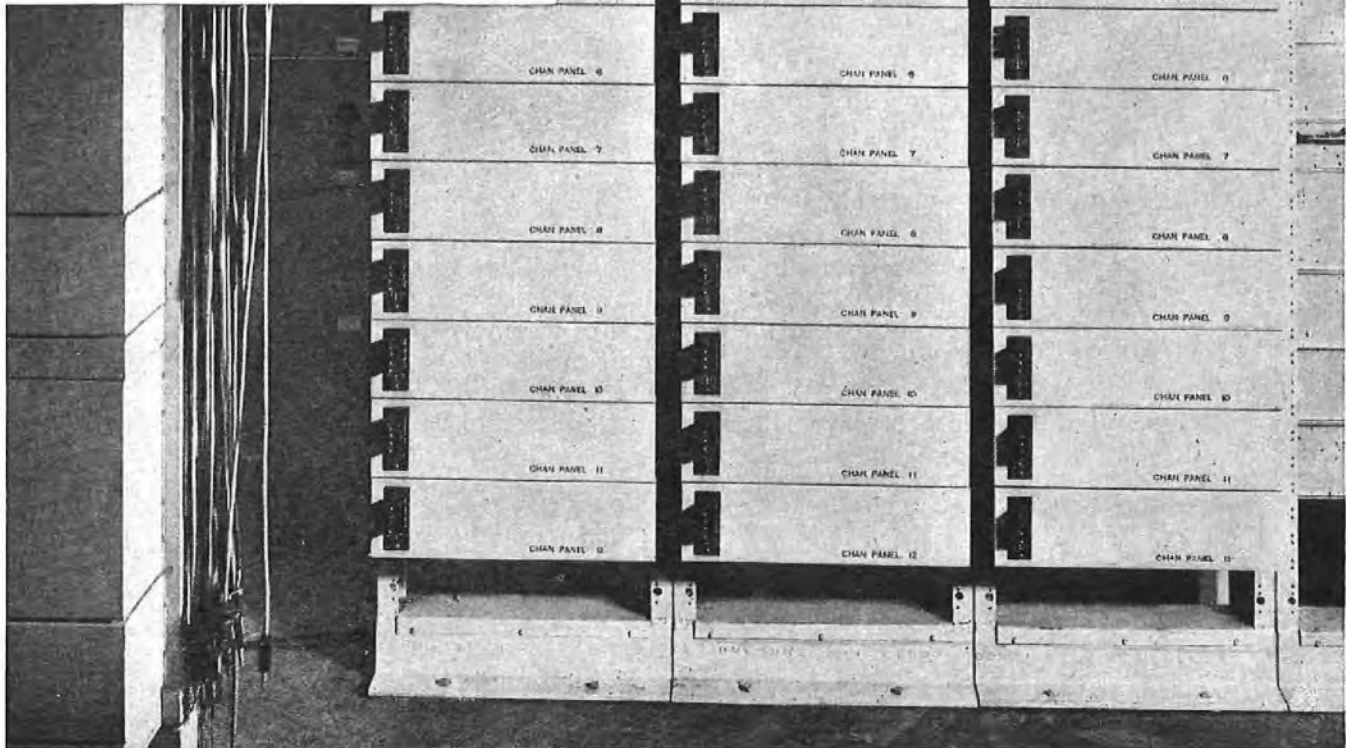

*And now it is the*

## *Okanagan Telephone Company*

*Operating in the famous Okanagan  
Valley of British Columbia.*



A huge modernisation programme was set in motion recently, and the first stage, completed in April this year, was the cut-over of 4,000 subscribers to the new No. 17 M·A·X System at Kelowna Exchange.

Kelowna is justifiably proud of this new automatic exchange of the most modern type.

Further No. 17 M·A·X Equipments are in hand for this Administration to serve subscribers at Penticton and Vernon.

**SIEMENS BROTHERS & CO., LIMITED**  
WOOLWICH · LONDON · S. E. 18.

Represented in Canada by  
SIEMENS BROTHERS (CANADA) LIMITED AT WINNIPEG AND EDMONTON

**Creed**



No. 47 Tape Model Teleprinter

No. 7 Page Model Teleprinter

**printing  
telegraph  
systems**

*Creed & Company Limited*  
TELEGRAPH HOUSE · CROYDON · ENGLAND

# TELEVISION LINKAGE OF



Standard are proud to have been entrusted with the development, manufacture and installation for the British Post Office of the coaxial television cable linking the London and Midland television transmitters, the coaxial cable and associated Vestigial Sideband terminal equipment linking the Midland and Northern television transmitters, and the microwave radio link between Manchester and the new Scottish television transmitter; these together constitute the longest television relay system in Europe.

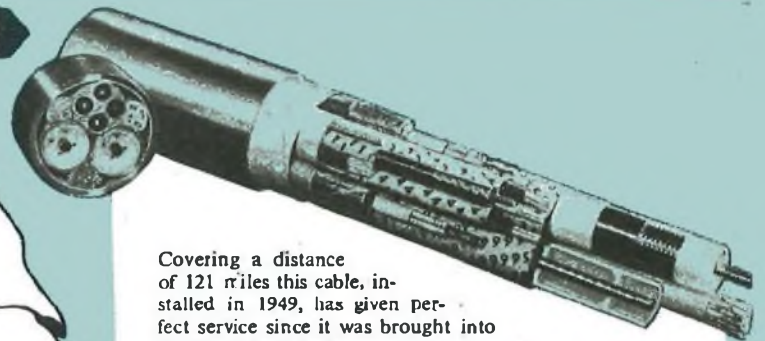

Covering a distance of 121 miles this cable, installed in 1949, has given perfect service since it was brought into regular use. It is designed to accommodate very-high-definition and colour television.

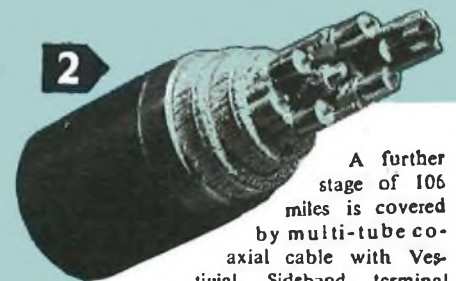

A further stage of 106 miles is covered by multi-tube coaxial cable with Vestigial Sideband terminal equipment.

*Standard Telephones*

TELECOMMUNICATION

CONNAUGHT HOUSE



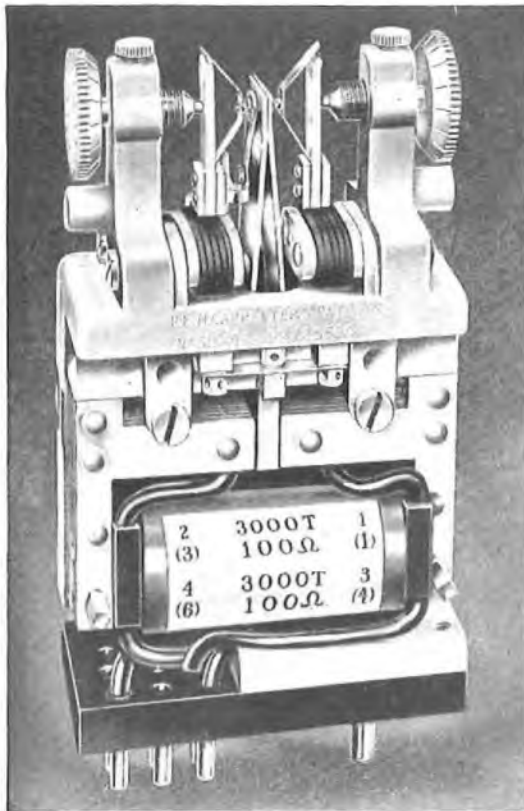

## CARPENTER POLARIZED RELAY TYPE 4

The chief characteristics of this relay are low transit time—high contact pressure—freedom from contact chatter and positional error—high sensitivity—stability—symmetrical action—and ease of adjustment.

On V.F. dialling systems its use facilitates the design of sensitive receiving equipment, and on trunk telephone circuits the relay's high sensitivity enables it to respond to D.C. dialled impulses received over unrepeated trunk lines of up to 100 miles long.

It is particularly suitable as an impulse accepting relay when a minimum of signal distortion is imperative, and because of the excellent change-over action and absence of contact chatter the relay is unequalled for impulsing the selector magnets in teleprinter automatic switching systems.

The relay responds satisfactorily to frequencies up to 100 c/s, when the contact gap is adjusted to 0.004 in. nominal, without serious bias disturbance. It can be left connected to line whilst awaiting a clearing signal, there being little distortion of through signals since the total leak can be of the order of 10,000 ohms.

Dimensionally the relay is interchangeable with the "3000" type relay. Terminations can either be made by means of a 12-pin plug base as illustrated, or with soldering tags in place of the pins. Protection is given by a magnetic screen and a transparent cap which is removable for contact adjustments.

*Complete details supplied on request.*

*Manufactured by the Sole Licensees:—*

**TELEPHONE MANUFACTURING COMPANY LIMITED**

*Contractors to Governments of the British Commonwealth and other Nations*

**HOLLINGSWORTH WORKS · DULWICH · LONDON S.E.21 TEL: GIPSY HILL 2211 (10 LINES)**

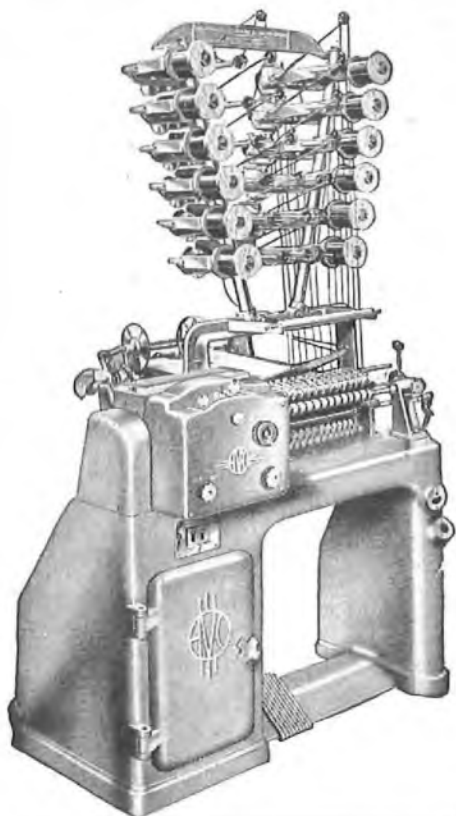

## DOUGLAS AND MACADIE

### Automatic COIL WINDERS

The large illustration depicts the improved "Douglas" Fully Automatic Multi-Winder, specially developed for the high-speed production of large quantities of coils with or without paper interleaving. It will produce round, square

or rectangular coils up to 6 in. each in length and up to 4½ in. diameter. As many as 12 smaller coils can be wound simultaneously within the total available winding length of 15 in. at headstock speeds of between 600 and 2,000 r.p.m.

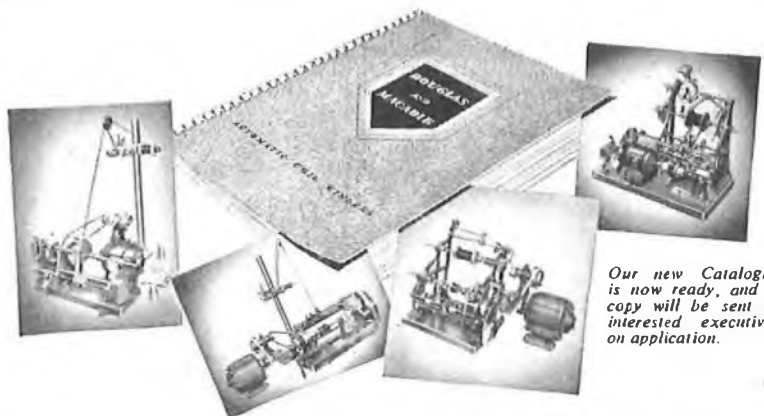

*Our new Catalogue is now ready, and a copy will be sent to interested executives on application.*

*Sole Proprietors and Manufacturers:*

**The AUTOMATIC COIL WINDER & ELECTRICAL EQUIPMENT CO. LTD.**  
WINDER HOUSE · DOUGLAS STREET · LONDON · S.W.1 Telephone: VICTORIA 3404/9



# MORSE TRANSMITTERS

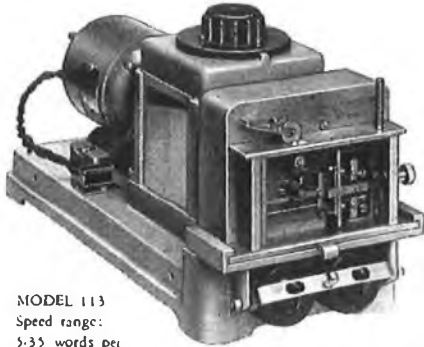

MODEL 113  
Speed range:  
5-35 words per  
minute.  
Specially suitable  
for radio  
training schools.

Absolutely constant speed  
at all settings not withstand-  
ing large voltage variations.

Noted for easy maintenance  
and quick adjustment.

Supplied with A.C. or D.C.  
motors as required.

*Universally adopted*

✂ Write for comprehensive catalogue.

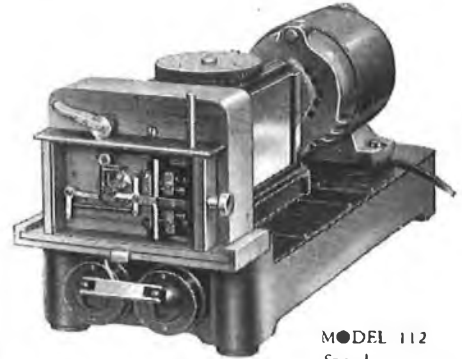

MODEL 112  
Speed range:  
13-250 words  
per minute  
without gear  
changes.

## THE GREAT NORTHERN TELEGRAPH COMPANY'S FACTORY

4, SYDHAVNS PLADS  
COPENHAGEN SV . DENMARK



LONDON OFFICE: 5, ST. HELENS PLACE  
LONDON E.C.3.

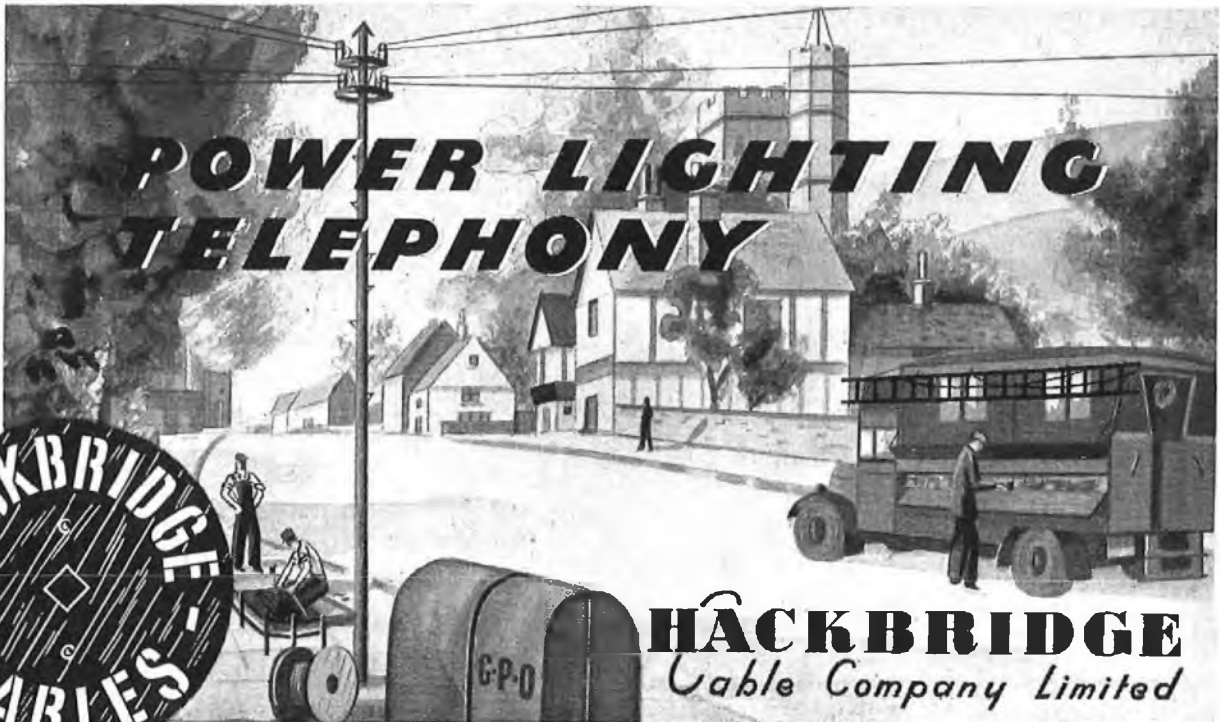

**HACKBRIDGE**  
*Cable Company Limited*

KELVIN WORKS, HACKBRIDGE, SURREY  
In Association with BRYCE ELECTRIC CONSTRUCTION CO. LTD.  
Branches at BIRMINGHAM, BRISTOL, CARDIFF, MANCHESTER, NEWCASTLE, SHEFFIELD

FOR **E.H.T. Supplies**

Type 36EHT rectifiers contain high-voltage "Westalite" elements resulting in a greatly reduced length of unit for any given output. They have been developed to meet the demand for small, compact metal rectifiers to provide E.H.T. in many forms of equipment where the current demand is unlikely to exceed 2 mA D.C., as, for example, cathode ray tubes, electron multipliers, condenser storage devices, etc. For further information and tables of outputs of these . . .

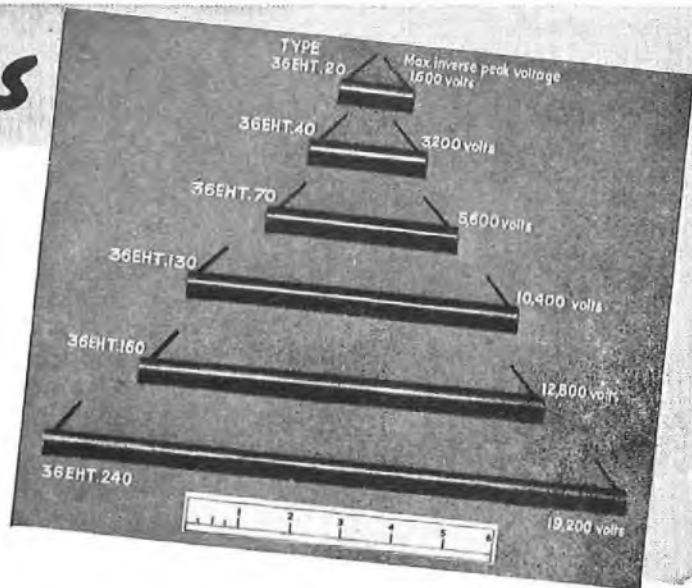

**WESTINGHOUSE**  
**WESTALITE**

## 36EHT MINIATURE HIGH-VOLTAGE RECTIFIERS

write for Data Sheet No. 60 to . . .

Dept. P.O.7,

**WESTINGHOUSE BRAKE & SIGNAL CO., LTD., 82 York Way, King's Cross, London, N.1**

SULLIVAN & GRIFFITHS

### DIRECT READING VARIABLE CONDENSERS

WITH NOVEL AIR CAPACITANCE  
DECADE RANGE EXTENSION

This air dielectric condenser comprises a decade of air capacitance and a continuously variable air condenser thus giving a scale accuracy ten times that of an ordinary variable condenser of the same range.

Thus a decade of capacitance is provided—permanent in value and entirely free from loss, the only loss present in the complete combination of decade and variable condenser being that due to the solid insulating material which is ordinarily employed in the construction of the latter.

The variable condenser has a range of  $100\mu\text{F}$  which is extended to  $1100\mu\text{F}$  by ten increments of  $100\mu\text{F}$ , all adjusted with accuracy so that the decade is absolutely direct reading in  $\mu\text{F}$ , no corrections or calibration being necessary.

## Electrical Standards for Research and Industry

Testing and Measuring Apparatus  
for Communication Engineering



**H. W. SULLIVAN, LTD., LONDON, S.E. 15.**



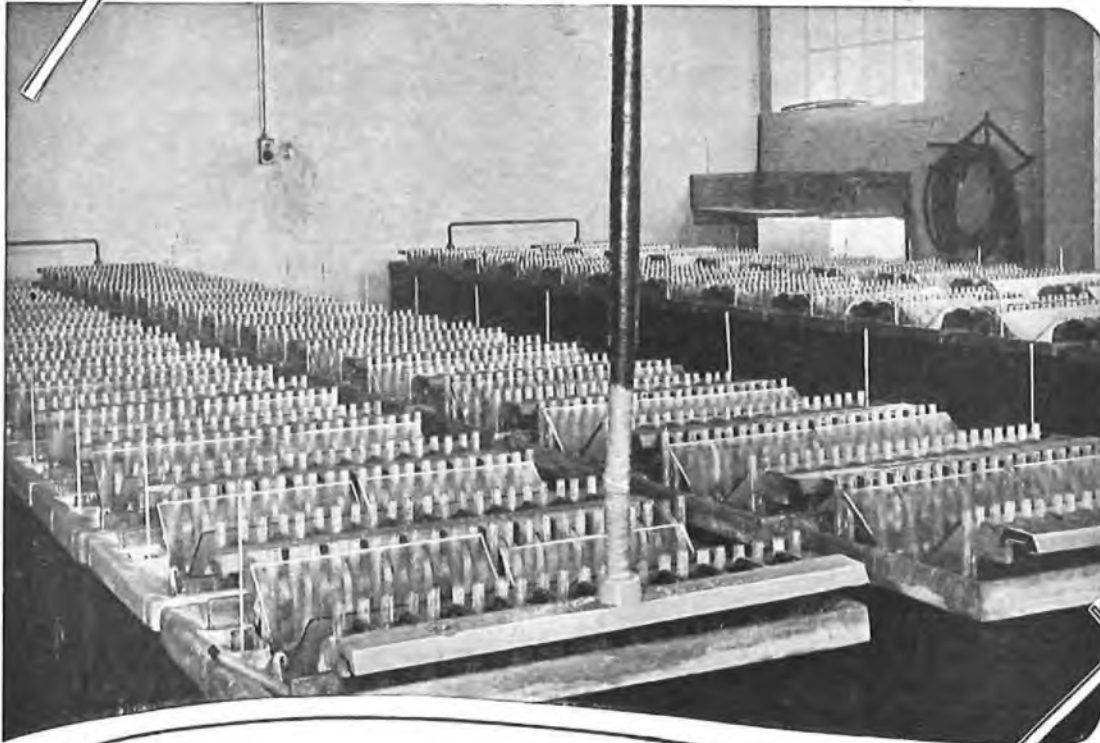

## POWER BEHIND THE LINES



**TUNGSTONE PLANTÉ CELLS** are being supplied to the British Post Office and Post and Telegraph Departments in many countries overseas. They conform fully to G.P.O. and British Standard specifications.

### OPEN TYPE CELLS

Similar to the illustration above, these are available in glass and/or lead lined wooden boxes in capacities from 100 a.h. to 5,000 a.h.

### REPLATALS

We are in a position to supply plates for the replating of any existing Planté Battery.

### ENCLOSED TYPE CELLS

As illustrated on the right, these are in moulded glass boxes with sealed-in lids. Capacity range from 10 a.h. to 200 a.h.

### HIGH VOLTAGE TELEPHONE BATTERIES

Portable Type. Standard layout for 50 volts, in waxed hard wood crates, exactly to the requirements of the G.P.O.

*Overseas customers are invited to cable or write their enquiries for batteries or parts. Visitors to London are welcome at our offices.*

# TUNGSTONE Batteries

For further particulars write: **TUNGSTONE PRODUCTS LIMITED**  
10 SALISBURY SQUARE · LONDON · E.C.4 · ENGLAND. Cables: "Dilutem" London.



T.B.12

# LONG DISTANCE TRUNK LINE SIGNALLING

This generator provides the X and Y tone voice frequency signalling currents for dialling and signalling over the trunk network and incorporates impulsing springs for chopping the tones.

The generator operates on a 46 to 52 volt battery. The speed, tone frequency and impulsing rate are controlled to high accuracy by a Type 4259 speed governor. The output per tone is 4 watts, 20 volts, 0.5 db. with unwanted components of the waves 28 db below the fundamental.

For further detailed information write for leaflet A 10

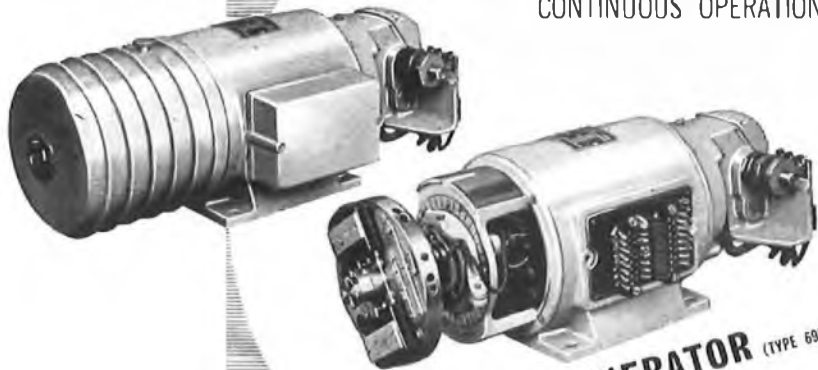

WITH A FREQUENCY ACCURATE  
TO 0.1% OVER LONG PERIODS OF  
CONTINUOUS OPERATION

**TWO VOICE FREQUENCY GENERATOR (TYPE 6950)**

**WALTER JONES & CO. (ENGINEERS) LTD.**  
NEWLANDS PARK, SYDENHAM, LONDON, S.E.26 • TELEPHONE: SYDENHAM 6264

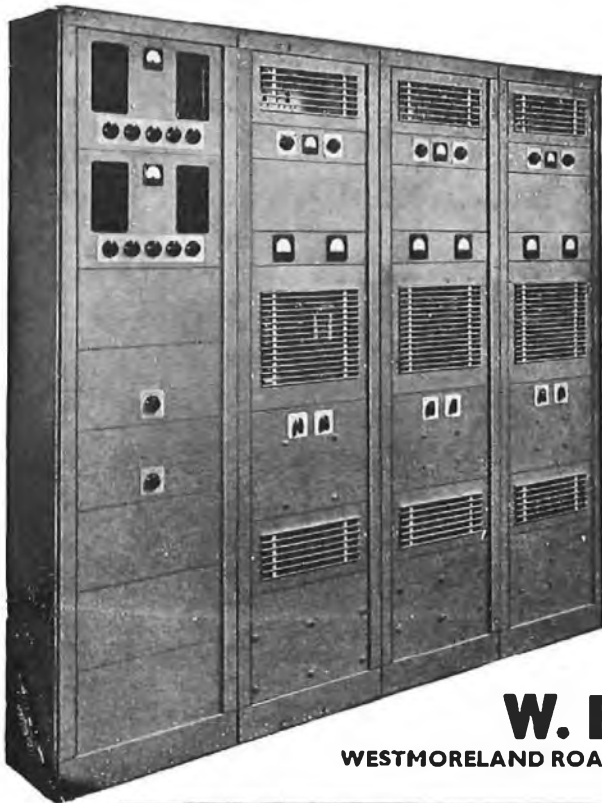

## *The Mark II series of* **SAVAGE AMPLIFIERS** *for Broadcast Relay*

● These Amplifiers are examples of what careful design can achieve. A lift-off back panel affords immediate access for maintenance purposes and the removal of six screws releases the side covers of the rack and exposes all the interpanel wiring. Even when the rack is sandwiched between others the side covers can be moved just as easily. All valves are accessible from the front of the rack, and are protected by quick release grilles. The rack is completely flat fronted. The general appearance is further enhanced by the absence of a projecting front foot, and the masking of all panel fixing bolts. Similar racks carrying auxiliary apparatus can be placed side by side with amplifiers so that the whole installation is uniform in appearance. Complete specifications available on request.

**W. BRYAN SAVAGE LIMITED**

WESTMORELAND ROAD • LONDON N.W.9 • TELEPHONE: COLINDALE 7131



**Build  
your own  
equipment**

with

**DEXION**  
S L O T T E D   A N G L E

- ★ Can be used over and over again
- ★ No drilling, measuring or painting
- ★ Just cut it and bolt it, that's all!

Write or telephone for illustrated literature D.29

**DEXION** 189, REGENT STREET  
L I M I T E D LONDON, W.1  
Telephone: REGent 4841

## SOUND INSTRUCTION by Postal Method

The I.C.S., largest school in the world devoted to spare-time training by the postal method, offers you highly specialised Courses for the following examinations:

- P.M.G. Certificates for Wireless Operators.
- C. & G. Illumination Engineering (Inter.)
- C. & G. Electrical Engineering Practice, Installation and Telecommunications.
- Graduateship of the B.I.R.E.
- C. & G. Radio Servicing Certificate (R.T.E.B.)

*I.C.S. Examination students are coached till successful.*

Other Courses meet the requirements of all who desire to qualify for responsible positions in Electric Power, Illumination, Heating and Traction Systems. Equally successful is our instruction for Radio Engineers, Radio Servicemen, and in Elementary Radar and Electronics, Advanced Short-Wave Radio and Television Technology.

Fees are moderate and include all books required.

WRITE FOR OUR FREE BOOKLET and state the particular subject or Examination in which you are interested.

Generous Discount to H.M. Forces.

-----YOU MAY USE THIS COUPON-----

### International Correspondence Schools Ltd.

Dept. 165A, International Buildings, Kingsway, London, W.C.2

Please send me, free of charge, your special

booklet on .....

Name..... Age.....

(BOOK LETTERS, PLEASE)

Address .....



## STABILISED POWER SUPPLY TYPE 705

**T**HIS unit provides a stabilised direct voltage, continuously variable from 200-350 volts, which may be used with either the positive or negative lines earthed or with the output floating. An unstabilised alternating supply of 6.3 volts, the centre-tap of which may be strapped to earth, is also available.

Both voltage and current meters are incorporated to enable a continuous check to be kept on the operating conditions, and the instrument is suitable for either bench use or forward mounting on a standard 19-inch rack.

Full details of this or any other Airmec instrument will be forwarded gladly upon request.

**AIRMEC** LABORATORIES **LIMITED**  
HIGH WYCOMBE · BUCKINGHAMSHIRE · ENGLAND  
TEL.: HIGH WYCOMBE 2060      CABLES: AIRMEC HIGH WYCOMBE

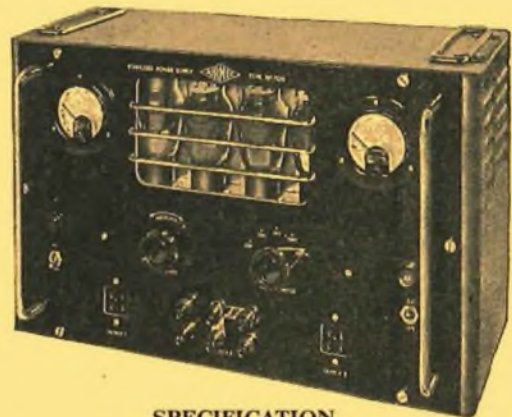

### SPECIFICATION

- **STABILISED OUTPUT:** Continuously variable from 200-350 volts at maximum currents of 200-100 milliamps.
- **STABILITY:** ±0.5% for ±10% supply voltage change +0, -0.5% from no load to full load.
- **IMPEDANCE:** 5 ohms.
- **A.C. OUTPUT:** 6.3 volts 5 amps.
- **DIMENSIONS:** 19" wide × 12" high × 8½" deep.

# TELEPHONE DISTRIBUTION

## EQUIPMENT

ENGINEERS WHO ARE INTERESTED  
IN TELEPHONE DISTRIBUTION EQUIP-  
MENT ARE INVITED TO REQUEST  
SECTION T.C.13 OF OUR TELECOM-  
MUNICATION CABLES CATALOGUE.

TELEPHONE:  
SOUTHAMPTON  
2141 (5 lines)

**IRELLI-GENERAL**  
CABLE WORKS, Ltd., SOUTHAMPTON.

TELEGRAMS  
"PIGEKAYBEL"  
SOUTHAMPTON

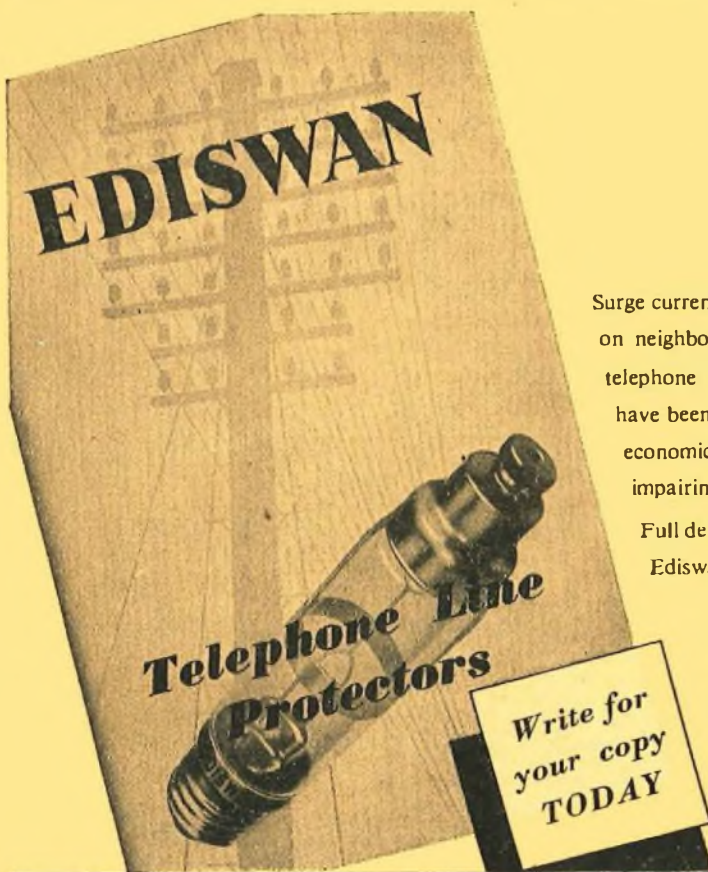

### *How to protect telephone lines*

Surge currents, induced on telephone lines by electric storms or breakdowns on neighbouring power lines, may be effectively controlled by Ediswan telephone line protectors. These special electrode gas discharge tubes have been developed in collaboration with G.P.O. Engineers to provide economical and effective protection for telephone systems without impairing the service.

Full details of these protectors and their application is given in the new Ediswan publication C.1581 which is now available free of charge.

# EDISWAN

THE EDISON SWAN ELECTRIC COMPANY, LTD.  
155 CHARING CROSS ROAD, LONDON, W.C.2.

*Member of the A.E.I. Group of Companies.*