

*ms E. Simpson*

# THE POST OFFICE ELECTRICAL ENGINEERS' JOURNAL

Vol. 44

JANUARY 1952

Part 4

## CONTENTS

	PAGE
NEW-TYPE ROUTINERS FOR AUTOMATIC TELEPHONE EXCHANGE EQUIPMENT —Part 1.—Rack Design, Routines Facilities and Outline of Operation—M. C. Stone ..	147
THE MEDRESCO HEARING AID—C. J. Cameron, A.M.I.E.E., and E. W. Ayers, B.Sc., A.M.I.E.E. .. .. .	153
THE BIRMINGHAM-MANCHESTER TELEVISION LINK .. .. .	158
THE CONDUCT OF ARTICULATION MEASUREMENTS—R. H. de Wardt, B.Sc.(Eng.), A.C.G.I. .. .. .	159
A PULSE ECHO TEST SET FOR THE QUALITY CONTROL AND MAINTENANCE OF IMPEDANCE UNIFORMITY OF COAXIAL CABLES—E. Baguley, B.Sc.Tech., M.I.E.E., and F. B. Cope, B.Sc.(Eng.), A.M.I.E.E. .. .. .	164
AN EXPERIMENTAL ELECTRONIC DIRECTOR—Part 2.—Circuit Operation—K. M. Heron, A.M.I.E.E., H. Baker, B.Sc.(Eng.), A.M.I.E.E., and D. L. Benson, A.M.I.E.E. ..	169
THE GROWTH AND PROPERTIES OF CATHODE INTERFACE LAYERS IN RECEIVING VALVES—M. R. Child, A.M.I.E.E. .. .. .	176
ELECTRONIC EQUIPMENT FOR SIGNALLING SYSTEM A.C. NO. 1—J. R. Tillman, Ph.D., A.R.C.S. .. .. .	179
TRIALS IN CONNECTION WITH LAYING RIGID REPEATERS IN DEEP WATER	181
NOTES AND COMMENTS .. .. .	182
REGIONAL NOTES .. .. .	184
INSTITUTION OF POST OFFICE ELECTRICAL ENGINEERS .. .. .	188
JUNIOR SECTION NOTES .. .. .	188
STAFF CHANGES .. .. .	190
INDEX TO VOL. 44 .. .. .	193
BOOK REVIEWS .. .. .	168, 175, 178, 192

Price 2/6 net

THE INSTITUTION OF POST OFFICE ELECTRICAL ENGINEERS

# How to make certain of your City & Guilds Certificates



**"I guarantee tuition until you have passed"**

If you consider taking one or the whole series of C. and G. examinations then I can help you. BY POST, in your own time, one of my Telecommunications specialists will coach you until you pass. He will give you individual attention, he will study you and your problems. And you will be surprised how fast you progress. For The Bennett College has specialised in technical subjects since it was founded 50 years ago. My system of personal postal tuition has helped thousands of students through their exams. It can do the same for you.

Send me the coupon to-day. I will send you—without obligation—full information on your subject.

*Rep. Bennett*  
GOVERNOR

YOU CAN START ON A BENNETT COURSE FOR ONLY **30/-**

**TEAR OUT**

with monthly instalments of 15/-

## WHICH IS YOUR NEXT STEP?

- Preliminary Course
- Telecommunications Principles I—V
- Telecommunications Practice
- Telephone Exchange Systems I—III
- Radio I—IV
- Telegraphy I & II
- Line Transmission I & II
- Mathematics for Telecommunications I—V
- Radio Servicing Certificate
- Television Servicing Certificate
- A.M.I. Mech.E.
- and many other subjects

## The BENNETT COLLEGE

To the Governor, Dept. A24, The Bennett College, Sheffield, England. I would like to have (at no cost) your prospectus and

particulars of .....

NAME .....

ADDRESS .....

AGE (if under 21) .....

PLEASE WRITE IN BLOCK LETTERS

## VALUABLE FREE BOOK

Tells You How to Pass Your C. & G. or Promotion Exam. at First Attempt!

All Post Office Engineering personnel who are anxious to obtain early promotion should at once send for a copy of our handbook "ENGINEERING OPPORTUNITIES," which, among other intensely interesting matter, describes our unique methods of preparation for TECHNICAL APPOINTMENTS IN THE POST OFFICE (Assistant Engineer—New Style and Assistant Traffic Superintendent), CITY AND GUILDS EXAMINATIONS in Principles of Telecommunications (1-5), Radio (1-4), Telephone Exchange Systems (1-3), Telegraphy (1 and 2), Line Transmission (1 and 2), Lines Plant Practice (1 and 2), Mathematics for Telecommunications (1-5), Electrical Engineering Practice (Prelim. Inter. and Final), and outlines a wide range of non-examination courses in all branches of Electrical, Mechanical, Civil, Automobile, Aeronautical and Radio Engineering.

Assistant Engineer and Assistant Traffic Superintendent. Open competitions now resumed. Age extensions for established Civil Servants. Ask us for full details

**We definitely guarantee "NO PASS—NO FEE"**

If you intend to make the most of to-day's opportunities, you cannot afford to miss reading "ENGINEERING OPPORTUNITIES." It tells you everything you want to know to secure advancement, and describes many opportunities you may now be missing through lack of information. Send for your copy to-day—FREE and without obligation.

BRITISH INSTITUTE OF ENGINEERING TECHNOLOGY  
369 SHAKESPEARE HOUSE,  
17-19 STRATFORD PLACE, LONDON, W.1

# BIET

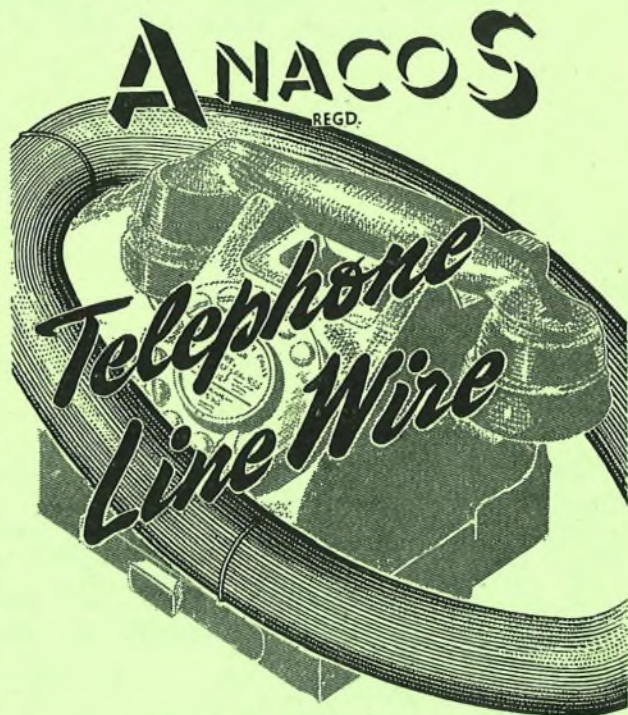

## FOR THE RIGHT CONNECTION

### FREDERICK SMITH & COMPANY

ANACONDA WORKS, SALFORD, 3, LANCS.

Incorporated in The London Electric Wire Company and Smiths Limited.  
Associated with The Liverpool Electric Cable Co. Ltd. and Yactite Wire Co. Ltd

*They're worth waiting for...*



A lot more people than ever before have been ordering a lot more Savage Transformers than ever before. This, and the shortages of raw materials are extending deliveries more than somewhat. As one of our Welsh customers said, however, "Savage Transformers are worth waiting for."



SAVAGE TRANSFORMERS LTD., Nursted Road, Devizes, Wilts.  
Telephone: Devizes 536

# THE POST OFFICE ELECTRICAL ENGINEERS' JOURNAL

Vol. 44

January 1952

Part 4

## New-type Routers for Automatic Telephone Exchange Equipment

M. C. STONE†

### Part I.—Rack Design, Router Facilities and Outline of Operation

U.D.C. 621.395.365

The general design of routine testing equipment and the fundamental methods of testing have been modified. Part 1 of this series of articles describes the features of a new standard rack for routers installed in telephone exchanges, and the principles followed in its design; subsequent articles will describe the circuit fundamentals and some of the novel arrangements applied. The docket-printing machine used with the router will be described in a separate article.

#### Introduction.

GROWTH in automatic methods of operation of the telephone service, including automatic switching of long-distance circuits, has caused an increase in direct connection of external lines and items of apparatus without the interposition of a telephone operator. As a consequence, fault localisation of trouble reported by subscribers becomes much more difficult, particularly as individual items of switching and signalling equipment are increasing in complexity. A considerable improvement in maintenance techniques is therefore necessary if service standards are not to fall. Thoughts naturally turn to methods which can assist the maintenance officers, and of these, routine testing equipment assumes prime importance.

#### Existing-type Routers.

Earlier articles\* in this Journal described the principles employed for fault location by the type of routers now fitted in the larger automatic telephone exchanges. These routers are designed to make a functional test of the equipment, usually by applying working conditions more onerous than are normally met in service; a failure of operation being indicated by a fault lamp and cessation of testing. An operation of this nature often comprises a combination of mechanical actions (e.g. a stepping switch may be influenced by a relay contact or interrupter spring or magnet armature), any of which may give similar fault indication. Location of the cause of failure is at present left to the maintenance officer in many instances. Another limitation of existing routers is the negative testing sometimes employed (e.g. if the normal condition on a wire is earth potential the test accepts receipt of this condition as correct, although the testing equipment may itself be earthy).

#### New-type Router Facilities.

The design of the new-type router has been based on principles which avoid the known weaknesses of previous testing methods, and with a view to simplifying the main-

tenance task of fault localisation; additional facilities include detection of defects in transmission bridges. The main features of the design of the new router are outlined as follows:—

- (1) To be capable of operating for long periods without attention.
- (2) Connections from the router to items under test to be of low, constant resistance.
- (3) Router distribution test leads not to include switching contacts other than those of distribution.
- (4) All relays to have ample factor of safety and ample contact pressure.
- (5) All tests to be positive. As an example, when a test for a disconnection is to be made, it must be preceded or followed immediately by a test for continuity.
- (6) Correct operation not to depend on limits gauged by slow-to-operate or slow-to-release relays.
- (7) Router rack to be a standard rack equipped with those items common to all routers and with specified elements suitable for the equipment to be tested.
- (8) Test elements to be interchangeable without cabling modification.
- (9) Designation of item under test to be indicated.
- (10) Indication when any component of an item fails to pass a test within the tolerances specified.
- (11) Item under test to be busied against normal operation.
- (12) Automatic docket printing of busy and faulty items.
- (13) Automatic application of self-test of the router equipment.
- (14) Facilities to start and stop the router under automatic (clock) control.

Economic considerations limit the extent to which segregation of tests on plant and recording of faults can be made, but improvement in testing technique, including application of positive testing and self-testing methods, has produced a more efficient router. The design of testing circuits ensures that any variations introduced by the tolerances in electrical values of testing components do not affect the testing condition.

† Senior Executive Engineer, Telephone Development and Maintenance Branch, E.-in-C.'s Office.

\* P.O.E.E.J., Vol. 22, pp. 24 and 108; Vol. 23, p. 118; Vol. 26, p. 305.

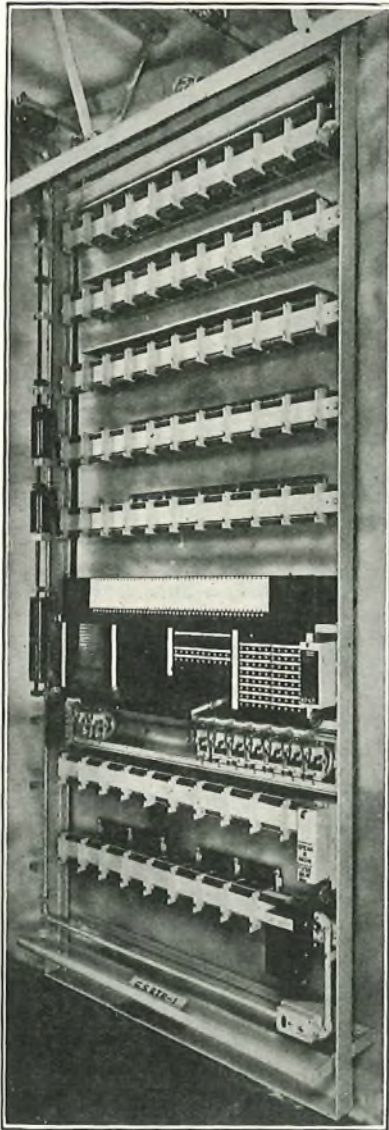

FIG. 1.—FRONT VIEW OF ROUTINER CONTROL RACK.

#### RACK DETAILS

A general view of the routiner rack is given in Fig. 1. The dimensions are similar to those of a standard rack, i.e. 4 ft. 6 in. wide and 10 ft. 6 in. high. The model shown is designed for testing 2,000-type group selectors, but the rack and control circuit is a standard item which can be used for all routiners, the requirements peculiar to each design being provided by jacked-in relay sets which are fitted on the lowest shelf and on the five upper shelves. Fig. 2 gives the layout of the front of the rack. The routiner control circuit, which is located between shelves A and D, comprises relay sets fitted on shelf B, uniselectors on the right-hand portion of shelf C, control keys and position-indicating lamps above, with a fault-indicating lamp panel immediately below shelf D. All of these items wired, together with the shelf wiring for relay sets on shelves A, D, E, F, G, H and the wiring for common services, form the standard rack. The particular circuit requirements for each design of routiner (e.g. 1st code, final selector, A/A relay set) are provided by the relay sets fitted on the shelves mentioned. Alteration to testing conditions of a routiner can be made by a change of one or more relay sets without interfering with the permanent wiring. These relay sets are of two types, as described below.

#### Common Test Relay Sets.

Circuit elements of a more complicated nature are provided as common test relay sets, which may be used for a succession of tests during a test cycle (i.e. a complete series of tests on one item). For this purpose they are cross-connected to one or more test relay sets in a manner described later. Wiring for these common relay sets is provided on shelf A and on positions 6 to 10 of shelf D. Positions 1 and 2 of shelf A are wired in a special manner for sending and counting relay sets which, although classified as common test relay sets, are peculiar to the design of routiner on which they are fitted; a common design for all routiners would be complicated. Positions 9 and 10, shelf A, are fitted with equipment which provides power services for thermionic circuits used on the rack.

#### Test Relay Sets.

Testing conditions for the main equipment are applied by test relay sets which can be fitted in positions 1 to 5 of shelf D and all positions on shelves E to H. Each relay set can provide a maximum of four fault indications which may be effected by the testing of one or more components, e.g. D relay loop, D relay non-operate, D loop resistance high, D loop resistance low. Commencing at the relay set in position D1, testing proceeds in sequence utilising relay sets along the shelf to position 5, then along shelves E, F, G and H to the last relay set provided; the number of relay sets fitted being the minimum essential for the tests required on a particular design of routiner.

#### Routiner Control and Lamp Panels.

The layout of the routiner control and fault-indication panels is illustrated in Figs. 1 and 2. Space on the left is allocated for control keys and lamps when required in conjunction with the sending and counting circuit. In operation a combination of keys would release a series of impulses to the main equipment, while an associated lamp panel indicates impulses received from the main equipment—a device suitable for checking correct operation of translator equipment. Immediately to the right are the routiner control keys, and lamps which indicate the conditions of routine testing and routiner faults. Further right, access lamps record the progress of testing by giving the designation of the item under test in the form:—rack, shelf and shelf position. Fitted above is the fault-indication panel comprising a horizontal strip of 45 lamps (one for each test relay set position), with a vertical strip of four lamps at each end to indicate the test number; a maximum of four testing conditions may be checked by one test relay set. The whole of the centre portion of this panel is fitted with labels showing the nature of the test, engraved in a space corresponding to the "horizontal" and "vertical" lamps. A retractile writing desk is provided below the centre control panels.

#### Wiring Arrangements.

Fig. 3 illustrates the layout of the rear of the rack. Connection strips mounted at the rear of the shelves provide terminating points for wiring from relay sets, to afford interconnection facilities. External cables are terminated on the connection strips provided at the rear of shelf B. The wiring form of the sending and counting circuit is shown for explanatory purposes. Wiring arrangements for this circuit are made on the connection strip fitted at the front of shelf C, from which permanent wiring is provided to connection strips on shelves A and D to H, with a multiple arrangement between all shelves. Wiring from shelf positions A1 and A2 is also terminated on the strips on shelf A. An individual wiring form for each routiner is provided from the strip on shelf C to the uniselectors and control keys fitted for circuit requirements when necessary. Appropriate

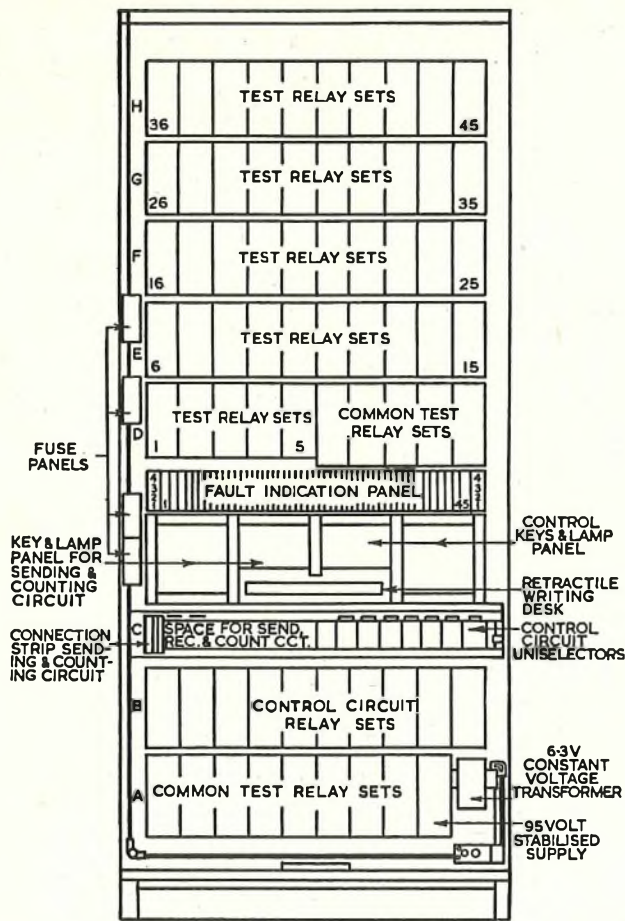

FIG. 2.—LAYOUT OF EQUIPMENT ON FRONT OF ROUTINER CONTROL RACK.

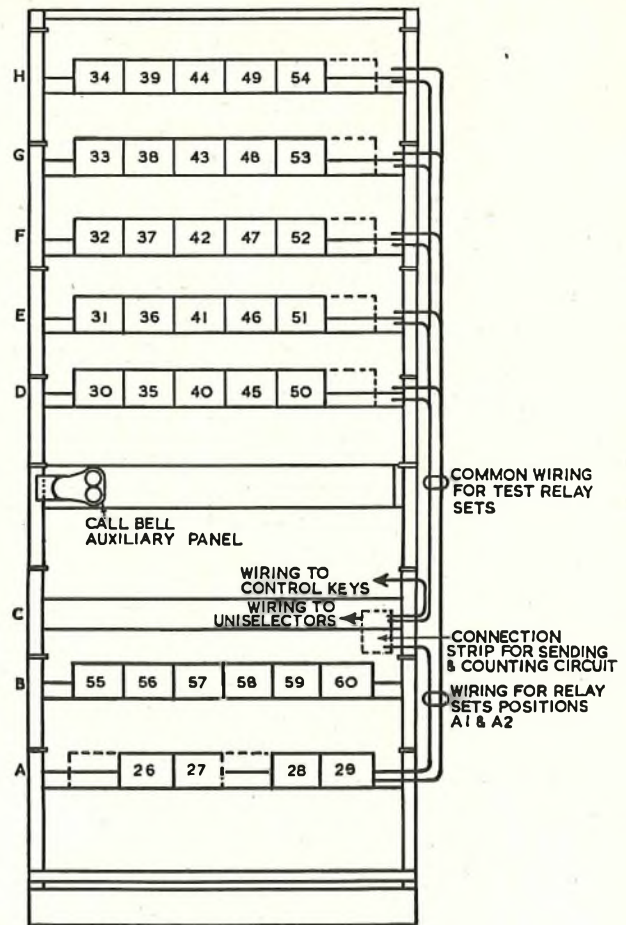

FIG. 3.—LAYOUT OF CONNECTION STRIPS AND WIRING ON REAR OF ROUTINER CONTROL RACK.

cross-connections between the terminal strips, shown on the relative circuit diagram, form a complete sending and counting circuit.

#### Power Supply.

The main power supply for the equipment fitted on the routiner rack is from the exchange 50V distribution. Filament supply of 6.3 V, for circuits incorporating valves, is obtained from a mains transformer of the constant voltage type fitted at the extreme right of shelf A. The mains wiring serves also a three-pin socket immediately below, providing a supply to the jacked-in relay set fitted in position A9. This relay set converts mains voltage to a stabilised 95 V positive supply utilising a neon voltage limiter device. A minimum of variation in voltage applied to valves is essential to accurate testing by the circuits affected. The whole arrangement permits multiple wiring of 6.3 V A.C. and 95 V D.C. power to the common test relay sets for filament and anode supplies respectively, both within the safe maximum voltage limits for unprotected wiring. Tappings from these supplies are extended to connection strips on shelves D to H to permit use with test relay sets if required.

#### TESTING ARRANGEMENTS

Many of the tests made by the new-type routiner are of a precision which will pass as correct only small tolerances from the specified electrical and mechanical adjustment values of components in the circuit under test. For this reason devices which may introduce error in a routiner testing circuit have been avoided. All testing leads in the

routiner are connected by relay contacts with adequate testing current, thus avoiding the risk of added circuit resistance if base metal contacts were used.

The method of associating the routiner with the equipment under test can be followed by reference to the typical diagram shown in Fig. 4 (sections A-D). A block schematic diagram similar to that illustrated will form the key diagram for each design of routiner, the diagram number representing the serial number of the routiner. Commencing with section A the main equipment under test is shown with test line switching relays fitted on the same rack. These relays are associated with an outlet on level 9 allocated for testing purposes. In section D are shown two items normally fitted on the miscellaneous apparatus rack, and it will be convenient to refer briefly to these before describing the main testing arrangements.

*Call Trap Circuit.* Incoming equipment associated with junctions frequently has no facility for busying outgoing equipment at the distant exchange when the former item is seized locally (e.g. by a routiner). To avoid a dual connection between the routiner and normal traffic, arrangement is made to divert the junction to a call trap circuit when the terminal equipment is taken for test, under which condition busy tone is connected to the junction line.

*Docket-printing Machine.* This machine (to be described in a future article), with its controlling circuit, can be associated with a maximum of 16 routiners. It prepares dockets recording the time and designation of equipment under test, when faults are found during the progress of testing and also at the start and finish of routine periods. A fault is recorded on a serially numbered docket giving

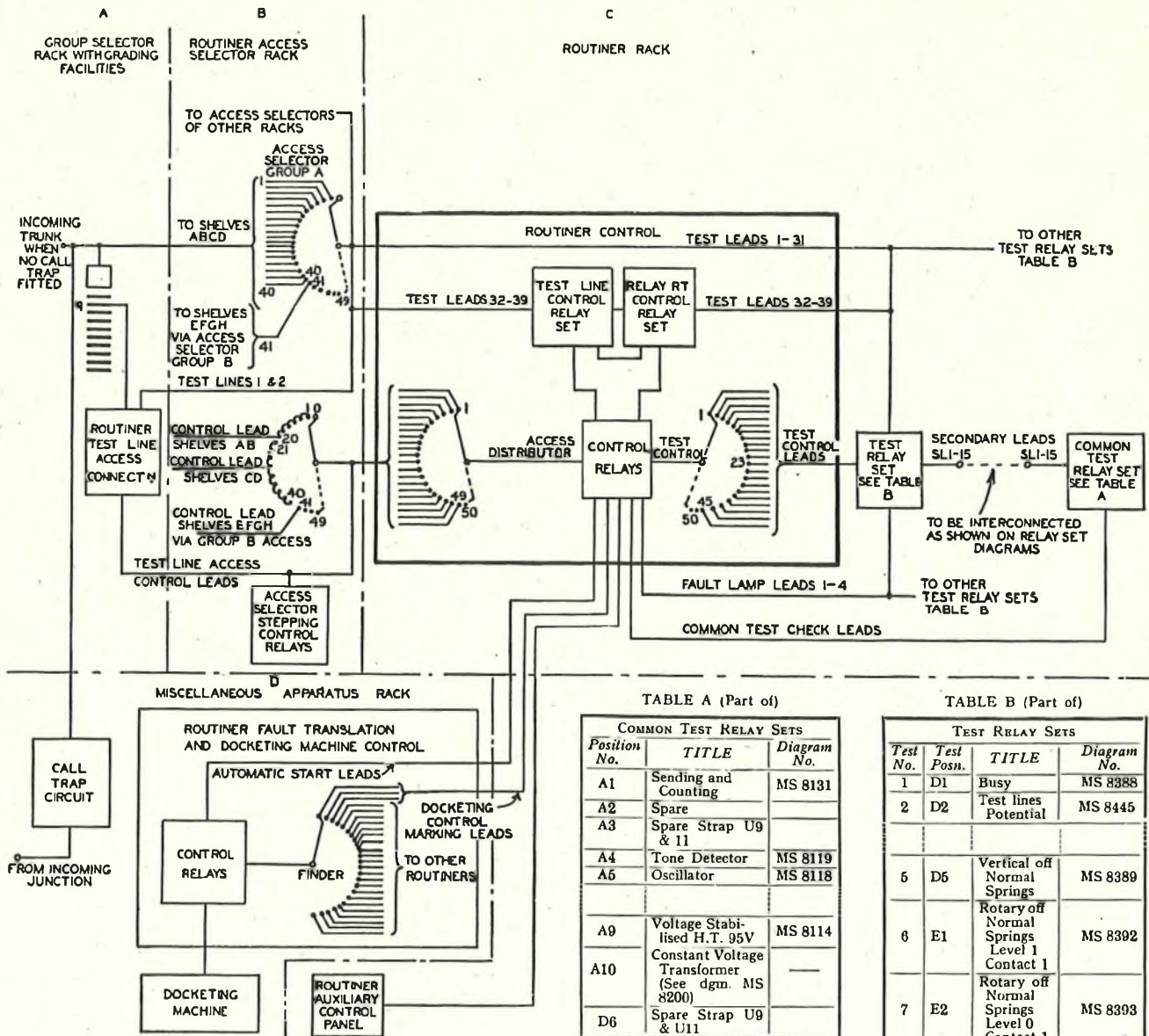

FIG. 4.—BLOCK SCHEMATIC DIAGRAM OF THE ROUTER.

details of the item affected, nature of fault and time; the router then steps to the next item and continues testing. When a fault occurs due to a defect in the router, testing stops and an alarm signal is given; a docket is printed recording "Router Fault".

*Access Equipment.*

Access equipment (section B) may be fitted on the same rack as the main equipment or on a separate access rack; adoption of the arrangement is subject to a study of the economy of each method. For the router illustrated a separate rack is provided; four main equipment racks being served by one access rack 10 ft. 6 in. high and 1ft. 6in. wide. Uniselectors are used as access switches, the bank contacts being wired to the main equipment. A uniselector arc serves one test lead, so that the number of arcs (and uniselectors) required is determined by the number of test leads added to the arcs needed for control purposes. A maximum of 40 items is served by the primary access switches serving one rack; additional items are served via secondary switches. As the main equipment has capacity for 80 switches per

TABLE A (Part of)

COMMON TEST RELAY SETS		
Position No.	TITLE	Diagram No.
A1	Sending and Counting	MS 8131
A2	Spare	
A3	Spare Strap U9 & 11	
A4	Tone Detector	MS 8119
A5	Oscillator	MS 8118
A9	Voltage Stabilised H.T. 95V	MS 8114
A10	Constant Voltage Transformer (See dgm. MS 8200)	
D6	Spare Strap U9 & U11	
D10	Spare Strap U9 & U11	

TABLE B (Part of)

TEST RELAY SETS			
Test No.	Test Posn.	TITLE	Diagram No.
1	D1	Busy	MS 8388
2	D2	Test lines Potential	MS 8445
5	D6	Vertical off Normal Springs	MS 8389
6	E1	Rotary off Normal Springs Level 1 Contact 1	MS 8392
7	E2	Rotary off Normal Springs Level 0 Contact 1	MS 8393
15	E10	Test Line 1: Wiper Potential	MS 8401
16	F1	Selector Release Timing	MS 8402
17	F2	Test Line 2 Seized	MS 8403
24	F9	Busy Tone: Level 1	MS 8410
25-45	F10 G1-10 H1-10	Spare	

rack, one group of secondary switches is required to serve the second group of 40 switches. Additional secondary groups can be connected from outlets 42, 43, etc., when required. The typical case under description has 10 test leads and two control leads requiring distribution by four primary and four secondary access switches, the latter wired from outlet 41; the whole serving 80 items on the main rack.

*Router Rack.*

Equipment forming the router rack is shown in section C. The control equipment is represented as enclosed within a thick line. The test relay sets and common test relay sets are on the extreme right. A schedule of the relay sets fitted,

quoting individual diagram numbers and shelf positions on the rack, forms part of the block schematic diagram, as illustrated.

#### Test Leads.

Test leads from the access switches are wired as a multiple over the jacks serving test relay sets, thus avoiding switching within the routiner by equipment with base metal contacts. These leads are also multiplied on the wiper connections of primary access switches, avoiding the alternative of an additional access switching point. From the banks of the access switches the test leads are wired to appropriate testing points of the main equipment.

#### Access and Control Distributors.

The multiple arrangement of test leads demands the use of access distributor and test control switches. The former determines, in conjunction with the access selector control circuit, which rack of main equipment will be associated with the routiner test leads, and ensures progression of routine testing in rack sequence. Associated circuits indicate the progress of routine testing on the control-lamp panel, and set up marking conditions in the docket machine control circuit when appropriate. The test control distributor switch connects the control circuit with each relay set in the sequence, as shown in Table B (Fig. 4), so that by operation of a relay in the test relay set, the selected test leads required for a particular test can be connected to the circuit arranged for making the test; for more complicated tests this will involve a common test circuit. Thus, a test relay set on its own may provide a complete testing circuit or may do so in conjunction with a common test relay set.

#### Secondary Leads.

From each test relay set 15 secondary leads (SL) are wired to the connection strips fitted at the rear of the shelves. These are utilised as required by the design of a particular routiner, to connect common test equipment. Connection is made by cross-connections between tags on these strips and similar tags serving the common test relay sets. SL leads from the common test relay sets are multiplied over shelves to avoid inter-shelf connections. Wiring from both test and common test circuits to the control circuit forms part of the permanent rack wiring.

#### Test Line Control Relay Set and Relay RT Control Relay Set.

These relay sets are variable items fitted in the control circuit, provision being dependent on the type of main equipment with which the routiner is associated. The test line relay set is required when tests of the main equipment are made in conjunction with a test number, as is the case with group selectors tested to the nineteenth outlet from level nine. The RT control relay set is provided in conjunction with RT relays which are fitted as part of the main circuit when it is necessary to isolate testing points (e.g. on a junction relay set it is desirable to isolate the line from the equipment during testing) and/or to busy the circuit under test.

#### Auxiliary Control Panel.

Auxiliary control panels can be provided for remote operation of the routiner at large exchanges. Circuit arrangements permit a maximum of two auxiliary panels, which are provided with control keys and lamps similar to those on the routiner control panel.

#### Sending and Counting Circuit.

Strowger pulses for serving the routiner are supplied by an impulse machine fitted on the M.A.R. The sending

elements of the sending and counting relay sets select a predetermined train (or trains) of impulses for positioning the equipment under test as required for the sequence of testing. Where main equipment incorporates impulse repetition or translation devices, impulses received from the main equipment are checked by the counting element. Keys can be provided on the control panel to permit sending and receiving suitable combinations of digits which conform with local trunking arrangements. Sending and counting equipment for various designs of routiner differs only in respect of the layout of the two relay sets fitted in positions A1 and A2, and in the arrangement of the uniselectors fitted on the left-hand portion of shelf C with control keys above.

#### RELAY SET WIRING

#### Test Relay Set.

A typical circuit arrangement of a test relay set is shown in Fig. 5. It is used to measure the level of dial tone as supplied from the main equipment. Consideration of its

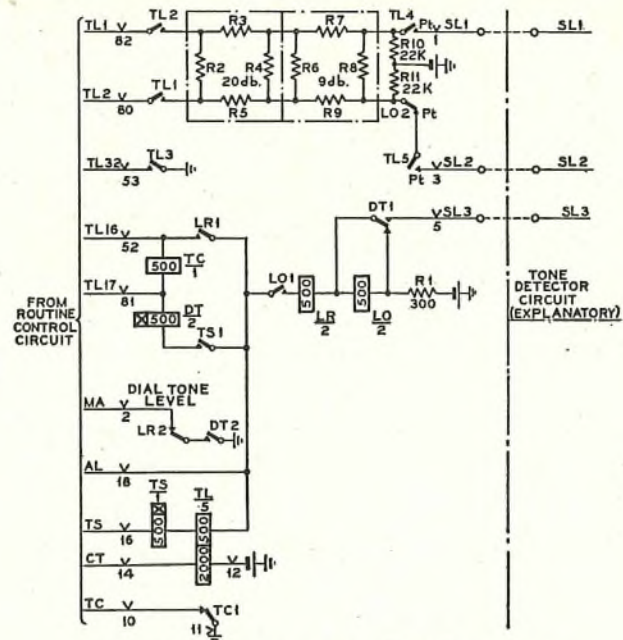

FIG. 5.—CIRCUIT OF A TYPICAL TEST RELAY SET.

application with reference to Fig. 4 will be helpful. TL leads are allotted by the circuit designer from a common form of 39 test leads multiplied over the shelf-jacks of the test relay sets, and terminated on a connection strip at the rear of the routiner rack. From this terminal point cables extend the number of access wires required for routine testing to the access selectors; these are designated "Test Leads" in Fig. 4. For testing purposes, eight of these leads are associated with the Test Line and RT control relay sets. The full number of test leads wired on the standard rack may not be required for any one routiner, and of the test leads provided, only those concerned with the test will be wired within the test relay set. The secondary leads (SL) are wired to connection strips fitted at the rear of the shelf on which the relay set is fitted. They are individual to each relay set, cross-connection being provided on the connection strips to the SL wiring from the common test circuits; in this instance to the tone detector circuit only. Leads MA, AL, TS, CT and TC are test control leads which apply suitable circuit conditions to the routiner control circuit at the start and completion of the test, give indication of the result of the test, and cause the distributor to step to the next test relay set. Leads TL1, TL2 and TL32, which in this instance are extended by the access switches to the negative,

positive and private wires of the equipment under test, are normally isolated by TL contacts. Similarly, the SL leads to the common test circuit are normally isolated to avoid "feed-back" conditions to other relay sets. Modification to the testing facilities can, with this combination of relay sets and jumpering, be effected without interference to the permanent wiring.

*Common Test Relay Set.*

As the name implies, the common test relay set may be associated with more than one test relay set. Common wiring arrangements (other than for the sending and counting circuit which has been described) are shown in Fig. 6. Fifteen SL leads from each relay set are formed as a multiple

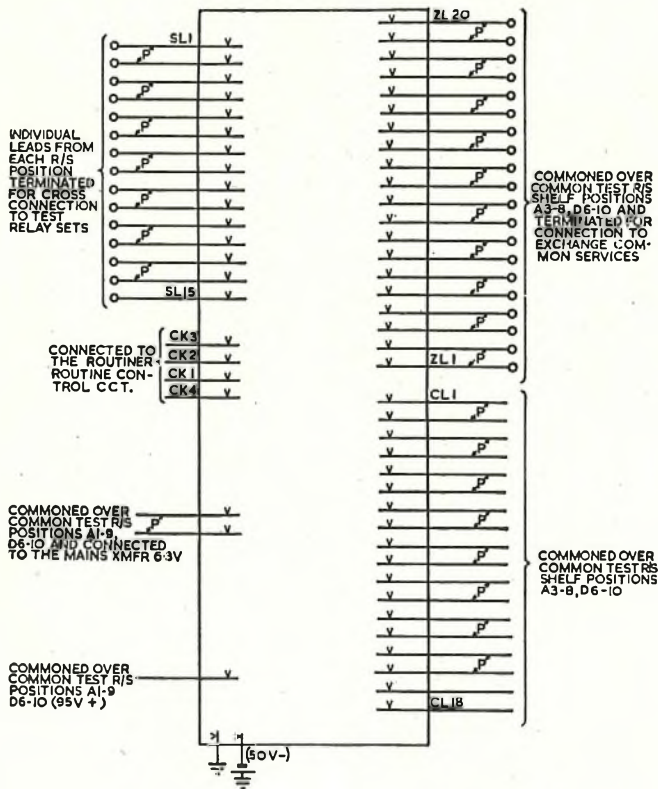

FIG. 6.—WIRING OF A COMMON TEST RELAY SET.

with one appearance on connection strips fitted on each shelf from D to H. From this point cross-connections are made to test relay set SL leads, as described already. The design engineer allocates as many of these SL leads as are required for the common test circuit. The ZL and CL leads form a common multiple over shelf positions A3 to A8 and D6 to D10; the ZL leads terminating on a connection strip on shelf D for connecting to the exchange common services. Four check wires (CK) to the routiner control circuit form the connections for self-checking arrangements made by the routiner prior to commencement of testing. The remaining leads feed the power supplies: 50 V and 95 V D.C., 6.3 V A.C., and earth.

*Automatic Control.*

With the AUTO CONTROL key operated the routiner is started and stopped automatically when earth pulses are received over start and stop wires connected to the docket machine control circuit, the time of each pulse being marked by connection to the banks of a uniselector, stepping hourly under influence of the exchange clock. Progressive routine testing of the main equipment is continuous except during the period between the stop and start signals, usually during the exchange busy hour. When the stop signal is received the routiner continues its routine test of all items on the rack under test before stopping. Testing recommences when the next start signal is received, on the next rack in routine sequence. Dockets are prepared by the docket printing machine recording the details of starting and stopping times with the relative rack designation, in addition to recording faults located during the progress of testing. Routine testing ceases and an exchange alarm signal is given when a fault occurs in the routiner.

*Manual Control.*

Manual operation of the routiner is effected by a MANUAL START key, which takes control from the automatic start and stop circuit, failures during testing being indicated by the fault-lamp panel and an audible alarm bell, the latter fitted adjacent to the rack. With this method of working, no docket is printed and the routiner stops testing pending attention to a fault. The normal manual control facilities provide progressive routine testing for a routine cycle (i.e. one complete test of all equipment associated with the routiner). Other keys provided for manual control give CONTINUOUS ROUTINE (repetition of testing one item), or LIMITED CONTINUOUS ROUTINE (test of each item repeated to a maximum of 20 times in the normal sequence of testing). An ACCESS DISTRIBUTOR STEPPING key is provided to position the access switch to a particular rack of equipment on which it is desired to commence testing. Selection of an item on the rack is effected by operation of the ACCESS SELECTOR STEPPING key. Visual indication of the stepping progress is given by the access lamp panel.

*Subsidiary Control Features.*

Other keys provided give the following facilities:—

**FORCED RELEASE CANCEL.** Permits certain tests to be omitted. These are predetermined and suitable strapping arrangements are made between terminals wired from the test distributor for this purpose.

**MONITOR.** To give listening-in facilities on the transmission path of an item under test.

**RINGING.** Means for signalling to each auxiliary control panel; a common speaking pair is provided.

**RESET.** Recommencement of the test cycle (i.e. complete test of one item).

**STEP ON.** Routine testing is advanced to commence at the next item in the routine sequence.

ACKNOWLEDGMENT

Thanks are expressed to Standard Telephones & Cables, Ltd., for supplying the photograph used in Fig. 1, and to colleagues in the Telephone Branch for helpful comments and advice.

(To be continued)



# The Medresco Hearing Aid

U.D.C. 534.773

C. J. CAMERON, A.M.I.E.E., and  
E. W. AYERS, B.Sc., A.M.I.E.E.†

An important development under the National Health Scheme has been the introduction of a new hearing aid for distribution to the deaf, a development in which the Post Office has been, and still is, actively concerned. This article gives a broad outline of the work done by the Post Office in this connection, and includes a description of typical Medresco Aids and their principal component parts. Mention is also made of the production and performance of such aids and possible future improvements in design.

## Introduction.

"MEDRESCO," an abbreviation of the title Medical Research Council, is the name given to hearing aids made available under the National Health Scheme, without charge, to members of the public suffering from defective hearing. The Medical Research Council's report<sup>1</sup> on hearing aids and audiometers provides a comprehensive background to the evolution and development of the Medresco Aid, and this article is, therefore, restricted primarily to an account of the design and engineering of the aid, as carried out by the Post Office.

Under the ægis of the Ministry of Health, initial production of Medresco Aids was vested in the Ministry of Supply, but was subsequently taken over by the Post Office in August, 1948. In taking over, the Post Office had the tasks of:—

- (a) developing and putting into production a magnetic insert receiver specially designed to replace the crystal receiver, as employed in the M.O.S. version—the change from crystal to magnetic receivers was decided in the light of manufacturing difficulties with the former, advantages offered by the latter, and prevailing practice both in this country and America to prefer electro-magnetic to crystal receivers in hearing-aid designs.
- (b) redesigning the microphone and the circuit of the hearing-aid amplifier to take account of the widely different electrical characteristics of the magnetic receiver in relation to those of the crystal type, and to ensure that the overall performance of the complete aid would be substantially unaltered.
- (c) developing, engineering and arranging for quantity production of the new aid by May, 1949—excluding initial exploratory work and discussions, the development and engineering time available was less than six months—to avoid a break in distribution of the aids to the public.

Naturally, the opportunity was taken in the development of the aid produced under Post Office direction to learn from the experience of the M.O.S. and also from information on such field experience as was available in August, 1948. Thus, for example, it was quickly realised that the mechanically coupled separate units of the volume control and switch of the M.O.S. production were prone to mechanical failure, and an important change introduced is the replacement of this arrangement by a combined volume control and switch which was developed specially for this purpose.

## Hearing Defects.

To help in understanding in what way, and to what extent, an electronic aid can assist in restoring impaired hearing, it is necessary to give some consideration to the nature of various hearing defects.

The external ear, comprising the ear-flap or shell (the pinna) and the canal leading into the skull (the meatus), is primarily a sound-collecting system. The only defects in

this collecting system likely to affect the hearing appreciably are gross congenital malformation or injury, or the accumulation of wax or other obstructing matter.

The middle ear comprises the drum and the chain of small bones (the ossicles), which act together to provide the most efficient transfer of energy from the airborne sound wave to the inner ear. Any part of this chain may be damaged by injury or disease, or may be absent altogether. The drum membrane may become stiffened or perforated, and the movements of the ossicles may be impeded by bony or fibrous growths (otosclerosis), or by fluids collecting in the middle-ear cavity. All these defects introduce attenuation into the path of the sound wave and result in what is known as *conductive deafness*, which may, in theory at least, be completely compensated by sufficient amplification.

The inner ear contains the organ of hearing proper, which analyses the complex vibrations in the sound wave and originates the nerve impulses which reach the brain and arouse the sensation of sound. Congenital defects, injury or disease of the inner ear or of the nerve paths up to and including the brain itself give rise to what is known as *perceptive deafness*, in which the individual's powers of discrimination and analysis may be reduced. Such deafness cannot be wholly offset by amplification, though selective amplification of speech to emphasise the smaller distinctions can give some assistance, especially if accompanied by auditory training to ensure that the residual powers of hearing are utilised to the fullest extent.

Perceptive deafness is frequently accompanied by other disturbances of the hearing, such as head noises (tinnitus) or "recruitment," in which intense sounds appear to have normal loudness though weaker sounds may be inaudible. These secondary phenomena unfortunately have a further deleterious effect on the intelligibility of speech and may make the use of a hearing aid less comfortable, especially since they often make the subject more susceptible to irritation by background noises, or by unduly loud sounds.

Conductive and perceptive types of deafness have many sub-divisions of classification, and are frequently present simultaneously in one ear, such cases being referred to as "mixed."

Pure conductive deafness does not normally cause hearing losses greater than about 50 db., since even with complete blockage of the normal path some stimulation can reach the inner ear by conduction of the vibrations through the bones of the skull. This property is, of course, used in bone-conduction aids.

## M.R.C. Recommendations.

During 1945 the Electro-Acoustics Committee of the Medical Research Council conducted large-scale clinical investigations in London and Manchester with the help of two master hearing aids,<sup>2</sup> designed and built at the Post Office Research Station, whose characteristics could be varied over a wide range. Some 228 patients exhibiting all varieties and degrees of deafness were examined by otologists and tested with specially recorded sets of word lists reproduced at known sound intensities through the master hearing aid. The numbers of words correctly heard were counted for different frequency/response characteristics and amplification settings, and the results subjected to statistical analysis.

† The authors are, respectively, Senior Executive Engineer, Subscribers' Apparatus and Miscellaneous Services Branch, E.-in-C.'s Office, and Principal Scientific Officer, Research Station.

<sup>1</sup> Medical Research Council Special Series Report No. 261. H.M. Stationery Office.

<sup>2</sup> E. Aspinall, *J. Brit. I.R.E.*, Vol. II, No. 2, pp. 45-50, Feb. 1951. "A Master Hearing Aid."

The conclusion was reached that one or other of two frequency/response characteristics would afford the majority of patients the greatest possible assistance they could obtain from a hearing aid. This result was strikingly corroborated by a theoretical analysis given in the M.R.C. Report (Appendix II) and by similar work performed at about the same time at Harvard University.<sup>3</sup>

The recommended characteristics, expressed in terms of air-to-air gain, are shown in Fig. 1. One pair of curves shown

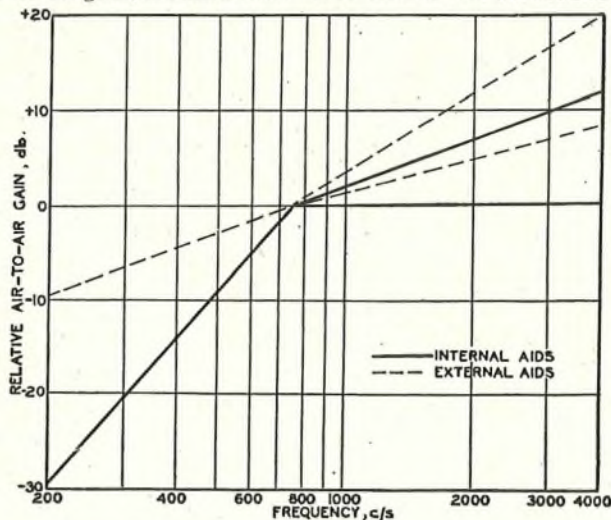

FIG. 1.—RECOMMENDED FREQUENCY/RESPONSE CHARACTERISTICS.

relates to aids using insert receivers which are plugged into the user's ear canal; the other pair relates to aids using external disc-type receivers with a headband. The air-to-air gain is the ratio of the sound pressure developed by the receiver of an aid in an artificial ear to the free-field sound pressure to which the microphone is exposed. The curves for insert and external types of aids are both intended to be equivalent to the characteristics of the master hearing aid at its best settings, and the differences are accounted for by such factors as the effectiveness of the acoustic seal to the ear, and the use of different artificial ears for the two types of receiver.

Further recommendations were that with new batteries the gain of an aid should not be less than 40 db. at 750 c/s, and its maximum undistorted acoustic output at this frequency should be at least 200 dynes per square centimetre. A fall of 6 db. in gain, and an acoustic output of not less than 100 dynes per square centimetre were permitted with the batteries discharged to two-thirds of their nominal voltages.

#### Types of Medresco Aids.

The existing types of Medresco Aids, all of which use air-conduction receivers, are designed in accordance with the foregoing M.R.C. recommendations, except that for the majority of patients a lower value of maximum acoustic output has been found adequate, and advantage has been taken of this fact to economise in current consumption. An insert-type receiver is normally used, support being provided by means of a plastic ear-mould tailored to the patient's ear. Where active discharge or infection of the ear canal prohibits the wearing of an insert receiver, an external receiver supported by a headband is used, but this type requires a much higher power input and a correspondingly heavy expenditure on battery replacements.

There are four current versions of each type, as shown in Table 1, and, although only Mark IIA aids are now being produced, all the types shown have still to be catered for.

The original Mark I aids were substantially similar to

<sup>3</sup> H. Davies, and others. "Hearing Aids—An Experimental Study of Design Objectives," Harvard University Press, 1947.

TABLE 1

Mark No.	Description	M.O.H. Code	
		Insert	External
I	Original M.O.S. model	OL 10	OL 20
IA	Mark I version repaired and converted to include combined volume control and switch	OL 10A	OL 20A
II	First Post Office model	OL 15	OL 25
IIA	Mark II with improved valves and components	OL 15A	OL 25A

those described in M.R.C. Report No. 261, though British-made valves and microphones were used soon after production commenced. For the Mark II version the aids were extensively redesigned to improve reliability and accessibility and to reduce manufacturing costs. The new magnetic receiver necessitated a completely new circuit, though the valves used were the same types as used with the later Mark I aids. The Mark IIA version was introduced to make use of later improvements in components and particularly of new valves with greatly reduced filament consumption and higher anode efficiency. At the same time a considerable increase in output power with lower distortion was achieved in the insert-receiver version.

For comparison the current consumptions of the various versions of the Medresco Aid are shown in Table 2.

TABLE 2

Type of Aid	Mark No.	Valves used		Average Filament Current (mA)	Average Anode Current (mA)		Type of Receiver
		1st & 2nd stage	Output stage		30 V	45 V	
External	I	CV 386	CV 387	50	—	φ2.5	Magnetic
	IA	CV 386 or 443*	CV 387	50	—	φ2.5	
	II	CV 443	CV 387	50	1.6	φ2.5	
Insert	I	CV 386	CV 385	50	φ0.4	—	Crystal
	IA	CV 386 or 443*	CV 385	50	φ0.4	—	
	II	CV 443	CV 385	50	φ0.36	0.64	
	IIA	CV 2107	CV 2106	30	φ0.35	0.57	Magnetic

Note.—φ indicates normal H.T. voltage. Voltages other than normal are used exceptionally to meet special output power requirements of individual patients. \* CV 443 is used as a replacement for defective CV 386 valves.

#### Description of Complete Medresco Aid.

A complete Medresco insert-type aid of the Mark IIA version is shown in Fig. 2. The black moulded case houses the microphone and three-stage valve amplifier, and has a clip on the back for attachment to the clothing. It is designed to be worn in a position such that sound waves

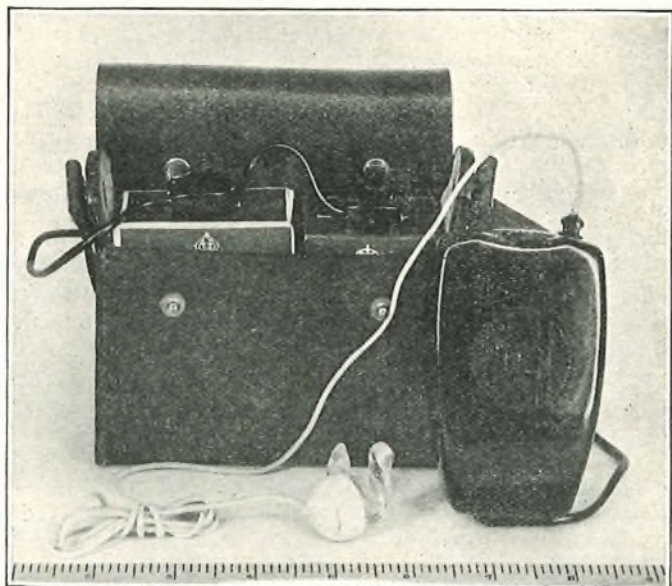

FIG. 2.—A COMPLETE, MK. IIA, INSERT AID.

have free access to the microphone grille, and the thumb-operated switch and volume control knob at the top can easily be operated. The insert receiver is wholly supported by a transparent plastic ear mould, and is connected to the amplifier output socket by a plug-ended tinsel cord with flesh-coloured P.V.C. covering. The ear mould supplied initially is a simple straight plug type, but is replaced subsequently by one which is tailored to the ear of the user. An ear-mould of the latter type is shown in Fig. 2. For economic reasons, batteries of comparatively large size are used and are contained in a separate leather pouch, which may be slung from the shoulder or strapped round the body. The batteries are connected by a four-way tinsel cord with black P.V.C. covering, terminating in non-interchangeable and non-reversible plugs.

The weight of a complete insert-type aid is 1 lb. 11 ozs., of which the amplifier, leads and receiver account for only 5 ozs. The corresponding figures for the external type are 2 lb. 3 ozs. and 7 ozs.

The front view of the amplifier chassis, shown in Fig. 3,

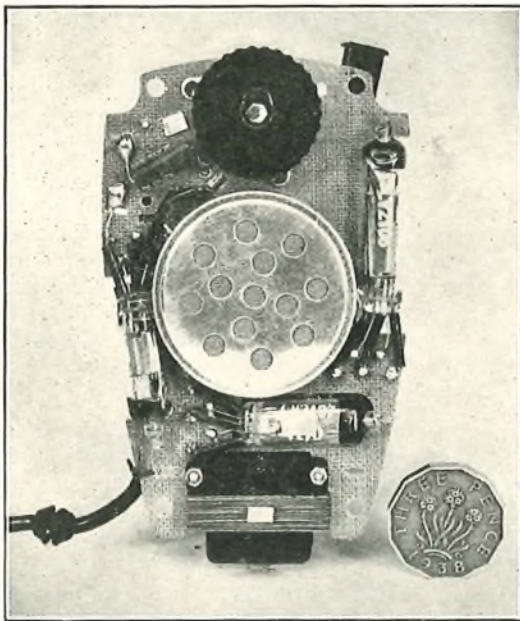

FIG. 3.—FRONT VIEW OF AMPLIFIER CHASSIS.

clearly reveals the microphone surrounded by the three sub-miniature valves, the volume control and the output transformer. In the complete assembly the microphone is sealed by a sorbo rubber ring to the case grille, which is covered by silk on the inside. At the rear of the chassis are the L.T. battery switch which forms part of the volume control, the output socket for the receiver lead, and the preset tone control which selects either of the two recommended frequency/response characteristics. The valves are mounted by their wire leads which are soldered direct to short pins pressed into the chassis fabric. The resistors and capacitors are supported in the wiring, and the battery leads are soldered direct to the appropriate connection points in the circuit.

In the circuit of this aid, as shown in Fig. 4, the filaments of the first and second stage valves are connected in series across the 1.5V L.T. battery and consume 15 mA. The first valve, to which the microphone output is applied, receives grid-leak bias through a 47 megohm resistor, and the voltage drop across its filament provides grid bias for the second stage. The coupling and feed resistors have very high values, and a stage gain of 30 is achieved with an anode

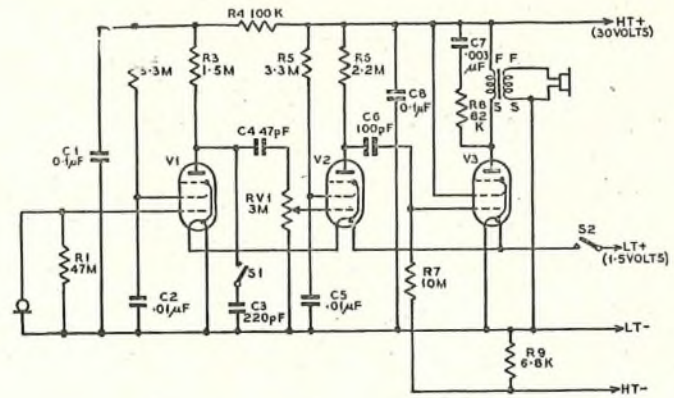

FIG. 4.—CIRCUIT OF THE MK. IIA, INSERT AID.

current of 15 to 20 microamps. The volume control is a simple potential divider connected between the first and second stages. The output valve filament draws a further 15 mA at the full voltage of the L.T. battery, and its anode current is about 300 microamps from a 30V H.T. supply. A resistor in the common H.T. return lead provides about 2 V bias for the output stage, and incidentally reduces the gain by 2 to 3 db. due to negative feedback.

The receiver impedance is about 40 ohms at 750 c/s, a step-down by the output transformer being provided. In conjunction with the impedance correcting resistance-capacitance combination shunted across the primary of the transformer, the transformed receiver impedance provides the output valve with an A.C. anode load of 100,000 ohms, which remains practically constant and resistive over the greater part of the frequency band.

Some choice can be exercised over the general form of the frequency/response characteristic of the microphone, the to a lesser extent over that of the receiver, but the final shaping of the frequency/response curve of the complete aid to meet the M.R.C. specification must be done in the amplifier. The inter-stage coupling networks, the output transformer with its correcting network, and the decoupling elements are all used to this end. The tone control which adjusts the aid to one or other of the standard characteristics switches a capacitor across the first stage anode load to attenuate the higher frequencies. A typical response curve for an amplifier of this type is shown in Fig. 5.

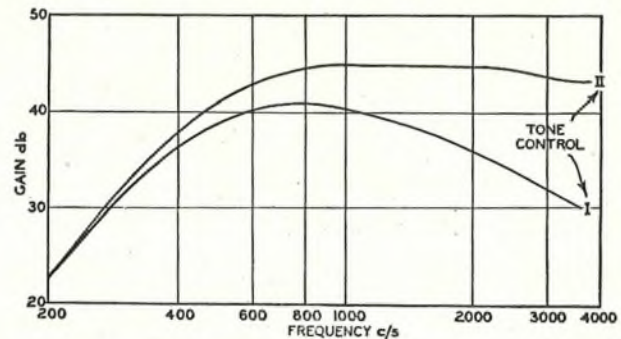

FIG. 5.—AMPLIFIER FREQUENCY/RESPONSE CHARACTERISTIC OF MK. IIA, INSERT AID.

#### Components of the Medresco Aid.

Dealing specifically with the Mark IIA Medresco Aids the following brief references to some of the more important components may be of interest:—

**Microphone.** Two types of crystal microphone are used, for the insert and external aids, respectively. Both types are of the same physical size (see Fig. 3) and make use of the piezo-electric properties of Rochelle Salt crystals. The usual advantages of crystal microphones apply, viz:—

- (a) relative cheapness,
- (b) lightness,
- (c) freedom from electro-magnetic induction, and
- (d) suitability of impedance for direct connection to a valve grid.

To obtain large mechanical amplification and greater voltage output than is possible from a *single* piezo-electric element (plate), the crystal unit comprises two identical thin square "X" cut plates cemented together. The adjoining faces of the two plates are specially treated before cementing to render them conductive. The "Y" and "Z" axes of the bottom plate are turned through 90° with respect to the top plate, the polarity of the plates being "series aiding." Foil leads serve to connect the top and bottom faces of the crystal unit to terminals at the back of the microphone case.

The processed unit is waterproofed to guard against loss of performance by changes in humidity. Three of the four corners of the bottom face of the crystal unit are mounted on compliant plastic pads fixed inside the back of the microphone case, a brass pin of small diameter being fixed to the fourth corner, but on the top face. The unit and pin are aligned during assembly to correspond with the axis of a conical aluminium diaphragm, the pin being attached to the apex of the diaphragm. A perforated guard is provided to cover the diaphragm, and is spun over to form a small compact unit.

It is possible by choice of crystal dimensions, by weighting the diaphragm, and by employing various grades and denier of silk on the inside face of the guard to "tailor" within defined limits the frequency/response characteristic of the microphone. The foregoing assumes importance in that it provides a means for obtaining the best shape of frequency response from the microphone to fit in electrically with the receiver and amplifier.

Fig. 6 shows the limits within which the response of

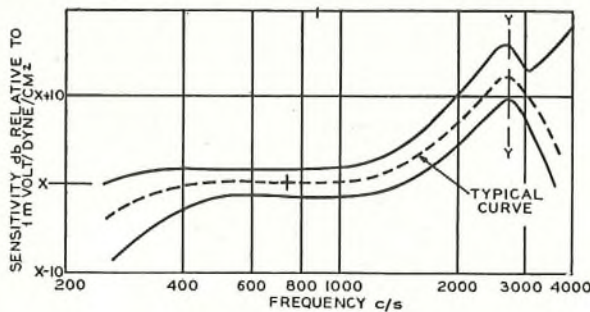

With the line Y-Y passing through the peak of the response curve, it should be possible to fit the curve within the limit lines of the mask. The "+" value of the mask must not be less than 12.5 db. relative to 1 volt/dyne/sq. cm. Peak frequency to lie between 2,500 and 3,000 c/s.

FIG. 6.—PERMISSIBLE LIMITS FOR THE RESPONSE OF MICROPHONES USED WITH INSERT AID.

microphones used with the insert aid is required to conform. Every microphone is checked for factory acceptance, laboratory checks being made on a sampling basis.

**Valves.** British-made sub-miniature pentode valves with wire tails are used throughout, the types being as shown in Table 2. A considerable saving (40 per cent. for the insert aid) has been achieved in filament current con-

sumption by the use of the latest types of valves, illustrated in Fig. 7. The valves are designed to work satisfactorily down to 1V L.T.

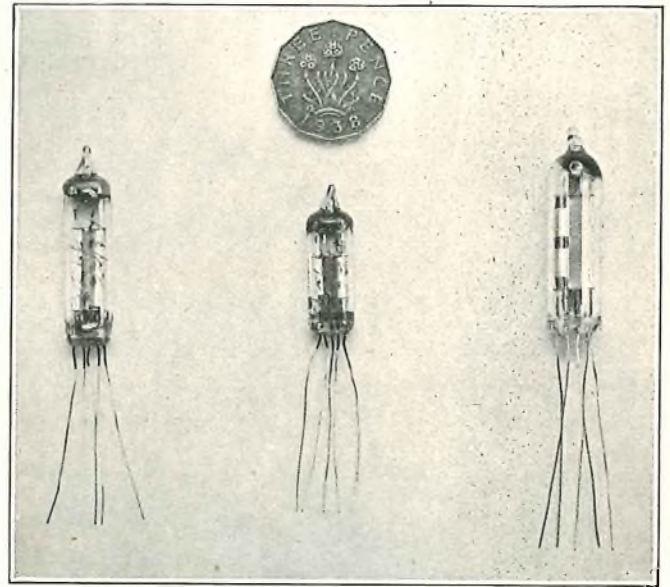

FIG. 7.—LATEST TYPES OF VALVES USED. Left, CV2106; centre, CV2107; right, CV387.

Each valve is tested individually and must comply with specified requirements as regards filament consumption and gain at limiting values of L.T. and H.T. voltage when tested in a circuit simulating that in which the valve is employed. Additionally the voltage-gain stage valves must comply with specified low-microphony requirements.

**Receiver.** A crystal receiver of American manufacture is used with the Mark I and Mark IA insert aids, but all the other types incorporate magnetic receivers.

The insert receiver is of monopolar construction with a "floating" diaphragm. A dished steel front plate relieves the diaphragm of excess magnetic flux to avoid saturation, and carries a spigot which engages a spring clip in a metal bush recessed into the ear-mould. The assembly is enclosed by a thermoplastic case, sealed over the front plate by the application of heat, and weighs about a third of an ounce. The back of the case carries the terminal plates and guides for the accommodation of the receiver slide plug.

The required frequency/response characteristics, measured in a 1.5 c.c. artificial ear, are shown in Fig. 8.

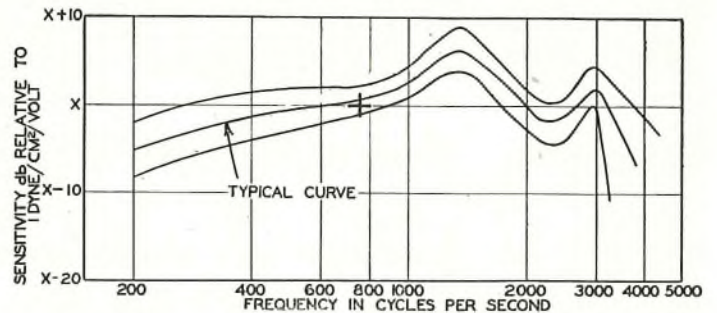

It should be possible to fit the response curve into the mask shown when measured under constant applied volts conditions; "+" value of the mask must be not less than +53 db. relative to 1 dyne/sq. cm./volt.

FIG. 8.—PERMISSIBLE LIMITS FOR THE RESPONSE OF INSERT MAGNETIC RECEIVERS.

For acceptance purposes the full frequency/response curve is measured on a sampling basis; every receiver is, however, subjected to a check of average sensitivity over the following three bands:—

- 450- 950 c/s
- 1,200-1,700 c/s
- 2,700-3,200 c/s

Additionally every receiver must comply with a specified impedance of 41 ohms, angle 55°.

The external receiver is of conventional bipolar construction with a clamped diaphragm. It was originally developed for Service applications, and the weight, with headband, has been reduced to about 2 ozs. The back of the case carries the terminal plates and the guides for the accommodation of the receiver slide plug.

For acceptance purposes the full response curve is measured on a sampling basis, but every receiver is subjected to a check of impedance and of average sensitivity over three frequency bands.

*Combined Volume Control and Switch.* The volume control and switch is designed to comply with dimensions which are largely dictated by the size of the aid, the chassis arrangement and position, and also by the amplifier case design, and the knob aperture incorporated therein. Two alternative types complying with the foregoing requirements are available, one with centre spindle fixing and enclosed switch, and one in which the switch is external to the control. In the latter, the switch connections serve the dual functions of tag points and fixing supports to the chassis.

A carbon track is employed in the volume control, its overall resistance being required to lie between limits of 3 and 6 megohms, and to obey an approximately logarithmic law. The law is such that with the wiper at the low potential end of the control the attenuation provided is in excess of 66 db.; with the wiper at the high potential end the attenuation is not greater than 0.5 db.

The unit is required to meet specified requirements as regards bearing track noise, end stop torque, track torque, knob bearing play, terminal resistance, "Hop-On" and "Hop-Off" resistance, electrical noise, switch contact resistance, and insulation. The unit must also comply with these requirements after a life test of 20,000 operations.

*Connectors.* Separate battery and receiver connectors are provided with each aid. Both connectors consist of tinsel conductors and strain cords, sheathed with black or flesh-coloured P.V.C. The conductors consist of tinsel threads of the appropriate number of ends to give loop resistances of 4 ohms for the receiver connector, and 1.1 ohms (L.T.) and 4 ohms (H.T.) for the battery connector.

Field surveys have indicated that the average service lives are approximately 6 and 12 months respectively, but are expected to be greater for improved forms of connectors now in use.

Present forms of P.V.C. used for sheathing the connectors suffer from defects such as hardening due to migration of the plasticiser, or from discoloration due to contact with sweat acids, and improved alternatives are being sought.

*Batteries.* The batteries at present used are Leclanché dry cell types of normal L.T. "dolly" and H.T. "layer type" construction.

The L.T. battery consists of two U.1 cells connected in parallel, encased in a cardboard container with a non-reversible two-pin socket. The battery is estimated to require annual replacements on the basis shown in Table 3.

Other forms of battery considered include those of the mercury, air-depolarised, and rechargeable types, but at present, for technical reasons, on economic considerations, or on grounds of administrative objections, the alternatives do not seriously compete with the existing Medresco L.T. battery.

TABLE 3

Type of Aid	Daily use of Aid (hours)			Estimated annual replacements per patient
	5	10	15	
Mark IIA External	10	19	28	}
Mark IIA Insert	7	14	20	

The H.T. battery voltage is either 30 or 45V, as previously mentioned, each battery consisting of layer-type Leclanché cells of nominal voltage 1.5, and stacking 4 cells to the inch. The 30V battery comprises two side-by-side stacks of 10 individual cells connected in series, whilst the 45V battery is similarly made of two side-by-side stacks of 15 cells each. Both batteries incorporate a three-pin non-reversible socket.

Estimated annual replacements of H.T. batteries are shown in Table 4.

TABLE 4

Type of Aid	Daily use of Aid (hours)			Estimated annual replacements per patient.
	5	10	15	
Mark IIA External	15	30	45	}
Mark IIA Insert (30 volt H.T.)	2	4	6	
Mark IIA Insert (45 volt H.T.)	3	6	9	

No suitable replacement for the Leclanché layer-type battery is foreseen—smaller weight and size is, however, possible by changing from 4 cells to the inch to 5 to the inch, which represents the limit of reduction for economic shelf life. Further reduction in weight and size can only be expected to arise from designing the aid for lower working H.T. voltages.

*Production of Aids and their Performance.*

Delivery of Medresco Aids under Post Office direction commenced in April 1949, and a production rate of 2,000 per week was achieved by the end of May 1949.

In addition to the production of aids the Post Office is responsible, as technical adviser to the M.O.H., for all associated problems including the preparation of all manufacturing specifications and drawings, and for factory repairs; the patient's ear-mould is, however, handled directly by the M.O.H.

Additionally, the Post Office acts as the inspection agency to all manufacturers for the acceptance of hearing aid components; this practice nevertheless still vests with the manufacturer the responsibility for ensuring that the final aid assembly complies with requirements as regards overall performance, for which the Post Office is sole arbiter.

At the time of writing, 150,000 Medresco Aids were in use in England and Wales. Figures for Scotland, Northern Ireland and the Isle of Man are not available. A recent field survey showed that 90 per cent. of the aids issued to adults were in regular service for an average of five hours per day, and that one repair visit was needed for every 1,250 hours of use. Spontaneous expressions of satisfaction were made by 83 per cent. of users, two-thirds of these being described as enthusiastic. The survey excluded the latest (Mark IIA) version, but field trials supported expectations of considerably improved performance despite savings in current consumption.

*Future Trends.*

Since the Medresco Aid is issued, maintained and repaired without charge to the user, reduction in manufacturing and running costs, and increase in reliability in service, are of paramount importance. Research is, there-

fore, being undertaken to effect improvements in the efficiency of valves and receivers so as to cut down battery current and voltage. New components and assembly techniques are constantly under review.

Fundamental investigations are also being pursued into the electro-acoustical problems posed by the small fraction of the deaf population (albeit a considerable number of people) who do not derive appreciable benefit from the standard air-conduction aids. Certain users, particularly those with large, predominantly conductive, hearing loss, will be catered for by a bone-conduction aid, and field trials of some experimental Medresco aids of this type are now in progress to confirm findings of laboratory and clinical tests.

Patients with nerve or perceptive deafness require speech to be reproduced at an enhanced level, but are often distressed by sounds above a certain intensity. For such patients an aid which regulates the output level to a constant value despite variations in input level, and protects the user from sudden loud noises such as door slams, is probably desirable. Automatic level control and peak limiting are devices which can achieve this end, and are the subject of clinical investigations now in progress with the master hearing aid. The purely electronic problems of providing such facilities satisfactorily in the limited compass of a hearing aid without undue circuit complexity are,

however, appreciable. In addition, consideration must be given, for example, to the possible disadvantageous effects on intelligibility of transient distortion, temporary paralysis by loud sounds, and the increase of background noise in the intervals between speech.

Fundamental advances in battery techniques have been few, but a close watch is maintained on all developments which could lead to reductions in cost and weight, and to improvements in shelf life.

The development of crystal triodes or "transistors" may in time render the filament heating battery redundant and, as a further possibility, printed circuit techniques may improve so that applications to hearing-aid designs will no longer be viewed with caution.

A design for an acoustic adaptor to permit the use of the Medresco Aid with any P.O. telephone instrument has been evolved, and a few samples have been made available to the National Institute for the Deaf, for trial and users' comments.

#### *Acknowledgments.*

Acknowledgment is gratefully made to the Ministry of Health for permission to quote from the results of the social survey, and to the authors' colleagues for helpful criticisms.

---

## The Birmingham-Manchester Television Link

U.D.C. 621.397.24:621.315.212.4

THE B.B.C. television station at Holme Moss came into operation on 12th October, 1951. Vision signals are relayed to the station by a point-to-point television link from Birmingham, as an extension to the existing London-Birmingham cable link. The Birmingham-Holme Moss link was provided by making use of two tubes of a new Birmingham-Manchester cable (84 miles), consisting of six coaxial tubes, external diameter 0.375 in., surrounded by 376 audio pairs. From Manchester, Telephone House, to Holme Moss (22 miles) the link uses two coaxial tubes in a 6 tube + 180 audio pair cable on the Manchester-Sheffield route as far as Mottram, and from this point a special 2 tube + 52 audio pair cable is laid over the last 10 miles up to the Holme Moss station.

At Manchester, tail cables connect Telephone House and the B.B.C. Piccadilly premises to enable the latter to act as a control centre. Similarly at Birmingham a short tail cable connects B.B.C. Broad Street and Telephone House.

Television signals comprise all frequencies in a band approximately 20 c/s to 3 Mc/s, and it is, therefore, not possible to transmit them directly to the coaxial cable, both on account of the unbalanced nature of the cable and the design of amplifiers. The whole band of vision frequencies is (for these reasons) raised by modulation. To economise in band width, however, two sidebands are not transmitted, but asymmetric sideband transmission is used, the carrier frequency (corresponding to 0 cycles of the vision signal) being 1,056 kc/s. The extent of the vestigial sideband is about 500 kc/s, so that the vision signals occupy a band from about 500 kc/s to 4,000 kc/s on the cable.

Amplifiers are fitted at the normal nominal spacing used for telephony, 6 miles, but the design of amplifier is different to allow for the higher attenuation at the top

frequency, and the somewhat different allowable noise limits in the two cases.

The shape of the television signal being of great importance, it is necessary that greater care be taken than for telephony in the speed of transmission of different frequencies since they must travel the line without significant change, either in their relative amplitude or phase. It is, therefore, of great importance that the line be equalised within narrow limits for attenuation and delay distortion. These requirements imply also that electrical irregularities at cable joints, within the cable itself and indeed at any point where reflections could occur, should receive minute attention.

The limits of design of the system were worked out so that the maximum number of television links in tandem could be tolerated, and the results viewed from every aspect, pulse transmission, test-card and normal programme, have been highly satisfactory and gratifying.

It should perhaps be mentioned that the question of the use of coaxial pair for the transmission of television signals has been discussed internationally on the C.C.I.F., and the Birmingham-Holme Moss system complies with the recommendations formulated.

In addition to the two-way television transmission and audio transmission, the cable will carry 1,200 telephone circuits on the remaining four coaxial tubes.

Finally, it is particularly pleasing to note that this project was carried through to a tight date by unstinting co-operation between the various parts of the Engineering Department, the Regions, the General Electric Co. who constructed the amplifiers, and Standard Telephones & Cables who made and laid the cable and produced the translating equipment.

H. W.

# The Conduct of Articulation Measurements

R. H. de WARDT, B.Sc.(Eng.), A.C.G.I.†

U.D.C. 621.317.34:534.78

Transmission performance ratings based on articulation tests are used for planning the telephone network of this country for transmission and are being studied for international use. The tests, although fundamentally simple, require a complex procedure to reduce to a minimum discrepancies of the kind which occur in subjective testing. The article describes the technique now in use by the Post Office.

## Introduction.

THE assessment of the performance of telephone channels by measurements of the proportion of sounds, syllables or words transmitted correctly, has been used in this country since the early years of the century, although the first published description seems to be by Campbell in 1910.<sup>1</sup> At the present time this method, known as articulation testing, is perhaps the most common form of laboratory technique for assessing the performance of telephone equipment. It has the advantage that it is one of the few techniques which, if suitably conducted, gives a reasonably high precision and takes into account most of the factors which affect transmission.

Measurements which depend on the reactions of subjects, in this case talkers and listeners, are most precise when used for the comparison of two or more items. Articulation testing comes in this category; for example, little useful meaning can be attached to the statement that the articulation (i.e. the percentage of sounds received correctly) of a particular telephone channel as measured by certain subjects is 90 per cent. If, however, the articulation of a channel "A" is said to be 90 per cent. and a channel "B" 95 per cent., it is at least possible to infer that channel B is better than channel A in the conditions used in the test. In practice, it has been found that more useful information can be obtained if the test is made in such a way that the sensitivity of channel B is altered until it gives the same articulation as channel A. The difference in sensitivity can, in practice, be measured in terms of the amount of non-reactive attenuation which must be added to channel B.

In the technique of relating differences in articulation to attenuation, which has been explained in detail by West,<sup>2</sup> a curve of articulation against added attenuation (i.e. sensitivity) is produced for each channel. Fig. 1 shows a set

of typical curves. The measurements are, therefore, directed towards measuring the percentage articulation at a number of sensitivity settings to define the curve of articulation versus sensitivity with sufficient accuracy to estimate the sensitivity at 80 per cent. articulation. This usually necessitates measurements over the range from maximum articulation down to 40 or 50 per cent. The figures of percentages quoted here are all for sound articulation, as these are the units commonly used by both the British Post Office and the C.C.I.F.

The technique of obtaining comparative assessments of circuits by articulation tests is also being studied by the Fourth Commission d'Etudes of the C.C.I.F., which is responsible, among other matters, for specifying the quality of transmission for international telephone circuits, with particular reference to the local network. It is in this field that the term A.E.N. (*Affaiblissement Equivalent pour la Netteté*) rating has been introduced for the attenuation difference between the 80 per cent. articulation points of different curves. For example, if channel C of Fig. 1 is a reference system the A.E.N. rating of channel B is  $x_2 - x_3$ .

This type of assessment is commonly used in the production of planning data, where it is necessary to assess the relative performance of different channels or changes within a channel. It is used as the basis of the "Transmission Performance Rating" technique which has recently been introduced for planning subscribers' circuits.<sup>3</sup> In this the various factors which affect transmission are brought to a common scale of non-reactive attenuation.

Thus a complete articulation test consists of counting the proportion of sounds which can be transmitted correctly over a number of telephone channels at a number of different sensitivity settings. A typical test would have six channels and five sensitivity settings. A test of this nature is usually planned so that each test crew member talks and listens to each other member on each sensitivity setting of each channel. For a crew of five, as commonly used, the rate of testing is increased by arranging the equipment so that four people can listen simultaneously. With this arrangement such a test would take about four days.

In each talk a list of 25 logatoms is read. The logatoms each consist of a consonant-vowel-consonant sound combination typical of the language, in this case English.

The time required for even a simple test of the type described above makes this method very expensive; consequently considerable attention has to be paid to the organisation and execution of the tests. Furthermore, the data obtained must be presented and analysed in such a way that the maximum amount of information is extracted; the principles of planning tests for this purpose are described elsewhere.<sup>4</sup> The tests are expensive, but important because decisions possibly involving considerable expenditure may depend on their results.

## ACCOMMODATION AND EQUIPMENT

Two rooms are required for articulation tests, one for the talker and the other for the listeners, and in each special care has to be taken of the acoustical conditions. The room in which the talker sits is 25 ft. × 10 ft. × 12 ft. high and is treated to reduce reverberation to a satisfactory level. The

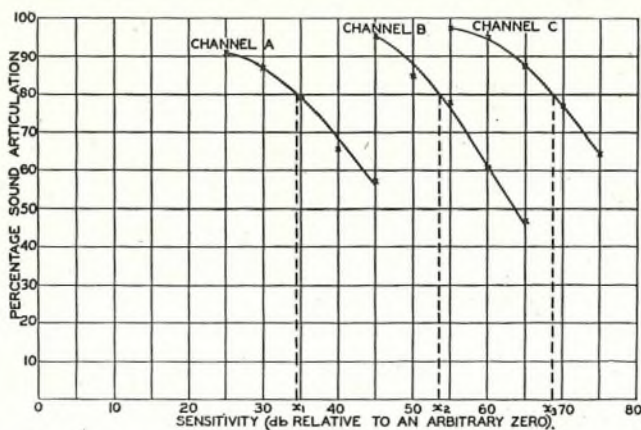

FIG. 1.—TYPICAL ARTICULATION/SENSITIVITY CURVES.

of typical curves. A suitable level of articulation having been chosen, the corresponding sensitivity settings  $x_1$ ,  $x_2$  and  $x_3$  are estimated. The value of sound articulation usually taken for this is 80 per cent. Articulation measure-

† Executive Engineer, Engineering Branch, London Telecommunications Region (formerly at Research Station).

<sup>1</sup> See references at end of article.

listeners' room, which is insulated from external sources of noise, is only made large enough to seat the four listeners in comfort. It is provided, because of its small size, with a silent ventilation system to ensure that the crew have satisfactory working conditions.

The talker's room contains a high-quality reference telephone channel (the ARAEN) together with a number of local telephone circuits and switching equipment. The ARAEN, which is similar to that installed in the C.C.I.F. Laboratory, has been described elsewhere;<sup>5</sup> the local telephone circuits consist of panels containing subscribers' sets, artificial subscribers' lines and exchange transmission bridges arranged in a form that facilitates the representation of various types of circuit; the switching equipment is provided to allow components to be switched from channel to channel by means of simple controls accessible to the testing crew. This latter provision has resulted in a considerable economy in equipment.

The talker sits at a table fitted with clamps for holding telephone handsets, the moving-coil microphone of the ARAEN and the vocal-level meter which is part of the ARAEN (see Fig. 2). The table is arranged so that there are no obstacles immediately in front of the talker which might produce reflections, and for this reason all the racks of equipment are placed behind the talker.

The listening room is fitted with loudspeakers which



FIG. 2.—TALKER AT THE TALKING POSITION OF THE ARAEN.

provide ambient room noise with the energy spectrum of average room noise. Each of the four listeners is provided with a complete set of local telephone equipment, the four circuits being obtained by splitting the circuit with hybrid transformers. A simple intercommunication system is provided between the talking and listening positions for passing test details and indicating the commencement of a list of logatoms.

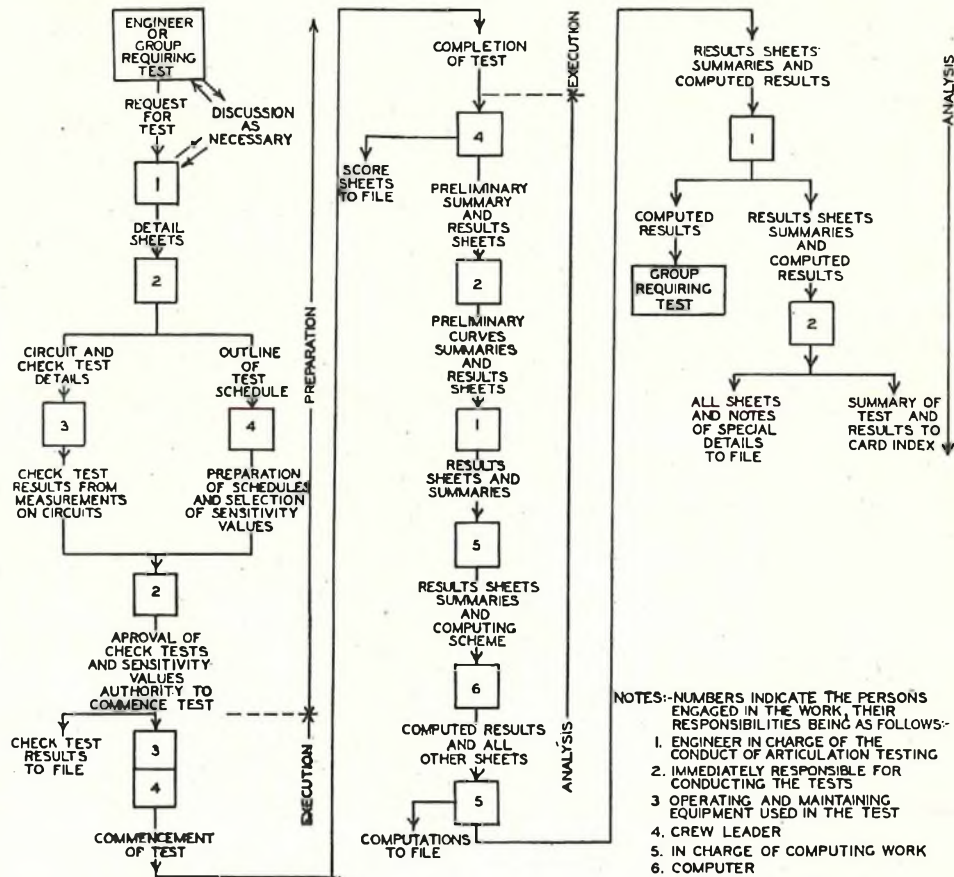

## ORGANISATION OF ARTICULATION TESTS

### General.

The method of conducting articulation tests has become increasingly complex as it has been found that increased precision usually involves more rigorous checks of equipment and a greater degree of uniformity in testing technique. Fig. 3 shows the organisation which has gradually evolved to meet these needs, and which in some respects is still evolving. The organisation can be considered in three parts: the preparation for the test, the execution of the test and the analysis and filing of results.

### Preparation.

Work which requires articulation tests often originates in groups outside the articulation testing group. In such cases the details are given to the engineer in charge of the articulation testing group who discusses the details with the originating group and then prepares detail sheets giving the outline of all aspects of the test. The detail sheets contain a complete description of the channels, a description of the type of pure tone measurements to be made to check the channels, the type of test schedule to be used, and all the incidental details which must be fixed, such as room noise, talking distance, and microphones and receivers. Although there is only one testing crew, there are two sets of testing equipment; thus, while one test is in progress the equipment can be prepared for the next. The two sets of equipment are not exact replicas, each having some special features. Hence tests must be made with the most suitable equipment, and it is necessary to arrange the order with some care, so as to ensure that the crew is not delayed by unprepared equipment. The detail sheets also specify which talking and listening rooms are to be used.

Details of the channels and check tests are then amplified as necessary and an outline of the test schedule prepared.



The equipment is prepared and tested in accordance with the channel and check test details, and the crew leader is provided with instructions for making preliminary tests to choose the sensitivity settings. It is possible, with experience, to estimate sufficiently accurately a preliminary value for the sensitivity setting to give 80 per cent. sound articulation; the crew then read four lists of 25 logatoms on this setting to check this estimate, which is usually made by their leader. An experienced tester can estimate the sensitivity setting for 80 per cent. to within  $\pm 5$  db. The crew leader also prepares the complete test schedule, which shows the details for each talk in the test, talkers, listeners, channels, sensitivity settings, microphones, receivers and any other conditions which may be changed. The sensitivity settings selected as a result of the preliminary test are entered on the detail sheet. At the same point the results of the check tests made with pure tones are returned.

For a test with six channels, involving only the ARAEN and commercial telephone circuits, the preparations take about two days.

### Execution.

In a conventional test a crew of five are used, one talking and four listening. After each talker has read a list of 25 logatoms the crew change positions. At each change the channel and sensitivity setting is changed in accordance with the test schedule and, if commercial circuits are being tested, the microphones and receivers at the sending and receiving ends are changed. The listeners write their results on prepared slips, known as score sheets, headed with a number identifying the test, the talk within the test, the circuit condition, the talker, the listener and the number of

ARTICULATION TEST SHEET  
CONDITION R 70 TEST NO. A 10/50  
TALKER D—LISTENER C TALK 94  
LISTENING POSITION C4 SHEET NO. 704

T	I	M			
—	AR	—			
K	EW	—			
—	I	N			
S	AI	—			
K	U	M			N
—	O	ST			
F	O	RT			
—	I	T			
TH	U	N	P		M
F	ER	—	PR	E	L
W	OO	T	L		K
L	AI	Z		E	LZ
TH	E	D	PR		
—	A	NZ			ND
T	I	N	CH		
SH	AI	T		E	NT
W	EE	CH	B	I	
T	A	ND			
B	I	T			
B	U	N			
—	AR	J			
—	A	J			Z
PR	I	K			
—	EE	N		I	TH
11	20	16			
TOTAL: 55					

FIG. 4.—SCORE SHEET WITH RESULTS RECORDED BY LISTENER.

the logatom sheet (see Fig. 4). The talker, listener and channel are usually identified by code letters. The listeners write their answers in the left-hand half of the sheet and, after the rotation of five talks has been completed, the sheets are scored against the original lists. To assist in a statistical study of the errors the correct sounds are written in the right-hand column when any error occurs. The total number of sounds received correctly is then noted at the bottom of the sheet. The totals are transferred from this to a testing schedule where they are entered individually against each listener. The totals are then transferred to a summary sheet (see Fig. 5) where they are entered under the

TEST CONDITIONS (SENSITIVITY SETTING)

55		60		65		70		75	
Talk No.	No. Correctly Rec'd.	Talk No.	No. Correctly Rec'd.	Talk No.	No. Correctly Rec'd.	Talk No.	No. Correctly Rec'd.	Talk No.	No. Correctly Rec'd.
79 D-E	73	76 A-B	72	39 D-E	71	23 C-D	59	24 D-E	58
A	73	C	69	A	62	E	52	A	47
B	74	D	71	B	65	A	57	B	48
C	73	E	74	C	66	B	51	C	50
82 B-C	74	77 B-C	68	41 A-B	63	37 B-C	71	65 E-A	46
D	72	D	70	C	54	D	60	B	32
E	74	E	71	D	63	E	70	C	52
A	74	A	73	E	68	A	71	D	45
113 C-D	71	78 C-D	71	47 B-C	64	86 A-B	64	71 A-B	50
E	73	E	68	D	64	C	57	C	36
A	72	A	72	E	66	D	65	D	58
B	71	B	74	A	66	E	66	E	65
131 A-B	72	130 E-A	71	100 E-A	70	94 D-E	65	83 C-D	38
C	72	B	70	B	60	A	55	E	44
D	72	C	69	C	69	B	54	A	38
E	74	D	72	D	69	C	55	B	35
Totals	1456		1425		1310		1172		960
Max. Possible	1500		1500		1500		1500		1500
% Artic.	97.1		95.0		87.3		78.1		64.0

FIG. 5.—ARTICULATION TEST SUMMARY SHEET "B" (R CHANNEL) TEST NO. A19/50. TOTAL NUMBER OF SOUNDS CORRECTLY RECEIVED PER CONDITION.

sensitivity setting for each channel, with the talker and listener noted against each entry.

In a normal test, five sensitivity settings are used on each channel, and each talker reads a list of 25 logatoms once over each. Thus a maximum of 1,500 sounds can be received at each sensitivity setting (each logatom consisting of 3 sounds). The normal rate of working is about 40 talks per day, hence a test with six channels each with five sensitivity settings will take about four days. The rate of 40 talks per day has been found to be near the maximum that can be accomplished without fatigue to the crew.

To increase the precision of the results, it has been found necessary to secure an extreme degree of uniformity in all the operations in the tests. A considerable increase in precision can be obtained by causing the talkers to speak at a fixed level instead of at their various natural levels. The level is maintained at a constant value throughout the tests with the aid of a vocal-level meter which is part of the ARAEN. In normal conversational speech the level of each syllable varies, and thus the problem of estimating speech levels is extremely complex. To obtain something approaching the relative natural levels for each logatom, it is inserted

in the "carrier" phrase "CAN CON BY — ALSO." The first three syllables are among those which in normal conversational speech are enunciated with equal high levels. The talkers are trained to control their voice level to give equal deflections on the vocal-level meter for each syllable. The logatom is then enunciated with the natural level corresponding to the level used for the first syllables of the carrier phrase. The talker makes no attempt to obtain the same deflection of the meter for the logatom.

The "ALSO" after the logatom is used to avoid any tendency to drop the level of the voice at the end of a phrase, and also to prevent talkers unduly accentuating the final consonant of the logatom by terminating it with an extra vowel. The talkers are also trained to use a closely defined system of pronunciation when speaking.

#### *Analysis.*

When the test is complete the sounds received correctly on each sensitivity setting on each channel are totalled on the summary sheets by the crew leader (see Fig. 5), and the score sheets are filed. Preliminary curves of articulation versus sensitivity are then prepared which provide crude results of use in determining the best method of analysis and in providing advance information.

The results sheets and preliminary curves are sent to another part of the group for statistical analysis. The first step in this is the preparation of the computing scheme applicable to the particular test. The scheme used varies according to the test, but with the normal type of test, made with the object of providing planning data, the whole of the experimental work is directed towards defining the sensitivity setting for 80 per cent. sound articulation. Therefore, to obtain the maximum value from the results it is necessary to obtain the most reliable estimate of the sensitivity setting for 80 per cent. articulation and a quantitative measure of the confidence which can be placed on it.

Various methods of estimating the sensitivity have been tried and it has been found that each has advantages for certain cases. The method most commonly used, particularly where there is an appreciable difference between the channels being tested, is to fit an empirical curve of articulation versus sensitivity to the experimental points by the statistical technique of Maximum Likelihood.<sup>6</sup> This method is essentially a refinement of the use of the ordinary "French curve" but yields a unique result.

The general shape of the articulation/sensitivity curve is shown in Fig. 1. Various forms of empirical curves have been used to approximate to this. The most useful are the exponential  $S = a + b \exp(x/c)$  (where  $S$  is the sound articulation and  $x$  the sensitivity in decibels), and the logistic  $S = C [\frac{1}{2} + \frac{1}{2} \tanh(A + Bx)]$ .

The results and computing scheme are given to the computer, who works through the scheme and then returns the computed results, which also include the confidence limits of the 80 per cent. articulation values, to the statistics part of the group. The computations are filed and the results sheets, summaries and the computed results are returned to the engineer in charge of the conduct of the observations. A copy of the computed results is given to the group who originated the test, and all the results sheets and summaries are filed together with any notes of special details.

The complete analysis and filing of results for a test involving six channels takes about eight days. The computational work involved in the analysis (assuming that logistic curves are fitted) takes about one day per channel.

#### LOGATOMS

In speech some sounds are more easily recognised than others, and thus the results obtained in an articulation test

will depend on the sounds which occur in the logatoms. If the results of the tests are to be comparable with the performance under normal conversational conditions, it is important that the logatoms should have a content similar to that of the speech.

Investigations of the English language<sup>7</sup> have revealed that any word can be broken down into syllables of the consonant-vowel-consonant type. In this investigation "blank" consonants were allowed, consequently syllables consisting of consonant-vowel, vowel-consonant or vowel only were permitted. The frequency of occurrence of sounds in each component of the syllable was also investigated and it was found that although it was comparatively simple to establish the frequency for initial consonants, the vowels and final consonants presented a more difficult problem. The frequency of occurrence of any particular sound is usually expressed as a percentage; thus, if the frequency of occurrence of "B" as an initial consonant is 3 per cent., it occurs, providing a sufficiently large sample is taken, three times in every 100 initial consonants.

The frequency of occurrence of any vowel is dependent on the particular initial consonant which it follows, and similarly the occurrence of final consonants depends on the preceding vowel. For example, if the initial consonant is "P" the frequency of occurrence of the vowel "A" (the long A) is 8 per cent., but if the initial consonant is "D" it is 12 per cent.

Until recently, no account was taken of this phenomenon (i.e. the correct relative frequency of transitions) when compiling logatom lists. Vowels and final consonants were then given frequencies of occurrence which were independent of the preceding sounds. Recently, however, new lists have been made based on the use of the correct transition frequencies. One result of using this method of constructing lists is the appreciable number of English words which are produced. These have been retained in the lists since it is believed that the crew do not recognise logatoms as words. The great advantage of these logatoms is that the combinations which do occur are always typical of ordinary English so that they are never unduly difficult to pronounce.

Both the initial and final consonants include a number of compound sounds, such as "BL," "KR" and "SKR" in the initials and "LK," "LVD" and "NT" in the finals, but some which occur rarely have been omitted. Altogether 46 initial consonants and 65 final consonants are used. An appreciable number of the rarer vowels have been omitted and the final list used contains only 16.

#### CREW SELECTION AND TRAINING

The crew consists of six members, three men and three women. Five are employed in a normal test and the sixth kept as a reserve to cover leave or sickness. However, it is generally not possible to change a crew member during a test; if work is stopped through prolonged sickness or some other unforeseen cause, it is usually necessary to recommence the test.

The problem of obtaining and training a crew has been given considerable attention. Since a training period of three months is required, it is necessary to be certain that when trained a crew member will be satisfactory, and in particular not dissatisfied by the monotony of the work. The basis of the crew problem is to find a group of individuals who, when trained and combined in a crew, give reproducible and uniform results. To check that the crew is satisfactory in this respect the statistical concept of heterogeneity has been invoked.

Heterogeneity factor is the ratio of the precision to be expected of an ideal crew to the actual precision obtained by the real crew. Precision is defined as the reciprocal of variance (mean squared deviation from the mean) so that

heterogeneity factor may also be defined as (observed variance)/(expected variance). An ideal talker/listener combination is defined as one which yields results which are dispersed (for a given sensitivity setting of a given channel) to the extent to be expected by pure chance alone (i.e. when there is a constant probability of correct reception of a sound). The amount of dispersion due to pure chance may be visualised by the following conception. Consider a barrel containing a very large number of black and white balls. The proportion of black balls represents the mean proportion of sounds correctly received. Now let the balls be thoroughly mixed and handfuls of 75 balls be drawn at random. The number of black balls out of each 75 is counted. If 80 per cent. of the entire barrel consisted of black balls the first ten numbers might be 59, 56, 53, 59, 63, 66, 63, 59, 65, 58. These would be dispersed (given a large enough sample) about the mean (60) with variance 12. An actual articulation test might yield the results 57, 60, 54, 62, 62, 67, 64, 47, 57, 55, having a variance 32. The heterogeneity factor for the articulation test would then be 32/12, i.e. 2.7. An articulation measurement is analogous to the problem of estimating the (unknown) proportion of black balls in a given barrel by drawing handfuls of 75. In the ideal case the population of the barrel is, although unknown, fixed. In the practical case there are two demons inside the barrel, one painting black balls white, and the other painting white balls black. On the average they work at equal rates but at the instant when any particular handful is drawn one demon may be slightly ahead of the other so that there is a varying proportion of black balls in the barrel although the *mean* proportion is constant. In such a system heterogeneity may be said to result from the instantaneously unequal rates of work of the two demons and the problem is then to estimate the *mean* proportion of black balls.

Heterogeneity arises within the results by each talker/listener pair and also between results by different talker/listener pairs within the crew. The aim of good training is to reduce both forms of heterogeneity.

Experience with this technique has shown that a highly trained crew has a heterogeneity factor in the region of two, whereas for a less skilled crew the factor is appreciably larger, being perhaps ten or more for a poor crew.

The crew are trained to enunciate the carrier phrase and logatoms at the controlled level required for these tests and to maintain this with the aid of a vocal-level meter. They are also trained in the correct method of pronouncing and writing all the sounds in the phonetic alphabet used for the logatoms.

#### TEST SCHEDULES

The foregoing gives a description of the organisation which is essential for the efficient conduct of articulation measurements. An equally important part of the articulation measurement technique is concerned with the neutralisation of the sources of variability which remain even when a highly trained crew is used. For example, consistent differences have been found still to exist between results for different talker/listener pairs; results on different days differ; various complicated interactions of these effects with circuits and sensitivity settings are also present.

In order to take advantage of modern methods of designing experiments, which have been developed for similar problems in the biological field, it is necessary to make the observations to a carefully designed plan.<sup>4</sup> Two

features are necessary, (i) the combinations of all factors whose effects it is desired either to estimate or to neutralise must be in accordance with an appropriate systematic design, and (ii) all other factors, known and unknown, must be allowed to operate only at random. These requirements cannot be considered here, but it is important to note that they result in quite complex arrangements regarding the sequence and necessary combinations of talker/listener, channels, sensitivity settings, microphones, receivers, etc. In order to avoid mistakes in conducting the observations the test schedule is drawn up in advance before any observations are made.

Fig. 6 shows part of a typical schedule. In this test the

Talk No.	SENDING END				RECEIVING END											
	Talker	Send End Handset	Channel	Channel Sensitivity (db.)	Position 1			Position 2			Position 3			Position 4		
					Listener	Handset or Receiver	Result	Listener	Handset or Receiver	Result	Listener	Handset or Receiver	Result	Listener	Handset or Receiver	Result
1	A	2	T	35	B	1	50	C	5	44	D	4	42	E	3	63
2	B	4	T	35	C	3	55	D	2	55	E	1	43	A	5	70
3	C	4	RG	60	D	1	36	E	2	40	A	3	29	B	4	43
4	D	5	TS	30	E	11	51	A	10	50	B	9	58	C	8	47
5	E	5	RG	60	A	1	36	B	2	42	C	3	51	D	4	48
6	A	11	S	25	B	10	67	C	9	60	D	8	56	E	13	60
7	B	8	S	25	C	13	65	D	11	58	E	10	59	A	9	65
8	C	8	RG	66	D	1	31	E	2	44	A	3	49	B	4	43
9	D	11	ST	35	E	2	63	A	2	66	B	5	66	C	4	60
10	E	11	R	70	A	1	54	B	2	42	C	3	54	D	4	50
11	A	10	S	15	B	9	72	C	8	71	D	13	62	E	11	69
12	B	13	ST	25	C	4	68	D	3	67	E	2	66	A	1	69
13	C	3	TS	30	D	9	60	E	8	64	A	13	66	B	11	58
14	D	9	S	35	E	8	58	A	14	52	B	11	64	C	10	57
15	E	9	RG	65	A	1	37	B	2	28	C	3	35	D	4	22

FIG. 6.—TYPICAL TEST SCHEDULE.

talkers, listeners, listening positions, handsets, channel and channel sensitivity settings are specified. The channels and sensitivity settings have been arranged to occur in a random order, but the handsets are arranged in a systematic order. The result (number of sounds received correctly) by each talker/listener is entered on the schedule before it is transferred to the summary sheets. This is of particular use in some of the more complex forms of statistical analysis where all the information on the test schedule is required in addition to the results.

#### ACKNOWLEDGMENTS

The author is grateful for the advice and help given by his colleagues in the preparation of this article. He would also like to thank Mr. D. L. Richards, who has been responsible for much of the statistical work, for permission to use hitherto unpublished information relating to the concept of heterogeneity in articulation testing.

#### References.

- <sup>1</sup> Campbell, G. A. "Telephonic Intelligibility," *Phil. Mag.* 1910, Vol. 19, p. 152.
- <sup>2</sup> West, W. "Telephone Transmission Testing by Subjective Methods," *P.O.E.E.J.*, 1939, Vol. 31, p. 286.
- <sup>3</sup> Barnes, E. J., Wood, A. E., and Richards, D. L. "Standards of Transmission and Local Line Limits," *P.O.E.E.J.*, 1947, Vol. 39, p. 151.
- <sup>4</sup> Richards, D. L. "An Outline of the Principles of Design and Analysis of Experiments," *P.O.E.E.J.*, 1951, Vol. 44, p. 55.
- <sup>5</sup> Swaffield, J., and de Wardt, R. H. "A Reference Telephone System for Articulation Tests," *P.O.E.E.J.*, 1950, Vol. 43, p. 1.
- <sup>6</sup> Hoel, P. G. "Introduction to Mathematical Statistics," John Wiley & Sons, Inc., 1947.
- <sup>7</sup> Dewey, G. "Relative Frequency of English Speech Sounds," Harvard University Press, 1927.

# A Pulse Echo Test Set for the Quality Control & Maintenance of Impedance Uniformity of Coaxial Cables

E. BAGULEY, B.Sc.Tech., M.I.E.E. and  
F. B. COPE, B.Sc.(Eng.), A.M.I.E.E.†

U.D.C. 621.317.73: 621.315.212

A description is given of a pulse echo test set designed primarily for use on 0.375-in. (type 375) coaxial cables. The set is capable of detecting impedance irregularities within a cable and differences between the end impedances of cables of the order of 0.05 per cent. The magnitudes of the reflections due to impedance irregularities are measured in decibels below incident pulse level, and end-impedances are measured directly in ohms. Impedance irregularities and mismatches can be located with an accuracy of 1 per cent. on a direct reading scale of yards or metres. A technique which has been developed using the apparatus for testing coaxial cables during various stages of manufacture and installation is described.

## Introduction.

THE detection and measurement of impedance irregularities in coaxial and other types of cable by means of short pulse echoes displayed on the screen of a cathode ray tube is not a new development, and several descriptions of apparatus for this purpose have appeared in the technical press. The adaptation of radar ranging technique for measuring distances to the reflections caused by mismatches in cables was a logical development.

The apparatus here described does not embody new principles and is only novel in the sense that it incorporates a considerable number of refinements. The sum total of these refinements, however, is such as to represent a significant development in the technique of quality control of coaxial cables during manufacture and installation. In addition to a precision ranging control, delayed and expanded time-base facilities, choice of pulse width, and provision for measurement of reflection coefficients, the apparatus also incorporates the means for accurately measuring the end impedances of cables in terms of a standard reference core.

The end impedance measured is an approximation to the 2.5 Mc/s ordinate of the resistive component of the sending end impedance presented to the incident pulse. The making of the measurement from both ends of cable cores is an essential feature of quality control for impedance uniformity because good uniformity at the wrong impedance level or slow changes in level along a length causing no internal reflections of the incident pulse might otherwise pass undetected until after jointing lengths together.

This article is divided into two parts. In the first the Pulse Echo Test Set is described together with some of the considerations which led to the present design, and, in the second, its method of use is discussed and examples of some typical tests are given.

## GENERAL REQUIREMENTS AND DESIGN CONSIDERATIONS

The Pulse Echo Test Set has been designed to give adequate sensitivity and ease of interpretation for the quality control of type 375 coaxial cables which may be required for the operation of wide-band carrier telephone or television systems at frequencies up to 10 Mc/s. The primary design considerations are pulse width and shape; pulse repetition frequency; sensitivity; time-base ranges and time-base delay facilities for tests on 75-ohm coaxial cables varying in length from about 100 yards to 10,000 yards.

### Pulse Width and Shape.

A unidirectional or D.C. pulse has been found to meet the requirements of cable testing more effectively than a modulated A.C. pulse. Two D.C. pulses of a train are shown plotted against time in Fig. 1. The pulse width,  $w$ , is customarily measured at half pulse height,  $h/2$ , and the reciprocal of the spacing,  $t_r$ , between successive pulses is the repetition frequency,  $f_r$ . The relative or equivalent fre-

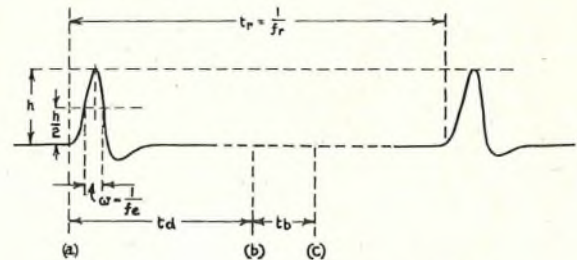

FIG. 1.—TWO OF A TRAIN OF D.C. PULSES.

quency,  $f_e$ , of the pulse train is the reciprocal of the width,  $w$ . The harmonic spectra of a variety of D.C. pulse shapes as functions of  $f_r$  and  $f_e$  have already been published.\* The ideal in pulse shape for coaxial cable tests is one giving negligible harmonics in the spectrum either below 60 kc/s, the lowest cable operating frequency, or above  $f_e$ , the equivalent frequency, and for the present set a shape approximating to that of the raised cosine shape, as shown in Fig. 1, is employed. As there are transformer couplings and a hybrid output transformer in the set, the D.C. component of the pulse is eliminated and in consequence there is a trailing overshoot to the pulse transmitted to the cable, giving an area below the base line equal to that of the pulse proper above the line. The overshoot falls to a maximum of about 15 per cent. of the pulse height,  $h$ , but recovers to within 4 per cent. within half the pulse width time, after which it becomes asymptotic. In the first two lobes of the envelope of the harmonic distribution curve, above the equivalent frequency,  $f_e$ , the maximum amplitudes for this pulse are approximately 33 db. and 52 db. down, respectively, and the effective harmonic content extends from just above the repetition frequency,  $f_r$ , up to about 0.8 times the equivalent frequency,  $f_e$ . Experience with tests on coaxial cables extending from 100-yard factory lengths to 10,000-yard repeater section lengths suggested a choice of three pulse widths, 0.05, 0.1 and 0.2 microseconds, for which the effective harmonic contents extend to 16, 8 and 4 Mc/s, respectively.

### Pulse Repetition Frequency.

Conflicting requirements have to be reconciled in selecting the pulse repetition frequency. Considerations of the harmonic content of the pulse suggest 60 kc/s but the time,  $t_r$ , between successive pulses would then be only 16.7 microseconds, the time taken for a pulse to travel to and from a point  $1\frac{1}{2}$  miles from the test end on a type 375 coaxial cable. To cater for tests on cables much longer than this and from other considerations, including the allowance of ample recovery time from amplifier overloading which may be caused by large reflections from

† Standard Telephones & Cables, Ltd.

\* See Bibliography.

unterminated distant ends, it was found to be desirable to fix  $t_r$  at 500 microseconds and to use a repetition frequency of 2 kc/s both to trigger the pulse and the time-base generators. The resulting harmonics in the pulse spectrum below 60 kc/s contribute to its energy rather than to its shape and in consequence their undesirable distorting effects on the trace displayed on the C.R. tube may be eliminated by inserting a simple high-pass filter at the input to the video amplifier feeding the vertical plates.

#### Sensitivity.

The reflected pulses from small irregularities in impedance require to have their amplitudes measured for quantitative assessments of the quality of the cables tested. This is most conveniently achieved by means of a R.F. attenuator and the results obtained as the difference in level, expressed in decibels, between the incident pulse and the reflected pulses arriving back at the cable test end. Since an 80 db. reflection in a 75-ohm coaxial is equivalent to an impedance change of 0.015 ohms, detection and measurement of reflected pulses down to 80 db. below incident pulse level has been found to be quite adequate for the quality control of high grade coaxial cables.

#### Time Bases : Ranges and Delay Facilities.

The linear sweep time-base has been found essential for the rapid and accurate location of irregularities, and single-shot generators provide convenient facilities for varying the speed of the linear sweeps to cater for wide variations in cable lengths. There is here a serious limitation in that however long the cable is, its displayed oscillogram must be compressed on to the cathode ray tube screen, which for a 6-in. tube means compression to fit a trace about 10 cm. in length. Accurate location may then be difficult if for example 1 cm. in the trace is equivalent to 1,000 yards of cable. The most elegant method of avoiding this limitation is to provide additional and completely separate delay circuits for adjusting and measuring the times at which the time-base starts in relation to the pulse transmitter cycle. This last is shown in Fig. 1, and the additional circuits enable the start of the time base to be delayed from (a) to (b) by a variable but measurable time-base delay,  $t_a$ , microseconds. The selected time base, displaying  $t_b$  microseconds per 10-cm trace then occupies the portion (b) to (c) of the pulse transmitter cycle. For tests on type 375 coaxial up to 6 miles in length, suitable ranges for these two variables are, time-base delay  $t_a$ , 0 to 100 microseconds; time base,  $t_b$ , 2.5 to 160 microseconds, both continuously variable. With these facilities the oscillograms for a long length of cable may be examined in a number of successive 10 cm. portions or frames on the tube screen.

#### PRACTICAL EMBODIMENT IN TEST UNITS.

Fig. 2 is a block schematic diagram showing the arrangement of the various circuits of the Pulse Echo Test Set. The approximate shapes of the waves in the main parts of the circuits are indicated thereon. The base oscillator is crystal controlled and multiplying circuits supply three sinusoidal waves at 100 kc/s, 1 Mc/s and 5 Mc/s for calibrating the time bases. A recurrence unit, consisting of frequency dividing circuits driven by the base oscillator, provides pulses at the repetition frequency of 2 kc/s. These pulses are used to trigger both the time base and pulse transmitter to obtain stationary pictures. Both are fed through variable delay circuits to control the times of triggering. A hybrid output transformer allows only a residuum of the incident pulse to get through the attenuator and video amplifier which control the vertical amplitudes

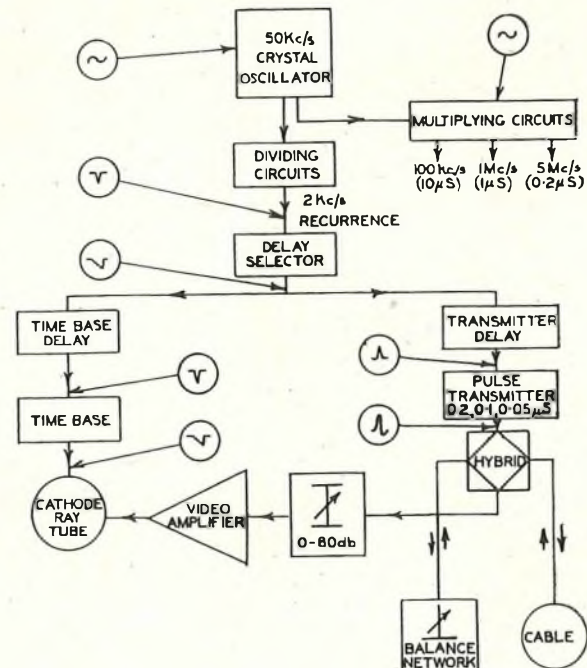

FIG. 2.—BLOCK SCHEMATIC DIAGRAM OF PULSE ECHO TEST SET.

of the reflections displayed on the tube screen. Particular attention has been devoted to adequate facilities for self-calibration and monitoring of the circuits provided.

The set is made up in five easily transportable steel cases and is shown ready for use, excepting for test leads, in Fig. 3. A special camera, not shown, may be bolted on to the front of the tube screen in place of the viewing hood.

#### Delay-Calibrator Unit.

This unit houses the base oscillator, multi-vibrator circuits, and 2 kc/s triggering circuits for both the time base and the pulse transmitter. The main control of this unit is the 10-revolution helical potentiometer for setting the time base delay,  $t_a$ , in microseconds or in equivalent length in yards of type 375 coaxial cable. Push-button switches supply monitoring signals for the base oscillator and multi-vibrators and the three time-base calibrating signals.

#### Transmitter Unit.

The pulse-forming, amplifying and transmitting stages, together with the R.F. attenuator, E.H.T. power pack and stabilised 300V negative supply are contained in this unit.

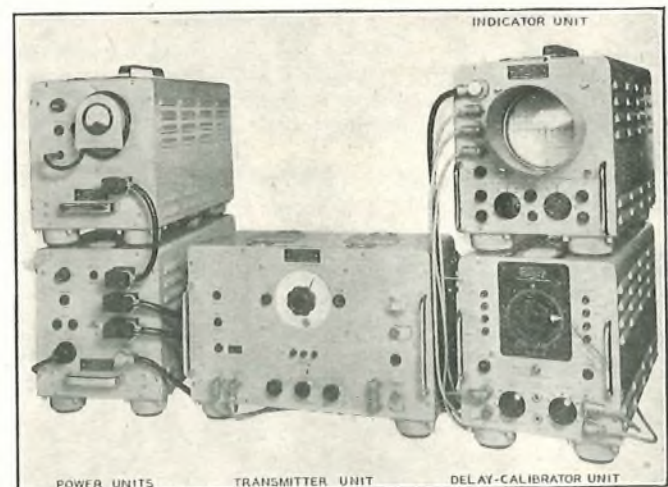

FIG. 3.—SET OF UNITS COMPRISING THE PULSE ECHO TEST SET.

The transmitting stage includes the hybrid output transformer and the cable balancing network whose engraved impedance scale occupies the central position of the front panel. The R.F. attenuator has three 6-position rotary switches giving 0-80 db. in steps of 1 db. Three push-button switches control the selection of the 0.05, 0.1 and 0.2 microsecond incident pulses.

#### *Indicator Unit.*

A 6-in. cathode ray tube of the VCR97 type used for the display is housed in this unit. On the same chassis are the video amplifier and the time-base generators. The response of the video amplifier is flat from 100 kc/s to 10 Mc/s, 3 db. down at 15 Mc/s and 10 db. down at 20 Mc/s. Below 100 kc/s a simple high-pass filter at the input causes the gain to fall off at approximately 3 db. per octave. The overall gain over the flat part of the response is about 55 db. The first three stages of the video amplifier have a common gain control operated from the front panel and used for setting the indicated pulse height to a suitable value. In addition to the usual controls for brilliance, focus, X-shift and Y-shift, the time-base range controls can be set to any value,  $t_s$ , within the limits 2.5 to 160 microseconds. A perspex, adjustable graticule divided into centimetre squares with the two axes further divided into millimetres is fitted to the front of the tube.

#### *Power Units.*

Two units are provided: one supplies stabilised +350V, 250 mA and the other stabilised +250V, 250 mA for the main H.T. feeds. The lower power unit has an input socket for the 230 V A.C. mains supply from which all five units are energised.

All units are equipped with meter jacks through which the voltages at various points in the circuits may be measured with a meter clipped on to the front panel of the upper power unit.

### COAXIAL CABLE TESTING WITH THE PULSE ECHO TEST SET

#### *Factory Testing During Manufacture.*

For factory tests the set may be installed in any test room conveniently placed in relation to the manufacturing product line. Unlike most other radio frequency tests, the pulse test admits of the use of comparatively long test leads, which may be installed between the test room and any point in the factory where cables may be required to be tested. For each test lead so installed there must be electrically identical leads coiled in the test room to enable the impedance measuring network in the set, and the remote test point to be always symmetrically placed with reference to the conjugate windings of the hybrid output transformer. The test may then in effect be made as though the set were actually at the remote test point, subject only to a small loss in sensitivity caused by the attenuation of the pulse going to and from the remote test point.

Before making a test there are five selections and calibrations to be made, as follows:—

*Time-Base Delay Range.* Required to be greater than the pulse transit time to and from the far end of the longest cable to be tested. Four ranges in microseconds: 5, 10, 50 and 100, and four in equivalent yardages of type 375 coaxial cable: 500, 1,000, 5,000 and 10,000 are provided; for most factory tests the 1,000-yard range is used, for which each scale sub-division of the T.B. delay potentiometer is equivalent to 1 yard of cable.

*Time-Base Range.* For any cable of known velocity of propagation this may conveniently be calibrated to give an integral number of yards per cm. of the trace displayed

on the C.R. tube sweep. For factory tests 40 yards per cm. has been found to be satisfactory and easily set up from the 5 Mc/s calibrator signal and the T.B. delay potentiometer.

*Incident Pulse Width.* In general the narrower the pulse the greater the sensitivity or ability to detect small impedance irregularities; but the narrower the pulse the greater the degradation in amplitude and width when transmitted along appreciable lengths of cable. It follows that a wide incident pulse may provide more data about distant portions of a cable than a narrower one. For factory tests the cable lengths are short and the 0.05 microsecond pulse gives the best results.

*Incident Pulse Amplitude.* The amplitude of the pulses generated by the set is fixed at about 150V into 75 ohms, but the indicated amplitude on the displayed trace may be controlled by adjusting the gain of the video amplifier feeding the Y-plates. To eliminate variations due to the use of varying lengths of test leads, the adjustment for indicated amplitude should be made upon the incident pulse as it appears after total reflection from the open end of the cable test lead immediately before it is connected to the cable to be tested. The adjustment most commonly adopted for both factory and field tests is an indicated pulse amplitude of 1 cm. on the tube graticule with the R.F. attenuator set to 70 db. Since the pulse displayed is from the end of the cable test lead it may also be set to zero on the horizontal datum line on the graticule to mark where the cable oscillograms start and the test lead oscillograms finish. For uniformity of interpretation it is desirable to make all measurements of the distance from the start of pulses, i.e. (a) of Fig. 1 rather than from the peaks.

*Impedance Measuring Network.* The measuring dial is engraved from 73.5 to 76.0 ohms by 0.05 ohms subdivisions but it may only be used for comparative tests. With each Pulse Echo Test Set a reference core of known end impedance is required, and for tests on type 375 coaxial cables it should be a length of type 375 coaxial core coiled up inside a portable sheet metal container. To effect a calibration the reference core is connected to the cable test lead and the measuring dial is set to the known value of its end impedance. There will then be two reflections of unknown magnitude, one at the test lead/reference core junction and the second at the conjugate test lead/network junction; these will appear on the C.R. tube screen, synchronised in phase opposition and their resultant will approach zero as the network impedance approaches equality with the reference core end impedance. By providing a network with an impedance/frequency characteristic slightly different from that of the type 375 coaxial core, this resultant will not pass through zero but will pass through a minimum which yields an easily recognisable residual balance pattern on the displayed trace. The adjustment is made by manipulating the network Set Zero and Phase Adjust controls.

To test a factory length of 375 coaxial core the cable test lead is plugged into one end of it and a simple 75 ohm resistive termination is plugged into the other end. With an attenuator setting of 10 db. the impedance measuring network dial and its phase adjust control are manipulated to reproduce the residual balance pattern obtained with the reference core. The dial reading then gives the end impedance of the coaxial core directly in ohms. To determine the impedance uniformity of the core, its oscillogram is next examined with the attenuator at zero, i.e. at maximum sensitivity, when (bearing in mind that the incident pulse was set to 10 mm. amplitude with 70 db. in circuit) the reflections coming from internal irregularities may be at once resolved into two groups—the smaller ones of amplitude 10 mm. or less on the screen graticule, which are

of electrical magnitude 70 db. or better than 70 db. below incident pulse level and which may in general be disregarded, and the larger ones, if any, showing an amplitude greater than 10 mm. and therefore a level worse than 70 db. below. These last named may be measured by manipulating the attenuator to give them an amplitude of 10 mm. on the screen. Their level in db. below the incident pulse is then obtained by deducting this attenuator setting from 70. A distinction may also be noted between positive reflections, i.e. those in the same direction as the incident pulse and due to a step-up in impedance, and negative reflections in the opposite direction due to a step-down in impedance. It may also be necessary to note the locations of the larger reflections either by directly scaling off horizontally along the screen graticule in centimetres and allowing 40 yards per cm., or more accurately by noting the scale reading of the T.B. delay potentiometer required to shift the reflection on to the zero datum line. For record purposes the oscillogram may be photographed or copied by hand and annotations made of the end impedance and of the magnitude, sign, and location of any reflections worse than 70 db. below incident pulse level. The coaxial core should then be tested in exactly the same manner by plugging into its other end.

An illustrative example of a pair of oscillograms obtained from a factory length of type 375 coaxial core is shown in Fig. 4. Between (a) and (b) are the combined

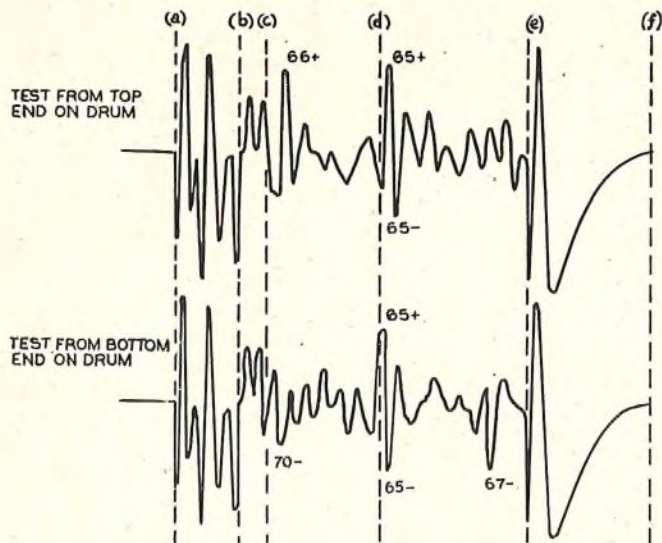

FIG. 4.—OSCILLOGRAMS OF TEST ON FACTORY DRUM LENGTH OF 375E-TYPE COAXIAL CORE.

reflections coming from the two test leads. Between (b) and (c) is the residual balance pattern of the end impedance tests, here in the form of a letter M. Briefly, and omitting certain refinements, the criteria for this pattern are that the shoulders of the M be of equal amplitude and its centre point be level with its feet. The core tested was 230 yards in length and its oscillogram extends from (b) to (e). Between (e) and (f) is the reflection caused by the 75 ohm terminating resistance. It will be noted that the residual balance pattern masks the first 20 yards of the core oscillogram but that there is no masking by the termination reflection. A complete picture will therefore be obtained by testing the core from both ends. On these oscillograms there are three reflections worse than 70 db. below and their magnitudes and signs are noted. The first one, 66 db. below, is 32 yards from the top end of the core and it indicates that at this point the impedance of the coaxial core rises by 0.1 per cent. At (d), 115 yards from either end, there is a double reflection 65 db. +, and 65 db. —,

below incident pulse, which for the purpose of this example was produced by an artificial irregularity. The coaxial core was cut at this point and roughly jointed again, using a normal ferrule for the inner conductors and a 3-in. length of wire braid for the outer conductors. All short irregularities give this characteristic double reflection and the sign of the first half indicates whether the short irregularity is of higher or lower impedance than the adjoining core. In this example, the rough joint has a higher impedance than the core.

#### Field Testing During Installation.

Field pulse tests may begin as soon as the drums of cable arrive on site, but, except for special investigations, routine field tests most commonly commence after the drum lengths have been installed and jointed into 2,000-yard slings. For these tests the set is most conveniently housed in a test van and a portable engine-driven A.C. generator with an output of 1 kVA at 230V is required. The preliminary calibration procedure for the set follows that already described above for factory tests. The time-base delay range is set to 5,000 yards of type 375 core, the time-base range is most conveniently set to the equivalent of 1,000 yards of core (i.e. 6.3 microseconds approximately) and the 0.1 microsecond incident pulse width is selected. The other two calibrations follow the factory procedure exactly. An example of a sling test on the Birmingham-Manchester television cable is given in Fig. 5, in which the

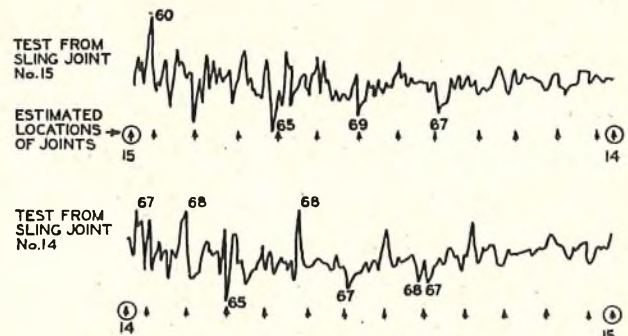

FIG. 5.—OSCILLOGRAMS OF FIELD TEST ON 2,000 YARDS OF 375E-TYPE COAXIAL CABLE.

oscillograms obtained from each end of core 1 are reproduced. There were 13 drum-lengths of cable in this sling and, as a matter of interest, the estimated positions of the 12 joints have been scaled off along each oscillogram. As the attenuation of the 0.1 microsecond pulse to and from a point 1,000 yards from the end of a type 375 coaxial core is only 7 db., a test on every sling of a cable ensures that a record is made of all irregularities in impedance, or changes in impedance level, exceeding 0.1 per cent. Thus, adequate routine field control of a high-grade factory product is ensured.

The oscillograms reproduced in Fig. 5 indicate that the effective impedance of the coaxial core joints accurately matches the impedance of the type 375 coaxial core for which they were designed. If for any reason a joint has been incorrectly assembled or damaged after assembly the sling oscillogram will show, at its location, the characteristic double reflection for a short irregularity, of which an example has been noted in Fig. 4.

A second routine field test may be made when the 6-mile repeater sections of a coaxial cable are completed. The test for end impedance at the sealing end terminals in the repeater stations, will, since they are normally equivalent to small capacitances bridged across the ends of the coaxial tail cables, give a true reading for the resistive component

of the end impedance at the tail cables. Comparison between these end impedances and those obtained at the turning manhole, outside the repeater station, during the sling tests will indicate how well the tail cable and leading-in cable cores match up with the impedance of those of the adjoining main cable. With the time-base range adjusted to 100 yards per cm., the complete oscillogram for a 6-mile length of core will be approximately 100 cm. long, i.e. 10 frames on the tube graticule. When tested from both ends it will consist of 5 frames from each end, but with high quality 375 coaxial core there will not usually be any measurable reflections returning from beyond the third frame, i.e. from the cable more than 3,000 yards from the repeater station, because of the attenuation of the pulse. For acceptance test record purposes it should suffice to make copies of only the first 3 frames of the oscillogram. An example of the 3 frames obtained from one end of one of the coaxial cores in a repeater section of the London-Bristol television cable is given in Fig. 6.

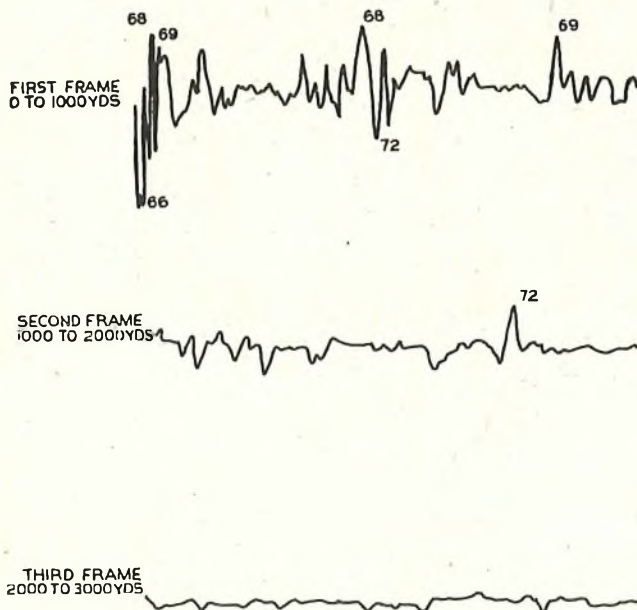

FIG. 6.—OSCILLOGRAMS OF TEST ON 6-MILE REPEATER SECTION OF 375E-TYPE COAXIAL CABLE.

#### Maintenance Testing and Fault Locating.

The pulse echo test set is proving to be a very valuable instrument for maintenance tests and fault locating tests on coaxial cables in service, and it is now being used for these purposes by the British Post Office and by telecommunication Administrations abroad.

Repeater section lengths of type 375 coaxial cores have been found to preserve their pulse oscillogram identity over long periods of time, providing that the cables have not been disturbed in any way. For maintenance tests

### Book Review

"Electrical Engineering Design Manual." Second Edition (Revised). S. Parker Smith, C.B.E., D.Sc., A.M.I.C.E., M.I.E.E., and M. G. Say, Ph.D., M.Sc., M.I.E.E., F.R.S.E. Chapman & Hall. 259 pp. 127 ill. 16s.

This book, first published in 1934, sets out to give students a concise introduction to the principles (particularly electrical) on which "heavy" electrical engineering design is based.

Part I is devoted to general principles of machine design, specifications, cooling, magnetic circuits, armature windings, synchronous machines, transformers, and D.C. machines. Part II deals with other subjects which are suitable for inclusion in a drawing-office course, viz. speed-time curves and

the complete oscillograms for all the coaxial cores in a repeater section may be photographed or accurately copied and placed on record either when the cable first goes into service or at a time when it is known to be in good condition throughout its length. At any future times, either at fixed intervals or on occasions when it is suspected that the cable may have been disturbed by external agency, the pulse test may be repeated in a matter of a few minutes testing time. A careful comparison between the new oscillograms and the originals should then direct attention to any part of the cable route at which any significant change in the oscillograms has occurred, and it is believed that this comparative procedure will provide a worth-while contribution to the detection of incipient fault conditions.

For locating faults—contacts or complete disconnection—good results are being obtained from simpler types of pulse echo test sets specifically designed for this limited purpose and in general only the expanded time base facilities of the present set give it a potential advantage in accuracy of location. For the detection of certain types of intermittent faults the long range sensitivity of the set may give it a decisive advantage. With the 0.2 microsecond pulse a series resistance fault of 0.5 ohms or a shunt fault of 10,000 ohms at a point 5,000 yards from the test end of a type 375 coaxial will yield a measurable reflection of about 5 mm. amplitude, and if the fault is intermittent the flickering of the reflection will identify it without ambiguity.

When a faulty length of a coaxial cable has to be withdrawn and replaced it may be necessary to check that the cores in the replacement length have impedances which will match up reasonably well with the cores on the good sides of the two points where the cable has been cut. The pulse end impedance test gives the appropriate data and it can be done quickly and conveniently at any roadside location. To facilitate such emergency operations a record may be kept of the end impedances of the cores in all reserve lengths of cable held in store for repair purposes.

#### ACKNOWLEDGMENTS

The authors are indebted to the directors of Standard Telephones & Cables, Ltd., for permission to publish this article and they have much pleasure in acknowledging their indebtedness to their colleagues in the Telephone Cable Laboratory who have been associated with the development work, and in particular to Mr. W. C. Slade, and to Dr. A. T. Starr and his staff at Standard Telecommunication Laboratories, Ltd.

#### Bibliography

F. F. Roberts. "New Methods for Locating Cable Faults, particularly on High Frequency Cables." *J.I.E.E.*, Vol. 93, Pt. III, November, 1946.

Abraham, Lebert, Maggio and Schott. "Pulse Echo Measurements on Telephone and Television Facilities." *Proc.A.I.E.E.*, Vol. 66, 1947.

F. F. Roberts. "A Pulse Test Set for the Measurement of Small Impedance Irregularities in High Frequency Cables." *J.I.E.E.*, Vol. 96, Pt. III, January, 1949.

energy consumption, harmonic analysis, field plotting (including solution by the relaxation method) and electrical transmission.

The revisions effected in the second edition are of a minor nature, apart from the addition of the chapters on field plotting and electrical transmission.

Although the book is intended for students, it would probably be useful to those practising general power engineers who are not concerned with detailed design of power plant, but, being responsible for performance specification and acceptance of plant, from time to time need to refresh their knowledge of the electrical design principles involved.

P. J. R.



# An Experimental Electronic Director

K. M. HERON, A.M.I.E.E.  
H. BAKER, B.Sc.(Eng.), A.M.I.E.E.  
D. L. BENSON, A.M.I.E.E. †

## Part 2.—Circuit Operation

U.D.C. 621.395.34:621.318.572

Part 1 of this article explained that the experimental director comprises two groups of equipment, the registers, which are individual, and the translator which may be common to many registers. Part 2 describes the complete circuit operation in general terms, the detailed operation of various elements having been described in Part 1.

### GENERAL PRINCIPLES

THE register, like a standard director, is connected to an outlet from a level of A-digit selectors and is designed to receive and store the B and C code digits and the four numerical digits dialled by a subscriber. It obtains the translation for the BC code from a translator which is common to all registers connected to one level of the A-digit selectors, but, to avoid providing equipment in the register to store the translation digits, or components, the register is designed to handle the translation digits one at a time. Thus, when a register has received the code digits of a call, the first component of the translation is obtained from the translator and the register sends this digit. After sending the digit the standard inter-train pause of 800 milliseconds must be observed to permit selectors to search and switch before another digit is sent. This period is used by the register to obtain the second component of the translation from the translator. The remaining components of the translation are similarly obtained, one at a time, during the preceding inter-train pause.

The translator does not handle calls individually, but offers each component of each translation, one after the other, cyclically, to every register. A register requiring translation information must observe these signals and detect the item it requires. The translator operates at a speed such that 48 working codes (spare codes need not be signalled) can be dealt with in less than 600 milliseconds. Registers can observe signals at this speed but they need a few milliseconds delay between detecting a required item and accepting the actual information. This delay is provided by arranging the register to pass a "demand" signal to the translator when a required item is detected. On receipt of a demand signal the translator pauses, signals the information demanded and then returns to the routine of offering each item at high speed.

#### *Signalling Between Registers and Translator.*

Forty-six common wires connect the translator with every register. Signalling is achieved by means of square waveform pulses which have an amplitude of about 45V, a duration of about 200 microseconds and are derived from a supply source of 1,440 c/s. Pulses of this frequency are used in groups of 16, each group forming a cycle of 11·1 milliseconds, i.e. 90 such cycles per second, and these pulses are signalled via the common wires to all registers, the particular wires used depending on the information being transmitted.

The first pulse of a cycle is signalled via one of the common wires, to indicate to each register that a new cycle is commencing. The second pulse is switched to one of ten common wires according to the value of the B digit of the code being offered by the translator. The third pulse is switched to one of another ten common wires according to the value of the C digit of the code being offered by the translator. Pulses four to ten are signalled, one after the other, via seven more common wires to offer each of the

possible components of the translation. (The experimental equipment is designed to deal with a translation of seven digits, or components, whereas the standard director can deal with a maximum of six components.)

If no register demands an item the eleventh pulse is used by the translator to change the code being offered, ready for the next cycle, and pulses 12 to 16 give time for the changeover to occur.

One of the common wires is used to pass the demand signal which is given by a register as soon as it detects the appropriate translation component offering pulse. (This can occur on any of the pulses four to ten already described.) The translator does not offer any further translation components during this cycle and pulse sixteen is switched to one of twelve common wires—ten of the wires being used to indicate a digit value and two wires to indicate DC (translation complete, commence sending numerical digits) or CO (translation complete, clear down without sending numerical digits). This information is recorded by the register, or registers which gave the demand signal. During the next cycle the code offered by the translator is unchanged but only the remaining components which were not offered during the previous cycle are now offered.

Five of the common connections have not been described. One is the start wire, by means of which any register requiring translation information can apply a start signal to the translator. Three common connections are used by the translator to supply a three-phase 10 p.p.s. supply to the registers for sending and control purposes. The last common connection is used to signal the spare code pulse.

As the operation of the register depends on its observing the sequence of signals sent out by the translator and sending a demand signal to the translator when this offers information that the register is waiting to use, the operation of the complete director can best be described by dealing first with the translator.

### THE TRANSLATOR

The translator equipment comprises three distinct sections, the main cycle, the component cycle and the code cycle. Hot-cathode valves are used for the main and component cycle equipments which operate continuously, but the code cycle equipment is almost entirely comprised of cold-cathode tubes and is only operated when a start signal is applied by a register. Fig. 10 is a block schematic diagram of the translator, showing the three sections, the operation of which are as follows.

#### *The Main Cycle.*

The translator is driven by a multi-vibrator operating at a speed of 1,440 c/s and providing two outputs which form a two-phase supply. The two outputs are connected to pulse shapers PSI and PS2 and each time the multi-vibrator switches, it triggers one of these pulse shapers. The pulse shapers produce a square-shaped pulse, having a duration of about 200 microseconds. The main distributor is a sixteen-position ring counter (formed by a four-stage binary circuit). Four positions are used for switching

† The Authors are Executive Engineers in the Telephone Development and Maintenance Branch, E.-in-C.'s Office.

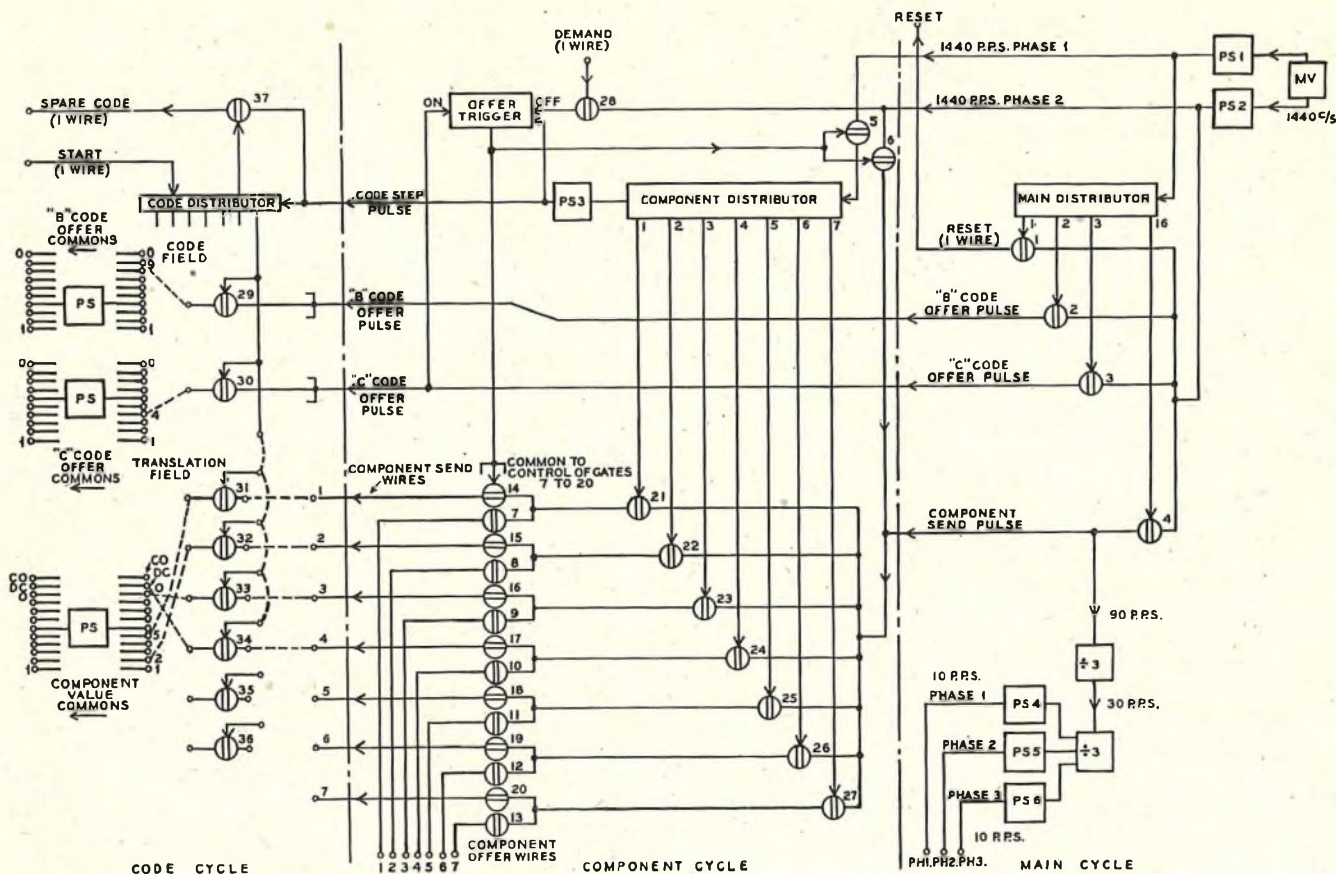

FIG. 10.—BLOCK SCHEMATIC DIAGRAM OF TRANSLATOR EQUIPMENT.

purposes; the other twelve positions measure off a time interval which is used by the rest of the equipment. The distributor is stepped continuously by phase 1 of the 1,440 p.p.s. supply and therefore the main cycle is regular, repeating at 90 cycles per second.

The sequence of each main cycle may be described thus:—

Phase 1 pulse steps distributor to *position 16*; gate 4 opens. Phase 2 pulse passes through gate 4 to form the *send component pulse*.

Phase 1 pulse steps distributor to *position 1*; gate 4 shuts, gate 1 opens.

Phase 2 pulse passes through gate 1 to form the *reset pulse*.

Phase 1 pulse steps distributor to *position 2*; gate 1 shuts, gate 2 opens.

Phase 2 pulse passes through gate 2 to form the *B code offer pulse*.

Phase 1 pulse steps distributor to *position 3*; gate 2 shuts, gate 3 opens.

Phase 2 pulse passes through gate 3 to form the *C code offer pulse*.

Phase 1 pulse steps distributor to *position 4*, gate 3 shuts.

Further phase 2 pulses have no effect until phase 1 pulses step the distributor on to *position 16*; the sequence described then repeats. Of the four pulses described, only the reset pulse is directly connected to the translator output.

The 10 p.p.s. circuit is also shown in the main cycle section of Fig. 10. The 90 p.p.s. component send pulse is connected to a ring-of-three counter which provides an output signal of 30 p.p.s. This is connected to another ring-of-three counter from which an output is taken from each of the three valves, so producing a three-phase 10 p.p.s. supply. Three pulse shapers are used to produce square shaped pulses having a duration of about 200 microseconds and an amplitude of about 45V, which are signalled to all registers.

### The Component Cycle.

The component distributor is an eight-position ring counter (formed by a three-stage binary circuit) and seven of the eight positions are used for switching purposes. Component cycle operations are controlled by the "Offer Trigger," a two-position trigger (Fig. 7(d), Part 1) which is operated, or switched on, during every main cycle by the C code offer pulse. The restoration, or switching off, of the trigger is not regular because it may be switched off by a demand signal from registers; thus, the component cycle is not regular but is varied by demand signals. When the offer trigger is switched on it operates gates 5 to 20. Gates 5 and 6 in opening connect the 1,440 p.p.s. two-phase supply to the component distributor and its associated gates so that phase 2 pulses are distributed via gates 21 to 27 in the same way as the main distributor distributed phase 2 pulses via gates 1 to 4. When one pulse has been signalled via each of gates 21 to 27 (and then via gates 7 to 13 to the register) the component distributor steps to position 8 and in so doing triggers pulse shaper PS3. This pulse shaper produces the "code step pulse" which marks the end of the component cycle. This pulse switches off the offer trigger which results in gates 5 to 20 restoring to their normal condition. No further action takes place until the offer trigger is switched on during the next main cycle. It should be noted that in this no-demand sequence the component cycle is contained within one main cycle; also, because the component distributor is in position 8 when the offer trigger is switched off, none of the gates 21 to 27 is left open and therefore the send component pulse, arriving at the end of the main cycle, finds no outlet and is ineffective.

If a demand signal is received by the translator in response to one of the seven component offer pulses, this signal opens gate 28 and results in the offer trigger being switched

off by the end of the component offer pulse. The offer trigger restores gates 5 to 20 to normal. Gates 5 and 6 stop the component cycle and the distributor is left off-normal indicating which component has been demanded. When the component send pulse arrives at the end of the main cycle it passes through one of the gates 21 to 27, according to the component demanded, and then via one of gates 14 to 20 (all of which are open) to the code cycle equipment. During the following main-cycle the component distributor will continue from where it was stopped and therefore only the remaining component offer pulses will be signalled. From the foregoing it can be seen that during every component cycle the seven components are each offered once only, followed by a code step pulse; every demand (simultaneous demands are treated as though they were a single demand) extends the component cycle into an additional main cycle.

### The Code Cycle.

The code distributor comprises 48 cold-cathode triode tubes connected to form a one-up ring counter (Fig. 4, Part I). Normally the code distributor is inoperative but when any register applies a start signal the H.T. supply is switched on and a particular tube is struck. Each of the 48 tubes controls one BC code and the associated translation. An output connection from each tube is used to control several cold-cathode diode gates (Fig. 5a, Part I) and one typical connection is shown in the code cycle section of Fig. 10. Several hundred of these cold-cathode diode gates are provided and all will be shut except those controlled by the one distributor tube which is conducting. Gates 29 and 30 are permanently connected to the controlling tube in the distributor and each tube in the distributor is permanently connected to two similar gates, thus there are 48 gates similar to gate 29, and 48 gates similar to gate 30. The number of components in a translation can vary from two to seven but because the average number is about 4.5 it has been arranged that 240 gates are provided and are made available for use by any tube in the distributor. Gates 31 to 36 represent this group of 240 gates and in Fig. 10 four gates are shown strapped as a typical translation whilst two gates are shown spare.

It has already been explained that the second pulse of each main cycle is the B code offer pulse. This pulse is connected to each of the 48 gates represented by gate 29 in Fig. 10. As long as a start signal is applied, one of these gates will be open according to the distributor tube which is conducting. The B code offer pulse passes through this gate and is connected to one of 10 terminals according to the value of the B digit of the code to be signalled. The output of many gates may be connected to the same terminal without interference but, because the pulse is somewhat distorted after passing through a cold-cathode diode gate, it is only used to trigger a pulse shaper which re-forms the pulse for transmission to the registers. Similarly, the third pulse of each main cycle is connected to 48 gates represented by gate 30 in Fig. 10, and is signalled to all registers on one of another 10 wires to indicate the value of the C digit of the code to be signalled. When a demand has been made by a register, pulse 16 of the main cycle is signalled on one of the seven component send wires according to the component demanded. The component send wires are strapped to as many gates as are required by the various translations but only one gate connected to each component send wire can be open at a time. Thus the component send pulse passes through the appropriate gate and is signalled to all registers on one of 12 wires according to the connections in the translation field. Fig. 10 shows the connections to translate code 94 into 520 and DC. The component following the last translation digit must be connected to DC or CO except when the translation is a

seven-digit number when the register will automatically proceed to the DC condition. At the end of each component cycle a code step pulse is signalled to the code distributor. This steps the distributor to the next position so that a different code is signalled during the next cycle.

It is not necessary to wire up translations for all 48 tubes in the code distributor; tubes not wired will be ineffective. If a large proportion of the tubes are not used, arrangements have been made for part of the distributor to be disconnected so that the number of effective tubes is reduced. Translations may be altered whilst the equipment is operating although it is preferable to withdraw the equipment from service if large scale alterations are necessary. A new translation can be wired up in advance on a spare tube and will be ineffective so long as one of the code strappings is left unconnected. This is useful when a change of translation occurs. At the changeover time it is only necessary to cut one strap of the old translation to put it out of service and to connect the remaining strap of the new translation to bring it into service, and this action is required on only one translation field. The old translation may be unwired later and the associated tube left spare. One of the 48 tubes in the code distributor is also used to open gate 37. This gate permits one code step pulse to be signalled to registers each time the distributor steps past that tube. These pulses are used for spare code identification as described later.

### THE REGISTER

The register will be described with the aid of a number of block schematic diagrams. Each diagram will show the equipment required for different circuit functions, thus some items of equipment appear in more than one of the diagrams.

#### Recording Digits Dialed Into the Register.

Fig. 11 shows the equipment for this function. The line supervisory circuit (the equivalent of A, B and C relays in

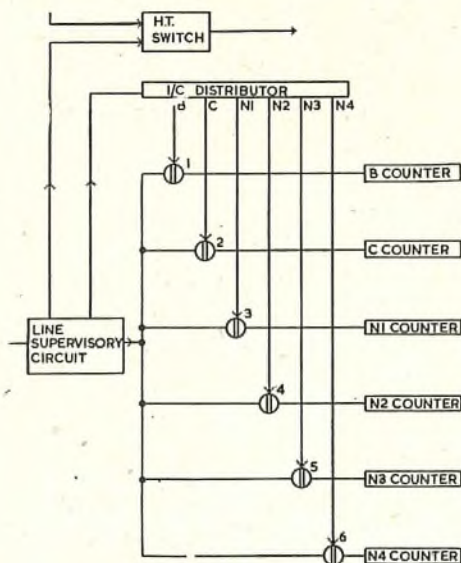

FIG. 11.—BLOCK SCHEMATIC DIAGRAM OF REGISTER EQUIPMENT FOR RECORDING DIGITS.

a standard director) was described in Part I of this article. At the beginning of a call the equivalent of a B relay operates, and provides a signal to the H.T. switch. The H.T. switch is a hot-cathode valve circuit which provides an H.T. supply of 150V to all cold-cathode tube circuits in the register. While the register is idle the H.T. switch is off and therefore no cold-cathode tube can be in a conducting condition. When the H.T. is switched on, the sudden change

of potential is used to strike the starting tubes of the various counters in the register. Fig. 11 shows six counters which record the digits dialled, the B and C code digits and the four numerical digits. These counters are 11-position, one-up counters (Fig. 4, Part 1). The first tube in each counter is the starting tube and is struck at the beginning of a call. The incoming digit distributor is a seven-position, one-up counter, and the cathode of the starting tube is connected to gate 1 so that when the starting tube is struck at the beginning of a call, gate 1 opens. The equivalent of an A relay in the line supervisory circuit provides a pulse every time a "break" signal, or dial impulse, is detected. These pulses are connected to cold-cathode gates 1 to 6 and thus when the first digit is dialled, pulses pass through gate 1 which is open, and are counted by the B digit counter. At the end of each impulse train the equivalent of a C relay in the line supervisory circuit releases and in so doing provides a pulse to the incoming digit distributor to step it. Thus, at the end of the first impulse train gate 1 is closed and gate 2 is opened. In this way the six digits are recorded by the six counters. When the last has been received, the incoming digit distributor steps to its seventh and final position so that none of the gates 1 to 6 is open.

*Obtaining Translation Information from the Translator.*

Fig. 12 shows the equipment for this function. The sequence control circuit is a cold-cathode counter which

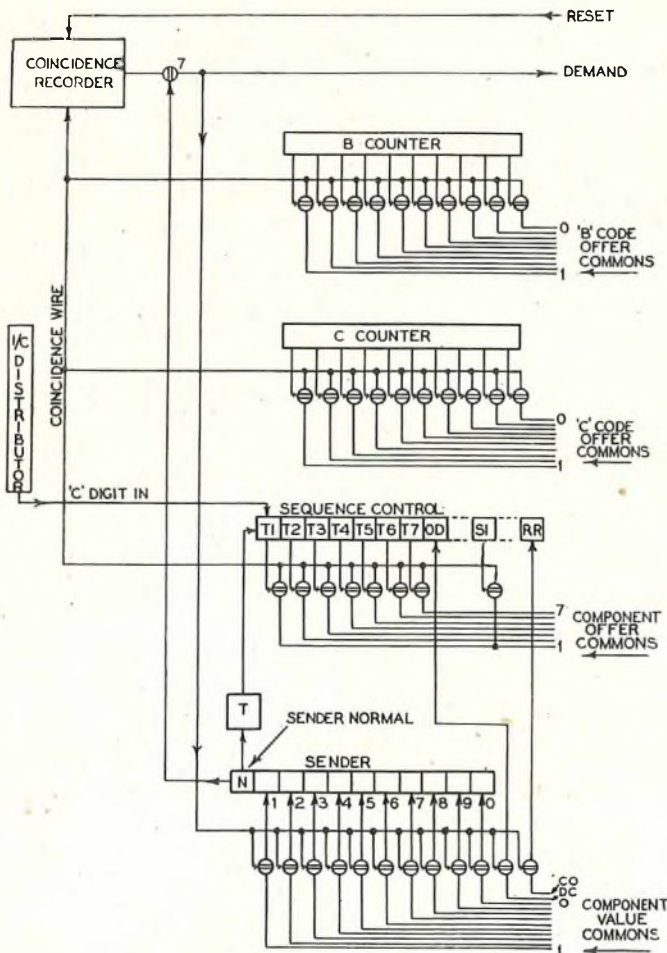

FIG. 12.—BLOCK SCHEMATIC DIAGRAM OF REGISTER EQUIPMENT FOR OBTAINING TRANSLATION INFORMATION FROM TRANSLATOR.

controls each sending operation. The starting tube is struck from the incoming digit distributor as soon as the complete code has been received. The sender, another cold-cathode counter, has its starting, or normal, tube struck when the

register is seized. The coincidence recorder controls the translation function and consists of a hot-cathode valve counter which can count up to three pulses at a speed of 1,440 p.p.s. During each pulse cycle from the translator the following operations occur :—

- (1) The reset pulse sets the coincidence recorder at normal.
- (2) The B code offer pulse from the translator is applied to one of ten cold-cathode diode gates according to the digit being signalled. If this digit is the same as the digit recorded in the B code counter then this gate will be open and the pulse will be passed to the coincidence recorder where it is counted. If the digit signalled is not the same as the digit recorded then the gate will be shut and nothing will happen.
- (3) The C code offer pulse is signalled to ten more cold-cathode diode gates and again, if the digit signalled is the same as the digit recorded by the C code counter, then a pulse is counted by the coincidence recorder.
- (4) The seven translation component offer pulses arrive one after the other and are applied to a further seven cold-cathode diode gates. A register requiring the first component of a translation will have the first of these seven gates open, controlled by tube T1 in the sequence control counter. When the appropriate component offer pulse arrives it will be passed to the coincidence recorder where it is counted.

If the information being offered by the translator is not that which is required by the register then the coincidence recorder will not receive three pulses; it may receive one or two pulses but no more. When this happens no further action occurs until the reset pulse sets the coincidence recorder back to normal. If the information being offered by the translator is the item required by the register, then the coincidence recorder will receive three pulses. The receipt of the third pulse (the component offer pulse) causes the coincidence recorder to issue a demand signal to the translator via gate 7 (which was opened when the sender normal tube was struck on seizure) and to give a signal (lasting until the next reset pulse) which opens twelve cold-cathode gates ready to accept the component value signal when it arrives. The translator then applies the last pulse of the cycle, pulse 16, to one of these twelve gates according to the value of the item being signalled. If the information is in respect of a digit to be sent, the pulse will strike one of ten tubes in the sender, according to the value of the digit. If the information is in respect of control signals DC or CO then the pulse will strike tube OD or tube RR of the sequence control counter. The former is the sequence which initiates numerical sending and the latter is the sequence which initiates clear-down.

When a numerical digit is received, the normal tube in the sender is deionised by one of the other tubes striking. The sender normal circuit is connected to a trigger circuit, T (similar to the A trigger in the line supervisory circuit). When the sender normal tube is deionised this trigger operates and provides a pulse to the sequence control counter which steps to the next position. It should be noted that, having received an item of translation information, the sequence control counter is positioned to "pre-select" the next sequence which is required. When information is received in respect of a digit to be sent, the sender normal tube closes gate 7 and prevents the coincidence recorder from issuing a demand or opening the 12 gates which accept component values, until the digit already held is sent. Each component of the translation is obtained in the same way as that already described and when all translation information is received either the OD or RR tube in the sequence control counter, will be left conducting.

### Control of Impulse Sending.

The inter-train pause (I.T.P.) generator (Fig. 13) is a two-tube counter which is arranged so that its normal tube is

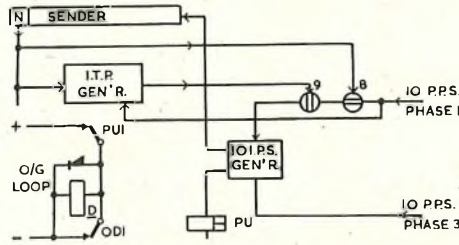

FIG. 13.—BLOCK SCHEMATIC DIAGRAM OF REGISTER EQUIPMENT FOR CONTROL OF IMPULSE SENDING.

struck by a 10 p.p.s. phase 1 pulse, approximately 800 milliseconds after its off-normal tube is struck. The normal tube opens gate 9. When a digit is to be sent, one of the ten off-normal tubes in the sender is struck according to the digital value and the normal tube deionises. This opens gate 8 and permits 10 p.p.s. phase 1 pulses to pass via gates 8 and 9 to the 10 i.p.s. generator (Fig. 7 (d). Part 1). This trigger circuit is operated by 10 p.p.s. phase 1 pulses and restored to normal by 10 p.p.s. phase 3 pulses, and therefore, when operating, the 10 i.p.s. generator will be in an operated condition for exactly twice as long as it will be in a normal condition, thereby producing the standard impulse ratio of two to one. Every time the 10 i.p.s. generator operates it supplies a pulse to the sender counter which counts down to the normal tube. Whilst the 10 i.p.s. generator is off-normal the PU relay is operated via an amplifier valve and the contacts of this relay provide 67 per cent. break pulses to the outgoing loop. At the beginning of the last impulse of a train the sender will be stepped to the normal position. This closes gate 8 and prevents further 10 p.p.s. phase 1 pulses reaching the 10 i.p.s. generator; meanwhile a period of 67 milliseconds elapses before a 10 p.p.s. phase 3 pulse restores the 10 i.p.s. generator to normal. The sender in restoring to the normal position, strikes the I.T.P. generator off-normal tube and therefore for a period of 800 milliseconds gate 9 also prevents 10 p.p.s. phase 1 pulses reaching the 10 i.p.s. generator, so ensuring an inter-train pause of 800 milliseconds. From the foregoing it will be seen that the sending of an impulse train follows automatically when the appropriate sender tube is struck.

### Transfer of Numerical Information to the Sender.

Fig. 14 shows the equipment for this facility. The transfer of numerical information is preceded by tube OD in the sequence control counter striking at the end of translation sending. Tube OD operates relay OD via an amplifier valve and the contacts of this relay offer the D relay to the outgoing loop. If the D relay detects a reversal (C.C.I. coder busy condition) it will operate and prevent further action. If the D relay does not operate, or when it releases due to the C.C.I. reversal clearing, tube N1 is struck by a 10 p.p.s. phase 1 pulse via gates 19 and 20. W, X and Y are three cold-cathode triode tubes which are auxiliary to the incoming distributor and their function is to restrain the sending of numerical digits. Tube W is struck when the second numerical digit starts to be received (when the

equivalent of a C relay operates), tube X is struck when the third numerical digit starts to be received and tube Y is struck when the last numerical digit starts to be received. Tube Z is the last tube of the incoming distributor and is struck when the last numerical digit is fully received. As soon as the sender counter returns to normal after sending the last translation digit it opens gate 10. Gate 11 is opened by the sequence counter tube N1 and gate 12 is opened by tube W which ensures that the first numerical digit is not sent until the second numerical digit is being received (a facility of standard directors). When gates 10, 11 and 12 are all open, 10 p.p.s. phase 1 pulses are applied to ten cold-cathode diode gates. One of these gates will be open according to the value of the first numerical digit, as indicated by the N1 counter, and a 10 p.p.s. phase 1 pulse passing through this gate will strike the appropriate tube in the sender. The sender in going off normal closes gate 10 to disconnect further pulses.

As already described, the sender in going off-normal operates trigger T which in turn applies a pulse to the sequence control counter to step it to the next tube, N2.

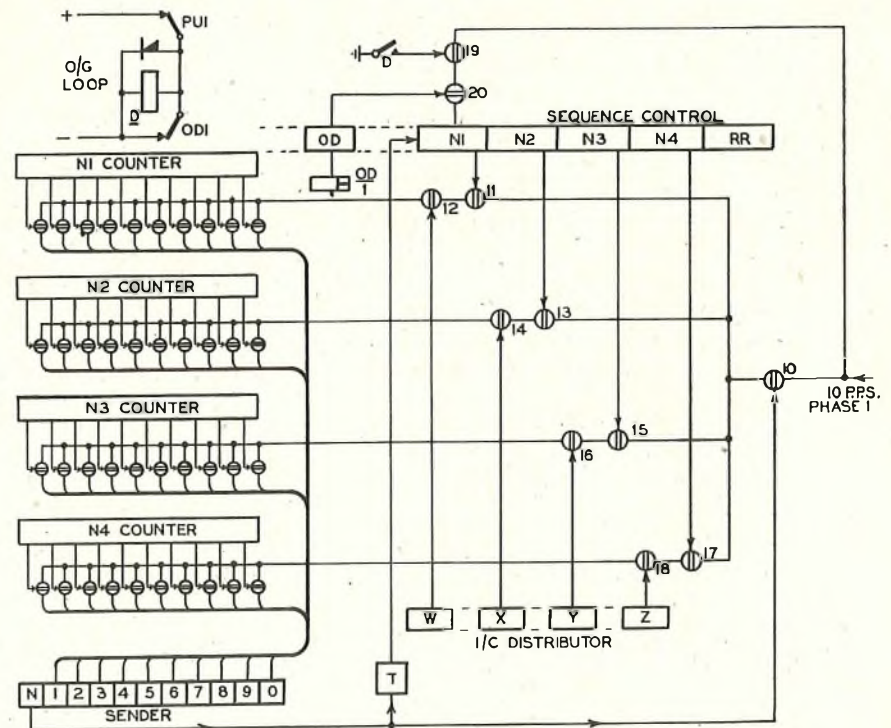

FIG. 14.—BLOCK SCHEMATIC DIAGRAM OF REGISTER EQUIPMENT FOR TRANSFER OF NUMERICAL INFORMATION TO THE SENDER.

When the first numerical digit has been sent the sender normal tube strikes and re-opens gate 10. Gate 11 is now shut but gate 13 is open. Gate 14 is controlled by tube X, again to prevent premature sending, and when gates 10, 13 and 14 are all open the second numerical digit is transferred to the sender via ten more cold-cathode diode gates. The transfer of the third and fourth numerical digits will be apparent from the above. When the fourth and last digit is transferred, the sequence control counter will be stepped to tube RR (which initiates clear-down).

Gate 10 is a hot-cathode valve circuit; gates 11 and 12 are formed by a single cold-cathode tube as also are each pair of gates 13-14, 15-16 and 17-18. Gates 19 and 20, controlling the striker of tube N1, are formed by small metal rectifiers.

### Control of Clear-down.

In designing the electronic director it was decided to simplify the signals given when clearing down. Thus the

register does not imitate exactly the standard director in this respect but, with one exception, only provides those signals which are required by the exchange equipment. The exception is the sending of the digit "0" on a spare code call, a signal which is used by maintenance staff to identify spare code calls.

Fig. 15 shows the equipment which controls clear-down, and operation is as follows:—

1. *Normal Call.* The signal to clear down is given by tube RR in the sequence control counter striking. This tube opens gate 21. Gate 10 is opened by the sender normal tube when the last digit is sent and gate 22 is opened by the I.T.P. generator when the inter-train pause expires after the last digit. When these three gates are open, cold-cathode tube CO strikes from a 10 p.p.s. phase 1 pulse. Tube CO operates relay CO via an amplifier valve and the contacts of this relay disconnect the P-wire which results in relay K in the first code selector, releasing. The first code selector then releases the register. The register HT switch is switched off by the combination of two signals (a) CO tube operated and (b) the "B relay" released. When this occurs the HT switch disconnects the H.T. supply to all cold-cathode tubes, including tube CO and therefore all tubes are deionised. Relay CO in releasing restores the P-wire conditions, permitting the register to be re-seized.

2. *Premature clear-down.* The "B relay" in releasing provides a pulse which strikes tube CO (provided that relay D is normal). Clear-down then proceeds as for a normal call. If the D relay is operated (C.C.I. reversal condition) when the "B relay" releases, then cold-cathode tube PU is struck instead of tube CO. Tube PU operates relay PU via an amplifier valve and the contacts of this relay open the outgoing loop to release a junction which may be held. A resistor-capacitor circuit between tube PU and cold-cathode tube M causes tube M to strike 800 milliseconds after tube PU strikes, thus allowing a junction guard period of 800 milliseconds. Tube M operates relay M via an amplifier valve and the contacts of this relay earth the FR-wire to operate relay M in the first code selector. A resistor-capacitor circuit connects tube M to tube CO and causes tube CO to strike 100 milliseconds after tube M strikes, thus allowing 100 milliseconds for relay M in the first code selector to operate. Clear-down then proceeds as for a normal call.

3. *Spare Code.* Tube T1, in the sequence control counter strikes and the register looks for the first component of the translation. The translator does not offer information about spare codes but each time information is offered in respect of all working codes, a spare code pulse is signalled. The first spare code pulse to arrive steps the sequence control counter to tube S1. Tube S1 still permits the register to look for the first component of a translation (Fig. 12 shows an additional gate controlled by tube S1 for this purpose) and should an item of information be detected the sequence control counter will be stepped to tube T2 as already described. However, in the case of a spare code no detection will occur and a second spare code pulse will be received. This second pulse steps the sequence control counter to tube S2 which is the spare code indication. Tube S2 opens gate 23, gate 10 is already open and therefore a 10 p.p.s. phase 1 pulse will strike the sender 0 tube, resulting in the digit 0 being sent. The trigger T, operated by the sender going off-normal, provides a pulse which steps the sequence control counter to tube S3. This closes gate 23 and opens gate 24. When the sender returns to normal after sending the digit

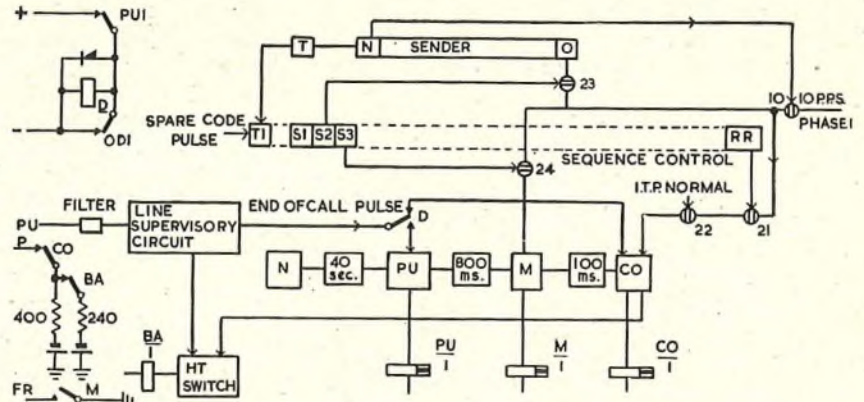

FIG. 15.—BLOCK SCHEMATIC DIAGRAM OF REGISTER EQUIPMENT FOR CONTROL OF CLEAR-DOWN.

0, gate 10 reopens and a 10 p.p.s. phase 1 pulse strikes tube M via gate 24. Tube M operates relay M and clear-down is completed as described for the previous case.

4. *Forced Release.* The tube N is struck at the beginning of a call together with other starting tubes. Two hot-cathode valves are used to provide a delay of approximately 40 seconds, after which, tube PU is struck and clear-down proceeds as described for premature clear-down from a C.C.I. reversal condition. The usual forced release cut-out key is provided on the equipment.

Gates 21 and 22, which control the input to tube CO, are formed by miniature rectifiers. Gates 23 and 24 are formed by the resistor-capacitor combination on the strikers of the sender 0 tube and the tube M respectively.

#### CONSTRUCTION AND PROTECTION

Because the experimental equipment was developed purely for a field trial, no great importance was attached to space, and the racks, for convenience, are only 6 ft. 6 in. high. Fig. 16 shows that the experimental equipment is

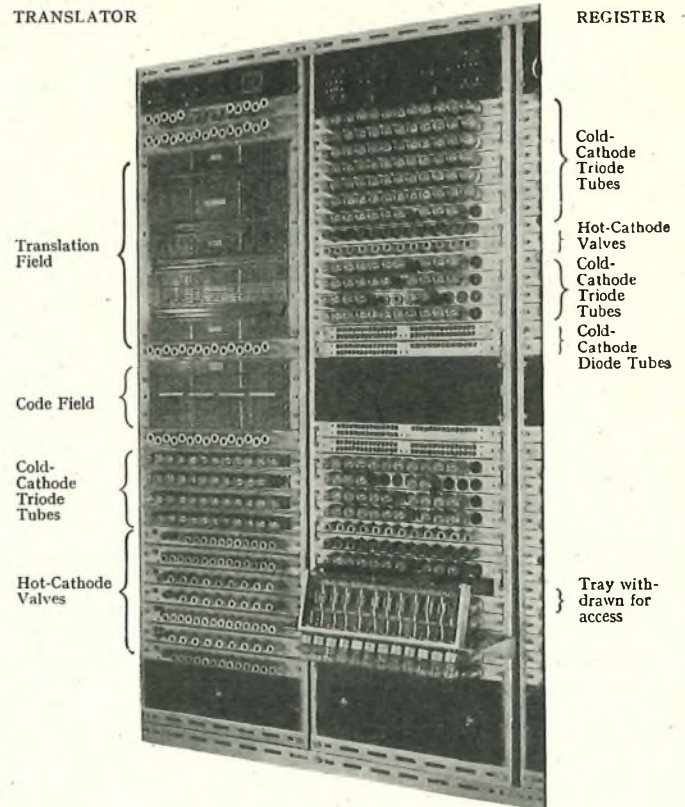

FIG. 16.—THE TRANSLATOR RACK AND ONE REGISTER RACK OF THE EXPERIMENTAL EQUIPMENT.

built up from a number of sub-assemblies. Each sub-assembly is housed in a metal tray and these are mounted on the rack so that each can be withdrawn to obtain access to the components and tags. This arrangement assists in guarding the power supplies which range from  $-100V$  to  $+230V$  and because of these voltages, shrouded type alarm fuses have been used. It is also necessary to protect heater wiring from fusing as a result of short circuit faults; but in order to avoid using heavy gauge conductors on valveholder tags, and because ordinary fusing is difficult (heaters can draw four or five times their rated current whilst warming up) the problem has been solved by employing constant voltage L.T. transformers with a self-limiting maximum current output.

A colour code has been used not only to indicate leads such as H.T. supplies, inter-connection leads, etc., but also to designate valve electrodes. This facilitates recognition and has proved as valuable as colour-coded resistors during the construction and testing stages of this equipment.

Each register incorporates 24 hot-cathode valves, 119 cold-cathode triode tubes and 94 cold-cathode diode tubes. Power consumption is about 55 watts when idle and about 65 watts during a call. Two registers are mounted per rack as illustrated in Fig. 16.

The translator incorporates 134 hot-cathode valves, 48 cold-cathode triode tubes and 336 cold-cathode diode tubes. Power consumption is about 260 watts, nearly all of which is absorbed by the hot-cathode valve heaters. The equipment is mounted on one rack which is 19 in. wide and 6 ft. 6 in. high.

#### CONCLUSIONS

During the past two years the experimental equipment has been tested, demonstrated and prepared for field trial. Demonstrations have been given to many interested parties and because of the wide interest shown, the demonstrations continued for several months. Experience already gained in operating the equipment shows that circuit elements employing cold-cathode tubes have so far proved to be more reliable than elements employing hot-cathode valves. However, detailed information about questions such as reliability and maintenance problems can only be obtained from the field trial and results are awaited with interest. Six registers and one translator are being installed in a London exchange, where they will handle all calls from one level of the A-digit selectors.

The experimental equipment has been designed to

imitate the standard director. This does not represent the most economic way of applying electronic techniques to the design of register-translators because alternative circuit arrangements can be more efficient, particularly if all three digits of the code are handled by the register. Recent developments in the miniaturisation of components, particularly cold-cathode tubes, permit a reduction in the size and cost of the various elements. This leads to the conclusion that any attempt to develop an electronic register-translator as a standard item would result in a different layout and a considerable reduction in size and cost compared with the existing experimental equipment.

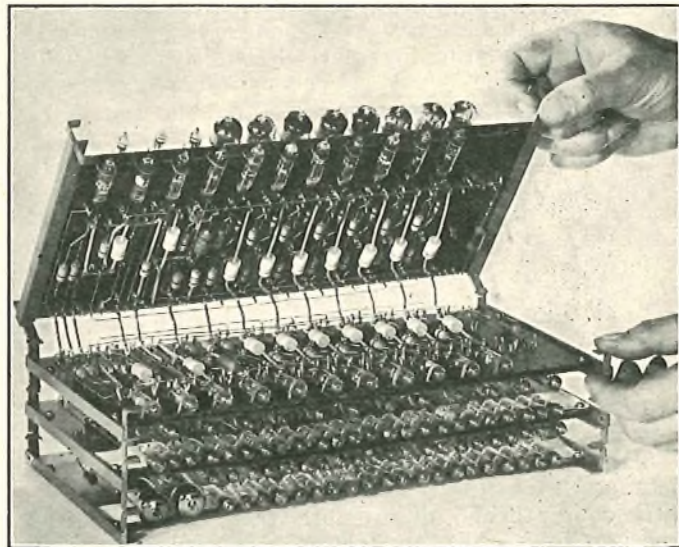

FIG. 17.—"BOOK" PRINCIPLE OF CONSTRUCTION USING MINIATURE COMPONENTS.

Fig. 17 illustrates a construction principle which takes full advantage of the miniaturisation of components. This compact block of equipment takes the form of a "book" which can be opened at any "leaf" to give access. Each leaf is a sub-assembly, and the sub-assemblies can be inter-connected by short direct leads.

#### ACKNOWLEDGMENTS

The authors wish to express their appreciation to the members of the Research Branch who collaborated in the development of the experimental equipment.

### Book Review

"Transients in Electric Circuits." (Using the Heaviside Operational Calculus). Second Edition, 1951. W. B. Coulthard, B.Sc., A.M.I.E.E., M.A.I.E.E. Sir Isaac Pitman & Sons, Ltd., London. 260 pp. 97 ill. 32s 6d.

This book, the first edition of which appeared in 1941, is primarily concerned with the mathematical analysis of problems connected with electric circuit transients. The author does not favour the formal mathematical approach to such problems but prefers the direct operational attack devised by Heaviside. Consequently, the first chapter is devoted to explaining the mathematical significance of Heaviside operational equations. The following eight chapters are then concerned with the development of explicit solutions from operational equations describing physical systems. These chapters contain the solutions of many important technical problems associated with transient effects in linear networks, transformers, electrical machines, bridge and valve circuits, transmission lines, etc.

To apply the direct Heaviside method with confidence to new problems it is necessary to have some grasp of the classic Fourier analysis for which it is the working tool; with this in

mind the author has included a survey of certain essential parts of Fourier analysis in his tenth chapter.

The last two chapters contain an interesting review of the theory and calculation of networks with variable parameters. For the analysis of non-linear networks there exists at present no convenient method comparable with the Heaviside method for linear networks. The author shows that such mathematical processes of analysis as are available have not yet been interpreted and systematised for practical engineering use.

In the second edition it is shown that the mathematical methods which Heaviside evolved are applicable to the solution of problems in other branches of engineering. In this category will be found applications to mechanical devices, linear control systems, spot welders, etc. Additional material on the operation of synchronous machines has been introduced and a new method of analysing periodic wave forms has been described.

This book gives an excellent account of the original Heaviside operational calculus and can be especially recommended to those engineers who have to predict and provide for the effects of transient surges in electrical systems.

H. J. J.

# The Growth and Properties of Cathode Interface Layers in Receiving Valves

M. R. CHILD, A.M.I.E.E.†

U.D.C. 621.3.032.216.2

An interface layer tends to grow between the barium strontium oxide matrix and the nickel core of conventional thermionic valves. Some of the characteristics of these layers have been investigated and are described in the present article.

## Introduction.

THE life testing of thermionic valves has been undertaken by the Post Office Engineering Department for many years. The main object of this work has in the past been assessment of quality of a valve type, but of recent years emphasis has changed and is now concentrated largely on discovering the principal factors which limit life span. It has been found<sup>1</sup> that commercial receiving valves fail in general from two primary causes—deterioration of the cathode by residual gas action and the growth of a resistive interface between the cathode matrix and its supporting core. Both causes are normally present in commercial valves although the presence of one frequently masks the effect of the other. Gas deactivation of the cathode shows up as an inadequacy of emission to meet the space-charge requirements; interface resistance as a reduction of mutual conductance by negative feedback. The present article deals with some aspects of the interface resistance growth.

## Formation of Silicate Interface Layers.

The precise chemical reaction which gives rise to the interface layer cannot be stated with certainty. There is little doubt, though, that its formation is dependent upon the impurities which are present in most nickel cores to assist in the activation of the matrix. One of these impurities, namely silicon, reacts with the barium oxide in the following manner:—

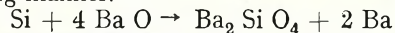

The barium orthosilicate forms as a hard compact layer of a few microns thickness between core and matrix. Its behaviour is that of a semi-conductor and the equation above indicates the probability of barium being the activator.

Extensive measurements have shown that the resistance of the interface at the beginning of the valve's life is very low (less than 1 ohm/sq. cm.), and that in certain circumstances this resistance may grow as high as 50 ohms or more in a few thousand hours. Microscopic examination of the interface layer of valves which have run for 10,000 hours or more seems to indicate that the physical thickness of the layer does not increase to any great extent with time. The rise of resistance is ascribed to an increase in the specific resistivity of the layer rather than to its physical growth; in short, the resistance growth is regarded as a deactivation phenomenon of a semi-conductor.

Because of the extreme thinness of the interface layer a considerable capacitance exists as a shunt across the resistance, and the effect of the interface layer on valve performance is analogous with that of a bias resistor and shunt capacitor inserted in the cathode lead.

## Effect of Interface on Valve Performance.

The presence of a resistor and shunt capacitor in the cathode circuit of a valve gives rise to negative feedback and hence to a reduction in effective mutual conductance at a given current, in accordance with the well-known equation :

$$g_m = \frac{g_{m0}}{1 + g_{m0} Z \alpha}$$

Where  $g_m$  and  $g_{m0}$  are the mutual conductances with and without feedback,  $Z$  is the feedback impedance (in this case the interface) and  $\alpha$  is the ratio cathode current/anode current.

The presence of the capacitor makes the feedback impedance, and hence the mutual conductance, frequency-dependent up to about  $10^7$  c/s. Above this frequency the capacitive reactance rarely exceeds 1 ohm and the mutual conductance is no longer affected by the interface. The importance of this frequency-dependent characteristic in the design of wide-band amplifiers will be obvious. Furthermore, the appreciable negative temperature coefficient associated with the interface resistance degrades the mutual conductance/heater supply characteristic and may cause trouble in stable amplifier design.

A valve is commonly considered to have reached the end of its useful life when the mutual conductance falls to 70 per cent. of its original value. A high slope pentode (e.g. CV 138) operating at a low frequency, with a nominal mutual conductance of 7.0 mA/V, will continue to function satisfactorily until  $R\alpha$  reaches the value of 61 ohms, provided the mutual conductance is not being simultaneously affected by other causes. ( $R$  is interface resistance in ohms.)

At first sight it would appear that interface resistance is of no consequence in high-frequency applications. This is only true provided the cathode current is maintained constant, since the growth of resistance will normally cause a reduction in the operating cathode current and hence a fall in mutual conductance.

It will be obvious, of course, that the rate of interface resistance growth is inversely proportional to the cathode area and a valve with half the cathode wattage of the CV 138 will probably "grow" resistance at twice the rate of the CV 138. This clearly sets a problem in miniaturisation.

## Properties of the Interface.

*Resistance/Temperature Characteristic of the Interface.* The interface resistances of a number of valves have been measured at various cathode temperatures and a straight

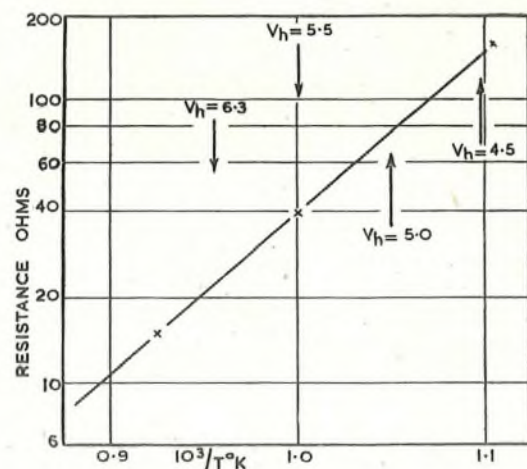

FIG. 1.—RESISTANCE/TEMPERATURE RELATIONSHIP FOR A TYPICAL INTERFACE.

† Experimental Officer, Research Station.

<sup>1</sup> Metson, G. H., Wagener, S., Holmes, M. F., and Child, M. R. The Life of Oxide Cathodes in Modern Receiving Valves. I.E.E. Printed Paper R 1137.



line relationship has been found between the log of the resistance and the reciprocal of the temperature. A typical plot is shown in Fig. 1. This resistance/temperature relationship is characteristic of semi-conductors, and the activation energies associated with the interface layers are similar to those of the barium strontium oxide matrix.

At a temperature of 1,000°K the resistance of the cathode matrix is usually in the range 2-20 ohms. Similar values of resistance are frequently associated with interface layers which are only 1/50th-1/100th of the thickness of the matrix and it seems probable that, in these circumstances, the concentration of impurity centres in the matrix is 50-100 times as great as in the interface layer. The presence of interface layers of similar thickness, but of negligible resistance in new valves, suggests that the concentration of impurity centres is much higher in newly formed interfaces: This evidence supports the suggestion made above that the growth of interface resistance is principally a deactivating process.

*Effect of Temperature on Rate of Growth of Interface Resistance.* A certain randomness about the growth of interface resistance of commercial valves, coupled with observed differences of cathode temperature has led to a carefully controlled investigation into the effect of cathode temperature on the rate of growth of interface resistance. The valves used for this work were high slope pentodes similar to the CV 138 and made by the Post Office for experimental purposes. A typical nickel containing 0.05 per cent. magnesium and 0.05 per cent. silicon was used for all the cathode sleeves. Care was taken to ensure that all the components were subjected to the same treatment before assembly, and the valves themselves were pumped and processed in identical fashion.

Batches of these valves were run on the life-test racks with  $V_a = V_{g2} = 250V$  and  $I_a = 8 mA$ , and with heater voltages of 4.5, 5.0, 5.5, 6.0, 6.5 and 7.0V.

Despite a spread of results within batches, it was very noticeable that the interface resistance developed more rapidly at high heater voltages. Fig. 2 shows the average

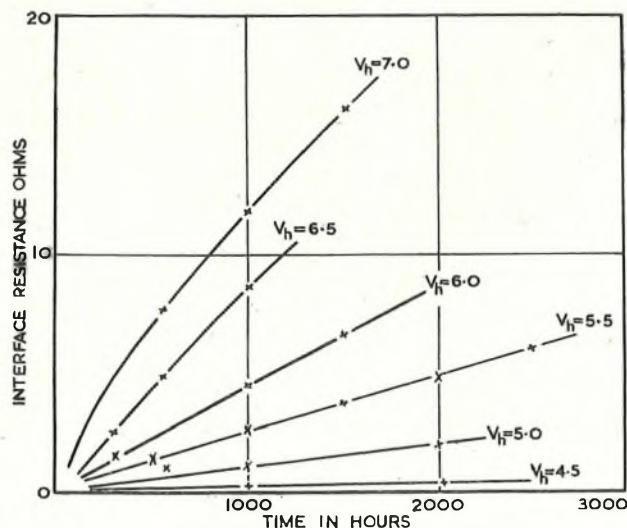

FIG. 2.—GROWTH OF INTERFACE RESISTANCE AT VARIOUS CATHODE TEMPERATURES.

value of interface resistance for the different heater voltages as a function of time, and Fig. 3 indicates an exponential relationship between the growth of interface resistance and temperature at least during the early stages of the valve's life. In a recent publication, Eaglesfield<sup>2</sup> has examined the

<sup>2</sup> Eaglesfield, C. C. Life of Valves with Oxide-Coated Cathodes. *Electrical Communication*. Vol. 28, No. 2, June 1951.

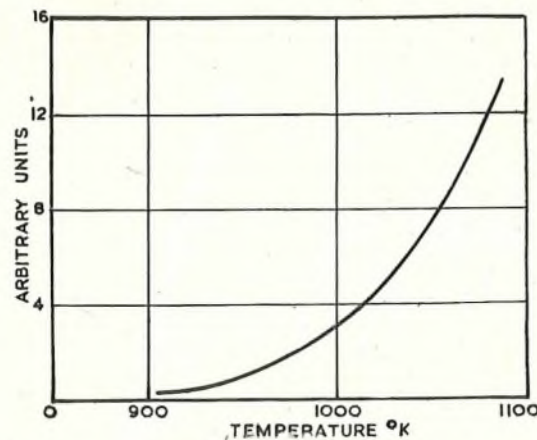

FIG. 3.—RELATIVE RATE OF GROWTH OF INTERFACE RESISTANCE WITH TEMPERATURE.

cause of failure of a number of types of valves and has come to the conclusion that interface resistance increases up to a certain limiting value and thereafter shows no change with time.

*Effect of Silicon Concentration on Rate of Growth of Interface Resistance.* The nickel commonly used for commercial valves contains about 0.05 per cent. silicon. A batch of experimental valves was made up with a nickel core material containing only about 0.005 per cent. silicon. Tests on these valves showed that the rate of interface resistance growth was on the average only  $\frac{1}{7}$ th that of the valves with the conventional silicon content. It appears, therefore, that the silicon concentration is one of the determining factors of rate of resistance growth.

*Effect of Cathode Current on Rate of Growth of Interface Resistance.* It has gradually become realised amongst valve users that damage is caused to the valve by running it in the cut-off state, i.e. with zero cathode current. It now seems that this may be due to some action occurring at the interface which requires the passage of current in certain circumstances to maintain its activation level. The phenomenon has been quantitatively examined on some experimental pentodes with the following results which average over 16 samples.

TABLE 1

Cathode Current = 2.5 mA		Cathode Current = 24 mA	
@ 500 Hrs. $R = 8$	@ 1,000 Hrs. $R = 15$	@ 500 Hrs. $R = 2$	@ 1,000 Hrs. $R = 3.5$

Where  $R$  is the interface resistance in ohms.

#### Experience on Commercial CV 138 Valves.

An extensive study has been made on the rate of growth of resistive interface on samples of the CV 138. Valves were drawn from various manufacturing sources and allowed to age under similar circuit conditions. The results of a 4,000-hour test run are shown in Fig. 4. The variation between manufacturing groups is interesting, particularly as measurements of cathode silicon content of all groups were found to be of comparable magnitude. It seems, therefore, that manufacturing conditions themselves are a powerful factor influencing the rate of growth. This point has interest, as it demonstrates the possibility of processing valves in such a way that the interfaces do not become deactivated during a reasonable life span.

It should be mentioned that another batch of valves from manufacturer "A" has shown a very slow rate of interface

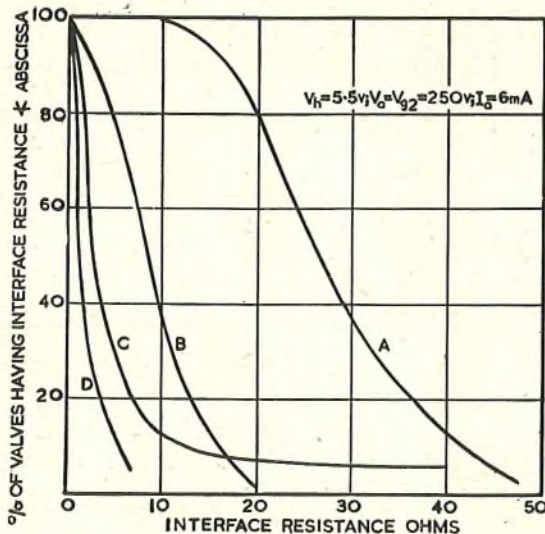

FIG. 4.—DISTRIBUTION OF INTERFACE RESISTANCE OF FOUR BATCHES OF VALVES TYPE CV138 (MADE BY DIFFERENT MANUFACTURERS) AFTER 4,000 HOURS ON LIFE-TEST RACKS.

resistance growth. This seems to indicate that the growth is due in part to a fortuitous occurrence which may happen in any valve batch and it will only be eliminated when its cause is identified and removed.

#### Method of Measurement.

The interface resistances quoted in this paper were obtained by measuring the valve gain at two suitably spaced frequencies. Details of the method were given in a recent publication.<sup>1</sup>

#### Conclusions.

Some of the factors affecting the growth of interface resistance in modern oxide-coated receiving valves have been investigated. The physical presence of the interface is accepted as inevitable in all valves employing nickel cathode sleeves which contain silicon. The resistance of the interface is thought to be due to a deactivating process and there is evidence to show that it can be controlled to some extent by the current density, the temperature of the cathode during life, and possibly by manufacturing processes.

## Book Reviews

"Transformers. Their Principles and Design for Light Electrical Engineers." F. C. Connelly, Ph.D., A.M.I.E.E., A.R.C.S., D.I.C. Pitman. 490 pp. 179 ill. 35s.

From the title the communication engineer might reasonably assume that this book contains a good deal of information on communication transformers, but, in fact, it is concerned with these only in so far as they are used in broadcast and television receivers. In this application, the precision required is substantially less than that necessary for line communication with its multiplicity of amplifiers and frequency-changing equipment. Most of the book is concerned with basic transformer theory and the design of power-frequency transformers, largely with an eye on the broadcast receiver. Radio- and carrier-frequency transformers (other than line scanning units), pulse transformers and other wide-band applications are not considered.

In the field of small power transformers of all types, the book contains a great deal of useful practical information and "know-how," the prime concern being with transformers as such rather than with magnetic materials used in the cores. There are substantially no performance or design data at frequencies other than power frequencies, although such data, for audio-frequencies at least, might reasonably have been expected in a work of this magnitude. The treatment of available magnetic materials is rather sketchy and the data given are full of inconsistencies, such as are so commonly found in publications on this subject. As an example, Fig. 158 gives harmonic distortion curves for Mumetal (sometimes written with a hyphen) and Permalloy C. Now, when these curves were taken—the reference is dated 1938—the two alloys were different in that Mumetal contained no molybdenum and had a resistivity of only 42 microhm-cms against 60 for Permalloy C; to-day they are almost indistinguishable when properly processed. Again, Table XV gives almost identical compositions for the two alloys, with losses in the ratio of 2 : 1 at 50 c/s. Incidentally, there are several references to the "recently introduced" nickel irons; since these have been in use in telephone transmission equipment for about 25 years, this serves to underline the differences in the two fields of application.

The equivalent circuit of the transformer is developed in easy stages to a point which is adequate for power frequencies, but which will hardly satisfy the more exacting requirements of the communication engineer. From the point of view of the student, the author has been none too careful in the matter of nomenclature, e.g. in references to inductances and capacitances as physical objects and, more seriously, in the use of the

deprecated term "frequency distortion" for "attenuation distortion" (vide B.S. 204).

On the subject of small transformers and especially in their applications to communications, there is a vast amount which can be written, so perhaps it is natural that the shortcomings of this book should obtrude and detract from the merit of the subject matter generally. A great deal of information is assembled under one cover for the first time and, even if much has been omitted, there is still a great deal which is very useful. In your reviewer's opinion, it would have been better to have confined this volume to small power transformers and left a more comprehensive treatment of communication transformers to a companion volume.

R. J. H.

"Plastics Progress." Published by Iliffe for "British Plastics." 310 pp. 50s.

This book contains the papers presented and the discussions at the British Plastics Convention, 1951.

The reviewer was unfortunately prevented from attending the convention, and this volume makes clear how much he missed. It is a record of the progress of the British Plastics Industry, and the papers reveal the breadth of the field now covered. The emphasis throughout is practical, and many problems of interest to the telephone engineer are discussed. To pick out a few of the papers: Some Aspects of Solid Polymers of Ethylene (Swallow); Principles of Formulation of P.V.C. Compounds (Jones); Terylene (Renfrew); Fundamentals and Applications of Adhesives (de Bruyne); and Plastics in Electrical Engineering for the Automobile Industry (Tomkins). There are also sections on Plastics in Surgery and Medicine, Packaging and Architecture.

"Plastics Progress" should interest everyone who wishes to keep himself abreast of progress in this field; it is easy reading and each paper is short enough to be digested in one session. Its importance, however, lies in the amount of information, from unimpeachable sources, which it makes available to chemists and engineers. To the reviewer it is especially pleasing since several of the papers are by the actual pioneers of the field, some of whose work he was privileged to see in its early stages some 15 years ago. How far we have come since then!

The only point found to criticise is the failure, on the part of the author and those discussing the matter, to point out that acrylic lights introduce a fire hazard—perhaps this is so obvious that it needs no reference.

The book is well produced and illustrated; it is recommended to all those interested in plastics.

C. E. R.

# Electronic Equipment for Signalling System A.C. No. 1

J. R. TILLMAN, Ph.D., A.R.C.S.†

## Part 2—The Oscillator No. 26

U.D.C. 621.396.615: 621.394.441

For 2 V.F. signalling and 4 V.F. keyending systems tone supplies are required to be constant in frequency within a small tolerance; the existing machine installations working from A.C. mains frequently cannot meet this condition because of mains frequency variations. A new oscillator has, therefore, been designed to provide the required frequencies (one per oscillator) to within  $\pm 0.3$  per cent. of their nominal values.

### Introduction.

**D**URING the past five years, or more, the frequency of the A.C. mains supply has been, for very many periods of several hours, largely outside the limits 49 and 51 c/s; moreover, the prospects of the frequency becoming continuously closely controlled are not yet bright. The machine installations supplying tones for the 2 V.F. trunk line signalling system (now known as Signalling System A.C. No. 1) and for the 4 V.F. keyending system are not, therefore, able to work as intended, i.e. with the synchronous A.C. machines supplying the tones (each at a multiple of the mains frequency) for very nearly all the time. The standby machine at each installation is driven by D.C. from the exchange battery and is governor-controlled; it is provided for use only when the A.C. machine is being serviced or for the occasion, originally very rare, when the mains frequency departs from its nominal by more than about 1 per cent. The governor-controlled machines are not intended for prolonged use; although they stood that use better than might have been expected during the winter of 1947, following on many periods of continuous use during the war, the danger of serious interruption of useful tone supplies was never sufficiently remote.

Valve oscillators (one for each frequency) offered a solution to the problem of securing greater constancy of frequency of the tones; they were accordingly designed and have already replaced the mains-driven machines at some 2 V.F. centres. Some early models were known as the Oscillator No. 25; the model now being produced has one or two refinements added, is known as the Oscillator No. 26, and is now described.

### Requirements.

The oscillators and their power supplies must be accommodated on the racks on which the generators are at present mounted and be capable of working as far as possible with the existing changeover and alarm arrangements. The oscillator must work satisfactorily in the face of all likely variations of frequency and voltage of the A.C. mains, from which it must be energised by means of a power unit.

The frequencies to be supplied are 500 c/s, 600 c/s, 750 c/s and 900 c/s, and each should be maintained within 0.3 per cent. of its nominal value. The output at each frequency must be 20V  $\pm 1$ V R.M.S. at all loadings between 0 and 4W.

The oscillators supplying 600 c/s and 750 c/s are required at all 2 V.F. centres; in addition, that supplying 900 c/s is required for testing purposes at most. All four frequencies are required only for the 4 V.F. keyending system.

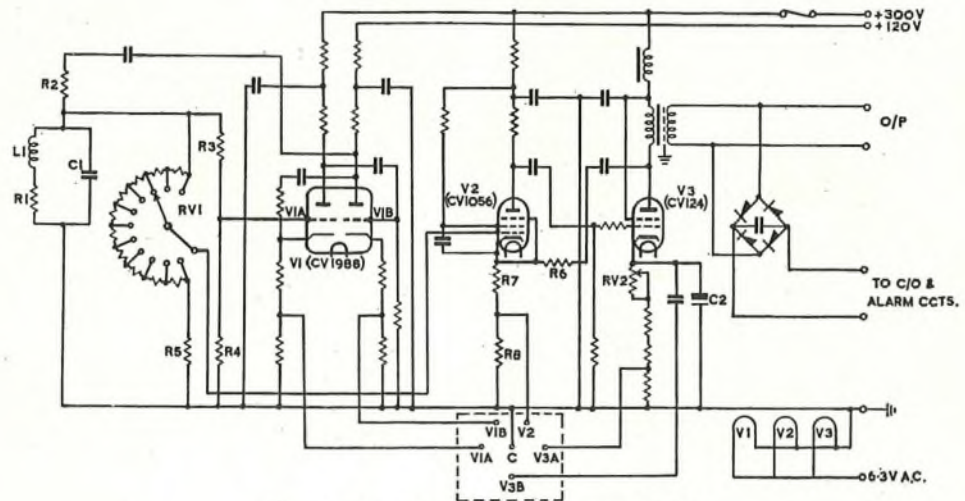

FIG. 1.—THE CIRCUIT OF OSCILLATOR NO. 26.

### CIRCUIT DESCRIPTION AND COMPONENT DETAILS

The equipment consists of a power unit which can feed up to four oscillators and two, three or four oscillators. The power unit is largely conventional; it supplies up to 8A at 6.3V A.C., up to 350 mA at 300V D.C. and up to 20 mA at the running voltage (115-123 V) of a stabiliser type CV 1731. Its performance, and hence that of the oscillators, is sufficiently independent of changes of 10 per cent. in the mains frequency.

### The Oscillators.

Each oscillator consists of an oscillatory circuit and a power, or output, amplifier (see Fig. 1).

The oscillatory circuit has been dealt with theoretically elsewhere.<sup>1</sup> It consists of a simple two-stage amplifier, using one double triode (CV 1988) with negative feedback stabilising its gain, and a regenerative coupling from output to input incorporating the discriminating or frequency-determining elements. The stabilised high-tension supply feeds the anode circuit of the second stage, that of V1B, and determines the peak-to-peak magnitude of the waveform appearing at the anode of V1B. The waveform is far from sinusoidal for V1B is the amplitude limiter of the oscillator; the waveform derived from it appearing across the resonant circuit is not only much more nearly sinusoidal (the harmonic content being less than 1 per cent.), but is equally stabilised in magnitude (being about 10V R.M.S.).

The resonant circuit consists of the inductor L1, which has the same value irrespective of the frequency required, and the capacitor C1, whose value is chosen for the frequency required. L1 is wound on a toroidal dust-core and has a temperature coefficient of from 100-200 parts per 10<sup>6</sup> °C. C1 is made of silvered mica plates and is unlikely to have a

† Principal Scientific Officer, Research Station.

<sup>1</sup> J. R. Tillman. "Valve Oscillator." *Wireless Engr.*, Vol. 24, p. 357 (1947).

temperature coefficient outside the limits  $\pm 100$  parts per  $10^6$  °C. Hence, the temperature coefficient of the resonant frequency should be from about zero to  $150/10^6$  °C. The circuit is degraded by resistor R1 to give specific overall magnifications ( $Q$ 's), 35 for 500 c/s, but 50 for 900 c/s.

The voltage gain from the grid of valve V1A to the anode of V1B is about 6. Resistor R2 in the positive feedback path—the only other component whose value depends on the frequency required—and the fixed potential divider R3-R4, reduce the loop gain to little more than unity. The relatively high level of signal across the resonant circuit is taken, only slightly attenuated by the variable potential divider RV1-R5, to feed the output amplifier. RV1 is the control of output level; it is necessary principally to enable compensation to be made for changes in the level of signal across the resonant circuit accompanying changes in the value of the stabilised high-tension supply with ageing of the neon stabiliser in the power unit.

The output amplifier, consisting of the circuits of V2 and V3, is of conventional design. About 27 db. of voltage negative feedback, provided by R6-R7-R8, ensures both a good measure of stability of gain and the low output impedance essential to meet the regulation requirement.

#### Test and Alarm Facilities.

A voltmeter (0-1.5V D.C.) is provided on the power unit to enable cathode currents in all valves of the oscillator, and the voltage of both high-tension supplies, to be measured. The variable resistor RV2 is provided in the cathode circuit of V3 to permit adjustment of the cathode current of V3 to 75 mA, as indicated by half-scale deflection of the meter when connected to V3A of the test panel. When the adjustment can no longer be made, a new valve is required.

There is already a voltmeter (0-25V A.C.) provided on the rack taking the new units, for measuring voltages at audio frequencies. It will now have the additional use of checking the voltage of the mains supply and of testing the electrolytic capacitor C2. If C2 fails in the usual way, by becoming open-circuited, an alternating voltage of about 8V will appear at the test socket V3B.

A full-wave rectifier, bridged across the output of each oscillator, feeds a relay, the contacts of which are incorporated in the changeover and alarm circuits. The D.C. governor-controlled machine will continue to be the standby generator, at least for the time being.

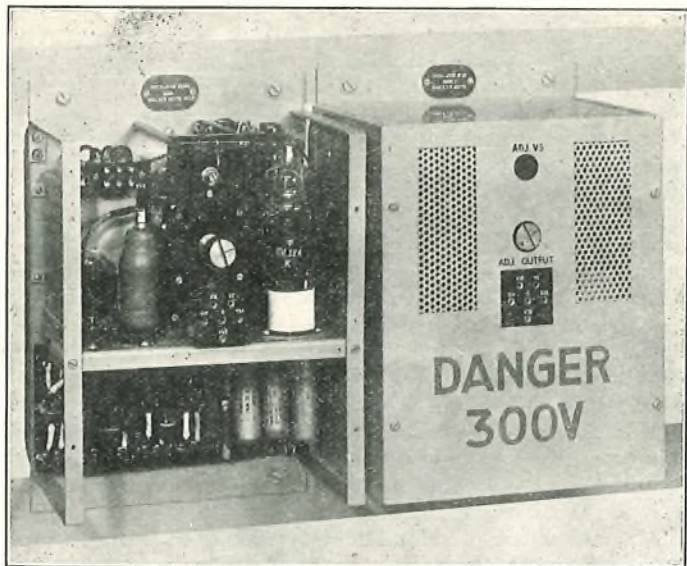

FIG. 2.—OSCILLATORS No. 26.

#### Mounting.

Fig. 2 shows two Oscillators No. 26, one with its cover removed, as they appear when mounted on the present equipment rack. Economic reasons made separate mounting of each oscillator preferable to a combined mounting. The components L1 and C1 which so largely determine the frequency of oscillation are sealed in a can.

#### PERFORMANCE

Fig. 3 shows typical curves obtained from prototype

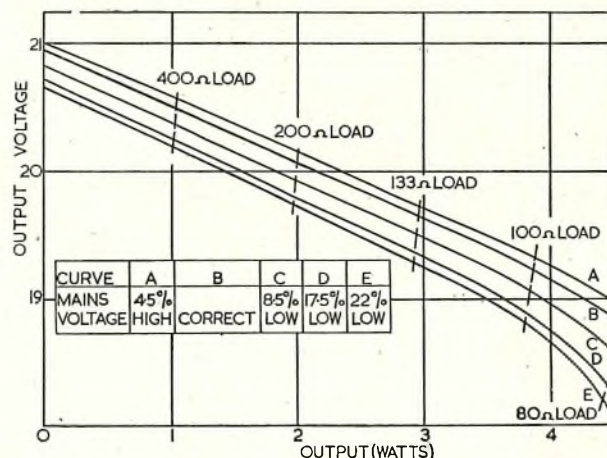

FIG. 3.—REGULATION AND STABILISATION OF OUTPUT OF OSCILLATOR No. 26.

oscillators of the variation of output voltage with load and with supply voltage. The voltage of the mains supply rarely falls more than 15 per cent.

The harmonic content is less than 1 per cent. for all loadings up to 4W when the voltage of the mains supply is normal and less than 4 per cent. when the supply voltage drops 15 per cent. (The present machine installation has a harmonic content often exceeding 10 per cent.) The outputs also contain a component at 100 c/s, 40 db. or more below the main signal. There is less than 0.02 per cent. leak from one oscillator to another.

When the ventilation was reduced considerably below that expected in service, the measured ultimate temperature rise of L1 and C1 due to self-heat of an oscillator was 20°C, reached within an hour of energisation. The temperature coefficient of frequency was only  $20/10^6$  °C. A much larger coefficient could be tolerated before expected changes of ambient temperatures would cause frequency shifts approaching  $\pm 0.15$  per cent. Most of the remaining tolerance on the frequency generated is needed to cater for the change of inductance, calculable from the hysteresis factor of L1, accompanying changes of the signal voltage across L1; this voltage, being proportional to the stabilised high-tension supply, can vary by  $\pm 3\frac{1}{2}$  per cent.

#### CONCLUSIONS

The oscillators perform better than the machines, particularly in present-day conditions. Because they contain valves, routine maintenance will be necessary; it should, however, be very simple and more than offset by the elimination of the attention—often very frequent—which now has to be paid to the machine installation because of uncertainty of the supply frequency.

Acknowledgment is made to Mr. J. H. P. Draper, who much accelerated the work by his assistance in making and testing prototype models.

# Trials in Connection with Laying Rigid Repeaters in Deep Water

U.D.C. 621.315.285: 621.395.645

IN February, 1951, H.M.T.S. *Monarch* carried out trials in connection with laying polythene-insulated cable with two Telcon MK1 repeaters in the cable line 14 miles apart. Each repeater weighed 12 cwt. in air and was of the rigid type, as indicated in the accompanying illustrations. The experiment took place in the Bay of Biscay in a depth of 2,700 fathoms, the cable and repeaters being laid over the ship's after gear.

The weather and sea conditions were far from ideal and the work had to be suspended for varying periods during gales. After laying out the length of cable, it was the intention to bottom-buoy the end but, when transferring the cable from the stern sheave to the bows, a new cable stopper parted and the cable end was lost. Grappling then commenced and the cable was hooked and hove to the surface with a strain of 280 cwt. on the grappling rope when the bight of cable was at the bows. The cable was cut and picking up towards Repeater No. 2 was commenced, but only the depth of water was picked up and the cable was found to have parted at a kink.

close to the No. 2 Repeater where the cable had parted at a kink. The weather conditions during this recovery were far from ideal and, by the completion of recovery, were a severe gale with accompanying rough sea.

When grappling was resumed the third drive was made on the other side of No. 2 Repeater which still had 5 miles of cable attached to it. The cable was hooked and raised to within 600 fathoms of the surface and then slipped over the grapnel and was lost. The surface-buoyed end of cable, which was on the 7-mile length attached to No. 1 Repeater, was next recovered, but only the depth of water was picked up to where the cable had parted at a kink. Further drives were made and the remaining section attached to No. 1 Repeater was hooked and brought to the surface. After cutting, the side leading to the repeater was swivelled to clear the turns and the other short side abandoned. Picking up was then commenced towards the repeater and it was successfully recovered, but was found to be leaking owing to faulty welding. Further drives were then made for No. 2 Repeater, but without success.

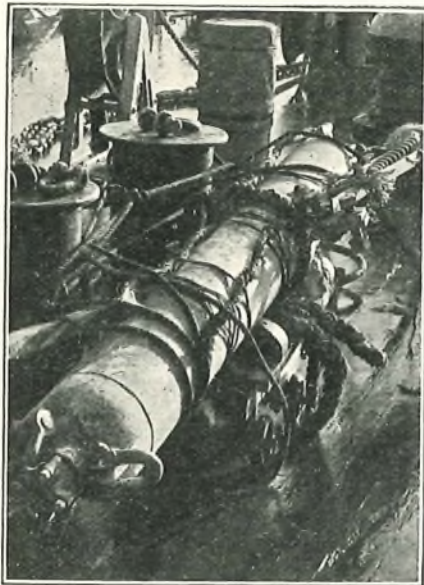

THE RECOVERED REPEATER.



TAKING TURNS OFF AFTER CABLE DRUM TO PASS THE REPEATER AFT.



THE REPEATER AT THE STERN SHEAVE.

The next drive for the cable was made halfway along the 14-mile section of the cable between the repeaters, using a Lucas cutting grapnel. The cable was hooked and hove to the surface, but, although the bolts in the Lucas had sheared, the cable was not cut and the bight was brought to the surface. The strain with cable at the bows was rising to 300 cwt. in the swell. The cable was cut and the No. 1 Repeater side was surface-buoyed and picking up towards No. 2 Repeater was commenced. The cable coiled satisfactorily and 7.243 nautical miles were recovered to an end

The conclusion arrived at as a result of these experiments is that it is a practical proposition to lay and raise rigid repeaters in these ocean depths, but further detailed research into the matter must be made. To this end an overhead rail transporter has now been installed in "Monarch" which will greatly facilitate the handling of the repeaters in getting them overboard. Further, the use of opposite-lay double armoured cable will doubtless solve many of the troubles through avoiding kinks near the repeaters or elsewhere in the line.

J. P. F. B.

## Notes and Comments

The Board of Editors has learnt with great pleasure of the honour recently conferred upon the following member of the Engineering Department:—

London Telecomms. Region .. Kimber, G. S. .. Technician IIA .. L/Cpl., Mentioned in  
Royal Engineers Despatches

### Retirement of Mr. A. Morris, A.R.C.S., D.I.C., Wh.Ex., M.I.E.E.

Mr. A. Morris, Staff Engineer, Local Lines and Wire Broadcasting Branch, retired on the 21st December after a service in the Department of unusually wide scope.

Commencing his engineering career as an apprentice in Portsmouth Dockyard, he gained a Whitworth Exhibition and a Royal Scholarship, the latter enabling him to study at the Imperial College of Science and Technology for three years.

Mr. Morris entered the Post Office Engineering Department in 1913, by open competition, as Assistant Engineer (old style), and, after a preliminary period in the Lines Branch, he joined the Research Branch, where for some 16 years his work was largely concerned with developing techniques in connection with cable balancing, loading and repeater, in which sphere he became a recognised authority.

In 1929 Mr. Morris was transferred to the Radio Branch, where as Assistant Staff Engineer he was actively concerned in the matter of radio interference and guided all the then pioneer work which has led to the recent regulations on this subject. During this period he was Technical Secretary to the I.E.E. Interference Committee.

Mr. Morris started the provincial part of his career in 1935 and, after short periods in Bristol and Leeds, became Superintending Engineer, Manchester, of the old South Lancs District in 1936.

In 1939 Mr. Morris became Chief Regional Engineer of the London Region and it was undoubtedly due to his wide experience and organising powers that London Region, in its telecommunication services, surmounted the difficulties to which the war conditions gave rise.

Mr. Morris, was in 1948 charged to take control of a new Branch formed at Headquarters, the Local Lines and Wire Broadcasting Branch, and here his work has been of great service to the Department. He has blazed a trail which will have results long after his departure.

Mr. Morris's career has been characterised by an ever zealous interest in the advancement of the telecommunication service and an abhorrence of chicanery in all its forms; his personality—full of charm, buoyant and always cheerful—has made him friends in all spheres and his retirement will be felt as a personal loss throughout a wide field of the service.

F. E. N.

### Retirement of Mr. S. Hanford, B.Sc., M.I.E.E.

Mr. Hanford, Staff Engineer of the Test and Inspection Branch, retired on the 15th October, 1951.

From Burton Grammar School and Birmingham University, where he graduated, he entered the Department in the Test Section in 1911. He served in R.E. Signals in World War I and on return was concerned in Lines Branch with the layout of local networks. Later he worked on line transmission and repeater equipments. In 1928 he went to Canterbury for two years and then returned to the Research Branch, taking over the Cable Test Section. This section, with Mr. Hanford, was transferred to the Test Branch in 1934. In 1937 he became Assistant Staff Engineer and in 1946 followed Mr. Barralet as Staff Engineer.

He returned to the Army as a cable expert in 1944 and spent an arduous year in providing Army trunk circuits.

Mr. Hanford's main work has been with cables, and he has been in the forefront of all the developments and changes in telephone cables for many years. In particular, the Department's specifications and testing methods owe more to him than to any other individual.

His outstanding qualities are leadership, power of decision, and industry. *Laissez-faire* and indecision are abhorrent to him, so much so that he could be reproached at times for making decisions for others. His outlook is an intensely individual one and his point of view undistorted by any truckling to popular opinion. He is a stout fighter and his staff found him a worthy champion of the interests of I. Branch.

Not so well known perhaps is his fundamental kindness and friendliness. Those who were not misled by a somewhat stern exterior found in him reserves of sympathy and understanding. He leaves with the good wishes of his colleagues, both of the Post Office and of Contractors Organisations, and with his exceptional fitness he can be expected to enjoy a well-earned retirement.

L. G. D.

### Mr. J. Stratton, A.C.G.F.C., M.I.E.E.

John Stratton who became Staff Engineer of the Local Lines Branch in December last is one of the now diminishing number of those who trained at the old City and Guilds Technical College in Finsbury. There he gained the college diploma and afterwards assisted Dr. Eccles in his work on radio valve construction.

After four years' experience in the radio industry, he entered the Post Office through the P.A.E. open competitive examination. A short but valuable period of field experience in the old London Engineering District was followed by a long spell of 16 years in the Lines Branch (then Section) of the Engineer-in-Chief's Office. Throughout his time there he was closely associated with Mr. R. M. Chamney in the development and utilisation of the trunk line network, and in particular with the inauguration of the trunk "demand" system. Successive promotions within the Branch brought him to the rank of Assistant Staff Engineer in 1939, when he assumed control also of the Lines Branch Drawing Office, which led to his Chairmanship of the Line Plant Records Committee. During the war he was in charge of the Lines Branch contingent at Harrogate and took over also the group dealing with local line plant provision.

In 1943 Mr. Stratton transferred to the Midland Region, and there he was responsible for power and radio services as well as external plant. It was in Birmingham that his social talents found fullest expression and he became a leading and well-known figure in all the varied activities of the Region, with the annual Christmas Party as the highlight.

1950 brought a change of scene, for, in July, he was called to the L.T.R. to become Deputy Chief Regional Engineer. His stay there, though short, still gave time for him to become known and appreciated by all Branches and ranks. His genial personality and fund of anecdotes will be as much missed as his shrewd commonsense and judgment. All his many friends throughout the Post Office will wish him well in his new sphere.

J. J. E.

### **Col. D. McMillan, O.B.E., B.Sc., M.I.E.E.**

In the days when transatlantic telephony was in its infancy and conversation on an overseas radio telephone circuit was a more difficult and adventurous affair than it is now, Donald McMillan joined the Radio Section staff at the Radio Terminal. He had entered the Department as Inspector in May, 1925, and had served a probationary period in the Engineer-in-Chief's Office and a District. His association with the Research Branch started in 1931, when he came to Dollis Hill, having succeeded in the Assistant Engineer competition; he was promoted to Executive Engineer in 1937.

This long and valued association with the Local Transmission and Electro-Acoustics Section of R. Branch was punctuated by military service during the war. He had joined the Territorial Army (Signals) in 1938 and was 2nd Lieut. when mobilised in August, 1939. He went overseas as Captain in June, 1940, and returned as Colonel in August, 1945, for demobilisation, having been twice mentioned in despatches and awarded the O.B.E.—a truly meteoric career which gives insight to his technical and administrative ability and the quiet force of his personality. On his return he became Assistant Staff Engineer in charge of the Section in 1946.

Col. McMillan's contributions to technical literature, especially on telephone receivers, microphones and loud-speakers, are well known; his contributions to the work of several committees have been most valuable, notably the 4th C.E. of the C.C.I.F., Acoustics committees of the B.S.I. and the Electro-Acoustics committee of the Medical Research Council. He takes with him our very sincere good wishes in his new appointment to I. Branch. W. W.

### **Mr. R. E. Jones, M.B.E., M.Sc.(Eng.), D.I.C., M.I.E.E.**

Mr. R. E. Jones has had a career in which main line transmission matters have figured largely, and in his promotion to Staff Engineer of the Exchange Equipment and Accommodation Branch he retains this interest whilst adding other interests covering switching and operating equipment.

Mr. Jones graduated from London University in 1926 and joined the International Standard Electric Corporation, where he was engaged in the planning, provision and testing of main underground cable systems in various European countries. In 1933 he joined the Post Office Research Branch by special selection as Assistant Engineer (old style) and was there engaged primarily in the development of audio-frequency transmission equipment.

Promoted to Executive Engineer in 1938, he added to purely Post Office problems, co-operation with the S.R.D.E. in the development of transmission equipment for Army Signals. In 1940 he co-operated with the War Group in emergency measures for the maintenance of communications to the Armed Forces in Europe until the collapse of France.

In 1941 Mr. Jones was transferred to the L.T.R. as Area Engineer, West Area, on maintenance, but in 1942 he was specially mobilised with Army Signals (with the rank of Major) in connection with the landing in North Africa. He served in North Africa, Italy and Austria until he returned to the Post Office in 1946 with the rank of Lieutenant-Colonel, having also been awarded the M.B.E.

After a few months in the L.T.R. (Centre Area) he was promoted in October, 1946, to Assistant Staff Engineer, E. Branch, and for five years had charge of the provision of transmission equipment, power plants and telecommunications buildings and accommodation.

Mr. Jones brings to his new post a wide experience and a personality highly suited to the necessary co-ordination between the Post Office and its Contractors. A. J. J.

### **Dollis Hill Open Day, 1951**

On 28th September Sir Archibald Gill and Brigadier Harris welcomed a large number of distinguished people who had come to Dollis Hill by invitation to view some of the work in progress. The visitors showed a keen interest in all that was going on and, though it is not possible to describe all the exhibits, the following short notes, about a few of those which proved most attractive, indicate the kind of problems which are receiving attention to-day.

An experimental automatic letter-facing machine with its streams of letters moving at high speed was a popular item. The letters pass before a series of photo-electric cells, and, from the signals they give, are diverted, turned over or reversed until they are in orderly stacks.

Two kinds of submerged repeater were on view, shallow and deep water. The shallow water repeater is no longer quite novel, the first model having been laid in the Irish Sea in 1943. The type exhibited is similar to eight units which were inserted into two Anglo-Dutch submarine cables last year, and enables 60 telephone circuits to be obtained on each cable. The deep water repeaters are designed for working in ocean depths up to 4 miles (4 tons/sq. in.) and they incorporate an amplifier which is unaffected by any single open-circuit or short-circuit in the majority of its components, including valves.

Typical of the very simple exhibits which attracted attention was the Magnetic Memory. This showed how, by the use of some of the newer magnetic materials, information can be stored by magnetising a small core in one direction or the other.

Wide-band amplifiers in which valves are connected in parallel by low-pass filters were on show. One fed the plates of an oscilloscope and amplified short ( $0.1 \mu\text{s}$ ) rectangular pulses; the amplified pulses had a rise time of  $0.013 \mu\text{s}$  and negligible overshoot. Another had a gain constant to  $\pm 0.2 \text{ db}$ . up to above 30 Mc/s.

The design of modern aerial systems is a matter of great precision and the performance of a layout may be seriously affected by nearby buildings, masts and other aerial systems. A 1/150 scale model of a 20 Mc/s rhombic aerial was shown operating at 3,000 Mc/s. The effect of obstructions of various kinds was readily shown on the polar diagram displayed on a cathode-ray oscilloscope.

On Saturday the staff were At Home to colleagues from other branches, friends and relations. C. E. R.

### **Premiums for Technical Writing**

To encourage the writing and publication of articles reporting technical progress and development in radio and electronics in Great Britain, the Radio Industry Council has announced that from 1st January, 1952, it will award premiums of 25 guineas each, up to an average of six a year, to the writers of published articles which, in the opinion of a panel of judges, deserve to be commended by the industry. Only "non-professional" writers are eligible for these awards.

Writers and editors are invited to submit published articles (five copies if possible) to the Secretary, Radio Industry Council, 59 Russell Square, London, W.C.1, for consideration, but the judges will also consider unpublished articles.

Articles published in this Journal are eligible for the awards.

### **Journal Binding**

This issue of the Journal completes Vol. 44 and readers wishing to have the volume bound should refer to p. 192 for details of the facilities available. It is regretted that price increases have been necessary, because of the higher labour and material costs now ruling.

# Regional Notes

## Welsh and Border Counties Region

### A 491-FT. SPAN

An interesting and somewhat unusual method of providing a telephone line was recently adopted in a remote corner of Wales to provide service to a farmer in the Llanarth exchange area. It would normally have been necessary to erect a new route for a considerable distance, but to avoid excessive expenditure in materials and manpower, it was decided to utilise the Electric Power Co.'s route to the farm. This route crosses a deep and wooded ravine, the power poles on each side of which are 491 ft. apart and, at a height of 110 ft. from the

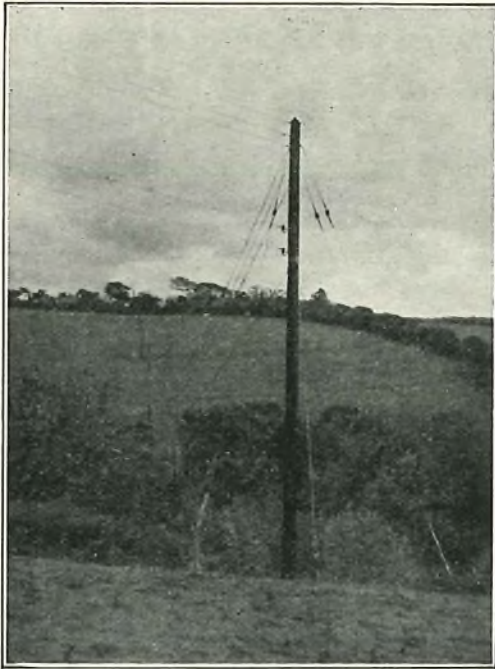

POWER ROUTE WITH TELEPHONE CABLE ATTACHED, CROSSING THE RAVINE.

centre of the ravine, carry 3/05 bare copper wires in vertical formation. As it was considered impracticable to obtain the required safety standards with the use of PBJ-covered wire, the matter was referred to the Engineer-in-Chief, who advised that 1pr/20 polythene cable should be used lashed to two 190-lb. steel wires. Fortunately, the route is in a very large field and it was possible to run out the steels on the ground and lash to them the polythene cable. The method of lashing was as follows.

The two steels were laid on the ground some 2 ft. apart with the polythene cable in the middle and then all three wires were lifted about 2 ft. from the ground and lashed together with a hand lashing machine supplied by the Engineer-in-Chief. The lashing wire utilised is Wire F.P. Plastic Insulated 1-wire/12½, and the lay of the lashing is about 7 in.

A rope had been run across the ravine and, with a snatch block on each pole, the suspension steels and cable were pulled across by hand without difficulty. The steels at one end were then terminated round the pole and regulated from the other end by a chain puller to a tension of 100 lb., when it was observed that the spacing between the lowest power wire and the Post Office wires was almost equal throughout the whole length. The separating distance on each terminating pole is 4 ft. The polythene cable is terminated on Insulators No. 16 (using a non-standard support by Spindles No. 16), whilst both power poles are earth-wired, and back-stayed against the pull of steel wires. This method of installation was carried out with the consent of the power company concerned. To guard against accident the power supply was disconnected during the erection and termination of the steels.

H. W. S.

## ROOT OBSTRUCTION IN DUCT

"Animal or Vegetable?" might be the caption accompanying this picture of a sycamore root formation found in a 4-in. duct line during rodding operations on the Haverfordwest-Fishguard duct route.

The original root stem that penetrated the collar of the duct had completed a circumference of the duct before terminating along the bore in its insatiable quest for moisture.

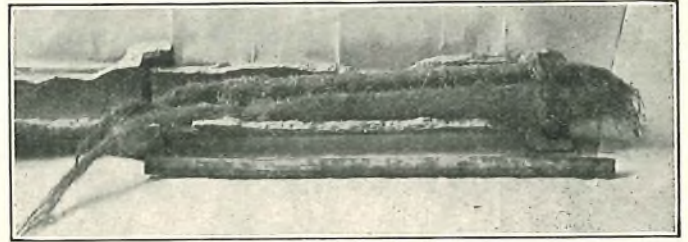

SYCAMORE ROOT IN 4-IN. DUCT.

The photograph was taken by Mr. J. Dayes, Technical Officer, Haverfordwest, who has won national repute with some of his photographic efforts.

J. S.

## GAS SOLDERING IRON FOR USE ON OVERHEAD WIRES

The arrears in renewal of overhead wires, with the continued material and manpower shortage, reached such formidable proportions that it was decided to insert 3-ft. tails of new wire at the point of wear, i.e., at the "binding-in" point. The experiment carried out in the Swansea Area proved most successful when soldered joints were used in place of twisted sleeve joints. The method of using the firepot and large soldering bit meant that two men were employed during the soldering operation and the soldering bit required constant cleaning and facing.

After some experiment a gas soldering iron has been devised which, although it appears rather heavy to use, is proving popular with the staff as a replacement for the firepot method. Calor (butane) gas blowlamps, although dangerous for use in man-holes, are very satisfactory on aerial cable works and appeared to offer some solution to the problem; eventually a "Wee Dex" blowlamp was converted to a gas soldering iron, as shown in the photograph. The underside of a copper bit has been



A GAS SOLDERING IRON.

hollowed out to fit the lamp nozzle and a "U" bolt clip holds the bit in position over the nozzle. The bit is, therefore, adjustable for high wind conditions. The flame is prevented from touching the wires by the specially shaped bit and the thin metal bridge of the "U" bolt clip prevents any molten solder from running on to the user's hand. The bit rarely requires refacing and can be kept at constant temperature during soldering operations, or the flame can be extinguished and the bit used to solder several joints at a time, dependent on



the experience of the user. The officer using the iron does not require any assistance.

One gas container lasts for about four hours constant burning, but with the intermittent use on the above-mentioned work a container lasts about four days. Refills are reasonably cheap and easy to obtain. The lamp is much easier to use than a petrol or paraffin type and the only special attention required is to avoid leakage at the valve when the lamp is not in use. This is catered for by removing the pistol grip torch from the container and screwing in its place a flat metal cap which does not operate the gas release valve in the cylinder. G. F.

### South Western Region RECOVERY OF STAYS

Owing to the shortage of "Rods Stay," it was necessary when recovering derelict plant at an aerodrome to dig out a number of stays. This work is always very arduous, partly due to the presence of the rod in the centre of the excavation; in some cases, even when the block is exposed, it cannot be lifted out without improvised leverage, owing to suction in wet soils. It was decided that a lifting bar to work between two pole jacks would be worth trying and the attached drawing shows the item which was made locally.

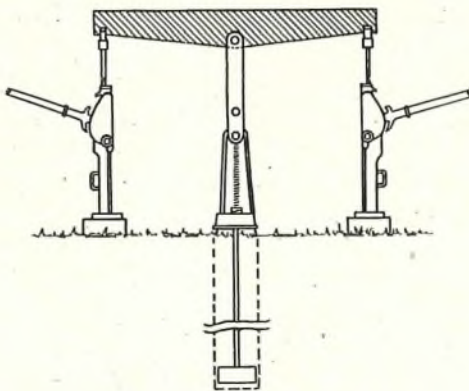

METHOD OF RECOVERING STAY RODS.

For a No. 1 stay, it is necessary to excavate from 12 to 30 in.—depending on the class of soil—and to loosen the soil with a bar or pick. The rod is then pulled or bent into a vertical position and the pole jacks set up on timber bases on either side of the hole with the lifting bar between them. The stay box is then bolted between the shackles and the jacks operated together to lift out the stay and block.

As a precaution against breaking the rod, not more than one man should operate either jack.

J. P. S. V.

### North Eastern Region

#### TELEVISION OUTSIDE BROADCASTS FROM LEEDS

The opening of the Holme Moss television transmitter on 12th October was the occasion of a number of television outside broadcasts from the North of England. Although the work of equalisation and amplification was carried out by members of the London Telecommunications Region staff, it is thought that a few remarks concerning the efforts of the staff within the North-Eastern Region may be of interest.

After much consideration it was decided that the outside broadcasts from Leeds should be made up of two main links; one to be by means of Post Office underground plant and the other by B.B.C. microwave link to Holme Moss. The obvious place to choose for mounting the microwave equipment was on the newly constructed tower of the Leeds University situated on a hill to the north-west of the centre of Leeds. The Post Office had to link the Theatre Royal and parish church to this point by means of existing plant. Ordinary 6½- and 10-lb. cable pairs were used as far as the automatic exchange, where the first amplifier was situated, and 10-lb. junction cable pairs were intercepted at the university, the site of the second amplifier. In order that the loss should be reduced to a

minimum, 1-pair polythene cables were used at the university and parish church. At the former site two 440-yard polythene cables were drawn into existing ducts and thence up the inside of the university tower. After a few minor setbacks the work was carried out by the required time and, as the outside broadcasts were conducted without hitch, all concerned were satisfied with their efforts. A. C. H.

### LAYING THE THIRD JUNCTION CABLE BETWEEN BEAL AND HOLY ISLAND

The second cable between the mainland at Beal and Holy Island, laid in 1926, has now been replaced. The first cable was laid in 1892. Preliminary survey showed:—

(1) That a new sea route of 2,230 yds. could be used in preference to the 3½-mile track of the existing cable. This new route, however, necessitated laying about 4,300 yds. of cable to link up the "sea" cable and the Holy Island U.A.X. Half of the latter cable would replace the existing overhead route.

(2) This new cable would comprise eight pairs of 40 lb. copper conductors, double-paper insulated, within a lead sheath; the sea cable to be protected by a P.V.C. sheath and that of the "land" portion by steel tape armour and a serving of tarred jute. The overall diameter of both cables to be 1 in.

(3) The sea cable would be laid in one length of 2,230 yds. and delivered on a drum, total weight of about 5½ tons. The land cable would be delivered on five drums each containing 585 yds. of cable and of a weight approximately 1½ tons.

(4) The cable would be transported to the Island by suitable lorry and laid at a depth of 18 in. along the whole of the land and sea routes.

To ensure that the whole operation would be carried out with a minimum of risk and delay, extensive enquiries and field trials were made locally. From the results of these it was clear that considerable difficulty could be anticipated in both the transport of the cable and cable-laying work at the sea crossing. These were due primarily to the condition of the "sand" along the sea route, tide and weather restrictions on working time and the limited selection of vehicles available for the work.

The outcome of this preliminary work was:—

- (a) In place of a lorry for transport of cable, a combination of cable drum trailer and Chevrolet F.W.D. tractor, or 4-ton vehicle could be used;
- (b) the cable could be laid along the route at a depth of 18 in. by use of the tractor and mole plough;
- (c) the sea-cable laying work and transport of cable should be done during the spring tides when "low tide" was at 9.0 a.m., during early summer;
- (d) a party of about 18 men would be needed for the work:—
  - (i) Six men for "laying out" cable.
  - (ii) Six men for mole-plough work.
  - (iii) Two men for marking out route and preparing records ahead for mole-plough party.
  - (iv) Four men for testing and jointing cable as it was laid.

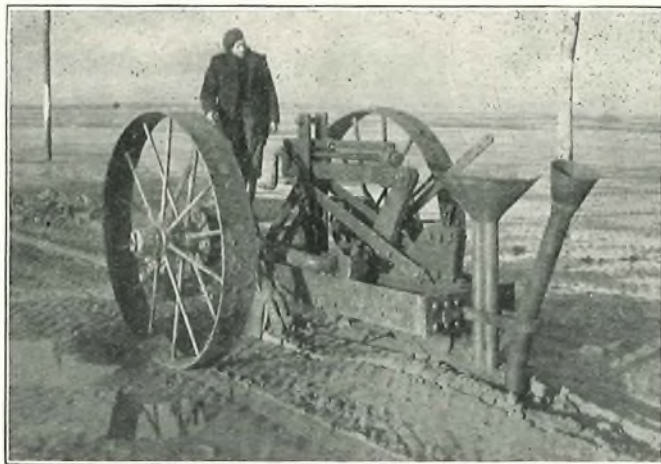

THE MOLE-PLOUGH.

The rate at which the cable could be laid would be:—

- (i) 2,000 yds. of sea cable in four hours, and,
- (ii) 4,000 yds. of land cable in two days.

After special arrangements had been made for the delivery of the cable, it was air-pressure tested on receipt at Beal railway station. On the 23rd April, 1951, the work of laying the cable was started after the men had been divided into their respective parties and given detailed instructions on how the cable had to be laid. The land sections were laid first and, as anticipated, the work was completed the next day. Some difficulty was experienced in the delivery of the sea cable and it was not until the fifth day that this work was started and completed. The tide conditions were satisfactory, but heavy hail and sleet



CABLE LAYING IN PROGRESS ON THE "SEA" SECTION.

showers were experienced during this work. The cable conductor insulation and continuity were checked during all phases of the operation.

Though the work was done in the anticipated time, considerable difficulties had to be overcome; its success is attributable to the enthusiasm and good teamwork of the staff concerned and the use of modern appliances. The second cable was laid by 30 men in five weeks, horse-drawn carts being used for transporting the cable and a plough for burying it along the 3½-mile sea crossing route.

J. Q.

### London Telecommunications Region

#### INSULATION OF MISCELLANEOUS ITEMS IN POLY-VINYL-CHLORIDE

In almost every telephone exchange power room in the L.T.R., the emergency switchboard tools, mainly single-ended spanners, require renewal of insulation, but replacements are not at present obtainable from the Supplies Department, although it is understood that P.V.C. insulated items will be available later. Although enquiries were made regarding the possibility of having the items re-insulated by outside firms, little satisfaction was obtained.

Consideration was therefore given to the possibility of insulating in P.V.C. by Power Section staff, and it was found that the work could be carried out quite cheaply and effectively, requiring only a baking oven fitted with a thermometer. The "dipping" technique has been adopted and is carried out in four stages:—

- (1) heating to 160°—175°C,
- (2) suspending in P.V.C. "paste" for 45 sec.,
- (3) storing for 15 min. at 160°—175°C,
- (4) placing on rack or in cold water to cool off.

The paste consists of P.V.C. resin, finely ground, forming an emulsion with a liquid plasticiser such as tricresyl phosphate. The ratio of resin to plasticiser determines not only the viscosity of the paste (which increases with increase of resin content), but also the hardness of the resulting insulation. The paste is supplied in its natural whitish colour, but pigment, normally black, is easily mixed in if required.

The highest viscosity of the paste compatible with good dipping is obtained with a mixture of about 1 : 1, and this

mixture is used for the spanners. The finished coating is relatively soft, but tough, with rubber-like properties.

A harder coating may be obtained by treatment with a solvent to dissolve off some of the plasticiser and this method has been found satisfactory and is used in coating jumper rings which are in short supply at present. Alternatively, the mixture may be thinned with white spirit before dipping, but this requires an oven in which there is no risk of explosion due to the presence of white spirit vapour, and for this reason has not been used.

The cost of P.V.C. paste in small quantities is about 3s. 0d. per lb. and 1 lb. will coat about 60 small spanners; a typical quotation for coating in P.V.C. would be 8d. each. Some hundreds of spanners have now been treated and the work is proceeding as quickly as possible, although supplies of P.V.C. are rather difficult to obtain.

R. M. H.

### North Western Region

#### TELEVISION FROM THE NORTH

The inaugural ceremony for the opening of the B.B.C. Holme Moss television transmitter was held in the Town Hall, Manchester. The proceedings were televised using an outside broadcast link routed from the Town Hall via Central exchange to Telephone House. Local cables were used and the links equalised to 3 Mc/s, amplifier equipment being inserted by the London Telecommunications Region, Television Group.

As part of the series of broadcasts associated with the opening, two programmes were televised from Blackpool. The events televised included the Tower Circus, a show from the Miners' Home, Bispham, and a tour of the Blackpool illuminations. The Department's task was to provide physical links between the outside broadcast points and the microwave transmitter on the Tower, 385 ft. above sea level. The links between Bispham and the B.B.C. control room at the 85 ft. level of the Tower were provided over three miles of ordinary cables of various gauges connected via two exchanges, Blackpool Central and North Shore, where amplifiers were installed. To cover the remaining 300 ft. up the Tower, it was necessary to run a P.C.T.D.A. 10/10 cable which was clipped to one leg of the Tower structure. From the 385 ft. level the signals were transmitted, via the B.B.C. microwave link and an intermediate mobile repeater on the moors 30 miles from Blackpool, to the microwave receiver on Ship Canal House, Manchester, and thence by a repeated section of local cable to Telephone House.

The success of the initial transmissions from Holme Moss has given great satisfaction to the Post Office staff concerned with providing the link from Birmingham to the site. Between Manchester and Birmingham the cable contains six 0.375 coaxial tubes plus 32 interstice pairs and 344 20-lb. audio pairs. Two of the coaxial tubes are used for television purposes and the remainder of the cable to augment the public network. Beyond Manchester the cable follows the Sheffield track and a cable containing six 0.375 coaxial tubes plus 180 audio pairs is provided to the junction with Holme Moss. From this point to the site—the only section provided solely for television purposes—the cable comprises two 0.375 tubes plus four screened pairs 40 lb. and 48 audio pairs.

The comprehensive scheme involved the recovery of the Birmingham-Manchester No. 1 cable to free a ductway for the new cable so expediting the cable provision. As an old track was involved, a certain amount of reconstruction work was necessary in order to provide suitable jointing facilities and ready access for maintenance purposes. In this connection, 120 jointing manholes were built in this Region. Approximately 11.5 miles of duct were laid on the Holme Moss side, most of which was provided during the winter months on high ground. Fortunately the winter was not unduly severe and the duct contractors carried on the work with a break of only 14 days.

Eight buildings were erected in this Region for intermediate repeater stations during a period when the building material supply position was somewhat difficult, particularly in respect of cement.

Installation of the line amplifiers was effected by the Area

staff, and Regional Office staff co-operated in the final alignment of the link. Newly designed equipment was brought into service and teething troubles necessitated realignment on several occasions. The final tests over the link have elicited favourable comment from the Engineering Department and the B.B.C. N. W.

### Home Counties Region

#### THE BRIGHTON RE-NUMBERING SCHEME

The Brighton dial had, until the completion of this scheme, the effect of limiting the multiple capacity of each exchange within the linked numbering scheme to 10,000. This was insufficient for Brighton and Hove exchanges and the re-numbering scheme was accompanied by the replacement of the Brighton dial by the standard Post Office dial. The dialling codes which preceded all exchange numbers are shown in Table 1, which also shows how much greater flexibility and availability resulted by making Rottingdean and Southwick independent exchanges and making use of all the levels for the two combined exchanges, Brighton and Hove.

The change was made in February, 1950, most of the changes being advised to subscribers by letter since, in general, they consisted of prefixing the existing four-figure number by the code digit. The new directory issue coincided with the change and the few radical changes were dealt with by means of portable Changed Number equipment.

The changes made at Southwick and Rottingdean were similar. Levels were teed to all exchanges to allow dual access to old and new numbers and to permit discrimination on both levels prior to the transfer. 2nd selectors were introduced at Southwick and Rottingdean. Final transfer involved a few circuit changes, the transfer at Southwick and Rottingdean from discriminating equipment to 1st selectors, and some junction re-routing.

TABLE 1  
Effect of Dial Change

Exchange and linked numbering scheme before transfer	Exchange lines at		20-year forecast 1970	After transfer dialling codes
	12.11.27	13.2.50		
Brighton .. Main auto—dialling code 2	3337	7561	14300	As before but exchanges combined and called "Brighton"—code dialling Rottingdean 82 Southwick 83
Preston .. Satellite on Brighton—dialling code 5	727	5058	9833	
Hove .. Main auto—dialling code 3	2916	8051	15062	As before but exchanges combined and called "Hove"—code dialling as for Brighton
Portslade .. Satellite on Hove—dialling code 4	274	2036	3087	
Rottingdean .. Satellite on Brighton—dialling code 6	98	1055	2386	Independent N.D. auto exchange outside the linked numbering scheme. Code dialling to Brighton (including Preston) } 8 Hove (including Portslade) } Southwick } 883
Southwick .. Satellite on Hove—dialling code 7	*	804	1750	

\* Transferred—December, 1927

Two hundred men were employed in 20 groups for the dial modifications and were controlled by four officers who circulated envelopes containing schedules of the subscribers on each distribution point in the area and labels and dial number rings for all numbers.

The scheme was in two parts. The first part consisted of the compilation of records, setting up the organisation, briefing the staff and finally issuing the first work envelopes so that workmen could start operations immediately on the transfer date. The subscribers were classified to give priority to kiosks, subscribers' coin-collecting box installations, important subscribers, large Private Branch Exchanges and blocks of flats. A special self-feed numbering machine was used for numbering the labels.

The second part of the operation comprised the changing of labels, starting immediately the circuit changes had been

carried out. Special arrangements were made for dealing with subscribers when access could not be obtained.

After 10 days only 400 remained to be dealt with out of the 37,000 telephones in the six exchanges, an excellent example of teamwork. R. G.

### BRISTOL-SLOUGH COAXIAL CABLE

Following the decision to provide this cable, operations on an unusual scale have been carried out in the Reading Telephone Area, using two different types of cable (6 Cx. pr. 0.375E + 32/20 PCQ + 344/20 PCQT and 6 Cx. pr. 0.375E + 32/20 PCQ). A total length of approximately 48 miles was concerned.

The audio conductors in a section of the first type mentioned were provided to permit the recovery of a 308-pr. aerial cable, the weight of which is responsible for the buckling of a number of the poles on the main overhead trunk route to the West. This decision has been more than justified since, as the result of pole testing in three different exchange areas along the route, a considerable number of decayed and suspect poles have been found.

Originally it was intended that four coaxial tubes should be used and manhole work was carried out accordingly. Eventually six tubes were provided and this entailed additional manholes and slewing on account of the larger bending radius of 21 in., as against 15 in. originally requested.

The project called for six new repeater station buildings, four of which were ordinary C.R.4's, one being a flood type, and the remaining two of the C.R.6 type. Building extensions were also necessary to two U.A.X.s and an existing repeater station.

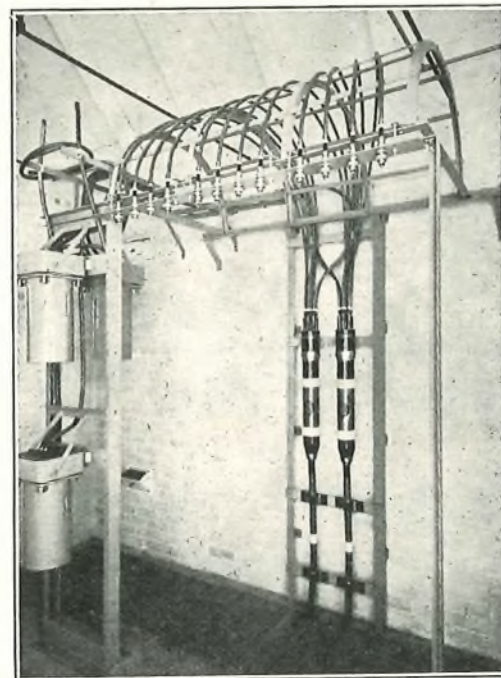

TERMINATION OF COAXIAL CABLES IN A CR4-TYPE BUILDING.

The work was considered of major importance and urgency, and it was necessary to co-ordinate carefully the activities of the cable, duct and building contractors with those of the Department's staff to ensure that the necessary general progress could be maintained. All are to be congratulated on the co-operation attained in what was at times a most difficult and awkward task. In spite of the flood conditions and appalling weather encountered, together with the unavoidable delay in obtaining access to the repeater stations, the duct and cabling work occupied a period of only nine months and was completed to schedule. F. G.

### CORRECTION

On page 139 of the October 1951 issue the caption to the illustration of a U.A.X. building should read, "Building for Orsett U.A.X. 13X."

# Institution of Post Office Electrical Engineers

## Annual Awards for Junior Section Papers—Session 1950/51

The Judging Committee has selected the following from the papers submitted by the Local Centre Committees, and awards of £3 3s. 0d. and Institution Certificates have been made accordingly.

Author	Junior Centre	Title of Paper
B. V. Northall	Darlington	"Television"
S. A. R. Packer	Bath	"Cathode Ray Oscillography"
J. B. Bedford	Lincoln	"The Television Receiver"
N. A. Branagh and S. J. Lemon	* Belfast	"Science and the Snapshot"

\* Award shared

The Council is indebted to Messrs. H. G. Davis, W. Stretch, W. H. Diack and H. Cheetham for kindly undertaking the adjudication of the papers forwarded for consideration.

H. E. WILCOCKSON,  
*Secretary.*

### London Centre

Following is the second half of the programme of meetings of the London Centre:—

#### Ordinary Meetings

Held at the Institution of Electrical Engineers, Savoy Place, W.C.2, commencing at 5.0 p.m.

Tuesday, 15th January.—"New Aids to the Maintenance Testing of Telephone Exchange Equipment," W. J. Marshall, A.M.I.E.E.

Tuesday, 12th February.—"Some Applications of Cold Cathode Tubes in Switching Circuits," J. A. Lawrence, A.M.I.E.E.

Tuesday, 11th March.—"The Control of External Major Works," E. A. Scholey, B.Sc.

Tuesday, 8th April.—"A.C. Signalling—A Review of Current Problems," B. R. Horsfield, A.M.I.E.E., and D. C. Smith, B.Sc., A.M.I.E.E.

Tuesday, 6th May.—"A General Introduction to Communication Theory," J. E. Flood, Ph.D., L. R. F. Harris, B.A., and A. D. V. Ridlington, M.A.

This meeting will be preceded by the Annual General Meeting of the Institution.

### Informal Meetings

Held in the Conference Room, 4th Floor, Waterloo Bridge House, S.E.1, commencing at 5.0 p.m.

Wednesday, 30th January.—"Cabinets and Pillars—The Experience of Five Years," J. P. Harding, B.Sc., A.M.I.C.E., A.M.I.E.E., and F. C. Streeton, B.Sc.

Wednesday, 27th February.—"Television Interference," J. S. Hizey and J. R. Turner.

Wednesday, 26th March.—"The Provincial Exchange Area—Some Aspects of its Design and Development," R. Thornton.

Wednesday, 23rd April.—"Explosives for Increased Production," L. W. Barratt, A.M.I.E.E., and S. T. Stevens.

In addition to the above meetings, an interesting programme of educational visits has been arranged, catering for over 1,000 man-visits. The number of applicants was approximately 200 in excess of the aforementioned figure, and those members who fail to receive an invitation to attend a visit during the course of the Session should take it that, under the method of selection adopted, they have been unsuccessful.

W. H. F.

### Additions to the Library

2021 *Testing Electrical Installations and Machines.* E. Molloy (Ed.), (Brit. 1947).

Describes clearly and simply the modern methods employed when testing various kinds of commercial electrical installations as distinct from laboratory test work.

2022 *Frequency Modulation Engineering.* C. E. Tibbs (Brit. 1947).

The approach here is that of the practical engineer and the book is a well-systematised treatment of the subject based directly on the standard published literature.

2023 *Sound.* F. G. Mee (Brit. 1950).

Covers the requirements of Advanced and Scholarship papers in the General Certificate Exam., and of the syllabus of most University Degree Courses.

1689 *Radio Technology.* B. F. Weller (Brit. 1951).

A new edition incorporating a lengthened chapter on Aerials and Radiation, and a new chapter on U.H.F. Technique.

W. D. FLORENCE, *Librarian.*

## Junior Section Notes

### Lincoln Centre

The 1951/52 Session was opened at Lincoln on 9th October with a three-way quiz in which Grantham, Grimsby and Lincoln took part. This was the first three-way quiz attempted and the first contest with Grantham, who are in the Peterborough Area of the Midland Region. Loudspeakers and microphones were provided at all three centres to enable the audiences of more than 100 people to hear the questions and answers.

The question masters introduced their teams in rotation; but after the Grantham and Grimsby introductions a previously recorded disc was played into the circuit to stage a "technical hitch" before the Lincoln team was introduced. After four rounds of questions a break of 15 minutes was made, during which refreshments were provided. A further four rounds were completed and Grimsby was then declared to be the winning team by the umpire, Mr. F. A. Smithers, Area Engineer. Mr. F. O. Watson, Telephone Manager, congratulated all teams on their performance and particularly Grimsby, the winners. The meeting was closed, for Lincoln, by the Chairman, Mr. R. Ellmore, who gave details of this session's programme and thanked all concerned in providing the excellent send-off.

R. H. E. F.

### Dundee Centre

The opening meeting of the 1951/52 session was marked by a most enlightening lecture on the "Present System of Appraisal and Promotion," by Col. C. E. Calveley, O.B.E., B.Sc., M.I.E.E., President of the Junior Section. The subject provided good opportunity for discussion and a lively question period followed.

The lecture was relayed to Montrose and Perth, and it is pleasing to note that this innovation proved beneficial in our endeavour to create an interest in our activities among the out-stationed staff.

On the 6th November, 1951, Mr. J. Knox, M.Sc., A.M.I.E.E., Area Engineer, gave a most informative talk on "Telecommunications in Greece." The lecture was illustrated by lantern slides devised by Mr. Knox, and interesting comparisons were made in relation to the system in use by the British Post Office.

The remainder of the programme for the session is as follows:—

22nd January.—"Cabinets and Pillars," by Mr. H. C. Stevenson, B.Sc., A.M.I.E.E.

19th February.—Visit to Carolina Port Power Station.

6th March.—"Present-Day Trends in Television," by Mr. K. S. Phillips, B.Sc., A.C.G.I., A.M.I.E.E.

1st April.—"Quiz" on Area Organisation.

D. M.

## Darlington Centre

Arrangements for the remainder of the 1951/52 Session are nearing completion and an endeavour has been made as usual to cater for all tastes. Forthcoming meetings are planned as follows:—

January.—“Computers and Calculators,” Mr. E. O. M. Grimshaw.

February.—“Saints and Salesmen,” Mr. C. R. Harrison, Sales Department.

March.—Two-way Quiz: Darlington v. Middlesbrough. The Section's new president, Col. Calveley, O.B.E., B.Sc., M.I.E.E., has accepted the invitation to address the Centre in the New Year on a date to be fixed. His subject, “The Present System of Appraisal and Promotion,” should prove interesting.

Finally, to use an election phrase—“We hope for support if our efforts to serve are approved.” It is ample reward for these efforts if the meetings are well attended by our members with the same enthusiasm as in the past. C. N. H.

## Harrogate Centre

At the Annual General Meeting the following Officers were elected for the 1951/52 Session:—

*Chairman:* Mr. J. T. Winspear; *Secretary & Treasurer:* Mr. L. Webster; *Committee:* Messrs. P. H. George, D. R. Lewis, R. Pullan, G. Waddington, A. King.

The first meeting was held on 12th September, when Mr. L. Elstree-Wilson came along to give a demonstration of wood-turning which proved most fascinating. The articles made during the evening, and the exhibition of finished articles previously made by Mr. Elstree-Wilson, were the envy of the audience.

On 10th October, Mr. H. E. Weston gave a most interesting talk, well illustrated by slides, on “Some Aspects of Ordnance Survey Work.” This was very much appreciated by his audience.

11th October found Harrogate linked with Scarborough and York by landlines, microphones and loudspeakers when Col. Calveley addressed the three Centres on “The Present System of Appraisal and Promotion,” evoking numerous questions from the scattered audience.

The remainder of the programme for the session is as follows:—

9th January.—Mr. J. J. Perkins, “Design of P.M.B.X.s.”

13th February.—Mr. P. H. George, “Diesel Engines.”

12th March.—Mr. H. Clough, “Technical Training in Telecommunications Theory.”

The members, having had an excellent start, are looking forward to the remainder of the items for the session. J. T. W.

## Middlesbrough Centre

Activities for our Winter Session commenced on 11th October. The meeting, which was in the form of a Film Show and Social Evening combined, was open to members and their friends. Thanks are due to our Chairman, Mr. D. Paterson, for obtaining the services of Mr. J. H. Brown, L.D.S., of Middlesbrough, who came along and showed his colour film entitled “Through Switzerland with a Movie Camera.” Mr. Brown's film and commentary were greatly appreciated by all who attended. Refreshments were followed by dancing and games. Col. J. R. Sutcliffe, Telephone Manager, Mr. J. S. Gill, Liaison Officer, and several Senior Section members were present to show their usual interest in our Centre's activities.

The following programme has been arranged for the remainder of the Session:—

22nd January.—“Fundamentals of Telephone Cable Design,” A. C. Holmes, A.M.I.E.E. (Regional Liaison Officer).

14th February.—“Modern Industrial Lighting,” H. Carr.

18th March.—Two-Way Quiz: Darlington v. Middlesbrough.

15th April.—Annual General Meeting.

It is pleasing to note that two of the papers in the 1951/52 programme were undertaken by our own members, Mr. W. J.

Costello and Mr. H. Carr. All members are asked to co-operate and submit questions for the Two-Way Quiz to committee members at an early date. It is hoped that the programme for this Session will appeal to all our members. J. B.

## London Centre

The Radio Group of the London Centre organised the largest exhibition of home-constructed radio, television and model equipment yet seen within the sphere of the Junior Section in a two-day display at Regional Headquarters.

The exhibition was opened by Mr. F. I. Ray, B.Sc., M.I.E.E., Regional Director, on Friday, 26th October. Of

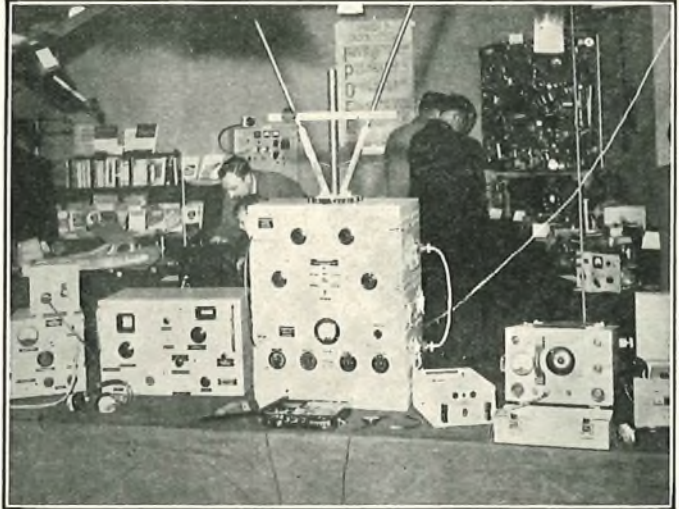

outstanding general interest were a radio-controlled tug, a magnetic tape recorder, scale models of locomotives and remote-controlled model aeroplanes. The cinema was an unqualified success.

Of specialist interest were the radio receivers and transmitters, television receivers, transmitting valves and a demonstration of speech transmission by light waves. The photographs show a small section of the very large number of items on display.

The presentation of prizes by Mr. W. S. Proctor, M.I.E.E., F.R.S.E., Chief Regional Engineer, was followed by a surprise item. Unknown to Mr. Proctor a record of his 1951 A.G.M. address had been made and this was handed to him by Mr. A. G. Welling, London Centre Chairman.

Thank you, Regional Headquarters and exhibitors for your kind co-operation in making this exhibition a success.

M. J. G.

# Staff Changes

## Promotions

Name	Region	Date	Name	Region	Date
<i>Deputy E.-in-C. to Engineer-in-Chief.</i>			<i>Tech. Officer to Asst. Engr.—continued.</i>		
Radley, Dr. W. G.	E.-in-C.O.	2.10.51	Harris, R. H.	H.C. Reg. to E.-in-C.O.	22.9.51
<i>Stf. Engr. to Asst. Engineer-in-Chief.</i>			Miller, C. B.	W.B.C. Reg. to E.-in-C.O.	22.9.51
Reading, Col. J.	E.-in-C.O.	2.10.51	Gammon, P. W. J.	H.C. Reg. to E.-in-C.O.	22.9.51
<i>S.P.Sc. Off. to Deputy Reg. Div.</i>			Porritt, W. R. A.	N.E. Reg. to E.-in-C.O.	22.9.51
Ryall, Dr. L. E.	E.-in-C.O. to H.C. Reg.	19.11.51	Thompson, J. A.	N.E. Reg. to E.-in-C.O.	22.9.51
<i>Asst. Stf. Engr. to C.R.E.</i>			Mills, C. S.	N.E. Reg. to E.-in-C.O.	22.9.51
Phillips, R. S.	E.-in-C.O. to L.P. Reg.	2.10.51	Bell, N.	N.E. Reg. to E.-in-C.O.	22.9.51
<i>Asst. Stf. Engr. to Staff Engr.</i>			Clarkstone, K. H.	N.E. Reg. to E.-in-C.O.	22.9.51
Jones, R. E.	E.-in-C.O.	2.10.51	Hoyle, J. H.	N.E. Reg. to E.-in-C.O.	22.9.51
McMillan, Col. D.	E.-in-C.O.	16.10.51	McLachlan, A. S.	Scot. to E.-in-C.O.	22.9.51
<i>Snr. Exec. Engr. to Asst. Stf. Engr.</i>			Lawson, R. N.	H.C. Reg. to E.-in-C.O.	22.9.51
Smith, P. E. C.	E.-in-C.O.	20.11.51	McGilvray, D. A.	Scot. to E.-in-C.O.	22.9.51
Floyd, C. F.	E.-in-C.O.	9.11.51	Mott, W. W.	L.T. Reg. to E.-in-C.O.	29.8.51
<i>Snr. Exec. Engr. to Principal.</i>			Fuller, J. A.	L.T. Reg. to E.-in-C.O.	13.9.51
Thompson, J. O.	E.-in-C.O. to A. & P.R.D.	17.9.51	Donn, G. S.	Scot. to E.-in-C.O.	29.8.51
<i>Manager Engr. to Asst. Stf. Engr.</i>			Meadows, A.	N.W. Reg. to E.-in-C.O.	22.9.51
Graham, E. F.	E.-in-C.O.	30.9.51	Gregson, G. S.	Scot. to E.-in-C.O.	22.9.51
<i>Deputy Engr. to Snr. Exec. Engr.</i>			Dodsworth, G. W.	N.E. Reg. to E.-in-C.O.	20.10.51
Beatson, H.	E.-in-C.O.	30.9.51	Lawton, R. F. N.	W.B.C. Reg. to E.-in-C.O.	29.9.51
<i>Exec. Engr. to Snr. Exec. Engr.</i>			Thomson, A. M. M.	Scot. to E.-in-C.O.	8.10.51
Birchall, J. V. R.	E.-in-C.O.	12.10.51	Andrews, A. C.	L.T. Reg. to E.-in-C.O.	1.10.51
Cooper, R. A.	E.-in-C.O.	19.11.51	Bannerman, C. L.	Scot. to E.-in-C.O.	8.10.51
Balchin, D. B.	E.-in-C.O.	13.11.51	Clipstone, S.	E.-in-C.O.	29.8.51
Clifford, F. G.	E.-in-C.O.	13.11.51	Birch, C. B.	E.-in-C.O.	29.8.51
Pearson, H. E.	E.-in-C.O.	13.11.51	Ambrose, F.	E.-in-C.O.	22.9.51
Lowry, W. R. H.	E.-in-C.O.	13.11.51	O'Neill, R. T.	E.-in-C.O.	29.8.51
Pride, C. A.	L.T. Reg.	13.11.51	Sheppard, H. G.	E.-in-C.O.	29.8.51
<i>Asst. Engr. to Exec. Engr.</i>			Foulkes, S. A.	E.-in-C.O.	29.8.51
Bird, J.	H.C. Reg.	25.9.51	Everett, D. T.	E.-in-C.O.	29.8.51
Blease, R. C.	N.W. Reg.	25.9.51	Roe, N. J.	E.-in-C.O.	29.8.51
Briggs, E.	E.-in-C.O.	12.11.51	Gilks, G. F. L.	E.-in-C.O.	29.8.51
Bull, W. H.	H.C. Reg.	25.9.51	Jarvis, E. G.	E.-in-C.O.	29.8.51
Self, G. A.	H.C. Reg.	1.11.51	Clatworthy, J. F.	E.-in-C.O.	22.9.51
Sturdy, F. H.	H.C. Reg.	25.9.51	Corner, F. B.	E.-in-C.O.	29.8.51
Hayward, R. W.	H.C. Reg. to E.-in-C.O.	7.11.51	Elliott, D. G.	E.-in-C.O.	29.8.51
<i>Asst. Engr. to Snr. Exp. Off.</i>			Gosby, J. T.	E.-in-C.O.	22.9.51
Hope, H. R.	E.-in-C.O.	19.11.51	Jackaman, C. N.	E.-in-C.O.	17.10.51
<i>Tech. Officer to Asst. Engr.</i>			Stokes, J. H.	E.-in-C.O.	17.10.51
Stephen, G.	Scot. to E.-in-C.O.	22.9.51	Jeffrey, R. J.	E.-in-C.O.	17.10.51
Gee, J. H.	Mid. Reg. to E.-in-C.O.	22.9.51	Albutt, L. A.	E.-in-C.O.	17.10.51
Notman, R. A.	Scot. to E.-in-C.O.	22.9.51	Wood, J. W.	E.-in-C.O.	17.10.51
Macbride, J. M. R.	Scot. to E.-in-C.O.	22.9.51	Veitch, S.	E.-in-C.O.	17.10.51
Spooner, J. H.	H.C. Reg. to E.-in-C.O.	22.9.51	Nix, H. G.	L.T. Reg. to E.-in-C.O.	3.11.51
<i>Asst. Engr. to Snr. Exp. Off.</i>			Bristow, H. A.	E.-in-C.O.	13.11.51
Hope, H. R.	E.-in-C.O.	19.11.51	Cooling, J. O.	N.W. Reg. to E.-in-C.O.	24.11.51
<i>Tech. Officer to Asst. Engr.</i>			Tolliday, E.	H.C. Reg. to E.-in-C.O.	17.11.51
Stephen, G.	Scot. to E.-in-C.O.	22.9.51	<i>M.T.O. III to M.T.O. II</i>		
Gee, J. H.	Mid. Reg. to E.-in-C.O.	22.9.51	Brownlow, P. E.	E.-in-C.O.	15.11.51
Notman, R. A.	Scot. to E.-in-C.O.	22.9.51	Thomas, A. W.	E.-in-C.O.	15.11.51
Macbride, J. M. R.	Scot. to E.-in-C.O.	22.9.51	<i>Asst. (Sc.) to Asst. Exp. Off.</i>		
Spooner, J. H.	H.C. Reg. to E.-in-C.O.	22.9.51	Laidlow, J. O.	E.-in-C.O.	1.9.51
<i>Asst. Engr. to Snr. Exp. Off.</i>			<i>Asst. (Sc.) to Snr. Asst. (Sc.).</i>		
Hope, H. R.	E.-in-C.O.	19.11.51	Waldie, F. A.	E.-in-C.O.	20.10.51
<i>Tech. Officer to Asst. Engr.</i>			Batey, H.	E.-in-C.O.	20.10.51
Stephen, G.	Scot. to E.-in-C.O.	22.9.51	<i>Transfers</i>		
Gee, J. H.	Mid. Reg. to E.-in-C.O.	22.9.51	<i>Asst. Stf. Engr.</i>		
Notman, R. A.	Scot. to E.-in-C.O.	22.9.51	Potts, E.	E.-in-C.O. to Min. of Supply	1.11.51
Macbride, J. M. R.	Scot. to E.-in-C.O.	22.9.51	<i>Snr. Exec. Engr.</i>		
Spooner, J. H.	H.C. Reg. to E.-in-C.O.	22.9.51	Bomford, K. D.	E.-in-C.O. to Min. of Supply	8.10.51
<i>Asst. Engr. to Snr. Exp. Off.</i>			<i>Exec. Engr.</i>		
Hope, H. R.	E.-in-C.O.	19.11.51	Moody, W. R. N.	E.-in-C.O. to S.W. Reg.	17.9.51
<i>Tech. Officer to Asst. Engr.</i>			Finnamore, A. J.	E.-in-C.O. to Admiralty	20.8.51
Stephen, G.	Scot. to E.-in-C.O.	22.9.51	McMillan, F. N.	Scot. to E.-in-C.O.	29.10.51
Gee, J. H.	Mid. Reg. to E.-in-C.O.	22.9.51	Baxter, E. C.	E.-in-C.O. to L.T. Reg.	15.10.51
Notman, R. A.	Scot. to E.-in-C.O.	22.9.51	Goman, L. V.	H.C. Reg. to E.-in-C.O.	12.11.51
Macbride, J. M. R.	Scot. to E.-in-C.O.	22.9.51	<i>Asst. Engr.</i>		
Spooner, J. H.	H.C. Reg. to E.-in-C.O.	22.9.51	Taylor, R. E.	E.-in-C.O. to Min. of Supply	1.8.51
<i>Asst. Engr. to Snr. Exp. Off.</i>			Bailey, G. W.	E.-in-C.O. to H.C. Reg.	30.9.51
Hope, H. R.	E.-in-C.O.	19.11.51	<i>Asst. (Sc.).</i>		
<i>Tech. Officer to Asst. Engr.</i>			Wilson, P. L.	E.-in-C.O. to P.M.G.s Dept., Australia	5.9.51
Stephen, G.	Scot. to E.-in-C.O.	22.9.51	<i>Asst. Engr.—continued.</i>		
Gee, J. H.	Mid. Reg. to E.-in-C.O.	22.9.51	Eastwood, D.	E.-in-C.O. to N.W. Reg.	30.9.51
Notman, R. A.	Scot. to E.-in-C.O.	22.9.51	Lewis, H.	E.-in-C.O. to Min. of Supply	15.10.51
Macbride, J. M. R.	Scot. to E.-in-C.O.	22.9.51	Sparkes, G.	E.-in-C.O. to Min. of Supply	22.10.51
Spooner, J. H.	H.C. Reg. to E.-in-C.O.	22.9.51	Edmondson, J. S.	E.-in-C.O. to N.E. Reg.	28.10.51
<i>Asst. Engr. to Snr. Exp. Off.</i>			Gale, F. G. L.	E.-in-C.O. to Min. of Supply	17.10.51
Hope, H. R.	E.-in-C.O.	19.11.51	Cooper, C. J.	E.-in-C.O. to Min. of Supply	17.10.51
<i>Tech. Officer to Asst. Engr.</i>			Newman, W. L.	E.-in-C.O. to L.T. Reg.	18.11.51
Stephen, G.	Scot. to E.-in-C.O.	22.9.51	<i>Snr. Sc. Off.</i>		
Gee, J. H.	Mid. Reg. to E.-in-C.O.	22.9.51	Garrett, F. S.	E.-in-C.O. to National Coal Board	17.9.51
Notman, R. A.	Scot. to E.-in-C.O.	22.9.51	<i>Asst. (Sc.).</i>		
Macbride, J. M. R.	Scot. to E.-in-C.O.	22.9.51	Wilson, P. L.	E.-in-C.O. to P.M.G.s Dept., Australia	5.9.51
Spooner, J. H.	H.C. Reg. to E.-in-C.O.	22.9.51	<i>Asst. Engr.—continued.</i>		

**Resignations**

Name	Region	Date	Name	Region	Date
<i>Snr. Exec. Engr.</i>			<i>Inspector.</i>		
Saville, W. . . . .	E.-in-C.O. . . . .	27.10.51	Roe, R. J. . . . .	H.C. Reg. . . . .	5.2.51
<i>Asst. Engr.</i>			<i>Temp. Asst. (Sc.).</i>		
Davey, W. P. . . . .	E.-in-C.O. . . . .	12.10.51	Charles, J. M. . . . .	E.-in-C.O. . . . .	21.9.51
Simmonds, J. P. . . . .	H.C. Reg. . . . .	18.5.51	<i>Asst. (Sc.).</i>		
			Butler, D. W. . . . .	E.-in-C.O. . . . .	31.8.51

**Retirements**

Name	Region	Date	Name	Region	Date
<i>Engineer-in-Chief.</i>			<i>Asst. Engr.</i>		
Gill, Sir Archibald J. . . . .	E.-in-C.O. . . . .	1.10.51	Wiper, H. S. . . . .	N.W. Reg. . . . .	9.9.51
<i>Chief Regional Engr.</i>			Sandford, F. . . . .	L.T. Reg. . . . .	3.10.51
Boryer, W. F. . . . .	L.P. Reg. . . . .	1.10.51	Johnson, A. E. . . . .	L.T. Reg. . . . .	31.10.51
<i>Staff Engr.</i>			Holloway, A. . . . .	Mid. Reg. . . . .	16.11.51
Hanford, S. . . . .	E.-in-C.O. . . . .	15.10.51	Yarrow, A. A. . . . .	L.T. Reg. . . . .	20.11.51
<i>Exec. Engr.</i>			Usher, C. W. G. . . . .	N.E. Reg. . . . .	22.10.51
Gosney, G. . . . .	L.T. Reg. . . . .	4.9.51	Tomlinson, F. S. . . . .	N.W. Reg. . . . .	30.11.51
Stanier, W. H. . . . .	H.C. Reg. . . . .	12.9.51	Thomson, A. . . . .	H.C. Reg. . . . .	30.5.51
Lee, J. A. . . . .	L.T. Reg. . . . .	20.10.51	Gray, V. P. . . . .	L.T. Reg. . . . .	31.12.51
Smith, C. A. . . . .	L.T. Reg. . . . .	31.10.51	<i>Inspector.</i>		
Verney, J. P. S. . . . .	S.W. Reg. . . . .	24.10.51	Rushworth, F. R. . . . .	Mid. Reg. . . . .	12.9.51
			Mann, D. . . . .	H.C. Reg. . . . .	22.5.51
			Reynolds, F. G. . . . .	L.T. Reg. . . . .	24.11.51
			Miller, P. . . . .	H.C. Reg. . . . .	20.4.51
			Mower, G. . . . .	L.T. Reg. . . . .	31.12.51
			Durien, R. L. . . . .	L.T. Reg. . . . .	20.11.51

**Deaths**

Name	Region	Date	Name	Region	Date
<i>Exec. Engr.</i>			<i>Asst. Engr.</i>		
Burdick, C. A. R. . . . .	L.T. Reg. . . . .	17.9.51	Marwood, S. A. . . . .	L.T. Reg. . . . .	28.10.51
Janks, F. A. E. . . . .	H.C. Reg. . . . .	4.10.51	Ball, H. . . . .	E.-in-C.O. . . . .	15.11.51
			Harrison, C. J. . . . .	E.-in-C.O. . . . .	17.11.51

♦  
**CLERICAL GRADES**

**Promotions**

Name	Region	Date	Name	Region	Date
<i>E.O. to H.E.O.</i>			<i>C.O. to E.O.</i>		
Bray, S. F. . . . .	E.-in-C.O. . . . .	1.10.51	Forsythe, Miss M. J. . . . .	E.-in-C.O. . . . .	26.9.51
Lyndoe, H. G. . . . .	E.-in-C.O. . . . .	29.9.51			

**Transfers**

Name	Region	Date	Name	Region	Date
<i>E.O.</i>			<i>E.O.—continued.</i>		
Lane, Miss N. . . . .	E.-in-C.O. to Foreign Office	4.9.51	Wilby, Miss M. . . . .	E.-in-C.O. to Commonwealth Telecomms. Board	1.4.51

**Retirement**

Name	Region	Date
<i>H E O</i>		
Cross, A. B. . . . .	E.-in-C.O. . . . .	30.9.51

♦  
**DRAUGHTSMEN**

**Transfers**

Name	Region	Date
<i>Leading D'man.</i>		
Lander, W. J. . . . .	Factories Dept. to E.-in-C.O.	19.8.51

## Book Reviews

"Alternating-Current Machinery." B. F. Bailey, Ph.D., and J. S. Gault, M.S.(E.E.). McGraw-Hill Publishing Co., Ltd., London. 421 pp. 359 ill. 51s.

This book deals with transformers, alternators, rotary converters, synchronous motors and induction motors of all the common types. It gives some information on selsyns, but rectifiers are not covered. It is entirely American, but this fact is not obtrusive in reading as the nomenclature and symbols agree generally with practice here.

The book is intended for those with a good knowledge of A.C. and D.C. theory, and the authors have avoided the common mistake of trying to compress this fundamental theory into an opening chapter. No time is lost in getting into transformer theory, but the stimulating effect of the very direct approach is marred a little by the authors feeling it necessary to explain that transformers cannot be used on D.C. and cannot change frequency. There are numerous worked examples in the text and a number of problems for the student is set at the end of each chapter. The answers are not included. Full details of speeds and outputs of the machines are given under most of the many photographs illustrating the text, but these are of little value as it is not possible to gauge the sizes of the machines.

The mathematical treatment of the subject has been reserved for three concluding chapters to keep mathematics in the text to a minimum. Unfortunately, in following this course, the authors have not avoided the error that so many earlier writers have fallen into, that of crediting physical quantities with intelligence. For example, on page 8 they say, "When current flows in the secondary, the primary current increases immediately to counteract it magnetically. . . ."

The layout of the text and the quality of the paper and binding leave little to be desired. Like most American textbooks it is easy to read and it should be useful to students in the fourth and fifth years of the Higher National Certificate Course in Electrical Engineering. A. E. P.

"Fractional Horse Power Motors." Stuart F. Philpott, M.I.E.E. Chapman & Hall. 367 pp. 262 ill. 30s.

Small electric motors have become so much a part of industrial, commercial and domestic mechanisation that nowadays they are regarded as indispensable, as, in fact, they are. It is not surprising, therefore, that the author claims that the manu-

facture of small motors and motor-driven appliances constitutes a major section of the electrical industry in Great Britain.

The author has adopted the usual classification dependent on characteristics of the electricity supply for which the motors are designed, viz., D.C., Universal (D.C. and A.C.) and A.C., and within these three broad categories he lists 18 types. The principles, operating characteristics, construction and applications of each type are given in successive chapters. Elementary theory of motors is included for the sake of completeness in treatment and to assist the reader who has little technical training. Chapters are devoted to mechanical features common to most types, to a comparison between types and to the selection of a motor to meet various applications. In the space of one chapter one cannot expect more than a brief selection of typical applications, but this selection has been well made to cover the domestic and industrial field with dictating machines as a commercial example. A brief reference is made to the precautions essential to ensure safety in use of portable electric tools. This section could with advantage have been expanded. The last two chapters cover the testing of motors, and radio interference suppressors.

The author has set out, not to present any new material but to collate a whole mass of information on small motors into a book of reasonable size. The method of presentation is to be commended as are also the excellent diagrams and photographs. It is a book that should have a wide appeal, presenting, as it does, very comprehensive information on small electric motors of British manufacture. W. T. G.

"Wireless World" Diary 1952. Iliffe & Sons, Ltd. 80 pages of reference material—plus the usual Diary pages of a week to an opening. Morocco leather, 6s. 1½d. Rexine, 4s. 3½d.

Diversity of information is one of the outstanding features of the "Wireless World" Diary, now in its 34th year of publication. In addition to general information and addresses of radio organisations both in the U.K. and abroad, the 80-page reference section includes base connections for some 670 valves, design data and the kind of technical information so often needed but seldom readily available in tabloid form.

Compiled by the staff of "Wireless World," the technical data includes formulæ ranging from Ohm's Law to P.A. power requirements; abacs for the graphical estimation of data such as coil windings and circuit constants; circuit diagrams varying from simple detector circuits to a 90-Mc/s converter; and details of television and F.M. aerials.

### BOARD OF EDITORS

H. FAULKNER, C.M.G., B.Sc., M.I.E.E., Chairman.  
F. E. NANCARROW, O.B.E., A.R.C.Sc., M.I.E.E.  
W. WEST, B.A., M.I.E.E.  
Capt. C. F. BOOTH, O.B.E., M.I.E.E.  
L. F. SCANTLEBURY, Whit.Sch., A.C.G.I., D.I.C., A.M.I.E.E.  
D. A. BARRON, M.Sc., A.M.I.E.E.  
E. DAVIS, A.M.I.E.E.  
L. CHANT.  
G. E. STYLES, A.M.I.E.E., Managing Editor.  
W. A. HUMPHRIES, A.M.I.E.E.  
J. P. HARDING, B.Sc.(ENG.). } Assistant Editors.  
A.M.INST.C.E., A.M.I.E.E. }  
A. J. HUTCHISON, Secretary-Treasurer.

### Copyright

The entire contents of this JOURNAL are covered by general copyright, and special permission is necessary for reprinting long extracts, but Editors are welcome to use not more than one-third of any article, provided credit is given at the beginning or end thus: "From the *Post Office Electrical Engineers' Journal*."

The Board of Editors is not responsible for the statements made or the opinions expressed in any of the articles in this JOURNAL, unless such statement is made specifically by the Board.

### Communications

All communications should be addressed to the Managing Editor, *P.O.E.E. Journal*, Engineer-in-Chief's Office, Alder House, Aldersgate Street, London, E.C.1. Telephone: HEADquarters 1234. Remittances should be made payable to "*The P.O.E.E. Journal*"

and should be crossed "& Co."

### Binding Cases

Cases for binding are available, and may be obtained from the Local Agents for 3s. Subscribers can have their copies of volumes bound, at a cost of 10s. 6d., by sending the complete set of parts to the Local Agents or to the *P.O.E.E. Journal*, Engineer-in-Chief's Office, Alder House, Aldersgate Street, London, E.C.1. Orders for binding for Vols. 1-19 should indicate whether the original binding case with black lettering, or the later pattern with gold, is required. Cases with gold lettering are the only type stocked from Vol. 20 onwards.

### Back Numbers

The price of the JOURNAL, which is published quarterly, is 2s. 6d. (2s. 9d. post free) per copy, or 11s. per annum, post free. Back numbers can be supplied, subject to availability of stocks, at 2s. 6d. each (2s. 9d. post free). Orders for back numbers may be sent to the *P.O.E.E. Journal*, Engineer-in-Chief's Office, Alder House, Aldersgate Street, London, E.C.1, or to the Publishers.

Employees of the British Post Office can obtain the *Journal* through Local Agents at the reduced price of 1s. 6d. per copy.

### Advertisements

All communications relating to space reservations should be addressed to the Advertisement Editor, *P.O.E.E. Journal*, Alder House, Aldersgate Street, London, E.C.1. Communications regarding advertisement copy, proofs, etc., should be addressed to the Publishers, Messrs. Birch & Whittington (Prop. Dorling & Co. [Epsom], Ltd.), 49 Upper High Street, Epsom, Surrey.



# Post Office Electrical Engineers' Journal

Volume 44, April 1951—January 1952

## INDEX

	PAGE NO.		PAGE NO.
<b>A</b>		<b>F</b>	
A.C. No. 1, Electronic Equipment for Signalling System	118, 179	Fagg, A. G. J., and J. J. Moffatt. Kiosk Trailers	112
A.C. No. 1 (2 V.F.), Signalling System	66, 114	Festival of Britain, Communications for the	81
Acceptance Testing of Coaxial Pairs for the Inland Trunk Network	1	Flowers, T. H. Introduction to Electronic Exchanges—Trunking and Selection Systems	10
Alexander, A. Communications for the Festival of Britain Alterations to H.M.T.S. <i>Ariel's</i> Cable Paying-Out Gear	81 17	Forster, A. E. T. Test Equipment for the Teleprinter Automatic Switching System	107
Application of Equaliser Curves to the Design of Two-Terminal Networks, An	31		
Articulation Measurements, The Conduct of	159	<b>G</b>	
Ayers, E. W., and C. J. Cameron. The Medresco Hearing Aid	153	Generating Set for Manhole Lighting, A New Portable	7
		Gerrard, J. Cathodic Protection of Underground Cables	71
<b>B</b>		Gill, Sir Archibald J.	130
Baguley, E., and F. B. Cope. A Pulse Echo Test Set for the Quality Control and Maintenance of Impedance Uniformity of Coaxial Cables	164	Growth and Properties of Cathode Interface Layers in Receiving Valves, The	176
Baker, H., D. L. Benson and K. M. Heron. An Experimental Electronic Director	97, 169		
Baker, T. W., and N. B. Rymer. Multiple Teeing in Local Line Networks	49	<b>H</b>	
Balchin, D. B., and C. W. Sowton. The New London Radio-Telephony Terminal	25	Hamer, R., B. R. Horsfield and J. H. H. Merriman. A Subscriber's Battery-Operated Single-Channel V.H.F. Radio-Telephone Equipment	75
Benson, D. L., K. M. Heron and H. Baker. An Experimental Electronic Director	97, 169	Hearing Aid, The Medresco	153
Birmingham-Manchester Television Link, The	158	Heron, K. M., H. Baker and D. L. Benson. An Experimental Electronic Director	97, 169
Book Reviews	24, 30, 32, 34, 45, 48, 74, 80, 84, 106, 111, 113, 117, 123, 129, 168, 175, 178, 192	Hill, B. C., and E. E. M. Smith. A New Portable Generating Set for Manhole Lighting	7
		Horsfield, B. R., J. H. H. Merriman and R. Hamer. A Subscriber's Battery-Operated Single-Channel V.H.F. Radio-Telephone Equipment	75
		Horsfield, B. R., and S. Welch. The Single-Commutation Direct Current Signalling and Impulsing System	18
<b>C</b>			
Cable and Pair Identification, Miniaturised Testing Equipment for	127	<b>I</b>	
Cable Paying-Out Gear, Alteration to H.M.T.S. <i>Ariel's</i>	17	Impedances, A Measuring Set for Electrical, Mechanical or Acoustic	54
Cameron, C. J., and E. W. Ayers. The Medresco Hearing Aid	153	Impulsing System, The Single-Commutation Direct Current Signalling and	18
Cathode Interface Layers in Receiving Valves, The Growth and Properties of	176	Institution of Post Office Electrical Engineers	38, 87, 135, 188
Cathodic Protection of Underground Cables	71	Introduction to Electronic Exchanges—Trunking and Selection Systems	10
C.C.I.R., Geneva, June, 1951, The VIth Plenary Meeting of the	132		
C.C.I.T. Study Group Meetings, Geneva, March, 1951	86	<b>J</b>	
Child, M. R. The Growth and Properties of Cathode Interface Layers in Receiving Valves	176	Junior Section Notes	43, 91, 142, 188
Coaxial Cables, A Pulse Echo Test Set for the Quality Control and Maintenance of Impedance Uniformity of	164		
Coaxial Pairs for the Inland Trunk Network, Acceptance Testing of	1	<b>K</b>	
Commonwealth Telecommunications	35	Kiosk Trailers	112
Communications for the Festival of Britain	81		
Conduct of Articulation Measurements, The	159	<b>L</b>	
Connections in Line Transmission Equipment, Detection of Defective	103	Lewis, N. W. Detection of Defective Connections in Line Transmission Equipment	103
Cope, F. B., and E. Baguley. A Pulse Echo Test Set for the Quality Control and Maintenance of Impedance Uniformity of Coaxial Cables	164	Lighting, A New Portable Generating Set for Manhole	7
Crystal Vibrators as Circuit Elements, Quartz	124	London Radio-Telephony Terminal, The New	25
<b>D</b>		<b>M</b>	
Detection of Defective Connections in Line Transmission Equipment	103	Manchester-Edinburgh Television Radio Relay System, The	33
de Wardt, R. H. The Conduct of Articulation Measurements	159	Manchester Television Link, The Birmingham-	158
Director, An Experimental Electronic	97, 169	Manhole Lighting, A New Portable Generating Set for	7
		Measuring Set for Electrical, Mechanical or Acoustic Impedances, A	54
<b>E</b>		Medresco Hearing Aid, The	153
Edinburgh Television Radio Relay System, The Manchester-Electronic Director, An Experimental	97, 169	Merriman, J. H. H., R. Hamer and B. R. Horsfield. A Subscriber's Battery-Operated Single-Channel V.H.F. Radio-Telephone Equipment	75
Electronic Equipment for Signalling System A.C. No. 1: Part 1.—The New 2 V.F. Signalling Receiver (AT4931)	118	Miniaturised Testing Equipment for Cable and Pair Identification	127
Part 2.—The Oscillator No. 26	179	Moffatt, J. J., and A. G. J. Fagg. Kiosk Trailers	112
Electronic Exchanges—Trunking and Selection Systems, Introduction to	10	Multiple Teeing in Local Line Networks	49
Experimental Electronic Director, An			
Part 1.—Basic Principles and Circuit Elements	97		
Part 2.—Circuit Operation	169		
Experimental Power-Operated Parcel Plough, An	61		
Experiments, An Outline of the Principles of Design and Analysis of	55		

N	PAGE NO.
Networks, An Application of Equaliser Curves to the Design of Two-Terminal .. .. .	31
New London Radio-Telephony Terminal, The .. .. .	25
New Mobile Tractor Winch, A .. .. .	65
New Portable Generating Set for Manhole Lighting, A .. .. .	7
New Principle for Obtaining Improved Speech Immunity with V.F. Signalling Receivers, A .. .. .	102
New Standard for Ringing Tone, The .. .. .	85
New-Type Routiners for Automatic Telephone Exchange Equipment. Part 1.—Rack Design, Routiner Facilities and Outline of Operation .. .. .	147
Notes and Comments .. .. .	30, 87, 133, 182
Notes, Junior Section .. .. .	43, 91, 142, 188
Notes, Regional .. .. .	39, 88, 137, 184

### O

Outline of the Principles of Design and Analysis of Experiments, An .. .. .	56
---	----

### P

P.A.B.X., Whitehall Gardens .. .. .	15
Pearson, H. E. Quartz Crystal Vibrators as Circuit Elements .. .. .	124
Perkins, F. T. Whitehall Gardens P.A.B.X. .. .. .	15
Pettit, E. W. An Experimental Power-Operated Parcel Plough .. .. .	61
Plough, An Experimental Power-Operated Parcel .. .. .	61
Protection of Underground Cables, Cathodic .. .. .	71
Pulse Echo Test Set for the Quality Control and Maintenance of Impedance Uniformity of Coaxial Cables, A .. .. .	164

### Q

Quartz Crystal Vibrators as Circuit Elements .. .. .	124
--	-----

### R

Radio Relay System, The Manchester-Edinburgh .. .. .	33
Radio-Telephone Equipment, A Subscriber's Battery-Operated Single-Channel V.H.F. .. .. .	75
Radio-Telephony Terminal, The New London .. .. .	25
Radley, W. G. .. .. .	131
Regional Notes .. .. .	39, 88, 137, 184
Richards, D. L. An Outline of the Principles of Design and Analysis of Experiments .. .. .	55
Ringing Tone, The New Standard for .. .. .	85
Routiners for Automatic Telephone Exchange Equipment, New-Type .. .. .	147
Rymer, N. B., and T. W. Baker. Multiple Teeing in Local Line Networks .. .. .	40

### S

	PAGE NO.
Seymour, P. W. An Application of Equaliser Curves to the Design of Two-Terminal Networks .. .. .	31
Signalling System A.C. No. 1, Electronic Equipment for .. .. .	118, 179
Signalling System A.C. No. 1 (2 V.F.): Part 1.—Modifications of the Existing 2 V.F. System for Trunk Mechanisation Requirements and Outline of the Operation of the Latest Equipment .. .. .	66
Part 2.—General Description of the New Equipment .. .. .	114
Single-Channel V.H.F. Radio-Telephone Equipment, A Subscriber's Battery-Operated .. .. .	75
Single-Commutation Direct Current Signalling and Impulsing System, The .. .. .	18
Smith, D. C. Signalling System A.C. No. 1 (2 V.F.) .. .. .	66, 114
Smith, E. E. M., and B. C. Hill. A New Portable Generating Set for Manhole Lighting .. .. .	7
Sowton, C. W., and D. B. Balchin. The New London Radio-Telephony Terminal .. .. .	25
Speech Immunity with V.F. Signalling Receivers, A New Principle for Obtaining Improved .. .. .	102
Staff Changes .. .. .	46, 93, 143, 190
Stone, M. C. New-Type Routiners for Automatic Telephone Exchange Equipment .. .. .	147
Subscriber's Battery-Operated Single-Channel V.H.F. Radio-Telephone Equipment, A .. .. .	75
Surman, W. L., and G. W. Thomas. Miniaturised Testing Equipment for Cable and Pair Identification .. .. .	127

### T

Taylor, R. E., and R. J. Turner. Acceptance Testing of Coaxial Pairs for the Inland Trunk Network .. .. .	1
Teeing in Local Line Networks, Multiple .. .. .	49
Teleprinter Automatic Switching System, Test Equipment for the .. .. .	107
Television Link, The Birmingham-Manchester .. .. .	158
Television Radio Relay System, The Manchester-Edinburgh .. .. .	33
Test Equipment for the Teleprinter Automatic Switching System .. .. .	107
Testing Equipment for Cable and Pair Identification, Miniaturised .. .. .	127
Testing of Coaxial Pairs for the Inland Trunk Network, Acceptance .. .. .	1
Thomas, G. W., and W. L. Surman. Miniaturised Testing Equipment for Cable and Pair Identification .. .. .	127
Tillman, J. R. Electronic Equipment for Signalling System A.C. No. 1 .. .. .	118, 179
Trailers, Kiosk .. .. .	112
Trials in connection with Laying Rigid Repeaters in Deep Water .. .. .	181
Trunking and Selection Systems, Introduction to Electronic Exchanges— .. .. .	10
Turner, R. J., and R. E. Taylor. Acceptance Testing of Coaxial Pairs for the Inland Trunk Network .. .. .	1

### V

V.F. Signalling Receivers, A New Principle for Obtaining Improved Speech Immunity with .. .. .	102
(2 V.F.), Signalling System A.C. No. 1 .. .. .	66, 114

### W

Welch, S., and B. R. Horsfield. The Single-Commutation Direct Current Signalling and Impulsing System .. .. .	18
Whitehall Gardens P.A.B.X. .. .. .	15
Winch, A New Mobile Tractor .. .. .	65

# TECHNIQUE

A JOURNAL OF INSTRUMENT ENGINEERING

# FREE ON REQUEST

POST  
THIS COUPON  
TODAY

MUIRHEAD & CO. LTD. BECKENHAM · KENT · ENGLAND  
Please place my name on your mailing list for "TECHNIQUE"

NAME \_\_\_\_\_

POSITION \_\_\_\_\_

COMPANY \_\_\_\_\_

ADDRESS \_\_\_\_\_

P.O.E.E.J.61

MUIRHEAD & CO., LTD.  
PRECISION ELECTRICAL INSTRUMENT MAKERS  
BECKENHAM · KENT · ENGLAND  
Phone: BECKENHAM 0041    Telegrams & Cables: MUIRHEADS ELMERS-END

PRECISION

**MUIRHEAD**

ELECTRICAL INSTRUMENTS



## DENSO

*flies to be  
of service*

At home and overseas DENSO TAPE is recognised as being indispensable for emergency repairs of damaged electricity and telephone cables, fractured gas mains, etc.—and we have had to make more express deliveries than we care to remember!

This particular consignment (part of which is seen in the illustration) is for hurricane damage repairs and was despatched by air in response to an urgent S.O.S. from Jamaica.

DENSO TAPE is an anti-corrosive of proved ability and provides full and lasting protection against corrosion to pipes and all metal structures, whether buried or exposed . . . and is a real aid to frost-proofing.

Use DENSO TAPE for the waterproof sealing of temporary cable joints and openings, cable ends, etc.

**Denso**

**WINN & COALES, LTD.**

DENSO WORKS, CHAPEL ROAD, LONDON, S.E.27

Telephone: GIPsy Hill 4247/8

Telegrams: Denselte, Westnor, London

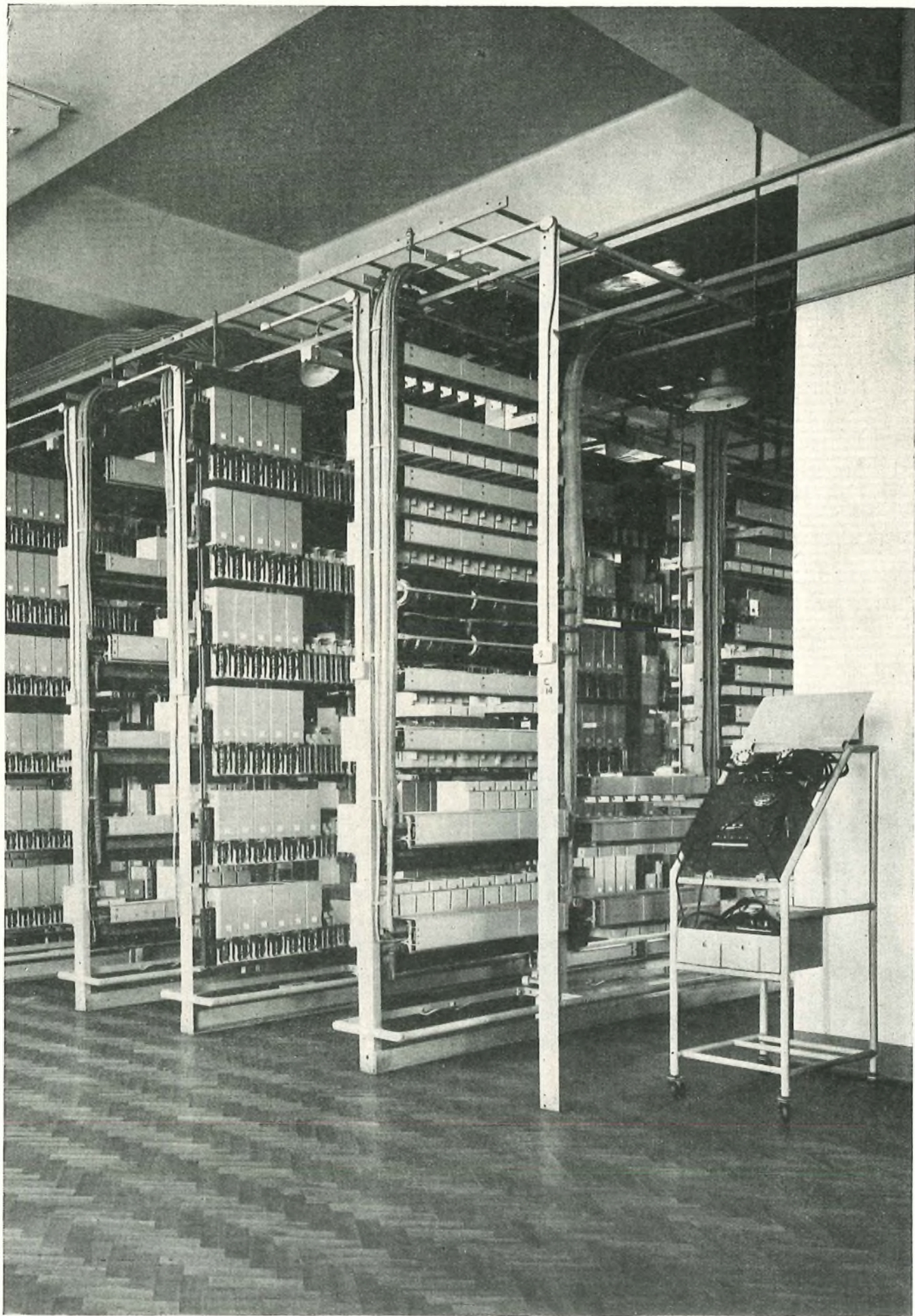

# ANOTHER STROWGER EXCHANGE

---

---



WEMBLEY AUTOMATIC EXCHANGE is the latest to be installed in the London Director area by Automatic Telephone & Electric Company Limited. Dialling facilities are provided for a maximum of 10,000 subscribers to 185 exchanges and the majority of the 1,500,000 telephones in the area.

The Strowger two-motion selector, thousands of which form part of the Wembley exchange equipment, is the principal selecting mechanism and incorporates in its design all the facilities which many years' operational experience have shown to be necessary, yet retains the simple straightforward step-by-step principle of operation characteristic of the Strowger system. These qualities are apparent to a marked extent in the type 32A Mark II Selector, which is the most recent model. To-day this selector offers the most suitable basis for automatic telephone systems of any size. Its simplicity, economy, reliability and ease of maintenance are the factors of principal appeal to telephone administrations in all parts of the world.



TYPE 32A MARK II SELECTOR

## Automatic Telephone & Electric Co. Ltd.

Strowger House, Arundel Street, London, W.C.2.

Telephone: TEMple Bar 4506. Telegrams: Strowger, Estrand, London. Strowger Works, Liverpool 7



AT.7781-AA28

# The 'DEKATRON'

A MULTI-ELECTRODE  
COLD-CATHODE  
COUNTING TUBE

for  
counting ..  
computing .. selecting ..

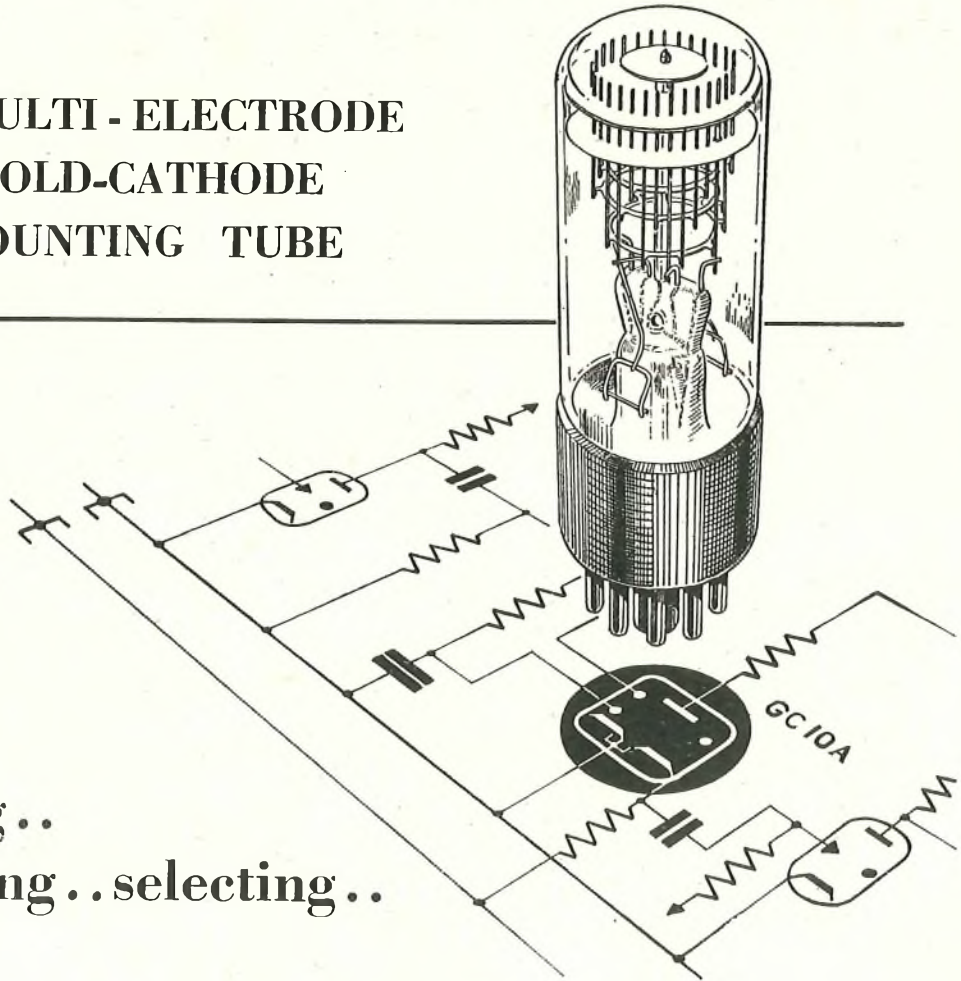

**Ericsson**

TELEPHONES LTD.

22 LINCOLN'S INN FIELDS, LONDON, W.C.2 · Tel. HOLborn 6936 · Works: BEESTON, NOTTS.

25



*By Appointment to the Professional Engineer...*

*Admiralty*

*Automatic Coil Winder &*

*Electrical Equipment Co Ltd*

*British Broadcasting Corporation*

*British Thomson-Houston Co Ltd*

*Crown Agents for the Colonies*

*De Havilland Engine Co Ltd*

*E. M. I. Group of Companies*

*Elliott Brothers (London) Ltd*

*English Electric Co Ltd*

*Ernest Turner Electrical Instruments Ltd*

*General Electric Co Ltd*

*General Post Office*

*Handley Page Ltd*

*Marconi's Wireless Telegraph Co Ltd*

*Metropolitan Vickers Electrical Co Ltd*

*Ministry of Supply*

*Rolls Royce Ltd*

*Short Brothers & Harland Ltd*

*Siemens Brothers & Co Ltd*

*Standard Telephones & Cables Ltd*

ATTENUATORS • FADERS • SWITCHES • WIREWOUND POTENTIOMETERS • PLUGS  
AND SOCKETS • WIREWOUND RESISTORS • HIGH STABILITY CARBON RESISTORS  
KNOBS DIALS AND POINTERS • TERMINALS

**PAINTON**

*Northampton England*

# Cold Cathode Diode

**NT 2**

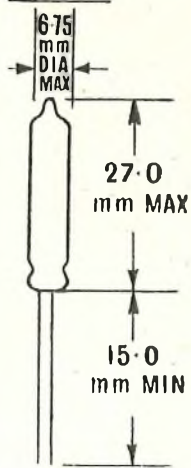

The NT2 is a very small cold cathode diode of wide application: e.g., in counters, storage circuits, low current stabilisers and so on.

It is moreover an ideal indicator tube giving a clear bright indication with currents as low as 0.3 mA.

## RATINGS

Nominal strike voltage ...	80 V.
Nominal maintaining voltage at 0.5 mA. ...	60 V.
Maximum power dissipation ... ..	0.06W.
Maximum current for continuous operation	1mA.

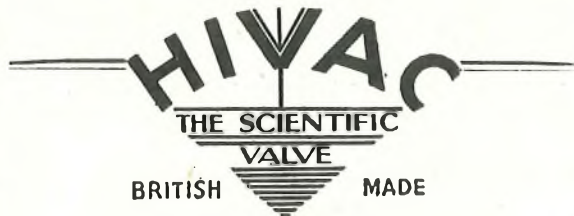

GREENHILL CRESCENT  
HARROW-ON-THE-HILL, MIDDX.

Telephone: HARrow 2655

## THE OSCILLOSCOPE BOOK

By E. N. Bradley. Full constructional details of a comprehensive but inexpensive oscilloscope, together with several auxiliary units: time base, wobulator, a.f. generator, and square wave unit. An explanation is given of a wide range of tests using this (or any other) oscilloscope; complete instructions for setting up, aided by copious illustrations, of typical circuits for testing; and the use of the oscilloscope for precision calibration of an a.f. generator, illustrated with a complete set of necessary traces. 88 pages, demy 8vo., 5/-.

## TELEVISION RECEIVER PRACTICE

By Roy Holland (*Chief Development Engineer, Scophony-Baird*). This book is devoted to practical descriptions of the circuit techniques in current use. The majority of the 80 illustrations are circuit diagrams with explanatory waveforms and typical component values. 80 pages, demy 8vo., 5/-. (To be published early February.)

## AUDIO HANDBOOKS

A new series specially written by N. H. Crowhurst, A.M.I.E.E.

No. 1: AMPLIFIERS. "This book is neither a theoretical treatise on the design of amplifiers, nor yet a constructional manual. It is, in fact, intended as a guide to 'Trouble Shooting' for the constructor who has built an amplifier, but then finds it doesn't work. To this end a TROUBLE TRACING GUIDE has been included which refers the reader to the appropriate chapter in the book. In the various chapters the most common causes of trouble (e.g., Distortion, Instability and Intermodulation, etc.) are dealt with in some detail, and sufficient basic theory is given to enable the constructor to locate the trouble and apply an intelligent remedy." "Electronic Engineering," 64 pages, demy 8vo., 3/6.

No. 2: FEEDBACK. An essentially practical approach to the problem, explaining what feedback can do, where and how, and what its limitations are. A simple presentation of the theory of closed loops, progressively developed without involved mathematics. Examples are given of practical application to actual circuits, showing how the methods can be applied to a wide range of problems and circuits. 64 pages, demy 8vo., 3/6. (To be published early February.)

Succeeding volumes in this series will cover TRANSFORMERS—USE AND DESIGN; PUBLIC ADDRESS; and QUALITY CONTROL.

**NORMAN PRICE (Publishers) LTD.,**  
283, CITY ROAD, LONDON, E.C.1.

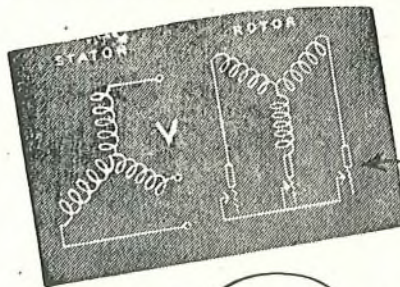

A.C. Polyphase Wound  
Rotor-Rheostat.

## FOR EVERY PHASE OF ELECTRICAL WORK

The British Electric Resistance Co. Ltd. can answer the multitude of resistance problems that beset the electrical circuit designer. For twenty years Berco resistances have been giving reliable and steadfast service, and the Berco range is designed to meet every requirement.

Berco engineers are specialists in resistance design and their knowledge is at your disposal.



RESISTANCES

THE BRITISH ELECTRIC RESISTANCE CO. LTD.  
Queensway, Ponders End, Middlesex

Telephone: Howard 1492

Telegrams: Vltrohm, Enfield

BR2033-AQ



# AUTOMATIC VOLTAGE REGULATORS by B.P.T

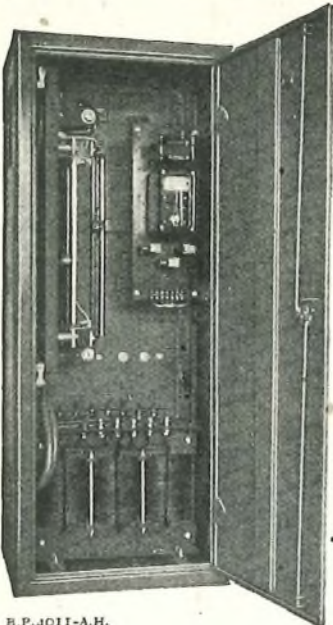
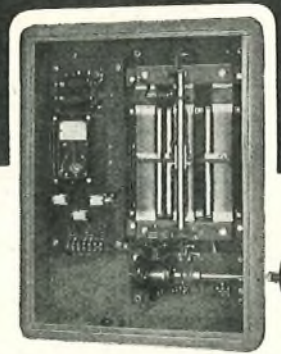

B.P.4011-A.H.

Maintaining a constant voltage unaffected by variation in the supply voltage, frequency, load and load power factor is a problem which can be solved by the aid of our standard range of Automatic Voltage Regulators. For single phase operation there are 11 models from 12½ to 240 amps, for three-phase there are 13 models from 7½ to 150 amps.

Three typical models are illustrated from our standard range of wall or floor mounting types.

**TOP** 3-phase, air cooled, wall mounting model. Input 440V ± 10%, output 440V ± 1%. 7½ amps.

**LEFT** 3-phase, air cooled, floor mounting (cubicle) model. Input 440V ± 10%, output 440V ± 1%. 40 amps.

**RIGHT** Single-phase, air cooled, wall mounting model. Input 250V ± 15%, output 250V ± 1%. 25 amps.

Please write for further information and literature. BP401 9

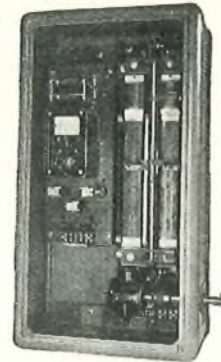

## BRITISH POWER TRANSFORMER CO. LTD.

Phone: HOWard 1492 QUEENSWAY, PONDERS END, MIDDLESEX Grams: "Vitrohm Enfield"

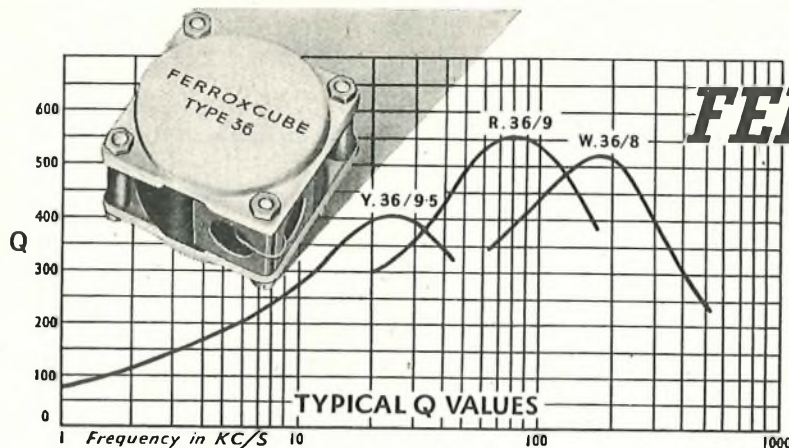

## FERROXCUBE

FERROMAGNETIC FERRITE

### For Line Communications :

IN THE design of Mullard pot core assemblies types 36 and 25 full advantage is taken of the characteristics of Ferroxcube to produce inductances of remarkably high "Q" factors. This, combined with ease of winding, makes these cores very suitable for use in filter networks and wherever high quality inductances are required.

Fine adjustment of inductance is obtained by control of the air gap rather than by variation of the turns.

The good screening properties of the Ferroxcube and the convenient shape of the assemblies, which allows stacking or individual mounting, are other features which distinguish these Mullard cores.

#### OUTSTANDING FEATURES

- ★ Low hysteresis coefficient
- ★ High values of inductance
- ★ Low self capacitance
- ★ Controllable air gap facilitating inductance adjustment
- ★ Self screening
- ★ Controlled temperature coefficient
- ★ Operation over a wide frequency range
- ★ Ease of winding and tapping
- ★ Easily mounted

PLEASE WRITE FOR FULL DETAILS



## Mullard FERROXCUBE

FERROMAGNETIC FERRITE

MULLARD LIMITED · CENTURY HOUSE · SHAFTESBURY AVENUE · LONDON · W.C.2

(MF375)

# MARCONI

## serves

## mankind



When Marconi died, one tribute said of him "What other men had been content to prove impossible, he accomplished". From simple beginnings his inventions in wireless have been extended to hundreds of activities. Every weather-ship report, every wireless-bearing taken from a flying-boat and every radio programme broadcast traces back to the pioneer who put his genius at the service of mankind.

# DELARON

## LAMINATED PLASTIC BOARD

is the perfect material for insulation. It gives constancy of performance within very close limits and can be sawn, drilled, punched and fabricated without difficulty with ordinary equipment. Delaron is supplied in thicknesses from 1/64" to 4", in black or brown, matt or glossy finish, and is available in the widest range of sizes from 38" x 28" to 8' x 4'. There is a grade of Delaron for every British Standard and Ministry Specification. Our Technical Service Department will be pleased to advise you in the correct grade of Delaron for your requirements. Please write for further details and samples.

*Electrical transformer bobbins fabricated from 'Delaron' sheet.*

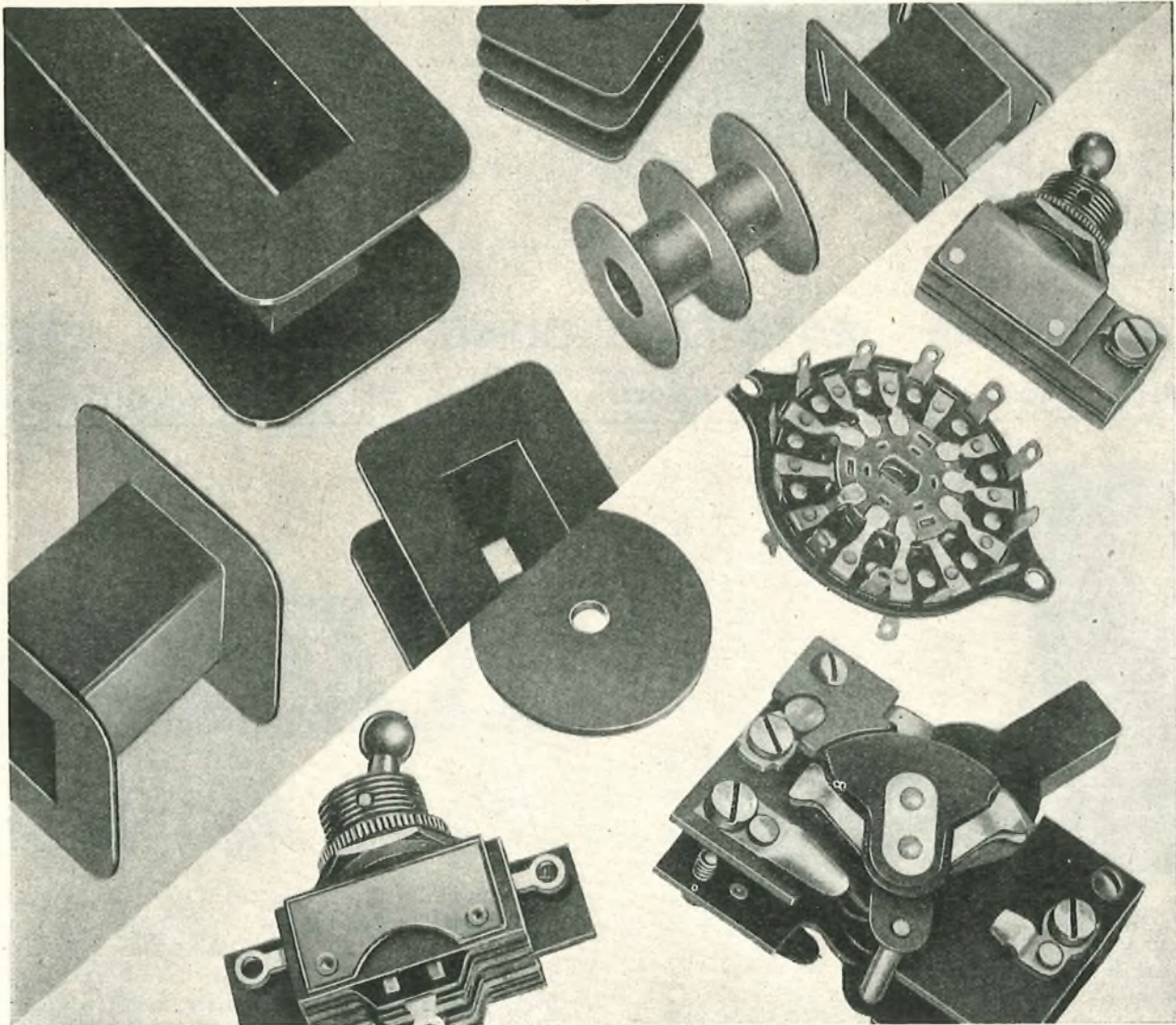

*Switch components manufactured by Messrs. Arrow Electric Switches Ltd. using 'Delaron' as an insulator.*

**THOMAS DE LA RUE & CO. LTD.** (*Plastics Division*), Imperial House, 84/86, Regent Street, London, W.1  
Phone: REGent 2901.

Grams: Delinsul, Piccy, London

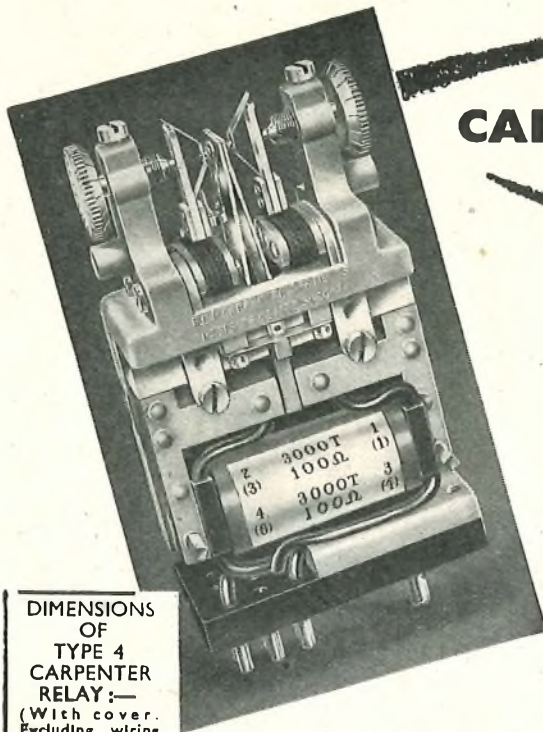

## CARPENTER POLARIZED RELAY TYPE 4

**DIMENSIONS  
OF  
TYPE 4  
CARPENTER  
RELAY:—**  
(With cover.  
Excluding wiring  
tags) 3.5 ins. high x  
2.2 ins. wide x 1 in.  
deep. Weight 13 ozs

**T**HIS is a medium speed, sensitive polarized relay designed primarily as a telephone impulsing relay (D.C. dialling up to 100 miles and V.F. dialling on trunk circuits). It has also been successfully adopted for use in Telex systems, but can be used satisfactorily up to speeds of 100 c/s without contact chatter or serious bias disturbances.

Its sensitivity is such that when the gap is adjusted to .004 in. nominal, the relay will just operate at 50 cycles with 3.5 ampere-turns R.M.S. (corresponding to approximately 2 mVA) or on 4.5 D.C. ampere-turns at low speeds. In service, however, the relay is normally operated at currents substantially larger than the minimum operating current quoted.

Contact chatter is absent if the contact gap does not exceed .005 in. The contact gap is adjustable by means of fine pitch screws with knurled heads marked with .001 in. divisions. Contacts on the armature tongue are insulated from it and thereby from the frame.

The relay has a magnetic screening cover with transparent removable top to facilitate contact adjustment.

Dimensionally the relay is interchangeable with the type "3000" relay and can be supplied to fit directly to the drilling normally provided for the "3000" relay.

Termination can either be made by means of a 12 in. plug base as illustrated, or with soldering tags in place of the pins.

Developed & Manufactured by the Sole Licensees:— Complete details available on request.

## TELEPHONE MANUFACTURING COMPANY LTD.

Contractors to the British Commonwealth and Foreign Governments

HOLLINGSWORTH WORKS • DULWICH • LONDON, S.E.21 GIPsy Hill 2211 (10 lines)



The AvoMeter is one of a useful range of "Avo" electrical testing instruments which are maintaining the "Avo" reputation for an unexcelled standard of accuracy and dependability—in fact, a standard by which other instruments are judged.

### ONE INSTRUMENT measures:—

Current, A.C. and D.C. (0 to 10 amps.)  
Voltage, A.C. and D.C. (0 to 1,000 v.)  
Resistance (up to 40 megohms)  
Capacity (.01 to 20 mfd.)  
Audio-frequency Power Output (0 to 2 watts)  
Decibels (— 25 Db. to + 16 Db.)

Write for fully descriptive pamphlet.

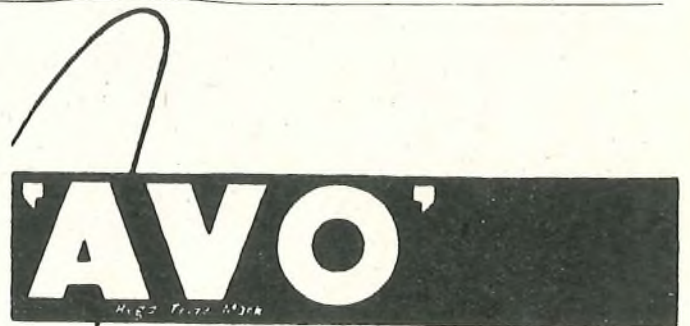

## Meters that Matter

**T**HE Model 7 Universal AvoMeter is the world's most widely used combination electrical measuring instrument. It provides 50 ranges of readings on a 5-inch hand-calibrated scale, and is guaranteed accurate to B.S. first grade limits on D.C. and A.C. from 25 c/s to 2 kc/s. It is self-contained, compact and portable, simple to operate and almost impossible to damage electrically. It is protected by an automatic cut-out against damage through severe overload.

Sole Proprietors and Manufacturers:—

THE AUTOMATIC COIL WINDER & ELECTRICAL EQUIPMENT Co. Ltd.  
Winder House, Douglas Street, London, S.W.1. Phone: VICTORIA 3404-9

**G.N.T.**

**MORSEINKERS  
MODEL 1515**

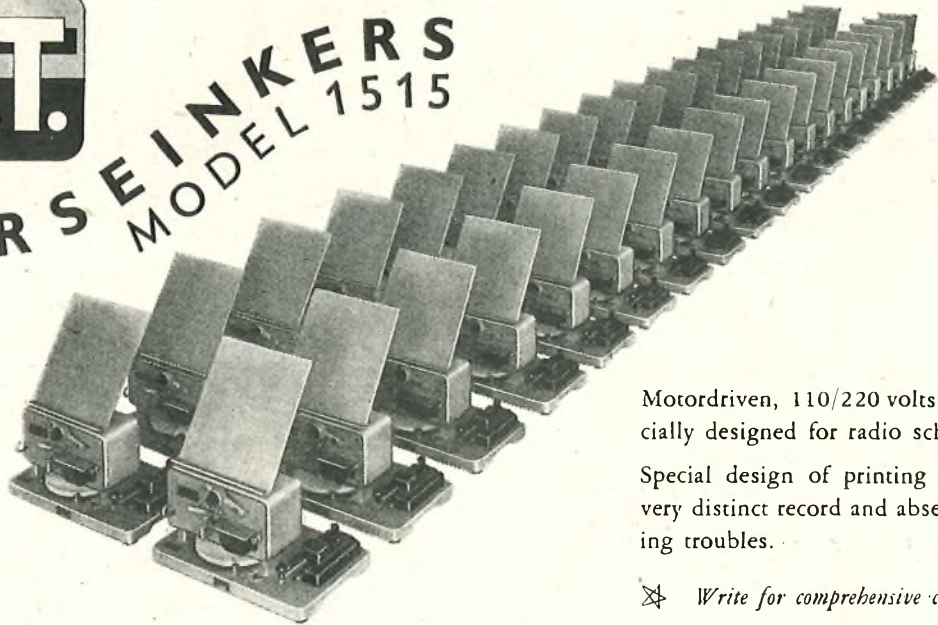

Motordriven, 110/220 volts A.C., especially designed for radio schools.

Special design of printing wheel gives very distinct record and absence of inking troubles.

✧ Write for comprehensive catalogue.

**THE GREAT NORTHERN TELEGRAPH COMPANY'S FACTORY**

4, SYDHAVNS PLADS  
COPENHAGEN SV . DENMARK



LONDON OFFICE: 5, ST. HELENS PLACE  
LONDON E.C.3.



**BEYOND THE BUTTON....**

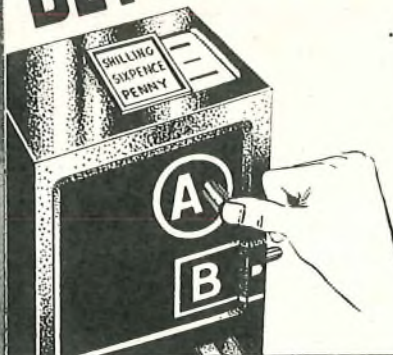

.... Hackbridge underground dry-core air-space lead covered and armoured cable.  
Contractors to G.P.O., British Railways, British and Colonial Government Departments.



**HACKBRIDGE**

*Cable Company Limited*

KELVIN WORKS, HACKBRIDGE, SURREY  
In Association with Bryce Electric Construction Company Ltd.

Branches at:  
Birmingham, Bristol, Cardiff, Manchester, Newcastle, Sheffield

# G.E.C. SELECTOR SE50

**COMBINES THE BEST IN THE "PRE-2000" SELECTOR**

Occupies the same space as the 2000 type.

Offers exceptional stability of adjustment.

Is easily adjusted when necessary, due to  
extreme accessibility.

Positive datum for all adjustments.

Absence of interdependent adjustments.

**..... WITH THE BEST IN THE "2000" SELECTOR**

*The Largest British Electrical Manufacturing Organisation*

# for the telephone services of the World

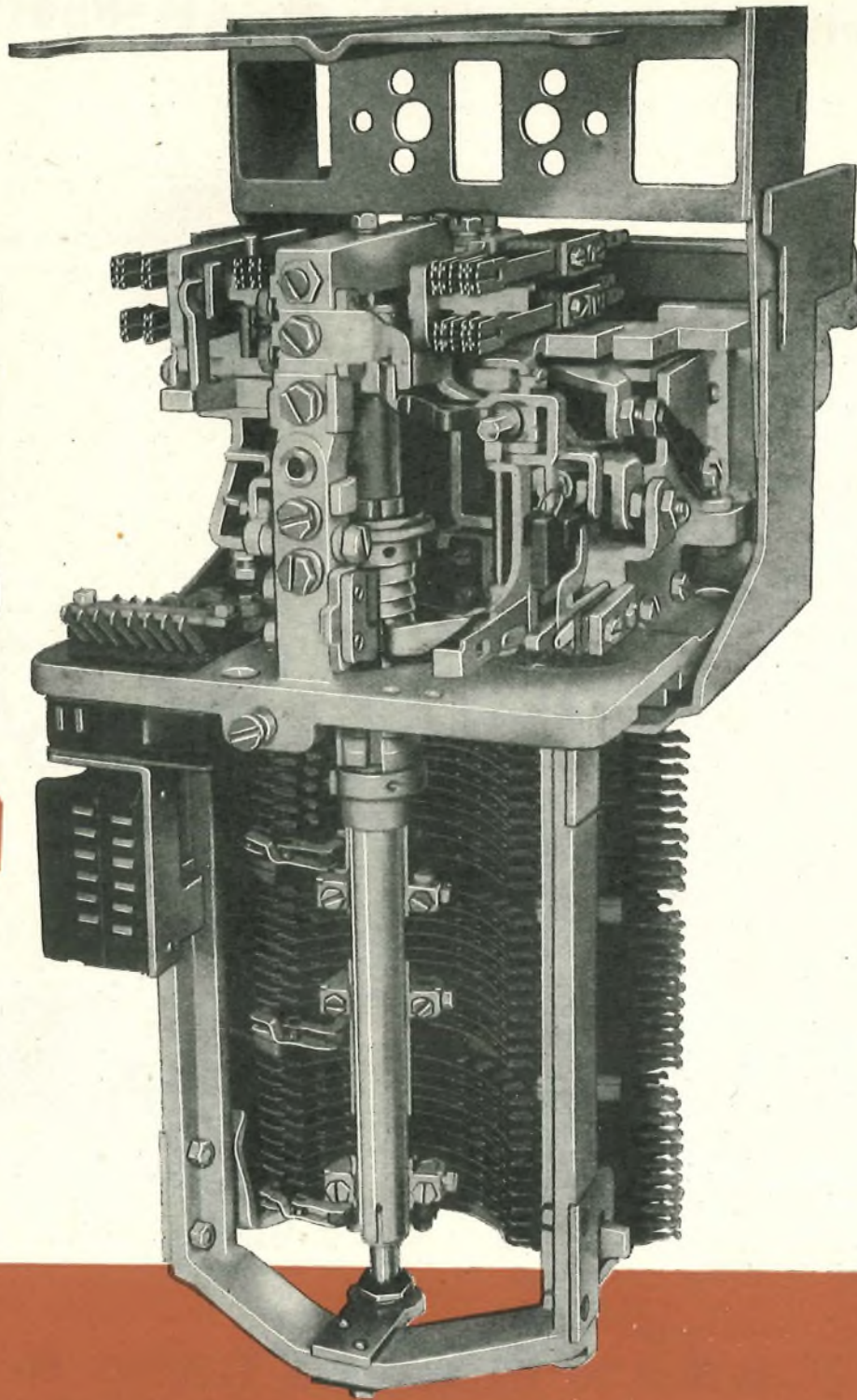

*Unit construction of magnet assemblies.*

*More efficient magnetic circuits.*

*B.P.O. 600 type springsets.*

*Direct operation of springsets.*

*Long-life wipers.*

*Simplified toggle interrupter.*

*Fixed main shaft.*

*Minimum flexing of main shaft during rotary stepping.*

*No wiper tube distortion.*

*No anti-bounce plate required.*

*Rotary overshoot practically eliminated.*

*Selector removable from shelf only when wipers are free of the bank.*

*Operates on original Strowger principles, allowing digit absorption.*

*Independent rotary release allows economical operation over large P.B.X. groups.*

*Lighter in weight than the 2000 type.*

THE GENERAL ELECTRIC COMPANY LTD., OF ENGLAND.

TELEPHONE, RADIO AND TELEVISION WORKS · COVENTRY · ENGLAND.

# ATE/TMC Type 600 Transmission

## Precision Measurement of Attenuation

This diagram shows the basic arrangement for measuring the loss of a filter by a comparison method. A signal derived from the oscillator is sent into the filter and a variable attenuator in parallel. By electronic switching the two attenuated signals which result are presented as adjacent rectangles of light on the screen of the cathode ray tube of the level comparator. The heights of these rectangles are proportional to the amplitudes of the respective signals. The standard attenuator, contained in the transmission measuring set, is adjusted until the two signals are shown by the comparator to be of equal amplitude. The final attenuator setting gives a direct reading of the loss of the filter. "Frequency runs" can be taken in a fraction of the usual time, by "sweeping" the oscillator frequency through the desired range and watching for variations of the signals displayed by the comparator. Fortuitous variations of output of the test oscillator are of no consequence since both amplitudes are affected in the same way.

The frequency range of the oscillator is 300 c/s to 160 kc/s, and when used with the level comparator the T.M.S. gives facilities for measurement of loss or gain of 70 db, with an accuracy of  $\pm 0.1$  db, in circuits of 600, 140 or 75 ohms impedance.

These three instruments form part of a comprehensive range covering the measurements of impedance, capacitance, singing point and crosstalk. All are arranged for mains or battery operation and are light, robust and portable. They are designed and constructed to the high standard of quality in material and workmanship which is a feature of all "ATM" products.

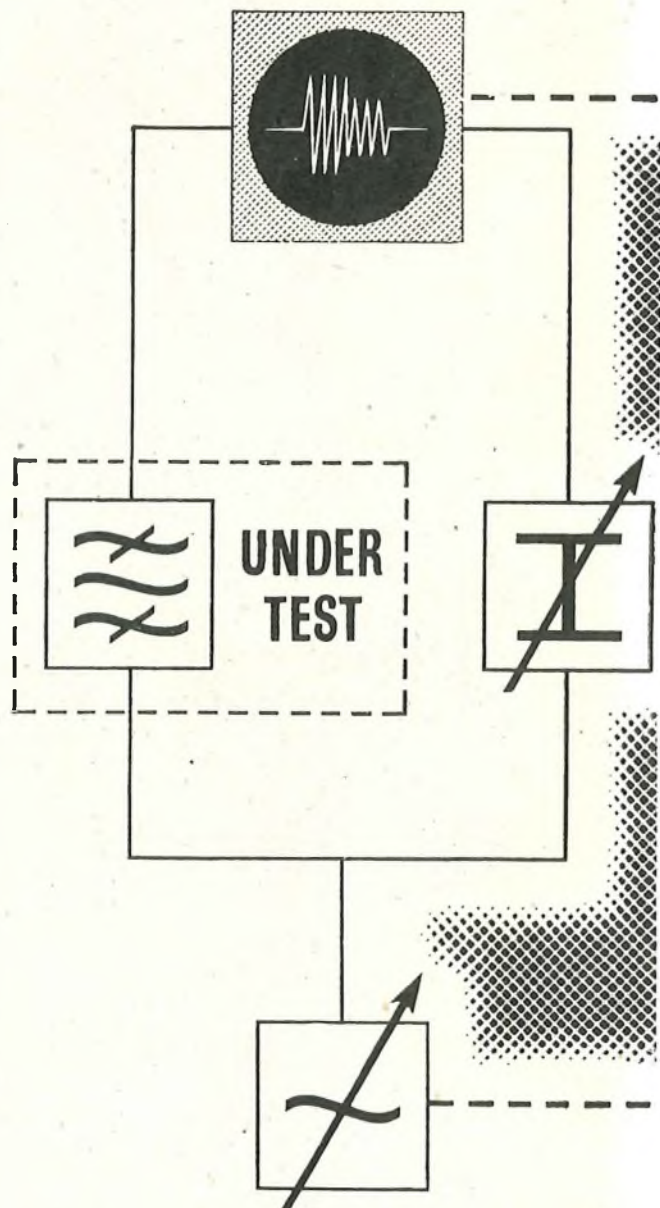

Distributors :—

**AUTOMATIC TELEPHONE & ELECTRIC CO. LTD.**

Radio and Transmission Division,  
STROWGER HOUSE, ARUNDEL STREET, LONDON, W.C.2.  
Telephone: TEMple Bar 9262. Cablegrams: Strowgerex, London.



# Testing Equipment...

or Gain by VISUAL Comparison



**LEVEL  
COMPARATOR**

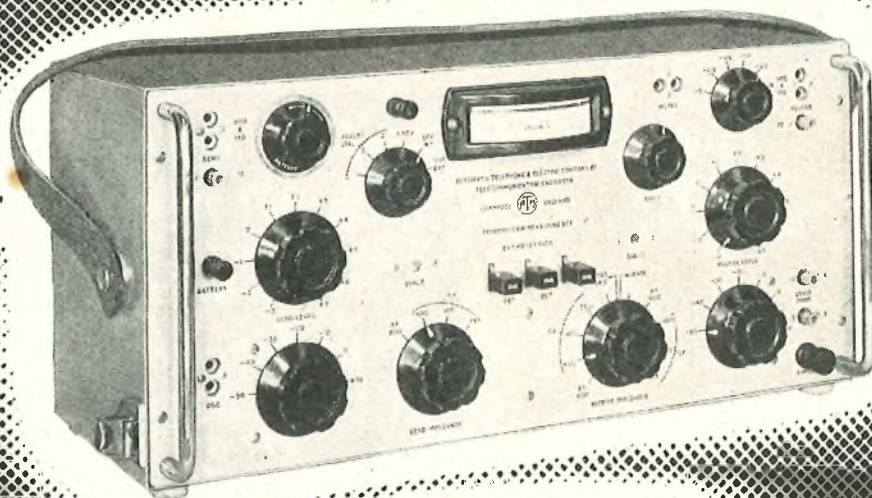

**TRANSMISSION  
MEASURING SET**

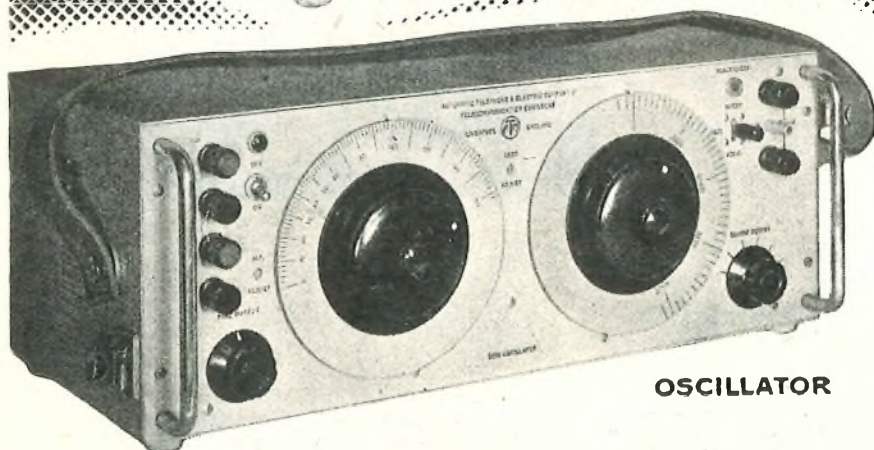

**OSCILLATOR**

Joint Manufacturers:—

**AUTOMATIC TELEPHONE & ELECTRIC CO. LTD., LIVERPOOL & LONDON**  
**TELEPHONE MANUFACTURING CO. LTD., ST. MARY CRAY, KENT.**

AT8421-AAX105

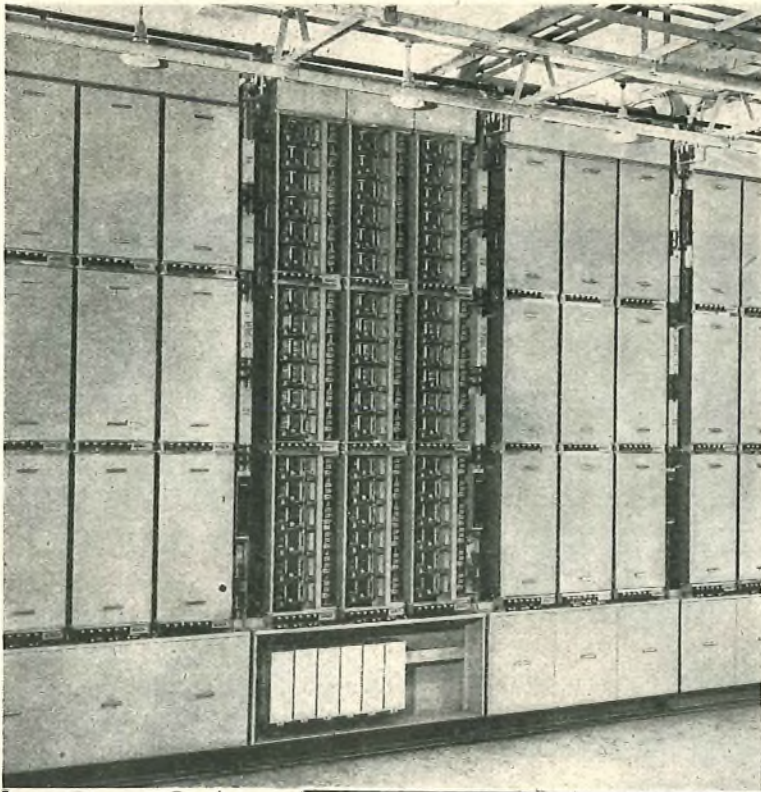

Fort Rouge Exchange, Winnipeg. Suite of Final Selector Racks with covers removed on one rack.

In addition to an extension of the equipment at Fort Rouge Exchange, orders are in hand for No. 17 M.A.X. Systems for installation at

<b>Kelowna. Penticton. Vernon.</b>	<b>British Columbia CANADA</b>
<b>Dauphin. Selkirk.</b>	<b>Manitoba CANADA</b>
<b>North Essendon</b>	<b>Victoria AUSTRALIA</b>
<b>Bulawayo</b>	<b>SOUTHERN RHODESIA</b>

The selectors in the No. 17 M.A.X. System are controlled directly from the dial. Apparatus of outstanding simplicity and reliability—mounted on covered racks—is one of the special features of this system which sets a new standard in low maintenance cost.

**SIEMENS BROTHERS & CO., LIMITED**  
WOOLWICH · LONDON · S. E. 18.

# MODERN CAPACITOR ENGINEERING

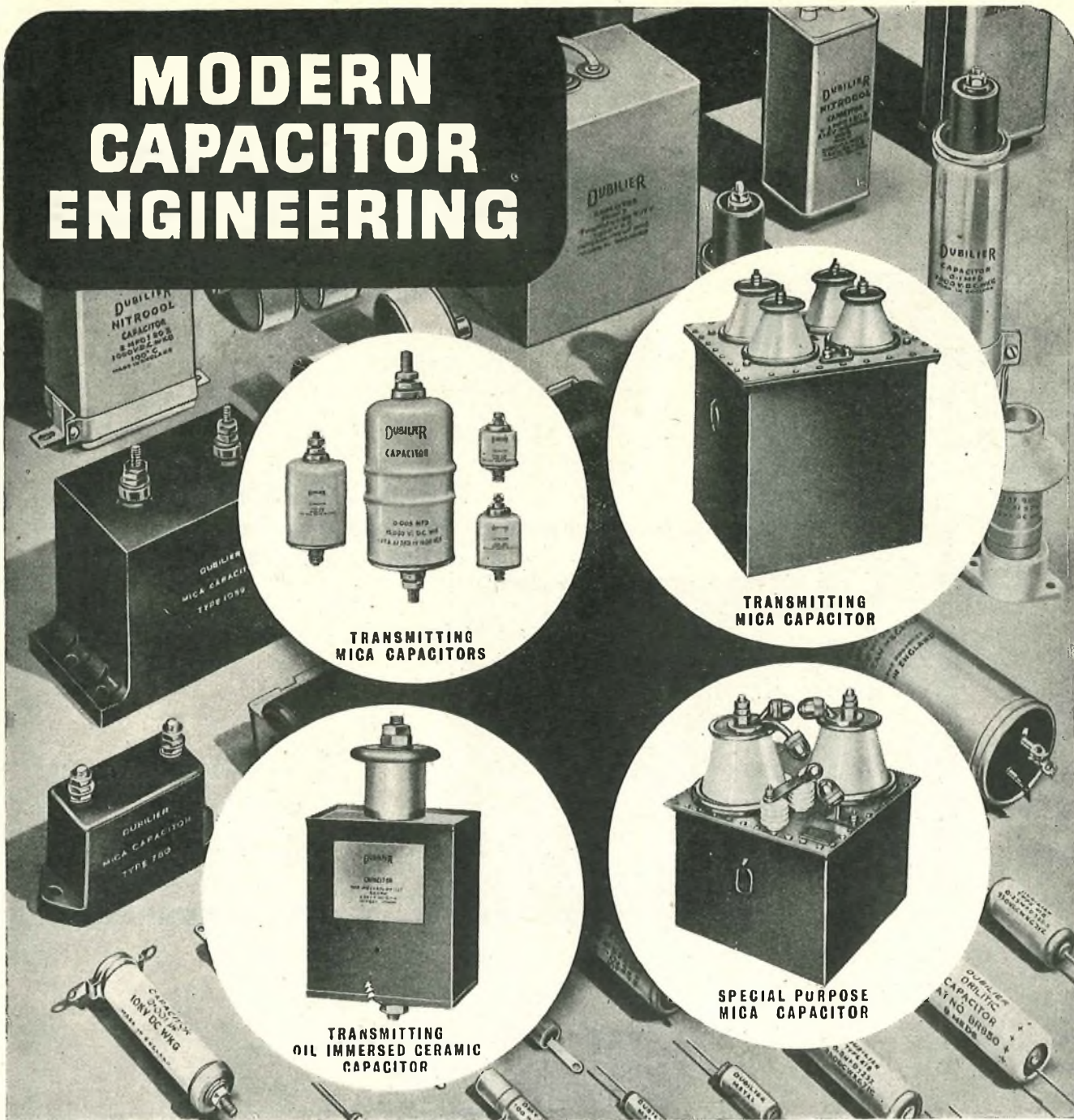

TRANSMITTING  
MICA CAPACITORS



TRANSMITTING  
MICA CAPACITOR



TRANSMITTING  
OIL IMMERSED CERAMIC  
CAPACITOR



SPECIAL PURPOSE  
MICA CAPACITOR

## DUBILIER CAPACITORS

Dubilier provide the most comprehensive range of Capacitors available today for Radio Transmitting and Receiving, in addition to Capacitors for Electronic and Industrial engineering.

Dubilier Capacitors are designed and manufactured to

a high standard of specification, suitability of purpose and meticulous capacitor engineering, and they satisfy the exacting demands of the British Postal Authorities whom we are proud to number amongst our customers.

Full details and technical service upon request.

**DUBILIER CONDENSER CO. (1925) LTD., DUCON WORKS, VICTORIA ROAD, N. ACTON, LONDON, W.3.**

'Phone: Acorn 2241 (5 lines).

Cables: Hivoltcon, London. Marconi International Code.

'Grams: Hivoltcon, Wespnone, London.

# Standard Radio

for

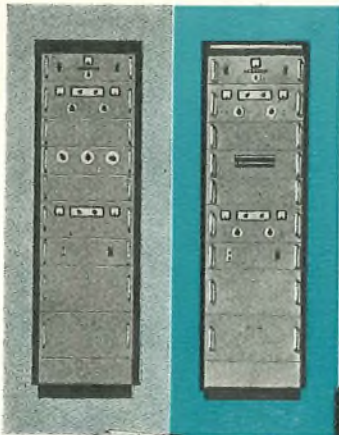

**VHF and UHF RADIO LINKS**  
complete with channel and terminating equipment, time sharing and frequency sharing

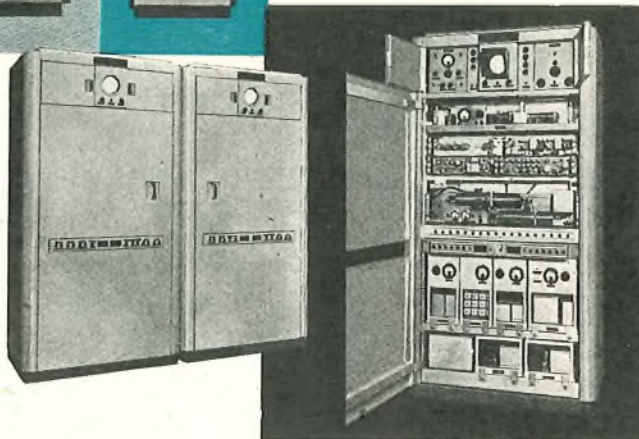

*Standard* engineers  
are always available  
for consultation on any problem  
connected with  
**telecommunications**

**MF, HF and VHF BROADCASTERS**  
and associated equipment

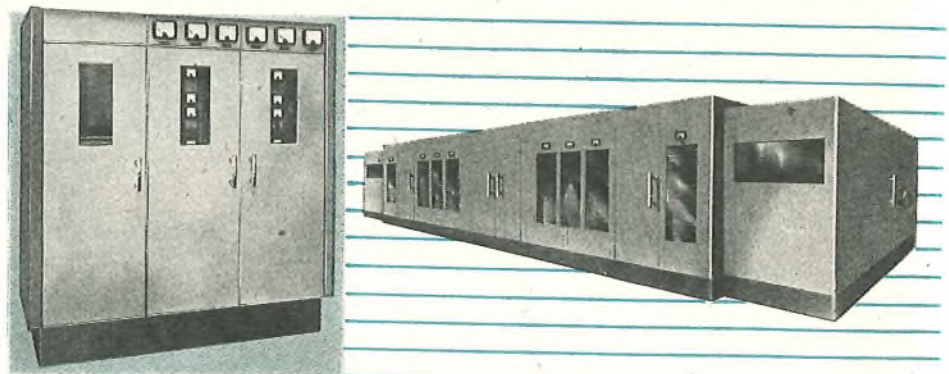

*Standard Telephones and Cables Limited*

Registered Office: Connaught House, Aldwych, London, W.C.2.

**HF RADIO COMMUNICATION**  
complete systems

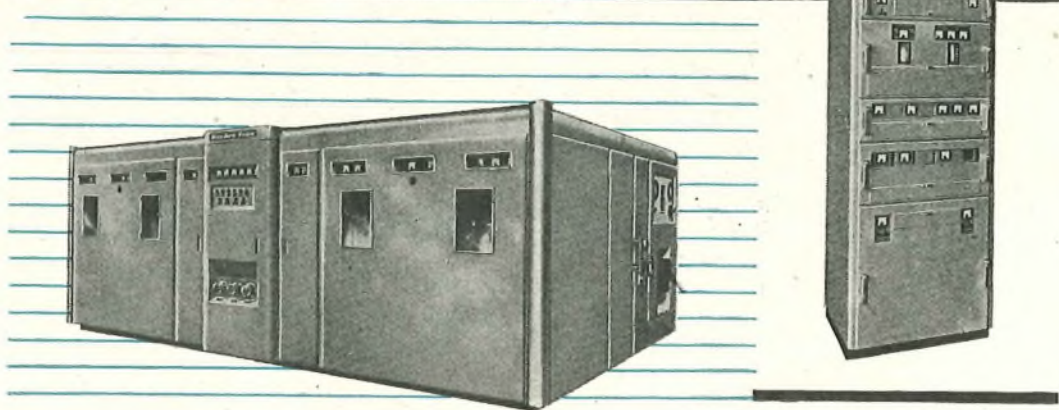
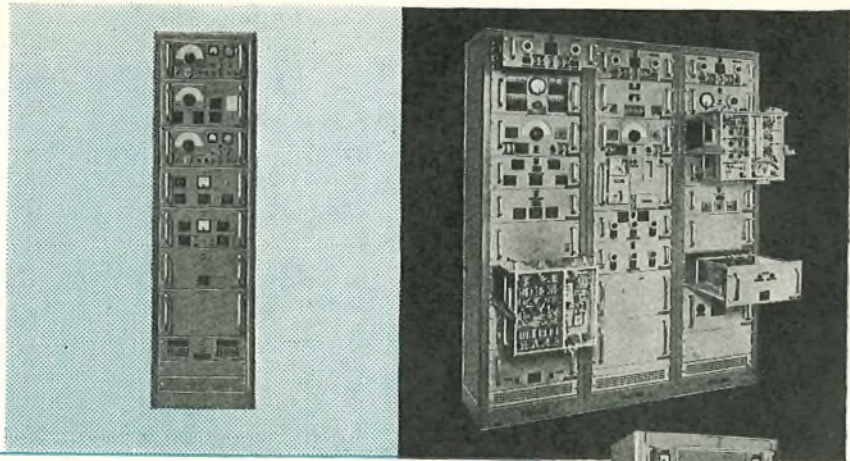

**MOBILE COMMUNICATION EQUIPMENT**  
air and ground

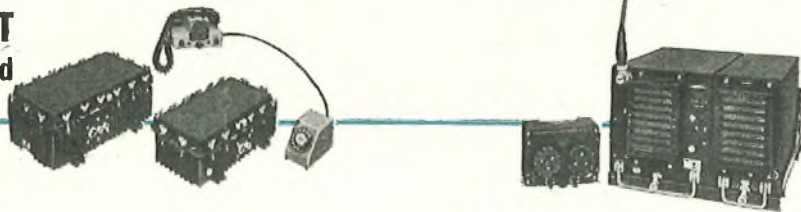

**TELEVISION**  
sound and vision transmitters

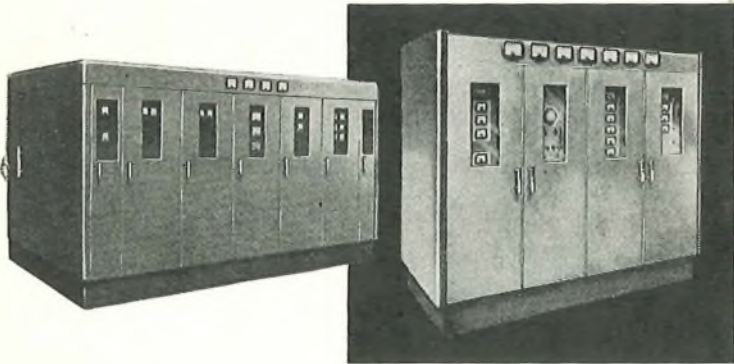

**NAVIGATIONAL AIDS**  
air and ground

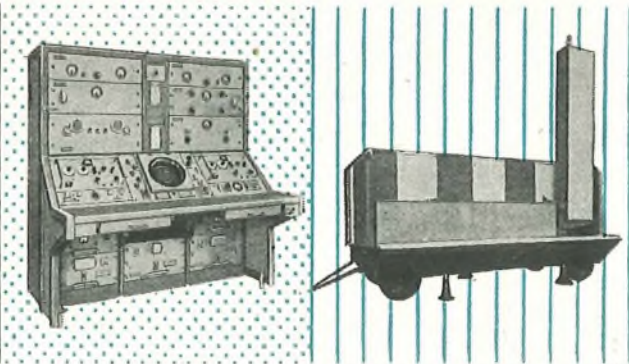

RADIO DIVISION, OAKLEIGH ROAD, NEW SOUTHGATE, LONDON, N.11

**FOR E.H.T. Supplies**

Type 36EHT rectifiers contain high-voltage "Westalite" elements resulting in a greatly reduced length of unit for any given output. They have been developed to meet the demand for small, compact metal rectifiers to provide E.H.T. in many forms of equipment where the current demand is unlikely to exceed 2 mA D.C., as, for example, cathode ray tubes, electron multipliers, condenser storage devices, etc.  
For further information and tables of outputs of these . . .

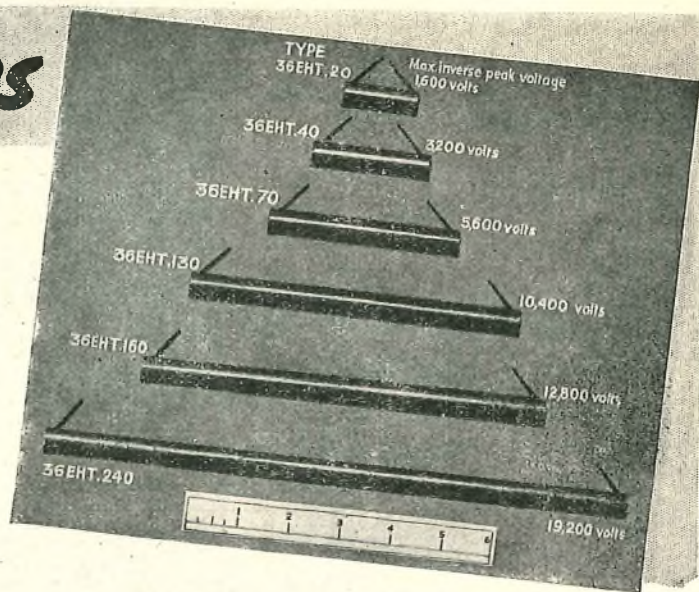

**WESTINGHOUSE**  
**WESTALITE**

## 36EHT MINIATURE HIGH-VOLTAGE RECTIFIERS

write for Data Sheet No. 60 and metal  
rectifiers for E.H.T. supplies to . . .

Dept. P.O.I,  
WESTINGHOUSE BRAKE & SIGNAL CO., LTD., 82 York Way, King's Cross, London, N.1

SULLIVAN & GRIFFITHS

### DIRECT READING VARIABLE CONDENSERS

WITH NOVEL AIR CAPACITANCE  
DECADE RANGE EXTENSION

This air dielectric condenser comprises a decade of air capacitance and a continuously variable air condenser thus giving a scale accuracy ten times that of an ordinary variable condenser of the same range.

Thus a decade of capacitance is provided—permanent in value and entirely free from loss, the only loss present in the complete combination of decade and variable condenser being that due to the solid insulating material which is ordinarily employed in the construction of the latter.

The variable condenser has a range of  $100\mu\mu\text{F}$  which is extended to  $1100\mu\mu\text{F}$  by ten increments of  $100\mu\mu\text{F}$ , all adjusted with accuracy so that the decade is absolutely direct reading in  $\mu\mu\text{F}$ , no corrections or calibration being necessary.

## Electrical Standards for Research and Industry

Testing and Measuring Apparatus  
for Communication Engineering



LIST No. C880

H. W. SULLIVAN, LTD., LONDON, S.E. 15.

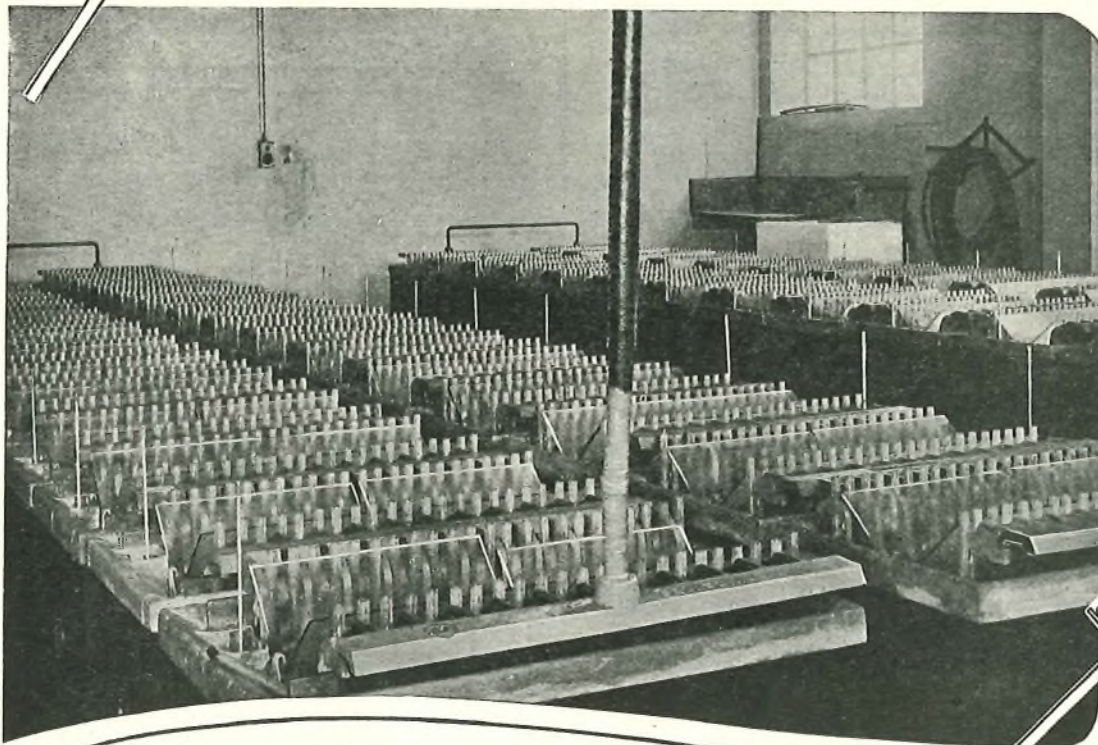

## POWER BEHIND THE LINES

**TUNGSTONE PLANTÉ CELLS** are being supplied to the British Post Office and Post and Telegraph Departments in many countries overseas. They conform fully to G.P.O. and British Standard specifications.

### OPEN TYPE CELLS

Similar to the illustration above, these are available in glass and/or lead lined wooden boxes in capacities from 100 a.h. to 500 a.h.

### REPLATALS

We are in a position to supply plates for the replating of any existing Planté Battery.

### ENCLOSED TYPE CELLS

As illustrated on the right, these are in moulded glass boxes with sealed-in lids. Capacity range from 10 a.h. to 200 a.h.

### HIGH VOLTAGE TELEPHONE BATTERIES

Portable Type. Standard layout for 50 volts, in waxed hard wood crates, exactly to the requirements of the G.P.O.

*Overseas customers are invited to cable or write their enquiries for batteries or parts. Visitors to London are welcome at our offices.*

# TUNGSTONE Batteries

For further particulars write : **TUNGSTONE PRODUCTS LIMITED**  
10 SALISBURY SQUARE · LONDON · E.C.4 · ENGLAND. Cables: "Dilutum" London.

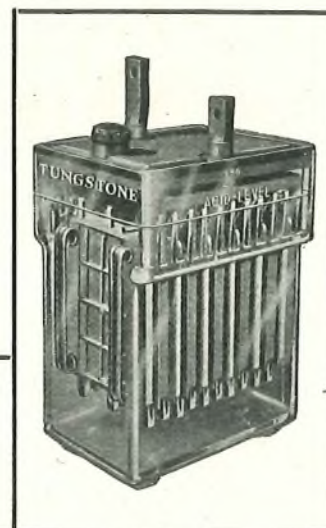

T.B.12

# SUCCESS?

The demand for qualified technicians to fill well-paid industrial posts grows daily. An E.M.I. course of training is your quickest way to a key position. Our Home Study courses cover all the subjects listed below. As part of the great E.M.I. Group ("H.M.V.", Marconiphone, etc.), we have first-hand knowledge of the Technical Training required in modern industry. No other college can offer you such a practical background of industrial experience.

**POST THIS COUPON NOW**

E.M.I. INSTITUTES, Postal Division, Dist. 97,  
43, GROVE PARK ROAD, CHISWICK, LONDON, W.4.

Please send, without obligation, your FREE BROCHURE  
I have marked the subjects which interest me.

Mechanical Eng.  Electrical Eng.  Draughtsmanship  
 Radio  Television  Production Eng.  Automobile Eng.  
 Aeronautical Eng.  General Cert. of Education (Metric.)  
 Civil Service. Also Courses for A.M.I.Mech.E., A.M.I.C.E.,  
A.M.Brit.I.R.E., A.F.R.Ae.S., CITY and GUILDS EXAMS. in Mech. Eng.,  
Elect. Eng., Telecommunications, etc.

NAME .....

ADDRESS .....



**E.M.I. INSTITUTES** — The College backed by an Industry

## PITMAN'S

*for Technical Books*



### Electrical Engineering

*Theory and Practice* (3 vols.)

Edited by Philip Kemp, M.Sc.Tech., M.I.E.E.; assisted by over 40 expert contributors. This notable work forms an up-to-date library of information on all aspects of electrical engineering. In three large volumes, it takes the place of a whole series of textbooks and reference works. With over 2,000 illustrations. £10 net per set. "The price of the publication in our view is a small one, having regard to the value of the authoritative information it provides."—*Electrical Review*.

### Telephony (2 vols.)

By J. Atkinson, A.M.I.E.E., Area Engineer, Post Office Engineering Dept. A standard textbook for Post Office engineers and students. Over 1,500 illustrations. Vol. I (General Principles and Manual Exchange Systems), 35/- net. Vol. II (Automatic Exchange Systems), 50/- net.

### Telecommunications Principles

By R. N. Renton, M.A.I.E.E. A useful work covering the syllabus for the City and Guilds examinations in Telecommunications Principles, Grades I, II and III. Illustrated. 37/6 net. "Good value . . . can be recommended confidently to all students of Telecommunications."—*Post Office Telecommunications Journal*.

**PITMAN**, Parker Street, Kingsway, London, W.C.2

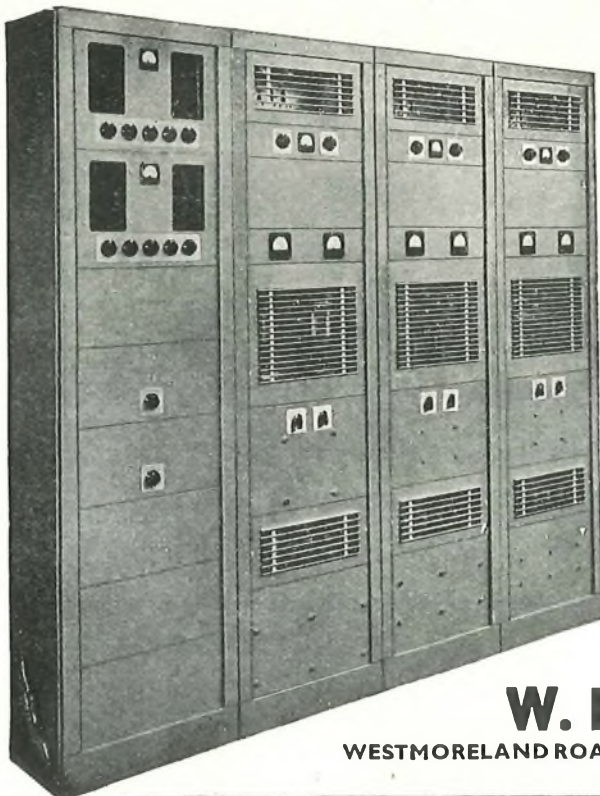

## The Mark II series of SAVAGE AMPLIFIERS for Broadcast Relay

● These Amplifiers are examples of what careful design can achieve. A lift-off back panel affords immediate access for maintenance purposes and the removal of six screws releases the side covers of the rack and exposes all the interpanel wiring. Even when the rack is sandwiched between others the side covers can be moved just as easily. All valves are accessible from the front of the rack, and are protected by quick release grilles. The rack is completely flat fronted. The general appearance is further enhanced by the absence of a projecting front foot, and the masking of all panel fixing bolts. Similar racks carrying auxiliary apparatus can be placed side by side with amplifiers so that the whole installation is uniform in appearance. Complete specifications available on request.

## W. BRYAN SAVAGE LIMITED

WESTMORELAND ROAD · LONDON N.W.9 · TELEPHONE: COLINDALE 7131



From Alton go batteries to power stations all over the world. Batteries, as their distant users tell us, that possess a certain distinctive merit all their own. Surprising, in these days of uniformity and standardisation? But Alton, in such an age, is perhaps a surprising place. Alton's a small country town, with a friendly, satisfying life of its own. A natural place unchanged, unspoiled, where the surrounding streams run down through lovely and varied country to feed the river Itchen pictured below. Where a man at leisure can follow his bent, be it sport or hobby or just plain peace of mind. Where a life worth living, a job worth doing are any man's natural right : and pride in himself and the work of his hands is a wholly natural consequence.

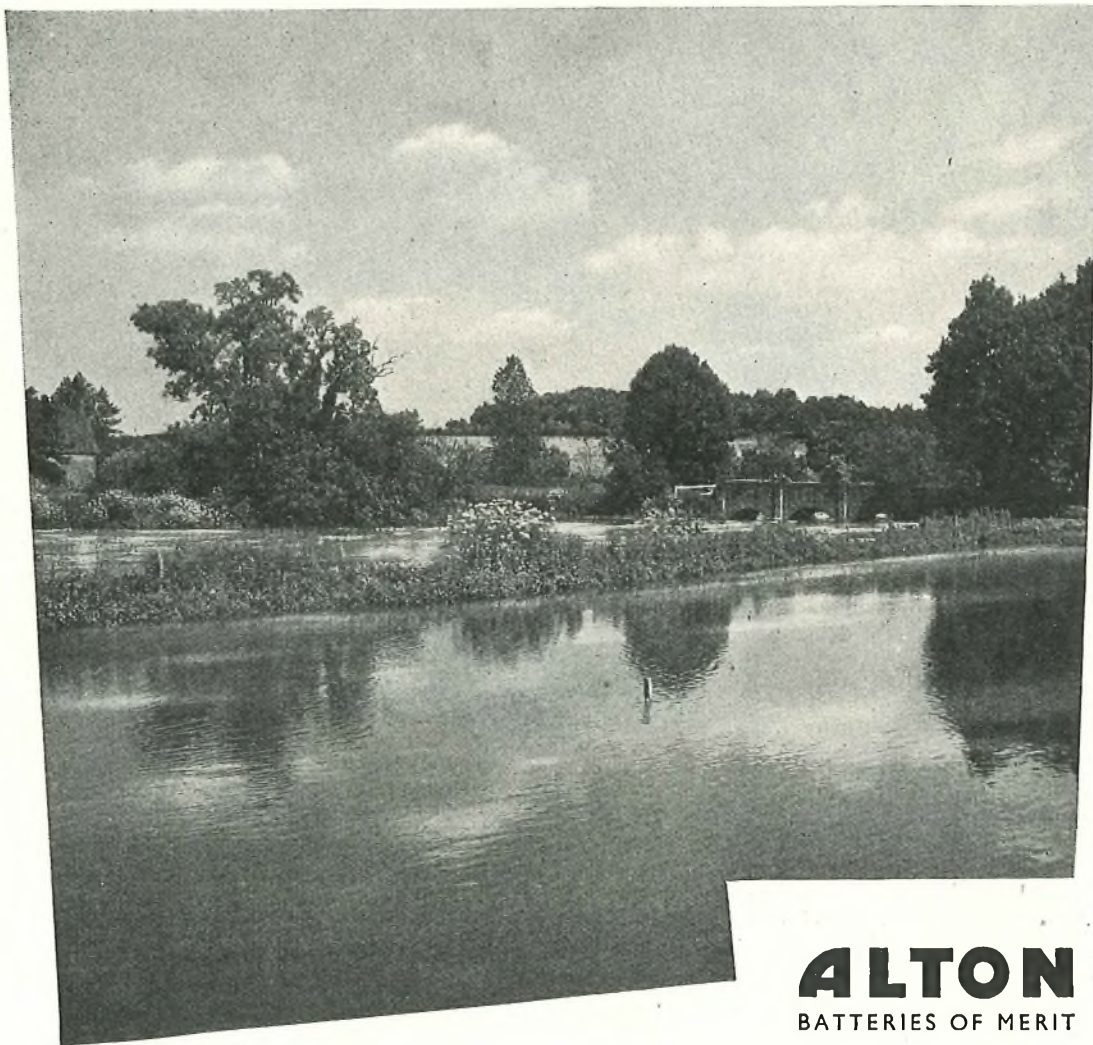

**ALTON**  
BATTERIES OF MERIT

Alton stationary batteries: 10 to 15,000 Ah. Also in regular production, renewal plates for all makes of battery, British and Continental

A23A

The Alton Battery Company Limited · Alton · Hants · Telephone: Alton 2267 and 2268 · Telegrams: Battery, Alton

**Creed**



No. 47 Tape Model Teleprinter

No. 7 Page Model Teleprinter

**printing  
telegraph  
systems**

**Creed & Company Limited**  
TELEGRAPH HOUSE · CROYDON · ENGLAND

Build your own  
equipment with

# DEXION

SLOTTED ANGLE

- ★ Can be used over and over again
- ★ No drilling, measuring or painting
- ★ Just cut it and bolt it, that's all

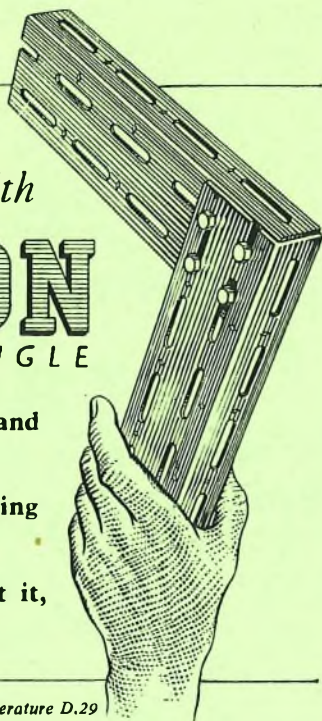

Write or phone for illustrated literature D.29

## DEXION LIMITED

Triumph House, 189 Regent Street, London, W.1.

TELEPHONE: REGENT 4841-5

## SOUND INSTRUCTION by Postal Method

The I.C.S., largest school in the world devoted to spare-time training by the postal method, offers you highly specialised Courses for the following examinations:

- P.M.G. Certificates for Wireless Operators.**
- C. & G. Illumination Engineering (Inter.)**
- C. & G. Electrical Engineering Practice, Installation and Telecommunications.**
- Graduateship of the B.I.R.E.**

*I.C.S. Examination students are coached till successful.*

Other Courses meet the requirements of all who desire to qualify for responsible positions in Electric Power, Illumination, Heating and Traction Systems. Equally successful is our instruction for Telegraph and Radio Engineers, Radio Servicemen, and in Elementary Radar and Electronics, Advanced Short-Wave Radio and Television Technology.

Instruction is by correspondence from textbooks specially prepared by many experts.

**WRITE FOR OUR SPECIAL BOOKLET** and state the particular subject or Examination in which you are interested.

Generous Discount granted to members of H.M. Forces.

**YOU MAY USE THIS COUPON**

### International Correspondence Schools Ltd.

Dept. 108, International Buildings, Kingsway, London, W.C.2

Please send me, free of charge, your special booklet on.....

Name..... Age.....

(BLOCK LETTERS, PLEASE)

Address.....

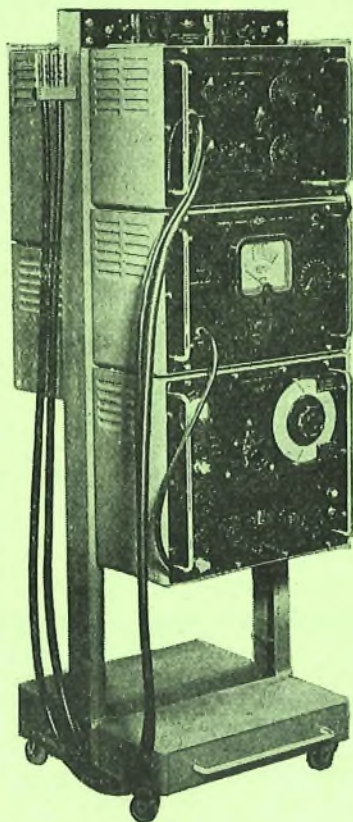

## PHASE MEASURING EQUIPMENT

Type RX 103

This equipment, which is based upon a Post Office design, is primarily intended for the measurement of the phase-shift and gain of the  $\mu\beta$  characteristics of feedback repeaters, over the frequency range of 50 kc/s to 20 Mc/s. It is also suitable for similar measurements on amplifiers, filters, equalisers and other four-terminal networks.

### AIRMEC LABORATORIES LTD

HIGH WYCOMBE · BUCKINGHAMSHIRE · ENGLAND

TEL. HIGH WYCOMBE 2060

CABLES: AIRMEC HIGH WYCOMBE

A. I. 1014

# TELEPHONE DISTRIBUTION

## EQUIPMENT

ENGINEERS WHO ARE INTERESTED  
IN TELEPHONE DISTRIBUTION EQUIP-  
MENT ARE INVITED TO REQUEST  
SECTION T.C.13 OF OUR TELECOM-  
MUNICATION CABLES CATALOGUE.

TELEPHONE  
SOUTHAMPTON  
2141 (5 lines)

**IRELLI-GENERAL**  
CABLE WORKS, Ltd., SOUTHAMPTON.

TELEGRAMS  
"PIGEKAYBEL"  
SOUTHAMPTON

# EDISWAN

## Telephone Line Protectors

*FOR THE PROTECTION OF LINES OF  
COMMUNICATION FROM SURGES INDUCED  
BY LIGHTNING OR FAULTS ON  
NEIGHBOURING POWER LINES*

Ediswan Telephone Line Protectors have now been in commission for nearly twenty years. They have proved their worth in all parts of the world and are being called for and installed in ever increasing numbers. Many thousands were employed during the war years for the protection of vital lines of communication and were eminently successful. Reports of their outstanding merit and successful operation continue to reach us and in recent years they have proved of particular interest for protection against surges caused by lightning discharges.

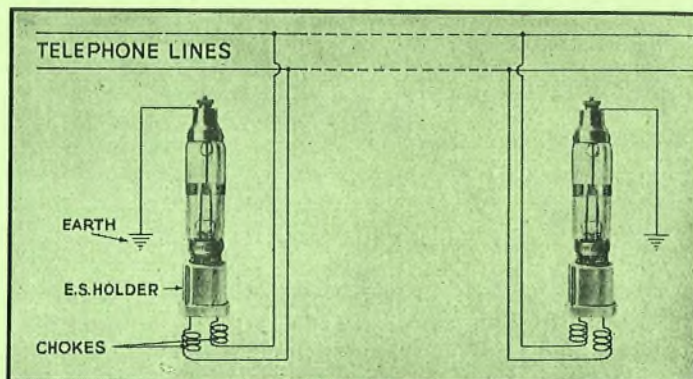

Continued research has enabled us to patent a further improvement which removes any suggestion of delay in operation.

*Further information and prices on application.*

**THE EDISON SWAN ELECTRIC CO. LTD., 155 CHARING CROSS ROAD, LONDON, W.C.2**

Member of the A.E.I. Group of Companies

T.E.3