

THE POST OFFICE ELECTRICAL ENGINEERS' JOURNAL

VOL. 40

APRIL, 1947

PART I

CONTENTS

	PAGE
THE RECONSTRUCTION OF LEAFIELD LONG WAVE RADIO MASTS—Part 1—Design Problems—J. P. Harding, B.Sc.(Eng.), A.M.Inst.C.E., A.M.I.E.E., and J. F. Harmon	1
STANDARDS OF TRANSMISSION AND LOCAL LINE LIMITS—Part 2—The Effective Transmission Technique—E. J. Barnes, A.C.G.I., A.M.I.E.E., A. E. Wood, B.Sc.(Eng.), A.C.G.I., D.I.C., and D. L. Richards, B.Sc.(Eng.), A.M.I.E.E.	8
SOME FEATURES OF DEEP LEVEL TUNNELLING IN LONDON—Part 2—Engineering Services—W. F. Boryer, A.R.C.Sc., M.I.E.E.	14
THE CENTRAL TRAINING SCHOOL, STONE—C. E. Calveley, O.B.E., B.Sc., M.I.E.E.	19
SOME NOTES ON TELEPHONE SWITCHING DEVELOPMENT IN SWEDEN—Capt. J. Legg, B.Sc., A.M.Inst.C.E., A.M.I.E.E.	25
REORGANISATION OF THE SKILLED WORKMAN AND INSPECTORATE CLASSES—L. F. Scantlebury, Whit.Sch., A.C.G.I., D.I.C., A.M.I.E.E.	28
THE PROVISION IN LONDON OF TELEVISION CHANNELS FOR THE B.B.C.—H. T. Mitchell, M.I.E.E.	33
FLOODS AT CRIGGION RADIO STATION	37
NOTES AND COMMENTS	38
REGIONAL NOTES	41
JUNIOR SECTION NOTES	45
STAFF CHANGES	46
BOOK REVIEWS	24, 32, & 48

Price 1/- net

THE INSTITUTION OF POST OFFICE ELECTRICAL ENGINEERS

GE CALLOY

RADIO CORES



Send for
New List
1944

SALFORD ELECTRICAL INSTRUMENTS LTD.

PEEL WORKS, SALFORD, 3. Telephones : BLAckfriars 6688 (6 lines). Telegrams and Cables : "Sparkless, Manchester"
PROPRIETORS: THE GENERAL ELECTRIC Co. Ltd., OF ENGLAND

EDISWAN

TELEPHONE LINE PROTECTORS.

FOR THE PROTECTION OF LINES OF COMMUNICATION FROM SURGES INDUCED BY LIGHTNING OR FAULTS ON NEIGHBOURING POWER LINES.

Ediswan Telephone Line Protectors have now been in commission for nearly twenty years. They have proved their worth in all parts of the world and are being called for and installed in ever increasing numbers.

Many thousands were employed during the war years for the protection of vital lines of communication and were eminently successful. Reports of their outstanding merit and successful operation continue to reach us and in recent years they have proved of particular interest for protection against surges caused by lightning discharges.

Continued research has enabled us to patent a further improvement which removes any suggestion of delay in operation.

Further information and prices on application.

THE EDISON SWAN ELECTRIC CO., LTD.
155 CHARING CROSS ROAD, LONDON, W.C.2

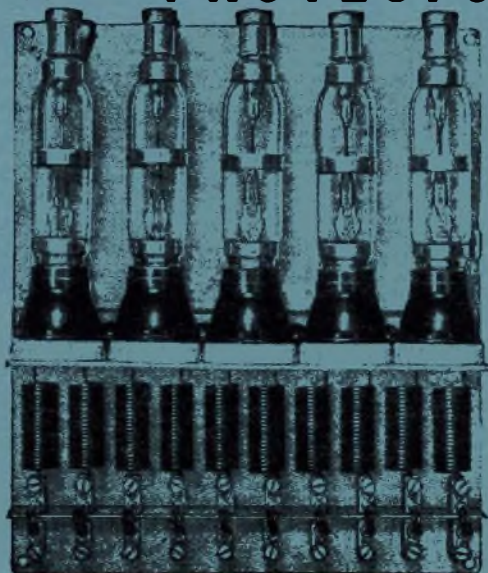

Prov. Patent
25850 45.

5-circuit
panel for
overhead
lines incor-
porating
choke
coils, spark
gaps, etc.

T.F.2

THE POST OFFICE ELECTRICAL ENGINEERS' JOURNAL

Vol. XL

April, 1947

Part I

The Reconstruction of Leaffield Long Wave Radio Masts

J. P. HARDING, B.Sc.(Eng.), A.M.Inst.C.E., A.M.I.E.E.
J. F. HARMON

U.D.C. 621.315.668.3 : 621.396.67

Part I.—Design Problems

The first part of this article deals with the considerations which led to the decision to reconstruct in reinforced concrete the long-wave masts at Leaffield Radio Station, and the design problems which this entailed. The second part of the article will describe the operations on site.

Introductory.

THE ten 305 ft. masts at Leaffield radio station were erected in 1912 by the Marconi Wireless Telegraph Co. as part of a chain of ten long-wave radio stations ("The Imperial Scheme") to be constructed in various localities throughout the British Empire. For various reasons, among them the improved reception being obtained with short waves, the programme was not completed, and the aerials were at first used only for experimental purposes. After transference of the installation to the Post Office in 1914, the aerials were brought into use for long-wave services, at first by Poulsen arc and later by valve transmitters.

Existing Masts.

The masts, which are of tubular steel construction, as shown in Fig. 1, are supported by wire rope stays at four levels, four stays disposed at 90° in plan being used at each level. Except at the base and at taper sections, each mast is built up from half-tubular lengths 10 ft. long and $\frac{3}{8}$ in. thick, each containing longitudinal and circumferential flanges. Circular plates, $\frac{1}{2}$ in. thick and of diameter equal to the external diameter of the circumferential flanges are interposed horizontally between each section. An aperture 16 in. square is cut in each plate. The longitudinal flanges are alternately staggered at each bolted section as shown. The external diameter of the mast (excluding flanges) is 2 ft. 6 in. up to 170 ft. and 2 ft. from this level to the top. At the base the mast rests on a substantial concrete foundation, the lowest tubular steel section being bolted to a system of rods embedded in the concrete. Although regular painting of the external surface had been carried out, treatment of the interior is more difficult,

since although access to the interior of the masts is possible via a manhole entrance near the base, the working space is exceedingly restricted as is evident from the dimensions quoted. Notwithstanding, attempts had been made to apply protective coatings throughout the interior of the masts.

Recent inspection of the masts, however, revealed that in some instances the cylindrical steel plating had seriously corroded—in parts right through. Corrosion was worst inside, near the circumferential flanges. This would be expected since, from condensation, water would collect at the diaphragm plates; further, since the circumferential flanges were formed from hot pressings, the metal at these points is somewhat reduced in section and, having been strained, is probably more prone to corrosion on this account. Inspection and test of wire rope stays as recovered from a mast showed that a certain

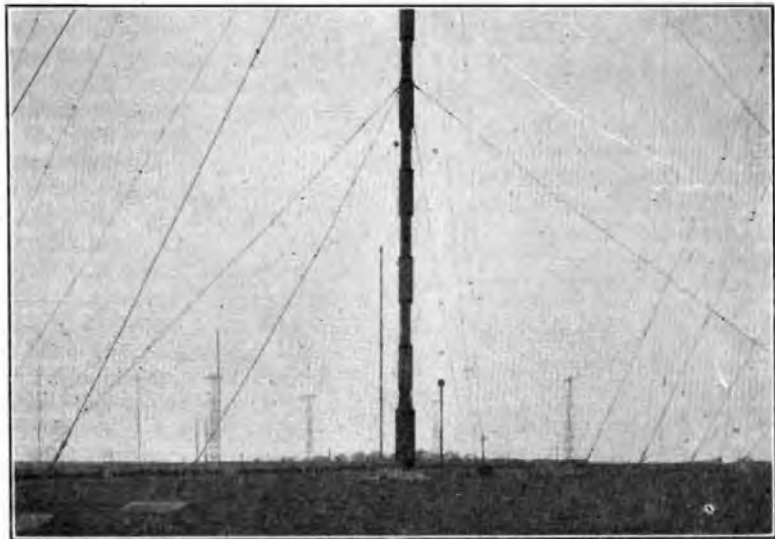

FIG. 1.—LOWER SECTION OF MAST PRIOR TO RECONSTRUCTION.

corrosion and loss of strength had occurred in the stays, although this was much less serious than in the tubular sections of the mast. Thus a galvanised wire rope stay, 2½ in. circumference, constructed of six strands of 19 wires over a hemp core showed, when tested after 30 years' service, ultimate strengths of between 24 and 26 tons compared with an estimated strength when new of 28 tons.

Methods of Reconstruction.

The extent and nature of the corrosion of the masts imperilled their safety under storm conditions, and either strengthening or renewal was urgently required. Although replacement of the ten existing masts by a smaller number of higher self-supporting masts would probably have been decided upon in normal times, the considerable expenditure of steel and labour which this would have entailed prohibited such a course in war-time. As a consequence, possible methods of reconstructing the existing structures were examined. Reconstruction in reinforced concrete was thus considered when three alternatives were presented:—

- (a) The existing tubular steel structure could be filled internally from top to bottom with concrete suitably reinforced by embedded steel rods.
- (b) 1. Concrete could be applied externally throughout the height of a mast in the form of an annular coating, reinforcing rods either passing through drillings in the circumferential flanges or through certain bolt holes after recovery of bolts.
2. Alternatively, reinforcement could be placed outside the circumferential flanges although this might entail application of a greater thickness of concrete than would otherwise be necessary.
- (c) Concrete could be placed both internally and externally but reinforcement used only as for (b).

The structural and practical implications of these three methods were examined in detail and, although all were feasible and would have permitted the design of a satisfactory structure, method (b) 1 was most economical in steel and concrete and enabled supervision of the work to be carried out most effectively, particularly in the correct fixing of reinforcement and consolidation of the concrete. Finally, this method permitted retention of the advantage of interior climbing until such time as further corrosion rendered this course unsafe. It should be mentioned that, due to the superior aerodynamical shape of a smooth cylindrical form compared with the projecting bolted flanges of the existing masts, the method of external concreting using an annular thickness of concrete of between 6 and 8 in., as envisaged, was not likely to involve increased wind loads from the additional overall diameter of the sections.

Method (b) 1 was decided upon and a final detailed design undertaken. Clearly, this required to be such that, not only would the finished structure withstand its imposed loads with an appropriate factor of safety, but also that all work should be carried out in such a way that additional loads during recon-

struction on the existing structure, already pronounced weak, should be kept at a minimum. For each mast approximately 70 cubic yards (120 tons) of concrete were involved which necessitated some form of mechanical hoisting. Renewal of all stays (160 stays in all) had been decided upon in view of the age and condition of existing stays and, because at no time could a mast be permitted to remain with a stay removed, operations had to be arranged so that new stays could be erected at the various levels and tensioned before the existing stays were recovered. Work at the mast head, to which further reference will be made in Part II of this article, presented special difficulties since the whole of the reconstruction work had to be carried out during transmission periods and precautions taken to minimise as far as possible the danger of shock when working in intense electric fields.

DESIGN.

Wind Loads.

A survey of the highest wind velocities recorded at meteorological stations near the site showed maximum values of 88 and 90 m.p.h. at an effective height¹ of about 100 ft. In the determination of the wind pressure on radio masts of small mass-to-stiffness ratio, it is important that the maximum wind velocities allowed should include gusts of short duration. Since there is some doubt whether the anemometers used at most British stations are capable of accurately recording these, a maximum velocity of 100 m.p.h. at ground level was allowed in the design. The increase of wind velocity with height has been investigated by Wing,² Hellman,³ Shaw⁴ and others. From these measurements it may be concluded that a wind velocity of 110 m.p.h. may be expected up to about 100 ft. and 120 m.p.h. from about 100 to 300 ft. Messrs. Dryden and Hill⁵ have conducted measurements of the wind pressures on cylindrical shapes. Their recorded figures, applied to the wind velocities quoted, give respective pressures of 28 and 32 lb. per sq. ft. Although, in practice, the full maximum values of the estimated pressures as quoted above may not occur simultaneously, it would not be prudent to allow any reduction on this account. On the other hand, stability of the mast must be ensured if any combination of reduced wind pressures should occur varying within these limits. For example, it is likely that maximum wind pressures may occur in the upper sections of the mast while the lower sections are subject to a much reduced pressure; additionally, the direction of the wind may vary considerably over the length of the mast.

¹ The effective height is that at which an anemometer records an equal mean velocity in a situation free from obstructions.

² "Wind Pressures and the Design of Radio and High Transmission Towers." *Electrician* (1921), 87.6, by S. P. Wing.

³ "Preuss. Akad." *Wiss.*, Berlin 10 (1917) by G. Hellman.

⁴ "Manual of Meteorology," Part IV, by Sir Napier Shaw.

⁵ "Wind Pressure on Circular Cylinders and Chimneys."—Research Paper No. 221 (1930). U.S. Dept. of Commerce (Bureau of Standards) by H. L. Dryden and G. C. Hill.

The Mast under Load.

The design⁶ of the structure must allow a reasonable margin of safety when the masts are under the influence of the most adverse conditions which may occur in practice.

Loads will arise from high winds which, if presumed to blow throughout the height of the mast will produce a horizontal distributed, but not necessarily uniform, load over the surface of the mast. The effect of this is clearly to produce bending and stress in the mast between each stayed section. Also, depending upon the elasticity of the stays under load and on their initial tensions, the mast will heel over as a whole, probably most at the top and less at the lower sections and, since the base will be fixed, stresses in the mast sections will be induced on this account. It may be shown that the restraint of the stays is not a linear function of the deflection of the mast nor, in fact, is the deflection generally in the same direction as the applied load or even in a constant direction. Typical traces d_1 , d_2 and d_3 of the deflection at a stay level for loads of increasing magnitude but applied in different constant directions, F_1 , F_2 and F_3 , are given in full line in Fig. 2. It will be observed that the

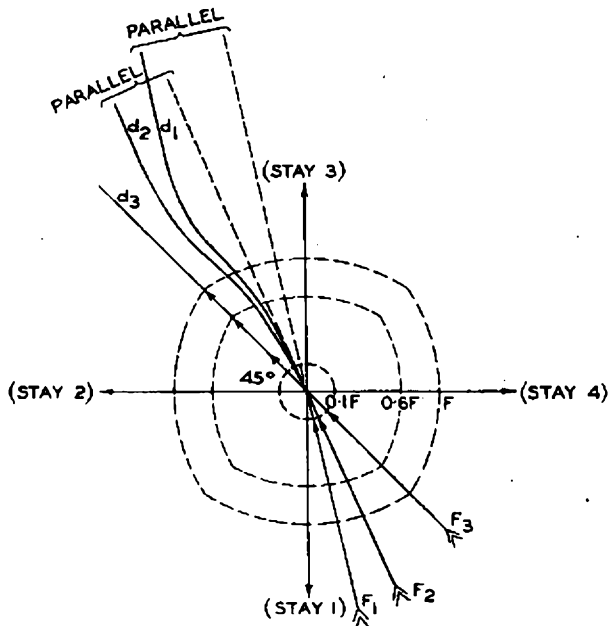

FIG. 2.- LOCI OF DEFLECTION FOR DIFFERENT DIRECTIONS OF APPLIED LOAD.

direction of the deflection eventually becomes parallel to the applied force. The corresponding polar curves of deflection are also recorded in broken line. In addition, there is a concentrated load at the top of the mast due to tension in the aerial triatic, the magnitude and direction of which depends on the aerial system, the prevailing wind and whether or not the aerial wires are laden with snow or ice. Also, since the aerial is usually attached at a point above that at which the top stays are fixed, there is an applied bending moment at the latter point.

⁶ The detailed structural design of the mast is given in the *Journal of the Institution of Civil Engineers*, Dec., 1946.

Further, in the deflected position of the mast, the various mast sections are inclined to the vertical if only slightly, and from this there will be an increase in the effective horizontal loadings to be allowed. Finally, the dead weight of the structure added to the downward component of stay tensions will induce an eccentric vertical compression throughout the height of the mast. Each stayed section of the mast will, therefore, be subject to a vertical load which, in conjunction with the total lateral loading, will modify the resultant bending moment. Due allowance must also be made for inequalities in construction which entails a knowledge of the initial crookedness of the various sections.

The calculation of stresses in a reinforced concrete structure as opposed to a steel structure is made more difficult and uncertain since the moment of inertia of a given section is not constant but is a function of the magnitude and position of the vertical thrust and the applied bending moment at that section. The moment of inertia of a reinforced concrete section may be found graphically but the method cannot be conveniently extended to include the effect of vertical loads. If, as in the present instance, the reinforced sections are symmetrically reinforced, or nearly so, and the concrete annuli not unduly thick in relation to their diameter, a mathematical treatment, the results of which are summarised graphically in Fig. 3, is applicable in which account can be taken of the effect of a vertical load. Depending on the applied bending moment M , the percentage reinforcement r , and the magnitude and eccentricity of the vertical load W , the position of the neutral axis may be determined. From this, the equivalent moment of inertia I and the value of the constant K may be read using the same value of r . The maximum stress in the concrete, f_c , may then be deduced from the relation quoted. The completed structure must also be capable of withstanding without excessive stress the various possible loading conditions mentioned earlier; additionally, allowance must be made for stresses due to vibration of the mast in any possible way and to unequal temperatures in different parts of the structure.

Mast Sections, Bending Moment and Shear Force Diagrams.

Calculations showed that an annular thickness of concrete of 6 in. in the upper sections and 8-9 in. in the lower sections with reinforcement between 1 and 2 per cent. (ratio of area of steel to concrete) would provide a satisfactory structure. Reinforcement at this density could conveniently take the form of rods passing through selected holes in the circumferential flanges from which bolts had been removed. The number of rods which could be used was evidently limited by the number of bolts it was prudent to remove during reconstruction. By utilising about half the number of bolt holes for the passage of reinforcing rods, it was found possible to obtain reasonably uniform reinforcement around the mast and ensure a margin of safety during reconstruction, providing work could be suspended or made secure under storm conditions. On this basis, the reinforce-

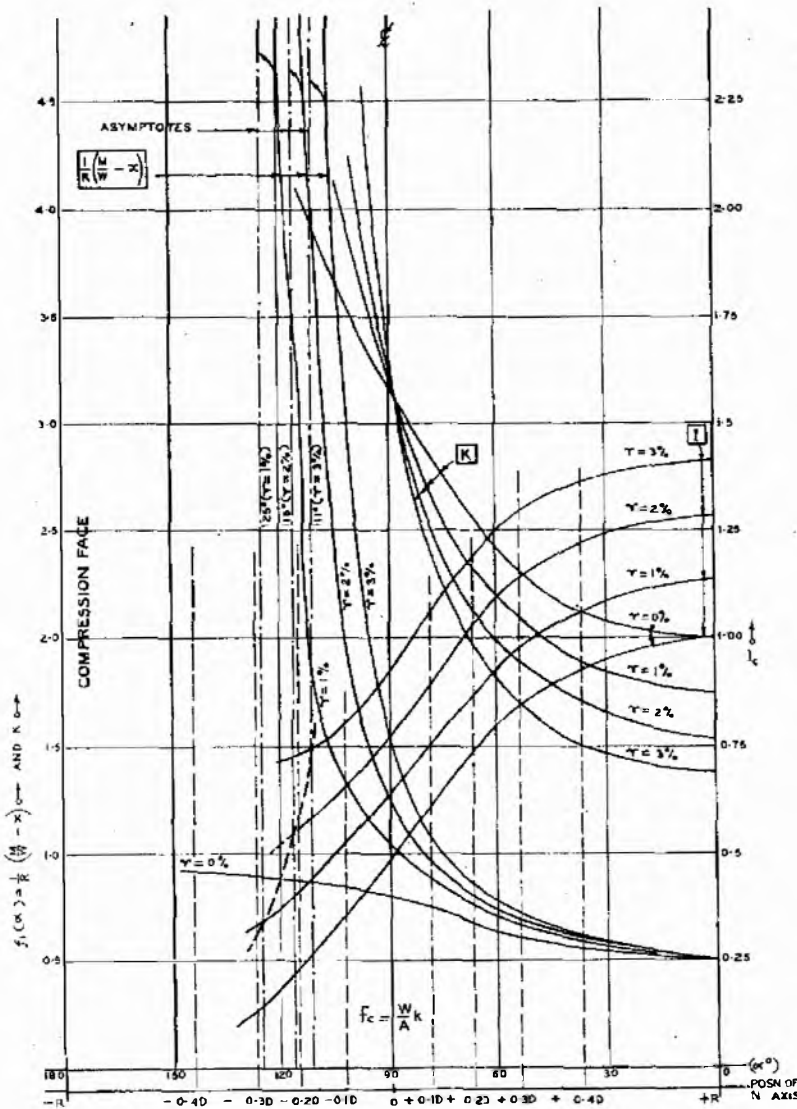
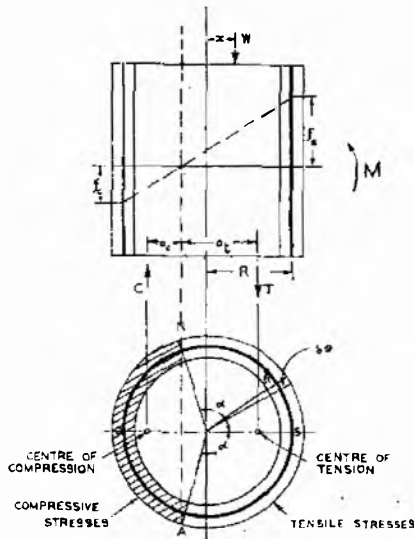

FIG. 3.—NEUTRAL AXIS, MOMENT OF INERTIA AND STRESS IN A THIN REINFORCED CONCRETE ANNULUS UNDER COMBINED BENDING AND VERTICAL LOADS.

ment chosen varied from ten $1\frac{1}{2}$ -in. diameter rods in the base to eight $1\frac{1}{8}$ -in. diameter rods in the top section as shown in Fig. 4; $\frac{3}{8}$ -in. diameter stirrups coiled around each rod were used at 1-ft. pitch. Reconstruction in reinforced concrete entailed a maximum working load on the foundation of about 170 tons compared with about 50 tons for the original structure, and to meet the increased vertical load and the bending moment at this point the existing foundations were extended as shown.

The calculation of the bending moment and shear force diagrams was made by the method of "moment distribution" which is specially suited to the solution of beams on elastic supports.

The initial tensions in stays, on which the deflected positions of the mast sections depend, were chosen to restrict the maximum stresses in the mast under all possible loading conditions to permissible values. These tensions were thus essentially a compromise and could not, in general, be productive of the lowest stresses under any particular condition of loading. The bending moment and deflection diagrams under maximum wind conditions and aerial load are given in Fig. 5 (a). Fig. 5 (b) shows the corresponding bending moments and deflections under still air conditions and maximum aerial load as may occur from a heavy ice coating on the aerial wires.

Stays, Bridles and Fittings.

The length of each new stay could be pre-determined. This involved the separate survey of each anchor block and the plot of its level above or below the base of the mast. The length of each of the 160 stays was then calculated allowing for its curved suspended form and the height of its anchor block in relation to the base of the mast. It was thus possible to arrange for the termination of all stays to their prescribed lengths to be carried out in the factory and to avoid the uncertainties of splicing the ropes on site or of resorting to the use of bull-dog grips.

To meet the minimum ultimate strength of 40 tons with as high a modulus of elasticity as possible, a rope of concentric construction would probably have been chosen. But such a rope cannot be spliced around a thimble and would have necessitated a socket type termination which was not convenient for the attachment of a stay to a rigging screw. It was desirable to adhere to the use of a rope which could be

7 "Continuous Frames of Reinforced Concrete," by Professor Hardy Cross and N. D. Morgan.

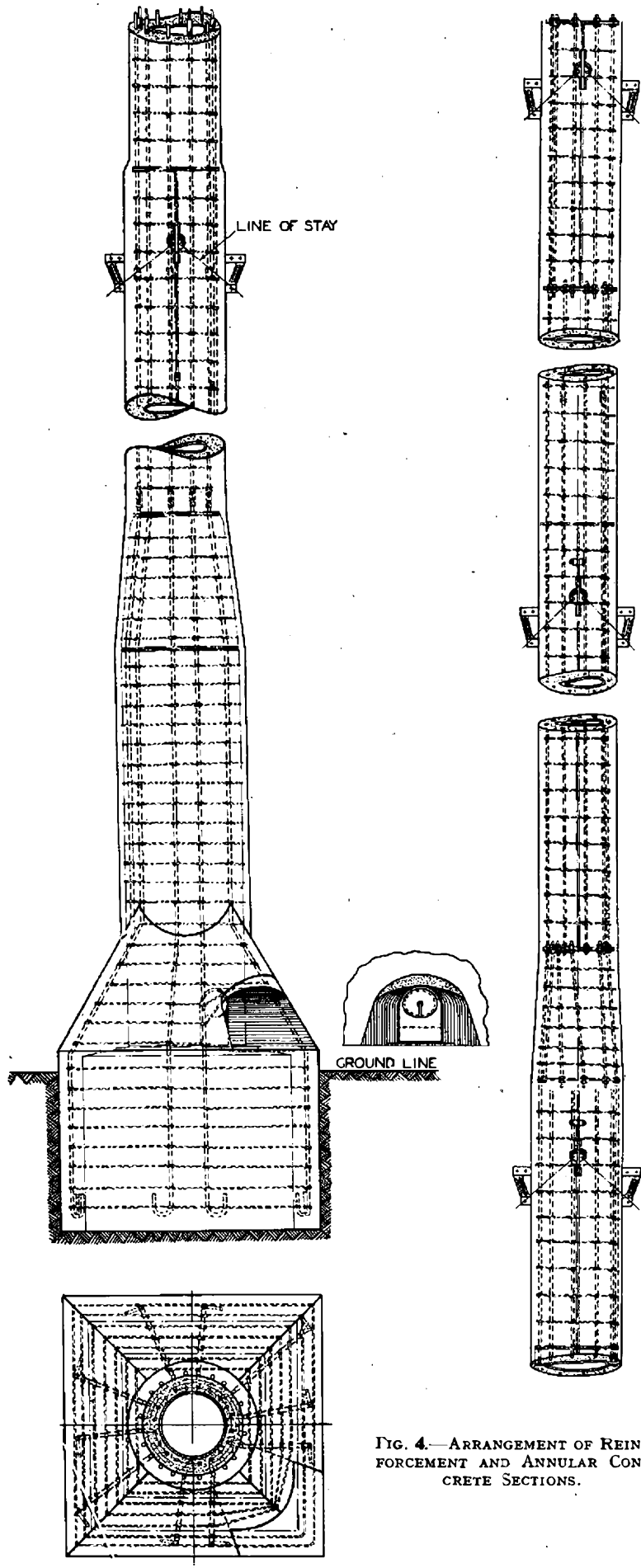

FIG. 4.—ARRANGEMENT OF REINFORCEMENT AND ANNULAR CONCRETE SECTIONS.

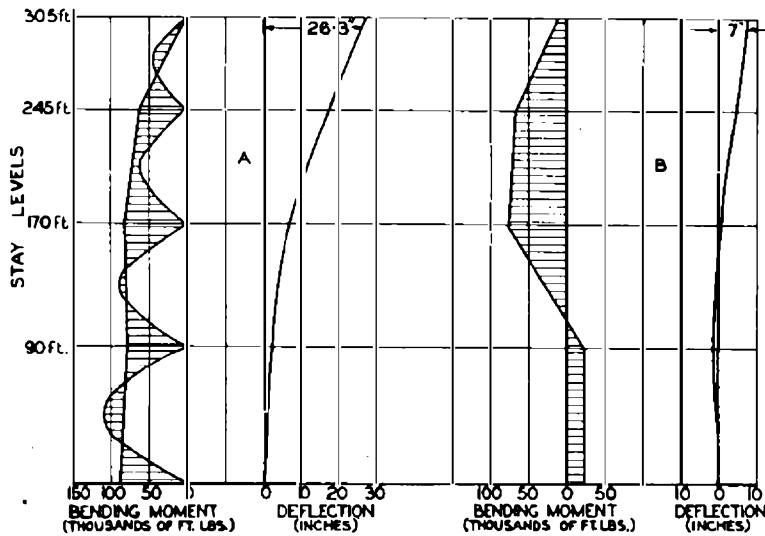

FIG. 5.—BENDING MOMENT AND DEFLECTION DIAGRAM.

spliced, and for this reason a 7-strand, 7-wire construction was chosen. The diameter of each wire was 0.105 in. and the circumference of the laid rope 3.00 in. The grade of steel used was Siemens basic quality of tensile strength 100/110 tons per sq. in. The rope was galvanized and additionally protected by black bitumastic varnish. The modulus of elasticity of such a rope is not quite so high as can be obtained with concentric construction, the minimum modulus called for in the specification being 22,000,000 lb. per sq. in. compared with 25,000,000 lb. per sq. in. attainable with concentric construction. Both these figures are reached only after prestressing of the ropes until the modulus is reasonably constant.⁸ Not only was the constancy of the modulus of elasticity reasonably ensured by this means, but also, since the stays were terminated at each end by splicing around thimbles, the prestressing constituted a valuable proof test of each complete stay including its spliced ends. The bridles, also terminated on thimbles, were proof tested but not prestressed since, due to their short length, their modulus of elasticity was unimportant.

A specially constructed double-yoke shackle as shown in Fig. 6 was used for the connection of bridles to stays. The yoke was arranged to separate the thimbles sufficiently to prevent "scrubbing" and the proportions of the shackle were based on the formulæ and design notes of B.S. 825, p.7, so far as applicable. The connection of a stay to its anchor block was made through the usual type of adjustable rigging screw, thence by a short length of long link chain to the embedded member in the anchor block.

Since no attempts were to be made to preserve the original steel sections which would be allowed to rust away, it was essential that no fitting which was to

⁸ The prestressing of ropes for use in suspension bridges is frequently undertaken to raise the modulus of elasticity and increase its constancy. Even after a rope is coiled for transport after prestressing and subsequently uncoiled for use, it is found that the modulus of elasticity is decreased by less than 1 per cent.—(vide "The Orleans Suspension Bridge."—*Journal of the Institution of Civil Engineers*, Oct., 1936.

form a permanent part of the finished structure should be attached to the original steelwork. An important fitting to be decided upon was that to be used for the attachment of the stay bridles to the mast. The conditions to be met were that the attachment should be capable of bearing a load of about 50 tons (to allow a margin over the nominal ultimate stay strength of 40 tons), should allow of the termination of stays as near to the mast as possible (to reduce eccentricity in the vertical load) and should not entail any fixing to the existing mast sections. A load of 50 tons is very great in comparison with the small annular thickness of concrete of 6 in. in the upper parts of the mast, and entirely precluded the use of a simple embedded anchor at each bridle end. The method of attachment adopted throughout is shown

in Fig. 6. Three mild steel bands, formed in sections, are embedded in the concrete annulus to give 1 in. cover to the exterior surface of the existing mast. The bands are interconnected at four points (as shown) by the bolting in of special malleable cast-

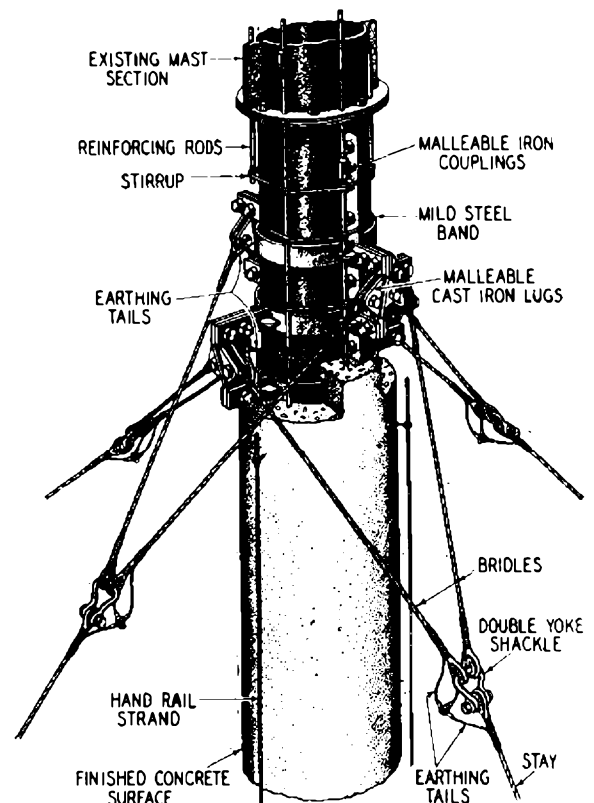
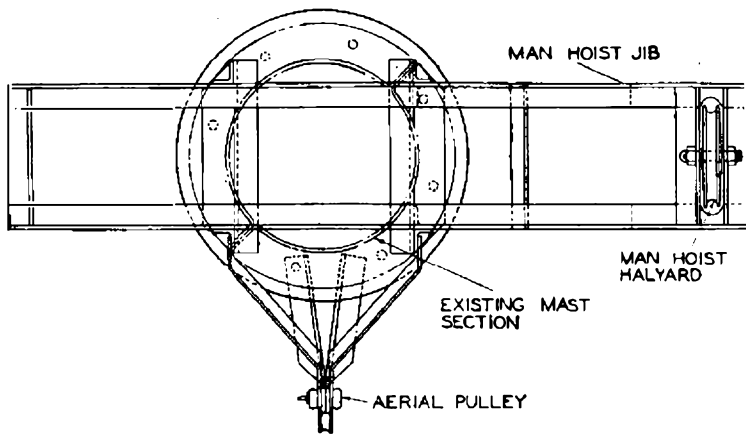

FIG. 6.—ATTACHMENT OF STAYS AND BRIDLES TO THE MAST.

iron lugs, the "ears" of which receive the solid thimbles of the bridles. This form of construction has the advantage that the "ears" of the lugs could be cast at the required angle and thus accept a direct pull on the bridles with no risk of distortion of the lugs



PLAN (PLATFORM OMITTED)

JIB STANCHIONS

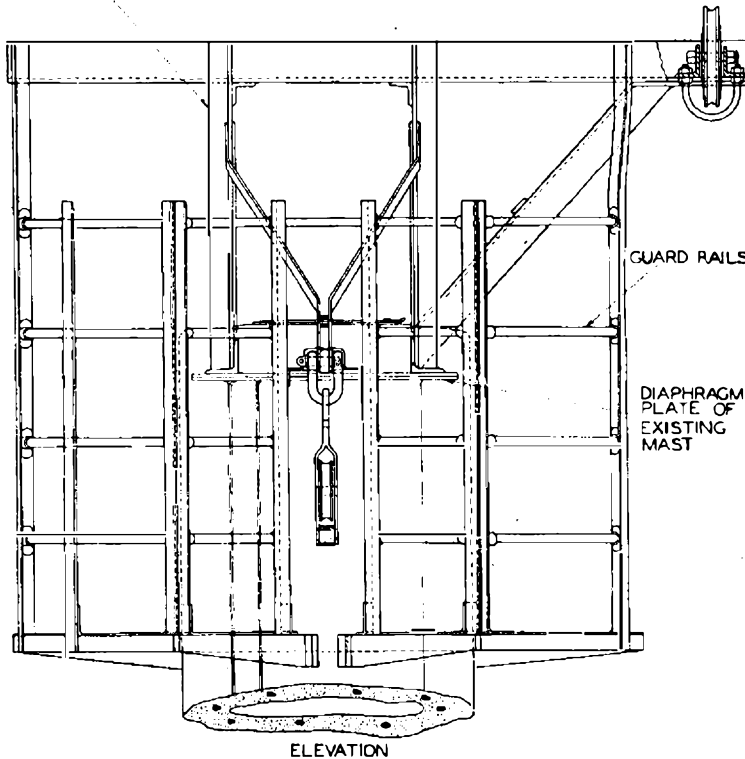

ELEVATION

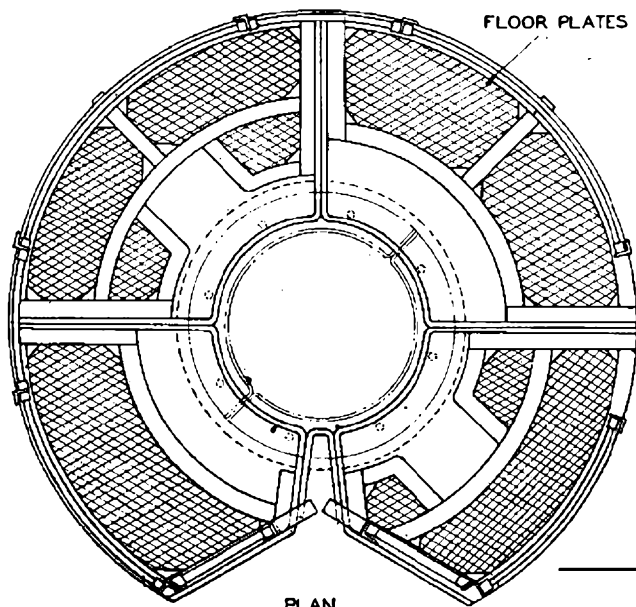

FIG. 7.—DETAILS OF MAST HEAD.

due to side loading. Further, the eccentricity of loading is kept at a minimum and the lugs are replaceable in the event of wear or damage. The quality of malleable cast iron used in the lugs was to B.S. No. 310 (Black-heart castings) for which the minimum ultimate tensile strength is 20 tons per sq. in.

The existing fittings at the mast head, including the jib and pulley, were in poor condition and it was necessary to design a new type of mast head for support of the aerial triatic and man-hoist. Details of the structure are shown in Fig. 7. The main support used is similar in principle to the band type of fixing used at the stay attachments, and is formed in four sections, the ends of which are bolted together and project from the surface of the concrete for fixing to the main vertical members. The jib is supported on four equal angle stanchions bolted to the top flange of the mast, on which is also terminated the final eight reinforcing rods. Concrete was continued to a point six inches above the top flange of the mast where a square trap door was fitted through which a man could emerge from the interior of the mast; $\frac{1}{8}$ in. steel chequer plate was used for the platform which is formed and supported in sections so shaped to clear and permit access to the projecting cast lugs of the stay attachment. Each of the four frameworks of angle iron which support the separate platform sections was welded together and finally bolted into position in the projecting parts of the main band fixing. Hand rails of 1-in. diameter tubular steel were fixed as shown and give rigidity to the whole.

The smooth surface of the reconstructed mast and the absence of projections compared with the original construction would have prevented a man from clinging to the mast while travelling in the boatswain's chair. To remove the danger of a man swinging as a pendulum on one or two hundred feet of rope (even though a tail rope be employed), three hand rails to which a man could cling were attached to the mast throughout its height at 120° spacing in plan.

Prior to reconstruction the decision had been taken that, for reasons of transmission efficiency it would not be justified to break up stays into separate insulated lengths, but that all stays should be earthed at the anchor block and bonded electrically to the mast at their point of attachment to it. All mast fittings, including the stay attachments and mast headwork, were separately bonded within the concrete to reinforcing rods which, being mechanically coupled, were electrically continuous. In view of the considerable surface of exposed metal at the mast head and the electrical continuity of the reinforcement and stays a separate lightning conductor was not employed.

Standards of Transmission and Local Line Limits

E. J. BARNES, A.C.G.I., A.M.I.E.E.
 A. E. WOOD, B.Sc.(Eng.), A.C.G.I., D.I.C.
 D. L. RICHARDS, B.Sc.(Eng.), A.M.I.E.E.

U.D.C. 621.395.1 621.395.8

Part 2.—The Effective Transmission Technique

In the previous part, the factors affecting the transmission of speech over a telephone circuit and the assessment of performance by volume and quality methods were reviewed. This article describes the effect of the overall frequency response and the latest method of using the Effective Transmission technique.

Effect of Overall Frequency Response.

TO explain how the presence, absence or partial loss of certain frequencies affects the quality of a speech transmission circuit, it is necessary to deal briefly with the physiology of speech and hearing.^{5, 6, 7}

If the frequency spectrum is considered to be divided into narrow frequency bands (say 200 c/s wide), the "band articulation," which defines the quality of the system, will depend upon the contribution that each of these narrow bands makes in any particular circuit. The band articulation is not the same as syllable articulation (as obtained by the usual speech articulation tests), but is related to it in a known manner.⁵

The maximum contribution of any band is proportional to its width (in c/s) and also depends on its location in the frequency scale. The variation of bands 200 c/s wide with their mean frequency is illustrated in Fig. 6. It will be seen from this curve that a band of given width is more useful in the middle frequency

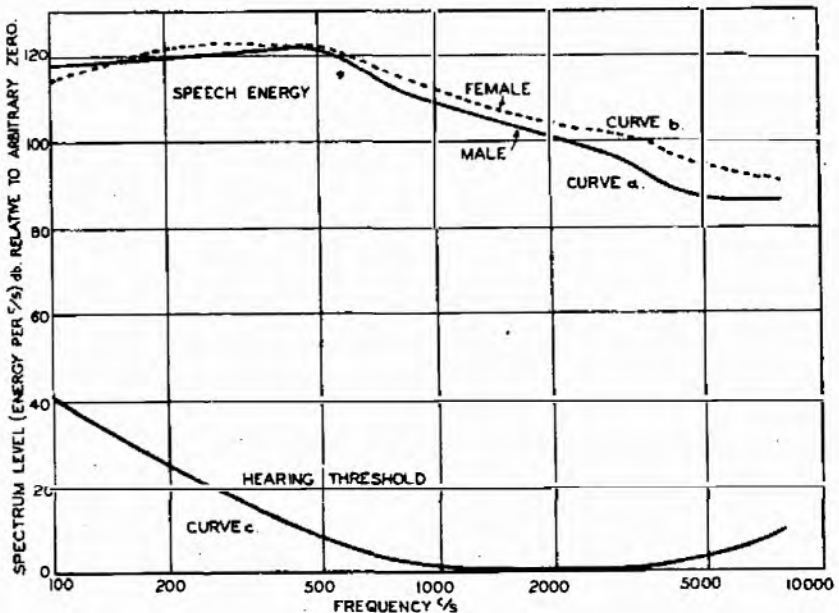

FIG. 7.—VARIATION OF SPEECH SOUND PRESSURE AND THRESHOLD OF HEARING WITH FREQUENCY.

range than at either high or low frequencies.

The contribution of a band will be at its maximum only when all the sounds within it are loud enough to be perceived by the listener. The perception of sounds in any band will depend upon three factors:— (a) the magnitude at the speaker's mouth as spoken, (b) the attenuation of the telephone system between the speaker's mouth and listener's ear, i.e. the air-to-air attenuation as well as that of the electrical circuit, and (c) the listener's threshold of hearing. Average curves of the peak sound pressure actually existing at a speaker's mouth within bands 200 c/s wide are shown by curves a and b in Fig. 7. Curve c shows the listener's threshold of hearing for such sounds. The change in the overall air-to-air attenuation of a typical telephone circuit with frequency is indicated in Fig. 8.

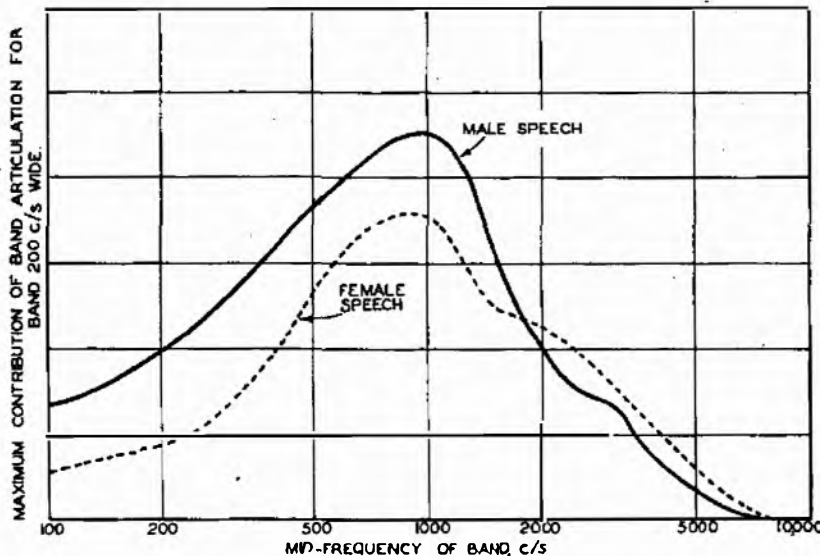

FIG. 6.—MAXIMUM CONTRIBUTION TO TOTAL BAND ARTICULATION OF FREQUENCY BANDS 200 c/s WIDE.

⁵ *Electrical Communication*, 141, January 8th, 1935.
⁶ *P.O. Research Report No. 7605*.
⁷ *Bell System Technical Journal*, October 8th, 1929.

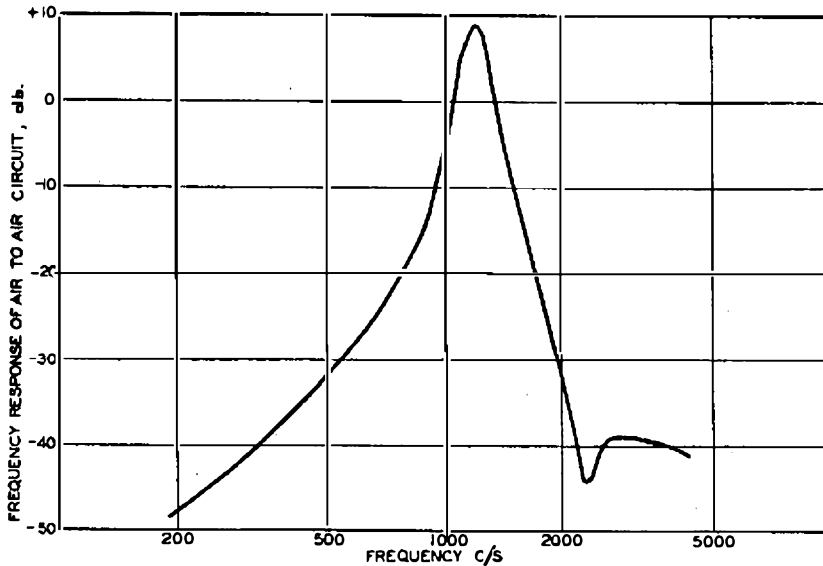

FIG. 8.—OVERALL FREQUENCY RESPONSE OF TELEPHONE CIRCUIT.

bute its maximum quota, the peak sound pressure must be at least 45 db. above the hearing threshold. A contribution less than the maximum will be made by peak pressures lying between these two limits. Above 45 db. no improvement in articulation results.

Consideration of the conditions existing on the typical telephone circuit used to obtain Fig. 8 showed that the relative importance of different parts of the frequency spectrum so far as articulation is concerned was as follows:—

- Frequencies below 100 c/s. No contribution.
- Frequencies between 100 and 400 c/s. Contribution less than maximum.
- Frequencies between 400 and 2,000 c/s. Full contribution.
- Frequencies between 2,000 and 6,000 c/s. Contribution less than maximum.
- Frequencies above 6,000 c/s. No contribution.

Several interesting facts are illustrated by this analysis. An important one is that over the frequency range of 400 to 2,000 c/s, any received sound pressure in excess of 45 db. above the hearing threshold serves no useful purpose as this range is already making full contribution to the articulation. Such excess sound pressure increases loudness but creates crosstalk problems and is therefore better eliminated. A very large increase in response would be required to give a small improvement with frequencies below 100 c/s or above 6,000 c/s, which at present make no contribution and there is no justification for attempting to reproduce these frequencies over a telephone system at the present time.

An improvement in articulation will result, however, from any increase in response over the range of frequencies making a contribution less than maximum, i.e. 100 to 400, and 2,000 to 6,000 c/s. Such an improvement can be obtained by the use of a receiver or transmitter having a wider frequency range even though it may result in a less loud signal. It has been found that any increase in frequency response is

most usefully made in the high frequency range of 2,000 to 6,000 c/s, and new designs of transmitters and receivers will exhibit a marked improvement over this range compared with those at present in use.

Effective Rating.

The only real measure of the extent to which a telephone circuit gives satisfactory service is to observe its behaviour under actual working conditions, and the C.C.I.F. has agreed that observations made under service conditions should serve the basis of telephone performance rating.

A comprehensive series of experiments was carried out in America during 1929-30 using circuits between the American Telephone and Telegraph Company headquarters building and the Bell Telephone Laboratories.⁸

By setting up telephone connections in such a way that the type of subscriber's set, line, etc., can be controlled and by taking observations on these connections while actual conversations are in progress, a comparison between various pairs of conditions can be obtained. Observations on the calls between two large official P.B.X.s were started by the Post Office in 1933. Observation may be made in a number of ways, but it has been found to be best to measure the effectiveness of the transmission by noting the number of repetitions made by the users in unit time. As an additional rather rough check, the number of adverse comments made by the users on the transmission is useful. To eliminate the effect of numerous uncontrollable factors, a large number of observations extending over considerable time is necessary.

The differences between the conditions in service and in the laboratory are illustrated by the fact that if the junction attenuation between two typical exchanges, subscriber's lines and subscriber's sets, is varied from zero upwards, the articulation remains fairly constant up to about 30 db., and only at higher attenuations commences to decrease as shown in Fig. 9. On the other hand, both the repetition rate and the adverse comments commence to increase from very low attenuations and are becoming too large for commercial use by the time 15 to 20 db. is reached.

The difference is due, among other reasons, to the laboratory tests being made under "fixed" conditions, i.e. speaking level and room noise do not vary during each test and observers are all skilled. In the field, however, speaking level, distance from mouth-piece and room noise all vary between wide limits, and some listeners will be hard of hearing. The amount by which the laboratory results should be "weighted" to take all these and other variations into account is not at present known. It is hoped shortly to obtain a correlation between repetition rate and articulation tests made in some suitable fashion, and a pro-

⁸ Bell System Technical Journal, January 10th, 1931.

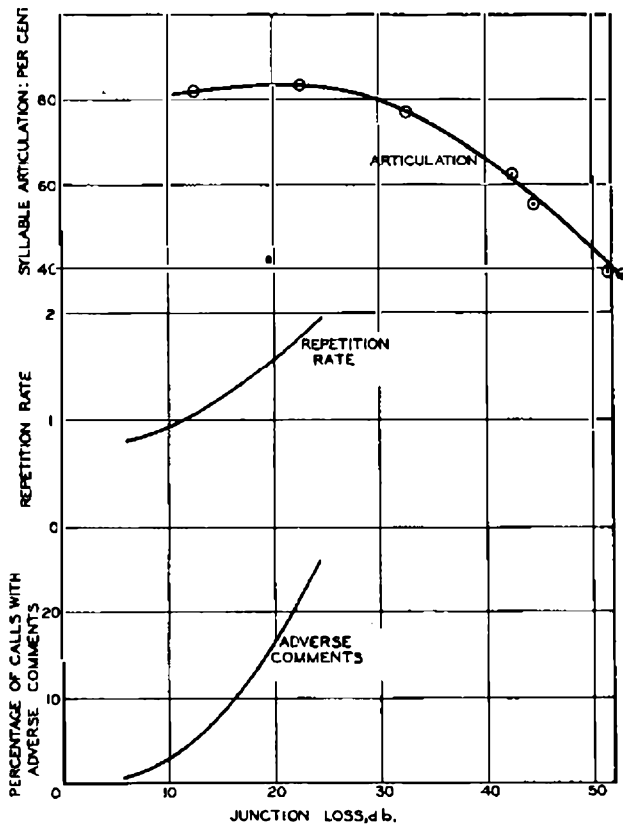

FIG. 9.—COMPARISON BETWEEN REPETITION RATE AND ARTICULATION.

gramme of work has been arranged by the C.C.I.F. Some important results have already been obtained, however. It was found that if between two typical subscribers' sets the attenuation is increased by N db, then $N = 50 \log_{10} R$ where R is the ratio of the rate of repetition after and before the change in attenuation. It is of interest to note that practically the same result was found in the American experiments.

If the repetition is observed on a typical circuit and on an exactly similar one with one item changed, and if the ratio of these repetitions in a given conversation time is R , then by the relation quoted above the transmission loss or gain due to the change can be expressed in decibels. This has been done for a number of the more important factors. For example, it has been found that, effectively, the loss due to unloaded cable is more accurately expressed if its attenuation is calculated at some frequency between 1,200 and 1,850 c/s in place of the old figure of 800 c/s. In this case a similar result was obtained by articulation tests in the laboratory.

Although the use of a single frequency for calculation purposes would lead to considerable simplification, it is probable that such a single figure would not be the best for all conditions and that possibly the mean of the attenuation at a number of frequencies would be more accurate. Tests covering various lengths of 10, 20 and 40 lb. cable, in both junctions and in subscribers' lines with various terminations, indi-

cated that the attenuation calculated at 1,600 c/s provided a reasonably accurate result when reflection losses were neglected.

It is of interest to compare the attenuation of some cables calculated at 800 and 1,600 c/s with the figures obtained by repetition rate and articulation tests. These are shown in Table 2.

TABLE 2

Gauge of Cable	Loop Resistance Ohms/mile	Capacitance μ F/mile	Attenuation db./mile		Speech Transmission Loss db./mile	
			800 c/s	1600 c/s	Repetition Rate Tests	Articulation Tests
10 lb.	178	0.075	1.56	2.23	1.9	2.3
20 lb.	88	0.075	1.12	1.56	1.6	1.3
40 lb.	44	0.075	0.78	1.12	1.2	—

It will be seen that the loss measured by repetition rate and articulation methods agrees more nearly with the attenuation calculated at 1,600 c/s than at 800 c/s.

It is proposed that the attenuation of cables calculated at 1,600 c/s should be used by the Post Office when laying out new work. This will mean that the permissible lengths of unloaded junction cable will be reduced by about 29 per cent.

A corresponding effective loss occurs with loaded lines on which the cut-off is below about 3,400 c/s. This loss has been investigated, but as no new lines of these types will be used and existing ones will eventually disappear, it is not intended at present to make any adjustment in the permissible length.

As an example of the use of repetition rate testing methods, illustrating the difference between the volume rating and effective rating of a telephone, an equalised receiver (Receiver Inset No. 2P) may be quoted. This gives approximately the same volume of speech as do the older types (such as the Receiver Inset No. 1L), but the frequency response characteristic has been equalised to make it much more even. A number of subscribers' sets, exactly similar except that some had 1L and the others 2P receivers, were set up on similar working lines. The repetitions made by the users were counted with a particular subscriber's line condition, and during about 900 calls, with a total conversation time of about 50 hours with each type of receiver, there were 667 repetitions required by the listeners using the 1L receiver against 445 by the users of the No. 2P receiver. This corresponded to an improvement of 8.7 db. and somewhat smaller improvements were also obtained under other conditions.

Calculation of Effective Transmission Rating.

It is not possible to test, even in the laboratory, and still less by observation of repetitions, all the various combinations of subscribers' sets, subscribers' lines and exchange circuits which may be encountered under the normal diverse conditions of usage. In order that their performance may be equated to that of a standard, a method has been devised known as the "Effective Transmission" technique which takes into account the major factors. This method is illustrated for a typical case in Table 3, showing how

the variation of the effective rating with the length of the subscriber's line may be determined from data obtained by laboratory tests on the effect of feeding current, sidetone and line attenuation as described in Part 1. In a number of typical combinations the results have been checked by observations of the repetition rate.

In this table the line current (column 4) is calculated from the exchange battery voltage and the total D.C. resistance of the circuit (including the effect of any transmitter shunt). The feeding current effect is obtained by reading off the curve shown on Fig. 5 for the appropriate value of line current. The subscriber's line rating (column 6) has been taken as the attenuation at 1,600 c/s considered negative (any factors which are associated with an impairment of transmission are regarded as having negative ratings). Reflection effects where appreciable can be included in the subscriber's line rating.

The relative circuit ratings (columns 7, 8 and 9) are values determined from measurements of the transmission loss of the electrical components of the subscriber's set and the exchange transmission bridge. The losses are expressed relative to those of a standard circuit. The sending and receiving ratings are measured using an average impedance subscriber's line, but the sidetone rating must be measured with the particular subscriber's line under consideration. The relative circuit ratings refer to a fixed standard value of transmitter feeding current.

The sidetone level (column 10) is equal to the sidetone rating (column 9) plus the feeding current effect (column 5). The sidetone effect, sending or receiving (columns 11 and 12), is obtained by reading off curves S and R of Fig. 3 for the appropriate value of sidetone level given in column 10.

The relative effective ratings, sending and receiving, are calculated by adding together algebraically the appropriate quantities which represent the effects of the various factors contributing to the overall grade of transmission. For sending, these factors are feeding current effect, subscriber's line

rating, relative circuit rating for sending and sidetone effect on sending. For receiving, the factors are subscriber's line rating, relative circuit rating for receiving and sidetone effect on receiving. Consequently the relative effective rating for sending (column 13) is given by the algebraic sum of columns 5, 6, 7 and 11, while for receiving (column 14) it is given by the algebraic sum of columns 6, 8 and 12.

All the above effective ratings will be in terms of the arbitrary datum lines used in Figs. 3, 4 and 5 and it is now necessary to decide on a circuit which can be used to represent the worst permissible transmission on an effective basis.

Choice of Circuit to Represent the Effective Transmission Limits.

It is advisable to depart from the old simple 300-ohms resistor for the subscriber's line as this does not represent a practical condition. To keep to the present C.C.I.F. international standard and also to fit in with the existing local plant layout it is desirable not to make any major change in the volume compared with the old standard. It seems desirable to keep to the subscriber's set 13-1L-18.35A, which is the most common at present in use, but to change to a 50V exchange as 22V systems are rapidly vanishing.

Examination of the figures for the various types of lines and exchanges showed that the rating for both sending and receiving on a volume basis for any gauge of conductor was nearly the same for the old standard as for a line of 450 ohms on a 50V non-ballast exchange. On an effective transmission basis, however, the rating of a line of 450 ohms will vary according to the gauge of conductor employed. It is therefore necessary also to specify the particular gauge for the standard circuit. As 10-lb. cable forms the largest proportion of lines in use at present, this gauge was chosen.

The new standard is, therefore, that given by a subscriber's set 13-1L-18.35A i.e. Telephone No.162 (C.B. or Auto) and Bell Set No. 25 connected by a line of 10-lb. cable, having a resistance of 450 ohms

TABLE 3

CALCULATION OF EFFECTIVE TRANSMISSION RATINGS.

Subscriber's set 13-1L-18.35A (Tele. No. 162 C.B. and Bell Set No. 25)

(Telephone No. 162 and Bell Set No. 25 on 10-lb. cable with 50V 200+200-ohm exchange)

(1)	(2)	(3)	(4)	(5)	(6)	(7)	(8)	(9)	(10)	(11)	(12)	(13)	(14)
Subscriber's Line				Feed Current Effect db	Subs. Line Rating db	Relative Circuit Rating			Side Tone Level db	Sidetone Effect		Relative Effective Rating	
Type	Length miles	Resis. ohms	Line current mA			Send db	Rec db	Side Tone db		Send db	Rec. db	Send db	Rec. db
10-lb. cable	1	176	78	+2.4	-2.0	0	0	+0.2	+2.6	+1.2	-14.3	+1.6	-16.3
	2	352	61	+0.8	-4.1	0	0	+0.1	+0.9	+1.8	-13.5	-1.5	-17.6
	2.6	458	55	0	-5.3	0	0	0	0	+2.0	-13.1	-3.3	-18.4
	3	528	50	-0.7	-6.1	0	0	-0.1	-0.8	+2.2	-12.7	-4.6	-18.8
	4	704	43	-1.7	-8.2	0	0	-0.2	-1.9	+2.4	-12.2	-7.5	-20.4

(i.e. 2.56 miles) to a 50V exchange with 200 + 200 ohm relays and 2 μ F capacitors.

Table 4 gives the limiting lengths of subscribers' lines which afford transmission effectively equal to this standard. The old volume limits have been included for comparison. The table gives the lower of the two limiting conditions (either sending or receiving) and they have been rounded up to the nearest 50 ohms or 0.1 mile. The existing volume limits were based on the use of a subscriber's set Type 13-1L-18.35A, and when the Type 13-1L-27, i.e. Tele. No. 332 with Coil Induction No. 27, was introduced the same limits were allowed, although the volume rating is lower. This was justified by the fact that the improved sidetone rendered this a better instrument in actual service. The effective ratings shown in Table 4 take this into account.

The following table shows the compromise limits which it has been proposed should be adopted.

TABLE 5
COMPROMISE TRANSMISSION LIMITS FOR SUBSCRIBERS' LINES USED WITH ANY TYPE OF SUBSCRIBERS' SET.

Exchange Type	4-lb. Cable		6½-lb. Cable		10-lb. Cable		20-lb. Cable	
	Ohms	Miles	Ohms	Miles	Ohms	Miles	Ohms	Miles
22V. C.B. ..	450	1.0	400	1.5	350	2.0	300	3.4
40V. C.B. ..	600	1.4	500	1.9	400	2.3	350	4.0
50V. Auto. (Ballast)	750	1.7	600	2.2	500	2.8	400	4.0
50V. Auto. (Non-ballast) ..	700	1.6	550	2.0	450	2.6	350	4.0

Note: (1) The limits for 4-lb. cable are restricted in practice by signalling to less than the above values.

(2) The mileage figures are approximate and have been given to the first decimal place only.

TABLE 4
LIMITING SUBSCRIBERS' LINES

Subscriber's set.	Method of Rating	4-lb. Cable		6½-lb. Cable		10-lb. Cable		20-lb. Cable	
		ohms	miles	ohms	miles	ohms	miles	ohms	miles
22V Exchange 13-1L-18.35A (Tele. 162 & B.S. 25)	Volume Effective	300	0.7	300	1.1	300	1.7	300	3.4
		450	1.1	350	1.3	300	1.7	250	2.8
13-1L-27 (Tele. 332) Anti-sidetone instrument)	Volume Effective	250	0.6	250	0.9	250	1.4	250	2.8
		450	1.1	400	1.5	400	2.3	300	3.4
50V Exchange (Ballast) 13-1L-18.35A (Tele. 162 & B.S. 25)	Volume* Effective	500	1.2	500	1.9	500	2.8	500	5.7
		750	1.8	550	2.0	350	2.0	250	2.8
13-1L-27 (Tele. 332) (Anti-sidetone instrument)	Volume* Effective	500	1.2	500	1.9	500	2.8	500	5.7
		800	2.0	700	2.6	600	3.4	500	5.7
50V Exchange (non-Ballast) 13-1L-18.35A (Tele. 162 & B.S. 25)	Volume Effective	450	1.1	450	1.7	450	2.6	450	5.1
		650	1.6	550	2.0	450	2.6	300	3.4
13-1L-27 (Tele. 332) (Anti-sidetone instrument)	Volume Effective	400	1.0	400	1.5	400	2.3	400	4.6
		700	1.7	600	2.2	550	3.1	450	5.1

* The rating is less than has been allowed in the past as a concession to 600 ohms was made on account of the much improved sending volume.

Practical Application of Effective Transmission Ratings for Planning Purposes.

When any subscriber's set is installed it is not possible to ensure that any particular one of the several types available is used and consequently it is necessary to fix compromise limits which will apply for any type of set connected to a given exchange. Different limits, however, must be used for each type of exchange, although it has been possible to group the exchanges into only four types. These compromise limits have been so chosen that transmission on an effective basis may be slightly below standard for the older types of set, but full advantage has not been taken of the improved performance of the newer anti-sidetone sets.

The above limits allow an exchange cable system to be planned so that a larger proportion of light-gauge conductors can be used than if the planning were on a volume efficiency basis. These light-gauge lines will result in a lower volume efficiency than has been permitted in the past. In the extreme example of a subscriber's set 13-1L-27 (Tele 332), the volume efficiency could be 4.4 db. lower for sending when connected via a 700-ohms subscriber's line of 4-lb. cable to a 50V non-ballast exchange. Similarly for receiving it could be 1.5 db. lower for a subscriber's set 13-1L-18.35A (Tele. 162 with Bell Set 25) with 700-ohms subscriber's line of 4-lb. cable and 50V non-ballast exchange. The margins between the volume efficiency limits to which the Post Office has worked

and those to which it is bound by international agreement are approximately equal to these values, so that a system planned on an effective transmission basis would still meet the international requirements for volume efficiency.

Conclusions.

The method of calculating effective transmission, by which the above limiting subscribers' lines have been derived, is a very great advance on the old volume method of rating. It is sufficiently accurate to enable a reasonable system of planning to be prepared although much of the data used is empirical.

For all the new limits so far proposed, it has been assumed that the present type of transmitter and receiver are used. The effective gain which may be obtained by the use of better types is very great; the actual amount, however, cannot at present be assessed reliably by laboratory methods only, observation under working conditions being necessary.

A considerable amount of research work could be justified to obtain further data on effective transmission. This would consist partly of statistical examinations of practical conditions in the existing telephone system and partly of laboratory work to determine more accurately the effect on the behaviour of newer types of receiver of such factors as the frequency response of the side-tone path, and room and circuit noise. The optimum relationship between sending and receiving ratings of induction coils also requires investigation. These future investigations would undoubtedly suggest better methods of dealing with those special cases where a subscriber must be connected who would normally be out of limits.

Nomenclature.

Since this article was written the Post Office Nomenclature and Symbols Committee have agreed provision-

ally to the following definitions. With these definitions the term "Transmission Performance" should be read in place of "Effective Transmission" throughout the article.

Transmission Performance of a telephone circuit used for transmitting or reproducing speech. The effectiveness of the circuit for transmitting or reproducing speech in the circumstances in which it is used.

Transmission Performance Rating of telephone equipment. The loss (constant at all frequencies transmitted) which it is necessary to add to or remove from a specified reference telephone circuit so as to give equal transmission performance when the equipment is added to or used to replace the whole, or the appropriate part, of the reference circuit.

Note. If the loss is added to the reference circuit the transmission performance rating may be termed "impairment," if the loss is removed from the reference circuit the transmission performance rating may be termed "improvement."

Effective Transmission of a telephone circuit. The transmission performance of the circuit as assessed by repetition rate tests or by calculations based on the results of repetition rate tests.

Acknowledgments.

The authors' thanks are due to Mr. J. O. Ackroyd for access to unpublished information forming the basis of Figs. 6 and 7, and also to those colleagues who have read the drafts and made helpful comments and suggestions.

It is deeply regretted that the late Mr. Barnes was unable to see the final draft of this article. The conception and proposed scope were, however, entirely due to him.

TELEGRAPH AND TELEPHONE STATISTICS—SINGLE WIRE MILEAGES AS AT DECEMBER, 1946.
THE PROPERTY OF, AND MAINTAINED BY, THE POST OFFICE

REGION	OVERHEAD			UNDERGROUND		
	Trunks and Telegraphs	Junctions	Subscribers*	Trunks and Telegraphs †	Junctions ‡	Subscribers ¶
Northern Ireland	10,139	11,486	35,050	109,867	43,592	145,962
Scottish	19,927	34,696	188,870	766,237	248,744	867,809
Home Counties	12,526	41,073	356,586	1,864,385	437,205	1,458,375
Midland	4,691	34,840	214,713	1,025,878	303,581	1,056,016
North Eastern	9,147	21,178	181,628	860,876	250,522	1,026,576
North Western	1,811	9,281	112,734	662,753	393,515	1,271,496
South Western	6,286	38,546	270,757	963,444	184,363	808,606
Welsh and Border Counties	6,843	30,875	151,135	533,796	84,628	335,557
Provinces	71,370	221,975	1,511,473	6,787,236	1,946,150	6,970,396
London	515	1,003	77,405	917,023	1,800,893	3,808,166
United Kingdom	71,885	222,978	1,588,878	7,704,259	3,747,043	10,778,552

* Includes all spare wires. † All wires (including spares) in M.U. Cables. ‡ All wires (including spares) in wholly Junction Cables.
¶ All wires (including spares) in Subscribers' and mixed Junction and Subscribers' Cables.

Some Features of Deep Level Tunnelling in London

W. F. BORYER, A.R.C.Sc., M.I.E.E.

U.D.C. 624.19 : 621.315.233

Part 2.—Engineering Services

Part 2 of this article describes the engineering services provided in the Post Office deep level tunnels in London to make them suitable for the accommodation of equipment and cables and to provide satisfactory working conditions for the staff required to work in them.

General.

THE decision to install telecommunications plant in the first of the series of tunnels to be constructed during the war and bring it into use with the utmost expedition gave rise to practical difficulties in securing, as far as possible, conditions comparable to those in an exchange building. The temperature of the body of the tunnel during the initial stages of the installation was 55°F (corresponding to that of the surrounding soil at the depth of approximately 100 ft.), and the relative humidity remained high for some time owing to seepage through the C.I. segment joints and bolt holes at various points. The conditions, however, slowly improved as the result of attention to the caulking given by the tunnel contractor and the operation of the ventilating system aided by electric radiators. In the smaller tunnels designed specifically for the accommodation of cables and where staff is not required to be in continuous attendance, the requirements for engineering services are not so exacting and in some respects less comprehensive.

Tunnel Flooring and Drainage.

The tunnels have a gradient of not less than 1 in 250, mostly down to the junctions with the short laterals leading to the shafts. Drainage channels to the sumps provided at the lowest points are incorporated in the concrete flooring close to the invert of the tunnel and on each side of the floor. Each sump is discharged via the nearby shaft to the surface drainage system by an electrically driven pump automatically controlled by a ball cock or electrode contact device fitted in the sump. The floors of the telecommunications tunnels are finished with granolithic which provides a relatively dust-free surface; those in the cable tunnels are finished with cement.

The floor depths, as shown in the following table, have been adopted as being the most suitable, sufficient depth being available in the larger tele-

Diameter of Tunnel	Floor depth at centre	Floor width (Approx.)
ft.	ft. in.	ft. in.
5	3	2 3
8	8½	4 7
12	2 0	9 0
16	4 2½	14 0 (tele-printer room)

munications tunnels to accommodate a ventilation duct.

Long Bolts.

In damp or wet situations particularly, tunnel segment bolts must be left undisturbed once the final bolting up and caulking of the joints is completed by the contractor; failure to observe this practice leads to seepage through the joints, and serious leakage may occur if two or more adjacent bolts are loosened. To comply with the request of the consulting engineer in this matter, it was necessary to determine in advance the relative positions to be taken up around the periphery of the tunnels and shafts by the various services, e.g. cable bearers, pipes, ventilation ducts, apparatus rack fittings, etc., and provide for long bolts and extra nuts to be supplied and fixed in the appropriate positions in the tunnel construction stage.

Watertight Bulkheads.

The watertight bulkheads provided in the laterals between the shafts and the main tunnels were provided primarily for the security of personnel and equipment under war conditions. The lay-out of the tunnel system with shafts offset from the main tunnels enables one bulkhead to suffice for the protection against the flooding of the nearby shaft, whereas two would be required if the shafts were constructed immediately over the line of the main tunnel. The arrangement adopted is, moreover, advantageous for cabling operations and provides for a more satisfactory cabling layout.

The framing round the door of the bulkhead is a fabricated M.S. plate 1 in. thick, which is located in a gap left for that purpose between adjacent segment rings in the lateral, the space remaining between the plate and the segments being caulked. The plate is strengthened with R.S.J's and is backed with reinforced concrete on the tunnel side over a length equal to the width of three segment rings—approximately 6 ft. M.S. pipes project through the bulkhead on the shaft side and have screwed ends for the attachment of gunmetal cable glands and caps. Each gland has a tapered end, the length of which is adjusted to suit the diameter of the cable. Fig. 1 shows one of the bulkheads in the telecommunications tunnel in the course of erection with the pipes being welded to the M.S. plate prior to concreting. Fig. 2 shows a completed bulkhead as viewed from the foot of a shaft. The ventilation duct is venturied through the bulkhead and is provided with an interlocking valve as a safeguard against the door being closed with the valve in the open position: the possibility of flood water



FIG. 1.—CABLE PIPES BEING WELDED TO MAIN PLATE OF BULKHEAD.

entering the tunnel through a damaged ventilation duct with the bulkhead door closed is thus avoided. Shafts are provided with protection above ground level, but they constitute a relatively weak link in a tunnel system under air-raid conditions.

The door of the bulkhead is fabricated and strengthened in a similar manner to its supporting frame, and sorbo packing strips 2 in. \times $\frac{3}{8}$ in. are securely attached to its periphery.

Each bulkhead is designed to withstand the full head of water in a flooded shaft operating against the shear stress of the M.S. plate and the C.I. segment ring flanges embedded in the concrete backing.

Lift Shafts and Stairways.

It was necessary to afford the tunnel contractors the unrestricted use of the shafts until the tunnel flooring and bulkheads were completed. Designs for the stairways, lift shafts and lifts were, however, put in hand and the contracts for these works placed in advance to ensure that normal means of access for staff and equipment would be available with the least possible delay. Shafts not less than 12 ft. in diameter are required to provide reasonable space for the accommodation of a lift and stairway, and shafts of that size have been provided for that dual purpose in all but one instance where, owing to the spacing of the main stanchions in the exchange from which the shaft was sunk, it was necessary to restrict the diameter to 8 ft. The lift in this case is necessarily of small capacity but it was designed to take the standard 10 ft. 6 in. apparatus rack and has in fact conveyed the bulk of the telecommunications apparatus to deep

level, in addition to providing the normal means of access for the staff. The lift well and stairway is of steelwork with ladders serving intermediate platforms on the side of the shaft adjacent to the lift entrance. This type of structure has been adopted also in all shafts to the cable tunnels, but in a number of the 12-ft. diameter shafts in the telecommunications tunnel system, where access for personnel was required from certain protected buildings, a reinforced concrete lift well and a spiral staircase of precast slabs has been incorporated. This form of construction presents a pleasing appearance and the spiral staircase has advantages over the ladders and platforms. It offers very limited accommodation, however, for engineering services, viz. ventilation ducts, pipes, cables, etc.

The reinforced concrete lift wells are 6 ft. in diameter and 6 in. thick and were built *in situ* between specially constructed shuttering raised by screw jacks disposed round the centre line of the well at the shaft head; the use of quick-setting cement enabled the work to be carried out in a continuous operation at a rate of approximately 6 in. per hour. It was thus necessary for the contractor to have the whole of the material readily available on site and to make arrangements for feeding the concrete without interruption over the whole period of construction. Pre-cast stair treads are set in the outer wall of the lift well and are supported at their wider ends by angle iron straps bolted to segments of the main shaft; landings are provided at each half spiral. Holes in the landing slabs against the main shaft provide a vertical run for the pipes and cables.



FIG. 2.—COMPLETED BULKHEAD IN 8 FT. DIA. LATERAL (VIEW FROM FOOT OF SHAFT).

Ventilation.

The Plenum system of ventilation has been adopted throughout the Post Office tunnel system, the air being filtered only for the larger tunnels in which apparatus is installed. In these tunnels a structural duct has been incorporated in the concrete flooring with branch ducts at intervals terminating in outlets at the sides of the tunnel; the air after circulating through the body of the tunnel is exhausted through the shafts. A separate exhaust system is provided for the battery rooms through metal ductwork terminating close to the bulkhead at the foot of one of the shafts. Relative humidity was high during the early stages of installation of the apparatus but, with the heat dissipated by the apparatus under working conditions, the need to maintain supplementary heating was obviated.

In the smaller cable tunnels where the depth of floor is insufficient to accommodate a structural duct, a metal or concrete duct is attached to the side of the tunnel; although adjustable ventilators are fitted to the duct, the cable tunnels are most effectively ventilated by allowing the full air delivery to pass to the furthest outlets of the system and find its way back along the body of the tunnel to the shaft head. Circulation is assisted by exhaust fans fitted in the wall of the enclosure over the head of the shaft.

Lighting and Power Services.

A main power and distribution board is provided in the tunnel equipped with telecommunications apparatus and on which a service from the Supply Co's mains is terminated (see Fig. 3). This supply is available from alternative sources and as a provision against failure, a contingency which fortunately did not arise during the war period, three emergency supplies limited in capacity were made available from primary sets installed in protected buildings connected to the tunnel system, each supply being terminated in a circuit breaker on the main power board.

In all the Post Office tunnels the lighting is fed from step-down transformers 230/50 V with the mid-point earthed, limiting the voltage to earth at any lighting fitting, plug socket or switch to 25 V. All wiring is in screwed conduit with lighting fittings of the Holo-phane bulkhead type. Along the cable tunnels a



FIG. 3.—MAIN LIGHTING AND POWER DISTRIBUTION BOARD IN TELECOMMUNICATIONS TUNNEL.

maximum of ten lighting points are controlled by a 2-way switch at each end of the group, a useful facility for an officer patrolling the tunnels and a reasonable safeguard against the possibility of lights being left on needlessly.

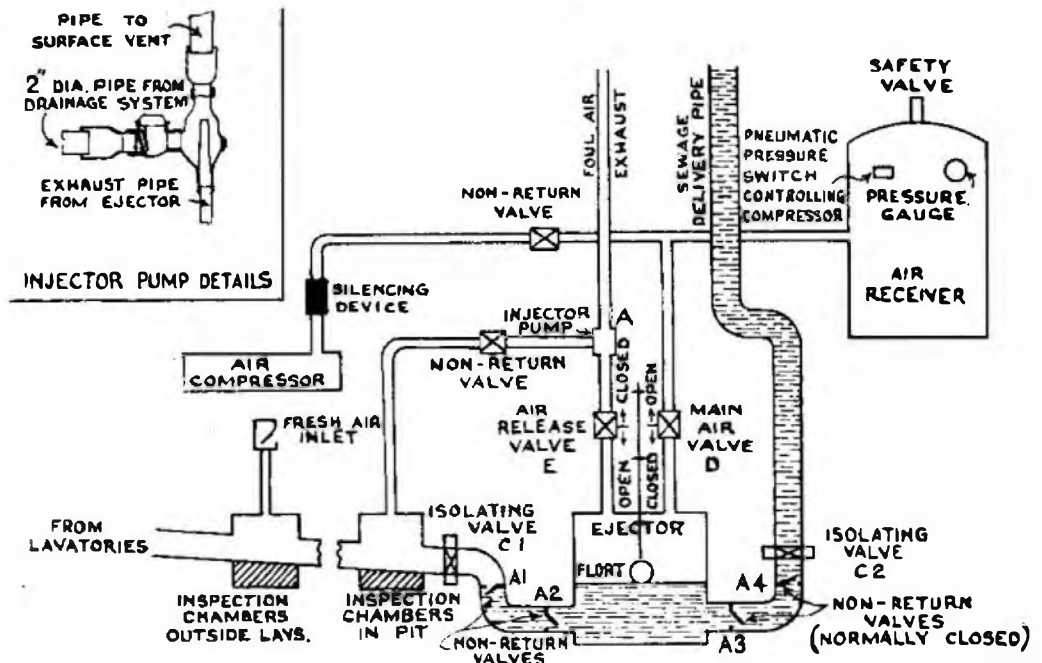

FIG. 4.—OUTLINE DIAGRAM OF EJECTOR SYSTEM.

Welfare Accommodation.

For the use of the staff responsible for the maintenance of the telecommunications equipment, mess-room facilities, necessarily on a limited scale, have been provided at deep level. Water supply is taken from the M.W.B. mains, a reducing valve being fitted to each service pipe at deep level.

Lavatories are provided in the body of the larger tunnels and in short laterals leading from the cable tunnels. The abandonment of a number of working shafts used for the tunnelling operations and offset from the line of the tunnels was fortuitous in making the short connecting laterals available for the purpose after the shafts had been filled in. Fig. 4 is a diagram of the ejector system which has been installed in all the tunnels. The effluent from the lavatories discharges by gravity to an interception chamber and thence to the ejector operated by a float, as shown. The discharge to the street sewers is by compressed air from the container, the pressure in which is regulated to the depth of the tunnel; in most tunnels the pressure is 80 lb. per sq. in. The air compressor starts up automatically by the reduced pressure in the container resulting from the operation of the ejector. The inlet valves to the ejector are closed and the outlet valves opened when the compressed air is admitted to the ejector by the lifting of the float.



FIG. 5.—CABLE GRIPS OVER BORE TUBE.

Cables in Bore Tubes and Shafts.

Reference has been made in Part 1 of this article to the bore tubes sunk from the basement of protected buildings to provide cable connections to the deep level tunnels. Armoured cables are used in the bore tubes and are anchored to R.S.J.'s fixed across the top of the bore pit, as shown in Fig. 5. It will be seen that the wire armouring at the top of each cable has been stripped from the cable and the free ends splayed and clamped in the gland: within the casting is a split conical cable grip pressed against the cable by the tightening of the flange bolts.

Ordinary lead-covered cables are used in the main shafts and these are lead tacked to M.S. straps dressed with lead sheet. The straps are bolted to the shaft lining and each cable is tacked at 5-ft. intervals.

Cable Tunnels and Cabling.

The main cable tunnel system is 7 ft. in diameter, and although almost one quarter of the space is occupied by the ventilation duct, the cable capacity is 130 full-size cables, which should meet the ultimate requirements for the most congested main cable route. The cable bearers have been designed to avoid wastage of space at the sides of the tunnel and the cantilever type of bearer offers the maximum facilities for cabling operations. The head room is little more than adequate for a person of average height, so that a smaller tunnel is obviously unsuitable except in isolated cases where short lengths of tunnel are concerned.

Fig. 6 is a photograph of the Holborn tunnel of reinforced concrete taken at the Holborn exchange end during the initial stages of the cabling operations. The cable drums were brought down in the lift and rolled through a short lateral and bulkhead door to the turntable set in the floor of the enlargement chamber. The drums were then turned through 90° to the position shown in readiness to paying off the cable.

A number of experiments were carried out to determine the most satisfactory means of transporting



FIG. 6. CABLING OPERATIONS IN HOLBORN TUNNEL.

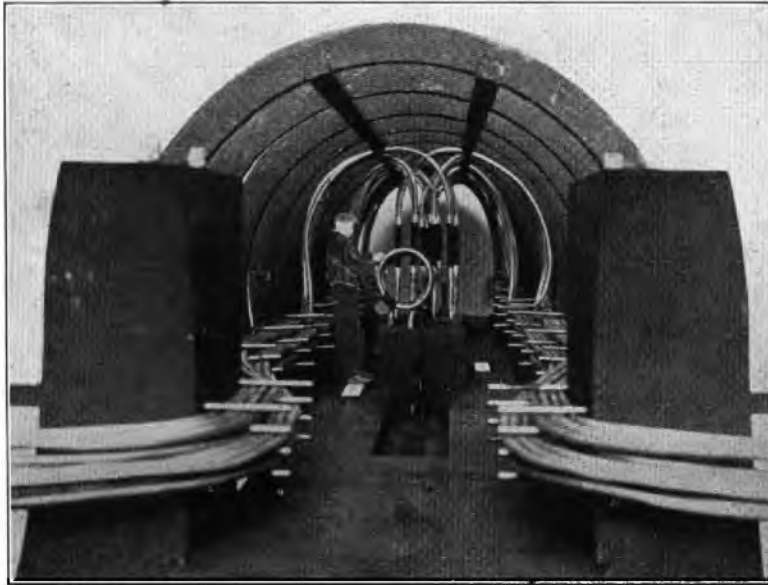

FIG. 7.—MODEL OF LOADING POT LATERAL, HOLBORN TUNNEL.

cable lengths to their allotted position on the bearers, the drums being too large to pass through the 7-ft. tunnel. A modified roller skate to which the cable is clamped at approximately 6-ft. intervals as it leaves the drum was found to be the most successful and labour-saving means of transport, it being possible for one or two gang hands stationed by the side of the cable to maintain it in approximately central position along the tunnel without difficulty.

The layout of the cables in a cable tunnel system demands careful planning in order that crossings at tunnel junctions, in shafts or at cable terminations may be avoided and each cable must be allotted its particular position on the cable bearers.

A loading coil lateral is provided in the Holborn section of the Faraday to Holborn tunnel at half spacing from Faraday exchange. An enlargement in the line of the main tunnel was first contemplated and a scale model prepared complete with one pair L.C. cables and blocks as loading pots. It was clear that a satisfactory cable layout could not be achieved by this method and a model lateral was constructed as shown in Fig. 7, with results which justified the adoption of this alternative.

Cable Connections to Central London Railway, etc.

In the Faraday section of the Holborn tunnel, cable connections have been provided to the Waterloo and City railway, and to the Central London railway east- and west-bound tunnels. Glands, similar to those already described, are set at an angle in the segments of the railway tunnels to enable the cables to pass immediately to the tunnel wall. Cable routes to the Post Office (London) railway are also provided. A view of the pipe connection to the Waterloo

and City railway is shown in Fig. 8.

Conclusion.

The diversion to deep level of a large number of main cables from heavily-congested areas between Faraday Building and Holborn has provided, in that section, almost complete immunity from cable breakdown with its attendant interruption to service, often of a serious nature. Much remains to be done, however, to free the main thoroughfares in London, and possibly in the larger provincial cities, of main cables which at various times have involved the construction of duct routes passing through some and by-passing other manholes in the same thoroughfare under expensive pavings. This in the course of time has led to unsatisfactory cable layouts in manholes, with joints difficult of access. Cabling operations in surface routes moreover not infrequently cause disturbance to existing cables.

On the basis of annual charges, the overall cost of a 7-ft.-diameter tunnel with its engineering services compares favourably with that of a 72-way duct route in open trench with reinforced concrete reinstatement, and, in making the comparison, consideration must be given to the fact that a tunnel of that diameter can accommodate an increase in cables up to a total of 130 without additional cost other than that incurred in drawing in cables, a cost which is common to both tunnels and surface routes. Maintenance conditions for jointers in manholes, many of which are in wet situations, are less favourable than those available in tunnels, and indeed in some cases far from satisfactory. It would appear, therefore, that consideration should be given to the provision of a tunnel on any route in London where the number of cables is likely to exceed 60.



FIG. 8.—PIPE CONNECTION FROM FARADAY TUNNEL TO WATERLOO AND CITY RAILWAY.

The Central Training School, Stone

C. E. CALVELEY, O.B.E., B.Sc., M.I.E.E.

U.D.C. 373.63 : 621.39

The author describes the conversion of three war-time hostels to serve as the first residential central training school of the Post Office Engineering Department. The school comprises three sections covering training in automatic exchange maintenance, transmission equipment maintenance and miscellaneous subjects respectively.

Introduction.

LEARNING is a continuous process. On the first day an engineer enters the service he commences learning the specialised subject of telecommunications engineering and thereafter learning and instructing form a large part of his everyday job. Much of this absorption or imparting of knowledge was and is unplanned. But since 1924 instruction to the Engineering grades of the Post Office on certain phases of their work has been carried out at the Central Engineering Training School, firstly at King Edward Building, and later at the P.O. Research Station, Dollis Hill. The School suspended its activities at the commencement of the war, but the release of so many trained engineers to the Forces and their replacement by green labour resulted in its reintroduction on a dispersed basis at Cambridge, Otley, Birmingham and Dollis Hill.

The difficulties in obtaining houses for instructors and lodgings for the students and the foreseen increase in training requirements at the end of the war, led to discussions with the Staff Associations and the agreed decision to establish a Central Residential Engineering Training School. As there was no possibility of obtaining new buildings to meet the training requirements, three hostels built under the direction of the Ministry of Supply for housing workers employed at the Royal Ordnance Factory, Swynnerton, Staffs, were earmarked for the new project.

Location and Layout.

The three hostels are adjacent to the village of Yarnfield, three miles west of Stone, a small town half-way between Stafford and Stoke. Each hostel consists of eleven H-shaped blocks, twenty-four double cubicles being provided in each leg of the H and a central common room, ablutions, lavatories and baths and air raid shelters in the cross bar. Canteens, kitchen, lounges, games rooms, cinema, dance hall and administrative accommodation are also provided at each hostel.

All the hostels associated with the R.O.F. were named after famous Admirals and the three taken over by the Post Office were allocated as follows :

Beatty Hall—For conversion into married quarters for the school staff.

Duncan Hall—For conversion into lecture rooms, rooms for practical adjustment, faulting equipment and demonstration equipment.

Howard Hall—Living accommodation for students and single members of the school staff.

When converted, Beatty Hall will provide eighty-eight mixed two- and three-bedroomed bungalows of approximately 650 sq. ft. and 1,000 sq. ft. respectively. Each bungalow will be centrally heated from one of two main boiler houses on the site and will have constant hot water, electric cookers and a built-in electric fire in the lounge. The space around the blocks is insufficient to provide for a garden to each bungalow, but an adjacent field has been ploughed up for allotments. Accommodation not suitable for conversion into bungalows is being reserved for sports and social facilities for residents, and for a nursery school. A general view of Beatty Hall showing the H blocks scheduled for conversion is shown in Fig. 1.

Duncan Hall presented the major problems in conversion as only certain accommodation had adequate ceiling height for apparatus racks and this accommodation had to be stripped of existing equipment. Provision has been made for two automatic exchange training schools, a transmission school and a miscellaneous school in which is included local line development, power, and Probationary Engineer and Probationary A.E. (N.S.) training. The general layout of the site and its allocation to the various schools is shown in Fig. 2.

Howard Hall is being used as originally designed and only minor alterations have been made. A view of one of the lounges is shown in Fig. 3. Single members of the school staff have a room individual to themselves which is furnished as a bed-sitting room.

Sports and Social Facilities.

In an isolated area activities to occupy the



FIG. 1.—BEATTY HALL—GENERAL VIEW.

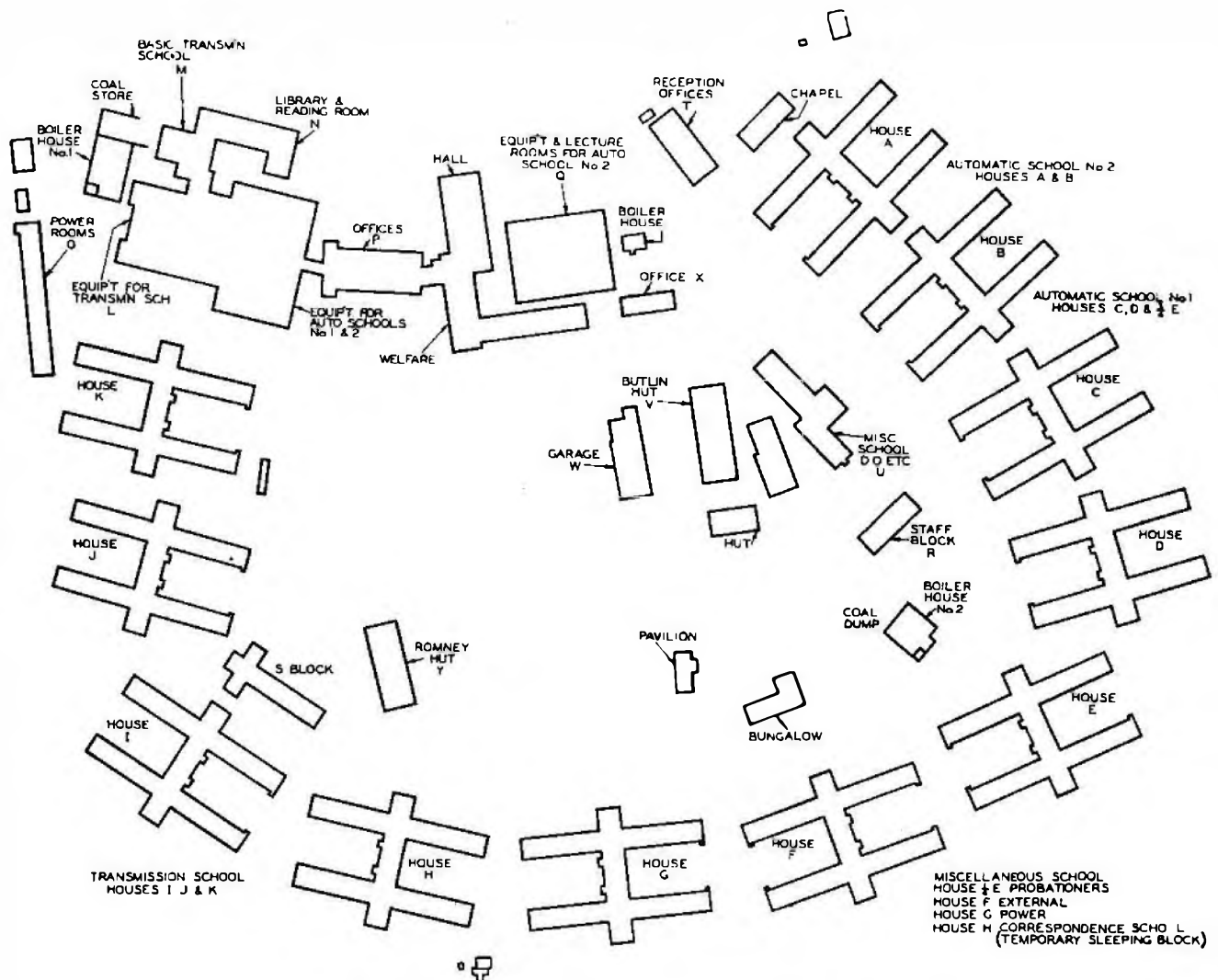

FIG. 2.—DUNCAN HALL—SITE PLAN AND GENERAL LAYOUT.

students' off duty hours are very important. A Sports and Social Club has been formed and is affiliated, through the Engineer-in-Chief's Sports Club, to the Civil Service Sports Council from whom very valuable help is being obtained.

The activities of the Sports and Social Club have already commenced. A club house with bar has been furnished and opened. Dances have been held, a football team has been entered for one of the local leagues and it is hoped to open the cinema shortly. The welfare accommodation in the Howard Hall hostel has table tennis, darts and bar billiards equipment.

In addition to these sporting and social activities arrangements have been made, in co-operation with the Workers' Educational Association, for lecturers on current affairs, musical appreciation and French classes to attend each week.



FIG. 3.—HOWARD HALL—LOUNGE.

Ground is available for cricket pitches, tennis courts, football and hockey pitches, and with the assistance of the Civil Service Sports Council it is hoped to provide all these facilities this year.

Within a year it is hoped to be able to cater for the hobbies, sporting and intellectual activities of all students.

Training Organisation.

After having agreed the training requirements with the Executive Branches in the E.-in-C's O., each subject

the common type of fault occurring in an automatic exchange area network and to check and adjust uniselectors and two-motion selectors, or, similarly, if he passes the basic transmission course he is qualified to co-operate in fault localisation and the straightforward lining-up of new audio circuits. After experience in the field he returns for a final course which for automatic exchange students will depend on the type of plant he is required to maintain, but is normally director, non-director or U.A.X. and for transmission students may be repeaters, multi-

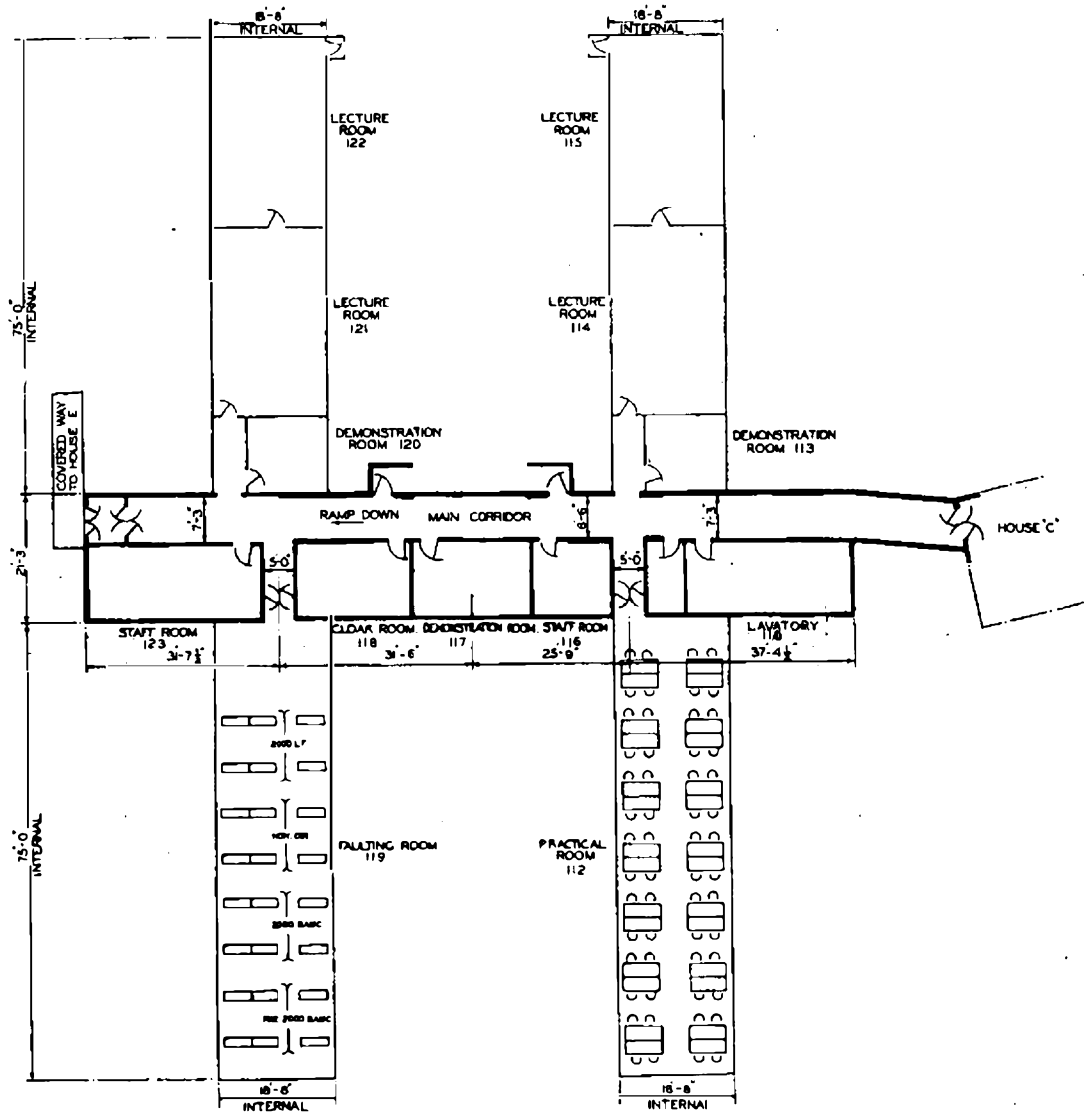

FIG. 4.—AUTOMATIC EXCHANGE SCHOOL LAYOUT, HOUSE D.

to be taught is divided into suitable courses, lectures, demonstrations and practical work. Since 1944 transmission training has been taught in two stages and more recently automatic training has been similarly divided. The first stage is a basic course of seven or eight weeks' duration in which the fundamentals and principles of the subject are taught, so that when a student has attended a basic automatic exchange course and passed he is qualified to locate

channel V.F. telegraphs, or carrier principles followed by a Carrier No. 5, 6 or 7 course. Successful candidates on a basic transmission course or on one of the second automatic exchange courses are eligible for consideration for Technician regrading.

The war has left considerable arrears of training and, to overcome these, the resources must first of all be mainly directed to the basic courses and then diverted to supplement the final training courses.



FIG. 5.—FAULTING ROOM FOR AUTOMATIC EQUIPMENT.

The Training School at Stone opened on 30th September, 1946, with two basic automatic exchange courses, followed by two more a week later. Basic transmission courses commenced on 4th November, 1946, and as more hostel accommodation becomes available the number of these courses will be increased.

Automatic Exchange School.

The lecture rooms, practical rooms, demonstration rooms and faulting rooms can readily be laid out in the wings of an H block, leaving the central portion for offices, lavatories and cloak rooms. The layout of D block in the automatic exchange school is shown in Fig. 4, and the faulting equipment for 2000 type selectors in Fig. 5. The faulting equipment, which is provided on an individual student basis, consists of a dial, group and final selector of the 2000 type inter-connected to form a train of switches. A similar arrangement is provided for pre-2000 type switches with mixed 100 and 200 outlet group and final selectors. Incorporated in the switches are U links which have been inserted in the internal connections of the switch and so enable faults to be readily put on by the demonstrator for the student to trace and locate by functionally operating the switch and checking the failure against the circuit diagram. The object of this part of the course is to train students in acquiring practice in deducing from the circuit diagram and the state of the relays or the switch the cause of the failure. The student can acquire knowledge of the cause of faults, e.g. worn contacts or parts, only by practical experience in a working exchange.

Because of the height limitations in the H blocks it has been unavoidably

necessary to locate the demonstration equipment away from the lecture and practical rooms. For the basic courses a temporary automatic exchange from emergency stock was erected by the P.O. Factories staff. The P.O. Factories staff are also erecting U.A.X.'s Nos. 5, 6, 12, 13 and 14, Siemens 16, and P.A.B.X.'s for demonstration purposes. Pre-2000 type and 2000 type director and non-director exchanges with bridge and sleeve control manual boards are being erected by the G.E.C. All exchanges will be interconnected for demonstration purposes.

Transmission School.

A layout similar to the automatic exchange school is adopted in the transmission school. A practical laboratory (Fig. 6), with twenty-four benches wired with an L.T. and H.T. supply and an individual oscillator generating 800 c/s is provided in which

students do A.C. experiments relative to transmission. The layout of K block is shown in Fig. 7.

The demonstration equipment is also located away from the H blocks and consists of nine repeater stations arranged in three groups of three terminal, intermediate and terminal repeater stations, Fig. 8. All stations can be interconnected through artificial and real lines specially looped back to provide training in lining-up new circuits and circuit fault localisation under the Control Station procedure. Faulting equipments consisting of Oscillators No. 13C, Amplifiers Nos. 5, 20A and 32 with Panels T and LC, Units Signalling No. 3A, Panels Signalling No. 7, and Ringer Test Panels RP 398, are also provided, and on these equipments the students are taught to clear faults on the equipment in a similar manner



FIG. 6.—PRACTICAL LABORATORY—TRANSMISSION SCHOOL.

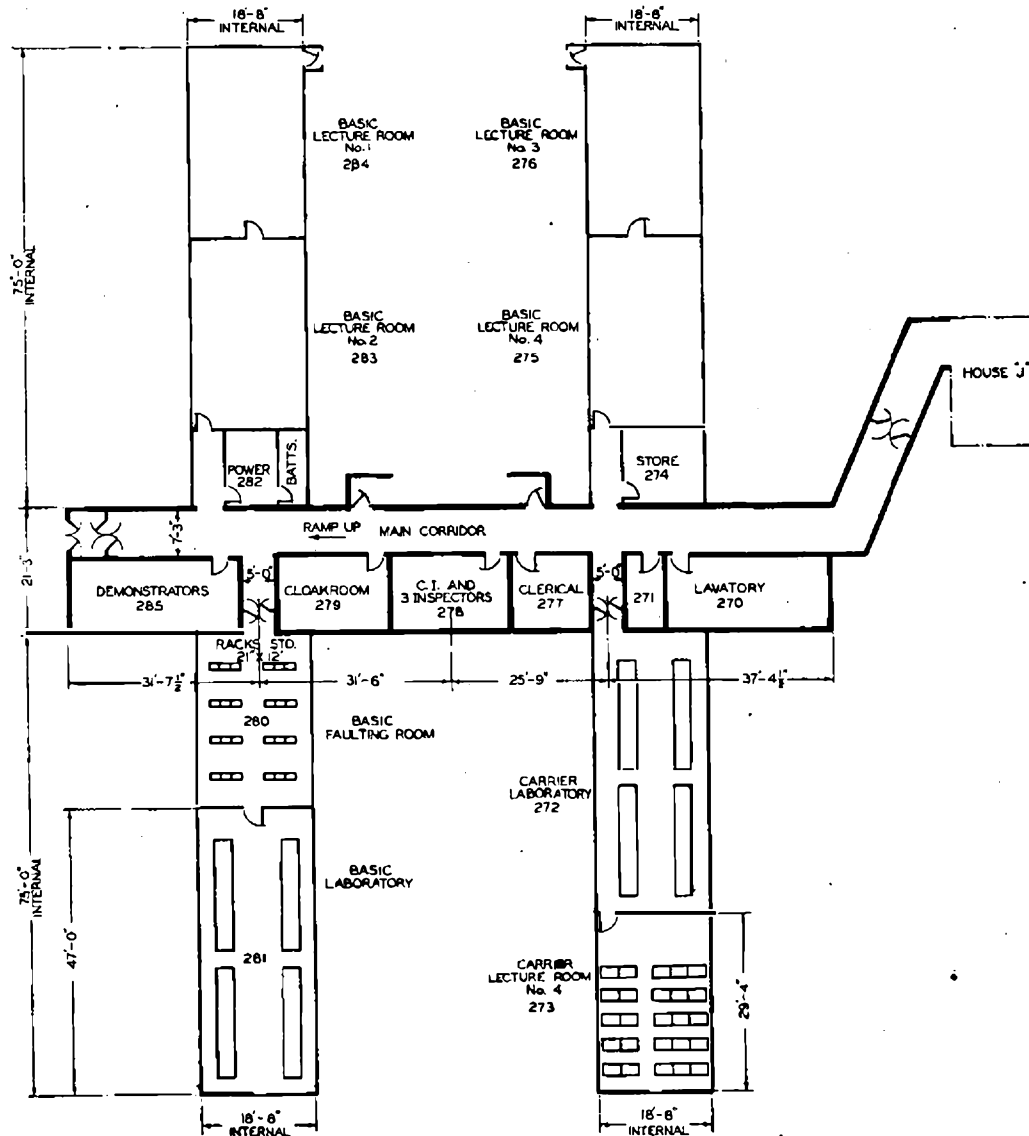

FIG. 7.—TRANSMISSION SCHOOL LAYOUT, HOUSE K.

to that used in the automatic exchange school.

Teleprinters, repeaters, M.C.V.F., 12-channel carrier and co-axial equipment are being installed and will be used in a similar manner for demonstration, faulting and laboratory work.

Miscellaneous School.

The principal subjects to be taught in this school are local line development and other external technical courses such as cable balancing, precision testing, etc., radio interference suppression, and power maintenance.

As a practical illustration of present construction practices for the benefit of students on local line development courses, new type manholes, and pillar and cabinet flexibility points have been provided as part of the UG cabling scheme for the site.

Radio interference suppression courses will follow existing practice, but for television interference courses

provision has been made for improved facilities and methods.

Power maintenance is a new subject and will include the power apparatus associated with telephone exchanges and repeater stations and also that associated with accommodation and postal services.

The courses for Probationary A.E.'s (New Style) and Probationary Engineers are associated with the miscellaneous school as a matter of administrative convenience.

Supervisory Training.

It has been realised that technical excellence alone is not sufficient to ensure an efficient staff. All engineering supervisory posts in the Areas and Regions and the majority of supervisory posts in the Engineer-in-Chief's Office involve meeting people, being responsible for the welfare of staff and the



FIG. 8.—REPEATER STATION DEMONSTRATION EQUIPMENT.

organisation of their work. Unless this side of a supervising officer's work is done properly the staff will not be happy at their work and cannot therefore be efficient. Also the higher supervisory ranks need to be trained in the broader practice of technical work, e.g. a trained supervising officer should be able to assess the condition of an automatic exchange and find out why the faults are high without necessarily knowing every relative circuit diagram.

Training for the development of the supervisory qualities of organisation method and ability to lead, control, train, select, and co-operate with people is much more difficult than imparting technical knowledge. All people possess these qualities to some degree and the object of training should be to give guidance on the basis of the principles used, perhaps unconsciously, by good staff managers and administrators so that the inherent capabilities of the individual may be developed on the right lines.

Book Review

"Modern Telegraph Systems and Equipment." W. T. Perkins, A.M.Brit.I.R.E., A.M.Inst.B.E. 216 pp., 128 ill. Newnes 10s. 6d.

This book contains descriptions of certain of the equipment used, and methods current, in present day telegraph practice. The treatment is, on the whole, somewhat superficial, and the scope, in some respects, restricted; and since no special attempt has been made to introduce fundamentals or inter-relate practice with theory, the book is likely to appeal rather to those having solely a general interest in the subject than to technicians or students, whose need is for information and guidance in regard to basic principles and technique.

The author has, however, dealt with the subject in a simple and direct manner, with an avoidance of technical complexities which makes for easy reading. This will, no doubt, be welcomed by the reader whose aim is to inform himself on the range of facilities and possibilities offered by modern telegraphy, and who, with the object of making most efficient use of these possibilities, desires

Some of these principles are already covered in the Training within Industry (TWI) courses of Job Instruction (JI) and Job Relations (JR) and it is hoped to include these subjects in the training of all probationers. The equally important matter of selection of staff with its known difficulties of accurately determining and assessing in an interview with a youth of sixteen, his inherent qualities as a workman and his potentialities as a supervising officer is the subject of a lot of interesting work in the analysis of jobs into their fundamental units and the measurement of inherent qualities and capabilities.

These matters are outside the scope of this article but when the results are published careful consideration will be merited by all supervisory officers concerned with the selection of staff, as there is probably no more important job in relation to the service as a whole that a supervisory officer is called

upon to do, than the selection of staff who will, for the whole of their career, be both satisfactory and efficient at their work as well as happy and contented individuals.

Conclusion.

The instruction given at the Central Training School is designed to impart the principles and fundamentals of the subject and is, therefore, only a portion of the general process of training a workman to be skilled. The amount of knowledge to be absorbed is considerable and even a limited previous practical experience of the subject provides a background which facilitates the instructor's job. Further, if this newly acquired knowledge is to be consolidated and full value from attendance at the training course obtained, it is essential that the student on his return to the Area should receive immediate and appropriate practical experience.

to acquire a general knowledge of the apparatus used. In the result the book may be somewhat disappointing to the discerning technical reader, particularly should he be already directly concerned in telegraph engineering.

Nevertheless, in so far as the book sets out to give a general informative approach to the subject, as distinct from a technical approach, then it goes a good way towards achieving its purpose.

Several inaccuracies call for mention, for example the term "impedance" is used in several places where "attenuation" or "loss" is strictly appropriate. The definition given on page 188 for the "Baud" is incorrect, and those for "Distortion" and "Margin" on pages 192 and 195 are misleading. The explanation, given on page 204, of teleprinter signalling speed in terms of cycles per second is fallacious.

The information regarding the linking of voice-frequency telegraph channels on page 41 cannot be regarded as representative or in conformity with good practice.

E.H.J.

Some Notes on Telephone Switching Development in Sweden

CAPT. J. LEGG,
B.Sc., A.M.Inst.C.E., A.M.I.E.E.

U.D.C. 621.395.34(485) 621.395.658 621.395.722

The author describes features of the Swedish telephone service of particular interest to British telecommunications engineers. These include the use of the crossbar switch for rural automatic exchanges and the extension of subscriber dialling.

Introduction.

SOME readers of this Journal may be aware that a visit was paid to Sweden last autumn by representatives of the Telecommunications Department, the Engineering Department, and the telephone operating staff of the British Post Office. The visit was part of a programme designed to inform the Post Office on the lines of development which had been followed by overseas administrations during the war, when normal sources of such information had perforce been lost. The party was principally concerned with the telephone service outside the purely local areas, and the associated engineering equipment. The following notes deal with some points of interest in this field.

Before the more recent developments are touched on, readers may like to be reminded in general terms of some of the features of the Swedish telephone system. As is well known, telephone development in Sweden has reached a point which places Sweden among the most highly telephoned countries in the world. On the 1st January, 1946, the number of telephone stations was 1,221,153, or an average of 183.0 stations per thousand of the population. Of these telephones 57 per cent. were at that date connected to automatic exchanges. The automatic exchanges in the large cities employ the L. M. Ericsson 500 line system, based on the well-known 500 outlet connecting switch made in Sweden by that firm. This is a power driven switch, and the system employs registers, and makes use of the revertive impulse principle for positioning switches. Considerable use is also made of a switch of the crossbar type, of which type Sweden may be regarded as the birthplace.

Rural Automatic Exchanges.

The last occasion on which any study was made of switching equipment in Sweden was in 1934, when a visit was paid to Stockholm by Messrs. I. H. Jenkins and H. Leigh of the Engineer-in-Chief's Office. Their studies were confined to the Stockholm area. At that time the extension of automatic equipment into the sparsely populated areas was, as in this country, still in the initial planning stage. One main point of interest in the recent visit therefore was the development of the automatic system for the rural areas, and the allied matter of the extension of the range over which the subscriber could set up his own call by automatic means.

Automatic exchange service in the rural areas is given by unattended exchanges, of which large numbers are in use. There are two main kinds:

A so-called terminal exchange which handles no tandem traffic. This is designed in unit form to cater for 20, 40, 60 or 100 lines.

A tandem exchange which is not in unit form, but is separately designed for each case. The subscribers' line capacity depends on the extent of the junction network, the majority of the exchanges inspected having about 400 working lines. These tandem exchanges act as switching centres to give access to the manual board or the main automatic centre from terminal exchanges around them.

Great care is taken in the construction of the buildings to exclude draughts, and to provide an air space between the inner and outer walls. Most of the buildings seen were of wooden construction outside and lined with synthetic board, the floor being of closely fitted boarding, and covered with linoleum. Windows are not normally fitted, but if provided are quite small. As regards heating, either one or two 1 kW electric heaters are provided, and a system of thermostatic control holds the temperature at 10° centigrade normally for tandem exchanges, and 4° centigrade for terminal exchanges. The control takes no account of the humidity of the air as in this country. The lighting is on a lavish scale, but there is no water supply. The battery is usually in a separate room, but if not is carefully enclosed with a ventilation flue to the outer air. Fully automatic power plant is provided. Ringing and tone generation is by rotary machines which are normally driven from the exchange battery.

The standard switch in all unattended exchanges is the crossbar. There are no registers at the terminal exchanges, but registers are necessary at all tandem exchanges. At a typical 300-line exchange which was visited, a rack approximately 8 ft. 6 ins. by 5 ft. provided accommodation for six registers, of which five were fitted. The subscriber at the terminal exchange, on lifting his receiver, is connected with the junction to his tandem exchange, or to the main automatic centre, and seizes a register at one of these exchanges. Counting equipment on the junction responds to the dialled impulses, and, if the call is for another subscriber on the terminal exchange, releases the junction and register as soon as this fact becomes apparent from the digits dialled.

The junction equipment provides for both-way working, and includes a type of sequence relay for counting the impulses dialled. The equipment is strip mounted, jacked-in equipment as understood in this country not being used. To provide for easy removal of relay sets, connection between the set and the external wiring is commonly made by multiple jacks and plugs.

As regards coin boxes, no technical arrangements are made for discrimination between coin box and ordinary subscribers when the manual board is reached. Each coin box has a distinctive number

marked on it which is outside the numbering scheme of the exchange or area concerned, and the operator can recognise a coin box call when this number is given. For automatically completed calls where multi-registration equipment exists, a call originating from a coin box station is disconnected after 25 seconds warning if it extends to a point at which a second fee would be chargeable.

As regards maintenance, these exchanges need a very small amount of attention, and the faults appear to be very low. A system is in force of centralised control of maintenance staff similar to that which exists in this country. Routine testing and inspection of unattended exchanges are dealt with by visits from a specially trained staff not included in the ordinary faulting staff.

The complete switching equipment, including the switches and relays themselves, is manufactured in the Swedish Board of Telegraphs own factory at Nynashamn, near Stockholm, and installed by Regional staff.

Long Distance Subscriber Dialling.

Before the arrangements for the extension of subscriber dialling are discussed, a brief reference to the present Swedish charging system as used in manual exchange areas is necessary. All exchange line rentals include a definite number of local calls (see below), rising in a series of steps from 1,200 calls per annum upwards. Although there are approximately 6,700 telephone exchanges, the country is divided into only 235 charge areas of varying size each of which is based on an exchange which serves as a centre of the area. Calls within a charge area count as local calls, and are included in the subscription rate up to the appropriate limit for the line concerned. Subject to local adjustments to deal with anomalies arising in the charges between exchanges lying on the borders of adjacent charge areas, calls from one charge area to another are subject to a trunk fee based on the distance between the area centres. In areas with extended subscriber dialling when a subscriber sets up a call outside his own charge area, the multi-registration equipment is designed to recognise this, and to provide for the call to be recorded on the subscriber's meter. The amount recorded on the meter is adjusted to correspond with the distance by a system of timing which provides for the subscriber's meter to be operated at shorter intervals as distance increases. This point will be referred to in more detail later.

To enable the extension of subscriber dialling to proceed smoothly to any extent desired, and to enable equipment design to proceed with a clear knowledge of the objectives,

about 350 centres have been selected as future charge areas and switching centres, and have been given routing codes of 2 or 3 digits. Each centre serves a group of exchanges (Nätgrupp) included in an area, usually somewhat smaller than the existing charge areas but characterised by the existence of one linked numbering scheme for the whole area. This means, of course, that individual exchanges in the group area lose their identity from the Directory point of view. For example, a subscriber living at Sjömarken just outside Borås, and connected to Sjömarken exchange, has a Borås number beginning with 54, the routing code for Sjömarken. All exchanges in the same group are subject to the same call charges.

As automatic working is introduced between the different group centres, the code allotted to a group will always be used to obtain access to that centre. Register equipment to perform the necessary translation for all the group centres employs the crossbar switch with, in addition, in some cases, a simple sequence switch, and in others only relays. As an example of the extension of the subscriber dialling range outside the local area, the illustration (Fig. 1) shows the arrangements at Borås in the Göteborg area. Here there is complete inter-dialling between three group centres, Borås (Code 33), Kinna (Code 320), and Svenljunga (Code 325). There are 95 exchanges and approximately 20,000 lines in the areas. Subscribers in each area dial the code for the other area required, listen for second dialling tone, and then dial the



FIG. 1.—ARRANGEMENTS FOR INTER-DIALLING BETWEEN 3 GROUP CENTRES.

Directory number of the wanted subscriber. The system of multi-registration is based upon the principle enunciated above, of reducing the time allowed per unit fee as the distance increases. For example, a call dialled by a subscriber to another number on his exchange would be charged one unit fee, and there would be no timing. A call to another exchange within the same charge area would be charged one unit fee, but the meter would be operated once for every six minutes, or part of six minutes while the conversation lasted. If the call were to an adjacent charge area, the period would be reduced to 1½ minutes. Extension beyond this range can be provided for by suitable reductions in the timing period between the meter impulses. The scheme provides for a very large number of exchanges to be reached without corresponding complexity in the discrimination as to charges.

For coin box calls, provision is made for the call to be cut off after a short warning period, when the single unit fee time is reached. This time would be 12 minutes within the charge area, and 3 minutes within adjacent charge areas.

Board of Telegraphs' Factories.

On the manufacturing side the Board of Telegraphs controls four factories, the largest of which is situated at Nynashåmn, a pleasant town on the sea coast about 30 miles from Stockholm. This factory is employed 90 per cent. on new construction, switch sections, crossbar switches, telephones, bell sets and generators being seen in production. A major item is the manufacture of equipment for unattended exchanges referred to above. The factory employs 1,300 operatives and is all on one floor. All normal machine operations, turning, drilling, milling, pressing, are catered for, and plating and woodwork shops exist. There is careful quality testing of all raw materials, a well fitted chemical and physical laboratory being available. An interesting feature is the care which is taken in training recruits for the skilled work of the factory in fitting and tool making. A separate well-equipped workshop is set apart for the use of 20 lads, who go through a course of either two or four years' duration, including theoretical work as well as systematic training at bench work and machine operations. Two full-time instructors are employed on this work.

Exchange Buildings.

As regards exchange buildings, a striking feature is the very high standard of accommodation provided,

and the care which is taken to give these buildings a distinctive character architecturally. The illustration (Fig. 2) shows the telegraph and telephone building in Kristianstad, a small town in the Malmö region. In addition to the automatic exchange and manual board, the building houses the Sectional Engineer's headquarters and Section Stock, and provides also public offices for telephone and telegraph traffic. The postal services in Sweden are under separate management from the telegraph and telephone services, so that no provision is made for postal services in this building.

The usual switchroom layout provides for short suites at right angles to the length of the room, with ample natural lighting from large windows in the side walls. The cabling runs under a false floor on one of the long sides, and is taken off to serve each suite. The switchboards are finished in an attractive shade of light oak, with green key shelves, and the multiple has a matt grey rather than a black appearance. Lavish use is made of sound-absorbent material not only in switchrooms but in telegraph rooms, public offices and other accommodation. Fluorescent lighting is normally provided. Air conditioning is not standard practice, but in one exchange visited there was a complete air conditioning plant providing for the introduction of fresh warm air in the winter, and for cooling if necessary during the summer months.

Acknowledgments.

Grateful acknowledgments are due to the Royal Board of Swedish Telegraphs for the supply of the material on which this article has been based, and to Mr. F. J. Tickner for the use of the photograph of Kristianstad exchange.



FIG. 2.—TELEGRAPH AND TELEPHONE BUILDING IN KRISTIANSTAD.

Reorganisation of the Skilled Workman and Inspectorate Classes

L. F. SCANTLEBURY,
Whit.Sch., A.C.G.I., D.I.C., A.M.I.E.E.

U.D.C. 331.87:654.1

The reorganisation scheme covering the skilled workman and inspectorate classes of the Post Office Engineering Department has now been introduced and the following is a brief outline of the scheme and of the reasons for its adoption.

SKILLED RANK AND FILE GRADES.

Former Organisation.

IN the past the skilled rank and file duties of the Post Office Engineering Dept. have been performed by two grades, viz. (a) Skilled Workmen Class I, and (b) Skilled Workmen Class II and Unestablished Skilled Workmen, the Class I men being employed on the higher grade duties and on minor supervision. There was no difference in the duties assigned to Skilled Workmen II or Unestablished Skilled Workmen, the Unestablished Skilled Workman becoming a Skilled Workman II after five years' service on skilled duties. At the time of the wage agreement of 1929 the opportunity was taken of recognising the wide variety of technical knowledge and skill required for the duties performed by Skilled Workmen II and Unestablished Skilled Workmen by the introduction of three types of duty allowances called B, C, and D respectively. Broadly a division was made between staff on internal duties, to whom generally allowances were paid, and staff on external duties. External staff, with a few exceptions such as plumber joiners and gang foremen, were not eligible for allowances. The D allowance was paid in respect of the simpler internal duties such as fitting and maintenance of manual exchanges and subscriber's apparatus, and the C allowance in respect of duties calling for greater skill and application such as the installation and maintenance of automatic exchanges and repeater stations. Gang foremen were granted the B allowance, and at that time only 25 per cent. of gang foremen could reach Skilled Workmen I rank. The duties for which the C and D allowances were paid had been considerably extended with the introduction of new apparatus and methods of working following discussion on the Standing Joint Committee, and in 1939 out of a total of 27,300 Skilled Workmen II and Unestablished Skilled Workmen, 2,525 were in receipt of a C allowance, 9,193 of a D allowance, and 1,356 of a B allowance, a total of 13,074, or just under 50 per cent. Although all allowances were subject to withdrawal if the recipients were permanently removed from allowance-carrying duties, a distinction was drawn between a permanent allowance which continued to be payable during temporary absences from the work due to leave, courses, etc., and an intermittent allowance which was payable on a daily basis only for the actual period during which the duties were performed. The system was further complicated by the necessity of conforming in certain cases to a stipulated percentage time factor, or to a qualifying period towards which a proportion of time spent as a Youth-in-Training could be counted.

The Need for Reorganisation.

The work of the P. O. Engineering Dept. has altered very materially since 1929 when this allowance system

was introduced, and it had become increasingly apparent latterly that the allowance system was cumbersome in operation, did not provide the flexibility necessary to meet easily the rapid technical developments of recent years and had generally outlived its usefulness. It also seemed that the time had come, in view of the number of staff in receipt of allowances, to adjust the basic rate paid to the requirements of the job, and to review the adequacy of the workman grading in the light of modern developments.

The developments in automatic telephony, carrier and co-axial transmission, voice-frequency telegraphs, long distance switching using 2 V.F. signalling and dialling systems, and in radio technique increasingly demanded for their construction, operation, and maintenance, a type of officer who in addition to the necessary technical skill has the ability to understand the fundamental principles involved, and it is therefore essential that the career offered by the P.O. Engineering Dept. should be such as to attract the right type of youth with the necessary basic education and aptitude to absorb highly specialised training. The career value offered by the existing system, however successful it may have been in attracting suitable entrants in the past, was considered inadequate to meet the keener competition which must be expected in the future.

The Technician Grade.

It was therefore decided that the more highly technical duties should be undertaken by a new grade of workman with a rate of pay which would afford a satisfactory career within the grade, and be more commensurate with the requirements of the duties, and with the general remuneration paid, or likely to be paid, in outside industry for similar high-grade work. Regard was also paid to the further advancement of these workmen into the supervising grades, as indicated later. The title of "Technician" was adopted for this new grade, retaining the title of "Skilled Workman" for the remainder of the skilled rank-and-file staff. Although the division of Technicians into two classes, and the introduction of an efficiency bar was considered at one stage, this was abandoned in favour of one grade, which could be entered at an early age (in the case of a workman who had been recruited as a Youth-in-training, after five years' service) with a scale of pay such that the maximum would normally be reached in the early thirties.

The skilled rank-and-file duties were examined to ascertain and classify those proper to be performed by the new grade of Technician. In general, Technicians will be responsible for the construction, maintenance, testing, and demonstration of automatic switching equipment, radio and transmission equipment, including carrier and co-axial multi-

channel terminal and intermediate station equipment, V.F. telegraph apparatus, 2 V.F. signalling and dialling equipment, and sleeve control trunk switchboards. Technicians will also be employed upon planning and estimating duties, the supervision of contract works, cable balancing, wireless interference investigation, and detailed investigation into plant defects on all internal equipment including power plant.

Selection for training as Technicians will be from Youths and Skilled Workmen who show aptitude for the work and make satisfactory progress in technical studies. Youths will receive preference who obtain an Intermediate Grouped Course City and Guilds certificate in Telecommunications or its equivalent. All men selected will be advised accordingly and given every facility by suitable field and school training to qualify in due course.

Where a number of Technicians are continuously employed together on similar duties at a centre, leadership of the group is recognised by the payment of a chargeship allowance provided the group consists of at least four Technicians.

A pool of reserve Technicians will be available to be drawn upon for substituting Technicians absent on leave, courses, etc., or to meet temporary peaks of work. The size of this pool has been fixed initially at 15 per cent. of the authorised number of Technicians' posts in any one telephone area.

The Skilled Workmen Grades.

On the Skilled Workmen side the present grades of Skilled Workmen I and Skilled Workmen II will be retained, but the grade of Unestablished Skilled Workmen will be abolished, establishment no longer being a condition of entry to the grade of Skilled Workmen II. The duties of Skilled Workmen I will be much the same as in the past, less those now proper to the Technician grade, and will in general cover control of Skilled Workmen, chargeship of important manual exchanges, and individual duties involving responsibilities or skill above that demanded of the Skilled Workmen II. The Skilled Workmen II will be divided into two categories, S.W.IIA and S.W.IIB. The former will include duties for which a C or D duty allowance was formerly paid and which demand a knowledge of electrical and mechanical principles and ability to read technical diagrams, but which are not such as to warrant Technician or Skilled Workman I grading. Examples are the installation and maintenance of subscribers' apparatus, P.M.B.X.'s and manual exchanges, plumber jointing, and E.L. & P. wiring. Skilled Workmen IIA will also comprise Technicians-in-training, and workmen assisting Technicians. Skilled Workmen IIB will comprise the remainder of the Skilled Workmen, including gang hands, motor-drivers and men employed on duties demanding little technical knowledge and a lesser degree of skill.

Men employed permanently upon Skilled Workman IIA duties will receive an allowance on a permanent basis, which will continue to be paid during absences due to leave and attendance at courses, and during temporary withdrawal from Skilled Workman IIA duties and will not be withdrawn unless the recipient

is permanently taken off Skilled Workman IIA duties.

At large automatic exchanges and repeater stations where the maintenance is performed by a number of Technicians assisted by Skilled Workmen IIA, the proportion of Skilled Workmen IIA assistance has, in the interests of uniformity, been fixed at a maximum of 25 per cent. of the total maintenance staff required. Similarly, a maximum ratio of 2 to 1 has been fixed for the number of Technicians employed in planning groups in relation to the number of Assistant Engineers (new style) they assist, to avoid the difficult and vexatious scheduling of precise duties which the Technicians may or may not perform. Assistant Engineers and Technicians will in future work as a team, the overall direction and responsibility resting with the Assistant Engineers and Technicians assisting to the fullest possible extent.

No change has been made in the duties and allowances of labourers, or in the employment of tradesmen on certain duties. Tradesmen who may subsequently enter the Skilled Workmen grades and continue to work in their trades will enter as Skilled Workmen IIA.

The Effect of the Reorganisation Scheme on the Workmen Grades.

The effect of the reorganisation scheme on the workmen grades is shown in the following table, which gives the numbers and gradings under the old and new systems, based on the number of workmen at January 1st, 1947. Youths-in-training, boys, tradesmen, wayleave officers and labourers who are unaffected by the scheme are excluded, as also are staff absent with the Forces. Female Assistants are gradually disappearing, but will for the next 12 months or so occupy posts which have been regraded as Skilled Workmen IIA or IIB. The figures shown are not final, as discussion is still proceeding on a number of outstanding points.

INSPECTORATE

Former Organisation.

It was apparent that the new rank-and-file structure necessitated a similar reorganisation in the grades of Inspector and Chief Inspector. The Inspector was the first line supervising officer, normally supervising about 25 workmen, though Inspectors were also employed on individual duties not involving the supervision of workmen such as planning and estimating, efficiency and investigation duties, and on specialist duties at Regional Headquarters and in the E.-in-C.'s office. The Inspectors were supervised by Chief Inspectors, normally four or five Inspectors per Chief Inspector, and Chief Inspectors again by Assistant Engineers (old style). Recruitment to the Inspector grade was partly by promotion from workmen (50 per cent.), partly by limited competition (40 per cent.), and partly by open competition (10 per cent.). Certain City and Guilds certificates in telecommunications were prescribed which a workman was expected to hold before he could be considered for direct promotion to the Inspector grade, representing normally one or two years' evening class study. The limited and open competitions were written

TABLE I—WORKMEN GRADES

REGION	PRIOR TO REORGANISATION			AFTER REORGANISATION			
	S.W.I	S.W.II and U.S.W.	Female Assistants	Technicians	S.W.I	S.W.IIA*	S.W.IIB*
London Telecoms.	1,998	9,213	497	2,660	1,280	6,200	1,560
London Postal	106	193	—	12	117	131	61
Home Counties	1,247	4,222	137	1,240	840	2,240	1,290
Midland	995	2,991	270	935	575	1,700	840
North East	782	2,884	130	810	495	1,595	900
North West	989	2,656	153	830	615	1,445	910
Scottish	974	2,876	124	943	600	1,470	996
South West	1,055	3,074	79	805	610	1,660	1,140
Welsh and Border Counties	545	1,433	43	380	360	795	485
Northern Ireland	196	569	—	206	119	257	185
Engineer-in-Chief's Office . .	797	796	147	1,070	75	450	160
Total	9,084	30,907	1,580	9,891	5,686	16,963	8,517

* Includes posts filled at present by Female Assistants.

examinations set by the Civil Service Commissioners. The open competition entrants usually held a higher school certificate or its equivalent and were of a similar type to those taking the open competition for Assistant Traffic Supt. or for the Treasury class of Executive Officer, and had in many cases some practical experience in engineering work. Although the competitions and competitors in all of these three examinations were of a similar standard, yet the maximum scale of pay of the Assistant Traffic Superintendent and Executive Officers not only considerably exceeded that of the Inspectors, but also that of the Chief Inspector. For a man about to enter the Service and with no knowledge of promotion prospects within the various grades, a comparison of this type carries considerable weight and has reacted unfavourably on the type of open competition entrant to the Inspector grade.

The Assistant Engineer (new style) Grade.

With the pay of the Technician reaching to within £25 of the Inspector's old maximum, and to provide a career for the Technician comparable to that offered to men of similar calibre and education in other fields, a new supervising grade over Technicians was introduced, having a salary at least equal at its maximum with the old Chief Inspector or Assistant Traffic Superintendent, to work direct to the Assistant Engineers (old style). The new grade was assigned the title of Assistant Engineer (new style) and the title of Engineer was suggested for the old-style Assistant Engineer. On the Skilled Workmen side it was decided that the former supervising grades of Inspector and Chief Inspector should be retained, though it was later realised that advantages would result from merging the Chief Inspector in the new Assistant Engineer grade and this was finally agreed. Careful consideration was given to the question of absorbing the Inspector grade as well as the Chief Inspector grade into the Assistant Engineer (new style) grade, a feature which was strongly pressed by the Staff Association concerned. It was decided, however, that the presence in one grade of two types of supervising officers drawn from different sources

and carrying differing responsibilities was undesirable and would depress the status not only of the Assistant Engineer grade, but of the Engineer grade above it. If it were possible to raise the standards and responsibilities normally associated with the supervision of Skilled Workmen by demanding a higher degree of technical knowledge and an increase in the numbers of staff supervised, this would preclude further advancement for Skilled Workmen, and it was considered would, in practice, necessitate the introduction of an intermediary grade between Assistant Engineers (new style) and Skilled Workmen supervised. It was, therefore, decided to retain the Inspector grade, but to cease recruitment to the grade by competition and to fill vacancies wholly by promotion, the previous certificate qualifications for such promotions being retained.

The new grade of Assistant Engineer will be recruited partly under a scheme of joint open competition with the grade of Assistant Traffic Superintendent, partly by limited competition, and partly by the promotion of Technicians or Inspectors.

With the abolition of the Chief Inspector grade the duties previously carried by that grade, together with all powers and responsibilities, including financial, are now transferred to the new grade of Assistant Engineer. A specific assurance has been given by the Post Office that in no circumstances will such duties be transferred to the Engineer, and the Engineer's status is therefore unimpaired. The number of Assistant Engineers who will be directly controlled by Engineers will be more than the number of Chief Inspectors controlled in the past, particularly in the Regions, which has necessitated the creation of additional Engineer posts, as there is a limit to the span of control which can be efficiently exercised. This span of control will necessarily vary with functions and duties, and can be higher where the officers controlled are on identical duties, as in planning groups. Some 112 additional Engineer posts have been authorised in the Regions, giving an overall ratio of Assistant Engineers to Engineers of a little over six. Conditions in the E.-in-C's office are different

the nature of the duties performed rather than the span of control being the predominating factor, and under wartime conditions many old-style Assistant Engineer posts have been covered by Chief Inspectors. An additional 65 Engineer posts have, however, been authorised for the E.-in.-C.'s Office. Most of the additional Engineers have been obtained by the promotion of former Chief Inspectors.

As in the rank-and-file duties, it has been necessary to examine thoroughly the duties previously performed by Inspectors and Chief Inspectors to ascertain those to be assigned to the new Assistant Engineer grade. In general Assistant Engineers will be engaged upon three types of duty which have been designated A1, A2, and A3 respectively. A1 covers the direct supervision of Technicians and Skilled Workmen; A2 covers those duties which do not normally involve the supervision of workmen such as estimating, efficiency and special maintenance investigation, and training; A3 covers the supervision of a group of Inspectors and are hence identical with the former Chief Inspector's duties. So far as A1 duties are concerned the supervision of a minimum of four Technicians is specified as normally required on certain duties, e.g. the supervision of external contract works, but on other duties, such as exchange construction and maintenance, Assistant Engineer grading is granted irrespective of the number of Technicians supervised, although in actual practice it will be found that such duties usually include the supervision of many more than the minimum of four indicated above.

Inspector Grade.

Inspectors will in general continue to supervise Skilled Workmen engaged upon external construction and maintenance, the installation of manual P.B.X.'s and subscribers' instruments, electric light and power works, and the less technical aspects of internal maintenance, such as subscribers' apparatus and teleprinters. As far as possible the supervision of Technicians by Inspectors has been avoided, but in no circumstances will the number of such Technicians exceed three.

The Result of the Reorganisation Scheme on the Inspectorate.

This is shown in the following table which gives details of the old and new establishments. As in the case of workmen the figures are liable to slight alterations as a result of discussions still proceeding on outstanding points.

ADVANCEMENT UNDER THE NEW ORGANISATION

Advancement by promotion from the basic recruitment grades to the Engineer grade is shown in diagrammatic form in Fig. 1, the main channel of

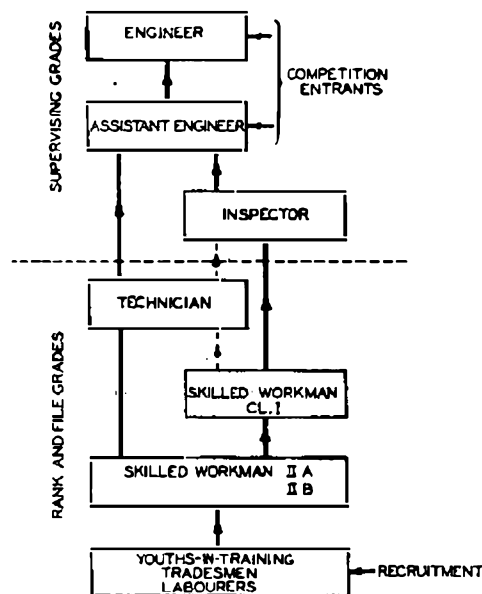

FIG. 1.—LINES OF PROMOTION.

advancement being shown by full lines and exceptional advancement by dotted lines.

Promotion to the Assistant Engineer grade will be from Technicians or suitably qualified Inspectors, and Technicians will also undoubtedly secure the majority of the limited competition vacancies. It has been

TABLE II—SUPERVISING GRADES

REGION	PRIOR TO REORGANISATION				AFTER REORGANISATION			
	Assistant Engineers	Chief Inspectors	Inspectors	Total	Engineers	Assistant Engineers	Inspectors	Total
London Telecoms.	82	121	882	1,085	116	669	300	1,085
London Postal	5	6	28	39	5	12	22	39
Home Counties	48	82	463	593	65	380	148	593
Midland	31	55	325	411	41	266	99	406
North East	33	53	283	369	42	240	92	374
North West	34	52	298	384	44	250	88	382
Scottish	36	57	316	409	46	270	95	411
South West	33	55	315	403	45	252	104	401
Welsh and Border Counties	20	34	192	246	27	159	62	248
Northern Ireland	5	12	59	76	8	45	23	76
Engineer-in-Chief's Office	290	136	736	1,162	355	801	2	1,158
Total	617	663	3,897	5,177	794	3,344	1,035	5,173

agreed that, for at least seven years, Assistant Engineer posts covering the supervision of a group of Inspectors, i.e., A3 duties, will be filled wholly by the promotion of Inspectors. This will safeguard the interests of senior officers left in the Inspector grade who had reasonable expectations of promotion to Chief Inspector posts under the former organisation. The promotion of Inspectors to A1 or A2 Assistant Engineer posts will, however, depend on their possessing the necessary technical qualifications. Vacancies in the Inspector grade will normally be filled by promotion from Skilled Workman I.

Further Qualifications for Advancement.

During the past year or so the City and Guilds of London Advisory Committee has been considering the reorganisation of their examination syllabuses in telecommunication engineering, and these have now been issued. The object of these new courses is to give those who desire to make progress in telecommunication engineering a very sound background of fundamental mathematical and electrical knowledge which will lead them to a much better understanding of their problems. The Post Office hope that in the future the standard to be attained before recruitment into the grade of Technician will be the intermediate grouped course certificate of the City and Guilds Institute. This represents to a man starting with a school certificate in mathematics and physics a two-year course of three evenings per week. Those workmen with less mathematical capabilities, however, will still be free to take their technological certificates in telephony, telegraphy, radio, line transmission, telecommunications principles, etc., or new subjects called Line Plant Practice and Elementary Telecommunications Practice, certain of which will qualify them for promotion to the Inspector grade.

Similarly, qualification for promotion to Assistant Engineer (new style) will in the future, it is hoped, be the possession of a final City and Guilds grouped course

certificate in telecommunications engineering which represents a further two years' work on a basis of three evenings per week, for those who are capable. It is felt that people who reach this standard should be able to do very valuable work in the new grade.

In future also, it is probable that recruitment or promotion to the basic professional grade of Engineer (new style) will necessitate the full status of Associate Member of the Institution of Electrical Engineers or some equivalent qualification such as an electrical degree. It may be a few years before these requirements can be imposed as rigorously as might be desirable, but it is as well that future entrants should realise what is expected of them if promotion is to be achieved.

Conclusion.

The absorption of the Workmen and Inspectorate into the new organisation has meant a laborious and painstaking scrutiny of the qualifications of each of some 50,000 Workmen and 4,000 Inspectors and Chief Inspectors to ensure that selection to the new grades of Technician and Assistant Engineer is on a fair and equitable basis. It has meant an appreciable additional burden to the Regional and Area staffs concerned at a time when they were already fully loaded with problems arising from the transition from war to peace, and the fact that the reorganisation scheme has been introduced with so little friction and with a minimum of inconvenience resulting from changed duties is a considerable achievement, and a tribute to the resilience of the Post Office Engineering Department. There has been frank and open discussion at all times with the staff associations concerned both in formulating the scheme, and in solving the problems arising from its introduction. Although due to the differing perspectives with which the problems were viewed it was not possible to reach complete agreement on all aspects, yet the help of the staff associations has been invaluable and contributed considerably to the effectiveness of the final scheme.

Book Reviews

"Reference Data for Radio Engineers"—compiled by W. L. McPherson, B.Sc., M.I.E.E., S.M.I.R.E. 175 pp. Standard Telephones & Cables, Ltd. 5s.

The compiler in his introduction comments that "in a book of Reference Data it is accuracy rather than explanation that is wanted" so that it is unfortunate that a number of printers' errors have crept in, e.g., a misplaced decimal point on page 7, R^2 for R_2 on page 54, incomplete references to charts on pages 36 and 44, a block upside down on page 76. The familiar error in the graticule of the Propagation Chart on page 96, certain inconsistencies such as the alternative use of kc/s and kc, and the incorrect implication in the Introduction that the U.S.W. 9-channel multiplex equipment is still in use, might well have been avoided.

Nevertheless this expanded version of "Reference Data for Radio Engineers," first presented in 1942, will be warmly welcomed by many engineers, for it contains in a handy form many general engineering tables, much engineering and material data, various audio and radio formulæ, data on valves, amplifiers, transmission lines,

radio propagation, aerials, extracts from the Cairo regulations dealing with frequency and harmonic tolerances, various mathematical formulæ and mathematical tables; the latter include tables of Bessel functions so necessary in dealing with frequency modulation. A. H. M.

"Alternating Current Practice." C. H. Claude Cooke, A.M.I.E.E., A.M.I.Mech.E. 232 pp. 93 ill. Crosby Lockwood & Son, Ltd. 15s.

This book is addressed particularly to those practical wiremen, installation engineers and students at Technical Institutes whose standard of mathematical knowledge is below that assumed in readers of standard text books.

Such books should be free from any looseness or obscurity in expression and although this book contains much from which members of all three classes for whom it is intended could profit, its failures in these respects make it unsuitable for students in particular.

I say this with regret about a book as well produced as this is. H. R. M.

The Provision in London of Television Channels for the B.B.C.

H. T. MITCHELL, M.I.E.E.

J.D.C. 621.397.74 : 621.315.212

The arrangements for providing vision channels for the B.B.C. over special balanced pair, telephone and coaxial cables during the summer of 1946 are described. Transmission over the coaxial cable was made as double-sideband modulation on a 7 Mc/s carrier.

Introduction.

A PREVIOUS article¹ in the JOURNAL has described in detail the special balanced pair cable which was installed in the West End of London and between Broadcasting House and Alexandra Palace in 1937, and its associated repeater equipment. The purpose of this cable was to provide a vision channel between points from which it was desired to make a television outside broadcast and the radio transmitter at Alexandra Palace.

The cable used for this system was manufactured by Siemens Bros. It has an internal diameter of $\frac{3}{8}$ in. and an external diameter over the lead sheath of $\frac{15}{16}$ in. The attenuation is such that lengths of up to 8 miles can be equalised up to a frequency of 2.3 Mc/s and used satisfactorily; the insertion loss of 1 mile is shown in Fig. 1, Curve A. When the cable

Strange as it may seem, in view of the wide frequency band required for television transmission, it is possible to equalise and amplify successfully ordinary 20 lb., 10 lb.

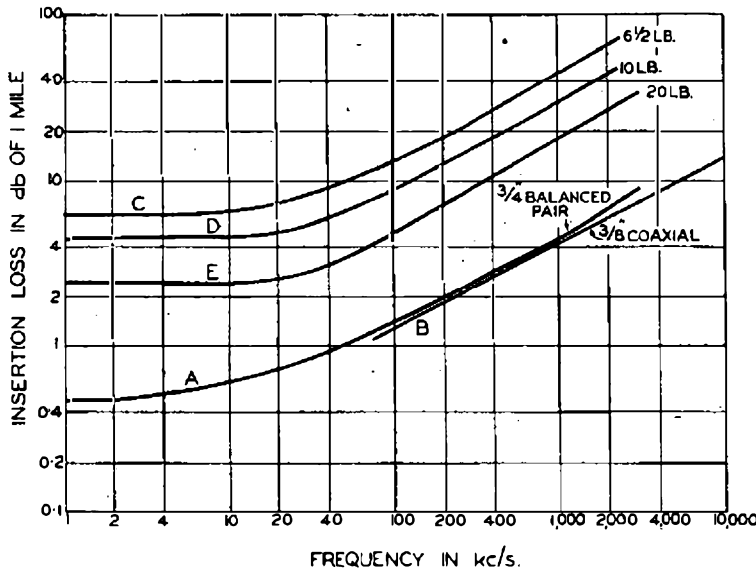

FIG. 1.—INSERTION LOSS OF TELEPHONE, BALANCED PAIR AND COAXIAL CABLES.

was laid it was not intended to extend it over ordinary telephone pairs, and accordingly it was taken into only one telephone exchange, Whitehall; the route of the balanced pair cable is shown in Fig. 2. The intention was to locate the B.B.C. scanning van close to the cable route and feed the vision signal into certain plug-points located in footway boxes. It soon became apparent that the facilities provided by this cable system could be greatly increased by providing access to it at telephone exchanges. Accordingly spurs were provided into Mayfair and Gerrard exchanges.

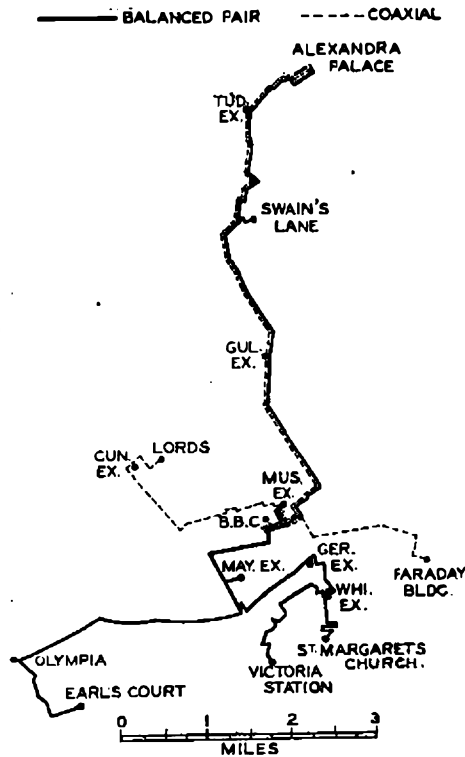

FIG. 2.—TELEVISION CABLES, JUNE, 1946.

and even 6½ lb. telephone circuits over worthwhile distances, and the B.B.C. built portable equipment² for this purpose in 1938. Typical values of insertion loss for 1 mile of each weight of cable are shown in Fig. 1, Curves C-E. The distance between repeaters is limited by either the induced clicks from adjacent pairs in the cables or noise in the input circuit of the amplifiers. For a channel equalised to 3 Mc/s the limiting lengths are of the order of $\frac{3}{4}$, 1, and 1½ miles for 6½, 10 and 20 lb. conductor respectively.

Some of the exchanges in the centre of London can be interconnected by this means, but a network to cover the whole of the London area on junction cables is out of the question. The role of the telephone cable should be to provide, where necessary, short links to the television cables and not to form the network itself.

Before the television service reopened in June, 1946, it was decided that in future the Post Office

¹ P.O.E.E.J. Vol. 30, p. 216.

² World Radio, 28th April and 5th May, 1939.

should supply to the B.B.C. complete television channels; that is, that the vision repeater equipment, as well as the cables, should be supplied and operated by the G.P.O. At the same time the question of providing additional television cables was discussed, and it was decided that any new cable should be coaxial and should be run between telephone exchanges, rather than along selected streets with intermediate tapping points. The first new length of coaxial cable has already been laid and during the summer of 1946 has been used, together with the balanced pair cable, to provide vision channels for the B.B.C. This article describes the equipment and cable provided by the Post Office for this purpose.

Vision Channels on Coaxial Cable.

The reasons which led to the adoption of coaxial rather than screened balanced pair cable for new routes are based to a large extent upon the fundamental properties of cables.

The attenuation of a cable to a very close approximation can be written as

$$\alpha = Af + B\sqrt{f}$$

where Af represents the loss in the cable dielectric.

$B\sqrt{f}$ represents the loss in the cable conductors.

In any cables which are likely to be used the dielectric loss is negligible compared with the conductor loss and the attenuation can be expressed as

$$\alpha = B\sqrt{f}$$

The loss of a coaxial cable made up of a copper inner and a copper outer conductor, and with the optimum ratio of conductor diameters of 3.59 is

$$\alpha_c = \frac{0.6779}{r} \sqrt{k} \sqrt{f} \text{ db/mile}$$

where r is the inner radius of the outer conductor in inches

k is the permittivity of the dielectric and f is in Mc/s.

For the balanced pair cable of copper conductors in a copper screen with the optimum ratios of screen/conductor of 5.4 and spacing/screen diameter of 0.46

$$\alpha_b = \frac{1.018}{r} \sqrt{k} \sqrt{f} \text{ db/mile}$$

where r is the inner radius of the screen.

Two interesting facts are apparent from these equations:—

- (i) For the same diameter of cable and the same value of permittivity, the frequencies at which the losses on the coaxial and balanced pair cables are equal are in the ratio of $(1.018/0.6779)^2$ namely, 2.25 : 1.
- (ii) Even if the dielectric loss is negligible, as has been assumed, the introduction of the dielectric increases the copper loss as the square root of the permittivity. Assuming polythene to have a permittivity of 2.2, the increase is 1.48 times for a solid polythene dielectric.

Attenuation/frequency curves are shown in Fig. 3

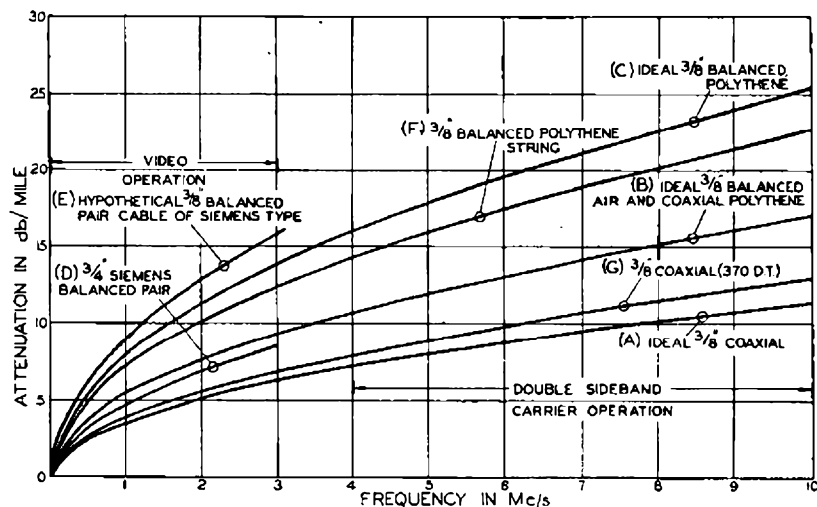

FIG. 3.—ATTENUATION OF IDEAL AND ACTUAL COAXIAL AND SCREENED BALANCED PAIR CABLES.

for four ideal $\frac{3}{8}$ in. cables, coaxial with air dielectric (Curve A), coaxial with solid polythene (Curve B), screened balanced pair cable with air (Curve C), and balanced pair with solid polythene dielectric (Curve D). The relative losses are 1, 1.48, 1.50 and 2.23; in Fig. 3 the second and third curves are shown as a single curve (Curve B).

The attenuation of the existing $\frac{3}{8}$ in. diameter Siemens cable is also shown in Fig. 3 (Curve D). It will be seen that it has a loss slightly less than the solid polythene coaxial and the air dielectric balanced pair cables of half the diameter (Curve B). A curve (Curve E) is also included for a hypothetical $\frac{3}{8}$ in. cable of this type, and it will be seen that its loss is extremely high. A suggested screened balanced pair cable with polythene string dielectric (i.e., partly air and partly polythene) is shown (Curve F) to have a loss, as would be expected, between that of the air and solid polythene dielectric cables. The attenuation of the $\frac{3}{8}$ in. coaxial cable with hard rubber disc separators, as used on coaxial trunk routes, is also shown (Curve G) and is seen to have a somewhat higher loss than the theoretical curve for an ideal air dielectric coaxial, but nevertheless is still the lowest loss cable of a practical type.

Summarising, it can be said that the two practical $\frac{3}{8}$ in. cables, which would be of approximately $\frac{1}{2}$ in. overall diameter, have values of

$$\alpha_{\text{coaxial}} = 3.8 \sqrt{f} \text{ db/mile}$$

$$\alpha_{\text{balanced}} = 7.2 \sqrt{f} \text{ db/mile}$$

The ratio of the frequencies at which these two cables have the same loss is

$$\left(\frac{7.2}{3.8}\right)^2 = 3.6 : 1$$

Coaxial cable can be used for video signal transmission over distances of the order of miles, but special measures have to be taken to balance out low frequency pick-up, especially voltages induced from the 50 c/s mains, and the most practical method of using coaxial cable is to use a carrier modulated with the video signal.

Experiments both before 1939 and during 1946 have shown that a vision channel can be provided with complex carrier equipment between, say, 200 and 3,200 kc/s, or with simple carrier equipment as a double-sideband modulation on a carrier at least twice the maximum video frequency. The repeater spacing will be of the order of 8 miles in the former case and 4 miles in the latter. For the provision of a vision channel network between exchanges in the London area the repeater spacing of 4 miles is quite suitable, and has the great advantage that only simple carrier equipment is necessary.

Apart from the fundamentally lower loss on the coaxial cable there are other advantages:—

- (i) the coaxial cable is cheaper than the screened balanced pair cable;
- (ii) the repeaters for the coaxial cable are simpler and smaller and thus cheaper and easier to maintain than the balanced pair repeaters;
- (iii) carrier type of transmission reduces the maximum to minimum frequency ratio from 100,000 : 1 to 2.5 : 1, and this eases the problem of equalisation.

The coaxial cable system provided by the Post Office and available for television in June, 1946, utilises equipment of the double-sideband type with a carrier frequency of 7 Mc/s.

Telephone Cable Equipment.

The equalising and amplifying equipment necessary for providing vision channels over normal telephone cable pairs has been designed and constructed by the Post Office since the cessation of hostilities in 1945.

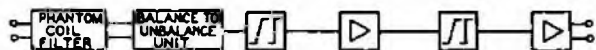

FIG. 4.—SCHEMATIC OF REPEATER FOR TELEPHONE CABLES.

The equipment is in transportable form so that it can be transferred from one telephone exchange to another, as required. A block schematic of the equipment required at the end of each repeater section is shown in Fig. 4. It consists of a phantom coil filter to attenuate the longitudinal components on the telephone pair, a balanced-to-unbalanced valve unit to allow the use of unbalanced equalisers and amplifiers, a non-resonant equaliser and non-feedback amplifier followed by a second equaliser and amplifier, the last unit providing a balanced output. The whole equipment is mounted on

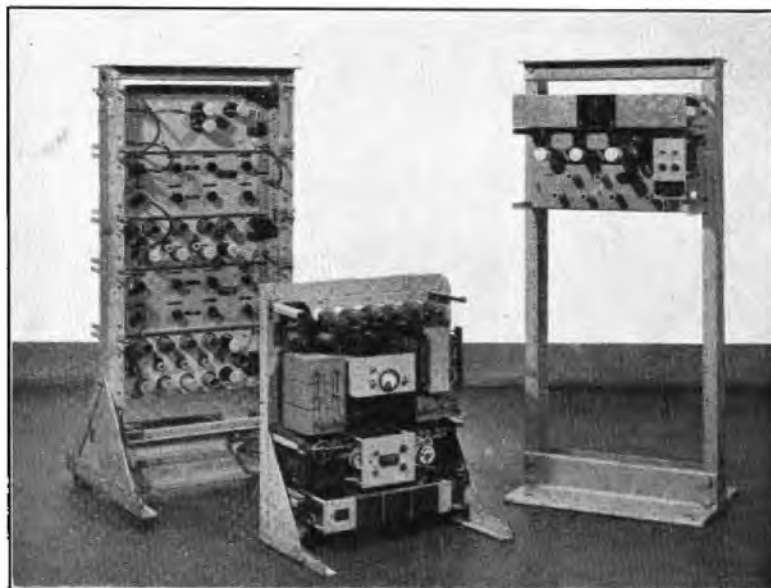

FIG. 5.—TELEPHONE CABLE REPEATER AND POWER PACK (LEFT), COAXIAL CABLE REPEATER (RIGHT).

a 4 ft. 6 in. channel rack and the power supplies, which include a valve stabilised high tension supply, are mounted on a small subsidiary rack, as shown in Fig. 5; the equipment is designed to run off normal 50 c/s A.C. mains.

The equalisers, which are capable of giving a top lift of 66 db., have a characteristic which is suitable for the average telephone cable and can be switched in to give the correct amount of equalisation for various lengths. Slight differences are taken up by small non-resonant equaliser and cable sections in what may be conveniently called a "mopping-up" equaliser. The response of the vision channels must be within ± 2 db. from 50 c/s up to at least 2.25 Mc/s.

The gain of the two amplifiers is 48 and 54 db. respectively.

Coaxial Cable Equipment.

The block schematic of a vision channel with one intermediate repeater station is shown in Fig. 6. It consists of a modulator and associated carrier oscillator together with a sending repeater at the transmitting end, an intermediate repeater and a

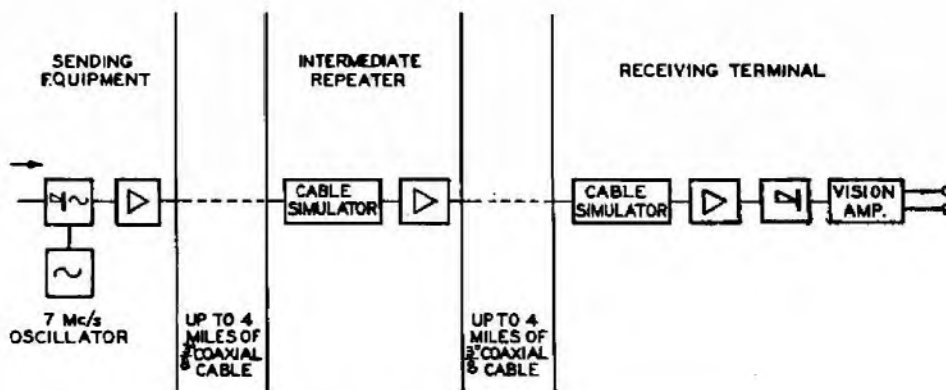

FIG. 6.—SCHEMATIC OF DOUBLE-SIDEBAND 7 Mc/s CARRIER CHANNEL.

balanced demodulator at the receiving end. For the broadcast from Lord's, which is discussed in some detail later, valve modulators and demodulators were employed, but since that time the units have been redesigned using crystal rectifiers of the type developed for radiolocation during the war. This has resulted in a considerable improvement and incidentally simplification of the equipment.

The amplifiers are of the feedback type and have a bandwidth of 6 Mc/s between 4 and 10 Mc/s. The intermediate and receiving repeaters have a fixed built-in equaliser to take up the difference in loss at 4 and 10 Mc/s of 4 miles of $\frac{3}{8}$ in. coaxial cable. Each repeater section is built out to 4 miles by a cable simulator. The simulator is of interest inasmuch as it consists of lengths of high loss cable as distinct from sections made up from lumped impedances. A photograph of the equipment at an intermediate repeater station is shown in Fig. 5, where its small size compared with the telephone cable equipment is quite noticeable.

Typical Vision Channels provided for the B.B.C.

The layouts of the plant involved in four typical broadcasts are of interest as they give some indication of the various arrangements which have to be set up.

Victory Parade, 8th June, 1946. The B.B.C. cameras and scanning van were set up opposite the saluting base in the Mall. The balanced pair cable passed through a footway box at Clarence Gate some 120 yards from the scanning van, but no plug-point was provided in this box, and it was decided in view of the importance of the broadcast that the cable should be cut and extended to the scanning van on the same type of cable.

A plug-point was available some 180 yards away in a footway box, but the running of overhead cables from this point to the scanning van would have been most difficult.

This broadcast showed the inconvenience of the balanced pair cable arrangement of plug-points.

Dorchester Hotel, 21st June, 1946. The balanced pair cable ran past the entrance to this hotel, but, unfortunately, the nearest plug-point was 400 yards away, and the B.B.C. scanning van had to park in a back street. Thus it was decided that the best way of providing the vision channel was to pick up a normal subscriber's pair back to Mayfair exchange, equalise and amplify this link, and feed into the balanced pair cable over the spur previously mentioned.

Test Match from Lord's, 22nd, 24th and 25th June, 1946. For this match a length of standard single tube $\frac{3}{8}$ in. coaxial cable was laid at very short notice from

Museum exchange to Cunningham exchange and a spur from Cunningham exchange to Lord's cricket ground, so that a trial of the 7 Mc/s double-sideband equipment could be made.

The transmission over this channel was not as good as the advocates of the system had hoped, but it provided a channel which was satisfactory for the broadcast; as has been mentioned earlier, this equipment has now been redesigned and made completely satisfactory.

Test Match from the Oval, 17th, 19th and 20th August, 1946. Neither the balanced pair cable nor the coaxial

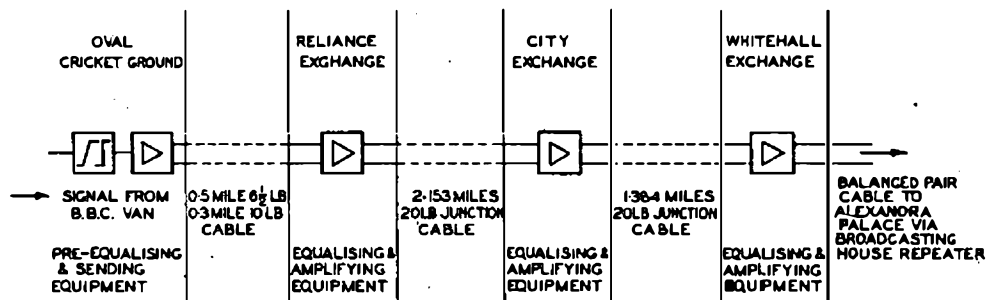

FIG. 7.—MAKE-UP OF THE OVAL-WHITEHALL CHANNEL.

route runs near the Oval and the vision channel for this broadcast was provided over ordinary telephone cable pairs as far as Whitehall exchange, where it fed into the balanced pair cable. The make-up of the channel is shown in Fig. 7. It will be seen that the channel consisted of 0.8 mile of mixed 6 1/2 and 10 lb. conductor to Reliance exchange, over 2 miles of 20 lb. junction cable to City exchange and nearly 1 1/2 miles of similar junction cable to Whitehall exchange. The satisfactory transmission over the 2-mile section between Reliance and City exchanges was made possible only by pre-equalising the vision signal before transmission from the cricket ground.

The overall response between the Oval and the output of the repeater of Broadcasting House was flat up to 2.2 Mc/s, 3 db. down at 2.5 Mc/s and 6 db. down at 2.8 Mc/s.

Acknowledgments.

The work involved in the provision of vision channels in the early months of the resumption of the television service from Alexandra Palace has been shared by various organisations and the Post Office. Special mention must be made of Electrical and Musical Industries, Ltd., who supplied the replacement repeater at Broadcasting House; Standard Telephones & Cables, Ltd., who made and laid the coaxial cable to Lord's at extremely short notice, and the Lines Department of the B.B.C. as most co-operative customers. Sincere thanks are also due to various colleagues in the Post Office, particularly those who, on one occasion, worked throughout a whole night so that the show could go on.

Floods at Criggion Radio Station

RECENT floods recall the conditions experienced at the P.O. Radio Station at Criggion in February of last year when the worst floods within living memory threatened the station.

The station is situated in the Severn Valley above Shrewsbury and floods are normally kept within



FIG. 1.—RIVER IN FULL FLOOD—VIEW TOWARDS WELSHPOOL FROM CENTRE MAST.

bounds by the "argal," or local flood embankment. This condition is shown in Fig. 1, in which the river has overflowed its banks to the extent of the "argal" on the 8th February. Fig. 2, taken at 4 p.m. on the same day, shows the flood water having reached the top of the "argal" and overflowing on the sur-

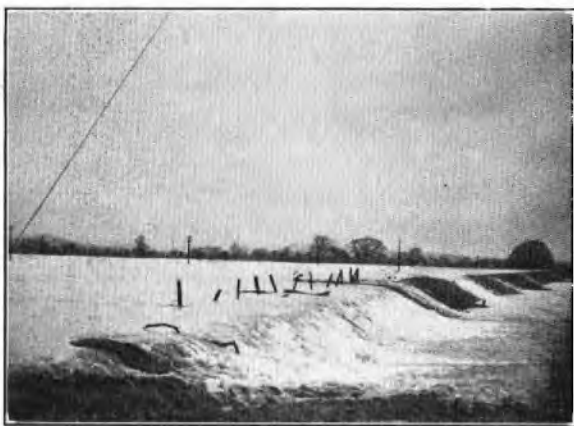

FIG. 2.—"ARGAL" OVERFLOWING AT POINT SOUTH OF L/W BUILDING.

rounding country. This water flowed down the length of the station site to a depth of some six feet in places and on the 9th had effectively marooned the staff in some of the station buildings.

One method of relieving the staff at one building was by a tractor-drawn trailer. The use of this method

was, however, limited owing to water causing the truck steering brakes to slip on the tractor.

Fig. 3 shows an attempt at navigation on the part of the staff at another building, using three telegraph poles and two kitchen tables. Another method of transport was provided by rubber dinghys dropped



FIG. 3.—S/WB STAFF USING RAFT CONSTRUCTED OF TELEGRAPH POLES AND KITCHEN TABLES.

by a Halifax from a neighbouring R.A.F. station, and Fig. 4 shows the plane coming in for the "drop" over the roof of one of the buildings where the staff are holding out dust sheets for identification.

The transport problem was finally solved by DUKW vehicles (amphibious "ducks"), kindly



FIG. 4.—HALIFAX COMING IN TO DROP DINGHYS TO STAFF ON ROOF OF S/WA BUILDING.

loaned from an army depot in the neighbourhood, which were able to carry the staff to and from the nearest "dry land" approach, and the various radio services were thus maintained throughout the whole of this difficult period.

H. C. W.

Notes and Comments

Roll of Honour

The Board of Editors deeply regrets to have to record the deaths of the following members of the Engineering Department :—

While serving with the Armed Forces.

Engineering Department ..	Matthews, R. R.	Skilled Workman, Class II ..	Pilot Officer, R.A.F.
Engineering Department ..	Woodman, J. T.	Skilled Workman, Class II ..	R.Q.M.S., Royal Signals
Leicester Telephone Area ..	Ainsworth, J. W.	Unestablished Skilled Workman	Signalman, Royal Signals
London Telecoms. Region ..	Betts, D. H.	Unestablished Skilled Workman	Sergeant Pilot, R.A.F.
London Telecoms. Region ..	Jones, F. G.	Labourer ..	Stoker, R.N.
London Telecoms. Region ..	Laybourn, G. W.	Unestablished Skilled Workman	Sergeant, R.A.F.
London Telecoms. Region ..	Lyon, J. D.	Unestablished Skilled Workman	A.C., Class II, R.A.F.
London Telecoms. Region ..	Wade, S. J. C.	Unestablished Skilled Workman	A.C., Class II, R.A.F.
Preston Telephone Area ..	Bowers, F.	Inspector ..	Captain, Royal Signals
Preston Telephone Area ..	Stansfield, B. B.	Skilled Workman, Class II ..	Flying Officer, R.A.F.

Recent Awards

The Board of Editors has learnt with great pleasure of the honours recently conferred upon the following members of the Engineering Department :—

Bradford Telephone Area ..	Long, E.	Skilled Workman, Class II	Corporal, Royal Signals	Mentioned in Despatches
Bradford Telephone Area ..	Mason, D. H.	Skilled Workman, Class II	Signalman, Royal Signals	Mentioned in Despatches
Bradford Telephone Area ..	Wright, C.K.	Skilled Workman, Class I	Sergeant, Royal Signals	Mentioned in Despatches
Cambridge Telephone Area	Baker, R. E.	Skilled Workman, Class II	Signalman, Royal Signals	British Empire Medal
Cambridge Telephone Area	Cassidy, F. A.	Skilled Workman, Class I	C.P.O./Telegraphist, R.N.	Mentioned in Despatches
Cambridge Telephone Area	Crane, J. E.	Skilled Workman, Class I	R.Q.M.S., Herts. Regt.	Mentioned in Despatches
Cambridge Telephone Area	Grantham, N. H.	Skilled Workman, Class I	Wt. Offr. Class II, R.A.	Mentioned in Despatches
Cambridge Telephone Area	Hall, J.	Skilled Workman, Class II	Corporal, Royal Signals	Mentioned in Despatches
Cambridge Telephone Area	Roe, R. J.	Skilled Workman, Class I	Flight Lieut., R.A.F.	Distinguished Flying Cross
Cambridge Telephone Area	Rowe, C. Q. G.	Skilled Workman, Class II	Corporal, Royal Signals	Mentioned in Despatches
Cambridge Telephone Area	Smith, A.	Skilled Workman, Class II	L/Sergeant, Royal Signals	Mentioned in Despatches
Cambridge Telephone Area	Taylor, C. A.	Skilled Workman, Class II	Sergeant, R.A.F.	Mentioned in Despatches
Colchester Telephone Area ..	Bloomfield, L.	Skilled Workman, Class II	Corporal, Royal Signals	Mentioned in Despatches
Edinburgh Telephone Area	Lamont, P.A.	Skilled Workman, Class II	Sergeant, Royal Signals	Mentioned in Despatches
Engineering Department ..	Allen, E. R.	Skilled Workman, Class II	L/Sergeant, Royal Signals	Mentioned in Despatches
Engineering Department ..	Kilford, R.	Mechanic in Charge, Grade III	Wt. Offr., Class I, R.E.M.E.	Member of the Order of the British Empire
Lancaster Telephone Area ..	Todhunter, V. W. S.	Skilled Workman, Class II	Signalman, Royal Signals	Mentioned in Despatches
Leeds Telephone Area ..	Smith, T. R.	Skilled Workman, Class II	Signalman, Royal Signals	Mentioned in Despatches
London Telecoms. Region ..	Bernard, J.	Skilled Workman, Class II	Leading Seaman R.N.	Mentioned in Despatches
London Telecoms. Region ..	Crossley, L. H.	Unestablished Skilled Workman	Signalman, Royal Signals	Mentioned in Despatches

London Telecoms. Region	Leckenby, A. J.	Area Engineer	Colonel, Royal Signals	Officer of the Legion of Merit (U.S.A.)
Manchester Telephone Area	Hill, E.	Skilled Workman, Class II	Sergeant, Lancashire Fusiliers	American Bronze Star
Newcastle-on-Tyne Telephone Area	Elliot, P.	Skilled Workman, Class II	Corporal, Royal Signals	Military Medal
Newcastle-on-Tyne Telephone Area	Lowe, C. R.	Skilled Workman, Class II	Corporal, Royal Signals	British Empire Medal
North-Eastern Region	Barratt, J. W.	Asst. Engineer	Major, Royal Signals	Mentioned in Despatches
Portsmouth Telephone Area	Rumford, G.	Skilled Workman, Class II	R.S.M., Royal Signals	Mentioned in Despatches
Preston Telephone Area	Hetherington, W. J.	Skilled Workman, Class II	Major, Royal Signals	Mentioned in Despatches

New Year's Honours

The Board of Editors offers its congratulations to the following members of the engineering staff of the Post Office, honoured by H.M. the King in the New Year's Honours List.

Birmingham Telephone Area	Thistlethwaite, H.	Draughtsman, Class I	British Empire Medal
Bristol Telephone Area	Regan, T.	Skilled Workman, Class I	British Empire Medal
Engineering Department	Biddlecombe, A. W.	Assistant Engineer	Member of the Order of the British Empire
Engineering Department	Stokes, F. W.	Motor Transport Officer, Class III	Member of the Order of the British Empire
London Telecoms. Region	Edwards, A.	Skilled Workman, Class I	British Empire Medal

Mr. H. Faulkner, B.Sc., M.I.E.E.

Few engineers can hope to obtain such a wide and varied experience of Post Office activities as has fallen to the lot of the new Deputy Engineer-in-Chief. Passing the Assistant Engineers' open competition in



1913 Mr. Faulkner made his first home in the Designs Section of the Engineer-in-Chief's Office, until he took up a commission with the Royal Engineers Signal Corps during the first world war. On his return from some two and a half years' war service he was transferred to the Radio Section where he became one of that body of pioneers who designed the Rugby radio station, becoming its first officer-in-charge in 1925 with the rank of Executive Engineer. He returned to Headquarters in 1929 to take charge of the design and development group of the Radio Section, attending the C.C.I.R. meeting at Copenhagen and the International Convention at Madrid. Promoted to Assistant Staff Engineer in 1932, the next year Mr. Faulkner transferred to North Wales as Assistant Superintending Engineer, becoming Superintending Engineer, North Wales District, in 1935 and Deputy Regional Director in 1939. From 1941 until 1944 he was Controller of the Factories Department, neglecting no opportunities of extending and improving its facilities so that it could play its full and proper part in the war effort. Appointed Assistant Engineer-in-Chief in 1944 his interests became those of the Lines, Power, Construction and Motor Transport Branches together with

staff matters; playing a major part in planning and negotiating the engineering staff reorganisation. Needless to say he is now actively supervising its implementation but with his latest promotion he has exchanged his Branch interests for those of the Radio Development and Radio Maintenance Branches.

Chairman of the South Midland Centre of the Institution of Electrical Engineers for the 1938-39 session, Mr. Faulkner has been a member of Council since 1945.

Maybe early associations did much to encourage that innate sense of good humour, good fellowship and geniality experienced by all in the vicinity of "H.F."; nevertheless his colleagues wish him well in this latest appointment which they feel cannot fail to be popular with all staff.

A. H. M.

Mr. G. J. S. Little, G.M., B.Sc., M.I.E.E.

The many friends of Mr. Little will all desire to convey their best wishes on his promotion to the rank of Assistant Engineer-in-Chief, on January 9th, 1947.

Mr. Little entered the Engineering Department by open competitive examination in 1922, as Probationary Assistant Engineer, and spent the next eight years in a section of the Research Branch at Marshalsea Road. Although trained as a mechanical engineer, he soon became an authority on telephone transmission. In 1930 he was transferred to the Lines Branch, and two years later promoted to Executive Engineer in that Branch. While



in the Lines Branch Mr. Little helped to lay the foundations of wide band carrier transmission as we now know it, his experience being widened by a visit to the U.S.A. in 1934 to study the progress of line transmission. In 1936 he was promoted to Assistant Staff Engineer in the same Branch. As President of the Wide Band Sub-Commission of the 3rd C.R. of the C.C.I.F. in 1938, Mr. Little helped to shape the recommended frequency allocations for twelve circuit carrier and coaxial systems which have been accepted as standard in this and other countries.

Promotion to Superintending Engineer, N.W. District, in 1938, to become Chief Regional Engineer of the newly formed North Western Region in 1939, severed Mr. Little's direct connection with the Chief's Office until 1945. It was while he was in Manchester that he was awarded the George Medal for meritorious work and conduct in connection with the saving of Central Exchange, Manchester, from fire, following air attack on the night of December 23rd and 24th, 1940.

In 1945 Mr. Little was transferred to the Radio Maintenance Branch as Staff Engineer, with which was combined the wartime Wire Broadcasting Branch. In 1946, he visited South Africa and Australia to study methods of trunk working.

Mr. Little's technical ability and wide experience, his kind and helpful manner are a combination which will assure for him success in his new post.

H. W.

Mr. H. G. Beer, Wh.Sch., A.C.G.I.

Mr. H. G. Beer, who succeeds Mr. Little as Staff Engineer in charge of Radio Maintenance Branch, entered the P.O. Engineering Department in 1925. His earlier practical training was gained as an engineering apprentice at Devonport Dockyard,



followed by some years' study, as a Whitworth Scholar, at the Imperial College of Science and Technology.

Mr. Beer's activities have been devoted wholly to the radio side of the Service where his capacity for seeing into the heart of things has left its mark in various branches of radio development. He was prominently associated with the early development of transoceanic telephony and in particular with the interlinking of the radio and land line connections. In 1938 Mr. Beer succeeded to the charge of the Radio Laboratories at Dollis Hill and was responsible for much of the development in connection with coaxial cable working, single side band operation and the design and installation of the special radio equipment at the Cooling receiving station.

His special qualities and abilities have marked him for much service abroad. In 1927 he toured Europe for six months, in company with Messrs. Chamney,

Hansford and Camp, with the object of facilitating telephone connections, via London, between the European capital cities and America. In 1930 he was selected to visit Australia to give of his knowledge and experience in co-ordinating the setting up of the Anglo-Australian radio telephone service. After six months in Australia he visited New Zealand, Canada and U.S.A., thus completing a world circling tour which must be unique among P.O. engineers. In 1941 he was charged to represent the Post Office in U.S.A., with the object of facilitating communications between this country and U.S.A. Since his return to this country in late 1943 Mr. Beer has been largely occupied in connection with the complex problem of radio-frequency allocations, a work carried out under the auspices of the Wireless Telegraphy Board.

F. E. N.

Edison and Bell Centenaries

The last two months have seen the centenaries of the birth of two outstanding pioneers of telecommunications, Thomas Alva Edison and Alexander Graham Bell. Edison was born in Ohio on 11th February, 1847, and was, throughout his long life, a most prolific inventor. In the telephone field his invention of the carbon transmitter was outstanding. Bell was born in Edinburgh on 3rd March of the same year and was the first man to transmit speech by wire. In the early days Bell and Edison were rivals in the telephone field but later they combined forces and Edison's carbon microphone with Bell's electromagnetic receiver have formed the basis of telephone instruments to the present day.

Bell's centenary was celebrated in London and Edinburgh, and included an address by Sir A. Stanley Angwin before the Institution of Electrical Engineers, under the chairmanship of the President, Mr. V. Z. de Ferranti. The Earl of Listowel, Postmaster-General, introduced the speaker and Sir Thomas A. Eades proposed a vote of thanks. The same evening the Telecommunications Engineering and Manufacturers' Association gave a centenary dinner at which the speakers included Sir Frank Gill, Sir Thomas Spencer, Lord Listowel, Sir John Falconer, Mr. V. Z. de Ferranti and Sir Thomas Eades.

Fuel Crisis

The power cuts, added to the general overloading of the printing industry and the difficulty in obtaining paper, have seriously affected the production of this JOURNAL. Until conditions return to normal it may be necessary to reduce the size of each issue and delays in publication may be inevitable. These will be minimised as far as practicable.

The same conditions are seriously affecting the reproduction in book form of the answers to the City and Guilds examinations in Telecommunications Subjects, announced in the last issue of this JOURNAL.

Regional Notes

Midland Region

DARLASTON C.B. No. 12 TYPE EXCHANGE

The above exchange was opened in 1915. It was designed for a maximum of six operators' positions and 400 subscribers' lines. In 1937 it was necessary to install two additional positions as an island suite at right angles to the main suite. Then, in 1946, three more "A" positions were necessary and the switchroom could be enlarged only by merging it with the Linemen's Room, which was at the rear of the main suite of switchboards. This involved moving both suites 7 ft. in the direction of the extension. The new sections could then be added to the island suite.

Movement of the sections was viewed with considerable trepidation because of the age of the wiring and cabling and because of the instability of the subscribers' line relays (the type known as Jacks, Lamp and Relays No. 120 B.N.) which do not respond favourably to severe shakings. Most attention was given to the movement of the main suite of six positions because it was anticipated that the island suite of two sections would follow more or less easily.

The first necessity was to brace the main suite so that it became a rigid structure thereby avoiding any strain on the section frameworks and cabling. This was achieved in the following manner.

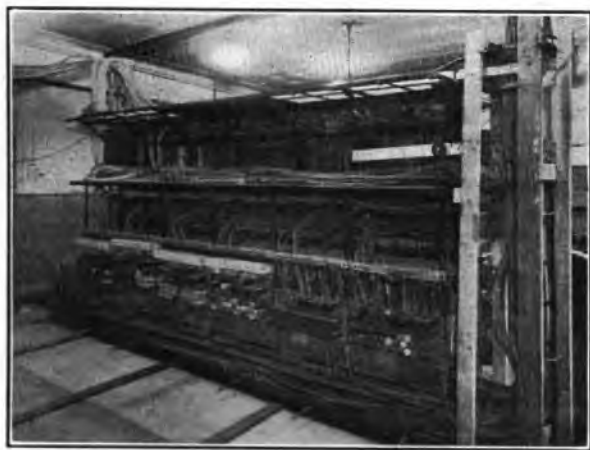

A cradle was prepared to carry the base of the main suite and consisted of two 4 in. x 4 in. x $\frac{3}{8}$ in. M.S. angles, one for the front and one for the rear. The cable turning sections were removed and the sections gently raised by pole jacks until the horizontal webs of the angles could be eased under the suite from end to end, first at the back and then at the front, until the whole rested on these angles. Front and rear angles were then tied by $\frac{1}{2}$ in. diameter screwed rods through their vertical webs. Nuts on the tie rods were screwed home until the sections were rigidly held.

On top of the sections were secured two 3 in. x 2 in. deal scantlings running the length of the suite and overhanging by about 18 in. at either end. Besides bracing the suite, these runners carried a clamp at each end which gripped the switchboard cables dropping from the cable racks into the C.T.S. The cable clamps each consisted of two 2 in. x 2 in. x $\frac{1}{2}$ in. M.S. angles fitted front and back of the "flat" of the cables, bolted together and coach-screwed to the timber runners. These various measures rendered the whole suite and its cabling completely rigid.

The switchroom floor was then levelled up by a timber template to carry the suite in its new position. Between the rear of the suite and the new floor template strips of iron, 3 in. wide and with the thickness of the template timbers, were laid on the floor in the direction of the move and suitably spaced, as will be seen from the accompanying illustration which shows the rear of the suite prepared for the move. These iron runners were liberally dressed with petroleum jelly to enable the suite to slide easily over them.

Two pole jacks backed by stout timber frames were placed between the front of the suite and an outside wall facing it, and when these were operated the move proceeded in excellent order. This sequence continued until the suite rested snugly in its new position. The two island positions followed the main suite as smoothly as had been hoped. The whole operation was completed in $3\frac{1}{2}$ hours and the resultant faults were negligible. H. T.

HARVINGTON U.A.X. 13

This U.A.X. was opened in September, 1945, and last November insects were found on the insulating material between the selector bank contacts, particularly on the spare equipment. A sample of these insects was sent to the Zoology Department of the Birmingham University who identified them as psocids or book lice. The psocids thrive under damp conditions and live on glue, starch and paste and are consequently a nuisance to librarians. Since these insects require damp conditions it seems probable that the auto units had been stored for a period prior to installation and the insects were present when the equipment was installed. Another theory is that during some stage of manufacture or storage, paper infested with these insects came in contact with the units.

The equipment was sprayed with Dekalin and this treatment apparently reduced the number of insects but did not entirely eliminate them. A small quantity of carbon-tetrachloride was then placed in an open vessel in the base of each unit for a few days and this completely exterminated the lice.

The U.A.X. building is of war-time construction not lined with molar bricks for absorbing moisture, but does not appear to be damp.

STEEL POLES 24 FT.

Towards the end of 1946 a new departure in overhead line provision was experimentally introduced in the



FIG. 1.

Birmingham Area in conjunction with the Construction Branch of the Engineer-in-Chief's Office. A field trial of sheet steel poles 24 ft. long and of

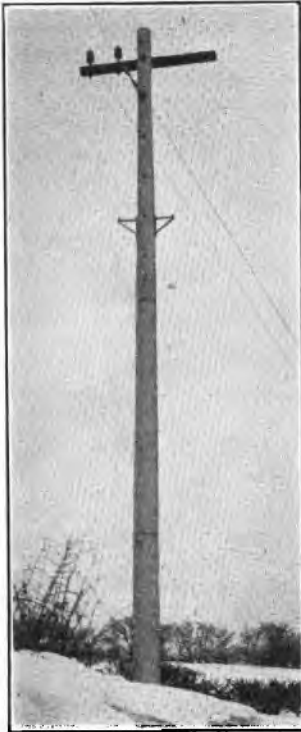

FIG. 2.

equivalent strength to L class of wooden poles was commenced.

These poles consist of four tapering cylindrical galvanised steel sections each 6 ft. 7 in. long. (Fig. 1.) The pole is assembled by inserting one section into the other, commencing with the base, and when assembled there is an overlap of approximately 9 in. at each joint. The diameter of the base of the pole is 10 in. and the top 4 in., the latter being provided with a cap. Incorporated in the top section are five distance tubes welded into place before galvanising. These take the arm bolts and in addition this section is tapped for the fixing of two steps by means of bolts at a point 4 ft. from the top of the section.

The sections were driven into one another with a hammer, blocks of wood being used at either end to act as buffers. On completion of the assembly standard type arms were fitted; these were bolted through the distance tubes already mentioned and held rigid by the insertion of a spring saddle between each arm and the pole. Arm braces were fitted in the normal manner. Each pole has a capacity for four arms with arm braces.

The poles were erected in accordance with standard methods and provision can be made if necessary for line or side stays. Some 48 poles have so far been erected, and no difficulties have been experienced in the assembly or erection, and since only two wires have been carried no stays have been necessary. (Fig. 2.)

The question of durability has yet to be determined but there is a definite advantage in handling as each pole weighs approximately 1 cwt., and since all the sections can be contained in the base portion, cartage and loading and unloading are relatively simple. The behaviour of these poles is being watched with great interest, and further information should be available at a later date.

STORM DAMAGE

The heavy snow-storm of mid-February, coupled with the prolonged freezing conditions, left its mark on the overhead plant in this Region. Fortunately, the service was not so badly affected as with previous severe snow-storms, but in Staffordshire and in the Peak District, and around Grantham and Sleaford Areas repair work has been greatly hampered by the lack of road communications. To a very large extent P.V.C. insulated 70 lb. C.C. wire has been used and laid over the snow drifts. This expedient has proved satisfactory and is expected to give service until a change in the weather makes possible permanent repairs. The experience that some of the men have had in the army has been most useful with regard to improvising and restoring service, although work in accordance with normal Post Office construction was not possible. The only trouble so far

encountered with the P.V.C. insulated wire has been that in one or two places the insulation has been eaten by rabbits.

As an example of the difficulties in reaching some of these isolated villages, in one case two men walked with improvised snow-shoes 12 miles over an average depth of 4 ft. of snow to restore communication.

In another case it was necessary to get a mobile charging set to a U.A.X. The set started off on a heavy lorry which, after much digging in the snow, was got to within a mile of the U.A.X. At this stage it was transferred to a 6-ft. sledge which was hauled over the frozen snow. The journey to the exchange was not without incident, but after many small difficulties the charging set was installed and the service kept going.

London Region

AN AUTO-TO-AUTO CONVERSION

Resulting from a decision that the manufacture of equipment of the Bypass type for new and existing exchanges should be discontinued, arrangements were made for the replacement of a Bypass exchange with equipment of the standard 2000 type, and for the re-use of the recovered equipment in the remaining Bypass exchanges. The "Advance" exchange in the London Region was selected for replacement. This has now been completed and the new equipment brought into service.

The new equipment had to be installed on the existing apparatus floors, consequently limited accommodation necessitated the installation being carried out in two stages. Stage one consisted of the equipment for the incoming service, namely, first and second numericals and final selectors. The new subscriber's multiple was teed to the existing multiple on the main distribution frame, and cabled to a new intermediate distribution frame. A duplicate group of incoming junction circuits were cabled to the new I.D.F., cross connected on the M.D.F. to the existing incoming junctions and wedged out on the arresters. The removal of the heat coils on the existing incoming junction group arresters, and the removal of the wedges on the new incoming group brought stage one into service. The local traffic was routed from the second code bypaths to second numerical selectors of the 2000 type, via a special relay circuit per trunk. This relay circuit was necessary on account of metering differences between the two systems. This stage also included the recovery of the bypass penultimate, and final selectors.

Stage two, consisting of subscriber's uniselectors, directors, "A" digit, and code selectors, was now installed in the accommodation made available by the recovery of equipment under stage one.

The simultaneous cut-over of this stage was impracticable without the installation of change-over strips. It was therefore decided to treat each circuit individually by disconnecting the old jumper on the existing I.D.F. and connecting the new jumper on the new frame. To permit the simultaneous working of the two calling systems during this period, the outgoing junctions from selector levels were commoned via a second special relay circuit per junction. This relay circuit provided a guarding feature to one system when the junction was engaged from the other. The 2,250 working subscribers' lines were changed over in five days. The final operation of disconnecting the old subscribers' multiple cable on the M.D.F. was then carried out.

The new installation consists of 3,600 subscribers' lines multiple with 2,600 calling equipments. In laying out the installation particular attention was given to the ultimate requirements, such as the re-positioning of the

test desk to allow for the growth of the new I.D.F., and the location of the various types of racks. The replacement also included the modernisation as far as possible of the existing manual board and test desk.

E. E. T. C.
F. J. W.

Scottish Region

FAULT LOCATION BY INDUCTION

To facilitate the clearance of faults and to reduce costs to a minimum, experiments were conducted in August, 1939, on a small lead-covered cable four miles in length to :

- (1) Plot the exact course of the cable.
- (2) Ascertain the approximate depth.
- (3) Determine the exact point of the damage.

The hook-up consisted of a discarded frame aerial roughly tuned, a headgear receiver and a "buzzer" to supply the interfering signal.

The first experiment was so promising that further tests were planned, but the war prevented these being carried out till March, 1942, when attempts were made to locate disconnections on the tubes of the Inverness-Wick Nos. 2 and 3 coaxial cables. The coil, connected to the input of a high-gain amplifier mounted in the test van, was used as the detector, an old uniselector rewound to operate on 12 V being used as the transmitter. The early tests had shown that a continuous signal is difficult to detect after a period of listening, and the uniselector was used to transmit the letter "S" in morse at a speed of 10 w.p.m., a silent period of 2 seconds being introduced once during each revolution of the switch. The faults were first roughly localised by ballistic methods as shown in Fig. 1.

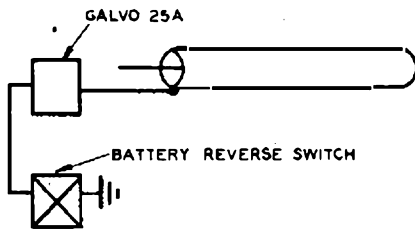

FIG. 1.

Accuracy was of little importance at this stage, as the defective joints were readily identified by the coil. It was possible by this method to locate and clear 15 tube disconnections in a week with the aid of one jointer and mate. The high capacitance of the tube permitted a fairly extensive field to be produced which made the localisation a fairly simple matter.

A month later these ideas were put to a more crucial test, the location of a positive earth fault over a 22-mile section with the test van on the move. The set-up was of a slightly different nature from that previously used. The frame was replaced by two 4 in. x 3 in. tuned iron-cored coils mounted in the rear section of the test van as shown in Fig. 2.

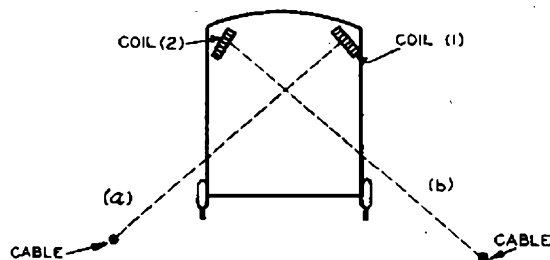

FIG. 2.

Coil 1 searched the one side of the carriageway (a) and coil 2 the other (b). Two signals were transmitted simultaneously as below, "S" being fed directly to faulty

S. - - - - - T. T.
P. - - - - -

line at near end and "P" relayed from far end. The signals combining at the fault forming the letter "T." The duration of the signals is approximately 2 seconds with a one-second silent period. By this means it was an easy matter to tell whether or not the fault had been "over-run."

Pressure of work has prevented further experiments being conducted, but tests with the moving vehicle have been made from time to time with speaker circuits between the repeater stations with promising results.

J. A. Y.

LANDSIDE AT GLENLUCE

Near the little village of Glenluce in Wigtownshire, the Dumfries-Stranraer road winds through a wooded glen alongside a small burn. At one of the bends this stream undermined the road retaining wall which, on the night of 15th December, 1946, collapsed along with a section of the road into the stream about 20 ft. below, leaving a three-way main underground duct route exposed and lying on a bank of rubble about 4 ft. below its normal level and in grave danger of sliding further. Other than broken collars on about half a dozen ducts the route was undamaged. The ducts carried an audio trunk and two carrier cables in which were provided a large number of circuits to Ireland.

As a preliminary measure to prevent further slipping, wires were put round the exposed ducts, brought over the edge of the remaining portion of the road and fastened to spikes driven into its surface.

A few days later, as there were indications that more of the road might fall away, steps were taken to make the route more secure. Pole stumps, stayed back, were erected on each side of the fall which was about fifty yards wide, and a suspension wire run across the gap in line with the duct track. The ducts resting on a bed of planks were supported from this on wire loops. Shortly after this was completed a further fall occurred, but the precautions taken proved adequate and no further damage was done. As an additional safeguard further bits of the road which looked as if they might fall later were eased away over the duct and between the suspension wires.

The arrangement has proved most successful and no interruption to the service has occurred. At the date of writing, two months after the original fall, the temporary repairs are still holding satisfactorily: the permanent restoration being delayed by uncertainty as to how the permanent road repairs are to be effected.

J. K.

NORTH OF SCOTLAND HYDRO-ELECTRIC SCHEME—LOCH SLOY

In the midst of development schemes to give service to waiting-list subscribers, the work of providing telephone service to the various contractors and resident engineer for the above scheme had to be undertaken. This involved the erection of an "A" type building and equipment for a U.A.X. No. 12, as the present C.S.X. at Ardlui was inadequate to take the hydro-electric requirements. The U.A.X. is situated at Inveruglas approximately midway between Arrochar and Ardlui and opposite the new road to the Loch Sloy dam.

A C.J. aerial cable (loaded) had to be erected from

Inveruglas to Arrochar and then connected to the Glasgow-Oban M.U. cable to Helensburgh which is the parent exchange for the junction outlets. An aerial cable from Inveruglas to Ardlui was also erected to transfer the present subscribers from the C.S.X. to the U.A.X.12. The pole route carrying this cable had to be recovered for a distance of 500 yards, due to blasting operations for road widening and the construction of the tail race across the road into Loch Lomond. To link-up the route, submarine cables were laid across Inveruglas Bay.

Work is proceeding in erecting a pole route and aerial cable up the mountainside to the dam, connecting various contractors en route.
R. C. L.

North Eastern Region

LEEDS H.P.O. TELEGRAPH TRANSFER

For war purposes an emergency telegraph installation had been provided in strengthened basement accom-

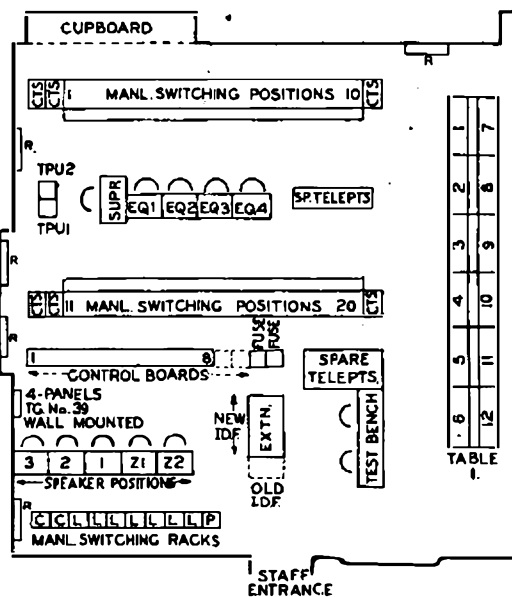

FIG. 1.

modation of the Leeds H.P.O. The M.C.V.F. terminal, also situated in the H.P.O., had been split into two parts, one part being transferred to the Burley Street repeater station about half a mile away. All the control and test boards had been transferred to the basement. All

physical telegraph circuits and the physical tails serving V.F. telegraph channels at Burley Street had been diverted externally directly into the protected basement accommodation, and terminated on a M.D.F. there. When teleprinter manual switching was introduced in February, 1944, and Leeds and Birmingham made the first two switching centres on the inland system, it was decided to instal the teleprinter switchboards (No. 17) in the protected part of the basement. This installation was gradually extended as the switched network grew until 14 positions had been installed and brought into service. In 1945 it was decided to provide a new suite of switchboards of a new type given the Rate Book description of Switchboards, Teleprinter No. 17A, and, as the accommodation in the basement did not permit further growth, to instal these in peacetime accommodation if possible, and to increase the number of positions to 20. The layout adopted is shown in Fig. 1, which covers that part of the instrumentroom cleared and strengthened to accommodate the manual teleprinter switchboards and other equipment.

The work took five months to carry out and commenced with lining up of the switchboards and the I.D.F. rearrangements. Before the old I.D.F. could be recovered, however, it had to be moved 3 ft. while still in service to allow space for installation of the new one. This had to be done very carefully, as it was overburdened with many heavy lead cables and 16-way strips, but was accomplished without interrupting the service. The installation of the new switchboards and other equipment proceeded as and when additional space was cleared, and work in connection with the multiple cables was put in hand, most of the latter being carried out by female assistants. Meanwhile, a 600-pair cable from the normal M.D.F. in another part of the H.P.O. to the new I.D.F. was put in hand by the external staff, and completed in readiness for testing out and transfer. This cable was provided to replace the tie cables from the basement M.D.F. At this stage a change in policy made it necessary to arrange for all circuits to be converted from bothway to unidirectional working, and therefore to alter the I.D.F. vertical layout, but apart from this no delays occurred.

To simplify the transfer as far as possible and to avoid the provision of transfer circuits between the old and new installations which would have been necessary if the transfer of circuits had been made piecemeal, a schedule of all the possible circuit routings was drawn up in schematic form in the Regional Office. Typical routings and new jumpering arrangements proposed for them are shown in Fig. 2. This schedule was passed to the Leeds

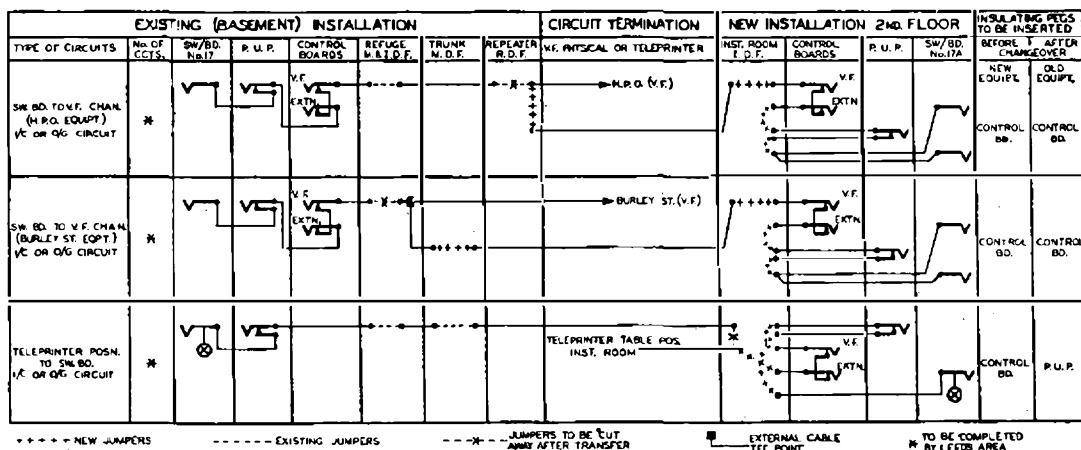

FIG. 2.

Area, who prepared from it detailed jumpering schedules. Later, as each circuit was jumpered to the new installation while still working to the old, it was isolated from the new installation by inserting an insulated peg into the line jack at the new control and test boards. It was thus possible to develop transfer arrangements on lines similar to those used for manual to auto. exchange

conversations. The transfer took place successfully on 12th May, 1946.

The Leeds Area staff are to be congratulated on carrying out a well organised piece of work with no faults attributable to the transfer.

R. T. A. D.
W. A. R.

Junior Section Notes

Aberdeen Centre

The annual general meeting will be held in April, so watch the notice boards for date. We would welcome any suggestions for our forthcoming session and look forward to a healthy attendance. Although the membership has soared since the centre recommenced activities the attendances at the meetings have not been proportionate.

I would recommend to other centres the film loaned by A.T.E. Co. Ltd., Strowger Works, Liverpool, "Where there's a will." The duration of the film is about 90 minutes and describes the manufacture of telephone equipment. The commentary given by John Snagge is also first class.

S. D. F. B.

Dundee Centre

An interesting evening was spent in Telephone House on January 26th, when Mr. D. B. Morrison gave a lecture on Radar in which the principles of radiolocation and its many practical applications were fully explained.

Our library was greatly increased by a handsome gift of technical books from our Telephone Manager, Mr. Dewar.

The programme for the latter part of the season includes lectures, a film show and a "Brains Trust." It is expected that these meetings will be well supported. A welcome is extended to Senior Section members.

H. M.

Stoke-on-Trent Centre

On January 17th, 1947, the Junior Section of the I.P.O.E.E. was resuscitated.

A well attended General Meeting elected a President and Committee, after which details of a forthcoming programme were discussed. Some lectures have already been arranged to fill in the remainder of the present session and progress has been made in forming a library for the centre. The initial membership is 65 and every effort is being made to broaden the interest in the section.

E. A. M.

London Centre

Since the last note on London centre activities, at the beginning of the 1946-47 session, the centre has enjoyed meetings of keen interest and high attendance.

The monthly central programme of lectures began in October with a most informative lecture on "The Principles of Coaxial Cable Transmission," by C. A. Floyd, M.A., A.M.I.E.E., followed in November by a lecture entitled "Television," by H. T. Mitchell, M.I.E.E. This lecture was of immense popularity and well supported—some 300 members attending. A general business meeting was held in December followed by the

showing of a film entitled, "Kelvin, Master of Measurement."

The second part of the session was opened in January by a lecture entitled, "The B.B.C. in Wartime," by J. H. Holmes, B.Sc., A.M.I.E.E.—a B.B.C. engineer.

Future central meetings include talks on "Radar" and "The Principles of Carrier Systems No. 7," by Junior Section members. Local areas have conducted meetings, lectures and visits to places of interest and are to be congratulated on their efforts.

J. G.

Tunbridge Wells Centre

The third winter session commenced on August 19th, 1946, and the following officers were elected:

Chairman, C. T. Polhill; Treasurer, A. E. Chapman; Secretary, J. R. Johnson; Committee: Messrs. W. A. Clarke, E. L. English, J. P. Laurence, F. W. Scott, A. G. Shoebridge and K. H. Waddell.

The programme for the session was as follows:

September. Visit to motor generator manufacturing establishment at Tonbridge.

October. Paper, "Teleprinter No. 7B," by T. J. Stevens.

November. Visit to Tunbridge Wells Corporation Power Station.

December. Paper, "Local Line Development," C. H. Etches.

January. Visit to local printing establishment.

February. Paper, "Principles of Radio Propagation," Messrs. Sparke and Hemsley.

March. Visit to Tunbridge Wells Gasworks.

Shrewsbury Centre

The Shrewsbury Junior Centre, which has been reorganised since the end of the war, started this year's session with nearly 100 members. Mr. H. S. Nock has been elected chairman, and Mr. Ed. Jones, Hon. Sec.

On October 5th, 1946, a visit was made to Criggion Radio Station, and over 60 members were present. Members from Oswestry and Wellington attended. They were conducted round the station by members of the Criggion Radio Section of the J.I.P.O.E.E. and everyone expressed satisfaction with the visit. A dinner at Oswestry completed a most enjoyable day. The following meetings have been held:

October 16th. "Brains Trust".

November 13th. House Telephone System. By Mr. B. R. Bradley.

December 11th. Principles of Radio Reception. Mr. B. F. Smith.

January 22nd. Principles of Super-Heterodyne. Mr. B. F. Smith.

A programme of interesting papers is being arranged and will be published shortly.

E. J.

Staff Changes

Promotions

Name	Region	Date	Name	Region	Date
<i>Dep. E-in-C to E-in-C.</i>			<i>Chief Insp. to Asst. Engr.—continued.</i>		
Gill, A. J.	1.1.47	Lee, J. A.	.. L.T.R. ..	15.1.47
<i>Asst. E-in-C. to Dep. E-in-C.</i>			Lamb, W. H.	.. L.T.R. ..	15.1.47
Faulkner, H.	1.1.47	<i>Asst. R.M.T.O. to R.M.T.O.</i>		
<i>Staff Eng. to Asst. E-in-C.</i>			Huxley, R. T.	.. London ..	9.12.46
Little, G. J. S.	9.1.47	<i>Insp. to Chief Insp.</i>		
<i>Asst. Staff Eng. to Staff Eng.</i>			Traynor, W. S.	.. N.W. Reg. ..	2.4.46
Beer, H. G.	.. E-in-C.O. ..	31.1.47	<i>Mech. i/c Gde. I to T.Asst.</i>		
<i>Exec. Eng. to Asst. Staff Eng.</i>			Partington, H.	.. H.C. Reg. to E-in-C.O. ..	29.7.46
Martin, J. A. S.	.. E-in-C.O. ..	21.11.46	<i>S.W.1 to Insp.</i>		
Stanesby, H.	.. E-in-C.O. ..	20.1.47	Bell, R. F.	.. Test Section ..	1.4.46
Cook, A.	.. E-in-C.O. ..	20.1.47	Underwood, T. W. E.	.. Test Section ..	11.6.46
Brockbank, R. A.	.. E-in-C.O. ..	20.1.47	Temple, H. C.	.. Test Section ..	28.4.45
Mitchell, C. A.	.. E-in-C.O. ..	21.1.47	<i>D'sman Cl. I to Senior D'sman.</i>		
<i>Asst. Eng. to Exec. Eng.</i>			Thistlethwaite, H.	.. Mid. Reg. ..	8.12.46
Renton, R. N.	.. E-in-C.O. ..	25.11.46	<i>D'sman Cl. II to D'sman Cl. I.</i>		
Roberts, W. G. *	.. E-in-C.O. ..	14.12.46	Humphries, A. J.	.. E-in-C.O. ..	1.12.46
Casterton, E. J. *	.. E-in-C.O. ..	14.12.46	Penhallow, E. W.	.. E-in-C.O. ..	1.12.46
Balcombe, F. G.	.. E-in-C.O. ..	14.12.46	Lander, W. J.	.. E-in-C.O. ..	1.12.46
Kilvington, T.	.. E-in-C.O. ..	14.12.46	Harding, J. F.	.. E-in-C.O. ..	8.12.46
Hoare, E. R.	.. E-in-C.O. ..	14.12.46	Morgan, R. E.	.. Mid. Reg. to L.T.R. ..	23.6.46
Merriman, J. H.	.. E-in-C.O. ..	14.12.46	Thornton, P. E.	.. S.W. Reg. ..	7.6.46
Thompson, J. O.	.. E-in-C.O. ..	14.12.46	Richardson, E. J.	.. L.T.R. ..	22.7.46
Welch, S.	.. E-in-C.O. ..	14.12.46	Johnson, R. F.	.. Scot. Reg. ..	1.8.46
Rimes, R. E.	.. N.E. Reg. ..	17.1.47	Watson, W. A.	.. Mid. Reg. to H.C. Reg. ..	13.1.47
Warren, F.	.. E-in-C.O. ..	17.1.47	Bartley, R. F. C.	.. S.W. Reg. ..	15.12.46
Colledge, T. A. P.	.. H.C. Reg. to W. & B.C. Reg. ..	2.2.47	Holt, E.	.. H.C. Reg. ..	16.12.46
Broadhurst, S. W.	.. E-in-C.O. ..	17.1.47	Keeping, H. W. L.	.. H.C. Reg. to L.P. Reg. ..	8.12.46
Glazier, E. V. D. *	.. E-in-C.O. ..	17.1.47	Mitchell, A. P.	.. Scot. Reg. ..	5.1.47
Ackroyd, J. O.	.. E-in-C.O. ..	17.1.47	Kiff, W. T. C.	.. L.T.R. to L.P. Reg. ..	8.12.46
Finlason, W. E.	.. E-in-C.O. ..	17.1.47	Preedy, A. E.	.. L.T.R. to L.P. Reg. ..	1.1.47
<i>Chief Insp. to Asst. Engr.</i>			Howell, K. G.	.. Factories Dept. ..	22.10.46
Brandum, W. H.	.. L.P. Reg. ..	18.12.46	Coutts, S. J.	.. N.W. Reg. ..	1.1.47
Gibbs, F. J.	.. H.C. Reg. ..	15.1.47	Smith, A. R.	.. S.W. Reg. ..	1.2.47

* In absentia.

Retirements

Name	Region	Date	Name	Region	Date
<i>Engineer-in-Chief</i>			<i>Chief Insp.—continued</i>		
Angwin, Col., Sir. A.	31.12.46	Lundy, E. H.	.. N.W. Reg. ..	31.12.46
Stanley, K.B.E., D.S.O., M.C., T.D.	31.12.46	Partington, B. G.	.. N.W. Reg. ..	31.12.46
<i>Exec. Engr.</i>			Vear, F.	.. N.E. Reg. ..	31.12.46
Elliott, G.	.. L.T.R. ..	30.11.46	Clarke, W. J. F.	.. E-in-C.O. (Resigned) ..	31.12.46
Hadfield, B. M.	.. E-in-C.O. (Resigned) ..	31.12.46	Sturges, A.	.. E-in-C.O. ..	31.12.46
Christie, G. C.	.. N.E. Reg. ..	31.12.36	Anderson, S. J.	.. E-in-C.O. ..	6.1.47
Bocock, W.	.. L.T.R. ..	31.1.47	<i>Inspector</i>		
<i>Asst. Engr.</i>			Barnes, F. G.	.. H.C. Reg. (Resigned) ..	6.7.46
Lockwood, R. A.	.. H.C. Reg. ..	24.12.46	Williams, G.	.. W. & B.C. Reg. (Resigned) ..	12.4.46
Cumberland, W. B.	.. E-in-C.O. ..	31.12.46	Heath, C. A. F.	.. L.T.R. ..	12.7.46
Bird, F. T.	.. E-in-C.O. ..	31.12.46	Hutchinson, J. S.	.. Scot. Reg. ..	28.7.46
Still, W.	.. E-in-C.O. ..	30.1.47	Steward, S. G.	.. L.T.R. ..	2.8.46
<i>Chief Insp.</i>			Williams, G. A.	.. N.W. Reg. ..	25.8.46
Goodwin, E. T.	.. H.C. Reg. ..	31.10.46	Pask, W. J.	.. L.T.R. ..	27.8.46
Smith, P. G.	.. E-in-C.O. ..	30.11.46	Watts, H. C.	.. H.C. Reg. ..	23.9.46
West, W.	.. L.T.R. ..	9.12.46	Godfrey, A. E.	.. L.T.R. ..	30.9.46
Grew, A. W.	.. H.C. Reg. ..	31.12.46	Park, A.	.. N.W. Reg. ..	13.10.46
Blackhall, F. W.	.. H.C. Reg. ..	31.12.46	Avery, A.	.. H.C. Reg. ..	19.10.46
Baines, F. G.	.. E-in-C.O. ..	31.12.46	Moore, J. J.	.. N.W. Reg. ..	27.10.46
Jackson, J. H.	.. N.E. Reg. ..	31.12.46	Frizelle, G. H. H.	.. N.E. Reg. ..	31.10.46

Retirements—continued

Name	Region	Date	Name	Region	Date
<i>Insp.—continued</i>			<i>Insp.—continued</i>		
Adair, C. J.	L.T.R.	31.10.46	Welsh, G. I.	E.-in-C.O. (Resigned)	21.1.47
Wooles, F. E.	W. & B.C. Reg.	1.12.46	Norfolk, J. D.	Mid. Reg. (Resigned)	24.1.47
Butler, E. S.	N.W. Reg.	31.12.46	Allen, A. T.	Test Section	23.2.47
Robinson, R.	N.E. Reg.	31.12.46	<i>Des'man Cl. I</i>		
Jones, J. E.	N.W. Reg.	31.12.46	Peake, E. W.	L.T.R.	31.12.46
Boraston, E. G. C.	E.-in-C.O. (Resigned)	31.12.46	Thomas, E. W.	N.W. Reg.	31.12.46
Wright, J. E.	E.-in-C.O. (Resigned)	11.1.47	Tibbitts, J. E.	S.W. Reg.	31.1.47

Deaths

Name	Region	Date	Name	Region	Date
<i>Asst. Engr.</i>			<i>Insp.</i>		
Brown, W. J.	L.P. Reg.	7.12.46	Haynes, W. V.	N.W. Reg.	15.7.46
			Bowers, F.	N.W. Reg. (on military service)	25.11.46

Transfers

Name	Region	Date	Name	Region	Date
<i>Asst. Engr.</i>			<i>Insp.—continued</i>		
Wright, J. S.	E.-in-C.O. to L.T.R.	1.12.46	Bennett, T. J.	L.P.R. to E.-in-C.O.	18.12.46
Birss, R. R.	E.-in-C.O. to N.E. Reg.	1.2.47	Grieve, J. W.	Mid. Reg. to Scot. Reg.	23.12.46
Richards, C. W. C.	E.-in-C.O. to W. & B.C.	1.2.47	Walker, E. H.	E.-in-C.O. to Asst. Eng., Min. of Transport	1.1.47
Turner, A. F.	E.-in-C.O. to L.T.R.	10.2.47	Whiteoak, H. J. G.	L.P.R. to E.-in-C.O.	1.1.47
Hopwood, R. W.	E.-in-C.O. to L.T.R.	17.2.47	Duff, J. T.	E.-in-C.O. to Asst. Eng., Min. of Transport	1.1.47
<i>Chief Insp.</i>			Roberts, G. H.	E.-in-C.O. to Asst. Tech. Costs Offr., Contracts Dept.	5.1.47
Carter, T.	E.-in-C.O. to L.T.R.	1.12.46	Cowie, J. M.	Scot. Reg. to L.T.R.	14.1.47
Bridges, J. T.	E.-in-C.O. to L.T.R.	1.12.46	Worley, H. W. R.	E.-in-C.O. to H.C. Reg.	1.2.47
Perkins, F. T.	E.-in-C.O. to L.T.R.	1.2.47	Burchell, J. R. L.	E.-in-C.O. to L.T.R.	1.2.47
<i>Insp.</i>			Saxey, A. E.	Mid. Reg. to H.C. Reg.	1.2.47
Groves, H.	N.W. Reg. to H.C. Reg.	19.10.46	Glover, A. G.	L.P.R. to E.-in-C.O.	15.2.47
Rumbellow, V. G.	Mid. Reg. to H.C. Reg.	1.11.46	Notley, C.	L.P.R. to E.-in-C.O.	15.2.47
Hardman, E.	E.-in-C.O. to N.W. Reg.	1.12.46	Graty, H. J.	E.-in-C.O. to Mid. Reg.	24.2.47
Mills, R. J.	E.-in-C.O. to Asst. Examiner B.O.T.	2.12.46			
Search, C. J.	E.-in-C.O. to H.C. Reg.	8.12.46			

CLERICAL GRADES

Promotions

Name	Region	Date	Name	Region	Date
<i>Exec. Cffr. to Staff Offr.</i>			<i>Exec. Offr. to Staff Offr.—continued</i>		
Baker, F. S.	E.-in-C.O.	1.5.46	Bernstein, L.	E.-in-C.O.	6.8.46
Rose, A. H.	E.-in-C.O.	6.8.46	Reynolds, E. G.	E.-in-C.O.	22.8.46
Nelson, W. J.	E.-in-C.O.	6.8.46	<i>Clerical Offr. to Exec. Cffr.</i>		
			Jackson, W. F.	E.-in-C.O.	21.10.46

Deaths

Name	Region	Date	Name	Region	Date
<i>Exec. Cffr.</i>			<i>Exec. Offr.—continued</i>		
Reason, P. C.	E.-in-C.O.	12.6.46	Jessop, R. H.	E.-in-C.O.	7.11.46

Retirements

Name	Region	Date	Name	Region	Date
<i>Staff Offr.</i>			<i>Exec. Offr.</i>		
Hannaford, E. J. G.	E.-in-C.O.	31.7.46	Booth, C. H.	E.-in-C.O. (on loan to War Damage Comn.)	10.9.46
Macleay, C.	E.-in-C.O.	21.8.46	Butterfield, P.	E.-in-C.O.	30.9.46
Price, C. E. (Capt.)	E.-in-C.O. (on loan to M.O.S.)	6.9.46	Davidson, R. S.	E.-in-C.O.	31.10.46
Weston, A. S. (Capt.)	E.-in-C.O. (on loan to T.D.)	30.9.46	Knight, H.	E.-in-C.O.	14.11.46
Murray, C. E.	E.-in-C.O. (on loan to War Office)	30.9.46			
	E.-in-C.O.	30.9.46			

Book Review

"Dictionary of Electrical Engineering" by G.W. Stubbins, B.Sc., F.Inst.P., A.M.I.E.E. E. & F. N. Spon, Ltd. 219 pp. 10s. 6d. net.

The author states that his object has been to produce a small and inexpensive work of reference which will, within the limits of its size, comprise some of the utilities of the exhaustive British Standard Glossary on the one hand and of the larger encyclopedias with their full length articles on the other.

A work of this kind must be a compromise and the author appears to have been reasonably successful in his attempt.

The dictionary differs from the Standard Glossary by including items which are not electrical terms such as for example "moment of inertia," "radian," terms relating to materials, e.g., bitumen, mica, micanite, etc., are also included as also are a number of terms which are the names of proprietary articles such as mumetal, Tirril regulator, Schrage (misspelt Scrage), etc. As the book is intended for students and junior engineers the inclusion of such terms, omitted in the Standard Glossary for obvious reasons, is likely to be useful. The book is not a substitute for the Standard Glossaries but on the other hand it contains much information essential to the engineer and not available in ordinary text books.

It should therefore have a field of usefulness for the class of reader for which it is intended.

In looking through the book a few errors and omissions have been noticed. For example, in the definition of a compound wound motor it is stated that in the cumulative compound motor the series winding opposes the shunt winding—this of course is the feature of the differentially wound motor—in the cumulatively wound motor the two fields are additive and the speed falls as the load increases instead of rising as stated. The decibel is wrongly defined as the conventional unit of loudness difference between two sounds. The decibel is not a unit in the ordinary meaning of the term and is merely a method of expressing a power ratio. Decibels express the ratio of two electrical powers, being ten times the common logarithm of their ratio. No reference is made to the "Bel." "Distributor" is correctly defined as a feeder but there is another meaning in telecommunications which is equally important but not mentioned. Electrolytic condenser is defined as containing electricity by the formation of a gas. In most electrolytic condensers nowadays the dielectric is an oxide on the surface of the aluminium electrodes.

A "two-phase four-wire system" is defined as a combination of two single phase 3-wire systems! It is hoped that an opportunity will be taken on the occasion of any reprinting to correct these points which somewhat impair the value of an otherwise useful little work.

A. J. G.

BOARD OF EDITORS

A. J. GILL, B.Sc., M.I.E.E., F.I.R.E., Chairman.
F. E. NANCARROW, O.B.E., A.R.C.Sc., M.I.E.E.
P. B. FROST, B.Sc., M.I.E.E.
A. H. MUMFORD, O.B.E., B.Sc.(ENG.), M.I.E.E.
C. W. BROWN, A.M.I.E.E.
C. E. C. SKUSE.
H. LEIGH, B.Sc.(ENG.), M.I.E.E., Managing Editor.
G. E. STYLES, A.M.I.E.E. } Assistant
J. P. HARDING, B.Sc.(Eng.), } Editors.
A.M.Inst.C.E., A.M.I.E.E., }
A. J. BAKER, Secretary-Treasurer.

Copyright

The entire contents of this JOURNAL are covered by general copyright, and special permission is necessary for reprinting long extracts, but Editors are welcome to use not more than one-third of any article, provided credit is given at the beginning or end thus: "From the *Post Office Electrical Engineers' Journal*."

The Board of Editors is not responsible for the statements made or the opinions expressed in any of the articles in this JOURNAL, unless such statement is made specifically by the Board.

Communications

All Communications should be addressed to the Managing Editor, *P.O.E.E. Journal*, Engineer-in-Chief's Office, Alder House, Aldersgate Street, London, E.C.1. Telephone: HEADquarters 1234. Remittances should be made payable to "The *P.O.E.E. Journal*" and should be crossed "& Co."

Binding Cases

Cases for binding are available, and may be obtained from the Local Agents for 2s. Subscribers can have their copies of Volumes bound, at a cost of 7s. 6d., by sending the complete set of parts to the Local Agents or to the *P.O.E.E. Journal*, Engineer-in-Chief's Office, Alder House, Aldersgate Street, London, E.C.1. Orders for binding for Vols. 1-19 should indicate whether the original binding case with black lettering, or the later pattern with gold, is required. Cases with gold lettering are the only type stocked from Vol. 20 onwards.

Back Numbers

The price of the JOURNAL, which is published quarterly, is 1s. (1s. 3d. post free) per copy, or 5s. per annum post free. Back numbers can be supplied, subject to availability of stocks, at 1s. each (1s. 3d. post free). Orders for back numbers may be sent to the Local Agents or to the Publishers.

Advertisements

All communications relating to space reservations should be addressed to the Advertisement Editor, *P.O.E.E. Journal*, Alder House, Aldersgate Street, London, E.C.1. Communications regarding advertisement copy, proofs, etc., should be addressed to the Publishers, Messrs. Birch & Whittington (Prop. Dorling & Co. [Epsom], Ltd.), 49 Upper High Street, Epsom, Surrey.



The AvoMeter is one of a useful range of "Avo" electrical testing instruments which are maintaining the "Avo" reputation for an unexcelled standard of accuracy and dependability—in fact, a standard by which other instruments are judged.

ONE INSTRUMENT
measures:—

Current, A.C. and D.C. (0 to 10 amps.)
Voltage, A.C. and D.C. (0 to 1,000 v.)
Resistance (up to 40 megohms)
Capacity (0 to 20 mfd.)
Audio-frequency Power Output (0 to 2 watts)
Decibels (–25 Db. to + 16 Db.)

Write for fully descriptive pamphlet.

'AVO'
Meters that Matter

THE Model 7 Universal AvoMeter is the world's most widely used combination electrical measuring instrument. It provides 50 ranges of readings and is guaranteed accurate to B.S. first grade limits on D.C. and A.C. from 25 c/s to 2 kc/s. It is self-contained, compact and portable, simple to operate and almost impossible to damage electrically. It is protected by an automatic cut-out against damage through severe overload, and is provided with automatic compensation for variations in ambient temperature.

Sole Proprietors and Manufacturers

THE AUTOMATIC COIL WINDER & ELECTRICAL EQUIPMENT Co. Ltd.
Winder House, Douglas Street, London, S.W.1. Phone: VICTORIA 3404-9

A HANDBOOK of TELECOMMUNICATION

By **BERTRAM S. COHEN, O.B.E., M.I.E.E., F.Inst.P.**

Edited by F. G. C. Baldwin, O.B.E., M.I.E.E.

An important and much needed book describing in full technical detail and with numerous illustrations, present practice and latest developments in Telegraphy and Telephony. Information, much of which has hitherto been unpublished, is not confined to British practice, but includes accounts of techniques in use in European countries and in the U.S.A. An invaluable book for Post Office electrical engineers, lecturers and students. **30s. net**

TELEPHONY

By **T. E. HERBERT, M.I.E.E., and W. S. PROCTER, A.M.I.E.E.**

VOL. I.

MANUAL SWITCHING SYSTEM AND LINE PLANT

For many years the standard authority on manual telephony, this work has been completely revised and brought up to date. It covers the syllabus of the City and Guilds of London Institute Examinations, and deals helpfully with many problems which occur in the servicing and maintenance of line plant. Second Edition. **25s. net**

VOL. II.

AUTOMATIC TELEPHONY

A detailed exposition of the automatic system which is employed in Great Britain, providing a valuable work of reference for all concerned with telephony. Candidates for the Post Office Engineering Department will find this volume an indispensable aid to their studies. Both volumes are extremely well illustrated. **20s. net**

PITMAN

Parker Street · Kingsway · London, W.C.2



7-Range

CLIP-ON AMMETER

Seven ranges in one instrument
Thumb-operated switch
Fully insulated
Accuracy within 3% of full scale
Weight . . . 3 lbs.

RANGES :
0-10 Amps.
0-25 Amps.
0-50 Amps.
0-100 Amps.
0-250 Amps.
0-500 Amps.
0-1000 Amps.

Can be applied to bare or insulated conductors up to $2\frac{1}{2}$ ins. diameter.
Write for List In. 17a.

FERRANTI LTD.

HOLLINWOOD · LANCS. London Office · KERN HOUSE, KINGSWAY, W.C.7

**ELECTRICAL MEASURING
INSTRUMENTS
OF THE HIGHER GRADES**

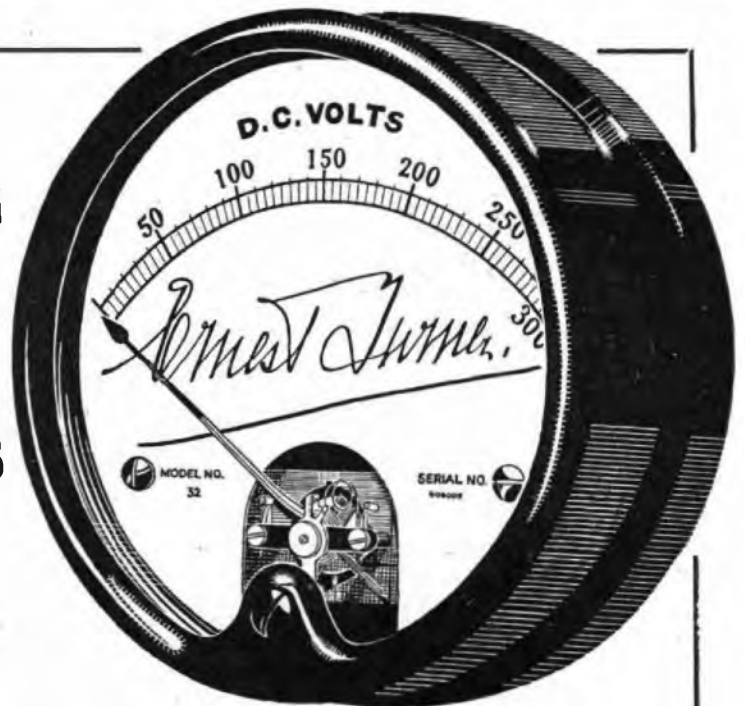

ERNEST TURNER ELECTRICAL INSTRUMENTS LTD.
CHILTERN WORKS, TOTTERIDGE AVENUE, HIGH WYCOMBE, BUCKS.
Telephone: High Wycombe 1301/2
Telegrams: Gorgeous, High Wycombe

INDEX TO ADVERTISERS

	PAGE
Aiton Battery Co., Ltd., The	xv
Automatic Coil Winder & Electrical Equipment Co., Ltd.	iii
Automatic Telephone & Electric Co., Ltd.	x, xi
Bennett College, The	vi
British Institute of Engineering Technology	xii
Frederick & Co., Ltd.	xiv
The Edison Swan Electric Co., Ltd.	ii
Elliott Bros. (London), Ltd.	xix
Ericsson Telephones, Ltd.	viii
Faversham & Vignoles, Ltd.	xvii
Ferranti, Ltd.	iv
General Electric Co., Ltd., The	xviii
Great Northern Telegraph Co., Ltd., The	ix
H. T. A., Ltd.	ix
International Correspondence School, Ltd.	xii
Leosid, Ltd.	xiv
Larmeko, Ltd.	vi
Melli-General Cable Works, Ltd.	xx
Witman, Sir Isaac & Sons, Ltd.	iii
Salford Electrical Instruments, Ltd.	ii
Siemens Brothers & Co., Ltd.	vii
Smith, Frederick, & Co.	v
Standard Telephones and Cables, Ltd.	xiii
Sullivan, H. W., Ltd.	xx
Telephone Manufacturing Company, Ltd.	xii, xvi
Ernest Turner Electrical Instruments, Ltd.	iv
United Insulator Co., Ltd.	v
Vestinghouse Brake & Signal Co., Ltd.	xvi
Vinn & Coales, Ltd.	vi

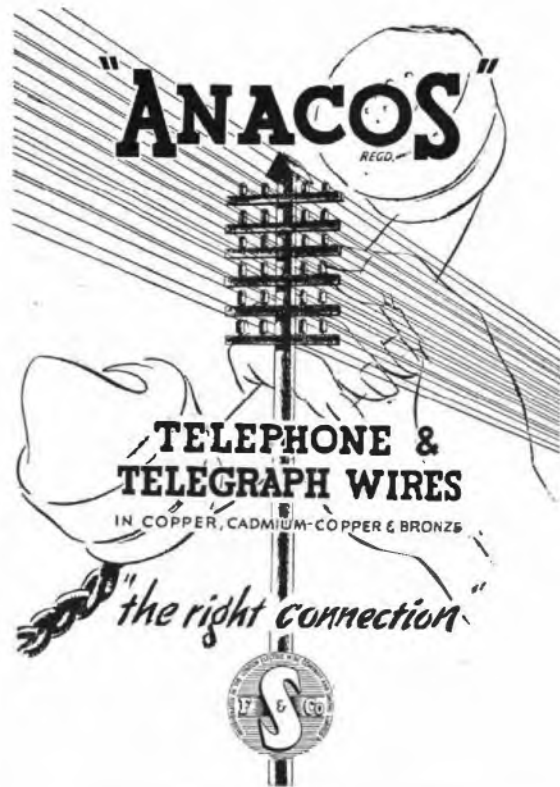

FREDERICK SMITH & COMPANY
 (Incorporated in The London Electric Wire Company and Smiths, Limited)
ANACONDA WORKS, SALFORD 3, LANCs.
 Phone: Blackfriars 8701 (9 lines) • Grams: "Anaconda," Manchester



U.I.C

Silvered Mica & Ceramic
CAPACITORS

A wide range of types for
 all purposes

UNITED INSULATOR CO. LTD.
 Oakcroft Rd., Tolworth, Surbiton, Surrey
 Phone: Elmbridge 5241 Grams: Colanel, Surbiton

Unsurpassed In Ceramics

Denso
PERMANENTLY PLASTIC PROTECTION

SPEEDY in application

PERMANENT in protection

Write for Specification and price list

WINN & COALES LTD
TERMINAL HOUSE, GROSVENOR GARDENS, LONDON, S.W.1
Telephone: Sloane 6264 Telegrams: Denselte, Sowest, London



EVERY
MAN
FOR
HIMSELF . . .

Well, maybe we could adopt that policy of slapping Transformers together and churning them out as fast as possible irrespective of quality - you know, bash the next J&K chap for all he is worth, let the future take care of itself.

But we think that attitude is wrong and in any case a Parmeko job always has been made up to a standard and not down to a price.

We realise that the success of our business depends upon the success of your business, if you go bust then we go bust because you don't buy any more Transformers. In any case when a new customer comes to us we like to feel that in 20 years time we shall still be making some very good Transformers for him . . .

PARMEKO OF LEICESTER.
MAKERS OF TRANSFORMERS.

STUDY AT HOME You Can Have a College Training For a Few Shillings Monthly **IN YOUR SPARE TIME**

FOUNDED 1900 40 YEARS OF SUCCESS

CITY and GUILDS (Telecommunication) EXAMINATIONS

To every student we send a written Guarantee of Tuition until the examination is actually passed

The most progressive and most successful Correspondence College in the world

Our tuition is so graded that each stage is reached without difficulty. Personal attention is given to every student. FULL PARTICULARS AND ADVICE SUPPLIED FREE. WE TEACH BY POST IN ALL PARTS OF THE WORLD.

Dept. 24, THE BENNETT COLLEGE, SHEFFIELD

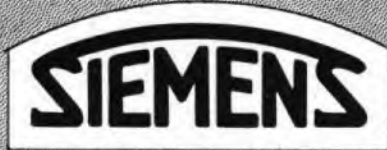

TELECOMMUNICATION EQUIPMENT

*Designed for service
in all parts of the world*

BY close attention to technical detail the Company has maintained its position in the forefront of Telecommunication Engineers throughout its long experience. Its products enjoy a world-wide reputation for sound design and technical excellence.

The Company undertakes the supply and installation of complete Automatic and Manual Telephone Exchanges for Public and Private service, Automatic and Manual Trunk Exchanges, all types of Telephone Cables for Trunk and Local Service, Carrier Transmission Equipment and Cables, Radio Equipments for Ships.

AUTOMATIC TELEPHONE EXCHANGES Including the following types

Trunk	T.A.X.
Main	M.A.X.
Rural	R.A.X.
Unit	U.A.X.
Private	P.A.X.
Private Branch	P.A.B.X.

MANUAL EXCHANGES of all types

CARRIER TRANSMISSION EQUIPMENT

TELEPHONE INSTRUMENTS of all types

TELEPHONE SWITCHING EQUIPMENT

PROTECTIVE DEVICES

RELAYS

TELEPHONE CABLES, WIRES & CORDS

LOADING COILS

MARINE RADIO EQUIPMENT

SHIPS' TELEGRAPHS & TELEPHONES

CELLS & BATTERIES Dry, Fluid and Inert



SIEMENS BROTHERS & CO., LIMITED
WOOLWICH · LONDON · S · E · 18

ESTABLISHED 1858

TEL: WOOLWICH 2020

Achievement...
by
Ericsson



ERICSSON TELEPHONES LTD., Head Office: 22 Lincoln's Inn Fields, London, W.C.2

Phone: HOLborn 6936

UNIVERSALLY ADOPTED

G.N.T.Co. TRANSMITTER MODEL 112

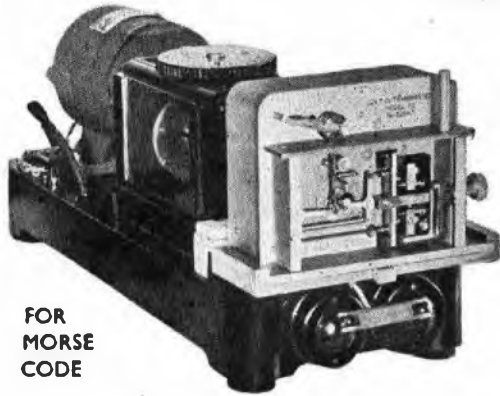

FOR
MORSE
CODE

13-250 words per minute without gear changes
or readjustments.

Absolutely constant speed at all settings not-
withstanding large voltage variations.

Noted for its easy maintenance.

Supplied with A.C. or D.C. motors as required.

THE GREAT NORTHERN TELEGRAPH CO. LTD.
OF DENMARK

KONGENS NYTORV 28
COPENHAGEN K. - DENMARK

AND

5, ST. HELEN'S PLACE,
LONDON, E.C.3

A Typical Example of **H.T.A. DESIGN**

Included in the range of H.T.A. Products are Telephone Coin Collectors, Stamp Selling Machines, Autodials, Commodity Vending Machines, Coin Operated Mechanisms, Kitchen Control Units, Gas Leak Indicators and Ticket Printing and Issuing Machines of which the model illustrated is a typical example.

★ *This H.T.A. all-electric Ticket Issuing Machine prints and dates each ticket when coin is inserted*

Designed for selling of railway travel and platform tickets this model can be adapted for a variety of other purposes.

Tickets are printed and dated on the insertion of the appropriate coin or coins from a roll of blank paper, the size of the ticket issued being approximately 3" x 1½" x .015" thick. The machine is electrically operated and full details and specification will be supplied on request.

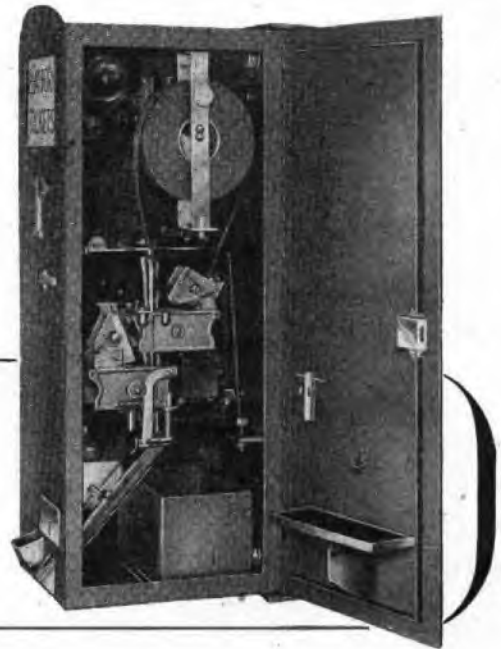

H.T.A. LIMITED

FORMERLY HALL TELEPHONE ACCESSORIES (1928) LTD

Precision Engineers & Instrument Makers

DUDDEN HILL LANE • WILLESDEN • LONDON • N. W. 10

PHONE: WILLESDEN 5141

Great Cities of



Greater London is the largest city in the world and within its limits can be seen every aspect of British national life. In the West End are fashionable shops and theatres. The East End includes dockland whilst "the City" is the centre of the nation's business life. In London is the home of the Royal Family, Buckingham Palace and the seat of democratic government, the Houses of Parliament. Green amidst the grey brickwork are leafy parks, Hyde Park, St. James's Park where Henry VIII played tennis and Hampstead Heath where the Cockneys throng the fair-grounds on Bank Holiday. Reverent peace lingers beneath the old towers of Westminster Abbey and the great dome and golden cross of St. Paul's whilst the applause of the sporting crowds resounds in the football arenas of Wembley and Twickenham and the cricket-grounds of Lord's and the Oval. So vast that it is a city and a county in one, London is the throbbing heart of a mighty Empire.



the World rely on-

STROWGER TELECOMMUNICATIONS

The conversion of the telephone system of London from manual to automatic working was an undertaking of the utmost magnitude. Several factors contributed to this. Firstly, the complete change-over could not be effected at one time but had to be made over a long period, throughout which time there could be no disruption of the service as a whole. Secondly, manual and automatic systems had to work smoothly and efficiently in conjunction with each other during the gradual process of change-over. Thirdly, the total number of subscribers to be provided with automatic service was an enormous one. After thoroughly investigating the merits of the various systems of automatic telephony available the British Post Office selected Strowger as the most advantageous. In their decision they were influenced by the simplicity of the step-by-step principle; its comparatively low initial capital outlay and its adaptability to both large and small areas and to both main and satellite exchanges. To meet the special problems of effecting mechanical switching throughout very large areas Strowger engineers evolved the "Director" as an adjunct to equipment already existing. To-day there are some one hundred and twenty Strowger "Director" Exchanges in London with nearly half-a-million direct lines serving a total of more than three-quarters-of-a-million telephones.

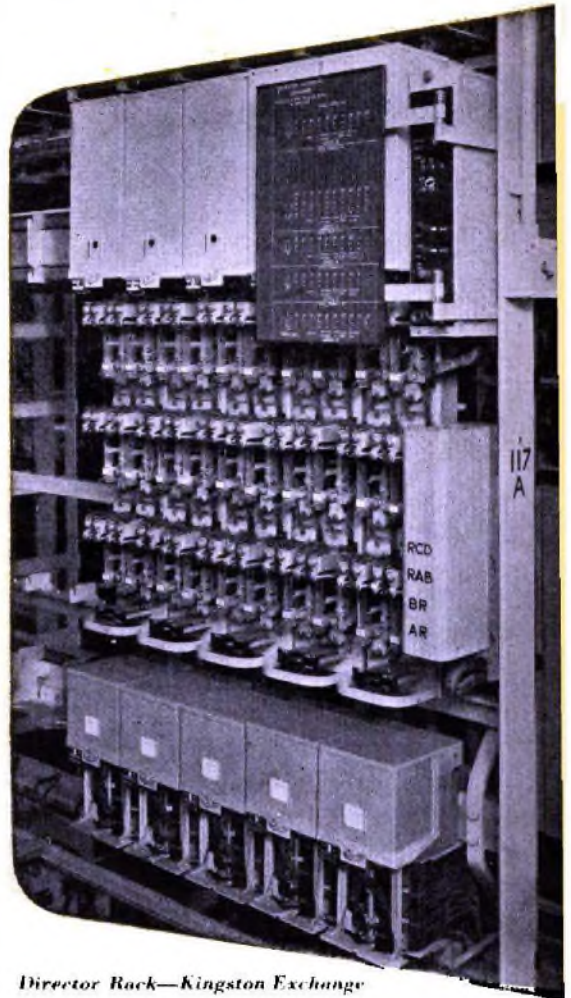

Director Rack—Kingston Exchange



AUTOMATIC TELEPHONE & ELECTRIC CO. LTD.

Export Department

NORFOLK HOUSE, NORFOLK STREET, LONDON, W.C.2

TEmple Bar 9262

STROWGER WORKS, LIVERPOOL. 7. ENGLAND

A7293-A72



"SYNCYCLE" FREQUENCY CONVERTER

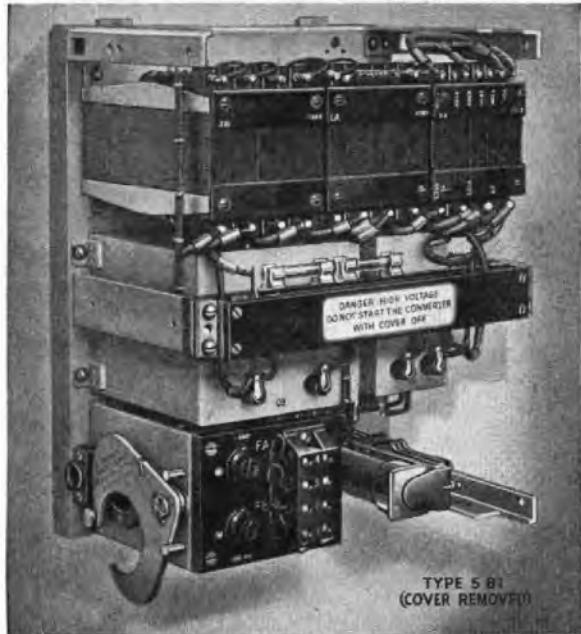

The Syncycle provides low frequency current at one-third mains supply frequency—e.g., 16⅔ c/s or 20 c/s for such purposes as signalling, alarm systems, laboratory use, etc. It is particularly suitable as a source of ringing current for telephone exchanges.

The Syncycle is compact and easily installed. It has no moving parts, thermionic valves, electrolytic capacitors, or any other components liable to require maintenance. It is automatically protected against overloads

"5 watt" series for Wall, Batten or Rack mounting:

Input:	Output:
from 90v. to 260v. A.C.	from 45v. to 90v. A.C.

"20 watt" series for Wall or Batten mounting:

Input:	Output:
from 200v. to 250v. A.C.	from 20v. to 90v. A.C.

Fully Tropical models for wall mounting are available.



Write for full details to the Sole Manufacturers and Patentees:

TELEPHONE MANUFACTURING CO. LTD.
HOLLINGSWORTH WORKS, DULWICH, LONDON, S.E.21

Telephone: GIPsy Hill 2211 (10 lines)

SOUND INSTRUCTION by Postal Method

The I.C.S., largest school in the world devoted to spare-time training by the postal method, offers you highly specialised Courses of Instruction for the following Examinations:

P.M.G. Certificates in Wireless Telegraphy
Associate Membership of I.E.E.

C. & G. Electrical Engineering Practice, Installation and Telecommunications.

Graduateship of the B.I.R.E.

Other Courses meet the requirements of all who desire to qualify for responsible positions in Electric Power, Illumination, Heating and Traction Stations. Equally successful is our instruction for Telegraph Engineers, Radio Engineers and Radio Servicemen.

Instruction is by correspondence from textbooks specially prepared by many experts in tuition by post.

WRITE FOR OUR SPECIAL BOOKLET and state the particular subject or Examination in which you are interested.

..... YOU MAY USE THIS COUPON

International Correspondence Schools Ltd.

Dept. 108, International Buildings, Kingsway, London, W.C.2

Please send me, free of charge, your special booklet on

Name..... Age.....

Address.....



A PRACTICAL PLAN for EARLY PROMOTION



Valuable Free Handbook Tells You How to Pass Your C. & G. or Promotion Exam. at First Attempt!

All Post Office Engineering personnel who are anxious to obtain early promotion should at once send for a copy of our handbook "ENGINEERING OPPORTUNITIES," which, among other intensely interesting matter, describes our unique methods of preparation for **TECHNICAL APPOINTMENTS IN THE POST OFFICE** (Assistant Engineer—New Style and Assistant Traffic Superintendent), **A.M.I.E.E., CITY AND GUILDS EXAMINATIONS** in Principles of Telecommunications (1-5), Radio (1-4), Telephone Exchange Systems (1-3), Telegraphy (1 and 2), Line Transmission (1 and 2), Lines Plant Practice (1 and 2), Mathematics for Telecommunications (1-5), Electrical Engineering Practice (Prelim. Inter. and Final), and outlines a wide range of non-examination courses in all branches of Electrical, Mechanical, Civil, Automobile, Aeronautical and Radio Engineering.

We definitely guarantee "NO PASS—NO FEE"

If you intend to make the most of to-day's opportunities, you cannot afford to miss reading "ENGINEERING OPPORTUNITIES." It tells you everything you want to know to secure advancement, and describes many opportunities you may now be missing through lack of information. Send for your copy to-day—**FREE** and without obligation.

BRITISH INSTITUTE OF ENGINEERING TECHNOLOGY
 369 SHAKESPEARE HOUSE, 17-19 STRATFORD PLACE, LONDON, W.1

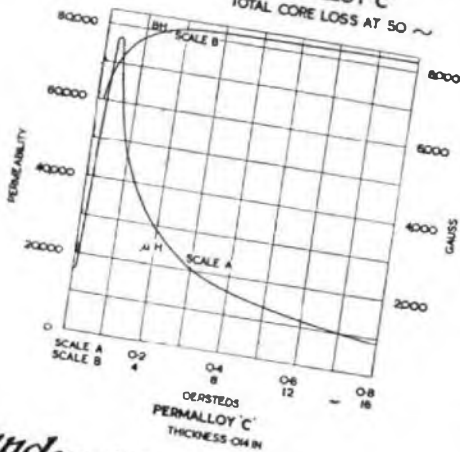
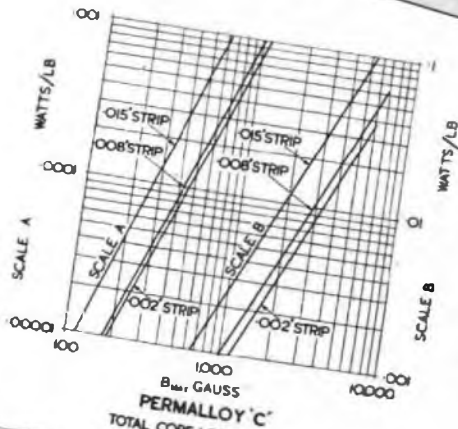
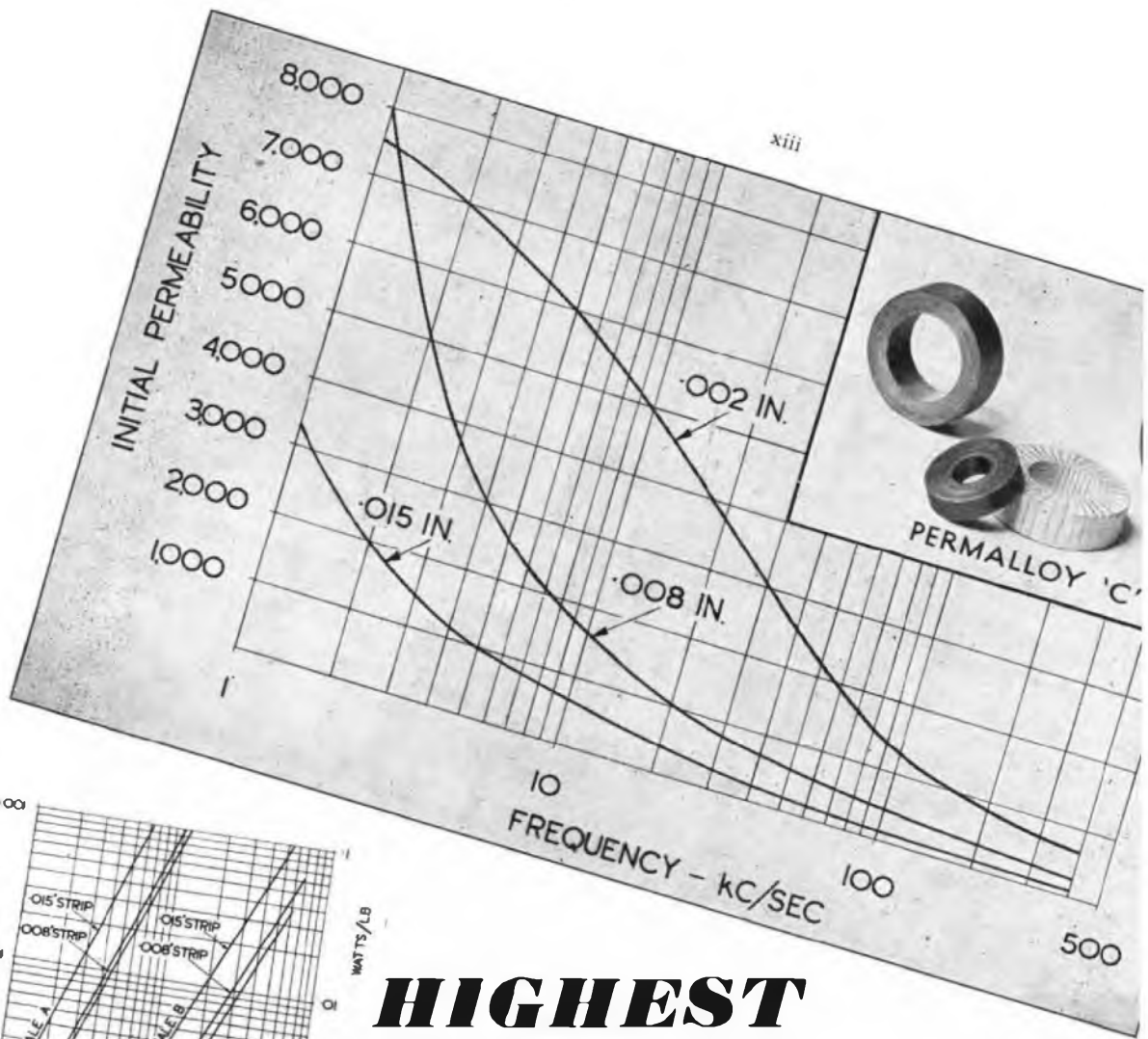

HIGHEST INITIAL PERMEABILITY

PERMALLOY "C," one of a range of high permeability nickel iron alloys which have been developed in the Standard laboratories, gives the unusually high initial permeability of 10,000-30,000 and a maximum permeability of 50,000 to 100,000.

APPLICATIONS · WIDE FREQUENCY BAND TRANSFORMERS
ACCURATE CURRENT TRANSFORMERS · SENSITIVE RELAYS · CHOKES · MAGNETIC SHIELDING



PERMALLOY

"C"

Standard Telephones and Cables Limited
ENGINEERS · NORTH WOOD

MODEL 47 TAPE TELEPRINTER FOR — RECORD COMMUNICATION

A NEW  PRODUCT
Creed

- Printing point is in ideal position on left side.
- Last character printed is immediately visible.
- Receiving cam orientation device for optimum adjustment for acceptance of distorted signals.
- Conforms to C.C.I.T. recommendations.



- Tape can be replenished without removing cover.
- Accessible printing unit using typewriter ink ribbon.
- Answer-back unit (20 characters).
- A cover attachment for accommodating message forms etc., can be provided for handling heavy traffic.
- Simplified maintenance with unit construction.

Creed and Company Limited

TELEGRAPH HOUSE, CROYDON, ENGLAND

TELEGRAMS: "CREDO, TELEX, CROYDON"
TELEPHONE: CROYDON 2121 (6 LINES)

● CABLES: "CREDO, CROYDON"
● TELEX CROYDON TELEX 1082

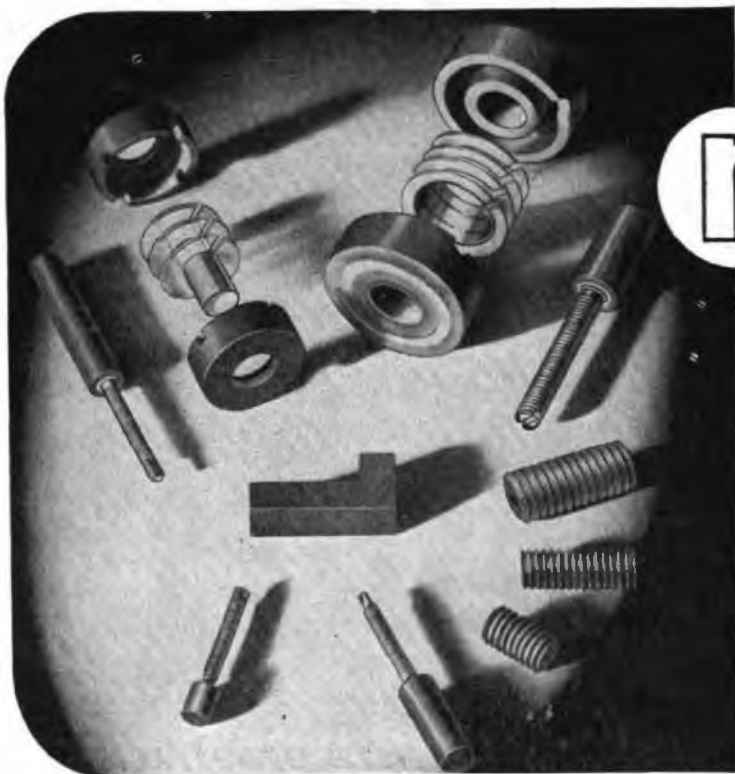

neosid

IRON DUST CORES

High performance : Strength : Stability
Close electrical and mechanical tolerances
Grades to suit various applications

neosid *limited*

23 and 25 Hyde Way, Welwyn
Garden City, Herts.

Tel : Welwyn Garden 925



FROST WARNING

'Possible danger, eh? Shouldn't have thought there'd be frost at tree level tonight, whatever the radio says. Still—better switch on. Silly to take any risks, now that we've got the current . . .'

Not very far ahead of us now lies the Electric Age—with universal, unlimited supplies of electricity. When that age is established, peace will at last begin to count her victories. Farmers will find new weapons against the wasteful treachery of the weather. City dwellers will break free from smoke and dirt and disease. Better days for all. And for us, here in Alton, where we make the batteries for generating stations all over the world, busier days than ever. Hydro-electric, Atomic or what you will, the new generating stations will all need batteries. Good batteries. The kind we have always made at Alton.

ALTON

BATTERIES OF MERIT

THE ALTON BATTERY COMPANY LTD · ALTON · HANTS
Sole Suppliers of Fuller Stationary Batteries

Telephone: ALTON 2267 & 2268 · Telegrams: 'BATTERY, ALTON'

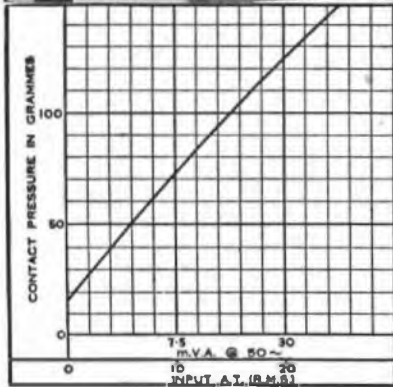
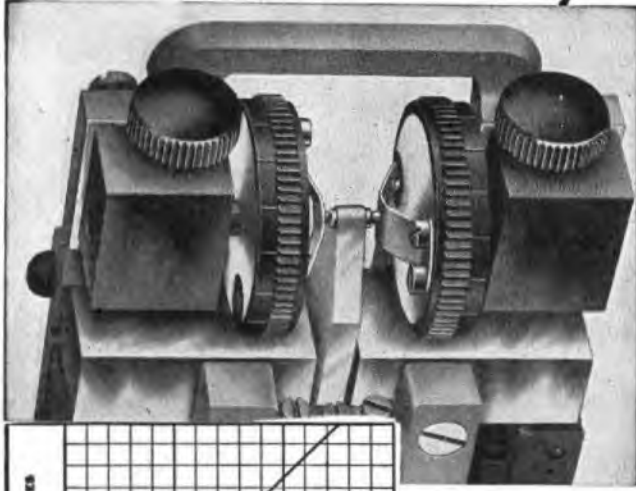
CARPENTER*High Speed Polarised***RELAY**

● Contact mechanism of Relay showing damped compliant mountings of side contacts.

● Graph showing contact pressures developed at 50 c/s against mA and ampere turns input for type 3B Carpenter Relay.

The Carpenter Relay in its standard adjustment reproduces, with a 5 AT input, square pulses from less than 2 milli-seconds upwards with a distortion of 0.1mS, i.e., 5% for 2mS pulses or 1% at 10mS.

This unequalled performance is due to inherent features of the design of the relay, ensuring short transit time, high sensitivity and low hysteresis. There is complete absence of contact rebound at any input power and contact pressures are exceptionally high (*see graph*). Adjustment can be made with great ease. Moreover, since the armature is suspended at its centre of gravity, the relay has high immunity from effects of mechanical vibration and there is no positional error. Effective screening is provided against external fields. Because of these characteristics, the Carpenter Relay has many applications in the fields of measurement, speed regulation, telecontrol and the like, in addition to the obvious use in telegraph circuits; details of models suitable for such purposes will be supplied willingly on request.

DIMENSIONS IN COVER: 2½ x 1¼ x 4½.
WEIGHT with standard socket: 22 ozs.

Ask for booklet 1017 P.O.

TELEPHONE MANUFACTURING CO. LTD.
HOLLINGSWORTH WORKS • DULWICH • LONDON • S.E.21
Telephone: GIPsy Hill 2211 (10 lines)

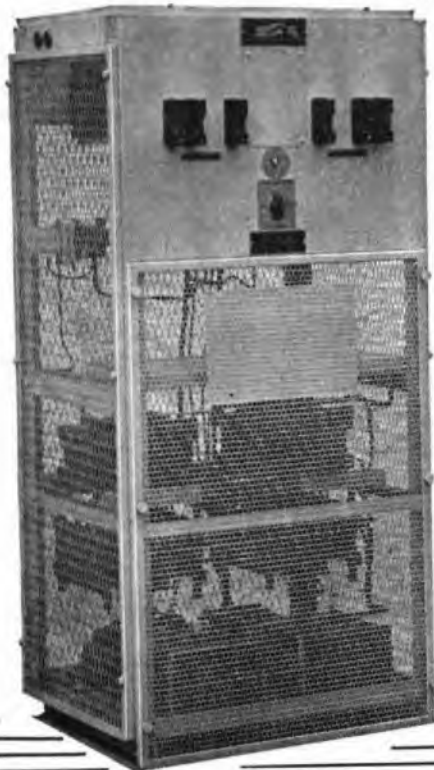
*Rectifiers***FOR TELEPRINTER OPERATION**

The latest practice in teleprinter operation from A.C. supplies is to employ separate Westinghouse metal rectifiers to feed the motor and provide power for the telegraph apparatus.

Large installations may be powered by 80 + 80 volt batteries, which are "floated" by special "Westat" constant voltage charging equipments in conjunction with "standby" and "recharge" rectifiers. An 80 + 80 volt 6.75 ampere power unit for teleprinter operation is illustrated.

WESTINGHOUSE
WESTALITE
METAL RECTIFIERS

Write for descriptive pamphlet No. M.R.9 to Dept. P.O.E.E.J.

WESTINGHOUSE BRAKE & SIGNAL CO. LTD.
82 YORK WAY, KING'S CROSS, LONDON, N.1

STANDARD WITH THE BRITISH POST OFFICE

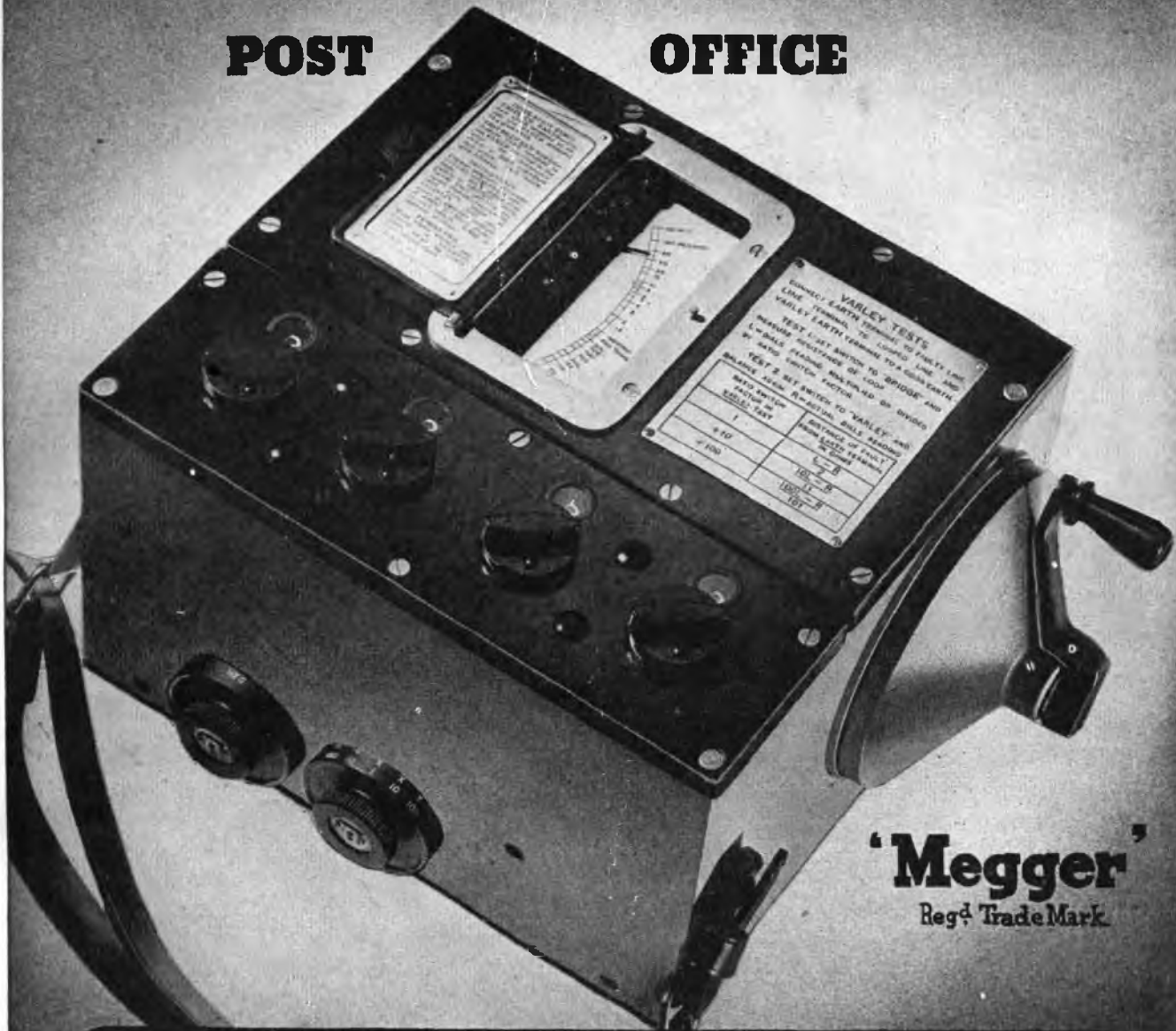

THE BRIDGE-MEG TESTING SET used by the British Post Office is a portable, self-contained instrument combining the functions of an Insulation Tester and a Wheatstone Bridge; it can be used for fault location by the Varley Loop method. Facilities can also be provided whereby, with the use of an external galvanometer and resistance box, the instrument may be used for making Murray Loop tests. Insulation range 100 megohms at 500 volts. Bridge range 0.01 to 999,900 ohms. Size $7 \times 8\frac{3}{4} \times 12$ ins. Weight $12\frac{3}{4}$ lbs. Mains operated instruments are also supplied to the British Post Office. Ask for list X 212.

EVERSHED & VIGNOLES LTD., CHISWICK, LONDON, W.4
TELEPHONE: CHISWICK 1370 * TELEGRAMS: "MEGGER" CHISK, LONDON

G.E.C.

Complete
Telecommunication
Equipment

Subscribers' Instruments
Automatic and Manual Exchanges
Voice-frequency and Carrier Equipment
Radio Transmitters and Receivers
Trunk and Distribution Cables
Overhead Lines
Wiring Supplies of all Kinds
Loading Coils
and Testing Apparatus

for

telephone projects of all sizes are designed, manufactured and installed by the largest all-British electrical manufacturing organisation in the Empire.

THE GENERAL ELECTRIC CO. LTD. OF ENGLAND

Head Office : MAGNET HOUSE, KINGSWAY, LONDON.

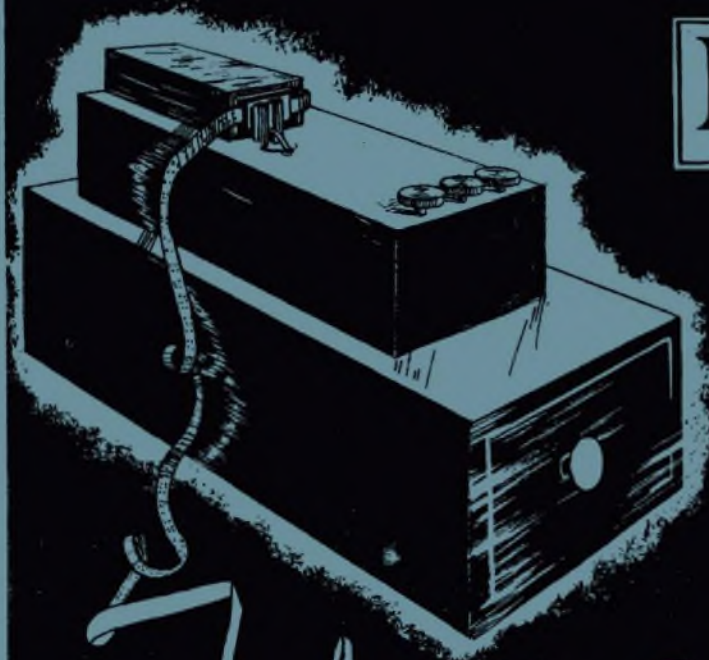

ELLIOTT

*Telegraph
apparatus*



ELLIOTT BROTHERS

(LONDON) LTD
CENTURY WORKS
LEWISHAM. S.E. 13.

MAINTAINING EFFICIENCY

THE HIGH STANDARD OF EFFICIENCY
OF PIRELLI - GENERAL TELEPHONE
CABLES IS MAINTAINED BY THE
CONTINUOUS RESEARCH WORK OF
AN EXPERIENCED TECHNICAL STAFF.

TELEPHONE
SOUTHAMPTON
2141 (5 lines)

PIRELLI-GENERAL
CABLE WORKS, Ltd., SOUTHAMPTON.

TELEGRAMS
"PICEKAYBEL"
SOUTHAMPTON

SULLIVAN-GRIFFITHS
DUAL DIAL NON-REACTIVE
DECADE RESISTANCES
FOR ALL FREQUENCIES
NOVEL AND PATENTED
ACCURACY BETTER THAN 0.1%

Screened Resistances of guaranteed accuracy exactly similar to our well-known Decade Resistances but specially arranged so that one box of a given number of dials gives many different values of maximum resistance. Thus a three dial box (as illustrated) may be used for instance for

three decades of Thousands, Hundreds and Tens	a total of 10000 ohms.
or three decades of Hundreds, Tens and Units	a total of 1000 ohms.
or three decades of Tens, Units and Tenths	a total of 100 ohms.
or three decades of Units, Tenths and Hundredths	a total of 10 ohms.

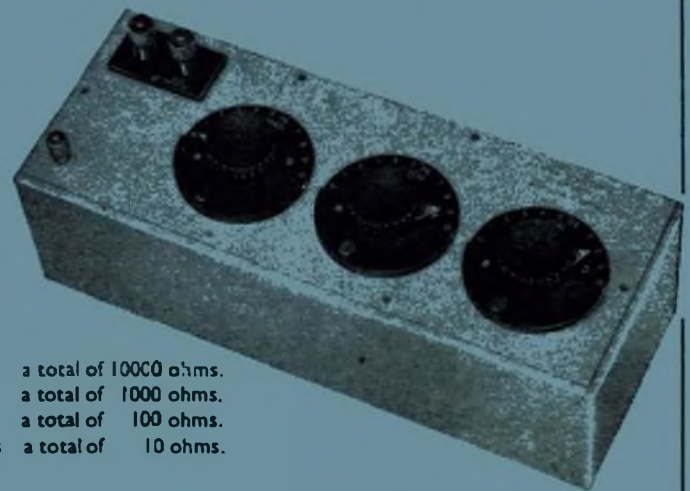

H. W. SULLIVAN
— LIMITED —

LONDON, S. E. 15

Telephone: New Cross 3225 (P.B.X.)

The advantages of such a system will be obvious, for in addition to the economy involved much space is saved and the residual resistance and inductance is much reduced.

The resistances are available in 3 dial, 4 dial and 5 dial types with subdivision of 0.001% to 0.1% depending of course on the number of dials incorporated.